

Desking + Tables

Effective January 1, 2023 USA
Revised November 1, 2024



PRICE LIST desking + tables



think global

THE GLOBAL EDGE

ERGONOMICS IN THE TOTAL OFFICE

- One stop shopping for a full range of office furniture.
- Seating, desks, tables, files, modular furniture, panels and accessories.
- Ergonomics, competitive pricing and built-in value.

STRENGTH AND STABILITY

- Established in 1966.
- One of North America's largest office furniture manufacturers.
- Manufacturing and showrooms worldwide.

QUICK SHIP - INSTOCK

- Hundreds of products in stock for immediate delivery.

STRONG LOCAL REPRESENTATION

- Service and expert advice where you are, when you need it!

MANUFACTURING CAPABILITY

- Vertical integration ensures "start to finish" control.
- Ongoing research and investment in new, innovative production technology.

QUALITY ASSURANCE

- Quality Assurance Program is qualified by C.G.S.B. ISO9001 standards.
- On-site furniture testing facility.
- Product and components are tested to ANSI/BIFMA standards.

ENVIRONMENTAL COMMITMENT

- Continuous development of "earth friendly" programs.
- One of the first molded foam manufacturers to create ozone-friendly, CFC and HFC-free processes.
- Seat and back pans are made from recyclable plastics and wood waste, enabling little waste and cost effective products.

SYMBOL IDENTIFICATION



Global's Certified Products are in compliance with the stringent emission guidelines set by the GREENGUARD Environmental Institute and include all Upholstered Seating. To obtain a GREENGUARD Certificate for any product, please go to the product page on our website www.globalfurnituregroup.com and click on "View GREENGUARD Certificate".

level™ certification, based on the ANSI/BIFMA e3-2012 furniture sustainability standard, sets furniture manufacturers on a path toward greater sustainability over time. Based on environmental and social criteria set forth in the standard, a product's entire supply chain is assessed.



Certification assessment includes an evaluation of specific corporate policies and guidelines and an assessment of associated company manufacturing facilities. Products must meet quantifiable milestones of environmental and social performance at every step of development.

The quantitative assessment addresses four categories: material use, energy and atmosphere impacts, human and ecosystem health and social responsibility.

Manufacturers earn points in each of the four categories. The level™ brand and its numeric rating of 1, 2 or 3 indicate what threshold of certification a product has achieved. level™ 3 is the highest rating.

TABLE OF CONTENTS

WORKPLACE

LAMINATE DESKS

Adaptabilities.....	9
Consumer Education	6
Office Accessories.....	467
Desking Comparison Chart.....	4
Genoa	48
Laminate Desk Notes.....	8
Princeton	61
Zira	109
Zira Boardroom + Reception	258

SOFTPOD

Softpod.....	413
--------------	-----

BENCHING

Bridges II	292
FreeFit.....	599

PANELS + COMPONENTS

Divide	376
--------------	-----

PRODUCTIVITY SOLUTIONS by Global

Productivity Solutions	442
FOLI Height Adjustable Tables.....	444
FreeFit Height Adjustable Tables.....	599
Keyboard Trays	454
Manual Height Adjustable Tables	443
Monitor Arms	449
Office Accessories.....	467
Power/Data	481
Revo + Voyage Task Lights.....	458

STORAGE

Sidebar Storage	390
Zira Lockers	283

TABLES - CAFE, MEETING + BOARDROOM

Boardroom tables.....	492
Collaborative Spaces	545
Kadin Tables.....	642
Swap tables	651
Zira Boardroom + Reception	258

TABLES - TRAINING

2gether tables	490
Bungee tables	513
Bungee SL tables	530
Bungee SL power/data management	537
ConnecTABLES	572
Junction.....	635
Terina.....	696

TABLES - RECEPTION + OCCASIONAL

Citi tables	712
Coat trees.....	713
Collaborative Spaces	545
Drift tables	716
Laminate occasional tables	714
Lite Lift II folding tables	720
River+ tables	721
Sirena tables	724
Wind tables.....	725

TABLE OF CONTENTS

WORKPLACE

TABLE POWER + TECHNOLOGY SOLUTIONS

Table Power + Technology Solutions490

WELLNESS SOLUTIONS

Linking Panels406

Wellness Screens402

ACOUSTIC SOLUTIONS

Priva pods.....410

Softpod.....413

REFERENCE

Custom Grommet Location Form.....735

Terms + Conditions.....742

Warranty.....744

Textiles + Finishes.....728

EDUCATION

CLASSROOM

2gether tables.....490

Bungee tables513

Bungee SL tables530

Bungee SL power/data management537

ConnecTABLES572

Duet tables.....588

CLASSROOM (cont'd)

Edventure591

Junction.....635

Terina.....696



Zook.....700

MEETING + COLLABORATIVE



Kadin Tables.....642

Swap tables651

DESKING COMPARISON CHART

	ADAPTABILITIES	BRIDGES II	GENOA
			
GENERAL FEATURES	<ul style="list-style-type: none"> • Top over end panel design • 400 color combinations • Virtually no loose hardware • Storage height is 66" • 2 handle options 	<ul style="list-style-type: none"> • Beam-based benching system • 8-wire, 4-circuit electrical • Storage height is 21", 25" and 29" 	<ul style="list-style-type: none"> • Top over end panel design • 3/4 pedestal standard • Virtually no loose hardware • Storage height is 66"
GOOD BETTER BEST	Better	Best	Good
STYLE	Transitional	Contemporary	Transitional
PRICE POINT (36 x 72 double pedestal desk)	\$1806	N/A	\$1376
WORKSURFACE THICKNESS	1"	1"	1"
SURFACE TYPE	High performance thermally laminate or HPL	High performance thermally laminate or HPL	High performance thermally laminate
EDGE THICKNESS	2mm	3mm	Self Edge
EDGE OPTIONS	Flat	N/A	N/A
HUTCH CLEARANCE (worksurface to underside of hutch)	17.75" to valance 20" to underside of hutch	N/A	20"
GREENGUARD CERTIFIED	Yes	Yes	Yes
BIFMA e3 LEVEL CERTIFIED	Level 3	Level 3	Level 3
USDA BIO-PREFERRED EDGING	Yes	No	Yes

DESKING COMPARISON CHART

	PRINCETON	ZIRA
		
GENERAL FEATURES	<ul style="list-style-type: none"> • Freestanding, modular components with overlapping architectural elements • 14 standard finishes; up to 3 color application on many components available • Optional 6mm tempered glass on hutches and desktop storage. • Storage height is 52" and 66" 	<ul style="list-style-type: none"> • Top over end panel design • 400+ color combinations • Virtually no loose hardware • Storage height is 42", 54", 66", 72" and 84" (nominal). • 9 handle options • 4 glazing options for storage doors and modesty panels
GOOD BETTER BEST	Best	Best
STYLE	Contemporary	Contemporary
PRICE POINT (36 x 72 double pedestal desk)	N/A	\$2465
WORKSURFACE THICKNESS	1"	1" or 1.5"
SURFACE TYPE	High performance thermally laminate or HPL	High performance thermally laminate or HPL
EDGE THICKNESS	2mm	2mm
EDGE OPTIONS	N/A	Flat, Fluted or Bicut
HUTCH CLEARANCE (Worksurface to underside of hutch)	15.75"	20.25" (23.5" Hutch) 17.75" (36" Hutch) 24.25" (42" Hutch) 24.25" (54" Hutch)
GREENGUARD CERTIFIED	Yes	Yes
BIFMA e3 LEVEL CERTIFIED	Level 3	Level 3
USDA BIO-PREFERRED EDGING	No	Yes

CONSUMER EDUCATION

How do I buy a desk?



Choose a non-reflective surface. Global uses colors that reduce glare to make your work easier to read while reducing eye strain.



Get a desk that lets you look ahead. A modular desk is easy to set up initially and then reorganize or reconfigure later to adapt to future needs.

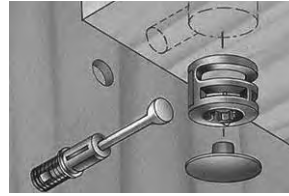

Look for European connectors if you're buying ready-to-assemble furniture. Global makes assembly easy - all you need is a screwdriver.



Give your business an edge. Each Global desk comes with its own attractive edge design.



Avoid tangles. Make sure your desk has at least one grommet hole to keep computer and telephone wires out of the way.



A hutch should have a sweep that manages computer and telephone wires.



Island workspaces let you meet with more than two people at once with ample leg room for all.



Choose one of Global's height/angle adjustable keyboard trays to go with your desk. Your arms can maintain a comfortable position, reducing shoulder, back and neck strain.

How do I select the right workstation?

When searching for the right workstation it is important to consider its purpose which will be decided by the nature of your tasks. It is best to look for products that have been designed and engineered to help make your workspace more productive.

Once these patterns have been identified, organize them according to their intended use and frequency of their use. Now you are ready to investigate the pertinent factors that will determine the workspace you eventually select.

This can be achieved in a variety of ways. As a guide, observe how your work flows through your office in a typical day. It is likely that you'll uncover a number of distinctive and repetitive task patterns.

Lighting - Protect yourself

- If you have to setup near a window make sure your computer sits perpendicular to it, minimize eye-strain inducing glare on sunny days.
- If you have fluorescent lights, try to position your set up between the lights.
- Use "Parabolic louvers" to reduce the glare from fluorescent lights
- Use window blinds to control the light source through the day
- Panels or screens may be used to control glare
- Protect your eyes from Ultraviolet A (UVA) and Ultraviolet B (UVB) by using an anti-glare screen

Noise

- Try to set up your office in a separate room if possible and away from the rest of the house

Chair

- Comfort is personal but should be part of the selection
- Seat pan design; deep and wide enough
- Rounded front edge (waterfall)
- Adjustable slope seat
- Able to adjust your chair, to obtain appropriate height
- Sit back in your chair, with your thighs parallel to the floor
- Place feet flat on the floor, a footlocker may be required

Footlocker

- A footlocker helps to prevent possible discomfort resulting from outstretched feet
- The rocking motion creates light activity in the legs and feet and will help stimulate muscles to improve overall circulation

Keyboard

- Has a palm rest
- Easily adjusts the angle of the keyboard
- Easily adjusts the keyboard height

Document Holder

- A curved back document holder reduces glare
- Position document holder in line with the monitor to reduce eyestrain

Monitor

- There should be a direct line from the center of monitor to the, "J" key on your keyboard which should line up with your belt buckle
- Position the monitor at arm's length
- Make sure that the top of your monitor screen is slightly below eye level
- A monitor stand may be used to achieve the desired height

Workstation

- Adequate space beneath the worksurface for your legs
- Depth of the worksurface depends on the task and equipment used to perform this responsibility
- Try to place tasks that are performed regularly within arm's reach
- Avoid unnecessary reaching and bending which leads to fatigue and possible muscle strains and can reduce efficiency
- Keep in mind other related tasks in your planning
- Establish your workflow then design the essential elements to meet your requirements

desking – laminate



Adaptabilities 9



Genoa 48



Princeton 61



Zira 109

LAMINATE DESK NOTES

The following applies to all series EXCEPT the Bridges II and Princeton series.

For information on the Bridges II series, please refer to page 292 and for the Princeton series, please refer to page 61.

- Outside and surface panels are made from 1" thick 45 lb. density particle board and covered on both sides with high performance thermally fused laminate. Modesty panels are 11/16" thick.
- **BOX AND FILE DRAWERS** use FULL EXTENSION STEEL BALL BEARING SLIDES for smooth action.
- **BOX AND FILE PEDESTALS** are standard and are CONSTRUCTED INDEPENDENTLY of the chassis, with fully closed bottoms. This PICTURE FRAME CONSTRUCTION technique prevents racking, and provides a product that lasts for years.
- **FILE DRAWERS** file both legal and letter documents as standard (LETTER FILES will file in BOTH DIRECTIONS, as will LATERAL FILES), except 15" w Zira units (side to side only).
- Drawers and END PANELS are **EDGE BANDED** on ALL FOUR SIDES to protect clothing and the floor covering.
- Locks are standard on all box and file pedestals, lateral files, storage cabinets and combination storage units.
- All locking components within each series can be keyed alike at no additional charge. Please specify the request at time of ordering.
- Drawers are opened with side pulls and are constructed 22" deep (Genoa 18"D) using French dovetail joints at the front and lap joints at the rear. Woodgrain enameled bottoms are routed into the woodgrain (MDF) sides on three edges.
- Full to the floor pedestal configurations can be switched for a **15% upcharge** (Adaptabilities series ONLY).
- Pencil tray included with each desk.
- **LEVELING GLIDES** are standard on ALL UNITS.
- All units are **shipped fully assembled** (except where noted) on 1" x 3" thick wood furniture skids with pedestal supports inside high quality cartons.
- **ALL "L" SHAPED DESKS** have flush backs on the return (modesty panels).
- Additional options available include (add suffix to item number):
FM = Full modesty panel. Available on any desk or credenza. Upcharge applies. See individual series notes.
- Desks with FULL TO FLOOR pedestals CANNOT have ¾ modesty panels.
- Corners must have matching modesty panels (both sides must be either ¾ or full modesty panels).
- **Modesty panels** on CORNERS will be 1" above the floor; **Modesty panels** on RETURNS are flush with the floor. It is recommended that corner units are used for corner spaces when configuring workstations so there is no visible difference if a corner is connected to a return.
- Custom widths are available for products that feature a worksurface as follows: desks, credenzas (applies to kneespace and single pedestal credenzas only), islands (excludes spanner islands), returns, bridges, extended corners and corners.
- Desks and credenzas that incorporate drawers and/or doors will be modified by changing the width of the worksurface and modesty panel, drawer and/or door dimensions are not affected.
- No upcharge for next size up
- Custom width does not apply to cabinets, hutches, pedestals or any other units
- Global Furniture Group will consider custom, specials and product alterations on an individual basis.
- Desk series can only be made in **Standard Global Laminates**.
- **PLEASE REFER TO SERIES FOR FINISHES AVAILABLE.** The following desk finishes are offered:

WOODGRAINS:

Absolute Acajou (ACJ)	Asian Night (ASN)	Avant Cherry (AWC)
Avant Honey (AWH)	Clear Maple (CMB)	Dark Espresso (DES)
Fashionista (FAS)	First Class (FCL)	Noce Biondo
Noce Grigio	Noce Leggero	Noce Medio
Quartered Mahogany (QTM)	Sheer Beauty (SBY)	Walnut Heights (WHE)
White Chocolate (WHC)	Winter Cherry (WCR)	

SOLIDS:

Black (BLK)	Designer White (DWT)	Storm Grey (SOG)
Blizzard (BZD)	Custom Grey (CGY)	Stonedust (SDT)

PATTERNS:

Brushed Cobalt (BRC)

- See **Productivity Solutions** and **Desk Accessories** for additional options



With over 370 components available in 400 color combinations, Adaptabilities provides the ultimate in flexibility and modularity. Rich laminate colors coordinate easily with any office or home decor. All surfaces are constructed from Global's exclusive premium grade, high performance laminate and preferred matching edges.

Adaptabilities features an extensive range of versatile components which can be configured into multi-user workstations suitable for intensive task functions, or for private executive suites requiring stately elegance and work-force functions. All laminate filing cabinets have a safety mechanism that prevents two drawers from being opened at the same time. File drawers have fully progressive ball bearing suspensions and accommodate letter and legal filing. For heavy duty usage, two, three and four drawer laminate files are available with steel drawer interiors.

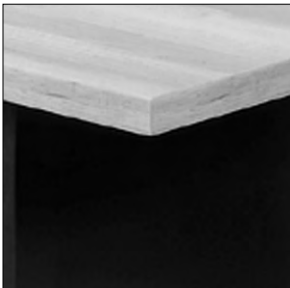

Tops are 1" thick and a top over side, edge panel design.



3/4 modesty panel available at no extra charge.



For heavy duty usage, two, three and four drawer laminate files are available with steel drawer interiors.

Features and Benefits

- 45lb. density particle board substructure with high performance thermally fused laminate
- 1" thick worksurfaces in thermally fused or high pressure laminate
- Worksurfaces feature 2mm edging in matching color.
- Full to floor or 3/4 pedestals available on most components
- All desks are size (incrementally) accurate
- 11/16" thick full modesty panel is standard
- 11/16" thick 3/4 modesty panel is available on most components
- Pencil tray included in box drawer
- File drawers can accommodate legal or letter documents
- Full progressive ball bearing suspension on file drawers
- All drawer fronts edge banded with side pull opening pedestals and standard with pedestal locks
- Compatible with **Divide** panel system for increased privacy and storage requirements

GENERAL INFORMATION

- Constructed of 45 lb. density particleboard with high performance thermally fused laminate
- Adaptabilities components are compatible with Divide transaction tops and partitioning panels. See page 376 for Divide specifications and prices.
- See pages 40-41 for keyboard drawers and additional accessory options.
- Adaptabilities desk and storage products have been tested and comply with all BIFMA mechanical tests.
- For environmental certifications, please visit globalfurnituregroup.com.

WORKSURFACES

- 1" thick high performance thermally fused laminate tops sealed with Global's Preferred edging in matching color
- Woodgrain surfaces feature edging with matching printed woodgrain
- High Pressure Tops are available in all Adaptabilities laminate finishes at an extended lead time. Please see model # for pricing and availability.
- Products specified with the high pressure laminate option are finished on the underside of the surface with a kraft paper backing.

CONSTRUCTION

- Constructed of 45 lb. density particleboard with high performance thermally fused laminate.
- Cabinets and Wardrobes are 65" high to match overall height of a worksurface with hutch (worksurface 29" + hutch 36" = 65").
- End Shelves are available as 65" high also to match overall height.
- Models with monoposts are available with a Black (**TBL**) or Tungsten (**TTU**) monoposts. Please specify.
- Models with handles are available with Black (**HX**) or Silver (**HS**) handles; please specify.
- All drawer fronts edge banded with side pull opening pedestals and standard pedestal locks
- Double wall pedestal housing with fully closed bottom

MODESTY PANELS

- 11/16" thick full modesty panel is standard
- 11/16" thick ¾ modesty panel available on most components
- ¾ height modesty panels available on most models at no additional charge. Please specify "**3MP**". (Corners must have both modesty panels as ¾ or full).
- **Note:** Woodgrain modesty panels 60" wide and up will have the grain pattern in the horizontal direction. All end panels and modesty panels 59" or less will have the grain pattern in the vertical direction.

STORAGE

- All lateral file drawer fronts feature the woodgrain running in a horizontal direction.
- Pencil tray included in box drawer
- File drawers can accommodate legal or letter documents
- Triple progressive ball bearing suspension on file drawers

LOCKS

- Optional locks available for all straight hutch unit doors. Add **\$126** each lock
- Front-to-back filing bars for all steel drawer files available separately. Order FBB file bars. See "FBB" on page 41.
- Key alike or specific key number optional for all products with locks
- Reserved for new orders greater than \$20,000 list, all Adaptabilities units with locks may be ordered with **CA** cap option and specific lock cores/keys can be ordered separately for field installation rather than specifying duplicate product lines with different key numbers.
- When **CA** option is specified, product will ship with a cap over the empty lock housing.
- Separately order the appropriate number of cores with keys; use product code **SIL-CORE-H-SHOE** for Silver core/key sets or product code **BLK-CORE-H-SHOE** for Black core/key sets. Specify quantity and lock number required. One order line per key number required. Key number range: 401-440. **Must be ordered at the same time product is ordered with CA lock cap option specified.**
- One core removal key is required. Recommend one core removal for every 25 cores ordered. Order as **REMOVE-K-H-SHOE**.
- No charge applies for separate lock cores or core removal keys only when ordered with product. If replacement lock core and key required, contact Customer Care for applicable product code and pricing.

SPECIAL SIZES

- Additional custom sized components available upon request.
- Secretarial height returns (26 ½") available at a 15% upcharge.
- Full to the floor pedestal configurations can be switched for a 15% upcharge.

1. SPECIFY MODEL NUMBER

2. SPECIFY FINISH

Top Finishes:

ACJ	Absolute Acajou	FCL	First Class
ASN	Asian Night	NBL	Noce Biondo
AWC	Avant Cherry	NGL	Noce Grigio
AWH	Avant Honey	NEL	Noce Leggero
BLK	Black	NML	Noce Medio
BZD	Blizzard	QTM	Quartered Mahogany
BRC	Brushed Cobalt	SBY	Sheer Beauty
CMB	Clear Maple	SOG	Storm Grey
CGY	Custom Grey	SDT	Stonedust
DES	Dark Espresso	WHE	Walnut Heights
DWT	Designer White	WHC	White Chocolate
FAS	Fashionista	WCR	Winter Cherry

Body Finishes (including pedestals):

ACJ	Absolute Acajou	FCL	First Class
ASN	Asian Night	NBL	Noce Biondo
AWC	Avant Cherry	NGL	Noce Grigio
AWH	Avant Honey	NEL	Noce Leggero
BLK	Black	NML	Noce Medio
BZD	Blizzard	QTM	Quartered Mahogany
BRC	Brushed Cobalt	SBY	Sheer Beauty
CMB	Clear Maple	SOG	Storm Grey
CGY	Custom Grey	SDT	Stonedust
DES	Dark Espresso	WHE	Walnut Heights
DWT	Designer White	WHC	White Chocolate
FAS	Fashionista	WCR	Winter Cherry

3. SPECIFY OPTIONS

Grommets

- Additional grommets available in standard worksurface locations (left, center or right).
- Order as: **AG1, AG2 or AG3. Add \$96.**

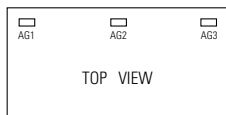

- Grommet hole dimensions are 3 1/4" wide x 1 7/8" deep.
- Actual grommet locations on the worksurface are depicted in the example drawings shown below. Dimensions shown are actual measurements (in inches).

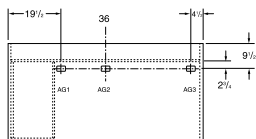

36 x 72 single pedestal left desks (A3672SPL)

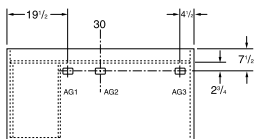

30 x 60 single pedestal left desks (A3060SPL)

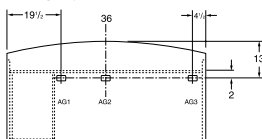

36 x 72 single pedestal left bow top desks (A3672SLB)

- Grommets may be placed at non-standard locations. Order as: **AGS - Add \$96.** A drawing must be supplied with vertical and horizontal dimensions to the center of the cut-out (as in drawing above). Please refer to CUSTOM GROMMET LOCATION FORM in the back reference section.
- Components that come standard with grommet may be ordered without a grommet. **Add \$53.**
- Grommets are available on modesty panels of extended corners and 5-sided corners 6 1/2" in where the two modesty panels meet at a 90° angle. Please specify FOGMPR for right grommet placement and FOGMPL for left grommet (placement is as shown on diagrams below). Cost is **\$96.**
- **Modesty panels are 1" off of ground**

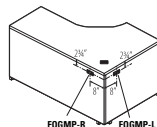

Left Extended Corner Unit

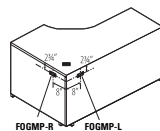

Right Extended Corner Unit

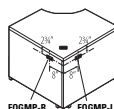

5-Sided Corner Unit

Power Block

- A Power Block (model PMSPDM) may be ordered on all worksurfaces.
- A Power Block is a rectangular worksurface power/data module with one electrical duplex receptacle and includes two data (CAT5) receptacles. 9 foot black cord included. Power Block dimensions are 3 1/2" deep x 6 1/2" wide x 2 3/4" high.
- To purchase a Power Block, you must specify both the Power Block cut-out location and the Power Block model #. Order Power Block as **PMSPDM, Add \$330.** Power Blocks are available in standard worksurface locations (left, center or right). Order as **E1, E2 or E3. Add \$96.**



Power Block **PMSPDM Add \$330**

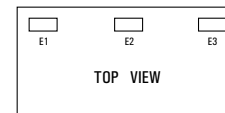

Specify location **E1, E2 or E3 Add \$96**

A ADAPTABILITIES®

DOUBLE PEDESTAL DESKS

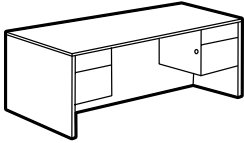

Double Pedestal Desk*

MODEL#	DIMENSIONS D x W x H	FREIGHT CLASS	WT./LBS.	CUBIC FT.	LIST PRICE	HP ADD
A3672DP	36 x 72 x 29.6	150	296	52.5	\$1806	\$532
A3072DP	29.69 x 72 x 29.6	125	263	43	\$1774	\$498
A3066DP	29.69 x 66 x 29.6	125	254	39.75	\$1759	\$498
A3060DP	29.69 x 60 x 29.6	125	247	36.25	\$1606	\$464

Standard with box/file pedestals on both sides. Pedestals lock. One pencil tray.

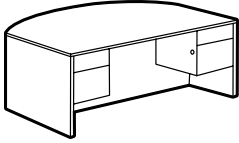

Double Pedestal Bow Top Desk*

A3672DPB	30-36 x 72 x 29.6	150	280	52.5	\$2151	\$532
----------	-------------------	-----	-----	------	---------------	--------------

Standard with box/file pedestals on both sides and bow top. Pedestals lock. One pencil tray.

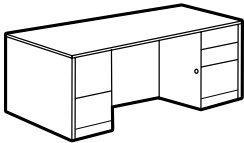

Full to Floor Double Pedestal Desk

A3672D4	36 x 72 x 29.6	125	330	52.5	\$2301	\$532
A3072D4	30 x 72 x 29.6	125	295	41.15	\$2261	\$532
A3066D4	29.69 x 66 x 29.6	125	285	39.75	\$2251	\$498
A3060D4	29.69 x 60 x 29.6	125	276	36.25	\$2097	\$464

Standard with full to floor box/box/file in right pedestal and file/file on left pedestal. Pedestals lock. On box/box/file pedestals, lower box drawer and file drawer lock. One pencil tray. Full to the floor pedestal configurations can be switched for a **15% upcharge**.

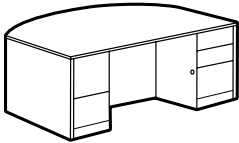

Full to Floor Double Pedestal Bow Top Desk

A3672DB4	32-36 x 72 x 29.6	150	311	52.5	\$2643	\$532
----------	-------------------	-----	-----	------	---------------	--------------

Standard with full to floor box/box/file in right pedestal and file/file on left pedestal. Bow top. Pedestals lock. On box/box/file pedestals, lower box drawer and file drawer lock. One pencil tray. Full to the floor pedestal configurations can be switched for a **15% upcharge**.

SINGLE PEDESTAL DESKS

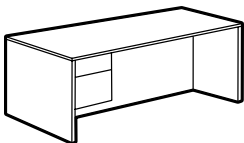

Single Pedestal Desk - LEFT*

MODEL#	DIMENSIONS	FREIGHT CLASS	WT./LBS.	CUBIC FT.	LIST PRICE	HP ADD
A3672SPL	36 x 72 x 29.6	150	245	52.5	\$1507	\$532
A3072SPL	29.69 x 72 x 29.6	150	216	43	\$1323	\$498
A3066SPL	29.69 x 66 x 29.6	150	207	39.75	\$1307	\$498
A3060SPL	29.69 x 60 x 29.6	150	197	36.25	\$1302	\$464
A3048SPL	29.69 x 48 x 29.6	125	177	29.25	\$1169	\$394
A2448SPL	24 x 48 x 29.6	125	150	24.25	\$1169	\$256

Standard with box/file pedestal. Pedestal locks. One pencil tray. Pedestal is on the **left**.

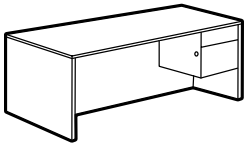

Single Pedestal Desk - RIGHT*

A3672SPR	36 x 72 x 29.6	150	245	52.5	\$1507	\$532
A3072SPR	29.69 x 72 x 29.6	150	216	43	\$1323	\$498
A3066SPR	29.69 x 66 x 29.6	150	207	39.75	\$1307	\$498
A3060SPR	29.69 x 60 x 29.6	150	197	36.25	\$1302	\$464
A3048SPR	29.69 x 48 x 29.6	125	177	29.25	\$1169	\$394
A2448SPR	24 x 48 x 29.6	125	150	24.25	\$1169	\$256

Standard with box/file pedestal. Pedestal locks. One pencil tray. Pedestal is on the **right**.

Required Specifications

Top finish
Base finish

Optional Specifications

Key #
Grommet/power block cut-out
HP laminate
Modesty panel, 3/4*

Accessories

Power block
Keyboard tray
Pencil tray

SINGLE PEDESTAL DESKS

MODEL# DIMENSIONS FREIGHT CLASS WT/LBS. CUBIC FT. LIST PRICE HP ADD

D x W x H

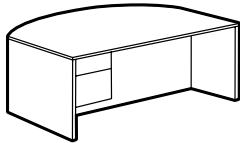

Single Pedestal Bow Top Desk - LEFT*

A3672SLB 30-36 x 72 x 29.6 150 233 52.5 \$1845 \$532

Standard with box/file pedestal on **left** and bow top. Pedestal locks. One pencil tray.

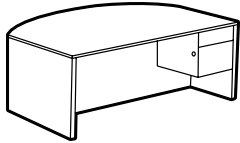

Single Pedestal Bow Top Desk - RIGHT*

A3672SRB 30-36 x 72 x 29.6 150 233 52.5 \$1845 \$532

Standard with box/file pedestal on **right** and bow top. Pedestal locks. One pencil tray.

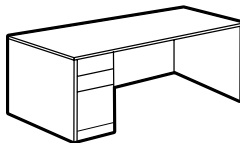

Full to Floor Single Pedestal Desk - LEFT

A3672S4L	36 x 72 x 29.6	150	261	52.5	\$1754	\$532
A3072S4L	29.69 x 72 x 29.6	150	232	43.75	\$1712	\$532
A3066S4L	29.69 x 66 x 29.6	150	221	39.5	\$1701	\$498
A3060S4L	29.69 x 60 x 29.6	150	211	36.25	\$1543	\$464
A3048S4L	29.69 x 48 x 29.6	125	191	29.5	\$1360	\$394
A2448S4L	24 x 48 x 29.6	125	164	24.25	\$1360	\$256

Standard with full to floor box/box/file pedestal on the **left**. One pencil tray. Lower box drawer and file drawer lock. Full to the floor pedestal configurations can be switched for a **15% upcharge**.

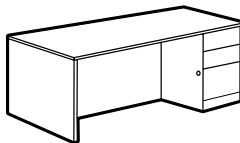

Full to Floor Single Pedestal Desk - RIGHT

A3672S4R	36 x 72 x 29.6	150	261	52.5	\$1754	\$532
A3072S4R	29.69 x 72 x 29.6	150	232	43.75	\$1712	\$532
A3066S4R	29.69 x 66 x 29.6	150	221	39.75	\$1701	\$498
A3060S4R	29.69 x 60 x 29.6	150	211	36.25	\$1543	\$464
A3048S4R	29.69 x 48 x 29.6	125	191	29.5	\$1360	\$394
A2448S4R	24 x 48 x 29.6	125	164	24.25	\$1360	\$256

Standard with full to floor box/box/file pedestal on the **right**. One pencil tray. Lower box drawer and file drawer lock. Full to the floor pedestal configurations can be switched for a **15% upcharge**.

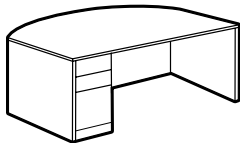

Full to Floor Single Pedestal Bow Top Desk - LEFT

A3672S4LB 32-36 x 72 x 29.6 150 247 52.5 \$2091 \$532

Standard with box/box/file pedestal on **left** and bow top. One pencil tray. Lower box drawer and file drawer lock. One pencil tray. Full to the floor pedestal configurations can be switched for a **15% upcharge**.

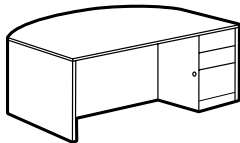

Full to Floor Single Pedestal Bow Top Desk - RIGHT

A3672S4RB 32-36 x 72 x 29.6 150 247 52.5 \$2091 \$532

Standard with box/box/file pedestal on **right** and bow top. One pencil tray. Lower box drawer and file drawer lock. One pencil tray. Full to the floor pedestal configurations can be switched for a **15% upcharge**.

Required Specifications

Top finish
Base finish

Optional Specifications

Key #
Grommet/power block cut-out
HP laminate
Modesty panel, 3/4*

Accessories

Power block
Keyboard tray
Pencil tray

A ADAPTABILITIES®

RETURNS

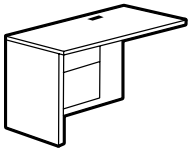

Flush Return - LEFT

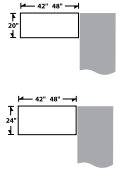

MODEL#	DIMENSIONS D x W x H	FREIGHT CLASS	WT/LBS.	CUBIC FT.	LIST PRICE	HP ADD
A2448FL	24 x 48 x 29.6	150	141	24	\$1102	\$273
A2442FL	24 x 42 x 29.6	125	131	21.25	\$1079	\$227
A2048FL	20 x 48 x 29.6	125	128	20.25	\$1036	\$227
A2042FL	20 x 42 x 29.6	125	119	18	\$1016	\$227

Standard with box/file drawer pedestal. One pencil tray. Pedestal locks. Grommet in worksurface. Pedestal is on the **left**.

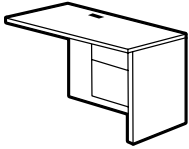

Flush Return - RIGHT

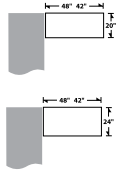

A2448FR	24 x 48 x 29.6	150	141	24	\$1102	\$273
A2442FR	24 x 42 x 29.6	125	131	21.25	\$1079	\$227
A2048FR	20 x 48 x 29.6	125	128	20.25	\$1036	\$227
A2042FR	20 x 42 x 29.6	125	119	18	\$1016	\$227

Standard with box/file drawer pedestal. One pencil tray. Pedestal locks. Grommet in worksurface. Pedestal is on the **right**.

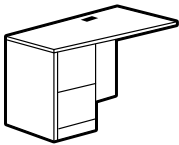

Full to Floor Flush Return - LEFT

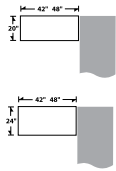

A2448L4	24 x 48 x 29.6	125	156	24.25	\$1347	\$273
A2442L4	24 x 42 x 29.6	125	146	21.5	\$1328	\$227
A2048L4	20 x 48 x 29.6	125	142	20.5	\$1284	\$227
A2042L4	20 x 42 x 29.6	125	133	18	\$1264	\$227

Standard with file/file drawer pedestal. One pencil tray. Pedestal locks. Grommet in worksurface. Pedestal is on the **left**. Full to the floor pedestal configurations can be switched for a **15% upcharge**.

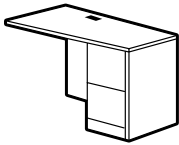

Full to Floor Flush Return - RIGHT

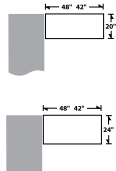

A2448R4	24 x 48 x 29.6	125	156	24.25	\$1347	\$273
A2442R4	24 x 42 x 29.6	125	146	21.5	\$1328	\$227
A2048R4	20 x 48 x 29.6	125	142	20.5	\$1284	\$227
A2042R4	20 x 42 x 29.6	125	133	18	\$1264	\$227

Standard with file/file drawer pedestal. One pencil tray. Pedestal locks. Grommet in worksurface. Pedestal is on the **right**. Full to the floor pedestal configurations can be switched for a **15% upcharge**.

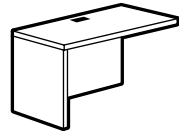

Flush Return - LEFT

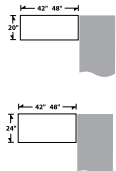

A2448EL	24 x 48 x 29.6	70	92	4.3	\$799	\$273
A2442EL	24 x 42 x 29.6	70	82	3.8	\$773	\$227
A2048EL	20 x 48 x 29.6	70	84	4.3	\$729	\$227
A2042EL	20 x 42 x 29.6	70	75	3.8	\$711	\$227

Return has no pedestal. Grommet in worksurface. Shipped RTA (ready to assemble).

- Cannot accept same depth storage shells due to 1" thick modesty

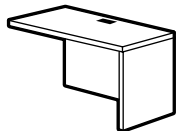

Flush Return - RIGHT

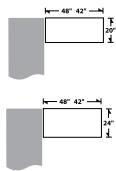

A2448ER	24 x 48 x 29.6	70	92	4.3	\$799	\$273
A2442ER	24 x 42 x 29.6	70	82	3.8	\$773	\$227
A2048ER	20 x 48 x 29.6	70	84	4.3	\$729	\$227
A2042ER	20 x 42 x 29.6	70	75	3.8	\$711	\$227

Return has no pedestal. Grommet in worksurface. Shipped RTA (ready to assemble).

- Cannot accept same depth storage shells due to 1" thick modesty

Required Specifications

Top finish
Base finish

Optional Specifications

Key #*
Grommet/power block cut-out
HP laminate

Accessories

Power block
Keyboard tray
Pencil tray

RETURNS

MODEL# DIMENSIONS FREIGHT CLASS WT/LBS. CUBIC FT. LIST PRICE HP ADD

D x W x H

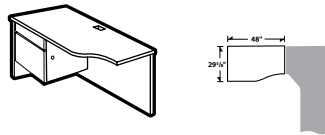

Space Saver Return - LEFT

A3048FSL 29.69 x 48 x 29.6 150 148 29 \$1169 \$394

Standard with box/file pedestal on the **left**, grommet in worksurface. One pencil tray. Pedestal locks. Connects to 24"D 5-sided corner unit and 2466/2472 NFL or NNL extended corner unit.



Space Saver Return - RIGHT

A3048FSR 29.69 x 48 x 29.6 150 148 29 \$1169 \$394

Standard with box/file pedestal on the **right**, grommet in worksurface. One pencil tray. Pedestal locks. Connects to 24"D 5-sided corner unit and 2466/2472 FNR or NNR extended corner unit.

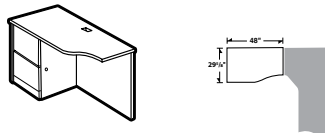

Space Saver Return - LEFT

A3048P4L 29.69 x 48 x 29.6 150 170 29 \$1414 \$394

Standard with file/file pedestal on the **left**, grommet in worksurface. One pencil tray. Pedestal locks. Connects to 24"D 5-sided corner unit and 2466/2472 NFL or NNL extended corner unit. Full to the floor pedestal configurations can be switched for a **15% upcharge**.



Space Saver Return - RIGHT

A3048P4R 29.69 x 48 x 29.6 150 170 29 \$1414 \$394

Standard with file/file pedestal on the **right**, grommet in worksurface. One pencil tray. Pedestal locks. Connects to 24"D 5-sided corner unit and 2466/2472 FNR or NNR extended corner unit. Full to the floor pedestal configurations can be switched for a **15% upcharge**.

FLUSH BRIDGE

MODEL# DIMENSIONS FREIGHT CLASS WT/LBS. CUBIC FT. LIST PRICE HP ADD

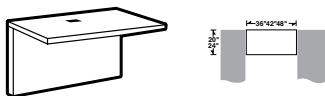

Flush Bridge*

A2448FB	24 x 48 x 29.6	70	75	4.3	\$601	\$273
A2442FB	24 x 42 x 29.6	70	65	3.8	\$577	\$227
A2436FB	24 x 36 x 29.6	70	58	3.3	\$577	\$172
A2048FB	20 x 48 x 29.6	70	71	4.3	\$577	\$227
A2042FB	20 x 42 x 29.6	70	54	3.3	\$553	\$227
A2036FB	20 x 36 x 29.6	70	54	3.3	\$553	\$117

Top surface, back panel and hardware to connect two units. Grommet in worksurface. Shipped RTA (ready to assemble).

CRENZAS

MODEL# DIMENSIONS FREIGHT CLASS WT/LBS. CUBIC FT. LIST PRICE HP ADD

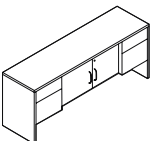

Center Storage Credenza

A2072C 20 x 72 x 29.6 100 243 30 \$2171 \$356

Standard with box/file pedestals on both sides and self-closing hinged center doors covering one adjustable shelf. Pedestals and doors lock. One pencil tray.

Required Specifications

Top finish
Base finish
Handles**

Optional Specifications

Key #
Additional grommet position (not A2072C)
HP laminate
Power block cut-out (not A2072C)

Accessories

Power block
Keyboard tray*
Pencil tray*

A ADAPTABILITIES®

CREDENZAS

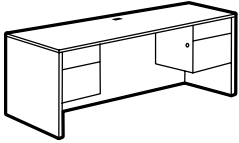

Kneespace Credenza

MODEL#	DIMENSIONS D x W x H	FREIGHT CLASS	WT/LBS.	CUBIC FT.	LIST PRICE	HP ADD
A2472CK	24 x 72 x 29.6	125	234	35.75	\$1817	\$372
A2466CK	24 x 66 x 29.6	125	225	32.75	\$1763	\$372
A2072CK	20 x 72 x 29.6	125	212	30.25	\$1659	\$356
A2066CK	20 x 66 x 29.6	125	204	27.75	\$1635	\$343
A2060CK	20 x 60 x 29.6	125	199	25.25	\$1593	\$314

Standard with box/file pedestals on both sides. Center is open. Pedestals lock. One pencil tray. Grommet in worksurface.

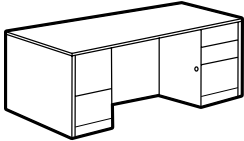

Full to Floor Kneespace Credenza

A2472D4	24 x 72 x 29.6	125	261	35.5	\$2302	\$372
A2466D4	24 x 66 x 29.6	125	252	33	\$2253	\$372
A2072D4	20 x 72 x 29.6	125	236	30	\$2151	\$356
A2066D4	20 x 66 x 29.6	100	228	27.75	\$2129	\$343
A2060D4	20 x 60 x 29.6	100	220	25.25	\$2118	\$314

Standard with full to floor box/box/file in right pedestal and file/file on left pedestal. Pedestals lock on box/box/file pedestals, lower box drawer and file drawer lock. One pencil tray. Grommet in worksurface.

- Full to the floor pedestal configurations can be switched for a **15% upcharge**.

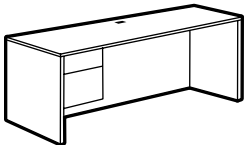

Single Pedestal Credenza - LEFT

A2472CSL	24 x 72 x 29.6	150	190	35.75	\$1539	\$372
A2466CSL	24 x 66 x 29.6	150	181	32.75	\$1487	\$372
A2072CSL	20 x 72 x 29.6	150	172	30.25	\$1388	\$356
A2066CSL	20 x 66 x 29.6	150	163	27.75	\$1366	\$343
A2060CSL	20 x 60 x 29.6	125	155	25.25	\$1320	\$314

Standard with box/file pedestal. Pedestal locks. One pencil tray. Pedestal is on the **left**. Grommet in worksurface.

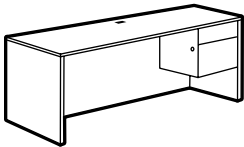

Single Pedestal Credenza - RIGHT

A2472CSR	24 x 72 x 29.6	150	190	35.75	\$1539	\$372
A2466CSR	24 x 66 x 29.6	150	181	32.75	\$1487	\$372
A2072CSR	20 x 72 x 29.6	150	171	30	\$1388	\$356
A2066CSR	20 x 66 x 29.6	150	163	27.75	\$1366	\$343
A2060CSR	20 x 60 x 29.6	125	155	25.25	\$1320	\$314

Standard with box/file pedestal. Pedestal locks. One pencil tray. Pedestal is on the **right**. Grommet in worksurface.

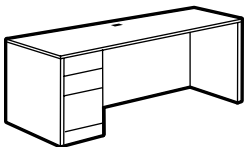

Full to Floor Single Pedestal Credenza - LEFT

A2472S4L	24 x 72 x 29.6	150	205	35.5	\$1754	\$372
A2466S4L	24 x 66 x 29.6	150	196	33	\$1701	\$372
A2072S4L	20 x 72 x 29.6	125	187	30	\$1543	\$356
A2066S4L	20 x 66 x 29.6	125	177	27.75	\$1516	\$356
A2060S4L	20 x 60 x 29.6	125	168	25.25	\$1478	\$314

Standard with full to floor box/box/file pedestal on the **left**. Lower box drawer and file drawer lock. Grommet in worksurface. One pencil tray.

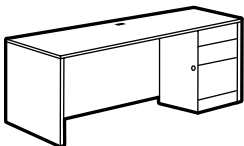

Full to Floor Single Pedestal Credenza - RIGHT

A2472S4R	24 x 72 x 29.6	150	205	35.5	\$1754	\$372
A2466S4R	24 x 66 x 29.6	150	196	33	\$1701	\$372
A2072S4R	20 x 72 x 29.6	125	187	30	\$1543	\$356
A2066S4R	20 x 66 x 29.6	125	177	27.75	\$1516	\$356
A2060S4R	20 x 60 x 29.6	125	168	25.25	\$1478	\$314

Standard with full to floor box/box/file pedestal on the **right**. Lower box drawer and file drawer lock. Grommet in worksurface. One pencil tray.

Required Specifications

Top finish
Base finish

Optional Specifications

Key #
Grommet/power block cut-out
HP laminate

Accessories

Power block
Keyboard tray
Pencil tray

CREDENZAS

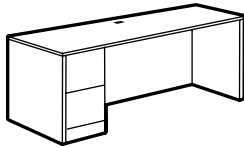

Full to Floor Single Pedestal Credenza- LEFT*

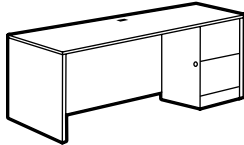

Full to Floor Single Pedestal Credenza- RIGHT*

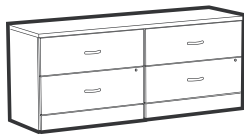

Lateral File Credenza

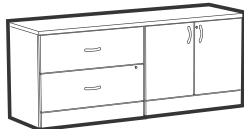

Lateral File/Storage Cabinet Credenza



Kneespace Lateral File Credenza - LEFT*



Kneespace Lateral File Credenza - RIGHT*

MODEL#	DIMENSIONS	FREIGHT CLASS	WT./LBS.	CUBIC FT.	LIST PRICE	HP ADD
--------	------------	---------------	----------	-----------	------------	--------

D x W x H

A2472S2L	24 x 72 x 29.6	150	205	35.5	\$1754	\$372
A2466S2L	24 x 66 x 29.6	150	196	33	\$1701	\$372
A2072S2L	20 x 72 x 29.6	125	187	30	\$1543	\$356
A2066S2L	20 x 66 x 29.6	125	177	27.75	\$1516	\$356
A2060S2L	20 x 60 x 29.6	125	168	25.25	\$1478	\$314

Standard with full to floor file/file pedestal on the **left**. Pedestal Locks. Grommet in worksurface.

A2472S2R	24 x 72 x 29.6	150	205	35.5	\$1754	\$372
A2466S2R	24 x 66 x 29.6	150	196	33	\$1701	\$372
A2072S2R	20 x 72 x 29.6	125	187	30	\$1543	\$356
A2066S2R	20 x 66 x 29.6	125	177	27.75	\$1516	\$356
A2060S2R	20 x 60 x 29.6	125	168	25.25	\$1478	\$314

Standard with full to floor file/file pedestal on the **right**. Pedestal locks. Grommet in worksurface.

A2472LF2	24 x 72 x 29.6	100	322	35.75	\$2652	\$372
A2072LF2	20 x 72 x 29.6	100	296	30.25	\$2599	\$356

Two 2-drawer lateral files side-by-side. Locking drawers, keyed alike. File bars included for side-to-side and front-to-back letter/legal filing capability. Anti-lock tilt suspension.

- Black handles are standard. Silver is available at no charge, please specify as **SI**.
- *File drawer construction is for accommodating hanging files NOT for stacking materials on the drawer bottom.*

A2472LS	24 x 72 x 29.6	100	297	35.75	\$2374	\$372
A2072LS	20 x 72 x 29.6	100	267	30.25	\$2318	\$356

One 2-drawer lateral file and one storage cabinet. Locking doors/drawers, keyed alike. Storage cabinet includes one adjustable shelf. File bars included for side-to-side and front-to-back letter/legal filing capability. Anti-lock tilt suspension.

- Black handles are standard. Silver is available at no charge, please specify as **SI**.
- *File drawer construction is for accommodating hanging files NOT for stacking materials on the drawer bottom.*

A2472LKL	24 x 72 x 29.6	125	239	35.75	\$2086	\$372
A2072LKL	20 x 72 x 29.6	125	216	30.25	\$2033	\$356

One 2-drawer lateral file on the **left**. Locking drawers. File bars included for side-to-side and front-to-back letter/legal filing capability. Anti-lock tilt suspension. Grommet in worksurface.

- Black handles are standard. Silver is available at no charge, please specify as **SI**.
- *File drawer construction is for accommodating hanging files NOT for stacking materials on the drawer bottom.*

A2472LKR	24 x 72 x 29.6	125	239	35.75	\$2086	\$372
A2072LKR	20 x 72 x 29.6	125	216	30.25	\$2033	\$356

One 2-drawer lateral file on the **right**. Locking drawers. File bars included for side-to-side and front-to-back letter/legal filing capability. Anti-lock tilt suspension. Grommet in worksurface.

- Black handles are standard. Silver is available at no charge, please specify as **SI**.
- *File drawer construction is for accommodating hanging files NOT for stacking materials on the drawer bottom.*

Required Specifications

Top finish
Base finish
Handles (not A2xxxS2L/A2xxxS2R)

Optional Specifications

Key #
Additional grommet
HP laminate
Power block cut-out*

Accessories

Power block*
Keyboard tray*
Pencil tray*

CREDENZAS

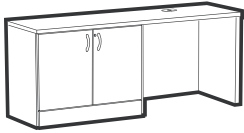

Kneespace Storage Cabinet Credenza - LEFT*

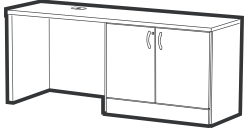

Kneespace Storage Cabinet Credenza - RIGHT*

MODEL#	DIMENSIONS	FREIGHT CLASS	WT/LBS.	CUBIC FT.	LIST PRICE	HP ADD
--------	------------	---------------	---------	-----------	------------	--------

D x W x H

A2472SKL	24 x 72 x 29.6	125	218	35.75	\$1647	\$372
A2072SKL	20 x 72 x 29.6	125	188	30.25	\$1592	\$356

One storage cabinet on the **left**. Locking doors. Storage cabinet has one adjustable shelf. Grommet in worksurface.

- Black handles are standard. Silver is available at no charge, please specify as **SI**.

A2472SKR	24 x 72 x 29.6	125	218	35.75	\$1647	\$372
A2072SKR	20 x 72 x 29.6	125	188	30.25	\$1592	\$356

One storage cabinet on the **right**. Locking doors. Storage cabinet has one adjustable shelf. Grommet in worksurface.

- Black handles are standard. Silver is available at no charge, please specify as **SI**.

5-SIDED CORNERS

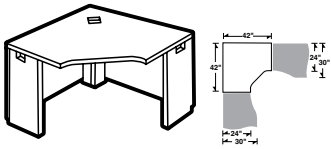

5-Sided Corner

MODEL#	DIMENSIONS	FREIGHT CLASS	WT/LBS.	CUBIC FT.	LIST PRICE	HP ADD
--------	------------	---------------	---------	-----------	------------	--------

A42245C	42 x 42 x 29.6	70	113	5.75	\$1031	\$498
---------	----------------	----	-----	------	---------------	--------------

Connects to **30" D** space saver connectable surfaces, **24" D** connectables, returns and bridge. Grommet in worksurface.

Narrow end panels on left and right. Predrilled to accept 22" keyboard trays. **Will not accept keyboard trays wider than 22"**. Shipped RTA (ready to assemble). *Not Freestanding*.

- **Modesty Panel is 1" off of ground.**
- Full End Panel(s) are available - add **15% upcharge**

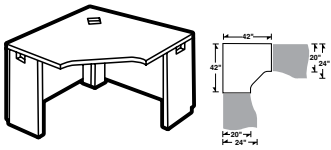

5-Sided Corner

A42205C	42 x 42 x 29.6	70	110	5.75	\$1001	\$498
---------	----------------	----	-----	------	---------------	--------------

Connects to **24" D** space saver connectable surfaces, **20" D** returns, lateral files, storage/lateral file credenzas, credenzas, bridges and end shelves. Grommet in worksurface. Narrow end panels on left and right. Predrilled to accept 22-28" keyboard trays. **Will not accept keyboard trays wider than 28"**. Shipped RTA (ready to assemble). *Not freestanding*.

Will not accept keyboard trays wider than 28". Shipped RTA (ready to assemble). *Not freestanding*.

- **Modesty Panel is 1" off of ground.**
- Full End Panel(s) are available - add **15% upcharge**

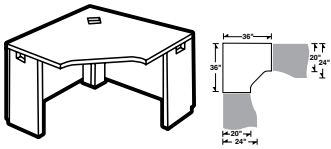

5-Sided Corner

A36205C	36 x 36 x 29.6	70	94	4.8	\$886	\$321
---------	----------------	----	----	-----	--------------	--------------

Connects to **24" D** space saver connectable surfaces, **20" D** returns, lateral files, storage/lateral file credenzas, credenzas, bridges and end shelves. Grommet in worksurface. Narrow end panels on left and right. Predrilled to accept 22" keyboard trays. **Will not accept keyboard trays wider than 22"**. Shipped RTA (ready to assemble). *Not freestanding*.

Will not accept keyboard trays wider than 22". Shipped RTA (ready to assemble). *Not freestanding*.

- **Modesty Panel is 1" off of ground.**
- Full End Panel(s) are available - add **15% upcharge**

Required Specifications

Top finish
Base finish
Handles*

Optional Specifications

Key #
Additional grommet position
HP laminate
Power block cut-out

Accessories

Power block
Keyboard tray
Pencil tray

LEFT EXTENDED CORNERS

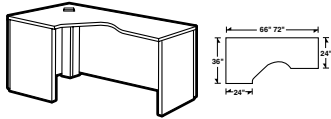

Left Extended Corner - Freestanding

MODEL#	DIMENSIONS	FREIGHT CLASS	WT/LBS.	CUBIC FT.	LIST PRICE	HP ADD
--------	------------	---------------	---------	-----------	------------	--------

D x W x H

A2472FFL	24-36 x 72 x 29.6	70	157	7	\$1323	\$532
A2466FFL	24-36 x 66 x 29.6	70	151	7	\$1323	\$532

Extended worksurface on right. **Full end panels on left and right. Cannot be connected on left or right, due to full end panel.** Corner has one grommet. Predrilled to accept 22" keyboard trays. **Will not accept keyboard trays wider than 22".** Shipped RTA (ready to assemble).

- Modesty Panel is 1" off of ground.
- **A2466FFL** cannot accept pedestals.

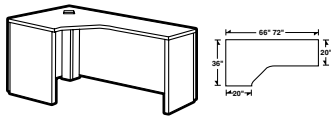

Left Extended Corner

A2072FFL	20-36 x 72 x 29.6	70	147	7	\$1266	\$511
A2066FFL	20-36 x 66 x 29.6	70	141	7	\$1266	\$511

Extended worksurface on right. **Full end panels on left and right. Cannot be connected on left or right, due to full end panel.** Corner has one grommet. Predrilled to accept 22" keyboard trays. **Will not accept keyboard trays wider than 22".** Shipped RTA (ready to assemble).

- Modesty Panel is 1" off of ground.

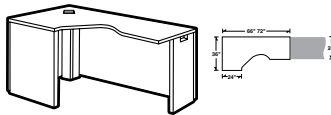

Left Extended Corner

A2472FNL	24-36 x 72 x 29.6	70	149	7	\$1281	\$532
A2466FNL	24-36 x 66 x 29.6	70	142	7	\$1281	\$532

Extended worksurface on right. **Narrow end panel on right. Full end panel on left.** Connects to 30"D space saver connectables, 24"D returns or 24"D connectable tables. **Full end panel cannot be connected.** Corner has one grommet. Predrilled to accept 22" keyboard trays. **Will not accept keyboard trays wider than 22".** Shipped RTA (ready to assemble).

- Modesty Panel is 1" off of ground.
- **A2466FNL** cannot accept pedestals.

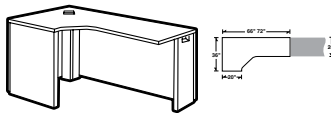

Left Extended Corner

A2072FNL	20-36 x 72 x 29.6	70	141	7	\$1220	\$511
A2066FNL	20-36 x 66 x 29.6	70	135	7	\$1220	\$511

Extended worksurface on right. **Narrow end panel on right. Full end panel on left.** Connects to 24"D space saver connectables, 20"D returns or 20"D connectable tables. **Full end panel cannot be connected.** Corner has one grommet. Predrilled to accept 22" keyboard trays. **Will not accept keyboard trays wider than 22".** Shipped RTA (ready to assemble).

- Modesty Panel is 1" off of ground.

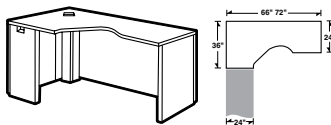

Left Extended Corner

A2472NFL	24-36 x 72 x 29.6	70	149	7	\$1281	\$532
A2466NFL	24-36 x 66 x 29.6	70	142	7	\$1281	\$532

Extended worksurface on right. **Narrow end panel on left. Full end panel on right.** Connects to 30"D space saver connectables, 24"D returns or 24"D connectable tables. **Full end panel cannot be connected.** Corner has one grommet. Predrilled to accept 22" keyboard trays. **Will not accept keyboard trays wider than 22".** Shipped RTA (ready to assemble).

- Modesty Panel is 1" off of ground.
- **A2466NFL** cannot accept pedestals.

Required Specifications

Top finish
Base finish

Optional Specifications

Additional grommet position
HP laminate
Power block cut-out

Accessories

Power block
Keyboard tray
Pencil tray

LEFT EXTENDED CORNERS

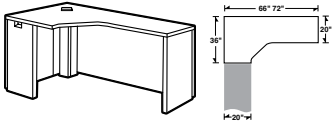

Left Extended Corner

MODEL#	DIMENSIONS D x W x H	FREIGHT CLASS	WT/LBS.	CUBIC FT.	LIST PRICE	HP ADD
A2072NFL	20-36 x 72 x 29.6	70	141	7	\$1220	\$532
A2066NFL	20-36 x 66 x 29.6	70	135	7	\$1220	\$511

Extended worksurface on right. **Narrow end panel on left. Full end panel on right.** Connects to 24"D space saver connectables and 20"D returns. **Full end panel cannot be connected.** Corner has one grommet. Predrilled to accept 22" keyboard trays. **Will not accept keyboard trays wider than 22"**. Shipped RTA (ready to assemble).

- Modesty Panel is 1" off of ground.

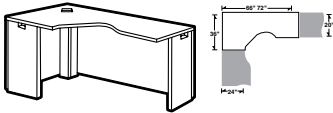

Left Extended Corner

A2472NNL	24-36 x 72 x 29.6	70	140	7	\$1239	\$532
A2466NNL	24-36 x 66 x 29.6	70	134	7	\$1239	\$532

Extended worksurface on right. **Narrow end panels on left and right.** Connects to 30"D space saver connectables, 24"D returns and 24"D connectable tables on either end. Corner has one grommet. Predrilled to accept 22" keyboard trays. **Will not accept keyboard trays wider than 22"**. Shipped RTA (ready to assemble).

- Modesty Panel is 1" off of ground.
- **A2466NNL** cannot accept pedestals.

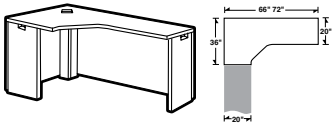

Left Extended Corner

A2072NNL	20-36 x 72 x 29.6	70	136	7	\$1205	\$532
A2066NNL	20-36 x 66 x 29.6	70	130	7	\$1205	\$511

Extended worksurface on right. **Narrow end panels on left and right.** Connects to 24"D space saver connectables and 20"D returns or bridge on either end. Corner has one grommet. Predrilled to accept 22" keyboard trays. **Will not accept keyboard trays wider than 22"**. Shipped RTA (ready to assemble).

- Modesty Panel is 1" off of ground.

RIGHT EXTENDED CORNERS

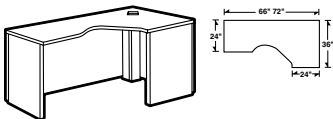

Right Extended Corner - Freestanding

MODEL#	DIMENSIONS	FREIGHT CLASS	WT/LBS.	CUBIC FT.	LIST PRICE	HP ADD
A2472FFR	24-36 x 72 x 29.6	70	157	7	\$1323	\$532
A2466FFR	24-36 x 66 x 29.6	70	151	7	\$1323	\$532

Extended worksurface on left. **Full end panels on left and right. Cannot be connected on left or right, due to full end panel.** Corner has one grommet. Predrilled to accept 22" keyboard trays. **Will not accept keyboard trays wider than 22"**. Shipped RTA (ready to assemble).

- Modesty Panel is 1" off of ground.
- **A2466FFR** cannot accept pedestals.

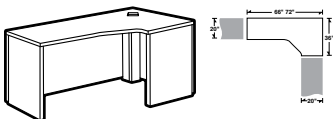

Right Extended Corner

A2072FFR	20-36 x 72 x 29.6	70	147	7	\$1266	\$511
A2066FFR	20-36 x 66 x 29.6	70	141	7	\$1266	\$511

Extended worksurface on left. **Full end panels on left and right. Cannot be connected on left or right, due to full end panel.** Corner has one grommet. Predrilled to accept 22" keyboard trays. **Will not accept keyboard trays wider than 22"**. Shipped RTA (ready to assemble).

- Modesty Panel is 1" off of ground.

Required Specifications

Top finish
Base finish

Optional Specifications

Additional grommet position
HP laminate
Power block cut-out

Accessories

Power block
Keyboard tray
Pencil tray

RIGHT EXTENDED CORNERS

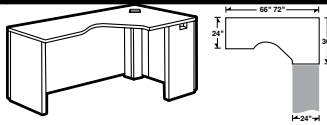

Right Extended Corner

MODEL#	DIMENSIONS	FREIGHT CLASS	WT/LBS.	CUBIC FT.	LIST PRICE	HP ADD
--------	------------	---------------	---------	-----------	------------	--------

D x W x H

A2472FNR	24-36 x 72 x 29.6	70	149	7	\$1281	\$548
A2466FNR	24-36 x 66 x 29.6	70	142	7	\$1281	\$532

Extended worksurface on left. **Narrow end panel on right. Full end panel on left.** Connects to 30"D space saver connectables, 24"D returns or 24"D connectable tables. **Full end panel cannot be connected.** Corner has one grommet. Predrilled to accept 22" keyboard trays. **Will not accept keyboard trays wider than 22"**. Shipped RTA (ready to assemble).

- Modesty Panel is 1" off of ground.
- **A2466FNR** cannot accept pedestals.

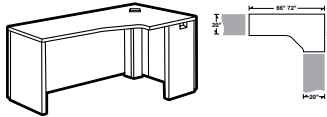

Right Extended Corner

A2072FNR	20-36 x 72 x 29.6	70	141	7	\$1220	\$511
A2066FNR	20-36 x 66 x 29.6	70	135	7	\$1220	\$511

Extended worksurface on left. **Narrow end panel on right. Full end panel on left.** Connects to 24"D space saver connectables, 20"D returns or 20"D connectable tables. **Full end panel cannot be connected.** Corner has one grommet. Predrilled to accept 22" keyboard trays. **Will not accept keyboard trays wider than 22"**. Shipped RTA (ready to assemble).

- Modesty Panel is 1" off of ground.

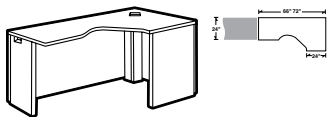

Right Extended Corner

A2472NFR	24-36 x 72 x 29.6	70	149	7	\$1281	\$532
A2466NFR	24-36 x 66 x 29.6	70	142	7	\$1281	\$532

Extended worksurface on left. **Narrow end panel on left. Full end panel on right.** Connects to 30"D space saver connectables, 24"D returns or 24"D connectable tables. **Full end panel cannot be connected.** Corner has one grommet. Predrilled to accept 22" keyboard trays. **Will not accept keyboard trays wider than 22"**. Shipped RTA (ready to assemble).

- Modesty Panel is 1" off of ground.
- **A2466NFR** cannot accept pedestals.

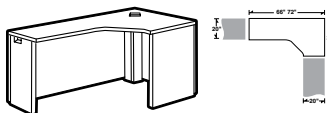

Right Extended Corner

A2072NFR	20-36 x 72 x 29.6	70	141	7	\$1220	\$532
A2066NFR	20-36 x 66 x 29.6	70	135	7	\$1220	\$511

Extended worksurface on left. **Narrow end panel on left. Full end panel on right.** Connects to 24"D space saver connectables and 20"D returns. **Full end panel cannot be connected.** Corner has one grommet. Predrilled to accept 22" keyboard trays. **Will not accept keyboard trays wider than 22"**. Shipped RTA (ready to assemble).

- Modesty Panel is 1" off of ground.

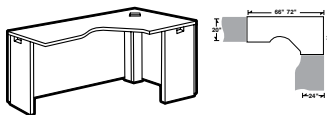

Right Extended Corner

A2472NNR	24-36 x 72 x 29.6	70	140	7	\$1239	\$532
A2466NNR	24-36 x 66 x 29.6	70	133	7	\$1239	\$532

Extended worksurface on left. **Narrow end panels on left and right.** Connects to 30"D space saver connectables, 24"D returns and 24"D connectable tables on either end. Corner has one grommet. Predrilled to accept 22" keyboard trays. **Will not accept keyboard trays wider than 22"**. Shipped RTA (ready to assemble).

- Modesty Panel is 1" off of ground.
- **A2466NNR** cannot accept pedestals.

Required Specifications

Top finish
Base finish

Optional Specifications

Additional grommet position
HP laminate
Power block cut-out

Accessories

Power block
Keyboard tray
Pencil tray

RIGHT EXTENDED CORNERS

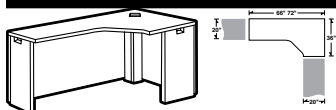

Right Extended Corner

MODEL#	DIMENSIONS	FREIGHT CLASS	WT/LBS.	CUBIC FT.	LIST PRICE	HP ADD
	D x W x H					
A2072NNR	20-36 x 72 x 29.6	70	136	7	\$1205	\$532
A2066NNR	20-36 x 66 x 29.6	70	130	7	\$1205	\$511

Extended worksurface on left. **Narrow end panels on left and right.** Connects to 24"D space saver connectables and 20"D returns or bridge on either end. Corner has one grommet. Predrilled to accept 22" keyboard trays. **Will not accept keyboard trays wider than 22"**. Shipped RTA (ready to assemble).

- Modesty Panel is 1" off of ground.

FREESTANDING TABLES

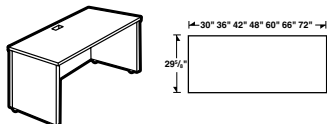

30" Deep Freestanding Table

MODEL#	DIMENSIONS	FREIGHT CLASS	WT/LBS.	CUBIC FT.	LIST PRICE	HP ADD
A3072T	29.69 x 72 x 29.6	65	148	6	\$1016	\$498
A3066T	29.69 x 66 x 29.6	65	140	6	\$1016	\$498
A3060T	29.69 x 60 x 29.6	65	131	5.25	\$928	\$464
A3048T	29.69 x 48 x 29.6	70	116	5.25	\$840	\$394
A3042T	29.69 x 42 x 29.6	70	108	5.25	\$840	\$356
A3036T	29.69 x 36 x 29.6	65	97	4.3	\$754	\$321
A3030T	29.69 x 30 x 29.6	65	88	3.6	\$711	\$286

Two full end panels. Cannot be connected on left or right side. Grommet in worksurface. Shipped RTA (ready to assemble).

- Modesty Panel is 1" off of ground

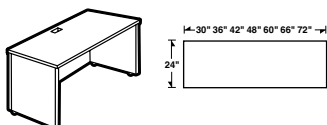

24" Deep Freestanding Table

A2472T	24 x 72 x 29.6	70	130	6	\$928	\$372
A2466T	24 x 66 x 29.6	70	123	6	\$928	\$372
A2460T	24 x 60 x 29.6	70	114	5.25	\$840	\$343
A2448T	24 x 48 x 29.6	65	99	4.3	\$754	\$273
A2442T	24 x 42 x 29.6	70	92	4.3	\$754	\$227
A2436T	24 x 36 x 29.6	70	84	4.2	\$667	\$172
A2430T	24 x 30 x 29.6	70	76	3.6	\$623	\$172

Two full end panels. Cannot be connected on left or right side. Grommet in worksurface. Shipped RTA (ready to assemble).

- Modesty Panel is 1" off of ground

CONNECTABLE TABLES - LEFT

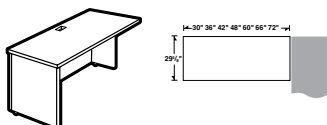

30" Deep Connectable Table - LEFT

MODEL#	DIMENSIONS	FREIGHT CLASS	WT/LBS.	CUBIC FT.	LIST PRICE	HP ADD
A3072L	29.69 x 72 x 29.6	65	140	6	\$980	\$498
A3066L	29.69 x 66 x 29.6	70	132	6	\$980	\$498
A3060L	29.69 x 60 x 29.6	65	123	5.25	\$897	\$464
A3048L	29.69 x 48 x 29.6	65	105	4.3	\$807	\$394
A3042L	29.69 x 42 x 29.6	65	98	4.3	\$807	\$356
A3036L	29.69 x 36 x 29.6	70	88	4.2	\$719	\$321
A3030L	29.69 x 30 x 29.6	70	80	3.6	\$677	\$286

Full end panel on left. Right narrow end panel connects to 30"D center/right connectable table, or at 90° angle to a freestanding table; and "D" islands or "P" islands with "T" and "H" bases. Grommet in worksurface. Shipped RTA (ready to assemble).

- Modesty Panel is 1" off of ground.

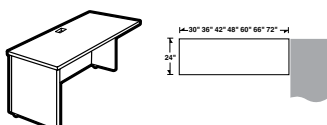

24" Deep Connectable Table - LEFT

A2472L	24 x 72 x 29.6	70	121	6	\$897	\$372
A2466L	24 x 66 x 29.6	70	115	6	\$897	\$372
A2460L	24 x 60 x 29.6	70	106	5.25	\$807	\$343
A2448L	24 x 48 x 29.6	70	90	4.3	\$719	\$273
A2442L	24 x 42 x 29.6	70	82	3.8	\$719	\$227
A2436L	24 x 36 x 29.6	70	74	3.3	\$634	\$172
A2430L	24 x 30 x 29.6	70	68	3.6	\$589	\$172

Full end panel on left. Right narrow end panel connects to 24"D center/right connectable table, or at 90° angle to a freestanding table; 24"D extended corners, 42" 5-sided corners or at the end of a straight run; "D" islands or "P" islands with "T" and "H" bases. Grommet in worksurface. Shipped RTA (ready to assemble).

- Modesty Panel is 1" off of ground.

Required Specifications

Top finish
Base finish

Optional Specifications

Additional grommet position
HP laminate
Power block cut-out

Accessories

Power block
Keyboard tray
Pencil tray

CONNECTABLE TABLES - RIGHT

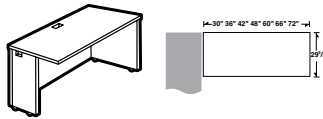

30" Deep Connectable Table - RIGHT

MODEL#	DIMENSIONS	FREIGHT CLASS	WT./LBS.	CUBIC FT.	LIST PRICE	HP ADD
D x W x H						
A3072R	29.69 x 72 x 29.6	65	140	6	\$980	\$498
A3066R	29.69 x 66 x 29.6	70	132	6	\$980	\$498
A3060R	29.69 x 60 x 29.6	65	123	5.25	\$897	\$464
A3048R	29.69 x 48 x 29.6	65	105	4.3	\$807	\$394
A3042R	29.69 x 42 x 29.6	65	98	4.3	\$807	\$356
A3036R	29.69 x 36 x 29.6	70	88	4.3	\$719	\$321
A3030R	29.69 x 30 x 29.6	70	80	3.6	\$677	\$286

Full end panel on **right**. Left narrow end panel connects to 30"D center/left connectable table, or at 90° angle to a freestanding table; "D" islands or "P" islands with "T" and "H" bases. Grommet in worksurface. Shipped RTA (ready to assemble).

• **Modesty Panel is 1" off of ground**

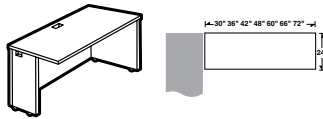

24" Deep Connectable Table - RIGHT

A2472R	24 x 72 x 29.6	70	121	6	\$897	\$384
A2466R	24 x 66 x 29.6	70	115	6	\$897	\$372
A2460R	24 x 60 x 29.6	70	105	5.25	\$807	\$343
A2448R	24 x 48 x 29.6	70	90	4.3	\$719	\$273
A2442R	24 x 42 x 29.6	70	82	3.8	\$719	\$227
A2436R	24 x 36 x 29.6	70	74	3.3	\$634	\$172
A2430R	24 x 30 x 29.6	70	67	3.6	\$589	\$172

Full end panel on **right**. Left narrow end panel connects to 24"D center/left connectable table, or at 90° angle to a freestanding table; 24"D extended corners, 42" 5-sided corners or at the end of a straight run; "D" islands or "P" islands with "T" and "H" bases. Grommet in worksurface. Shipped RTA (ready to assemble).

• **Modesty Panel is 1" off of ground**

CONNECTABLE TABLES

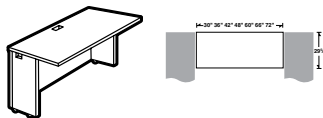

30" Deep Connectable Table

MODEL#	DIMENSIONS	FREIGHT CLASS	WT./LBS.	CUBIC FT.	LIST PRICE	HP ADD
A3072N	29.69 x 72 x 29.6	70	131	6	\$950	\$498
A3066N	29.69 x 66 x 29.6	70	124	6	\$950	\$498
A3060N	29.69 x 60 x 29.6	70	114	5.25	\$859	\$464
A3048N	29.69 x 48 x 29.6	65	97	4.3	\$773	\$394
A3042N	29.69 x 42 x 29.6	65	89	3.8	\$773	\$356
A3036N	29.69 x 36 x 29.6	65	80	3.3	\$686	\$321
A3030N	29.69 x 30 x 29.6	70	71	3.6	\$642	\$286

Narrow end panels on both sides connects to 30"D worksurfaces; "D" islands or "P" islands with "T" and "H" bases; or at 90° angle to freestanding table(s). Grommet in worksurface. Shipped RTA (ready to assemble).

• **Modesty Panel is 1" off of ground**

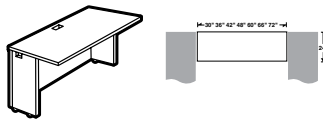

24" Deep Connectable Table

A2472N	24 x 72 x 29.6	70	113	6	\$859	\$372
A2466N	24 x 66 x 29.6	70	105	6	\$859	\$372
A2460N	24 x 60 x 29.6	70	100	4.5	\$773	\$343
A2448N	24 x 48 x 29.6	70	82	4.3	\$686	\$273
A2442N	24 x 42 x 29.6	70	73	3.8	\$686	\$227
A2436N	24 x 36 x 29.6	70	66	3.3	\$601	\$172
A2430N	24 x 30 x 29.6	70	59	3.6	\$553	\$172

Narrow end panels on both sides connects to 24"D worksurfaces; "D" islands or "P" islands with "T" and "H" bases; or at 90° angle to freestanding table(s). Grommet in worksurface. Shipped RTA (ready to assemble).

• **Modesty Panel is 1" off of ground**

SPACE SAVER CONNECTABLE TABLES - LEFT

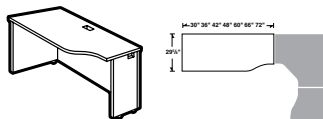

30" Deep Space Saver Connectable Table - LEFT

A3072LK	29.69 x 72 x 29.6	70	133	6	\$991	\$498
A3066LK	29.69 x 66 x 29.6	70	126	6	\$991	\$498
A3060LK	29.69 x 60 x 29.6	70	117	5.25	\$906	\$464
A3048LK	29.69 x 48 x 29.6	65	100	4.3	\$817	\$394
A3042LK	29.69 x 42 x 29.6	65	92	3.8	\$817	\$356
A3036LK	29.69 x 36 x 29.6	70	83	4.3	\$729	\$321
A3030LK	29.69 x 30 x 29.6	70	74	3.6	\$686	\$286

Full end panel on left. Narrow right end panel connects to 24"D 5-sided corner unit. Grommet in worksurface. Shipped RTA (ready to assemble).

• **Modesty Panel is 1" off of ground**

• *Keyboard and pencil trays for use on units 42" and above*

Required Specifications

Top finish
Base finish

Optional Specifications

Additional grommet position
HP laminate
Power block cut-out

Accessories

Power block
Keyboard tray
Pencil tray

SPACE SAVER CONNECTABLE TABLES - LEFT

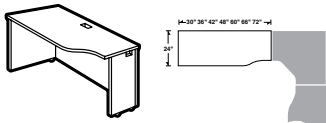

24" Deep Space Saver Connectable Table - LEFT

MODEL#	DIMENSIONS	FREIGHT CLASS	WT/LBS.	CUBIC FT.	LIST PRICE	HP ADD
	D x W x H					
A2472LK	24 x 72 x 29.6	70	120	6	\$906	\$372
A2466LK	24 x 66 x 29.6	70	114	6	\$906	\$372
A2460LK	24 x 60 x 29.6	70	105	5.25	\$817	\$343
A2448LK	24 x 48 x 29.6	70	89	4.3	\$729	\$273
A2442LK	24 x 42 x 29.6	70	81	3.8	\$729	\$227
A2436LK	24 x 36 x 29.6	70	73	3.3	\$642	\$172
A2430LK	24 x 30 x 29.6	70	66	3.6	\$601	\$172

Full end panel on left. Narrow right end panel connects to 20"D 5-sided corner unit. Grommet in worksurface. Shipped RTA (ready to assemble).

- **Modesty Panel is 1" off of ground.**
- *Keyboard and pencil trays for use on units 42" and above*

SPACE SAVER CONNECTABLE TABLES - RIGHT

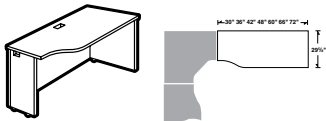

30" Deep Space Saver Connectable Table - RIGHT

MODEL#	DIMENSIONS	FREIGHT CLASS	WT/LBS.	CUBIC FT.	LIST PRICE	HP ADD
A3072RK	29.69 x 72 x 29.6	70	133	6	\$991	\$498
A3066RK	29.69 x 66 x 29.6	70	126	6	\$991	\$498
A3060RK	29.69 x 60 x 29.6	70	117	5.25	\$906	\$464
A3048RK	29.69 x 48 x 29.6	65	100	4.3	\$817	\$394
A3042RK	29.69 x 42 x 29.6	65	91	3.8	\$817	\$356
A3036RK	29.69 x 36 x 29.6	70	83	4.3	\$729	\$321
A3030RK	29.69 x 30 x 29.6	70	74	3.6	\$686	\$286

Full end panel on right. Narrow right end panel connects to 24"D 5-sided corner unit. Grommet in worksurface. Shipped RTA (ready to assemble).

- **Modesty Panel is 1" off of ground**
- *Keyboard and pencil trays for use on units 42" and above*

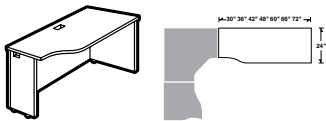

24" Deep Space Saver Connectable Table - RIGHT

A2472RK	24 x 72 x 29.6	70	120	6	\$906	\$372
A2466RK	24 x 66 x 29.6	70	114	6	\$906	\$372
A2460RK	24 x 60 x 29.6	70	105	5.25	\$817	\$343
A2448RK	30 x 48 x 29.6	70	89	4.3	\$729	\$273
A2442RK	24 x 42 x 29.6	70	81	3.8	\$729	\$227
A2436RK	24 x 36 x 29.6	70	73	3.3	\$642	\$172
A2430RK	24 x 30 x 29.6	70	66	3.6	\$601	\$172

Full end panel on right. Narrow right end panel connects to 20"D 5-sided corner unit. Grommet in worksurface. Shipped RTA (ready to assemble).

- **Modesty Panel is 1" off of ground.**
- *Keyboard and pencil trays for use on units 42" and above*

SPACE SAVER CONNECTABLE TABLES

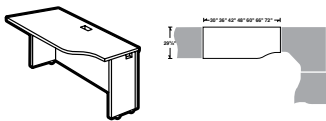

30" Deep Space Saver Connectable Table

MODEL#	DIMENSIONS	FREIGHT CLASS	WT/LBS.	CUBIC FT.	LIST PRICE	HP ADD
A3072LN	29.69 x 72 x 29.6	70	125	6	\$961	\$498
A3066LN	29.69 x 66 x 29.6	70	117	6	\$961	\$498
A3060LN	29.69 x 60 x 29.6	70	108	5.25	\$875	\$464
A3048LN	29.69 x 48 x 29.6	70	91	4.3	\$788	\$394
A3042LN	29.69 x 42 x 29.6	70	83	3.8	\$788	\$356
A3036LN	29.69 x 36 x 29.6	70	74	3.3	\$700	\$321
A3030LN	29.69 x 30 x 29.6	70	66	3.6	\$655	\$286

Narrow end panels on both sides. Connects the **right end only to 24"D 5-sided corner unit.** Left end allows the continuation of additional connectable center or left connectable worksurface. Grommet in worksurface. Shipped RTA (ready to assemble).

- **Modesty Panel is 1" off of ground.**
- *Keyboard and pencil trays for use on units 42" and above*

Required Specifications

Top finish
Base finish

Optional Specifications

Additional grommet position
HP laminate
Power block cut-out

Accessories

Power block
Keyboard tray
Pencil tray

SPACE SAVER CONNECTABLE TABLES

MODEL# DIMENSIONS FREIGHT CLASS WT/LBS. CUBIC FT. LIST PRICE HP ADD

D x W x H

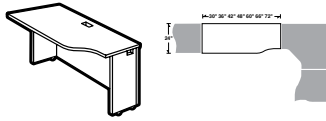

24" Deep Space Saver Connectable Table

A2472LN	24 x 72 x 29.6	70	112	6	\$875	\$372
A2466LN	24 x 66 x 29.6	70	105	6	\$875	\$372
A2460LN	24 x 60 x 29.6	70	96	5.25	\$788	\$343
A2448LN	24 x 48 x 29.6	70	81	4.3	\$700	\$273
A2442LN	24 x 42 x 29.6	70	73	3.8	\$700	\$227
A2436LN	24 x 36 x 29.6	70	65	3.3	\$614	\$172
A2430LN	24 x 30 x 29.6	70	58	3.6	\$570	\$172

Narrow end panels on both sides. Connects the **right end only to 20"D 5-sided corner unit.** Left end allows the continuation of additional connectable center or left connectable worksurface. Grommet in worksurface. Shipped RTA (ready to assemble).

- **Modesty Panel is 1" off of ground.**
- *Keyboard and pencil trays for use on units 42" and above*

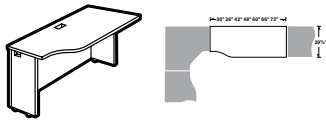

30" Deep Space Saver Connectable Table

A3072RN	29.69 x 72 x 29.6	70	125	6	\$961	\$498
A3066RN	29.69 x 66 x 29.6	70	117	6	\$961	\$498
A3060RN	29.69 x 60 x 29.6	70	108	5.25	\$875	\$464
A3048RN	29.69 x 48 x 29.6	70	91	4.3	\$788	\$394
A3042RN	29.69 x 42 x 29.6	70	83	3.8	\$788	\$356
A3036RN	29.69 x 36 x 29.6	70	74	3.3	\$700	\$321
A3030RN	29.69 x 30 x 29.6	70	66	3.6	\$655	\$286

Narrow end panels on both sides. Connects the **left end only to 24"D 5-sided corner unit.** Right end allows the continuation of additional connectable center or right connectable worksurface. Grommet in worksurface. Shipped RTA (ready to assemble).

- **Modesty Panel is 1" off of ground.**
- *Keyboard and pencil trays for use on units 42" and above*

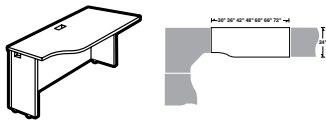

24" Deep Space Saver Connectable Table

A2472RN	24 x 72 x 29.6	70	112	6	\$875	\$372
A2466RN	24 x 66 x 29.6	70	105	6	\$875	\$372
A2460RN	24 x 60 x 29.6	70	96	5.25	\$788	\$343
A2448RN	24 x 48 x 29.6	70	81	4.3	\$700	\$273
A2442RN	24 x 42 x 29.6	70	72	3.8	\$700	\$227
A2436RN	24 x 36 x 29.6	70	59	3.3	\$614	\$172
A2430RN	24 x 30 x 29.6	85	53	3.6	\$570	\$172

Narrow end panels on both sides. Connects the **left end only to 20"D 5-sided corner unit.** Right end allows the continuation of additional connectable center or right connectable worksurface. Grommet in worksurface. Shipped RTA (ready to assemble).

- **Modesty Panel is 1" off of ground.**
- *Keyboard and pencil trays for use on units 42" and above*

"D" ISLANDS

MODEL# DIMENSIONS FREIGHT CLASS WT/LBS. CUBIC FT. LIST PRICE HP ADD

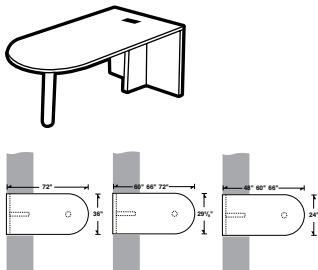

"D" Island - Full End Panel & Post (T-Base)

A3672FI	36 x 72 x 29.6	85	124	8.5	\$1079	\$532
A3072FI	29.69 x 72 x 29.6	85	107	7.5	\$1048	\$499
A3066FI	29.69 x 66 x 29.6	85	102	7.5	\$991	\$498
A3060FI	29.69 x 60 x 29.6	85	96	6.76	\$939	\$464
A2466FI	24 x 66 x 29.6	85	90	7.5	\$883	\$372
A2460FI	24 x 60 x 29.6	85	84	6.76	\$831	\$343
A2448FI	24 x 48 x 29.6	85	74	5.76	\$773	\$273

Connects to narrow end panel. Attaching hardware included. Not freestanding. Grommet in worksurface. Shipped RTA (ready to assemble).

- Post is shipped in separate carton. Standard in Black (**TBL**); Tungsten is available at no charge, please specify (**TTU**).

Required Specifications

Top finish
Base finish

Optional Specifications

Additional grommet position
HP laminate
Power block cut-out

Accessories

Power block
Keyboard tray
Pencil tray

A ADAPTABILITIES®

"D" ISLANDS

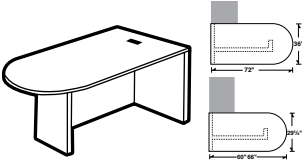

"D" Island LEFT - Full Modesty Panel (H-Base)

MODEL#	DIMENSIONS	FREIGHT CLASS	WT/LBS.	CUBIC FT.	LIST PRICE	HP ADD
	D x W x H					
A3672FIL	36 x 72 x 29.6	70	139	7	\$991	\$532
A3066FIL	29.69 x 66 x 29.6	70	116	6	\$883	\$498
A3060FIL	29.69 x 60 x 29.6	70	106	5.25	\$831	\$464

Connects to the left side of a worksurface. Accommodates all 19" pedestals (freestanding, mobile and hanging pedestals). Grommet in worksurface. Shipped RTA (ready to assemble).

- Modesty Panel is 1" off of ground.

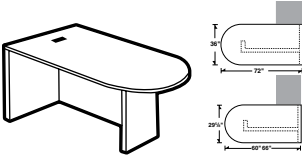

"D" Island RIGHT - Full Modesty Panel (H-Base)

A3672FIR	36 x 72 x 29.6	70	139	7	\$991	\$532
A3066FIR	29.69 x 66 x 29.6	70	116	6	\$883	\$498
A3060FIR	29.69 x 60 x 29.6	70	106	5.25	\$831	\$464

Connects to the right side of a worksurface. Accommodates all 19" pedestals (freestanding, mobile and hanging pedestals). Grommet in worksurface. Shipped RTA (ready to assemble).

- Modesty Panel is 1" off of ground.

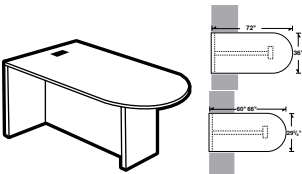

"D" Island Center - Full Modesty Panel (H-Base)

A3672FIC	36 x 72 x 29.6	70	139	7	\$991	\$532
A3066FIC	29.69 x 66 x 29.6	70	116	6	\$883	\$498
A3060FIC	29.69 x 60 x 29.6	70	106	5.25	\$831	\$464

Connects in between two worksurfaces. Will not accommodate pedestals. Grommet in worksurface. Shipped RTA (ready to assemble).

- Modesty Panel is 1" off of ground.

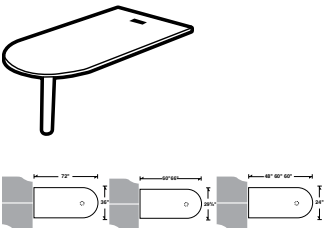

Attachable "D" Island with Post*

A3672I	36 x 72 x 29.6	92.5	88	8.5	\$939	\$532
A3066I	29.69 x 66 x 29.6	100	71	7.5	\$831	\$498
A3060I	29.69 x 60 x 29.6	100	65	6.76	\$773	\$464
A2466I	24 x 66 x 29.6	100	63	7.5	\$719	\$372
A2460I	24 x 60 x 29.6	100	57	6.76	\$667	\$343
A2448I	24 x 48 x 29.6	100	47	5.76	\$614	\$273

Attaches to edge of worksurfaces. Attaching hardware included. Grommet in worksurface. Shipped RTA (ready to assemble).

- Post is shipped in separate carton. Standard in Black (**TBL**); Tungsten is available at no charge, please specify (**TTU**).

EXTENDED CORNER ISLANDS

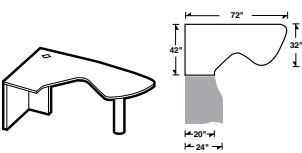

Extended Corner Island - RIGHT*

MODEL#	DIMENSIONS	FREIGHT CLASS	WT/LBS.	CUBIC FT.	LIST PRICE	HP ADD
A4272EIR	42-32 x 72 x 29.6	100	104	11.5	\$1294	\$710

Extended island worksurface on right. Connects to 20"D returns or 24"D space saver connectables on the left. **Not freestanding.** Predrilled to accept 22"-28" keyboard trays. Grommet in worksurface. Shipped RTA (ready to assemble).

- Post is shipped in separate carton. Standard in Black (**TBL**); Tungsten is available at no charge, please specify (**TTU**).

Required Specifications

Top finish
Base finish
Post finish*

Optional Specifications

Additional grommet position
HP laminate
Power block cut-out

Accessories

Power block
Keyboard tray
Pencil tray

EXTENDED CORNER ISLANDS

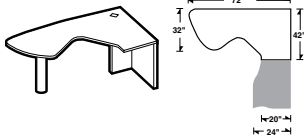

Extended Corner Island - LEFT*

MODEL#	DIMENSIONS	FREIGHT CLASS	WT/LBS.	CUBIC FT.	LIST PRICE	HP ADD
D x W x H						
A4272EIL	42-32 x 72 x 29.6	100	104	11.5	\$1294	\$710

Extended island worksurface on left. Connects to 20"D returns or 24"D space saver connectables on the right. **Not freestanding.** Predrilled to accept 22"-28" keyboard trays. Grommet in worksurface. Shipped RTA (ready to assemble).
 • Post is shipped in separate carton. Standard in Black (TBL); Tungsten is available at no charge, please specify (TTU).

"P" ISLANDS

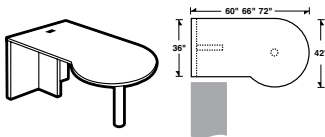

"P" Island LEFT - Full End Panel & Post (T-Base)*

MODEL#	DIMENSIONS	FREIGHT CLASS	WT/LBS.	CUBIC FT.	LIST PRICE	HP ADD
A3672FPL	36-42 x 72 x 29.6	85	128	9.26	\$1267	\$710
A3666FPL	36-42 x 66 x 29.6	85	122	8.76	\$1157	\$710
A3660FPL	36-42 x 60 x 29.6	85	116	8	\$1102	\$603

Connects to left side of worksurface. Attaching hardware included. **Not freestanding.** Grommet in worksurface. Shipped RTA (ready to assemble).
 • Post is shipped in separate carton. Standard in Black (TBL); Tungsten is available at no charge, please specify (TTU).

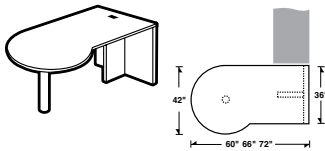

"P" Island RIGHT - Full End Panel & Post (T-Base)*

A3672FPR	36-42 x 72 x 29.6	85	128	9.26	\$1267	\$710
A3666FPR	36-42 x 66 x 29.6	85	122	8.76	\$1157	\$710
A3660FPR	36-42 x 60 x 29.6	85	116	8	\$1102	\$603

Connects to right side of worksurface. Attaching hardware included. **Not freestanding.** Grommet in worksurface. Shipped RTA (ready to assemble).
 • Post is shipped in separate carton. Standard in Black (TBL); Tungsten is available at no charge, please specify (TTU).

"P" ISLANDS WITH FULL MODESTY PANEL

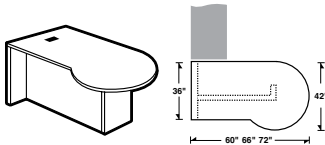

"P" Island LEFT - Full Modesty Panel (H-Base)

MODEL#	DIMENSIONS	FREIGHT CLASS	WT/LBS.	CUBIC FT.	LIST PRICE	HP ADD
A3672PL	36-42 x 72 x 29.6	70	143	7.75	\$1157	\$710
A3666PL	36-42 x 66 x 29.6	70	136	7.25	\$1048	\$710
A3660PL	36-42 x 60 x 29.6	70	126	6.5	\$991	\$603

Connects to the left side of a worksurface. Accommodates all 19" pedestals (freestanding, mobile and hanging pedestals). Grommet in worksurface. Shipped RTA (ready to assemble).
 • Modesty Panel is 1" off of ground.

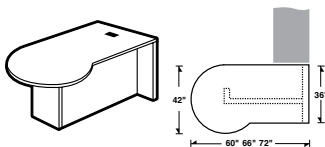

"P" Island RIGHT - Full Modesty Panel (H-Base)

A3672PR	36-42 x 72 x 29.6	70	143	7.75	\$1157	\$710
A3666PR	36-42 x 66 x 29.6	70	136	7.25	\$1048	\$710
A3660PR	36-42 x 60 x 29.6	70	126	6.5	\$991	\$603

Connects to the right side of a worksurface. Accommodates all 19" pedestals (freestanding, mobile and hanging pedestals). Grommet in worksurface. Shipped RTA (ready to assemble).
 • Modesty Panel is 1" off of ground.

Required Specifications

Top finish
 Base finish
 Post finish*

Optional Specifications

Additional grommet position
 HP laminate
 Power block cut-out

Accessories

Power block
 Keyboard tray
 Pencil tray

A ADAPTABILITIES®

"P" ISLANDS (ATTACHABLE)

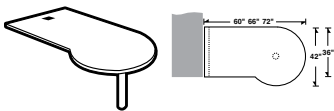

"P" Island LEFT with Post*

MODEL#	DIMENSIONS	FREIGHT CLASS	WT/LBS.	CUBIC FT.	LIST PRICE	HP ADD
A3672IPL	36-42 x 72 x 29.6	100	92	9.26	\$1102	\$710
A3666IPL	36-42 x 66 x 29.6	100	86	8.76	\$991	\$710
A3660IPL	36-42 x 60 x 29.6	92.5	80	8	\$939	\$603

Attaches to edge of worksurfaces. Attaching hardware included. Grommet in worksurface. Shipped RTA (ready to assemble).
 • Post is shipped in separate carton. Standard in Black (TBL); Tungsten is available at no charge, please specify (TTU).

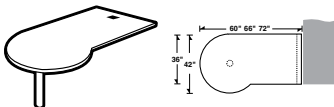

"P" Island RIGHT with Post*

A3672IPR	36-42 x 72 x 29.6	100	92	9.26	\$1102	\$710
A3666IPR	36-42 x 66 x 29.6	100	86	8.76	\$991	\$710
A3660IPR	36-42 x 60 x 29.6	92.5	80	8	\$939	\$603

Attaches to edge of worksurfaces. Attaching hardware included. Grommet in worksurface. Shipped RTA (ready to assemble).
 • Post is shipped in separate carton. Standard in Black (TBL); Tungsten is available at no charge, please specify (TTU).

RADIUS SPANNER ISLANDS

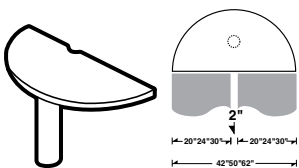

Radius Spanner Island with Panel Cut-Out*

MODEL#	DIMENSIONS	FREIGHT CLASS	WT/LBS.	CUBIC FT.	LIST PRICE	HP ADD
A62RS	31 x 62 x 29.6	100	59	6.76	\$1016	\$427
A50RS	25 x 50 x 29.6	125	46	5.76	\$883	\$356
A42RS	21 x 42 x 29.6	125	41	5.26	\$799	\$286

Used to connect two back-to-back units of same depth with a panel. Includes monopost. Requires "L" bracket (model **MLB90**) for connection to full end panels. Shipped RTA (ready to assemble).

- MLB90 must be ordered separately - see page 470.
- Post is shipped in separate carton. Standard in Black (TBL); Tungsten is available at no charge, please specify (TTU).
- **Cannot accept keyboard trays or pencil tray**

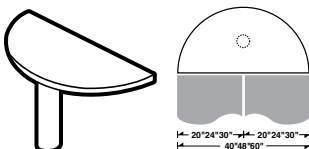

Radius Spanner Island*

A60RS	29.69 x 60 x 29.6	100	56	5.76	\$1016	\$356
A48RS	24 x 48 x 29.6	125	43	5.76	\$883	\$286
A40RS	20 x 40 x 29.6	125	40	5.26	\$799	\$286

Used to connect two back-to-back units of same depth. Includes monopost. Requires "L" bracket (model **MLB90**) for connection to full end panels. Shipped RTA (ready to assemble).

- MLB90 must be ordered separately - see page 470.
- Post is shipped in separate carton. Standard in Black (TBL); Tungsten is available at no charge, please specify (TTU).
- **Cannot accept keyboard trays or pencil tray**

RECEPTION DESKS

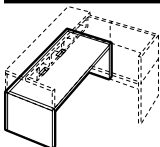

Lower Desk Unit**

MODEL#	DIMENSIONS	FREIGHT CLASS	WT/LBS.	CUBIC FT.	LIST PRICE	HP ADD
A3072RD	29.69 x 72 x 29.6	70	149	7	\$1102	\$498

No pedestals. Two grommets in worksurface. Shipped RTA (ready to assemble).
 • Cannot be used with Divide.

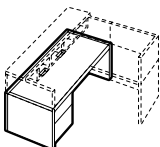

Single Pedestal Lower Desk Unit - LEFT**

A3072RDL	29.69 x 72 x 29.6	150	222	43.75	\$1593	\$498
A3060RDL	29.63 x 60 x 29	150	201	36	\$1376	\$464

Box/file pedestal on **left** with lock. Two grommets in worksurface.
 • Cannot be used with Divide.

Required Specifications

Top finish
 Base finish (not radius spanner islands)
 Post finish*

Optional Specifications

Additional grommet position*
 HP laminate*
 Power block cut-out*

Accessories

Power block*
 Keyboard tray**
 Pencil tray**

RECEPTION DESKS

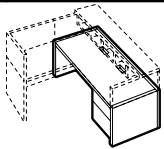

Single Pedestal Lower Desk Unit - RIGHT

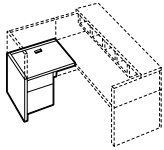

Reception Return - LEFT

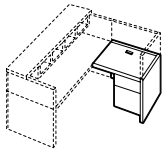

Reception Return - RIGHT



Reception Return - LEFT



Reception Return - RIGHT

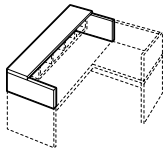

Transaction Counter

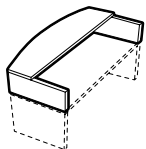

Bow Front Transaction Counter

MODEL#	DIMENSIONS	FREIGHT CLASS	WT/LBS.	CUBIC FT.	LIST PRICE	HP ADD
--------	------------	---------------	---------	-----------	------------	--------

D x W x H

A3072RDR	29.69 x 72 x 29.6	150	222	43.75	\$1593	\$498
A3060RDR	29.63 x 60 x 29	150	201	36	\$1376	\$464

Box/file pedestal on **right** with lock. Two grommets in worksurface.

- Cannot be used with Divide.

A2442RRL	24 x 42 x 29.6	125	131	21.25	\$1048	\$227
----------	----------------	-----	-----	-------	--------	-------

Box/file pedestal on **left** with lock. Grommet in worksurface.

- Cannot be used with Divide.
- **Cannot accept keyboard trays or pencil tray**

A2442RRR	24 x 42 x 29.6	125	131	21.25	\$1048	\$227
----------	----------------	-----	-----	-------	--------	-------

Box/file pedestal on **right** with lock. Grommet in worksurface.

- Cannot be used with Divide.
- **Cannot accept keyboard trays or pencil tray**

A2442KRL	24 x 42 x 29.6	70	83	3.8	\$773	\$227
----------	----------------	----	----	-----	-------	-------

No pedestal. Grommet in worksurface.

- Cannot be used with Divide.

A2442KRR	24 x 42 x 29.6	70	83	3.8	\$773	\$227
----------	----------------	----	----	-----	-------	-------

No pedestal. Grommet in worksurface.

- Cannot be used with Divide.

A3072URD	29.69 x 72 x 13.75	70	67	4.3	\$667	\$286
A3060URD	29.63 x 60 x 13.75	65	59	2.6	\$626	\$286

For main reception desk. Shipped RTA (ready to assemble). Depth of reception top is 12".

- Reception top units are to be used only with lower reception units. Tops have mini-fix fasteners to attach the reception top units.

A3072URB	29.69-36 x 72 x 13.75	70	72	4.3	\$904	\$356
----------	-----------------------	----	----	-----	-------	-------

For main reception desk. To be used on A3072RD, A3072RDL or A3072RDR. Shipped RTA (ready to assemble). Depth of reception bow top is 12-15".

- Reception top units are to be used only with desks listed. Tops have mini-fix fasteners to attach the reception top units.

Required Specifications

Top finish
Base finish

Optional Specifications

Additional grommet position*
HP laminate*
Power block cut-out*

Accessories

Power block*
Keyboard tray*
Pencil tray*

RECEPTION DESKS

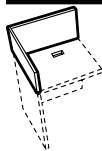

Return Screen Unit - LEFT

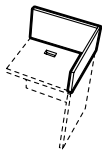

Return Screen Unit - RIGHT

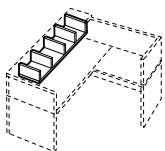

Desk Top Organizer

MODEL#	DIMENSIONS	FREIGHT CLASS	WT/LBS.	CUBIC FT.	LIST PRICE	HP ADD
--------	------------	---------------	---------	-----------	------------	--------

D x W x H

A2442URL	24 x 42 x 12.75	85	27	2	\$337	N/A
----------	-----------------	----	----	---	--------------	-----

To be used on top of left reception return (A2442RRL/KRL). Shipped RTA (ready to assemble).

- Reception top units are to be used only with returns listed. Tops have mini-fix fasteners to attach the reception top units.

A2442URR	24 x 42 x 12.75	85	27	2	\$337	N/A
----------	-----------------	----	----	---	--------------	-----

To be used on top of right reception return (A2442RRR/KRR). Shipped RTA (ready to assemble).

- Reception top units are to be used only with returns listed. Tops have mini-fix fasteners to attach the reception top units.

A1172ORD	11 x 52 x 6	100	22	2.6	\$226	N/A
----------	-------------	-----	----	-----	--------------	-----

To be used under transaction counter. Black (BK) finish only. Shipped RTA (ready to assemble).

WALL/PANEL MOUNT OVERSTORAGE UNITS

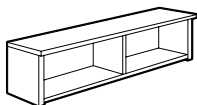

Overstorage Unit*

MODEL#	DIMENSIONS	FREIGHT CLASS	WT/LBS.	CUBIC FT.	LIST PRICE	HP ADD
--------	------------	---------------	---------	-----------	------------	--------

A00S60	15 x 60 x 16	70	86	5.25	\$829	N/A
A00S48	15 x 48 x 16	70	70	4.3	\$677	N/A
A00S42	15 x 42 x 16	70	62	3.8	\$667	N/A
A00S36	15 x 36 x 16	70	56	3.3	\$589	N/A
A00S30	15 x 30 x 16	70	48	3	\$551	N/A

Standard with pre-mounted "J" bracket for wall mount applications. One fixed shelf, closed back. Uses standard Adaptabilities hutch doors. Shipped RTA (ready to assemble).

- **NOTE:** Care should be taken to mount the units. Units should be mounted to wall studs using correct fasteners. Failure to do so may result in collapse of the unit and subsequent personal injury. **Mounting hardware not included.** Mounting hardware used should be based on wall material. Consult an installation professional for proper wall mounting.

OPEN HUTCHES

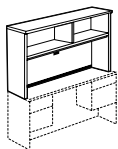

Open Hutch with Closed Back*

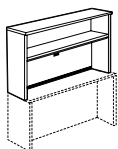
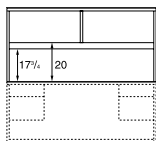

Open Hutch with Closed Back

MODEL#	DIMENSIONS	FREIGHT CLASS	WT/LBS.	CUBIC FT.	LIST PRICE	HP ADD
--------	------------	---------------	---------	-----------	------------	--------

A72HOCB	15 x 72 x 36	125	175	28.25	\$1187	N/A
A71HOCB	15 x 71.69 x 36	125	175	28.25	\$1187	N/A
A66HOCB	15 x 66 x 36	125	164	26	\$1133	N/A
A60HOCB	15 x 60 x 36	125	151	23.75	\$1048	N/A

One fixed shelf and fixed shelf divider. Closed back features a grommet and flexible sweep for wire management. All hutches shipped pre-assembled. ***A71HOCB** for use when spanning 30" x 60/66" SPL/R and 20/24" x 42" FL/FR/L4/R4.

- Clearance from worksurface to valance is 17 3/4"; clearance from worksurface to hutch doors is 20".
- Woodgrain runs horizontal on both the upper and lower back panels.

A48HOCB	15 x 48 x 36	125	124	19	\$831	N/A
A42HOCB	15 x 42 x 36	125	111	16.75	\$831	N/A
A36HOCB	15 x 36 x 36	125	99	14.5	\$719	N/A
A30HOCB	15 x 30 x 36	125	88	12.25	\$667	N/A

One fixed shelf. Closed back features a grommet and flexible sweep for wire management. All hutches shipped pre-assembled.

- Clearance from worksurface to valance is 17 3/4"; clearance from worksurface to hutch doors is 20".
- Woodgrain runs horizontal on both the upper and lower back panels.

Required Specifications

Top finish
Base finish

Optional Specifications

Doors*

PIGEON-HOLE STORAGE

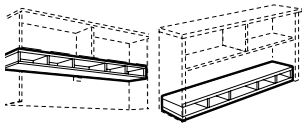

Horizontal Pigeon-Hole Storage

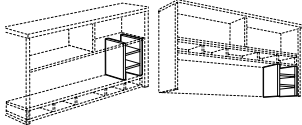

Vertical Pigeon-Hole Storage

MODEL#	DIMENSIONS D x W x H	FREIGHT CLASS	WT./LBS.	CUBIC FT.	LIST PRICE	HP ADD
AHS72	11.25 x 70 x 5.62	85	41	3	\$698	N/A
AHS71	11.25 x 69 x 5.62	70	43.5	2.3	\$698	N/A
AHS66	11.25 x 64 x 5.62	85	38	2.8	\$698	N/A
AHS60	11.25 x 58 x 5.62	85	35	2.5	\$572	N/A
AHS48	11.25 x 46 x 5.62	85	28	2	\$423	N/A
AHS42	11.25 x 40 x 5.62	85	24	2	\$423	N/A
AHS36	11.25 x 34 x 5.62	92.5	22	2	\$346	N/A

For additional storage. Can be **top** or **bottom** mounted. For use inside hutch. Shipped RTA (ready to assemble).

- **Cannot be used on A00S and C00S Overstorage Units.**
- Black finish is standard. Brushed Cobalt is available at no charge, please specify as **BRC**.

AVS14	11.25 x 13.37 x 14.37	85	13	0.9	\$436	N/A
-------	-----------------------	----	----	-----	--------------	-----

For use in conjunction with the Horizontal Pigeon-Hole Storage. Can be used under or over horizontal unit. Shipped RTA (ready to assemble).

- Black finish is standard. Brushed Cobalt is available at no charge, please specify as **BRC**.

CORNER HUTCHES

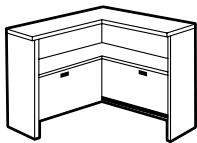

Corner Hutch with Closed Back

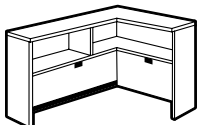

RIGHT Corner Hutch with Closed Back

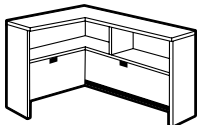

LEFT Corner Hutch with Closed Back

MODEL#	DIMENSIONS	FREIGHT CLASS	WT./LBS.	CUBIC FT.	LIST PRICE	HP ADD
A42CH	15 x 42 x 36	65	144	6.25	\$1398	N/A
A36CH	15 x 36 x 36	65	125	4.8	\$1178	N/A

One fixed shelf. Closed back features a grommet in both back panels and flexible sweep for wire management. Shipped RTA (ready to assemble).

- Woodgrain runs horizontal on both the upper and lower back panels.

A3672CHR	15 x 36-72 x 36	65	186	7	\$1539	N/A
A3666CHR	15 x 36-66 x 36	65	177	7	\$1483	N/A

One fixed shelf and shelf divider on left side. Closed back features a grommet in both back panels and flexible sweep for wire management on the left side. Shipped RTA (ready to assemble).

- Woodgrain runs horizontal on both the upper and lower back panels.

A3672CHL	15 x 36-72 x 36	65	186	7.25	\$1539	N/A
A3666CHL	15 x 36-66 x 36	65	177	7.25	\$1483	N/A

One fixed shelf and shelf divider on right side. Closed back features a grommet in both back panels and flexible sweep for wire management on the right side. Shipped RTA (ready to assemble).

- Woodgrain runs horizontal on both the upper and lower back panels.

Required Specifications

Top finish
Base finish

Optional Specifications

Doors

HUTCH DOORS

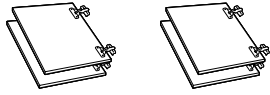

Four-Door Kit

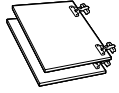

Two-Door Kit

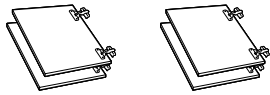

Corner Hutch Four-Door Kit

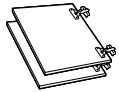

Corner Hutch Two-Door Kit

MODEL#	DIMENSIONS	FREIGHT CLASS	WT/LBS.	CUBIC FT.	LIST PRICE	HP ADD
--------	------------	---------------	---------	-----------	------------	--------

D x W x H

ADOOR72	.69 x 17.75 x 15	85	25	1.8	\$436	N/A
ADOOR71	.69 x 17.12 x 15	85	25	1.8	\$436	N/A
ADOOR66	.69 x 16.75 x 15	85	24	1.8	\$436	N/A
ADOOR60	.69 x 14.75 x 15	85	22	1.8	\$436	N/A

For use on 72", 71", 66" and 60"W straight hutches. Hinges included. Locks available. Add **\$137** each lock. Doors for units 60" wide or more require two locks.

ADOOR48	.69 x 23.5 x 15	92.5	18	1.8	\$283	N/A
ADOOR42	.69 x 20.5 x 15	100	17	1.8	\$283	N/A
ADOOR36	.69 x 17.5 x 15	100	15	1.8	\$283	N/A
ADOOR30	.69 x 14.5 x 15	125	13	1.8	\$283	N/A

For use on 48", 42" 36" and 30"W straight hutches. Hinges included. Locks available, Add **\$137** each lock. Doors for units 48" wide or less require one lock.

ADOOR72C	.69 x 56.5 x 15	70	27	1.8	\$553	N/A
ADOOR66C	.69 x 50.5 x 15	85	25	1.8	\$505	N/A

For use on 72" and 66"W corner hutches. Hinges included. Locks not available on corner hutch doors.

ADOOR42C	.69 x 26.5 x 15	92.5	20	1.8	\$480	N/A
ADOOR36C	.69 x 21.5 x 15	100	17	1.8	\$314	N/A

For use on 42" and 36"W corner hutches. Hinges included. Locks not available on corner hutch doors.

Required Specifications

Finish

TACKBOARDS FOR HUTCHES

MODEL# DIMENSIONS FREIGHT CLASS WT/LBS. CUBIC FT. FABRIC GRADE LIST PRICE

D x W x H

TACKBOARD Notes: Tackboards can be upholstered in all of the following fabrics:

Grade 1: Jenny, Quilt, Terrace, Urban, Waterfall

Grade 2: Imprint, Lola

Grade 3: Anchorage, Merge

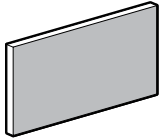

Tackboard

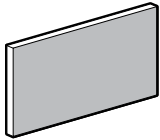

Tackboard

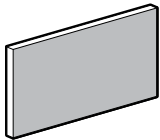

Tackboard

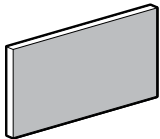

Tackboard

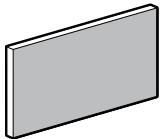

Tackboard

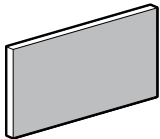

Tackboard

ATB7016	1 x 70 x 15	92.5	7	0.65	1	\$442
					2	\$528
					3	\$588
					4	\$688
					5	\$790

For use on **A72HOCB** straight hutch. Includes mounting screws and covers.

ATB6916	1 x 69.5 x 15	92.5	7	0.65	1	\$442
					2	\$528
					3	\$589
					4	\$688
					5	\$790

For use on **A71HOCB** straight hutch. Includes mounting screws and covers.

ATB6416	1 x 64 x 15	100	6.4	0.65	1	\$435
					2	\$510
					3	\$568
					4	\$651
					5	\$749

For use on **A66HOCB** straight hutch. Includes mounting screws and covers.

ATB5816	1 x 58 x 15	92.5	5.8	0.54	1	\$424
					2	\$499
					3	\$554
					4	\$643
					5	\$740

For use on **A60HOCB** straight hutch. Includes mounting screws and covers.

ATB4616	1 x 46 x 15	92.5	4.6	0.43	1	\$295
					2	\$356
					3	\$398
					4	\$462
					5	\$531

For use on **A48HOCB** straight hutch. Includes mounting screws and covers.

ATB4016	1 x 40 x 15	100	4	0.43	1	\$287
					2	\$337
					3	\$374
					4	\$432
					5	\$495

For use on **A42HOCB** straight hutch. Includes mounting screws and covers.

Required Specifications

Fabric

TACKBOARDS FOR HUTCHES

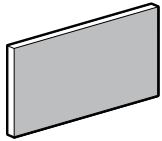

Tackboard

MODEL#	DIMENSIONS D x W x H	FREIGHT CLASS	WT/LBS.	CUBIC FT.	FABRIC GRADE	LIST PRICE
ATB3416	1 x 34 x 15	125	3.40	.43	1	\$278
					2	\$326
					3	\$364
					4	\$416
					5	\$480

For use on **A36HOCB** straight hutch. Includes mounting screws and covers.

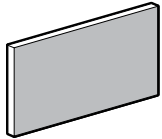

Tackboard

ATB2816	1 x 28 x 15	125	2.8	0.43	1	\$267
					2	\$307
					3	\$336
					4	\$377
					5	\$434

For use on **A30HOCB** straight hutch. Includes mounting screws and covers.

TACKBOARDS FOR CORNER HUTCHES

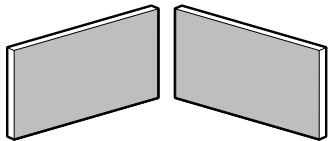

Tackboard

MODEL#	DIMENSIONS	FREIGHT CLASS	WT/LBS.	CUBIC FT.	LIST PRICE	HP ADD
ATB72CH	1 x 33-72 x 15 70 w x 15¾ h	125	9.94	1.3	1	\$682
					2	\$769
					3	\$830
					4	\$929
					5	\$1068

For use on **A3672CHR/L corner** hutch. Includes mounting screws and covers.

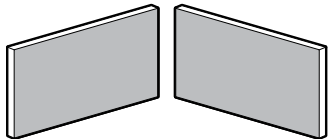

Tackboard

ATB66CH	1 x 33-64 x 15 64 w x 15¾ h	125	9.4	1.3	1	\$671
					2	\$746
					3	\$808
					4	\$890
					5	\$1024

For use on **A3666CHR/L corner** hutch. Includes mounting screws and covers.

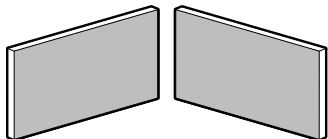

Tackboard

ATB42CH	1 x 39-40 x 15	100	7.7	0.85	1	\$536
					2	\$590
					3	\$639
					4	\$703
					5	\$809

For use on **A42CH corner** hutch. Includes mounting screws and covers.

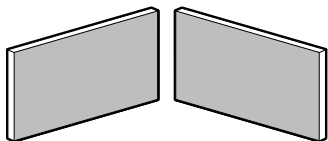

Tackboard

ATB36CH	1 x 33-34 x 15	125	6.6	0.85	1	\$513
					2	\$566
					3	\$602
					4	\$675
					5	\$777

For use on **A36CH corner** hutch. Includes mounting screws and covers.

Required Specifications

Fabric - Tackboards
Finish - Transaction Top

WALL MOUNTED TACKBOARDS

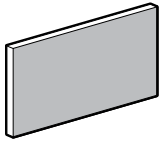

Wall Mounted Tackboard

MODEL#	DIMENSIONS	FREIGHT CLASS	WT./LBS.	CUBIC FT.	FABRIC GRADE	LIST PRICE
AWHT3019	1.25 x 30 x 19	125	6.3	1		
					D x W x H	
					1	\$343
					2	\$397
					3	\$457
4	\$523					
5	\$601					

For use under **A00S30** overstorage unit. Standard with pre-mounted "J" bracket for wall mount applications. There will be a 1.75" clearance between the top of the tackboard and bottom of the overhead, and a .25" clearance between the bottom of the tackboard and the worksurface.

- **NOTE:** Care should be taken to mount the units. Units should be mounted to wall studs using correct fasteners. Failure to do so may result in collapse of the unit and subsequent personal injury. **Mounting hardware not included.** Mounting hardware used should be based on wall material. Consult an installation professional for proper wall mounting.

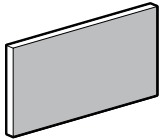

Wall Mounted Tackboard

AWHT3619	1.25 x 36 x 19	125	7.6	1		
					1	\$382
					2	\$443
					3	\$507
					4	\$581
5	\$668					

For use under **A00S36** overstorage unit. Standard with pre-mounted "J" bracket for wall mount applications. There will be a 1.75" clearance between the top of the tackboard and bottom of the overhead, and a .25" clearance between the bottom of the tackboard and the worksurface.

- **NOTE:** Care should be taken to mount the units. Units should be mounted to wall studs using correct fasteners. Failure to do so may result in collapse of the unit and subsequent personal injury. **Mounting hardware not included.** Mounting hardware used should be based on wall material. Consult an installation professional for proper wall mounting.

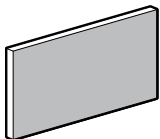

Wall Mounted Tackboard

AWHT4219	1.25 x 42 x 19	100	8.9	1		
					1	\$443
					2	\$512
					3	\$588
					4	\$675
5	\$774					

For use under **A00S42** overstorage unit. Standard with pre-mounted "J" bracket for wall mount applications. There will be a 1.75" clearance between the top of the tackboard and bottom of the overhead, and a .25" clearance between the bottom of the tackboard and the worksurface.

- **NOTE:** Care should be taken to mount the units. Units should be mounted to wall studs using correct fasteners. Failure to do so may result in collapse of the unit and subsequent personal injury. **Mounting hardware not included.** Mounting hardware used should be based on wall material. Consult an installation professional for proper wall mounting.

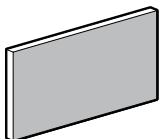

Wall Mounted Tackboard

AWHT4819	1.25 x 48 x 19	92.5	10.1	1		
					1	\$482
					2	\$556
					3	\$639
					4	\$735
5	\$842					

For use under **A00S48** overstorage unit. Standard with pre-mounted "J" bracket for wall mount applications. There will be a 1.75" clearance between the top of the tackboard and bottom of the overhead, and a .25" clearance between the bottom of the tackboard and the worksurface.

- **NOTE:** Care should be taken to mount the units. Units should be mounted to wall studs using correct fasteners. Failure to do so may result in collapse of the unit and subsequent personal injury. **Mounting hardware not included.** Mounting hardware used should be based on wall material. Consult an installation professional for proper wall mounting.

Required Specifications

Fabric

WALL MOUNTED TACKBOARDS

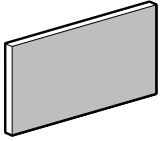

Wall Mounted Tackboard

MODEL#	DIMENSIONS D x W x H	FREIGHT CLASS	WT/LBS.	CUBIC FT.	FABRIC GRADE	LIST PRICE
AWHT6019	1.25 x 60 x 19	125	12.7	1.8	1	\$594
					2	\$686
					3	\$789
					4	\$907
					5	\$1039

For use under **A00S60** overstorage unit. Standard with pre-mounted "J" bracket for wall mount applications. There will be a 1.75" clearance between the top of the tackboard and bottom of the overhead, and a .25" clearance between the bottom of the tackboard and the worksurface.

- **NOTE:** Care should be taken to mount the units. Units should be mounted to wall studs using correct fasteners. Failure to do so may result in collapse of the unit and subsequent personal injury. **Mounting hardware not included.** Mounting hardware used should be based on wall material. Consult an installation professional for proper wall mounting.

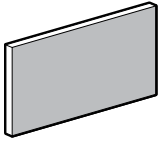

Wall Mounted Tackboard

AWHT6619	1.25 x 66 x 19	125	13.9	1.8	1	\$632
					2	\$731
					3	\$838
					4	\$963
					5	\$1107

For use under **multiple** Adaptabilities wall mounted overstorage units. Standard with pre-mounted "J" bracket for wall mount applications. There will be a 1.75" clearance between the top of the tackboard and bottom of the overhead, and a .25" clearance between the bottom of the tackboard and the worksurface.

- **NOTE:** Care should be taken to mount the units. Units should be mounted to wall studs using correct fasteners. Failure to do so may result in collapse of the unit and subsequent personal injury. **Mounting hardware not included.** Mounting hardware used should be based on wall material. Consult an installation professional for proper wall mounting.

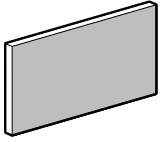

Wall Mounted Tackboard

AWHT7219	1.25 x 72 x 19	100	15.2	1.8	1	\$693
					2	\$799
					3	\$917
					4	\$1055
					5	\$1212

For use under **multiple** Adaptabilities wall mounted overstorage units. Standard with pre-mounted "J" bracket for wall mount applications. There will be a 1.75" clearance between the top of the tackboard and bottom of the overhead, and a .25" clearance between the bottom of the tackboard and the worksurface.

- **NOTE:** Care should be taken to mount the units. Units should be mounted to wall studs using correct fasteners. Failure to do so may result in collapse of the unit and subsequent personal injury. **Mounting hardware not included.** Mounting hardware used should be based on wall material. Consult an installation professional for proper wall mounting.

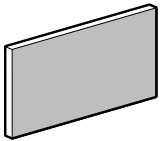

Wall Mounted Tackboard

AWHT7819	1.25 x 78 x 19	100	16.5	1.8	1	\$732
					2	\$844
					3	\$968
					4	\$1114
					5	\$1278

For use under **multiple** Adaptabilities wall mounted overstorage units. Standard with pre-mounted "J" bracket for wall mount applications. There will be a 1.75" clearance between the top of the tackboard and bottom of the overhead, and a .25" clearance between the bottom of the tackboard and the worksurface.

- **NOTE:** Care should be taken to mount the units. Units should be mounted to wall studs using correct fasteners. Failure to do so may result in collapse of the unit and subsequent personal injury. **Mounting hardware not included.** Mounting hardware used should be based on wall material. Consult an installation professional for proper wall mounting.

Required Specifications

Fabric

ACCESSORY PIECES

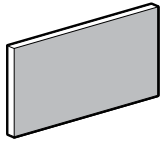

Wall Mounted Tackboard**

MODEL#	DIMENSIONS	FREIGHT CLASS	WT/LBS.	CUBIC FT.	LIST PRICE	HP ADD
	D x W x H					
AWHT8419	1.25 x 84 x 19	100	17.7	1.8	1	\$791
					2	\$914
					3	\$1049
					4	\$1205
					5	\$1385

For use under **multiple** Adaptabilities wall mounted overstorage units. Standard with pre-mounted "J" bracket for wall mount applications. There will be a 1.75" clearance between the top of the tackboard and bottom of the overhead, and a .25" clearance between the bottom of the tackboard and the worksurface.

- **NOTE:** Care should be taken to mount the units. Units should be mounted to wall studs using correct fasteners. Failure to do so may result in collapse of the unit and subsequent personal injury. **Mounting hardware not included.** Mounting hardware used should be based on wall material. Consult an installation professional for proper wall mounting.

ACCESSORY PIECES



Mixed Drawer Cabinet - LEFT*

MODEL#	DIMENSIONS	FREIGHT CLASS	WT/LBS.	CUBIC FT.	LIST PRICE	HP ADD
A2036MDL	20 x 36 x 29.6	92.5	162	15.5	\$2094	\$172
A2436MDL	24 x 36 x 29.6	100	176	18.25	\$2126	\$172

Two box drawers on **right**, one file drawer on **left** and one lateral file drawer on bottom. File on lateral file drawers locking. 1 pencil tray. Front-to-back filing bars.

- Black handles are standard. Silver is available at no charge, please specify as **SI**.
- To comply with ANSI/BIFMA stability tests, the Lateral File Counter Weight Kit, model "LFCWKIT36" on page 41 MUST be used.
- *File drawer construction is for accommodating hanging files NOT for stacking materials on the drawer bottom.*
- Top file drawer supports hanging folders only. Does not accept hanging folders with plastic tabs.



Mixed Drawer Cabinet - RIGHT*

A2036MDR	20 x 36 x 29.6	92.5	162	15.5	\$2094	\$172
A2436MDR	24 x 36 x 29.6	100	176	18.25	\$2126	\$172

Two box drawers on **left**, one file drawer on **right** and one lateral file drawer on bottom. File on lateral file drawers locking. 1 pencil tray. Front-to-back filing bars.

- Black handles are standard. Silver is available at no charge, please specify as **SI**.
- To comply with ANSI/BIFMA stability tests, the Lateral File Counter Weight Kit, model "LFCWKIT36" on page 41 MUST be used.
- *File drawer construction is for accommodating hanging files NOT for stacking materials on the drawer bottom.*
- Top file drawer supports hanging folders only. Does not accept hanging folders with plastic tabs.



Mixed Drawer Cabinet Shell - LEFT*

A2036MDLS	19.25 x 36 x 28.6	100	137	15	\$2041	N/A
A2436MDLS	23.25 x 36 x 28.6	100	150	18	\$2075	N/A

For use **under 29"H limited single pedestal desks, workstations or limited single pedestal credenzas. Unfinished top, no back.** Two box drawers on **right**, one file drawer on **left** and one lateral file drawer on bottom. File and lateral file drawers locking. 1 pencil tray. Front-to-back filing bars.

- Black handles are standard. Silver is available at no charge, please specify as **SI**.
- *File drawer construction is for accommodating hanging files NOT for stacking materials on the drawer bottom.*
- *For 24" deep worksurfaces, order **A2436MDLS**. For 20" deep worksurfaces, order **A2036MDLS**.*
- Top file drawer supports hanging folders only. Does not accept hanging folders with plastic tabs.

Required Specifications

Fabric**
Top finish*
Handle finish*
Base finish*

Optional Specifications

Key #*

ACCESSORY PIECES



Mixed Drawer Cabinet Shell - RIGHT

MODEL#	DIMENSIONS D x W x H	FREIGHT CLASS	WT/LBS.	CUBIC FT.	LIST PRICE	HP ADD
A2036MDRS	19.25 x 36 x 28.6	100	137	15	\$2041	N/A
A2436MDRS	23.25 x 36 x 28.6	100	150	18	\$2075	N/A

For use **under 29"H limited single pedestal desks, workstations or limited single pedestal credenzas. Unfinished top, no back.** Two box drawers on **left**, one file drawer on **right** and one lateral file drawer on bottom. File and lateral file drawers locking. 1 pencil tray. Front-to-back filing bars.

- Black handles are standard. Silver is available at no charge, please specify as **SI**.
- File drawer construction is for accommodating hanging files **NOT** for stacking materials on the drawer bottom.
- For 24" deep worksurfaces, order **A2436MDRS**. For 20" deep worksurfaces, order **A2036MDRS**.
- Top file drawer supports hanging folders only. Does not accept hanging folders with plastic tabs.

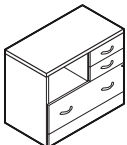

Mixed Storage Cabinet*

A2436MSC	24 x 36 x 29.6	100	163	18.25	\$1566	\$172
A2036MSC	20 x 36 x 29.6	100	147	15.5	\$1447	\$172

Features open storage compartment with access grommet on back. 2 box drawers and 1 lateral file drawer, all locking. 1 pencil tray. Front-to-back filing bars.

- To comply with ANSI/BIFMA stability tests, the Lateral File Counter Weight Kit, model "LFCWKIT36" on page 41 **MUST** be used.
- Black handles are standard. Silver is available at no charge, please specify as **SI**.
- File drawer construction is for accommodating hanging files **NOT** for stacking materials on the drawer bottom.

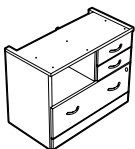

Mixed Storage Cabinet Shell

A2436MSCS	23.25 x 36 x 28	100	121	14.9	\$1527	N/A
A2036MSCS	19.25 x 36 x 28	125	136	17.45	\$1407	N/A

For use **under 29"H limited single pedestal desks, workstations or limited single pedestal credenzas. Unfinished top, no back.** Features open storage compartment with access grommet on back. 2 box drawers and 1 lateral file drawer, all locking. 1 pencil tray. Front-to-back filing bars.

- Black handles are standard. Silver is available at no charge, please specify as **SI**.
- File drawer construction is for accommodating hanging files **NOT** for stacking materials on the drawer bottom.
- For 24" deep worksurfaces, order **A2436MSCS**. For 20" deep worksurfaces, order **A2036MSCS**.



2 Drawer Lateral File*

A2036LF	20 x 36 x 29.6	100	145	15.5	\$1294	\$172
---------	----------------	-----	-----	------	---------------	--------------

Two full suspension drawers. Front-to-back and side-to-side letter/legal filing capability with lock. Anti-lock tilt suspension.

- To comply with ANSI/BIFMA stability tests, the Lateral File Counter Weight Kit, model "LFCWKIT36" on page 41 **MUST** be used.
- Black handles are standard. Silver is available at no charge, please specify as **SI**.
- File drawer construction is for accommodating hanging files **NOT** for stacking materials on the drawer bottom.

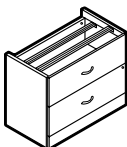

2 Drawer Lateral File Shell

A2436S2	24 x 36 x 28.6	125	114	18	\$1717	N/A
A2036S2	20 x 36 x 28.5	125	104	14.75	\$1717	N/A

For use **under 29"H limited single pedestal desks, workstations or limited single pedestal credenzas. No top or back.** Two full suspension locking drawers with **steel drawer interior**. Steel drawer construction includes metal sides and masonite bottoms. Side-to-side file bars included. Anti-lock tilt suspension.

- Black handles are standard. Silver is available at no charge, please specify as **SI**.
- To prevent overloading, steel drawers do not include a back panel
- For 24" deep worksurfaces, order **A2436S2**. For 20" deep worksurfaces, order **A2036S2**.
- For front-to-back file bars order **FBB**, "FBB" on page 41.

Required Specifications

Top finish*
Base finish
Handles

Optional Specifications

Key #
HP laminate*

ACCESSORY PIECES

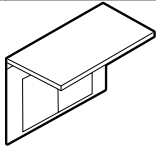
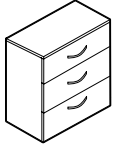
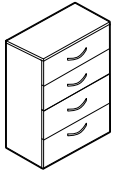
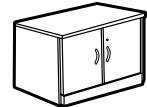
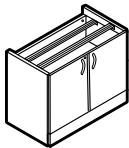
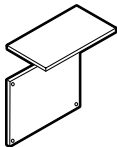
**2 Drawer Lateral File Top and Back*****3 Drawer Lateral File*****4 Drawer Lateral File*****Storage Cabinet*****Storage Cabinet Shell****Storage Cabinet Top and Back***

MODEL#	DIMENSIONS	FREIGHT CLASS	WT./LBS.	CUBIC FT.	LIST PRICE	HP ADD
--------	------------	---------------	----------	-----------	------------	--------

D x W x H

ALF24TB	24 x 36 x 29.6	65	82	3.3	\$537	\$215
ALF20TB	20 x 36 x 29.6	65	78	3.3	\$537	\$215

For use with Lateral File Shell. Counterweights included. Shipped RTA (ready to assemble).

- Use **ALF24TB** for model A2436S2. Use **ALF20TB** for model A2036S2.

A2036S3	20 x 36 x 37.75	92.5	219	20	\$2479	\$172
---------	-----------------	------	-----	----	--------	-------

Three full suspension locking drawers with **steel drawer interior**. Steel drawer construction includes metal sides and masonite bottoms. Side-to-side file bars included. Anti-lock tilt suspension.

- Black handles are standard. Silver is available at no charge, please specify as **SI**.
- For front-to-back file bars order **FBB**; See "FBB" on page 41.
- To prevent overloading, steel drawers do not include a back panel

A2036S4	20 x 36 x 49.5	92.5	267	25.75	\$3142	\$172
---------	----------------	------	-----	-------	--------	-------

Four full suspension locking drawers with **steel drawer interior**. Steel drawer construction includes metal sides and masonite bottoms. Side-to-side file bars included. Anti-lock tilt suspension.

- Black handles are standard. Silver is available at no charge, please specify as **SI**.
- For front-to-back file bars order **FBB**; See "FBB" on page 41.
- To prevent overloading, steel drawers do not include a back panel

A2036SC	20 x 36 x 29.6	125	121	15.5	\$991	\$172
---------	----------------	-----	-----	------	-------	-------

Self-closing hinged doors cover one adjustable shelf. Standard with lock.

- Black handles are standard. Silver is available at no charge, please specify as **SI**.

A2436SCS	23.25 x 36 x 28.6	150	106	18	\$856	N/A
A2036SCS	19.25 x 36 x 28.6	125	91	14.75	\$856	N/A

For use **under 29" H limited single pedestal desks, workstations or limited single pedestal credenzas. No top or back**. Self-closing hinged doors cover one adjustable shelf. Standard with lock.

- Black handles are standard. Silver is available at no charge, please specify as **SI**.
- For 24" deep worksurfaces, order **A2436SCS**. For 20" deep worksurfaces, order **A2036SCS**.

ASC24TB	24 x 36 x 29.6	85	49	3.3	\$362	\$215
ASC20TB	20 x 36 x 29.6	85	45	3.3	\$362	\$215

For use with **Storage Cabinet Shell**. Shipped RTA (ready to assemble).

- Use **ASC24TB** for model A2436SCS/MSCS; use **ASC20TB** for model A2036SCS/MSCS.

Required Specifications

Top finish*
Base finish
Handles

Optional Specifications

Key #
HP laminate*

ACCESSORY PIECES

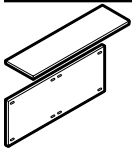

Credenza Top and Back*

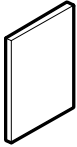

Full Leg



Personal Tower**

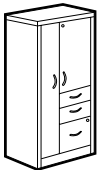

Personal Tower**

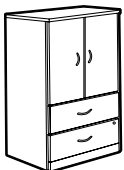

Vertical Storage/Lateral File Cabinet**

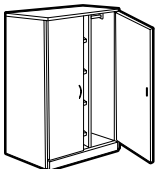

Storage Wardrobe Cabinet**

MODEL#	DIMENSIONS D x W x H	FREIGHT CLASS	WT./LBS.	CUBIC FT.	LIST PRICE	HP ADD
A2472TB	24 x 72 x 29.6	70	95	6	\$741	\$372
A2072TB	20 x 72 x 29.6	85	87	6	\$741	\$356

For use with the following: **two Lateral File Shells**, or **two Storage Cabinet Shells**, or **two Mixed Storage Cabinet Shells**, or any combination. May also be used with **one Lateral File Shell plus one Full Leg**, or **one Storage Cabinet/Mixed Storage Cabinet Shell plus one Full Leg**. Shipped RTA (ready to assemble).

- For 24" deep worksurfaces, order **A2472TB**. For 20" deep worksurfaces, order **A2072TB**.
- **Does not include hardware to attach to storage shells.**

A24FL	23.4 x 1 x 28.6	92.5	20	1.7	\$261	N/A
A20FL	19.3 x 1 x 28.6	65	16	0.6	\$261	N/A

For use at **either end of A24/2072TB Credenza Top and Back** to create a kneespace. Non-handed; can be used left or right. Shipped RTA (ready to assemble).

- For 24" deep worksurfaces, order **A24FL**. For 20" deep worksurfaces, order **A20FL**.
- **Does not include hardware for installation.**

A24PTFF	24 x 24 x 65.5	100	219	27	\$2580	N/A
A20PTFF	20 x 24 x 65.5	100	198	22.75	\$2580	N/A

Includes 7" wardrobe section with a hanging rod; storage section with one adjustable shelf; and file section with **two file drawers**. Locks are keyed alike. Upper lock secures wardrobe and storage section. Lower lock secures both file drawers.

- Black handles are standard. Silver is available at no charge, please specify as **SI**.

A24PTBBF	24 x 24 x 65.5	125	213	27	\$2580	N/A
A20PTBBF	20 x 24 x 65.5	100	193	22.75	\$2580	N/A

Includes 7" wardrobe section with a hanging rod; storage section with one adjustable shelf; and file section with **box-box-file drawers**. Locks are keyed alike. Upper lock secures wardrobe and storage section. Lower lock secures all drawers.

- Black handles are standard. Silver is available at no charge, please specify as **SI**.

A3665VSL	20 x 36 x 65.5	100	273	33	\$2412	N/A
----------	----------------	-----	-----	----	---------------	-----

Contains storage area with one adjustable shelf behind a self-closing hinged door, plus two full suspension file drawers. Lateral file drawers lock.

- File drawer construction is for accommodating hanging files NOT for stacking materials on the drawer bottom.
- Black handles are standard. Silver is available at no charge, please specify as **SI**.

A2436DI	24 x 36 x 65.5	70	254	11.5	\$2982	N/A
A3665DI	20 x 36 x 65.5	70	237	11.5	\$2631	N/A

Includes 16" hanging rod on one side and four adjustable shelves on the other. Lock. Shipped RTA (ready to assemble).

- Black handles are standard. Silver is available at no charge, please specify as **SI**.

Required Specifications

Top finish
Base finish
Handles (only personal towers)

Optional Specifications

Key #**
HP laminate*

ACCESSORY PIECES

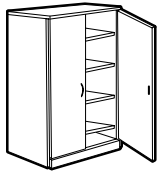

Storage Cabinet**

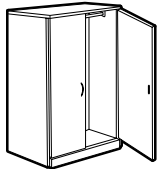

Wardrobe Cabinet**

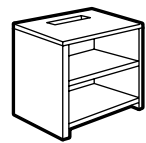

Printer Table*

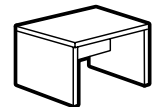

Magazine Table*

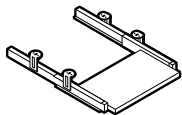

Pull-Out Keyboard

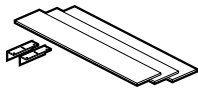

Counter Weight Kit

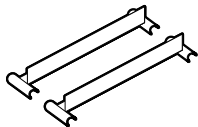

Front-to-Back Hanging File Bars

MODEL#	DIMENSIONS	FREIGHT CLASS	WT/LBS.	CUBIC FT.	LIST PRICE	HP ADD
--------	------------	---------------	---------	-----------	------------	--------

D x W x H

A2436SH	24 x 36 x 65.5	65	280	11.5	\$2626	N/A
A3665SH	20 x 36 x 65.5	65	261	11.5	\$2302	N/A

Includes four adjustable shelves. Lock. Shipped RTA (ready to assemble).

- Black handles are standard. Silver is available at no charge, please specify as **SI**.

A2436ROD	24 x 36 x 65.5	70	205	11.5	\$2842	N/A
A3665ROD	20 x 36 x 65.5	70	198	11.5	\$2412	N/A

Includes full width hanging rod. Lock. Shipped RTA (ready to assemble).

- Black handles are standard. Silver is available at no charge, please specify as **SI**.

A2430PT	24 x 30 x 29.6	65	108	4.3	\$991	\$172
---------	----------------	----	-----	-----	--------------	--------------

Includes two fixed shelves, cut-back top shelf allows paper to fall onto lower shelf. Shipped RTA (ready to assemble).

A2248MT	22 x 48 x 18.5	85	61	4.3	\$553	\$245
A2222MT	22 x 22 x 18.5	85	40	3	\$447	\$130

Shipped RTA (ready to assemble).

APOKL28	17 x 28 x 3.5	85	13	0.9	\$337	N/A
APOKL22	17 x 22 x 3.5	85	12	0.9	\$305	N/A

Constructed of thermofused laminate. **APOKL28** will accommodate keyboard and mousepad. **APOKL28** will only fit on a single pedestal desk, freestanding table, or **A42205C**. Please specify color from available finishes listed on pg. 11.

- **APOKL28** will not fit extended corners or **A42245C, A36205C** 5-sided corners.

LFCWKIT36	6 x 33 x 1	60	40	0.25	\$754	N/A
-----------	------------	----	----	------	--------------	-----

3 metal plates. Plates mount to the underside of any 36" wide Lateral File or Mixed Storage/Drawer cabinet. Includes mounting hardware. Must be ordered separately. Field installed.

- To comply with ANSI/BIFMA stability tests, the Lateral File Counter Weight Kit MUST be used with the appropriate Lateral Files and Mixed Storage Cabinets.

FBB	-- x 15.2 x --	70	1	0.01	\$30	N/A
FBB-50	-- x 15.2 x --	60	50	0.5	\$910	N/A
FBB-100	-- x 15.2 x --	60	100	2.71	\$1666	N/A

Includes two bars. Grey. FBB is one pair; FBB-50 is fifty pairs; FBB-100 is 100 pairs.

- Not recommended for "L" opening with receding door and roll-out shelves.

Required Specifications

Top finish
Base finish
Handles**

Optional Specifications

Key #**
HP laminate*

A ADAPTABILITIES®

BOOKCASES

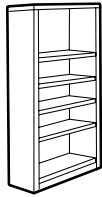

Bookcase - 72" High*

MODEL#	DIMENSIONS D x W x H	FREIGHT CLASS	WT/LBS.	CUBIC FT.	LIST PRICE	HP ADD
ABC72	12 x 36 x 72.5	125	170	23	\$1187	N/A

One fixed heavy duty shelf and **three adjustable shelves**. Shipped fully assembled.

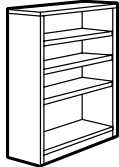

Bookcase - 65" High*

ABC65	12 x 36 x 65.5	125	150	21	\$1157	N/A
-------	----------------	-----	-----	----	---------------	-----

One fixed heavy duty shelf and **two adjustable shelves**. Shipped fully assembled.

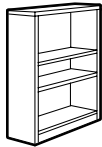

Bookcase - 48" High*

ABC48	12 x 36 x 48.5	125	116	15.75	\$883	N/A
-------	----------------	-----	-----	-------	--------------	-----

Two adjustable shelves. Shipped fully assembled.

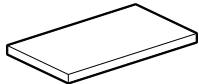

Bookcase Shelf

ABCSELF	11 x 34 x 1	100	13	1.5	\$276	N/A
---------	-------------	-----	----	-----	--------------	-----

Extra shelf for bookcases. 1" thick.

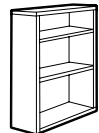
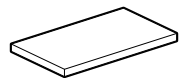

Table Top Bookcase

A3636TBC	15 x 36 x 36	125	111	17	\$759	N/A
ADOOR3636	.69 x 36 x 36	125	35	4.5	\$384	N/A

To be placed on top of 36" w lateral file or storage cabinet. Two adjustable shelves.

- For a set of doors, order **ADOOR3636**
- Locks available on ADOOR3636. Add \$101 each lock.



Bookcase Shelf

ATBC36SH	13.25 x 34 x 1	100	16	1.7	\$212	N/A
----------	----------------	-----	----	-----	--------------	-----

Extra shelf for TABLE TOP bookcases. 1" thick.

Required Specifications

Top finish*
Base finish*

END SHELVES

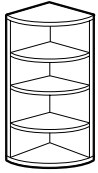

End Shelf - 65" High

MODEL#	DIMENSIONS D x W x H	FREIGHT CLASS	WT/LBS.	CUBIC FT.	LIST PRICE	HP ADD
A2465ESHL	24 x 24 x 65.5	65	136	5	\$1246	N/A
A2065ESHL	20 x 20 x 65.5	65	113	5	\$1048	N/A
A2465ESHR	24 x 24 x 65.5	65	136	5	\$1246	N/A
A2065ESHR	20 x 20 x 65.5	65	113	5	\$1048	N/A

For use at end of **wardrobe/storage, vertical storage cabinets, and personal towers**. Four fixed shelves. Shipped RTA (ready to assemble). **Specify left or right.**

- For 24" deep cabinet, order **A2465ESH**. For 20" deep cabinet, order **A2065ESH**.

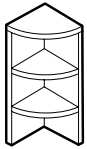

End Shelf - 36" High

A1536ESHL	15 x 15 x 36	85	44	3.3	\$505	N/A
A1536ESHR	15 x 15 x 36	85	44	3.3	\$505	N/A

For use at end of **hutches**. Two fixed shelves. To be used on top of **A3029ESHL/R, A2429ESHL/R or A2029ESHL/R**. Shipped RTA (ready to assemble). **Specify left or right.**

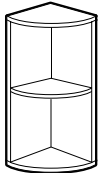

End Shelf - 29" High

A3029ESHL	30 x 30 x 29.6	70	104	5.25	\$883	\$286
A2429ESHL	24 x 24 x 29.6	70	77	4.3	\$719	\$145
A2029ESHL	20 x 20 x 29.6	70	60	3.8	\$614	\$117
A3029ESHR	30 x 30 x 29.6	70	104	5.25	\$883	\$286
A2429ESHR	24 x 24 x 29.6	70	77	4.3	\$719	\$145
A2029ESHR	20 x 20 x 29.6	70	60	3.8	\$614	\$117

For use at end of **worksurfaces**. Two fixed shelves. Shipped RTA (ready to assemble). **Specify left or right.**

- For 30" deep worksurface, order **A3029ESH**. For 24" deep worksurface, order **A2429ESH**.
For 20" deep worksurface, order **A2029ESH**.

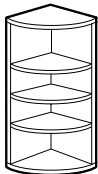

End Shelf - 49 1/2" High

A2049ESHL	20 x 20 x 49.5	65	94	3.8	\$924	N/A
A2049ESHR	20 x 20 x 49.5	65	94	3.8	\$924	N/A

For use at end of **A2036S4 4-high lateral file**. Four fixed shelves. Shipped RTA (ready to assemble). **Specify left or right.**

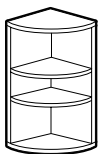

End Shelf - 37 1/4" High

A2037ESHL	20 x 20 x 38.2	70	77	5	\$672	N/A
A2037ESHR	20 x 20 x 38.2	70	77	5	\$672	N/A

For use at end of **A2036S3 3-high lateral file**. Three fixed shelves. Shipped RTA (ready to assemble). **Specify left or right.**

Required Specifications

Top finish
Base finish

Optional Specifications

HP Laminate (End Shelf, 29"h)

PEDESTALS



Freestanding Pedestal

MODEL#	DIMENSIONS D x W x H	FREIGHT CLASS	WT/LBS.	CUBIC FT.	LIST PRICE	HP ADD
AFPBBF19	19 x 16 x 28.6	100	68	7.25	\$1079	N/A
AFPBBF22	22 x 16 x 28.6	100	72	8.25	\$1105	N/A
AFPBBF28	28 x 16 x 28.6	100	88	10.25	\$1151	N/A

For use under a freestanding worksurface (20", 24" or 30"); attaches to worksurface top. No top and unfinished back. Two box and one file drawer. One pencil tray. File drawer and lower box drawer are locking.

- *Cannot be used with **A2466** extended corners.*
- *When used with Connectable Tables (e.g. A2472T) bottom rear of pedestal will show because of the modesty on table units*



Freestanding Pedestal

AFPFF19	19 x 16 x 28.6	100	67	7.25	\$1169	N/A
AFPFF22	22 x 16 x 28.6	100	75	8.25	\$1183	N/A
AFPFF28	28 x 16 x 28.6	100	89	10.25	\$1250	N/A

For use under a freestanding worksurface (20", 24" or 30"); attaches to worksurface top. No top and unfinished back. Two file drawers. Locking.

- *Cannot be used with **A2466** extended corners.*
- *When used with Connectable Tables (e.g. A2472T) bottom rear of pedestal will show because of the modesty on table units*

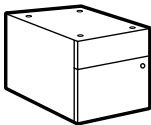

Hanging Pedestal

AHPBF18	18 x 16 x 18	92.5	48	4.5	\$754	N/A
---------	--------------	------	----	-----	--------------	-----

For use under a freestanding worksurface (20", 24" or 30"); attaches to worksurface top. No top and unfinished back. One box and one file drawer. One pencil tray. Locking. 18" high.

- *Cannot be used with **A2466** extended corners.*
- *When used with Connectable Tables (e.g. A2472T) bottom rear of pedestal will show because of the modesty on table units*



Mobile Pedestal*

AMPBBF19	19 x 16 x 28	85	96	6.5	\$1128	\$215
AMPBBF22	23 x 16 x 28	92.5	92	7.75	\$1140	\$221
AMPBBF28	29 x 16 x 28	92.5	105	9.5	\$1183	\$223

Pedestal on casters. Front casters lock. Fits under worksurfaces and is easily moved. Two box and one file drawer. One pencil tray. File drawer and lower box drawer are locking. Includes counterweight to prevent tipping.

- *Cannot be used with **A2466** extended corners.*



Mobile Pedestal*

AMPFF19	19 x 16 x 28	85	97	6.5	\$1214	\$215
AMPFF22	23 x 16 x 28	85	95	7.75	\$1231	\$223
AMPFF28	29 x 16 x 28	92.5	106	9.5	\$1294	\$223

Pedestal on casters. Front casters lock. Fits under worksurfaces and is easily moved. Two file drawers. Locking. Includes counterweight to prevent tipping.

- *Cannot be used with **A2466** extended corners.*

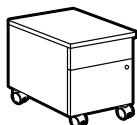

Mobile Pedestal*

AMPBF19	19 x 16 x 22	85	77	5.25	\$991	\$215
AMPBF22	23 x 16 x 22	85	73	6	\$1016	\$223
AMPBF28	29 x 16 x 22	92.5	83	7.5	\$1043	\$223

Pedestal on casters. Front casters lock. Fits under worksurfaces and is easily moved. One box and one file drawer. One pencil tray. Locking. 22" high. Includes counterweight to prevent tipping.

Required Specifications

Top finish
Base finish*

Optional Specifications

Key #
HP laminate (mobile pedestal)
Handle

BOARDROOM TABLES



Boardroom Table - Round Top*

MODEL#	DIMENSIONS D x W x H	FREIGHT CLASS	WT/LBS.	CUBIC FT.	LIST PRICE	HP ADD
A48R	48 x 48 x 1.5	85	95	7.5	\$642	\$498
A42R	42 x 42 x 1.5	85	73	5.75	\$614	\$498
A36R	36 x 36 x 1.5	92.5	54	4.9	\$447	\$286

- Available with the **Bicut edge** at no upcharge. Please specify "**CR**".
- **A48R** to be used with four monopost legs only, model **A5L**.
- **A42R** to be used with cross base **A2727XB** only
- **A36R** to be used with drum base **A18Z** or cross base **A2727XB**



Boardroom Table - Rectangular Top*

A48120RE	48 x 120 x 1.5	70	274	13	\$1376	\$1132
A4896RE	48 x 96 x 1.5	65	314	11.5	\$1048	\$923
A3672RE	36 x 72 x 1.5	65	175	7	\$773	\$532

For use with two drum bases, two "V" bases, one panel base OR four monoposts. Predrilled for "V" base and panel base.

Top comes in one piece, except for A48120RE (two pieces)

- Available with the **Bicut Edge** at no upcharge. Please Specify "**CR**".
- **A48120RE** uses three drum bases, three "V" bases, one double panel base OR six monoposts.



Boardroom Table - Boat Shape Top*

A48144B	48 x 144 x 1.5	60	237	7.5	\$1593	\$1344
A48120B	48 x 120 x 1.5	60	198	6.3	\$1376	\$1132
A4896B	48 x 96 x 1.5	70	193	9.8	\$1079	\$923

For use with three drum bases, three "V" bases, one double panel base OR six monoposts. Predrilled for "V" base and panel base. **Top comes in two pieces, except for A4896B.**

- Available with the **Bicut Edge** at no upcharge. Please Specify "**CR**".
- **A4896B** uses two drum bases, two "V" bases, one panel base OR four monoposts.



Boardroom Table - Racetrack Top*

A48144RT	48 x 144 x 1.5	60	251	7.5	\$1593	\$1344
A48120RT	48 x 120 x 1.5	60	204	6.3	\$1376	\$1132
A4896RT	48 x 96 x 1.5	70	200	9.8	\$1079	\$923
A3672RT	36 x 72 x 1.5	70	112	5.8	\$831	\$532

For use with three drum bases, three "V" bases, one double panel base OR six monoposts. Predrilled for "V" base and panel base. **Top comes in two pieces except for A4896RT and A3672RT.**

- Available with the **Bicut Edge** at no upcharge. Please Specify "**CR**".
- **NOTE:** 48" x 120" and 48" x 144" woodgrain finish Adaptabilities tables will not have a perfect match of grain at the center where the two halves meet.
- **A4896RT** and **A3672RT** use two drum bases, two "V" bases, one panel base OR four monoposts.

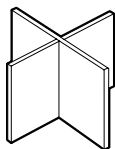

Cross Base

A2727XB	27 x 27 x 29.6	70	63	3.6	\$412	N/A
---------	----------------	----	----	-----	--------------	-----

Use as the base for **36" or 42" round tops (model A36R or A42R)**. Shipped RTA (ready to assemble).

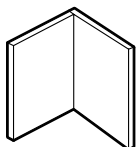

"V" Base

A1616V	16 x 16 x 28.6	60	39	1.1	\$351	N/A
A1616V2	16 x 16 x 28.6	60	74	2.2	\$693	N/A

Use as the base for **rectangular, boat shaped or racetrack tops**. Shipped RTA (ready to assemble).

- **A1616V2** is shipped 2 bases per carton.

Required Specifications

Finish
Edge detail*

Optional Specifications

HP laminate*

A ADAPTABILITIES®

BOARDROOM TABLES

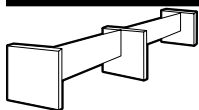

Panel Base

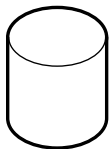

Drum Base

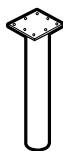

Mono Post

MODEL#	DIMENSIONS D x W x H	FREIGHT CLASS	WT./LBS.	CUBIC FT.	LIST PRICE	HP ADD
A2488PB	24 x 88 x 29.6	70	119	6	\$1102	N/A
A2445PB	24 x 45 x 28.6	70	76	4.3	\$719	N/A

Use as the base for **rectangular, boat shaped or racetrack tops**. Shipped RTA (ready to assemble).

- Use **A2488PB** for 120 - 144" wide tops.
- Use **A2445PB** for 72 - 96" wide tops.

A18Z	18 x 18 x 28.6	250	29	7.5	\$773	N/A
------	----------------	-----	----	-----	--------------	-----

Use as the base for **36" round top (model A36R) and 72", 96", 120" or 144" wide tops**.

Available in Black finish only.

- All Drum Bases require approx. 125 lb. of sand in each base for adequate stability. Sand not included.

A5L	4 x 4 x 28.6	100	13	1.5	\$337	N/A
-----	--------------	-----	----	-----	--------------	-----

Use as the base for **48" (model A48R) round tops and 72", 96", 120" or 144" wide tops**.

- Post is shipped in separate carton. Standard in Black (**TBL**); Tungsten is available at no charge, please specify (**TTU**).

BOARDROOM ACCESSORIES



Serving Cart*

A2036SK	20 x 36 x 36.5	100	179	19	\$2302	\$172
---------	----------------	-----	-----	----	---------------	--------------

Includes **two** side opening, self-closing hinged doors, **two box drawers**, one slide-out tray and storage shelf. On casters.

- Available with the **Bicut Edge** at no upcharge. Please Specify "**AR**".
- Black handles are standard. Silver is available at no charge, please specify as **SI**.



Serving Cart*

A2020SK	20 x 20 x 36	92.5	114	11	\$1444	\$117
---------	--------------	------	-----	----	---------------	--------------

Includes **one** side opening, self-closing hinged door, **one box drawer**, one slide-out tray and storage shelf. On casters.

- Available with the **Bicut Edge** at no upcharge. Please Specify "**CR**".
- Black handles are standard. Silver is available at no charge, please specify as **SI**.

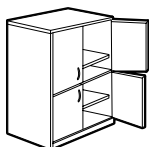

Audio/Visual Cabinet*

A2436AV	24 x 36 x 65.5	65	272	11.25	\$2631	N/A
---------	----------------	----	-----	-------	---------------	-----

Includes **four** side opening doors covering two adjustable and two fixed shelves. Wire access through one grommet on back panel. Holds up to 27"H TV monitor. Shipped RTA (ready to assemble).

- Black handles are standard. Silver is available at no charge, please specify as **SI**.

Required Specifications

Top finish *
Base finish
Handles*

Optional Specifications

Key #*
HP laminate*

BOARDROOM ACCESSORIES

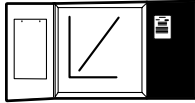

Visual Board

MODEL#	DIMENSIONS	FREIGHT CLASS	WT./LBS.	CUBIC FT.	LIST PRICE	HP ADD
	D x W x H					
AVB4848	4 x 48 x 48	70	135	9	\$1650	N/A

Includes white board and two side opening doors containing cork board on right door and 50-sheet paper writing pad on left door. Marker board can be used for projection.

• **NOTE:** Care should be taken to mount the units. Units should be mounted to wall studs using correct fasteners. Failure to do so may result in collapse of the unit and subsequent personal injury. Mounting hardware not included. Mounting hardware used should be based on wall material. Consult an installation professional for proper wall mounting.

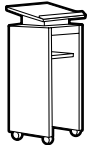

Lectern*

A1844LC	18 x 24 x 44	70	92	4.8	\$883	\$117
---------	--------------	----	----	-----	--------------	--------------

Features angled stand, storage shelf and casters. Shipped RTA (ready to assemble).

Required Specifications

Top finish
Base finish

Optional Specifications

HP laminate*



The **Genoa**® series combines the value of laminate furniture with the contemporary styling of top over end panel design. This versatile offering of components and wide selection of laminate finish options is the perfect complement to any office environment.

For added security of confidential material, all desks and credenzas are equipped with one locking pedestal. Genoa's kneespace credenza easily accommodates a computer, books, binders and files to maximize space.

Genoa features quality construction with the added strength of dovetailed box and file drawers. Fully progressive ball bearing suspensions ensure years of smooth, trouble-free drawer service.

Genoa's classic styling and simplicity integrate easily with existing furnishings and any interior decor. For new offices or current office expansions, Genoa is clearly the affordable and practical choice.

Features and Benefits

- 45lb. density particle board substructure with high performance thermally fused laminate
- Available bow front desk provides extra legroom and work area for visitors
- ¾ modesty panel is standard
- Most components shipped fully assembled, 1 per carton
- Pencil tray included in box drawer
- Box drawers mounted on ¾ extension steel ball bearings
- All drawers feature French dovetail joint in front and lapjoint in back
- Drawers open with side pull
- Compatible with **Divide** panel system for increased privacy and storage requirements

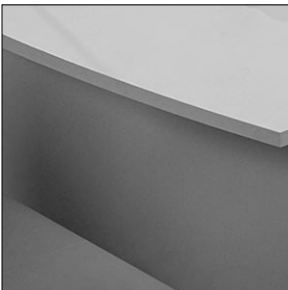

Bow front available on 36" x 72" desks



Contemporary top-over-end panel design



Drawer fronts are edge banded on all sides

GENERAL INFORMATION

- Constructed of 45 lb. density particle board with high performance thermally fused laminate
- Genoa components are compatible with **Divide** partitioning panels.
- Large offering of extended corners, full to floor pedestals, islands and storage options
- Double wall pedestal housing
- Genoa desk and storage products have been tested and comply with all BIFMA mechanical tests.
- For environmental certifications, please visit globalfurnituregroup.com

CONSTRUCTION

- 1" worksurfaces constructed of 45 lb. density particleboard with high performance thermally fused laminate
- Double wall pedestal housing
- Panel end style with top over side panel design
- 1" adjustable leveling glides standard on all units
- Standard with locks

MODESTY PANELS

- Recessed ¾ height modesty panel is standard. Full modesty panel available. **Add \$75.**
- All full to floor units, bridges and returns are standard with a full modesty panel

STORAGE

- All lateral file drawer fronts feature the woodgrain running in a horizontal direction
- Pencil tray included in box drawer
- All drawers feature French dovetail joint in front and lapjoint in back

FINISHES

LAMINATE FINISHES

ACJ Absolute Acajou	NBL Noce Biondo
ASN Asian Night	NGL Noce Grigio
AWC Avant Cherry	NEL Noce Leggero
AWH Avant Honey	NML Noce Medio
BLK Black	QTM Quartered Mahogany
BRC Brushed Cobalt	SOG Storm Grey
CMB Clear Maple	WHE Walnut Heights
DES Dark Espresso	WHC White Chocolate
DWT Designer White	WCR Winter Cherry

GROMMETS

- Grommets may be ordered on Genoa hutch back panel
- Additional grommets available in standard worksurface locations (left, center or right). Order as: **AG1, AG2 or AG3. Add \$96.**
- Grommet hole dimensions are 3 ¼" wide x 1 7/8" deep



- Actual grommet locations on the worksurface are depicted in the example drawings shown below. Dimensions shown are actual measurements (in inches).

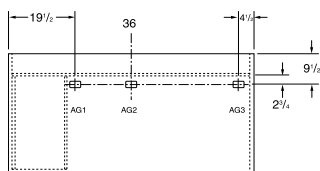

36 x 72 single pedestal left desks (3672SLP)

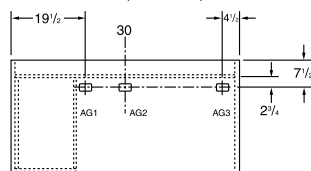

30 x 60 single pedestal left desks (3060SLP)

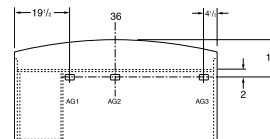

36 x 72 single pedestal left bow top desks (3672SLB)

- Grommets may be placed at non-standard locations. Order as: **AGS - Add \$96.** A drawing must be supplied with vertical and horizontal dimensions to the center of the cut-out (as in drawing above). Please refer to CUSTOM GROMMET LOCATION FORM in the back reference section.
 - Components that come standard with grommet may be ordered without a grommet. **Add \$53.**
 - Grommets are available on modesty panels of **5-sided corners** 6 ½" in where the two modesty panels meet at a 90° angle. Please specify **FOGMPL** for right grommet placement and **FOGMPR** for left grommet (placement is as shown on diagrams below). Cost is **\$96.**
- *Modesty Panels are 1" off of ground

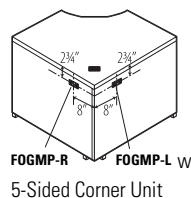

POWER BLOCK

- A Power Block (model **PMSPPDM**) may be ordered on all worksurfaces
- A Power Block is a rectangular worksurface power/data module with one electrical duplex receptacle and two data (RJ45) receptacles. 9 foot black cord included. Power Block dimensions are 3 ½" deep x 6 ½" wide x 2 ¾" high.
- To purchase a Power Block, you must specify both the Power Block cut-out location and the Power Block model #. Order Power Block as **PMSPPDM, Add \$330.** Power Blocks are available in standard worksurface locations (left, center or right). Order as **E1, E2 or E3. Add \$96.**

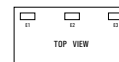

Power Block **PMSPPDM. Add \$330** Specify location **E1, E2 or E3. Add \$96.**

DOUBLE PEDESTAL DESKS

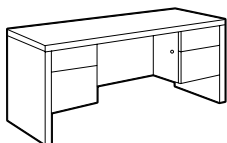

Double Pedestal Desk

MODEL#	DIMENSIONS D x W x H	FREIGHT CLASS	WT/LBS.	CUBIC FT.	LIST PRICE
G3672DP	36 x 72 x 29.4	150	286	50.5	\$1376
G3072DP	29.63 x 72 x 29	150	245	43.75	\$1341
G3066DP	29.69 x 66 x 29.4	150	235	39.25	\$1302
G3060DP	29.69 x 60 x 29.4	125	226	35.5	\$1092

Standard with box/file pedestals on both sides. Pedestals lock. One pencil tray.

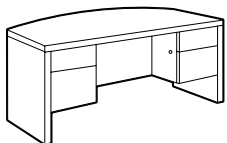

Double Pedestal Bow Top Desk

G3672DPB	32-36 x 72 x 29.4	150	256	50.5	\$1687
----------	-------------------	-----	-----	------	---------------

Standard with box/file pedestals on both sides and bow top. Pedestals lock. One pencil tray.

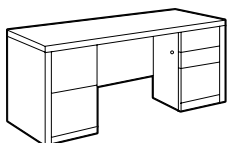

Full to Floor Double Pedestal Desk

G3072D4	29.69 x 72 x 29	125	277	43.75	\$1755
---------	-----------------	-----	-----	-------	---------------

Standard with full to floor box/box/file on right pedestal and file/file on left pedestal. Pedestals lock. One pencil tray.

SINGLE PEDESTAL DESKS

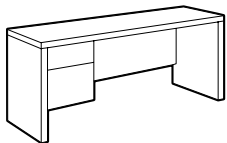

Single Pedestal Desk - LEFT

G3672SPL	36 x 72 x 29.4	150	235	50.5	\$1251
G3072SPL	30 x 72 x 29	150	192	43.75	\$1187
G3066SPL	29.69 x 66 x 29.4	150	192	39.25	\$1167
G3060SPL	29.69 x 60 x 29.4	150	183	35.5	\$965
G3048SPL	29.69 x 48 x 29.4	150	166	28.75	\$965
G2445SPL	24 x 45 x 29.4	150	137	23.5	\$754

Standard with box/file pedestal. Pedestal locks. One pencil tray. Pedestal is on the **left**.

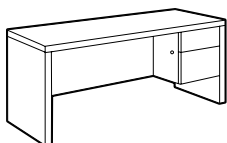

Single Pedestal Desk - RIGHT

G3672SPR	36 x 72 x 29.4	150	235	50.5	\$1251
G3072SPR	30 x 72 x 29	150	192	43.75	\$1187
G3066SPR	29.69 x 66 x 29.4	150	192	39.25	\$1167
G3060SPR	29.69 x 60 x 29.4	150	183	35.5	\$965
G3048SPR	29.69 x 48 x 29.4	150	166	28.75	\$965
G2445SPR	24 x 45 x 29.4	150	137	23.5	\$754

Standard with box/file pedestal. Pedestal locks. One pencil tray. Pedestal is on the **right**.

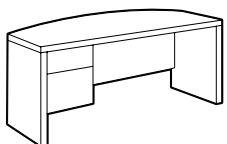

Single Pedestal Bow Top Desk - LEFT

G3672SLB	36-36 x 72 x 29	150	270	50	\$1544
----------	-----------------	-----	-----	----	---------------

Standard with box/file pedestal on **left** and bow top. Pedestal locks. One pencil tray.

Required Specifications

Finish

Optional Specifications

Full modesty
Grommet
Key #

Accessories

Power block
Keyboard tray
Pencil tray

SINGLE PEDESTAL DESKS

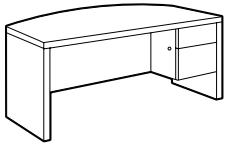

Single Pedestal Bow Top Desk - RIGHT

MODEL#	DIMENSIONS	FREIGHT CLASS	WT/LBS.	CUBIC FT.	LIST PRICE
--------	------------	---------------	---------	-----------	------------

D x W x H					
G3672SRB	36 x 72 x 29	150	270	50	\$1544

Standard with box/file pedestal on **right** and bow top. Pedestal locks. One pencil tray.

RETURNS

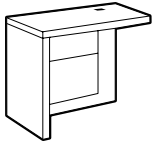

Typing Return - LEFT

G2448SDL	24 x 48 x 26	150	137	23.5	\$777
G2040SDL	20 x 40 x 26	125	111	17.5	\$754

Standard with box/file pedestal and lower **26" height**. Pedestal locks. Grommet in worksurface. Pedestal is on the **left**.

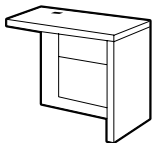

Typing Return - RIGHT

G2448SDR	24 x 48 x 26	150	137	23.5	\$777
G2040SDR	20 x 40 x 26	125	111	17.5	\$754

Standard with box/file pedestal and lower **26" height**. Pedestal locks. Grommet in worksurface. Pedestal is on the **right**.

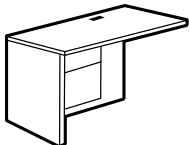

Flush Return - LEFT

G2454FL	24 x 54 x 29	150	127	27	\$943
G2448FL	24 x 48 x 29.4	125	142	23.5	\$837
G2442FL	24 x 42 x 29	150	111	21.5	\$807
G2054FL	20 x 54 x 29	150	114	23	\$943
G2048FL	20 x 48 x 29	150	107	20.5	\$837
G2042FL	20 x 42 x 29	150	100	18	\$807
G2040FL	20 x 40 x 29.4	125	115	17.5	\$796
G2036FL	20 x 36 x 29	125	93	15.5	\$796

Standard with box/file drawer pedestal. Pedestal locks. Grommet in worksurface. Pedestal is on the **left**.

- For 24" deep worksurfaces, order **G24__FL**. For 20" deep worksurfaces, order **G20__FL**.
- Keyboard and pencil trays for use on units 42" and above

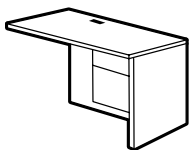

Flush Return - RIGHT

G2454FR	24 x 54 x 29	150	127	27	\$943
G2448FR	24 x 48 x 29.4	125	142	23.5	\$837
G2442FR	24 x 42 x 29	150	111	21.5	\$807
G2054FR	20 x 54 x 29	150	114	23	\$943
G2048FR	20 x 48 x 29	150	107	20.5	\$837
G2042FR	20 x 42 x 29	150	100	18	\$807
G2040FR	20 x 40 x 29.4	125	115	17.5	\$796
G2036FR	20 x 36 x 29	125	93	15.5	\$796

Standard with box/file drawer pedestal. Pedestal locks. Grommet in worksurface. Pedestal is on the **right**.

- For 24" deep worksurfaces, order **G24__FR**. For 20" deep worksurfaces, order **G20__FR**.
- Keyboard and pencil trays for use on units 42" and above

Required Specifications

Finish

Optional Specifications

Key #

Accessories

- Power block
- Keyboard tray
- Pencil tray

RETURNS

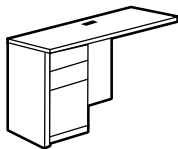

Full to Floor Flush Return - LEFT

MODEL#	DIMENSIONS D x W x H	FREIGHT CLASS	WT./LBS.	CUBIC FT.	LIST PRICE
G2448BL4	24 x 48 x 29.4	150	136	25	\$1215
G2442BL4	24 x 42 x 29.4	150	128	21.5	\$1199
G2436BL4	24 x 36 x 29.4	125	120	18	\$1174
G2048BL4	20 x 48 x 29	150	121	20.5	\$1183
G2042BL4	20 x 42 x 29	125	114	18	\$1154
G2036BL4	20 x 36 x 29	125	108	15.5	\$1133

Standard with box/box/file drawer pedestal. Lower box drawer and file drawer lock. Grommet in worksurface. Pedestal is on the **left**.

- For 24" deep worksurfaces, order **G24__BL4**. For 20" deep worksurfaces, order **G20__BL4**.
- Keyboard and pencil trays for use on units 42" and above

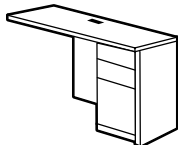

Full to Floor Flush Return - RIGHT

G2448BR4	24 x 48 x 29.4	150	136	25	\$1215
G2442BR4	24 x 42 x 29.4	150	128	21.5	\$1199
G2436BR4	24 x 36 x 29.4	125	120	18	\$1174
G2048BR4	20 x 48 x 29	150	121	20.5	\$1183
G2042BR4	20 x 42 x 29	125	114	18	\$1154
G2036BR4	20 x 36 x 29	125	108	15.5	\$1133

Standard with box/box/file drawer pedestal. Lower box drawer and file drawer lock. Grommet in worksurface. Pedestal is on the **right**.

- For 24" deep worksurfaces, order **G24__BR4**. For 20" deep worksurfaces, order **G20__BR4**.
- Keyboard and pencil trays for use on units 42" and above

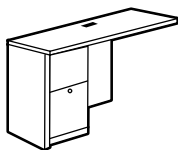

Full to Floor Flush Return - LEFT

G2448L4	24 x 48 x 29.4	150	132	25	\$1251
G2442L4	24 x 42 x 29.4	150	124	21.5	\$1227
G2436L4	24 x 36 x 29.4	125	116	18	\$1207
G2048L4	20 x 48 x 29	150	118	20.5	\$1215
G2042L4	20 x 42 x 29	125	111	18	\$1183
G2036L4	20 x 36 x 29	125	104	15.5	\$1167

Standard with file/file drawer pedestal. Pedestal locks. Grommet in worksurface. Pedestal is on the **left**.

- For 24" deep worksurfaces, order **G24__L4**. For 20" deep worksurfaces, order **G20__L4**.
- Keyboard and pencil trays for use on units 42" and above

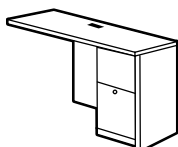

Full to Floor Flush Return - RIGHT

G2448R4	24 x 48 x 29.4	150	132	25	\$1251
G2442R4	24 x 42 x 29.4	150	124	21.5	\$1227
G2436R4	24 x 36 x 29.4	125	116	18	\$1207
G2048R4	20 x 48 x 29	150	118	20.5	\$1215
G2042R4	20 x 42 x 29	125	111	18	\$1183
G2036R4	20 x 36 x 29	125	104	15.5	\$1167

Standard with file/file drawer pedestal. Pedestal locks. Grommet in worksurface. Pedestal is on the **right**.

- For 24" deep worksurfaces, order **G24__R4**. For 20" deep worksurfaces, order **G20__R4**.
- Keyboard and pencil trays for use on units 42" and above

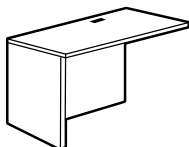

Flush Return - LEFT

G2454EL	24 x 54 x 29	70	87	5.25	\$777
G2448EL	24 x 48 x 29	70	96	4.5	\$672
G2442EL	24 x 42 x 29	70	71	3.8	\$672
G2054EL	20 x 54 x 29	85	78	5.25	\$737
G2048EL	20 x 48 x 29	70	70	4.2	\$693
G2042EL	20 x 42 x 29	70	56	3.3	\$672
G2040EL	20 x 40 x 29	70	78	4.5	\$648
G2036EL	20 x 36 x 29	70	56	3.3	\$648

Return has no pedestal. Grommet in worksurface. Shipped RTA (ready to assemble).

- For 24" deep worksurfaces, order **G24__EL**. For 20" deep worksurfaces, order **G20__EL**.

Required Specifications

Finish

Optional Specifications

Additional grommet
Key #

Accessories

Power block
Keyboard tray
Pencil tray

RETURNS

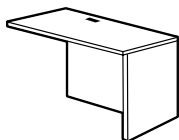

Flush Return - RIGHT

MODEL# DIMENSIONS FREIGHT CLASS WT/LBS. CUBIC FT. LIST PRICE

	D x W x H				
G2454ER	24 x 54 x 29	70	87	5.25	\$777
G2448ER	24 x 48 x 29	70	96	4.5	\$672
G2442ER	24 x 42 x 29	70	71	3.8	\$672
G2054ER	20 x 54 x 29	85	78	5.25	\$737
G2048ER	20 x 48 x 29	70	70	4.2	\$693
G2042ER	20 x 42 x 29	70	63	3.8	\$672
G2040ER	20 x 40 x 29	70	78	4.5	\$648
G2036ER	20 x 36 x 29	70	56	3.3	\$648

Return has no pedestal. Grommet in worksurface. Shipped RTA (ready to assemble).

- For 24" deep worksurfaces, order **G24__ER**. For 20" deep worksurfaces, order **G20__ER**.

FLUSH BRIDGE

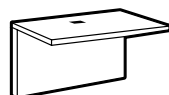

Flush Bridge

G2448FB	24 x 48 x 29.4	70	78	3.5	\$511
G2442FB	24 x 42 x 29	70	65	3.06	\$494
G2436FB	24 x 36 x 29.4	70	58	3.5	\$492
G2048FB	20 x 48 x 29	70	71	3.3	\$511
G2042FB	20 x 42 x 29	70	61	4	\$494

Top surface, back panel and hardware to connect two units. Grommet in worksurface. Shipped RTA (ready to assemble).

- **G2448/G2442** models will connect 66" and 72" units plus all D islands.
- **G2048/G2042** models will connect 60", 66" and 72" units plus all D islands and 5 sided corners.

CREDENZAS



Center Storage Credenza*

G2066C	20 x 66 x 29	100	225	27	\$1492
--------	--------------	-----	-----	----	---------------

Standard with box/file pedestals on both sides and self-closing hinged center doors covering one adjustable shelf. Right pedestal and doors lock. One pencil tray.

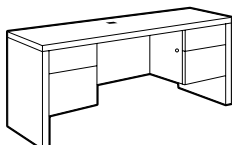

Kneespace Credenza*

G2072CK	20 x 72 x 29.4	125	209	29.5	\$1376
G2066CK	20 x 66 x 29.4	125	201	27	\$1302
G2060CK	20 x 60 x 29	125	193	24.5	\$1207

Standard with box/file pedestals on both sides. Center is open. Pedestals lock. One pencil tray. Grommet in worksurface.

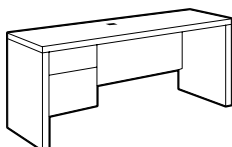

Single Pedestal Credenza - LEFT*

G2072CSL	20 x 72 x 29.4	150	171	29.5	\$1167
G2066CSL	20 x 66 x 29	150	163	27.75	\$1144
G2060CSL	20 x 60 x 29	125	155	24.5	\$1007

Standard with box/file pedestal. Pedestal locks. One pencil tray. Pedestal is on the **left**. Grommet in worksurface.

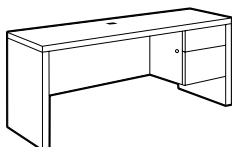

Single Pedestal Credenza - RIGHT*

G2072CSR	20 x 72 x 29.4	150	150	29.5	\$1167
G2066CSR	20 x 66 x 29	150	150	29.4	\$1144
G2060CSR	20 x 60 x 29	150	136	24.5	\$1007

Standard with box/file pedestal. Pedestal locks. One pencil tray. Pedestal is on the **right**. Grommet in worksurface.

Required Specifications

Finish

Optional Specifications

Full modesty*
Grommet
Key #

Accessories

Power block
Keyboard tray
Pencil tray

5-SIDE CORNERS

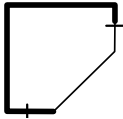
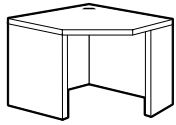

5-Sided Corner

MODEL#	DIMENSIONS D x W x H	FREIGHT CLASS	WT/LBS.	CUBIC FT.	LIST PRICE
G42205C9	20 x 42 x 29	70	123	5.75	\$1048
G36205C9	20 x 36 x 29	65	105	4.3	\$889

Connects to lateral file, storage cabinet, single pedestal credenza with half end panel, and flush bridge. Grommet in worksurface. Full and narrow end panels supplied. Can be assembled left or right. Shipped RTA (ready to assemble)

- ¾ Modesty Panel is not available

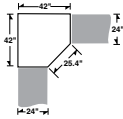
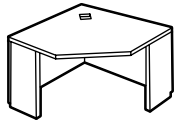

5-Sided Corner

G42245C	42 x 42 x 29.4	65	114	5	\$1063
---------	----------------	----	-----	---	---------------

Connects to **24"** returns, bridges and other **24"** units. Grommet in worksurface. Narrow end panels on left and right. Shipped RTA (ready to assemble).

- ¾ Modesty Panel is not available

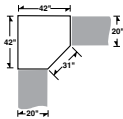
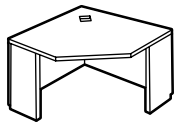

5-Sided Corner

G42205C	42 x 42 x 29.4	70	108	5	\$1030
G36205C	36 x 36 x 29.4	70	92	4.75	\$912

Connects to **20"** returns, bridges and other **20"** units. Grommet in worksurface. Narrow end panels on left and right. Shipped RTA (ready to assemble).

- ¾ Modesty Panel is not available

"D" ISLANDS

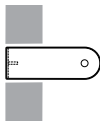
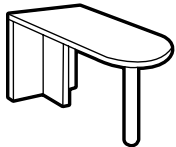

"D" Island - Full End Panel & Post

G3072FI	29.69 x 72 x 29.4	70	101	5	\$1016
G3066FI	29.69 x 66 x 29.4	70	96	4.6	\$996
G3060FI	29.69 x 60 x 29.4	70	91	4.2	\$925

Connects to single pedestal credenza with half end panel or bridge to create a "T" grouping. **Not freestanding.** Connecting hardware for flush installation included. Shipped RTA (ready to assemble). Post is Black only.

Required Specifications
Finish

Optional Specifications
Grommet

Accessories
Power Block
Keyboard Tray
Pencil Tray
Doors*

HUTCHES

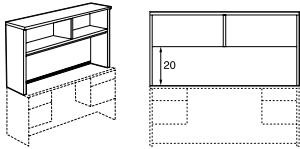

Open Hutch with Closed Back*

MODEL# DIMENSIONS FREIGHT CLASS WT./LBS. CUBIC FT. LIST PRICE

D x W x H

G72HOCB	15 x 72 x 36	70	138	7	\$1167
G71HOCB	15 x 71.5 x 36	70	137	7	\$1167
G69HOCB	15 x 69 x 36	70	135	7	\$1167
G66HOCB	15 x 66 x 36	70	133	7	\$1120
G60HOCB	15 x 60 x 36	65	123	5.25	\$1007

One 1" thick fixed shelf **and fixed shelf divider**. Closed back features a flexible sweep for wire management. Available in single color only. Rectangular grommet available on back panel - **Add \$96**. Shipped RTA (ready to assemble).

- **G71HOCB** for use when spanning 30" x 60/66" SPL/R and 20/24" x 42" FL/FR/L4/R4.
- **G69HOCB** for use when spanning 30" x 60/66" SPL/R and 20" x 40" FL/FR/EL/ER.
- Clearance from worksurface to hutch doors is 20".
- Woodgrain runs horizontal on both the upper and lower back panels.

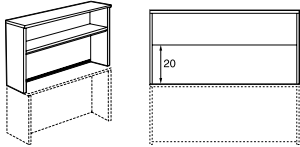

Open Hutch with Closed Back*

G48HOCB	15 x 48 x 36	65	100	4.2	\$807
G42HOCB	15 x 42 x 36	65	91	3.8	\$807
G40HOCB	15 x 40 x 36	65	88	3.8	\$807
G36HOCB	15 x 36 x 36	65	82	3.3	\$712

One 1" thick fixed shelf. Closed back features a flexible sweep for wire management. Available in single color only. Rectangular grommet available on back panel - **Add \$96**. Shipped RTA (ready to assemble).

- Clearance from worksurface to hutch doors is 20".
- Woodgrain runs horizontal on both the upper and lower back panels.

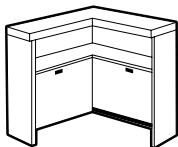

Corner Hutch with Closed Back*

G4242CH	15 x 42 x 36	70	137	6.25	\$1284
G3636CH	15 x 36 x 36	65	119	4.8	\$1167

One 1" thick fixed shelf. Closed back features a flexible sweep for wire management on lower right panel. Available in single color only. Rectangular grommet available on back panel - **Add \$96**. Shipped RTA (ready to assemble).

- Woodgrain runs horizontal on both the upper and lower back panels.

PIGEON HOLE STORAGE

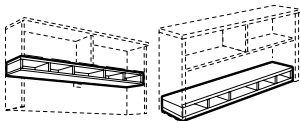

Horizontal Pigeon-Hole Storage

AHS72	11.25 x 70 x 5.62	85	41	3	\$698
AHS71	11.25 x 69 x 5.62	70	43.5	2.3	\$698
AHS66	11.25 x 64 x 5.62	85	38	2.8	\$698
AHS60	11.25 x 58 x 5.62	85	35	2.5	\$572
AHS48	11.25 x 46 x 5.62	85	28	2	\$423
AHS42	11.25 x 40 x 5.62	85	24	2	\$423
AHS36	11.25 x 34 x 5.62	92.5	22	2	\$346

For additional storage. Can be **top** or **bottom** mounted. For use inside **straight hutch** (end panels not finished). Shipped RTA (ready to assemble). **Black finish only**.

- Cannot be used on A00S and C00S Overstorage Units.

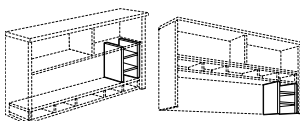

Vertical Pigeon-Hole Storage

AVS14	11.25 x 13.37 x 14.37	85	13	.90	\$436
-------	-----------------------	----	----	-----	--------------

For use in conjunction with the Horizontal Pigeon-Hole Storage. Can be used **under** or **over** horizontal unit. Shipped RTA (ready to assemble). **Black finish only**.

Required Specifications

Finish

Accessories

Doors*

HUTCH DOORS

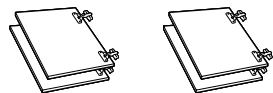

Four-Door Kit

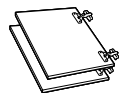

Two-Door Kit

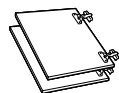

Corner Hutch Two-Door Kit

MODEL#	DIMENSIONS D x W x H	FREIGHT CLASS	WT/LBS.	CUBIC FT.	LIST PRICE
GDOOR72	.69 x 72 x 15	85	24	1.75	\$429
GDOOR71	0 x 17.5 x 15	85	24	1.75	\$429
GDOOR69	0 x 17 x 15	85	23	1.75	\$429
GDOOR66	.69 x 66 x 15	85	22	1.75	\$429
GDOOR60	.69 x 60 x 15	92.5	20	1.75	\$429

For use on 72", 71", 69", 66" and 60"W straight hutches. Hinges included. Locks available. Add **\$126** for each lock. Doors for units 60" wide or more require two locks.

GDOOR48	.69 x 48 x 15	100	17	1.75	\$270
GDOOR42	.69 x 42 x 15	100	16	1.75	\$270
GDOOR40	.69 x 40 x 15	100	15	1.75	\$270
GDOOR36	.69 x 36 x 15	100	14	1.75	\$270

For use on 48", 42" 40" and 36"W straight hutches. Hinges included. Locks available. Add **\$126** for each lock. Doors for units 48" wide or less require one lock.

GDOOR42C	0 x 26.5 x 15	92.5	19	1.75	\$461
GDOOR36C	0 x 21.5 x 15	100	16	1.75	\$300

For use on 42" and 36"W corner hutches. Hinges included. **Locks not available on corner hutch doors.**

TACKBOARDS FOR HUTCHES

TACKBOARD Notes: Tackboards can be upholstered in all of the following fabrics:

Grade 1: Jenny, Quilt, Terrace, Urban, Waterfall

Grade 2: Imprint, Lola

Grade 3: Anchorage, Merge

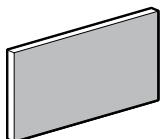

Tackboard

					FABRIC GRADE	LIST PRICE
TB7018	1 x 70 x 18	92.5	12	1.1	1	\$536
					2	\$621
					3	\$683
					4	\$782
					5	\$898

For use on **G72HOCB** straight hutch. Includes mounting screws and covers.

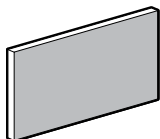

Tackboard

TB6918	1 x 69.5 x 18	92.5	12	1.05	1	\$536
					2	\$621
					3	\$683
					4	\$782
					5	\$898

For use on **G71HOCB** straight hutch. Includes mounting screws and covers.

Required Specifications

Fabric (Tackboards)

TACKBOARDS

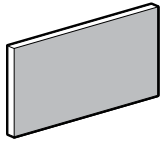

Tackboard

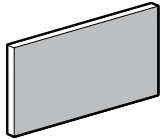

Tackboard

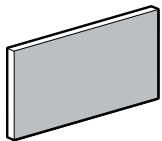

Tackboard

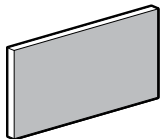

Tackboard

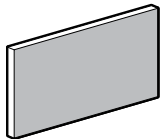

Tackboard

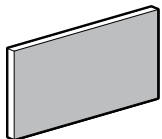

Tackboard

MODEL#	DIMENSIONS	FREIGHT CLASS	WT./LBS.	CUBIC FT.	FABRIC GRADE	LIST PRICE
--------	------------	---------------	----------	-----------	--------------	------------

D x W x H

TB6718	1 x 67.5 x 18	92.5	12	1.05	1	\$536
					2	\$621
					3	\$683
					4	\$782
					5	\$898

For use on **G69HOCB** straight hutch. Includes mounting screws and covers.

TB6418	1 x 64 x 18	92.5	11	1	1	\$482
					2	\$556
					3	\$617
					4	\$704
					5	\$811

For use on **G66HOCB** straight hutch. Includes mounting screws and covers.

TB5818	1 x 58 x 18	92.5	10	0.9	1	\$445
					2	\$512
					3	\$568
					4	\$643
					5	\$740

For use on **G60HOCB** straight hutch. Includes mounting screws and covers.

TB4618	1 x 46 x 18	92.5	9	0.8	1	\$307
					2	\$367
					3	\$412
					4	\$474
					5	\$545

For use on **G48HOCB** straight hutch. Includes mounting screws and covers.

TB4018	1 x 40 x 18	92.5	8	0.7	1	\$297
					2	\$345
					3	\$384
					4	\$439
					5	\$506

For use on **G42HOCB** straight hutch. Includes mounting screws and covers.

TB3818	1 x 38 x 18	92.5	7	0.7	1	\$297
					2	\$344
					3	\$382
					4	\$436
					5	\$503

For use on **G40HOCB** straight hutch. Includes mounting screws and covers.

Required Specifications

Fabric

TACKBOARDS

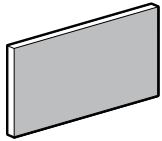

Tackboard

MODEL#	DIMENSIONS D x W x H	FREIGHT CLASS	WT./LBS.	CUBIC FT.	FABRIC GRADE	LIST PRICE
TB3418	1 x 34 x 18	92.5	6	0.6	1	\$287
					2	\$333
					3	\$372
					4	\$425
					5	\$486

For use on **G36HOCB** straight hutch. Includes mounting screws and covers.

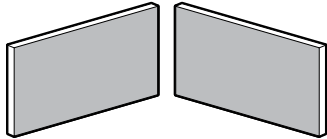

Tackboard

TB42CH	1 x 40 x 15.75	70	16	0.85	1	\$536
					2	\$590
					3	\$639
					4	\$703
					5	\$809

For use on **G4242CH corner** hutch. Includes mounting screws and covers.

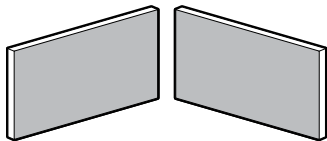

Tackboard

TB36CH	1 x 34 x 15.25	85	12	0.85	1	\$513
					2	\$566
					3	\$602
					4	\$675
					5	\$777

For use on **G3636CH** corner hutch. Includes mounting screws and covers.

ACCESSORY PIECES

LIST PRICE



2 Drawer Lateral File*

G2036LF	20 x 36 x 29.4	100	145	15	\$1167
---------	----------------	-----	-----	----	---------------

Two full suspension drawers. Front-to-back and side-to-side letter/legal filing capability with lock. Anti-lock tilt suspension.

- To comply with ANSI/BIFMA stability tests, the Lateral File Counter Weight Kit (model "LFCWKIT36") MUST be used.
- *Back of file is always Black.*
- *File drawer construction is for accommodating hanging files NOT for stacking materials on the drawer bottom.*

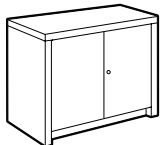

Storage Cabinet*

G2036SC	20 x 36 x 29.4	100	121	15	\$830
---------	----------------	-----	-----	----	--------------

Hinged doors cover one adjustable shelf. Standard with lock.

- *Back of storage cabinet is always Black.*

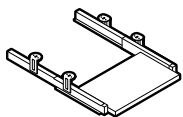

Pull-Out Keyboard

GPOKL28	17 x 28 x 3.5	85	13	0.9	\$300
GPOKL22	17 x 22 x 3.5	85	11	0.9	\$283

Constructed of thermally fused laminate.

Required Specifications

Fabric (tackboards)
Finish (accessories)

Optional Specifications

Key #*
Grommet (only G2036LF)

ACCESSORIES

MODEL# DIMENSIONS FREIGHT CLASS WT/LBS. CUBIC FT. LIST PRICE

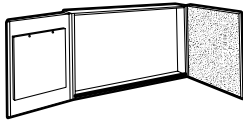

Visual Board

MODEL#	DIMENSIONS	FREIGHT CLASS	WT/LBS.	CUBIC FT.	LIST PRICE
GVB4848	D x W x H 4 x 48 x 48	85	122	9.25	\$1695

Includes white board and two side opening doors containing cork board on right door and 50-sheet paper writing pad on left door. Marker board can be used for projection.

• **NOTE:** Care should be taken to mount the units. Units should be mounted to wall studs using correct fasteners. Failure to do so may result in collapse of the unit and subsequent personal injury. **Mounting hardware not included.** Mounting hardware used should be based on wall material. Consult an installation professional for proper wall mounting.

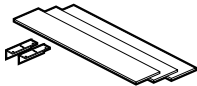

Counter Weight Kit

LFCWKIT36	6 x 33 x 1	60	40	0.25	\$754
-----------	------------	----	----	------	--------------

3 metal plates. Plates mount to the underside of any 36" wide Lateral File or Mixed Storage/Drawer cabinet. Includes mounting hardware. Must be ordered separately. Field installed.

• To comply with ANSI/BIFMA stability tests, the Lateral File Counter Weight Kit MUST be used with the appropriate Lateral Files and Mixed Storage Cabinets.

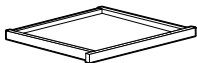

Center Drawer

CD20	18 x 20 x 3	100	8	1	\$214
------	-------------	-----	---	---	--------------

Laminate drawer front is attached to a 4-sided frame. Recommended for use on small L-shaped units, and on 30" x 60" and 66" desks.

Required Specifications

Finish (bookcases)

BOOKCASES

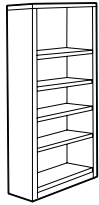

Bookcase - 84" High

MODEL#	DIMENSIONS D x W x H	FREIGHT CLASS	WT/LBS.	CUBIC FT.	LIST PRICE
GHBC84	12 x 36 x 84	125	198	26	\$1466

One fixed heavy duty shelf and **four adjustable shelves**. Shipped fully assembled.

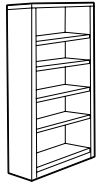

Bookcase - 72" High

GHBC72	12 x 36 x 72	100	173	20	\$1223
--------	--------------	-----	-----	----	---------------

One fixed heavy duty shelf and **four adjustable shelves**. Shipped fully assembled.

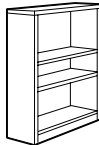

Bookcase - 48½" High

GHBC48	12 x 36 x 48	100	118	13.7	\$899
--------	--------------	-----	-----	------	--------------

Two adjustable heavy duty shelves. Shipped fully assembled.

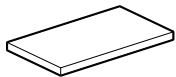

Bookcase Shelf

GHBCSHELF	11 x 34 x 1	100	13	1.60	\$276
-----------	-------------	-----	----	------	--------------

Extra shelf for bookcases. 1" thick.

Required Specifications

Finish



The design of Princeton reflects the personality of today's young, dynamic workforce. The freestanding, modular components build out from you and where you work. With over 500 available components, Princeton offers a flexible footprint that's simple to reconfigure. A variety of storage options allows you to do more with less space.

Princeton delivers contemporary design to the workplace; whether it be in Commercial and Corporate offices, Government offices, Small Businesses, Banking, Legal, Accounting, Hospitality or the professional home office. Every element, from the mix of materials and finishes to open storage pieces, floating modesties and overlapping surfaces, has been designed to provide visual appeal and intelligent function. Princeton is a freestanding and fully modular collection offering maximum flexibility; ease of installation and facilitates simple reconfigurations. The overlapping worksurface design also allows the footprint to adapt to smaller spaces by just a few inches.

Features and Benefits

- 1" thick worksurfaces in thermally fused or high pressure laminate
- Worksurfaces feature Global's preferred edging in matching color
- Counterweights standard on all mobile pedestals, lateral files and credenzas
- Handles & pulls in satin anodized finish standard on all credenza, pedestal drawers and cabinet doors
- Monoposts and hutch supports standard in tungsten finish
- Benches double as lateral filing
- Pull-out equipment shelves on select credenzas
- Energy efficient LED lighting for overhead storage cabinets
- Grommets and power blocks to accommodate power/data needs
- Choose glass or fabric equipment screens



Bench doubles as lateral filing



Pull out equipment shelf (printer not included)



Bookshelf with accessory hook

GENERAL INFORMATION

- Over 500 components are available
- No cubicles or panels needed for configurations
- Product can be added and reconfigured as needed
- Princeton desk and storage products have been tested and comply with all BIFMA mechanical tests.
- For environmental certifications, please visit globalfurnituregroup.com.

WORKSURFACES

- 1" thick high performance thermally fused laminate tops sealed with Global's preferred edge detail in matching color
- High Pressure Tops are available in all Princeton laminate finishes at an extended lead time. Please see model # for pricing and availability
- Products specified with the high pressure laminate option are finished on the underside of the surface with a kraft paper backing.
- Worksurfaces with metal legs which have a span of 54" and over are standard with metal support channel. Support channels come in Black (BLK) only. 24"D and 30"D - 1 - 2"H support channel 36"D - 2 - 2"H support channels

CONSTRUCTION

- Laminate end panel and metal leg products are **not intended** to be combined for the most visually compatible design. They are, however, interchangeable if required.
- All components have Global's preferred matching edge
- Leveling glides are standard on all floor units.
- End panels are 1.5" thick on laminate end panel desks and credenzas. Cabinet end panels are 11/16" thick.
- 1" x 2" metal frame legs finished in Tungsten (TTU), Black (TBL) or Designer White (TDW) for desks and returns (closed 'O' style leg)
- 1" x 2.5" metal frame legs finished in Tungsten (TTU), Black (TBL) or Designer White (TDW) for freestanding tables (open 'U' style leg)
- Constructed of 45 lb. density particleboard with high performance thermally fused laminate.
- Mobile pedestals and mobile lateral files come standard with front locking casters
- Counterweights are standard on all pedestals, lateral files, credenzas and cabinets
- Rolling table come standard with non-locking casters
- Laminate shelves are 11/16" thick and edged on all 4 sides.
- Tempered glass is 6mm thick with satin-etched finish on one side.
- Credenzas come standard with file bars for side-to-side and front-to-back letter and legal filing capability.
- Handles and pulls in satin anodized finish are standard on all credenza, pedestal drawers and cabinet doors.
- Pull-out equipment shelves are available on select credenzas.
- Grommets and power blocks are available to accommodate power/data needs.

EDGE DETAILS

- All worksurfaces and components have Global's preferred matching edge detail on all sides
- Edging cannot be specified separately. No substitutions.

STORAGE

- Mobile storage greater than 25.5"H may only be used with 29"H Princeton products with laminate end panels or gables. Princeton products with **metal legs** will not accommodate anything higher than 25.5".
- Roll-out shelf on credenza holds up to 80 lbs
- All cabinets with side open shelf area that aligns with 29"H or 27"H credenzas - fixed shelf is 1" thick
- Recycling/waste drawer accommodates 1 recycling basket and 1 waste basket

LAMINATE MODESTY PANELS

- Standard on all desks with laminate end panels, returns with laminate end panels and bridges for laminate end panel desks.
- Flush on Freestanding Returns with laminate end panels
- Recessed 4"D on 24"D desks with laminate end panels, 5"D on 30"D desks with laminate end panels and 6"D on 36"D desks with laminate end panels.
- Recessed 4"D on 24"D, 5"D on 30"D, and 6"D on 36"D flush and overlapping returns with laminate end panels.
- Recessed 4" on 24"D and 5"D on 30"D flush and overlapping bridges with laminate end panels.
- Desks and returns feature modesty panel that is flush with end panel
- Bottom of laminate modesty panel is 17 3/4" from floor.

GLASS DESKTOP PANELS

- Glass desktop panel is sold separately. See selection on page 77.
- Available for installation onto desks, returns, bridges and conference tops
- Made of 6mm tempered glass with satin-etched finish on one side
- On-site installation is required. Installation instructions will be provided.

FABRIC DESKTOP/MODESTY PANELS

- Fabric desktop/fabric modesty panels are sold separately. See selection on page 77.
- Available in:
 - Grade 2:** Lola
 - Grade 3:** Anchorage, Merge
- On-site installation is required. Installation instructions included with product.
- Non-tackable
- Bottom of fabric modesty panel is 15.5" from floor

CREDENZAS

- Available in 29", 27" and 23" heights
- 29"H connect to flush returns, flush conference tops and flush bridges
- 27"H connect to overlapping returns, overlapping conference tops and overlapping bridges
- Fixed drawer widths - see individual models for details
- Upper adjustable shelf must be removed when products with laminate modesty panels are installed (i.e. PN2448RFR flush return with laminate end panel or PN2436BF flush bridge for laminate end panel desk)
- Connection of flush or overlapping surfaces to credenzas is only possible over full height opening
- All credenza tops are 1" thick
- Grommet location is 2.5" from the back edge to the cut out edge

LOCKS

- Standard on all credenzas, storage cabinets, lateral files, pedestals & benches
- Lock on all credenzas, cabinets and pedestals is always on the bottom drawer
- All components within a workstation or private office can be keyed alike. For up to 40 key numbers, the lead times are standard. For projects larger than 40 offices, additional lock numbers are available. Delivery will be extended an additional week at no upcharge.
- To order specified keying, tag each component of each workstation or office with a lock number between 401 and 440.
- Storage cabinets and pedestal with box/box/file drawer - only five drawer and lower box drawer are locking. Credenza file drawer lock secures both drawers.
- Key alike or specific key number optional for all products with locks
- Reserved for new orders greater than \$20,000 list, all Princeton units with locks may be ordered with **CA** cap option and specific lock cores/keys can be ordered separately for field installation rather than specifying duplicate product lines with different key numbers.
- When **CA** option is specified, product will ship with a cap over the empty lock housing.
- Separately order the appropriate number of cores with keys; use product code **SIL-CORE-H-SHOE** for Silver core/key sets. Specify quantity and lock number required. One order line per key number required. Key number range: 401-440. **Must be ordered at the same time product is ordered with CA lock cap option specified.**
- One core removal key is required. Recommend one core removal for every 25 cores ordered. Order as **REMOVE-K-H-SHOE**.
- No charge applies for separate lock cores or core removal keys only when ordered with product. If replacement lock core and key required, contact Customer Care for applicable product code and pricing.

HUTCHES & OVERHEAD STORAGE

- Available in 60", 72" and 84" widths
- Hutches with full back feature one small hole in each corner for wire pass through
- 15.75" height clearance between worksurface and underside of hutch
- Overhead Storage Cabinets have full width lower storage with center divider
- Hutches feature 1" x 2" steel support frame in Black (**TBL**), Designer White (**TDW**) or Tungsten (**TTU**).
- Laminate and tempered glass sliding doors available
- Hutches cannot be placed on desks with laminate end panels
- Wall hung mounting rails are provided; wall fastener hardware is not included.
- Locks are not available
- Energy efficient LED lighting available (page 106)

TABLES

- 1" x 2.5" open metal frame leg. Available finish options: Black (**TBL**), Designer White (**TDW**) or Tungsten (**TTU**).
- Standard with 1" thick top and Global's preferred edging in matching color
- 120" and 144" wide table tops with center leg are shipped in two pieces
- Tables which have a span of 54" or wider are standard with 2"H metal support channel(s)
- Grommets and power block cutouts are available for most tables. Due to support channel location(s) for all 29" high tables, quote request required. Contact our Specials Department.
- Available standard with levelers or locking casters.
- Locking casters available in grey finish only.
- Casters prevent tables from sitting flush against each other, vertically or horizontally

KEYBOARDS

- Keyboard tray adapter kits are required to accommodate worksurface support channels on the following: freestanding desks with metal legs, returns with metal legs, bridges for desks and returns with metal legs, and returns with bookshelf.

TACKBOARDS

- Tackboards available for hutches and overhead units.
- Available to fit 60", 72" and 84" widths
- Available in:
 - Grade 1:** Jenny, Quilt, Terrace, Urban, Waterfall
 - Grade 2:** Imprint, Lola
 - Grade 3:** Anchorage, Merge
- Contact customer care for COM selection.

CUSHIONS

- Sold separately.
- Cushions available in all Global seating fabrics. Contact customer care for COM selection and procedure.

CONNECTION

- Metal flat plates and wood screws are provided for connection between two units.

SPECIAL SIZES

- Custom widths, depths and heights are available, but require a custom quote. Please contact Customer Care for more information.
- Custom orders must indicate the "custom quote number" and list price as provided by Customer Care.
- Changes to a custom quote are not permissible. Any revisions will necessitate a new quotation.

TASK LIGHTS

- Optional, energy efficient LED task lights (ultra slim design) are available for mounting under hutches and overheads
- Hutches and overhead storage cabinets are pre-drilled for easy installation
- Available in 12", 20" and 40" widths

WIRE MANAGEMENT

- 2"W x 2"H
- Plastic tray flexes to receive and hold electrical and data wires
- Quickly attaches with double-sided tape (included)

MONOPOST

- Standard support for conference tops; support for select desks and returns
- 4" square post with 10" square base

PLANTERS

- Plastic planter pots provided
- 8½" diameter x 8"H
- Available in Black (**BK**) or White (**WT**). Must specify at time of order.

SHIPPING

- Items are shipped R.T.A. (Ready To Assemble) unless otherwise noted
- Shipped in 1 carton unless otherwise noted
- Connecting hardware included

1. SPECIFY MODEL NUMBER

2. SPECIFY FINISHES

Laminate Finishes

Top/base/door, drawer and cabinet fronts:

ACJ	Absolute Acajou
ASN	Asian Night
AWC	Avant Cherry
AWH	Avant Honey
BLK	Black
BZD	Blizzard
BRC	Brushed Cobalt
CMB	Clear Maple
CGY	Custom Grey
DES	Dark Espresso
DWT	Designer White
FAS	Fashionista
FCL	First Class
NBL	Noce Biondo
NGL	Noce Grigio
NEL	Noce Leggero
NML	Noce Medio
QTM	Quartered Mahogany
SBY	Sheer Beauty
SDT	Stonedust
WHE	Walnut Heights
WCR	Winter Cherry
WHC	White Chocolate

Monopost Finishes

4" square monopost is available in Tungsten (TTU), Black (TBL) or Designer White (TDW)

Planters

Planter pots are standard in white. Available in Black (BK) at no upcharge. Must specify at time of order.

Metal Frame Desk Legs

1" x 2" metal frame legs are available in Tungsten (TTU), Black (TBL) or Designer White (TDW)

Metal Frame Table Legs

1" x 2.5" metal frame legs are available in Tungsten (TTU), Black (TBL) or Designer White (TDW)

Metal Hutch Supports

1" x 2" metal supports are available in Tungsten (TTU), Black (TBL) or Designer White (TDW)

For detailed finish specification guidelines, please download the **Princeton Design Guide** at www.globalfurnituregroup.com

3. SPECIFY OPTIONS

GROMMETS

- One grommet in satin anodized finish is standard on many components, as specified
- Additional grommets may be available in other standard worksurface locations (left, center or right)
- Order as: **Left POG1, Center POG2 or Right POG3: Add \$96**

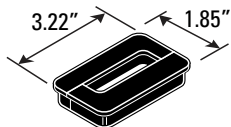

- Worksurface Grommet hole dimensions are 3.22" W x 1.85"D
- Standard grommet position is POG2 in desks, returns, bridges and conference tops
- Modesty panel pass through hole dimensions are 3.43"W x 2"H
- Grommets may be placed at non-standard locations. Order as **PCSG - Add \$96**. A drawing must be supplied with vertical and horizontal dimensions to the center of the cut-out (as in drawing above)
- Components that come standard with grommet may be ordered without a grommet. Order as **RSG - Add \$53**.
- Grommet only available at POG2 on the following 48"W worksurfaces:
 - Desks: PN2448DK, PN3048DK, PN3648DK
 - Returns, flush: PN2448RFR, PN2448RFL

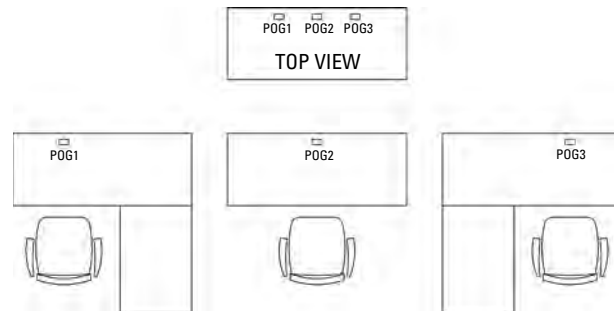

POWER BLOCK

- Power Block (model **PGDPS20**) with 1 power outlet, 12 foot long power cord, for mounting under worksurfaces or inside of laminate end panels
- Power Block (model **PGDPS21**) with 2 power outlets and 1 data opening, 12 foot long power cord, for mounting under worksurfaces or inside of laminate end panels
- Power Bar (model **PGDPS41**) with 4 power outlets and 1 data opening, 12 foot long power cord, for mounting behind credenza pull-out shelf or at back of credenza opening
- Rectangular shape. Finished in Tungsten (TUN)
- Power Block dimensions:
 - PGDPS20: 2.5"D x 3.5"W x 2.25"H
 - PGDPS21: 2.5"D x 6.75"W x 2.25"H
- Power Bar dimensions:
 - PGDPS41: 2.5"D x 10.25"W x 2.22"H

FREESTANDING DESKS - LAMINATE END PANELS **MODEL#** **DIMENSIONS** **FREIGHT CLASS** **WT/LBS.** **CUBIC FT.** **LIST PRICE** **HP ADD**

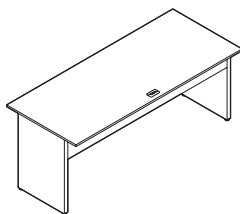

Freestanding Desk

D x W x H							
PN2484DK	24 x 84 x 29	65	117	5	\$1033	\$120	
PN2478DK	24 x 78 x 29	70	111	5	\$1003	\$119	
PN2472DK	24 x 72 x 29	70	105	5	\$963	\$118	
PN2466DK	24 x 66 x 29	65	101	4	\$951	\$118	
PN2460DK	24 x 60 x 29	65	95	4	\$906	\$118	
PN2454DK	24 x 54 x 29	60	95	3	\$906	\$119	
PN2448DK	24 x 48 x 29	70	84	4	\$868	\$114	
PN3084DK	30 x 84 x 29	70	133	6.50	\$1049	\$123	
PN3078DK	30 x 78 x 29	70	127	6	\$1021	\$121	
PN3072DK	30 x 72 x 29	70	120	5.50	\$988	\$121	
PN3066DK	30 x 66 x 29	65	114	5	\$958	\$120	
PN3060DK	30 x 60 x 29	70	109	5	\$925	\$118	
PN3054DK	30 x 54 x 29	60	108	3.25	\$925	\$119	
PN3048DK	30 x 48 x 29	65	98	4	\$882	\$118	
PN3684DK	36 x 84 x 29	70	152	8	\$1104	\$137	
PN3678DK	36 x 78 x 29	70	145	7	\$1074	\$132	
PN3672DK	36 x 72 x 29	70	138	7	\$1055	\$129	
PN3666DK	36 x 66 x 29	70	130	6	\$1007	\$121	
PN3660DK	36 x 60 x 29	70	117	6	\$974	\$119	
PN3654DK	36 x 54 x 29	60	120	4	\$974	\$120	
PN3648DK	36 x 48 x 29	70	111.50	6.50	\$891	\$118	

Standard with inset end panel on both ends and 10" h modesty panel with pass through grommet. Connects to flush return with laminate end panel, bridges for laminate end panel desks, flush return with bookshelf, flush conference tops. Can be placed over 27" H freestanding returns or 23" H/27" H credenzas. Grommet in worksurface. Shipped in 2 cartons.

RETURNS - LAMINATE END PANELS **MODEL#** **DIMENSIONS** **FREIGHT CLASS** **WT/LBS.** **CUBIC FT.** **LIST PRICE** **HP ADD**

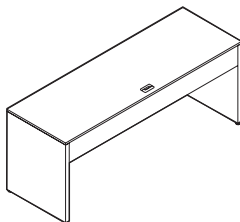

Freestanding Return- 29" H

PN248429R	24 x 84 x 29	65	131	5	\$1008	\$135
PN247829R	24 x 78 x 29	65	127	5	\$980	\$130
PN247229R	24 x 72 x 29	65	123	5	\$953	\$123
PN246629R	24 x 66 x 29	65	118	4	\$907	\$120
PN246029R	24 x 60 x 29	65	112	4	\$901	\$118

Standard with flush laminate 1.5" thick end panels. 10" h thick modesty panel without pass through grommet. Connects to flush return with laminate end panel, bridges for laminate end panel desks, flush return with bookshelf, flush conference tops. Can be placed over 27" H freestanding returns or 23" H/27" H credenzas. Grommet in worksurface.

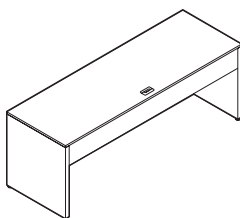

Freestanding Return- 27" H

PN248427R	24 x 84 x 27	65	129	5	\$996	\$131
PN247827R	24 x 78 x 27	65	125	5	\$965	\$127
PN247227R	24 x 72 x 27	65	120	5	\$939	\$121
PN246627R	24 x 66 x 27	65	116	4	\$911	\$119
PN246027R	24 x 60 x 27	65	109	4	\$852	\$117

Standard with flush laminate 1.5" thick end panels. 10" h thick modesty panel without pass through grommet. Supports overlapping return with laminate end panel, overlapping bridge for laminate end panel desks, overlapping return with bookshelf, overlapping conference top. Can be placed under desk. Grommet in worksurface.

Required Specifications

Top finish
Base finish

Optional Specifications

HP laminate
POG1, POG3 - additional grommet
PCSG - custom grommet
RSG - remove grommet

Accessories

Power block Wire manager
Keyboard tray Desktop screen
Keyboard mechanism (*not available on 27" H return*)

RETURNS - LAMINATE END PANELS

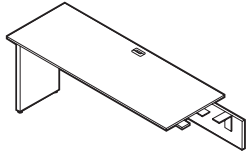

Flush Return - 29" H - LEFT

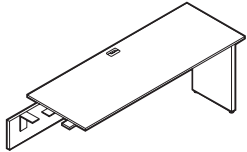

Flush Return - 29" H - RIGHT

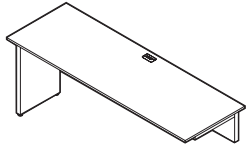

Overlapping Return - 29" H - LEFT

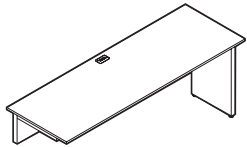

Overlapping Return - 29" H - RIGHT

MODEL#	DIMENSIONS D x W x H	FREIGHT CLASS	WT/LBS.	CUBIC FT.	LIST PRICE	HP ADD
PN2472RFL	24 x 72 x 29	70	95	5.50	\$834	\$129
PN2466RFL	24 x 66 x 29	70	90	5	\$805	\$123
PN2460RFL	24 x 60 x 29	70	84	4.50	\$759	\$119
PN2454RFL	24 x 54 x 29	70	78	4	\$739	\$120
PN2448RFL	24 x 48 x 29	70	72	4	\$706	\$117

Return has no pedestal. Standard with inset end panel on **left**. 10" h modesty panel with pass-through grommet. Connects to Freestanding Desk with laminate end panels, **29" H** Freestanding Returns and **29" H** Credenzas. Grommet in worksurface.

PN2472RFR	24 x 72 x 29	70	95	5.50	\$834	\$129
PN2466RFR	24 x 66 x 29	70	90	5	\$805	\$123
PN2460RFR	24 x 60 x 29	70	84	4.50	\$759	\$119
PN2454RFR	24 x 54 x 29	70	88	4	\$739	\$120
PN2448RFR	24 x 48 x 29	70	72	4	\$706	\$117

Return has no pedestal. Standard with inset end panel on **right**. 10" h modesty panel with pass-through grommet. Connects to Freestanding Desk with laminate end panels, **29" H** Freestanding Returns and **29" H** Credenzas. Grommet in worksurface.

PN2484ROL	24 x 84 x 29	70	118	6	\$925	\$107
PN2478ROL	24 x 78 x 29	65	126	5	\$861	\$106
PN2472ROL	24 x 72 x 29	70	104	5	\$832	\$100

Standard with inset laminate end panel on **left** and 10" h modesty panel with pass-through grommet. Overlaps **27" H** Credenza and **27" H** Freestanding Returns. Grommet in worksurface. 1" spacer included.

PN2484ROR	24 x 84 x 29	70	118	6	\$925	\$107
PN2478ROR	24 x 78 x 29	65	126	5	\$861	\$106
PN2472ROR	24 x 72 x 29	70	104	5	\$832	\$100

Standard with inset laminate end panel on **right** and 10" h modesty panel with pass-through grommet. Overlaps **27" H** Credenza and **27" H** Freestanding Returns. Grommet in worksurface. 1" spacer included.

Required Specifications

Top finish
Base finish

Optional Specifications

HP laminate
POG1, POG3 - additional grommet
PCSG - custom grommet
RSG - remove grommet

Accessories

Power block
Keyboard tray
Desktop screen
Wire manager
Keyboard mechanism

BRIDGES FOR LAMINATE END PANEL DESKS

MODEL# DIMENSIONS FREIGHT CLASS WT/LBS. CUBIC FT. LIST PRICE HP ADD

D x W x H

PN2454BF	24 x 54 x 12	65	97	3.50	\$659	\$106
PN2448BF	24 x 48 x 12	70	77	4.50	\$600	\$87
PN2442BF	24 x 42 x 12	70	70	4	\$572	\$88
PN2436BF	24 x 36 x 12	70	63	4	\$538	\$86

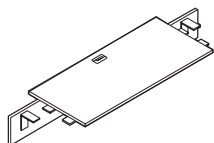

Flush Bridge

Standard with 10" h modesty panel with pass-through grommet. Connects between any two: Freestanding Desk with laminate end panels, **29" H** Freestanding Returns, Conference top for U configurations or **29" H** Credenzas opening. Subtop finish is Granite with black edge. Grommet in worksurface.

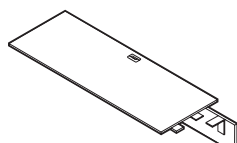

Overlapping Bridge - LEFT*

PN2478BOL	24 x 78 x 12	65	119	4	\$788	\$118
PN2472BOL	24 x 72 x 12	70	96	5	\$748	\$108
PN2466BOL	24 x 66 x 12	70	90	4.50	\$722	\$100
PN2460BOL	24 x 60 x 12	70	83	4.50	\$712	\$96

Standard with 10" h modesty panel with pass-through grommet. Connects Freestanding Desk with laminate end panels, **29" H** Freestanding Returns, Conference top for U configurations on one end, and overlaps **27" H** Credenza or **27" H** Freestanding Return on other end. Subtop finish is Granite with black edge. Grommet in worksurface. Includes 1" spacer, one side only.

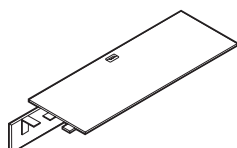

Overlapping Bridge - RIGHT*

PN2478BOR	24 x 78 x 12	65	119	4	\$788	\$118
PN2472BOR	24 x 72 x 12	70	96	5	\$748	\$108
PN2466BOR	24 x 66 x 12	70	90	4.50	\$722	\$100
PN2460BOR	24 x 60 x 12	70	83	4.50	\$712	\$96

Standard with 10" h modesty panel with pass-through grommet. Connects Freestanding Desk with laminate end panels, **29" H** Freestanding Returns, Conference top for U configurations on one end, and overlaps **27" H** Credenza or **27" H** Freestanding Return on other end. Subtop finish is Granite with black edge. Grommet in worksurface. Includes 1" spacer, one side only.

Required Specifications

Top finish
Base finish

Optional Specifications

HP laminate
POG1, POG3 - additional grommet*
PCSG - custom grommet
RSG - remove grommet

Accessories

Power block
Keyboard tray
Desktop screen
Wire manager
Keyboard mechanism

FREESTANDING DESKS WITH METAL LEGS

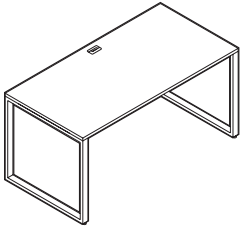

Freestanding Desk with Metal Legs

MODEL#	DIMENSIONS D x W x H	FREIGHT CLASS	WT/LBS.	CUBIC FT.	LIST PRICE	HP ADD
PN2484DM	24 x 84 x 29	250	111	43.41	\$1595	\$253
PN2478DM	24 x 78 x 29	250	109	41.92	\$1475	\$236
PN2472DM	24 x 72 x 29	250	106	38.92	\$1293	\$208
PN2466DM	24 x 66 x 29	250	102	31.44	\$1281	\$206
PN2460DM	24 x 60 x 29	250	91	29.94	\$1253	\$202
PN2454DM	24 x 54 x 29	250	88	29.94	\$1217	\$197
PN2448DM	24 x 48 x 29	250	76	28.44	\$1077	\$175
PN3084DM	30 x 84 x 29	250	137	53.89	\$1659	\$262
PN3078DM	30 x 78 x 29	250	124	52.40	\$1542	\$247
PN3072DM	30 x 72 x 29	250	117	47.90	\$1382	\$221
PN3066DM	30 x 66 x 29	250	110	38.92	\$1335	\$213
PN3060DM	30 x 60 x 29	250	104	38.17	\$1293	\$208
PN3054DM	30 x 54 x 29	250	99	37.43	\$1267	\$205
PN3048DM	30 x 48 x 29	250	82	35.93	\$1119	\$182
PN3684DM	36 x 84 x 29	250	154	65.87	\$1883	\$297
PN3678DM	36 x 78 x 29	250	139	62.87	\$1725	\$273
PN3672DM	36 x 72 x 29	250	132	59.88	\$1679	\$264
PN3666DM	36 x 66 x 29	250	123	47.16	\$1471	\$235
PN3660DM	36 x 60 x 29	250	117	46.41	\$1422	\$226
PN3654DM	36 x 54 x 29	250	106	44.91	\$1343	\$214
PN3648DM	36 x 48 x 29	250	92	44.91	\$1215	\$197

Standard with two 1" x 2" metal open frame legs with support channel(s). Connects to flush returns with metal leg, bridges for desks and returns with metal leg, flush return with bookshelf and flush conference tops. Grommet in worksurface. Shipped in 3 cartons.

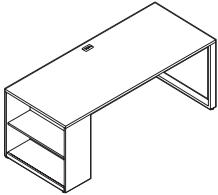

LEFT

Freestanding Desk with Bookshelf*

PN3060DBL	30 x 60 x 29	250	123	51.65	\$1402	\$236
PN3066DBL	30 x 66 x 29	250	129	52.40	\$1549	\$258
PN3072DBL	30 x 72 x 29	250	136	61.38	\$1595	\$261
PN3078DBL	30 x 78 x 29	250	150	65.87	\$1724	\$283
PN3084DBL	30 x 84 x 29	250	156	67.37	\$1817	\$319
PN3672DBL	36 x 72 x 29	250	154	73.35	\$1657	\$261
PN3678DBL	36 x 78 x 29	250	161	76.35	\$1799	\$283
PN3684DBL	36 x 84 x 29	250	176	79.34	\$2027	\$319

12"D Bookcase with adjustable shelf on **left**. One 1" x 2" metal open frame leg with support channel(s). Right side connects to flush returns with metal leg, bridges for desks and returns with metal leg, flush return with bookshelf, flush conference tops. Grommet in worksurface. Shipped in 3 cartons.

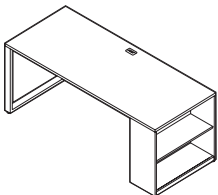

RIGHT

Freestanding Desk with Bookshelf*

PN3060DBR	30 x 60 x 29	250	123	51.65	\$1402	\$218
PN3066DBR	30 x 66 x 29	250	129	52.40	\$1549	\$239
PN3072DBR	30 x 72 x 29	250	136	61.38	\$1595	\$247
PN3078DBR	30 x 78 x 29	250	150	65.87	\$1724	\$260
PN3084DBR	30 x 84 x 29	250	156	67.37	\$1817	\$278
PN3672DBR	36 x 72 x 29	250	154	73.35	\$1657	\$253
PN3678DBR	36 x 78 x 29	250	161	76.35	\$1799	\$273
PN3684DBR	36 x 84 x 29	250	176	79.34	\$2027	\$286

12"D Bookcase with adjustable shelf on **right**. One 1" x 2" metal open frame leg with support channel(s). Left side connects to flush returns with metal leg, bridges for desks and returns with metal leg, flush return with bookshelf, flush conference tops. Grommet in worksurface. Shipped in 3 cartons.

Required Specifications

Top finish
Base finish*
Leg finish*

Optional Specifications

HP laminate
POG1, POG3 - additional grommet
PCSG - custom grommet
RSG - remove grommet

Accessories

Power block
Keyboard tray
Desktop screen
Keyboard tray mounting kit*
Wire manager
Keyboard mechanism

RETURNS WITH METAL LEGS

MODEL# DIMENSIONS FREIGHT CLASS WT/LBS. CUBIC FT. LIST PRICE HP ADD

D x W x H

PN2448FML	24 x 48 x 29	150	56	12	\$744	\$114
PN2454FML	24 x 54 x 29	150	68	13	\$893	\$137
PN2460FML	24 x 60 x 29	150	71	13	\$937	\$144
PN2466FML	24 x 66 x 29	150	82	14	\$974	\$151
PN2472FML	24 x 72 x 29	150	86	20	\$1004	\$156
PN2478FML	24 x 78 x 29	150	89	21	\$1118	\$170

PN3048FML	30 x 48 x 29	150	61	15	\$790	\$121
PN3054FML	30 x 54 x 29	150	78	16	\$931	\$142
PN3060FML	30 x 60 x 29	150	82	16.50	\$976	\$151
PN3066FML	30 x 66 x 29	150	89	17	\$1008	\$156
PN3072FML	30 x 72 x 29	150	96	23	\$1072	\$164
PN3078FML	30 x 78 x 29	250	103	26	\$1172	\$180

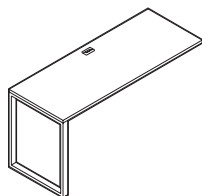

LEFT

Flush Return with Metal Leg

1" x 2" metal frame leg on **left**. Support channel(s) included for units 72"W and above. Connects to freestanding desk with metal legs, freestanding desk with bookshelf and metal leg, 29"H credenza opening. Grommet in worksurface. Shipped in 2 cartons.

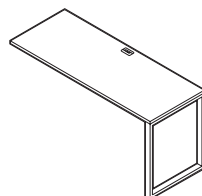

RIGHT

Flush Return with Metal Leg

PN2448FMR	24 x 48 x 29	150	56	12	\$744	\$114
PN2454FMR	24 x 54 x 29	150	68	13	\$893	\$137
PN2460FMR	24 x 60 x 29	150	71	13	\$937	\$144
PN2466FMR	24 x 66 x 29	150	82	14	\$974	\$151
PN2472FMR	24 x 72 x 29	150	86	20	\$1004	\$156
PN2478FMR	24 x 78 x 29	150	89	21	\$1118	\$170

PN3048FMR	30 x 48 x 29	150	61	7.50	\$790	\$121
PN3054FMR	30 x 54 x 29	150	78	16	\$931	\$142
PN3060FMR	30 x 60 x 29	150	83	16.50	\$976	\$151
PN3066FMR	30 x 66 x 29	150	89	17	\$1008	\$156
PN3072FMR	30 x 72 x 29	150	96	23	\$1072	\$164
PN3078FMR	30 x 78 x 29	250	103	26	\$1172	\$180

1" x 2" metal frame leg on **right**. Support channel(s) included for units 72"W and above. Connects to freestanding desk with metal legs, freestanding desk with bookshelf and metal leg, 29"H credenza opening. Grommet in worksurface. Shipped in 2 cartons.

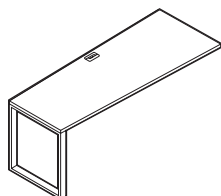

LEFT

Flush Wedge Return w/Metal Leg

PN3048FTL	30 x 48 x 29	150	61	15	\$780	\$120
PN3054FTL	30 x 54 x 29	150	78	16	\$921	\$142
PN3060FTL	30 x 60 x 29	150	83	16.50	\$976	\$151
PN3066FTL	30 x 66 x 29	150	89	17	\$1029	\$158
PN3072FTL	30 x 72 x 29	150	96	23	\$1072	\$164

1" x 2" metal frame leg on **left**. Support channel(s) included for units 72"W and above. 30"D has 24"D leg. 36"D has 30"D leg. Connects to freestanding desk with metal legs, freestanding desk with bookshelf and metal leg, 29"H credenza opening. Grommet in worksurface. Shipped in 2 cartons.

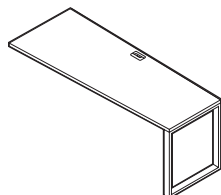

RIGHT

Flush Wedge Return w/Metal Leg

PN3048FTR	30 x 48 x 29	150	61	15	\$780	\$120
PN3054FTR	30 x 54 x 29	150	78	16	\$921	\$142
PN3060FTR	30 x 60 x 29	150	83	16.50	\$976	\$151
PN3066FTR	30 x 66 x 29	150	89	17	\$1029	\$158
PN3072FTR	30 x 72 x 29	150	96	23	\$1072	\$164

1" x 2" metal frame leg on **right**. Support channel(s) included for units 72"W and above. 30"D has 24"D leg. 36"D has 30"D leg. Connects to freestanding desk with metal legs, freestanding desk with bookshelf and metal leg, 29"H credenza opening. Grommet in worksurface. Shipped in 2 cartons.

Required Specifications

Top finish
Leg finish

Optional Specifications

HP laminate
POG1, POG3 - additional grommet
PCSG - custom grommet
RSG - remove grommet

Accessories

Power block
Keyboard tray
Desktop screen
Keyboard tray mounting kit
Wire manager
Keyboard mechanism

OVERLAPPING RETURNS WITH METAL LEGS

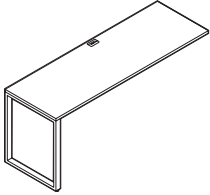

LEFT
Overlapping Return w/Metal Leg

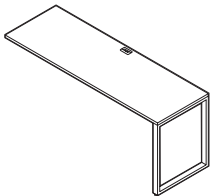

RIGHT
Overlapping Return w/Metal Leg

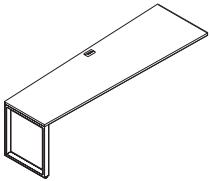

LEFT
Overlapping Wedge Return w/Metal Leg

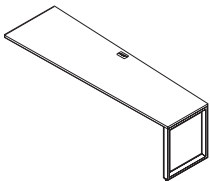

RIGHT
Overlapping Wedge Return w/Metal Leg

MODEL#	DIMENSIONS D x W x H	FREIGHT CLASS	WT/LBS.	CUBIC FT.	LIST PRICE	HP ADD
PN24600ML	24 x 60 x 29	150	71	13	\$835	\$129
PN24660ML	24 x 66 x 29	150	82	14	\$859	\$132
PN24720ML	24 x 72 x 29	150	86	20	\$889	\$137
PN24780ML	24 x 78 x 29	150	89	21	\$1059	\$162
PN24840ML	24 x 84 x 29	150	91	22	\$1225	\$187
PN30600ML	30 x 60 x 29	150	83	16.50	\$873	\$133
PN30660ML	30 x 66 x 29	150	89	17	\$904	\$139
PN30720ML	30 x 72 x 29	150	96	23	\$956	\$146
PN30780ML	30 x 78 x 29	250	103	26	\$1134	\$175
PN30840ML	30 x 84 x 29	150	116	27	\$1269	\$194

1" x 2" metal frame leg on **left**. Support channel(s) included for 84"W unit only. Overlaps 27"H credenza opening. Grommet in worksurface. Shipped in 2 cartons.

PN24600MR	24 x 60 x 29	150	71	13	\$835	\$129
PN24660MR	24 x 66 x 29	150	82	14	\$859	\$132
PN24720MR	24 x 72 x 29	150	86	20	\$889	\$137
PN24780MR	24 x 78 x 29	150	89	21	\$1059	\$162
PN24840MR	24 x 84 x 29	150	91	22	\$1225	\$187
PN30600MR	30 x 60 x 29	150	83	16.50	\$873	\$133
PN30660MR	30 x 66 x 29	150	89	17	\$904	\$139
PN30720MR	30 x 72 x 29	150	96	23	\$956	\$146
PN30780MR	30 x 78 x 29	250	103	26	\$1134	\$175
PN30840MR	30 x 84 x 29	150	137	27	\$1269	\$194

1" x 2" metal frame leg on **right**. Support channel(s) included for 84"W unit only. Overlaps 27"H credenza opening. Grommet in worksurface. Shipped in 2 cartons.

PN30600TL	30 x 60 x 29	150	83	16.50	\$890	\$137
PN30660TL	30 x 66 x 29	150	89	17	\$923	\$142
PN30720TL	30 x 72 x 29	150	96	23	\$965	\$148
PN30780TL	30 x 78 x 29	250	103	26	\$1154	\$177
PN30840TL	30 x 84 x 29	150	116	27	\$1289	\$197

1" x 2" metal frame leg on **left**. Support channel(s) included for 84"W unit only. 30"D has 24"D leg. 36"D has 30"D leg. Overlaps 27"H credenza opening. Grommet in worksurface. Includes 1" spacer. Shipped in 2 cartons.

PN30600TR	30 x 60 x 29	150	83	16.50	\$890	\$137
PN30660TR	30 x 66 x 29	150	89	17	\$923	\$142
PN30720TR	30 x 72 x 29	150	96	23	\$965	\$148
PN30780TR	30 x 78 x 29	250	103	26	\$1154	\$177
PN30840TR	30 x 84 x 29	150	116	27	\$1289	\$197

1" x 2" metal frame leg on **right**. Support channel(s) included for 84"W unit only. 30"D has 24"D leg. 36"D has 30"D leg. Overlaps 27"H credenza opening. Grommet in worksurface. Includes 1" spacer. Shipped in 2 cartons.

Required Specifications

Top finish
Leg finish

Optional Specifications

HP laminate
POG1, POG3 - additional grommet
PCSG - custom grommet
RSG - remove grommet

Accessories

Power block
Keyboard tray
Desktop screen
Keyboard tray mounting kit
Wire manager
Keyboard mechanism

OVERLAPPING RETURNS WITH METAL LEGS

MODEL# DIMENSIONS FREIGHT CLASS WT/LBS. CUBIC FT. LIST PRICE HP ADD

D x W x H

PN2460SOL	24 x 60 x 29	250	83	23.95	\$1226	\$187
PN2466SOL	24 x 66 x 29	250	94	25.45	\$1264	\$194
PN2472SOL	24 x 72 x 29	250	98	34.43	\$1296	\$199
PN2478SOL	24 x 78 x 29	250	101	35.93	\$1409	\$214
PN2484SOL	24 x 84 x 29	250	103	37.43	\$1484	\$226
PN3060SOL	30 x 60 x 29	250	95	26.20	\$1304	\$200
PN3066SOL	30 x 66 x 29	250	101	26.95	\$1343	\$206
PN3072SOL	30 x 72 x 29	250	108	35.93	\$1376	\$209
PN3078SOL	30 x 78 x 29	250	115	40.42	\$1473	\$224
PN3084SOL	30 x 84 x 29	250	128	41.92	\$1571	\$239

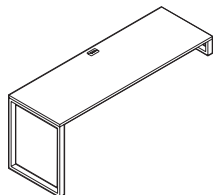

LEFT

Overlapping Return w/Metal Leg and Spacer for 23"H Credenza

1" x 2" metal frame leg on **left** and 5"H metal frame spacer on right. Support channel(s) included for units 78"W and above. Overlaps 23"H credenza. Grommet in worksurface. Shipped in 3 cartons.

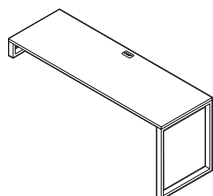

RIGHT

Overlapping Return w/Metal Leg and Spacer for 23"H Credenza

PN2460SOR	24 x 60 x 29	250	83	23.95	\$1226	\$187
PN2466SOR	24 x 66 x 29	250	94	25.45	\$1264	\$194
PN2472SOR	24 x 72 x 29	250	98	34.43	\$1296	\$199
PN2478SOR	24 x 78 x 29	250	101	35.93	\$1409	\$214
PN2484SOR	24 x 84 x 29	250	103	37.43	\$1484	\$226
PN3060SOR	30 x 60 x 29	250	95	26.20	\$1304	\$200
PN3066SOR	30 x 66 x 29	250	101	26.95	\$1343	\$206
PN3072SOR	30 x 72 x 29	250	108	35.93	\$1376	\$209
PN3078SOR	30 x 78 x 29	250	115	40.42	\$1473	\$224
PN3084SOR	30 x 84 x 29	250	128	41.92	\$1571	\$239

1" x 2" metal frame leg on **right** and 5"H metal frame spacer on left. Support channel(s) included for units 78"W and above. Overlaps 23"H credenza. Grommet in worksurface. Shipped in 3 cartons.

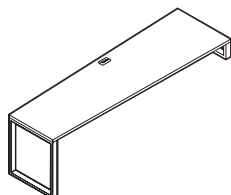

LEFT

Overlapping Wedge Return w/Metal Leg and Spacer for 23"H Credenza

PN3060TSL	30 x 60 x 29	250	95	26.20	\$1281	\$197
PN3066TSL	30 x 66 x 29	250	101	26.95	\$1329	\$205
PN3072TSL	30 x 72 x 29	250	108	35.93	\$1363	\$208
PN3078TSL	30 x 78 x 29	250	115	40.42	\$1460	\$223
PN3084TSL	30 x 84 x 29	250	128	41.92	\$1544	\$236

1" x 2" metal frame leg on **left** and 5"H metal frame spacer on right. Support channel(s) included for units 78"W and above. 24"D leg and 30"D spacer. Overlaps 23"H credenza. Grommet in worksurface. Shipped in 3 cartons.

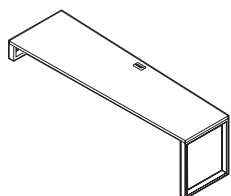

RIGHT

Overlapping Wedge Return w/Metal Leg and Spacer for 23"H Credenza

PN3060TSR	30 x 60 x 29	250	95	26.20	\$1281	\$197
PN3066TSR	30 x 66 x 29	250	101	26.95	\$1329	\$205
PN3072TSR	30 x 72 x 29	250	108	35.93	\$1363	\$208
PN3078TSR	30 x 78 x 29	250	115	40.42	\$1460	\$223
PN3084TSR	30 x 84 x 29	250	128	41.92	\$1544	\$236

1" x 2" metal frame leg on **right** and 5"H metal frame spacer on left. Support channel(s) included for units 78"W and above. 24"D leg and 30"D spacer. Overlaps 23"H credenza. Grommet in worksurface. Shipped in 3 cartons.

Required Specifications

Top finish
Leg finish

Optional Specifications

HP laminate
POG1, POG3 - additional grommet
PCSG - custom grommet
RSG - remove grommet

Accessories

Power block
Keyboard tray
Desktop screen
Keyboard tray mounting kit
Wire manager
Keyboard mechanism

BRIDGES FOR DESKS + RETURNS W/ METAL LEGS

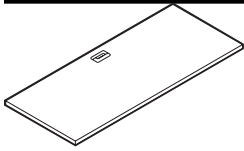

Flush Bridge for Metal Leg Configurations

MODEL#	DIMENSIONS D x W x H	FREIGHT CLASS	WT/LBS.	CUBIC FT.	LIST PRICE	HP ADD
PN2436BFM	24 x 36 x 1	70	31	2	\$351	\$80
PN2442BFM	24 x 42 x 1	70	40	2.50	\$358	\$83
PN2448BFM	24 x 48 x 1	85	44	3	\$376	\$85
PN2454BFM	24 x 54 x 1	70	51	3	\$511	\$113

Connects between any two: freestanding desk with metal legs, freestanding desk with bookshelf and metal leg, conference top for U configurations, 29"H credenza opening. Grommet in worksurface.

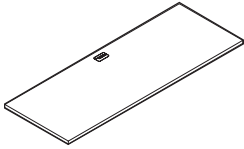

LEFT

Overlapping Bridge for Metal Leg Configurations

PN2460OBL	24 x 60 x 2	70	51	3	\$489	\$102
PN2466OBL	24 x 66 x 2	70	62	3.25	\$505	\$106
PN2472OBL	24 x 72 x 2	92.5	66	6.50	\$515	\$107
PN2478OBL	24 x 78 x 2	92.5	76	6.50	\$697	\$142

Connects freestanding desk with metal legs, freestanding desk with bookshelf and metal leg, conference top for U configurations flush on one end, and overlaps 27"H credenza opening on the other end. Includes 1" spacer. Grommet in worksurface.

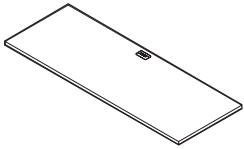

RIGHT

Overlapping Bridge for Metal Leg Configurations

PN2460OBR	24 x 60 x 2	70	51	3	\$489	\$102
PN2466OBR	24 x 66 x 2	70	62	3.25	\$505	\$106
PN2472OBR	24 x 72 x 2	92.5	66	6.50	\$515	\$107
PN2478OBR	24 x 78 x 2	92.5	76	6.50	\$697	\$142

Connects freestanding desk with metal legs, freestanding desk with bookshelf and metal leg, conference top for U configurations flush on one end, and overlaps 27"H credenza opening on the other end. Includes 1" spacer. Grommet in worksurface.

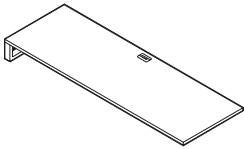

LEFT

Overlapping Bridge with Metal Spacer for 23"H Credenza*

PN2460OSL	24 x 60 x 6	125	63	9	\$806	\$178
PN2466OSL	24 x 66 x 6	125	74	9.50	\$845	\$186
PN2472OSL	24 x 72 x 6	150	78	16	\$874	\$193
PN2478OSL	24 x 78 x 6	150	88	16	\$988	\$215

One 5"H metal frame spacer with support channel(s). Connects flush on **right** side to freestanding desk with metal legs, freestanding desk with bookshelf and metal leg, or conference top for U configurations. Overlaps 23"H credenza opening on the **left**. Grommet in worksurface. Shipped in 2 cartons.

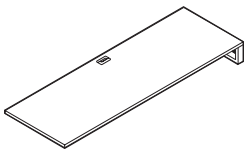

RIGHT

Overlapping Bridge with Metal Spacer for 23"H Credenza*

PN2460OSR	24 x 60 x 6	125	63	9	\$806	\$178
PN2466OSR	24 x 66 x 6	125	74	9.50	\$845	\$186
PN2472OSR	24 x 72 x 6	150	78	16	\$874	\$193
PN2478OSR	24 x 78 x 6	150	88	16	\$988	\$215

One 5"H metal frame spacer with support channel(s). Connects flush on **left** side to freestanding desk with metal legs, freestanding desk with bookshelf and metal leg, or conference top for U configurations. Overlaps 23"H credenza opening on the **right**. Grommet in worksurface. Shipped in 2 cartons.

Required Specifications

Top finish
Leg finish*

Optional Specifications

HP laminate
POG1, POG3 - additional grommet
PCSG - custom grommet
RSG - remove grommet

Accessories

Power block Wire manager
Keyboard tray Keyboard mechanism
Desktop screen
Keyboard tray mounting kit

RETURNS WITH BOOKSHELF

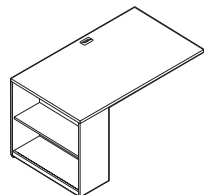

LEFT

Flush Return with Bookshelf

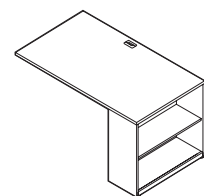

RIGHT

Flush Return with Bookshelf

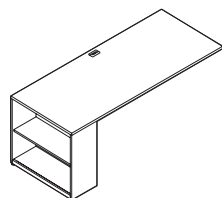

LEFT

Overlapping Return with Bookshelf

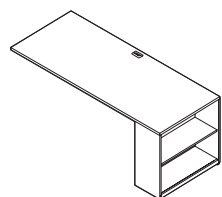

RIGHT

Overlapping Return with Bookshelf

MODEL#	DIMENSIONS D x W x H	FREIGHT CLASS	WT/LBS.	CUBIC FT.	LIST PRICE	HP ADD
PN2460FBL	24 x 60 x 29	150	86	20	\$951	\$145
PN2466FBL	24 x 66 x 29	150	97	20.50	\$1082	\$165
PN2472FBL	24 x 72 x 29	250	101	27	\$1117	\$169
PN2478FBL	24 x 78 x 29	150	111	27	\$1182	\$182
PN2484FBL	24 x 84 x 29	250	106	29	\$1250	\$189
PN3060FBL	30 x 60 x 29	150	102	25.50	\$1007	\$156
PN3066FBL	30 x 66 x 29	150	108	26	\$1144	\$175
PN3072FBL	30 x 72 x 29	250	115	32	\$1180	\$181
PN3078FBL	30 x 78 x 29	250	129	35	\$1265	\$194
PN3084FBL	30 x 84 x 29	250	135	36	\$1385	\$210

12"D Bookcase with adjustable shelf on **left**. With support channel(s). Connects on **right** side to freestanding desk with metal legs or laminate end panels, 29"H freestanding returns, 29"H credenza opening. Laminate shelf is standard. Grommet in worksurface. Shipped in 2 cartons.

PN2460FBR	24 x 60 x 29	150	86	20	\$951	\$145
PN2466FBR	24 x 66 x 29	150	97	20.50	\$1082	\$165
PN2472FBR	24 x 72 x 29	250	101	27	\$1117	\$169
PN2478FBR	24 x 78 x 29	150	111	27	\$1182	\$182
PN2484FBR	24 x 84 x 29	250	106	29	\$1250	\$189
PN3060FBR	30 x 60 x 29	150	102	25.50	\$1007	\$156
PN3066FBR	30 x 66 x 29	150	108	26	\$1144	\$175
PN3072FBR	30 x 72 x 29	250	115	32	\$1180	\$181
PN3078FBR	30 x 78 x 29	250	129	35	\$1265	\$194
PN3084FBR	30 x 84 x 29	250	135	36	\$1385	\$210

12"D Bookcase with adjustable shelf on **right**. With support channel(s). Connects on **left** side to freestanding desk with metal legs or laminate end panels, 29"H freestanding returns, 29"H credenza opening. Laminate shelf is standard. Grommet in worksurface. Shipped in 2 cartons.

PN2484RBL	24 x 84 x 29	250	106	29	\$1231	\$187
PN2490RBL	24 x 90 x 29	250	110	30	\$1369	\$209
PN2496RBL	24 x 96 x 29	250	123	31	\$1440	\$219
PN3084RBL	30 x 84 x 29	250	135	36	\$1281	\$197
PN3090RBL	30 x 90 x 29	250	142	42	\$1402	\$213
PN3096RBL	30 x 96 x 29	250	146	38.50	\$1478	\$225

12"D Bookcase with adjustable shelf on **left**. With support channel(s). **Right** side overlaps 27"H credenza opening, 27"H freestanding return. Laminate shelf is standard. Grommet in worksurface. Shipped in 2 cartons.

PN2484RBR	24 x 84 x 29	250	106	29	\$1231	\$187
PN2490RBR	24 x 90 x 29	250	110	30	\$1369	\$209
PN2496RBR	24 x 96 x 29	250	123	31	\$1440	\$219
PN3084RBR	30 x 84 x 29	250	135	36	\$1281	\$197
PN3090RBR	30 x 90 x 29	250	142	42	\$1402	\$213
PN3096RBR	30 x 96 x 29	250	146	38.50	\$1478	\$225

12"D Bookcase with adjustable shelf on **right**. With support channel(s). **Left** side overlaps 27"H credenza opening, 27"H freestanding return. Laminate shelf is standard. Grommet in worksurface. Shipped in 2 cartons.

Required Specifications

Top finish
Base finish

Optional Specifications

HP laminate
POG1, POG3 - additional grommet
PCSG - custom grommet
RSG - remove grommet

Accessories

Power block
Keyboard tray
Desktop screen
Keyboard tray mounting kit
Wire manager
Keyboard mechanism

CONFERENCE TOPS - FLUSH

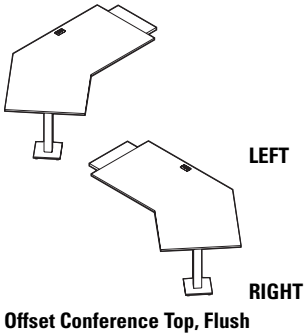

MODEL#	DIMENSIONS D x W x H	FREIGHT CLASS	WT/LBS.	CUBIC FT.	LIST PRICE	HP ADD
PN3066CFL	47 x 66 x 29	150	142	25	\$1223	\$159
PN3072CFL	47 x 72 x 29	92.5	52	5	\$1276	\$151

PN3066CFR	47 x 66 x 29	150	142	25	\$1223	\$159
PN3072CFR	47 x 72 x 29	92.5	52	5	\$1276	\$151

Specify PNxxxxCFL for **LEFT** or PNxxxxCFR for **RIGHT**.

Standard with square monopost and base. Connects to freestanding desks with metal legs or laminate end panels, 29"H freestanding returns, 29"H credenza opening. Subtop finish is Granite with black edge. Grommet in worksurface. Shipped in 2 cartons.

Recommended Maximum Modesty Panel Size:

PN3066CFR/CFL: 36"W (PN3613DMF)
 PN3072CFR/CFL: 42"W (PN4213DMF)

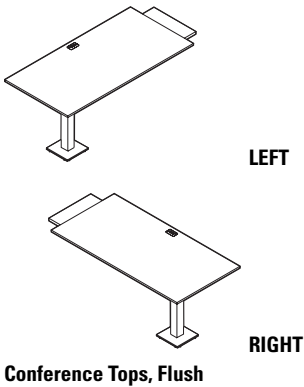

PN2448DFL	24 x 48 x 29	125	55	8.50	\$781	\$113
PN3048DFL	30 x 48 x 29	150	59	5.50	\$834	\$121
PN3060DFL	30 x 60 x 29	125	76	6	\$866	\$127

PN2448DFR	24 x 48 x 29	125	55	8.50	\$781	\$113
PN3048DFR	30 x 48 x 29	150	59	5.50	\$834	\$121
PN3060DFR	30 x 60 x 29	125	76	6	\$866	\$127

Specify PNxxxxDFL for **LEFT** or PNxxxxDFR for **RIGHT**.

Standard with square monopost with base. Connects to Freestanding Desks with metal legs or laminate end panels, 29"H Freestanding Returns or 29"H credenza opening. Subtop finish is Granite with black edge. Grommet in worksurface. Shipped in 2 cartons.

Recommended Maximum Modesty Panel Size:

PN2448DFR/DFL: 30"W (PN3013DMF)
 PN3048DFR/DFL: 30"W (PN3013DMF)
 PN3060DFR/DFL: 36"W (PN3613DMF)

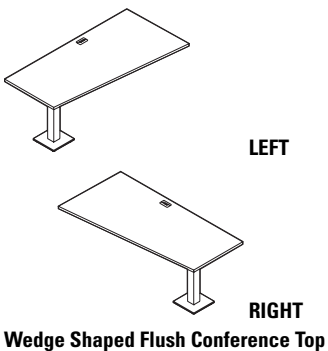

PN3048TFL	30 x 48 x 29	150	59	11	\$834	\$121
PN3060TFL	30 x 60 x 29	125	81	12.50	\$866	\$127

PN3048TFR	30 x 48 x 29	150	59	11	\$834	\$121
PN3060TFR	30 x 60 x 29	125	81	12.50	\$866	\$127

Specify PNxxxxTFL for **LEFT** or PNxxxxTFR for **RIGHT**.

Standard with square monopost with base. 30"D at connecting end, 24"D at monopost end. Connects to Freestanding Desks with metal legs or laminate end panels, 29"H Freestanding Returns or 29"H credenza opening. Subtop finish is Granite with black edge. Grommet in worksurface. Shipped in 2 cartons.

Recommended Maximum Modesty Panel Size:

PN3048TFR/TFL: 30"W (PN3013DMF)
 PN3060TFR/TFL: 36"W (PN3013DMF)

Required Specifications

Top finish
 Monopost finish

Optional Specifications

HP laminate
 PCSG - custom grommet
 RSG - remove grommet

Accessories

Power block
 Keyboard tray
 Desktop screen
 Keyboard tray mounting kit
 Wire manager
 Keyboard mechanism

CONFERENCE TOPS - OVERLAPPING

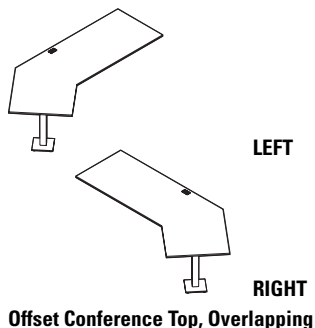

Offset Conference Top, Overlapping

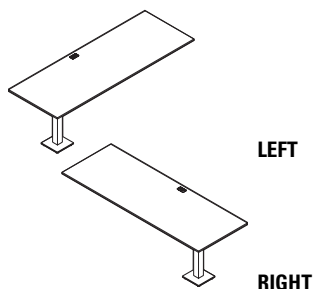

Conference Top, Overlapping

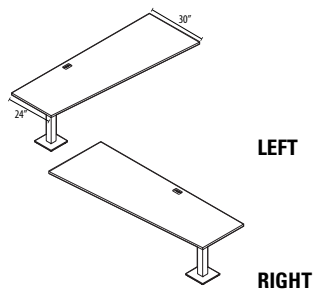

Wedge Shaped Overlapping Conference Top

MODEL#	DIMENSIONS D x W x H	FREIGHT CLASS	WT/LBS.	CUBIC FT.	LIST PRICE	HP ADD
PN3090COL	47 x 90 x 29	150	174	32	\$1379	\$148
PN3096COL	47 x 96 x 29	100	58.50	6.50	\$1393	\$157

PN3090COR	47 x 90 x 29	150	174	32	\$1379	\$148
PN3096COR	47 x 96 x 29	100	58.50	6.50	\$1393	\$157

Specify PNxxxxCOL for **LEFT** or PNxxxxCOR for **RIGHT**.

Standard with square monopost and base. Overlaps **27"H** credenza opening or **27"H** Freestanding Return. Subtop finish is Granite with black edge. Grommet in worksurface. 1" spacer included. Shipped in 2 cartons.

Recommended Maximum Modesty Panel Size:

PN3090COR/COL: 36"W (PN3613DMF)

PN3096COR/COL: 42"W (PN4213DMF)

PN3072DOL	30 x 72 x 29	150	94	19	\$1056	\$132
PN3078DOL	30 x 78 x 29	150	101	23	\$1076	\$133
PN3084DOL	30 x 84 x 29	92.5	44.50	4	\$1155	\$142

PN3072DOR	30 x 72 x 29	150	94	9.50	\$1056	\$132
PN3078DOR	30 x 78 x 29	150	101	23	\$1076	\$133
PN3084DOR	30 x 84 x 29	92.5	44.50	4	\$1155	\$142

Specify PNxxxxDOL for **LEFT** or PNxxxxDOR for **RIGHT**.

Standard with square monopost and base. Overlaps **27"H** credenza opening or **27"H** Freestanding Return. Subtop finish is Granite with black edge. Grommet in worksurface. 1" spacer included. Shipped in 2 cartons.

Recommended Maximum Modesty Panel Size:

PN3072DOR/DOL: 30"W (PN3013DMF)

PN3078DOR/DOL: 30"W (PN3013DMF)

PN3084DOR/DOL: 36"W (PN3613DMF)

PN3072TOL	30 x 72 x 29	150	94	19	\$1056	\$145
PN3084TOL	30 x 84 x 29	150	114	23	\$1155	\$160

PN3072TOR	30 x 72 x 29	150	94	19	\$1056	\$145
PN3084TOR	30 x 84 x 29	150	114	23	\$1155	\$160

Specify PNxxxxDOL for **LEFT** or PNxxxxDOR for **RIGHT**.

Standard with square monopost and base. 30"d at overlapping end, 24"d at monopost end. Overlaps **27"H** Credenza opening or **27"H** Freestanding Return. Grommet in worksurface. 1" spacer included. Shipped in 2 cartons.

Recommended Maximum Modesty Panel Size:

PN3072TOR/TOL: 30"W (PN3013DMF)

PN3084TOR/TOL: 36"W (PN3613DMF)

Required Specifications

Top finish
Monopost finish

Optional Specifications

HP laminate
PCSG - custom grommet
RSG - remove grommet

Accessories

Power block
Keyboard tray
Desktop screen
Keyboard tray mounting kit
Wire manager
Keyboard mechanism

CONFERENCE TOPS FOR U CONFIGURATIONS

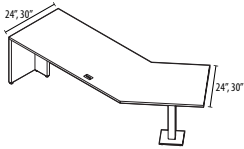

LEFT

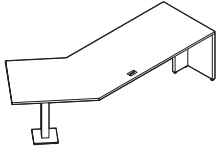

RIGHT

Offset Conference Top, for U Configurations*

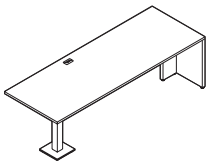

LEFT

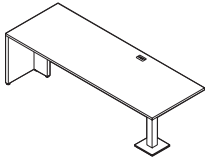

RIGHT

Conference Top for U Configurations*

MODEL#	DIMENSIONS	FREIGHT CLASS	WT/LBS.	CUBIC FT.	LIST PRICE	HP ADD
--------	------------	---------------	---------	-----------	------------	--------

D x W x H						
PN3090CUL	47 x 90 x 29	125	194	32	\$1458	\$201
PN3096CUL	47 x 96 x 29	125	195	32	\$1475	\$202

PN3090CUR	47 x 90 x 29	125	194	32	\$1458	\$201
PN3096CUR	47 x 96 x 29	125	195	32	\$1475	\$202

Specify PNxxxxCUL for **LEFT** or PNxxxxCUR for **RIGHT**.

Standard with T base with square monopost and base. End panel is 1" thick. 1.5" thick support gable extends 12" for end panel. Not freestanding, must be connected. Connects to bridges. Grommet in worksurface. Shipped in 2 cartons.

Recommended Maximum Modesty Panel Size:

PN3090CUR/CUL: 60"W (PN6013DMF)

PN3096CUR/CUL: 66"W (PN6613DMF)

PN3072DUL	30 x 72 x 29	125	114	19	\$1240	\$169
PN3084DUL	30 x 84 x 29	150	134	23	\$1457	\$201

PN3072DUR	30 x 72 x 29	125	114	19	\$1240	\$169
PN3084DUR	30 x 84 x 29	150	134	23	\$1457	\$201

Specify PNxxxxDUL for **LEFT** or PNxxxxDUR for **RIGHT**.

Standard with T base with square monopost and base. End panel is 1" thick. 1.5" thick support gable extends 12" for end panel. Not freestanding, must be connected. Connects to bridges. Grommet in worksurface. Shipped in 2 cartons.

Recommended Maximum Modesty Panel Size:

PN3072DUR/DUL: 48"W (PN4813DMF)

PN3084DUR/DUL: 60"W (PN6013DMF)

DESKTOP/MODESTY PANELS

MODEL#	DIMENSIONS	FREIGHT CLASS	WT/LBS.	CUBIC FT.	LIST PRICE
--------	------------	---------------	---------	-----------	------------

PN3013DML	.69 x 30 x 13	85	10	.75	\$407
PN3613DML	.69 x 36 x 13	70	12	.75	\$441
PN4213DML	.69 x 42 x 13	70	14	.75	\$475
PN4813DML	.69 x 48 x 13	70	16	1	\$494
PN5413DML	.69 x 54 x 13	70	18	1	\$553
PN6013DML	.69 x 60 x 13	70	20	1.50	\$648
PN6613DML	.69 x 66 x 13	70	22	1.50	\$668
PN7213DML	.69 x 72 x 13	70	24	1.50	\$691
PN7813DML	.69 x 78 x 13	70	26	1.70	\$810
PN8413DML	.69 x 84 x 13	70	28	1.70	\$1004

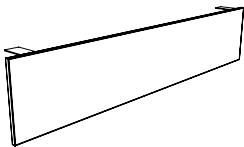

Laminate Modesty Panel

Attaches to worksurface with black "L" brackets. Laminate modesty panels up to 54"w include two brackets. Panels 60" and wider have three brackets. Specify a nominal size 6" shorter than worksurface size. If using modesty with overlapping worksurface or lower storage, contact Customer Care.

Required Specifications

- Top finish*
- Base finish
- Monopost finish*

Optional Specifications

- HP laminate*
- POG1, POG3 - additional grommet*
- PCSG - custom grommet*
- RSG - remove grommet*

Accessories

- Power block*
- Keyboard tray*
- Desktop screen*
- Keyboard tray mounting kit*
- Wire manager*
- Keyboard mechanism*

DESKTOP AND MODESTY PANELS

Fabric Desktop/Modesty Panel*

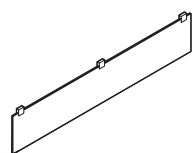

MODEL#	DIMENSIONS D x W x H	FREIGHT CLASS	WT/LBS.	CUBIC FT.	GRADE	LIST PRICE
PN3013DMF	.37 x 30 x 13	250	3	1	1	\$493
					2	\$531
					3	\$560
					4	\$603
PN3613DMF	.37 x 36 x 13	250	3.60	1	1	\$521
					2	\$568
					3	\$605
					4	\$656
PN4213DMF	.37 x 42 x 13	150	4.20	1	1	\$547
					2	\$594
					3	\$631
					4	\$682
PN4813DMF	.37 x 48 x 13	250	4.80	1.50	1	\$561
					2	\$619
					3	\$660
					4	\$723
PN5413DMF	.37 x 54 x 13	250	5.40	1.50	1	\$586
					2	\$651
					3	\$700
					4	\$772
PN6013DMF	.37 x 60 x 13	150	6	1.50	1	\$621
					2	\$686
					3	\$735
					4	\$807
PN6613DMF	.37 x 66 x 13	150	6.60	1.50	1	\$729
					2	\$802
					3	\$859
					4	\$943
PN7213DMF	.37 x 72 x 13	150	7.20	1.75	1	\$776
					2	\$860
					3	\$921
					4	\$1015
PN7813DMF	.37 x 78 x 13	150	7.80	1.75	1	\$782
					2	\$872
					3	\$944
					4	\$1047

Panels up to 54" w have two clamps. Panels 60" and wider have three clamps. **When used as a modesty panel, specify a nominal size 6" shorter than worksurface size.**

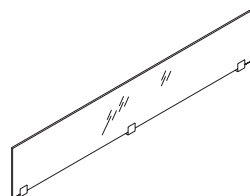

Frosted Glass Desktop Panel

PN3013DG	.25 x 30 x 13	85	10	.75		\$384
PN3613DG	.25 x 36 x 13	70	14	.75		\$401
PN4213DG	.25 x 42 x 13	70	16	.75		\$436
PN4813DG	.25 x 48 x 13	70	20	1		\$453
PN5413DG	.25 x 54 x 13	70	22	1		\$510
PN6013DG	.25 x 60 x 13	70	24	1.50		\$598
PN6613DG	.25 x 66 x 13	70	26	1.50		\$616
PN7213DG	.25 x 72 x 13	70	28	1.50		\$634

Panels up to 54" w have two clamps. Panels 60" and wider have three clamps.

Required Specifications

Fabric*

FELT PANELS **MODEL#** **DIMENSIONS** **FREIGHT CLASS** **WT./LBS.** **CUBIC FT.** **LIST PRICE** **HP ADD**

D x W x H

- 9mm thick panels offered in 9 finishes
- Made from 100% PET (polyester) fiber with a high content (50%) of post-recycled material, free of added chemicals, binders and adhesives
- Lightweight panels are tackable, impact and tear resistant, bacteria resistant, moisture resistant, and installation friendly
- Variation in fiber mix and color are inherent to the character of the product
- Clamps are included. Available in satin anodized finish only.

FELT COLORS

BLK	Black	MTS	Mist
BRI	Brick	PWT	Pewter
DEN	Denim	SHR	Shamrock
GPH	Graphite	WHT	White
HVT	Harvest		

FELT DESKTOP/MODESTY PANELS

MODEL# **DIMENSIONS** **FREIGHT CLASS** **WT./LBS.** **CUBIC FT.** **LIST PRICE**

D x W x H

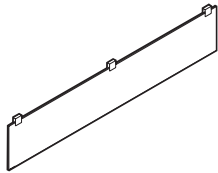

PET Felt Desktop/Modesty Panel, 1 pk.

PN3013PT9-1	.36 x 30 x 12.5	150	2.48	.57	\$198
PN3613PT9-1	.36 x 36 x 12.5	250	2.74	.69	\$208
PN4213PT9-1	.36 x 42 x 12.5	250	2.99	.80	\$282
PN4813PT9-1	.36 x 48 x 12.5	150	3.85	.91	\$294
PN5413PT9-1	.36 x 54 x 12.5	250	4.11	1.03	\$357
PN6013PT9-1	.36 x 60 x 12.5	250	4.36	1.14	\$367
PN6613PT9-1	.36 x 66 x 12.5	150	5.22	1.25	\$441
PN7213PT9-1	.36 x 72 x 12.5	150	5.48	1.36	\$450
PN7813PT9-1	.36 x 78 x 12.5	250	5.73	1.48	\$458

PET Felt Desktop/Modesty Panel available in 9 finishes, please specify. 2, 3 or 4 clamps are included depending on screen size. Clamps available in satin anodized finish only. **When used as a modesty panel, specify a nominal size 6" shorter than worksurface size.**

- Up to 42" w - 2 clamps per panel
- 48"-60" w - 3 clamps per panel
- 66"-78" w - 4 clamps per panel

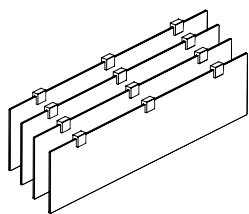

PET Felt Desktop/Modesty Panel, 4 pk.

PN3013PT9-4	0.36 x 30 x 12.5	85	8.93	.60	\$754
PN3613PT9-4	0.36 x 36 x 12.5	85	9.86	.71	\$791
PN4213PT9-4	0.36 x 42 x 12.5	85	10.80	.83	\$1082
PN4813PT9-4	0.36 x 48 x 12.5	85	13.90	.98	\$1119
PN5413PT9-4	0.36 x 54 x 12.5	85	14.80	1.09	\$1369
PN6013PT9-4	0.36 x 60 x 12.5	85	15.70	1.20	\$1402
PN6613PT9-4	0.36 x 66 x 12.5	85	18.80	1.32	\$1692
PN7213PT9-4	0.36 x 72 x 12.5	85	19.70	1.43	\$1725
PN7813PT9-4	0.36 x 78 x 12.5	85	20.60	1.54	\$1759

PET Felt Desktop/Modesty Panel available in 9 finishes, please specify. 2, 3 or 4 clamps are included depending on screen size. Clamps available in satin anodized finish only. **When used as a modesty panel, specify a nominal size 6" shorter than worksurface size.**

- Up to 42" w - 2 clamps per panel
- 48"-60" w - 3 clamps per panel
- 66"-78" w - 4 clamps per panel

Required Specifications

Felt color

FELT DESKTOP/MODESTY PANELS

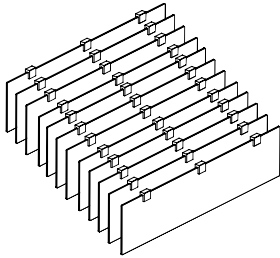

PET Felt Desktop/Modesty Panel, 12 pk.

MODEL#	DIMENSIONS	FREIGHT CLASS	WT/LBS.	CUBIC FT.	LIST PRICE
--------	------------	---------------	---------	-----------	------------

	D x W x H				
PN3013PT9-12	0.36 x 30 x 12.5	85	25.30	1.92	\$2213
PN3613PT9-12	0.36 x 36 x 12.5	85	27.90	2.26	\$2320
PN4213PT9-12	0.36 x 42 x 12.5	92.5	30.50	2.60	\$3181
PN4813PT9-12	0.36 x 48 x 12.5	85	39.30	3.05	\$3284
PN5413PT9-12	0.36 x 54 x 12.5	85	41.90	3.39	\$4029
PN6013PT9-12	0.36 x 60 x 12.5	92.5	44.50	3.72	\$4119
PN6613PT9-12	0.36 x 66 x 12.5	85	53.20	4.18	\$4983
PN7213PT9-12	0.36 x 72 x 12.5	85	55.90	4.51	\$5071
PN7813PT9-12	0.36 x 78 x 12.5	85	58.50	4.85	\$5163

PET Felt Desktop/Modesty Panel available in 9 finishes, please specify. 2, 3 or 4 clamps are included depending on screen size. Clamps available in satin anodized finish only. **When used as a modesty panel, specify a nominal size 6" shorter than worksurface size.**

- Up to 42"w - 2 clamps per panel
- 48"-60"w - 3 clamps per panel
- 66"-78"w - 4 clamps per panel

Required Specifications

Felt color

29" H CREDENZAS

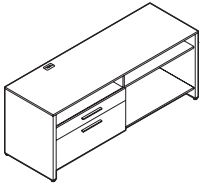

29" H Credenza - LEFT

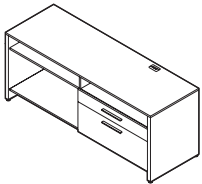

29" H Credenza - RIGHT

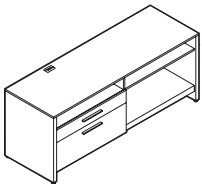

29" H Credenza w/Pull-Out Equipment Tray - LEFT

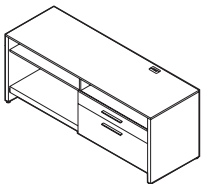

29" H Credenza w/Pull-Out Equipment Tray - RIGHT

MODEL#	DIMENSIONS	FREIGHT CLASS	WT/LBS.	CUBIC FT.	LIST PRICE	HP ADD
--------	------------	---------------	---------	-----------	------------	--------

D x W x H

PN2984CRL	24 x 84 x 29	100	320	33.83	\$2064	\$240
PN2972CRL	24 x 72 x 29	92.5	290	29	\$1956	\$236
PN2966CRL	24 x 66 x 29	100	265	31	\$1936	\$238
PN2960CRL	24 x 60 x 29	92.5	242	24.17	\$1906	\$223

Standard with locking 34"W box and lateral file drawer on **left**. File bars included for front-to-back letter and legal filing capability. Lock on file drawer secures both drawers. Adjustable 5 position shelf. Wire management grommet on surface and internal pass-through behind equipment shelf. Connects to flush returns, flush bridges and flush conference tops. Shipped Fully Assembled.

PN2984CRR	24 x 84 x 29	100	320	33.83	\$2064	\$240
PN2972CRR	24 x 72 x 29	92.5	290	29	\$1956	\$236
PN2966CRR	24 x 66 x 29	100	265	31	\$1936	\$238
PN2960CRR	24 x 60 x 29	92.5	242	24.17	\$1906	\$223

Standard with locking 34"W box and lateral file drawer on **right**. File bars included for front-to-back letter and legal filing capability. Lock on file drawer secures both drawers. Adjustable 5 position shelf. Wire management grommet on surface and internal pass-through behind equipment shelf. Connects to flush returns, flush bridges and flush conference tops. Shipped Fully Assembled.

PN2984CPL	24 x 84 x 29	100	320	33.83	\$2331	\$253
PN2978CPL	24 x 78 x 29	100	310	36	\$2266	\$258
PN2972CPL	24 x 72 x 29	92.5	290	29	\$2211	\$250
PN2966CPL	24 x 66 x 29	100	270	31	\$2127	\$252
PN2960CPL	24 x 60 x 29	92.5	242	24.17	\$2073	\$229

Standard with locking 34"W box and lateral file drawer on **left**. File bars included for front-to-back letter and legal filing capability. Lock on file drawer secures both drawers. Adjustable 5 position shelf. Pull-out equipment shelf can support up to 80lbs. Wire management grommet on surface and internal pass-through behind equipment shelf. Connects to flush returns, flush bridges and flush conference tops. Shipped Fully Assembled.

PN2984CPR	24 x 84 x 29	100	320	33.83	\$2331	\$253
PN2978CPR	24 x 78 x 29	100	310	36	\$2266	\$258
PN2972CPR	24 x 72 x 29	92.5	290	29	\$2211	\$250
PN2966CPR	24 x 66 x 29	100	270	31	\$2127	\$252
PN2960CPR	24 x 60 x 29	92.5	242	24.17	\$2073	\$229

Standard with locking 34"W box and lateral file drawer on **right**. File bars included for front-to-back letter and legal filing capability. Lock on file drawer secures both drawers. Adjustable 5 position shelf. Pull-out equipment shelf can support up to 80lbs. Wire management grommet on surface and internal pass-through behind equipment shelf. Connects to flush returns, flush bridges and flush conference tops. Shipped Fully Assembled.

Required Specifications

Top finish
Base finish
Drawer front finish

Optional Specifications

HP laminate
RSG - remove grommet

29" H CREDENZAS

MODEL#	DIMENSIONS	FREIGHT CLASS	WT/LBS.	CUBIC FT.	LIST PRICE	HP ADD
--------	------------	---------------	---------	-----------	------------	--------

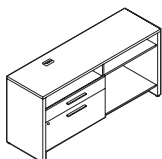

LEFT

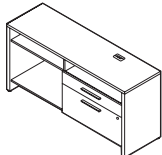

RIGHT

29" H Narrow Credenza*

	D x W x H					
PN2954NCL	20 x 54 x 29	92.5	250	22	\$1885	\$259
PN2960NCL	20 x 60 x 29	92.5	260	24	\$1910	\$261

PN2954NCR	20 x 54 x 29	92.5	250	22	\$1885	\$259
PN2960NCR	20 x 60 x 29	92.5	260	24	\$1910	\$261

Specify PNxxxxNCL for **LEFT** or PNxxxxNCR for **RIGHT**.

20"D. Standard with 30"W box and lateral file drawer. Front-to-back letter and legal filing capability. Lock on file drawer secures both drawers. Adjustable 5 position shelf. Wire management grommet on surface and internal pass-through behind lower shelf. Connects to flush returns, flush bridges and flush conference tops. File bars included. Shipped Fully Assembled.

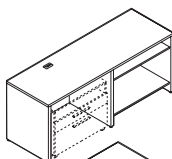

LEFT

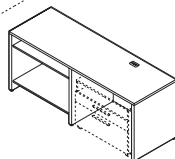

RIGHT

29" H Credenza for Mobile Lateral File

PN2972MCL	24 x 72 x 29	125	252	34	\$1542	\$212
PN2984MCL	24 x 84 x 29	125	268	39.50	\$1664	\$227

PN2972MCR	24 x 72 x 29	125	252	34	\$1542	\$212
PN2984MCR	24 x 84 x 29	125	268	39	\$1664	\$227

Specify PNxxxxMCL for **LEFT** or PNxxxxMCR for **RIGHT**.

Standard with 42" w space for lateral file. Adjustable 5 position shelf. Wire management grommet on surface and internal pass-through behind lower shelf. Connects to flush returns, flush bridges and flush conference tops. Accepts all mobile lateral file units. Shipped Fully Assembled.

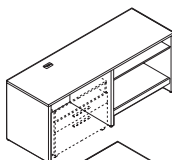

LEFT

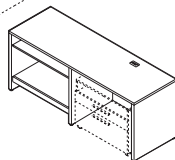

RIGHT

29" H Credenza for Mobile Lateral File w/Pull-Out Equipment Tray*

PN2972MPL	24 x 72 x 29	125	258	34	\$1764	\$240
PN2984MPL	24 x 84 x 29	125	274	39.50	\$1880	\$258

PN2972MPR	24 x 72 x 29	125	258	34	\$1764	\$240
PN2984MPR	24 x 84 x 29	125	274	39.50	\$1880	\$258

Specify PNxxxxMPL for **LEFT** or PNxxxxMPR for **RIGHT**.

Standard with 42" w space for lateral file, adjustable 5 position shelf, and pull-out equipment shelf that can support up to 80lbs. Grommet in worksurface and internal pass-through behind equipment shelf. Connects to flush returns, flush bridges and flush conference tops. Accepts all mobile lateral file units. Shipped Fully Assembled.

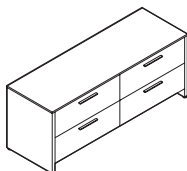

29" H Lateral File Credenza*

PN2972LF	24 x 72 x 29	92.5	290	29	\$2327	\$300
----------	--------------	------	-----	----	---------------	--------------

Standard with four lateral file drawers. File bars included for front-to-back letter and legal filing capability. Lock on lower drawer secures both drawers. Anti-tip mechanism. Shipped Fully Assembled.

Required Specifications

Top finish
Base finish
Drawer front finish*

Optional Specifications

HP laminate
RSG - remove grommet
Grommet (PN2972LF)

29" H CREDENZAS

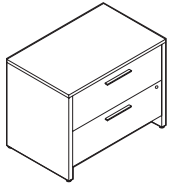

29" H Single Lateral File Credenza*

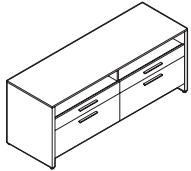

29" H Double Credenza*

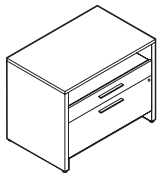

29" H Single Credenza*

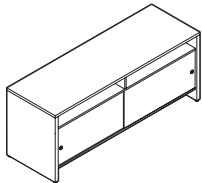

29" H Credenza w/Sliding Laminate Doors*

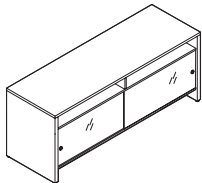

29" H Credenza w/Sliding Glass Doors

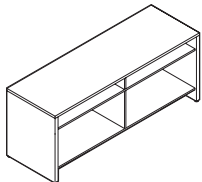

29" H Open Credenza

MODEL#	DIMENSIONS	FREIGHT CLASS	WT/LBS.	CUBIC FT.	LIST PRICE	HP ADD
--------	------------	---------------	---------	-----------	------------	--------

D x W x H

PN2937LFS	24 x 37 x 29	100	155	18	\$1578	\$215
-----------	--------------	-----	-----	----	---------------	--------------

Standard with two lateral file drawers. File bars included for front-to-back letter and legal filing capability. Lock on lower drawer secures both drawers. Anti-tip mechanism. Shipped Fully Assembled.

PN2972CRD	24 x 72 x 29	92.5	290	29	\$2239	\$280
-----------	--------------	------	-----	----	---------------	--------------

Standard with 34" w box and lateral file drawer on each side. File bars included for front-to-back letter and legal filing capability. Lock on file drawer secures both drawers. Shipped Fully Assembled.

PN2937CRS	24 x 37 x 29	100	145	18	\$1578	\$215
-----------	--------------	-----	-----	----	---------------	--------------

Standard with 34" w box and lateral file drawer. File bars included for front-to-back letter and legal filing capability. Lock on file drawer secures both drawers. Shipped Fully Assembled.

PN2960CLS	24 x 60 x 29	100	265	28.25	\$1826	\$250
PN2972CLS	24 x 72 x 29	100	289	34	\$1914	\$261
PN2984CLS	24 x 84 x 29	100	337	39.50	\$2089	\$285

Standard with sliding laminate doors in upper plastic track. Recessed brushed aluminum finger pulls. No lock. Shipped Fully Assembled.

PN2960CGS	24 x 60 x 29	100	265	28.25	\$2304	\$314
PN2972CGS	24 x 72 x 29	100	289	34	\$2549	\$348
PN2984CGS	24 x 84 x 29	100	337	39.50	\$2817	\$384

Standard with sliding glass doors in upper aluminum track. Satin etched 6mm glass. Brushed aluminum finger pulls. No lock. Shipped assembled in 2 cartons. Glass doors shipped separately.

PN2960CO	24 x 60 x 29	92.5	296	28.25	\$1536	\$210
PN2972CO	24 x 72 x 29	100	316	34	\$1628	\$224
PN2984CO	24 x 84 x 29	100	336	39.50	\$1805	\$248

Open storage with adjustable 5 position upper shelves with pass-throughs at back of lower shelves. Connects to flush returns, flush bridges and flush conference tops. Shipped Fully Assembled.

Required Specifications

Top finish
Base finish
Drawer front finish*

Optional Specifications

HP laminate
Grommet

29" H CREDENZAS

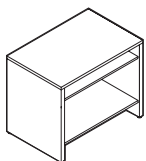

29" H Single Open Credenza**

MODEL#	DIMENSIONS	FREIGHT CLASS	WT./LBS.	CUBIC FT.	LIST PRICE	HP ADD
	D x W x H					
PN2930CO	24 x 30 x 29	92.5	153	15	\$988	\$137
PN2936CO	24 x 36 x 29	100	158	18	\$1033	\$142

Open storage with adjustable 5 position upper shelf with pass-through at back of lower shelf. Connects to flush returns, flush bridges and flush conference tops. Shipped Fully Assembled.

27" H CREDENZAS

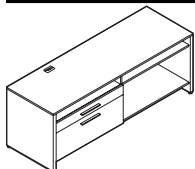

27" H Credenza - LEFT *

MODEL#	DIMENSIONS	FREIGHT CLASS	WT./LBS.	CUBIC FT.	LIST PRICE	HP ADD
PN2760CRL	24 x 60 x 27	92.5	241	22.50	\$1887	\$214
PN2766CRL	24 x 66 x 27	100	262	29	\$1917	\$226
PN2772CRL	24 x 72 x 27	92.5	290	27	\$1936	\$226
PN2778CRL	24 x 78 x 27	100	290	34	\$1995	\$237
PN2784CRL	24 x 84 x 27	92.5	335	31.50	\$2045	\$235

Standard with locking 34"W box and lateral file drawer on **left**. File bars included for front-to-back letter and legal filing capability. Lock on file drawer secures both drawers. Adjustable 5 position shelf. Wire management grommet on surface and internal pass-through behind equipment shelf. Supports overlapping returns, bridges, and conference tops that have a 1" spacer (example: PN24600MR). Cannot nest under 29"H products with metal legs. Shipped Fully Assembled.

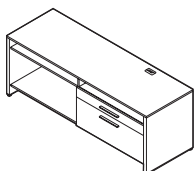

27" H Credenza - RIGHT *

PN2760CRR	24 x 60 x 27	92.5	241	22.50	\$1887	\$214
PN2766CRR	24 x 66 x 27	100	262	29	\$1917	\$226
PN2772CRR	24 x 72 x 27	92.5	290	27	\$1936	\$226
PN2778CRR	24 x 78 x 27	100	290	34	\$1995	\$237
PN2784CRR	24 x 84 x 27	92.5	335	31.50	\$2045	\$235

Standard with locking 34"W box and lateral file drawer on **right**. File bars included for front-to-back letter and legal filing capability. Lock on file drawer secures both drawers. Adjustable 5 position shelf. Wire management grommet on surface and internal pass-through behind equipment shelf. Supports overlapping returns, bridges, and conference tops that have a 1" spacer (example: PN24600MR). Cannot nest under 29"H products with metal legs. Shipped Fully Assembled.

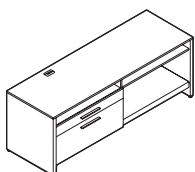

27" H Credenza w/Pull-Out Equipment Tray - LEFT*

PN2760CPL	24 x 60 x 27	92.5	241	22.50	\$2052	\$224
PN2766CPL	24 x 66 x 27	100	267	29	\$2111	\$239
PN2772CPL	24 x 72 x 27	92.5	290	27	\$2194	\$242
PN2778CPL	24 x 78 x 27	100	300	34	\$2249	\$253
PN2784CPL	24 x 84 x 27	92.5	335	31.50	\$2312	\$255

Standard with locking 34"W box and lateral file drawer on **left**. File bars included for front-to-back letter and legal filing capability. Lock on file drawer secures both drawers. Adjustable 5 position shelf. Pull-out equipment tray can support up to 80 lbs. Wire management grommet on surface and internal pass-through behind equipment shelf. Supports overlapping returns, bridges, and conference tops that have a 1" spacer (example: PN24600MR). Cannot nest under 29"H products with metal legs. Shipped Fully Assembled.

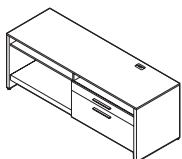

27" H Credenza w/Pull-Out Equipment Tray - RIGHT*

PN2760CPR	24 x 60 x 27	92.5	241	22.50	\$2052	\$224
PN2766CPR	24 x 66 x 27	100	267	29	\$2111	\$239
PN2772CPR	24 x 72 x 27	92.5	290	27	\$2194	\$242
PN2778CPR	24 x 78 x 27	100	300	34	\$2249	\$253
PN2784CPR	24 x 84 x 27	92.5	335	31.50	\$2312	\$255

Standard with locking 34"W box and lateral file drawer on **right**. File bars included for front-to-back letter and legal filing capability. Lock on file drawer secures both drawers. Adjustable 5 position shelf. Pull-out equipment tray can support up to 80 lbs. Wire management grommet on surface and internal pass-through behind equipment shelf. Supports overlapping returns, bridges, and conference tops that have a 1" spacer (example: PN24600MR). Cannot nest under 29"H products with metal legs. Shipped Fully Assembled.

Required Specifications

Top finish
Base finish
Drawer/door front finish*

Optional Specifications

HP laminate
Grommet**
RSG - remove grommet*

27" H CREDENZAS

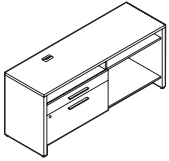

LEFT

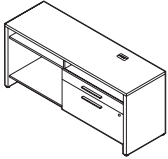

RIGHT

27" H Narrow Credenza*

MODEL#	DIMENSIONS D x W x H	FREIGHT CLASS	WT/LBS.	CUBIC FT.	LIST PRICE	HP ADD
PN2754NCL	20 x 54 x 27	92.5	250	22	\$1835	\$252
PN2760NCL	20 x 60 x 27	92.5	260	24	\$1859	\$255

PN2754NCR	20 x 54 x 27	92.5	250	22	\$1835	\$252
PN2760NCR	20 x 60 x 27	92.5	260	24	\$1859	\$255

Specify PNxxxxNCL for **LEFT** or PNxxxxNCR for **RIGHT**.

20"D. Standard with 30"W box and lateral file drawer. Front-to-back letter and legal filing capability. Lock on file drawer secures both drawers. Adjustable 5 position shelf. Wire management grommet on surface and internal pass-through at back of lower shelf. Supports overlapping returns, bridges, and conference tops that have a 1" spacer (example: PN24600MR). Cannot nest under 29"H products with metal legs. File bars included. Shipped Fully Assembled.

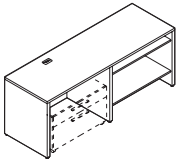

LEFT

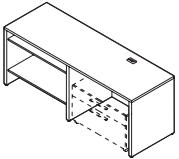

RIGHT

27" H Credenza for Mobile Lateral File

PN2772MCL	24 x 72 x 27	125	252	31.75	\$1522	\$209
PN2784MCL	24 x 84 x 27	125	268	37	\$1644	\$225

PN2772MCR	24 x 72 x 27	125	252	31.75	\$1522	\$209
PN2784MCR	24 x 84 x 27	125	268	37	\$1644	\$225

Specify PNxxxxMCL for **LEFT** or PNxxxxMCR for **RIGHT**.

Standard with 42"W space for lateral file. Adjustable 5 position shelf. Wire management grommet on surface and internal pass-through at back of lower shelf. Supports overlapping returns, bridges, and conference tops that have a 1" spacer (example: PN24600MR). Cannot nest under 29"H products with metal legs. Accepts mobile lateral file units: PN21MLSF and PN22MLBF with and without cushions, and PN25MLSBF without cushions. Shipped Fully Assembled.

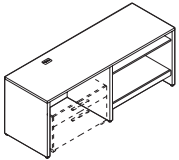

LEFT

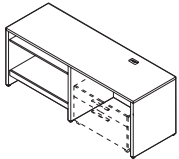

RIGHT

27" H Credenza for Mobile Lateral File w/Pull-Out Equipment Tray

PN2772MPL	24 x 72 x 27	100	258	31.75	\$1748	\$239
PN2784MPL	24 x 84 x 27	125	274	37	\$1859	\$255

PN2772MPR	24 x 72 x 27	100	258	31.75	\$1748	\$239
PN2784MPR	24 x 84 x 27	125	274	37	\$1859	\$255

Specify PNxxxxMPL for **LEFT** or PNxxxxMPR for **RIGHT**.

Standard with 42"W space for lateral file, adjustable 5 position shelf, and pull-out equipment shelf that can support up to 80lbs. Wire management grommet in surface and internal pass-through at back of pull-out equipment shelf. Supports overlapping returns, bridges, and conference tops that have a 1" spacer (example: PN24600MR). Cannot nest under 29"H products with metal legs. Accepts mobile lateral file units: PN21MLSF and PN22MLBF with and without cushions, and PN25MLSBF without cushions. Shipped Fully Assembled.

Required Specifications

Top finish
Base finish
Drawer/door front finish*

Optional Specifications

HP laminate
RSG - remove grommet

27"H CREENZAS

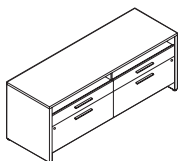

27"H Double Credenza*

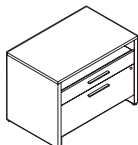

27"H Single Credenza*

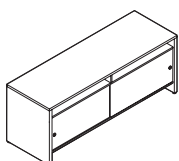

27"H Credenza w/Sliding Laminate Doors*

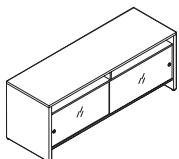

27"H Credenza w/Sliding Glass Doors

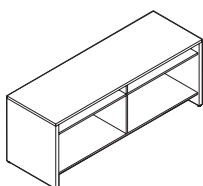

27"H Open Credenza

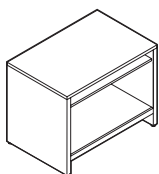

27"H Single Open Credenza

MODEL#	DIMENSIONS	FREIGHT CLASS	WT/LBS.	CUBIC FT.	LIST PRICE	HP ADD
--------	------------	---------------	---------	-----------	------------	--------

D x W x H

PN2772CRD	24 x 72 x 27	100	290	31.75	\$2197	\$280
-----------	--------------	-----	-----	-------	--------	-------

Standard with locking 34"W box and lateral file drawer on each side. File bars included for front-to-back letter and legal filing capability. Lock on file drawer secures both drawers. Shipped Fully Assembled.

PN2737CRS	24 x 37 x 27	100	145	18	\$1534	\$210
-----------	--------------	-----	-----	----	--------	-------

Standard with 34"W box and lateral file drawer. Lock on file drawer secures both drawers. File bars included for front-to-back letter and legal filing capability. Shipped Fully Assembled.

PN2760CLS	24 x 60 x 27	92.5	265	26.50	\$1807	\$248
PN2772CLS	24 x 72 x 27	100	289	31.75	\$1896	\$260
PN2784CLS	24 x 84 x 27	100	337	37	\$2071	\$283

Standard with sliding laminate doors in upper plastic track. Recessed brushed aluminum finger pulls. No lock. Shipped Fully Assembled.

PN2760CGS	24 x 60 x 27	92.5	265	26.50	\$2285	\$312
PN2772CGS	24 x 72 x 27	100	289	31.75	\$2542	\$348
PN2784CGS	24 x 84 x 27	100	337	37	\$2797	\$381

Standard with sliding glass doors in upper aluminum track. Satin etched 6mm glass. Brushed aluminum finger pulls. No lock. Shipped assembled in 2 cartons. Glass doors shipped separately.

PN2760CO	24 x 60 x 27	92.5	296	26.50	\$1536	\$210
PN2772CO	24 x 72 x 27	100	316	31.75	\$1628	\$224
PN2784CO	24 x 84 x 27	100	336	37	\$1805	\$248

Open storage with adjustable 5 position upper shelves with pass-throughs at back of lower shelves. Supports overlapping returns, bridges, and conference tops that have a 1" spacer (example: PN24600MR). Cannot nest under 29"H products with metal legs. Shipped Fully Assembled.

PN2730CO	24 x 30 x 27	92.5	153	14	\$969	\$133
PN2736CO	24 x 36 x 27	100	158	16	\$1015	\$142

Open storage with adjustable 5 position upper shelf with pass-through at back of lower shelf. Supports overlapping returns, bridges, and conference tops that have a 1" spacer (example: PN24600MR). Cannot nest under 29"H products with metal legs. Shipped Fully Assembled.

Required Specifications

Top finish
Base finish
Drawer/door front finish*

Optional Specifications

HP laminate
Grommet

23"H CREDENZAS

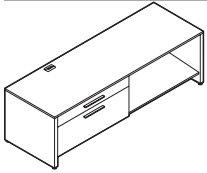

LEFT

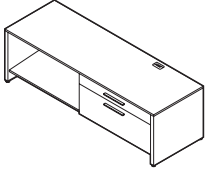

RIGHT

23"H Credenza*

MODEL#	DIMENSIONS D x W x H	FREIGHT CLASS	WT./LBS.	CUBIC FT.	LIST PRICE	HP ADD
PN2360CRL	24 x 60 x 23	100	190	19.17	\$1574	\$199
PN2366CRL	24 x 66 x 23	100	227	25	\$1610	\$208
PN2372CRL	24 x 72 x 23	100	228	23	\$1635	\$206
PN2378CRL	24 x 78 x 23	100	248	30	\$1671	\$213
PN2384CRL	24 x 84 x 23	100	266	26.83	\$1705	\$213

PN2360CRR	24 x 60 x 23	100	190	19.17	\$1574	\$199
PN2366CRR	24 x 66 x 23	100	227	25	\$1610	\$208
PN2372CRR	24 x 72 x 23	100	228	23	\$1635	\$206
PN2378CRR	24 x 78 x 23	100	248	30	\$1671	\$213
PN2384CRR	24 x 84 x 23	100	266	26.83	\$1705	\$213

Standard with 34"W box and lateral file drawer. File bars included for front-to-back letter and legal filing capability. Lock on file drawer secures both drawers. Wire management grommet on surface and internal pass-through at back of lower shelf. Supports Overlapping Return with metal leg and spacer for 23"H credenza, Overlapping Wedge Shaped Return with metal leg and spacer for 23"H credenza, and Overlapping Bridges with metal spacer for 23"H credenza. Shipped Fully Assembled.

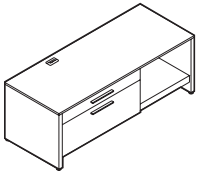

LEFT

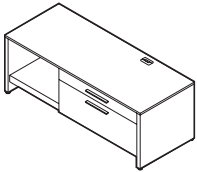

RIGHT

23"H Credenza w/Pull-Out Equipment Tray - RIGHT*

PN2360CPL	24 x 60 x 23	100	190	19.17	\$1785	\$209
PN2366CPL	24 x 66 x 23	100	233	25	\$1844	\$221
PN2372CPL	24 x 72 x 23	100	228	23	\$1902	\$218
PN2378CPL	24 x 78 x 23	100	254	30	\$1947	\$226
PN2384CPL	24 x 84 x 23	100	266	26.83	\$1983	\$226

PN2360CPR	24 x 60 x 23	100	190	19.17	\$1785	\$209
PN2366CPR	24 x 66 x 23	100	233	25	\$1844	\$221
PN2372CPR	24 x 72 x 23	100	228	23	\$1902	\$218
PN2378CPR	24 x 78 x 23	100	254	30	\$1947	\$226
PN2384CPR	24 x 84 x 23	100	266	26.83	\$1983	\$226

Standard with 34"W box and lateral file drawer. Pull-out equipment shelf can support up to 80lbs. Adjustable 5 position shelf. File bars included for front-to-back letter and legal filing capability. Lock on file drawer secures both drawers. Wire management grommet on surface and internal pass-through at back of lower shelf. Supports Overlapping Return with metal leg and spacer for 23"H credenza, Overlapping Wedge Shaped Return with metal leg and spacer for 23"H credenza, and Overlapping Bridges with metal spacer for 23"H credenza. Shipped Fully Assembled.

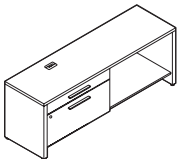

LEFT

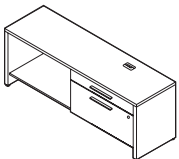

RIGHT

23"H Narrow Credenza

PN2354NCL	20 x 54 x 23	92.5	230	21	\$1539	\$210
PN2360NCL	20 x 60 x 23	92.5	240	23	\$1546	\$212

PN2354NCR	20 x 54 x 23	92.5	230	21	\$1539	\$210
PN2360NCR	20 x 60 x 23	92.5	240	23	\$1546	\$212

Specify PNxxxxNCL for **LEFT** or PNxxxxNCR for **RIGHT**.

20"D. Standard with 30"W box and lateral file drawer. File bars included for front-to-back letter and legal filing capability. Lock on file drawer secures both drawers. Wire management grommet on surface and internal pass-through at back of lower shelf. Supports Overlapping Return with metal leg and spacer for 23"H credenza, Overlapping Wedge Shaped Return with metal leg and spacer for 23"H credenza, and Overlapping Bridges with metal spacer for 23"H credenza. Shipped Fully Assembled.

Required Specifications

Top finish
Base finish
Drawer front finish

Optional Specifications

HP laminate
RSG - remove grommet

Accessories

Cushion

23"H CREDENZAS

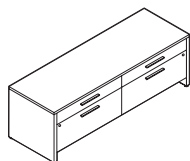

23"H Double Credenza*

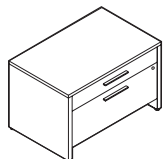

23"H Single Credenza*

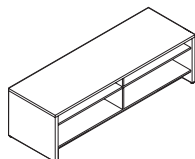

23"H Open Credenza

MODEL#	DIMENSIONS	FREIGHT CLASS	WT/LBS.	CUBIC FT.	LIST PRICE	HP ADD
--------	------------	---------------	---------	-----------	------------	--------

D x W x H

PN2372CRD	24 x 72 x 23	92.5	275	27	\$2027	\$278
-----------	--------------	------	-----	----	---------------	--------------

Standard with locking 34"W box and lateral file drawer on each side. File bars included for front-to-back letter and legal filing capability. Lock on file drawer secures both drawers. Shipped Fully Assembled.

PN2337CRS	24 x 37 x 23	100	125	15	\$1379	\$188
-----------	--------------	-----	-----	----	---------------	--------------

Standard with 34" w box and lateral file drawer. File bars included for front-to-back letter and legal filing capability. Lock on file drawer secures both drawers. Shipped Fully Assembled.

PN2360CO	24 x 60 x 23	85	276	23	\$1357	\$186
PN2372CO	24 x 72 x 23	92.5	296	27.50	\$1471	\$202
PN2384CO	24 x 84 x 23	100	316	32	\$1637	\$225

Open storage with adjustable 5 position upper shelves with pass-throughs at back of lower shelves. Supports Overlapping Return with metal leg and spacer for 23"H credenza, Overlapping Wedge Shaped Return with metal leg and spacer for 23"H credenza, and Overlapping Bridges with metal spacer for 23"H credenza. Shipped Fully Assembled.

Required Specifications

Top finish
Base finish
Drawer front finish*

Optional Specifications

HP laminate
Grommet

Accessories

Cushion

CUSHIONS FOR 23"H CREDENZAS

MODEL#	DIMENSIONS	FREIGHT CLASS	WT/LBS.	CUBIC FT.	GRADE	LIST	GRADE	LIST
PN2430CU	24 x 30 x 2.5	150	13	2.40		D x W x H		
					1	\$309	7	\$667
					2	\$367	8	\$814
					3	\$408	9	\$886
					4	\$469	10	\$1023
					5	\$557	11	\$1210
PN2433CU	24 x 33 x 2.5	150	13	2.40	1	\$337	7	\$813
					2	\$410	8	\$1010
					3	\$466	9	\$1104
					4	\$550	10	\$1287
					5	\$669	11	\$1536
					6	\$709	12	\$1846
PN2436CU	24 x 36 x 2.5	250	7	2	1	\$358	7	\$892
					2	\$441	8	\$1113
					3	\$503	9	\$1220
					4	\$596	10	\$1427
					5	\$729	11	\$1705
					6	\$775	12	\$2054
PN2439CU	24 x 39 x 2.5	150	14	2.40	1	\$382	7	\$916
					2	\$465	8	\$1137
					3	\$527	9	\$1244
					4	\$620	10	\$1451
					5	\$753	11	\$1729
					6	\$799	12	\$2078
PN2442CU	24 x 42 x 2.5	150	14	2.40	1	\$400	7	\$934
					2	\$483	8	\$1155
					3	\$545	9	\$1262
					4	\$638	10	\$1469
					5	\$771	11	\$1747
					6	\$817	12	\$2096

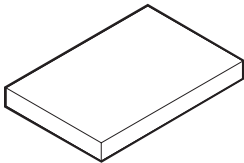

Cushion for 23"H Credenzas

Cushion attaches with Velcro strips. Fits **24" d** credenzas.

PN2027CU	20 x 27 x 2.5	150	12	2.40	1	\$273	7	\$570
					2	\$320	8	\$695
					3	\$356	9	\$755
					4	\$406	10	\$867
					5	\$481	11	\$1025
					6	\$508	12	\$1217
PN2030CU	20 x 30 x 2.5	150	12	2.40	1	\$295	7	\$592
					2	\$342	8	\$717
					3	\$378	9	\$777
					4	\$428	10	\$889
					5	\$503	11	\$1047
					6	\$530	12	\$1239

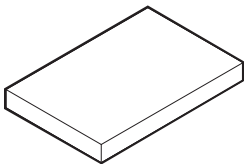

Cushion for 23"H Narrow Credenzas

Cushion attaches with Velcro strips. Fits **20" d** credenzas.

Required Specifications
Fabric

CUSHIONS FOR 23" H CREDENZAS

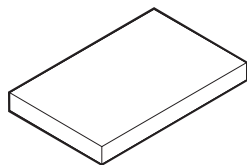

Cushion for 23" H Single Credenza**

MODEL#	DIMENSIONS	FREIGHT CLASS	WT/LBS.	CUBIC FT.	GRADE	LIST	GRADE	LIST
D x W x H								
PN2437CU	24 x 37 x 2.5	150	14	2.40	1	\$377	7	\$911
					2	\$460	8	\$1133
					3	\$522	9	\$1239
					4	\$615	10	\$1446
					5	\$748	11	\$1724
					6	\$794	12	\$2073

Cushion attaches with Velcro strips. Fits **PN2337CRS** credenza.

52" H STORAGE CABINETS

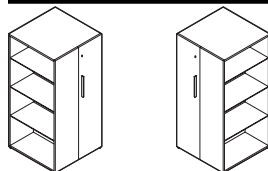

LEFT

RIGHT

52" H Tower Wardrobe w/Full Height Bookcase*

MODEL#	DIMENSIONS	FREIGHT CLASS	WT/LBS.	CUBIC FT.	LIST PRICE
PN52TWBL	24 x 24 x 52	125	129	17.33	\$1805
PN52TWBR	24 x 24 x 52	125	129	17.33	\$1805

Specify PN52TWBL for **LEFT** or PN52TWBR for **RIGHT**.

Locking wardrobe with full height bookcase. Three adjustable laminate shelves with fixed bottom laminate shelf. Coat rail. Shipped Fully Assembled.

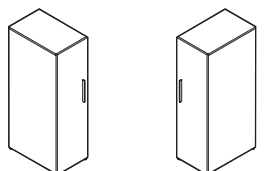

LEFT

RIGHT

52" H Wardrobe*

PN1652WDL	24 x 16 x 52	125	84	11.56	\$1075
PN1652WDR	24 x 16 x 52	125	84	11.56	\$1075

Specify PN1652WDL for **LEFT** or PN1652WDR for **RIGHT**.

Locking wardrobe with coat rail. Shipped Fully Assembled.

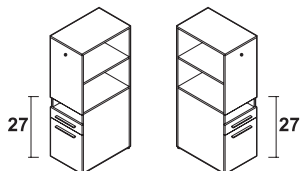

LEFT

RIGHT

52" H Storage Cabinet w/Bookshelf at 27" H*

PN57CSBFL	24 x 16 x 52	100	102	11.56	\$1543
PN57CSBFR	24 x 16 x 52	100	102	11.56	\$1543

Specify PN57CSBFL for **LEFT** or PN57CSBFR for **RIGHT**.

Open Shelf/Box/File Drawer. Lock on file drawer secures both drawers. One adjustable laminate shelf. Fixed bottom shelf aligns with **27" H** surfaces. Outside accessory hook. Shipped Fully Assembled.

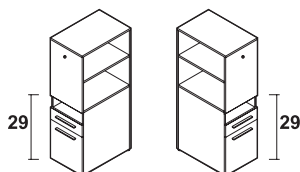

LEFT

RIGHT

52" H Storage Cabinet w/Bookshelf at 29" H

PN59CSBFL	24 x 16 x 52	100	102	11.56	\$1566
PN59CSBFR	24 x 16 x 52	100	102	11.56	\$1566

Specify PN59CSBFL for **LEFT** or PN59CSBFR for **RIGHT**.

Open Shelf/Box/File Drawer. Lock on file drawer secures both drawers. One adjustable laminate shelf. Fixed bottom shelf aligns with **29" H** surfaces. Outside accessory hook. Shipped fully assembled.

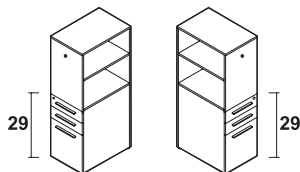

LEFT

RIGHT

52" H Storage Cabinet w/Bookshelf at 29" H

PN59CBBFL	24 x 16 x 52	100	102	11.56	\$1656
PN59CBBFR	24 x 16 x 52	100	102	11.56	\$1656

Specify PN59CBBFL for **LEFT** or PN59CBBFR for **RIGHT**.

Box/Box/File Drawer. Lock on upper box drawer secures both drawers. One adjustable laminate shelf. Fixed bottom shelf aligns with **29" H** surfaces. Outside accessory hook. Shipped fully assembled.

Required Specifications

- Top finish*
- Base finish*
- Drawer/door front finish*
- Fabric**

52" H STORAGE CABINETS

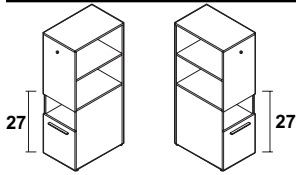

LEFT
52" H Recycling Cabinet
w/Bookshelf at 27" H

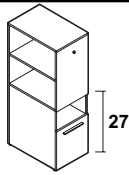

RIGHT

MODEL#	DIMENSIONS D x W x H	FREIGHT CLASS	WT/LBS.	CUBIC FT.	LIST PRICE
PN57RCSL	24 x 16 x 52	100	102	11.56	\$1447
PN57RCSR	24 x 16 x 52	100	102	11.56	\$1447

Specify PN57RCSL for **LEFT** or PN57RCSR for **RIGHT**.

Drawer with one waste bin, one recycling bin and an open shelf above. One adjustable laminate shelf. Fixed bottom shelf aligns with **27" H** surfaces. Outside accessory hook. Shipped Fully Assembled.

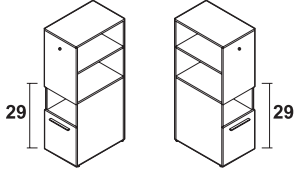

LEFT
52" H Recycling Cabinet
w/Bookshelf at 29" H

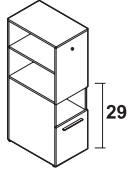

RIGHT

PN59RCSL	24 x 16 x 52	100	102	11.56	\$1464
PN59RCSR	24 x 16 x 52	100	102	11.56	\$1464

Specify PN59RCSL for **LEFT** or PN59RCSR for **RIGHT**.

Drawer with one waste bin, one recycling bin and an open shelf above. One adjustable laminate shelf. Fixed bottom shelf aligns with **29" H** surfaces. Outside accessory hook. Shipped Fully Assembled.

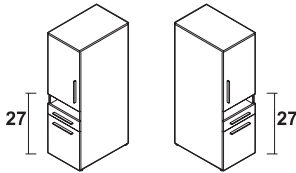

LEFT
52" H Storage Cabinet w/Door at 27" H

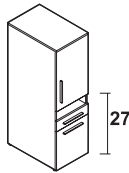

RIGHT

PN57DSBFL	24 x 16 x 52	100	102	11.56	\$1698
PN57DSBFR	24 x 16 x 52	100	102	11.56	\$1698

Specify PN57DSBFL for **LEFT** or PN57DSBFR for **RIGHT**.

Open Shelf/Box/File Drawer. Lock on file drawer secures both drawers. Upper storage cabinet with locking door and one adjustable laminate shelf inside. Door aligns with **27" H** surfaces. Shipped Fully Assembled.

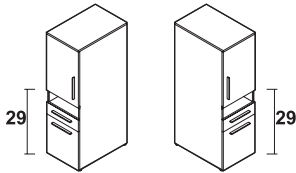

LEFT
52" H Storage Cabinet w/Door at 29" H

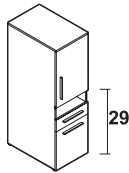

RIGHT

PN59DSBFL	24 x 16 x 52	100	102	11.56	\$1731
PN59DSBFR	24 x 16 x 52	100	102	11.56	\$1731

Specify PN59DSBFL for **LEFT** or PN59DSBFR for **RIGHT**.

Open Shelf/Box/File Drawer. Lock on file drawer secures both drawers. Upper storage cabinet with locking door and one adjustable laminate shelf inside. Door aligns with **29" H** surfaces. Shipped Fully Assembled.

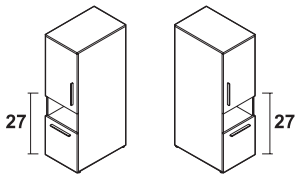

LEFT
52" H Recycling Cabinet w/Door at 27" H

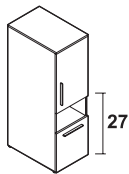

RIGHT

PN57DRCSL	24 x 16 x 52	100	102	11.56	\$1504
PN57DRCSR	24 x 16 x 52	100	102	11.56	\$1504

Specify PN57DRCSL for **LEFT** or PN57DRCSR for **RIGHT**.

Upper storage cabinet with locking door. Drawer with one waste bin, one recycling bin, and an open shelf above. One adjustable laminate shelf inside locking cabinet door. Door aligns with **27" H** surfaces. Shipped Fully Assembled.

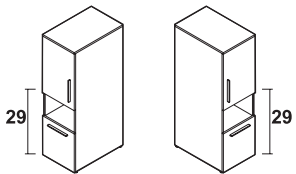

LEFT
52" H Recycling Cabinet w/Door at 29" H

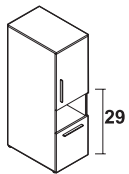

RIGHT

PN59DRCSL	24 x 16 x 52	100	102	11.56	\$1536
PN59DRCSR	24 x 16 x 52	100	102	11.56	\$1536

Specify PN59DRCSL for **LEFT** or PN59DRCSR for **RIGHT**.

Upper storage cabinet with locking door. Drawer with one waste bin, one recycling bin, and an open shelf above. One adjustable laminate shelf inside locking cabinet door. Door aligns with **29" H** surfaces. Shipped Fully Assembled.

Required Specifications

- Top finish
- Base finish
- Drawer/door front finish

52" H STORAGE CABINETS

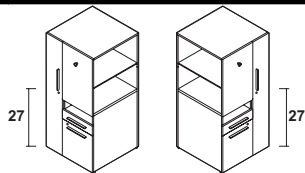

LEFT **RIGHT**

52" H Storage Tower w/Wardrobe, Shelf and Bookshelf at 27" H

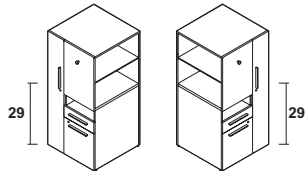

LEFT **RIGHT**

52" H Storage Tower w/Wardrobe, Shelf and Bookshelf at 29" H

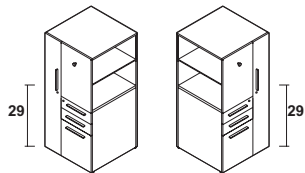

LEFT **RIGHT**

52" H Storage Tower w/Wardrobe, and Bookshelf at 29" H

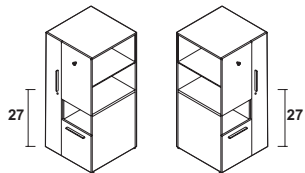

LEFT **RIGHT**

52" H Storage Tower w/Wardrobe, Shelf, Recycling and Bookshelf at 27" H

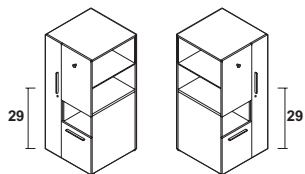

LEFT **RIGHT**

52" H Storage Tower w/Wardrobe, Shelf, Recycling and Bookshelf at 29" H

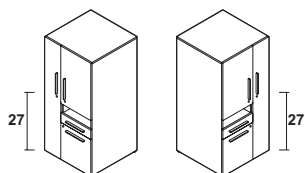

LEFT **RIGHT**

52" H Storage Tower w/Wardrobe, Shelf/Box/File and Door at 27" H

MODEL#	DIMENSIONS	FREIGHT CLASS	WT/LBS.	CUBIC FT.	LIST PRICE
--------	------------	---------------	---------	-----------	------------

D x W x H

PN57TSBFL	24 x 24 x 52	92.5	225	21	\$1855
PN57TSBFR	24 x 24 x 52	92.5	225	21	\$1855

Specify PN57TSBFL for **LEFT** or PN57TSBFR for **RIGHT**.

Open Shelf/Box/File drawer. Lock on file drawer secures both drawers. One adjustable laminate shelf. Fixed bottom shelf aligns with **27" H** surfaces. Outside accessory hook and locking wardrobe with coat rail. Shipped Fully Assembled.

PN59TSBFL	24 x 24 x 52	92.5	225	21	\$1570
PN59TSBFR	24 x 24 x 52	92.5	225	21	\$1570

Specify PN59TSBFL for **LEFT** or PN59TSBFR for **RIGHT**.

Open Shelf/Box/File drawer. Lock on file drawer secures both drawers. One adjustable laminate shelf. Fixed bottom shelf aligns with **29" H** surfaces. Outside accessory hook and locking wardrobe with coat rail. Shipped Fully Assembled.

PN59TBBFL	24 x 24 x 52	92.5	250	21	\$2142
PN59TBBFR	24 x 24 x 52	92.5	250	21	\$2142

Specify PN59TBBFL for **LEFT** or PN59TBBFR for **RIGHT**.

Box/Box/File drawer. Lock on upper box drawer secures file and lower box drawer. One adjustable laminate shelf. Fixed bottom shelf aligns with **29" H** surfaces. Outside accessory hook and locking wardrobe with coat rail. Shipped fully assembled.

PN57RTSL	24 x 24 x 52	92.5	238	21	\$1991
PN57RTSR	24 x 24 x 52	92.5	238	21	\$1991

Specify PN57RTSL for **LEFT** or PN57RTSR for **RIGHT**.

Drawer with one waste and one recycling bin. Open shelf above. One adjustable laminate shelf. Fixed bottom shelf aligns with **27" H** surfaces. Outside accessory hook. Locking wardrobe with coat rail. Shipped Fully Assembled.

PN59RTSL	24 x 24 x 52	92.5	238	21	\$1991
PN59RTSR	24 x 24 x 52	92.5	238	21	\$1991

Specify PN59RTSL for **LEFT** or PN59RTSR for **RIGHT**.

Drawer with one waste and one recycling bin. Open shelf above. One adjustable laminate shelf. Fixed bottom shelf aligns with **29" H** surfaces. Outside accessory hook. Locking wardrobe with coat rail. Shipped Fully Assembled.

PN57SBFTL	24 x 24 x 52	92.5	234	21	\$2085
PN57SBFTR	24 x 24 x 52	92.5	234	21	\$2085

Specify PN57SBFTL for **LEFT** or PN57SBFTR for **RIGHT**.

Open Shelf/Box/File drawer. Lock on file drawer secures both drawers. Upper storage cabinet with locking door and one adjustable laminate shelf inside. Door aligns with **27" H** surfaces. Locking wardrobe with coat rail. Shipped Fully Assembled.

Required Specifications

- Top finish
- Base finish
- Drawer/door front finish

52" H STORAGE CABINETS

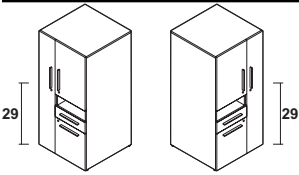

LEFT RIGHT
52" H Storage Tower w/Wardrobe, Shelf/Box/File and Door at 29" H

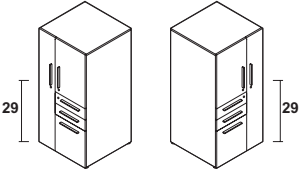

LEFT RIGHT
52" H Storage Tower w/Wardrobe, Shelf, Box/Box/File and Door at 29" H

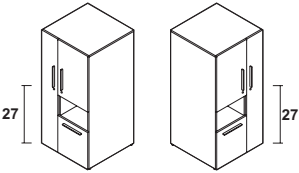

LEFT RIGHT
52" H Storage Tower w/Wardrobe, Shelf, Recycling and Door at 27" H

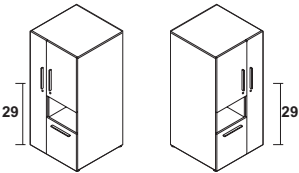

LEFT RIGHT
52" H Storage Tower w/Wardrobe, Shelf, Recycling and Door at 29" H

MODEL#	DIMENSIONS D x W x H	FREIGHT CLASS	WT/LBS.	CUBIC FT.	LIST PRICE
PN59SBFTL	24 x 24 x 52	92.5	234	21	\$2085
PN59SBFTR	24 x 24 x 52	92.5	234	21	\$2085

Specify PN59SBFTL for **LEFT** or PN59SBFTR for **RIGHT**.

Open Shelf/Box/File drawer. Lock on file drawer secures both drawers. Upper storage cabinet with locking door and one adjustable laminate shelf inside. Door aligns with **29" H** surfaces. Locking wardrobe with coat rail. Shipped Fully Assembled.

PN59BBFTL	24 x 24 x 52	92.5	234	21	\$2198
PN59BBFTR	24 x 24 x 52	92.5	234	21	\$2198

Specify PN59BBFTL for **LEFT** or PN59BBFTR for **RIGHT**.

Box/Box/File drawer. Lock on upper box drawer secures file and lower box drawers. Upper storage cabinet with locking door and one adjustable laminate shelf inside. Door aligns with **29" H** surfaces. Locking wardrobe with coat rail. Shipped fully assembled.

PN57DRTSL	24 x 24 x 52	92.5	234	21	\$2122
PN57DRTSR	24 x 24 x 52	92.5	234	21	\$2122

Specify PN57DRTSL for **LEFT** or PN57DRTSR for **RIGHT**.

Drawer with one waste and one recycling bin Open shelf above. Upper storage cabinet with locking door and one adjustable laminate shelf inside. Door aligns with **27" H** surfaces. Locking wardrobe with coat rail. Shipped Fully Assembled.

PN59DRTSL	24 x 24 x 52	92.5	234	21	\$2122
PN59DRTSR	24 x 24 x 52	92.5	234	21	\$2122

Specify PN59DRTSL for **LEFT** or PN59DRTSR for **RIGHT**.

Drawer with one waste and one recycling bin Open shelf above. Upper storage cabinet with locking door and one adjustable laminate shelf inside. Door aligns with **29" H** surfaces. Locking wardrobe with coat rail. Shipped Fully Assembled.

Required Specifications

- Top finish
- Base finish
- Drawer/door front finish

66" H STORAGE CABINETS

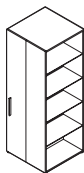
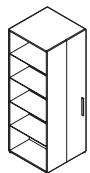

LEFT
66" H Tower Wardrobe w/Full Height Bookcase



LEFT
66" H Wardrobe

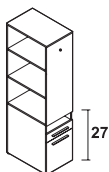
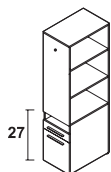

LEFT
66" H Storage Cabinet w/Bookshelf at 27" H

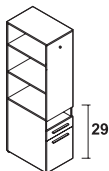
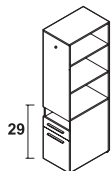

LEFT
66" H Storage Cabinet w/Bookshelf at 29" H

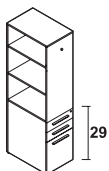
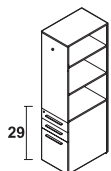

LEFT
66" H Storage Cabinet w/Bookshelf at 29" H

MODEL# DIMENSIONS FREIGHT CLASS WT/LBS. CUBIC FT. LIST PRICE

D x W x H

PN66TWBL	24 x 24 x 66	125	165	22	\$2094
PN66TWBR	24 x 24 x 66	125	165	22	\$2094

Specify PN66TWBL for **LEFT** or PN66TWBR for **RIGHT**.

Locking wardrobe and full height bookcase. Four adjustable laminate shelves with fixed bottom laminate shelf. Coat rail. Shipped Fully Assembled.

PN1666WDL	24 x 16 x 66	125	106	14.67	\$1215
PN1666WDR	24 x 16 x 66	125	106	14.67	\$1215

Specify PN1666WDL for **LEFT** or PN1666WDR for **RIGHT**.

Locking wardrobe with coat rail and fixed shelf above. Shipped Fully Assembled.

PN67CSBFL	24 x 16 x 66	100	130	14.67	\$1659
PN67CSBFR	24 x 16 x 66	100	130	14.67	\$1659

Specify PN67CSBFL for **LEFT** or PN67CSBFR for **RIGHT**.

Open Shelf/Box/File Drawer. Lock on file drawer secures both drawers. Two adjustable laminate shelves. Fixed bottom shelf aligns with **27" H** surfaces. Outside accessory hook. Shipped Fully Assembled.

PN69CSBFL	24 x 16 x 66	100	130	14.67	\$1659
PN69CSBFR	24 x 16 x 66	100	130	14.67	\$1659

Specify PN69CSBFL for **LEFT** or PN69CSBFR for **RIGHT**.

Open Shelf/Box/File Drawer. Lock on file drawer secures both drawers. Two adjustable laminate shelves. Fixed bottom shelf aligns with **29" H** surfaces. Outside accessory hook. Shipped Fully Assembled.

PN69CBBFL	24 x 16 x 66	100	130	14.67	\$1774
PN69CBBFR	24 x 16 x 66	100	130	14.67	\$1774

Specify PN69CBBFL for **LEFT** or PN69CBBFR for **RIGHT**.

Box/Box/File Drawer. Lock on upper box drawer secures file and lower box drawer. Two adjustable laminate shelves. Fixed bottom shelf aligns with **29" H** surfaces. Outside accessory hook. Shipped fully assembled.

Required Specifications

- Top finish
- Base finish
- Drawer/door front finish

66" H STORAGE CABINETS

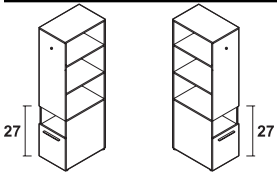

LEFT **RIGHT**
66" H Recycling Cabinet
w/Bookshelf at 27" H

MODEL#	DIMENSIONS D x W x H	FREIGHT CLASS	WT/LBS.	CUBIC FT.	LIST PRICE
PN67RCSL	24 x 16 x 66	100	130	14.67	\$1592
PN67RCSR	24 x 16 x 66	100	130	14.67	\$1592

Specify PN67RCSL for **LEFT** or PN67RCSR for **RIGHT**.

Drawer with one waste bin and one recycling bin. Open shelf above. Two adjustable laminate shelves. Fixed bottom shelf aligns with **27" H** surfaces. Outside accessory hook. Shipped Fully Assembled.

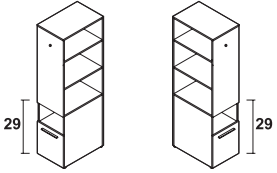

LEFT **RIGHT**
66" H Recycling Cabinet
w/Bookshelf at 29" H

PN69RCSL	24 x 16 x 66	100	130	14.67	\$1592
PN69RCSR	24 x 16 x 66	100	130	14.67	\$1592

Specify PN69RCSL for **LEFT** or PN69RCSR for **RIGHT**.

Drawer with one waste bin and one recycling bin. Open shelf above. Two adjustable laminate shelves. Fixed bottom shelf aligns with **29" H** surfaces. Outside accessory hook. Shipped Fully Assembled.

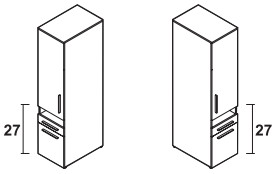

LEFT **RIGHT**
66" H Storage Cabinet w/Door at 27" H

PN67DSBFL	24 x 16 x 66	100	130	14.67	\$1759
PN67DSBFR	24 x 16 x 66	100	130	14.67	\$1759

Specify PN67DSBFL for **LEFT** or PN67DSBFR for **RIGHT**.

Open Shelf/Box/File Drawer. Lock on file drawer secures both drawers. Upper storage cabinet with locking door and two adjustable laminate shelves inside. Door aligns with **27" H** surfaces. Shipped Fully Assembled.

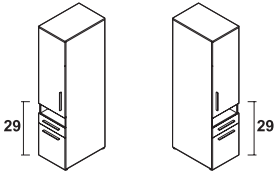

LEFT **RIGHT**
66" H Storage Cabinet w/Door at 29" H

PN69DSBFL	24 x 16 x 66	100	130	14.67	\$1820
PN69DSBFR	24 x 16 x 66	100	130	14.67	\$1820

Specify PN69DSBFL for **LEFT** or PN69DSBFR for **RIGHT**.

Open Shelf/Box/File Drawer. Lock on file drawer secures both drawers. Upper storage cabinet with locking door and two adjustable laminate shelves inside. Door aligns with **29" H** surfaces. Shipped Fully Assembled.

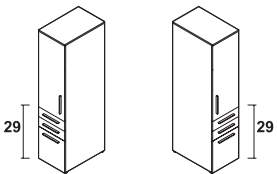

LEFT **RIGHT**
66" H Storage Cabinet w/Door at 29" H

PN69DBBFL	24 x 16 x 66	100	130	14.67	\$1932
PN69DBBFR	24 x 16 x 66	100	130	14.67	\$1932

Specify PN69DBBFL for **LEFT** or PN69DBBFR for **RIGHT**.

Box/Box/File Drawer. Lock on upper box drawer secures file and lower box drawer. Upper storage cabinet with locking door and two adjustable laminate shelves inside. Door aligns with **29" H** surfaces. Shipped Fully Assembled.

Required Specifications

- Top finish
- Base finish
- Drawer/door front finish

66" H STORAGE CABINETS

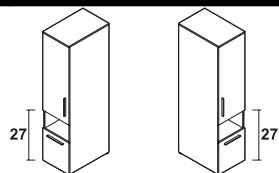

LEFT

RIGHT

66" H Recycling Cabinet w/Door at 27" H

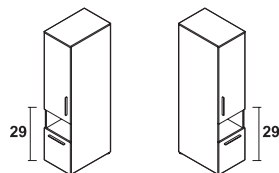

LEFT

RIGHT

66" H Recycling Cabinet w/Door at 29" H

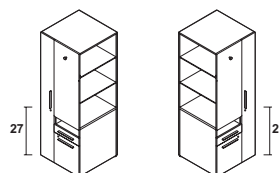

LEFT

RIGHT

66" H Storage Tower w/Wardrobe, Shelf, Box/File and Bookshelf at 27" H

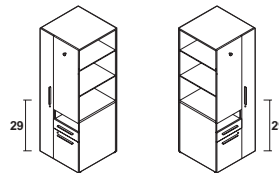

LEFT

RIGHT

66" H Storage Tower w/Wardrobe, Shelf, Box/File and Bookshelf at 29" H

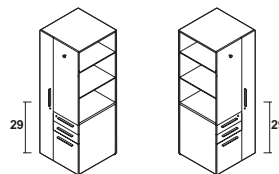

LEFT

RIGHT

66" H Storage Tower w/Wardrobe, Shelf, Box/Box/File and Bookshelf at 29" H

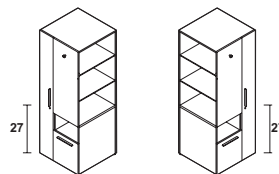

LEFT

RIGHT

66" H Storage Tower w/Wardrobe, Shelf, Recycling and Bookshelf at 27" H

MODEL#	DIMENSIONS	FREIGHT CLASS	WT/LBS.	CUBIC FT.	LIST PRICE
--------	------------	---------------	---------	-----------	------------

D x W x H

PN67DRCSL	24 x 16 x 66	100	130	14.67	\$1653
PN67DRCSR	24 x 16 x 66	100	130	14.67	\$1653

Specify PN67DRCSL for **LEFT** or PN67DRCSR for **RIGHT**.

Upper storage cabinet with locking door and two adjustable laminate shelves inside. Drawer with one waste bin, one recycling bin, and an open shelf above. Door aligns with **27" H** surfaces. Shipped Fully Assembled.

PN69DRCSL	24 x 16 x 66	100	130	14.67	\$1739
PN69DRCSR	24 x 16 x 66	100	130	14.67	\$1739

Specify PN69DRCSL for **LEFT** or PN69DRCSR for **RIGHT**.

Upper storage cabinet with locking door and two adjustable laminate shelves inside. Drawer with one waste bin, one recycling bin, and an open shelf above. Door aligns with **29" H** surfaces. Shipped fully assembled.

PN67TSBFL	24 x 24 x 66	92.5	260	26	\$2605
PN67TSBFR	24 x 24 x 66	92.5	260	26	\$2605

Specify PN67TSBFL for **LEFT** or PN67TSBFR for **RIGHT**.

Open Shelf/Box/File drawer. Lock on file drawer secures both drawers. Two adjustable laminate shelves. Fixed bottom shelf aligns with **27" H** surfaces. Outside accessory hook and locking wardrobe with coat rail. Shipped fully assembled.

PN69TSBFL	24 x 24 x 66	92.5	260	26	\$2605
PN69TSBFR	24 x 24 x 66	92.5	260	26	\$2605

Specify PN69TSBFL for **LEFT** or PN69TSBFR for **RIGHT**.

Open Shelf/Box/File drawer. Lock on file drawer secures both drawers. Two adjustable laminate shelves. Fixed bottom shelf aligns with **29" H** surfaces. Outside accessory hook and locking wardrobe with coat rail. Shipped Fully Assembled.

PN69TBBFL	24 x 24 x 66	92.5	262	26	\$2744
PN69TBBFR	24 x 24 x 66	92.5	262	26	\$2744

Specify PN69TBBFL for **LEFT** or PN69TBBFR for **RIGHT**.

Box/Box/File drawer. Lock on upper box drawer secures file and lower box drawer. Two adjustable laminate shelves. Fixed bottom shelf aligns with **29" H** surfaces. Outside accessory hook and locking wardrobe with coat rail. Shipped fully assembled.

PN67RTSL	24 x 24 x 66	92.5	260	26	\$2617
PN67RTSR	24 x 24 x 66	92.5	260	26	\$2617

Specify PN67RTSL for **LEFT** or PN67RTSR for **RIGHT**.

Drawer with one waste and one recycling bin. Open shelf above. Two adjustable laminate shelves. Fixed bottom shelf aligns with **27" H** surfaces. Outside accessory hook. Locking wardrobe with coat rail. Shipped fully assembled.

Required Specifications

- Top finish
- Base finish
- Drawer/door front finish

66" H STORAGE CABINETS

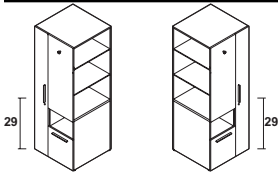

LEFT RIGHT

66" H Storage Tower w/Wardrobe, Shelf, Recycling and Bookshelf at 29" H

MODEL#	DIMENSIONS D x W x H	FREIGHT CLASS	WT./LBS.	CUBIC FT.	LIST PRICE
PN69RTSL	24 x 24 x 66	92.5	260	26	\$2617
PN69RTSR	24 x 24 x 66	92.5	260	26	\$2617

Specify PN69RTSL for **LEFT** or PN69RTSR for **RIGHT**.

Drawer with one waste and one recycling bin. Open shelf above. Two adjustable laminate shelves. Fixed bottom shelf aligns with **29" H** surfaces. Outside accessory hook. Locking wardrobe with coat rail. Shipped Fully Assembled.

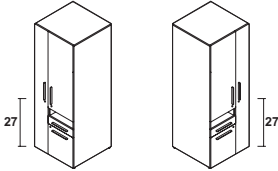

LEFT RIGHT

66" H Storage Tower w/Wardrobe, Shelf, Box/File and Door at 27" H

PN67SBFTL	24 x 24 x 66	100	257	26	\$2702
PN67SBFTR	24 x 24 x 66	100	257	26	\$2702

Specify PN67SBFTL for **LEFT** or PN67SBFTR for **RIGHT**.

Open Shelf/Box/File Drawer. Lock on file drawer secures both drawers. Upper storage cabinet with locking door and two adjustable laminate shelves inside. Door aligns with **27" H** surfaces. Outside accessory hook. Locking wardrobe with coat rail. Shipped Fully Assembled.

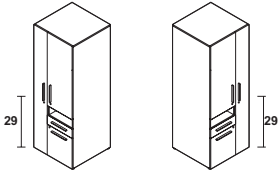

LEFT RIGHT

66" H Storage Tower w/Wardrobe, Shelf, Box/File and Door at 29" H

PN69SBFTL	24 x 24 x 66	100	257	26	\$2702
PN69SBFTR	24 x 24 x 66	100	257	26	\$2702

Specify PN69SBFTL for **LEFT** or PN69SBFTR for **RIGHT**.

Open Shelf/Box/File Drawer. Lock on file drawer secures both drawers. Upper storage cabinet with locking door and two adjustable laminate shelves inside. Door aligns with **29" H** surfaces. Locking wardrobe with coat rail. Shipped Fully Assembled.

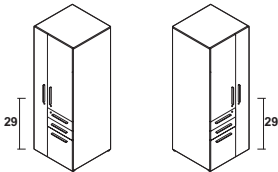

LEFT RIGHT

66" H Storage Tower w/Wardrobe, Box/Box/File and Door at 29" H

PN69BBFTL	24 x 24 x 66	100	257	26	\$2840
PN69BBFTR	24 x 24 x 66	100	257	26	\$2840

Specify PN69BBFTL for **LEFT** or PN69BBFTR for **RIGHT**.

Box/Box/File Drawer. Lock on upper box drawer secures file and lower box drawer. Upper storage cabinet with locking door and two adjustable laminate shelves inside. Door aligns with **29" H** surfaces. Locking wardrobe with coat rail. Shipped fully assembled.

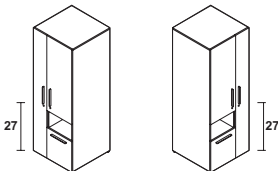

LEFT RIGHT

66" H Storage Tower w/Wardrobe, Large Shelf, Recycling and Door at 27" H

PN67DRTSL	24 x 24 x 66	100	230	26	\$2769
PN67DRTSR	24 x 24 x 66	100	230	26	\$2769

Specify PN67DRTSL for **LEFT** or PN67DRTSR for **RIGHT**.

Drawer with one waste and one recycling bin. Open shelf above. Upper storage cabinet with locking door and two adjustable laminate shelves inside. Door aligns with **27" H** surfaces. Locking wardrobe with coat rail. Shipped Fully Assembled.

Required Specifications

- Top finish
- Base finish
- Drawer/door front finish

66" H STORAGE CABINETS

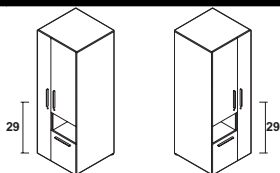

LEFT

RIGHT

66" H Storage Tower w/Wardrobe,
Large Shelf, Recycling and Door at 29" H

MODEL#	DIMENSIONS D x W x H	FREIGHT CLASS	WT/LBS.	CUBIC FT.	LIST PRICE
PN69DRTSL	24 x 24 x 66	100	230	26	\$2769
PN69DRTSR	24 x 24 x 66	100	230	26	\$2769

Specify PN69DRTSL for **LEFT** or PN69DRTSR for **RIGHT**.

Drawer with one waste and one recycling bin. Open shelf above. Upper storage cabinet with locking door and two adjustable laminate shelves inside. Door aligns with 29" H surfaces. Locking wardrobe with coat rail. Shipped Fully Assembled.

MOBILE PEDESTALS

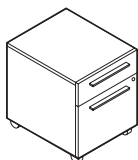

20.9" H Mobile Pedestal

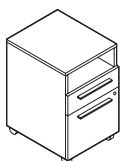

25.4" H Mobile Pedestal



25.4" H Mobile Pedestal



26.8" H Mobile Pedestal

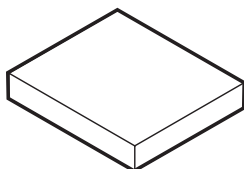

Pedestal Cushion*

MODEL#	DIMENSIONS	FREIGHT CLASS	WT/LBS.	CUBIC FT.	LIST PRICE	HP ADD
PN22MBF	22 x 16 x 20.9	85	79	5.75	\$967	\$102

Box/File drawer. Lock on box drawer secures both drawers. Front casters are locking. Shipped Fully Assembled.

PN25MSBF	22 x 16 x 25.4	92.5	80	7	\$1025	\$110
----------	----------------	------	----	---	--------	-------

Open Shelf/Box/File drawer. Lock on file drawer secures both drawers. Front casters are locking. Shipped Fully Assembled.

PN25MBBF	22 x 16 x 25.4	92.5	95	8	\$1080	\$131
----------	----------------	------	----	---	--------	-------

Box/Box/File drawer. Lock on file drawer secures file and lower box drawer. Front casters are locking. Shipped Fully Assembled.

PN27MFF	22 x 16 x 26.8	85	101	8	\$1058	\$121
---------	----------------	----	-----	---	--------	-------

File/File. Lock on lower file drawer secures both drawers. Front casters are locking. Shipped assembled in 1 carton.

- 26.8" H mobile storage can only be used with 29" H Princeton products that have laminate end panels/gables. 29" H units with HAT channels have underside clearance of only 25.9" H.

PN1622CU	21 x 16 x 2.5	125	6	.90	1	\$193	7	\$432
					2	\$231	8	\$532
					3	\$260	9	\$580
					4	\$301	10	\$670
					5	\$360	11	\$795
					6	\$380	12	\$948

For **PN22MBF** mobile pedestals.

Required Specifications

Top finish
Base finish
Drawer/door front finish
Fabric*

Optional Specifications

HP laminate

Accessories

Pedestal cushion

MOBILE LATERAL FILES

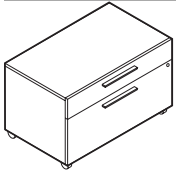

20.5”h Mobile Lateral File*

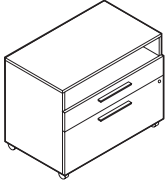

25.5”h Mobile Lateral File

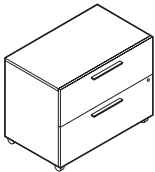

27”H Mobile Lateral File

MODEL#	DIMENSIONS	FREIGHT CLASS	WT/LBS.	CUBIC FT.	LIST PRICE	HP ADD
--------	------------	---------------	---------	-----------	------------	--------

	D x W x H					
PN22MLBF	22 x 35.5 x 20.5	100	132	14	\$1524	\$209

Box/File drawer. Lock on file drawer secures both drawers. File bars included for front-to-back letter and legal filing capability. Front casters are locking. Shipped Fully Assembled. Can fit under 29”H and 27”H credenzas for mobile lateral file with or without a cushion. Can fit under 23”H credenzas without cushion only.

PN25MLSBF	22 x 35.5 x 25.5	100	138	16	\$1595	\$219
-----------	------------------	-----	-----	----	---------------	--------------

Open Shelf/Box/File drawer. Lock on file drawer secures both drawers. File bars included for front-to-back letter and legal filing capability. Front casters are locking. Shipped Fully Assembled. Can fit under 29”H credenzas for mobile lateral file without cushion only.

PN27MLFF	22 x 35.5 x 27	92.5	170	16	\$1664	\$227
----------	----------------	------	-----	----	---------------	--------------

File/File drawer. Lock on bottom file drawer secures both drawers. File bars included for front-to-back letter and legal filing capability. Front casters are locking. Shipped Fully Assembled. Can fit under 29”H credenzas for mobile lateral file without cushion only.

- 27”H mobile pedestals can only be used with 29”H Princeton products that have laminate end panels/gables. Princeton products with metal legs will not accommodate 27”H mobile units.

CUSHIONS FOR MOBILE LATERAL FILE

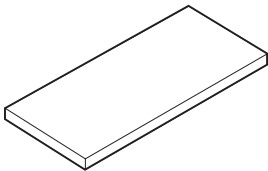

Mobile Lateral File Cushion**

MODEL#	DIMENSIONS	FREIGHT CLASS	WT/LBS.	CUBIC FT.	GRADE	LIST	GRADE	LIST
--------	------------	---------------	---------	-----------	-------	------	-------	------

PN3622CU	21 x 35.5 x 2.5	150	14	2.40	1	\$387	7	\$863
					2	\$460	8	\$1060
					3	\$516	9	\$1154
					4	\$600	10	\$1337
					5	\$719	11	\$1586
					6	\$759	12	\$1896

For **PN21MLSF** and **PN22MLBF** mobile lateral files.

Required Specifications

Fabric**
 Top finish (Mobile Laterals)
 Base finish (Mobile Laterals)
 Door/drawer front finish (Mobile Laterals)

Optional Specifications

HP laminate (Mobile Laterals)

Accessories

Cushion*

STOOLS

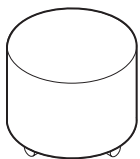

Round Mobile Stool

MODEL#	DIMENSIONS	FREIGHT CLASS	WT/LBS.	CUBIC FT.	LIST PRICE
	D x W x H				
PN1920ST	19 x 19 x 19.5	250	20	5.50	\$744

Laminate base for use with cushion. **CANNOT BE USED WITHOUT CUSHION. Cushion sold separately.** Six casters.

• **NOTE: Maximum weight capacity is 200 lbs.**

• Recommended for carpet applications.

CUSHION FOR MOBILE STOOL

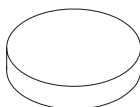

Cushion for Round Mobile Stool*

MODEL#	DIMENSIONS	FREIGHT CLASS	WT/LBS.	CUBIC FT.	GRADE	LIST	GRADE	LIST
SEAT-PN1920ST	--	150	8	1.60	1	\$266	7	\$471
					2	\$299	8	\$540
					3	\$322	9	\$594
					4	\$355	10	\$653
					5	\$404	11	\$777
					6	\$425	12	\$908

To be used with PN1920ST.

PLANTERS

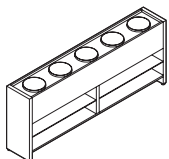

Five Pot Planter**

MODEL#	DIMENSIONS	FREIGHT CLASS	WT/LBS.	CUBIC FT.	LIST PRICE
PN7229PL	12 x 72 x 29	100	124	14.50	\$1410

Five plastic pots - specify Black (**BK**) or White (**WT**). Adjustable 3 position laminate shelves/open pass through. Shipped fully assembled.

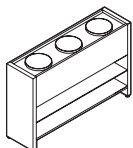

Three Pot Planter**

PN4229PL	12 x 42 x 29	92.5	86	8.46	\$1074
----------	--------------	------	----	------	---------------

Three plastic pots - specify Black (**BK**) or White (**WT**). Adjustable 3 position laminate shelf/open pass through. Shipped fully assembled.

DIVIDER SHELVES

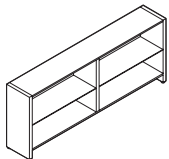

72" w Divider Shelf

MODEL#	DIMENSIONS	FREIGHT CLASS	WT/LBS.	CUBIC FT.	LIST PRICE
PN7229BGS	12 x 72 x 29	125	124	18	\$1167

Fixed laminate shelves/open pass through. Shipped fully assembled.

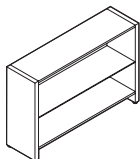

42" w Divider Shelf

PN4229BGS	12 x 42 x 29	125	86	11	\$940
-----------	--------------	-----	----	----	--------------

Fixed laminate shelf/open pass through. Shipped fully assembled.

Required Specifications

- Fabric*
- Planter pot finish**
- Top finish
- Base finish

BOOKSHELVES

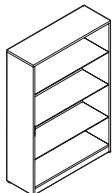

Bookshelf w/Laminate Shelves

MODEL#	DIMENSIONS D x W x H	FREIGHT CLASS	WT/LBS.	CUBIC FT.	LIST PRICE	HP ADD
PN2429BLS	12 x 24 x 29	70	37	2	\$717	\$114
PN2452BLS	12 x 24 x 52	70	60	3	\$908	N/A
PN2466BLS	12 x 24 x 66	70	74	4	\$998	N/A
PN3029BLS	12 x 30 x 29	70	44	2	\$806	\$132
PN3052BLS	12 x 30 x 52	65	68	3	\$941	N/A
PN3066BLS	12 x 30 x 66	70	79	4	\$1038	N/A
PN3629BLS	12 x 36 x 29	70	66	3	\$866	\$142
PN3652BLS	12 x 36 x 52	70	80	4	\$991	N/A
PN3666BLS	12 x 36 x 66	70	106	5	\$1091	N/A

66"H models have four adjustable shelves. 52"H models have 3 adjustable shelves. 29"H models have 1 adjustable shelf. Shipped Fully Assembled.

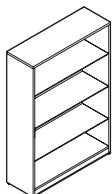

Bookshelf w/Glass Shelves

PN2429BGS	12 x 24 x 29	70	37	2	\$747	\$114
PN2452BGS	12 x 24 x 52	70	60	3	\$1105	N/A
PN2466BGS	12 x 24 x 66	70	74	4	\$1316	N/A
PN3029BGS	12 x 30 x 29	70	44	2	\$863	\$132
PN3052BGS	12 x 30 x 52	65	68	3	\$1192	N/A
PN3066BGS	12 x 30 x 66	70	79	4	\$1373	N/A
PN3629BGS	12 x 36 x 29	70	66	3	\$862	\$142
PN3652BGS	12 x 36 x 52	70	80	4	\$1295	N/A
PN3666BGS	12 x 36 x 66	70	106	5	\$1520	N/A

66"H models have four adjustable shelves. 52"H models have 3 adjustable shelves. 29"H models have 1 adjustable shelf. Shipped Fully Assembled.

DESKTOP AND OVERHEAD STORAGE

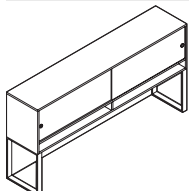

Hutch w/Laminate Doors*

MODEL#	DIMENSIONS	FREIGHT CLASS	WT/LBS.	CUBIC FT.	LIST PRICE
PN3560LCH	16 x 60 x 35	125	131	18	\$1831
PN3572LCH	16 x 72 x 35	125	135	21	\$1895
PN3584LCH	16 x 84 x 35	150	145	25	\$2033

Sliding laminate doors in upper plastic track. Recessed brushed aluminum finger pulls. No lock. Metal hutch supports. Laminate back board. 15.75" clearance between worksurface and underside. Shipped Partially Assembled.

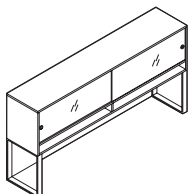

Hutch w/Glass Doors*

PN3560CH	16 x 60 x 35	125	120	19.44	\$2657
PN3572CH	16 x 72 x 35	125	144	23.33	\$2857
PN3584CH	16 x 84 x 35	150	145	25	\$3136

Sliding glass doors in upper aluminum track. Satin etched 6mm glass. Brushed aluminum finger pulls. No lock. Metal hutch supports. Laminate back board. 15.75" clearance between worksurface and underside. Shipped partially assembled in 2 cartons. Glass doors shipped separately.

Required Specifications

- Top finish
- Base finish
- Door finish (laminated doors)
- Hutch support finish*

Optional Specifications

- HP laminate (29"H bookshelves)

DESKTOP AND OVERHEAD STORAGE

MODEL# DIMENSIONS FREIGHT CLASS WT/LBS. CUBIC FT. LIST PRICE

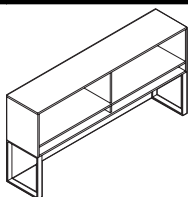

Open Hutch*

	D x W x H				
PN3560CHO	16 x 60 x 35	125	124	18	\$1598
PN3572CHO	16 x 72 x 35	125	128	21	\$1644
PN3584CHO	16 x 84 x 35	150	138	25	\$1775

Metal hutch supports. Laminate back board. 15.75" clearance between worksurface and underside. Shipped Partially Assembled.

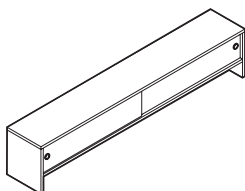

Desktop Storage w/Laminate Doors

PN1160LDS	11 x 60 x 12	100	54	6.50	\$961
PN1172LDS	11 x 72 x 12	100	62	7.75	\$1034

Sliding laminate doors in upper plastic track. Recessed brushed aluminum finger pulls. No lock. Shipped Fully Assembled.

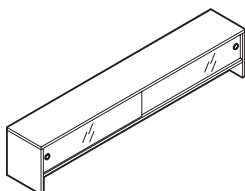

Desktop Storage w/Glass Doors

PN1160DS	11 x 60 x 12	100	43	4.58	\$1543
PN1172DS	11 x 72 x 12	100	51	5.50	\$1739

Sliding glass doors in upper aluminum track. Satin etched 6mm glass. Recessed aluminum finger pulls. No lock. Shipped assembled in 2 cartons. Glass doors shipped separately.

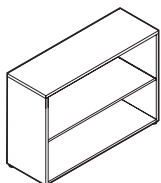

Desktop Shelf - Two High w/Laminate Shelf

PN2423LDB	12 x 24 x 23	60	45	1.50	\$454
PN3023LDB	12 x 30 x 23	60	49	1.50	\$496
PN3623LDB	12 x 36 x 23	65	53	2	\$502
PN2425LDB	12 x 24 x 25	60	47	1.50	\$454
PN3025LDB	12 x 30 x 25	65	51	2	\$496
PN3625LDB	12 x 36 x 25	65	55	2	\$502

One multiple-position adjustable laminate shelf. Shipped Fully Assembled.

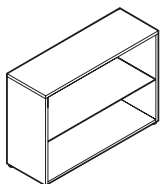

Desktop Shelf - Two High w/Glass Shelf

PN2423GDB	12 x 24 x 23	60	45	1.50	\$523
PN3023GDB	12 x 30 x 23	60	49	1.50	\$572
PN3623GDB	12 x 36 x 23	65	53	2	\$610
PN2425GDB	12 x 24 x 25	60	47	1.50	\$523
PN3025GDB	12 x 30 x 25	65	51	2	\$572
PN3625GDB	12 x 36 x 25	65	55	2	\$610

One multiple-position adjustable glass shelf. Shipped Fully Assembled.

Required Specifications

- Top finish
- Base finish
- Door finish (laminate doors)
- Hutch support finish*

DESKTOP AND OVERHEAD STORAGE

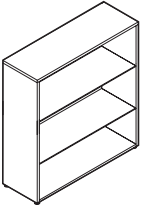

Desktop Shelf - Three High w/Laminate Shelves

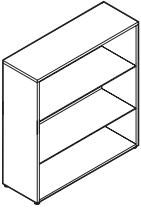

Desktop Shelf - Three High w/Glass Shelves

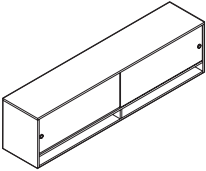

Large Overhead Storage w/Laminate Doors, Wall-Mounted

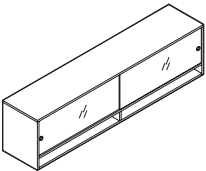

Large Overhead Storage w/Glass Doors Wall-Mounted

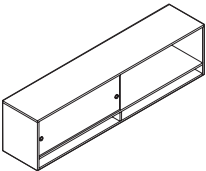

Large Overhead Storage w/Single Laminate Door, Wall-Mounted

MODEL#	DIMENSIONS D x W x H	FREIGHT CLASS	WT/LBS.	CUBIC FT.	LIST PRICE
PN2437LDB	12 x 24 x 37	65	58	2	\$567
PN3037LDB	12 x 30 x 37	70	64	3	\$603
PN3637LDB	12 x 36 x 37	65	71	3	\$627
PN2439LDB	12 x 24 x 39	65	58	2	\$567
PN3039LDB	12 x 30 x 39	70	64	3	\$603
PN3639LDB	12 x 36 x 39	65	71	3	\$627

Two multiple-position adjustable laminate shelves. Shipped Fully Assembled.

PN2437GDB	12 x 24 x 37	65	58	2	\$732
PN3037GDB	12 x 30 x 37	70	64	3	\$810
PN3637GDB	12 x 36 x 37	65	71	3	\$843
PN2439GDB	12 x 24 x 39	65	58	2	\$732
PN3039GDB	12 x 30 x 39	70	64	3	\$810
PN3639GDB	12 x 36 x 39	65	71	3	\$843

Two multiple-position adjustable glass shelves. Shipped Fully Assembled.

PN1960LWH	16 x 60 x 19	100	119	13.25	\$1350
PN1972LWH	16 x 72 x 19	100	138	16	\$1411
PN1984LWH	16 x 84 x 19	100	158	19	\$1554

Sliding laminate doors in upper plastic track. Recessed brushed aluminum finger pulls. No lock. Shipped Fully Assembled.
 • **NOTE:** Care should be taken to mount the units. Units should be mounted to wall studs using correct fasteners. Failure to do so may result in collapse of the unit and subsequent personal injury. **Mounting hardware not included.** Mounting hardware used should be based on wall material. Consult an installation professional for proper wall mounting.

PN1960WH	16 x 60 x 19	100	101	10.56	\$2108
PN1972WH	16 x 72 x 19	100	121	12.67	\$2361
PN1984WH	16 x 84 x 19	100	158	19	\$2588

Sliding glass doors in upper aluminum track. Satin etched 6mm glass. Brushed aluminum finger pulls. No lock. Shipped assembled in two cartons. Glass doors shipped separately.
 • **NOTE:** Care should be taken to mount the units. Units should be mounted to wall studs using correct fasteners. Failure to do so may result in collapse of the unit and subsequent personal injury. **Mounting hardware not included.** Mounting hardware used should be based on wall material. Consult an installation professional for proper wall mounting.

PN1960LS	16 x 60 x 19	100	117	13.25	\$1255
PN1972LS	16 x 72 x 19	100	136	16	\$1320
PN1984LS	16 x 84 x 19	100	156	19	\$1449

Sliding laminate door in upper plastic track. Recessed brushed aluminum finger pulls. No lock. Shipped Fully Assembled.
 • **NOTE:** Care should be taken to mount the units. Units should be mounted to wall studs using correct fasteners. Failure to do so may result in collapse of the unit and subsequent personal injury. **Mounting hardware not included.** Mounting hardware used should be based on wall material. Consult an installation professional for proper wall mounting.

Required Specifications

- Top finish
- Base finish
- Door finish (laminate doors)

DESKTOP AND OVERHEAD STORAGE

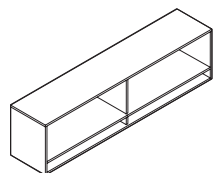

Large Overhead Storage, Wall-Mounted

MODEL#	DIMENSIONS D x W x H	FREIGHT CLASS	WT/LBS.	CUBIC FT.	LIST PRICE
PN1960WHO	16 x 60 x 19	100	112	13.25	\$1137
PN1972WHO	16 x 72 x 19	100	131	16	\$1182
PN1984WHO	16 x 84 x 19	125	151	19	\$1315

Open storage with center divider. Shipped Fully Assembled.

• **NOTE:** Care should be taken to mount the units. Units should be mounted to wall studs using correct fasteners. Failure to do so may result in collapse of the unit and subsequent personal injury. **Mounting hardware not included.** Mounting hardware used should be based on wall material. Consult an installation professional for proper wall mounting.

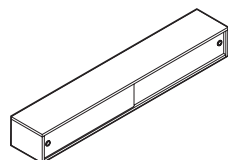

Small Overhead Storage w/Laminate Doors, Wall-Mounted

PN1260LWH	12 x 60 x 8	100	49	5.25	\$990
PN1272LWH	12 x 72 x 8	100	56	6.25	\$1074
PN1284LWH	12 x 84 x 8	100	64	8	\$1128

Sliding laminate doors in upper plastic track. Recessed brushed aluminum finger pulls. No lock. Shipped Fully Assembled.

• **NOTE:** Care should be taken to mount the units. Units should be mounted to wall studs using correct fasteners. Failure to do so may result in collapse of the unit and subsequent personal injury. **Mounting hardware not included.** Mounting hardware used should be based on wall material. Consult an installation professional for proper wall mounting.

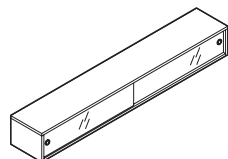

Small Overhead Storage w/Glass Doors, Wall-Mounted

PN1260WH	12 x 60 x 8	100	31	3.33	\$1937
PN1272WH	12 x 72 x 8	100	38	4	\$2183
PN1284WH	12 x 84 x 8	100	64	8	\$2307

Sliding glass doors in upper aluminum track. Satin etched 6mm glass. Brushed aluminum finger pulls. No lock. Shipped assembled in 2 cartons. Glass doors shipped separately.

• **NOTE:** Care should be taken to mount the units. Units should be mounted to wall studs using correct fasteners. Failure to do so may result in collapse of the unit and subsequent personal injury. **Mounting hardware not included.** Mounting hardware used should be based on wall material. Consult an installation professional for proper wall mounting.

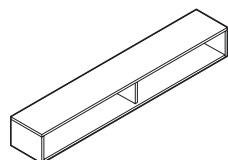

Small Overhead Storage, Wall-Mounted

PN1260WHO	12 x 60 x 8	100	45	5.25	\$760
PN1272WHO	12 x 72 x 8	100	52	6.25	\$854
PN1284WHO	12 x 84 x 8	125	60	8	\$928

Open storage shelf with center divider. Shipped Fully Assembled.

• **NOTE:** Care should be taken to mount the units. Units should be mounted to wall studs using correct fasteners. Failure to do so may result in collapse of the unit and subsequent personal injury. **Mounting hardware not included.** Mounting hardware used should be based on wall material. Consult an installation professional for proper wall mounting.

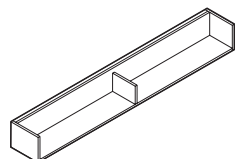

Wall-Mounted Shelf

PN1260WHS	12 x 60 x 8	150	31	5.50	\$564
PN1272WHS	12 x 72 x 8	125	37	6	\$611
PN1284WHS	12 x 84 x 8	125	44	7	\$659

Open storage shelf with center divider. Shipped Fully Assembled.

• **NOTE:** Care should be taken to mount the units. Units should be mounted to wall studs using correct fasteners. Failure to do so may result in collapse of the unit and subsequent personal injury. **Mounting hardware not included.** Mounting hardware used should be based on wall material. Consult an installation professional for proper wall mounting.

Required Specifications

- Top finish
- Base finish
- Door finish (laminated doors)

TACKBOARD NOTES

D x W x H

TACKBOARD Notes: Tackboards can be upholstered in all of the following fabrics:

Grade 1: Jenny, Quilt, Terrace, Urban, Waterfall

Grade 2: Imprint, Lola

Grade 3: Anchorage, Merge

TACKBOARDS

MODEL# DIMENSIONS FREIGHT CLASS WT/LBS. CUBIC FT. FABRIC GRD. LIST PRICE

PN1556TBH	1 x 56 x 14.5	100	9.50	1	1	\$583
					2	\$702
					3	\$842
					4	\$1006
					5	\$1157
PN1568TBH	1 x 68 x 14.5	92.5	11	1	1	\$606
					2	\$730
					3	\$873
					4	\$1048
					5	\$1203
PN1580TBH	1 x 80 x 14.5	125	10	1.50	1	\$964
					2	\$1160
					3	\$1388
					4	\$1666
					5	\$1917

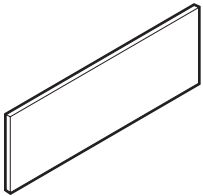

Tackboard for Hutches

Attaches with Velcro to Hutch backboard.

Required Specifications

Fabric

TACKBOARDS

MODEL# DIMENSIONS FREIGHT CLASS WT/LBS. CUBIC FT. FABRIC GRD. LIST PRICE

D x W x H

PN1560TBW	1 x 60 x 14.5	85	14	1	1	\$596
					2	\$716
					3	\$859
					4	\$1031
					5	\$1185
PN1566TBW	.62 x 66 x 14.4	85	12	1	1	\$794
					2	\$956
					3	\$1148
					4	\$1376
					5	\$1580
PN1572TBW	1 x 72 x 14.5	70	16.50	1	1	\$695
					2	\$837
					3	\$1003
					4	\$1202
					5	\$1381
PN1578TBW	.62 x 78 x 14.4	100	14	1.50	1	\$1002
					2	\$1207
					3	\$1444
					4	\$1733
					5	\$1991
PN1584TBW	.62 x 84 x 14.4	92.5	15	1.50	1	\$1090
					2	\$1310
					3	\$1572
					4	\$1882
					5	\$2165

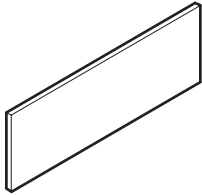

Tackboard for Overhead Storage

Attaches with adhesive-backed Velcro.

Required Specifications

Fabric

ELECTRICAL / DATA

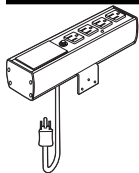

4 Outlet, 1 Telecom Blank Plate

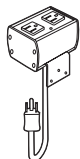

2 Outlet Power Block

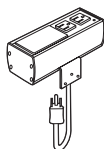

2 Outlet, 1 Telecom Blank Plate

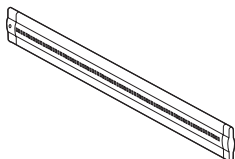

LED Task Light

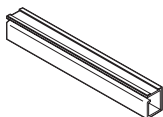

Wire Manager

MODEL#	DIMENSIONS D x W x H	FREIGHT CLASS	WT/LBS.	CUBIC FT.	LIST PRICE
PGDPS41	2.5 x 10.25 x 2.22	70	1.50	.02	\$234
4 power receptacles and 1 telecom blank plate. For mounting behind pull-out shelf or open space credenza. Tungsten (TUN) finish. 12 foot black cord. UL listed: UL153.					
PGDPS20	2.5 x 3.58 x 2.22	70	1	.01	\$168
2 power receptacles. For side mounted installation. Tungsten (TUN) finish. 12 foot black cord. UL listed: UL153.					
PGDPS21	2.5 x 6.75 x 2.22	70	1.25	.01	\$217
2 power receptacles and 1 telecom blank plate. For side mounted installation. Tungsten (TUN) finish. 12 foot black cord. UL listed: UL153.					
PLED30	1.5 x 15.5 x .5	150	2	.50	\$494
PLED50	1.5 x 23.5 x .5	150	2	.50	\$569
PLED100	1.5 x 43.5 x .5	125	3	.50	\$660
Energy efficient LED. Ultra slim design. Suitable for hanging under Hutch or Wallhung units. 6' power cord. UL listed: UL153.					
PEWM5.5	2 x 66 x 2	70	.60	.10	\$198
PEWM5	2 x 60 x 2	70	.60	.10	\$166
PEWM4.5	2 x 54 x 2	70	.50	.10	\$148
PEWM4	2 x 48 x 2	70	.50	.10	\$135
PEWM3.5	2 x 42 x 2	70	.40	.10	\$116
PEWM3	2 x 36 x 2	70	.40	.10	\$104
PEWM2.5	2 x 30 x 2	70	.30	.10	\$85
PEWM2	2 x 24 x 2	70	.30	.10	\$70
PEWM1.5	2 x 18 x 2	70	.20	.10	\$55
PEWM1	2 x 12 x 2	70	.20	.10	\$40
Plastic tray flexes to receive and hold electrical and data wires. Quickly attaches with two strips of double-sided tape. Black (BLK) only.					

TABLES

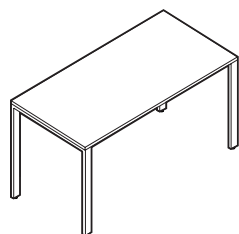

29" H Table

MODEL#	DIMENSIONS	FREIGHT CLASS	WT/LBS.	CUBIC FT.	LIST PRICE	HP ADD
D x W x H						
PN242429	24 x 24 x 29	150	53	10	\$1028	\$144
PN482429	24 x 48 x 29	125	71	10.50	\$1097	\$156
PN542429	24 x 54 x 29	125	83	13	\$1302	\$183
PN602429	24 x 60 x 29	125	86	13	\$1323	\$186
PN662429	24 x 66 x 29	125	90	14	\$1352	\$188
PN722429	24 x 72 x 29	150	97	21	\$1361	\$189
PN782429	24 x 78 x 29	150	101	21	\$1492	\$209
PN842429	24 x 84 x 29	150	106	22	\$1612	\$225
PN902429	24 x 90 x 29	150	110	23	\$1694	\$237
PN962429	24 x 96 x 29	150	123	24	\$1754	\$245
PN303029	30 x 30 x 29	150	66	12	\$1131	\$159
PN483029	30 x 48 x 29	150	77	13	\$1205	\$168
PN543029	30 x 54 x 29	150	94	16	\$1419	\$199
PN603029	30 x 60 x 29	125	99	16.50	\$1428	\$200
PN663029	30 x 66 x 29	125	105	17	\$1468	\$206
PN723029	30 x 72 x 29	150	112	23	\$1492	\$209
PN783029	30 x 78 x 29	150	119	26	\$1630	\$227
PN843029	30 x 84 x 29	150	132	27	\$1749	\$245
PN903029	30 x 90 x 29	150	139	33	\$1830	\$256
PN963029	30 x 96 x 29	150	143	29.50	\$1874	\$261
PN363629	36 x 36 x 29	150	80	15	\$1203	\$168
PN603629	36 x 60 x 29	150	113	20	\$1638	\$227
PN663629	36 x 66 x 29	150	119	21	\$1692	\$236
PN723629	36 x 72 x 29	150	128	29	\$1718	\$239
PN783629	36 x 78 x 29	150	135	31	\$1694	\$237
PN843629	36 x 84 x 29	150	150	32	\$1812	\$253
PN903629	36 x 90 x 29	150	161	33.50	\$1947	\$273
PN963629	36 x 96 x 29	150	164	35	\$1968	\$274
PN424229	42 x 42 x 29	150	96	17	\$1388	\$195
PN604229	42 x 60 x 29	150	125	22	\$1712	\$239
PN664229	42 x 66 x 29	150	134	23	\$1767	\$248
PN724229	42 x 72 x 29	150	142	32	\$1802	\$252
PN784229	42 x 78 x 29	150	150	35	\$2002	\$280
PN844229	42 x 84 x 29	150	167	36	\$2184	\$303
PN904229	42 x 90 x 29	150	176	38	\$2340	\$327
PN964229	42 x 96 x 29	150	182	40	\$2387	\$332
PN484829	48 x 48 x 29	150	114	21	\$1434	\$201
PN604829	48 x 60 x 29	150	138	26	\$1775	\$248
PN664829	48 x 66 x 29	150	147	27	\$1836	\$256
PN724829	48 x 72 x 29	150	158	38	\$1861	\$260
PN784829	48 x 78 x 29	150	166	40	\$2106	\$294
PN844829	48 x 84 x 29	150	184	42	\$2285	\$319
PN904829	48 x 90 x 29	150	193	43	\$2439	\$337
PN964829	48 x 96 x 29	150	202	45	\$2478	\$346

Freestanding. 1" x 2.5" open metal frame legs with levelers, finished in Tungsten (TTU), Designer White (TDW) or Black (TBL). Metal support hat channel(s) provided on tables exceeding 54" in width. Shipped in 2 cartons.

Required Specifications

Top finish
Leg finish

Optional Specifications

HP laminate

Accessories

Wire manager
Desktop screen

TABLES

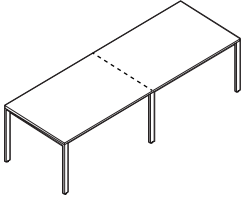

29" H Table with Center Leg

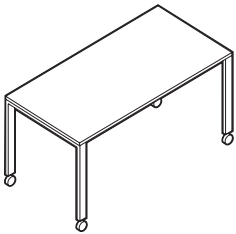

29" H Table with Casters

MODEL#	DIMENSIONS	FREIGHT CLASS	WT/LBS.	CUBIC FT.	LIST PRICE	HP ADD
--------	------------	---------------	---------	-----------	------------	--------

D x W x H

PN1203629	36 x 120 x 29	250	221	86.83	\$2995	\$416
PN1443629	36 x 144 x 29	250	246	97.31	\$3174	\$441
PN1204229	42 x 120 x 29	250	246	101.8	\$3116	\$431
PN1444229	42 x 144 x 29	250	287	110.7	\$3286	\$454
PN1204829	48 x 120 x 29	250	271	113.7	\$3300	\$456
PN1444829	48 x 144 x 29	250	291	116.7	\$3472	\$480

Freestanding. 1" x 2.5" open metal frame legs with levelers, finished in Tungsten (TTU), Designer White (TDW) or Black (TBL). 120" and 144"W with 2 piece top. Metal support hat channel(s) provided on tables exceeding 54" in width. Shipped in 4 cartons.

PN242429C	24 x 24 x 29	92.5	53	4.50	\$1061	\$151
PN482429C	24 x 48 x 29	85	71	5.26	\$1126	\$159
PN542429C	24 x 54 x 29	85	83	6.50	\$1348	\$188
PN602429C	24 x 60 x 29	85	86	6.50	\$1373	\$193
PN662429C	24 x 66 x 29	85	90	7	\$1398	\$197
PN722429C	24 x 72 x 29	85	97	7	\$1421	\$200
PN303029C	30 x 30 x 29	92.5	66	6	\$1168	\$164
PN483029C	30 x 48 x 29	100	77	9.50	\$1232	\$174
PN543029C	30 x 54 x 29	92.5	94	8	\$1466	\$206
PN603029C	30 x 60 x 29	92.5	99	8.26	\$1478	\$207
PN663029C	30 x 66 x 29	85	105	8.50	\$1510	\$210
PN723029C	30 x 72 x 29	85	112	9	\$1561	\$218
PN363629C	36 x 36 x 29	92.5	80	7.50	\$1226	\$170
PN603629C	36 x 60 x 29	92.5	113	10	\$1546	\$215
PN663629C	36 x 66 x 29	92.5	119	10.50	\$1586	\$221
PN723629C	36 x 72 x 29	100	124	14.50	\$1812	\$253
PN424229C	42 x 42 x 29	92.5	96	8.50	\$1420	\$200
PN484829C	48 x 48 x 29	150	114	21	\$1469	\$206

Freestanding. 1" x 2.5" open metal frame legs with casters, finished in Tungsten (TTU), Designer White (TDW) or Black (TBL). All casters are locking. Metal support hat channel(s) provided on tables exceeding 54" in width. Shipped in 2 cartons.

Required Specifications

Top finish
Leg finish

Optional Specifications

HP laminate

Accessories

Wire manager
Desktop screen



Zira™ is a contemporary desking solution with extensive options to personalize your workspace. Components can be freestanding for single workstation configurations, or joined together to form multiple work groups. Create a work environment that meets your worksurface needs and storage requirements - then go ahead and personalize it!

Select from the following: hundreds of components for any size or shape office, storage components that can tower to 84" high, 20 laminate finishes, 5 edge options, 9 handle options in silver, black, nickel or brass finishes, 2 glazing options with 2 frame finishes on doors and modesty panels, and lastly, work surface grommets and power blocks for your electrical needs.

Zira is your most functional solution to work environment efficiency and organization.



Tops are available in a choice of 1" or 1 1/2" thick with a variety of edge details and a top over side, edge panel design
* Shown with 1.5" thick top and Bicut Edge (CR).



Optional Frosted or Ribbed glazing on doors and modesty panels. Available with Tungsten or Black frames.



Collator option is available for the convenient storage of day-to-day documents. Available in Black or Brushed Cobalt finish.

Features and Benefits

- 45 lb. density particle board substructure with high performance thermally fused laminate
- Top over side panel design
- Worksurfaces feature preferred edging in matching color
- Available in 1" or 1.5" thick top with a variety of edge details
- 11/16" thick full modesty panel is standard
- 11/16" thick 3/4 modesty panel available on most components
- Pencil tray included in box drawer
- Lateral file drawers can accommodate legal or letter documents
- Premium full extension progressive ball bearing slides on file drawers & box drawers
- All drawer fronts edge banded with side pull opening pedestals and standard pedestal locks
- Compatible with Divide partitioning system for increased privacy and storage requirements

GENERAL INFORMATION

- Over 5300 different standard components are available
- Zira components are compatible with **Divide** partitioning panels.
- Handles, lock finish and trim color (if applicable) **MUST MATCH**
- Dimensionally compatible with the Adaptabilities series.
- For environmental certification, please visit globalfurnituregroup.com

WORKSURFACES

- Available in 1" or 1.5" thick thermally fused laminate tops with a variety of edge details
- Tops are sealed with Global's preferred edge in matching color. Woodgrain surfaces feature edging with matching printed woodgrain.
- High pressure tops are available in all Zira laminate finishes at an extended lead time. Please see model # for pricing and availability.
- Products specified with the high pressure laminate option are finished on the underside of the surface with a kraft paper backing.

CONSTRUCTION

- Constructed of 45 lb. density particleboard with high performance thermally fused laminate
- All desks are size (incrementally) accurate
- Desk drawers/storage open with side pulls and feature a French dovetail joint in front, lap joint in back. Pulls are available for these units at an upcharge, see below. All other drawers/storage feature built-in pulls available in 9 different styles
- Virtually no loose hardware
- Models with Monopost are standard with 4" Square Monopost. Optional 5" Round and 4" Round Monopost are available at no upcharge. Available in Black (**TBL**) or Tungsten (**TTU**) finish. Please Specify
- Leveling glides are standard on all floor units
- Premium full extension progressive ball bearing slides on file drawers & box drawers
- All drawer fronts edge banded with side pull opening pedestals and standard pedestal locks

HEIGHT ADJUSTABLE DESKS

- Zira height adjustable desks include a laminate chassis. **Height adjustable base mechanism sold separately.**
- Use **FTZ52SFNL** with all **ZHxx60Fxx**, **ZHxx66Fxx**, **ZHxx72Fxx** and **ZHxx60NP** models.
- Use **FTZ52LFNL** with all **ZHxx84Fxx** and **ZHxx66NP**, **ZHxx72NP** and **ZH3684NP** models.
- Use **FTZ539FSLNL** with all **ZH60xx24L/R** models.
- Steel constructed leg tubing and cross bar.
- Table frame designed with 3.15" x 1.97" rectangular outer leg with the larger tube attaching to a bracket within the pedestal.
- Powder coat finishes for bases is standard in Black (**BLK**) or Tungsten (**TUN**).
- Wire management channels available in Black (**BLK**) or Silver (**SIL**). Silver (**SIL**) complements Tungsten.
- Zira Height Adjustable desks have 2-stages and feature an adjustment range of 29.5"/30" – 49"/49.5".
- Lifts 350 pounds.
- Operates at 1.5" per second.
- All bases feature a dual actuator system with a motor driving each leg.

STANDARD RANGE COLUMNS

The 2-part lifting column is a perfect choice for a wide range of different desk applications in the office.

- Compact design where guide and actuator functions are an integrated unit
- Reinforced column and optimized motor housing design for extra strength and stability
- Max. load 800 N per column
- Max. speed 1.5"/second unloaded
- Standard installation dimension 25.4"
- Standard stroke length 19.7"
- Weight: Approximately 14.3 lbs. per column
- Column dimensions: 1.97" x 3.15" (outer profile) and 1.71" x 2.89" (inner profile)
- Motor housing dimensions: 6.97" x 3.82" x 1.81"
- Low noise level
- No visible gliding pads
- Standard Range Tables have 2-stages and feature an adjustment range of 27.5" – 45.5" (18" travel).

DESK MOUNT FRAME

- All metal parts are Black
- Cantilever length: 21.7"
- Includes all connecting hardware

CONTROL BOX

- Two leg tables come standard with a 200 W Control Box
 - Mains voltage 230 VAC, 50 Hz, or 120 VAC, 60 Hz
 - Ultra-compact; 8.25" long
 - Lightweight control box; weight is approximately 1 lb.
- Common features for the (200 W and 300 W):
- Ultra-low; only 1.5" high
- Environment: Operation Storage
 - Ambient temperature: 5 to 40 °C -10 to +50 °C
 - Relative humidity: 20 to 80 % at 30 °C 20 to 80 % at 30 °C
 - Atmospheric pressure: 700 to 1060 hPa 700 to 1060 hPa
- Compact high-power SMPS (Switch Mode Power Supply)
- Color: Black
- Protection against overload (EOP), by individual current limitation
- The control box is designed with a soft start/stop function
- Autodetection of the number and type of columns connected
- Cable grooves at the bottom to optimise cable management
- White plugs for easy recognition when mounting/dismounting
- PVC-Free™
- Low standby power consumption – only 0.1 W.
- Exchangeable standard mains cable

STANDARD HANDSET (S)

- Features Bluetooth® connection, two favorite positions and an LED reminder to prompt users to change position.
- Controller is activated by tilting the desk panel in the same direction as the desk is intended to drive.
- Pulsating orange and green LED lights remind users to change positions.
- Using the integrated Bluetooth® and downloading the Desk Control App, users can also be reminded via notifications on their computer or smart devices.
- Black only. Black cable with RJ45 modular plug. 63" long.
- PVC-Free™, featuring ZERO™. Very low power consumption in standby mode.
- Approved according to EN 60335-1 and UL962

DISPLAY HANDSET (D)

- Features Bluetooth® connection, four favorite positions, a display to guide users, and a light strip to prompt users to change position.
- Controller is activated by tilting the desk panel in the same direction as the desk is intended to drive.
- Display controller features a modern, discreet design with a glossy surface and integrated display to ensure a clean and minimalist design.
- The display provides guidance to users when operating the desk.
- Via pulsating orange and green lights, the light strip reminds users to change positions.
- Using the integrated Bluetooth® and downloading the Desk Control App, users can also be reminded via notifications on their computer or smart devices.
- Black only. Black cable with RJ45 modular plug. 63" long.
- PVC-Free™, featuring ZERO™. Very low power consumption in standby mode.
- Approved according to EN 60335-1 and UL962
- A basic handset without Bluetooth® capabilities is available and must be purchased separately, replacing the **S** or **D** handset in the field. See page 619 for details and pricing.

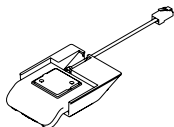
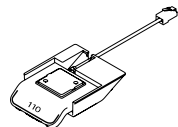
Standard handset (**S**)Display handset (**D**)**ANTI-COLLISION SENSOR**

- Features enhanced Anti-Collision protection which can limit material damage to a desk or an object if a collision occurs during driving of the desk.
- The sensor is a compact plug-in adapter based on gyroscope-technology, and it detects even slight tilting of the desk when the desk is driving up or down.
- Upon detected tilting, the system stops and drives in the opposite direction to avoid collision and damage to the desk or the object.
- The sensor can detect both hard and soft obstacles.
- The Anti-Collision Sensor is standard on all desks.
- Reacts to angle changes bigger than 0.7° per second
- Just plug it in – no mounting required
- ZERO™ power capable
- PVC-Free™

USAGE

- Ambient temperature: 41 to 104 °C
- Storage temperature: 32 to 113 °C

Approved according to:

- EN 62133 (Battery safety testing)
- UL 1642 (Lithium cells, standard test)
- UN 38.3 (transportation of Lithium batteries)
- UL 2054 (Household and commercial batteries)
- EN 60335-1 with CBH Advanced

MODESTY PANELS

- Laminate full modesty panel is standard. Laminate ¾ modesty panel is available on select models at no additional charge. Please specify (**3MP**).
- Glazing options are available on the full modesty panel, ¾ modesty panel and the 12" modesty panel (where available). Please specify. See next page for options and codes.
- 11/16" thick full modesty panel is standard on most components
- 11/16" thick ¾ modesty panel available on most components
- **Note:** Woodgrain modesty panels 60" wide and up will have the grain pattern in the horizontal direction. All end panels and modesty panels 59" or less will have the grain pattern in the vertical direction

CUSTOM WIDTHS

- Custom widths are available for products that feature a worksurface as follows: desks, credenzas (applies to kneespace and single pedestal credenzas only), islands (excludes spanner islands), returns, bridges, extended corners and corners.
- Desks and credenzas that incorporate drawers and/or doors will be modified by changing the width of the worksurface and modesty panel, drawer and/or door dimensions are not affected.
- No upcharge for next size up
- Custom width does not apply to cabinets, hutches, pedestals or any other units.

STORAGE

- All lateral files feature a foolproof interlock device
- Pencil tray included in box drawer
- Lateral file drawers can accommodate legal or letter documents
- All drawers are locking unless otherwise noted
- Front-to-back filing bars for all steel drawer files available separately. Order FBB bars. See "FBB" on page 41.
- All desks, returns and credenzas with fixed storage are shipped standard with box/box/file, file/file or box/file 16" wide pedestals.
- Storage modules, wardrobe cabinets, personal towers, hutches and table top bookcases have 11/16" thick shelves
- End shelves, bookcases and table top end shelves have 1" thick shelves
- **All shelves are 3 position fixed/height adjustable.**
- Storage cabinets **less than 30" wide are not intended to be freestanding** and should be ganged or otherwise anchored. Ganging hardware and instructions are provided. Interior of all cabinets are pre-drilled for ganging connections; does require drill through on site.
- Adjustable shelves can be positioned to accept **binder** storage as follows:
 - For units **29" to 53" H** where applicable:
 - with one shelf - cannot accommodate binder row
 - with two shelves - can accommodate one row of binders
 - with three shelves - can accommodate two rows of binders
 - with four shelves - can accommodate three rows of binders
 - For units **65.5" to 84.5" H** where applicable:
 - with one shelf - can accommodate one row of binders
 - with two shelves - 65.5" and 72" H can accommodate one row of binders
 - 84" H can accommodate two rows of binders
 - with three shelves - can accommodate two rows of binders
 - with four shelves - can accommodate three rows of binders
 - with five shelves - can accommodate four rows of binders
 - with six shelves - can accommodate five rows of binders

LOCKS

- Locks are standard on all storage modules. Finish will coordinate with handles and/or aluminum doors. For desk, return or table components, etc. please specify finish: Black (**BK**) or Silver (**SI**).
- Please note that Flared Brass (**HW**) handle defaults to Black locks, so trim options must be Black to match.
- Key alike or specific key number optional for all products with locks
- Reserved for new orders greater than \$20,000 list, all Zira units with locks may be ordered with **CA** cap option and specific lock cores/keys can be ordered separately for field installation rather than specifying duplicate product lines with different key numbers.
- When **CA** option is specified, product will ship with a cap over the empty lock housing.
- Separately order the appropriate number of cores with keys; use product code **SIL-CORE-H-SHOE** for Silver core/key sets or product code **BLK-CORE-H-SHOE** for Black core/key sets. Specify quantity and lock number required. One order line per key number required. Key number range: 401-440. **Must be ordered at the same time product is ordered with CA lock cap option specified.**
- One core removal key is required. Recommend one core removal for every 25 cores ordered. Order as **REMOVE-K-H-SHOE**.
- No charge applies for separate lock cores or core removal keys only when ordered with product. If replacement lock core and key required, contact Customer Care for applicable product code and pricing.

SHIPPING

- Shipped assembled, 1 per carton, unless otherwise noted. Other components are easy to assemble.

HUTCHES

- 71" hutches (actual width 71.69") are for use when a hutch is placed across the back of a 42" wide return and across the depth of a 30" deep surface top (actual depth 29.69").
 - ZxxxxDK, ZxxxxDM and ZxxxxDML/DMR are exactly 30" deep. Therefore 72" hutches may be used.
- Hutches should not be placed on the approach side of any single pedestal and double pedestal desks with an overhang.

SPECIFICATIONS

- Specifications marked with an * are applicable to only those products which have the * symbol beside the product name.

GLAZING (Doors and Modesty Panels)



Z1 frosted glazing, Tungsten (TUN) frame



Z2 frosted glazing, Black (BLK) frame



Z3 ribbed glazing, Tungsten (TUN) frame

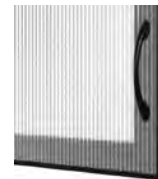

Z4 ribbed glazing, Black (BLK) frame



Full modesty panel - **Z1** frosted glazing, Tungsten (TUN) frame
 $\frac{3}{4}$ modesty (shown) - **Z1 + 3MP**
ZA - 12"H modesty (select models)



Full modesty panel - **Z2** frosted glazing, Black (BLK) frame
 $\frac{3}{4}$ modesty (shown) - **Z2 + 3MP**
ZB - 12"H modesty (select models)



Full modesty panel - **Z3** ribbed glazing, Tungsten (TUN) frame
 $\frac{3}{4}$ modesty (shown) - **Z3 + 3MP**
ZC - 12"H modesty (select models)



Full modesty panel - **Z4** ribbed glazing, Black (BLK) frame
 $\frac{3}{4}$ modesty (shown) - **Z4 + 3MP**
ZD - 12"H modesty (select models)

1. SPECIFY MODEL NUMBER

2. SPECIFY FINISH AND TOP THICKNESS/EDGE DETAIL

- All units available in solid color (Top and Chassis matching) or Two-Tone combination except for the following units:
 - Shells: One Tone in all standard finishes
 - Collators: One Tone in Black (**K**) or Brushed Cobalt (**T**)
 - Horizontal Pigeon Holes: One Tone in all standard finishes
 - Vertical and Transitional Pigeon Holes: Two-Tone - Chassis/Shell in all standard finishes, Collator Shelves in Black (**K**) or Brushed Cobalt (**T**).

Finishes:

ACJ Absolute Acajou	FCL First Class
ASN Asian Night	NBL Noce Biondo
AWC Avant Cherry	NGL Noce Grigio
AWH Avant Honey	NEL Noce Leggero
BLK Black	NML Noce Medio
BZD Blizzard	QTM Quartered Mahogany
BRC Brushed Cobalt	SBY Sheer Beauty
CMB Clear Maple	SOG Storm Grey
CGY Custom Grey	SDT Stonedust
DES Dark Espresso	WHE Walnut Heights
DWT Designer White	WHC White Chocolate
FAS Fashionista	WCR Winter Cherry

Top Thickness/Edge Detail

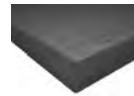

A3 1" top, standard flat edge



AR 1" top, bicut edge



C3 1.5" top, standard flat edge



CR 1.5" top, bicut edge



CF 1.5" top, fluted edge

3. SPECIFY OPTIONS

BOX DRAWERS for lateral file drawers (no upcharge)

- Specify **B_** (Drawer Position **1-4** must be specified)

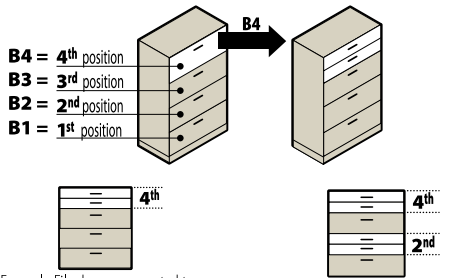

Example: File drawer converted to 2 box drawers on 4th position
Please Specify: Z36L54F - **B4**

Converting 2 or more drawers please contact customer service

- Not available on drawers with steel interiors

HANDLES

- Handles are applied to all lateral drawers and doors, and are included in the published list price. When ordering, please indicate handle choice from the list of options below. Integrated vertical finger pulls are the standard default for mobile pedestals, hanging pedestals, or where BBF or FF pedestals are part of a desk, return credenza or corner desk. Handles are optional on these units with a list upcharge of **\$54**. If a handle is not desired, select lock finish **BK** for Black or **SI** for Silver.
- General guideline: when handles are shown in individual product line art within the price list, handles are included; and where not shown in line art, **\$54** list upcharge applies when handle option is selected.
- To order handles, please specify corresponding code to image as below (**HS, HO, HW, HX, HV, HU, HQ, HZ, or HR**):



HS Flared Silver



HV Square Edge Silver



HO Crescent Black



HW Flared Brass



HU Square Edge Black



HZ Dimpled Nickel



HX Flared Black



HQ Bar Silver



HR Bar Black

MONOPOST



P1 square 4" Tungsten



P2 square 4" Black



P3 round 4" Tungsten



P4 round 4" Black



P5 round 5" Tungsten



P6 round 5" Black

GROMMETS

- Additional grommets available in standard worksurface locations (left, center or right).
- Order as: **AG1, AG2 or AG3. Add \$96**
- Grommets may be placed at non-standard locations. Order as: **AGS - Add \$96**. A drawing must be supplied with vertical and horizontal dimensions to the center of the cut-out (as in drawing above). Please refer to **CUSTOM GROMMET LOCATION FORM** in the back reference section.
- Components that come standard with grommet as stated within the product descriptions or shown in the corresponding price list line art, may be ordered without a grommet. **Add \$53**.
- Option to remove standard grommet when required - specify **RSG - Add \$53**.
- Option to remove standard grommet position and add another position - specify **RSG** and **AG_** or **AGS**, upcharge applies. For **RSG + AG_** combination, **Add \$149**. For **RSG + AGS** combination, **Add \$149**.

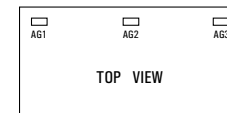
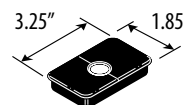

- Grommet hole dimensions are 3 1/4" wide x 1 7/8" deep.

- Actual grommet locations on the worksurface are depicted in the example drawings shown below. Dimensions shown are actual measurements (in inches).

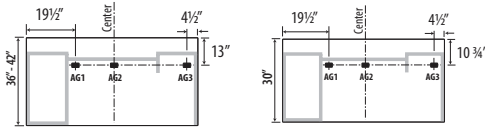

Straight Front, 36" - 42"D

Straight Front, 30"D

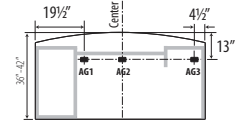

Bow Front

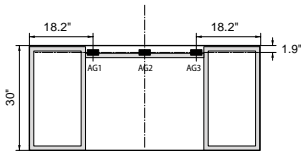

HA Double Ped

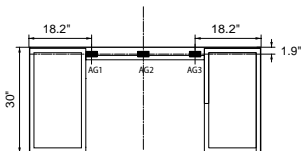
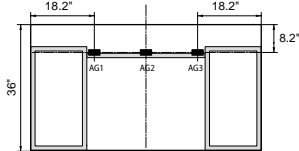

HA Single Ped

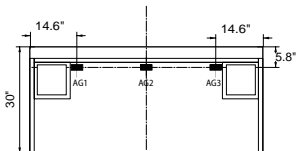
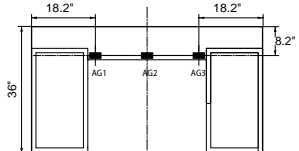

Freestanding HA

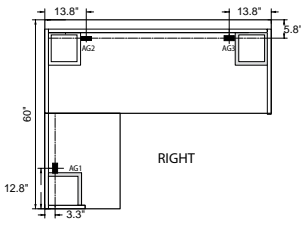
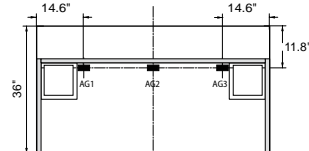

L HA desk

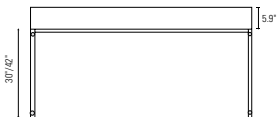
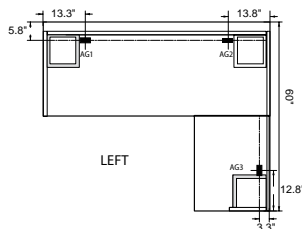

NHD desk



- Grommets are available on modesty panels of **extended corners** and **5-sided corners** 8" in where the two modesty panels meet at a 90° angle. Please specify **FOGMP-R** for right grommet placement and **FOGMP-L** for left grommet (placement is as shown on diagrams below). Cost is **\$96**.

***Modesty Panels are 1" off of ground*

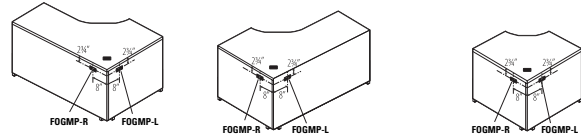

Left Extended Corner Unit

Right Extended Corner Unit

5-Sided Corner Unit

POWER BLOCK

- A Power Block (model **PMSPDM**) may be ordered on all worksurfaces.
- A Power Block is a rectangular worksurface power/data module with one electrical duplex receptacle and two data (RJ45) receptacles. 9 foot black cord included. Power Block dimensions are 3 1/2" deep x 6 1/2" wide x 2 3/4" high.
- To purchase a Power Block, you must specify both the Power Block cut-out location and the Power Block model #. Order Power Block as **PMSPDM**, **Add \$330**. Power Blocks are available in standard worksurface locations (left, center or right). Order as **E1**, **E2** or **E3**. **Add \$96**.

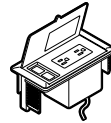

Power Block **PMSPDM** Add **\$330**

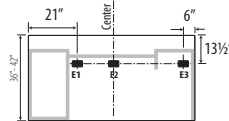

Straight Front

Specify location **E1**, **E2** or **E3**. **Add \$96**

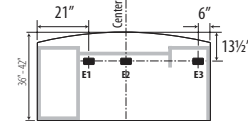

Bow Front

Executive Height Adjustable Desks

Available widths: 60", 66", 72", 84"

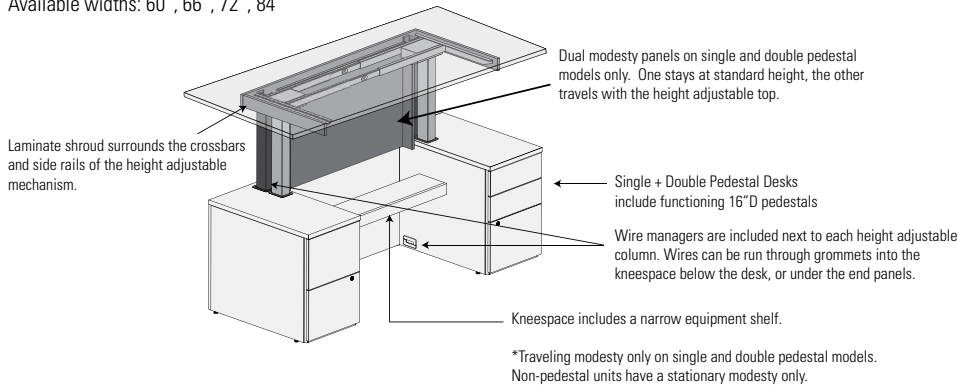

Returns

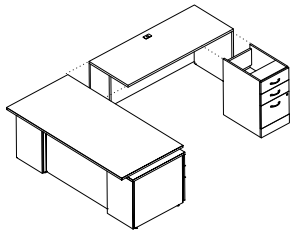

For "L" Shape Layouts

- Pre-configured
- With custom shell storage

Bridges

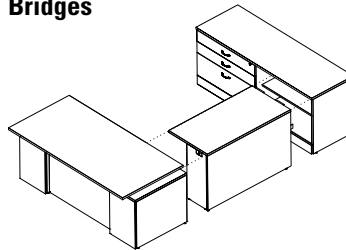

For "U" shape Layouts

Top conditions for Height Adjustable Desks

Top recesses are to minimize potential pinch points when adjacent to fixed surfaces.

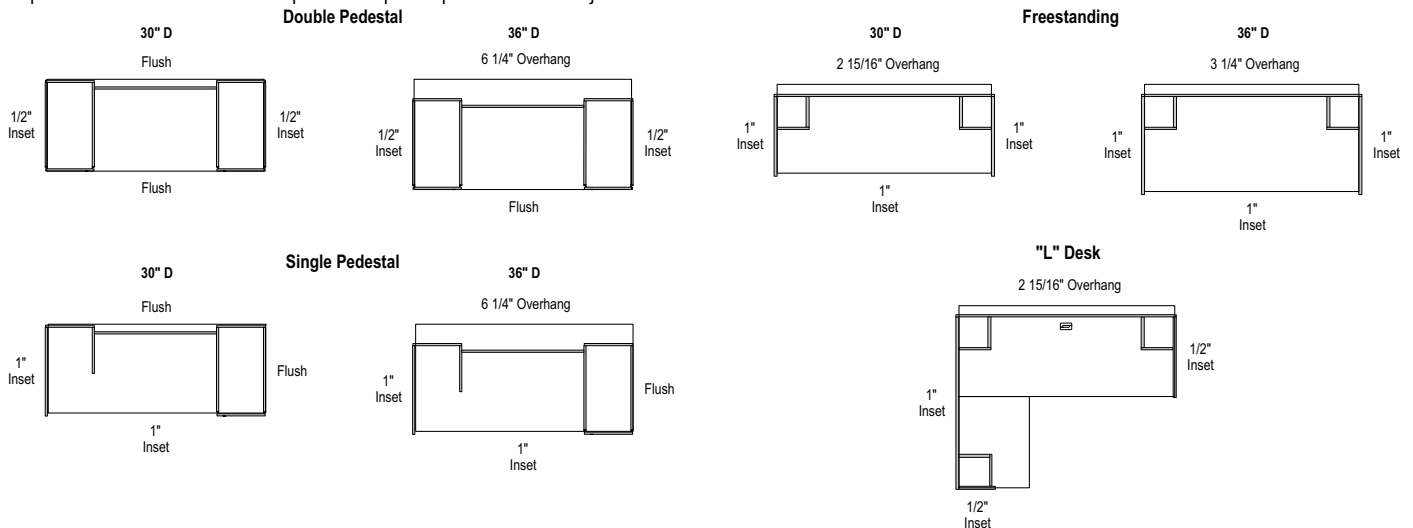

Wall Panels

Weight capacities for wall panels

- When mounting customer supplied flat screen or other to a wall panel, total weight including mounting hardware **should not exceed 140 lbs.** in total. Not approved for use with articulating or extendable mounting arms.
- Wall panels with floating shelves:
 - 1 mm space between shelves when units side by side.
 - **24"W** up to 50 lbs.; **30"W** up to 65 lbs.; **36"W** up to 75 lbs.; **42"W** up to 90 lbs. per floating shelf
 - Note: weight should be evenly distributed over surface
- Wall panels with overhead cabinet storage:
 - Note: weight should be evenly distributed over surface
 - **66"H - 24"W**: 30 lbs. top/55 lbs. inside bottom; **30"W**: 40 lbs. top/70 lbs. inside bottom; **36"W**: 45 lbs. top/85 lbs. inside bottom; **42"W**: 55 lbs. top/95 lbs. inside bottom.
 - **72"H - 24"W**: 30 lbs. top/65 lbs. inside bottom; **30"W**: 40 lbs. top/80 lbs. inside bottom; **36"W**: 50 lbs. top/95 lbs. inside bottom; **42"W**: 60 lbs. top/100 lbs. inside bottom.
 - **84"H - 24"W**: 30 lbs. top/65 lbs. shelf & inside bottom; **30"W**: 40 lbs. top/80 lbs. shelf & inside bottom; **36"W**: 50 lbs. top/95 lbs. shelf & inside bottom; **42"W**: 60 lbs. top/100 lbs. shelf & inside bottom.

Wall Panels

*Grommet locations for wall panels

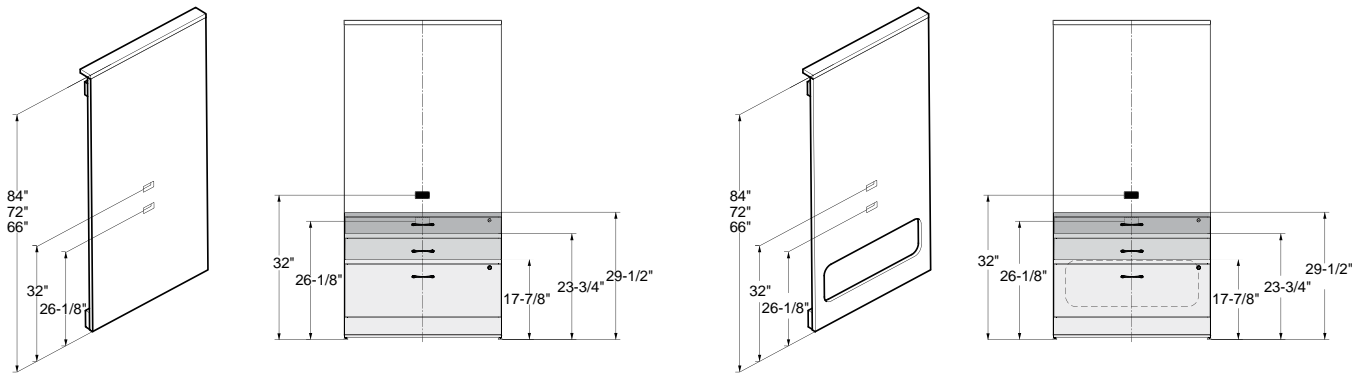

- AG1 grommet sits at 26-1/8" above the floor, just about 1-1/2" high storage, but below standard 29-1/2" storage
- AG2 grommet sits at 32" above the floor, above 29-1/2" storage
- *Cove Mini power units are not for use in this application due to depth.
- When the wall with wire management access is specified, the wire management access opening will sit below all storage heights (see chart below).

Wall Width	Opening Width
42"	35.75"
36"	29.75"
30"	23.75"
24"	17.75"

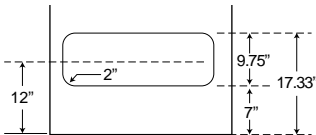

Desks / Extended Corner Desks - available width: 60", 66", 72", 84"

Modesty Treatments

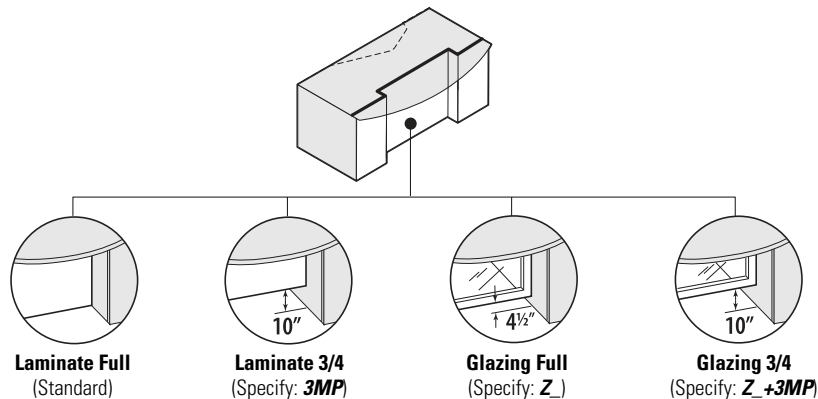

Overhang Dimensions

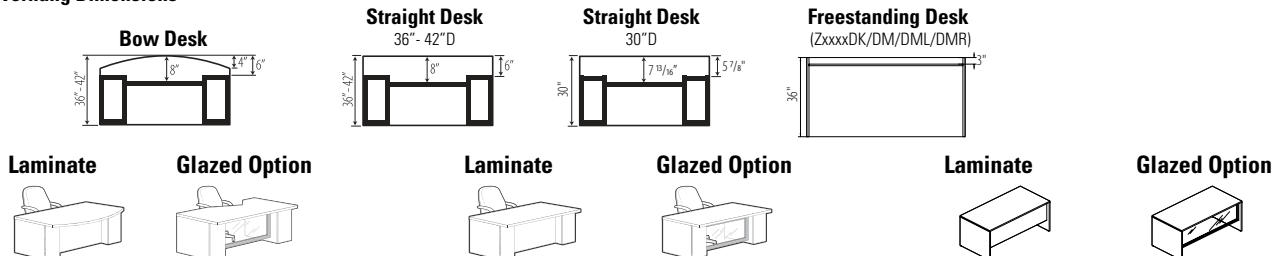

Returns - available width: 36", 42", 48", 54", 60", 66", 72"

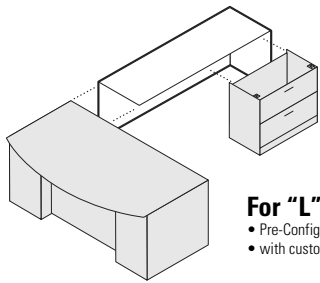

For "L" shape Layouts

- Pre-Configured
- with custom shell storage

Transitional Pigeon-Hole

Accepts all (same width) Transitional Pigeon-Holes.

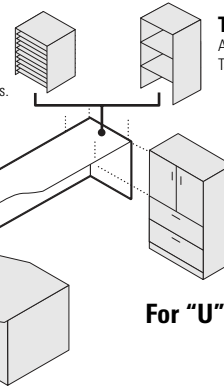
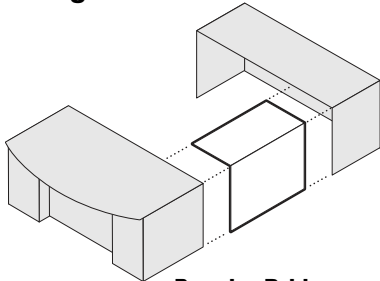

Table Top Bookcase

Accepts all (same width) Table Top Bookcases.

For "U" shape Layouts

Bridges - available width: 42", 48"



Regular Bridge

- join worksurface to worksurface

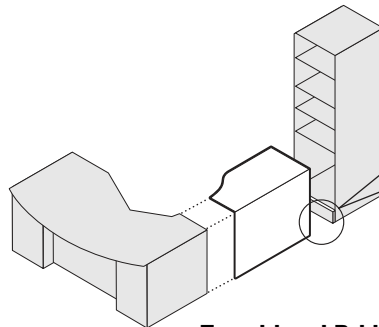

Transitional Bridge

- join worksurface to storage modules

Remove Existing Kickbase

Replace with supplied Kickbase (shorter)

Extended Corners - available widths: 60", 66", 72", 84"

Modesty Treatments

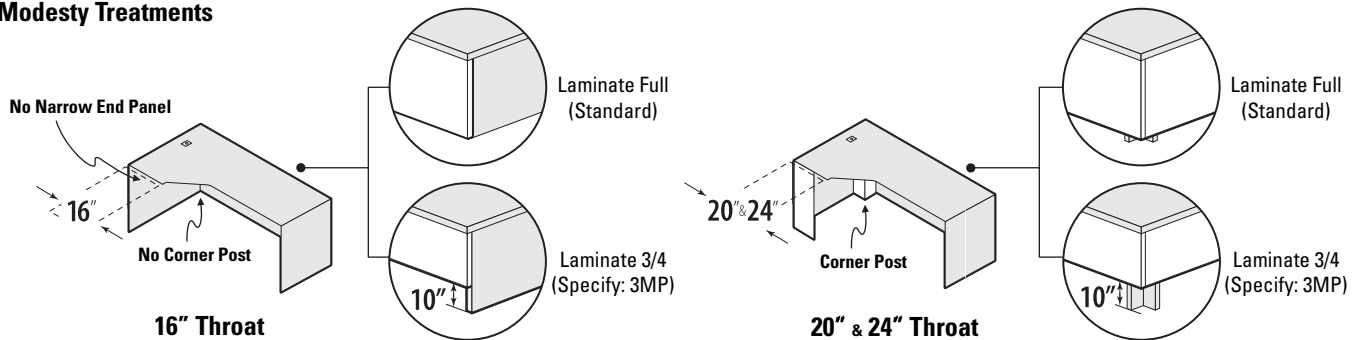

Shells - available width: 12", 15", 16", 18", 21", 30", 36"

For Extended Corners, Space Saver Returns and Connectables

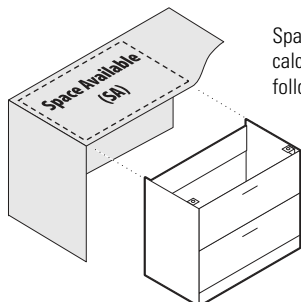

Space Available can be calculated with the following formulas:

Space Saver Returns

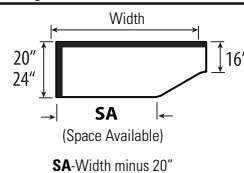

Space Saver Connectables

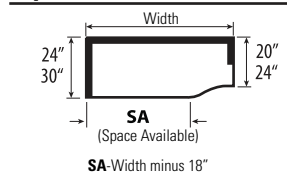

Extended Corners

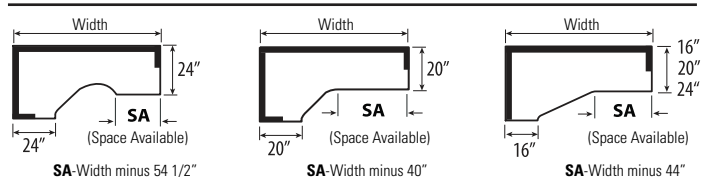

Extended Corner Islands - available width: 60", 66", 72" 84"

Modesty Treatments

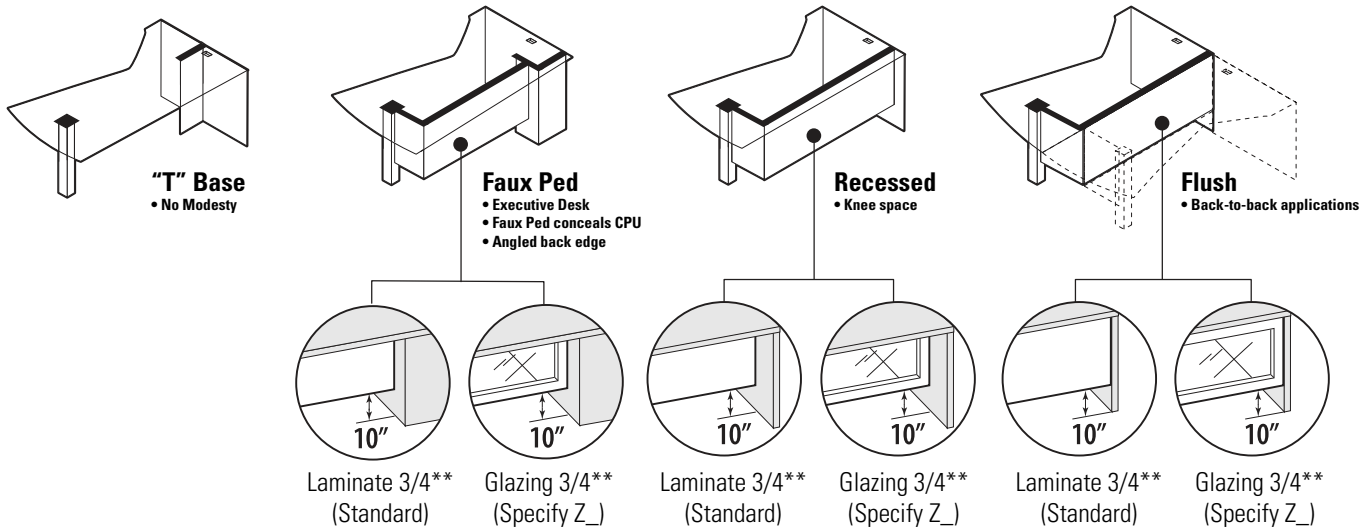

** Full modesty not available

Overhang Dimensions

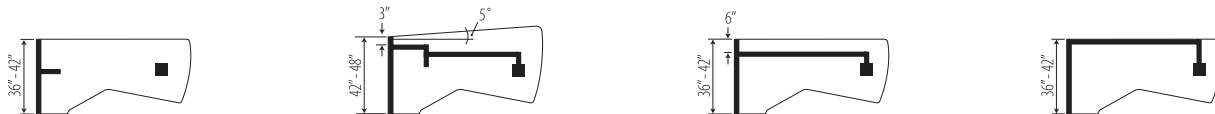

Storage

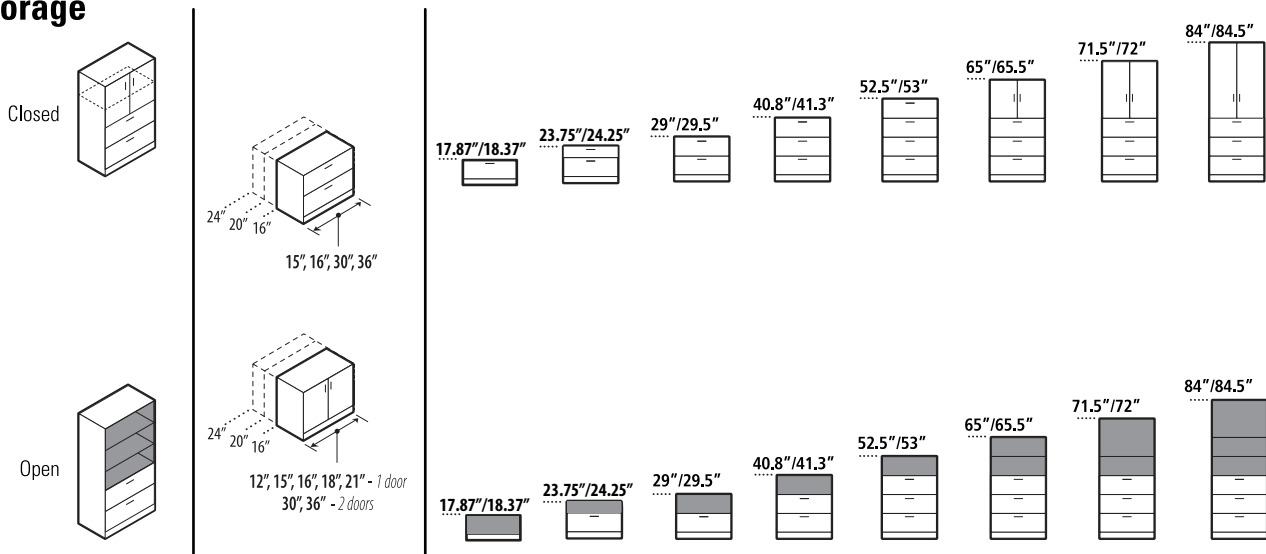

Wardrobe & Personal Towers

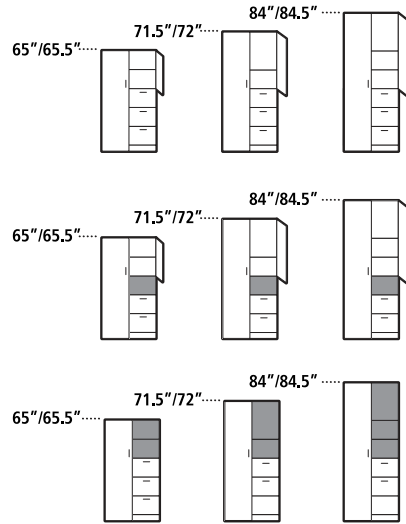
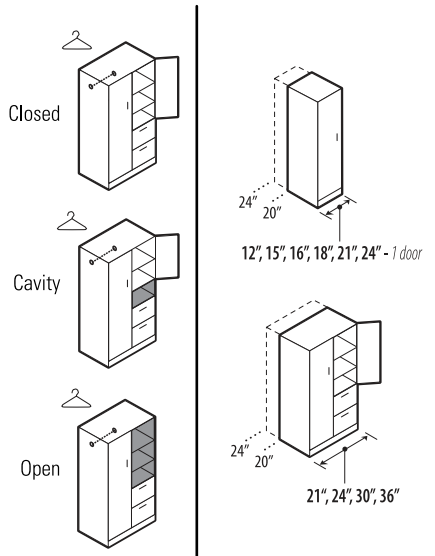

Drawer & Cavity Positions

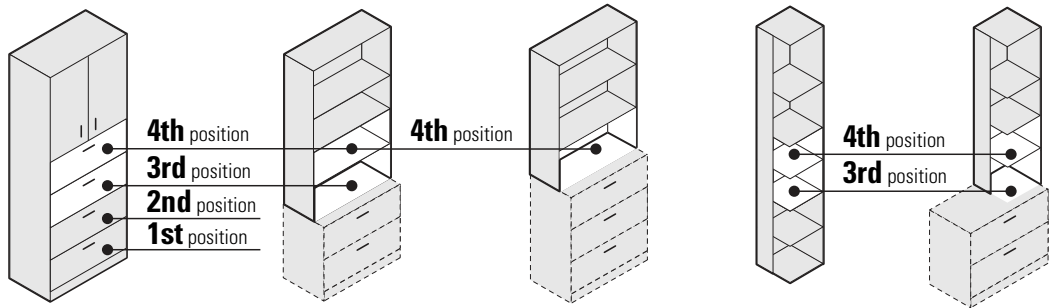

Box Drawer Option

Lateral file drawers can be converted to box/box drawers in any of the four standard positions

- B1** = 2 box drawers on 1st position
- B2** = 2 box drawers on 2nd position
- B3** = 2 box drawers on 3rd position
- B4** = 2 box drawers on 4th position

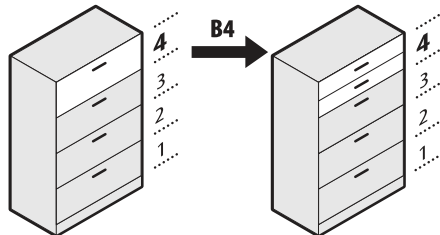

Example
File drawer converted to 2 box drawers on **4th** position

Please specify: Z36L54F - **B4**

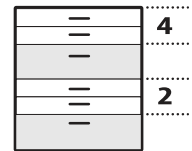

Converting 2 or more drawers please contact customer service.

Collator Positions

All storage units can be specified with an optional collator on 2nd, 3rd and/or 4th position.

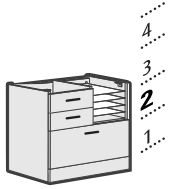

Collator on 2nd position
Specify: **2K - Black** or
2T - Brushed Cobalt

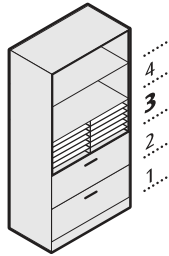

Collator on 3rd position
Specify: **3K - Black** or
3T - Brushed Cobalt

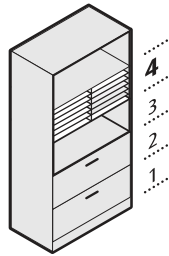

Collator on 4th position
Specify: **4K - Black** or
4T - Brushed Cobalt

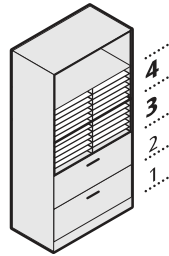

Collator on 3rd & 4th positions
Specify: **7K - Black** or
7T - Brushed Cobalt

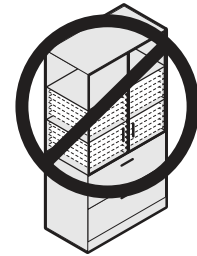

Collators do not fit behind doors

For 2K / 2T, 3K / 3T OR 4K / 4T - Add \$305

For 7K / 7T - Add \$538

Glazing

Glazing is available in the following options:

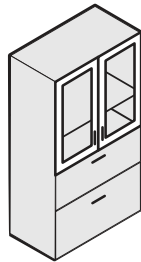

Tungsten Frame
Frosted Glazing
Z1

Please specify:
Z36L6E - **Z1**

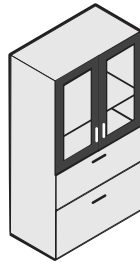

Black Frame
Frosted Glazing
Z2

Please specify:
Z36L6E - **Z2**

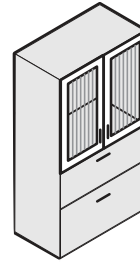

Tungsten Frame
Ribbed Glazing
Z3

Please specify:
Z36L6E - **Z3**

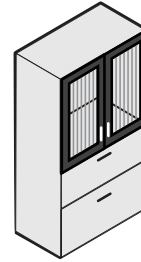

Black Frame
Ribbed Glazing
Z4

Please specify:
Z36L6E - **Z4**

Filing Options - For Filing Components

On 16" deep files, drawer interiors are only 13" deep. On 20" and 24" deep files, drawer interiors are 16" deep.
 Full to floor BBF, FF and BF pedestals are 16" wide with all pedestal desks, returns with pedestals and credenzas with pedestals.
 Full to floor BBF and FF storage shells 15" wide x 28.5" high are required under 36" wide Space Saver Return with 16" deep connection top. re: Zxx3616R.
 Filing hardware included with all laminate drawer models. Steel drawer models do NOT include FBB bars.

Side-To-Side

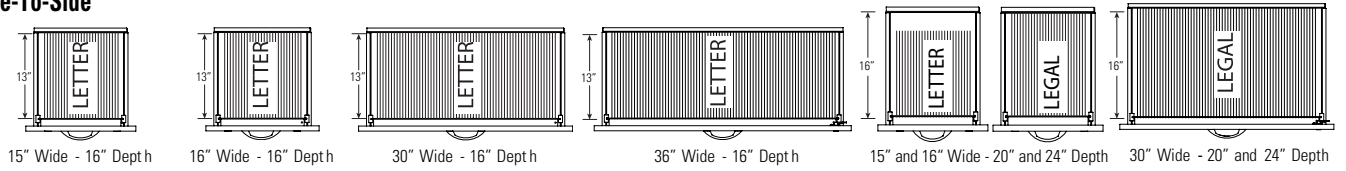

Front-To-Back

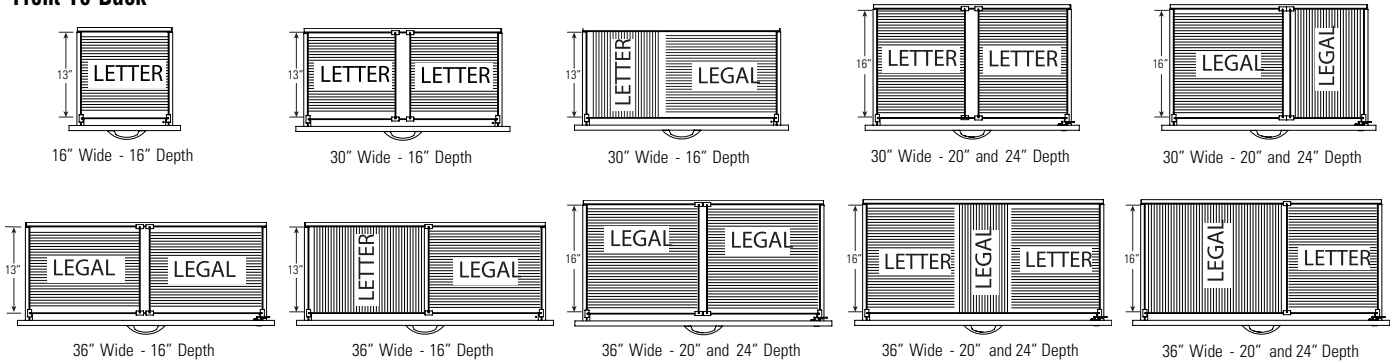

Height Map

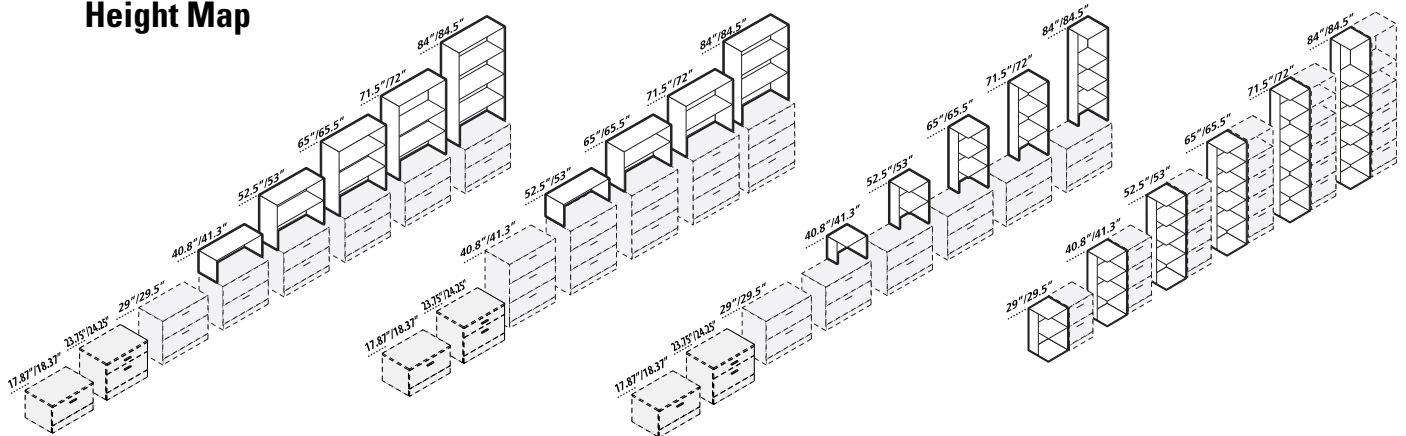

Drawer & Cavity Positions

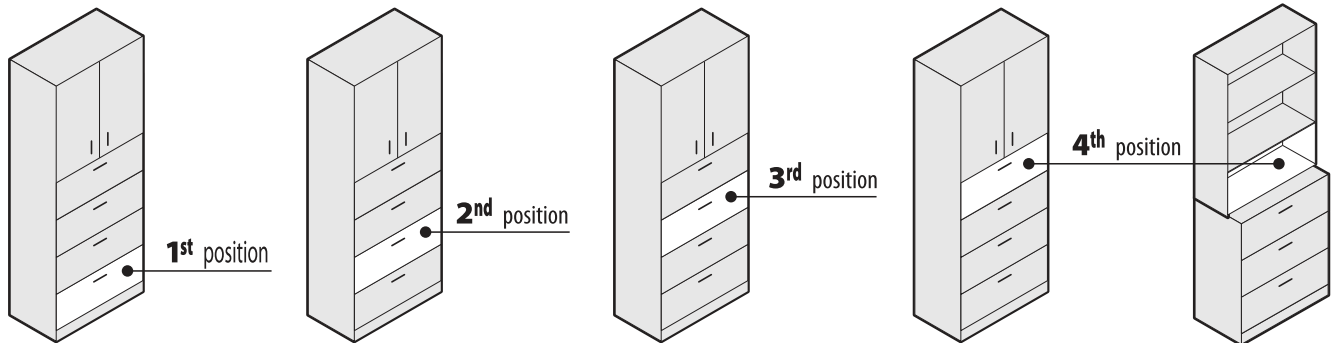

Collator Positions

For 12" to 21" wide units

**If no collator is desired, must specify when placing order.

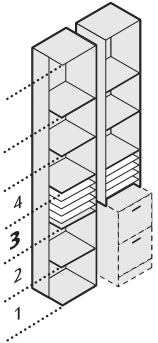

Collator on 3rd position
Specify: **3K - Black** or
3T - Brushed Cobalt

For 3K / 3T or 4K / 4T.....Add \$305

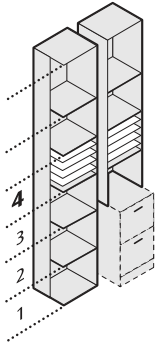

Collator on 4th position
Specify: **4K - Black** or
4T - Brushed Cobalt

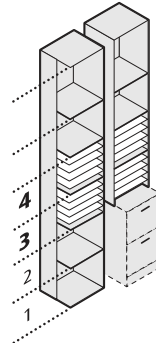

Collator on 3rd & 4th position
Specify: **7K - Black** or
7T - Brushed Cobalt

For 7K / 7T.....Add \$538

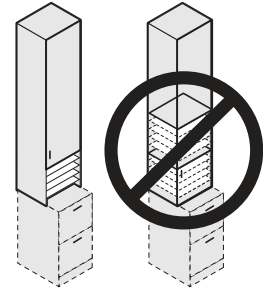

Collators do not fit behind door

Table Top Bookcase

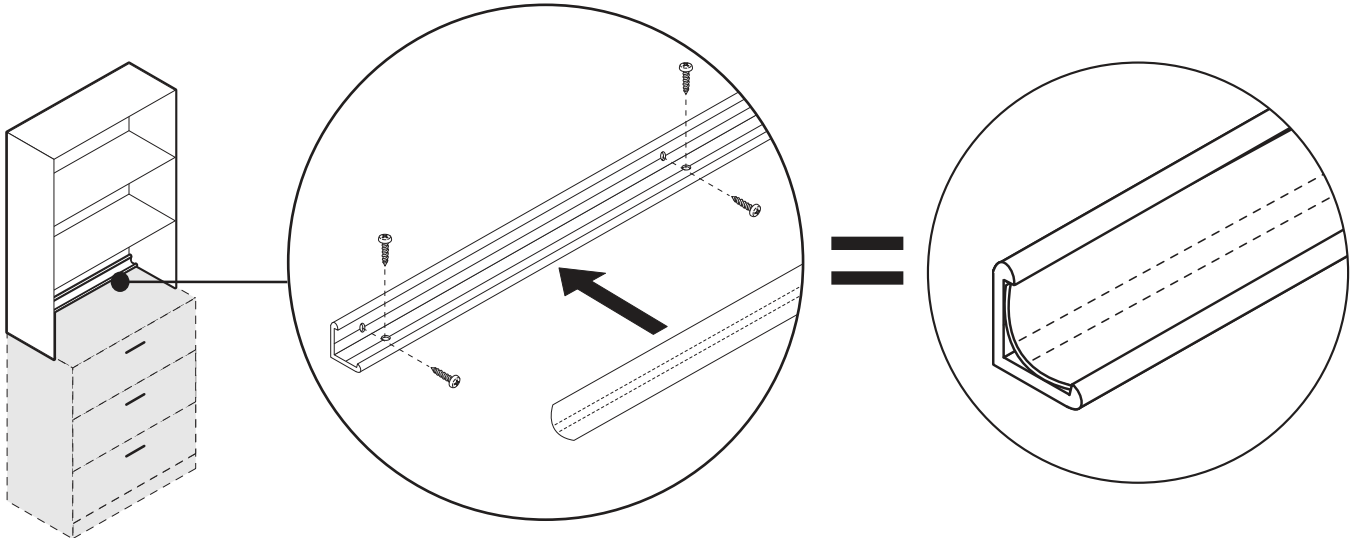

Hutches

Monitor clearance dimensions

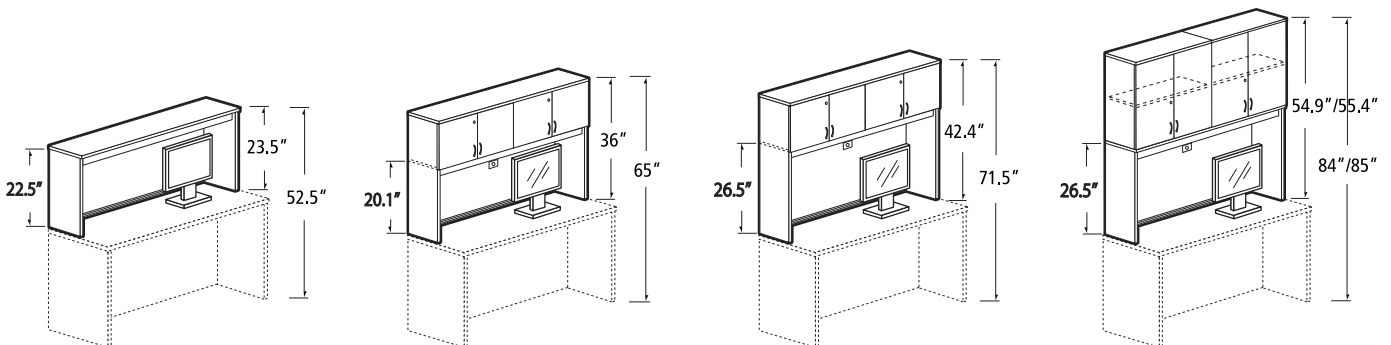

HEIGHT ADJUSTABLE DESKS

MODEL#	DIMENSIONS	FREIGHT CLASS	WT/LBS.	CUBIC FT.	1"TOP	1.5" TOP	GLAZE ADD	HP ADD
--------	------------	---------------	---------	-----------	-------	----------	-----------	--------

D x W x H

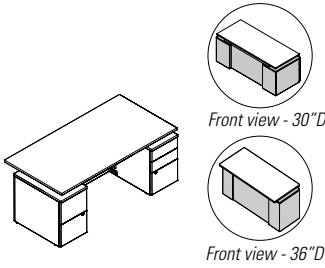

Double Pedestal Desk for Height Adj. Base

ZH3684F23	36 x 84 x 29.5-49.5	85	362	26.68	\$3908	\$4140	\$642	\$685
ZH3672F23	36 x 72 x 29.5-49.5	85	335	26.68	\$3878	\$4084	\$550	\$587
ZH3666F23	36 x 66 x 29.5-49.5	85	321	25.18	\$3773	\$3959	\$495	\$538
ZH3660F23	36 x 60 x 29.5-49.5	85	307	24.70	\$3643	\$3829	\$532	\$489
ZH3084F23	30 x 84 x 29.5-49.5	85	347	25.69	\$4001	\$4201	\$642	\$567
ZH3072F23	30 x 72 x 29.5-49.5	85	321	24.70	\$3810	\$3985	\$550	\$489
ZH3066F23	30 x 66 x 29.5-49.5	85	309	24.19	\$3707	\$3869	\$495	\$451
ZH3060F23	30 x 60 x 29.5-49.5	85	296	23.68	\$3600	\$3744	\$538	\$409

- Specify FTZ52SFNL for 60" - 72" wide desks and FTZ52LFNL for 84" wide desks.

Height adjustable frame sold separately. Standard with file/file (FF) pedestal on **left** and box/box/file (BBF) pedestal on **right**. **30"D**: Top is recessed 1/2" on either side over chassis, flush on user and guest side. **36"D**: Top is recessed 1/2" on either side over chassis, flush on user side, 6.25" overhang on guest side. BBF - file drawer and lower box drawer lock. FF - drawers lock. Unit has dual modesty panels - one stationary/one traveling. See notes on page 115 for illustration. Shipped RTA (ready to assemble).

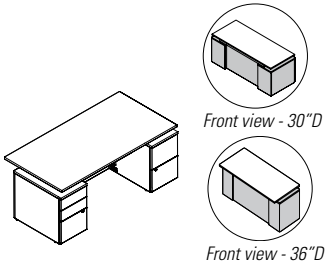

Double Pedestal Desk for Height Adj. Base

ZH3684F32	36 x 84 x 29.5-49.5	85	362	26.68	\$3908	\$4140	\$642	\$685
ZH3672F32	36 x 72 x 29.5-49.5	85	335	26.68	\$3878	\$4084	\$550	\$587
ZH3666F32	36 x 66 x 29.5-49.5	85	321	25.18	\$3773	\$3959	\$495	\$538
ZH3660F32	36 x 60 x 29.5-49.5	85	307	24.70	\$3643	\$3829	\$532	\$489
ZH3084F32	30 x 84 x 29.5-49.5	85	347	25.69	\$4001	\$4201	\$642	\$567
ZH3072F32	30 x 72 x 29.5-49.5	85	321	24.70	\$3810	\$3985	\$550	\$489
ZH3066F32	30 x 66 x 29.5-49.5	85	309	24.19	\$3707	\$3869	\$495	\$451
ZH3060F32	30 x 60 x 29.5-49.5	85	296	23.68	\$3600	\$3744	\$538	\$409

- Specify FTZ52SFNL for 60" - 72" wide desks and FTZ52LFNL for 84" wide desks.

Height adjustable frame sold separately. Standard with box/box/file (BBF) pedestal on **left** and file/file (FF) pedestal on **right**. **30"D**: Top is recessed 1/2" on either side over chassis, flush on user and guest side. **36"D**: Top is recessed 1/2" on either side over chassis, flush on user side, 6.25" overhang on guest side. BBF - file drawer and lower box drawer lock. FF - drawers lock. Unit has dual modesty panels - one stationary/one traveling. See notes on page 115 for illustration. Shipped RTA (ready to assemble).

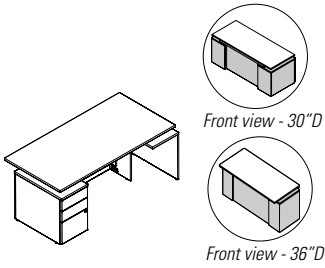

Single Pedestal Desk for Height Adj. Base

ZH3684F3S	36 x 84 x 29.5-49.5	85	325	26.68	\$3558	\$3782	\$642	\$685
ZH3672F3S	36 x 72 x 29.5-49.5	92.5	298	25.69	\$3508	\$3714	\$550	\$587
ZH3666F3S	36 x 66 x 29.5-49.5	92.5	284	25.18	\$3405	\$3591	\$495	\$538
ZH3660F3S	36 x 60 x 29.5-49.5	92.5	271	24.70	\$3274	\$3449	\$434	\$489
ZH3084F3S	30 x 84 x 29.5-49.5	85	310	25.69	\$3633	\$3833	\$642	\$567
ZH3072F3S	30 x 72 x 29.5-49.5	92.5	285	24.70	\$3441	\$3616	\$550	\$489
ZH3066F3S	30 x 66 x 29.5-49.5	92.5	272	24.19	\$3337	\$3499	\$495	\$451
ZH3060F3S	30 x 60 x 29.5-49.5	92.5	260	23.68	\$3232	\$3376	\$439	\$409

- Specify FTZ52SFNL for 60" - 72" wide desks and FTZ52LFNL for 84" wide desks.

Height adjustable frame sold separately. Standard with box/box/file pedestal on **left**. **30"D**: Top is recessed 1" on non-ped side and user side over chassis; flush on ped side and guest side. **36"D**: Top is recessed 1" on non-ped side and user side over chassis; flush on ped side and 6.25" overhang on guest side. File drawer and lower box drawer lock. Unit has dual modesty panels - one stationary/one traveling. See notes on page 115 for illustration. Shipped RTA (ready to assemble).

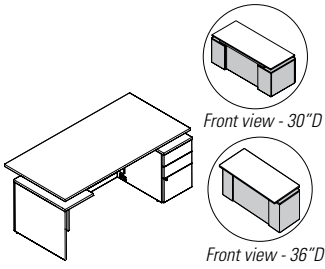

Single Pedestal Desk for Height Adj. Base

ZH3684FS3	36 x 84 x 29.5-49.5	85	325	26.68	\$3558	\$3782	\$642	\$685
ZH3672FS3	36 x 72 x 29.5-49.5	92.5	298	25.69	\$3508	\$3714	\$550	\$587
ZH3666FS3	36 x 66 x 29.5-49.5	92.5	284	25.18	\$3405	\$3591	\$495	\$538
ZH3660FS3	36 x 60 x 29.5-49.5	92.5	271	24.70	\$3274	\$3449	\$434	\$489
ZH3084FS3	30 x 84 x 29.5-49.5	85	310	25.69	\$3633	\$3833	\$642	\$567
ZH3072FS3	30 x 72 x 29.5-49.5	92.5	285	24.70	\$3441	\$3616	\$550	\$489
ZH3066FS3	30 x 66 x 29.5-49.5	92.5	272	24.19	\$3337	\$3499	\$495	\$451
ZH3060FS3	30 x 60 x 29.5-49.5	92.5	260	23.68	\$3232	\$3376	\$439	\$409

- Specify FTZ52SFNL for 60" - 72" wide desks and FTZ52LFNL for 84" wide desks.

Height adjustable frame sold separately. Standard with box/box/file pedestal on **right**. **30"D**: Top is recessed 1" on non-ped side and user side over chassis; flush on ped side and guest side. **36"D**: Top is recessed 1" on non-ped side and user side over chassis; flush on ped side and 6.25" overhang on guest side. File drawer and lower box drawer lock. Unit has dual modesty panels - one stationary/one traveling. See notes on page 115 for illustration. Shipped RTA (ready to assemble).

Required Specifications

Top finish / Base finish
 Top/edge detail
 Wire management finish
 Default no handle, specify lock finish

Must use with FTZ52SFNL or FTZ52LFNL (sold separately)

Optional Specifications

HP laminate, Handles, Key #
 Glazed modesty / modesty type

Grommet position or power block cut-out

Accessories

Power block / Pencil drawer

HEIGHT ADJUSTABLE DESKS

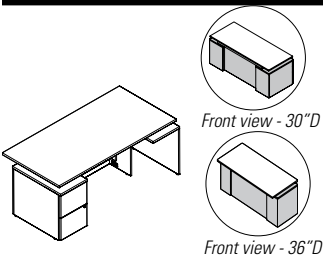

Single Pedestal Desk for Height Adj. Base**

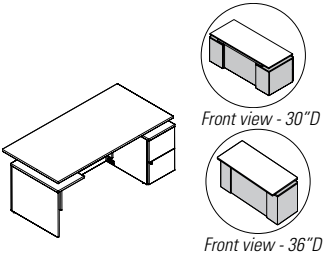

Single Pedestal Desk for Height Adj. Base**

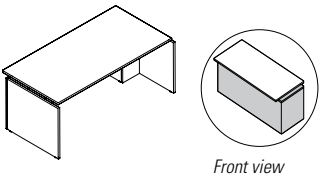

Height Adj. Desk - Freestanding

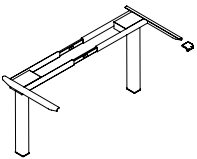

Height Adjustable Frame*

MODEL#	DIMENSIONS D x W x H	FREIGHT CLASS	WT/LBS.	CUBIC FT.	1" TOP	1.5" TOP	GLAZE ADD	HP ADD
ZH3684F2S	36 x 84 x 29.5-49.5	85	323	26.68	\$3508	\$3732	\$642	\$685
ZH3672F2S	36 x 72 x 29.5-49.5	92.5	296	26.68	\$3460	\$3660	\$550	\$587
ZH3666F2S	36 x 66 x 29.5-49.5	92.5	282	25.18	\$3348	\$3534	\$495	\$538
ZH3660F2S	36 x 60 x 29.5-49.5	92.5	268	24.70	\$3224	\$3392	\$434	\$489
ZH3084F2S	30 x 84 x 29.5-49.5	92.5	308	25.69	\$3583	\$3783	\$642	\$567
ZH3072F2S	30 x 72 x 29.5-49.5	92.5	283	24.70	\$3392	\$3560	\$550	\$489
ZH3066F2S	30 x 66 x 29.5-49.5	92.5	270	24.19	\$3288	\$3445	\$495	\$451
ZH3060F2S	30 x 60 x 29.5-49.5	92.5	258	23.68	\$3182	\$3326	\$434	\$409

• Specify FTZ52SFNL for 60" - 72" wide desks and FTZ52LFNL for 84" wide desks.

Height adjustable frame sold separately. Standard with file/file pedestal on **left. 30"D**: Top is recessed 1" on non-ped side and user side over chassis; flush on ped side and guest side. **36"D**: Top is recessed 1" on non-ped side and user side over chassis; flush on ped side and 6.25" overhang on guest side. Pedestal locks. Unit has dual modesty panels - one stationary/one traveling. See notes on page 115 for illustration. *30"D desks are not compatible with monitor arm models MONxxxx/M775xxx.* Shipped RTA (ready to assemble).

ZH3684FS2	36 x 84 x 29.5-49.5	85	323	26.68	\$3508	\$3732	\$642	\$685
ZH3672FS2	36 x 72 x 29.5-49.5	92.5	296	26.68	\$3460	\$3660	\$550	\$587
ZH3666FS2	36 x 66 x 29.5-49.5	92.5	282	25.18	\$3348	\$3534	\$495	\$538
ZH3660FS2	36 x 60 x 29.5-49.5	92.5	268	24.70	\$3224	\$3392	\$434	\$489
ZH3084FS2	30 x 84 x 29.5-49.5	92.5	308	25.69	\$3583	\$3783	\$642	\$567
ZH3072FS2	30 x 72 x 29.5-49.5	92.5	283	24.70	\$3392	\$3560	\$550	\$489
ZH3066FS2	30 x 66 x 29.5-49.5	92.5	270	24.19	\$3288	\$3445	\$495	\$451
ZH3060FS2	30 x 60 x 29.5-49.5	92.5	258	23.68	\$3182	\$3326	\$434	\$409

• Specify FTZ52SFNL for 60" - 72" wide desks and FTZ52LFNL for 84" wide desks.

Height adjustable frame sold separately. Standard with file/file pedestal on **right. 30"D**: Top is recessed 1" on non-ped side and user side over chassis; flush on ped side and guest side. **36"D**: Top is recessed 1" on non-ped side and user side over chassis; flush on ped side and 6.25" overhang on guest side. Pedestal locks. Unit has dual modesty panels - one stationary/one traveling. See notes on page 115 for illustration. *30"D desks are not compatible with monitor arm models MONxxxx/M775xxx.* Shipped RTA (ready to assemble).

ZH3684NP	36 x 84 x 29.5-49.5	70	231	10.48	\$2427	\$2659	N/A	\$685
ZH3672NP	36 x 72 x 29.5-49.5	125	206	27.69	\$2389	\$2589	N/A	\$587
ZH3666NP	36 x 66 x 29.5-49.5	65	198	8.47	\$2315	\$2501	N/A	\$538
ZH3660NP	36 x 60 x 29.5-49.5	65	198	8.47	\$2261	\$2429	N/A	\$489
ZH3072NP	30 x 72 x 29.5-49.5	70	188	8.71	\$2273	\$2448	N/A	\$489
ZH3066NP	30 x 66 x 29.5-49.5	70	178	7.96	\$2198	\$2360	N/A	\$451
ZH3060NP	30 x 60 x 29.5-49.5	70	168	7.49	\$2162	\$2306	N/A	\$409

• Specify FTZ52SFNL for 60" wide desks and FTZ52LFNL for 66" - 84" wide desks.

Height adjustable frame sold separately. **30"D** - Top is recessed 1" on user and both sides over chassis; 2.9375" overhang on guest side. **36"D** - Top is recessed 1" on user and both sides over chassis; 3.25" overhang on guest side. Shipped RTA (ready to assemble). Unit has a stationary modesty only. *30"D desks are not compatible with monitor arm models MONxxxx/M775xxx.*

FTZ52SFNL	22 x -- x 26	60	67	1.47	\$1138
FTZ52LFNL	22 x -- x 26	60	67	1.47	\$1138

- For models ending in F23/F32/F3S/FS3/F2S/FS2, specify FTZ52SFNL for 60" - 72" and FTZ52LFNL for 84" wide desks.
- For models ending in NP, specify FTZ52SFNL for 60" wide, and FTZ52LFNL for 66" - 84" wide desks

For use with Zira height adjustable desks. Lifts 350 lbs. Each motor is mounted within the top of the column and will connect directly into one another without the need for a control box. Available in Black or Tungsten. Shipped RTA (ready to assemble).

• **Recommended torque range for installing all fasteners is 3-5 foot pounds and should not be exceeded. In addition, no impact drivers or high-torque equipment are to be used for any fasteners included in the table assembly kits, as this creates a high risk for damage that is not covered under warranty. The use of hand tools is highly recommended.**

Required Specifications

Top finish Top/edge detail
Base finish*
Wire management finish
Must use with base (sold separately)

Optional Specifications

HP laminate Handles**
Key *** Modesty finish glazed**
Modesty Type
Grommet position or power block cut-out

Accessories

Power block
Pencil drawer

HEIGHT ADJUSTABLE DESKS

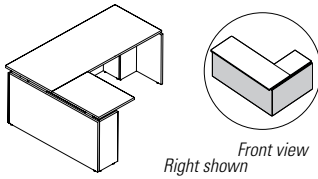

L Desk Shell for Height Adj. Base

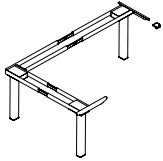

Height Adjustable Frame*

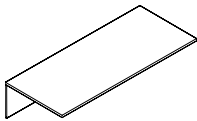

Top and Modesty Panel Kit

MODEL#	DIMENSIONS D x W x H	FREIGHT CLASS	WT/LBS.	CUBIC FT.	1" TOP	1.5" TOP	GLAZE ADD	HP ADD
ZH608424L	60 x 84 x 29.5-49.5	70	294	14.48	\$3202	\$3457	N/A	\$876
ZH607224L	60 x 72 x 29.5-49.5	70	273	13.24	\$3059	\$3291	N/A	\$778
ZH608424R	60 x 84 x 29.5-49.5	70	294	14.48	\$3202	\$3457	N/A	\$876
ZH607224R	60 x 72 x 29.5-49.5	70	273	13.24	\$3059	\$3291	N/A	\$778

• Specify FTZ539FSLNL separately.

Height adjustable frame sold separately. Specify ZH60xx24L for **LEFT** with return on the right side or ZH60xx24R for **RIGHT** with return on left side. Top on long return side is recessed 1" over chassis, 1/2" recessed on primary top (non-return side) and 2.9375" overhang on guest side. Return top is 24"D x 30"W. Shipped RTA (ready to assemble). *Not compatible with monitor arm models MONxxxx/M775xxx.*

FTZ539FSLNL	10 x -- x 26.8	60	101	1.47	\$1847	N/A	N/A	N/A
-------------	----------------	----	-----	------	--------	-----	-----	-----

For use with Zira height adjustable L desks. Lifts 350 lbs. Each motor is mounted within the top of the column and will connect directly into one another without the need for a control box. Available in Black, Designer White or Tungsten. Shipped RTA (ready to assemble).

• **Recommended torque range for installing all fasteners is 3-5 foot pounds and should not be exceeded. In addition, no impact drivers or high-torque equipment are to be used for any fasteners included in the table assembly kits, as this creates a high risk for damage that is not covered under warranty. The use of hand tools is highly recommended.**

ZH3084TB	29 x 82 x 16-16.5	85	99	6.75	\$1084	\$1375	\$680	\$567
ZH3072TB	29 x 70 x 16-16.5	85	85	6	\$956	\$1206	\$600	\$489
ZH3066TB	29 x 64 x 16-16.5	85	79	5.50	\$894	\$1126	\$556	\$451
ZH3060TB	29 x 58 x 16-16.5	85	71	5	\$796	\$1008	\$545	\$409
ZH3054TB	29 x 52 x 16-16.5	85	64	4.50	\$735	\$929	\$476	\$372
ZH3048TB	29 x 46 x 16-16.5	85	57	4	\$673	\$841	\$439	\$329
ZH3042TB	29 x 40 x 16-16.5	85	50	3.75	\$604	\$755	\$397	\$285
ZH2484TB	23 x 82 x 16-16.5	85	74	5	\$967	\$1203	\$580	\$457
ZH2472TB	23 x 70 x 16-16.5	70	86	5.50	\$857	\$1063	\$600	\$390
ZH2466TB	23 x 64 x 16-16.5	70	68	4.50	\$796	\$990	\$556	\$359
ZH2460TB	23 x 58 x 16-16.5	85	61	4.25	\$711	\$886	\$545	\$329
ZH2454TB	23 x 52 x 16-16.5	85	55	3.75	\$655	\$812	\$476	\$312
ZH2448TB	23 x 46 x 16-16.5	85	49	3.50	\$600	\$744	\$439	\$261
ZH2442TB	23 x 40 x 16-16.5	85	43	3	\$532	\$670	\$409	\$232

For use with height adjustable mechanisms. Height adjustable frame not included. Shipped RTA (ready to assemble).

- Compatible with FreeFit + FOLI Height Adjustable bases (FOLI compatible with 48"w – 72"w tops)
- Cannot be used with FTZ52SFNL or FTZ52LFNL

CONNECTABLE TABLES

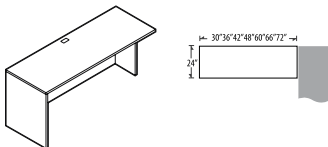

24" Deep Connectable Table - Left

MODEL#	DIMENSIONS	FREIGHT CLASS	WT/LBS.	CUBIC FT.	1" TOP	1.5" TOP	GLAZE ADD	HP ADD
Z2472L	24 x 72 x 29.5-30	65	144	6	\$880	\$1036	N/A	\$384
Z2466L	24 x 66 x 29.5-30	65	135	6	\$880	\$1015	N/A	\$384
Z2460L	24 x 60 x 29.5-30	65	125	5.25	\$796	\$914	N/A	\$353
Z2448L	24 x 48 x 29.5-30	65	106	4.30	\$725	\$827	N/A	\$281
Z2442L	24 x 42 x 29.5-30	65	95	3.80	\$725	\$814	N/A	\$236
Z2436L	24 x 36 x 29.5-30	65	86	3.30	\$637	\$710	N/A	\$178
Z2430L	24 x 30 x 29.5-30	70	77	3.60	\$600	\$658	N/A	\$178

Full end panel on left. Right narrow end panel connects to **24"D** center/right connectable table, or at 90° angle to a freestanding table, height adjustable desk, 24"D extended corners or at the end of a straight run; "D" islands or "P" islands with "T" and "H" bases. Groppet in worksurface. Shipped RTA (ready to assemble).

- Units 48" and under require storage for stability
- **Modesty Panel is 1" off of ground.**

Required Specifications

Top finish
Top/edge detail
Base finish
Wire management finish

Optional Specifications

HP laminate
Groppet position or power block cut-out

Accessories

Power block

BRIDGES COMPATIBLE W/ ZXXXXBBOL/R AND ZXXXXBLF/R CREDENZAS DIMENSIONS FREIGHT CLASS WT/LBS. CUBIC FT. 1"TOP 1.5" TOP GLAZE ADD HP ADD

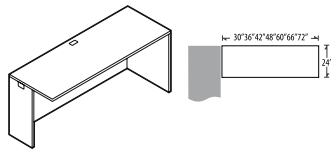

24" Deep Connectable Table - Right

	D x W x H								
Z2472R	24 x 72 x 29.5-30	65	144	6	\$880	\$1036	N/A	\$384	
Z2466R	24 x 66 x 29.5-30	65	135	6	\$880	\$1015	N/A	\$384	
Z2460R	24 x 60 x 29.5-30	65	125	5.25	\$796	\$914	N/A	\$353	
Z2448R	24 x 48 x 29.5-30	65	106	4.30	\$725	\$827	N/A	\$281	
Z2442R	24 x 42 x 29.5-30	65	95	3.80	\$725	\$814	N/A	\$236	
Z2436R	24 x 36 x 29.5-30	65	86	3.30	\$637	\$710	N/A	\$178	
Z2430R	24 x 30 x 29.5-30	70	77	3.60	\$600	\$658	N/A	\$178	

Full end panel on right. Left narrow end panel connects to **24"D** center/right connectable table, or at 90° angle to a freestanding table, height adjustable desk, 24"D extended corners or at the end of a straight run; "D" islands or "P" islands with "T" and "H" bases. Grommet in worksurface. Shipped RTA (ready to assemble).

- Units 48" and under require storage for stability
- **Modesty Panel is 1" off of ground.**

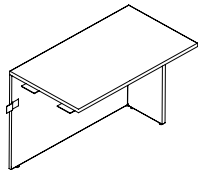

Bridge w/Full Laminate Modesty, Left

ZA2448RL	24 x 48 x 29.5-30	70	78	4.30	\$831	\$973	N/A	\$261
ZA2442RL	24 x 42 x 29.5-30	70	66	3.80	\$723	\$848	N/A	\$229
ZA2436RL	24 x 36 x 29.5-30	70	59	3.30	\$673	\$781	N/A	\$197
ZA2048RL	20 x 48 x 29.5-30	70	72	4.30	\$792	\$913	N/A	\$219
ZA2042RL	20 x 42 x 29.5-30	70	62	3.80	\$691	\$797	N/A	\$189
ZA2036RL	20 x 36 x 29.5-30	70	56	3.30	\$643	\$735	N/A	\$164

For use with height adjustable desks - single pedestal. Connects to credenza on **left**. Shipped RTA (ready to assemble).

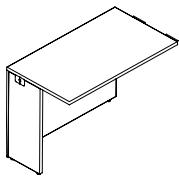

Bridge w/Full Laminate Modesty, Right

ZA2448RR	24 x 48 x 29.5-30	70	78	4.30	\$831	\$973	N/A	\$261
ZA2442RR	24 x 42 x 29.5-30	70	66	3.80	\$723	\$848	N/A	\$229
ZA2436RR	24 x 36 x 29.5-30	70	59	3.30	\$673	\$781	N/A	\$197
ZA2048RR	20 x 48 x 29.5-30	70	72	4.30	\$792	\$913	N/A	\$219
ZA2042RR	20 x 42 x 29.5-30	70	62	3.80	\$691	\$797	N/A	\$189
ZA2036RR	20 x 36 x 29.5-30	70	56	3.30	\$643	\$735	N/A	\$164

For use with height adjustable desks - single pedestal. Connects to credenza on **right**. Shipped RTA (ready to assemble).

CREDENZAS COMPATIBLE W/HT ADJ. BRIDGES

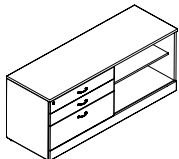

Credenza

MODEL#	DIMENSIONS	FREIGHT CLASS	WT/LBS.	CUBIC FT.	1"TOP	1.5" TOP	GLAZE ADD	HP ADD
Z2472BBOL	24 x 72 x 29.5-30	125	261	35.75	\$2468	\$2601	N/A	\$390
Z2460BBOL	24 x 60 x 29.5-30	125	231	30	\$2216	\$2327	N/A	\$327
Z2072BBOL	20 x 72 x 29.5-30	125	234	30.25	\$2358	\$2469	N/A	\$327
Z2060BBOL	20 x 60 x 29.5-30	100	207	25.25	\$2141	\$2234	N/A	\$273

Compatible with height adjustable bridges. Box/box/lateral file on **left** with open storage on the **right**. Connects to bridge on **right**. Adjustable shelf. Shipped assembled in 1 carton.

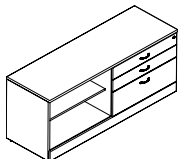

Credenza

Z2472BBOR	24 x 72 x 29.5-30	125	261	35.75	\$2468	\$2601	N/A	\$390
Z2460BBOR	24 x 60 x 29.5-30	125	231	30	\$2216	\$2327	N/A	\$327
Z2072BBOR	20 x 72 x 29.5-30	125	234	30.25	\$2358	\$2469	N/A	\$327
Z2060BBOR	20 x 60 x 29.5-30	100	207	25.25	\$2141	\$2234	N/A	\$273

Compatible with height adjustable bridges. Box/box/lateral file on **right** with open storage on the **left**. Connects to bridge on **left**. Adjustable shelf. Shipped assembled in 1 carton.

Required Specifications

Top finish
Top/edge detail
Base finish

Optional Specifications

HP laminate
Modesty panel type
Grommet position or power block cut-out

Accessories

Power block
Keyboard
Pencil drawer

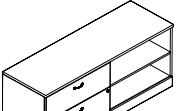
CREENZAS COMPATIBLE W/HT ADJ. BRIDGES	DIMENSIONS	FREIGHT CLASS	WT/LBS.	CUBIC FT.	1"TOP	1.5" TOPGLAZE ADD	HP ADD		
	D x W x H								
	Z2472BLFL	24 x 72 x 29.5-30	125	265	35.75	\$2430	\$2563	N/A	\$390
	Z2460BLFL	24 x 60 x 29.5-30	125	235	30	\$2191	\$2302	N/A	\$327
	Z2072BLFL	20 x 72 x 29.5-30	125	239	30.25	\$2320	\$2431	N/A	\$327
Z2060BLFL	20 x 60 x 29.5-30	100	212	25.25	\$2112	\$2205	N/A	\$273	

Credenza

Compatible with height adjustable bridges. Two drawer lateral file on **left** with open storage on the **right**. Connects to bridge on **right**. Adjustable shelf. Shipped assembled in 1 carton.

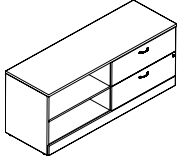

Credenza

Compatible with height adjustable bridges. Two drawer lateral file on **right** with open storage on the **left**. Connects to bridge on **left**. Adjustable shelf. Shipped assembled in 1 carton.

Z2472BLFR	24 x 72 x 29.5-30	125	265	35.75	\$2430	\$2563	N/A	\$390
Z2460BLFR	24 x 60 x 29.5-30	125	235	30	\$2191	\$2302	N/A	\$327
Z2072BLFR	20 x 72 x 29.5-30	125	239	30.25	\$2320	\$2431	N/A	\$327
Z2060BLFR	20 x 60 x 29.5-30	100	212	25.25	\$2112	\$2205	N/A	\$273

DOUBLE PEDESTAL DESKS	MODEL#	DIMENSIONS	FREIGHT CLASS	WT/LBS.	CUBIC FT.	1"TOP	1.5" TOP	GLAZE ADD	HP ADD
-----------------------	--------	------------	---------------	---------	-----------	-------	----------	-----------	--------

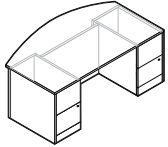

Double Pedestal Bow Top Desk

Z4284FB22	42 x 84 x 29.5-30	250	381.15	102.5	\$2843	\$3163	\$916	\$1015
Z4272FB22	42 x 72 x 29.5-30	125	377	59	\$2734	\$3014	\$760	\$762
Z3672FB22	36 x 72 x 29.5-30	125	317.10	50.75	\$2553	\$2801	\$760	\$573
Z3666FB22	36 x 66 x 29.5-30	125	305.55	46.75	\$2502	\$2731	\$678	\$573
Z3660FB22	36 x 60 x 29.5-30	125	295.05	42.50	\$2427	\$2637	\$600	\$477

Standard with **freestanding** file/file pedestals on **left** and **right**. Pedestals lock. Bow top overhangs 2 ¼" at ends and 8" on center.

- 84" wide desks are shipped RTA (ready to assemble) in 3 cartons.

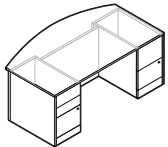

Double Pedestal Bow Top Desk

Z4284FB32	42 x 84 x 29.5-30	250	379.05	102.5	\$2881	\$3201	\$916	\$1015
Z4272FB32	42 x 72 x 29.5-30	125	375	59	\$2770	\$3050	\$760	\$762
Z3672FB32	36 x 72 x 29.5-30	125	315	50.75	\$2586	\$2836	\$760	\$573
Z3666FB32	36 x 66 x 29.5-30	125	303.45	46.75	\$2535	\$2762	\$678	\$573
Z3660FB32	36 x 60 x 29.5-30	125	292.95	42.50	\$2465	\$2675	\$600	\$477

Standard with **Freestanding** file/file pedestal on **right** and box/box/file pedestal on **left**. File drawer and lower box drawer lock. File pedestal locks. Bow top overhangs 2 ¼" at ends and 8" on center.

- 84" wide desks are shipped RTA (ready to assemble) in 3 cartons.

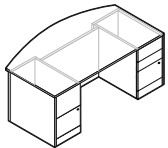

Double Pedestal Bow Top Desk

Z4284FB23	42 x 84 x 29.5-30	250	379.05	102.5	\$2881	\$3201	\$916	\$1015
Z4272FB23	42 x 72 x 29.5-30	125	375	59	\$2770	\$3050	\$760	\$762
Z3672FB23	36 x 72 x 29.5-30	125	315	50.75	\$2586	\$2836	\$760	\$573
Z3666FB23	36 x 66 x 29.5-30	125	303.45	46.75	\$2535	\$2762	\$678	\$573
Z3660FB23	36 x 60 x 29.5-30	125	292.95	42.50	\$2465	\$2675	\$600	\$477

Standard with **Freestanding** file/file pedestal on **left** and box/box/file pedestal on **right**. File drawer and lower box drawer lock. File pedestal locks. Bow top overhangs 2 ¼" at ends and 8" on center.

- 84" wide desks are shipped RTA (ready to assemble) in 3 cartons.

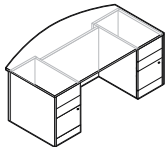

Double Pedestal Bow Top Desk

Z4284FB33	42 x 84 x 29.5-30	250	381.15	102.5	\$2916	\$3236	\$916	\$1015
Z4272FB33	42 x 72 x 29.5-30	125	378	59	\$2805	\$3086	\$760	\$762
Z3672FB33	36 x 72 x 29.5-30	125	317.10	50.75	\$2624	\$2874	\$760	\$573
Z3666FB33	36 x 66 x 29.5-30	125	305.55	46.75	\$2573	\$2800	\$678	\$573
Z3660FB33	36 x 60 x 29.5-30	125	295.05	42.50	\$2507	\$2731	\$600	\$477

Standard with **Freestanding** box/box/file pedestals on **left** and **right**. File drawer and lower box drawer lock. Bow top overhangs 2 ¼" at ends and 8" on center.

- 84" wide desks are shipped RTA (ready to assemble) in 3 cartons.

Required Specifications

Top finish
Top/edge detail
Base finish
Lock finish

Optional Specifications

HP laminate
Key #
Modesty panel type
Grommet position or power block cut-out

Handles

Modesty finish glazed

Accessories

Power block
Keyboard
Pencil drawer

DOUBLE PEDESTAL DESKS

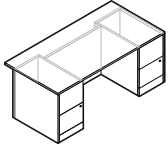

Double Pedestal Desk

MODEL#	DIMENSIONS D x W x H	FREIGHT CLASS	WT./LBS.	CUBIC FT.	1" TOP	1.5" TOP	GLAZE ADD	HP ADD
Z4284F22	42 x 84 x 29.5-30	250	385.35	102.5	\$2744	\$3017	\$916	\$1015
Z4272F22	42 x 72 x 29.5-30	125	373	59	\$2643	\$2878	\$760	\$762
Z3684F22	36 x 84 x 29.5-30	250	366.12	176.6	\$2583	\$2819	\$916	\$762
Z3672F22	36 x 72 x 29.5-30	125	326.01	50.75	\$2465	\$2671	\$760	\$573
Z3666F22	36 x 66 x 29.5-30	125	314.77	46.75	\$2419	\$2607	\$678	\$573
Z3660F22	36 x 60 x 29.5-30	125	294.93	42.50	\$2374	\$2546	\$600	\$477
Z3072F22	29.7 x 72 x 29.5-30	125	326.01	50.75	\$2465	\$2670	\$760	\$573
Z3066F22	29.7 x 66 x 29.5-30	125	314.77	46.75	\$2419	\$2606	\$678	\$573
Z3060F22	29.7 x 60 x 29.5-30	125	294.93	42.50	\$2374	\$2544	\$600	\$477

Standard with **Freestanding** file/file pedestals on **left** and **right**. Pedestals lock.

- 84" wide desks are shipped RTA (ready to assemble) in 3 cartons.
- Hutches may not be placed on this desk

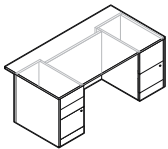

Double Pedestal Desk

Z4284F32	42 x 84 x 29.5-30	250	383.25	102.5	\$2780	\$3050	\$916	\$1015
Z4272F32	42 x 72 x 29.5-30	125	371	59	\$2679	\$2914	\$760	\$762
Z3684F32	36 x 84 x 29.5-30	250	364.54	176.6	\$2619	\$2855	\$916	\$762
Z3672F32	36 x 72 x 29.5-30	125	324.43	50.75	\$2503	\$2709	\$760	\$573
Z3666F32	36 x 66 x 29.5-30	125	313.18	46.75	\$2455	\$2643	\$678	\$573
Z3660F32	36 x 60 x 29.5-30	125	267.10	42.50	\$2410	\$2584	\$600	\$477
Z3072F32	29.69 x 72 x 29.5-30	125	324.43	50.75	\$2503	\$2709	\$760	\$573
Z3066F32	29.7 x 66 x 29.5-30	125	313.18	46.75	\$2455	\$2643	\$678	\$573
Z3060F32	29.7 x 60 x 29.5-30	125	267.10	42.50	\$2410	\$2582	\$600	\$477

Standard with **Freestanding** box/box/file pedestal on **left** and file/file pedestal on **right**. File drawer and lower box drawer lock. File pedestal locks.

- 84" wide desks are shipped RTA (ready to assemble) in 3 cartons.
- Hutches may not be placed on this desk

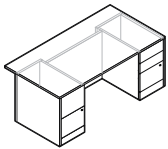

Double Pedestal Desk

Z4284F23	42 x 84 x 29.5-30	250	383.25	102.5	\$2780	\$3050	\$916	\$1015
Z4272F23	42 x 72 x 29.5-30	125	371	59	\$2679	\$2914	\$760	\$762
Z3684F23	36 x 84 x 29.5-30	250	364.54	176.6	\$2619	\$2855	\$916	\$762
Z3672F23	36 x 72 x 29.5-30	125	324.43	50.75	\$2503	\$2709	\$760	\$573
Z3666F23	36 x 66 x 29.5-30	125	313.18	46.75	\$2455	\$2643	\$678	\$573
Z3660F23	36 x 60 x 29.5-30	125	267.10	42.50	\$2410	\$2584	\$600	\$477
Z3072F23	29.7 x 72 x 29.5-30	125	324.43	50.75	\$2503	\$2709	\$760	\$573
Z3066F23	29.7 x 66 x 29.5-30	125	313.18	46.75	\$2455	\$2643	\$678	\$573
Z3060F23	29.7 x 60 x 29.5-30	125	267.10	42.50	\$2410	\$2582	\$600	\$477

Standard with **Freestanding** file/file pedestal on **left** and box/box/file pedestal on **right**. File drawer and lower box drawer lock. File pedestal locks.

- 84" wide desks are shipped RTA (ready to assemble) in 3 cartons.
- Hutches may not be placed on this desk

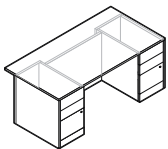

Double Pedestal Desk

Z4284F33	42 x 84 x 29.5-30	250	381.15	102.5	\$2817	\$3087	\$916	\$1015
Z4272F33	42 x 72 x 29.5-30	125	370	59	\$2717	\$2951	\$760	\$762
Z3684F33	36 x 84 x 29.5-30	300	341.25	176.6	\$2656	\$2892	\$916	\$762
Z3672F33	36 x 72 x 29.5-30	125	316.05	50.75	\$2536	\$2742	\$760	\$573
Z3666F33	36 x 66 x 29.5-30	125	304.50	46.75	\$2492	\$2680	\$678	\$573
Z3660F33	36 x 60 x 29.5-30	125	261.45	42.50	\$2447	\$2621	\$600	\$477
Z3072F33	29.7 x 72 x 29.5-30	125	316.05	50.75	\$2536	\$2742	\$760	\$573
Z3066F33	29.7 x 66 x 29.5-30	125	304.50	46.75	\$2492	\$2675	\$678	\$573
Z3060F33	29.69 x 60 x 29.5-30	125	261.45	42.50	\$2447	\$2621	\$600	\$477

Standard with **Freestanding** box/box/file pedestals on **left** and **right**. File drawer and lower box drawer lock.

- 84" wide desks are shipped RTA (ready to assemble) in 3 cartons.
- Hutches may not be placed on this desk

Required Specifications

Top finish
Top/edge detail
Base finish
Lock finish

Optional Specifications

HP laminate
Key #
Modesty Type
Grommet position or power block cut-out

Handles
Modesty finish glazed

Accessories

Power block
Keyboard
Pencil drawer

SINGLE PEDESTAL DESKS

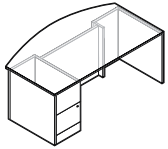

Single Pedestal Bow Top Desk - LEFT

MODEL#	DIMENSIONS D x W x H	FREIGHT CLASS	WT./LBS.	CUBIC FT.	1" TOP	1.5" TOP	GLAZE ADD	HP ADD
Z4284FB2L	42 x 84 x 29.5-30	125	322.35	43.50	\$2175	\$2495	\$916	\$1015
Z4272FB2L	42 x 72 x 29.5-30	150	315	59	\$2064	\$2345	\$760	\$762
Z3672FB2L	36 x 72 x 29.5-30	150	281.35	50.75	\$1914	\$2162	\$760	\$573
Z3666FB2L	36 x 66 x 29.5-30	150	274.68	46.75	\$1861	\$2090	\$678	\$573
Z3660FB2L	36 x 60 x 29.5-30	125	259.86	42.50	\$1792	\$2002	\$600	\$477

Standard with **Freestanding** file/file pedestal on **left** and faux pedestal **right**. Pedestal locks. Bow top overhangs 2 ¼" at ends and 8" on center.

- 84" wide desks are shipped RTA (ready to assemble) in 2 cartons.

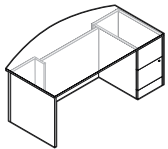

Single Pedestal Bow Top Desk - RIGHT

Z4284FB2R	42 x 84 x 29.5-30	125	322.35	43.50	\$2175	\$2495	\$916	\$1015
Z4272FB2R	42 x 72 x 29.5-30	150	315	59	\$2064	\$2345	\$760	\$762
Z3672FB2R	36 x 72 x 29.5-30	150	281.35	50.75	\$1914	\$2162	\$760	\$573
Z3666FB2R	36 x 66 x 29.5-30	150	274.68	46.75	\$1861	\$2090	\$678	\$573
Z3660FB2R	36 x 60 x 29.5-30	125	259.86	42.50	\$1792	\$2002	\$600	\$477

Standard with **Freestanding** faux pedestal **left** and file/file pedestal on **right**. Pedestal locks. Bow top overhangs 2 ¼" at ends and 8" on center.

- 84" wide desks are shipped RTA (ready to assemble) in 2 cartons.

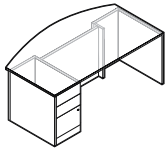

Single Pedestal Bow Top Desk - LEFT

Z4284FB3L	42 x 84 x 29.5-30	125	320.25	43.50	\$2212	\$2531	\$916	\$1015
Z4272FB3L	42 x 72 x 29.5-30	150	313	59	\$2099	\$2379	\$760	\$762
Z3672FB3L	36 x 72 x 29.5-30	150	279.77	50.75	\$1950	\$2200	\$760	\$573
Z3666FB3L	36 x 66 x 29.5-30	150	273.10	46.75	\$1900	\$2127	\$678	\$573
Z3660FB3L	36 x 60 x 29.5-30	125	258.27	42.50	\$1848	\$2061	\$600	\$477

Standard with **Freestanding** box/box/file pedestal on **left** and faux pedestal **right**. File drawer and lower box drawer lock. Bow top overhangs 2 ¼" at ends and 8" on center.

- 84" wide desks are shipped RTA (ready to assemble) in 2 cartons.

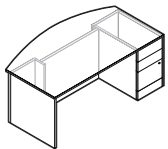

Single Pedestal Bow Top Desk - RIGHT

Z4284FB3R	42 x 84 x 29.5-30	125	320.25	43.50	\$2212	\$2531	\$916	\$1015
Z4272FB3R	42 x 72 x 29.5-30	150	313	59	\$2099	\$2379	\$760	\$762
Z3672FB3R	36 x 72 x 29.5-30	150	279.77	50.75	\$1950	\$2200	\$760	\$573
Z3666FB3R	36 x 66 x 29.5-30	150	273.10	46.75	\$1900	\$2127	\$678	\$573
Z3660FB3R	36 x 60 x 29.5-30	125	258.27	42.50	\$1848	\$2061	\$600	\$477

Standard with **Freestanding** faux pedestal **left** and box/box/file pedestal on **right**. File drawer and lower box drawer lock. Bow top overhangs 2 ¼" at ends and 8" on center.

- 84" wide desks are shipped RTA (ready to assemble) in 2 cartons.

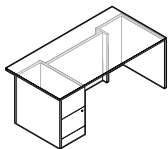

Single Pedestal Desk - LEFT

Z4284F2L	42 x 84 x 29.5-30	125	326.55	43.50	\$2074	\$2347	\$916	\$1015
Z4272F2L	42 x 72 x 29.5-30	150	327	59	\$1974	\$2209	\$760	\$762
Z3684F2L	36 x 84 x 29.5-30	250	290.85	118	\$1947	\$2183	\$916	\$762
Z3672F2L	36 x 72 x 29.5-30	150	265.65	50.75	\$1826	\$2032	\$760	\$573
Z3666F2L	36 x 66 x 29.5-30	150	254.10	46.75	\$1781	\$1969	\$678	\$573
Z3660F2L	36 x 60 x 29.5-30	150	243.60	42.50	\$1736	\$1911	\$600	\$477
Z3072F2L	29.69 x 72 x 29.5-30	150	265.65	50.75	\$1826	\$2032	\$760	\$573
Z3066F2L	29.7 x 66 x 29.5-30	150	254.10	46.75	\$1781	\$1968	\$678	\$573
Z3060F2L	29.7 x 60 x 29.5-30	150	243.60	42.50	\$1736	\$1911	\$600	\$477

Standard with **Freestanding** file/file pedestal on **left** and faux pedestal **right**. Pedestal locks.

- 84" wide desks are shipped RTA (ready to assemble) in 2 cartons.
- Hutches may not be placed on this desk

Required Specifications

Top finish
Top/edge detail
Base finish
Lock finish

Optional Specifications

HP laminate
Key #
Modesty Type
Grommet position or power block cut-out

Handles

Modesty finish glazed

Accessories

Power block
Keyboard
Pencil drawer

SINGLE PEDESTAL DESKS

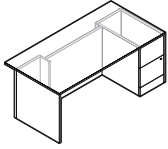

Single Pedestal Desk - RIGHT*

MODEL#	DIMENSIONS D x W x H	FREIGHT CLASS	WT/LBS.	CUBIC FT.	1" TOP	1.5" TOP	GLAZE ADD	HP ADD
Z4284F2R	42 x 84 x 29.5-30	125	326.55	43.50	\$2074	\$2347	\$916	\$1015
Z4272F2R	42 x 72 x 29.5-30	150	327	59	\$1974	\$2209	\$760	\$762
Z3684F2R	36 x 84 x 29.5-30	250	290.85	118	\$1947	\$2183	\$916	\$762
Z3672F2R	36 x 72 x 29.5-30	150	265.65	50.75	\$1826	\$2032	\$760	\$573
Z3666F2R	36 x 66 x 29.5-30	150	254.10	46.75	\$1781	\$1969	\$678	\$573
Z3660F2R	36 x 60 x 29.5-30	150	243.60	42.50	\$1736	\$1911	\$600	\$477
Z3072F2R	29.7 x 72 x 29.5-30	150	265.65	50.75	\$1826	\$2032	\$760	\$573
Z3066F2R	29.7 x 66 x 29.5-30	150	254.10	46.75	\$1781	\$1968	\$678	\$573
Z3060F2R	29.7 x 60 x 29.5-30	150	243.60	42.50	\$1736	\$1911	\$600	\$477

Standard with **Freestanding** faux pedestal on **left** and file/file pedestal **right**. Pedestal locks.

- 84" wide desks are shipped RTA (ready to assemble) in 2 cartons.
- Hutches may not be placed on this desk

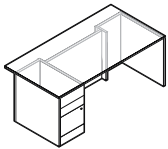

Single Pedestal Desk - LEFT*

Z4284F3L	42 x 84 x 29.5-30	125	324.45	43.50	\$2112	\$2382	\$916	\$1015
Z4272F3L	42 x 72 x 29.5-30	150	324	59	\$2011	\$2246	\$760	\$762
Z3684F3L	36 x 84 x 29.5-30	250	288.75	118	\$1947	\$2183	\$916	\$762
Z3672F3L	36 x 72 x 29.5-30	150	263.55	50.75	\$1863	\$2069	\$760	\$573
Z3666F3L	36 x 66 x 29.5-30	150	252	46.75	\$1819	\$2007	\$678	\$573
Z3660F3L	36 x 60 x 29.5-30	150	241.50	42.50	\$1750	\$1922	\$600	\$477
Z3072F3L	29.7 x 72 x 29.5-30	150	253.55	50.75	\$1863	\$2069	\$760	\$573
Z3066F3L	29.7 x 66 x 29.5-30	150	252	46.75	\$1819	\$2006	\$678	\$573
Z3060F3L	29.7 x 60 x 29.5-30	150	241.50	42.50	\$1750	\$1922	\$600	\$477

Standard with **Freestanding** box/box/file pedestal on **left** and faux pedestal **right**. File drawer and lower box drawer lock.

- 84" wide desks are shipped RTA (ready to assemble) in 2 cartons.
- Hutches may not be placed on this desk

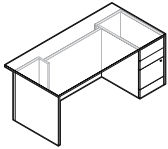

Single Pedestal Desk - RIGHT*

Z4284F3R	42 x 84 x 29.5-30	125	324.45	43.50	\$2112	\$2382	\$916	\$1015
Z4272F3R	42 x 72 x 29.5-30	150	324	59	\$2011	\$2246	\$760	\$762
Z3684F3R	36 x 84 x 29.5-30	250	288.75	118	\$1947	\$2183	\$916	\$762
Z3672F3R	36 x 72 x 29.5-30	150	263.55	50.75	\$1863	\$2069	\$760	\$573
Z3666F3R	36 x 66 x 29.5-30	150	252	46.75	\$1819	\$2007	\$678	\$573
Z3660F3R	36 x 60 x 29.5-30	150	241.50	42.50	\$1750	\$1922	\$600	\$477
Z3072F3R	29.7 x 72 x 29.5-30	150	253.55	50.75	\$1863	\$2069	\$760	\$573
Z3066F3R	29.7 x 66 x 29.5-30	150	252	46.75	\$1819	\$2006	\$678	\$573
Z3060F3R	29.7 x 60 x 29.5-30	150	241.50	42.50	\$1750	\$1922	\$600	\$477

Standard with **Freestanding** faux pedestal on **left** and box/box/file pedestal **right**. File drawer and lower box drawer lock.

- 84" wide desks are shipped RTA (ready to assemble) in 2 cartons.
- Hutches may not be placed on this desk

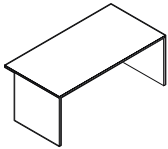

Non-Handed Desk

Z4284NHD	42 x 84 x 29.5-30	65	267	9.5	\$1583	\$1893	n/a	\$796
Z3684NHD	36 x 84 x 29.5-30	70	182	8.3	\$1436	\$1697	n/a	\$685
Z3672NHD	36 x 72 x 29.5-30	70	159	7.2	\$1294	\$1517	n/a	\$587
Z3666NHD	36 x 66 x 29.5-30	65	152	6.7	\$1220	\$1432	n/a	\$538
Z3660NHD	36 x 60 x 29.5-30	65	143	6.1	\$1153	\$1347	n/a	\$489
Z3072NHD	29.7 x 72 x 29.5-30	65	140	6.2	\$1178	\$1364	n/a	\$489
Z3066NHD	29.7 x 66 x 29.5-30	65	133	5.7	\$1092	\$1273	n/a	\$451
Z3060NHD	29.7 x 60 x 29.5-30	65	124	5.2	\$1030	\$1186	n/a	\$409

Two laminate end panels + recessed full modesty panel (laminated only). Accepts all standard Zira storage shells. Shipped RTA (ready to assemble).

- Hutches may not be placed on this desk

Required Specifications

Top finish
Top/edge detail
Base finish
Lock finish

Optional Specifications

HP laminate
Key #
Modesty Type
Grommet position or power block cut-out

Accessories

Power block
Keyboard
Pencil drawer

FREESTANDING DESKS

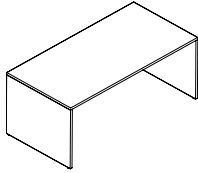

Freestanding Desk

MODEL#	DIMENSIONS D x W x H	FREIGHT CLASS	WT/LBS.	CUBIC FT.	1" TOP	1.5" TOP	GLAZE ADD	HP ADD
Z3684DK	36 x 84 x 29.5-30	70	168	8.25	\$1239	\$1494	\$957	\$681
Z3672DK	36 x 72 x 29.5-30	70	152	7.25	\$1133	\$1357	\$854	\$585
Z3666DK	36 x 66 x 29.5-30	70	144	6.75	\$1084	\$1290	\$780	\$537
Z3660DK	36 x 60 x 29.5-30	65	137	6	\$1036	\$1222	\$729	\$488
Z3072DK	30 x 72 x 29.5-30	70	130	6.25	\$1011	\$1197	\$854	\$488
Z3066DK	30 x 66 x 29.5-30	70	123	5.75	\$963	\$1149	\$780	\$448
Z3060DK	30 x 60 x 29.5-30	70	117	5.25	\$913	\$1099	\$729	\$407

Two full laminate end panels. 12"H laminate modesty panel. Shipped RTA (ready to assemble).

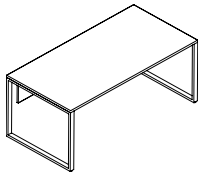

Freestanding Desk - Metal Legs*

Z3684DM	36 x 84 x 29.5-30	100	167	18.44	\$2648	\$2909	\$734	\$681
Z3672DM	36 x 72 x 29.5-30	100	151	17.46	\$2549	\$2773	\$630	\$585
Z3666DM	36 x 66 x 29.5-30	100	143	16.95	\$2500	\$2706	\$556	\$488
Z3660DM	36 x 60 x 29.5-30	100	143	16.95	\$2500	\$2706	\$504	\$488
Z3072DM	30 x 72 x 29.5-30	100	133	14.70	\$2427	\$2613	\$630	\$488
Z3066DM	30 x 66 x 29.5-30	100	126	14.22	\$2378	\$2564	\$556	\$448
Z3060DM	30 x 60 x 29.5-30	100	120	13.95	\$2327	\$2513	\$504	\$407

Double metal legs. 12"H laminate modesty panel. Metal leg available in Black (BLK) or Tungsten (TUN). Shipped RTA (ready to assemble).

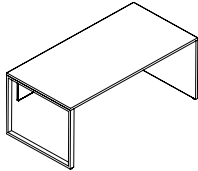

Freestanding Desk - Metal Legs*

Z3684DML	36 x 84 x 29.5-30	85	167	13.50	\$1946	\$2201	\$840	\$681
Z3672DML	36 x 72 x 29.5-30	85	151	12.04	\$1847	\$2066	\$738	\$585
Z3666DML	36 x 66 x 29.5-30	85	144	11.74	\$1799	\$2005	\$664	\$537
Z3660DML	36 x 60 x 29.5-30	85	135	11.24	\$1749	\$1935	\$614	\$488
Z3072DML	30 x 72 x 29.5-30	85	131	10.50	\$1725	\$1911	\$738	\$488
Z3066DML	30 x 66 x 29.5-30	85	125	10	\$1676	\$1862	\$664	\$448
Z3060DML	30 x 60 x 29.5-30	85	118	9.50	\$1628	\$1814	\$614	\$407

Single metal leg on **left** and laminate end panel on **right**. 12"H laminate modesty panel. Metal leg available in Black (BLK) or Tungsten (TUN). Shipped RTA (ready to assemble).

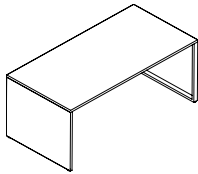

Freestanding Desk - Metal Legs*

Z3684DMR	36 x 84 x 29.5-30	85	167	13.50	\$1946	\$2201	\$840	\$681
Z3672DMR	36 x 72 x 29.5-30	85	151	12.04	\$1847	\$2066	\$738	\$585
Z3666DMR	36 x 66 x 29.5-30	85	144	11.74	\$1799	\$2005	\$664	\$537
Z3660DMR	36 x 60 x 29.5-30	85	135	11.24	\$1749	\$1935	\$614	\$488
Z3072DMR	30 x 72 x 29.5-30	85	131	10.50	\$1725	\$1911	\$738	\$488
Z3066DMR	30 x 66 x 29.5-30	85	125	10	\$1676	\$1862	\$664	\$448
Z3060DMR	30 x 60 x 29.5-30	85	118	9.50	\$1628	\$1814	\$614	\$407

Single metal leg on **right** and laminate end panel on **left**. 12"H laminate modesty panel. Metal leg available in Black (BLK) or Tungsten (TUN). Shipped RTA (ready to assemble).

Required Specifications

Top finish
Top/edge detail
Base finish
Lock finish

Optional Specifications

HP laminate
Key #
Modesty Type*
Grommet position or power block cut-out

Handles

Modesty finish glazed*

Accessories

Power block
Keyboard
Pencil drawer

TRANSITIONAL TABLES

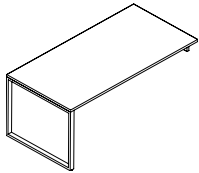

LEFT

Overlapping Table

MODEL#	DIMENSIONS D x W x H	FREIGHT CLASS	WT./LBS.	CUBIC FT.	1" TOP	1.5" TOP	GLAZE ADD	HP ADD
Z3684OML	36 x 84 x 29.5-30	100	132	13.50	\$1780	\$2035	N/A	\$681
Z3672OML	36 x 72 x 29.5-30	100	120	12.24	\$1700	\$1955	N/A	\$585
Z3666OML	36 x 66 x 29.5-30	100	112	11.74	\$1663	\$1918	N/A	\$537
Z3660OML	36 x 60 x 29.5-30	100	105	11.24	\$1632	\$1882	N/A	\$488
Z3072OML	30 x 72 x 29.5-30	100	104	10.50	\$1609	\$1851	N/A	\$488
Z3066OML	30 x 66 x 29.5-30	100	97	10	\$1571	\$1821	N/A	\$448
Z3060OML	30 x 60 x 29.5-30	100	90	9.50	\$1541	\$1791	N/A	\$407

Metal open frame leg with support channels on **left**. To be placed on top of 23.75"/24.25" high units.
Not freestanding. Metal leg available in Black (**BLK**) or Tungsten (**TUN**). Shipped RTA (ready to assemble).

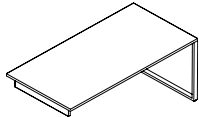

RIGHT

Overlapping Table

Z3684OMR	36 x 84 x 29.5-30	100	132	13.50	\$1780	\$2035	N/A	\$681
Z3672OMR	36 x 72 x 29.5-30	100	120	12.24	\$1700	\$1955	N/A	\$585
Z3666OMR	36 x 66 x 29.5-30	100	112	11.74	\$1663	\$1918	N/A	\$537
Z3660OMR	36 x 60 x 29.5-30	100	105	11.24	\$1632	\$1882	N/A	\$488
Z3072OMR	30 x 72 x 29.5-30	100	104	10.50	\$1609	\$1851	N/A	\$488
Z3066OMR	30 x 66 x 29.5-30	100	97	10	\$1571	\$1821	N/A	\$448
Z3060OMR	30 x 60 x 29.5-30	100	90	9.50	\$1541	\$1791	N/A	\$407

Metal open frame leg with support channels on **right**. To be placed on top of 23.75"/24.25" high units.
Not freestanding. Metal leg available in Black (**BLK**) or Tungsten (**TUN**). Shipped RTA (ready to assemble).

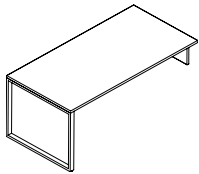

LEFT

Overlapping Table

Z3684SOL	36 x 84 x 29.5-30	92.5	139	13.50	\$1799	\$2054	N/A	\$681
Z3672SOL	36 x 72 x 29.5-30	92.5	126	12.24	\$1720	\$1975	N/A	\$585
Z3666SOL	36 x 66 x 29.5-30	92.5	118	11.74	\$1682	\$1937	N/A	\$537
Z3660SOL	36 x 60 x 29.5-30	100	110	11.24	\$1651	\$1901	N/A	\$488
Z3072SOL	30 x 72 x 29.5-30	92.5	108	10.50	\$1628	\$1870	N/A	\$488
Z3066SOL	30 x 66 x 29.5-30	92.5	100	10	\$1590	\$1840	N/A	\$448
Z3060SOL	30 x 60 x 29.5-30	92.5	96	9.50	\$1559	\$1809	N/A	\$407

Metal open frame leg with support channels on **left**. To be placed on top of 17.87"/18.37" high units.
Not freestanding. Metal leg available in Black (**BLK**) or Tungsten (**TUN**). Shipped RTA (ready to assemble).

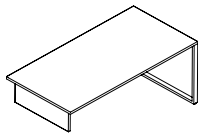

RIGHT

Overlapping Table

Z3684SOR	36 x 84 x 29.5-30	92.5	139	13.50	\$1799	\$2054	N/A	\$681
Z3672SOR	36 x 72 x 29.5-30	92.5	126	12.24	\$1720	\$1975	N/A	\$585
Z3666SOR	36 x 66 x 29.5-30	92.5	118	11.74	\$1682	\$1937	N/A	\$537
Z3660SOR	36 x 60 x 29.5-30	100	110	11.24	\$1651	\$1901	N/A	\$488
Z3072SOR	30 x 72 x 29.5-30	92.5	108	10.50	\$1628	\$1870	N/A	\$488
Z3066SOR	30 x 66 x 29.5-30	92.5	100	10	\$1590	\$1840	N/A	\$448
Z3060SOR	30 x 60 x 29.5-30	92.5	96	9.50	\$1559	\$1809	N/A	\$407

Metal open frame leg with support channels on **right**. To be placed on top of 17.87"/18.37" high units.
Not freestanding. Metal leg available in Black (**BLK**) or Tungsten (**TUN**). Shipped RTA (ready to assemble).

Required Specifications

Top finish
Top/edge detail
Base finish
Leg finish (BLK or TUN)

Optional Specifications

HP laminate
Grommet position or power block cut-out

Accessories

Power block
Keyboard
Pencil drawer

FLUSH RETURNS

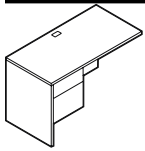

Flush Return - LEFT*

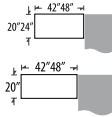

MODEL#	DIMENSIONS	FREIGHT CLASS	WT./LBS.	CUBIC FT.	1" TOP	1.5" TOP	GLAZE ADD	HP ADD
D x W x H								
Z2448FL	24 x 48 x 29.5-30	125	155	24	\$1015	\$1117	N/A	\$281
Z2442FL	24 x 42 x 29.5-30	125	144	21.25	\$1015	\$1104	N/A	\$236
Z2048FL	20 x 48 x 29.5-30	125	140	20.25	\$941	\$1030	N/A	\$236
Z2042FL	20 x 42 x 29.5-30	125	130	18	\$941	\$1030	N/A	\$236

Standard with **box/file** drawer pedestal. One pencil tray. Pedestal locks. Grommet in worksurface. Pedestal is on the **left**. For use with right handed single pedestal desks, 20"/24" deep extended corners with narrow end panel or 20"/24" deep five-sided corners with narrow end panel.

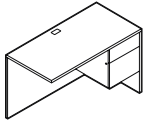

Flush Return - RIGHT*

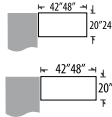

Z2448FR	24 x 48 x 29.5-30	125	155	24	\$1015	\$1117	N/A	\$281
Z2442FR	24 x 42 x 29.5-30	125	144	21.25	\$1015	\$1104	N/A	\$236
Z2048FR	20 x 48 x 29.5-30	125	140	20.25	\$941	\$1030	N/A	\$236
Z2042FR	20 x 42 x 29.5-30	125	130	18	\$941	\$1030	N/A	\$236

Standard with **box/file** drawer pedestal. One pencil tray. Pedestal locks. Grommet in worksurface. Pedestal is on the **right**. For use with left handed single pedestal desks, 20"/24" deep extended corners with narrow end panel or 20"/24" deep five-sided corners with narrow end panel.

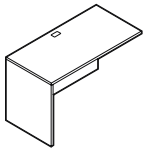

Flush Return - LEFT*

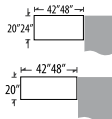

Z2448EL	24 x 48 x 29.5-30	65	107	4.30	\$718	\$820	N/A	\$281
Z2442EL	24 x 42 x 29.5-30	65	96	3.80	\$718	\$807	N/A	\$236
Z2048EL	20 x 48 x 29.5-30	65	97	4.30	\$663	\$754	N/A	\$236
Z2042EL	20 x 42 x 29.5-30	65	86	3.80	\$663	\$754	N/A	\$236

Return has **no pedestal**. Grommet in worksurface. Shipped RTA (ready to assemble). For use with right handed single pedestal desks, 20"/24" deep extended corners with narrow end panel or 20"/24" deep five-sided corners with narrow end panel.

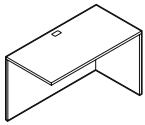

Flush Return - RIGHT**

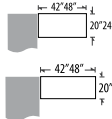

Z2448ER	24 x 48 x 29.5-30	65	107	4.30	\$718	\$820	N/A	\$281
Z2442ER	24 x 42 x 29.5-30	65	96	3.80	\$718	\$807	N/A	\$236
Z2048ER	20 x 48 x 29.5-30	65	97	4.30	\$663	\$754	N/A	\$236
Z2042ER	20 x 42 x 29.5-30	65	86	3.80	\$663	\$754	N/A	\$236

Return has **no pedestal**. Grommet in worksurface. Shipped RTA (ready to assemble). For use with left handed single pedestal desks, 20"/24" deep extended corners with narrow end panel or 20"/24" deep five-sided corners with narrow end panel.

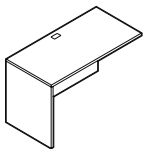

Flush Return - LEFT

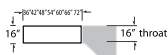

Z1672RL	15.8 x 72 x 29.5-30	70	109.20	6	\$714	\$839	N/A	\$289
Z1666RL	15.8 x 66 x 29.5-30	70	101.85	5.75	\$684	\$801	N/A	\$289
Z1660RL	1w5.8 x 60 x 29.5-30	70	94.50	5.25	\$645	\$752	N/A	\$240
Z1654RL	15.8 x 54 x 29.5-30	70	87.15	5.25	\$611	\$711	N/A	\$240
Z1648RL	15.8 x 48 x 29.5-30	70	79.80	4.25	\$562	\$650	N/A	\$195
Z1642RL	15.8 x 42 x 29.5-30	70	70.35	4	\$503	\$584	N/A	\$195
Z1636RL	15.8 x 36 x 29.5-30	70	61.95	3.50	\$450	\$522	N/A	\$146

16" Throat. Return has **no pedestal**. Grommet in worksurface. Shipped RTA (ready to assemble). For use with extended corners, desks and islands with 16" throat.

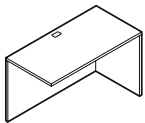

Flush Return - RIGHT

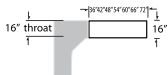

Z1672RR	15.8 x 72 x 29.5-30	70	109.20	6	\$714	\$839	N/A	\$289
Z1666RR	15.8 x 66 x 29.5-30	70	101.85	5.75	\$684	\$801	N/A	\$289
Z1660RR	15.8 x 60 x 29.5-30	70	94.50	5.25	\$645	\$752	N/A	\$240
Z1654RR	15.8 x 54 x 29.5-30	70	87.15	5.25	\$611	\$711	N/A	\$240
Z1648RR	15.8 x 48 x 29.5-30	70	79.80	4.25	\$562	\$650	N/A	\$195
Z1642RR	15.8 x 42 x 29.5-30	70	70.35	4	\$503	\$584	N/A	\$195
Z1636RR	15.8 x 36 x 29.5-30	70	61.95	3.50	\$450	\$522	N/A	\$146

16" Throat. Return has **no pedestal**. Grommet in worksurface. Shipped RTA (ready to assemble). For use with extended corners, desks and islands with 16" throat.

Required Specifications

Top finish
Top/edge detail
Base finish
Lock finish*

Optional Specifications

HP laminate
Key #
Modesty Type
Grommet position or power block cut-out

Accessories

Power block
Keyboard
Pencil drawer

NON-HANDED RETURN

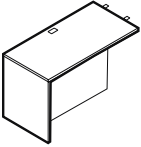

Non-Handed Return

MODEL#	DIMENSIONS D x W x H	FREIGHT CLASS	WT/LBS.	CUBIC FT.	1" TOP	1.5" TOP	GLAZE ADD	HP ADD
Z2448NHR	24 x 48 x 29.5-30	70	83	4.3	\$740	\$852	N/A	\$261
Z2442NHR	24 x 42 x 29.5-30	70	75	3.8	\$642	\$761	N/A	\$232
Z2048NHR	20 x 48 x 29.5-30	70	75	4.3	\$673	\$780	N/A	\$219
Z2042NHR	20 x 42 x 29.5-30	70	67	3.8	\$617	\$693	N/A	\$194

Non-handed (reversible) return. 24" d returns accept all standard 23.4" storage shells. 20" d returns accept all standard 19.3" storage shells. Full modesty panel (laminate only). Shipped RTA (ready to assemble).

SPACE SAVER RETURNS

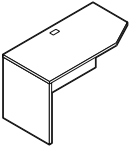

Space Saver Return - LEFT

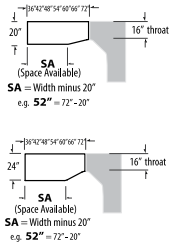

MODEL#	DIMENSIONS	FREIGHT CLASS	WT/LBS.	CUBIC FT.	1" TOP	1.5" TOP	GLAZE ADD	HP ADD
Z247216RL	24 x 72 x 29.5-30	65	135.45	6	\$849	\$1033	N/A	\$384
Z246616RL	24 x 66 x 29.5-30	70	127.05	5.75	\$812	\$981	N/A	\$384
Z246016RL	24 x 60 x 29.5-30	70	117.60	5.25	\$761	\$919	N/A	\$319
Z245416RL	24 x 54 x 29.5-30	70	108.15	5.25	\$718	\$862	N/A	\$319
Z244816RL	24 x 48 x 29.5-30	65	99.75	4.25	\$659	\$789	N/A	\$258
Z244216RL	24 x 42 x 29.5-30	70	88.20	4	\$590	\$707	N/A	\$258
Z243616RL	24 x 36 x 29.5-30	70	77.70	3.50	\$536	\$641	N/A	\$195
Z207216RL	20 x 72 x 29.5-30	70	122.85	6	\$777	\$933	N/A	\$384
Z206616RL	20 x 66 x 29.5-30	70	114.45	5.75	\$740	\$882	N/A	\$384
Z206016RL	20 x 60 x 29.5-30	70	106.05	5.25	\$696	\$827	N/A	\$319
Z205416RL	20 x 54 x 29.5-30	70	97.65	5.25	\$655	\$774	N/A	\$319
Z204816RL	20 x 48 x 29.5-30	70	90.30	4.25	\$602	\$710	N/A	\$258
Z204216RL	20 x 42 x 29.5-30	70	79.80	4	\$540	\$640	N/A	\$258
Z203616RL	20 x 36 x 29.5-30	70	70.35	3.50	\$488	\$573	N/A	\$195

16" Throat. Return has **no pedestal**. Grommet in worksurface. Shipped RTA (ready to assemble). For use with extended corners, desks and islands with 16" throat. Accepts same depth storage shells under worksurface.

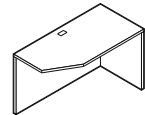

Space Saver Return - RIGHT

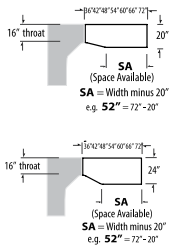

Z247216RR	24 x 72 x 29.5-30	65	135.45	6	\$849	\$1033	N/A	\$384
Z246616RR	24 x 66 x 29.5-30	70	127.05	5.75	\$812	\$981	N/A	\$384
Z246016RR	24 x 60 x 29.5-30	70	117.60	5.25	\$761	\$919	N/A	\$319
Z245416RR	24 x 54 x 29.5-30	70	108.15	5.25	\$718	\$862	N/A	\$319
Z244816RR	24 x 48 x 29.5-30	65	99.75	4.25	\$659	\$789	N/A	\$258
Z244216RR	24 x 42 x 29.5-30	70	88.20	4	\$590	\$707	N/A	\$258
Z243616RR	24 x 36 x 29.5-30	70	77.70	3.50	\$536	\$641	N/A	\$195
Z207216RR	20 x 72 x 29.5-30	70	122.85	6	\$777	\$933	N/A	\$384
Z206616RR	20 x 66 x 29.5-30	70	114.45	5.75	\$740	\$882	N/A	\$384
Z206016RR	20 x 60 x 29.5-30	70	106.05	5.25	\$696	\$827	N/A	\$319
Z205416RR	20 x 54 x 29.5-30	70	97.65	5.25	\$655	\$774	N/A	\$319
Z204816RR	20 x 48 x 29.5-30	70	90.30	4.25	\$602	\$710	N/A	\$258
Z204216RR	20 x 42 x 29.5-30	70	79.80	4	\$540	\$640	N/A	\$258
Z203616RR	20 x 36 x 29.5-30	70	70.35	3.50	\$488	\$573	N/A	\$195

16" Throat. Return has **no pedestal**. Grommet in worksurface. Shipped RTA (ready to assemble). For use with extended corners, desks and islands with 16" throat. Accepts same depth storage shells under worksurface.

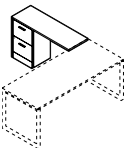

Full to Floor Return, No Modesty - LEFT

Z2448NRL	24 x 48 x 29.5-30	150	127	24.25	\$1170	\$1276	N/A	\$261
Z2442NRL	24 x 42 x 29.5-30	150	123	21.25	\$1158	\$1250	N/A	\$229
Z2048NRL	20 x 48 x 29.5-30	150	114	20.50	\$1102	\$1191	N/A	\$219
Z2042NRL	20 x 42 x 29.5-30	125	111	18	\$1076	\$1156	N/A	\$189

Return has no modesty. File/file pedestal on **left**. Pedestal locks.

Required Specifications

- Top finish
- Top/edge detail
- Base finish
- Lock finish

Optional Specifications

- HP laminate
- Handles*
- Key #
- Modesty Type*
- Grommet position or power block cut-out

Accessories

- Power block
- Keyboard
- Pencil drawer

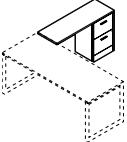
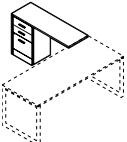
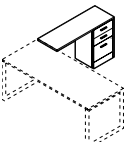
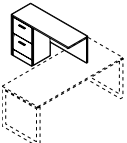
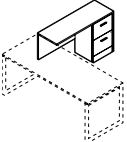
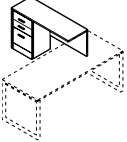
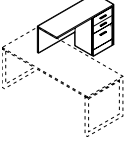
RETURNS	MODEL#	DIMENSIONS	FREIGHT CLASS	WT/LBS.	CUBIC FT.	1" TOP	1.5" TOP	GLAZE ADD	HP ADD	
 <p>Full to Floor Return, No Modesty - RIGHT</p>	D x W x H									
	Z2448NRR	24 x 48 x 29.5-30	150	127	24.25	\$1170	\$1276	N/A	\$261	
	Z2442NRR	24 x 42 x 29.5-30	150	123	21.25	\$1158	\$1250	N/A	\$229	
	Z2048NRR	20 x 48 x 29.5-30	150	114	20.50	\$1102	\$1191	N/A	\$219	
	Z2042NRR	20 x 42 x 29.5-30	125	111	18	\$1076	\$1156	N/A	\$189	
Return has no modesty. File/file pedestal on right . Pedestal locks.										
 <p>Full to Floor Return, No Modesty - LEFT</p>	Z2448BNRL	24 x 48 x 29.5-30	150	130	24.25	\$1170	\$1276	N/A	\$261	
	Z2442BNRL	24 x 42 x 29.5-30	150	126	21.5	\$1158	\$1250	N/A	\$229	
	Z2048BNRL	20 x 48 x 29.5-30	150	117	20.5	\$1102	\$1191	N/A	\$219	
	Z2042BNRL	20 x 42 x 29.5-30	125	113	18	\$1076	\$1156	N/A	\$189	
Return has no modesty. Box/box/file pedestal on left . Pedestal locks.										
 <p>Full to Floor Return, No Modesty - RIGHT</p>	Z2448BNRR	24 x 48 x 29.5-30	150	130	24.25	\$1170	\$1276	N/A	\$261	
	Z2442BNRR	24 x 42 x 29.5-30	150	126	21.5	\$1158	\$1250	N/A	\$229	
	Z2048BNRR	20 x 48 x 29.5-30	150	117	20.5	\$1102	\$1191	N/A	\$219	
	Z2042BNRR	20 x 42 x 29.5-30	125	113	18	\$1076	\$1156	N/A	\$189	
Return has no modesty. Box/box/file pedestal on right . Pedestal locks.										
 <p>Full to Floor Return - LEFT</p>	Z2448SRL	24 x 48 x 29.5-30	150	135	24.25	\$1272	\$1378	N/A	\$261	
	Z2442SRL	24 x 42 x 29.5-30	125	130	21.25	\$1251	\$1343	N/A	\$229	
	Z2048SRL	20 x 48 x 29.5-30	125	123	20.5	\$1205	\$1294	N/A	\$219	
	Z2042SRL	20 x 42 x 29.5-30	125	119	18	\$1169	\$1249	N/A	\$189	
File/file pedestal on left . 12"H modesty panel. Pedestal locks.										
 <p>Full to Floor Return - RIGHT</p>	Z2448SRR	24 x 48 x 29.5-30	150	135	24.25	\$1272	\$1378	N/A	\$261	
	Z2442SRR	24 x 42 x 29.5-30	125	130	21.25	\$1251	\$1343	N/A	\$229	
	Z2048SRR	20 x 48 x 29.5-30	125	123	20.5	\$1205	\$1294	N/A	\$219	
	Z2042SRR	20 x 42 x 29.5-30	125	119	18	\$1169	\$1249	N/A	\$189	
File/file pedestal on right . 12"H modesty panel. Pedestal locks.										
 <p>Full to Floor Return - LEFT</p>	Z2448BSRL	24 x 48 x 29.5-30	150	138	24.25	\$1272	\$1378	N/A	\$261	
	Z2442BSRL	24 x 42 x 29.5-30	125	132	21.5	\$1251	\$1343	N/A	\$229	
	Z2048BSRL	20 x 48 x 29.5-30	125	125	20.5	\$1205	\$1294	N/A	\$219	
	Z2042BSRL	20 x 42 x 29.5-30	125	121	18	\$1169	\$1249	N/A	\$189	
Box/box/file pedestal on left . 12"H modesty panel. Pedestal locks.										
 <p>Full to Floor Return - RIGHT</p>	Z2448BSRR	24 x 48 x 29.5-30	150	138	24.25	\$1272	\$1378	N/A	\$261	
	Z2442BSRR	24 x 42 x 29.5-30	125	132	21.5	\$1251	\$1343	N/A	\$229	
	Z2048BSRR	20 x 48 x 29.5-30	125	125	20.5	\$1205	\$1294	N/A	\$219	
	Z2042BSRR	20 x 42 x 29.5-30	125	121	18	\$1169	\$1249	N/A	\$189	
Box/box/file pedestal on right . 12"H modesty panel. Pedestal locks.										

Required Specifications

Top finish
 Top/edge detail
 Base finish
 Handles

Optional Specifications

HP laminate
 Key #
 Grommet position or power block cut-out

Accessories

Power block
 Keyboard
 Pencil drawer

RETURNS

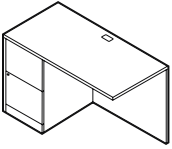

Full to Floor Flush Return - LEFT

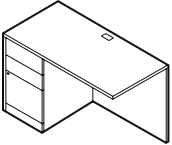

Full to Floor Flush Return - LEFT

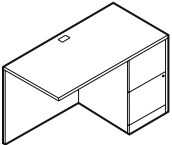

Full to Floor Flush Return - RIGHT

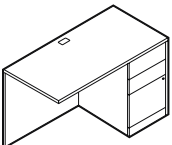

Full to Floor Flush Return - RIGHT

MODEL#	DIMENSIONS D x W x H	FREIGHT CLASS	WT./LBS.	CUBIC FT.	1" TOP	1.5" TOP	GLAZE ADD	HP ADD
Z24722L	24 x 72 x 29.5-30	150	206	35.75	\$1528	\$1621	N/A	\$384
Z24662L	24 x 66 x 29.5-30	150	195	32.75	\$1459	\$1551	N/A	\$384
Z24602L	24 x 60 x 29.5-30	125	184	30	\$1389	\$1482	N/A	\$353
Z24542L	24 x 54 x 29.5-30	150	165	29.75	\$1320	\$1413	N/A	\$353
Z24482L	24 x 48 x 29.5-30	125	156	24.25	\$1250	\$1343	N/A	\$281
Z20722L	20 x 72 x 29.5-30	150	169	30.25	\$1343	\$1436	N/A	\$384
Z20662L	20 x 66 x 29.5-30	150	162	27.75	\$1320	\$1413	N/A	\$384
Z20602L	20 x 60 x 29.5-30	125	153	25.25	\$1297	\$1389	N/A	\$319
Z20542L	20 x 54 x 29.5-30	150	136	23	\$1274	\$1366	N/A	\$319
Z20482L	20 x 48 x 29.5-30	125	129	20.5	\$1213	\$1297	N/A	\$236

Standard with file/file pedestal on **left**. Grommet in worksurface. One pencil tray. Pedestal locks.

- Does not accommodate storage shells.

Z24723L	24 x 72 x 29.5-30	125	171	24.5	\$1686	\$1841	N/A	\$384
Z24663L	24 x 66 x 29.5-30	125	171	24.5	\$1656	\$1795	N/A	\$384
Z24603L	24 x 60 x 29.5-30	125	171	24.5	\$1549	\$1682	N/A	\$353
Z24543L	24 x 54 x 29.5-30	125	171	24.5	\$1496	\$1617	N/A	\$353
Z24483L	24 x 48 x 29.5-30	125	171	24.5	\$1411	\$1519	N/A	\$281
Z20723L	20 x 72 x 29.5-30	65	97	4.3	\$1543	\$1675	N/A	\$384
Z20663L	20 x 66 x 29.5-30	65	97	4.3	\$1492	\$1619	N/A	\$384
Z20603L	20 x 60 x 29.5-30	65	97	4.3	\$1466	\$1580	N/A	\$319
Z20543L	20 x 54 x 29.5-30	65	97	4.3	\$1406	\$1514	N/A	\$319
Z20483L	20 x 48 x 29.5-30	125	154	20.75	\$1373	\$1467	N/A	\$236

Standard with box/box/file pedestal on **left**. Grommet in worksurface. One pencil tray. File drawer and lower box drawer lock.

- Does not accommodate storage shells.

Z24722R	24 x 72 x 29.5-30	150	206	35.75	\$1528	\$1621	N/A	\$384
Z24662R	24 x 66 x 29.5-30	150	195	32.75	\$1459	\$1551	N/A	\$384
Z24602R	24 x 60 x 29.5-30	125	184	30	\$1389	\$1482	N/A	\$353
Z24542R	24 x 54 x 29.5-30	150	165	29.75	\$1320	\$1413	N/A	\$353
Z24482R	24 x 48 x 29.5-30	125	156	24.25	\$1250	\$1343	N/A	\$281
Z20722R	20 x 72 x 29.5-30	150	169	30.25	\$1343	\$1436	N/A	\$384
Z20662R	20 x 66 x 29.5-30	150	162	27.75	\$1320	\$1413	N/A	\$384
Z20602R	20 x 60 x 29.5-30	125	153	25.25	\$1297	\$1389	N/A	\$319
Z20542R	20 x 54 x 29.5-30	150	136	23	\$1274	\$1366	N/A	\$319
Z20482R	20 x 48 x 29.5-30	125	129	20.5	\$1213	\$1297	N/A	\$236

Standard with file/file pedestal on **right**. Grommet in worksurface. One pencil tray. Pedestal locks.

- Does not accommodate storage shells.

Z24723R	24 x 72 x 29.5-30	125	171	24.5	\$1686	\$1841	N/A	\$384
Z24663R	24 x 66 x 29.5-30	125	171	24.5	\$1656	\$1795	N/A	\$384
Z24603R	24 x 60 x 29.5-30	125	171	24.5	\$1549	\$1682	N/A	\$353
Z24543R	24 x 54 x 29.5-30	125	171	24.5	\$1496	\$1617	N/A	\$353
Z24483R	24 x 48 x 29.5-30	125	171	24.5	\$1411	\$1519	N/A	\$281
Z20723R	20 x 72 x 29.5-30	65	97	4.3	\$1543	\$1675	N/A	\$384
Z20663R	20 x 66 x 29.5-30	65	97	4.3	\$1492	\$1619	N/A	\$384
Z20603R	20 x 60 x 29.5-30	65	97	4.3	\$1466	\$1580	N/A	\$319
Z20543R	20 x 54 x 29.5-30	65	97	4.3	\$1406	\$1514	N/A	\$319
Z20483R	20 x 48 x 29.5-30	125	154	20.75	\$1373	\$1467	N/A	\$236

Standard with box/box/file pedestal on **right**. Grommet in worksurface. One pencil tray. File drawer and lower box drawer lock.

- Does not accommodate storage shells.

Required Specifications

Top finish
Top/edge detail
Base finish
Handles

Optional Specifications

HP laminate
Key #
Grommet position or power block cut-out

Accessories

Power block
Keyboard
Pencil drawer

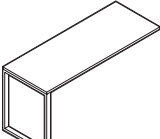
METAL LEG RETURNS	MODEL#	DIMENSIONS	FREIGHT CLASS	WT./LBS.	CUBIC FT.	1" TOP	1.5" TOP	GLAZE ADD	HP ADD
		D x W x H							
	Z3672MRL	36 x 72 x 29	100	116	11.25	\$1101	\$1301	N/A	\$624
	Z3072MRL	30 x 72 x 29	92.5	100	10	\$1008	\$1182	N/A	\$513
	Z3066MRL	30 x 66 x 29	70	94	9.75	\$970	\$1125	N/A	\$513
	Z3060MRL	30 x 60 x 29	70	88	9.25	\$925	\$1073	N/A	\$477
	Z2472MRL	24 x 72 x 29	70	85	8.25	\$925	\$1064	N/A	\$384
	Z2466MRL	24 x 66 x 29	70	80	8	\$890	\$1017	N/A	\$384
	Z2460MRL	24 x 60 x 29	70	75	7.75	\$853	\$974	N/A	\$353
	Z2448MRL	24 x 48 x 29	70	56	5.75	\$736	\$830	N/A	\$281

Return w/Metal Legs - LEFT*

Flush return attached to the edge of work surface. Attaching hardware included. Leg shipped in separate carton. Shipped RTA (ready to assemble). **Not freestanding.** Metal leg available in Black (**BLK**) or Tungsten (**TUN**).

- Please note, glides need to be extended a small amount to accommodate the 29.5" height of standard Zira pieces.

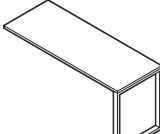
	Z3672MRR	36 x 72 x 29	100	116	11.25	\$1101	\$1301	N/A	\$624
	Z3072MRR	30 x 72 x 29	92.5	100	10	\$1008	\$1182	N/A	\$513
	Z3066MRR	30 x 66 x 29	70	94	9.75	\$970	\$1125	N/A	\$513
	Z3060MRR	30 x 60 x 29	70	88	9.25	\$925	\$1073	N/A	\$477
	Z2472MRR	24 x 72 x 29	70	85	8.25	\$925	\$1064	N/A	\$384
	Z2466MRR	24 x 66 x 29	70	80	8	\$890	\$1017	N/A	\$384
	Z2460MRR	24 x 60 x 29	70	75	7.75	\$853	\$974	N/A	\$353
	Z2448MRR	24 x 48 x 29	70	56	5.75	\$736	\$830	N/A	\$281

Return w/Metal Legs - RIGHT*

Flush return attached to the edge of work surface. Attaching hardware included. Leg shipped in separate carton. Shipped RTA (ready to assemble). **Not freestanding.** Metal leg available in Black (**BLK**) or Tungsten (**TUN**).

- Please note, glides need to be extended a small amount to accommodate the 29.5" height of standard Zira pieces.

	Z72LMP	.69 x 66 x 18.1	70	28	1.25	\$291	N/A	N/A	N/A
	Z66LMP	.69 x 60 x 18.1	65	26	1	\$278	N/A	N/A	N/A
	Z60LMP	.69 x 54 x 18.1	65	23	1	\$259	N/A	N/A	N/A
	Z48LMP	.69 x 42 x 18.1	65	19	.75	\$219	N/A	N/A	N/A

Melamine Modesty Panel

For returns with metal legs. Modular laminate modesty panel. Specify model # corresponding to work surface length.

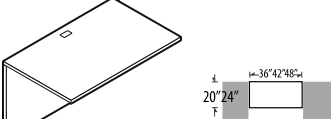
BRIDGES	MODEL#	DIMENSIONS	FREIGHT CLASS	WT./LBS.	CUBIC FT.	1" TOP	1.5" TOP	GLAZE ADD	HP ADD
	Z2448FB	24 x 48 x 29.5-30	70	91	4.30	\$627	\$729	N/A	\$258
	Z2442FB	24 x 42 x 29.5-30	70	79	3.80	\$580	\$669	N/A	\$258
	Z2436FB	24 x 36 x 29.5-30	70	69	3.30	\$580	\$669	N/A	\$195
	Z2048FB	20 x 48 x 29.5-30	70	83	4.30	\$609	\$698	N/A	\$258
	Z2042FB	20 x 42 x 29.5-30	70	72	3.80	\$564	\$653	N/A	\$258
	Z2036FB	20 x 36 x 29.5-30	70	63	3.30	\$564	\$653	N/A	\$195

Flush Bridge*

Top surface, back panel and hardware to create a "U" shape by connecting two units with full end panels. Grommet in work surface. Shipped RTA (ready to assemble).

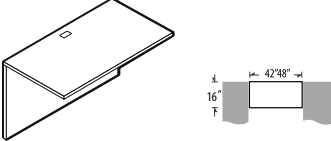
	Z1648B	15.8 x 48 x 29.5-30	70	66.15	4.25	\$476	\$564	N/A	\$195
	Z1642B	15.8 x 42 x 29.5-30	70	59.85	3.75	\$416	\$497	N/A	\$195

Flush Bridge

16" Throat. Top surface, back panel and hardware to create a "U" shape by connecting two units with a 16" throat and full end panels. Grommet in work surface. Shipped RTA (ready to assemble).

Required Specifications

- Top finish
- Top/edge detail
- Base finish
- Leg finish* (BLK or TUN)
- Lock finish

Optional Specifications

- HP laminate
- Handles
- Key #
- Modesty type
- Grommet position or power block cut-out

Accessories

- Power block
- Pencil drawer

SPACE SAVER BRIDGES

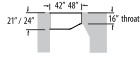
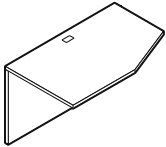

Space Saver Bridge - LEFT

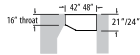
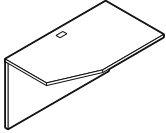

Space Saver Bridge - RIGHT

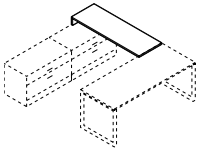

Overlapping Bridge - LEFT*

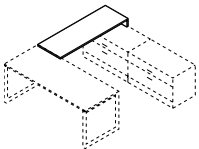

Overlapping Bridge - RIGHT*

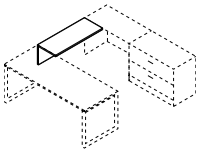

Flush Bridge

MODEL#	DIMENSIONS	FREIGHT CLASS	WT./LBS.	CUBIC FT.	1" TOP	1.5" TOP	GLAZE ADD	HP ADD
--------	------------	---------------	----------	-----------	--------	----------	-----------	--------

D x W x H

Z244816BL	24 x 48 x 29.5-30	70	82	4.25	\$556	\$686	N/A	\$258
Z244216BL	24 x 42 x 29.5-30	70	71	3.75	\$489	\$606	N/A	\$258
Z214816BL	21 x 48 x 29.5-30	70	76	4.25	\$516	\$624	N/A	\$258
Z214216BL	21 x 42 x 29.5-30	70	65	3.75	\$447	\$547	N/A	\$258

16" Throat. Top surface, back panel and hardware to connect extended corners, desks and islands with a 16" throat. Grommet in worksurface. Shipped RTA (ready to assemble).

Z244816BR	24 x 48 x 29.5-30	70	82	4.25	\$556	\$686	N/A	\$258
Z244216BR	24 x 42 x 29.5-30	70	71	3.75	\$489	\$606	N/A	\$258
Z214816BR	21 x 48 x 29.5-30	70	76	4.25	\$516	\$624	N/A	\$258
Z214216BR	21 x 42 x 29.5-30	70	65	3.75	\$447	\$547	N/A	\$258

16" Throat. Top surface, back panel and hardware to connect extended corners, desks and islands with a 16" throat. Grommet in worksurface. Shipped RTA (ready to assemble).

Z2468TRL	24 x 68 x 5.9	85	64	5.25	\$590	\$745	N/A	\$370
Z2462TRL	24 x 62 x 5.9	85	59	4.70	\$550	\$690	N/A	\$336
Z2472TRL	24 x 72 x 5.9	85	64	5.25	\$600	\$755	N/A	\$390
Z2466TRL	24 x 66 x 5.9	85	62	4.70	\$564	\$706	N/A	\$358

For 20"/24"D, 23.75"/24.25"H Storage with No Modesty. Overlaps storage on **left**.

- Use Z2462TRR and Z2468TRR for 20"D storage.
- Use Z2466TRR and Z2472TRR for 24"D storage.

Z2468TRR	24 x 68 x 5.9	85	64	5.25	\$590	\$745	N/A	\$370
Z2462TRR	24 x 62 x 5.9	85	59	4.70	\$550	\$690	N/A	\$336
Z2472TRR	24 x 72 x 5.9	85	64	5.25	\$600	\$755	N/A	\$390
Z2466TRR	24 x 66 x 5.9	85	62	4.70	\$564	\$706	N/A	\$358

For 20"/24"D, 23.75"/24.25"H Storage with No Modesty. Overlaps storage on **right**.

- Use Z2462TRR and Z2468TRR for 20"D storage.
- Use Z2466TRR and Z2472TRR for 24"D storage.

Z24483BR	24 x 48 x 13-13.5	70	55	3.50	\$627	\$729	N/A	\$258
Z24423BR	24 x 42 x 13-13.5	70	48	3.10	\$580	\$705	N/A	\$229
Z24363BR	24 x 36 x 13-13.5	70	43	2.70	\$580	\$688	N/A	\$197
Z20483BR	20 x 48 x 13-13.5	70	48	3	\$609	\$728	N/A	\$219
Z20423BR	20 x 42 x 13-13.5	70	43	2.70	\$564	\$670	N/A	\$189
Z20363BR	20 x 36 x 13-13.5	70	38	2.40	\$564	\$656	N/A	\$164

12"H modesty panel.

Required Specifications

Top finish
Top/edge detail
Base finish

Optional Specifications

HP laminate
Grommet position or power block cut-out

Accessories

Power block
Pencil drawer*

TRANSITIONAL BRIDGES

MODEL#	DIMENSIONS	FREIGHT CLASS	WT/LBS.	CUBIC FT.	1" TOP	1.5" TOP	GLAZE ADD	HP ADD
--------	------------	---------------	---------	-----------	--------	----------	-----------	--------

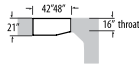
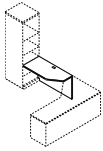

Transitional Bridge - LEFT

For 21" Wide Storage Module. Top surface, back panel, shorter kickplate and hardware to connect 21" wide storage module with 16" throat. Grommet in worksurface. Shipped RTA (ready to assemble).

D x W x H								
Z2148TRBL	21 x 48 x 29.5-30	70	75.83	4.25	\$537	\$645	N/A	\$258
Z2142TRBL	21 x 42 x 29.5-30	70	64.78	3.75	\$469	\$569	N/A	\$258

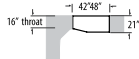
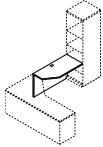

Transitional Bridge - RIGHT

For 21" Wide Storage Module. Top surface, back panel, shorter kickplate and hardware to connect 21" wide storage module with 16" throat. Grommet in worksurface. Shipped RTA (ready to assemble).

Z1648TRBL	16 x 48 x 29.5-30	70	68.58	4.25	\$496	\$584	N/A	\$195
Z1642TRBL	16 x 42 x 29.5-30	70	58.96	3.75	\$438	\$521	N/A	\$195

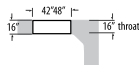
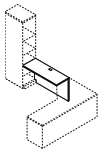

Transitional Bridge - LEFT

For 16" Wide Storage Module. Top surface, back panel and hardware to connect 16" wide storage module with 16" throat. Grommet in worksurface. Shipped RTA (ready to assemble).

Z1648TRBR	16 x 48 x 29.5-30	70	68.58	4.25	\$496	\$584	N/A	\$195
Z1642TRBR	16 x 42 x 29.5-30	70	58.96	3.75	\$438	\$521	N/A	\$195

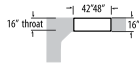
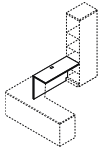

Transitional Bridge - RIGHT

For 16" Wide Storage Module. Top surface, back panel and hardware to connect 16" wide storage module with 16" throat. Grommet in worksurface. Shipped RTA (ready to assemble).

Required Specifications

- Top finish
- Top/edge detail
- Base finish

Optional Specifications

- HP laminate
- Grommet position or power block cut-out

Accessories

- Power block
- Pencil drawer*

18" H CREDENZAS

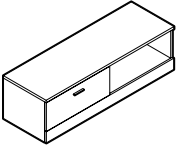

Lateral File Credenza - LEFT

MODEL#	DIMENSIONS D x W x H	FREIGHT CLASS	WT/LBS.	CUBIC FT.	1" TOP	1.5" TOP	GLAZE ADD	HP ADD
Z2472LOFL	24 x 72 x 17.87-18.37	125	181	22.75	\$1626	\$1759	N/A	\$390
Z2460LOFL	24 x 60 x 17.87-18.37	100	160	19.25	\$1444	\$1555	N/A	\$327
Z2072LOFL	20 x 72 x 17.87-18.37	100	164	19.25	\$1515	\$1626	N/A	\$327
Z2060LOFL	20 x 60 x 17.87-18.37	100	143	16.25	\$1335	\$1427	N/A	\$273

1 high lateral file on the **left**, open storage on the **right**.

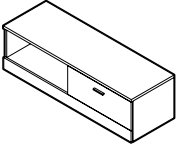

Lateral File Credenza - RIGHT

Z2472LOFR	24 x 72 x 17.87-18.37	125	181	22.75	\$1626	\$1759	N/A	\$390
Z2460LOFR	24 x 60 x 17.87-18.37	100	160	19.25	\$1444	\$1555	N/A	\$327
Z2072LOFR	20 x 72 x 17.87-18.37	100	164	19.25	\$1515	\$1626	N/A	\$327
Z2060LOFR	20 x 60 x 17.87-18.37	100	143	16.25	\$1335	\$1427	N/A	\$273

1 high lateral file on the **right**, open storage on the **left**.

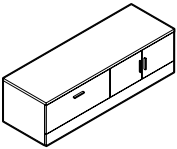

Lateral File Credenza - LEFT*

Z2472LSFL	24 x 72 x 17.87-18.37	100	197	22.75	\$1895	\$2028	\$403	\$390
Z2460LSFL	24 x 60 x 17.87-18.37	100	174	19.25	\$1708	\$1819	\$359	\$327
Z2072LSFL	20 x 72 x 17.87-18.37	100	178	19.25	\$1774	\$1885	\$403	\$327
Z2060LSFL	20 x 60 x 17.87-18.37	100	155	16.25	\$1592	\$1684	\$359	\$273

1 high lateral file on the **left**, closed storage on the **right**.

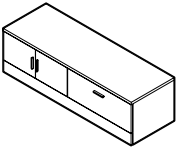

Lateral File Credenza - RIGHT*

Z2472LSFR	24 x 72 x 17.87-18.37	100	197	22.75	\$1895	\$2028	\$403	\$390
Z2460LSFR	24 x 60 x 17.87-18.37	100	174	19.25	\$1708	\$1819	\$359	\$327
Z2072LSFR	20 x 72 x 17.87-18.37	100	178	19.25	\$1774	\$1885	\$403	\$327
Z2060LSFR	20 x 60 x 17.87-18.37	100	155	16.25	\$1592	\$1684	\$359	\$273

1 high lateral file on the **right**, closed storage on the **left**.

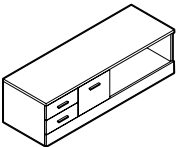

Mixed Storage Credenza - LEFT

Z2472LMOL	24 x 72 x 17.87-18.37	100	197	22.75	\$1873	\$2006	N/A	\$390
Z2460LMOL	24 x 60 x 17.87-18.37	100	176	19.25	\$1709	\$1820	N/A	\$327
Z2072LMOL	20 x 72 x 17.87-18.37	100	178	19.25	\$1754	\$1865	N/A	\$327
Z2060LMOL	20 x 60 x 17.87-18.37	100	157	16.25	\$1595	\$1688	N/A	\$273

1 high mixed drawers on the **left**, open storage on the **right**.

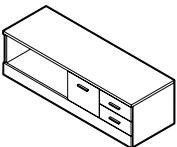

Mixed Storage Credenza - RIGHT

Z2472LMOR	24 x 72 x 17.87-18.37	100	197	22.75	\$1873	\$2006	N/A	\$390
Z2460LMOR	24 x 60 x 17.87-18.37	100	176	19.25	\$1709	\$1819	N/A	\$327
Z2072LMOR	20 x 72 x 17.87-18.37	100	178	19.25	\$1754	\$1865	N/A	\$327
Z2060LMOR	20 x 60 x 17.87-18.37	100	157	16.25	\$1595	\$1688	N/A	\$273

1 high mixed drawers on the **right**, open storage on the **left**.

Required Specifications

- Top finish
- Top/edge detail
- Base finish
- Handles

Optional Specifications

- HP laminate
- Key #
- Glazed doors*
- Box drawer - no upcharge

24"H CRENZAS

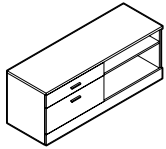

Lateral File Credenza - LEFT

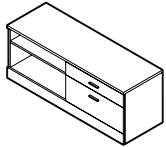

Lateral File Credenza - RIGHT

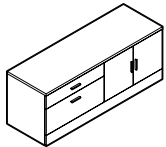

Lateral File Credenza - LEFT

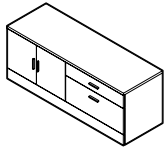

Lateral File Credenza - RIGHT

MODEL#	DIMENSIONS D x W x H	FREIGHT CLASS	WT/LBS.	CUBIC FT.	1" TOP	1.5" TOP	GLAZE ADD	HP ADD
Z2472HBFL	24 x 72 x 23.75-24.25	125	229	29.25	\$2037	\$2170	N/A	\$390
Z2460HBFL	24 x 60 x 23.75-24.25	100	201	24.50	\$1805	\$1916	N/A	\$327
Z2072HBFL	20 x 72 x 23.75-24.25	100	207	24.75	\$1919	\$2030	N/A	\$327
Z2060HBFL	20 x 60 x 23.75-24.25	100	180	20.75	\$1691	\$1784	N/A	\$273

1.5 high box/lateral file on the **left**, open storage on the **right**.

Z2472HBFR	24 x 72 x 23.75-24.25	125	229	29.25	\$2037	\$2170	N/A	\$390
Z2460HBFR	24 x 60 x 23.75-24.25	100	201	24.50	\$1805	\$1916	N/A	\$327
Z2072HBFR	20 x 72 x 23.75-24.25	100	207	24.75	\$1919	\$2030	N/A	\$327
Z2060HBFR	20 x 60 x 23.75-24.25	100	180	20.75	\$1691	\$1784	N/A	\$273

1.5 high box/lateral file on the **right**, open storage on the **left**.

Z2472HFSL	24 x 72 x 23.75-24.25	100	251	29.25	\$2384	\$2517	\$553	\$390
Z2460HFSL	24 x 60 x 23.75-24.25	100	221	24.50	\$2126	\$2237	\$479	\$327
Z2072HFSL	20 x 72 x 23.75-24.25	100	227	24.75	\$2239	\$2350	\$553	\$327
Z2060HFSL	20 x 60 x 23.75-24.25	100	198	20.75	\$2001	\$2094	\$479	\$273

1.5 high box/lateral file on the **left**, closed storage on the **right**.

Z2472HFSL	24 x 72 x 23.75-24.25	100	251	29.25	\$2384	\$2517	\$553	\$390
Z2460HFSL	24 x 60 x 23.75-24.25	100	221	24.50	\$2126	\$2237	\$479	\$327
Z2072HFSL	20 x 72 x 23.75-24.25	100	227	24.75	\$2239	\$2350	\$553	\$327
Z2060HFSL	20 x 60 x 23.75-24.25	100	198	20.75	\$2001	\$2094	\$479	\$273

1.5 high box/lateral file on the **right**, closed storage on the **left**.

Required Specifications

Top finish
Top/edge detail
Base finish
Handles

Optional Specifications

HP laminate
Key #
Glazed doors*
Box drawer - no upcharge

CREDENZAS

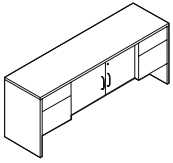

Glazed door option

Center Storage Credenza**

MODEL#	DIMENSIONS D x W x H	FREIGHT CLASS	WT/LBS.	CUBIC FT.	1" TOP	1.5" TOP	GLAZE ADD	HP ADD
Z2072C	20 x 72 x 29.5-30	100	286	30	\$2059	\$2564	\$677	\$384

Standard with box/file pedestals on both sides and self-closing hinged center doors covering one adjustable shelf. Pedestals and doors lock, keyed alike. Two pencil trays.

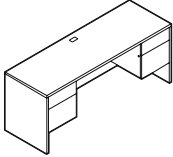

Kneespace Credenza*

Z2472CK	24 x 72 x 29.5-30	125	262	35.50	\$1671	\$1954	N/A	\$384
Z2466CK	24 x 66 x 29.5-30	125	250	33	\$1671	\$1893	N/A	\$384
Z2072CK	20 x 72 x 29.5-30	125	235	30	\$1596	\$1758	N/A	\$384
Z2066CK	20 x 66 x 29.5-30	100	225	27.75	\$1596	\$1723	N/A	\$384
Z2060CK	20 x 60 x 29.5-30	100	219	25.25	\$1535	\$1637	N/A	\$319

Standard with box/file pedestals on both sides. Center is open. Pedestals lock, keyed alike. Two pencil trays. Grommet in worksurface.

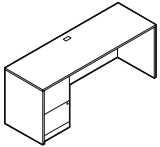

Full to Floor Single Pedestal Credenza- LEFT*

Z2472CS2L	24 x 72 x 29.5-30	100	228	25.75	\$1571	\$1731	N/A	\$384
Z2466CS2L	24 x 66 x 29.5-30	125	217	32.75	\$1542	\$1690	N/A	\$384
Z2072CS2L	20 x 72 x 29-29.5	125	203	30.25	\$1440	\$1573	N/A	\$384
Z2066CS2L	20 x 66 x 29-29.5	125	193	27.75	\$1386	\$1506	N/A	\$384

Standard with full to floor file/file pedestal on the **left**. Pedestal locks. Grommet in worksurface.

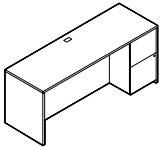

Full to Floor Single Pedestal Credenza- RIGHT*

Z2472CS2R	24 x 72 x 29.5-30	100	228	25.75	\$1571	\$1731	N/A	\$384
Z2466CS2R	24 x 66 x 29.5-30	125	217	32.75	\$1542	\$1690	N/A	\$384
Z2072CS2R	20 x 72 x 29.5-30	125	203	30.25	\$1440	\$1573	N/A	\$384
Z2066CS2R	20 x 66 x 29.5-30	125	193	27.75	\$1386	\$1506	N/A	\$384

Standard with full to floor file/file pedestal on the **right**. Pedestal locks. Grommet in worksurface.

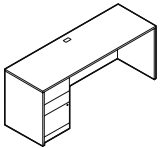

Full to Floor Single Pedestal Credenza- LEFT*

Z2472CS4L	24 x 72 x 29-29.5	125	228	35.75	\$1635	\$1795	N/A	\$384
Z2466CS4L	24 x 66 x 29-29.5	125	217	32.75	\$1609	\$1757	N/A	\$384
Z2072CS4L	20 x 72 x 29-29.5	125	203	30.25	\$1492	\$1622	N/A	\$384
Z2066CS4L	20 x 66 x 29-29.5	125	193	25.75	\$1440	\$1567	N/A	\$384

Standard with full to floor box/box/file pedestal on the **left**. File drawer and lower box drawer lock. One pencil tray. Grommet in worksurface.

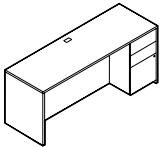

Full to Floor Single Pedestal Credenza- RIGHT*

Z2472CS4R	24 x 72 x 29-29.5	125	228	35.75	\$1635	\$1795	N/A	\$384
Z2466CS4R	24 x 66 x 29-29.5	125	217	32.75	\$1609	\$1757	N/A	\$384
Z2072CS4R	20 x 72 x 29-29.5	125	203	30.25	\$1492	\$1624	N/A	\$384
Z2066CS4R	20 x 66 x 29-29.5	125	193	25.75	\$1440	\$1567	N/A	\$384

Standard with full to floor box/box/file pedestal on the **right**. File drawer and lower box drawer lock. One pencil tray. Grommet in worksurface.

Required Specifications

- Top finish
- Top/edge detail
- Base finish
- Lock finish*

Optional Specifications

- HP laminate
- Key #*
- Modesty type (only Z2xxxxCK)
- Grommet position or power block cut-out
- Handles*
- Glazed door**

Accessories

- Keyboard**
- Power block (not Z2072C)
- Pencil drawer (Z2472S2L/R only)

CRENZAS	MODEL#	DIMENSIONS	FREIGHT CLASS	WT/LBS.	CUBIC FT.	1" TOP	1.5" TOP	GLAZE ADD	HP ADD
  <p>Glazed door option</p> <p>Storage Cabinet Credenza**</p>		D x W x H							
	Z2472SCSC	24 x 72 x 29.5-30	100	345	35.75	\$2254	\$2410	\$1516	\$384
	Z2072SCSC	20 x 72 x 29.5-30	92.5	315	30.25	\$1981	\$2148	\$1516	\$384
Two storage cabinets side-by-side. Hinged doors cover one adjustable shelf. Locking doors keyed alike.									
 <p>Lateral File Credenza**</p>									
	Z2472LF2	24 x 72 x 29.5-30	100	345	35.75	\$2600	\$2966	N/A	\$384
	Z2072LF2	20 x 72 x 29.5-30	92.5	315	30.25	\$2547	\$2963	N/A	\$384
Two 2-drawer lateral files side-by-side. Locking drawers, keyed alike. File bars included for side-to-side and front-to-back letter and legal filing capability. Anti-lock tilt suspension									
  <p>Glazed door option</p> <p>Lateral File/Storage Cabinet Credenza**</p>									
	Z2472LS	24 x 72 x 29.5-30	100	321	35.75	\$2326	\$2679	\$760	\$384
	Z2072LS	20 x 72 x 29.5-30	100	286	30.25	\$2273	\$2677	\$760	\$384
One 2-drawer lateral file and one storage cabinet. Locking door/drawers, keyed alike. Storage cabinet includes one adjustable shelf. File bars included for side-to-side and front-to-back letter and legal filing capability. Anti-lock tilt suspension. <ul style="list-style-type: none"> • File drawer construction is for accommodating hanging files NOT for stacking materials on the drawer bottom. 									
  <p>Glazed door option</p> <p>Buffet Credenza**</p>									
	Z482036BD	20 x 48 x 36	125	163	22.50	\$2209	\$2338	\$953	\$415
Buffet credenza with one locking storage compartment with two doors. Hinged doors cover one three-position height adjustable shelf. Two 6" drawers above storage compartment are non-locking.									
   <p>Glazed door option</p> <p>Buffet Credenza*</p>									
	Z722036BD	20 x 72 x 36	125	242	33.50	\$3203	\$3360	\$1902	\$668
	Z602036BD	20 x 60 x 36	125	188	28	\$2777	\$2919	\$1747	\$542
Buffet credenza with two locking storage compartments side by side. Hinged doors cover 1 three-position height adjustable shelf. Two 6" drawers above storage compartment are non-locking.									
 <p>Kneespace Lateral File Credenza - LEFT</p>									
	Z2472LKL	24 x 72 x 29.5-30	125	262	35.75	\$2045	\$2359	N/A	\$384
	Z2072LKL	20 x 72 x 29.5-30	125	235	30.25	\$1993	\$2360	N/A	\$384
One 2-drawer lateral file on the left . Locking drawers. File bars included for side-to-side and front-to-back letter/legal filing capability. Anti-lock tilt suspension. Grommet in worksurface. <ul style="list-style-type: none"> • File drawer construction is for accommodating hanging files NOT for stacking materials on the drawer bottom. 									

Required Specifications

Top finish
 Top/edge detail
 Base finish
 Lock finish*

Optional Specifications

HP laminate
 Key #*
 Modesty type (only Z2xxxxCK)
 Grommet position or power block cut-out

Handles*
 Glazed door**

Accessories

Keyboard**
 Power block (not Z2072C)
 Pencil drawer (Z2472S2L/R only)

CREDENZAS

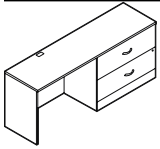

Kneespace Lateral File Credenza - RIGHT

MODEL#	DIMENSIONS D x W x H	FREIGHT CLASS	WT./LBS.	CUBIC FT.	1" TOP	1.5" TOP	GLAZE ADD	HP ADD
Z2472LKR	24 x 72 x 29.5-30	125	262	35.75	\$2045	\$2359	N/A	\$384
Z2072LKR	20 x 72 x 29.5-30	125	235	30.25	\$1993	\$2360	N/A	\$384

One 2-drawer lateral file on the **right**. Locking drawers. File bars included for side-to-side and front-to-back letter/legal filing capability. Anti-lock tilt suspension. Grommet in worksurface.

- File drawer construction is for accommodating hanging files *NOT* for stacking materials on the drawer bottom.

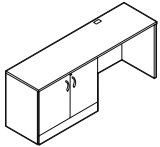

Kneespace Storage Cabinet Credenza- LEFT**



Glazed door option

Z2472SKL	24 x 72 x 29.5-30	125	241	35.75	\$1612	\$1939	\$760	\$384
Z2072SKL	20 x 72 x 29.5-30	125	207	30.25	\$1559	\$1936	\$760	\$384

One storage cabinet on the **left**. Locking doors. Storage cabinet has one adjustable shelf. Grommet in worksurface.

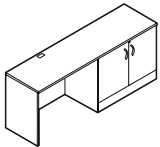

Kneespace Storage Cabinet Credenza- RIGHT**



Glazed door option

Z2472SKR	24 x 72 x 29.5-30	125	241	35.75	\$1612	\$1939	\$760	\$384
Z2072SKR	20 x 72 x 29.5-30	125	207	30.25	\$1559	\$1936	\$760	\$384

One storage cabinet on the **right**. Locking doors. Storage cabinet has one adjustable shelf. Grommet in worksurface.

Required Specifications

Top finish Base finish
Top/edge detail
Handles*
Lock finish*

Optional Specifications

HP laminate Handles
Key # Glazed door*
Grommet position or power block cut-out

Accessories

Power block

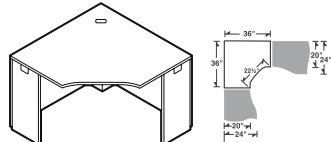
5-SIDED CORNERS	MODEL#	DIMENSIONS D x W x H	FREIGHT CLASS	WT/LBS.	CUBIC FT.	1" TOP	1.5" TOP	GLAZE ADD	HP ADD
 <p>5-Sided Corner, 24" Throat</p>	Z42245C	42 x 42 x 29.5-30	65	133	5.75	\$978	\$1187	N/A	\$513
<p>Connects to 30" D space saver connectable surfaces, 24" D connectables, returns and bridge. Grommet in worksurface. Narrow end panels on left and right. Shipped RTA (ready to assemble). <i>Not freestanding.</i></p> <ul style="list-style-type: none"> • Modesty Panel is 1" off of ground. • Full End Panel(s) are available - add 15% upcharge 									
 <p>5-Sided Corner, 20" Throat</p>	Z42205C	42 x 42 x 29.5-30	70	129	5.75	\$978	\$1187	N/A	\$513
<p>Connects to 24" D space saver connectable surfaces, 20" D returns, lateral files, storage/lateral file credenzas, credenzas, and bridges. Grommet in worksurface. Narrow end panels on left and right. Shipped RTA (ready to assemble). <i>Not freestanding.</i></p> <ul style="list-style-type: none"> • Modesty Panel is 1" off of ground. • Full End Panel(s) are available - add 15% upcharge 									
 <p>5-Sided Corner, 16" Throat</p>	Z42165C	42 x 42 x 29.5-30	70	124	5.75	\$1007	\$1159	N/A	\$510
<p>Connects to 20" D space saver connectable surfaces, 16" D returns, lateral files, storage/lateral file credenzas, credenzas, and bridges. Grommet in worksurface. Narrow end panels on left and right. Shipped RTA (ready to assemble). <i>Not freestanding.</i></p> <ul style="list-style-type: none"> • Modesty Panel is 1" off of ground. • Full End Panel(s) are available - add 15% upcharge 									
 <p>5-Sided Corner, 20" Throat</p>	Z36205C	36 x 36 x 29.5-30	65	109	4.80	\$827	\$947	N/A	\$332
<p>Connects to 24" D space saver connectable surfaces, 20" D returns, lateral files, storage/lateral file credenzas, credenzas, and bridges. Grommet in worksurface. Narrow end panels on left and right. Shipped RTA (ready to assemble). <i>Not freestanding.</i></p> <ul style="list-style-type: none"> • Modesty Panel is 1" off of ground. • Full End Panel(s) are available - add 15% upcharge 									
 <p>5-Sided Corner, 16" Throat</p>	Z36165C	36 x 36 x 29.5-30	70	105	4.80	\$881	\$999	N/A	\$289
<p>Connects to 20" D space saver connectable surfaces, 16" D returns, lateral files, storage/lateral file credenzas, credenzas, and bridges. Grommet in worksurface. Narrow end panels on left and right. Shipped RTA (ready to assemble). <i>Not freestanding.</i></p> <ul style="list-style-type: none"> • Modesty Panel is 1" off of ground. • Full End Panel(s) are available - add 15% upcharge 									

Required Specifications

Top finish
Top/edge detail
Base finish

Optional Specifications

HP laminate
Grommet position or power block cut-out

Accessories

Power block
Keyboard (*Not available on Z36165C*)

LEFT EXTENDED CORNER DESKS

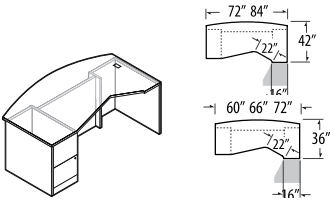

Single Pedestal Bow Top
Extended Corner Desk - LEFT*

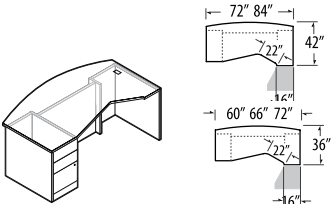

Single Pedestal Bow Top
Extended Corner Desk - LEFT*

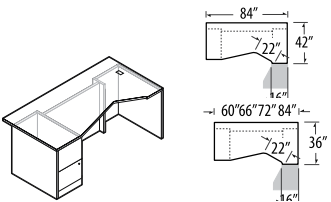

Single Pedestal Extended
Corner Desk - LEFT*

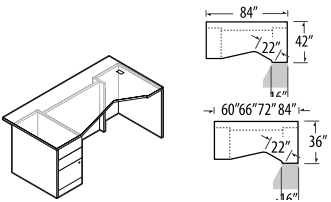

Single Pedestal Extended
Corner Desk - LEFT

MODEL# DIMENSIONS FREIGHT CLASS WT/LBS. CUBIC FT. 1" TOP 1.5" TOP GLAZE ADD HP ADD

	D x W x H								
Z4284EB2L	42 x 84 x 29.5-30	70	316.05	20.50	\$2086	\$2376	\$916	\$1015	
Z4272EB2L	42 x 72 x 29.5-30	150	331	59	\$2059	\$2309	\$760	\$762	
Z3672EB2L	36 x 72 x 29.5-30	150	273	50.75	\$1874	\$2093	\$760	\$573	
Z3666EB2L	36 x 66 x 29.5-30	150	260.40	46.75	\$1844	\$2045	\$678	\$573	
Z3660EB2L	36 x 60 x 29.5-30	125	257.25	42.50	\$1792	\$1975	\$600	\$477	

Extended worksurface on right. Standard with **Freestanding** full to floor file/file pedestal on **left** and faux pedestal on **right**. Pedestal locks. Connects to returns or bridges with a 16" throat. Corner has one grommet. Bow top overhangs 2¼" at ends and 6" on center.

- 84" wide desks are shipped RTA (ready to assemble) in 2 cartons.
- Hutches may not be placed on this desk.

Z4284EB3L	42 x 84 x 29.5-30	70	315	20.50	\$2106	\$2395	\$916	\$1015	
Z4272EB3L	42 x 72 x 29.5-30	150	329	59	\$2083	\$2333	\$760	\$762	
Z3672EB3L	36 x 72 x 29.5-30	150	270.90	50.75	\$1910	\$2129	\$760	\$573	
Z3666EB3L	36 x 66 x 29.5-30	150	259.35	46.75	\$1856	\$2057	\$678	\$573	
Z3660EB3L	36 x 60 x 29.5-30	125	255.15	42.50	\$1825	\$2008	\$600	\$477	

Extended worksurface on right. Standard with **Freestanding** full to floor box/box/file pedestal on **left** and faux pedestal on **right**. File drawer and lower box drawer lock. Connects to returns or bridges with a 16" throat. Corner has one grommet. Bow top overhangs 2¼" at ends and 6" on center.

- 84" wide desks are shipped RTA (ready to assemble) in 2 cartons.
- Hutches may not be placed on this desk.

Z4284E2L	42 x 84 x 29.5-30	70	321.30	20.50	\$2171	\$2447	\$916	\$1015	
Z3684E2L	36 x 84 x 29.5-30	250	311.85	118	\$2082	\$2358	\$916	\$762	
Z3672E2L	36 x 72 x 29.5-30	150	278.25	50.75	\$1867	\$2074	\$760	\$573	
Z3666E2L	36 x 66 x 29.5-30	150	265.65	46.75	\$1817	\$2006	\$678	\$573	
Z3660E2L	36 x 60 x 29.5-30	125	259.35	42.50	\$1786	\$1958	\$600	\$477	

Extended worksurface on right. Standard with **Freestanding** full to floor file/file pedestal on **left** and faux pedestal on **right**. Pedestal locks. Connects to returns or bridges with a 16" throat. Corner has one grommet. Top overhangs 2¼"

- 84" wide desks are shipped RTA (ready to assemble) in 2 cartons.
- Hutches may not be placed on this desk.

Z4284E3L	42 x 84 x 29.5-30	70	318.15	20.50	\$2098	\$2374	\$916	\$1015	
Z3684E3L	36 x 84 x 29.5-30	250	309.75	118	\$2115	\$2390	\$916	\$762	
Z3672E3L	36 x 72 x 29.5-30	150	275.10	50.75	\$1905	\$2112	\$760	\$573	
Z3666E3L	36 x 66 x 29.5-30	150	263.55	46.75	\$1853	\$2042	\$678	\$573	
Z3660E3L	36 x 60 x 29.5-30	125	257.25	42.50	\$1821	\$1991	\$600	\$477	

Extended worksurface on right. Standard with **Freestanding** full to floor box/box/file pedestal on **left** and faux pedestal on **right**. File drawer and lower box drawer lock. Connects to returns or bridges with a 16" throat. Corner has one grommet. Top overhangs 2¼".

- 84" wide desks are shipped RTA (ready to assemble) in 2 cartons.
- Hutches may not be placed on this desk.

Required Specifications

Top finish
Top/edge detail
Lock finish
Base finish

Optional Specifications

HP laminate Handles
Key # Modesty panel type
Grommet position or power block cut-out

Accessories

Power block
Keyboard
Pencil drawer

RIGHT EXTENDED CORNER DESKS

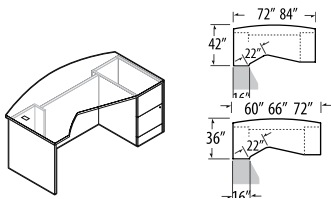

**Single Pedestal Bow Top
Extended Corner Desk - RIGHT**

MODEL#	DIMENSIONS	FREIGHT CLASS	WT/LBS.	CUBIC FT.	1" TOP	1.5" TOP	GLAZE ADD	HP ADD	
D x W x H									
Z4284EB2R	42 x 84 x 29.5-30	70	316.05	20.50	\$2086	\$2376	\$916	\$1015	
Z4272EB2R	42 x 72 x 29.5-30	150	331	59	\$2059	\$2309	\$760	\$762	
Z3672EB2R	36 x 72 x 29.5-30	150	273	50.75	\$1874	\$2093	\$760	\$573	
Z3666EB2R	36 x 66 x 29.5-30	150	260.40	46.75	\$1844	\$2045	\$678	\$573	
Z3660EB2R	36 x 60 x 29.5-30	125	257.25	42.50	\$1792	\$1975	\$600	\$477	

Extended worksurface on right. Standard with faux pedestal on **left** and **Freestanding** full to floor file/file pedestal on **right**. Pedestal locks. Connects to returns or bridges with a 16" throat. Corner has one grommet. Bow top overhangs 2¼" at ends and 6" on center.

- 84" wide desks are shipped RTA (ready to assemble) in 2 cartons.
- Hutches may not be placed on this desk.

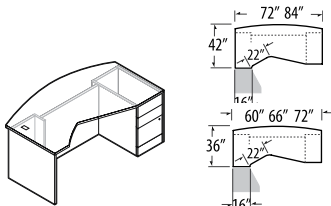

**Single Pedestal Bow Top
Extended Corner Desk - RIGHT**

Z4284EB3R	42 x 84 x 29.5-30	70	315	20.50	\$2106	\$2395	\$916	\$1015
Z4272EB3R	42 x 72 x 29.5-30	150	329	59	\$2083	\$2333	\$760	\$762
Z3672EB3R	36 x 72 x 29.5-30	150	270.90	50.75	\$1910	\$2129	\$760	\$573
Z3666EB3R	36 x 66 x 29.5-30	150	259.35	46.75	\$1856	\$2057	\$678	\$573
Z3660EB3R	36 x 60 x 29.5-30	125	255.15	42.50	\$1825	\$2008	\$600	\$477

Extended worksurface on right. Standard with faux pedestal on **left** and **Freestanding** full to floor box/box/file pedestal on **right**. File drawer and lower box drawer lock. Connects to returns or bridges with a 16" throat. Corner has one grommet. Bow top overhangs 2¼" at ends and 6" on center.

- 84" wide desks are shipped RTA (ready to assemble) in 2 cartons.
- Hutches may not be placed on this desk.

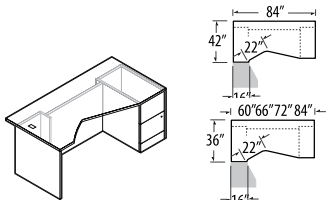

**Single Pedestal Extended
Corner Desk - RIGHT**

Z4284E2R	42 x 84 x 29.5-30	70	321.30	20.50	\$2171	\$2447	\$916	\$1015
Z3684E2R	36 x 84 x 29.5-30	250	311.85	118	\$2082	\$2358	\$916	\$762
Z3672E2R	36 x 72 x 29.5-30	150	278.25	50.75	\$1867	\$2074	\$760	\$573
Z3666E2R	36 x 66 x 29.5-30	150	265.65	46.75	\$1817	\$2006	\$678	\$573
Z3660E2R	36 x 60 x 29.5-30	125	259.35	42.50	\$1786	\$1958	\$600	\$477

Extended worksurface on right. Standard with **Freestanding** full to floor file/file pedestal on **right** and faux pedestal on **left**. Pedestal locks. Connects to returns or bridges with a 16" throat. Corner has one grommet. Top overhangs 2¼"

- 84" wide desks are shipped RTA (ready to assemble) in 2 cartons.
- Hutches may not be placed on this desk.

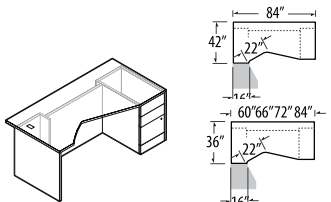

**Single Pedestal Extended
Corner Desk - RIGHT**

Z4284E3R	42 x 84 x 29.5-30	70	318.15	20.50	\$2098	\$2374	\$916	\$1015
Z3684E3R	36 x 84 x 29.5-30	250	309.75	118	\$2115	\$2390	\$916	\$762
Z3672E3R	36 x 72 x 29.5-30	150	275.10	50.75	\$1905	\$2112	\$760	\$573
Z3666E3R	36 x 66 x 29.5-30	150	263.55	46.75	\$1853	\$2042	\$678	\$573
Z3660E3R	36 x 60 x 29.5-30	125	257.25	42.50	\$1821	\$1991	\$600	\$477

Extended worksurface on right. Standard with **Freestanding** full to floor box/box/file pedestal on **right** and faux pedestal on **left**. File drawer and lower box drawer lock. Connects to returns or bridges with a 16" throat. Corner has one grommet. Top overhangs 2¼".

- 84" wide desks are shipped RTA (ready to assemble) in 2 cartons.
- Hutches may not be placed on this desk.

Required Specifications

Top finish
Top/edge detail
Lock finish
Base finish

Optional Specifications

HP laminate
Key #
Grommet position or power block cut-out
Handles
Modesty panel type

Accessories

Power block
Keyboard
Pencil drawer

LEFT EXTENDED CORNERS (DOES NOT CONNECT)

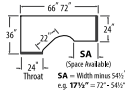
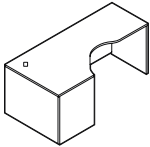

Left Extended Corner, 24" Throat Freestanding

MODEL# DIMENSIONS FREIGHT CLASS WT/LBS. CUBIC FT. 1" TOP 1.5" TOP GLAZE ADD HP ADD

	D x W x H								
Z2472FFL	36 x 72 x 29.5-30	65	184	7	\$1247	\$1412	N/A	\$548	
Z2466FFL	36 x 66 x 29.5-30	65	175	7	\$1247	\$1406	N/A	\$548	

Extended worksurface on right. **Full end panels on left and right. Cannot be connected on left or right, due to full end panel.** Corner has one grommet. Shipped RTA (ready to assemble).

- Modesty Panel is 1" off of ground.
- Z2466FFL cannot accept pedestals

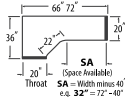
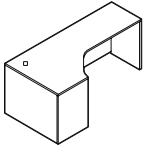

Left Extended Corner, 20" Throat

Z2072FFL	36 x 72 x 29.5-30	65	171	7	\$1212	\$1406	N/A	\$526
Z2066FFL	36 x 66 x 29.5-30	65	164	7	\$1212	\$1370	N/A	\$526

Extended worksurface on right. **Full end panels on left and right. Can be placed next to** lateral files, storage cabinets, wardrobe units, credenzas and end-shelves. Corner has one grommet. Shipped RTA (ready to assemble).

- Modesty Panel is 1" off of ground.

LEFT EXTENDED CORNERS (CONNECTS ON EXTENDED SIDE)

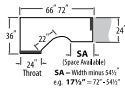
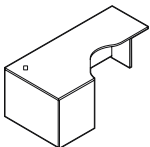

Left Extended Corner, 24" Throat

MODEL# DIMENSIONS FREIGHT CLASS WT/LBS. CUBIC FT. 1" TOP 1.5" TOP GLAZE ADD HP ADD

Z2472FNL	36 x 72 x 29.5-30	65	175	7	\$1212	\$1377	N/A	\$548
Z2466FNL	36 x 66 x 29.5-30	65	167	7	\$1212	\$1370	N/A	\$548

Extended worksurface on right. **Narrow end panel on right. Full end panel on left.** Connects to 30"D space saver connectables, 24"D returns, 24"D connectable tables or "D" and "P" islands with "T" or "H" bases. **Full end panel can be placed next to** lateral files, storage cabinets, wardrobe units, credenzas and end-shelves. Corner has one grommet. Shipped RTA (ready to assemble).

- Modesty Panel is 1" off of ground.
- Z2466FNL cannot accept pedestals.

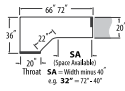
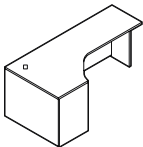

Left Extended Corner, 20" Throat

Z2072FNL	36 x 72 x 29.5-30	65	165	7	\$1176	\$1370	N/A	\$526
Z2066FNL	36 x 66 x 29.5-30	65	158	7	\$1176	\$1334	N/A	\$526

Extended worksurface on right. **Narrow end panel on right. Full end panel on left.** Connects to 24"D space saver connectables, 20"D returns, 20"D connectable tables or "D" and "P" islands with "T" or "H" bases. **Full end panel can be placed next to** lateral files, storage cabinets, wardrobe units, credenzas and end-shelves. Corner has one grommet. Shipped RTA (ready to assemble).

- Modesty Panel is 1" off of ground.
- FNL end panels can be switched to make NFL.

Required Specifications

Top finish
Top/edge detail
Lock finish
Base finish

Optional Specifications

HP laminate Handles
Key # Modesty panel type
Grommet position or power block cut-out

Accessories

Power block
Keyboard
Pencil drawer

LEFT EXTENDED CORNERS (CONNECTS ON THROAT SIDE)

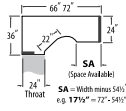
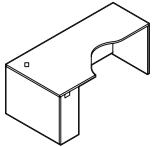

Left Extended Corner, 24" Throat

MODEL#	DIMENSIONS	FREIGHT CLASS	WT/LBS.	CUBIC FT.	1" TOP	1.5" TOP	GLAZE ADD	HP ADD
D x W x H								
Z2472NFL	36 x 72 x 29.5-30	65	175	7	\$1212	\$1377	N/A	\$548
Z2466NFL	36 x 66 x 29.5-30	65	167	7	\$1212	\$1370	N/A	\$548

Extended worksurface on right. **Narrow end panel on left. Full end panel on right.** Connects to 30"D space saver connectables, 30"D space saver returns, 24"D returns or 24"D connectable tables. **Full end panel can be placed next to** lateral files, storage cabinets, wardrobe units, credenzas and end-shelves. Corner has one grommet. Shipped RTA (ready to assemble).

- **Modesty Panel is 1" off of ground.**
- **Z2466NFL cannot accept pedestals.**

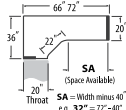
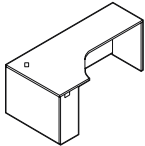

Left Extended Corner, 20" Throat

Z2072NFL	36 x 72 x 29.5-30	65	165	7	\$1176	\$1370	N/A	\$548
Z2066NFL	36 x 66 x 29.5-30	65	158	7	\$1176	\$1334	N/A	\$526

Extended worksurface on right. **Narrow end panel on left. Full end panel on right.** Connects to 24"D space saver connectables and 20"D returns. **Full end panel can be placed next to** lateral files, storage cabinets, wardrobe units, credenzas and end-shelves. Corner has one grommet. Shipped RTA (ready to assemble).

- **Modesty Panel is 1" off of ground.**
- *NFL end panels can be switched to make FNL.*

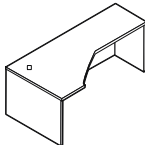
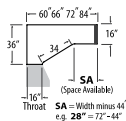
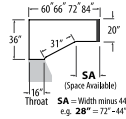
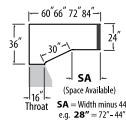

Left Extended Corner, 16" Throat

Z2484ECFL	36 x 84 x 29.5-30	65	196.35	8	\$1215	\$1502	N/A	\$762
Z2472ECFL	36 x 72 x 29.5-30	65	176.40	7.50	\$1087	\$1339	N/A	\$573
Z2466ECFL	36 x 66 x 29.5-30	70	168	7.50	\$1034	\$1268	N/A	\$573
Z2460ECFL	36 x 60 x 29.5-30	65	158.55	6	\$983	\$1198	N/A	\$477
Z2084ECFL	36 x 84 x 29.5-30	65	184.80	8	\$1212	\$1501	N/A	\$762
Z2072ECFL	36 x 72 x 29.5-30	70	168	7.50	\$1082	\$1335	N/A	\$573
Z2066ECFL	36 x 66 x 29.5-30	70	159.60	7.50	\$1030	\$1265	N/A	\$573
Z2060ECFL	36 x 60 x 29.5-30	65	151.20	6	\$965	\$1175	N/A	\$477
Z1684ECFL	36 x 84 x 29.5-30	70	175.35	8	\$1207	\$1496	N/A	\$762
Z1672ECFL	36 x 72 x 29.5-30	70	159.60	7.50	\$1078	\$1331	N/A	\$573
Z1666ECFL	36 x 66 x 29.5-30	70	153.30	7.50	\$1026	\$1261	N/A	\$573
Z1660ECFL	36 x 60 x 29.5-30	65	147	6	\$957	\$1166	N/A	\$477

Extended worksurface on right. **No narrow end panel on left. Full end panel on right.** Connects to returns and bridges with 16" throat on the left. **Full end panel can be placed next to** lateral files, storage cabinets, wardrobe units, credenzas and end-shelves. Corner has one grommet. **Does not accept pencil drawers.** Shipped RTA (ready to assemble).

Required Specifications

Top finish
Top/edge detail
Lock finish
Base finish

Optional Specifications

HP laminate Handles
Key # Modesty panel type
Grommet position or power block cut-out

Accessories

Power block
Keyboard
Pencil drawer

LEFT EXTENDED CORNERS (CONNECTS ON BOTH SIDES)

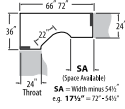
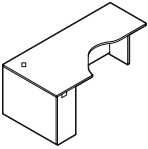

Left Extended Corner, 24" Throat

MODEL#	DIMENSIONS	FREIGHT CLASS	WT/LBS.	CUBIC FT.	1" TOP	1.5" TOP	GLAZE ADD	HP ADD
Z2472NNL	36 x 72 x 29.5-30	65	166	7	\$1176	\$1341	N/A	\$548
Z2466NNL	36 x 66 x 29.5-30	65	158	7	\$1176	\$1334	N/A	\$548

Extended worksurface on right. **Narrow end panels on left and right.** Connects to 30"D space saver connectables, 30"D space saver returns, 24"D returns or 24"D connectable tables or "D" and "P" islands with "T" or "H" bases on either end. **Full end panel can be placed next to** lateral files, storage cabinets, wardrobe units, credenzas and end-shelves. Corner has one grommet. Shipped RTA (ready to assemble).

- **Modesty Panel is 1" off of ground.**
- **Z2466NNL cannot accept pedestals.**

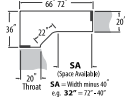
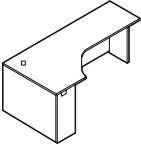

Left Extended Corner, 20" Throat

Z2072NNL	36 x 72 x 29.5-30	65	160	7	\$1140	\$1334	N/A	\$548
Z2066NNL	36 x 66 x 29.5-30	70	152	7	\$1140	\$1299	N/A	\$526

Extended worksurface on right. **Narrow end panels on left and right.** Connects to 24"D space saver connectables and 20"D returns, bridges or "D" and "P" islands with "T" or "H" bases one either end. **Full end panel can be placed next to** lateral files, storage cabinets, wardrobe units, credenzas and end-shelves. Corner has one grommet. Shipped RTA (ready to assemble).

- **Modesty Panel is 1" off of ground.**

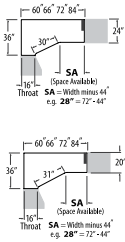
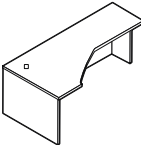

Left Extended Corner, 16" Throat

Z2484ECNL	36 x 84 x 29.5-30	65	186.90	8	\$1180	\$1469	N/A	\$762
Z2472ECNL	36 x 72 x 29.5-30	70	168	7.50	\$1051	\$1306	N/A	\$573
Z2466ECNL	36 x 66 x 29.5-30	70	158.55	7.50	\$999	\$1233	N/A	\$573
Z2460ECNL	36 x 60 x 29.5-30	65	150.15	6	\$935	\$1144	N/A	\$477
Z2084ECNL	36 x 84 x 29.5-30	70	178.50	8	\$1176	\$1465	N/A	\$762
Z2072ECNL	36 x 72 x 29.5-30	70	161.70	7.50	\$1048	\$1300	N/A	\$573
Z2066ECNL	36 x 66 x 29.5-30	70	153.30	7.50	\$996	\$1230	N/A	\$573
Z2060ECNL	36 x 60 x 29.5-30	65	145.95	6	\$930	\$1140	N/A	\$477

Extended worksurface on right. **No narrow end panel on left. Narrow end panel on right.** Connects to returns and bridges with 16" throat on the left. **Full end panel can be placed next to** lateral files, storage cabinets, wardrobe units, credenzas and end-shelves. Corner has one grommet. **Does not accept pencil drawers.** Shipped RTA (ready to assemble).

RIGHT EXTENDED CORNERS (DOES NOT CONNECT)

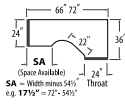
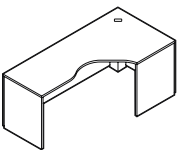

Right Extended Corner, 24" Throat Freestanding

MODEL#	DIMENSIONS	FREIGHT CLASS	WT/LBS.	CUBIC FT.	1" TOP	1.5" TOP	GLAZE ADD	HP ADD
Z2472FFR	36 x 72 x 29.5-30	65	184	7	\$1247	\$1412	N/A	\$548
Z2466FFR	36 x 66 x 29.5-30	65	175	7	\$1247	\$1406	N/A	\$548

Extended worksurface on left. **Full end panels on left and right. Cannot be connected on left or right, due to full end panel.** Corner has one grommet. Shipped RTA (ready to assemble).

- **Modesty Panel is 1" off of ground.**
- **Z2466FFR cannot accept pedestals**

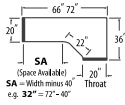
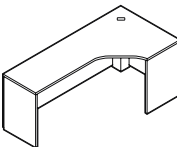

Right Extended Corner, 20" Throat

Z2072FFR	36 x 72 x 29.5-30	65	171	7	\$1212	\$1406	N/A	\$526
Z2066FFR	36 x 66 x 29.5-30	65	164	7	\$1212	\$1370	N/A	\$526

Extended worksurface on left. **Full end panels on left and right. Can be placed next to** lateral files, storage cabinets, wardrobe units, credenzas and end-shelves. Corner has one grommet. Shipped RTA (ready to assemble).

- **Modesty Panel is 1" off of ground.**

Required Specifications

Top finish
Top/edge detail
Base finish

Optional Specifications

HP laminate
Modesty panel type
Grommet position or power block cut-out

Accessories

Power block
Keyboard (*Not available on 16" throat*)
Pencil drawer (*Not available on 16" throat*)

RIGHT EXTENDED CORNERS (CONNECTS ON THROAT SIDE)

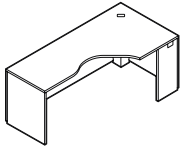

Right Extended Corner, 24" Throat

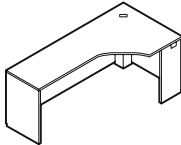

Right Extended Corner, 20" Throat

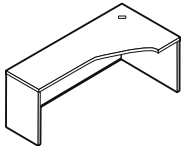
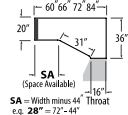
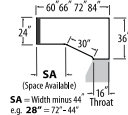
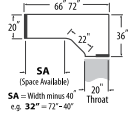
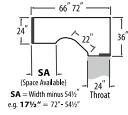

Right Extended Corner, 16" Throat

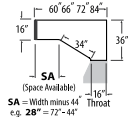

MODEL#	DIMENSIONS	FREIGHT CLASS	WT/LBS.	CUBIC FT.	1" TOP	1.5" TOP	GLAZE ADD	HP ADD
D x W x H								
Z2472FNR	36 x 72 x 29.5-30	65	175	7	\$1212	\$1377	N/A	\$548
Z2466FNR	36 x 66 x 29.5-30	65	167	7	\$1212	\$1370	N/A	\$548

Extended worksurface on left. **Narrow end panel on right. Full end panel on left.** Connects to 30"D space saver connectables, 24"D returns, 24"D connectable tables or "D" and "P" islands with "T" or "H" bases. **Full end panel can be placed next to** lateral files, storage cabinets, wardrobe units, credenzas and end-shelves. Corner has one grommet. Shipped RTA (ready to assemble).

- **Modesty Panel is 1" off of ground.**
- **Z2466FNR cannot accept pedestals.**

Z2072FNR	36 x 72 x 29.5-30	65	165	7	\$1176	\$1370	N/A	\$526
Z2066FNR	36 x 66 x 29.5-30	65	158	7	\$1176	\$1334	N/A	\$526

Extended worksurface on left. **Narrow end panel on right. Full end panel on left.** Connects to 24"D space saver connectables, 20"D returns, 20"D connectable tables or "D" and "P" islands with "T" or "H" bases. **Full end panel can be placed next to** lateral files, storage cabinets, wardrobe units, credenzas and end-shelves. Corner has one grommet. Shipped RTA (ready to assemble).

- **Modesty Panel is 1" off of ground.**
- **FNR end panels can be switched to make NFR.**

Z2484ECFR	36 x 84 x 29.5-30	65	196.35	8	\$1215	\$1502	N/A	\$762
Z2472ECFR	36 x 72 x 29.5-30	65	176.40	7.50	\$1087	\$1339	N/A	\$573
Z2466ECFR	36 x 66 x 29.5-30	70	168	7.50	\$1034	\$1268	N/A	\$573
Z2460ECFR	36 x 60 x 29.5-30	65	158.55	6	\$983	\$1198	N/A	\$477

Z2084ECFR	36 x 84 x 29.5-30	65	184.80	8	\$1212	\$1501	N/A	\$762
Z2072ECFR	36 x 72 x 29.5-30	70	168	7.50	\$1082	\$1335	N/A	\$573
Z2066ECFR	36 x 66 x 29.5-30	70	159.60	7.50	\$1030	\$1265	N/A	\$573
Z2060ECFR	36 x 60 x 29.5-30	65	151.20	6	\$965	\$1175	N/A	\$477

Z1684ECFR	36 x 84 x 29.5-30	70	175.35	8	\$1207	\$1496	N/A	\$762
Z1672ECFR	36 x 72 x 29.5-30	70	159.60	7.50	\$1078	\$1331	N/A	\$573
Z1666ECFR	36 x 66 x 29.5-30	70	153.30	7.50	\$1026	\$1261	N/A	\$573
Z1660ECFR	36 x 60 x 29.5-30	65	147	6	\$957	\$1166	N/A	\$477

Extended worksurface on left. **No narrow end panel on right. Full end panel on left.** Connects to returns and bridges with 16" throat on the right. **Full end panel can be placed next to** lateral files, storage cabinets, wardrobe units, credenzas and end-shelves. Corner has one grommet. **Does not accept pencil drawers.** Shipped RTA (ready to assemble).

Required Specifications

Top finish
Top/edge detail
Base finish

Optional Specifications

HP laminate
Modesty panel type
Grommet position or power block cut-out

Accessories

Power block
Keyboard (*Not available on 16" throat*)
Pencil drawer (*Not available on 16" throat*)

RIGHT EXTENDED CORNERS (CONNECTS ON EXTENDED SIDE)

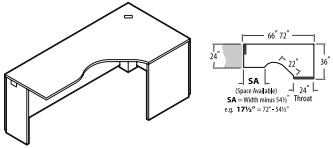

Right Extended Corner, 24" Throat

MODEL#	DIMENSIONS	FREIGHT CLASS	WT/LBS.	CUBIC FT.	1" TOP	1.5" TOP	GLAZE ADD	HP ADD
Z2472NFR	36 x 72 x 29.5-30	65	175	7	\$1212	\$1377	N/A	\$548
Z2466NFR	36 x 66 x 29.5-30	65	167	7	\$1212	\$1370	N/A	\$548

Extended worksurface on left. **Narrow end panel on left. Full end panel on right.** Connects to 30"D space saver connectables, 24"D returns, 24"D connectable tables, or "D" and "P" islands with "T" or "H" bases. **Full end panel can be placed next to** lateral files, storage cabinets, wardrobe units, credenzas and end-shelves. Corner has one grommet. Shipped RTA (ready to assemble).

- Modesty Panel is 1" off of ground.
- Z2466NFR cannot accept pedestals.

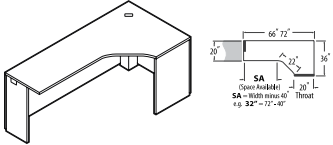

Right Extended Corner, 20" Throat

Z2072NFR	36 x 72 x 29.5-30	65	165	7	\$1176	\$1370	N/A	\$548
Z2066NFR	36 x 66 x 29.5-30	65	158	7	\$1176	\$1334	N/A	\$526

Extended worksurface on left. **Narrow end panel on left. Full end panel on right.** Connects to 24"D space saver connectables, 20"D returns or "D" and "P" islands with "T" or "H" bases. **Full end panel can be placed next to** lateral files, storage cabinets, wardrobe units, credenzas and end-shelves. Corner has one grommet. Shipped RTA (ready to assemble).

- Modesty Panel is 1" off of ground.
- NFR end panels can be switched to make FNR.

RIGHT EXTENDED CORNERS (CONNECTS ON BOTH SIDES)

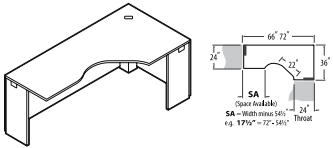

Left Extended Corner, 24" Throat

MODEL#	DIMENSIONS	FREIGHT CLASS	WT/LBS.	CUBIC FT.	1" TOP	1.5" TOP	GLAZE ADD	HP ADD
Z2472NNR	36 x 72 x 29.5-30	65	166	7	\$1176	\$1341	N/A	\$548
Z2466NNR	36 x 66 x 29.5-30	65	158	7	\$1176	\$1334	N/A	\$548

Extended worksurface on left. **Narrow end panels on left and right.** Connects to 30"D space saver connectables, 30"D space saver returns, 24"D returns, 24"D connectable tables or "D" and "P" islands with "T" or "H" bases on either end. Corner has one grommet. Shipped RTA (ready to assemble).

- Modesty Panel is 1" off of ground.
- Z2466NNR cannot accept pedestals.

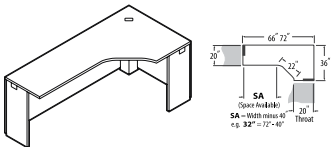

Right Extended Corner, 20" Throat

Z2072NNR	36 x 72 x 29.5-30	65	160	7	\$1140	\$1334	N/A	\$548
Z2066NNR	36 x 66 x 29.5-30	70	152	7	\$1140	\$1284	N/A	\$526

Extended worksurface on left. **Narrow end panels on left and right.** Connects to 24"D space saver connectables and 20"D returns, bridges or "D" and "P" islands with "T" or "H" bases on either end. **Full end panel can be placed next to** lateral files, storage cabinets, wardrobe units, credenzas and end-shelves. Corner has one grommet. Shipped RTA (ready to assemble).

- Modesty Panel is 1" off of ground.

Required Specifications

Top finish
Top/edge detail
Base finish

Optional Specifications

HP laminate
Modesty panel type
Grommet position or power block cut-out

Accessories

Power block
Keyboard
Pencil drawer

RIGHT EXTENDED CORNERS (CONNECTS ON BOTH SIDES)

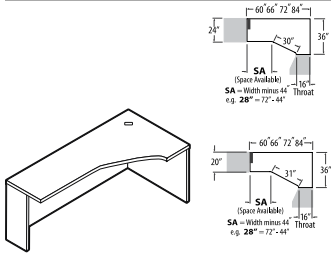

Right Extended Corner, 16" Throat

MODEL#	DIMENSIONS	FREIGHT CLASS	WT/LBS.	CUBIC FT.	1" TOP	1.5" TOP	GLAZE ADD	HP ADD
D x W x H								
Z2484ECNR	36 x 84 x 29.5-30	65	186.90	8	\$1180	\$1469	N/A	\$762
Z2472ECNR	36 x 72 x 29.5-30	70	168	7.50	\$1051	\$1306	N/A	\$573
Z2466ECNR	36 x 66 x 29.5-30	70	158.55	7.50	\$999	\$1233	N/A	\$573
Z2460ECNR	36 x 60 x 29.5-30	65	150.15	6	\$935	\$1144	N/A	\$477
Z2084ECNR	36 x 84 x 29.5-30	70	178.50	8	\$1176	\$1465	N/A	\$762
Z2072ECNR	36 x 72 x 29.5-30	70	161.70	7.50	\$1048	\$1300	N/A	\$573
Z2066ECNR	36 x 66 x 29.5-30	70	153.30	7.50	\$996	\$1230	N/A	\$573
Z2060ECNR	36 x 60 x 29.5-30	65	145.95	6	\$930	\$1140	N/A	\$477

Extended worksurface on left. **No narrow end panel on right. Narrow end panel on left.** Connects to returns and bridges with 16" throat on the right. **Full end panel can be placed next to** lateral files, storage cabinets, wardrobe units, credenzas and end-shelves. Corner has one grommet. **Does not accept pencil drawers.** Shipped RTA (ready to assemble).

FREESTANDING TABLES

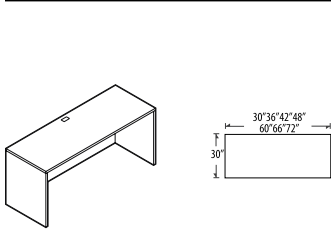

30" Deep Freestanding Table

MODEL#	DIMENSIONS	FREIGHT CLASS	WT/LBS.	CUBIC FT.	1" TOP	1.5" TOP	GLAZE ADD	HP ADD
Z3072T	29.7 x 72 x 29.5-30	65	176	6	\$1031	\$1192	N/A	\$513
Z3066T	29.7 x 66 x 29.5-30	65	166	6	\$1031	\$1183	N/A	\$513
Z3060T	29.7 x 60 x 29.5-30	60	159	5.25	\$941	\$1083	N/A	\$477
Z3048T	29.7 x 48 x 29.5-30	65	135	5.25	\$852	\$979	N/A	\$404
Z3042T	29.7 x 42 x 29.5-30	65	125	5.25	\$852	\$970	N/A	\$367
Z3036T	29.7 x 36 x 29.5-30	65	111	4.30	\$753	\$861	N/A	\$332
Z3030T	29.7 x 30 x 29.5-30	65	100	3.60	\$706	\$795	N/A	\$296

Two full end panels. Cannot be connected on left or right side. Grommet in worksurface. Shipped RTA (ready to assemble).

- Modesty Panel is 1" off of ground.

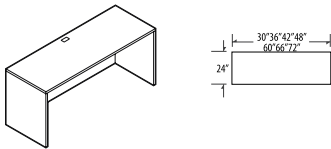

24" Deep Freestanding Table

Z2472T	24 x 72 x 29.5-30	65	152	6	\$926	\$1078	N/A	\$384
Z2466T	24 x 66 x 29.5-30	65	144	6	\$926	\$1078	N/A	\$384
Z2460T	24 x 60 x 29.5-30	65	133	5.25	\$843	\$960	N/A	\$353
Z2448T	24 x 48 x 29.5-30	65	114	4.30	\$761	\$863	N/A	\$281
Z2442T	24 x 42 x 29.5-30	65	105	4.30	\$761	\$850	N/A	\$236
Z2436T	24 x 36 x 29.5-30	65	95	4.20	\$680	\$755	N/A	\$178
Z2430T	24 x 30 x 29.5-30	65	85	3.60	\$645	\$702	N/A	\$178

Two full end panels. Cannot be connected on left or right side. Grommet in worksurface. Shipped RTA (ready to assemble).

- Modesty Panel is 1" off of ground.

Required Specifications

Top finish
Top/edge detail
Base finish

Optional Specifications

HP laminate
Modesty panel type
Grommet position or power block cut-out

Accessories

Power block
Keyboard (Not available on 16" throat)
Pencil drawer (Not available on 16" throat)

CONNECTABLE TABLES - LEFT

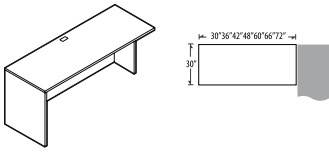

30" Deep Connectable Table - Left

MODEL#	DIMENSIONS D x W x H	FREIGHT CLASS	WT/LBS.	CUBIC FT.	1" TOP	1.5" TOP	GLAZE ADD	HP ADD
Z3072L	29.7 x 72 x 29.5-30	65	168	6	\$996	\$1157	N/A	\$513
Z3066L	29.7 x 66 x 29.5-30	65	158	6	\$996	\$1148	N/A	\$513
Z3060L	29.7 x 60 x 29.5-30	65	150	5.25	\$906	\$1048	N/A	\$477
Z3048L	29.7 x 48 x 29.5-30	65	124	4.30	\$815	\$942	N/A	\$404
Z3042L	29.7 x 42 x 29.5-30	65	115	4.30	\$815	\$933	N/A	\$367
Z3036L	29.7 x 36 x 29.5-30	65	103	4.20	\$718	\$828	N/A	\$332
Z3030L	29.7 x 30 x 29.5-30	65	92	3.60	\$672	\$761	N/A	\$296

Full end panel on left. Right narrow end panel connects to **30"D** center/right connectable table, or at 90° angle to a freestanding table; and "D" islands or "P" islands with "T" and "H" bases. Grommet in worksurface. Shipped RTA (ready to assemble).

- Modesty Panel is 1" off of ground.

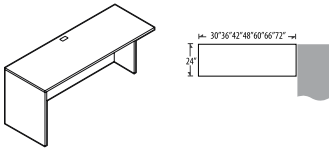

24" Deep Connectable Table - Left

Z2472L	24 x 72 x 29.5-30	65	144	6	\$880	\$1036	N/A	\$384
Z2466L	24 x 66 x 29.5-30	65	135	6	\$880	\$1015	N/A	\$384
Z2460L	24 x 60 x 29.5-30	65	125	5.25	\$796	\$914	N/A	\$353
Z2448L	24 x 48 x 29.5-30	65	106	4.30	\$725	\$827	N/A	\$281
Z2442L	24 x 42 x 29.5-30	65	95	3.80	\$725	\$814	N/A	\$236
Z2436L	24 x 36 x 29.5-30	65	86	3.30	\$637	\$710	N/A	\$178
Z2430L	24 x 30 x 29.5-30	70	77	3.60	\$600	\$658	N/A	\$178

Full end panel on left. Right narrow end panel connects to **24"D** center/right connectable table, or at 90° angle to a freestanding table; 24"D extended corners or at the end of a straight run; "D" islands or "P" islands with "T" and "H" bases. Grommet in worksurface. Shipped RTA (ready to assemble).

- Modesty Panel is 1" off of ground.

CONNECTABLE TABLES - RIGHT

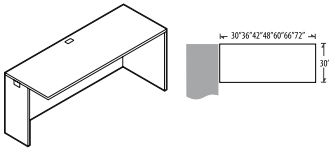

30" Deep Connectable Table - Right

MODEL#	DIMENSIONS D x W x H	FREIGHT CLASS	WT/LBS.	CUBIC FT.	1" TOP	1.5" TOP	GLAZE ADD	HP ADD
Z3072R	29.7 x 72 x 29.5-30	65	168	6	\$996	\$1157	N/A	\$513
Z3066R	29.7 x 66 x 29.5-30	65	158	6	\$996	\$1148	N/A	\$513
Z3060R	29.7 x 60 x 29.5-30	65	150	5.25	\$906	\$1048	N/A	\$477
Z3048R	29.7 x 48 x 29.5-30	65	124	4.30	\$815	\$942	N/A	\$404
Z3042R	29.7 x 42 x 29.5-30	65	115	4.30	\$815	\$933	N/A	\$367
Z3036R	29.7 x 36 x 29.5-30	65	103	4.20	\$718	\$828	N/A	\$332
Z3030R	29.7 x 30 x 29.5-30	65	92	3.60	\$672	\$761	N/A	\$296

Full end panel on right. Left narrow end panel connects to **30"D** center/right connectable table, or at 90° angle to a freestanding table; and "D" islands or "P" islands with "T" and "H" bases. Grommet in worksurface. Shipped RTA (ready to assemble).

- Modesty Panel is 1" off of ground.

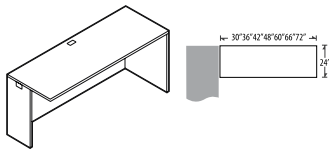

24" Deep Connectable Table - Right

Z2472R	24 x 72 x 29.5-30	65	144	6	\$880	\$1036	N/A	\$384
Z2466R	24 x 66 x 29.5-30	65	135	6	\$880	\$1015	N/A	\$384
Z2460R	24 x 60 x 29.5-30	65	125	5.25	\$796	\$914	N/A	\$353
Z2448R	24 x 48 x 29.5-30	65	106	4.30	\$725	\$827	N/A	\$281
Z2442R	24 x 42 x 29.5-30	65	95	3.80	\$725	\$814	N/A	\$236
Z2436R	24 x 36 x 29.5-30	65	86	3.30	\$637	\$710	N/A	\$178
Z2430R	24 x 30 x 29.5-30	70	77	3.60	\$600	\$658	N/A	\$178

Full end panel on right. Left narrow end panel connects to **24"D** center/right connectable table, or at 90° angle to a freestanding table; 24"D extended corners or at the end of a straight run; "D" islands or "P" islands with "T" and "H" bases. Grommet in worksurface. Shipped RTA (ready to assemble).

- Modesty Panel is 1" off of ground.

Required Specifications

Top finish
Top/edge detail
Base finish

Optional Specifications

HP laminate
Modesty panel type
Grommet position or power block cut-out

Accessories

Power block
Keyboard
Pencil drawer

CONNECTABLE TABLES	MODEL#	DIMENSIONS	FREIGHT CLASS	WT/LBS.	CUBIC FT.	1"TOP	1.5" TOP	GLAZE ADD	HP ADD	
	D x W x H									
	Z3072N	29.7 x 72 x 29.5-30	65	159	6	\$958	\$1120	N/A	\$513	
	Z3066N	29.7 x 66 x 29.5-30	65	149	6	\$958	\$1114	N/A	\$513	
	Z3060N	29.7 x 60 x 29.5-30	65	142	5.25	\$859	\$1003	N/A	\$477	
	Z3048N	29.7 x 48 x 29.5-30	65	116	4.30	\$753	\$879	N/A	\$404	
	Z3042N	29.7 x 42 x 29.5-30	65	106	3.80	\$753	\$870	N/A	\$367	
	Z3036N	29.7 x 36 x 29.5-30	65	94	3.30	\$672	\$782	N/A	\$332	
Z3030N	29.7 x 30 x 29.5-30	65	83	3.60	\$637	\$726	N/A	\$296		

30" Deep Connectable Table

Narrow end panels on both sides connect to **30"D** worksurfaces, "D" islands or "P" islands with "T" and "H" bases; or at 90° angle to freestanding table(s). Grommet in worksurface. Shipped RTA (ready to assemble).

- Modesty Panel is 1" off of ground.

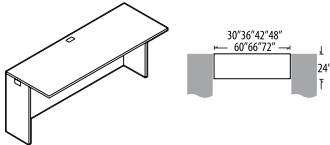

24" Deep Connectable Table

Z2472N	24 x 72 x 29.5-30	65	135	6	\$835	\$987	N/A	\$384
Z2466N	24 x 66 x 29.5-30	70	127	6	\$835	\$968	N/A	\$384
Z2460N	24 x 60 x 29.5-30	65	116	4.50	\$753	\$870	N/A	\$353
Z2448N	24 x 48 x 29.5-30	65	97	4.30	\$680	\$782	N/A	\$281
Z2442N	24 x 42 x 29.5-30	65	87	3.80	\$680	\$764	N/A	\$236
Z2436N	24 x 36 x 29.5-30	65	77	3.30	\$589	\$662	N/A	\$178
Z2430N	24 x 30 x 29.5-30	70	68	3.60	\$553	\$610	N/A	\$178

Narrow end panels on both sides connect to **24"D** worksurfaces, "D" islands or "P" islands with "T" and "H" bases; or at 90° angle to freestanding table(s). Grommet in worksurface. Shipped RTA (ready to assemble).

- Modesty Panel is 1" off of ground.

SPACE SAVER CONNECTABLE TABLES - LEFT	MODEL#	DIMENSIONS	FREIGHT CLASS	WT/LBS.	CUBIC FT.	1"TOP	1.5" TOP	GLAZE ADD	HP ADD
	Z3072LK	29.7 x 72 x 29.5-30	65	161	6	\$1015	\$1189	N/A	\$513
	Z3066LK	29.7 x 66 x 29.5-30	65	151	6	\$1015	\$1180	N/A	\$513
	Z3060LK	29.7 x 60 x 29.5-30	65	144	5.25	\$926	\$1084	N/A	\$477
	Z3048LK	29.7 x 48 x 29.5-30	65	118	4.30	\$835	\$973	N/A	\$404
	Z3042LK	29.7 x 42 x 29.5-30	65	107	3.80	\$835	\$965	N/A	\$367
	Z3036LK	29.7 x 36 x 29.5-30	70	96	4.30	\$736	\$856	N/A	\$332
	Z3030LK	29.7 x 30 x 29.5-30	65	85	3.60	\$691	\$797	N/A	\$296

30" Deep Space Saver Connectable Table - Left

Full end panel on left. Narrow right end panel connects to any corner unit with a 24" throat. Grommet in worksurface. Shipped RTA (ready to assemble).

- Modesty Panel is 1" off of ground.

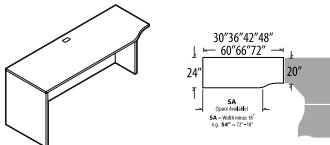

24" Deep Space Saver Connectable Table - Left

Z2472LK	24 x 72 x 29.5-30	65	140	6	\$906	\$1071	N/A	\$384
Z2466LK	24 x 66 x 29.5-30	70	134	6	\$906	\$1054	N/A	\$384
Z2460LK	24 x 60 x 29.5-30	65	123	5.25	\$827	\$957	N/A	\$353
Z2448LK	24 x 48 x 29.5-30	65	104	4.30	\$753	\$865	N/A	\$281
Z2442LK	24 x 42 x 29.5-30	65	94	3.80	\$753	\$858	N/A	\$236
Z2436LK	24 x 36 x 29.5-30	65	85	3.30	\$663	\$750	N/A	\$178
Z2430LK	24 x 30 x 29.5-30	70	75	3.60	\$627	\$697	N/A	\$178

Full end panel on left. Narrow right end panel connects to any corner unit with a 20" throat. Grommet in worksurface. Shipped RTA (ready to assemble).

- Modesty Panel is 1" off of ground.

Required Specifications

Top finish
Top/edge detail
Base finish

Optional Specifications

HP laminate
Modesty panel type
Grommet position or power block cut-out

Accessories

Power block
Keyboard
Pencil drawer

SPACE SAVER CONNECTABLE TABLES - RIGHT

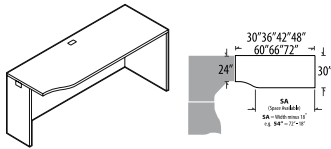

30" Deep Space Saver Connectable Table - Right

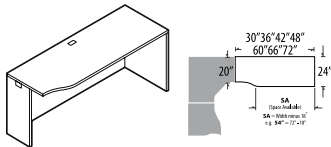

24" Deep Space Saver Connectable Table - Right

MODEL#	DIMENSIONS	FREIGHT CLASS	WT./LBS.	CUBIC FT.	1" TOP	1.5" TOP	GLAZE ADD	HP ADD
	D x W x H							
Z3072RK	29.7 x 72 x 29.5-30	65	161	6	\$1015	\$1189	N/A	\$513
Z3066RK	29.7 x 66 x 29.5-30	65	151	6	\$1015	\$1180	N/A	\$513
Z3060RK	29.7 x 60 x 29.5-30	65	144	5.25	\$926	\$1084	N/A	\$477
Z3048RK	29.7 x 48 x 29.5-30	65	119	4.30	\$835	\$973	N/A	\$404
Z3042RK	29.7 x 42 x 29.5-30	65	107	3.80	\$835	\$965	N/A	\$367
Z3036RK	29.7 x 36 x 29.5-30	70	96	4.30	\$736	\$856	N/A	\$332
Z3030RK	29.7 x 30 x 29.5-30	65	85	3.60	\$691	\$797	N/A	\$296

Full end panel on right. Narrow left end panel connects to any corner unit with a 24" throat. Grommet in worksurface. Shipped RTA (ready to assemble).

- Modesty Panel is 1" off of ground.

Z2472RK	24 x 72 x 29.5-30	65	142	6	\$906	\$1071	N/A	\$384
Z2466RK	24 x 66 x 29.5-30	70	134	6	\$906	\$1054	N/A	\$384
Z2460RK	24 x 60 x 29.5-30	65	123	5.25	\$827	\$957	N/A	\$353
Z2448RK	24 x 48 x 29.5-30	65	104	4.30	\$753	\$865	N/A	\$281
Z2442RK	24 x 42 x 29.5-30	65	94	3.80	\$753	\$858	N/A	\$236
Z2436RK	24 x 36 x 29.5-30	65	85	3.30	\$663	\$750	N/A	\$178
Z2430RK	24 x 30 x 29.5-30	70	75	3.60	\$627	\$697	N/A	\$178

Full end panel on right. Narrow left end panel connects to any corner unit with a 20" throat. Grommet in worksurface. Shipped RTA (ready to assemble).

- Modesty Panel is 1" off of ground.

SPACE SAVER CONNECTABLE TABLES

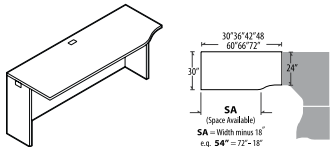

30" Deep Space Saver Connectable Table

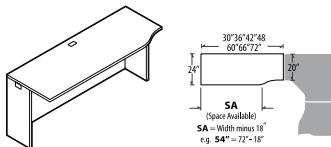

24" Deep Space Saver Connectable Table

MODEL#	DIMENSIONS	FREIGHT CLASS	WT./LBS.	CUBIC FT.	1" TOP	1.5" TOP	GLAZE ADD	HP ADD
Z3072LN	29.7 x 72 x 29.5-30	65	153	6	\$978	\$1152	N/A	\$513
Z3066LN	29.7 x 66 x 29.5-30	65	143	6	\$978	\$1143	N/A	\$513
Z3060LN	29.7 x 60 x 29.5-30	65	136	5.25	\$880	\$1039	N/A	\$477
Z3048LN	29.7 x 48 x 29.5-30	65	110	4.30	\$769	\$908	N/A	\$404
Z3042LN	29.7 x 42 x 29.5-30	65	100	3.80	\$769	\$900	N/A	\$367
Z3036LN	29.7 x 36 x 29.5-30	65	88	3.30	\$691	\$812	N/A	\$332
Z3030LN	29.7 x 30 x 29.5-30	70	77	3.60	\$653	\$759	N/A	\$296

Narrow end panels on both sides. Connects the **right end only** to any corner unit with a 24" throat. Left end allows the continuation of additional 30" connectable center or left connectable worksurface. Grommet in worksurface. Shipped RTA (ready to assemble).

- Modesty Panel is 1" off of ground.

Z2472LN	24 x 72 x 29.5-30	70	134	6	\$859	\$1026	N/A	\$384
Z2466LN	24 x 66 x 29.5-30	70	125	6	\$859	\$1009	N/A	\$384
Z2460LN	24 x 60 x 29.5-30	70	115	5.25	\$780	\$919	N/A	\$353
Z2448LN	24 x 48 x 29.5-30	70	96	4.30	\$706	\$819	N/A	\$281
Z2442LN	24 x 42 x 29.5-30	70	85	3.80	\$706	\$812	N/A	\$236
Z2436LN	24 x 36 x 29.5-30	65	76	3.30	\$618	\$704	N/A	\$178
Z2430LN	24 x 30 x 29.5-30	70	67	3.60	\$580	\$651	N/A	\$178

Narrow end panels on both sides. Connects the **right end only** to any corner unit with a 24" throat. Left end allows the continuation of additional 24" connectable center or left connectable worksurface. Grommet in worksurface. Shipped RTA (ready to assemble).

- Modesty Panel is 1" off of ground.

Required Specifications

- Top finish
- Top/edge detail
- Base finish

Optional Specifications

- HP laminate
- Modesty panel type
- Grommet position or power block cut-out

Accessories

- Power block
- Keyboard
- Pencil drawer

SPACE SAVER CONNECTABLE TABLES

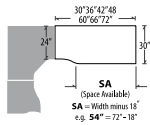
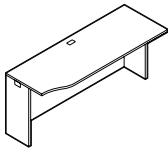

30" Deep Space Saver Connectable Table

MODEL#	DIMENSIONS	FREIGHT CLASS	WT/LBS.	CUBIC FT.	1" TOP	1.5" TOP	GLAZE ADD	HP ADD
D x W x H								
Z3072RN	29.7 x 72 x 29.5-30	65	153	6	\$978	\$1152	N/A	\$513
Z3066RN	29.7 x 66 x 29.5-30	65	143	6	\$978	\$1143	N/A	\$513
Z3060RN	29.7 x 60 x 29.5-30	65	136	5.25	\$880	\$1039	N/A	\$477
Z3048RN	29.7 x 48 x 29.5-30	65	110	4.30	\$769	\$908	N/A	\$404
Z3042RN	29.7 x 42 x 29.5-30	65	99	3.80	\$769	\$900	N/A	\$367
Z3036RN	29.7 x 36 x 29.5-30	65	88	3.30	\$691	\$812	N/A	\$332
Z3030RN	29.7 x 30 x 29.5-30	70	77	3.60	\$653	\$759	N/A	\$296

Narrow end panels on both sides. Connects the **left end only** to any corner unit with a 24" throat. Right end allows the continuation of additional 30" connectable center or right connectable worksurface. Grommet in worksurface. Shipped RTA (ready to assemble).

- Modesty Panel is 1" off of ground.

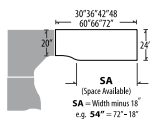
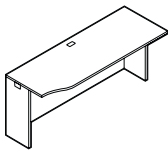

24" Deep Space Saver Connectable Table

Z2472RN	24 x 72 x 29.5-30	70	134	6	\$859	\$1026	N/A	\$384
Z2466RN	24 x 66 x 29.5-30	70	125	6	\$859	\$1009	N/A	\$384
Z2460RN	24 x 60 x 29.5-30	70	115	5.25	\$780	\$919	N/A	\$353
Z2448RN	24 x 48 x 29.5-30	70	95	4.30	\$706	\$819	N/A	\$281
Z2442RN	24 x 42 x 29.5-30	70	85	3.80	\$706	\$812	N/A	\$236
Z2436RN	24 x 36 x 29.5-30	65	76	3.30	\$618	\$704	N/A	\$178
Z2430RN	24 x 30 x 29.5-30	70	67	3.60	\$580	\$651	N/A	\$178

Narrow end panels on both sides. Connects the **left end only** to any corner unit with a 20" throat. Right end allows the continuation of additional 30" connectable center or right connectable worksurface. Grommet in worksurface. Shipped RTA (ready to assemble).

- Modesty Panel is 1" off of ground.

EXTENDED CORNER ISLANDS

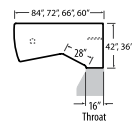
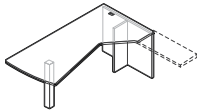

Extended Corner Island - LEFT Full End Panel & Post (T-Base)*

MODEL#	DIMENSIONS	FREIGHT CLASS	WT/LBS.	CUBIC FT.	1" TOP	1.5" TOP	GLAZE ADD	HP ADD
Z4284EDTL	42 x 84 x 29.5-30	70	180.60	10.76	\$1227	\$1546	N/A	\$1015
Z4272EDTL	42 x 72 x 29.5-30	70	164.85	9.50	\$1154	\$1437	N/A	\$762
Z3672EDTL	36 x 72 x 29.5-30	70	139.65	8.76	\$1053	\$1252	N/A	\$573
Z3666EDTL	36 x 66 x 29.5-30	70	133.35	8.76	\$1008	\$1205	N/A	\$573
Z3660EDTL	36 x 60 x 29.5-30	70	127.05	6.50	\$961	\$1160	N/A	\$477

Extended island worksurface on **left**. Connects to returns or bridges with a 16" throat on the right. **Not freestanding.** Grommet in worksurface. Shipped RTA (ready to assemble).

- Post is shipped in separate carton.

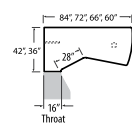
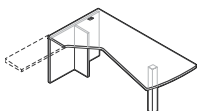

Extended Corner Island - RIGHT Full End Panel & Post (T-Base)*

Z4284EDTR	42 x 84 x 29.5-30	70	180.60	10.76	\$1227	\$1546	N/A	\$1015
Z4272EDTR	42 x 72 x 29.5-30	70	164.85	9.50	\$1154	\$1437	N/A	\$762
Z3672EDTR	36 x 72 x 29.5-30	70	139.65	8.76	\$1053	\$1252	N/A	\$573
Z3666EDTR	36 x 66 x 29.5-30	70	133.35	8.76	\$1008	\$1205	N/A	\$573
Z3660EDTR	36 x 60 x 29.5-30	70	127.05	6.50	\$961	\$1160	N/A	\$477

Extended island worksurface on **right**. Connects to returns or bridges with a 16" throat on the left. **Not freestanding.** Grommet in worksurface. Shipped RTA (ready to assemble).

- Post is shipped in separate carton.

Required Specifications

- Top finish
- Top/edge detail
- Base finish

Optional Specifications

- HP laminate
- Modesty panel type
- Grommet position or power block cut-out

Accessories

- Power block
- Keyboard
- Pencil drawer

EXTENDED CORNER ISLANDS (WITH FAUX PEDESTAL)

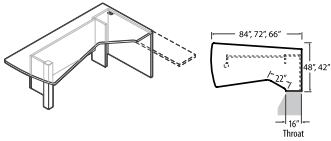

**Extended Corner Island - LEFT
Faux Pedestal and Post**

MODEL#	DIMENSIONS D x W x H	FREIGHT CLASS	WT/LBS.	CUBIC FT.	1" TOP	1.5" TOP	GLAZE ADD	HP ADD
Z4884EDFL	48 x 84 x 29.5-30	70	214.20	12	\$1535	\$1891	\$690	\$1015
Z4872EDFL	48 x 72 x 29.5-30	70	192.15	10.76	\$1423	\$1733	\$570	\$762
Z4284EDFL	42 x 84 x 29.5-30	70	186.90	10.76	\$1441	\$1760	\$690	\$1015
Z4272EDFL	42 x 72 x 29.5-30	70	168	8.76	\$1341	\$1619	\$570	\$762
Z4266EDFL	42 x 66 x 29.5-30	70	158.55	8.76	\$1288	\$1547	\$510	\$762

Extended island worksurface on **left**. Connects to returns or bridges with a 16" throat on the right. **Not freestanding**. Faux pedestal on the **right** is ideal for concealing a CPU. ¾ modesty panel is standard. Grommet in worksurface. Shipped RTA (ready to assemble) in 2 cartons.

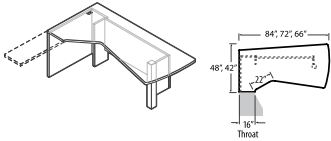

**Extended Corner Island - RIGHT
Faux Pedestal and Post**

Z4884EDFR	48 x 84 x 29.5-30	70	214.20	12	\$1535	\$1891	\$690	\$1015
Z4872EDFR	48 x 72 x 29.5-30	70	192.15	10.76	\$1423	\$1733	\$570	\$762
Z4284EDFR	42 x 84 x 29.5-30	70	186.90	10.76	\$1441	\$1760	\$690	\$1015
Z4272EDFR	42 x 72 x 29.5-30	70	168	8.76	\$1341	\$1619	\$570	\$762
Z4266EDFR	42 x 66 x 29.5-30	70	158.55	8.76	\$1288	\$1547	\$510	\$762

Extended island worksurface on **right**. Connects to returns or bridges with a 16" throat on the right. **Not freestanding**. Faux pedestal on the **left** is ideal for concealing a CPU. ¾ modesty panel is standard. Grommet in worksurface. Shipped RTA (ready to assemble) in 2 cartons.

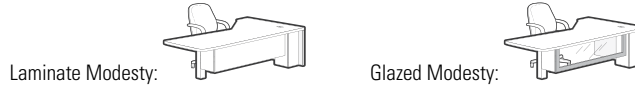

EXTENDED CORNER ISLANDS (WITH RECESSED MODESTY)

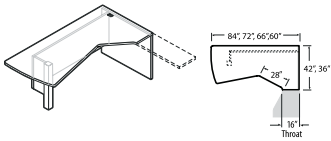

**Extended Corner Island - LEFT
Recessed Modesty and Post**

MODEL#	DIMENSIONS	FREIGHT CLASS	WT/LBS.	CUBIC FT.	1" TOP	1.5" TOP	GLAZE ADD	HP ADD
Z4284EDRL	42 x 84 x 29.5-30	70	199	10.76	\$1361	\$1681	\$810	\$1015
Z4272EDRL	42 x 72 x 29.5-30	70	180	9.50	\$1278	\$1560	\$738	\$762
Z3672EDRL	36 x 72 x 29.5-30	70	154	8.76	\$1132	\$1372	\$738	\$573
Z3666EDRL	36 x 66 x 29.5-30	70	144	8.76	\$1091	\$1314	\$678	\$573
Z3660EDRL	36 x 60 x 29.5-30	70	136	6.50	\$1048	\$1255	\$620	\$477

Extended island worksurface on **left**. Connects to returns or bridges with a 16" throat on the right. **Not freestanding**. Grommet in worksurface. ¾ **recessed** modesty panel is standard. Shipped RTA (ready to assemble) in 2 cartons.

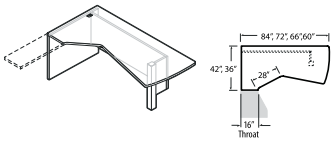

**Extended Corner Island - RIGHT
Recessed Modesty and Post**

Z4284EDRR	42 x 84 x 29.5-30	70	199	10.76	\$1361	\$1681	\$810	\$1015
Z4272EDRR	42 x 72 x 29.5-30	70	180	9.50	\$1278	\$1560	\$738	\$762
Z3672EDRR	36 x 72 x 29.5-30	70	154	8.76	\$1132	\$1372	\$738	\$573
Z3666EDRR	36 x 66 x 29.5-30	70	144	8.76	\$1091	\$1314	\$678	\$573
Z3660EDRR	36 x 60 x 29.5-30	70	136	6.50	\$1048	\$1255	\$620	\$477

Extended island worksurface on **right**. Connects to returns or bridges with a 16" throat on the left. **Not freestanding**. Grommet in worksurface. ¾ **recessed** modesty panel is standard. Shipped RTA (ready to assemble) in 2 cartons.

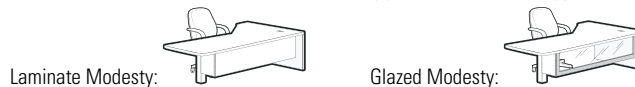

Required Specifications

- Top finish
- Top/edge detail
- Base finish
- Monopost finish*

Optional Specifications

- HP laminate
- Modesty panel type
- Grommet position or power block cut-out

Accessories

- Power block
- Keyboard
- Pencil drawer

EXTENDED CORNER ISLANDS (WITH FLUSH MODESTY)	MODEL#	DIMENSIONS	FREIGHT CLASS	WT/LBS.	CUBIC FT.	1" TOP	1.5" TOP	GLAZE ADD	HP ADD
	Z4284EDML	42 x 84 x 29.5-30	70	208.95	10.76	\$1381	\$1701	\$810	\$1015
	Z4272EDML	42 x 72 x 29.5-30	70	183.75	9.50	\$1293	\$1575	\$738	\$762
	Z3672EDML	36 x 72 x 29.5-30	70	158.55	8.76	\$1144	\$1380	\$738	\$573
	Z3666EDML	36 x 66 x 29.5-30	70	150.15	8.76	\$1097	\$1347	\$678	\$573
	Z3660EDML	36 x 60 x 29.5-30	70	141.75	6.50	\$1069	\$1264	\$620	\$477

Extended Corner Island - LEFT
Flush Modesty and Post

Extended island worksurface on **left**. Connects to returns or bridges with a 16" throat on the right. **Not freestanding.** Grommet in worksurface. $\frac{3}{4}$ flush modesty panel is standard. Shipped RTA (ready to assemble) in 2 cartons.

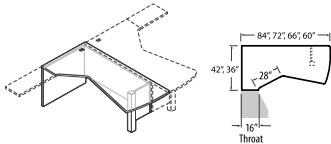

Extended Corner Island - RIGHT
Flush Modesty and Post

Extended island worksurface on **right**. Connects to returns or bridges with a 16" throat on the left. **Not freestanding.** Grommet in worksurface. $\frac{3}{4}$ flush modesty panel is standard. Shipped RTA (ready to assemble) in 2 cartons.

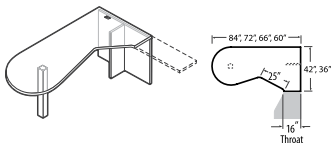
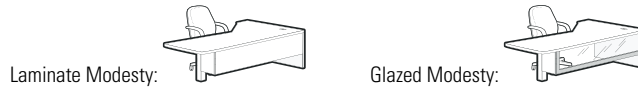

Extended Corner "P" Island - LEFT
Full End Panel & Post (T-Base)

Z4284EPTL	42 x 84 x 29.5-30	70	178.50	10.76	\$1219	\$1538	N/A	\$1015
Z3684EPTL	36 x 84 x 29.5-30	100	153.30	19	\$1124	\$1407	N/A	\$762
Z3672EPTL	36 x 72 x 29.5-30	70	144.90	8.76	\$1036	\$1246	N/A	\$573
Z3666EPTL	36 x 66 x 29.5-30	70	138.60	8.76	\$994	\$1220	N/A	\$573
Z3660EPTL	36 x 60 x 29.5-30	70	129.15	6.50	\$957	\$1167	N/A	\$477

Extended island worksurface on **left**. Connects to returns or bridges with a 16" throat on the right. **Not freestanding.** Grommet in worksurface. Shipped RTA (ready to assemble).

- Post is shipped in separate carton.

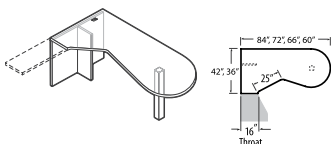

Extended Corner "P" Island - RIGHT
Full End Panel & Post (T-Base)

Z4284EPTR	42 x 84 x 29.5-30	70	178.50	10.76	\$1219	\$1538	N/A	\$1015
Z3684EPTR	36 x 84 x 29.5-30	100	153.30	19	\$1124	\$1407	N/A	\$762
Z3672EPTR	36 x 72 x 29.5-30	70	144.90	8.76	\$1036	\$1246	N/A	\$573
Z3666EPTR	36 x 66 x 29.5-30	70	138.60	8.76	\$994	\$1220	N/A	\$573
Z3660EPTR	36 x 60 x 29.5-30	70	129.15	6.50	\$957	\$1167	N/A	\$477

Extended island worksurface on **right**. Connects to returns or bridges with a 16" throat on the left. **Not freestanding.** Grommet in worksurface. Shipped RTA (ready to assemble).

- Post is shipped in separate carton.

EXTENDED CORNER ISLANDS (WITH FAUX MODESTY)	MODEL#	DIMENSIONS	FREIGHT CLASS	WT/LBS.	CUBIC FT.	1" TOP	1.5" TOP	GLAZE ADD	HP ADD
	Z4884EPFL	48 x 84 x 29.5-30	70	217	12	\$1535	\$1888	\$690	\$1015
	Z4872EPFL	48 x 72 x 29.5-30	70	194	10.50	\$1422	\$1731	\$570	\$762
	Z4284EPFL	42 x 84 x 29.5-30	70	191	10.76	\$1441	\$1759	\$690	\$1015
	Z4272EPFL	42 x 72 x 29.5-30	70	172	8.76	\$1340	\$1618	\$570	\$762
	Z4266EPFL	42 x 66 x 29.5-30	70	160	8.76	\$1286	\$1544	\$510	\$762

Extended Corner "P" Island - LEFT
Faux Pedestal and Post

Extended island worksurface on **left**. Connects to returns or bridges with a 16" throat on the right. **Not freestanding.** Faux pedestal on the **right** is ideal for concealing a CPU. $\frac{3}{4}$ modesty panel is standard. Grommet in worksurface. Shipped RTA (ready to assemble) in 2 cartons.



Required Specifications

- Top finish
- Top/edge detail
- Base finish
- Monopost finish

Optional Specifications

- HP laminate
- Glazing - modesty panel
- Grommet position or power block cut-out

Accessories

- Power block
- Keyboard
- Pencil drawer

EXTENDED CORNER ISLANDS (WITH FAUX MODESTY)

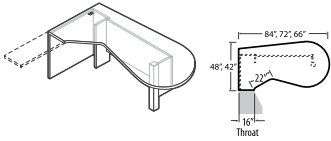

Extended Corner "P" Island - RIGHT Faux Pedestal and Post

MODEL#	DIMENSIONS	FREIGHT CLASS	WT./LBS.	CUBIC FT.	1"TOP	1.5" TOP	GLAZE ADD	HP ADD
D x W x H								
Z4884EPFR	48 x 84 x 29.5-30	70	217	12	\$1535	\$1888	\$690	\$1015
Z4872EPFR	48 x 72 x 29.5-30	70	194	10.50	\$1422	\$1731	\$570	\$762
Z4284EPFR	42 x 84 x 29.5-30	70	191	10.76	\$1441	\$1759	\$690	\$1015
Z4272EPFR	42 x 72 x 29.5-30	70	172	8.76	\$1340	\$1618	\$570	\$762
Z4266EPFR	42 x 66 x 29.5-30	70	160	8.76	\$1286	\$1544	\$510	\$762

Extended island worksurface on **left**. Connects to returns or bridges with a 16" throat on the right. **Not freestanding.** Faux pedestal on the **right** is ideal for concealing a CPU. ¾ modesty panel is standard. Grommet in worksurface. Shipped RTA (ready to assemble) in 2 cartons.

Laminate Modesty:



Glazed Modesty:

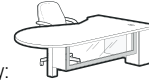

EXTENDED CORNER ISLANDS (WITH RECESSED MODESTY)

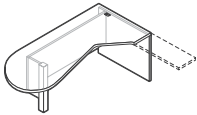

Extended Corner "P" Island - LEFT Recessed Modesty and Post

MODEL#	DIMENSIONS	FREIGHT CLASS	WT./LBS.	CUBIC FT.	1"TOP	1.5" TOP	GLAZE ADD	HP ADD
Z4284EPRL	42 x 84 x 29.5-30	70	199.50	10.76	\$1358	\$1677	\$810	\$1015
Z3684EPRL	36 x 84 x 29.5-30	70	173.25	9.50	\$1231	\$1543	\$810	\$762
Z3672EPRL	36 x 72 x 29.5-30	70	156.45	8.76	\$1132	\$1372	\$738	\$573
Z3666EPRL	36 x 66 x 29.5-30	70	149.10	8.76	\$1103	\$1330	\$678	\$573
Z3660EPRL	36 x 60 x 29.5-30	70	140.70	6.50	\$1056	\$1266	\$620	\$477

Extended island worksurface on **left**. Connects to returns or bridges with a 16" throat on the right. **Not freestanding.** Grommet in worksurface. ¾ **recessed** modesty panel is standard. Shipped RTA (ready to assemble) in 2 cartons.

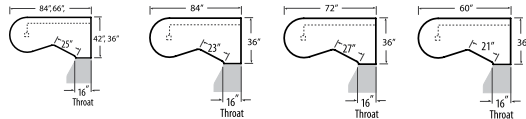

Laminate Modesty:

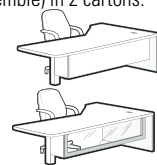

Glazed Modesty:

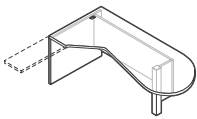

Extended Corner "P" Island - RIGHT Recessed Modesty and Post

Z4284EPRR	42 x 84 x 29.5-30	70	199.50	10.76	\$1358	\$1677	\$810	\$1015
Z3684EPRR	36 x 84 x 29.5-30	70	173.25	9.50	\$1231	\$1543	\$810	\$762
Z3672EPRR	36 x 72 x 29.5-30	70	156.45	8.76	\$1132	\$1372	\$738	\$573
Z3666EPRR	36 x 66 x 29.5-30	70	149.10	8.76	\$1103	\$1330	\$678	\$573
Z3660EPRR	36 x 60 x 29.5-30	70	140.70	6.50	\$1056	\$1266	\$620	\$477

Extended island worksurface on **right**. Connects to returns or bridges with a 16" throat on the right. **Not freestanding.** Grommet in worksurface. ¾ **recessed** modesty panel is standard. Shipped RTA (ready to assemble) in 2 cartons.

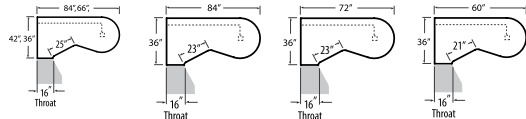

Laminate Modesty:

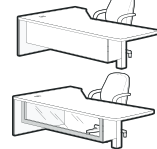

Glazed Modesty:

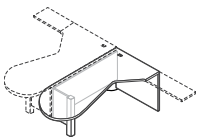

Extended Corner "P" Island - LEFT Flush Modesty and Post

Z4284EPML	42 x 84 x 29.5-30	70	200	10.76	\$1373	\$1692	\$810	\$1015
Z3684EPML	36 x 84 x 29.5-30	70	172	9.50	\$1244	\$1527	\$810	\$762
Z3672EPML	36 x 72 x 29.5-30	70	156	8.76	\$1141	\$1380	\$738	\$573
Z3666EPML	36 x 66 x 29.5-30	70	150	8.76	\$1096	\$1296	\$678	\$573
Z3660EPML	36 x 60 x 29.5-30	70	141	6.50	\$1063	\$1272	\$620	\$477

Extended island worksurface on **left**. Connects to returns or bridges with a 16" throat on the right. **Not freestanding.** Grommet in worksurface. ¾ **flush** modesty panel is standard. Shipped RTA (ready to assemble) in 2 cartons.

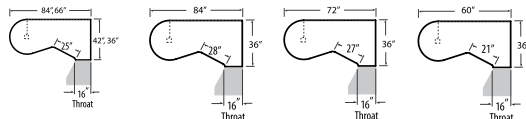

Laminate Modesty:

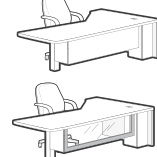

Glazed Modesty:

Required Specifications

- Top finish
- Top/edge detail
- Base finish
- Monopost finish

Optional Specifications

- HP laminate
- Glazing - modesty panel
- Grommet position or power block cut-out

Accessories

- Power block
- Keyboard
- Pencil drawer

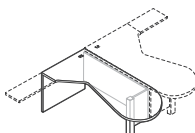
EXTENDED CORNER ISLANDS (WITH RECESSED MODESTY)	MODEL#	DIMENSIONS	FREIGHT CLASS	WT/LBS.	CUBIC FT.	1"TOP	1.5" TOP	GLAZE ADD	HP ADD
		D x W x H							
	Z4284EPMR	42 x 84 x 29.5-30	70	200	10.76	\$1373	\$1692	\$810	\$1015
	Z3684EPMR	36 x 84 x 29.5-30	70	172	9.50	\$1244	\$1527	\$810	\$762
	Z3672EPMR	36 x 72 x 29.5-30	70	156	8.76	\$1141	\$1380	\$738	\$573
	Z3666EPMR	36 x 66 x 29.5-30	70	150	8.76	\$1096	\$1296	\$678	\$573
Z3660EPMR	36 x 60 x 29.5-30	70	141	6.50	\$1063	\$1272	\$620	\$477	

Extended Corner "P" Island - RIGHT Flush Modesty and Post

Extended island worksurface on **left**. Connects to returns or bridges with a 16" throat on the right. **Not freestanding.** Grommet in worksurface. $\frac{3}{4}$ " flush modesty panel is standard. Shipped RTA (ready to assemble) in 2 cartons.

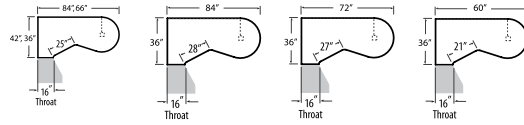

Laminate Modesty:

Glazed Modesty:

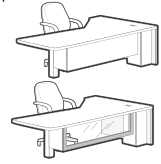

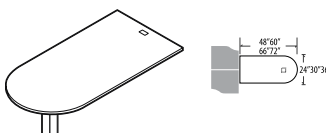
"D" ISLANDS	MODEL#	DIMENSIONS	FREIGHT CLASS	WT/LBS.	CUBIC FT.	1"TOP	1.5" TOP	GLAZE ADD	HP ADD
	Z3672I	36 x 72 x 29.5-30	70	144	8.50	\$789	\$1003	N/A	\$548
	Z3066I	29.7 x 66 x 29.5-30	70	115	7.50	\$736	\$905	N/A	\$513
	Z3060I	29.7 x 60 x 29.5-30	70	104	6.76	\$736	\$897	N/A	\$477
	Z2466I	24 x 66 x 29.5-30	85	101	7.50	\$672	\$822	N/A	\$384
	Z2460I	24 x 60 x 29.5-30	85	92	6.76	\$637	\$770	N/A	\$353
	Z2448I	24 x 48 x 29.5-30	85	74	5.76	\$589	\$707	N/A	\$281

"D" Island with Monopost

Attaches to edge of worksurfaces. Attaching hardware included. Includes grommet as shown. Shipped RTA (ready to assemble).

- Post is shipped in separate carton.

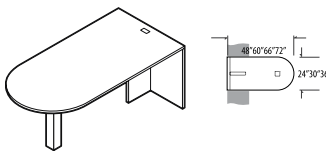

"D" Island - Full End Panel and Monopost (T-Base)

Z3672FI	36 x 72 x 29.5-30	85	123	8.50	\$967	\$1181	N/A	\$548
Z3072FI	29.7 x 72 x 29.5-30	85	106	7.50	\$967	\$1145	N/A	\$515
Z3066FI	29.7 x 66 x 29.5-30	85	101	7.50	\$880	\$1049	N/A	\$513
Z3060FI	29.7 x 60 x 29.5-30	85	94	6.76	\$827	\$988	N/A	\$477
Z2466FI	24 x 66 x 29.5-30	85	90	7.50	\$815	\$967	N/A	\$384
Z2460FI	24 x 60 x 29.5-30	85	84	6.76	\$780	\$915	N/A	\$353
Z2448FI	24 x 48 x 29.5-30	85	74	5.76	\$736	\$853	N/A	\$281

Attaches to edge of worksurfaces. Attaching hardware included. Includes grommet as shown. **Not freestanding.** Shipped RTA (ready to assemble).

- Post is shipped in separate carton.

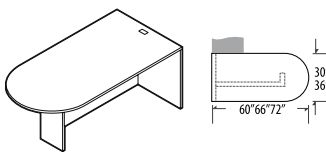

"D" Island LEFT - Full Modesty Panel (H-Base)

Z3672FIL	36 x 72 x 29.5-30	65	171	7	\$913	\$1127	N/A	\$548
Z3066FIL	29.7 x 66 x 29.5-30	65	140	6	\$815	\$1044	N/A	\$513
Z3060FIL	29.7 x 60 x 29.5-30	65	128	5.25	\$742	\$903	N/A	\$477

Connects to the left side of a worksurface. Attaching hardware included. Accommodates all 19" pedestals (mobile and hanging pedestals and 19.3" deep storage shells). Includes grommet as shown. Shipped RTA (ready to assemble).

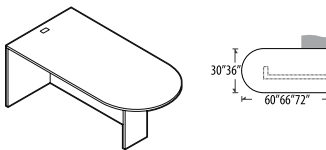

"D" Island RIGHT - Full Modesty Panel (H-Base)

Z3672FIR	36 x 72 x 29.5-30	65	171	7	\$913	\$1127	N/A	\$548
Z3066FIR	29.7 x 66 x 29.5-30	65	140	6	\$815	\$1044	N/A	\$513
Z3060FIR	29.7 x 60 x 29.5-30	65	128	5.25	\$742	\$903	N/A	\$477

Connects to the right side of a worksurface. Attaching hardware included. Accommodates all 19" pedestals (mobile and hanging pedestals and 19.3" deep storage shells). Includes grommet as shown. Shipped RTA (ready to assemble).

Required Specifications

- Top finish
- Top/edge detail
- Base finish
- Monopost finish

Optional Specifications

- HP laminate
- Glazing - modesty panel
- Remove standard grommet (RSG)

Accessories

- Power block
- Keyboard
- Pencil drawer

"D" ISLANDS

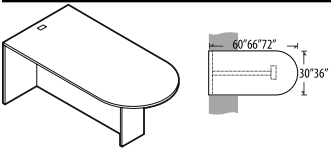

"D" Island CENTER - Full Modesty Panel (H-Base)

MODEL#	DIMENSIONS	FREIGHT CLASS	WT./LBS.	CUBIC FT.	1" TOP	1.5" TOP	GLAZE ADD	HP ADD	
D x W x H									
Z3672FIC	36 x 72 x 29.5-30	65	171	7	\$913	\$1127	N/A	\$548	
Z3066FIC	29.7 x 66 x 29.5-30	65	140	6	\$815	\$1044	N/A	\$513	
Z3060FIC	29.7 x 60 x 29.5-30	65	123	5.25	\$742	\$903	N/A	\$477	

Connects in between two worksurfaces. Attaching hardware included. **Will not accommodate pedestals.** Includes grommet as shown. Shipped RTA (ready to assemble).

"P" ISLANDS

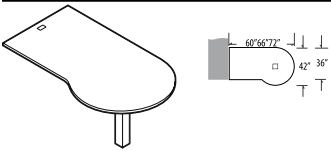

"P" Island LEFT with Post

MODEL#	DIMENSIONS	FREIGHT CLASS	WT./LBS.	CUBIC FT.	1" TOP	1.5" TOP	GLAZE ADD	HP ADD
Z3672IPL	42 x 72 x 29.5-30	85	128	9.26	\$899	\$1118	N/A	\$731
Z3666IPL	42 x 66 x 29.5-30	85	119	8.76	\$899	\$1068	N/A	\$731
Z3660IPL	42 x 60 x 29.5-30	85	110	8	\$815	\$984	N/A	\$623

Attaches to edge of worksurfaces. Attaching hardware included. Includes grommet as shown. Shipped RTA (ready to assemble).
 • Post is shipped in separate carton.

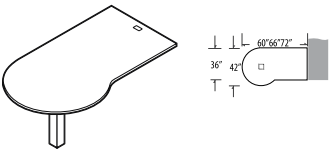

"P" Island RIGHT with Post

Z3672IPR	42 x 72 x 29.5-30	85	128	9.26	\$899	\$1118	N/A	\$731
Z3666IPR	42 x 66 x 29.5-30	85	119	8.76	\$899	\$1068	N/A	\$731
Z3660IPR	42 x 60 x 29.5-30	85	110	8	\$815	\$984	N/A	\$623

Attaches to edge of worksurfaces. Attaching hardware included. Includes grommet as shown. Shipped RTA (ready to assemble).
 • Post is shipped in separate carton.

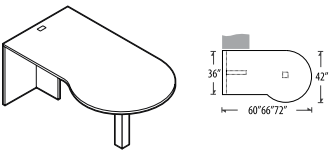

"P" Island LEFT - Full End Panel and Post (T-Base)

Z3672FPL	42 x 72 x 29.5-30	70	163	9.26	\$1077	\$1296	N/A	\$731
Z3666FPL	42 x 66 x 29.5-30	70	155	8.76	\$1077	\$1255	N/A	\$731
Z3660FPL	42 x 60 x 29.5-30	70	145	8	\$996	\$1165	N/A	\$623

Connects to left side of worksurface. Attaching hardware included. **Not freestanding.** Includes grommet as shown. Shipped RTA (ready to assemble).
 • Post is shipped in separate carton.

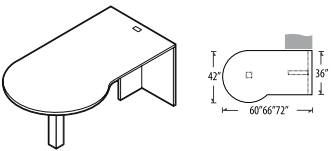

"P" Island RIGHT - Full End Panel and Post (T-Base)

Z3672FPR	42 x 72 x 29.5-30	70	163	9.26	\$1077	\$1296	N/A	\$731
Z3666FPR	42 x 66 x 29.5-30	70	155	8.76	\$1077	\$1255	N/A	\$731
Z3660FPR	42 x 60 x 29.5-30	70	145	8	\$996	\$1165	N/A	\$623

Connects to right side of worksurface. Attaching hardware included. **Not freestanding.** Includes grommet as shown. Shipped RTA (ready to assemble).
 • Post is shipped in separate carton.

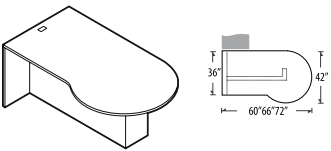

"P" Island LEFT - Full Modesty Panel (H-Base)

Z3672PL	42 x 72 x 29.5-30	65	178	7.75	\$1015	\$1233	N/A	\$731
Z3666PL	42 x 66 x 29.5-30	65	167	7.25	\$926	\$1095	N/A	\$731
Z3660PL	42 x 60 x 29.5-30	65	155	6.50	\$852	\$1022	N/A	\$623

Connects to the left side of a worksurface. Attaching hardware included. Accommodates all 19" pedestals (freestanding, mobile and hanging pedestals). Includes grommet as shown. Shipped RTA (ready to assemble).

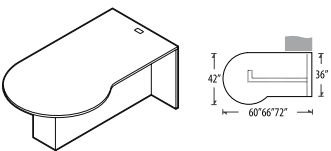

"P" Island RIGHT - Full Modesty Panel (H-Base)

Z3672PR	42 x 72 x 29.5-30	65	178	7.75	\$1015	\$1233	N/A	\$731
Z3666PR	42 x 66 x 29.5-30	65	167	7.25	\$926	\$1095	N/A	\$731
Z3660PR	42 x 60 x 29.5-30	65	155	6.50	\$852	\$1022	N/A	\$623

Connects to the left side of a worksurface. Attaching hardware included. Accommodates all 19" pedestals (freestanding, mobile and hanging pedestals). Includes grommet as shown. Shipped RTA (ready to assemble).

Required Specifications

- Top finish
- Top/edge detail
- Base finish
- Monopost finish

Optional Specifications

- HP laminate
- Remove standard grommet (RSG)

Accessories

- Power block
- Keyboard
- Pencil drawer

RECTANGULAR ISLANDS

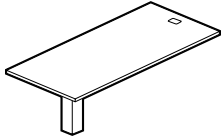

Rectangular Island w/Monopost

MODEL#	DIMENSIONS D x W x H	FREIGHT CLASS	WT/LBS.	CUBIC FT.	1" TOP	1.5" TOP	GLAZE ADD	HP ADD
Z3672RI	36 x 72 x 29.5-30	125	90	14.50	\$780	\$993	N/A	\$624
Z3066RI	30 x 66 x 29.5-30	150	72	12.50	\$728	\$895	N/A	\$513
Z3060RI	30 x 60 x 29.5-30	125	66	10.50	\$728	\$888	N/A	\$480
Z2466RI	24 x 66 x 29.5-30	150	63	15	\$664	\$820	N/A	\$384
Z2460RI	24 x 60 x 29.5-30	150	57	13	\$630	\$763	N/A	\$356
Z2448RI	24 x 48 x 29.5-30	150	47	11.50	\$586	\$706	N/A	\$285

Attaches to edge of worksurfaces. Attaching hardware included. Includes grommet as shown. Shipped RTA (ready to assemble). **Not freestanding.**

- Post is shipped in separate carton.

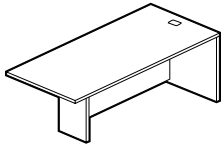

Rectangular Island LEFT - Full Modesty Panel (H-Base)

Z3672RFIL	36 x 72 x 29.5-30	70	145	7.25	\$904	\$1117	N/A	\$624
Z3084RFIL	29.69 x 84 x 29.5-30	70	146	7.25	\$900	\$1112	N/A	\$618
Z3066RFIL	29.69 x 66 x 29.5-30	70	121	6.25	\$807	\$1040	N/A	\$513
Z3060RFIL	29.69 x 60 x 29.5-30	70	110	5.25	\$736	\$896	N/A	\$480
Z2472RFIL	24 x 72 x 29.5-30	70	116	6.25	\$691	\$856	N/A	\$390
Z2466RFIL	24 x 66 x 29.5-30	70	109	5.75	\$656	\$823	N/A	\$384
Z2460RFIL	24 x 60 x 29.5-30	70	99	5.25	\$624	\$757	N/A	\$356
Z2448RFIL	24 x 48 x 29.5-30	70	85	4.20	\$590	\$694	N/A	\$285

Connects to the **left** side of a worksurface. Attaching hardware included. 36" and 30"D accommodates all 19" pedestals (freestanding, mobile and hanging pedestals). Includes grommet as shown. Shipped RTA (ready to assemble). **Not freestanding.**

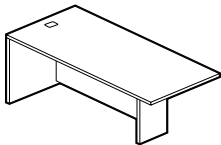

Rectangular Island RIGHT - Full Modesty Panel (H-Base)

Z3672RFIR	36 x 72 x 29.5-30	70	145	7.25	\$904	\$1117	N/A	\$624
Z3084RFIR	29.69 x 84 x 29.5-30	70	146	7.25	\$900	\$1112	N/A	\$618
Z3066RFIR	29.69 x 66 x 29.5-30	70	121	6.25	\$807	\$1040	N/A	\$513
Z3060RFIR	29.69 x 60 x 29.5-30	70	110	5.25	\$736	\$896	N/A	\$480
Z2472RFIR	24 x 72 x 29.5-30	70	116	6.25	\$691	\$856	N/A	\$390
Z2466RFIR	24 x 66 x 29.5-30	70	109	5.75	\$656	\$823	N/A	\$384
Z2460RFIR	24 x 60 x 29.5-30	70	99	5.25	\$624	\$757	N/A	\$356
Z2448RFIR	24 x 48 x 29.5-30	70	85	4.20	\$590	\$694	N/A	\$285

Connects to the **right** side of a worksurface. Attaching hardware included. 36" and 30"D accommodates all 19" pedestals (freestanding, mobile and hanging pedestals). Includes grommet as shown. Shipped RTA (ready to assemble). **Not freestanding.**

Required Specifications

Top finish
Top/edge detail
Base finish
Monopost finish

Optional Specifications

HP laminate
Remove standard grommet (RSG)

Accessories

Power block
Keyboard
Pencil drawer

UNIVERSAL TOPS

MODEL#	DIMENSIONS	FREIGHT CLASS	WT/LBS.	CUBIC FT.	1" TOP	1.5" TOP	GLAZE ADD	HP ADD
D x W x H								
ZUT1696	16 x 96 x 1	100	42	5	\$556	\$742	N/A	\$334
ZUT1690	16 x 90 x 1	100	39	4.75	\$525	\$700	N/A	\$310
ZUT1684	16 x 84 x 1	100	37	4.50	\$476	\$637	N/A	\$291
ZUT1678	16 x 78 x 1	100	34	4.25	\$457	\$607	N/A	\$274
ZUT1672	16 x 72 x 1	85	31	2.25	\$427	\$565	N/A	\$250
ZUT1666	16 x 66 x 1	85	29	2	\$397	\$522	N/A	\$232
ZUT1660	16 x 60 x 1	85	26	1.75	\$367	\$479	N/A	\$212
ZUT1654	16 x 54 x 1	85	24	1.75	\$329	\$436	N/A	\$186
ZUT1648	16 x 48 x 1	85	21	1.50	\$299	\$392	N/A	\$168
ZUT1642	16 x 42 x 1	85	18	1.25	\$267	\$350	N/A	\$151
ZUT1636	16 x 36 x 1	85	16	1.25	\$232	\$302	N/A	\$126
ZUT1630	16 x 30 x 1	85	13	1	\$200	\$257	N/A	\$107
ZUT1896	18 x 96 x 1	100	47	5.50	\$567	\$749	N/A	\$372
ZUT1890	18 x 90 x 1	100	44	5.25	\$538	\$706	N/A	\$353
ZUT1884	18 x 84 x 1	100	41	4.75	\$501	\$663	N/A	\$329
ZUT1878	18 x 78 x 1	100	38	4.50	\$470	\$614	N/A	\$303
ZUT1872	18 x 72 x 1	70	35	2.25	\$439	\$577	N/A	\$280
ZUT1866	18 x 66 x 1	85	32	2.25	\$401	\$527	N/A	\$261
ZUT1860	18 x 60 x 1	85	29	2	\$372	\$485	N/A	\$236
ZUT1854	18 x 54 x 1	85	26	1.75	\$334	\$441	N/A	\$212
ZUT1848	18 x 48 x 1	85	23	1.75	\$310	\$403	N/A	\$186
ZUT1842	18 x 42 x 1	85	20	1.50	\$280	\$363	N/A	\$168
ZUT1836	18 x 36 x 1	85	18	1.25	\$236	\$306	N/A	\$144
ZUT1830	18 x 30 x 1	85	15	1.25	\$206	\$264	N/A	\$119
ZUT2096	20 x 96 x 1	100	52	6	\$575	\$761	N/A	\$415
ZUT2090	20 x 90 x 1	100	49	5.50	\$545	\$720	N/A	\$390
ZUT2084	20 x 84 x 1	100	45	5.25	\$507	\$668	N/A	\$367
ZUT2078	20 x 78 x 1	100	42	4.75	\$447	\$597	N/A	\$341
ZUT2072	20 x 72 x 1	70	39	2.50	\$447	\$585	N/A	\$310
ZUT2066	20 x 66 x 1	70	36	2.25	\$409	\$540	N/A	\$285
ZUT2060	20 x 60 x 1	85	32	2.25	\$377	\$489	N/A	\$261
ZUT2054	20 x 54 x 1	85	29	2	\$348	\$449	N/A	\$236
ZUT2048	20 x 48 x 1	85	26	1.75	\$318	\$405	N/A	\$212
ZUT2042	20 x 42 x 1	70	23	1.50	\$285	\$361	N/A	\$186
ZUT2036	20 x 36 x 1	85	20	1.50	\$242	\$312	N/A	\$157
ZUT2030	20 x 30 x 1	85	16	1.25	\$212	\$270	N/A	\$132
ZUT2496	24 x 96 x 1	100	62	6.75	\$661	\$879	N/A	\$495
ZUT2490	24 x 90 x 1	100	58	6.25	\$624	\$830	N/A	\$465
ZUT2484	24 x 84 x 1	100	55	6	\$580	\$773	N/A	\$434
ZUT2478	24 x 78 x 1	100	51	5.50	\$545	\$726	N/A	\$401
ZUT2472	24 x 72 x 1	100	47	5.25	\$507	\$664	N/A	\$372
ZUT2466	24 x 66 x 1	100	43	4.75	\$470	\$627	N/A	\$341
ZUT2460	24 x 60 x 1	100	39	4.50	\$434	\$571	N/A	\$310
ZUT2454	24 x 54 x 1	100	35	4	\$397	\$522	N/A	\$280
ZUT2448	24 x 48 x 1	70	31	2	\$359	\$471	N/A	\$250
ZUT2442	24 x 42 x 1	70	27	1.75	\$318	\$419	N/A	\$219
ZUT2436	24 x 36 x 1	70	23	1.50	\$280	\$368	N/A	\$186
ZUT2430	24 x 30 x 1	85	20	1.50	\$242	\$312	N/A	\$157

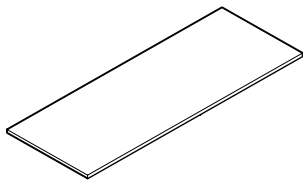

Laminate Tops

Laminate tops for placement over Zira storage.

- Contact Global for pricing on special size tops.
- No drilling or hardware included.

Required Specifications

- Top finish
- Top/edge detail
- Leg finish

UNIVERSAL TOPS	MODEL#	DIMENSIONS	FREIGHT CLASS	WT/LBS.	CUBIC FT.	1" TOP	1.5" TOP	GLAZE ADD	HP ADD
		D x W x H							
ZUT3096		29.7 x 96 x 1	100	77	8	\$778	\$1056	N/A	\$617
ZUT3090		29.7 x 90 x 1	100	72	7.50	\$735	\$996	N/A	\$580
ZUT3084		29.7 x 84 x 1	100	67	7.25	\$692	\$934	N/A	\$545
ZUT3078		29.7 x 78 x 1	100	62	6.75	\$642	\$866	N/A	\$507
ZUT3072		29.7 x 72 x 1	100	58	6.25	\$624	\$834	N/A	\$465
ZUT3066		29.7 x 66 x 1	100	53	5.75	\$556	\$742	N/A	\$427
ZUT3060		29.7 x 60 x 1	100	48	5.25	\$513	\$681	N/A	\$390
ZUT3054		29.7 x 54 x 1	100	43	4.75	\$470	\$620	N/A	\$353
ZUT3048		29.7 x 48 x 1	70	38	2.50	\$422	\$566	N/A	\$310
ZUT3042		29.7 x 42 x 1	70	34	2.25	\$377	\$496	N/A	\$274
ZUT3036		29.7 x 36 x 1	85	29	2	\$329	\$436	N/A	\$236
ZUT3030		29.7 x 30 x 1	85	24	1.75	\$285	\$373	N/A	\$200
ZUT3696		36 x 96 x 1	92.5	93	9.25	\$907	\$1235	N/A	\$740
ZUT3690		36 x 90 x 1	100	87	8.75	\$852	\$1162	N/A	\$698
ZUT3684		36 x 84 x 1	100	81	8.25	\$785	\$1076	N/A	\$648
ZUT3678		36 x 78 x 1	100	76	7.75	\$748	\$1013	N/A	\$604
ZUT3672		36 x 72 x 1	100	70	7.25	\$698	\$946	N/A	\$556
ZUT3666		36 x 66 x 1	100	64	6.75	\$630	\$853	N/A	\$513
ZUT3660		36 x 60 x 1	100	58	6.25	\$587	\$793	N/A	\$465
ZUT3654		36 x 54 x 1	100	52	5.50	\$545	\$726	N/A	\$422
ZUT3648		36 x 48 x 1	100	47	5	\$489	\$657	N/A	\$372
ZUT3642		36 x 42 x 1	100	41	4.50	\$439	\$583	N/A	\$329
ZUT3636		36 x 36 x 1	100	35	4	\$385	\$510	N/A	\$280
ZUT3630		36 x 30 x 1	100	29	3.50	\$329	\$436	N/A	\$236
ZUT4296		42 x 96 x 1	92.5	108	10	\$1024	\$1408	N/A	\$864
ZUT4290		42 x 90 x 1	92.5	102	10	\$967	\$1326	N/A	\$815
ZUT4284		42 x 84 x 1	92.5	95	9.50	\$888	\$1222	N/A	\$760
ZUT4278		42 x 78 x 1	92.5	88	8.75	\$852	\$1162	N/A	\$704
ZUT4272		42 x 72 x 1	100	81	8.25	\$790	\$1081	N/A	\$648
ZUT4266		42 x 66 x 1	92.5	75	7.50	\$735	\$996	N/A	\$600
ZUT4260		42 x 60 x 1	100	68	7	\$673	\$915	N/A	\$545
ZUT4254		42 x 54 x 1	100	61	6.25	\$613	\$831	N/A	\$489
ZUT4248		42 x 48 x 1	100	54	5.75	\$556	\$750	N/A	\$434
ZUT4242		42 x 42 x 1	100	48	5.25	\$495	\$663	N/A	\$385
ZUT4236		42 x 36 x 1	100	41	4.50	\$422	\$608	N/A	\$329
ZUT4230		42 x 30 x 1	100	34	4	\$341	\$467	N/A	\$274
ZUT4896		48 x 96 x 1	92.5	124	11.25	\$1153	\$1592	N/A	\$987
ZUT4890		48 x 90 x 1	92.5	116	10.50	\$1092	\$1500	N/A	\$926
ZUT4884		48 x 84 x 1	92.5	108	10.50	\$1018	\$1402	N/A	\$864
ZUT4878		48 x 78 x 1	92.5	101	10	\$950	\$1303	N/A	\$802
ZUT4872		48 x 72 x 1	92.5	93	9.25	\$888	\$1217	N/A	\$740
ZUT4866		48 x 66 x 1	92.5	85	8.50	\$819	\$1122	N/A	\$680
ZUT4860		48 x 60 x 1	92.5	77	7.25	\$760	\$1034	N/A	\$617
ZUT4854		48 x 54 x 1	100	70	7.25	\$692	\$940	N/A	\$556
ZUT4848		48 x 48 x 1	100	62	6.50	\$617	\$841	N/A	\$495
ZUT4842		48 x 42 x 1	100	54	5.75	\$556	\$750	N/A	\$434
ZUT4836		48 x 36 x 1	100	47	5	\$489	\$651	N/A	\$372
ZUT4830		48 x 30 x 1	100	36	4.25	\$415	\$553	N/A	\$310

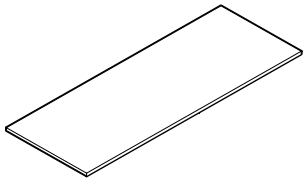

Laminate Tops

Laminate tops for placement over Zira storage.

- Contact Global for pricing on special size tops.
- **No drilling or hardware included.**

Required Specifications

Top finish
Top/edge detail

Optional Specifications

HP laminate
Grommet position or power block cut-out

Accessories

Power block

UNIVERSAL TOPS

MODEL#	DIMENSIONS D x W x H	FREIGHT CLASS	WT/LBS.	CUBIC FT.	1" TOP	1.5" TOP	GLAZE ADD	HP ADD
ZUT5496	54 x 96 x 1	92.5	139	12.50	\$1281	\$1770	N/A	\$1110
ZUT5490	54 x 90 x 1	92.5	131	11.75	\$1208	\$1672	N/A	\$1043
ZUT5484	54 x 84 x 1	92.5	122	11	\$1141	\$1573	N/A	\$976
ZUT5478	54 x 78 x 1	92.5	113	10.25	\$1074	\$1470	N/A	\$907
ZUT5472	54 x 72 x 1	92.5	105	9.50	\$999	\$1371	N/A	\$832
ZUT5466	54 x 66 x 1	92.5	96	9.50	\$931	\$1265	N/A	\$766
ZUT5460	54 x 60 x 1	100	87	8.75	\$857	\$1166	N/A	\$698
ZUT5454	54 x 54 x 1	100	78	8	\$766	\$1044	N/A	\$630
ZUT5448	54 x 48 x 1	100	70	7.25	\$692	\$940	N/A	\$556
ZUT5442	54 x 42 x 1	100	61	6.25	\$613	\$831	N/A	\$489
ZUT5436	54 x 36 x 1	100	52	5.50	\$470	\$651	N/A	\$422
ZUT5430	54 x 30 x 1	100	44	4.75	\$470	\$627	N/A	\$353
ZUT6096	60 x 96 x 1	92.5	155	14	\$1411	\$1954	N/A	\$1232
ZUT6090	60 x 90 x 1	92.5	145	13	\$1330	\$1843	N/A	\$1158
ZUT6084	60 x 84 x 1	92.5	135	12.25	\$1251	\$1733	N/A	\$1079
ZUT6078	60 x 78 x 1	92.5	126	11.50	\$1178	\$1623	N/A	\$1005
ZUT6072	60 x 72 x 1	92.5	116	10.50	\$1079	\$1487	N/A	\$926
ZUT6066	60 x 66 x 1	92.5	106	9.75	\$999	\$1376	N/A	\$852
ZUT6060	60 x 60 x 1	92.5	97	8.75	\$926	\$1267	N/A	\$772
ZUT6054	60 x 54 x 1	100	87	8.75	\$857	\$1166	N/A	\$698
ZUT6048	60 x 48 x 1	100	77	7.75	\$760	\$1034	N/A	\$617
ZUT6042	60 x 42 x 1	100	68	7	\$673	\$915	N/A	\$545
ZUT6036	60 x 36 x 1	100	58	6.25	\$617	\$823	N/A	\$465
ZUT6030	60 x 30 x 1	100	49	5.25	\$513	\$681	N/A	\$390

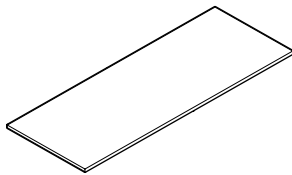

Laminate Tops

Laminate tops for placement over Zira storage.

- Contact Global for pricing on special size tops.
- No drilling or hardware included.

ZPHAT2370	23 x 70 x 1	100	39	4.5	\$501	\$663	N/A	\$348
ZPHAT2364	23 x 64 x 1	100	39	4.5	\$457	\$614	N/A	\$322
ZPHAT2358	23 x 58 x 1	70	35	2.25	\$422	\$560	N/A	\$291
ZPHAT2352	23 x 52 x 1	70	32	2	\$385	\$510	N/A	\$261
ZPHAT2346	23 x 46 x 1	85	29	2	\$348	\$460	N/A	\$232
ZPHAT2340	23 x 40 x 1	85	25	1.75	\$310	\$403	N/A	\$200
ZPHAT2334	23 x 34 x 1	85	21	1.5	\$274	\$357	N/A	\$175
ZPHAT2970	29 x 70 x 1	100	43	5	\$593	\$799	N/A	\$439
ZPHAT2964	29 x 64 x 1	100	49	5.5	\$550	\$735	N/A	\$801
ZPHAT2958	29 x 58 x 1	100	45	5	\$501	\$676	N/A	\$367
ZPHAT2952	29 x 52 x 1	70	40	2.5	\$457	\$614	N/A	\$329
ZPHAT2946	29 x 46 x 1	70	35	2.25	\$415	\$553	N/A	\$291
ZPHAT2940	29 x 40 x 1	70	31	2	\$367	\$492	N/A	\$255
ZPHAT2934	29 x 34 x 1	85	26	1.75	\$322	\$429	N/A	\$219

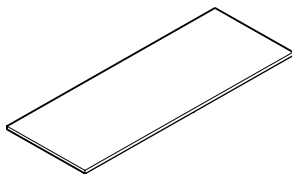

Laminate Tops

Laminate tops for placement over height adjustable tables.

- Contact Global for pricing on special size tops.
- No drilling or hardware included.

Required Specifications

Top finish
Top/edge detail

Optional Specifications

HP laminate
Grommet position or power block cut-out

Accessories

Power block

UNIVERSAL TOPS	MODEL#	DIMENSIONS	FREIGHT CLASS	WT/LBS.	CUBIC FT.	1" TOP	1.5" TOP	GLAZE ADD	HP ADD
		D x W x H							
ZUFT1896		18.11 x 96.10 x 1	100	47	5.50	\$567	\$749	N/A	\$377
ZUFT1890		18.11 x 90.12 x 1	100	44	5.25	\$538	\$706	N/A	\$353
ZUFT1884		18.11 x 84.09 x 1	100	41	4.75	\$501	\$663	N/A	\$329
ZUFT1878		18.11 x 78.11 x 1	100	38	4.50	\$470	\$614	N/A	\$310
ZUFT1872		18.11 x 72.13 x 1	70	35	2.25	\$439	\$577	N/A	\$285
ZUFT1866		18.11 x 66.10 x 1	85	32	2.25	\$401	\$527	N/A	\$261
ZUFT1860		18.11 x 60.12 x 1	85	29	2	\$372	\$485	N/A	\$236
ZUFT1854		18.11 x 54.09 x 1	70	27	1.75	\$334	\$441	N/A	\$219
ZUFT1848		18.11 x 48.11 x 1	85	24	1.75	\$299	\$400	N/A	\$194
ZUFT1842		18.11 x 42.13 x 1	85	21	1.50	\$267	\$354	N/A	\$168
ZUFT1836		18.11 x 36.10 x 1	85	18	1.25	\$236	\$294	N/A	\$144
ZUFT1830		18.11 x 30.12 x 1	85	15	1.25	\$206	\$264	N/A	\$119
ZUFT1996		19.25 x 96.10 x 1	100	50	5.75	\$575	\$761	N/A	\$401
ZUFT1990		19.25 x 90.12 x 1	100	47	5.50	\$545	\$720	N/A	\$377
ZUFT1984		19.25 x 84.09 x 1	100	44	5	\$507	\$668	N/A	\$353
ZUFT1978		19.25 x 78.11 x 1	100	41	4.75	\$476	\$626	N/A	\$329
ZUFT1972		19.25 x 72.13 x 1	70	38	2.50	\$447	\$585	N/A	\$303
ZUFT1966		19.25 x 66.10 x 1	70	34	2.25	\$409	\$535	N/A	\$280
ZUFT1960		19.25 x 60.12 x 1	70	31	2	\$377	\$489	N/A	\$255
ZUFT1954		19.25 x 54.09 x 1	85	27	2	\$348	\$449	N/A	\$232
ZUFT1948		19.25 x 48.11 x 1	85	25	1.75	\$310	\$403	N/A	\$206
ZUFT1942		19.25 x 42.13 x 1	85	22	1.50	\$280	\$363	N/A	\$182
ZUFT1936		19.25 x 36.10 x 1	70	19	1.25	\$242	\$312	N/A	\$157
ZUFT1930		19.25 x 30.12 x 1	85	16	1.25	\$212	\$270	N/A	\$132

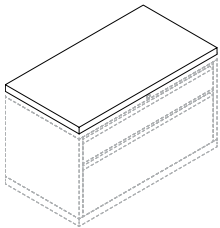

Lateral File Tops

Laminate tops for placement over 1900 Series Lateral Files + Storage. **No drilling or hardware included.**

- Contact Global for pricing on special size tops.

ZUFT3696		36.14 x 96.10 x 1	100	93	9.50	\$907	\$1235	N/A	\$748
ZUFT3690		36.14 x 90.12 x 1	92.5	88	8.75	\$852	\$1162	N/A	\$704
ZUFT3684		36.14 x 84.09 x 1	92.5	82	7.75	\$785	\$1076	N/A	\$654
ZUFT3678		36.14 x 78.11 x 1	100	76	7.75	\$748	\$1013	N/A	\$613
ZUFT3672		36.14 x 72.13 x 1	100	70	7.25	\$698	\$920	N/A	\$563
ZUFT3666		36.14 x 66.10 x 1	100	64	6.75	\$630	\$853	N/A	\$513
ZUFT3660		36.14 x 60.12 x 1	100	59	6.25	\$587	\$793	N/A	\$470
ZUFT3654		36.14 x 54.09 x 1	100	53	5.50	\$545	\$726	N/A	\$422
ZUFT3648		36.14 x 48.11 x 1	100	47	5	\$489	\$657	N/A	\$377
ZUFT3642		36.14 x 42.13 x 1	100	41	4.50	\$439	\$583	N/A	\$329
ZUFT3636		36.14 x 36.10 x 1	70	35	2.25	\$385	\$510	N/A	\$285
ZUFT3630		36.14 x 30.12 x 1	85	29	2	\$334	\$436	N/A	\$236
ZUFT3896		38.62 x 96.10 x 1	92.5	100	10	\$1011	\$1395	N/A	\$796
ZUFT3890		38.62 x 90.12 x 1	100	94	9.50	\$950	\$1309	N/A	\$748
ZUFT3884		38.62 x 84.09 x 1	100	87	8.75	\$894	\$1228	N/A	\$698
ZUFT3878		38.62 x 78.11 x 1	100	81	8.25	\$832	\$1150	N/A	\$648
ZUFT3872		38.62 x 72.13 x 1	100	75	7.75	\$778	\$1063	N/A	\$600
ZUFT3866		38.62 x 66.10 x 1	100	69	7	\$717	\$982	N/A	\$550
ZUFT3860		38.62 x 60.12 x 1	100	62	6.50	\$661	\$901	N/A	\$501
ZUFT3854		38.62 x 54.09 x 1	100	56	6	\$604	\$816	N/A	\$451
ZUFT3848		38.62 x 48.11 x 1	100	50	5.25	\$545	\$738	N/A	\$401
ZUFT3842		38.62 x 42.13 x 1	100	44	4.75	\$483	\$657	N/A	\$353
ZUFT3836		38.62 x 36.10 x 1	100	38	4.25	\$427	\$569	N/A	\$303
ZUFT3830		38.62 x 30.12 x 1	100	31	3.75	\$367	\$492	N/A	\$255

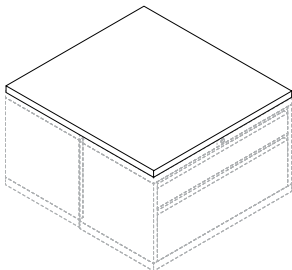

Lateral File Tops - Back to Back

Laminate tops for placement over back-to-back metal filing + storage. **No drilling or hardware included.**

- Use ZUFT36xx models for 18" D laterals back-to-back
- Use ZUFT38xx models for 19.25" D laterals back-to-back
- Contact Global for pricing on special size tops.

Required Specifications

Top finish
Top/edge detail

Optional Specifications

HP laminate
Grommet position or power block cut-out

Accessories

Power block

FILE TOPS



Mobile Pedestal with Overhang*

MODEL#	DIMENSIONS D x W x H	FREIGHT CLASS	WT/LBS.	CUBIC FT.	1" TOP	1.5" TOP	GLAZE ADD	HP ADD
ZMPFF28	29 x 16 x 28	92.5	106	10.25	\$1286	N/A	N/A	\$223
ZMPFF22	23 x 16 x 28	92.5	95	8.25	\$1221	N/A	N/A	\$223

File/File drawers on fully progressive ball bearing slides, accommodate letter and legal size hanging files. Pedestal top features 1" overhang with built-in grip for ease of mobility. Includes counterweight to prevent tipping. Drawers are locking. Only front casters are locking.



Mobile Pedestal*

ZMPFF19	19 x 16 x 28	85	97	7.25	\$1155	N/A	N/A	\$223
---------	--------------	----	----	------	--------	-----	-----	-------

File/File drawers on fully progressive ball bearing slides, accommodate letter and legal size hanging files. Drawers are locking. Only front casters are locking.



Mobile Pedestal with Overhang*

ZMPBBF28	29 x 16 x 28	92.5	105	10.25	\$1179	N/A	N/A	\$223
ZMPBBF22	23 x 16 x 28	92.5	92	8.25	\$1134	N/A	N/A	\$221

Box/Box/File drawers on fully progressive ball bearing slides, accommodate letter and legal size hanging files. Pedestal top features 1" overhang with built-in grip for ease of mobility. Includes counterweight to prevent tipping. File drawer and lower box drawer are locking. Only front casters are locking.



Mobile Pedestal*

ZMPBBF19	19 x 16 x 28	85	96	7.25	\$1076	N/A	N/A	\$223
----------	--------------	----	----	------	--------	-----	-----	-------

Box/Box/File drawers on fully progressive ball bearing slides, accommodate letter and legal size hanging files. File drawer and lower box drawer are locking. Only front casters are locking.

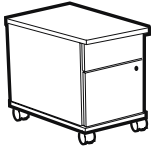

Mobile Pedestal with Overhang*

ZMPBF28	29 x 16 x 22	92.5	83	8.25	\$1036	N/A	N/A	\$223
ZMPBF22	23 x 16 x 22	92.5	73	6.75	\$1010	N/A	N/A	\$223

Box/File drawers on fully progressive ball bearing slides, accommodate letter and legal size hanging files. Pedestal top features 1" overhang with built-in grip for ease of mobility. Includes counterweight to prevent tipping. Drawers are locking. Only front casters are locking.

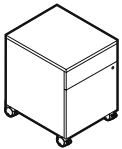

Mobile Pedestal*

ZMPBF19	19 x 16 x 22	85	77	6.25	\$949	N/A	N/A	\$223
---------	--------------	----	----	------	-------	-----	-----	-------

Box/File drawers on fully progressive ball bearing slides, accommodate letter and legal size hanging files. Drawers are locking. Only front casters are locking.

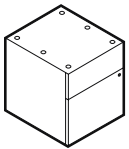

Hanging Pedestal

ZHPBF18	19 x 16 x 18	92.5	48	4.50	\$706	N/A	N/A	N/A
---------	--------------	------	----	------	-------	-----	-----	-----

Box/File drawers on fully progressive ball bearing slides, accommodate letter and legal size hanging files. Drawers are locking.

Required Specifications

Top finish
Top/edge detail

Optional Specifications

HP laminate
Grommet position or power block cut-out

Accessories

Power block

PEDESTALS	MODEL#	DIMENSIONS	FREIGHT CLASS	WT/LBS.	CUBIC FT.	1" TOP	1.5" TOP	GLAZE ADD	HP ADD
-----------	--------	------------	---------------	---------	-----------	--------	----------	-----------	--------

D x W x H

Required Specifications

Top finish
 Base finish
 Lock finish

Optional Specifications

HP laminate*
 Handles

STORAGE SHELLS - 16.87" HIGH

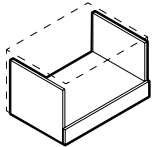

Open Storage Shell

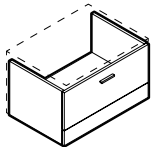

Lateral File Shell

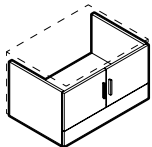

Glazed door option

Closed Storage Shell**

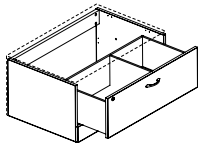

Split Drawer Storage Shell* - LEFT

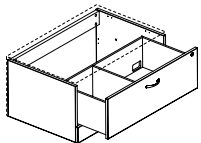

Split Drawer Storage Shell* - RIGHT

MODEL#	DIMENSIONS D x W x H	FREIGHT CLASS	WT./LBS.	CUBIC FT.	1" TOP	1.5" TOP	GLAZE ADD	HP ADD
Z36L21SNS	24 x 36 x 16.87	150	62	11.25	\$639	N/A	N/A	N/A
Z30L21SNS	24 x 30 x 16.87	150	55	9.50	\$573	N/A	N/A	N/A
Z36M21SNS	20 x 36 x 16.87	150	56	9.50	\$589	N/A	N/A	N/A
Z30M21SNS	20 x 30 x 16.87	125	49	8	\$526	N/A	N/A	N/A

For use under Zxxxx1TB 17.37" H top and back kit. **No top or back.**

Z36L21ES	24 x 36 x 16.87	125	82	11.25	\$935	N/A	N/A	N/A
Z30L21ES	24 x 30 x 16.87	100	77	9.50	\$816	N/A	N/A	N/A
Z36M21ES	20 x 36 x 16.87	100	78	9.50	\$901	N/A	N/A	N/A
Z30M21ES	20 x 30 x 16.87	100	73	8	\$780	N/A	N/A	N/A

For use under Zxxxx1TB 17.37" H top and back kit. **No top or back.** For filing capabilities, see page 121.

- Lateral file drawer construction is for accommodating hanging files NOT for stacking materials on the drawer bottom.

Z36L21SHS	24 x 36 x 16.87	125	71	11.25	\$850	N/A	\$407	N/A
Z30L21SHS	24 x 30 x 16.87	125	62	9.50	\$767	N/A	\$362	N/A
Z36M21SHS	20 x 36 x 16.87	125	65	9.50	\$801	N/A	\$407	N/A
Z30M21SHS	20 x 30 x 16.87	125	57	8	\$722	N/A	\$361	N/A

For use under Zxxxx1TB 17.37" H top and back kit. **No top or back.** Laminate doors are standard. Standard with lock.

Z36L21XSL	24 x 36 x 16.87	125	81	11.25	\$866	N/A	N/A	N/A
Z30L21XSL	24 x 30 x 16.87	125	72	9.50	\$790	N/A	N/A	N/A
Z36M21XSL	20 x 36 x 16.87	100	78	9.50	\$831	N/A	N/A	N/A
Z30M21XSL	20 x 30 x 16.87	100	69	8	\$756	N/A	N/A	N/A

For use under Zxxxx1TB 17.37" H top and back kit. **No top or back.** Pull out drawer includes filing space on **left** and storage on **right**. Front-to-back letter capability.

- Lateral file drawer construction is for accommodating hanging files NOT for stacking materials on the drawer bottom.

Z36L21XSR	24 x 36 x 16.87	125	81	11.25	\$866	N/A	N/A	N/A
Z30L21XSR	24 x 30 x 16.87	125	72	9.50	\$790	N/A	N/A	N/A
Z36M21XSR	20 x 36 x 16.87	100	78	9.50	\$831	N/A	N/A	N/A
Z30M21XSR	20 x 30 x 16.87	100	69	8	\$756	N/A	N/A	N/A

For use under Zxxxx1TB 17.37" H top and back kit. **No top or back.** Pull out drawer includes filing space on **right** and storage on **left**. Front-to-back letter capability.

- Lateral file drawer construction is for accommodating hanging files NOT for stacking materials on the drawer bottom.

Required Specifications

Base finish
Handles*

Optional Specifications

Key #*
Glazed doors**

TOP AND BACK KITS FOR 16.87" H SHELLS

MODEL#	DIMENSIONS D x W x H	FREIGHT CLASS	WT/LBS.	CUBIC FT.	1" TOP	1.5" TOP	GLAZE ADD	HP ADD
Z24961TB	24 x 96 x 17.37-17.87	70	104	6.75	\$802	\$979	N/A	\$520
Z24901TB	24 x 90 x 17.37-17.87	70	97	6.25	\$762	\$927	N/A	\$488
Z24841TB	24 x 84 x 17.37-17.87	70	91	6	\$717	\$873	N/A	\$454
Z24781TB	24 x 78 x 17.37-17.87	70	86	5.50	\$672	\$814	N/A	\$423
Z24721TB	24 x 72 x 17.37-17.87	85	78	5.25	\$624	\$757	N/A	\$390
Z24661TB	24 x 66 x 17.37-17.87	70	72	4.75	\$577	\$700	N/A	\$358
Z24601TB	24 x 60 x 17.37-17.87	85	66	4.50	\$529	\$640	N/A	\$327
Z24541TB	24 x 54 x 17.37-17.87	85	59	4	\$479	\$580	N/A	\$294
Z24481TB	24 x 48 x 17.37-17.87	85	55	3.75	\$441	\$530	N/A	\$261
Z24421TB	24 x 42 x 17.37-17.87	85	47	3.25	\$390	\$470	N/A	\$229
Z24361TB	24 x 36 x 17.37-17.87	85	40	3	\$337	\$406	N/A	\$197
Z24301TB	24 x 30 x 17.37-17.87	85	34	2.50	\$291	\$348	N/A	\$164
Z20961TB	20 x 96 x 17.37-17.87	70	93	6	\$739	\$885	N/A	\$434
Z20901TB	20 x 90 x 17.37-17.87	70	86	5.50	\$693	\$831	N/A	\$407
Z20841TB	20 x 84 x 17.37-17.87	70	76	4.75	\$652	\$782	N/A	\$378
Z20781TB	20 x 78 x 17.37-17.87	70	80	5.25	\$616	\$736	N/A	\$353
Z20721TB	20 x 72 x 17.37-17.87	70	69	4.50	\$570	\$681	N/A	\$327
Z20661TB	20 x 66 x 17.37-17.87	70	64	4.25	\$526	\$628	N/A	\$299
Z20601TB	20 x 60 x 17.37-17.87	70	58	3.75	\$484	\$577	N/A	\$273
Z20541TB	20 x 54 x 17.37-17.87	70	53	3.50	\$442	\$527	N/A	\$246
Z20481TB	20 x 48 x 17.37-17.87	70	50	3.25	\$407	\$482	N/A	\$219
Z20421TB	20 x 42 x 17.37-17.87	70	42	2.75	\$358	\$424	N/A	\$189
Z20361TB	20 x 36 x 17.37-17.87	85	35	2.50	\$309	\$366	N/A	\$164
Z20301TB	20 x 30 x 17.37-17.87	85	28	2.25	\$265	\$312	N/A	\$138

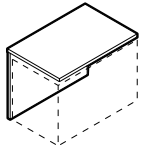

Credenza Top and Back Kit

For use with 16.87" high storage shells. Shipped RTA (ready to assemble).

- Does not include hardware to attach to storage shells.

Required Specifications

Top finish
Top/edge detail
Base finish

Optional Specifications

HP laminate

STORAGE SHELLS - 22.75" HIGH

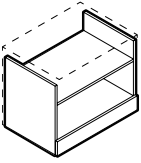

1.5H Open Storage Shell

MODEL#	DIMENSIONS D x W x H	FREIGHT CLASS	WT./LBS.	CUBIC FT.	1" TOP	1.5" TOP	GLAZE ADD	HP ADD
Z36L2HSHNS	24 x 36 x 22.75	150	83	14.50	\$791	N/A	N/A	N/A
Z30L2HSHNS	24 x 30 x 22.75	125	75	12.25	\$715	N/A	N/A	N/A
Z24L2HSHNS	24 x 24 x 22.75	125	66	10	\$636	N/A	N/A	N/A
Z36M2HSHNS	20 x 36 x 22.75	150	73	12.25	\$722	N/A	N/A	N/A
Z30M2HSHNS	20 x 30 x 22.75	125	64	10.50	\$645	N/A	N/A	N/A
Z24M2HSHNS	20 x 24 x 22.75	125	55	8.50	\$576	N/A	N/A	N/A

For use under ZxxxxHTB 23.25"H top and back kit. **No top or back.**

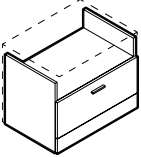

1.5H Open/Lateral File Shell*

Z36L2HFS	24 x 36 x 22.75	125	102	14.50	\$1087	N/A	N/A	N/A
Z30L2HFS	24 x 30 x 22.75	125	97	12.25	\$957	N/A	N/A	N/A
Z36M2HFS	20 x 36 x 22.75	125	95	12.25	\$1034	N/A	N/A	N/A
Z30M2HFS	20 x 30 x 22.75	100	88	10.50	\$900	N/A	N/A	N/A

For use under ZxxxxHTB 23.25"H top and back kit. **No top or back.** Open shelf and lateral file storage. For filing capabilities, see page 121.

- Lateral file drawer construction is for accommodating hanging files NOT for stacking materials on the drawer bottom

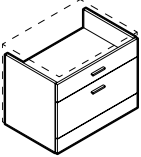

1.5H Box/Lateral File Shell*

Z36L2HES	24 x 36 x 22.75	125	103	14.50	\$1143	N/A	N/A	N/A
Z30L2HES	24 x 30 x 22.75	100	99	12.25	\$1015	N/A	N/A	N/A
Z36M2HES	20 x 36 x 22.75	100	98	12.25	\$1105	N/A	N/A	N/A
Z30M2HES	20 x 30 x 22.75	100	92	10.50	\$969	N/A	N/A	N/A

For use under ZxxxxHTB 23.25"H top and back kit. **No top or back.** Box drawer and lateral file storage. For filing capabilities, see page 121.

- Lateral file drawer construction is for accommodating hanging files NOT for stacking materials on the drawer bottom

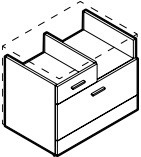

1.5H Mixed Storage Shell - LEFT*

Z36L2HXSL	24 x 36 x 22.75	125	110	14.50	\$1232	N/A	N/A	N/A
Z30L2HXSL	24 x 30 x 22.75	100	105	12.25	\$1104	N/A	N/A	N/A
Z36M2HXSL	20 x 36 x 22.75	100	104	12.25	\$1164	N/A	N/A	N/A
Z30M2HXSL	20 x 30 x 22.75	100	97	10.50	\$1030	N/A	N/A	N/A

For use under ZxxxxHTB 23.25"H top and back kit. **No top or back.** Open shelf on **right**, box drawer on **left** and lateral file storage below. For filing capabilities, see page 121.

- Lateral file drawer construction is for accommodating hanging files NOT for stacking materials on the drawer bottom

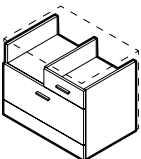

1.5H Mixed Storage Shell - RIGHT*

Z36L2HXSR	24 x 36 x 22.75	125	110	14.50	\$1232	N/A	N/A	N/A
Z30L2HXSR	24 x 30 x 22.75	100	105	12.25	\$1104	N/A	N/A	N/A
Z36M2HXSR	20 x 36 x 22.75	100	104	12.25	\$1164	N/A	N/A	N/A
Z30M2HXSR	20 x 30 x 22.75	100	97	10.50	\$1030	N/A	N/A	N/A

For use under ZxxxxHTB 23.25"H top and back kit. **No top or back.** Open shelf on **left**, box drawer on **right** and lateral file storage below. For filing capabilities, see page 121.

- Lateral file drawer construction is for accommodating hanging files NOT for stacking materials on the drawer bottom

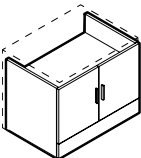

Glazed door option

1.5H Closed Storage Shell**

Z36L2HSHS	24 x 36 x 22.75	125	96	14.50	\$1044	N/A	\$505	N/A
Z30L2HSHS	24 x 30 x 22.75	125	86	12.25	\$943	N/A	\$449	N/A
Z36M2HSHS	20 x 36 x 22.75	125	86	12.25	\$976	N/A	\$505	N/A
Z30M2HSHS	20 x 30 x 22.75	125	75	10.50	\$873	N/A	\$449	N/A

For use under ZxxxxHTB 23.25"H top and back kit. **No top or back.** Laminate doors are standard. Standard with lock.

Required Specifications

Base finish
Handles*

Optional Specifications

Key #*
Glazed doors**

STORAGE SHELLS - 22.75" HIGH

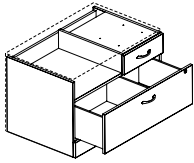

1.5H Split Drawer Storage Shell* - LEFT

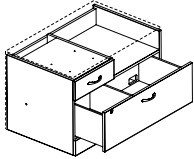

1.5H Split Drawer Storage Shell* - RIGHT

MODEL#	DIMENSIONS D x W x H	FREIGHT CLASS	WT/LBS.	CUBIC FT.	1" TOP	1.5" TOP	GLAZE ADD	HP ADD
Z36L2HCSL	24 x 36 x 22.75	125	110	14.50	\$1174	N/A	N/A	N/A
Z30L2HCSL	24 x 30 x 22.75	100	101	12.25	\$1095	N/A	N/A	N/A
Z36M2HCSL	20 x 36 x 22.75	100	104	12.25	\$1104	N/A	N/A	N/A
Z30M2HCSL	20 x 30 x 22.75	100	92	10.50	\$1019	N/A	N/A	N/A

For use **under ZxxxxHTB 23.25" H** top and back kit. **No top or back.** Open shelf on **right**, box drawer on **left**. Pull out drawer includes filing space on **left** and storage on **right**. Front-to-back letter capability.

- Lateral file drawer construction is for accommodating hanging files **NOT** for stacking materials on the drawer bottom.

Z36L2HCSR	24 x 36 x 22.75	125	110	14.50	\$1174	N/A	N/A	N/A
Z30L2HCSR	24 x 30 x 22.75	100	101	12.25	\$1095	N/A	N/A	N/A
Z36M2HCSR	20 x 36 x 22.75	100	104	12.25	\$1104	N/A	N/A	N/A
Z30M2HCSR	20 x 30 x 22.75	100	92	10.50	\$1019	N/A	N/A	N/A

For use **under ZxxxxHTB 23.25" H** top and back kit. **No top or back.** Open shelf on **left**, box drawer on **right**. Pull out drawer includes filing space on **right** and storage on **left**. Front-to-back letter capability.

- Lateral file drawer construction is for accommodating hanging files **NOT** for stacking materials on the drawer bottom.

TOP AND BACK KITS FOR 22.75" H SHELLS

MODEL#	DIMENSIONS	FREIGHT CLASS	WT/LBS.	CUBIC FT.	1" TOP	1.5" TOP	GLAZE ADD	HP ADD
Z2496HTB	24 x 96 x 23.25-23.75	70	114	6.75	\$849	\$1026	N/A	\$520
Z2490HTB	24 x 90 x 23.25-23.75	70	107	6.25	\$806	\$971	N/A	\$488
Z2484HTB	24 x 84 x 23.25-23.75	70	100	6	\$756	\$912	N/A	\$454
Z2478HTB	24 x 78 x 23.25-23.75	70	94	5.50	\$710	\$854	N/A	\$423
Z2472HTB	24 x 72 x 23.25-23.75	70	87	5.25	\$659	\$792	N/A	\$390
Z2466HTB	24 x 66 x 23.25-23.75	70	80	4.75	\$610	\$733	N/A	\$358
Z2460HTB	24 x 66 x 23.25-23.75	70	72	4.50	\$561	\$672	N/A	\$327
Z2454HTB	24 x 54 x 23.25-23.75	70	65	4	\$507	\$608	N/A	\$294
Z2448HTB	24 x 48 x 23.25-23.75	85	55	3.75	\$463	\$552	N/A	\$261
Z2442HTB	24 x 42 x 23.25-23.75	70	51	3.25	\$411	\$491	N/A	\$229
Z2436HTB	24 x 36 x 23.25-23.75	85	44	3	\$357	\$426	N/A	\$197
Z2430HTB	24 x 30 x 23.25-23.75	85	37	2.50	\$309	\$366	N/A	\$164
Z2096HTB	20 x 96 x 23.25-23.75	70	103	6.25	\$793	\$939	N/A	\$434
Z2090HTB	20 x 90 x 23.25-23.75	70	97	6	\$750	\$888	N/A	\$407
Z2084HTB	20 x 84 x 23.25-23.75	70	91	5.75	\$705	\$835	N/A	\$378
Z2078HTB	20 x 78 x 23.25-23.75	70	86	5.25	\$660	\$780	N/A	\$353
Z2072HTB	20 x 72 x 23.25-23.75	70	78	5	\$616	\$727	N/A	\$327
Z2066HTB	20 x 66 x 23.25-23.75	70	71	4.50	\$564	\$666	N/A	\$299
Z2060HTB	20 x 66 x 23.25-23.75	70	65	4.25	\$520	\$612	N/A	\$273
Z2054HTB	20 x 54 x 23.25-23.75	70	59	3.75	\$474	\$559	N/A	\$246
Z2048HTB	20 x 48 x 23.25-23.75	70	55	3.50	\$434	\$509	N/A	\$219
Z2042HTB	20 x 42 x 23.25-23.75	70	47	3	\$384	\$450	N/A	\$189
Z2036HTB	20 x 36 x 23.25-23.75	85	40	2.75	\$331	\$388	N/A	\$164
Z2030HTB	20 x 30 x 23.25-23.75	85	33	2.25	\$286	\$333	N/A	\$138

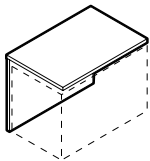

Credenza Top and Back Kit**

For use with 22.75" high storage shells. Shipped RTA (ready to assemble).

- **Does not include hardware to attach to storage shells.**

Required Specifications

- Top finish**
- Top/edge detail**
- Base finish
- Handles*

Optional Specifications

- HP laminate**

STORAGE SHELLS - 28" HIGH

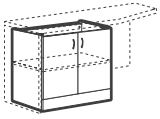

Storage Shell*



Glazed door option

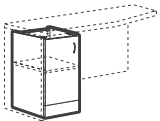

Storage Shell - LEFT*

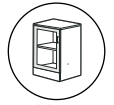

Glazed door option

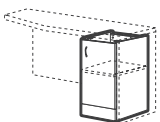

Storage Shell - RIGHT*

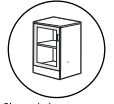

Glazed door option

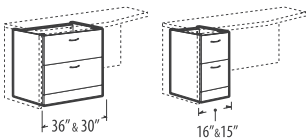

File/File Shell

MODEL#	DIMENSIONS D x W x H	FREIGHT CLASS	WT/LBS.	CUBIC FT.	1" TOP	1.5" TOP	GLAZE ADD	HP ADD
Z36L2SHS	23.4 x 36 x 28-28.5	150	100	18.50	\$978	N/A	\$762	N/A
Z30L2SHS	23.4 x 30 x 28-28.5	150	88	15.50	\$873	N/A	\$699	N/A
Z36M2SHS	19.3 x 36 x 28-28.5	150	89	15.50	\$856	N/A	\$762	N/A
Z30M2SHS	19.3 x 30 x 28-28.5	150	78	13.25	\$777	N/A	\$699	N/A

For use under 29" H returns, extended corners, freestanding and connectable tables of the same depth. **No top or back. One adjustable shelf.** Standard with lock.

Z21L2SHSL	23.4 x 21 x 28-28.5	125	70	11	\$674	N/A	\$432	N/A
Z18L2SHSL	23.4 x 18 x 28-28.5	125	64	9.75	\$646	N/A	\$395	N/A
Z16L2SHSL	23.4 x 16 x 28-28.5	125	60	9	\$607	N/A	\$386	N/A
Z15L2SHSL	23.4 x 15 x 28-28.5	125	59	8.25	\$587	N/A	\$348	N/A
Z12L2SHSL	23.4 x 12 x 28-28.5	125	53	6.75	\$548	N/A	\$314	N/A
Z21M2SHSL	19.3 x 21 x 28-28.5	125	61	9.50	\$577	N/A	\$432	N/A
Z18M2SHSL	19.3 x 18 x 28-28.5	125	56	8.25	\$551	N/A	\$395	N/A
Z16M2SHSL	19.3 x 16 x 28-28.5	125	52	7	\$523	N/A	\$386	N/A
Z15M2SHSL	19.3 x 15 x 28-28.5	125	52	6.75	\$495	N/A	\$348	N/A
Z12M2SHSL	19.3 x 12 x 28-28.5	100	47	5.75	\$465	N/A	\$314	N/A

For use under 29" H returns, extended corners, freestanding and connectable tables of the same depth. **No top or back. One adjustable shelf.** Standard with lock.

Z21L2SHSR	23.4 x 21 x 28-28.5	125	70	11	\$674	N/A	\$432	N/A
Z18L2SHSR	23.4 x 18 x 28-28.5	125	64	9.75	\$646	N/A	\$395	N/A
Z16L2SHSR	23.4 x 16 x 28-28.5	125	60	9	\$607	N/A	\$386	N/A
Z15L2SHSR	23.4 x 15 x 28-28.5	125	59	8.25	\$587	N/A	\$348	N/A
Z12L2SHSR	23.4 x 12 x 28-28.5	125	53	6.75	\$548	N/A	\$314	N/A
Z21M2SHSR	19.3 x 21 x 28-28.5	125	61	9.50	\$577	N/A	\$432	N/A
Z18M2SHSR	19.3 x 18 x 28-28.5	125	56	8.25	\$551	N/A	\$395	N/A
Z16M2SHSR	19.3 x 16 x 28-28.5	125	52	7	\$523	N/A	\$386	N/A
Z15M2SHSR	19.3 x 15 x 28-28.5	125	52	6.75	\$495	N/A	\$348	N/A
Z12M2SHSR	19.3 x 12 x 28-28.5	100	47	5.75	\$465	N/A	\$314	N/A

For use under 29" H returns, extended corners, freestanding and connectable tables of the same depth. **No top or back. One adjustable shelf.** Standard with lock.

Z36L2ES	23.4 x 36 x 28-28.5	125	121	18.50	\$1469	N/A	N/A	N/A
Z30L2ES	23.4 x 30 x 28-28.5	125	110	15.50	\$1347	N/A	N/A	N/A
Z16L2ES	23.4 x 16 x 28-28.5	100	75	9	\$812	N/A	N/A	N/A
Z15L2ES	23.4 x 15 x 28-28.5	100	75	8.25	\$791	N/A	N/A	N/A
Z36M2ES	19.3 x 36 x 28-28.5	125	114	15.50	\$1353	N/A	N/A	N/A
Z30M2ES	19.3 x 30 x 28-28.5	125	102	13.25	\$1265	N/A	N/A	N/A
Z16M2ES	19.3 x 16 x 28-28.5	100	69	7	\$741	N/A	N/A	N/A
Z15M2ES	19.3 x 15 x 28-28.5	92.5	68	6.75	\$723	N/A	N/A	N/A

For use under 29" H returns, extended corners, freestanding and connectable tables of the same depth. **No top or back. Two file drawers.** Lock secures all drawers. For filing capabilities, see page 121.

- 15" wide models have only side-to-side filing capability
- Lateral file drawer construction is for accommodating hanging files NOT for stacking materials on the drawer bottom.

Required Specifications

Base finish
Handles

Optional Specifications

Glazed doors - storage shell doors*
Key #

STORAGE SHELLS - 28" HIGH

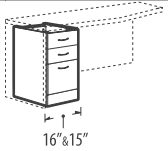

Box/Box/File Shell*

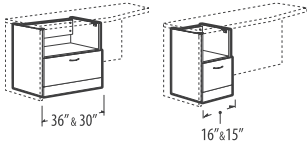

File Shell with Open Shelf*

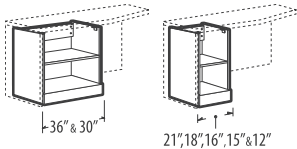

Open Shelving Shell

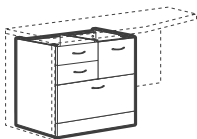

Mixed Storage Shell - LEFT*

MODEL#	DIMENSIONS D x W x H	FREIGHT CLASS	WT/LBS.	CUBIC FT.	1" TOP	1.5" TOP	GLAZE ADD	HP ADD
Z16L2BFS	23.4 x 16 x 28-28.5	100	77	9	\$935	N/A	N/A	N/A
Z15L2BFS	23.4 x 15 x 28-28.5	100	77	8.25	\$915	N/A	N/A	N/A
Z16M2BFS	19.3 x 16 x 28-28.5	92.5	71	7	\$847	N/A	N/A	N/A
Z15M2BFS	19.3 x 15 x 28-28.5	92.5	71	6.75	\$831	N/A	N/A	N/A

For use **under 29" H** returns, extended corners, freestanding and connectable tables of the same depth. **No top or back. Two box and one file drawer.** One pencil tray. Lock secures all drawers.

- 15" wide models have only side-to-side filing capability

Z36L2FS	23.4 x 36 x 28-28.5	150	109	18.50	\$1144	N/A	N/A	N/A
Z30L2FS	23.4 x 30 x 28-28.5	125	98	15.50	\$1028	N/A	N/A	N/A
Z16L2FS	23.4 x 16 x 28-28.5	125	68	9	\$684	N/A	N/A	N/A
Z15L2FS	23.4 x 15 x 28-28.5	100	67	8.25	\$675	N/A	N/A	N/A
Z36M2FS	19.3 x 36 x 28-28.5	125	99	15.50	\$1018	N/A	N/A	N/A
Z30M2FS	19.3 x 30 x 28-28.5	125	89	13.25	\$937	N/A	N/A	N/A
Z16M2FS	19.3 x 16 x 28-28.5	100	59	7	\$576	N/A	N/A	N/A
Z15M2FS	19.3 x 15 x 28-28.5	100	57	6.75	\$564	N/A	N/A	N/A

For use **under 29" H** returns, extended corners, freestanding and connectable tables of the same depth. **No top or back. One file drawer.** Lock secures file drawer. For filing capabilities, see page 121.

- 15" wide models have only side-to-side filing capability
- Lateral file drawer construction is for accommodating hanging files NOT for stacking materials on the drawer bottom.

Z36L2SHSN	23.4 x 36 x 28-28.5	150	84.03	18.50	\$699	N/A	N/A	N/A
Z30L2SHSN	23.4 x 30 x 28-28.5	150	74.69	15.50	\$620	N/A	N/A	N/A
Z21L2SHSN	23.4 x 21 x 28-28.5	150	60.69	11	\$522	N/A	N/A	N/A
Z18L2SHSN	23.4 x 18 x 28-28.5	150	56.02	9.75	\$503	N/A	N/A	N/A
Z16L2SHSN	23.4 x 16 x 28-28.5	150	52.90	9	\$467	N/A	N/A	N/A
Z15L2SHSN	23.4 x 15 x 28-28.5	125	52.35	8.25	\$456	N/A	N/A	N/A
Z12L2SHSN	23.4 x 12 x 28-28.5	125	47.68	6.75	\$428	N/A	N/A	N/A
Z36M2SHSN	19.3 x 36 x 28-28.5	150	73.03	15.50	\$579	N/A	N/A	N/A
Z30M2SHSN	19.3 x 30 x 28-28.5	150	64.69	13.25	\$526	N/A	N/A	N/A
Z21M2SHSN	19.3 x 21 x 28-28.5	150	51.69	9.50	\$424	N/A	N/A	N/A
Z18M2SHSN	19.3 x 18 x 28-28.5	150	48.02	8.25	\$408	N/A	N/A	N/A
Z16M2SHSN	19.3 x 16 x 28-28.5	125	44.90	7	\$382	N/A	N/A	N/A
Z15M2SHSN	19.3 x 15 x 28-28.5	125	45.35	6.75	\$367	N/A	N/A	N/A
Z12M2SHSN	19.3 x 12 x 28-28.5	125	41.68	5.75	\$344	N/A	N/A	N/A

For use **under 29" H** returns, extended corners, freestanding and connectable tables of the same depth. **No top or back. One adjustable shelf.**

Z36L2XSL	23.4 x 36 x 28-28.5	100	152	18.50	\$1770	N/A	N/A	N/A
Z30L2XSL	23.4 x 30 x 28-28.5	100	136	15.50	\$1619	N/A	N/A	N/A
Z36M2XSL	19.3 x 36 x 28-28.5	100	139	15.50	\$1668	N/A	N/A	N/A
Z30M2XSL	19.3 x 30 x 28-28.5	100	124	13.25	\$1550	N/A	N/A	N/A

For use **under 29" H** returns, extended corners, freestanding and connectable tables of the same depth. **No top or back.** Two box drawers on **left**, one file drawer on **right** accommodates letter filing side to side, and one lateral file drawer on bottom (see filing orientations on page 120). Right lock secures one file drawer, the left lock secures two box and the lateral file. One pencil tray. For filing capabilities, see page 121.

- Lateral file drawer construction is for accommodating hanging files NOT for stacking materials on the drawer bottom.
- Top file drawer supports hanging folders only. Does not accept hanging folders with plastic tabs.

Required Specifications

Base finish
Handles*

Optional Specifications

Box Drawer Option (no upcharge - not available on Open Shelving Shell)
Key #

STORAGE SHELLS - 28" HIGH

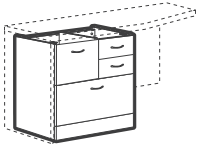

Mixed Storage Shell - RIGHT**

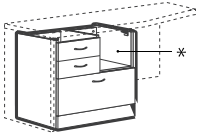

Mixed Storage Shell with Open Shelf - LEFT*

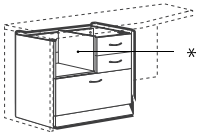

Mixed Storage Shell with Open Shelf - RIGHT*



* Accepts collator



* Accepts collator

MODEL#	DIMENSIONS D x W x H	FREIGHT CLASS	WT/LBS.	CUBIC FT.	1" TOP	1.5" TOP	GLAZE ADD	HP ADD
Z36L2XSR	23.4 x 36 x 28.5	100	152	18.50	\$1770	N/A	N/A	N/A
Z30L2XSR	23.4 x 30 x 28.5	100	136	15.50	\$1619	N/A	N/A	N/A
Z36M2XSR	19.3 x 36 x 28.5	100	139	15.50	\$1668	N/A	N/A	N/A
Z30M2XSR	19.3 x 30 x 28.5	100	124	13.25	\$1550	N/A	N/A	N/A

For use **under 29" H** returns, extended corners, freestanding and connectable tables of the same depth. **No top or back.** Two box drawers on **right**, one file drawer on **left** accommodates letter filing side to side, and one lateral file drawer on bottom (see filing orientations on page 120). Right lock secures two box and lateral file, the left lock secures one file drawer. One pencil tray. For filing capabilities, see page 121.

- Lateral file drawer construction is for accommodating hanging files NOT for stacking materials on the drawer bottom.
- Top file drawer supports hanging folders only. Does not accept hanging folders with plastic tabs.

Z36L2XNSL	23.4 x 36 x 28.5	125	133	18.50	\$1495	N/A	N/A	N/A
Z30L2XNSL	23.4 x 30 x 28.5	125	121	15.50	\$1361	N/A	N/A	N/A
Z36M2XNSL	19.3 x 36 x 28.5	125	121	15.50	\$1393	N/A	N/A	N/A
Z30M2XNSL	19.3 x 30 x 28.5	100	109	13.25	\$1296	N/A	N/A	N/A

For use **under 29" H** returns, extended corners, freestanding and connectable tables of the same depth. **No top or back.** Two box drawers on **left**, one open shelf on **right** and one lateral file drawer on bottom. Lock secures all drawers. One pencil tray. For filing capabilities, see page 121.

- Lateral file drawer construction is for accommodating hanging files NOT for stacking materials on the drawer bottom.

Z36L2XNSR	23.4 x 36 x 28-28.5	125	133	18.50	\$1495	N/A	N/A	N/A
Z30L2XNSR	23.4 x 30 x 28-28.5	125	121	15.50	\$1361	N/A	N/A	N/A
Z36M2XNSR	19.3 x 36 x 28-28.5	125	121	15.50	\$1393	N/A	N/A	N/A
Z30M2XNSR	19.3 x 30 x 28-28.5	100	109	13.25	\$1296	N/A	N/A	N/A

For use **under 29" H** returns, extended corners, freestanding and connectable tables of the same depth. **No top or back.** Two box drawers on **right**, one open shelf on **left** and one lateral file drawer on bottom. Lock secures all drawers. One pencil tray. For filing capabilities, see page 121.

- Lateral file drawer construction is for accommodating hanging files NOT for stacking materials on the drawer bottom.

Required Specifications

Base finish
Handles

Optional Specifications

Box drawer - no upcharge
Collator (open shelves)

TOP AND BACK KITS FOR 28" H STORAGE SHELLS

MODEL#	DIMENSIONS	FREIGHT CLASS	WT/LBS.	CUBIC FT.	1" TOP	1.5" TOP	GLAZE ADD	HP ADD
D x W x H								
Z2496TB	24 x 96 x 29-29.5	70	126	7.75	\$930	\$1107	N/A	\$520
Z2490TB	24 x 90 x 29-29.5	70	118	7.25	\$877	\$1042	N/A	\$488
Z2484TB	24 x 84 x 29-29.5	70	111	6.75	\$827	\$983	N/A	\$454
Z2478TB	24 x 78 x 29-29.5	70	104	6.25	\$769	\$913	N/A	\$423
Z2472TB	24 x 72 x 29-29.5	70	117	5.90	\$681	\$842	N/A	\$384
Z2466TB	24 x 66 x 29-29.5	70	117	5.90	\$656	\$804	N/A	\$384
Z2460TB	24 x 60 x 29-29.5	70	117	5.90	\$598	\$731	N/A	\$319
Z2454TB	24 x 54 x 29-29.5	70	72	4.50	\$550	\$651	N/A	\$294
Z2448TB	24 x 48 x 29-29.5	70	66	4	\$503	\$592	N/A	\$261
Z2442TB	24 x 42 x 29-29.5	70	57	3.75	\$449	\$529	N/A	\$229
Z2436TB	24 x 36 x 29-29.5	70	49	3.25	\$378	\$447	N/A	\$197
Z2430TB	24 x 30 x 29-29.5	85	41	2.75	\$336	\$393	N/A	\$164
Z2096TB	20 x 96 x 29-29.5	85	116	7.75	\$877	\$1023	N/A	\$434
Z2090TB	20 x 90 x 29-29.5	70	102	6.75	\$828	\$966	N/A	\$407
Z2084TB	20 x 84 x 29-29.5	70	102	6.75	\$778	\$908	N/A	\$378
Z2078TB	20 x 78 x 29-29.5	70	95	6.25	\$725	\$845	N/A	\$353
Z2072TB	20 x 72 x 29-29.5	70	106	6	\$656	\$789	N/A	\$384
Z2066TB	20 x 66 x 29-29.5	70	106	6	\$643	\$756	N/A	\$384
Z2060TB	20 x 60 x 29-29.5	70	106	6	\$564	\$684	N/A	\$319
Z2054TB	20 x 54 x 29-29.5	85	66	4.50	\$521	\$606	N/A	\$246
Z2048TB	20 x 48 x 29-29.5	70	61	4	\$475	\$550	N/A	\$219
Z2042TB	20 x 42 x 29-29.5	85	52	3.75	\$424	\$490	N/A	\$189
Z2036TB	20 x 36 x 29-29.5	85	45	3.25	\$358	\$415	N/A	\$164
Z2030TB	20 x 30 x 29-29.5	85	38	2.75	\$319	\$366	N/A	\$138

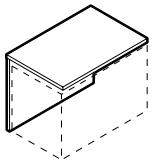

Top and Back Kits - 29" H

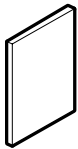

Full Leg

For use with 28" high storage shells. Shipped RTA (ready to assemble).

- Does not include hardware to attach to storage shells.

Z24FL	23.4 x 1 x 28.5	92.5	20	1.70	\$261	N/A	N/A	N/A
Z20FL	19.3 x 1 x 28.5	65	16	.60	\$261	N/A	N/A	N/A

For use at either end of 29" H top and back kits. Non-handed; can be used left or right. Shipped RTA (ready to assemble).

- For 24" deep worksurfaces, order **Z24FL**.
- For 20" deep worksurfaces, order **Z20FL**.
- Does not include hardware for installation.

Required Specifications

Top finish
Top/edge detail
Base finish

Optional Specifications

HP laminate

STORAGE MODULES - 17.87"/18.37" HIGH

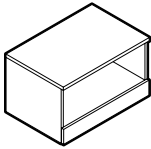

Open Storage

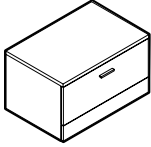

Lateral File*

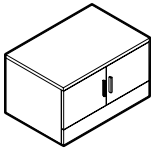

Storage Cabinet*



Glazed door option

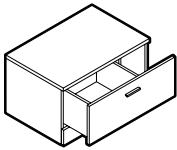

Split Drawer Storage* - LEFT

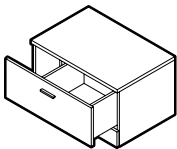

Split Drawer Storage* - RIGHT

MODEL#	DIMENSIONS D x W x H	FREIGHT CLASS	WT./LBS.	CUBIC FT.	1" TOP	1.5" TOP	GLAZE ADD	HP ADD
Z36L21SHN	24 x 36 x 17.87-18.37	125	82	11.75	\$753	\$822	N/A	\$197
Z30L21SHN	24 x 30 x 17.87-18.37	125	74	10	\$691	\$748	N/A	\$164
Z36M21SHN	20 x 36 x 17.87-18.37	125	71	10	\$683	\$740	N/A	\$164
Z30M21SHN	20 x 30 x 17.87-18.37	125	62	8.50	\$615	\$662	N/A	\$138

Open Shelf.

Z36L21E	24 x 36 x 17.87-18.37	100	103	11.75	\$1112	\$1181	N/A	\$197
Z30L21E	24 x 30 x 17.87-18.37	100	97	10	\$950	\$1007	N/A	\$164
Z36M21E	20 x 36 x 17.87-18.37	100	95	10	\$1056	\$1113	N/A	\$164
Z30M21E	20 x 30 x 17.87-18.37	92.5	88	8.50	\$887	\$934	N/A	\$138

One file drawer. Lock secures drawer. For filing capabilities, see page 121.

- Lateral file drawer construction is for accommodating hanging files NOT for stacking materials on the drawer bottom

Z36L21SH	24 x 36 x 17.87-18.37	125	90	11.75	\$964	\$1033	\$407	\$197
Z30L21SH	24 x 30 x 17.87-18.37	100	81	10	\$886	\$943	\$361	\$164
Z36M21SH	20 x 36 x 17.87-18.37	100	80	10	\$893	\$950	\$407	\$164
Z30M21SH	20 x 30 x 17.87-18.37	100	69	8.50	\$810	\$857	\$361	\$138

Laminate doors are standard. Standard with lock.

Z36L21XHL	24 x 36 x 17.87-18.37	100	102	11.75	\$1045	\$1114	N/A	\$197
Z30L21XHL	24 x 30 x 17.87-18.37	100	92	10	\$928	\$985	N/A	\$164
Z36M21XHL	20 x 36 x 17.87-18.37	100	95	10	\$989	\$1046	N/A	\$164
Z30M21XHL	20 x 30 x 17.87-18.37	100	83	8.50	\$866	\$913	N/A	\$138

Pull out drawer includes filing space on **left** and storage on **right**. Lock secures drawer. For filing capabilities, see page 121.

- Lateral file drawer construction is for accommodating hanging files NOT for stacking materials on the drawer bottom

Z36L21XHR	24 x 36 x 17.87-18.37	100	102	11.75	\$1045	\$1114	N/A	\$197
Z30L21XHR	24 x 30 x 17.87-18.37	100	92	10	\$928	\$985	N/A	\$164
Z36M21XHR	20 x 36 x 17.87-18.37	100	95	10	\$989	\$1046	N/A	\$164
Z30M21XHR	20 x 30 x 17.87-18.37	100	83	8.50	\$866	\$913	N/A	\$138

Pull out drawer includes filing space on **right** and storage on **left**. Lock secures drawer. For filing capabilities, see page 121.

- Lateral file drawer construction is for accommodating hanging files NOT for stacking materials on the drawer bottom

Required Specifications

Top finish
Top/edge detail
Base finish
Handles*

Optional Specifications

HP laminate
Key #

STORAGE MODULES - 23.75" / 24.25" HIGH

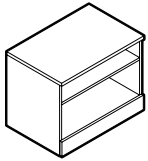

1.5H Open Storage

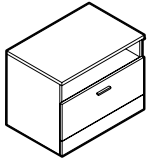

1.5H Open/Lateral File Storage*

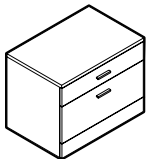

1.5H Box/Lateral File Storage**

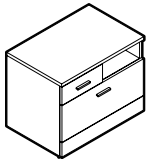

1.5H Mixed Storage - LEFT*

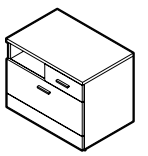

1.5H Mixed Storage - RIGHT*

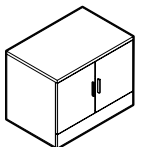

Closed Storage**



Glazed door option

MODEL#	DIMENSIONS D x W x H	FREIGHT CLASS	WT/LBS.	CUBIC FT.	1" TOP	1.5" TOP	GLAZE ADD	HP ADD
Z36L2HSHN	24 x 36 x 23.75-24.25	125	106	15	\$926	\$995	N/A	\$197
Z30L2HSHN	24 x 30 x 23.75-24.25	125	94	12.75	\$839	\$896	N/A	\$164
Z36M2HSHN	20 x 36 x 23.75-24.25	125	92	12.75	\$834	\$891	N/A	\$164
Z30M2HSHN	20 x 30 x 23.75-24.25	125	80	10.75	\$749	\$796	N/A	\$138

One adjustable shelf.

Z36L2HFN	24 x 36 x 23.75-24.25	100	127	15	\$1284	\$1353	N/A	\$197
Z30L2HFN	24 x 30 x 23.75-24.25	100	118	12.75	\$1097	\$1154	N/A	\$164
Z36M2HFN	20 x 36 x 23.75-24.25	100	116	12.75	\$1207	\$1264	N/A	\$164
Z30M2HFN	20 x 30 x 23.75-24.25	100	106	10.75	\$1020	\$1067	N/A	\$138

Open shelf on top. Lateral file below. Lock secures drawer. For filing capabilities, see page 121.

- Lateral file drawer construction is for accommodating hanging files NOT for stacking materials on the drawer bottom

Z36L2HE	24 x 36 x 23.75-24.25	100	126	15	\$1357	\$1426	N/A	\$197
Z30L2HE	24 x 30 x 23.75-24.25	100	118	12.75	\$1357	\$1414	N/A	\$164
Z36M2HE	20 x 36 x 23.75-24.25	100	118	12.75	\$1295	\$1352	N/A	\$164
Z30M2HE	20 x 30 x 23.75-24.25	92.5	108	10.75	\$1102	\$1149	N/A	\$138

Box drawer on top. Lateral file below. Lock secures both drawers. For filing capabilities, see page 121.

- Lateral file drawer construction is for accommodating hanging files NOT for stacking materials on the drawer bottom

Z36L2HXNL	24 x 36 x 23.75-24.25	100	132	15	\$1401	\$1470	N/A	\$197
Z30L2HXNL	24 x 30 x 23.75-24.25	100	123	12.75	\$1217	\$1274	N/A	\$164
Z36M2HXNL	20 x 36 x 23.75-24.25	100	121	12.75	\$1328	\$1385	N/A	\$164
Z30M2HXNL	20 x 30 x 23.75-24.25	92.5	111	10.75	\$1142	\$1189	N/A	\$138

Open shelf on **right**, box drawer on **left** and lateral file storage below. Lock secures both drawers. For filing capabilities, see page 121.

- Lateral file drawer construction is for accommodating hanging files NOT for stacking materials on the drawer bottom

Z36L2HXNR	24 x 36 x 23.75-24.25	100	132	15	\$1401	\$1470	N/A	\$197
Z30L2HXNR	24 x 30 x 23.75-24.25	100	123	12.75	\$1217	\$1274	N/A	\$164
Z36M2HXNR	20 x 36 x 23.75-24.25	100	121	12.75	\$1328	\$1385	N/A	\$164
Z30M2HXNR	20 x 30 x 23.75-24.25	92.5	111	10.75	\$1142	\$1189	N/A	\$138

Open shelf on **left**, box drawer on **right** and lateral file storage below. Lock secures both drawers. For filing capabilities, see page 121.

- Lateral file drawer construction is for accommodating hanging files NOT for stacking materials on the drawer bottom

Z36L2HSH	24 x 36 x 23.75-24.25	125	119	15	\$1177	\$1246	\$505	\$197
Z30L2HSH	24 x 30 x 23.75-24.25	100	105	12.75	\$1066	\$1123	\$449	\$164
Z36M2HSH	20 x 36 x 23.75-24.25	100	105	12.75	\$1086	\$1143	\$505	\$164
Z30M2HSH	20 x 30 x 23.75-24.25	100	91	10.75	\$977	\$1024	\$449	\$138

Laminate doors are standard. Includes one adjustable shelf. Standard with lock.

Required Specifications

Top finish
Top/edge detail
Base finish
Handles*

Optional Specifications

HP laminate
Key #
Glazed doors**
Box drawer† - no upcharge

STORAGE MODULES - 23.75" / 24.25" HIGH

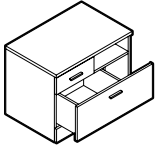

1.5H Split Drawer Storage - LEFT

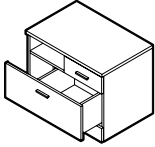

1.5H Split Drawer Storage - RIGHT

MODEL#	DIMENSIONS D x W x H	FREIGHT CLASS	WT/LBS.	CUBIC FT.	1" TOP	1.5" TOP	GLAZE ADD	HP ADD
Z36L2HXHL	24 x 36 x 23.75-24.25	100	132	15	\$1345	\$1414	N/A	\$197
Z30L2HXHL	24 x 30 x 23.75-24.25	100	118	12.75	\$1207	\$1264	N/A	\$164
Z36M2HXHL	20 x 36 x 23.75-24.25	100	121	12.75	\$1272	\$1329	N/A	\$164
Z30M2HXHL	20 x 30 x 23.75-24.25	100	107	10.75	\$1132	\$1179	N/A	\$138

Open shelf on **right**, box drawer on **left**. Pull out drawer includes filing space on **left** and storage on **right**.

Z36L2HXHR	24 x 36 x 23.75-24.25	100	132	15	\$1345	\$1414	N/A	\$197
Z30L2HXHR	24 x 30 x 23.75-24.25	100	118	12.75	\$1207	\$1264	N/A	\$164
Z36M2HXHR	20 x 36 x 23.75-24.25	100	121	12.75	\$1272	\$1329	N/A	\$164
Z30M2HXHR	20 x 30 x 23.75-24.25	100	107	10.75	\$1132	\$1179	N/A	\$138

Open shelf on **left**, box drawer on **right**. Pull out drawer includes filing space on **right** and storage on **left**.

STORAGE MODULES - 29.5" / 30" HIGH

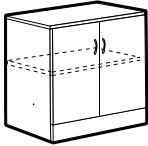

Glazed door option

Storage Cabinet with Doors*

MODEL#	DIMENSIONS	FREIGHT CLASS	WT/LBS.	CUBIC FT.	1" TOP	1.5" TOP	GLAZE ADD	HP ADD
Z36L2SH	24 x 36 x 29.5-30	125	142.80	18.50	\$1305	\$1385	\$762	\$195
Z30L2SH	24 x 30 x 29.5-30	125	123.90	15.50	\$1174	\$1241	\$699	\$162
Z36M2SH	20 x 36 x 29.5-30	100	126	15.50	\$1197	\$1267	\$762	\$195
Z30M2SH	20 x 30 x 29.5-30	100	109.20	13.25	\$1086	\$1144	\$699	\$162
Z36S2SH	16 x 36 x 29.5-30	100	110.25	12.50	\$1105	\$1172	\$762	\$146
Z30S2SH	16 x 30 x 29.5-30	100	93.45	10.50	\$976	\$1022	\$699	\$131

Laminate doors are standard. **Includes one adjustable shelf.** Standard with lock.

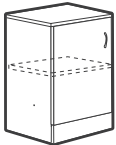

Glazed door option

Storage Cabinet with Door - LEFT*

Z21L2SHL	24 x 21 x 29.5-30	100	94.50	11	\$957	\$1013	\$432	\$131
Z18L2SHL	24 x 18 x 29.5-30	100	85.05	9.75	\$903	\$950	\$395	\$101
Z16L2SHL	24 x 16 x 29.5-30	100	79.80	9	\$866	\$912	\$386	\$76
Z15L2SHL	24 x 15 x 29.5-30	100	76.65	8.25	\$801	\$839	\$348	\$76
Z12L2SHL	24 x 12 x 29.5-30	92.5	68.25	6.75	\$759	\$792	\$314	\$69
Z21M2SHL	20 x 21 x 29.5-30	100	84	9.50	\$849	\$896	\$432	\$101
Z18M2SHL	20 x 18 x 29.5-30	100	75.60	8.25	\$804	\$847	\$395	\$101
Z16M2SHL	20 x 16 x 29.5-30	100	69.30	7	\$762	\$804	\$386	\$76
Z15M2SHL	20 x 15 x 29.5-30	100	66.15	6.75	\$725	\$760	\$348	\$69
Z12M2SHL	20 x 12 x 29.5-30	92.5	60	5.75	\$675	\$705	\$314	\$69
Z21S2SHL	16 x 21 x 29.5-30	100	71.40	7.50	\$777	\$814	\$432	\$69
Z18S2SHL	16 x 18 x 29.5-30	100	64.05	6.75	\$742	\$780	\$395	\$69
Z16S2SHL	16 x 16 x 29.5-30	100	58.80	6	\$711	\$749	\$386	\$69
Z15S2SHL	16 x 15 x 29.5-30	100	56.70	5.75	\$671	\$704	\$348	\$69
Z12S2SHL	16 x 12 x 29.5-30	92.5	50.40	4.75	\$624	\$654	\$314	\$69

Laminate doors are standard. **Includes one adjustable shelf.** Standard with lock.

Required Specifications

Top finish
Handles
Top/edge detail
Base finish

Optional Specifications

Glazed doors*
HP laminate
Key #

STORAGE MODULES - 29.5" / 30" HIGH

MODEL# DIMENSIONS FREIGHT CLASS WT/LBS. CUBIC FT. 1" TOP 1.5" TOP GLAZE ADD HP ADD

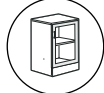
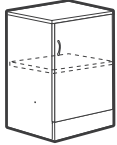

Glazed door option

Storage Cabinet with Door - RIGHT**

	D x W x H								
Z21L2SHR	24 x 21 x 29.5-30	100	94.50	11	\$957	\$1013	\$432	\$131	
Z18L2SHR	24 x 18 x 29.5-30	100	85.05	9.75	\$903	\$950	\$395	\$101	
Z16L2SHR	24 x 16 x 29.5-30	100	79.80	9	\$866	\$912	\$386	\$76	
Z15L2SHR	24 x 15 x 29.5-30	100	76.65	8.25	\$801	\$839	\$348	\$76	
Z12L2SHR	24 x 12 x 29.5-30	92.5	68.25	6.75	\$759	\$792	\$314	\$69	
Z21M2SHR	20 x 21 x 29.5-30	100	84	9.50	\$849	\$896	\$432	\$101	
Z18M2SHR	20 x 18 x 29.5-30	100	75.60	8.25	\$804	\$847	\$395	\$101	
Z16M2SHR	20 x 16 x 29.5-30	100	69.30	7	\$762	\$804	\$386	\$76	
Z15M2SHR	20 x 15 x 29.5-30	100	66.15	6.75	\$725	\$760	\$348	\$69	
Z12M2SHR	20 x 12 x 29.5-30	92.5	60	5.75	\$675	\$705	\$314	\$69	
Z21S2SHR	16 x 21 x 29.5-30	100	71.40	7.50	\$777	\$814	\$432	\$69	
Z18S2SHR	16 x 18 x 29.5-30	100	64.05	6.75	\$742	\$780	\$395	\$69	
Z16S2SHR	16 x 16 x 29.5-30	100	58.80	6	\$711	\$749	\$386	\$69	
Z15S2SHR	16 x 15 x 29.5-30	100	56.70	5.75	\$671	\$704	\$348	\$69	
Z12S2SHR	16 x 12 x 29.5-30	92.5	50.40	4.75	\$624	\$654	\$314	\$69	

Laminate doors are standard. Includes one adjustable shelf. Standard with lock

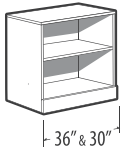

21", 18", 16", 15" & 12"

Open Storage Cabinet

Z36L2SHN	24 x 36 x 29.5-30	125	127	18.50	\$1029	\$1109	N/A	\$195	
Z30L2SHN	24 x 30 x 29.5-30	125	111	15.50	\$925	\$994	N/A	\$162	
Z21L2SHN	24 x 21 x 29.5-30	125	86	11	\$804	\$860	N/A	\$131	
Z18L2SHN	24 x 18 x 29.5-30	100	78	9.75	\$760	\$807	N/A	\$101	
Z16L2SHN	24 x 16 x 29.5-30	100	73	9	\$725	\$771	N/A	\$76	
Z15L2SHN	24 x 15 x 29.5-30	100	71	8.25	\$673	\$711	N/A	\$69	
Z12L2SHN	24 x 12 x 29.5-30	100	63	6.75	\$638	\$671	N/A	\$69	
Z36M2SHN	20 x 36 x 29.5-30	125	111.95	15.50	\$918	\$987	N/A	\$146	
Z30M2SHN	20 x 30 x 29.5-30	125	97.14	13.25	\$835	\$895	N/A	\$131	
Z21M2SHN	20 x 21 x 29.5-30	125	74.40	9.50	\$696	\$743	N/A	\$101	
Z18M2SHN	20 x 18 x 29.5-30	100	67.53	8.25	\$660	\$703	N/A	\$84	
Z16M2SHN	20 x 16 x 29.5-30	100	62.59	7	\$623	\$665	N/A	\$69	
Z15M2SHN	20 x 15 x 29.5-30	100	60.65	6.75	\$596	\$631	N/A	\$69	
Z12M2SHN	20 x 12 x 29.5-30	100	55	5.75	\$552	\$583	N/A	\$69	
Z36S2SHN	16 x 36 x 29.5-30	125	96.24	12.50	\$829	\$896	N/A	\$146	
Z30S2SHN	16 x 30 x 29.5-30	125	82.82	10.50	\$723	\$769	N/A	\$131	
Z21S2SHN	16 x 21 x 29.5-30	100	62.70	7.50	\$623	\$660	N/A	\$101	
Z18S2SHN	16 x 18 x 29.5-30	100	55.99	6.75	\$601	\$643	N/A	\$84	
Z16S2SHN	16 x 16 x 29.5-30	100	52.22	6	\$572	\$610	N/A	\$69	
Z15S2SHN	16 x 15 x 29.5-30	100	50.34	5.75	\$540	\$572	N/A	\$69	
Z12S2SHN	16 x 12 x 29.5-30	100	44.68	4.75	\$502	\$532	N/A	\$69	

One adjustable shelf.

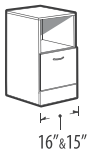

File Module with Open Shelf**

Z36L2FN	24 x 36 x 29.5-30	100	153.30	18.50	\$1473	\$1552	N/A	\$195	
Z30L2FN	24 x 30 x 29.5-30	100	134.40	15.50	\$1330	\$1399	N/A	\$162	
Z16L2FN	24 x 16 x 29.5-30	100	87.15	9	\$930	\$976	N/A	\$101	
Z15L2FN	24 x 15 x 29.5-30	92.5	82.95	8.25	\$876	\$914	N/A	\$84	
Z36M2FN	20 x 36 x 29.5-30	100	135.45	15.50	\$1361	\$1430	N/A	\$195	
Z30M2FN	20 x 30 x 29.5-30	100	118.65	13.25	\$1252	\$1310	N/A	\$162	
Z16M2FN	20 x 16 x 29.5-30	92.5	75.60	7	\$830	\$872	N/A	\$101	
Z15M2FN	20 x 15 x 29.5-30	92.5	72.45	6.75	\$793	\$828	N/A	\$84	
Z36S2FN	16 x 36 x 29.5-30	100	114.45	12.50	\$1231	\$1298	N/A	\$146	
Z30S2FN	16 x 30 x 29.5-30	100	97.65	10.50	\$1091	\$1137	N/A	\$131	
Z16S2FN	16 x 16 x 29.5-30	92.5	63	6	\$769	\$807	N/A	\$76	
Z15S2FN	16 x 15 x 29.5-30	92.5	60.90	5.75	\$736	\$768	N/A	\$69	

Open shelf and one file drawer on bottom. Lock secures file drawer. For filing capabilities, see page 121.

- 15" wide models have only side-to-side filing capability
- Lateral file drawer construction is for accommodating hanging files NOT for stacking materials on the drawer bottom

Required Specifications

Top finish
Handles*
Top/edge detail
Base finish

Optional Specifications

Glazed doors**
HP laminate
Key #

Box drawer† - no upcharge (30" - 36" wide models only)

STORAGE MODULES - 29.5" / 30" HIGH



36" & 30"



16" & 15"

Two File Module†

MODEL#	DIMENSIONS D x W x H	FREIGHT CLASS	WT./LBS.	CUBIC FT.	1" TOP	1.5" TOP	GLAZE ADD	HP ADD
Z36L2E	24 x 36 x 29.5-30	100	164.85	18.50	\$1805	\$1884	N/A	\$195
Z30L2E	24 x 30 x 29.5-30	100	145.95	15.50	\$1651	\$1720	N/A	\$162
Z16L2E	24 x 16 x 29.5-30	92.5	95.55	9	\$1063	\$1109	N/A	\$101
Z15L2E	24 x 15 x 29.5-30	92.5	91.35	8.25	\$1003	\$1041	N/A	\$84
Z36M2E	20 x 36 x 29.5-30	100	149.10	15.50	\$1706	\$1776	N/A	\$195
Z30M2E	20 x 30 x 29.5-30	92.5	133.35	13.25	\$1582	\$1642	N/A	\$162
Z16M2E	20 x 16 x 29.5-30	85	85.05	7	\$965	\$1007	N/A	\$101
Z15M2E	20 x 15 x 29.5-30	85	81.90	6.75	\$931	\$966	N/A	\$84
Z36S2E	16 x 36 x 29.5-30	92.5	128.10	12.50	\$1600	\$1667	N/A	\$146
Z30S2E	16 x 30 x 29.5-30	92.5	110.25	10.50	\$1454	\$1500	N/A	\$131
Z16S2E	16 x 16 x 29.5-30	85	73.50	6	\$957	\$995	N/A	\$76
Z15S2E	16 x 15 x 29.5-30	85	71.40	5.75	\$925	\$958	N/A	\$69

Two file drawers. Lock secures all drawers. For filing capabilities, see page 121.

- 15" wide models have only side-to-side filing capability
- *Lateral file drawer construction is for accommodating hanging files NOT for stacking materials on the drawer bottom*



Two File Module†

Z36L2SE	24 x 36 x 29.5-30	100	180	18.50	\$2183	\$2262	N/A	\$195
Z36M2SE	20 x 36 x 29.5-30	92.5	164	15.50	\$2038	\$2108	N/A	\$195

Two lateral file drawers with steel drawer interior. Steel drawer construction includes metal sides and masonite bottoms. Lock secures all drawers. Front-to-back and side-to-side letter/legal filing capability. For filing capabilities, see page 121.

- Front-to-back filing bars sold separately. Order **FBB** bars. See "FBB" on page 41.
- *Lateral file drawer construction is for accommodating hanging files NOT for stacking materials on the drawer bottom*
- To prevent overloading, steel drawers do not include a back panel



16" & 15"

Box/Box/File Module†

Z16L2BF	24 x 16 x 29.5-30	92.5	97.65	9	\$1197	\$1243	N/A	\$101
Z15L2BF	24 x 15 x 29.5-30	92.5	93.45	8.25	\$1142	\$1180	N/A	\$101
Z16M2BF	20 x 16 x 29.5-30	85	87.15	7	\$1097	\$1139	N/A	\$101
Z15M2BF	20 x 15 x 29.5-30	85	84	6.75	\$1069	\$1104	N/A	\$101
Z16S2BF	16 x 16 x 29.5-30	85	73.50	6	\$1023	\$1061	N/A	\$76
Z15S2BF	16 x 15 x 29.5-30	85	71.40	5.75	\$977	\$1010	N/A	\$76

Two box and one file drawer. One pencil tray. Lock secures all drawers.



Mixed Storage Cabinet - LEFT†

Z36L2XL	24 x 36 x 29.5-30	92.5	187	18.50	\$2058	\$2130	N/A	\$195
Z30L2XL	24 x 30 x 29.5-30	92.5	166	15.50	\$1876	\$1945	N/A	\$162
Z36M2XL	20 x 36 x 29.5-30	92.5	177	15.50	\$1933	\$2002	N/A	\$195
Z30M2XL	20 x 30 x 29.5-30	92.5	152	13.25	\$1779	\$1839	N/A	\$162
Z36S2XL	16 x 36 x 29.5-30	92.5	145	12.50	\$1658	\$1720	N/A	\$146
Z30S2XL	16 x 30 x 29.5-30	92.5	124	10.50	\$1485	\$1539	N/A	\$131

Two box drawers on **left**, one file drawer on **right** which accommodates letter filing side to side, and one lateral file drawer on bottom. Right lock secures one file drawer, the left lock secures two box and lateral file. One pencil tray. For filing capabilities, see page 121.

- *Lateral file drawer construction is for accommodating hanging files NOT for stacking materials on the drawer bottom*
- Top file drawer supports hanging folders only. Does not accept hanging folders with plastic tabs.

Required Specifications

Top finish
Top/edge detail
Handles
Base finish

Optional Specifications

HP laminate
Key #
Box drawer† - no upcharge (30"-36" wide models only)

STORAGE MODULES - 29.5" / 30" HIGH



Mixed Storage Cabinet - RIGHT

MODEL#	DIMENSIONS D x W x H	FREIGHT CLASS	WT/LBS.	CUBIC FT.	1" TOP	1.5" TOP	GLAZE ADD	HP ADD
Z36L2XR	24 x 36 x 29.5-30	92.5	187	18.50	\$2058	\$2130	N/A	\$195
Z30L2XR	24 x 30 x 29.5-30	92.5	166	15.50	\$1876	\$1945	N/A	\$162
Z36M2XR	20 x 36 x 29.5-30	92.5	177	15.50	\$1933	\$2002	N/A	\$195
Z30M2XR	20 x 30 x 29.5-30	92.5	152	13.25	\$1779	\$1839	N/A	\$162
Z36S2XR	16 x 36 x 29.5-30	92.5	145	12.50	\$1658	\$1720	N/A	\$146
Z30S2XR	16 x 30 x 29.5-30	92.5	124	10.50	\$1485	\$1539	N/A	\$131

Two box drawers on **right**, one file drawer on **left** which accommodates letter filing side to side, and one lateral file drawer on bottom. Right lock secures two box and lateral file, the left lock secures one file drawer. One pencil tray. For filing capabilities, see page 121.

- Lateral file drawer construction is for accommodating hanging files NOT for stacking materials on the drawer bottom
- Top file drawer supports hanging folders only. Does not accept hanging folders with plastic tabs.

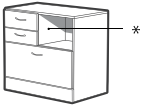

Mixed Drawer Cabinet with Open Shelf - LEFT*



* Accepts collator

Z36L2XNL	24 x 36 x 29.5-30	100	176.40	18.50	\$1781	\$1861	N/A	\$195
Z30L2XNL	24 x 30 x 29.5-30	92.5	155.40	15.50	\$1636	\$1705	N/A	\$162
Z36M2XNL	20 x 36 x 29.5-30	92.5	157.50	15.50	\$1667	\$1736	N/A	\$195
Z30M2XNL	20 x 30 x 29.5-30	92.5	138.60	13.25	\$1542	\$1602	N/A	\$162
Z36S2XNL	16 x 36 x 29.5-30	92.5	128.10	12.50	\$1494	\$1552	N/A	\$146
Z30S2XNL	16 x 30 x 29.5-30	92.5	114.45	10.50	\$1354	\$1396	N/A	\$131

Two box drawers on **left**, open shelf on **right** and one lateral file drawer on bottom. Right lock secures two box and one file drawer, the left lock secures the lateral file. One pencil tray. For filing capabilities, see page 121.

- Lateral file drawer construction is for accommodating hanging files NOT for stacking materials on the drawer bottom

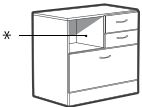

Mixed Drawer Cabinet with Open Shelf - RIGHT*



* Accepts collator

Z36L2XNR	24 x 36 x 29.5-30	100	176.40	18.50	\$1781	\$1861	N/A	\$195
Z30L2XNR	24 x 30 x 29.5-30	92.5	155.40	15.50	\$1636	\$1705	N/A	\$162
Z36M2XNR	20 x 36 x 29.5-30	92.5	157.50	15.50	\$1667	\$1736	N/A	\$195
Z30M2XNR	20 x 30 x 29.5-30	92.5	138.60	13.25	\$1542	\$1602	N/A	\$162
Z36S2XNR	16 x 36 x 29.5-30	92.5	128.10	12.50	\$1494	\$1552	N/A	\$146
Z30S2XNR	16 x 30 x 29.5-30	92.5	114.45	10.50	\$1354	\$1396	N/A	\$131

Two box drawers on **right**, open shelf on **left** and one lateral file drawer on bottom. Right lock secures two box and one file drawer, the left lock secures the lateral file. One pencil tray. For filing capabilities, see page 121.

- Lateral file drawer construction is for accommodating hanging files NOT for stacking materials on the drawer bottom

Required Specifications

Top finish
Top/edge detail
Base finish
Handles

Optional Specifications

HP laminate
Key #
Collator*

STORAGE MODULES - 41.3"/41.8" HIGH

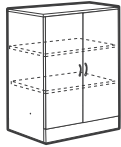

Storage Cabinet with Doors**

MODEL#	DIMENSIONS D x W x H	FREIGHT CLASS	WT/LBS.	CUBIC FT.	1" TOP	1.5" TOP	GLAZE ADD	HP ADD
Z36L4SH	24 x 36 x 41.3-41.8	125	185.85	25	\$1591	\$1671	\$1016	\$195
Z30L4SH	24 x 30 x 41.3-41.8	125	161.70	21.25	\$1457	\$1524	\$887	\$162
Z36M4SH	20 x 36 x 41.3-41.8	125	165.90	21.25	\$1485	\$1555	\$1016	\$195
Z30M4SH	20 x 30 x 41.3-41.8	125	143.85	18	\$1344	\$1404	\$887	\$162
Z36S4SH	16 x 36 x 41.3-41.8	100	142.80	17.50	\$1345	\$1412	\$1016	\$146
Z30S4SH	16 x 30 x 41.3-41.8	100	121.80	14.50	\$1207	\$1253	\$887	\$84

Laminate doors are standard. **Includes two 3-position fixed/height adjustable shelves.** Standard with lock.

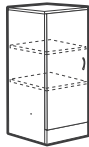

Storage Cabinet with Door - LEFT*

Z21L4SHL	24 x 21 x 41.3-41.8	100	123.90	15.25	\$1180	\$1237	\$560	\$131
Z18L4SHL	24 x 18 x 41.3-41.8	100	112.35	13.25	\$1112	\$1158	\$503	\$101
Z16L4SHL	24 x 16 x 41.3-41.8	100	105	12	\$1045	\$1092	\$496	\$101
Z15L4SHL	24 x 15 x 41.3-41.8	100	100.80	11.25	\$1002	\$1039	\$441	\$101
Z12L4SHL	24 x 12 x 41.3-41.8	100	89.25	9.25	\$928	\$961	\$398	\$69
Z21M4SHL	20 x 21 x 41.3-41.8	100	116.55	13	\$1064	\$1111	\$560	\$131
Z18M4SHL	20 x 18 x 41.3-41.8	100	98.70	11.25	\$1007	\$1049	\$503	\$101
Z16M4SHL	20 x 16 x 41.3-41.8	100	91.35	10.25	\$945	\$987	\$496	\$84
Z15M4SHL	20 x 15 x 41.3-41.8	100	88.20	9.50	\$906	\$939	\$441	\$84
Z12M4SHL	20 x 12 x 41.3-41.8	100	78.75	8	\$842	\$872	\$398	\$69
Z21S4SHL	16 x 21 x 41.3-41.8	100	94.50	10.50	\$951	\$989	\$560	\$101
Z18S4SHL	16 x 18 x 41.3-41.8	100	84	9.50	\$912	\$950	\$503	\$84
Z16S4SHL	16 x 16 x 41.3-41.8	100	76.65	8.50	\$855	\$893	\$496	\$84
Z15S4SHL	16 x 15 x 41.3-41.8	100	73.50	8	\$809	\$842	\$441	\$84
Z12S4SHL	16 x 12 x 41.3-41.8	92.5	65.10	6.50	\$749	\$778	\$398	\$69

Laminate doors are standard. **Includes two 3-position fixed/height adjustable shelves.** Standard with lock.

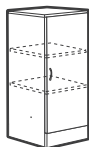

Storage Cabinet with Door - RIGHT*

Z21L4SHR	24 x 21 x 41.3-41.8	100	123.90	15.25	\$1180	\$1237	\$560	\$131
Z18L4SHR	24 x 18 x 41.3-41.8	100	112.35	13.25	\$1112	\$1158	\$503	\$101
Z16L4SHR	24 x 16 x 41.3-41.8	100	105	12	\$1045	\$1092	\$496	\$101
Z15L4SHR	24 x 15 x 41.3-41.8	100	100.80	11.25	\$1002	\$1039	\$441	\$101
Z12L4SHR	24 x 12 x 41.3-41.8	100	89.25	9.25	\$928	\$961	\$398	\$69
Z21M4SHR	20 x 21 x 41.3-41.8	100	116.55	13	\$1064	\$1111	\$560	\$131
Z18M4SHR	20 x 18 x 41.3-41.8	100	98.70	11.25	\$1007	\$1049	\$503	\$101
Z16M4SHR	20 x 16 x 41.3-41.8	100	91.35	10.25	\$945	\$987	\$496	\$84
Z15M4SHR	20 x 15 x 41.3-41.8	100	88.20	9.50	\$906	\$939	\$441	\$84
Z12M4SHR	20 x 12 x 41.3-41.8	100	78.75	8	\$842	\$872	\$398	\$69
Z21S4SHR	16 x 21 x 41.3-41.8	100	94.50	10.50	\$951	\$989	\$560	\$101
Z18S4SHR	16 x 18 x 41.3-41.8	100	84	9.50	\$912	\$950	\$503	\$84
Z16S4SHR	16 x 16 x 41.3-41.8	100	76.65	8.50	\$855	\$893	\$496	\$84
Z15S4SHR	16 x 15 x 41.3-41.8	100	73.50	8	\$809	\$842	\$441	\$84
Z12S4SHR	16 x 12 x 41.3-41.8	92.5	65.10	6.50	\$749	\$778	\$398	\$69

Laminate doors are standard. **Includes two 3-position fixed/height adjustable shelves.** Standard with lock.

Required Specifications

- Top finish
- Top/edge detail
- Handles*
- Base finish

Optional Specifications

- HP laminate
- Glazed doors**
- Key #

STORAGE MODULES - 41.3"/41.8" HIGH

MODEL#	DIMENSIONS	FREIGHT CLASS	WT/LBS.	CUBIC FT.	1" TOP	1.5" TOP	GLAZE ADD	HP ADD
--------	------------	---------------	---------	-----------	--------	----------	-----------	--------

D x W x H

Z36L4SHN	24 x 36 x 41.3-41.8	125	162.55	25	\$1253	\$1332	N/A	\$195
Z30L4SHN	24 x 30 x 41.3-41.8	125	142.46	21.25	\$1155	\$1224	N/A	\$162
Z21L4SHN	24 x 21 x 41.3-41.8	125	111.80	15.25	\$991	\$1047	N/A	\$131
Z18L4SHN	24 x 18 x 41.3-41.8	125	101.23	13.25	\$937	\$984	N/A	\$101
Z16L4SHN	24 x 16 x 41.3-41.8	125	94.53	12	\$874	\$920	N/A	\$101
Z15L4SHN	24 x 15 x 41.3-41.8	100	91.70	11.25	\$845	\$883	N/A	\$101
Z12L4SHN	24 x 12 x 41.3-41.8	100	81.13	9.25	\$786	\$819	N/A	\$69
Z36M4SHN	20 x 36 x 41.3-41.8	125	141.59	21.25	\$1147	\$1216	N/A	\$195
Z30M4SHN	20 x 30 x 41.3-41.8	125	123.94	18	\$1043	\$1103	N/A	\$162
Z21M4SHN	20 x 21 x 41.3-41.8	125	102.19	13	\$876	\$923	N/A	\$131
Z18M4SHN	20 x 18 x 41.3-41.8	125	86.54	11.25	\$835	\$877	N/A	\$101
Z16M4SHN	20 x 16 x 41.3-41.8	125	81.01	10.25	\$773	\$815	N/A	\$101
Z15M4SHN	20 x 15 x 41.3-41.8	100	78.24	9.50	\$750	\$783	N/A	\$101
Z12M4SHN	20 x 12 x 41.3-41.8	100	69.95	8	\$698	\$728	N/A	\$69
Z36S4SHN	16 x 36 x 41.3-41.8	125	119.57	17.50	\$1004	\$1073	N/A	\$146
Z30S4SHN	16 x 30 x 41.3-41.8	125	111.72	14.50	\$906	\$953	N/A	\$131
Z21S4SHN	16 x 21 x 41.3-41.8	125	81.04	10.50	\$762	\$799	N/A	\$101
Z18S4SHN	16 x 18 x 41.3-41.8	125	72.91	9.50	\$738	\$780	N/A	\$84
Z16S4SHN	16 x 16 x 41.3-41.8	125	67.49	8.50	\$683	\$721	N/A	\$84
Z15S4SHN	16 x 15 x 41.3-41.8	100	64.78	8	\$653	\$685	N/A	\$84
Z12S4SHN	16 x 12 x 41.3-41.8	100	57.71	6.50	\$604	\$634	N/A	\$69

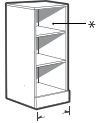

21", 18", 16", 15" & 12"

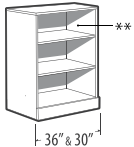

Open Storage Cabinet**



* Accepts collator 11" high
** Accepts collator 11.3" high

Includes two 3-position fixed/height adjustable shelves.

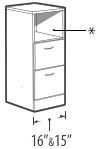
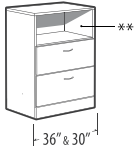

Two File Module with Open Shelf**†



* Accepts collator 11" high
** Accepts collator 11.3" high

Z36L4EN	24 x 36 x 41.3-41.8	125	199.50	25	\$2025	\$2104	N/A	\$195
Z30L4EN	24 x 30 x 41.3-41.8	100	178.50	21.25	\$1934	\$2001	N/A	\$162
Z16L4EN	24 x 16 x 41.3-41.8	100	116.55	12	\$1215	\$1262	N/A	\$101
Z15L4EN	24 x 15 x 41.3-41.8	100	112.35	11.25	\$1181	\$1219	N/A	\$101
Z36M4EN	20 x 36 x 41.3-41.8	100	182	21.25	\$1932	\$2001	N/A	\$195
Z30M4EN	20 x 30 x 41.3-41.8	100	163	18	\$1831	\$1889	N/A	\$162
Z16M4EN	20 x 16 x 41.3-41.8	92.5	105	10.25	\$1118	\$1160	N/A	\$101
Z15M4EN	20 x 15 x 41.3-41.8	92.5	101	9.50	\$1087	\$1120	N/A	\$101
Z36S4EN	16 x 36 x 41.3-41.8	100	153.30	17.50	\$1771	\$1838	N/A	\$146
Z30S4EN	16 x 30 x 41.3-41.8	100	131.25	14.50	\$1612	\$1658	N/A	\$131
Z16S4EN	16 x 16 x 41.3-41.8	92.5	85.05	8.50	\$1026	\$1064	N/A	\$84
Z15S4EN	16 x 15 x 41.3-41.8	92.5	82.95	8	\$1001	\$1033	N/A	\$84

Open fixed shelf and two file drawers on bottom. Lock secures all drawers. For filing capabilities, see page 121.

- Lateral file drawer construction is for accommodating hanging files NOT for stacking materials on the drawer bottom.



Three File Module†

Z36L43F	24 x 36 x 41.3-41.8	100	210	25	\$2380	\$2459	N/A	\$195
Z30L43F	24 x 30 x 41.3-41.8	100	190.05	21.25	\$2261	\$2330	N/A	\$162
Z16L43F	24 x 16 x 41.3-41.8	92.5	126	12	\$1398	\$1444	N/A	\$84
Z15L43F	24 x 15 x 41.3-41.8	92.5	120.75	11.25	\$1360	\$1398	N/A	\$84
Z36M43F	20 x 36 x 41.3-41.8	100	198.45	21.25	\$2316	\$2385	N/A	\$195
Z30M43F	20 x 30 x 41.3-41.8	100	177.45	18	\$2163	\$2223	N/A	\$162
Z16M43F	20 x 16 x 41.3-41.8	92.5	114.45	10.25	\$1304	\$1346	N/A	\$84
Z15M43F	20 x 15 x 41.3-41.8	92.5	110.25	9.50	\$1271	\$1304	N/A	\$84
Z36S43F	16 x 36 x 41.3-41.8	100	165.90	17.50	\$2090	\$2157	N/A	\$146
Z30S43F	16 x 30 x 41.3-41.8	92.5	148.05	14.50	\$1925	\$1972	N/A	\$131
Z16S43F	16 x 16 x 41.3-41.8	92.5	94.50	8.50	\$1233	\$1271	N/A	\$84
Z15S43F	16 x 15 x 41.3-41.8	92.5	91.35	8	\$1193	\$1226	N/A	\$84

Three file drawers. Lock secures all drawers. For filing capabilities, see page 121.

- Lateral file drawer construction is for accommodating hanging files NOT for stacking materials on the drawer bottom.

Required Specifications

Top finish
Top/edge detail
Handles*
Base finish

Optional Specifications

Glazed door*
HP laminate
Collator**

STORAGE MODULES - 41.3"/41.8" HIGH



Three File Module

MODEL#	DIMENSIONS D x W x H	FREIGHT CLASS	WT./LBS.	CUBIC FT.	1" TOP	1.5" TOP	GLAZE ADD	HP ADD
Z36L4S3F	24 x 36 x 41.3-41.8	100	233	25	\$2931	\$3010	N/A	\$195
Z36M4S3F	20 x 36 x 41.3-41.8	92.5	221	21.25	\$2843	\$2913	N/A	\$162

Three lateral file drawers with steel drawer interior. Steel drawer construction includes metal sides and masonite bottoms. Lock secures all drawers Front-to-back and side-to-side letter/legal filing capability. For filing capabilities, see page 121.

- Front-to-back filing bars sold separately. Order **FBB** bars. See "FBB" on page 41
- Lateral file drawer construction is for accommodating hanging files NOT for stacking materials on the drawer bottom.
- To prevent overloading, steel drawers do not include a back panel

STORAGE MODULES - 53" / 53.5" HIGH

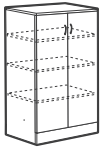

Glazed door option

Storage Cabinet with Doors**

MODEL#	DIMENSIONS	FREIGHT CLASS	WT./LBS.	CUBIC FT.	1" TOP	1.5" TOP	GLAZE ADD	HP ADD
Z36L5SH	24 x 36 x 53-53.5	125	229.95	31.25	\$1919	\$1998	\$1246	\$195
Z30L5SH	24 x 30 x 53-53.5	125	199.50	27	\$1748	\$1817	\$1082	\$162
Z36M5SH	20 x 36 x 53-53.5	125	203.70	27	\$1787	\$1856	\$1246	\$195
Z30M5SH	20 x 30 x 53-53.5	100	184.80	22.75	\$1569	\$1627	\$1082	\$162
Z36S5SH	16 x 36 x 53-53.5	100	175.35	21.75	\$1674	\$1741	\$1246	\$146
Z30S5SH	16 x 30 x 53-53.5	100	152.25	18.50	\$1467	\$1513	\$1082	\$131

Laminate doors are standard. **Includes three 3-position fixed/height adjustable shelves.** Standard with lock.

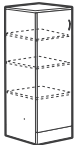

Glazed door option

Storage Cabinet with Door - LEFT**

Z21L5SHL	24 x 21 x 53-53.5	125	154.35	19.50	\$1382	\$1439	\$691	\$131
Z18L5SHL	24 x 18 x 53-53.5	100	139.65	17	\$1316	\$1363	\$620	\$101
Z16L5SHL	24 x 16 x 53-53.5	100	130.20	15.50	\$1246	\$1293	\$614	\$101
Z15L5SHL	24 x 15 x 53-53.5	100	124.95	14.25	\$1188	\$1226	\$539	\$101
Z12L5SHL	24 x 12 x 53-53.5	100	110.25	11.75	\$1106	\$1139	\$486	\$69
Z21M5SHL	20 x 21 x 53-53.5	100	142.80	16.50	\$1264	\$1311	\$691	\$131
Z18M5SHL	20 x 18 x 53-53.5	100	122.85	14.25	\$1197	\$1240	\$620	\$101
Z16M5SHL	20 x 16 x 53-53.5	100	113.40	13	\$1134	\$1176	\$614	\$101
Z15M5SHL	20 x 15 x 53-53.5	100	109.20	12.25	\$1077	\$1112	\$539	\$101
Z12M5SHL	20 x 12 x 53-53.5	100	96.60	10	\$999	\$1030	\$486	\$69
Z21S5SHL	16 x 21 x 53-53.5	100	116.55	13.25	\$1176	\$1213	\$691	\$101
Z18S5SHL	16 x 18 x 53-53.5	100	103.95	11.50	\$1118	\$1156	\$620	\$84
Z16S5SHL	16 x 16 x 53-53.5	100	96.60	10.50	\$1059	\$1097	\$614	\$84
Z15S5SHL	16 x 15 x 53-53.5	100	91.35	9.75	\$1019	\$1051	\$539	\$84
Z12S5SHL	16 x 12 x 53-53.5	100	79.80	8.25	\$937	\$967	\$486	\$69

Laminate doors are standard. **Includes three 3-position fixed/height adjustable shelves.** Standard with lock.

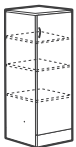

Glazed door option

Storage Cabinet with Door - RIGHT**

Z21L5SHR	24 x 21 x 53-53.5	125	154.35	19.50	\$1382	\$1439	\$691	\$131
Z18L5SHR	24 x 18 x 53-53.5	100	139.65	17	\$1316	\$1363	\$620	\$101
Z16L5SHR	24 x 16 x 53-53.5	100	130.20	15.50	\$1246	\$1293	\$614	\$101
Z15L5SHR	24 x 15 x 53-53.5	100	124.95	14.25	\$1188	\$1226	\$539	\$101
Z12L5SHR	24 x 12 x 53-53.5	100	110.25	11.75	\$1106	\$1139	\$486	\$69
Z21M5SHR	20 x 21 x 53-53.5	100	142.80	16.50	\$1264	\$1311	\$691	\$131
Z18M5SHR	20 x 18 x 53-53.5	100	122.85	14.25	\$1197	\$1240	\$620	\$101
Z16M5SHR	20 x 16 x 53-53.5	100	113.40	13	\$1134	\$1176	\$614	\$101
Z15M5SHR	20 x 15 x 53-53.5	100	109.20	12.25	\$1077	\$1112	\$539	\$101
Z12M5SHR	20 x 12 x 53-53.5	100	96.60	10	\$999	\$1030	\$486	\$69
Z21S5SHR	16 x 21 x 53-53.5	100	116.55	13.25	\$1176	\$1213	\$691	\$101
Z18S5SHR	16 x 18 x 53-53.5	100	103.95	11.50	\$1118	\$1156	\$620	\$84
Z16S5SHR	16 x 16 x 53-53.5	100	96.60	10.50	\$1059	\$1097	\$614	\$84
Z15S5SHR	16 x 15 x 53-53.5	100	91.35	9.75	\$1019	\$1051	\$539	\$84
Z12S5SHR	16 x 12 x 53-53.5	100	79.80	8.25	\$937	\$967	\$486	\$69

Laminate doors are standard. **Includes three 3-position fixed/height adjustable shelves.** Standard with lock.

Required Specifications

- Top finish
- Top/edge detail
- Handles
- Base finish

Optional Specifications

- Glazed doors*
- HP laminate
- Collator**

Box drawer† - no upcharge (30" - 36" wide models only)

STORAGE MODULES - 53" / 53.5" HIGH

MODEL# DIMENSIONS FREIGHT CLASS WT/LBS. CUBIC FT. 1" TOP 1.5" TOP GLAZE ADD HP ADD

D x W x H

Z36L5SHN	24 x 36 x 53-53.5	125	198.49	31.25	\$1493	\$1573	N/A	\$195
Z30L5SHN	24 x 30 x 53-53.5	125	173.45	27	\$1395	\$1464	N/A	\$162
Z21L5SHN	24 x 21 x 53-53.5	125	136.43	19.50	\$1147	\$1204	N/A	\$131
Z18L5SHN	24 x 18 x 53-53.5	125	124.44	17	\$1102	\$1149	N/A	\$101
Z16L5SHN	24 x 16 x 53-53.5	125	116.10	15.50	\$1030	\$1076	N/A	\$101
Z15L5SHN	24 x 15 x 53-53.5	125	112.45	14.25	\$996	\$1034	N/A	\$101
Z12L5SHN	24 x 12 x 53-53.5	100	100.46	11.75	\$930	\$963	N/A	\$69
Z36M5SHN	20 x 36 x 53-53.5	125	172.27	27	\$1359	\$1429	N/A	\$195
Z30M5SHN	20 x 30 x 53-53.5	125	158.08	22.75	\$1215	\$1275	N/A	\$162
Z21M5SHN	20 x 21 x 53-53.5	125	123.68	16.50	\$1026	\$1073	N/A	\$131
Z18M5SHN	20 x 18 x 53-53.5	125	106.61	14.25	\$980	\$1023	N/A	\$101
Z16M5SHN	20 x 16 x 53-53.5	125	99.43	13	\$916	\$958	N/A	\$101
Z15M5SHN	20 x 15 x 53-53.5	125	95.84	12.25	\$885	\$920	N/A	\$101
Z12M5SHN	20 x 12 x 53-53.5	100	85.07	10	\$822	\$853	N/A	\$69
Z36S5SHN	16 x 36 x 53-53.5	125	145.01	21.75	\$1187	\$1254	N/A	\$146
Z30S5SHN	16 x 30 x 53-53.5	125	126.96	18.50	\$1069	\$1115	N/A	\$131
Z21S5SHN	16 x 21 x 53-53.5	125	98.33	13.25	\$902	\$940	N/A	\$101
Z18S5SHN	16 x 18 x 53-53.5	125	88.78	11.50	\$864	\$906	N/A	\$84
Z16S5SHN	16 x 16 x 53-53.5	125	82.76	10.50	\$807	\$845	N/A	\$84
Z15S5SHN	16 x 15 x 53-53.5	100	78.18	9.75	\$794	\$826	N/A	\$84
Z12S5SHN	16 x 12 x 53-53.5	100	69.69	8.25	\$736	\$766	N/A	\$69

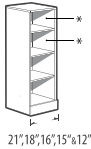
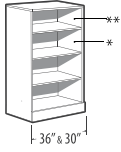

* Accepts collator 11" high
** Accepts collator 11.3" high

Open Storage Cabinet*

Includes three 3-position fixed/height adjustable shelves

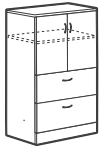

Glazed door option

Two File Module with Doors**

Z36L5E	24 x 36 x 53-53.5	100	250.95	31.25	\$2602	\$2682	\$762	\$195
Z30L5E	24 x 30 x 53-53.5	100	222.60	27	\$2427	\$2496	\$668	\$162
Z36M5E	20 x 36 x 53-53.5	100	229.95	27	\$2482	\$2552	\$792	\$195
Z30M5E	20 x 30 x 53-53.5	100	201.60	22.75	\$2261	\$2321	\$699	\$162
Z36S5E	16 x 36 x 53-53.5	100	193.20	21.75	\$2190	\$2257	\$792	\$146
Z30S5E	16 x 30 x 53-53.5	100	170.10	18.50	\$2015	\$2061	\$699	\$131

Two lateral file drawers on bottom. Laminate doors are standard. Includes one 3-position fixed/height adjustable shelf. Upper lock secures storage compartment. Lower lock secures two file drawers. For filing capabilities, see page 121.

- Lateral file drawer construction is for accommodating hanging files NOT for stacking materials on the drawer bottom.

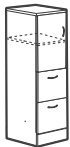

Glazed door option

Two File Module with Door - LEFT

Z16L5EL	24 x 16 x 53-53.5	100	144.90	15.50	\$1512	\$1558	\$387	\$101
Z15L5EL	24 x 15 x 53-53.5	100	139.65	14.25	\$1456	\$1494	\$348	\$101
Z16M5EL	20 x 16 x 53-53.5	92.5	130.20	13	\$1406	\$1448	\$386	\$101
Z15M5EL	20 x 15 x 53-53.5	92.5	126	12.25	\$1350	\$1385	\$348	\$101
Z16S5EL	16 x 16 x 53-53.5	92.5	109.20	10.50	\$1290	\$1328	\$386	\$84
Z15S5EL	16 x 15 x 53-53.5	92.5	105	9.75	\$1266	\$1299	\$348	\$84

Two file drawers on bottom. Laminate door is standard. Includes one 3-position fixed/height adjustable shelf. Upper lock secures storage compartment. Lower lock secures two file drawers.

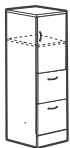

Glazed door option

Two File Module with Door - RIGHT

Z16L5ER	24 x 16 x 53-53.5	100	144.90	15.50	\$1512	\$1558	\$387	\$101
Z15L5ER	24 x 15 x 53-53.5	100	139.65	14.25	\$1456	\$1494	\$348	\$101
Z16M5ER	20 x 16 x 53-53.5	92.5	130.20	13	\$1406	\$1448	\$386	\$101
Z15M5ER	20 x 15 x 53-53.5	92.5	126	12.25	\$1350	\$1385	\$348	\$101
Z16S5ER	16 x 16 x 53-53.5	92.5	109.20	10.50	\$1290	\$1328	\$386	\$84
Z15S5ER	16 x 15 x 53-53.5	92.5	105	9.75	\$1266	\$1299	\$348	\$84

Two file drawers on bottom. Laminate door is standard. Includes one 3-position fixed/height adjustable shelf. Upper lock secures storage compartment. Lower lock secures two file drawers.

Required Specifications

- Top finish
- Top/edge detail
- Handles
- Base finish

Optional Specifications

- HP laminate
- Box drawer³ - no upcharge (30" - 36" wide models only)
- Collator*

STORAGE MODULES - 53" / 53.5" HIGH

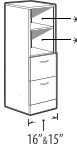
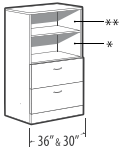

Two File Module with Open Shelves**



MODEL#	DIMENSIONS D x W x H	FREIGHT CLASS	WT./LBS.	CUBIC FT.	1" TOP	1.5" TOP	GLAZE ADD	HP ADD
Z36L5EN	24 x 36 x 53-53.5	125	235.45	31.25	\$2324	\$2404	N/A	\$195
Z30L5EN	24 x 30 x 53-53.5	125	209.86	27	\$2175	\$2242	N/A	\$162
Z16L5EN	24 x 16 x 53-53.5	100	137.89	15.50	\$1370	\$1416	N/A	\$101
Z15L5EN	24 x 15 x 53-53.5	100	133.80	14.25	\$1328	\$1366	N/A	\$101
Z36M5EN	20 x 36 x 53-53.5	125	213.43	27	\$2207	\$2276	N/A	\$195
Z30M5EN	20 x 30 x 53-53.5	100	188.19	22.75	\$2007	\$2067	N/A	\$162
Z16M5EN	20 x 16 x 53-53.5	100	123.33	13	\$1264	\$1306	N/A	\$101
Z15M5EN	20 x 15 x 53-53.5	100	119.29	12.25	\$1220	\$1253	N/A	\$101
Z36S5EN	16 x 36 x 53-53.5	100	178.82	21.75	\$1912	\$1979	N/A	\$146
Z30S5EN	16 x 30 x 53-53.5	100	158.12	18.50	\$1762	\$1808	N/A	\$131
Z16S5EN	16 x 16 x 53-53.5	100	102.46	10.50	\$1147	\$1185	N/A	\$84
Z15S5EN	16 x 15 x 53-53.5	92.5	98.48	9.75	\$1139	\$1171	N/A	\$84

Two open shelves and two file drawers on bottom. **Includes one 3-position fixed/height adjustable shelf.** Lock secures all drawers. For filing capabilities, see page 121.

- Lateral file drawer construction is for accommodating hanging files NOT for stacking materials on the drawer bottom.



Four File Module†

Z36L54F	24 x 36 x 53-53.5	100	256.20	31.25	\$2934	\$3013	N/A	\$195
Z30L54F	24 x 30 x 53-53.5	100	234.15	27	\$2814	\$2883	N/A	\$162
Z16L54F	24 x 16 x 53-53.5	92.5	155.40	15.50	\$1684	\$1730	N/A	\$101
Z15L54F	24 x 15 x 53-53.5	92.5	148.05	14.25	\$1628	\$1666	N/A	\$101
Z36M54F	20 x 36 x 53-53.5	100	239.40	27	\$2843	\$2912	N/A	\$195
Z30M54F	20 x 30 x 53-53.5	100	218.40	22.75	\$2670	\$2730	N/A	\$162
Z16M54F	20 x 16 x 53-53.5	92.5	141.75	13	\$1590	\$1632	N/A	\$101
Z15M54F	20 x 15 x 53-53.5	92.5	136.50	12.25	\$1535	\$1568	N/A	\$101
Z36S54F	16 x 36 x 53-53.5	100	205	21.75	\$2544	\$2611	N/A	\$146
Z30S54F	16 x 30 x 53-53.5	100	180	18.50	\$2318	\$2364	N/A	\$131
Z16S54F	16 x 16 x 53-53.5	92.5	122	10.50	\$1562	\$1600	N/A	\$84
Z15S54F	16 x 15 x 53-53.5	92.5	116	9.75	\$1505	\$1538	N/A	\$84

Four file drawers. Lock secures all drawers. For filing capabilities, see page 121.

- Lateral file drawer construction is for accommodating hanging files NOT for stacking materials on the drawer bottom.



Four File Module

Z36L5S4F	24 x 36 x 53-53.5	100	286	31.25	\$3508	\$3587	N/A	\$195
Z36M5S4F	20 x 36 x 53-53.5	100	269	27	\$3582	\$3652	N/A	\$195

Four file drawers with steel drawer interior. Steel drawer construction includes metal sides and masonite bottoms. Lock secures all drawers. Front-to-back and side-to-side letter/legal filing capability. For filing capabilities, see page 121.

- Front-to-back filing bars sold separately. Order **FBB** bars. See "FBB" on page 41.
- Lateral file drawer construction is for accommodating hanging files NOT for stacking materials on the drawer bottom.
- To prevent overloading, steel drawers do not include a back panel

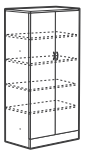

Storage Cabinet with Doors**



Z36L6SH	24 x 36 x 65.5-66	125	273	39	\$2273	\$2353	\$1475	N/A
Z30L6SH	24 x 30 x 65.5-66	125	238.35	32.75	\$1987	\$2056	\$1276	N/A
Z36M6SH	20 x 36 x 65.5-66	125	246.75	33.25	\$2109	\$2179	\$1475	N/A
Z30M6SH	20 x 30 x 65.5-66	125	212.10	27.75	\$1840	\$1898	\$1276	N/A
Z36S6SH	16 x 36 x 65.5-66	125	210	26.50	\$1908	\$1975	\$1475	N/A
Z30S6SH	16 x 30 x 65.5-66	100	183.75	22.50	\$1640	\$1687	\$1276	N/A

Laminate doors are standard. **Includes four 3-position fixed/height adjustable shelves.** Standard with lock.

Required Specifications

Top finish
Top/edge detail
Handles
Base finish

Optional Specifications

HP laminate
Collator*
Glazed doors**

STORAGE MODULES - 53" / 53.5" HIGH

MODEL# DIMENSIONS FREIGHT CLASS WT/LBS. CUBIC FT. 1" TOP 1.5" TOP GLAZE ADD HP ADD

D x W x H

Z21L6SHL	24 x 21 x 65.5-66	125	185.85	23.50	\$1629	\$1686	\$817	N/A
Z18L6SHL	24 x 18 x 65.5-66	100	168	20.50	\$1521	\$1568	\$736	N/A
Z16L6SHL	24 x 16 x 65.5-66	100	156.45	18.75	\$1434	\$1480	\$728	N/A
Z15L6SHL	24 x 15 x 65.5-66	100	149.10	17.50	\$1390	\$1428	\$637	N/A
Z12L6SHL	24 x 12 x 65.5-66	100	133.35	14.50	\$1263	\$1298	\$572	N/A
Z21M6SHL	20 x 21 x 65.5-66	100	170.10	20	\$1457	\$1504	\$817	N/A
Z18M6SHL	20 x 18 x 65.5-66	100	148.05	17.25	\$1390	\$1432	\$736	N/A
Z16M6SHL	20 x 16 x 65.5-66	100	137.55	15.75	\$1308	\$1350	\$728	N/A
Z15M6SHL	20 x 15 x 65.5-66	100	133.35	14.75	\$1247	\$1282	\$637	N/A
Z12M6SHL	20 x 12 x 65.5-66	100	116.55	12.25	\$1155	\$1186	\$572	N/A
Z21S6SHL	16 x 21 x 65.5-66	100	140.70	16	\$1344	\$1381	\$817	N/A
Z18S6SHL	16 x 18 x 65.5-66	100	126	14	\$1245	\$1283	\$736	N/A
Z16S6SHL	16 x 16 x 65.5-66	100	116.55	13	\$1170	\$1208	\$728	N/A
Z15S6SHL	16 x 15 x 65.5-66	100	111.30	12	\$1112	\$1145	\$637	N/A
Z12S6SHL	16 x 12 x 65.5-66	100	96.60	10	\$1020	\$1050	\$572	N/A

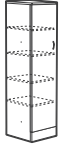

Glazed door option

Storage Cabinet with Door - LEFT**

Laminate doors are standard. Includes four 3-position fixed/height adjustable shelves. Standard with lock.

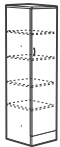

Glazed door option

Storage Cabinet with Door - RIGHT**

Z21L6SHR	24 x 21 x 65.5-66	125	185.85	23.50	\$1629	\$1686	\$817	N/A
Z18L6SHR	24 x 18 x 65.5-66	100	168	20.50	\$1521	\$1568	\$736	N/A
Z16L6SHR	24 x 16 x 65.5-66	100	156.45	18.75	\$1434	\$1480	\$728	N/A
Z15L6SHR	24 x 15 x 65.5-66	100	149.10	17.50	\$1390	\$1428	\$637	N/A
Z12L6SHR	24 x 12 x 65.5-66	100	133.35	14.50	\$1263	\$1298	\$572	N/A
Z21M6SHR	20 x 21 x 65.5-66	100	170.10	20	\$1457	\$1504	\$817	N/A
Z18M6SHR	20 x 18 x 65.5-66	100	148.05	17.25	\$1390	\$1432	\$736	N/A
Z16M6SHR	20 x 16 x 65.5-66	100	137.55	15.75	\$1308	\$1350	\$728	N/A
Z15M6SHR	20 x 15 x 65.5-66	100	133.35	14.75	\$1247	\$1282	\$637	N/A
Z12M6SHR	20 x 12 x 65.5-66	100	116.55	12.25	\$1155	\$1186	\$572	N/A
Z21S6SHR	16 x 21 x 65.5-66	100	140.70	16	\$1344	\$1381	\$817	N/A
Z18S6SHR	16 x 18 x 65.5-66	100	126	14	\$1245	\$1283	\$736	N/A
Z16S6SHR	16 x 16 x 65.5-66	100	116.55	13	\$1170	\$1208	\$728	N/A
Z15S6SHR	16 x 15 x 65.5-66	100	111.30	12	\$1112	\$1145	\$637	N/A
Z12S6SHR	16 x 12 x 65.5-66	100	96.60	10	\$1020	\$1050	\$572	N/A

Laminate doors are standard. Includes four 3-position fixed/height adjustable shelves. Standard with lock.

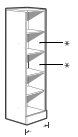
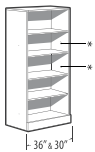

21" x 18" x 16" x 15" x 12"

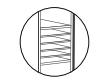

* Accepts collator 11" high

Open Storage Cabinet

Z36L6SHN	24 x 36 x 65.5-66	125	234.42	39	\$1761	\$1841	N/A	N/A
Z30L6SHN	24 x 30 x 65.5-66	125	205.50	32.75	\$1560	\$1629	N/A	N/A
Z21L6SHN	24 x 21 x 65.5-66	125	163.17	23.50	\$1354	\$1411	N/A	N/A
Z18L6SHN	24 x 18 x 65.5-66	125	148.71	20.50	\$1271	\$1318	N/A	N/A
Z16L6SHN	24 x 16 x 65.5-66	125	139.77	18.75	\$1183	\$1229	N/A	N/A
Z15L6SHN	24 x 15 x 65.5-66	125	134.25	17.50	\$1171	\$1209	N/A	N/A
Z12L6SHN	24 x 12 x 65.5-66	100	119.79	14.50	\$1063	\$1096	N/A	N/A
Z36M6SHN	20 x 36 x 65.5-66	125	206.11	33.25	\$1593	\$1662	N/A	N/A
Z30M6SHN	20 x 30 x 65.5-66	125	178.58	27.75	\$1410	\$1468	N/A	N/A
Z21M6SHN	20 x 21 x 65.5-66	125	146.22	20	\$1183	\$1230	N/A	N/A
Z18M6SHN	20 x 18 x 65.5-66	125	127.73	17.25	\$1142	\$1185	N/A	N/A
Z16M6SHN	20 x 16 x 65.5-66	125	119.95	15.75	\$1061	\$1103	N/A	N/A
Z15M6SHN	20 x 15 x 65.5-66	125	116.59	14.75	\$1029	\$1064	N/A	N/A
Z12M6SHN	20 x 12 x 65.5-66	100	102.30	12.25	\$957	\$987	N/A	N/A
Z36S6SHN	16 x 36 x 65.5-66	125	172.54	26.50	\$1397	\$1464	N/A	N/A
Z30S6SHN	16 x 30 x 65.5-66	125	151.66	22.50	\$1213	\$1260	N/A	N/A
Z21S6SHN	16 x 21 x 65.5-66	125	117.71	16	\$1068	\$1106	N/A	N/A
Z18S6SHN	16 x 18 x 65.5-66	125	105.70	14	\$996	\$1034	N/A	N/A
Z16S6SHN	16 x 16 x 65.5-66	125	99.09	13	\$926	\$964	N/A	N/A
Z15S6SHN	16 x 15 x 65.5-66	125	94.73	12	\$893	\$926	N/A	N/A
Z12S6SHN	16 x 12 x 65.5-66	100	83.76	10	\$822	\$852	N/A	N/A

Includes four 3-position fixed/height adjustable shelves.

Required Specifications

- Top finish
- Top/edge detail
- Handles
- Base finish

Optional Specifications

- HP laminate
- Collator*
- Glazed doors**

STORAGE MODULES - 65.5" / 66" HIGH

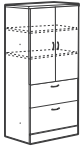

Glazed door option

Two File Module with Doors**

MODEL#	DIMENSIONS D x W x H	FREIGHT CLASS	WT./LBS.	CUBIC FT.	1" TOP	1.5" TOP	GLAZE ADD	HP ADD
Z36L6E	24 x 36 x 65.5-66	125	294	39	\$2867	\$2947	\$1021	N/A
Z30L6E	24 x 30 x 65.5-66	125	260.40	32.75	\$2621	\$2690	\$893	N/A
Z36M6E	20 x 36 x 65.5-66	100	269.85	33.25	\$2745	\$2814	\$1021	N/A
Z30M6E	20 x 30 x 65.5-66	100	236.25	27.75	\$2482	\$2542	\$893	N/A
Z36S6E	16 x 36 x 65.5-66	100	225	26.50	\$2349	\$2418	\$1021	N/A
Z30S6E	16 x 30 x 65.5-66	100	197	22.50	\$2247	\$2293	\$893	N/A

Two lateral file drawers on bottom. Laminate doors are standard. **Includes two 3-position fixed/height adjustable shelves.** Upper lock secures storage compartment. Lower lock secures two file drawers. For filing capabilities, see page 121.

- Lateral file drawer construction is for accommodating hanging files NOT for stacking materials on the drawer bottom.

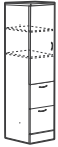

Glazed door option

Two File Module with Door - LEFT

Z16L6EL	24 x 16 x 65.5-66	100	171.15	18.75	\$1698	\$1745	\$499	N/A
Z15L6EL	24 x 15 x 65.5-66	100	163.80	17.50	\$1658	\$1696	\$444	N/A
Z16M6EL	20 x 16 x 65.5-66	100	153.30	15.75	\$1579	\$1621	\$499	N/A
Z15M6EL	20 x 15 x 65.5-66	92.5	148.05	14.75	\$1521	\$1556	\$444	N/A
Z16S6EL	16 x 16 x 65.5-66	100	129.15	13	\$1442	\$1480	\$499	N/A
Z15S6EL	16 x 15 x 65.5-66	92.5	123.90	12	\$1397	\$1430	\$444	N/A

Two file drawers on bottom. Laminate door is standard. **Includes two 3-position fixed/height adjustable shelves.** Upper lock secures storage compartment. Lower lock secures two file drawers.

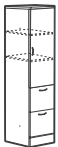

Glazed door option

Two File Module with Door - RIGHT

Z16L6ER	24 x 16 x 65.5-66	100	171.15	18.75	\$1698	\$1745	\$499	N/A
Z15L6ER	24 x 15 x 65.5-66	100	163.80	17.50	\$1658	\$1696	\$444	N/A
Z16M6ER	20 x 16 x 65.5-66	100	153.30	15.75	\$1579	\$1621	\$499	N/A
Z15M6ER	20 x 15 x 65.5-66	92.5	148.05	14.75	\$1521	\$1556	\$444	N/A
Z16S6ER	16 x 16 x 65.5-66	100	129.15	13	\$1442	\$1480	\$499	N/A
Z15S6ER	16 x 15 x 65.5-66	92.5	123.90	12	\$1397	\$1430	\$444	N/A

Two file drawers on bottom. Laminate door is standard. **Includes three 3-position fixed/height adjustable shelves.** Upper lock secures storage compartment. Lower lock secures two file drawers.

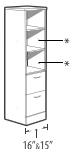
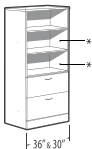

* Accepts collator 11" high

Two File Module with Open Shelves†

Z36L6EN	24 x 36 x 65.5-66	125	271.38	39	\$2504	\$2584	N/A	N/A
Z30L6EN	24 x 30 x 65.5-66	125	240.85	32.75	\$2295	\$2364	N/A	N/A
Z16L6EN	24 x 16 x 65.5-66	100	161.56	18.75	\$1524	\$1570	N/A	N/A
Z15L6EN	24 x 15 x 65.5-66	100	155.60	17.50	\$1503	\$1541	N/A	N/A
Z36M6EN	20 x 36 x 65.5-66	125	243.07	33.25	\$2381	\$2450	N/A	N/A
Z30M6EN	20 x 30 x 65.5-66	125	213.93	27.75	\$2158	\$2218	N/A	N/A
Z16M6EN	20 x 16 x 65.5-66	100	142.80	15.75	\$1407	\$1449	N/A	N/A
Z15M6EN	20 x 15 x 65.5-66	100	137.94	14.75	\$1365	\$1400	N/A	N/A
Z36S6EN	16 x 36 x 65.5-66	125	202.15	26.50	\$1983	\$2052	N/A	N/A
Z30S6EN	16 x 30 x 65.5-66	125	177.56	22.50	\$1921	\$1967	N/A	N/A
Z16S6EN	16 x 16 x 65.5-66	100	118.78	13	\$1267	\$1305	N/A	N/A
Z15S6EN	16 x 15 x 65.5-66	100	113.98	12	\$1242	\$1275	N/A	N/A

Three open shelves and two file drawers on bottom. **Includes two 3-position fixed/height adjustable shelves.** Lock secures all drawers. For filing capabilities, see page 121.

- Lateral file drawer construction is for accommodating hanging files NOT for stacking materials on the drawer bottom.

Required Specifications

Top finish
Top/edge detail
Handles
Base finish

Optional Specifications

HP laminate
Collator*
Glazed doors**

Box drawer† - no upcharge (30" - 36" wide models only)

WARDROBE MODULES - 65.5" / 66" HIGH

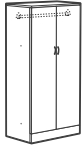

Wardrobe Cabinet

MODEL#	DIMENSIONS	FREIGHT CLASS	WT/LBS.	CUBIC FT.	1" TOP	1.5" TOP	GLAZE ADD	HP ADD
Z36L6WA	24 x 36 x 65.5-66	150	216.30	39	\$1947	\$2026	N/A	N/A
Z30L6WA	24 x 30 x 65.5-66	150	192.15	32.75	\$1753	\$1822	N/A	N/A
Z36M6WA	20 x 36 x 65.5-66	125	200.55	33.25	\$1865	\$1934	N/A	N/A
Z30M6WA	20 x 30 x 65.5-66	125	173.25	27.75	\$1651	\$1711	N/A	N/A

Laminate doors are standard. Full length hanging rod included. Standard with lock.



Wardrobe Cabinet - LEFT

MODEL#	DIMENSIONS	FREIGHT CLASS	WT/LBS.	CUBIC FT.	1" TOP	1.5" TOP	GLAZE ADD	HP ADD
Z24L6WAL	24 x 24 x 65.5-66	125	165.90	26.75	\$1608	\$1665	N/A	N/A
Z21L6WAL	24 x 21 x 65.5-66	125	152.25	23.50	\$1480	\$1536	N/A	N/A
Z18L6WAL	24 x 18 x 65.5-66	125	139.65	20.50	\$1314	\$1361	N/A	N/A
Z16L6WAL	24 x 16 x 65.5-66	125	132.30	18.75	\$1286	\$1333	N/A	N/A
Z15L6WAL	24 x 15 x 65.5-66	125	128.10	17.50	\$1233	\$1271	N/A	N/A
Z12L6WAL	24 x 12 x 65.5-66	125	115.50	14.50	\$1140	\$1173	N/A	N/A
Z24M6WAL	20 x 24 x 65.5-66	125	149.10	22.50	\$1383	\$1430	N/A	N/A
Z21M6WAL	20 x 21 x 65.5-66	125	143.85	20	\$1341	\$1387	N/A	N/A
Z18M6WAL	20 x 18 x 65.5-66	125	124.95	17.25	\$1214	\$1256	N/A	N/A
Z16M6WAL	20 x 16 x 65.5-66	125	116.55	15.75	\$1183	\$1225	N/A	N/A
Z15M6WAL	20 x 15 x 65.5-66	125	113.40	14.75	\$1113	\$1148	N/A	N/A
Z12M6WAL	20 x 12 x 65.5-66	100	102.90	12.25	\$1061	\$1091	N/A	N/A

Laminate doors are standard. Full length hanging rod included. Standard with lock.



Wardrobe Cabinet - RIGHT

MODEL#	DIMENSIONS	FREIGHT CLASS	WT/LBS.	CUBIC FT.	1" TOP	1.5" TOP	GLAZE ADD	HP ADD
Z24L6WAR	24 x 24 x 65.5-66	125	165.90	26.75	\$1608	\$1665	N/A	N/A
Z21L6WAR	24 x 21 x 65.5-66	125	152.25	23.50	\$1480	\$1536	N/A	N/A
Z18L6WAR	24 x 18 x 65.5-66	125	139.65	20.50	\$1314	\$1361	N/A	N/A
Z16L6WAR	24 x 16 x 65.5-66	125	132.30	18.75	\$1286	\$1333	N/A	N/A
Z15L6WAR	24 x 15 x 65.5-66	125	128.10	17.50	\$1233	\$1271	N/A	N/A
Z12L6WAR	24 x 12 x 65.5-66	125	115.50	14.50	\$1140	\$1173	N/A	N/A
Z24M6WAR	20 x 24 x 65.5-66	125	149.10	22.50	\$1383	\$1430	N/A	N/A
Z21M6WAR	20 x 21 x 65.5-66	125	143.85	20	\$1341	\$1387	N/A	N/A
Z18M6WAR	20 x 18 x 65.5-66	125	124.95	17.25	\$1214	\$1256	N/A	N/A
Z16M6WAR	20 x 16 x 65.5-66	125	116.55	15.75	\$1183	\$1225	N/A	N/A
Z15M6WAR	20 x 15 x 65.5-66	125	113.40	14.75	\$1113	\$1148	N/A	N/A
Z12M6WAR	20 x 12 x 65.5-66	100	102.90	12.25	\$1061	\$1091	N/A	N/A

Laminate doors are standard. Full length hanging rod included. Standard with lock.

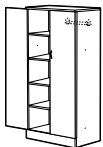

Wardrobe Cabinet/Shelving Combo with Doors - LEFT*



Glazed door option

MODEL#	DIMENSIONS	FREIGHT CLASS	WT/LBS.	CUBIC FT.	1" TOP	1.5" TOP	GLAZE ADD	HP ADD
Z36L6DIL	24 x 36 x 65.5-66	125	269.85	39	\$2325	\$2405	\$1475	N/A
Z30L6DIL	24 x 30 x 65.5-66	125	240.45	32.75	\$2060	\$2127	\$1276	N/A
Z24L6DIL	24 x 24 x 65.5-66	125	208.95	26.75	\$1922	\$1980	\$1153	N/A
Z21L6DIL	24 x 21 x 65.5-66	100	193.20	23.50	\$1805	\$1862	\$1142	N/A
Z36M6DIL	20 x 36 x 65.5-66	125	243.60	33.25	\$2187	\$2256	\$1475	N/A
Z30M6DIL	20 x 30 x 65.5-66	100	226.80	27.75	\$1910	\$1970	\$1276	N/A
Z24M6DIL	20 x 24 x 65.5-66	100	184.80	22.50	\$1713	\$1760	\$1153	N/A
Z21M6DIL	20 x 21 x 65.5-66	100	171.15	20	\$1664	\$1711	\$1142	N/A

Laminate doors are standard. Storage compartment on **left includes four 3-position fixed/height adjustable shelves**. Wardrobe compartment on **right** includes hanging rod. Two locks secure storage and wardrobe compartments.

Required Specifications

- Top finish
- Top/edge detail
- Handles
- Base finish

Optional Specifications

- Collator*
- Glazed doors**

WARDROBE MODULES - 65.5" / 66" HIGH

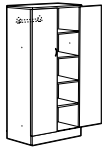

Glazed door option

Wardrobe Cabinet/Shelving Combo with Doors - RIGHT*

MODEL#	DIMENSIONS D x W x H	FREIGHT CLASS	WT./LBS.	CUBIC FT.	1"TOP	1.5" TOP	GLAZE ADD	HP ADD
Z36L6DIR	24 x 36 x 65.5-66	125	269.85	39	\$2325	\$2405	\$1475	N/A
Z30L6DIR	24 x 30 x 65.5-66	125	240.45	32.75	\$2060	\$2127	\$1276	N/A
Z24L6DIR	24 x 24 x 65.5-66	125	208.95	26.75	\$1922	\$1980	\$1153	N/A
Z21L6DIR	24 x 21 x 65.5-66	100	193.20	23.50	\$1805	\$1862	\$1142	N/A
Z36M6DIR	20 x 36 x 65.5-66	125	243.60	33.25	\$2187	\$2256	\$1475	N/A
Z30M6DIR	20 x 30 x 65.5-66	100	226.80	27.75	\$1910	\$1970	\$1276	N/A
Z24M6DIR	20 x 24 x 65.5-66	100	184.80	22.50	\$1713	\$1760	\$1153	N/A
Z21M6DIR	20 x 21 x 65.5-66	100	171.15	20	\$1664	\$1711	\$1142	N/A

Laminate doors are standard. Storage compartment on **right includes four 3-position fixed/height adjustable shelves**. Wardrobe compartment on **left** includes hanging rod. Two locks secure storage and wardrobe compartments.

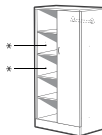

Glazed door option



* Accepts collator 11" high

Wardrobe Cabinet/Open Shelving Combo - LEFT*

Z36L6DINL	24 x 36 x 65.5-66	125	251.50	39	\$2077	\$2157	\$737	N/A
Z30L6DINL	24 x 30 x 65.5-66	125	224.46	32.75	\$1856	\$1925	\$638	N/A
Z24L6DINL	24 x 24 x 65.5-66	125	196.37	26.75	\$1750	\$1807	\$573	N/A
Z21L6DINL	24 x 21 x 65.5-66	125	183.37	23.50	\$1633	\$1690	\$570	N/A
Z36M6DINL	20 x 36 x 65.5-66	125	223.19	33.25	\$1943	\$2013	\$737	N/A
Z30M6DINL	20 x 30 x 65.5-66	125	197.54	27.75	\$1707	\$1767	\$638	N/A
Z24M6DINL	20 x 24 x 65.5-66	125	174.14	22.50	\$1542	\$1589	\$573	N/A
Z21M6DINL	20 x 21 x 65.5-66	125	159.07	20	\$1492	\$1539	\$570	N/A

Laminate door is standard. Storage compartment on **left includes four 3-position fixed/height adjustable shelves**. Wardrobe compartment on **right** includes hanging rod. Single lock secures storage and wardrobe compartments.



Glazed door option



* Accepts collator 11" high

Wardrobe Cabinet/Open Shelving Combo - RIGHT*

Z36L6DINR	24 x 36 x 65.5-66	125	251.50	39	\$2077	\$2157	\$737	N/A
Z30L6DINR	24 x 30 x 65.5-66	125	224.46	32.75	\$1856	\$1925	\$638	N/A
Z24L6DINR	24 x 24 x 65.5-66	125	196.37	26.75	\$1750	\$1807	\$573	N/A
Z21L6DINR	24 x 21 x 65.5-66	125	183.37	23.50	\$1633	\$1690	\$570	N/A
Z36M6DINR	20 x 36 x 65.5-66	125	223.19	33.25	\$1943	\$2013	\$737	N/A
Z30M6DINR	20 x 30 x 65.5-66	125	197.54	27.75	\$1707	\$1767	\$638	N/A
Z24M6DINR	20 x 24 x 65.5-66	125	174.14	22.50	\$1542	\$1589	\$573	N/A
Z21M6DINR	20 x 21 x 65.5-66	125	159.07	20	\$1492	\$1539	\$570	N/A

Laminate door is standard. Storage compartment on **right includes four 3-position fixed/height adjustable shelves**. Wardrobe compartment on **left** includes hanging rod. Single lock secures storage and wardrobe compartments.

PERSONAL TOWERS - 65.5" / 66" HIGH

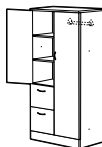

Glazed door option

Personal Tower with Doors - LEFT

MODEL#	DIMENSIONS D x W x H	FREIGHT CLASS	WT./LBS.	CUBIC FT.	1"TOP	1.5" TOP	GLAZE ADD	HP ADD
Z36L6EL	24 x 36 x 65.5-66	125	290.85	39	\$2551	\$2630	\$1239	N/A
Z30L6EL	24 x 30 x 65.5-66	100	266.70	32.75	\$2360	\$2429	\$1128	N/A
Z24L6EL	24 x 24 x 65.5-66	100	243.24	26.75	\$2263	\$2320	\$988	N/A
Z36M6EL	20 x 36 x 65.5-66	125	256.20	33.25	\$2414	\$2483	\$1239	N/A
Z30M6EL	20 x 30 x 65.5-66	100	229.95	27.75	\$2205	\$2265	\$1128	N/A
Z24M6EL	20 x 24 x 65.5-66	100	217	22.50	\$2114	\$2161	\$988	N/A

Two file drawers on bottom. Laminate doors are standard. Storage compartment on **left includes two 3-position fixed/height adjustable shelves**. Wardrobe compartment on **right** includes hanging rod. Two upper locks, one per each hinged door, and one lower lock secures drawers, all keyed alike.

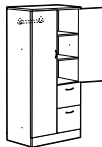

Glazed door option

Personal Tower with Doors - RIGHT

Z36L6ER	24 x 36 x 65.5-66	125	290.85	39	\$2551	\$2630	\$1239	N/A
Z30L6ER	24 x 30 x 65.5-66	100	266.70	32.75	\$2360	\$2429	\$1128	N/A
Z24L6ER	24 x 24 x 65.5-66	100	243.24	26.75	\$2263	\$2320	\$988	N/A
Z36M6ER	20 x 36 x 65.5-66	125	256.20	33.25	\$2414	\$2483	\$1239	N/A
Z30M6ER	20 x 30 x 65.5-66	100	229.95	27.75	\$2205	\$2265	\$1128	N/A
Z24M6ER	20 x 24 x 65.5-66	100	217	22.50	\$2114	\$2161	\$988	N/A

Two file drawers on bottom. Laminate doors are standard. Storage compartment on **right includes four 3-position fixed/height adjustable shelves**. Wardrobe compartment on **left** includes hanging rod. Two upper locks, one per each hinged door, and one lower lock secures drawers, all keyed alike.

Required Specifications

- Top finish
- Top/edge detail
- Handles
- Base finish

Optional Specifications

- Collator
- Glazed doors*

PERSONAL TOWERS - 65.5" / 66" HIGH

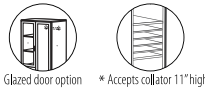
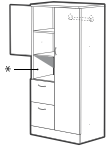

Personal Tower with Doors and cavity - LEFT*

MODEL#	DIMENSIONS D x W x H	FREIGHT CLASS	WT/LBS.	CUBIC FT.	1" TOP	1.5" TOP	GLAZE ADD	HP ADD
Z36L6ECL	24 x 36 x 65.5-66	125	288.74	39	\$2518	\$2598	\$1181	N/A
Z30L6ECL	24 x 30 x 65.5-66	100	264.24	32.75	\$2328	\$2397	\$1074	N/A
Z24L6ECL	24 x 24 x 65.5-66	100	239.24	26.75	\$2232	\$2289	\$931	N/A
Z36M6ECL	20 x 36 x 65.5-66	125	252.03	33.25	\$2371	\$2440	\$1181	N/A
Z30M6ECL	20 x 30 x 65.5-66	100	226.82	27.75	\$2160	\$2218	\$1074	N/A
Z24M6ECL	20 x 24 x 65.5-66	100	213	22.50	\$2085	\$2132	\$931	N/A

Two file drawers on bottom. Laminate doors are standard. Storage compartment on left includes one 3-position fixed/height adjustable shelf. Wardrobe compartment on right includes hanging rod. Two upper locks, one per each hinged door, and one lower lock secures drawers, all keyed alike.

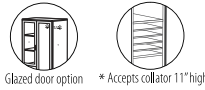
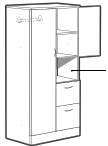

Personal Tower with Doors and cavity - RIGHT*

Z36L6ECR	24 x 36 x 65.5-66	125	288.74	39	\$2518	\$2598	\$1181	N/A
Z30L6ECR	24 x 30 x 65.5-66	100	264.24	32.75	\$2328	\$2397	\$1074	N/A
Z24L6ECR	24 x 24 x 65.5-66	100	239.24	26.75	\$2232	\$2289	\$931	N/A
Z36M6ECR	20 x 36 x 65.5-66	125	252.03	33.25	\$2371	\$2440	\$1181	N/A
Z30M6ECR	20 x 30 x 65.5-66	100	226.82	27.75	\$2160	\$2218	\$1074	N/A
Z24M6ECR	20 x 24 x 65.5-66	100	213	22.50	\$2085	\$2132	\$931	N/A

Two file drawers on bottom. Laminate doors are standard. Storage compartment on right includes one 3-position fixed/height adjustable shelf. Wardrobe compartment on left includes hanging rod. Two upper locks, one per each hinged door, and one lower lock secures drawers, all keyed alike.

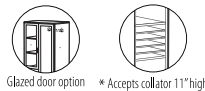
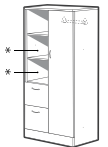

Personal Tower with Open Shelves - LEFT*

Z36L6ENL	24 x 36 x 65.5-66	125	280.48	39	\$2380	\$2459	\$741	N/A
Z30L6ENL	24 x 30 x 65.5-66	125	257.36	32.75	\$2187	\$2256	\$634	N/A
Z24L6ENL	24 x 24 x 65.5-66	100	230.24	26.75	\$2094	\$2151	\$492	N/A
Z36M6ENL	20 x 36 x 65.5-66	125	243.77	33.25	\$2230	\$2299	\$741	N/A
Z30M6ENL	20 x 30 x 65.5-66	125	219.94	27.75	\$2020	\$2080	\$634	N/A
Z24M6ENL	20 x 24 x 65.5-66	100	204	22.50	\$1915	\$1978	\$492	N/A

Two file drawers on bottom. Laminate doors are standard on wardrobe section. Storage compartment on left includes two 3-position fixed/height adjustable shelves. Wardrobe compartment on right includes hanging rod. Upper lock secures storage and wardrobe compartments. Lower lock secures all drawers.

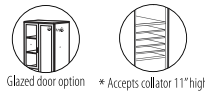
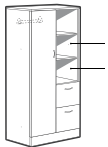

Personal Tower with Open*

Z36L6ENR	24 x 36 x 65.5-66	125	280.48	39	\$2380	\$2459	\$741	N/A
Z30L6ENR	24 x 30 x 65.5-66	125	257.36	32.75	\$2187	\$2256	\$634	N/A
Z24L6ENR	24 x 24 x 65.5-66	100	230.24	26.75	\$2094	\$2151	\$492	N/A
Z36M6ENR	20 x 36 x 65.5-66	125	243.77	33.25	\$2230	\$2299	\$741	N/A
Z30M6ENR	20 x 30 x 65.5-66	125	219.94	27.75	\$2020	\$2080	\$634	N/A
Z24M6ENR	20 x 24 x 65.5-66	100	204	22.50	\$1915	\$1978	\$492	N/A

Two file drawers on bottom. Laminate doors is standard on wardrobe section. Storage compartment on right includes two 3-position fixed/height adjustable shelves. Wardrobe compartment on left includes hanging rod. Upper lock secures storage and wardrobe compartments. Lower lock secures all drawers.

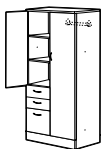

Personal Tower with Doors - LEFT

Z36L6BFL	24 x 36 x 65.5-66	125	294	39	\$2682	\$2761	\$1239	N/A
Z30L6BFL	24 x 30 x 65.5-66	100	268.80	32.75	\$2492	\$2561	\$1128	N/A
Z24L6BFL	24 x 24 x 65.5-66	100	244.24	26.75	\$2368	\$2426	\$988	N/A
Z36M6BFL	20 x 36 x 65.5-66	125	258.30	33.25	\$2554	\$2623	\$1239	N/A
Z30M6BFL	20 x 30 x 65.5-66	100	232.05	27.75	\$2343	\$2403	\$1128	N/A
Z24M6BFL	20 x 24 x 65.5-66	100	218	22.50	\$2222	\$2269	\$988	N/A

Two box and one file drawer on bottom. Laminate doors are standard. Storage compartment on left includes two 3-position fixed/height adjustable shelves. Wardrobe compartment on right includes hanging rod. Two upper locks, one per each hinged door, and one lower lock secures drawers, all keyed alike.

Required Specifications

- Top finish
- Top/edge detail
- Handles
- Base finish

Optional Specifications

- Collator**
- Glazed doors*
- Box drawer† - no upcharge (30"-36" wide models only)

PERSONAL TOWERS - 65.5" / 66" HIGH



Glazed door option

Personal Tower with Doors - RIGHT

MODEL#	DIMENSIONS D x W x H	FREIGHT CLASS	WT./LBS.	CUBIC FT.	1" TOP	1.5" TOP	GLAZE ADD	HP ADD
Z36L6BFR	24 x 36 x 65.5-66	125	294	39	\$2682	\$2761	\$1239	N/A
Z30L6BFR	24 x 30 x 65.5-66	100	268.80	32.75	\$2492	\$2561	\$1128	N/A
Z24L6BFR	24 x 24 x 65.5-66	100	244.24	26.75	\$2368	\$2426	\$988	N/A
Z36M6BFR	20 x 36 x 65.5-66	125	258.30	33.25	\$2554	\$2623	\$1239	N/A
Z30M6BFR	20 x 30 x 65.5-66	100	232.05	27.75	\$2343	\$2403	\$1128	N/A
Z24M6BFR	20 x 24 x 65.5-66	100	218	22.50	\$2222	\$2269	\$988	N/A

Two box and one file drawer on bottom. Laminate doors are standard. Storage compartment on **right** includes **two 3-position fixed/height adjustable shelves**. Wardrobe compartment on **left** includes hanging rod. Two upper locks, one per each hinged door, and one lower lock secures drawers, all keyed alike.

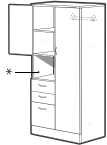

Glazed door option



* Accepts collator 11" high

Personal Tower with Doors*

Z36L6BFCL	24 x 36 x 65.5-66	125	291.89	39	\$2652	\$2732	\$1181	N/A
Z30L6BFCL	24 x 30 x 65.5-66	100	266.34	32.75	\$2462	\$2531	\$1074	N/A
Z24L6BFCL	24 x 24 x 65.5-66	100	240.24	26.75	\$2338	\$2396	\$931	N/A
Z36M6BFCL	20 x 36 x 65.5-66	125	254.13	33.25	\$2503	\$2572	\$1181	N/A
Z30M6BFCL	20 x 30 x 65.5-66	100	228.92	27.75	\$2290	\$2350	\$1074	N/A
Z24M6BFCL	20 x 24 x 65.5-66	100	214	22.50	\$2191	\$2238	\$931	N/A

Two box and one file drawer on bottom. Laminate doors are standard. Storage compartment on **left** includes **one 3-position fixed/height adjustable shelf**. Wardrobe compartment on **right** includes hanging rod. Two upper locks, one per each hinged door, and one lower lock secures drawers, all keyed alike.

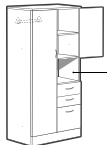

Glazed door option



* Accepts collator 11" high

Personal Tower with Doors and Cavity - RIGHT*

Z36L6BFCL	24 x 36 x 65.5-66	125	291.89	39	\$2652	\$2732	\$1181	N/A
Z30L6BFCL	24 x 30 x 65.5-66	100	266.34	32.75	\$2462	\$2531	\$1074	N/A
Z24L6BFCL	24 x 24 x 65.5-66	100	240.24	26.75	\$2338	\$2396	\$931	N/A
Z36M6BFCL	20 x 36 x 65.5-66	125	254.13	33.25	\$2503	\$2572	\$1181	N/A
Z30M6BFCL	20 x 30 x 65.5-66	100	228.92	27.75	\$2290	\$2350	\$1074	N/A
Z24M6BFCL	20 x 24 x 65.5-66	100	214	22.50	\$2191	\$2238	\$931	N/A

Two box and one file drawer on bottom. Laminate doors are standard. Storage compartment on **left** includes **one 3-position fixed/height adjustable shelf**. Wardrobe compartment on **right** includes hanging rod. Two upper locks, one per each hinged door, and one lower lock secures drawers, all keyed alike.

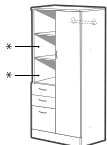

Glazed door option



* Accepts collator 11" high

Personal Tower with Open Shelves - LEFT*

Z36L6BFNL	24 x 36 x 65.5-66	125	280	39	\$2513	\$2592	\$741	N/A
Z30L6BFNL	24 x 30 x 65.5-66	125	257	32.75	\$2322	\$2391	\$634	N/A
Z24L6BFNL	24 x 24 x 65.5-66	100	232	26.75	\$2202	\$2259	\$492	N/A
Z36M6BFNL	20 x 36 x 65.5-66	125	242	33.25	\$2383	\$2452	\$741	N/A
Z30M6BFNL	20 x 30 x 65.5-66	125	219	27.75	\$2172	\$2232	\$634	N/A
Z24M6BFNL	20 x 24 x 65.5-66	100	206	22.50	\$2072	\$2119	\$492	N/A

Two box and one file drawer on bottom. Laminate doors are standard. Storage compartment on **left** includes **two 3-position fixed/height adjustable shelves**. Wardrobe compartment on **right** includes hanging rod. Upper lock secures storage and wardrobe compartments. Lower lock secures all drawers.

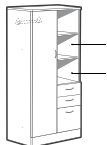

Glazed door option



* Accepts collator 11" high

Personal Tower with Open Shelves - RIGHT*

Z36L6BFNR	24 x 36 x 65.5-66	125	280	39	\$2513	\$2592	\$741	N/A
Z30L6BFNR	24 x 30 x 65.5-66	125	257	32.75	\$2322	\$2391	\$634	N/A
Z24L6BFNR	24 x 24 x 65.5-66	100	232	26.75	\$2202	\$2259	\$492	N/A
Z36M6BFNR	20 x 36 x 65.5-66	125	242	33.25	\$2383	\$2452	\$741	N/A
Z30M6BFNR	20 x 30 x 65.5-66	125	219	27.75	\$2172	\$2232	\$634	N/A
Z24M6BFNR	20 x 24 x 65.5-66	100	206	22.50	\$2072	\$2119	\$492	N/A

Two box and one file drawer on bottom. Laminate doors are standard. Storage compartment on **right** includes **two 3-position fixed/height adjustable shelves**. Wardrobe compartment on **left** includes hanging rod. Upper lock secures storage and wardrobe compartments. Lower lock secures all drawers.

Required Specifications

- Top finish
- Top/edge detail
- Handles
- Base finish

Optional Specifications

- Collator*
- Glazed doors
- Box drawer - no upcharge† (30"-36" wide models only)

STORAGE MODULES - 65.5" / 66" HIGH

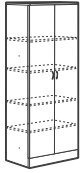

Glazed door option

Storage Cabinet with Doors

MODEL#	DIMENSIONS	FREIGHT CLASS	WT./LBS.	CUBIC FT.	1" TOP	1.5" TOP	GLAZE ADD	HP ADD	
D x W x H									
Z36L7SH	24 x 36 x 71.9-72.4	125	295.05	43.25	\$2374	\$2453	\$1590	N/A	
Z30L7SH	24 x 30 x 71.9-72.4	125	253.05	36.25	\$2072	\$2141	\$1376	N/A	
Z36M7SH	20 x 36 x 71.9-72.4	125	261.45	36.75	\$2204	\$2273	\$1590	N/A	
Z30M7SH	20 x 30 x 71.9-72.4	125	225.75	30.50	\$1910	\$1968	\$1376	N/A	
Z36S7SH	16 x 36 x 71.9-72.4	125	225.75	29.50	\$1976	\$2043	\$1590	N/A	
Z30S7SH	16 x 30 x 71.9-72.4	125	195.30	25	\$1736	\$1782	\$1376	N/A	

Laminate doors are standard. **Includes four 3-position fixed/height adjustable shelves.** Standard with lock.



Glazed door option

Storage Cabinet with Door - LEFT

Z21L7SHL	24 x 21 x 71.9-72.4	125	196.35	26	\$1716	\$1773	\$883	N/A
Z18L7SHL	24 x 18 x 71.9-72.4	125	178.50	22.75	\$1600	\$1647	\$792	N/A
Z16L7SHL	24 x 16 x 71.9-72.4	100	166.95	20.75	\$1504	\$1551	\$787	N/A
Z15L7SHL	24 x 15 x 71.9-72.4	100	160.65	19.25	\$1439	\$1477	\$683	N/A
Z12L7SHL	24 x 12 x 71.9-72.4	100	136.50	16	\$1321	\$1356	\$614	N/A
Z21M7SHL	20 x 21 x 71.9-72.4	100	174.30	21.25	\$1535	\$1581	\$883	N/A
Z18M7SHL	20 x 18 x 71.9-72.4	100	156.45	19.25	\$1465	\$1508	\$792	N/A
Z16M7SHL	20 x 16 x 71.9-72.4	100	147	17.50	\$1376	\$1418	\$787	N/A
Z15M7SHL	20 x 15 x 71.9-72.4	100	139.65	16.25	\$1313	\$1346	\$683	N/A
Z12M7SHL	20 x 12 x 71.9-72.4	100	123.90	13.25	\$1205	\$1235	\$614	N/A
Z21S7SHL	16 x 21 x 71.9-72.4	100	150.15	18	\$1416	\$1454	\$883	N/A
Z18S7SHL	16 x 18 x 71.9-72.4	100	134.40	15.50	\$1316	\$1358	\$792	N/A
Z16S7SHL	16 x 16 x 71.9-72.4	100	124.95	14	\$1263	\$1301	\$787	N/A
Z15S7SHL	16 x 15 x 71.9-72.4	100	118.65	12.50	\$1214	\$1246	\$683	N/A
Z12S7SHL	16 x 12 x 71.9-72.4	100	103.95	11	\$1066	\$1096	\$614	N/A

Laminate doors are standard. **Includes four 3-position fixed/height adjustable shelves.** Standard with lock.



Glazed door option

Storage Cabinet with Door - RIGHT

Z21L7SHR	24 x 21 x 71.9-72.4	125	196.35	26	\$1716	\$1773	\$883	N/A
Z18L7SHR	24 x 18 x 71.9-72.4	125	178.50	22.75	\$1600	\$1647	\$792	N/A
Z16L7SHR	24 x 16 x 71.9-72.4	100	166.95	20.75	\$1504	\$1551	\$787	N/A
Z15L7SHR	24 x 15 x 71.9-72.4	100	160.65	19.25	\$1439	\$1477	\$683	N/A
Z12L7SHR	24 x 12 x 71.9-72.4	100	136.50	16	\$1321	\$1356	\$614	N/A
Z21M7SHR	20 x 21 x 71.9-72.4	100	174.30	21.25	\$1535	\$1581	\$883	N/A
Z18M7SHR	20 x 18 x 71.9-72.4	100	156.45	19.25	\$1465	\$1508	\$792	N/A
Z16M7SHR	20 x 16 x 71.9-72.4	100	147	17.50	\$1376	\$1418	\$787	N/A
Z15M7SHR	20 x 15 x 71.9-72.4	100	139.65	16.25	\$1313	\$1346	\$683	N/A
Z12M7SHR	20 x 12 x 71.9-72.4	100	123.90	13.25	\$1205	\$1235	\$614	N/A
Z21S7SHR	16 x 21 x 71.9-72.4	100	150.15	18	\$1416	\$1454	\$883	N/A
Z18S7SHR	16 x 18 x 71.9-72.4	100	134.40	15.50	\$1316	\$1358	\$792	N/A
Z16S7SHR	16 x 16 x 71.9-72.4	100	124.95	14	\$1263	\$1301	\$787	N/A
Z15S7SHR	16 x 15 x 71.9-72.4	100	118.65	12.50	\$1214	\$1246	\$683	N/A
Z12S7SHR	16 x 12 x 71.9-72.4	100	103.95	11	\$1066	\$1096	\$614	N/A

Laminate doors are standard. **Includes four 3-position fixed/height adjustable shelves.** Standard with lock.

Required Specifications

- Top finish
- Top/edge detail
- Handles
- Base finish

Optional Specifications

- Collator*
- Glazed doors**
- Box drawer† - no upcharge (30"-36" wide models only)

STORAGE MODULES - 72" / 72.5" HIGH

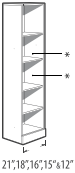
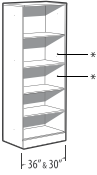

Open Storage Cabinet



MODEL#	DIMENSIONS D x W x H	FREIGHT CLASS	WT./LBS.	CUBIC FT.	1" TOP	1.5" TOP	GLAZE ADD	HP ADD
Z36L7SHN	24 x 36 x 71.9-72.4	150	249.61	43.25	\$1855	\$1935	N/A	N/A
Z30L7SHN	24 x 30 x 71.9-72.4	150	216.23	36.25	\$1644	\$1713	N/A	N/A
Z21L7SHN	24 x 21 x 71.9-72.4	125	171.94	26	\$1424	\$1481	N/A	N/A
Z18L7SHN	24 x 18 x 71.9-72.4	125	156.83	22.75	\$1340	\$1387	N/A	N/A
Z16L7SHN	24 x 16 x 71.9-72.4	125	147.10	20.75	\$1244	\$1290	N/A	N/A
Z15L7SHN	24 x 15 x 71.9-72.4	125	141.72	19.25	\$1207	\$1245	N/A	N/A
Z12L7SHN	24 x 12 x 71.9-72.4	125	121.35	16	\$1117	\$1235	N/A	N/A
Z36M7SHN	20 x 36 x 71.9-72.4	150	217.09	36.75	\$1684	\$1753	N/A	N/A
Z30M7SHN	20 x 30 x 71.9-72.4	125	188.26	30.50	\$1482	\$1542	N/A	N/A
Z21M7SHN	20 x 21 x 71.9-72.4	125	148.69	21.25	\$1128	\$1174	N/A	N/A
Z18M7SHN	20 x 18 x 71.9-72.4	125	134.80	19.25	\$1200	\$1243	N/A	N/A
Z16M7SHN	20 x 16 x 71.9-72.4	125	127.29	17.50	\$1113	\$1155	N/A	N/A
Z15M7SHN	20 x 15 x 71.9-72.4	125	121.96	16.25	\$1080	\$1115	N/A	N/A
Z12M7SHN	20 x 12 x 71.9-72.4	100	109.11	13.25	\$999	\$1029	N/A	N/A
Z36S7SHN	16 x 36 x 71.9-72.4	125	181.43	29.50	\$1457	\$1526	N/A	N/A
Z30S7SHN	16 x 30 x 71.9-72.4	125	158.19	25	\$1309	\$1355	N/A	N/A
Z21S7SHN	16 x 21 x 71.9-72.4	125	124.38	18	\$1125	\$1162	N/A	N/A
Z18S7SHN	16 x 18 x 71.9-72.4	125	112.77	15.50	\$1055	\$1097	N/A	N/A
Z16S7SHN	16 x 16 x 71.9-72.4	125	105.37	14	\$999	\$1037	N/A	N/A
Z15S7SHN	16 x 15 x 71.9-72.4	100	100.10	12.50	\$985	\$1017	N/A	N/A
Z12S7SHN	16 x 12 x 71.9-72.4	100	89.53	11	\$861	\$891	N/A	N/A

Four adjustable shelves.

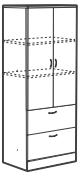

Two File Module with Doors*



Z36L7E	24 x 36 x 71.9-72.4	125	316.05	43.25	\$3028	\$3107	\$1252	N/A
Z30L7E	24 x 30 x 71.9-72.4	125	276.15	36.25	\$2765	\$2834	\$1091	N/A
Z36M7E	20 x 36 x 71.9-72.4	125	285.60	36.75	\$2866	\$2935	\$1252	N/A
Z30M7E	20 x 30 x 71.9-72.4	100	249.90	30.50	\$2613	\$2673	\$1091	N/A
Z36S7E	16 x 36 x 71.9-72.4	100	244.65	29.50	\$2619	\$2688	\$1252	N/A
Z30S7E	16 x 30 x 71.9-72.4	100	213.15	25	\$2361	\$2407	\$1091	N/A

Two lateral file drawers. Laminate doors are standard. **Includes two adjustable shelves.** Upper lock secures storage compartment. Lower lock secures two file drawers. For filing capabilities, see page 121.

- Lateral file drawer construction is for accommodating hanging files NOT for stacking materials on the drawer bottom.



Two File Module with Door - LEFT



Z16L7EL	24 x 16 x 71.9-72.4	100	181.65	20.75	\$1786	\$1833	\$617	N/A
Z15L7EL	24 x 15 x 71.9-72.4	100	176.40	19.25	\$1716	\$1754	\$542	N/A
Z16M7EL	20 x 16 x 71.9-72.4	100	162.75	17.50	\$1659	\$1701	\$617	N/A
Z15M7EL	20 x 15 x 71.9-72.4	100	155.40	16.25	\$1593	\$1628	\$542	N/A
Z16S7EL	16 x 16 x 71.9-72.4	100	137.55	14	\$1544	\$1582	\$617	N/A
Z15S7EL	16 x 15 x 71.9-72.4	92.5	132.30	12.50	\$1510	\$1542	\$542	N/A

Two file drawers on bottom. Laminate door is standard. **Includes two 3-position fixed/height adjustable shelves.** Upper lock secures storage compartment. Lower lock secures two file drawers.



Two File Module with Door - RIGHT



Z16L7ER	24 x 16 x 71.9-72.4	100	181.65	20.75	\$1786	\$1833	\$617	N/A
Z15L7ER	24 x 15 x 71.9-72.4	100	176.40	19.25	\$1716	\$1754	\$542	N/A
Z16M7ER	20 x 16 x 71.9-72.4	100	162.75	17.50	\$1659	\$1701	\$617	N/A
Z15M7ER	20 x 15 x 71.9-72.4	100	155.40	16.25	\$1593	\$1628	\$542	N/A
Z16S7ER	16 x 16 x 71.9-72.4	100	137.55	14	\$1544	\$1582	\$617	N/A
Z15S7ER	16 x 15 x 71.9-72.4	92.5	132.30	12.50	\$1510	\$1542	\$542	N/A

Two file drawers on bottom. Laminate door is standard. **Includes two 3-position fixed/height adjustable shelves.** Upper lock secures storage compartment. Lower lock secures two file drawers.

Required Specifications

- Top finish
- Top/edge detail
- Handles
- Base finish

Optional Specifications

- Collator*
- Glazed doors**
- Box drawer† - no upcharge (30" - 36" wide models only)

STORAGE MODULES - 72"/72.5" HIGH

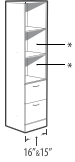
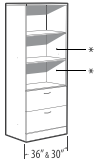

* Accepts collator 11" high

Two File Module with Open Shelves*

MODEL#	DIMENSIONS	FREIGHT CLASS	WT/LBS.	CUBIC FT.	1" TOP	1.5" TOP	GLAZE ADD	HP ADD
D x W x H								
Z36L7EN	24 x 36 x 71.9-72.4	125	286.57	43.25	\$2628	\$2708	N/A	N/A
Z30L7EN	24 x 30 x 71.9-72.4	125	252.63	36.25	\$2419	\$2488	N/A	N/A
Z16L7EN	24 x 16 x 71.9-72.4	100	168.90	20.75	\$1586	\$1632	N/A	N/A
Z15L7EN	24 x 15 x 71.9-72.4	100	164.12	19.25	\$1539	\$1577	N/A	N/A
Z36M7EN	20 x 36 x 71.9-72.4	125	257.21	36.75	\$2472	\$2542	N/A	N/A
Z30M7EN	20 x 30 x 71.9-72.4	125	225.71	30.50	\$2265	\$2325	N/A	N/A
Z16M7EN	20 x 16 x 71.9-72.4	100	150.13	17.50	\$1458	\$1500	N/A	N/A
Z15M7EN	20 x 15 x 71.9-72.4	100	144.36	16.25	\$1419	\$1452	N/A	N/A
Z36S7EN	16 x 36 x 71.9-72.4	125	216.29	29.50	\$2223	\$2290	N/A	N/A
Z30S7EN	16 x 30 x 71.9-72.4	125	189.34	25	\$2015	\$2061	N/A	N/A
Z16S7EN	16 x 16 x 71.9-72.4	100	125.06	14	\$1345	\$1383	N/A	N/A
Z15S7EN	16 x 15 x 71.9-72.4	100	120.40	12.50	\$1332	\$1365	N/A	N/A

Three open shelves and two file drawers on bottom. **Includes two 3-position fixed/height adjustable shelves.** Lock secures all drawers. For filing capabilities, see page 121.

- Lateral file drawer construction is for accommodating hanging files NOT for stacking materials on the drawer bottom.

WARDROBE CABINETS - 72"/72.5" HIGH



Wardrobe Cabinet

MODEL#	DIMENSIONS	FREIGHT CLASS	WT/LBS.	CUBIC FT.	1" TOP	1.5" TOP	GLAZE ADD	HP ADD
Z36L7WA	24 x 36 x 71.9-72.4	150	252	43.25	\$2158	\$2237	N/A	N/A
Z30L7WA	24 x 30 x 71.9-72.4	125	218.40	36.25	\$2015	\$2084	N/A	N/A
Z36M7WA	20 x 36 x 71.9-72.4	125	226.80	36.75	\$2029	\$2098	N/A	N/A
Z30M7WA	20 x 30 x 71.9-72.4	125	196.35	30.50	\$1801	\$1861	N/A	N/A

Laminate doors are standard. Full length hanging rod included. **Includes one 3-position fixed/height adjustable shelf** above hanging rod. Standard with lock.



Wardrobe Cabinet - LEFT

Z24L7WAL	24 x 24 x 71.9-72.4	125	191.10	29.75	\$1635	\$1692	N/A	N/A
Z21L7WAL	24 x 21 x 71.9-72.4	125	178.50	26	\$1577	\$1634	N/A	N/A
Z18L7WAL	24 x 18 x 71.9-72.4	125	158.55	22.75	\$1448	\$1495	N/A	N/A
Z16L7WAL	24 x 16 x 71.9-72.4	125	149.10	20.75	\$1390	\$1436	N/A	N/A
Z15L7WAL	24 x 15 x 71.9-72.4	125	144.90	19.25	\$1322	\$1360	N/A	N/A
Z12L7WAL	24 x 12 x 71.9-72.4	100	130.20	16	\$1232	\$1265	N/A	N/A
Z24M7WAL	20 x 24 x 71.9-72.4	125	171.15	25.25	\$1512	\$1561	N/A	N/A
Z21M7WAL	20 x 21 x 71.9-72.4	125	154.35	21.25	\$1449	\$1496	N/A	N/A
Z18M7WAL	20 x 18 x 71.9-72.4	125	139.65	19.25	\$1340	\$1382	N/A	N/A
Z16M7WAL	20 x 16 x 71.9-72.4	125	131.25	17.50	\$1278	\$1320	N/A	N/A
Z15M7WAL	20 x 15 x 71.9-72.4	125	126	16.25	\$1214	\$1249	N/A	N/A
Z12M7WAL	20 x 12 x 71.9-72.4	100	113.40	13.25	\$1139	\$1169	N/A	N/A

Laminate doors are standard. Full length hanging rod included. **Includes one 3-position fixed/height adjustable shelf** above hanging rod. Standard with lock.



Wardrobe Cabinet - RIGHT

Z24L7WAR	24 x 24 x 71.9-72.4	125	191.10	29.75	\$1635	\$1692	N/A	N/A
Z21L7WAR	24 x 21 x 71.9-72.4	125	178.50	26	\$1577	\$1634	N/A	N/A
Z18L7WAR	24 x 18 x 71.9-72.4	125	158.55	22.75	\$1448	\$1495	N/A	N/A
Z16L7WAR	24 x 16 x 71.9-72.4	125	149.10	20.75	\$1390	\$1436	N/A	N/A
Z15L7WAR	24 x 15 x 71.9-72.4	125	144.90	19.25	\$1322	\$1360	N/A	N/A
Z12L7WAR	24 x 12 x 71.9-72.4	100	130.20	16	\$1232	\$1265	N/A	N/A
Z24M7WAR	20 x 24 x 71.9-72.4	125	171.15	25.25	\$1512	\$1561	N/A	N/A
Z21M7WAR	20 x 21 x 71.9-72.4	125	154.35	21.25	\$1449	\$1496	N/A	N/A
Z18M7WAR	20 x 18 x 71.9-72.4	125	139.65	19.25	\$1340	\$1382	N/A	N/A
Z16M7WAR	20 x 16 x 71.9-72.4	125	131.25	17.50	\$1278	\$1320	N/A	N/A
Z15M7WAR	20 x 15 x 71.9-72.4	125	126	16.25	\$1214	\$1249	N/A	N/A
Z12M7WAR	20 x 12 x 71.9-72.4	100	113.40	13.25	\$1139	\$1169	N/A	N/A

Laminate doors are standard. Full length hanging rod included. **Includes one 3-position fixed/height adjustable shelf** above hanging rod. Standard with lock.

Required Specifications

- Top finish
- Top/edge detail
- Handles
- Base finish

Optional Specifications

- Glazed doors*

WARDROBE CABINETS - 72"/72.5" HIGH

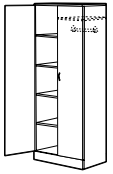

Wardrobe Cabinet/Shelving Combo with Doors - LEFT

MODEL#	DIMENSIONS D x W x H	FREIGHT CLASS	WT./LBS.	CUBIC FT.	1" TOP	1.5" TOP	GLAZE ADD	HP ADD
Z36L7DIL	24 x 36 x 71.9-72.4	125	300.30	43.25	\$2544	\$2624	\$1590	N/A
Z30L7DIL	24 x 30 x 71.9-72.4	125	262.50	36.25	\$2223	\$2292	\$1376	N/A
Z24L7DIL	24 x 24 x 71.9-72.4	125	232.05	29.75	\$2022	\$2079	\$1239	N/A
Z21L7DIL	24 x 21 x 71.9-72.4	125	200.55	26	\$1963	\$2019	\$1228	N/A
Z36M7DIL	20 x 36 x 71.9-72.4	125	276.15	36.75	\$2388	\$2457	\$1590	N/A
Z30M7DIL	20 x 30 x 71.9-72.4	125	241.50	30.50	\$2073	\$2133	\$1376	N/A
Z24M7DIL	20 x 24 x 71.9-72.4	100	214.20	25.25	\$1901	\$1948	\$1239	N/A
Z21M7DIL	20 x 21 x 71.9-72.4	100	196.35	21.25	\$1825	\$1872	\$1228	N/A

Laminate doors are standard. Storage compartment on **left includes four 3-position fixed/height adjustable shelves**. Wardrobe compartment on **right** includes hanging rod and one adjustable shelf above rod. Storage and wardrobe compartments lock independently. Each door lock keyed alike.

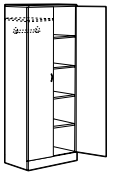

Wardrobe Cabinet/Shelving Combo with Doors - RIGHT

Z36L7DIR	24 x 36 x 71.9-72.4	125	300.30	43.25	\$2544	\$2624	\$1590	N/A
Z30L7DIR	24 x 30 x 71.9-72.4	125	262.50	36.25	\$2223	\$2292	\$1376	N/A
Z24L7DIR	24 x 24 x 71.9-72.4	125	232.05	29.75	\$2022	\$2079	\$1239	N/A
Z21L7DIR	24 x 21 x 71.9-72.4	125	200.55	26	\$1963	\$2019	\$1228	N/A
Z36M7DIR	20 x 36 x 71.9-72.4	125	276.15	36.75	\$2388	\$2457	\$1590	N/A
Z30M7DIR	20 x 30 x 71.9-72.4	125	241.50	30.50	\$2073	\$2133	\$1376	N/A
Z24M7DIR	20 x 24 x 71.9-72.4	100	214.20	25.25	\$1901	\$1948	\$1239	N/A
Z21M7DIR	20 x 21 x 71.9-72.4	100	196.35	21.25	\$1825	\$1872	\$1228	N/A

Laminate doors are standard. Storage compartment on **right includes four 3-position fixed/height adjustable shelves**. Wardrobe compartment on **left** includes hanging rod and one adjustable shelf above rod. Storage and wardrobe compartments lock independently. Each door lock keyed alike.

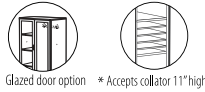
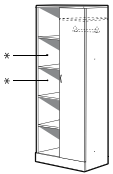

Wardrobe Cabinet/Open Shelving Combo - LEFT

Z36L7DINL	24 x 36 x 71.9-72.4	125	277.47	43.25	\$2295	\$2375	\$793	N/A
Z30L7DINL	24 x 30 x 71.9-72.4	125	244.53	36.25	\$2020	\$2089	\$686	N/A
Z24L7DINL	24 x 24 x 71.9-72.4	125	217.88	29.75	\$1840	\$1897	\$617	N/A
Z21L7DINL	24 x 21 x 71.9-72.4	125	189.33	26	\$1777	\$1834	\$611	N/A
Z36M7DINL	20 x 36 x 71.9-72.4	125	254.41	36.75	\$2139	\$2208	\$793	N/A
Z30M7DINL	20 x 30 x 71.9-72.4	125	222.86	30.50	\$1868	\$1928	\$686	N/A
Z24M7DINL	20 x 24 x 71.9-72.4	100	202.22	25.25	\$1716	\$1763	\$617	N/A
Z21M7DINL	20 x 21 x 71.9-72.4	100	183.93	21.25	\$1641	\$1688	\$611	N/A

Laminate door is standard on wardrobe section. Storage compartment on **left includes four 3-position fixed/height adjustable shelves**. Wardrobe compartment on **right** includes hanging rod and one adjustable shelf above rod. Single lock secures wardrobe compartment.

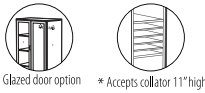
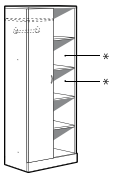

Wardrobe Cabinet/Open Shelving Combo - RIGHT

Z36L7DINR	24 x 36 x 71.9-72.4	125	277.47	43.25	\$2295	\$2375	\$793	N/A
Z30L7DINR	24 x 30 x 71.9-72.4	125	244.53	36.25	\$2020	\$2089	\$686	N/A
Z24L7DINR	24 x 24 x 71.9-72.4	125	217.88	29.75	\$1840	\$1897	\$617	N/A
Z21L7DINR	24 x 21 x 71.9-72.4	125	189.33	26	\$1777	\$1834	\$611	N/A
Z36M7DINR	20 x 36 x 71.9-72.4	125	254.41	36.75	\$2139	\$2208	\$793	N/A
Z30M7DINR	20 x 30 x 71.9-72.4	125	222.86	30.50	\$1868	\$1928	\$686	N/A
Z24M7DINR	20 x 24 x 71.9-72.4	100	202.22	25.25	\$1716	\$1763	\$617	N/A
Z21M7DINR	20 x 21 x 71.9-72.4	100	183.93	21.25	\$1641	\$1688	\$611	N/A

Laminate door is standard on wardrobe section. Storage compartment on **right includes four 3-position fixed/height adjustable shelves**. Wardrobe compartment on **left** includes hanging rod and one adjustable shelf above rod. Single lock secures wardrobe compartment.

Required Specifications

- Top finish
- Top/edge detail
- Handles
- Base finish

Optional Specifications

- Collator*
- Glazed doors

PERSONAL TOWERS - 72"/72.5" HIGH

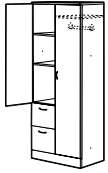

Glazed door option

Personal Tower with Doors - LEFT

MODEL#	DIMENSIONS D x W x H	FREIGHT CLASS	WT/LBS.	CUBIC FT.	1" TOP	1.5" TOP	GLAZE ADD	HP ADD
Z36L7EL	24 x 36 x 71.9-72.4	125	324.45	43.25	\$2788	\$2867	\$1410	N/A
Z30L7EL	24 x 30 x 71.9-72.4	125	289.80	36.25	\$2557	\$2626	\$1294	N/A
Z24L7EL	24 x 24 x 71.9-72.4	100	260.76	29.75	\$2436	\$2494	\$1145	N/A
Z36M7EL	20 x 36 x 71.9-72.4	125	288.75	36.75	\$2607	\$2677	\$1410	N/A
Z30M7EL	20 x 30 x 71.9-72.4	100	259.35	30.50	\$2391	\$2451	\$1294	N/A
Z24M7EL	20 x 24 x 71.9-72.4	100	231.65	25.25	\$2276	\$2323	\$1145	N/A

Two file drawers on bottom. Laminate doors are standard. Storage compartment on **left includes two 3-position fixed/height adjustable shelves**. Wardrobe compartment on **right** includes hanging rod and one adjustable shelf above rod. Two upper locks, one per each hinged door, and one lower lock secures drawers, all keyed alike.

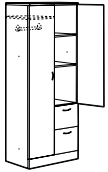

Glazed door option

Personal Tower with Doors - RIGHT

Z36L7ER	24 x 36 x 71.9-72.4	125	324.45	43.25	\$2788	\$2867	\$1410	N/A
Z30L7ER	24 x 30 x 71.9-72.4	125	289.80	36.25	\$2557	\$2626	\$1294	N/A
Z24L7ER	24 x 24 x 71.9-72.4	100	260.76	29.75	\$2436	\$2494	\$1145	N/A
Z36M7ER	20 x 36 x 71.9-72.4	125	288.75	36.75	\$2607	\$2677	\$1410	N/A
Z30M7ER	20 x 30 x 71.9-72.4	100	259.35	30.50	\$2391	\$2451	\$1294	N/A
Z24M7ER	20 x 24 x 71.9-72.4	100	231.65	25.25	\$2276	\$2323	\$1145	N/A

Two file drawers on bottom. Laminate doors are standard. Storage compartment on **right includes two 3-position fixed/height adjustable shelves**. Wardrobe compartment on **left** includes hanging rod and one adjustable shelf above rod. Two upper locks, one per each hinged door, and one lower lock secures drawers, all keyed alike.

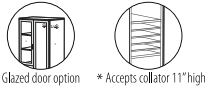
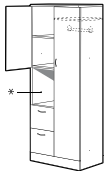

Glazed door option * Accepts collator 11" high

Personal Tower with Doors and cavity - LEFT

Z36L7ECL	24 x 36 x 71.9-72.4	125	320.24	43.25	\$2770	\$2850	\$1284	N/A
Z30L7ECL	24 x 30 x 71.9-72.4	125	287.34	36.25	\$2541	\$2610	\$1166	N/A
Z24L7ECL	24 x 24 x 71.9-72.4	100	257.23	29.75	\$2410	\$2467	\$1016	N/A
Z36M7ECL	20 x 36 x 71.9-72.4	125	285.63	36.75	\$2565	\$2634	\$1284	N/A
Z30M7ECL	20 x 30 x 71.9-72.4	100	256.22	30.50	\$2351	\$2409	\$1166	N/A
Z24M7ECL	20 x 24 x 71.9-72.4	100	228.11	25.25	\$2233	\$2280	\$1016	N/A

Two file drawers on bottom. Laminate doors are standard. Storage compartment on **left includes one 3-position fixed/height adjustable shelf**. Wardrobe compartment on **right** includes hanging rod and one adjustable shelf above rod. Two upper locks, one per each hinged door, and one lower lock secures drawers, all keyed alike.

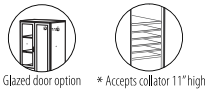
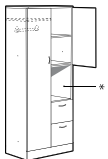

Glazed door option * Accepts collator 11" high

Personal Tower with Doors and cavity - RIGHT

Z36L7ECR	24 x 36 x 71.9-72.4	125	320.24	43.25	\$2770	\$2850	\$1284	N/A
Z30L7ECR	24 x 30 x 71.9-72.4	125	287.34	36.25	\$2541	\$2610	\$1166	N/A
Z24L7ECR	24 x 24 x 71.9-72.4	100	257.23	29.75	\$2410	\$2467	\$1016	N/A
Z36M7ECR	20 x 36 x 71.9-72.4	125	285.63	36.75	\$2565	\$2634	\$1284	N/A
Z30M7ECR	20 x 30 x 71.9-72.4	100	256.22	30.50	\$2351	\$2409	\$1166	N/A
Z24M7ECR	20 x 24 x 71.9-72.4	100	228.11	25.25	\$2233	\$2280	\$1016	N/A

Two file drawers on bottom. Laminate doors are standard. Storage compartment on **left includes one 3-position fixed/height adjustable shelf**. Wardrobe compartment on **right** includes hanging rod and one adjustable shelf above rod. Two upper locks, one per each hinged door, and one lower lock secures drawers, all keyed alike.

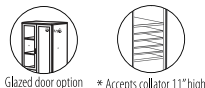
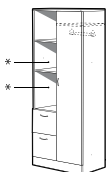

Glazed door option * Accepts collator 11" high

Personal Tower with Open Shelves - LEFT

Z36L7ENL	24 x 36 x 71.9-72.4	125	309.60	43.25	\$2630	\$2710	\$799	N/A
Z30L7ENL	24 x 30 x 71.9-72.4	125	278.48	36.25	\$2405	\$2474	\$681	N/A
Z24L7ENL	24 x 24 x 71.9-72.4	100	247.90	29.75	\$2286	\$2343	\$533	N/A
Z36M7ENL	20 x 36 x 71.9-72.4	125	274.99	36.75	\$2439	\$2508	\$799	N/A
Z30M7ENL	20 x 30 x 71.9-72.4	100	247.36	30.50	\$2226	\$2286	\$681	N/A
Z24M7ENL	20 x 24 x 71.9-72.4	100	218.79	25.25	\$2124	\$2173	\$533	N/A

Two file drawers on bottom. Laminate door is standard on wardrobe section. Storage compartment on **left includes two 3-position fixed/height adjustable shelves**. Wardrobe compartment on **right** includes hanging rod and one adjustable shelf above rod. Single lock secures wardrobe compartment. Lower lock secures all drawers.

Required Specifications

Top finish
Top/edge detail
Handles
Base finish

Optional Specifications

Collator*
Glazed doors

PERSONAL TOWERS - 72"/72.5" HIGH

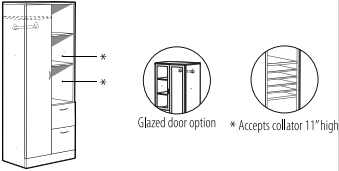

Personal Tower with Open Shelves - RIGHT

MODEL#	DIMENSIONS D x W x H	FREIGHT CLASS	WT./LBS.	CUBIC FT.	1" TOP	1.5" TOP	GLAZE ADD	HP ADD
Z36L7ENR	24 x 36 x 71.9-72.4	125	309.60	43.25	\$2630	\$2710	\$799	N/A
Z30L7ENR	24 x 30 x 71.9-72.4	125	278.48	36.25	\$2405	\$2474	\$681	N/A
Z24L7ENR	24 x 24 x 71.9-72.4	100	247.90	29.75	\$2286	\$2343	\$533	N/A
Z36M7ENR	20 x 36 x 71.9-72.4	125	274.99	36.75	\$2439	\$2508	\$799	N/A
Z30M7ENR	20 x 30 x 71.9-72.4	100	247.36	30.50	\$2226	\$2286	\$681	N/A
Z24M7ENR	20 x 24 x 71.9-72.4	100	218.79	25.25	\$2124	\$2173	\$533	N/A

Two file drawers on bottom. Laminate door is standard on wardrobe section. Storage compartment on **right includes two 3-position fixed/height adjustable shelves**. Wardrobe compartment on **left** includes hanging rod and one adjustable shelf above rod. Single lock secures wardrobe compartment. Lower lock secures all drawers.

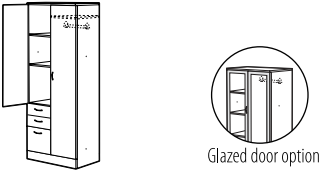

Personal Tower with Doors - LEFT

Z36L7BFL	24 x 36 x 71.9-72.4	125	326.55	43.25	\$2928	\$3007	\$1410	N/A
Z30L7BFL	24 x 30 x 71.9-72.4	100	292.95	36.25	\$2704	\$2773	\$1294	N/A
Z24L7BFL	24 x 24 x 71.9-72.4	100	262.10	29.75	\$2544	\$2601	\$1145	N/A
Z36M7BFL	20 x 36 x 71.9-72.4	125	291.90	36.75	\$2745	\$2814	\$1410	N/A
Z30M7BFL	20 x 30 x 71.9-72.4	100	262.50	30.50	\$2562	\$2620	\$1219	N/A
Z24M7BFL	20 x 24 x 71.9-72.4	100	232.98	25.25	\$2383	\$2430	\$1145	N/A

Two box and one file drawer on bottom. Laminate doors are standard. Storage compartment on **left includes two 3-position fixed/height adjustable shelves**. Wardrobe compartment on **right** includes hanging rod and one adjustable shelf above rod. Two upper locks, one per each hinged door, and one lower lock secures drawers, all keyed alike.

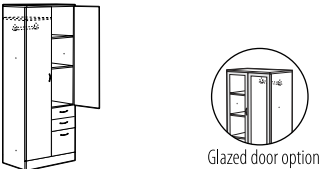

Personal Tower with Doors - RIGHT

Z36L7BFR	24 x 36 x 71.9-72.4	125	326.55	43.25	\$2928	\$3007	\$1410	N/A
Z30L7BFR	24 x 30 x 71.9-72.4	100	292.95	36.25	\$2704	\$2773	\$1294	N/A
Z24L7BFR	24 x 24 x 71.9-72.4	100	262.10	29.75	\$2544	\$2601	\$1145	N/A
Z36M7BFR	20 x 36 x 71.9-72.4	125	291.90	36.75	\$2745	\$2814	\$1410	N/A
Z30M7BFR	20 x 30 x 71.9-72.4	100	262.50	30.50	\$2562	\$2620	\$1219	N/A
Z24M7BFR	20 x 24 x 71.9-72.4	100	232.98	25.25	\$2383	\$2430	\$1145	N/A

Two box and one file drawer on bottom. Laminate doors are standard. Storage compartment on **right includes two 3-position fixed/height adjustable shelves**. Wardrobe compartment on **left** includes hanging rod and one adjustable shelf above rod. Two upper locks, one per each hinged door, and one lower lock secures drawers, all keyed alike.

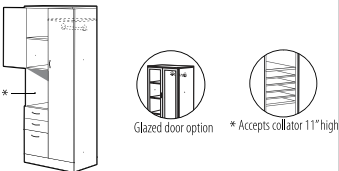

Personal Tower with Doors and Cavity - LEFT

Z36L7BFCL	24 x 36 x 71.9-72.4	125	317.68	43.25	\$2895	\$2942	\$1284	N/A
Z30L7BFCL	24 x 30 x 71.9-72.4	125	287	36.25	\$2675	\$2713	\$1166	N/A
Z24L7BFCL	24 x 24 x 71.9-72.4	100	258.59	29.75	\$2503	\$2560	\$1016	N/A
Z36M7BFCL	20 x 36 x 71.9-72.4	125	288.78	36.75	\$2695	\$2764	\$1284	N/A
Z30M7BFCL	20 x 30 x 71.9-72.4	100	259.37	30.50	\$2509	\$2569	\$1166	N/A
Z24M7BFCL	20 x 24 x 71.9-72.4	100	229.45	25.25	\$2339	\$2386	\$1016	N/A

Two box and one file drawer on bottom. Laminate doors are standard. Storage compartment on **left includes one 3-position fixed/height adjustable shelves**. Wardrobe compartment on **right** includes hanging rod and one adjustable shelf above rod. Two upper locks, one per each hinged door, and one lower lock secures drawers, all keyed alike.

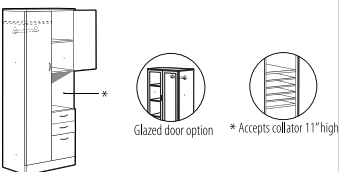

Personal Tower with Doors and Cavity - RIGHT

Z36L7BFCD	24 x 36 x 71.9-72.4	125	317.68	43.25	\$2895	\$2942	\$1284	N/A
Z30L7BFCD	24 x 30 x 71.9-72.4	125	287	36.25	\$2675	\$2713	\$1166	N/A
Z24L7BFCD	24 x 24 x 71.9-72.4	100	258.59	29.75	\$2503	\$2560	\$1016	N/A
Z36M7BFCD	20 x 36 x 71.9-72.4	125	288.78	36.75	\$2695	\$2764	\$1284	N/A
Z30M7BFCD	20 x 30 x 71.9-72.4	100	259.37	30.50	\$2509	\$2569	\$1166	N/A
Z24M7BFCD	20 x 24 x 71.9-72.4	100	229.45	25.25	\$2339	\$2386	\$1016	N/A

Two box and one file drawer on bottom. Laminate doors are standard. Storage compartment on **left includes one 3-position fixed/height adjustable shelves**. Wardrobe compartment on **right** includes hanging rod and one adjustable shelf above rod. Two upper locks, one per each hinged door, and one lower lock secures drawers, all keyed alike.

Required Specifications

- Top finish
- Top/edge detail
- Handles
- Base finish

Optional Specifications

- Collator*
- Glazed doors

PERSONAL TOWERS - 72"/72.5" HIGH

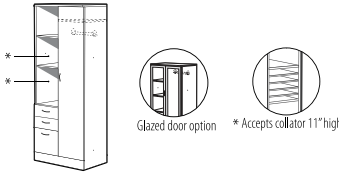

Personal Tower with Open Shelves - LEFT

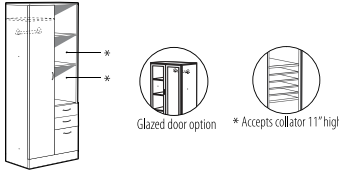

Personal Tower with Open Shelves - RIGHT

MODEL#	DIMENSIONS	FREIGHT CLASS	WT/LBS.	CUBIC FT.	1" TOP	1.5" TOP	GLAZE ADD	HP ADD
D x W x H								
Z36L7BFNL	24 x 36 x 71.9-72.4	125	309	43.25	\$2762	\$2816	\$799	N/A
Z30L7BFNL	24 x 30 x 71.9-72.4	125	277	36.25	\$2535	\$2577	\$681	N/A
Z24L7BFNL	24 x 24 x 71.9-72.4	100	249.24	29.75	\$2335	\$2392	\$533	N/A
Z36M7BFNL	20 x 36 x 71.9-72.4	125	274	36.75	\$2553	\$2623	\$799	N/A
Z30M7BFNL	20 x 30 x 71.9-72.4	100	246	30.50	\$2366	\$2426	\$681	N/A
Z24M7BFNL	20 x 24 x 71.9-72.4	100	220.12	25.25	\$2173	\$2220	\$533	N/A

Two box and one file drawer on bottom. Laminate doors are standard. Storage compartment on **left** includes **two 3-position fixed/height adjustable shelves**. Wardrobe compartment on **right** includes hanging rod and **one adjustable shelf** above rod. Upper lock secures wardrobe compartment. Lower lock secures all drawers.

Z36L7BFNR	24 x 36 x 71.9-72.4	125	309	43.25	\$2762	\$2816	\$799	N/A
Z30L7BFNR	24 x 30 x 71.9-72.4	125	277	36.25	\$2535	\$2577	\$681	N/A
Z24L7BFNR	24 x 24 x 71.9-72.4	100	249.24	29.75	\$2335	\$2392	\$533	N/A
Z36M7BFNR	20 x 36 x 71.9-72.4	125	274	36.75	\$2553	\$2623	\$799	N/A
Z30M7BFNR	20 x 30 x 71.9-72.4	100	246	30.50	\$2366	\$2426	\$681	N/A
Z24M7BFNR	20 x 24 x 71.9-72.4	100	220.12	25.25	\$2173	\$2220	\$533	N/A

Two box and one file drawer on bottom. Laminate doors are standard. Storage compartment on **right** includes **two 3-position fixed/height adjustable shelves**. Wardrobe compartment on **left** includes hanging rod and **one adjustable shelf** above rod. Upper lock secures wardrobe compartment. Lower lock secures all drawers.

STORAGE MODULES - 84.5"/85" HIGH

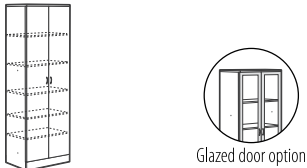

Storage Cabinet with Doors

MODEL#	DIMENSIONS	FREIGHT CLASS	WT/LBS.	CUBIC FT.	1" TOP	1.5" TOP	GLAZE ADD	HP ADD
Z36L8SH	24 x 36 x 84.4-84.9	125	332.85	50	\$2716	\$2796	\$1934	N/A
Z30L8SH	24 x 30 x 84.4-84.9	125	290.85	42	\$2409	\$2478	\$1655	N/A
Z36M8SH	20 x 36 x 84.4-84.9	125	299.25	42.25	\$2504	\$2573	\$1934	N/A
Z30M8SH	20 x 30 x 84.4-84.9	125	259.35	35.50	\$2239	\$2299	\$1655	N/A
Z36S8SH	16 x 36 x 84.4-84.9	125	259.35	34	\$2256	\$2323	\$1934	N/A
Z30S8SH	16 x 30 x 84.4-84.9	125	224.70	29	\$2011	\$2058	\$1655	N/A

Laminate doors are standard. **Includes five 3-position fixed/height adjustable shelves**. Standard with lock.

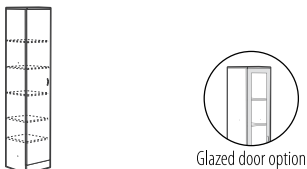

Storage Cabinet with Door - LEFT

Z21L8SHL	24 x 21 x 84.4-84.9	125	226.80	30.25	\$1965	\$2022	\$1079	N/A
Z18L8SHL	24 x 18 x 84.4-84.9	125	205.80	26.25	\$1848	\$1895	\$964	N/A
Z16L8SHL	24 x 16 x 84.4-84.9	125	186.90	24	\$1734	\$1780	\$957	N/A
Z15L8SHL	24 x 15 x 84.4-84.9	100	181.65	22.50	\$1711	\$1749	\$823	N/A
Z12L8SHL	24 x 12 x 84.4-84.9	100	163.80	18.50	\$1593	\$1626	\$736	N/A
Z21M8SHL	20 x 21 x 84.4-84.9	125	201.60	25.50	\$1774	\$1820	\$1079	N/A
Z18M8SHL	20 x 18 x 84.4-84.9	100	180.60	22.25	\$1700	\$1742	\$964	N/A
Z16M8SHL	20 x 16 x 84.4-84.9	100	169.05	20.25	\$1593	\$1635	\$957	N/A
Z15M8SHL	20 x 15 x 84.4-84.9	100	162.75	19	\$1527	\$1560	\$823	N/A
Z12M8SHL	20 x 12 x 84.4-84.9	100	144.90	15.75	\$1415	\$1445	\$736	N/A
Z21S8SHL	16 x 21 x 84.4-84.9	100	172.20	21	\$1622	\$1659	\$1079	N/A
Z18S8SHL	16 x 18 x 84.4-84.9	100	154.35	18	\$1518	\$1556	\$964	N/A
Z16S8SHL	16 x 16 x 84.4-84.9	100	142.80	16.50	\$1423	\$1461	\$957	N/A
Z15S8SHL	16 x 15 x 84.4-84.9	100	137.55	15.50	\$1357	\$1389	\$823	N/A
Z12S8SHL	16 x 12 x 84.4-84.9	100	120.75	13	\$1252	\$1281	\$736	N/A

Laminate doors are standard. **Includes five 3-position fixed/height adjustable shelves**. Standard with lock.

Required Specifications

- Top finish
- Top/edge detail
- Handles
- Base finish

Optional Specifications

- Collator*
- Glazed doors

STORAGE MODULES - 84.5"/85" HIGH

MODEL#	DIMENSIONS D x W x H	FREIGHT CLASS	WT./LBS.	CUBIC FT.	1" TOP	1.5" TOP	GLAZE ADD	HP ADD
Z21L8SHR	24 x 21 x 84.4-84.9	125	226.80	30.25	\$1965	\$2022	\$1079	N/A
Z18L8SHR	24 x 18 x 84.4-84.9	125	205.80	26.25	\$1848	\$1895	\$964	N/A
Z16L8SHR	24 x 16 x 84.4-84.9	125	186.90	24	\$1734	\$1780	\$957	N/A
Z15L8SHR	24 x 15 x 84.4-84.9	100	181.65	22.50	\$1711	\$1749	\$823	N/A
Z12L8SHR	24 x 12 x 84.4-84.9	100	163.80	18.50	\$1593	\$1626	\$736	N/A
Z21M8SHR	20 x 21 x 84.4-84.9	125	201.60	25.50	\$1774	\$1820	\$1079	N/A
Z18M8SHR	20 x 18 x 84.4-84.9	100	180.60	22.25	\$1700	\$1742	\$964	N/A
Z16M8SHR	20 x 16 x 84.4-84.9	100	169.05	20.25	\$1593	\$1635	\$957	N/A
Z15M8SHR	20 x 15 x 84.4-84.9	100	162.75	19	\$1527	\$1560	\$823	N/A
Z12M8SHR	20 x 12 x 84.4-84.9	100	144.90	15.75	\$1415	\$1445	\$736	N/A
Z21S8SHR	16 x 21 x 84.4-84.9	100	172.20	21	\$1622	\$1659	\$1079	N/A
Z18S8SHR	16 x 18 x 84.4-84.9	100	154.35	18	\$1518	\$1556	\$964	N/A
Z16S8SHR	16 x 16 x 84.4-84.9	100	142.80	16.50	\$1423	\$1461	\$957	N/A
Z15S8SHR	16 x 15 x 84.4-84.9	100	137.55	15.50	\$1357	\$1389	\$823	N/A
Z12S8SHR	16 x 12 x 84.4-84.9	100	120.75	13	\$1252	\$1281	\$736	N/A



Glazed door option

Storage Cabinet with Door - RIGHT

Laminate doors are standard. **Includes five 3-position fixed/height adjustable shelves.** Standard with lock.

Z36L8SHN	24 x 36 x 84.4-84.9	150	281.34	50	\$2111	\$2190	N/A	N/A
Z30L8SHN	24 x 30 x 84.4-84.9	150	247.23	42	\$1880	\$1949	N/A	N/A
Z21L8SHN	24 x 21 x 84.4-84.9	125	227.72	30.25	\$1626	\$1682	N/A	N/A
Z18L8SHN	24 x 18 x 84.4-84.9	125	206.74	26.25	\$1541	\$1588	N/A	N/A
Z16L8SHN	24 x 16 x 84.4-84.9	125	189.25	24	\$1430	\$1477	N/A	N/A
Z15L8SHN	24 x 15 x 84.4-84.9	100	182.61	22.50	\$1407	\$1445	N/A	N/A
Z12L8SHN	24 x 12 x 84.4-84.9	100	164.78	18.50	\$1350	\$1385	N/A	N/A
Z36M8SHN	20 x 36 x 84.4-84.9	150	245.68	42.25	\$1898	\$1967	N/A	N/A
Z30M8SHN	20 x 30 x 84.4-84.9	125	215.06	35.50	\$1711	\$1771	N/A	N/A
Z21M8SHN	20 x 21 x 84.4-84.9	125	170.18	25.50	\$1437	\$1484	N/A	N/A
Z18M8SHN	20 x 18 x 84.4-84.9	125	154.86	22.25	\$1390	\$1433	N/A	N/A
Z16M8SHN	20 x 16 x 84.4-84.9	125	145.71	20.25	\$1291	\$1333	N/A	N/A
Z15M8SHN	20 x 15 x 84.4-84.9	125	140.60	19	\$1257	\$1290	N/A	N/A
Z12M8SHN	20 x 12 x 84.4-84.9	100	126.34	15.75	\$1171	\$1201	N/A	N/A
Z36S8SHN	16 x 36 x 84.4-84.9	125	206.87	34	\$1651	\$1718	N/A	N/A
Z30S8SHN	16 x 30 x 84.4-84.9	125	180.79	29	\$1483	\$1529	N/A	N/A
Z21S8SHN	16 x 21 x 84.4-84.9	125	141.67	21	\$1285	\$1322	N/A	N/A
Z18S8SHN	16 x 18 x 84.4-84.9	125	127.58	18	\$1152	\$1190	N/A	N/A
Z16S8SHN	16 x 16 x 84.4-84.9	125	119.59	16.50	\$1118	\$1156	N/A	N/A
Z15S8SHN	16 x 15 x 84.4-84.9	125	115.59	15.50	\$1088	\$1120	N/A	N/A
Z12S8SHN	16 x 12 x 84.4-84.9	125	102.56	13	\$1007	\$1037	N/A	N/A

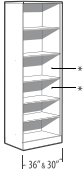

36" x 30"

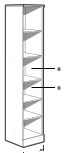

21"18"16"15"12"



* Accepts collator 11" high

Open Storage Cabinet

Five adjustable shelves.

Z36L8E	24 x 36 x 84.4-84.9	125	365.40	50	\$3369	\$3448	\$1443	N/A
Z30L8E	24 x 30 x 84.4-84.9	125	306.60	42	\$3068	\$3135	\$1246	N/A
Z36M8E	20 x 36 x 84.4-84.9	125	323.40	42.25	\$3167	\$3236	\$1443	N/A
Z30M8E	20 x 30 x 84.4-84.9	100	284.55	35.50	\$2916	\$2976	\$1246	N/A
Z36S8E	16 x 36 x 84.4-84.9	100	285	34	\$2892	\$2961	\$1443	N/A
Z30S8E	16 x 30 x 84.4-84.9	100	244.65	29	\$2614	\$2660	\$1246	N/A



Glazed door option

Two File Module with Doors*

Two lateral file drawers. Laminate doors are standard. **Includes three adjustable shelves.** Upper lock secures storage compartment. Lower lock secures two file drawers. For filing capabilities, see page 121.

- Lateral file drawer construction is for accommodating hanging files NOT for stacking materials on the drawer bottom.

Required Specifications

Finishes
Top/Edge Detail
Handles

Optional Specifications

Glazing - Doors
Collator (Open Shelves)

STORAGE MODULES - 84.5"/85" HIGH



Glazed door option

Two File Module with Door - LEFT



Glazed door option

Two File Module with Door - RIGHT

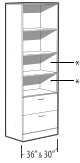

* Accepts collator 11" high

Two File Module with Open Shelves*

MODEL#	DIMENSIONS	FREIGHT CLASS	WT/LBS.	CUBIC FT.	1" TOP	1.5" TOP	GLAZE ADD	HP ADD	
D x W x H									
Z16L8EL	24 x 16 x 84.4-84.9	100	205.80	24	\$2006	\$2053	\$712	N/A	
Z15L8EL	24 x 15 x 84.4-84.9	100	192.15	22.50	\$1950	\$1988	\$620	N/A	
Z16M8EL	20 x 16 x 84.4-84.9	100	185.85	20.25	\$1880	\$1922	\$712	N/A	
Z15M8EL	20 x 15 x 84.4-84.9	100	179.55	19	\$1807	\$1842	\$620	N/A	
Z16S8EL	16 x 16 x 84.4-84.9	100	156.45	16.50	\$1708	\$1746	\$712	N/A	
Z15S8EL	16 x 15 x 84.4-84.9	100	149.10	15.50	\$1653	\$1685	\$620	N/A	

Two file drawers on bottom. Laminate door is standard. **Includes three 3-position fixed/height adjustable shelves.** Upper lock secures storage compartment. Lower lock secures two file drawers.

Z16L8ER	24 x 16 x 84.4-84.9	100	205.80	24	\$2006	\$2053	\$712	N/A
Z15L8ER	24 x 15 x 84.4-84.9	100	192.15	22.50	\$1950	\$1988	\$620	N/A
Z16M8ER	20 x 16 x 84.4-84.9	100	185.85	20.25	\$1880	\$1922	\$712	N/A
Z15M8ER	20 x 15 x 84.4-84.9	100	179.55	19	\$1807	\$1842	\$620	N/A
Z16S8ER	16 x 16 x 84.4-84.9	100	156.45	16.50	\$1708	\$1746	\$712	N/A
Z15S8ER	16 x 15 x 84.4-84.9	100	149.10	15.50	\$1653	\$1685	\$620	N/A

Two file drawers on bottom. Laminate door is standard. **Includes three 3-position fixed/height adjustable shelves.** Upper lock secures storage compartment. Lower lock secures two file drawers.

Z36L8EN	24 x 36 x 84.4-84.9	125	329.85	50	\$2888	\$2967	N/A	N/A
Z30L8EN	24 x 30 x 84.4-84.9	125	276.28	42	\$2644	\$2713	N/A	N/A
Z16L8EN	24 x 16 x 84.4-84.9	125	191.52	24	\$1762	\$1809	N/A	N/A
Z15L8EN	24 x 15 x 84.4-84.9	125	177.51	22.50	\$1736	\$1774	N/A	N/A
Z36M8EN	20 x 36 x 84.4-84.9	125	285.79	42.25	\$2685	\$2754	N/A	N/A
Z30M8EN	20 x 30 x 84.4-84.9	125	253.56	35.50	\$2497	\$2557	N/A	N/A
Z16M8EN	20 x 16 x 84.4-84.9	100	169.60	20.25	\$1636	\$1678	N/A	N/A
Z15M8EN	20 x 15 x 84.4-84.9	100	164.05	19	\$1592	\$1627	N/A	N/A
Z36S8EN	16 x 36 x 84.4-84.9	125	247	34	\$2232	\$2299	N/A	N/A
Z30S8EN	16 x 30 x 84.4-84.9	125	213	29	\$2014	\$2060	N/A	N/A
Z16S8EN	16 x 16 x 84.4-84.9	100	139.28	16.50	\$1465	\$1503	N/A	N/A
Z15S8EN	16 x 15 x 84.4-84.9	100	133.79	15.50	\$1437	\$1469	N/A	N/A

Four open shelves and two file drawers on bottom. **Includes two 3-position fixed/height adjustable shelves.** Lock secures all drawers. For filing capabilities, see page 121.

- Lateral file drawer construction is for accommodating hanging files NOT for stacking materials on the drawer bottom.

Required Specifications

Top finish
Base finish
Top/edge detail
Handles

Optional Specifications

Glazing - Doors
Collator (Open Shelves)

WARDROBE CABINETS - 84.5"/85" HIGH



Wardrobe Cabinet



Wardrobe Cabinet - LEFT



Wardrobe Cabinet - RIGHT

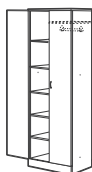

Glazed door option

Wardrobe Cabinet/Shelving Combo with Doors - LEFT



Glazed door option

Wardrobe Cabinet/Shelving Combo with Doors - RIGHT

MODEL#	DIMENSIONS D x W x H	FREIGHT CLASS	WT/LBS.	CUBIC FT.	1" TOP	1.5" TOP	GLAZE ADD	HP ADD
Z36L8WA	24 x 36 x 84.4-84.9	150	290.85	50	\$2519	\$2598	N/A	N/A
Z30L8WA	24 x 30 x 84.4-84.9	125	256.20	42	\$2262	\$2331	N/A	N/A
Z36M8WA	20 x 36 x 84.4-84.9	125	264.60	42.25	\$2354	\$2423	N/A	N/A
Z30M8WA	20 x 30 x 84.4-84.9	125	231	35.50	\$2127	\$2187	N/A	N/A

Laminate doors are standard. Full length hanging rod included. **One adjustable shelf** above hanging rod. Standard with lock.

Z24L8WAL	24 x 24 x 84.4-84.9	125	220.50	34.25	\$1888	\$1945	N/A	N/A
Z21L8WAL	24 x 21 x 84.4-84.9	125	192.15	30.25	\$1819	\$1875	N/A	N/A
Z18L8WAL	24 x 18 x 84.4-84.9	125	184.80	26.25	\$1695	\$1742	N/A	N/A
Z16L8WAL	24 x 16 x 84.4-84.9	125	172.20	24	\$1617	\$1663	N/A	N/A
Z15L8WAL	24 x 15 x 84.4-84.9	125	161.70	22.50	\$1571	\$1609	N/A	N/A
Z12L8WAL	24 x 12 x 84.4-84.9	100	150.15	18.50	\$1444	\$1479	N/A	N/A
Z24M8WAL	20 x 24 x 84.4-84.9	125	197.40	28.50	\$1759	\$1806	N/A	N/A
Z21M8WAL	20 x 21 x 84.4-84.9	125	182.70	25.50	\$1694	\$1741	N/A	N/A
Z18M8WAL	20 x 18 x 84.4-84.9	125	164.85	22.25	\$1570	\$1612	N/A	N/A
Z16M8WAL	20 x 16 x 84.4-84.9	125	154.35	20.25	\$1496	\$1538	N/A	N/A
Z15M8WAL	20 x 15 x 84.4-84.9	125	149.10	19	\$1436	\$1471	N/A	N/A
Z12M8WAL	20 x 12 x 84.4-84.9	100	133.35	15.75	\$1341	\$1371	N/A	N/A

Laminate doors are standard. Full length hanging rod included. **One adjustable shelf** above hanging rod. Standard with lock.

Z24L8WAR	24 x 24 x 84.4-84.9	125	220.50	34.25	\$1888	\$1945	N/A	N/A
Z21L8WAR	24 x 21 x 84.4-84.9	125	192.15	30.25	\$1819	\$1875	N/A	N/A
Z18L8WAR	24 x 18 x 84.4-84.9	125	184.80	26.25	\$1695	\$1742	N/A	N/A
Z16L8WAR	24 x 16 x 84.4-84.9	125	172.20	24	\$1617	\$1663	N/A	N/A
Z15L8WAR	24 x 15 x 84.4-84.9	125	161.70	22.50	\$1571	\$1609	N/A	N/A
Z12L8WAR	24 x 12 x 84.4-84.9	100	150.15	18.50	\$1444	\$1479	N/A	N/A
Z24M8WAR	20 x 24 x 84.4-84.9	125	197.40	28.50	\$1759	\$1806	N/A	N/A
Z21M8WAR	20 x 21 x 84.4-84.9	125	182.70	25.50	\$1694	\$1741	N/A	N/A
Z18M8WAR	20 x 18 x 84.4-84.9	125	164.85	22.25	\$1570	\$1612	N/A	N/A
Z16M8WAR	20 x 16 x 84.4-84.9	125	154.35	20.25	\$1496	\$1538	N/A	N/A
Z15M8WAR	20 x 15 x 84.4-84.9	125	149.10	19	\$1436	\$1471	N/A	N/A
Z12M8WAR	20 x 12 x 84.4-84.9	100	133.35	15.75	\$1341	\$1371	N/A	N/A

Laminate doors are standard. Full length hanging rod included. **One adjustable shelf** above hanging rod. Standard with lock.

Z36L8DIL	24 x 36 x 84.4-84.9	125	339	50	\$2913	\$2992	\$1934	N/A
Z30L8DIL	24 x 30 x 84.4-84.9	125	301	42	\$2557	\$2626	\$1655	N/A
Z24L8DIL	24 x 24 x 84.4-84.9	125	269	34.25	\$2313	\$2370	\$1518	N/A
Z21L8DIL	24 x 21 x 84.4-84.9	100	252	30.25	\$2239	\$2272	\$1505	N/A
Z36M8DIL	20 x 36 x 84.4-84.9	125	306	42.25	\$2742	\$2811	\$1934	N/A
Z30M8DIL	20 x 30 x 84.4-84.9	125	266	35.50	\$2416	\$2476	\$1655	N/A
Z24M8DIL	20 x 24 x 84.4-84.9	100	233	28.50	\$2180	\$2229	\$1518	N/A
Z21M8DIL	20 x 21 x 84.4-84.9	100	215	25.50	\$2072	\$2130	\$1505	N/A

Laminate doors are standard. Storage compartment on **left includes five adjustable shelves**. Wardrobe compartment on **right** includes hanging rod and **one adjustable shelf** above rod. Two locks secure storage and wardrobe.

Z36L8DIR	24 x 36 x 84.4-84.9	125	339	50	\$2913	\$2992	\$1934	N/A
Z30L8DIR	24 x 30 x 84.4-84.9	125	301	42	\$2557	\$2626	\$1655	N/A
Z24L8DIR	24 x 24 x 84.4-84.9	125	269	34.25	\$2313	\$2370	\$1518	N/A
Z21L8DIR	24 x 21 x 84.4-84.9	100	252	30.25	\$2239	\$2272	\$1505	N/A
Z36M8DIR	20 x 36 x 84.4-84.9	125	306	42.25	\$2742	\$2811	\$1934	N/A
Z30M8DIR	20 x 30 x 84.4-84.9	125	266	35.50	\$2416	\$2476	\$1655	N/A
Z24M8DIR	20 x 24 x 84.4-84.9	100	233	28.50	\$2180	\$2229	\$1518	N/A
Z21M8DIR	20 x 21 x 84.4-84.9	100	215	25.50	\$2072	\$2130	\$1505	N/A

Laminate doors are standard. Storage compartment on **right includes five adjustable shelves**. Wardrobe compartment on **left** includes hanging rod and **one adjustable shelf** above rod. Two locks secure storage and wardrobe.

Required Specifications

- Top finish
- Base finish
- Top/Edge Detail
- Handles

Optional Specifications

- Glazing - Doors
- Collator (Open Shelves)
- Box drawer* - no upcharge (30"-36" wide models only)

WARDROBE CABINETS - 84.5"/85" HIGH

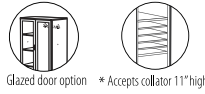
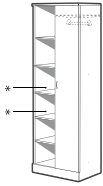

Wardrobe Cabinet/Open Shelving Combo - LEFT

MODEL#	DIMENSIONS	FREIGHT CLASS	WT./LBS.	CUBIC FT.	1" TOP	1.5" TOP	GLAZE ADD	HP ADD	
D x W x H									
Z36L8DINL	24 x 36 x 84.4-84.9	125	312	50	\$2608	\$2687	\$964	N/A	
Z30L8DINL	24 x 30 x 84.4-84.9	125	278	42	\$2289	\$2358	\$823	N/A	
Z24L8DINL	24 x 24 x 84.4-84.9	125	245	34.25	\$2095	\$2152	\$736	N/A	
Z21L8DINL	24 x 21 x 84.4-84.9	125	236	30.25	\$2041	\$2066	\$731	N/A	
Z36M8DINL	20 x 36 x 84.4-84.9	125	275	42.25	\$2436	\$2505	\$964	N/A	
Z30M8DINL	20 x 30 x 84.4-84.9	125	243	35.50	\$2153	\$2213	\$823	N/A	
Z24M8DINL	20 x 24 x 84.4-84.9	125	215	28.50	\$1962	\$2009	\$736	N/A	
Z21M8DINL	20 x 21 x 84.4-84.9	125	199	25.50	\$1875	\$1922	\$731	N/A	

Laminate door is standard on wardrobe section. Storage compartment on **left includes five adjustable shelves**. Wardrobe compartment on **right** includes hanging rod and **one adjustable shelf** above rod. Single lock secures wardrobe compartment.

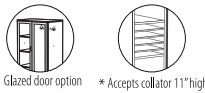
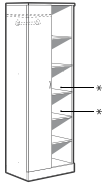

Wardrobe Cabinet/Open Shelving Combo - RIGHT

Z36L8DINR	24 x 36 x 84.4-84.9	125	312	50	\$2608	\$2687	\$964	N/A
Z30L8DINR	24 x 30 x 84.4-84.9	125	278	42	\$2289	\$2358	\$823	N/A
Z24L8DINR	24 x 24 x 84.4-84.9	125	245	34.25	\$2095	\$2152	\$736	N/A
Z21L8DINR	24 x 21 x 84.4-84.9	125	236	30.25	\$2041	\$2066	\$731	N/A
Z36M8DINR	20 x 36 x 84.4-84.9	125	275	42.25	\$2436	\$2505	\$964	N/A
Z30M8DINR	20 x 30 x 84.4-84.9	125	243	35.50	\$2153	\$2213	\$823	N/A
Z24M8DINR	20 x 24 x 84.4-84.9	125	215	28.50	\$1962	\$2009	\$736	N/A
Z21M8DINR	20 x 21 x 84.4-84.9	125	199	25.50	\$1875	\$1922	\$731	N/A

Laminate door is standard on wardrobe section. Storage compartment on **right includes five adjustable shelves**. Wardrobe compartment on **left** includes hanging rod and **one adjustable shelf** above rod. Single lock secures wardrobe compartment.

PERSONAL TOWERS - 84.5"/85" HIGH

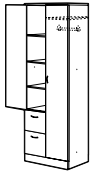

Personal Tower with Doors - LEFT

MODEL#	DIMENSIONS	FREIGHT CLASS	WT./LBS.	CUBIC FT.	1" TOP	1.5" TOP	GLAZE ADD	HP ADD
Z36L8EL	24 x 36 x 84.4-84.9	125	368.55	50	\$3112	\$3192	\$1676	N/A
Z30L8EL	24 x 30 x 84.4-84.9	125	334.95	42	\$2841	\$2910	\$1530	N/A
Z24L8EL	24 x 24 x 84.4-84.9	100	299.24	34.25	\$2746	\$2804	\$1320	N/A
Z36M8EL	20 x 36 x 84.4-84.9	125	332.85	42.25	\$2941	\$3010	\$1676	N/A
Z30M8EL	20 x 30 x 84.4-84.9	100	298.20	35.50	\$2712	\$2772	\$1530	N/A
Z24M8EL	20 x 24 x 84.4-84.9	100	266	29	\$2586	\$2633	\$1320	N/A

Two file drawers on bottom. Laminate doors are standard. Storage compartment on **left includes three adjustable shelves**. Wardrobe compartment on **right** includes hanging rod and **one adjustable shelf** above rod. Two upper locks secure storage and wardrobe compartments. Lower lock secures all drawers.

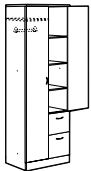

Personal Tower with Doors - RIGHT

Z36L8ER	24 x 36 x 84.4-84.9	125	368.55	50	\$3112	\$3192	\$1676	N/A
Z30L8ER	24 x 30 x 84.4-84.9	125	334.95	42	\$2841	\$2910	\$1530	N/A
Z24L8ER	24 x 24 x 84.4-84.9	100	299.24	34.25	\$2746	\$2804	\$1320	N/A
Z36M8ER	20 x 36 x 84.4-84.9	125	332.85	42.25	\$2941	\$3010	\$1676	N/A
Z30M8ER	20 x 30 x 84.4-84.9	100	298.20	35.50	\$2712	\$2772	\$1530	N/A
Z24M8ER	20 x 24 x 84.4-84.9	100	266	29	\$2586	\$2633	\$1320	N/A

Two file drawers on bottom. Laminate doors are standard. Storage compartment on **right includes three adjustable shelves**. Wardrobe compartment on **left** includes hanging rod and **one adjustable shelf** above rod. Two upper locks secure storage and wardrobe compartments. Lower lock secures all drawers.

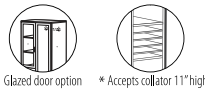
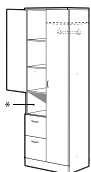

Personal Tower with Doors and cavity - LEFT

Z36L8ECL	24 x 36 x 84.4-84.9	125	366.44	50	\$3082	\$3161	\$1583	N/A
Z30L8ECL	24 x 30 x 84.4-84.9	125	332.49	42	\$2812	\$2881	\$1436	N/A
Z24L8ECL	24 x 24 x 84.4-84.9	100	295.24	34.25	\$2705	\$2762	\$1227	N/A
Z36M8ECL	20 x 36 x 84.4-84.9	125	328.68	42.25	\$2895	\$2964	\$1583	N/A
Z30M8ECL	20 x 30 x 84.4-84.9	100	295.07	35.50	\$2667	\$2725	\$1436	N/A
Z24M8ECL	20 x 24 x 84.4-84.9	100	263	29	\$2544	\$2591	\$1227	N/A

Two file drawers on bottom. Laminate doors are standard. Storage compartment on **left includes two 3-position fixed/height adjustable shelves**. Wardrobe compartment on **right** includes hanging rod and **one adjustable shelf** above rod. Two upper locks secure storage and wardrobe compartments. Lower lock secures all drawers.

Required Specifications

- Top finish
- Base finish
- Top/Edge Detail
- Handles

Optional Specifications

- Glazing - Doors
- Collator (Open Shelves)
- Box drawer - no upcharge* (30"-36" wide models only)

PERSONAL TOWERS - 84.5"/85" HIGH

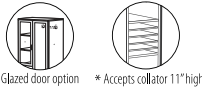
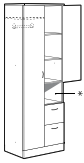

Personal Tower with Doors and cavity - RIGHT

MODEL#	DIMENSIONS D x W x H	FREIGHT CLASS	WT./LBS.	CUBIC FT.	1" TOP	1.5" TOP	GLAZE ADD	HP ADD
Z36L8ECR	24 x 36 x 84.4-84.9	125	366.44	50	\$3082	\$3161	\$1583	N/A
Z30L8ECR	24 x 30 x 84.4-84.9	125	332.49	42	\$2812	\$2881	\$1436	N/A
Z24L8ECR	24 x 24 x 84.4-84.9	100	295.24	34.25	\$2705	\$2762	\$1227	N/A
Z36M8ECR	20 x 36 x 84.4-84.9	125	328.68	42.25	\$2895	\$2964	\$1583	N/A
Z30M8ECR	20 x 30 x 84.4-84.9	100	295.07	35.50	\$2667	\$2725	\$1436	N/A
Z24M8ECR	20 x 24 x 84.4-84.9	100	263	29	\$2544	\$2591	\$1227	N/A

Two file drawers on bottom. Laminate doors are standard. Storage compartment on **right** includes **two 3-position fixed/height adjustable shelves**. Wardrobe compartment on **left** includes hanging rod and **one adjustable shelf** above rod. Two upper locks secure storage and wardrobe compartments. Lower lock secures all drawers.

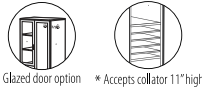
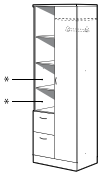

Personal Tower with Open Shelves - LEFT

Z36L8ENL	24 x 36 x 84.4-84.9	125	351.72	50	\$2914	\$2993	\$969	N/A
Z30L8ENL	24 x 30 x 84.4-84.9	125	320.22	42	\$2643	\$2712	\$819	N/A
Z24L8ENL	24 x 24 x 84.4-84.9	100	283.24	34.25	\$2507	\$2564	\$613	N/A
Z36M8ENL	20 x 36 x 84.4-84.9	125	313.96	42.25	\$2729	\$2798	\$964	N/A
Z30M8ENL	20 x 30 x 84.4-84.9	125	282.80	35.50	\$2502	\$2560	\$823	N/A
Z24M8ENL	20 x 24 x 84.4-84.9	100	249	29	\$2349	\$2396	\$613	N/A

Two file drawers on bottom. Laminate door is standard on wardrobe section. Storage compartment on **left** includes **three 3-position fixed/height adjustable shelves**. Wardrobe compartment on **right** includes hanging rod and **one adjustable shelf** above rod. Upper lock secures wardrobe compartment. Lower lock secures all drawers.

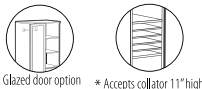
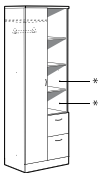

Personal Tower with Open Shelves - RIGHT

Z36L8ENR	24 x 36 x 84.4-84.9	125	351.72	50	\$2914	\$2993	\$969	N/A
Z30L8ENR	24 x 30 x 84.4-84.9	125	320.22	42	\$2643	\$2712	\$819	N/A
Z24L8ENR	24 x 24 x 84.4-84.9	100	283.24	34.25	\$2507	\$2564	\$613	N/A
Z36M8ENR	20 x 36 x 84.4-84.9	125	313.96	42.25	\$2729	\$2798	\$964	N/A
Z30M8ENR	20 x 30 x 84.4-84.9	125	282.80	35.50	\$2502	\$2560	\$823	N/A
Z24M8ENR	20 x 24 x 84.4-84.9	100	249	29	\$2349	\$2396	\$613	N/A

Two file drawers on bottom. Laminate door is standard on wardrobe section. Storage compartment on **right** includes **three 3-position fixed/height adjustable shelves**. Wardrobe compartment on **right** includes hanging rod and **one adjustable shelf** above rod. Upper lock secures wardrobe compartment. Lower lock secures all drawers.

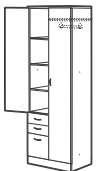

Personal Tower with Doors - LEFT

Z36L8BFL	24 x 36 x 84.4-84.9	125	371.70	50	\$3258	\$3337	\$1676	N/A
Z30L8BFL	24 x 30 x 84.4-84.9	100	337.05	42	\$3001	\$3070	\$1530	N/A
Z24L8BFL	24 x 24 x 84.4-84.9	100	301.24	34.25	\$2856	\$2913	\$1320	N/A
Z36M8BFL	20 x 36 x 84.4-84.9	125	334.95	42.25	\$3074	\$3143	\$1676	N/A
Z30M8BFL	20 x 30 x 84.4-84.9	100	300.30	35.50	\$2856	\$2916	\$1530	N/A
Z24M8BFL	20 x 24 x 84.4-84.9	100	268	29	\$2695	\$2742	\$1320	N/A

Two box and one file drawer on bottom. Laminate doors are standard. Storage compartment on **left** includes **three 3-position fixed/height adjustable shelves**. Wardrobe compartment on **right** includes hanging rod and **one adjustable shelf** above rod. Two upper locks secure storage and wardrobe compartments. Lower lock secures all drawers.

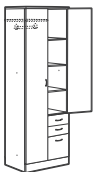

Personal Tower with Doors - RIGHT

Z36L8BFR	24 x 36 x 84.4-84.9	125	371.70	50	\$3258	\$3337	\$1676	N/A
Z30L8BFR	24 x 30 x 84.4-84.9	100	337.05	42	\$3001	\$3070	\$1530	N/A
Z24L8BFR	24 x 24 x 84.4-84.9	100	301.24	34.25	\$2856	\$2913	\$1320	N/A
Z36M8BFR	20 x 36 x 84.4-84.9	125	334.95	42.25	\$3074	\$3143	\$1676	N/A
Z30M8BFR	20 x 30 x 84.4-84.9	100	300.30	35.50	\$2856	\$2916	\$1530	N/A
Z24M8BFR	20 x 24 x 84.4-84.9	100	268	29	\$2695	\$2742	\$1320	N/A

Two box and one file drawer on bottom. Laminate doors are standard. Storage compartment on **right** includes **three 3-position fixed/height adjustable shelves**. Wardrobe compartment on **left** includes hanging rod and **one adjustable shelf** above rod. Two upper locks secure storage and wardrobe compartments. Lower lock secures all drawers.

Required Specifications

- Top finish
- Base finish
- Top/Edge Detail
- Handles

Optional Specifications

- Glazing - Doors
- Collator (Open Shelves)
- Box drawer* - no upcharge (30" - 36" wide models only)

PERSONAL TOWERS - 84.5"/85" HIGH

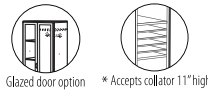
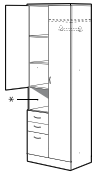

Personal Tower with Doors and Cavity - LEFT

MODEL#	DIMENSIONS D x W x H	FREIGHT CLASS	WT./LBS.	CUBIC FT.	1"TOP	1.5" TOP	GLAZE ADD	HP ADD
Z36L8BFCL	24 x 36 x 84.4-84.9	125	369.59	50	\$3215	\$3295	\$1583	N/A
Z30L8BFCL	24 x 30 x 84.4-84.9	125	334.59	42	\$2955	\$3024	\$1436	N/A
Z24L8BFCL	24 x 24 x 84.4-84.9	100	297.24	34.25	\$2812	\$2870	\$1227	N/A
Z36M8BFCL	20 x 36 x 84.4-84.9	125	330.78	42.25	\$3030	\$3099	\$1583	N/A
Z30M8BFCL	20 x 30 x 84.4-84.9	100	299.27	35.50	\$2812	\$2872	\$1436	N/A
Z24M8BFCL	20 x 24 x 84.4-84.9	100	265	29	\$2652	\$2699	\$1227	N/A

Two box and one file drawer on bottom. Laminate doors are standard. Storage compartment on **left** includes **two 3-position fixed/height adjustable shelves**. Wardrobe compartment on **left** includes hanging rod and **one adjustable shelf** above rod. Two upper locks secure storage and wardrobe compartments. Lower lock secures all drawers.

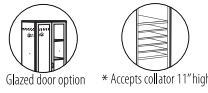
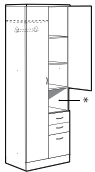

Personal Tower with Doors and Cavity - RIGHT

Z36L8BFCL	24 x 36 x 84.4-84.9	125	369.59	50	\$3215	\$3295	\$1583	N/A
Z30L8BFCL	24 x 30 x 84.4-84.9	125	334.59	42	\$2955	\$3024	\$1436	N/A
Z24L8BFCL	24 x 24 x 84.4-84.9	100	297.24	34.25	\$2812	\$2870	\$1227	N/A
Z36M8BFCL	20 x 36 x 84.4-84.9	125	330.78	42.25	\$3030	\$3099	\$1583	N/A
Z30M8BFCL	20 x 30 x 84.4-84.9	100	299.27	35.50	\$2812	\$2872	\$1436	N/A
Z24M8BFCL	20 x 24 x 84.4-84.9	100	265	29	\$2652	\$2699	\$1227	N/A

Two box and one file drawer on bottom. Laminate doors are standard. Storage compartment on **right** includes **two 3-position fixed/height adjustable shelves**. Wardrobe compartment on **left** includes hanging rod and **one adjustable shelf** above rod. Two upper locks secure storage and wardrobe compartments. Lower lock secures all drawers.

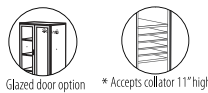
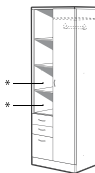

Personal Tower with Open Shelves - LEFT

Z36L8BFNL	24 x 36 x 84.4-84.9	125	354.87	50	\$3044	\$3124	\$969	N/A
Z30L8BFNL	24 x 30 x 84.4-84.9	125	322.32	42	\$2790	\$2859	\$819	N/A
Z24L8BFNL	24 x 24 x 84.4-84.9	100	285.24	34.25	\$2616	\$2673	\$613	N/A
Z36M8BFNL	20 x 36 x 84.4-84.9	125	316.06	42.25	\$2861	\$2944	\$964	N/A
Z30M8BFNL	20 x 30 x 84.4-84.9	100	287	35.50	\$2643	\$2703	\$823	N/A
Z24M8BFNL	20 x 24 x 84.4-84.9	100	251	29	\$2454	\$2501	\$613	N/A

Two box and one file drawer on bottom. Laminate door is standard on wardrobe section. Storage compartment on **left** includes **three 3-position fixed/height adjustable shelves**. Wardrobe compartment on **right** includes hanging rod and **one adjustable shelf** above rod. Upper lock secures wardrobe compartment. Lower lock secures all drawers.

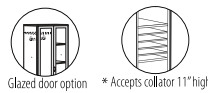
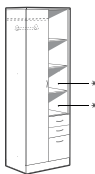

Personal Tower with Open Shelves - RIGHT

Z36L8BFNR	24 x 36 x 84.4-84.9	125	354.87	50	\$3044	\$3124	\$969	N/A
Z30L8BFNR	24 x 30 x 84.4-84.9	125	322.32	42	\$2790	\$2859	\$819	N/A
Z24L8BFNR	24 x 24 x 84.4-84.9	100	285.24	34.25	\$2616	\$2673	\$613	N/A
Z36M8BFNR	20 x 36 x 84.4-84.9	125	316.06	42.25	\$2861	\$2944	\$964	N/A
Z30M8BFNR	20 x 30 x 84.4-84.9	100	287	35.50	\$2643	\$2703	\$823	N/A
Z24M8BFNR	20 x 24 x 84.4-84.9	100	251	29	\$2454	\$2501	\$613	N/A

Two box and one file drawer on bottom. Laminate door is standard on wardrobe section. Storage compartment on **right** includes **three 3-position fixed/height adjustable shelves**. Wardrobe compartment on **left** includes hanging rod and **one adjustable shelf** above rod. Upper lock secures wardrobe compartment. Lower lock secures all drawers.

CLOSED FRONT OVERHEAD STORAGE - 33"H

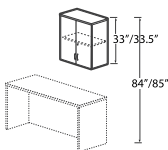

Closed Front Overhead Storage with Doors - 32.5"/33"H

MODEL#	DIMENSIONS	FREIGHT CLASS	WT./LBS.	CUBIC FT.	1"TOP	1.5" TOP	GLAZE ADD	HP ADD
Z42S33OS	16 x 42 x 32.5-33	100	135.98	16.25	\$1140	\$1216	\$1105	N/A
Z36S33OS	16 x 36 x 32.5-33	100	119.70	14	\$1034	\$1101	\$998	N/A
Z30S33OS	16 x 30 x 32.5-33	100	104.42	11.75	\$926	\$969	\$870	N/A
Z24S33OS	16 x 24 x 32.5-33	100	81.13	9.75	\$830	\$876	\$761	N/A

Includes steel hanging rail for wall mount applications. Includes one fixed shelf. Doors lock.

• **NOTE:** Care should be taken to mount the units. Units should be mounted to wall studs using correct fasteners. Failure to do so may result in collapse of the unit and subsequent personal injury. **Fastening hardware not included.** Mounting hardware used should be based on wall material. Consult an installation professional for proper wall mounting.

Required Specifications

Top finish
Base finish
Top/Edge Detail
Handles

Optional Specifications

Glazing - Doors
Collator (Open Shelves)

OVERHEAD STORAGE - 33"H

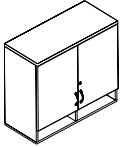

Glazed door option

Closed Front Overhead Storage with Pigeon Hole - 32.5"/33" H

MODEL#	DIMENSIONS D x W x H	FREIGHT CLASS	WT/LBS.	CUBIC FT.	1" TOP	1.5" TOP	GLAZE ADD	HP ADD
Z42S33OP	16 x 42 x 32.5-33	100	140	16.25	\$1455	\$1534	\$729	N/A
Z36S33OP	16 x 36 x 32.5-33	100	122	14	\$1257	\$1328	\$664	N/A
Z30S33OP	16 x 30 x 32.5-33	100	105	12	\$1126	\$1184	\$590	N/A
Z24S33OP	16 x 24 x 32.5-33	100	88	9.75	\$1011	\$1065	\$537	N/A

Includes steel hanging rail for wall mount applications. Includes one fixed shelf. Doors lock.

• **NOTE:** Care should be taken to mount the units. Units should be mounted to wall studs using correct fasteners. Failure to do so may result in collapse of the unit and subsequent personal injury. **Fastening hardware not included.** Mounting hardware used should be based on wall material. Consult an installation professional for proper wall mounting.

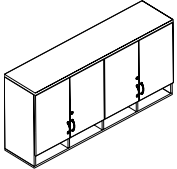

Glazed door option

Closed Front Overhead Storage with Pigeon Hole - 32.5"/33" H

Z72S33OS	16 x 72 x 32.5-33	100	230	26	\$2356	\$2460	\$1329	N/A
Z66S33OS	16 x 66 x 32.5-33	100	215	24	\$2264	\$2358	\$1305	N/A
Z60S33OS	16 x 60 x 32.5-33	100	199	22	\$2088	\$2175	\$1182	N/A
Z54S33OS	16 x 54 x 32.5-33	100	184	21	\$1984	\$2067	\$1158	N/A

Includes steel hanging rail for wall mount applications. Includes one fixed shelf. Doors lock.

• **NOTE:** Care should be taken to mount the units. Units should be mounted to wall studs using correct fasteners. Failure to do so may result in collapse of the unit and subsequent personal injury. **Fastening hardware not included.** Mounting hardware used should be based on wall material. Consult an installation professional for proper wall mounting.

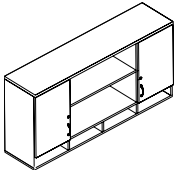

Glazed door option

Overhead Storage, 2 Outer Doors with Pigeon Hole - 32.5"/33" H

Z72S33SOS	16 x 72 x 32.5-33	100	215	26	\$2131	\$2235	\$666	N/A
Z66S33SOS	16 x 66 x 32.5-33	100	201	24	\$2035	\$2129	\$654	N/A
Z60S33SOS	16 x 60 x 32.5-33	100	187	22	\$1912	\$1999	\$642	N/A
Z54S33SOS	16 x 54 x 32.5-33	100	173	21	\$1779	\$1862	\$580	N/A

6 compartments. **Doors on outer compartments only.** Includes steel hanging rail for wall mount applications. Includes one fixed shelf. Doors lock.

• **NOTE:** Care should be taken to mount the units. Units should be mounted to wall studs using correct fasteners. Failure to do so may result in collapse of the unit and subsequent personal injury. **Fastening hardware not included.** Mounting hardware used should be based on wall material. Consult an installation professional for proper wall mounting.

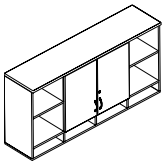

Glazed door option

Overhead Storage, 2 Center Doors with Pigeon Hole - 32.5"/33" H

Z72S33OSO	16 x 72 x 32.5-33	100	214	26	\$2090	\$2194	\$666	N/A
Z66S33OSO	16 x 66 x 32.5-33	100	200	24	\$2000	\$2094	\$654	N/A
Z60S33OSO	16 x 60 x 32.5-33	100	186	22	\$1876	\$1963	\$593	N/A
Z54S33OSO	16 x 54 x 32.5-33	100	172	21	\$1774	\$1857	\$580	N/A

6 compartments. **Doors on inner compartments only.** Includes steel hanging rail for wall mount applications. Includes one fixed shelf. Doors lock.

• **NOTE:** Care should be taken to mount the units. Units should be mounted to wall studs using correct fasteners. Failure to do so may result in collapse of the unit and subsequent personal injury. **Fastening hardware not included.** Mounting hardware used should be based on wall material. Consult an installation professional for proper wall mounting.

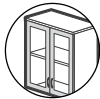
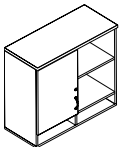

Glazed door option

Overhead Storage, 1 Door - LEFT with Pigeon Hole - 32.5"/33" H

Z36S33OSL	16 x 36 x 32.5-33	100	119	14	\$1177	\$1248	\$333	N/A
Z30S33OSL	16 x 30 x 32.5-33	100	104	11.75	\$1074	\$1132	\$297	N/A
Z24S33OSL	16 x 24 x 32.5-33	100	88	9.75	\$964	\$1018	\$260	N/A

Includes steel hanging rail for wall mount applications. Includes one fixed shelf. Door locks. Open storage on **right.**

• **NOTE:** Care should be taken to mount the units. Units should be mounted to wall studs using correct fasteners. Failure to do so may result in collapse of the unit and subsequent personal injury. **Fastening hardware not included.** Mounting hardware used should be based on wall material. Consult an installation professional for proper wall mounting.

Required Specifications

Top finish
Base finish
Top/Edge Detail
Handles

Optional Specifications

Glazing - Doors

OVERHEAD STORAGE - 33"H

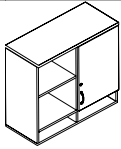

Glazed door option

Overhead Storage, 1 Door - RIGHT with Pigeon Hole - 32.5"/33"H

MODEL#	DIMENSIONS D x W x H	FREIGHT CLASS	WT/LBS.	CUBIC FT.	1" TOP	1.5" TOP	GLAZE ADD	HP ADD
Z36S33OSR	16 x 36 x 32.5-33	100	119	14	\$1177	\$1248	\$333	N/A
Z30S33OSR	16 x 30 x 32.5-33	100	104	11.75	\$1074	\$1132	\$297	N/A
Z24S33OSR	16 x 24 x 32.5-33	100	88	9.75	\$964	\$1018	\$260	N/A

Includes steel hanging rail for wall mount applications. Includes one fixed shelf. Door locks. Open storage on **left**.
 • **NOTE:** Care should be taken to mount the units. Units should be mounted to wall studs using correct fasteners. Failure to do so may result in collapse of the unit and subsequent personal injury. **Fastening hardware not included.** Mounting hardware used should be based on wall material. Consult an installation professional for proper wall mounting.

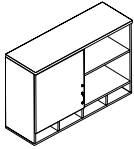

Glazed door option

Overhead Storage, 1 Door - LEFT with Pigeon Hole - 32.5"/33"H

Z48S33OSL	16 x 48 x 32.5-33	100	135	16.25	\$1522	\$1605	\$375	N/A
Z42S33OSL	16 x 42 x 32.5-33	100	135	16.25	\$1354	\$1433	\$367	N/A

Includes steel hanging rail for wall mount applications. Includes one fixed shelf. Door locks. Open storage on **right**.
 • **NOTE:** Care should be taken to mount the units. Units should be mounted to wall studs using correct fasteners. Failure to do so may result in collapse of the unit and subsequent personal injury. **Fastening hardware not included.** Mounting hardware used should be based on wall material. Consult an installation professional for proper wall mounting.

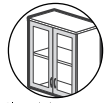
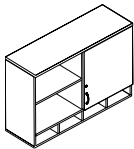

Glazed door option

Overhead Storage, 1 Door - RIGHT with Pigeon Hole - 32.5"/33"H*

Z48S33OSR	16 x 48 x 32.5-33	100	135	16.25	\$1522	\$1605	\$375	N/A
Z42S33OSR	16 x 42 x 32.5-33	100	135	16.25	\$1354	\$1433	\$367	N/A

Includes steel hanging rail for wall mount applications. Includes one fixed shelf. Door locks. Open storage on **left**.
 • **NOTE:** Care should be taken to mount the units. Units should be mounted to wall studs using correct fasteners. Failure to do so may result in collapse of the unit and subsequent personal injury. **Fastening hardware not included.** Mounting hardware used should be based on wall material. Consult an installation professional for proper wall mounting.

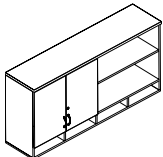

Glazed door option

Overhead Storage, 1 Door - LEFT with Pigeon Hole - 32.5"/33"H*

Z72S33OSL	16 x 72 x 32.5-33	125	207	26	\$2047	\$2151	\$665	N/A
Z66S33OSL	16 x 66 x 32.5-33	100	193	24	\$1953	\$2047	\$656	N/A
Z60S33OSL	16 x 60 x 32.5-33	100	179	22	\$1809	\$1896	\$596	N/A
Z54S33OSL	16 x 54 x 32.5-33	125	166	21	\$1711	\$1794	\$578	N/A

Includes steel hanging rail for wall mount applications. Includes one fixed shelf. Doors lock. Open storage on **right**.
 • **NOTE:** Care should be taken to mount the units. Units should be mounted to wall studs using correct fasteners. Failure to do so may result in collapse of the unit and subsequent personal injury. **Fastening hardware not included.** Mounting hardware used should be based on wall material. Consult an installation professional for proper wall mounting.

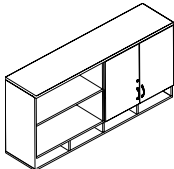

Glazed door option

Overhead Storage, 1 Door - RIGHT with Pigeon Hole - 32.5"/33"H*

Z72S33OSR	16 x 72 x 32.5-33	125	207	26	\$2047	\$2151	\$665	N/A
Z66S33OSR	16 x 66 x 32.5-33	100	193	24	\$1953	\$2047	\$656	N/A
Z60S33OSR	16 x 60 x 32.5-33	100	179	22	\$1809	\$1896	\$596	N/A
Z54S33OSR	16 x 54 x 32.5-33	125	166	21	\$1711	\$1794	\$578	N/A

Includes steel hanging rail for wall mount applications. Includes one fixed shelf. Doors lock. Open storage on **left**.
 • **NOTE:** Care should be taken to mount the units. Units should be mounted to wall studs using correct fasteners. Failure to do so may result in collapse of the unit and subsequent personal injury. **Fastening hardware not included.** Mounting hardware used should be based on wall material. Consult an installation professional for proper wall mounting.

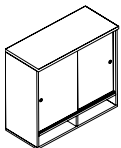

Overhead Storage, Glass Doors with Pigeon Hole - 32.5"/33"H

Z36S33OSD	16 x 36 x 32.5-33	100	127	14	\$2497	\$2568	N/A	N/A
Z30S33OSD	16 x 30 x 32.5-33	100	110	12	\$2197	\$2255	N/A	N/A
Z24S33OSD	16 x 24 x 32.5-33	100	91	9.75	\$1947	\$2001	N/A	N/A

Includes steel hanging rail for wall mount applications. Includes one fixed shelf. Sliding glass doors do not lock. Shipped easy to assemble in 2 cartons. Glass doors shipped separately. Finger pull is silver.
 • **NOTE:** Care should be taken to mount the units. Units should be mounted to wall studs using correct fasteners. Failure to do so may result in collapse of the unit and subsequent personal injury. **Fastening hardware not included.** Mounting hardware used should be based on wall material. Consult an installation professional for proper wall mounting.

Required Specifications

- Top finish
- Base finish
- Top/Edge Detail
- Handles

Optional Specifications

- Glazing - Doors
- Key #*

OVERHEAD STORAGE

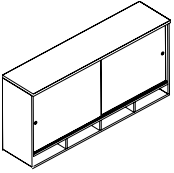

Overhead Storage, Glass Doors with Pigeon Hole - 32.5"/33"H

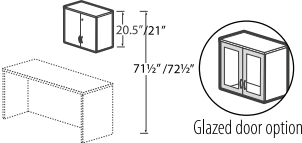

Closed Front Overhead Storage with Doors - 20"/20.5"H*

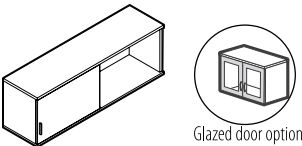

Overhead Storage w/1 door - LEFT* 20"/20.5"H

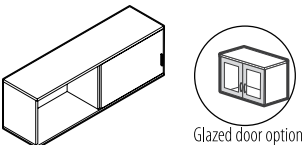

Overhead Storage w/1 door - RIGHT 20"/20.5"H*

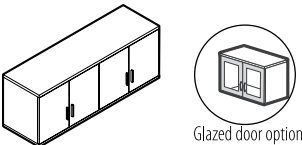

Closed Front Overhead Storage w/Center Divider- 20/20.5"H*

MODEL#	DIMENSIONS D x W x H	FREIGHT CLASS	WT/LBS.	CUBIC FT.	1" TOP	1.5" TOP	GLAZE ADD	HP ADD
Z72S330SD	16 x 72 x 32.5-33	100	224	26	\$4401	\$4505	N/A	N/A
Z66S330SD	16 x 66 x 32.5-33	100	208	24	\$4115	\$4209	N/A	N/A
Z60S330SD	16 x 60 x 32.5-33	100	193	22	\$3807	\$3894	N/A	N/A
Z54S330SD	16 x 54 x 32.5-33	100	178	21	\$3546	\$3629	N/A	N/A
Z48S330SD	16 x 48 x 32.5-33	100	162	17.70	\$3240	\$3323	N/A	N/A
Z42S330SD	16 x 42 x 32.5-33	100	145	16.25	\$2895	\$2974	N/A	N/A

Includes steel hanging rail for wall mount applications. Includes one fixed shelf. Sliding glass doors do not lock.

Shipped easy to assemble in 2 cartons. Glass doors shipped separately. Finger pull is silver.

- **NOTE:** Care should be taken to mount the units. Units should be mounted to wall studs using correct fasteners. Failure to do so may result in collapse of the unit and subsequent personal injury. **Fastening hardware not included.** Mounting hardware used should be based on wall material. Consult an installation professional for proper wall mounting.

Z42S200S	16 x 42 x 20-20.5	100	93.99	10.50	\$815	\$890	\$789	N/A
Z36S200S	16 x 36 x 20-20.5	100	82.70	9	\$747	\$814	\$721	N/A
Z30S200S	16 x 30 x 20-20.5	100	72.42	7.50	\$674	\$717	\$640	N/A
Z24S200S	16 x 24 x 20-20.5	100	56.13	6.25	\$633	\$680	\$572	N/A

Includes steel hanging rail for wall mount applications. Doors lock.

- **NOTE:** Care should be taken to mount the units. Units should be mounted to wall studs using correct fasteners. Failure to do so may result in collapse of the unit and subsequent personal injury. **Fastening hardware not included.** Mounting hardware used should be based on wall material. Consult an installation professional for proper wall mounting.

Z48S200SL	16 x 48 x 20-20.5	125	95	12.50	\$926	\$1009	\$321	N/A
Z42S200SL	16 x 42 x 20-20.5	100	85	10.50	\$818	\$897	\$297	N/A
Z36S200SL	16 x 36 x 20-20.5	100	76	9	\$750	\$821	\$273	N/A
Z30S200SL	16 x 30 x 20-20.5	100	67	7.60	\$687	\$745	\$234	N/A
Z24S200SL	16 x 24 x 20-20.5	100	58	6.50	\$637	\$691	\$214	N/A

Door on **left**. Includes steel hanging rail for wall mount applications. Includes one fixed shelf. Door locks.

- **NOTE:** Care should be taken to mount the units. Units should be mounted to wall studs using correct fasteners. Failure to do so may result in collapse of the unit and subsequent personal injury. **Fastening hardware not included.** Mounting hardware used should be based on wall material. Consult an installation professional for proper wall mounting.

Z48S200SR	16 x 48 x 20-20.5	125	95	12.50	\$926	\$1009	\$321	N/A
Z42S200SR	16 x 42 x 20-20.5	100	85	10.50	\$818	\$897	\$297	N/A
Z36S200SR	16 x 36 x 20-20.5	100	76	9	\$750	\$821	\$273	N/A
Z30S200SR	16 x 30 x 20-20.5	100	67	7.60	\$687	\$745	\$234	N/A
Z24S200SR	16 x 24 x 20-20.5	100	58	6.50	\$637	\$691	\$214	N/A

Door on **right**. Includes steel hanging rail for wall mount applications. Includes one fixed shelf. Door locks.

- **NOTE:** Care should be taken to mount the units. Units should be mounted to wall studs using correct fasteners. Failure to do so may result in collapse of the unit and subsequent personal injury. **Fastening hardware not included.** Mounting hardware used should be based on wall material. Consult an installation professional for proper wall mounting.

Z72S200S	16 x 72 x 20-20.5	100	149	18	\$1560	\$1664	\$1076	N/A
Z66S200S	16 x 66 x 20-20.5	100	139	16.50	\$1487	\$1581	\$1052	N/A
Z60S200S	16 x 60 x 20-20.5	100	129	15	\$1372	\$1459	\$963	N/A
Z54S200S	16 x 54 x 20-20.5	100	119	13.75	\$1307	\$1390	\$938	N/A

Includes steel hanging rail for wall mount applications. Includes one fixed shelf. Doors lock.

- **NOTE:** Care should be taken to mount the units. Units should be mounted to wall studs using correct fasteners. Failure to do so may result in collapse of the unit and subsequent personal injury. **Fastening hardware not included.** Mounting hardware used should be based on wall material. Consult an installation professional for proper wall mounting.

Required Specifications

Top finish
Base finish
Top/Edge Detail
Handles

Optional Specifications

Glazed doors*
Key #*

OVERHEAD STORAGE

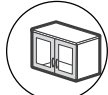
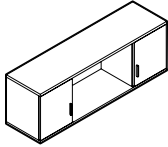

Glazed door option

Overhead Storage w/2 Outer Doors
20/20.5"H*

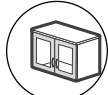
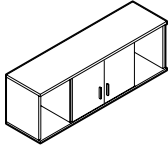

Glazed door option

Overhead Storage w/2 Inner Doors
20/20.5"H*

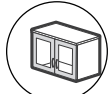
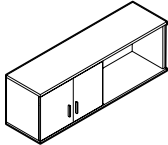

Glazed door option

Overhead Storage w/2 Doors - LEFT
20/20.5"H*

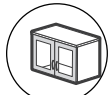
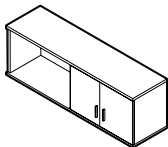

Glazed door option

Overhead Storage w/2 Doors - RIGHT
20/20.5"H*

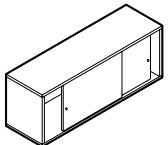

Overhead Storage, w/Glass Doors
20/20.5"H

MODEL#	DIMENSIONS D x W x H	FREIGHT CLASS	WT/LBS.	CUBIC FT.	1" TOP	1.5" TOP	GLAZE ADD	HP ADD
Z72S20SOS	16 x 72 x 20-20.5	125	137	18	\$1341	\$1445	\$543	N/A
Z66S20SOS	16 x 66 x 20-20.5	125	128	16.50	\$1269	\$1363	\$530	N/A
Z60S20SOS	16 x 60 x 20-20.5	100	120	15	\$1194	\$1281	\$520	N/A
Z54S20SOS	16 x 54 x 20-20.5	100	110	13.75	\$1113	\$1196	\$474	N/A

4 compartments. **Doors on outer compartments only.** Includes steel hanging rail for wall mount applications. Doors lock.
 • **NOTE:** Care should be taken to mount the units. Units should be mounted to wall studs using correct fasteners. Failure to do so may result in collapse of the unit and subsequent personal injury. **Fastening hardware not included.** Mounting hardware used should be based on wall material. Consult an installation professional for proper wall mounting.

Z72S20OSO	16 x 72 x 20-20.5	125	137	18	\$1357	\$1461	\$539	N/A
Z66S20OSO	16 x 66 x 20-20.5	125	128	16.50	\$1286	\$1380	\$526	N/A
Z60S20OSO	16 x 60 x 20-20.5	100	120	15	\$1209	\$1296	\$483	N/A
Z54S20OSO	16 x 54 x 20-20.5	100	110	13.75	\$1129	\$1212	\$470	N/A

4 compartments. **Doors on inner compartments only.** Includes steel hanging rail for wall mount applications. Doors lock.
 • **NOTE:** Care should be taken to mount the units. Units should be mounted to wall studs using correct fasteners. Failure to do so may result in collapse of the unit and subsequent personal injury. **Fastening hardware not included.** Mounting hardware used should be based on wall material. Consult an installation professional for proper wall mounting.

Z72S20OSL	16 x 72 x 20-20.5	125	132	18	\$1301	\$1405	\$540	N/A
Z66S20OSL	16 x 66 x 20-20.5	125	123	16.50	\$1230	\$1324	\$528	N/A
Z60S20OSL	16 x 60 x 20-20.5	125	114	15	\$1137	\$1224	\$484	N/A
Z54S20OSL	16 x 54 x 20-20.5	125	105	13.75	\$1074	\$1157	\$471	N/A

2 doors on **left** cavity. Includes steel hanging rail for wall mount applications. Includes one fixed shelf. Doors lock.
 • **NOTE:** Care should be taken to mount the units. Units should be mounted to wall studs using correct fasteners. Failure to do so may result in collapse of the unit and subsequent personal injury. **Fastening hardware not included.** Mounting hardware used should be based on wall material. Consult an installation professional for proper wall mounting.

Z72S20OSR	16 x 72 x 20-20.5	125	132	18	\$1301	\$1405	\$540	N/A
Z66S20OSR	16 x 66 x 20-20.5	125	123	16.50	\$1230	\$1324	\$528	N/A
Z60S20OSR	16 x 60 x 20-20.5	125	114	15	\$1137	\$1224	\$484	N/A
Z54S20OSR	16 x 54 x 20-20.5	125	105	13.75	\$1074	\$1157	\$471	N/A

2 doors on **right** cavity. Includes steel hanging rail for wall mount applications. Includes one fixed shelf. Doors lock.
 • **NOTE:** Care should be taken to mount the units. Units should be mounted to wall studs using correct fasteners. Failure to do so may result in collapse of the unit and subsequent personal injury. **Fastening hardware not included.** Mounting hardware used should be based on wall material. Consult an installation professional for proper wall mounting.

Z72S20OSD	16 x 72 x 20-20.5	100	145	18	\$3291	\$3395	N/A	N/A
Z66S20OSD	16 x 66 x 20-20.5	100	135	16	\$3064	\$3158	N/A	N/A
Z60S20OSD	16 x 60 x 20-20.5	100	125	15	\$2826	\$2913	N/A	N/A
Z54S20OSD	16 x 54 x 20-20.5	100	115	13.75	\$2704	\$2787	N/A	N/A
Z48S20OSD	16 x 48 x 20-20.5	100	104	12.50	\$2391	\$2474	N/A	N/A
Z42S20OSD	16 x 42 x 20-20.5	100	93	10.50	\$2136	\$2215	N/A	N/A
Z36S20OSD	16 x 36 x 20-20.5	100	83	9	\$1888	\$1959	N/A	N/A
Z30S20OSD	16 x 30 x 20-20.5	100	75	7.60	\$1691	\$1749	N/A	N/A
Z24S20OSD	16 x 24 x 20-20.5	100	63	6.40	\$1566	\$1620	N/A	N/A

Includes steel hanging rail for wall mount applications. Sliding glass doors do not lock. Shipped easy to assemble in 2 cartons. Glass doors shipped separately. Finger pull is silver.
 • **NOTE:** Care should be taken to mount the units. Units should be mounted to wall studs using correct fasteners. Failure to do so may result in collapse of the unit and subsequent personal injury. **Fastening hardware not included.** Mounting hardware used should be based on wall material. Consult an installation professional for proper wall mounting.

Required Specifications

Top finish
 Base finish
 Top/Edge Detail
 Handles

Optional Specifications

Glazed doors*
 Key #*

CLOSED FRONT OVERHEAD STORAGE - 16" H

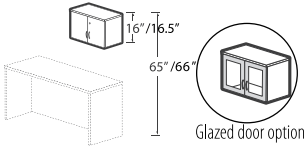

Closed Front Overhead Storage* with Doors - 16"/16.5"H*

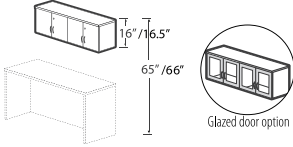

Closed Front Overhead Storage* with Doors - 16"/16.5" High, 60" Wide

MODEL#	DIMENSIONS D x W x H	FREIGHT CLASS	WT/LBS.	CUBIC FT.	1" TOP	1.5" TOP	GLAZE ADD	HP ADD
Z48S160S	15 x 48 x 16-16.5	92.5	98.63	9.25	\$813	\$884	\$761	N/A
Z42S160S	15 x 42 x 16-16.5	92.5	87.42	7.75	\$705	\$767	\$737	N/A
Z36S160S	15 x 36 x 16-16.5	92.5	77.22	6.75	\$643	\$699	\$665	N/A
Z30S160S	15 x 30 x 16-16.5	92.5	64.02	5.75	\$587	\$634	\$584	N/A

Standard with pre-mounted "J" bracket for wall mount applications. Doors lock.

• **NOTE:** Care should be taken to mount the units. Units should be mounted to wall studs using correct fasteners. Failure to do so may result in collapse of the unit and subsequent personal injury. **Fastening hardware not included.** Mounting hardware used should be based on wall material. Consult an installation professional for proper wall mounting.

Z60S160S	15 x 60 x 16-16.5	92.5	118.03	11	\$1068	\$1153	\$1159	N/A
----------	-------------------	------	--------	----	--------	--------	--------	-----

Standard with pre-mounted "J" bracket for wall mount applications. Doors lock.

• **NOTE:** Care should be taken to mount the units. Units should be mounted to wall studs using correct fasteners. Failure to do so may result in collapse of the unit and subsequent personal injury. **Fastening hardware not included.** Mounting hardware used should be based on wall material. Consult an installation professional for proper wall mounting.

OVERHEAD STORAGE W/OPEN FRONTS - 33"

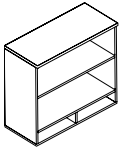

Open Front Overhead Storage w/Pigeon Hole - 32.5"/33"H

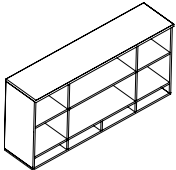

Open Front Overhead Storage w/Pigeon Hole - 32.5"/33"H

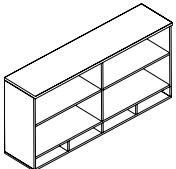

Open Front Overhead Storage w/Pigeon Hole - 32.5"/33"H

MODEL#	DIMENSIONS	FREIGHT CLASS	WT/LBS.	CUBIC FT.	1" TOP	1.5" TOP	GLAZE ADD	HP ADD
Z42S330PN	16 x 42 x 32.5-33	125	116	16.25	\$1117	\$1196	N/A	N/A
Z36S330PN	16 x 36 x 32.5-33	125	101	14	\$951	\$1022	N/A	N/A
Z30S330PN	16 x 30 x 32.5-33	125	88	12	\$854	\$912	N/A	N/A
Z24S330PN	16 x 24 x 32.5-33	125	74	9.75	\$762	\$816	N/A	N/A

Includes steel hanging rail for wall mount applications. Includes one fixed shelf.

• **NOTE:** Care should be taken to mount the units. Units should be mounted to wall studs using correct fasteners. Failure to do so may result in collapse of the unit and subsequent personal injury. **Fastening hardware not included.** Mounting hardware used should be based on wall material. Consult an installation professional for proper wall mounting.

Z72S330N	16 x 72 x 32.5-33	125	194	26	\$1846	\$1940	N/A	N/A
Z66S330N	16 x 66 x 32.5-33	125	181	24	\$1734	\$1821	N/A	N/A
Z60S330N	16 x 60 x 32.5-33	125	169	22	\$1608	\$1691	N/A	N/A
Z54S330N	16 x 54 x 32.5-33	125	157	21	\$1507	\$1590	N/A	N/A

6 compartments. Includes steel hanging rail for wall mount applications. Includes one fixed shelf.

• **NOTE:** Care should be taken to mount the units. Units should be mounted to wall studs using correct fasteners. Failure to do so may result in collapse of the unit and subsequent personal injury. **Fastening hardware not included.** Mounting hardware used should be based on wall material. Consult an installation professional for proper wall mounting.

Z72S330SN	16 x 72 x 32.5-33	125	187	26	\$1739	\$1833	N/A	N/A
Z66S330SN	16 x 66 x 32.5-33	125	174	24	\$1651	\$1738	N/A	N/A
Z60S330SN	16 x 60 x 32.5-33	125	162	22	\$1542	\$1625	N/A	N/A
Z54S330SN	16 x 54 x 32.5-33	125	149	21	\$1441	\$1524	N/A	N/A

4 compartments. Includes steel hanging rail for wall mount applications. Includes one fixed shelf.

• **NOTE:** Care should be taken to mount the units. Units should be mounted to wall studs using correct fasteners. Failure to do so may result in collapse of the unit and subsequent personal injury. **Fastening hardware not included.** Mounting hardware used should be based on wall material. Consult an installation professional for proper wall mounting.

Required Specifications

- Top finish
- Base finish
- Top/Edge Detail
- Handles

Optional Specifications

- Glazed doors*
- Key #*

OVERHEAD STORAGE W/OPEN FRONTS - 33"

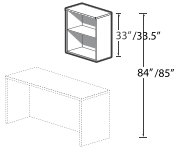

Open Front Overhead Storage
33"/33.5"H

MODEL#	DIMENSIONS	FREIGHT CLASS	WT/LBS.	CUBIC FT.	1"TOP	1.5" TOP	GLAZE ADD	HP ADD	
D x W x H									
Z42S33OSN	16 x 42 x 32.5-33	125	108.98	16.25	\$772	\$848	N/A	N/A	
Z36S33OSN	16 x 36 x 32.5-33	125	96.70	14	\$700	\$767	N/A	N/A	
Z30S33OSN	16 x 30 x 32.5-33	125	84.42	11.75	\$627	\$670	N/A	N/A	
Z24S33OSN	16 x 24 x 32.5-33	125	67.20	9.75	\$578	\$625	N/A	N/A	

Includes steel hanging rail for wall mount applications. Includes one fixed shelf.

- **NOTE:** Care should be taken to mount the units. Units should be mounted to wall studs using correct fasteners. Failure to do so may result in collapse of the unit and subsequent personal injury. **Fastening hardware not included.** Mounting hardware used should be based on wall material. Consult an installation professional for proper wall mounting.

OVERHEAD STORAGE W/OPEN FRONTS - 33"

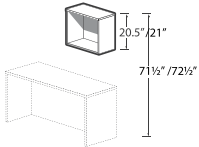

Open Front Overhead Storage
20"/20.5" High

MODEL#	DIMENSIONS	FREIGHT CLASS	WT/LBS.	CUBIC FT.	1"TOP	1.5" TOP	GLAZE ADD	HP ADD
Z42S20OSN	16 x 42 x 20-20.5	125	77.98	10.50	\$539	\$615	N/A	N/A
Z36S20OSN	16 x 36 x 20-20.5	125	69.70	9	\$489	\$556	N/A	N/A
Z30S20OSN	16 x 30 x 20-20.5	100	60.42	7.50	\$439	\$482	N/A	N/A
Z24S20OSN	16 x 24 x 20-20.5	125	48.13	6.25	\$397	\$444	N/A	N/A

Includes steel hanging rail for wall mount applications.

- **NOTE:** Care should be taken to mount the units. Units should be mounted to wall studs using correct fasteners. Failure to do so may result in collapse of the unit and subsequent personal injury. **Fastening hardware not included.** Mounting hardware used should be based on wall material. Consult an installation professional for proper wall mounting.

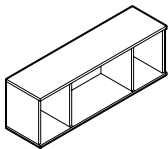

Open Front Overhead Storage
20/20.5"H

Z72S200N	16 x 72 x 20-20.5	125	122	18	\$1083	\$1187	N/A	N/A
Z66S200N	16 x 66 x 20-20.5	125	114	16.50	\$1015	\$1109	N/A	N/A
Z60S200N	16 x 60 x 20-20.5	125	106	15	\$945	\$1032	N/A	N/A
Z54S200N	16 x 54 x 20-20.5	125	99	13.75	\$883	\$966	N/A	N/A

4 compartments. Includes steel hanging rail for wall mount applications.

- **NOTE:** Care should be taken to mount the units. Units should be mounted to wall studs using correct fasteners. Failure to do so may result in collapse of the unit and subsequent personal injury. **Fastening hardware not included.** Mounting hardware used should be based on wall material. Consult an installation professional for proper wall mounting.

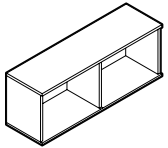

Open Front Overhead Storage
w/Center Divider - 20"/20.5"H

Z72S20OSN	16 x 72 x 20-20.5	125	117	18	\$1046	\$1150	N/A	N/A
Z66S20OSN	16 x 66 x 20-20.5	125	109	16.50	\$976	\$1070	N/A	N/A
Z60S20OSN	16 x 60 x 20-20.5	125	101	15	\$906	\$993	N/A	N/A
Z54S20OSN	16 x 54 x 20-20.5	125	94	13.75	\$843	\$926	N/A	N/A

Standard with pre-mounted "J" bracket for wall mount applications.

- **NOTE:** Care should be taken to mount the units. Units should be mounted to wall studs using correct fasteners. Failure to do so may result in collapse of the unit and subsequent personal injury. **Fastening hardware not included.** Mounting hardware used should be based on wall material. Consult an installation professional for proper wall mounting.

OVERHEAD STORAGE W/OPEN FRONTS - 16"

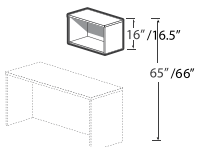

Open Front Overhead Storage
16"/16.5"H

MODEL#	DIMENSIONS	FREIGHT CLASS	WT/LBS.	CUBIC FT.	1"TOP	1.5" TOP	GLAZE ADD	HP ADD
Z48S16OSN	15 x 48 x 16-16.5	100	79.63	9.25	\$539	\$610	N/A	N/A
Z42S16OSN	15 x 42 x 16-16.5	100	70.42	7.75	\$470	\$533	N/A	N/A
Z36S16OSN	15 x 36 x 16-16.5	100	63.22	6.75	\$432	\$488	N/A	N/A
Z30S16OSN	15 x 30 x 16-16.5	100	54.02	5.75	\$395	\$441	N/A	N/A

Standard with pre-mounted "J" bracket for wall mount applications.

- **NOTE:** Care should be taken to mount the units. Units should be mounted to wall studs using correct fasteners. Failure to do so may result in collapse of the unit and subsequent personal injury. **Fastening hardware not included.** Mounting hardware used should be based on wall material. Consult an installation professional for proper wall mounting.

Required Specifications

- Top finish
- Base finish
- Top/Edge Detail

OVERHEAD STORAGE W/OPEN FRONTS - 16"H

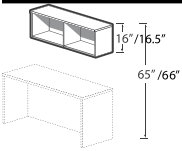

Open Front Overhead Storage
16"/16.5" High, 60" Wide

MODEL#	DIMENSIONS D x W x H	FREIGHT CLASS	WT/LBS.	CUBIC FT.	1" TOP	1.5" TOP	GLAZE ADD	HP ADD
Z60S160SN	15 x 60 x 16-16.5	100	98.03	11	\$665	\$750	N/A	N/A

Standard with pre-mounted "J" bracket for wall mount applications.

- **NOTE:** Care should be taken to mount the units. Units should be mounted to wall studs using correct fasteners. Failure to do so may result in collapse of the unit and subsequent personal injury. **Fastening hardware not included.** Mounting hardware used should be based on wall material. Consult an installation professional for proper wall mounting.

OPEN HUTCHES

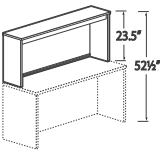

Open Hutch w/Closed Back - 23.5"H

MODEL#	DIMENSIONS	FREIGHT CLASS	WT/LBS.	CUBIC FT.	1" TOP	1.5" TOP	GLAZE ADD	HP ADD
Z84S23HN	15 x 84 x 23-23.5	150	129	23	\$974	\$1091	N/A	N/A
Z72S23HN	15 x 72 x 23-23.5	150	114	19.75	\$854	\$968	N/A	N/A
Z71S23HN	15 x 71.7 x 23-23.5	150	113	19.75	\$854	\$956	N/A	N/A
Z66S23HN	15 x 66 x 23-23.5	150	106	18.25	\$785	\$876	N/A	N/A
Z60S23HN	15 x 60 x 23-23.5	125	99	16.50	\$693	\$779	N/A	N/A
Z48S23HN	15 x 48 x 23-23.5	125	84	13.50	\$600	\$671	N/A	N/A
Z42S23HN	15 x 42 x 23-23.5	125	76	11.75	\$558	\$620	N/A	N/A
Z36S23HN	15 x 36 x 23-23.5	125	68	10.25	\$515	\$572	N/A	N/A
Z30S23HN	15 x 30 x 23-23.5	125	61	8.50	\$477	\$531	N/A	N/A

Closed back features one grommet and flexible sweep for wire management. All hutches shipped pre-assembled.

- Clearance from worksurface to valance is 20.25".
- Woodgrain runs horizontal on both the upper and lower back panels.

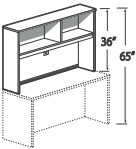

Open Hutch w/Closed Back - 36"H

Z84S36HN	15 x 84 x 35.5-36	125	206	33	\$1263	\$1380	N/A	N/A
Z72S36HN	15 x 72 x 35.5-36	125	181	28.25	\$1156	\$1258	N/A	N/A
Z71S36HN	15 x 71.7 x 35.5-36	125	173	28.25	\$1145	\$1249	N/A	N/A
Z66S36HN	15 x 66 x 35.5-36	125	161	26	\$1082	\$1176	N/A	N/A
Z60S36HN	15 x 60 x 35.5-36	125	150	23.75	\$1014	\$1099	N/A	N/A
Z54S36HN	15 x 54 x 35.5-36	125	128	21	\$1014	\$1099	N/A	N/A

One fixed shelf **and fixed shelf divider**. Closed back features one grommet and flexible sweep for wire management. All hutches shipped pre-assembled.

- Clearance from worksurface to valance is 17.75".
- Woodgrain runs horizontal on both the upper and lower back panels.

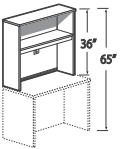

Open Hutch w/Closed Back - 36"H

Z48S36HN	15 x 48 x 35.5-36	125	123	19	\$836	\$907	N/A	N/A
Z42S36HN	15 x 42 x 35.5-36	125	112	16.75	\$773	\$835	N/A	N/A
Z36S36HN	15 x 36 x 35.5-36	125	100	14.50	\$709	\$765	N/A	N/A
Z30S36HN	15 x 30 x 35.5-36	125	89	12.25	\$646	\$692	N/A	N/A

One fixed shelf. Closed back features one grommet and flexible sweep for wire management. All hutches shipped pre-assembled.

- Clearance from worksurface to valance is 17.75".
- Woodgrain runs horizontal on both the upper and lower back panels.

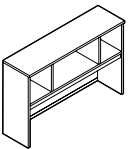

Open Hutch w/Closed Back - 36"H

Z72S360HN	15 x 72 x 35.5-36	150	162	27.75	\$1332	\$1439	N/A	N/A
Z66S360HN	15 x 66 x 35.5-36	150	152	25.50	\$1264	\$1364	N/A	N/A
Z60S360HN	15 x 60 x 35.5-36	125	142	23.25	\$1188	\$1277	N/A	N/A
Z54S360HN	15 x 54 x 35.5-36	125	133	21	\$1113	\$1196	N/A	N/A

Four compartments. Closed back features one grommet and flexible sweep for wire management. All hutches shipped pre-assembled.

- Clearance from worksurface to valance is 17.75".
- Woodgrain runs horizontal on both the upper and lower back panels.

Required Specifications

- Top finish
- Base finish
- Top/Edge Detail

Accessories

- Tackboard
- Pigeon-hole storage

OPEN HUTCHES

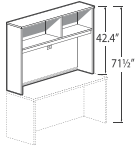

Open Hutch w/Closed Back - 42.4"H

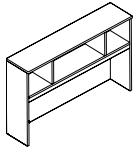

Open Hutch w/Closed Back - 42.4"H

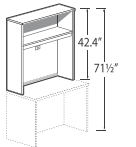

Open Hutch w/Closed Back - 42.4"H

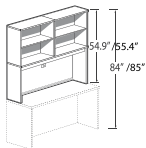

Open Hutch w/Closed Back
54.9"/55.4"H

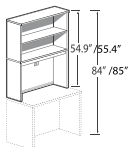

Open Hutch w/Closed Back
54.9"/55.4"H

MODEL#	DIMENSIONS D x W x H	FREIGHT CLASS	WT/LBS.	CUBIC FT.	1" TOP	1.5" TOP	GLAZE ADD	HP ADD
Z84S42HN	15 x 84 x 41.9-42.4	150	223	38.50	\$1346	\$1463	N/A	N/A
Z72S42HN	15 x 72 x 41.9-42.4	150	196	33	\$1246	\$1348	N/A	N/A
Z71S42HN	15 x 71.7 x 41.9-42.4	150	188	33	\$1239	\$1341	N/A	N/A
Z66S42HN	15 x 66 x 41.9-42.4	150	175	30.75	\$1166	\$1257	N/A	N/A
Z60S42HN	15 x 60 x 41.9-42.4	150	164	27.75	\$1091	\$1176	N/A	N/A
Z54S42HN	15 x 54 x 41.9-42.4	150	140	24.50	\$1091	\$1176	N/A	N/A

One fixed shelf **and fixed shelf divider**. Closed back features one grommet and flexible sweep for wire management. All hutches shipped pre-assembled.

- Clearance from worksurface to valance is 24.25".
- Woodgrain runs horizontal on both the upper and lower back panels.

Z72S42OHN	15 x 72 x 41.9-42.4	150	177	32.50	\$1487	\$1585	N/A	N/A
Z66S42OHN	15 x 66 x 41.9-42.4	150	166	29.75	\$1363	\$1452	N/A	N/A
Z60S42OHN	15 x 60 x 41.9-42.4	150	155	27.25	\$1281	\$1364	N/A	N/A
Z54S42OHN	15 x 54 x 41.9-42.4	150	145	24.50	\$1201	\$1273	N/A	N/A

Four compartments. Closed back features one grommet and flexible sweep for wire management. All hutches shipped pre-assembled.

- Clearance from worksurface to valance is 24.25".
- Woodgrain runs horizontal on both the upper and lower back panels.

Z48S42HN	15 x 48 x 41.9-42.4	125	134	22.25	\$906	\$977	N/A	N/A
Z42S42HN	15 x 42 x 41.9-42.4	125	123	19.50	\$836	\$899	N/A	N/A
Z36S42HN	15 x 36 x 41.9-42.4	125	110	17	\$766	\$822	N/A	N/A
Z30S42HN	15 x 30 x 41.9-42.4	125	105	14.25	\$694	\$741	N/A	N/A

One fixed shelf. Closed back features one grommet and flexible sweep for wire management. All hutches shipped pre-assembled.

- Clearance from worksurface to valance is 24.25".
- Woodgrain runs horizontal on both the upper and lower back panels.

Z84S55HN	15 x 84 x 54.4-54.9	150	306	62.37	\$2208	\$2328	N/A	N/A
Z72S55HN	15 x 72 x 54.4-54.9	150	272	53.65	\$2060	\$2166	N/A	N/A
Z71S55HN	15 x 71.7 x 54.4-54.9	150	271	53.65	\$2049	\$2156	N/A	N/A
Z66S55HN	15 x 66 x 54.4-54.9	150	254	49.40	\$1980	\$2085	N/A	N/A
Z60S55HN	15 x 60 x 54.4-54.9	150	238	45.15	\$1772	\$1860	N/A	N/A
Z54S55HN	15 x 54 x 54.4-54.9	100	190	19.75	\$2278	\$2366	N/A	N/A

One fixed shelf and one adjustable shelf (per compartment). Closed back features one grommet and flexible sweep for wire management. Top portion ships pre-assembled. Lower portion ships RTA.

- Clearance from worksurface to valance is 24.25".
- Woodgrain runs horizontal on both the upper and lower back panels.

Z48S55HN	15 x 48 x 54.4-54.9	150	183	36	\$1334	\$1405	N/A	N/A
Z42S55HN	15 x 42 x 54.4-54.9	150	168	31.50	\$1233	\$1296	N/A	N/A
Z36S55HN	15 x 36 x 54.4-54.9	150	149	27.26	\$1124	\$1180	N/A	N/A
Z30S55HN	15 x 30 x 54.4-54.9	150	132	23	\$1020	\$1069	N/A	N/A

One fixed shelf and one adjustable shelf. Closed back features one grommet and flexible sweep for wire management. Shipped RTA (ready to assemble).

- Clearance from worksurface to valance is 24.25".
- Woodgrain runs horizontal on both the upper and lower back panels.

Required Specifications

Top finish
Base finish
Top/Edge Detail

Accessories

Tackboard
Pigeon-hole storage

OPEN HUTCHES

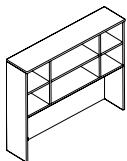

Open Hutch w/Closed Back
54.9"/55.4"H

MODEL#	DIMENSIONS D x W x H	FREIGHT CLASS	WT/LBS.	CUBIC FT.	1"TOP	1.5" TOP	GLAZE ADD	HP ADD
Z72S550HN	15 x 72 x 54.4-54.9	100	242	26	\$2191	\$2295	N/A	N/A
Z66S550HN	15 x 66 x 54.4-54.9	100	228	24	\$2064	\$2158	N/A	N/A
Z60S550HN	15 x 60 x 54.4-54.9	100	214	22	\$1943	\$2029	N/A	N/A
Z54S550HN	15 x 54 x 54.4-54.9	92.5	199	19.76	\$1824	\$1903	N/A	N/A

Four compartments. Closed back features one grommet and flexible sweep for wire management. Top portion ships pre-assembled. Lower portion ships RTA.

- Clearance from worksurface to valance is 24.25".
- Woodgrain runs horizontal on both the upper and lower back panels.

CLOSED HUTCHES

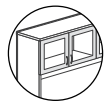
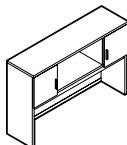

Glazed door option

Hutch w/2 Outer Doors - 36"H*

MODEL#	DIMENSIONS	FREIGHT CLASS	WT/LBS.	CUBIC FT.	1"TOP	1.5" TOP	GLAZE ADD	HP ADD
Z72S36HOH	15 x 72 x 35.5-36	125	172	27.75	\$1561	\$1668	\$471	N/A
Z66S36HOH	15 x 66 x 35.5-36	125	161	25.50	\$1492	\$1592	\$458	N/A
Z60S36HOH	15 x 60 x 35.5-36	125	151	23.25	\$1397	\$1488	\$423	N/A
Z54S36HOH	15 x 54 x 35.5-36	125	140	21	\$1320	\$1403	\$410	N/A

4 compartments. **Doors on outer compartments only.** Closed back features one grommet and flexible sweep for wire management. Doors lock. All hutches shipped pre-assembled.

- Clearance from worksurface to valance is 17.75".
- Woodgrain runs horizontal on both the upper and lower back panels.

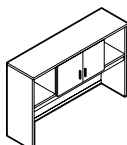

Glazed door option

Hutch w/2 Inner Doors - 36"H*

Z72S36OHO	15 x 72 x 35.5-36	125	173	27.75	\$1559	\$1672	\$476	N/A
Z66S36OHO	15 x 66 x 35.5-36	125	162	25.50	\$1494	\$1594	\$464	N/A
Z60S36OHO	15 x 60 x 35.5-36	125	151	23.25	\$1416	\$1505	\$447	N/A
Z54S36OHO	15 x 54 x 35.5-36	125	141	21	\$1323	\$1406	\$415	N/A

4 compartments. **Doors on inner compartments only.** Closed back features one grommet and flexible sweep for wire management. Doors lock. All hutches shipped pre-assembled.

- Clearance from worksurface to valance is 17.75".
- Woodgrain runs horizontal on both the upper and lower back panels.

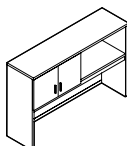

Glazed door option

Hutch w/2 Doors - LEFT, 36"H*

Z72S36HSL	15 x 72 x 35.5-36	125	169	27.75	\$1529	\$1635	\$470	N/A
Z66S36HSL	15 x 66 x 35.5-36	125	157	25.50	\$1456	\$1556	\$454	N/A
Z60S36HSL	15 x 60 x 35.5-36	125	146	23.25	\$1363	\$1454	\$424	N/A
Z54S36HSL	15 x 54 x 35.5-36	125	135	21	\$1286	\$1370	\$411	N/A

4 compartments. Doors on **left** side, open storage on **right**. Closed back features one grommet and flexible sweep for wire management. Doors lock. All hutches shipped pre-assembled.

- Clearance from worksurface to valance is 17.75".
- Woodgrain runs horizontal on both the upper and lower back panels.

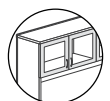
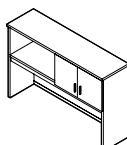

Glazed door option

Hutch w/2 Doors - RIGHT, 36"H*

Z72S36HSR	15 x 72 x 35.5-36	125	169	27.75	\$1529	\$1635	\$470	N/A
Z66S36HSR	15 x 66 x 35.5-36	125	157	25.50	\$1456	\$1556	\$454	N/A
Z60S36HSR	15 x 60 x 35.5-36	125	146	23.25	\$1363	\$1454	\$424	N/A
Z54S36HSR	15 x 54 x 35.5-36	125	135	21	\$1286	\$1370	\$411	N/A

4 compartments. Doors on **right** side, open storage on **left**. Closed back features one grommet and flexible sweep for wire management. Doors lock. All hutches shipped pre-assembled.

- Clearance from worksurface to valance is 17.75".
- Woodgrain runs horizontal on both the upper and lower back panels.

Required Specifications

Top finish
Base finish
Top/Edge Detail

Optional Specifications

Glazing - Doors*

Accessories

Tackboard
Pigeon-hole storage

CLOSED HUTCHES

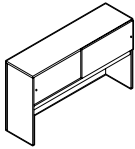

Hutch w/Sliding Glass Doors - 36" H

MODEL#	DIMENSIONS D x W x H	FREIGHT CLASS	WT/LBS.	CUBIC FT.	1" TOP	1.5" TOP	GLAZE ADD	HP ADD
Z72S36HSD	15 x 72 x 35.5-36	125	178	27.75	\$3332	\$3439	N/A	N/A
Z66S36HSD	15 x 66 x 35.5-36	125	166	25.50	\$3110	\$3210	N/A	N/A
Z60S36HSD	15 x 60 x 35.5-36	125	154	23.25	\$2887	\$2978	N/A	N/A
Z54S36HSD	15 x 54 x 35.5-36	125	143	21	\$2669	\$2760	N/A	N/A

Sliding glass doors do not lock. Closed back features one grommet and flexible sweep for wire management. Shipped easy to assemble in 2 cartons. Glass doors shipped separately. Finger pull is silver.

- Clearance from worksurface to valance is 17.75".
- Woodgrain runs horizontal on both the upper and lower back panels.

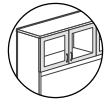
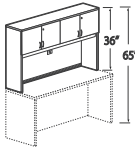

Glazed door option

Closed Hutch with Doors - 36" H*

Z84S36H	15 x 84 x 35.5-36	125	231	33	\$1731	\$1849	\$1386	N/A
Z72S36H	15 x 72 x 35.5-36	125	201	28.25	\$1612	\$1716	\$1266	N/A
Z71S36H	15 x 71.7 x 35.5-36	125	193	28.25	\$1598	\$1702	\$1264	N/A
Z66S36H	15 x 66 x 35.5-36	125	179	26	\$1519	\$1613	\$1205	N/A
Z60S36H	15 x 60 x 35.5-36	125	167	23.75	\$1416	\$1501	\$1132	N/A

One fixed shelf and fixed shelf divider. Closed back features one grommet and flexible sweep for wire management. Doors lock. All hutches shipped pre-assembled.

- Clearance from worksurface to valance is 17.75".
- Woodgrain runs horizontal on both the upper and lower back panels.

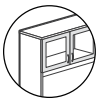
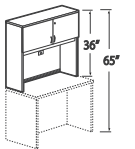

Glazed door option

Closed Hutch with Doors - 36" H*

Z48S36H	15 x 48 x 35.5-36	125	136	19	\$1110	\$1181	\$719	N/A
Z42S36H	15 x 42 x 35.5-36	125	124	16.75	\$1007	\$1070	\$696	N/A
Z36S36H	15 x 36 x 35.5-36	125	110	14.50	\$923	\$979	\$637	N/A
Z30S36H	15 x 30 x 35.5-36	100	98	12.25	\$840	\$887	\$570	N/A

One fixed shelf. Closed back features one grommet and flexible sweep for wire management. Doors lock. All hutches shipped pre-assembled.

- Clearance from worksurface to valance is 17.75".
- Woodgrain runs horizontal on both the upper and lower back panels.

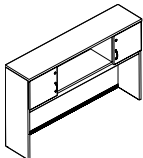

Glazed door option

Hutch w/2 Outer Doors - 42.4" H*

Z72S42HOH	15 x 72 x 41.9-42.4	150	187	32.50	\$1718	\$1816	\$471	N/A
Z66S42HOH	15 x 66 x 41.9-42.4	150	176	29.75	\$1590	\$1679	\$458	N/A
Z60S42HOH	15 x 60 x 41.9-42.4	125	164	27.25	\$1493	\$1576	\$423	N/A
Z54S42HOH	15 x 54 x 41.9-42.4	125	153	24.50	\$1410	\$1483	\$410	N/A

4 compartments. **Doors on outer compartments only.** Closed back features one grommet and flexible sweep for wire management. Doors lock. All hutches shipped pre-assembled.

- Clearance from worksurface to valance is 24.25".
- Woodgrain runs horizontal on both the upper and lower back panels.

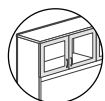
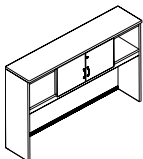

Glazed door option

Hutch w/2 Inner Doors - 42.4" H*

Z72S42OHO	15 x 72 x 41.9-42.4	150	188	32.50	\$1721	\$1819	\$476	N/A
Z66S42OHO	15 x 66 x 41.9-42.4	150	176	29.75	\$1592	\$1681	\$464	N/A
Z60S42OHO	15 x 60 x 41.9-42.4	125	165	27.25	\$1510	\$1591	\$447	N/A
Z54S42OHO	15 x 54 x 41.9-42.4	125	153	24.50	\$1414	\$1487	\$415	N/A

4 compartments. **Doors on inner compartments only.** Closed back features one grommet and flexible sweep for wire management. Doors lock. All hutches shipped pre-assembled.

- Clearance from worksurface to valance is 24.25".
- Woodgrain runs horizontal on both the upper and lower back panels.

Required Specifications

Top finish
Base finish
Top/Edge Detail

Optional Specifications

Glazing - Doors*

Accessories

Tackboard
Pigeon-hole storage

CLOSED HUTCHES

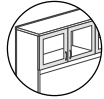
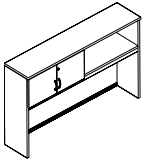

Glazed door option

Hutch w/2 Doors - LEFT, 42.4" H*

MODEL#	DIMENSIONS D x W x H	FREIGHT CLASS	WT/LBS.	CUBIC FT.	1" TOP	1.5" TOP	GLAZE ADD	HP ADD
Z72S42HSL	15 x 72 x 41.9-42.4	150	184	32.50	\$1683	\$1781	\$470	N/A
Z66S42HSL	15 x 66 x 41.9-42.4	150	171	29.75	\$1554	\$1645	\$454	N/A
Z60S42HSL	15 x 60 x 41.9-42.4	150	159	27.25	\$1457	\$1538	\$424	N/A
Z54S42HSL	15 x 54 x 41.9-42.4	125	148	24.50	\$1373	\$1446	\$411	N/A

4 compartments. Doors on **left** side, open storage on **right**. Closed back features one grommet and flexible sweep for wire management. Doors lock. All hutches shipped pre-assembled.

- Clearance from worksurface to valance is 24.25".
- Woodgrain runs horizontal on both the upper and lower back panels.

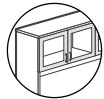
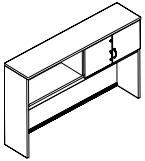

Glazed door option

Hutch w/2 Doors - RIGHT, 42.4" H*

Z72S42HSR	15 x 72 x 41.9-42.4	150	184	32.50	\$1683	\$1781	\$470	N/A
Z66S42HSR	15 x 66 x 41.9-42.4	150	171	29.75	\$1554	\$1645	\$454	N/A
Z60S42HSR	15 x 60 x 41.9-42.4	150	159	27.25	\$1457	\$1538	\$424	N/A
Z54S42HSR	15 x 54 x 41.9-42.4	125	148	24.50	\$1373	\$1446	\$411	N/A

4 compartments. Doors on **right** side, open storage on **left**. Closed back features one grommet and flexible sweep for wire management. Doors lock. All hutches shipped pre-assembled.

- Clearance from worksurface to valance is 24.25".
- Woodgrain runs horizontal on both the upper and lower back panels.

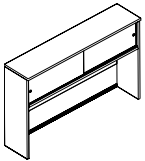

Hutch w/Sliding Glass Doors - 42.4" H

Z72S42HSD	15 x 72 x 41.9-42.4	150	193	32.50	\$3480	\$3578	N/A	N/A
Z66S42HSD	15 x 66 x 41.9-42.4	125	180	29.75	\$3208	\$3297	N/A	N/A
Z60S42HSD	15 x 60 x 41.9-42.4	125	168	27.25	\$2979	\$3062	N/A	N/A
Z54S42HSD	15 x 54 x 41.9-42.4	125	156	24.50	\$2759	\$2831	N/A	N/A

Sliding glass doors do not lock. Closed back features one grommet and flexible sweep for wire management. Shipped easy to assemble in 2 cartons. Glass doors shipped separately. Finger pull is silver.

- Clearance from worksurface to valance is 24.25".
- Woodgrain runs horizontal on both the upper and lower back panels.

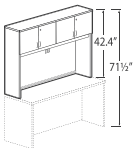

Glazed door option

Closed Hutch with Doors - 42.4" High

Z84S42H	15 x 84 x 41.9-42.4	125	247	38.50	\$1923	\$2041	\$1386	N/A
Z72S42H	15 x 72 x 41.9-42.4	125	217	33	\$1706	\$1808	\$1266	N/A
Z71S42H	15 x 71.7 x 41.9-42.4	125	207	33	\$1694	\$1796	\$1264	N/A
Z66S42H	15 x 66 x 41.9-42.4	125	194	30.75	\$1600	\$1694	\$1205	N/A
Z60S42H	15 x 60 x 41.9-42.4	125	180	27.75	\$1494	\$1579	\$1132	N/A

One fixed shelf **and fixed shelf divider**. Closed back features one grommet and flexible sweep for wire management. Doors lock. All hutches shipped pre-assembled.

- Clearance from worksurface to valance is 24.25".
- Woodgrain runs horizontal on both the upper and lower back panels.

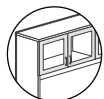
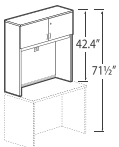

Glazed door option

Closed Hutch with Doors - 42.4" High

Z48S42H	15 x 48 x 41.9-42.4	125	148	22.25	\$1180	\$1251	\$719	N/A
Z42S42H	15 x 42 x 41.9-42.4	125	134	19.50	\$1069	\$1132	\$696	N/A
Z36S42H	15 x 36 x 41.9-42.4	125	120	17	\$978	\$1035	\$637	N/A
Z30S42H	15 x 30 x 41.9-42.4	125	106	14.25	\$899	\$945	\$570	N/A

One fixed shelf. Closed back features one grommet and flexible sweep for wire management. Doors lock. All hutches shipped pre-assembled.

- Clearance from worksurface to valance is 24.25".
- Woodgrain runs horizontal on both the upper and lower back panels.

Required Specifications

Top finish
Base finish
Top/Edge Detail

Optional Specifications

Glazing - Doors*

Accessories

Tackboard
Pigeon-hole storage

CLOSED HUTCHES

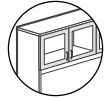
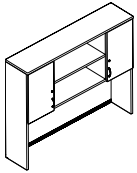

Glazed door option

Hutch w/2 Outer Doors - 55"H*

MODEL#	DIMENSIONS D x W x H	FREIGHT CLASS	WT/LBS.	CUBIC FT.	1" TOP	1.5" TOP	GLAZE ADD	HP ADD
Z72S55HOH	15 x 72 x 54.4-54.9	92.5	262	26	\$2502	\$2604	\$674	N/A
Z66S55HOH	15 x 66 x 54.4-54.9	92.5	246	24	\$2372	\$2466	\$661	N/A
Z60S55HOH	15 x 60 x 54.4-54.9	92.5	229	22	\$2217	\$2373	\$600	N/A
Z54S55HOH	15 x 54 x 54.4-54.9	92.5	213	19.76	\$2095	\$2240	\$588	N/A

4 compartments. **Doors on outer compartments only.** Closed back features one grommet and flexible sweep for wire management. Doors lock. Top portion ships pre-assembled. Lower portion ships RTA.

- Clearance from worksurface to valance is 24.25".
- Woodgrain runs horizontal on both the upper and lower back panels.

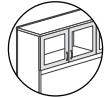
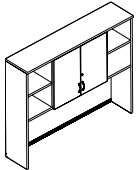

Glazed door option

Hutch w/2 Inner Doors - 55"H*

Z72S55OHO	15 x 72 x 54.4-54.9	92.5	263	26	\$2504	\$2608	\$677	N/A
Z66S55OHO	15 x 66 x 54.4-54.9	92.5	247	24	\$2375	\$2469	\$665	N/A
Z60S55OHO	15 x 60 x 54.4-54.9	92.5	230	22	\$2251	\$2337	\$603	N/A
Z54S55OHO	15 x 54 x 54.4-54.9	92.5	214	19.76	\$2097	\$2176	\$590	N/A

4 compartments. **Doors on inner compartments only.** Closed back features one grommet and flexible sweep for wire management. Doors lock. Top portion ships pre-assembled. Lower portion ships RTA.

- Clearance from worksurface to valance is 24.25".
- Woodgrain runs horizontal on both the upper and lower back panels.

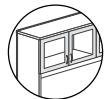
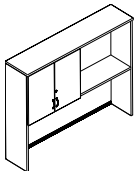

Glazed door option

Hutch w/2 Doors - LEFT, 55"H*

Z72S55HSL	15 x 72 x 54.4-54.9	100	258	26	\$2416	\$2520	\$651	N/A
Z66S55HSL	15 x 66 x 54.4-54.9	100	237	24	\$2307	\$2401	\$639	N/A
Z60S55HSL	15 x 60 x 54.4-54.9	92.5	221	22	\$2141	\$2228	\$600	N/A
Z54S55HSL	15 x 54 x 54.4-54.9	92.5	204	19.76	\$2031	\$2111	\$588	N/A

4 compartments. Doors on **left** side, open storage on **right**. Closed back features one grommet and flexible sweep for wire management. Doors lock. Top portion ships pre-assembled. Lower portion ships RTA.

- Clearance from worksurface to valance is 24.25".
- Woodgrain runs horizontal on both the upper and lower back panels.

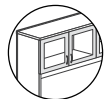
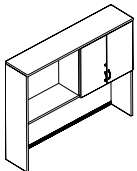

Glazed door option

Hutch w/2 Doors - RIGHT, 55"H*

Z72S55HSR	15 x 72 x 54.4-54.9	100	258	26	\$2416	\$2520	\$651	N/A
Z66S55HSR	15 x 66 x 54.4-54.9	100	237	24	\$2307	\$2401	\$639	N/A
Z60S55HSR	15 x 60 x 54.4-54.9	92.5	221	22	\$2141	\$2228	\$600	N/A
Z54S55HSR	15 x 54 x 54.4-54.9	92.5	204	19.76	\$2031	\$2111	\$588	N/A

4 compartments. Doors on **right** side, open storage on **left**. Closed back features one grommet and flexible sweep for wire management. Doors lock. Top portion ships pre-assembled. Lower portion ships RTA.

- Clearance from worksurface to valance is 24.25".
- Woodgrain runs horizontal on both the upper and lower back panels.

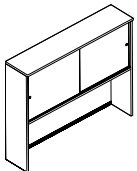

Hutch w/Sliding Glass Doors - 55"H

Z72S55HSD	15 x 72 x 54.4-54.9	92.5	271	26	\$4729	\$4831	N/A	N/A
Z66S55HSD	15 x 66 x 54.4-54.9	92.5	253	24	\$4421	\$4514	N/A	N/A
Z60S55HSD	15 x 60 x 54.4-54.9	92.5	235	22	\$4092	\$4178	N/A	N/A
Z54S55HSD	15 x 54 x 54.4-54.9	92.5	217	19.75	\$3789	\$3868	N/A	N/A

Sliding glass doors do not lock. Closed back features one grommet and flexible sweep for wire management. Shipped easy to assemble in 3 cartons. Glass doors shipped separately. Finger pull is silver.

- Clearance from worksurface to valance is 24.25".
- Woodgrain runs horizontal on both the upper and lower back panels.

Required Specifications

Top finish
Base finish
Top/Edge Detail

Optional Specifications

Glazing - Doors*

Accessories

Tackboard
Pigeon-hole storage

CLOSED HUTCHES

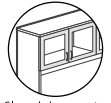
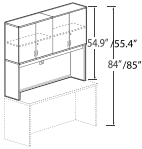

Glazed door option

Closed Hutch w/Doors - 55" H

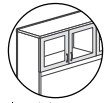
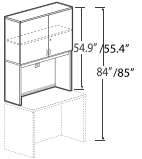

Glazed door option

Closed Hutch w/Doors - 55" H

MODEL#	DIMENSIONS	FREIGHT CLASS	WT/LBS.	CUBIC FT.	1" TOP	1.5" TOP	GLAZE ADD	HP ADD
D x W x H								
Z84S55H	15 x 84 x 54.4-54.9	150	349	62.37	\$2916	\$3036	\$2014	N/A
Z72S55H	15 x 72 x 54.4-54.9	150	308	53.65	\$2628	\$2747	\$1820	N/A
Z71S55H	15 x 71.7 x 54.4-54.9	150	307	53.65	\$2619	\$2726	\$1799	N/A
Z66S55H	15 x 66 x 54.4-54.9	150	287	49.40	\$2478	\$2584	\$1713	N/A
Z60S55H	15 x 60 x 54.4-54.9	150	269	45.15	\$2278	\$2366	\$1593	N/A

One fixed shelf and one adjustable shelf (per compartment). Closed back features one grommet and flexible sweep for wire management. Doors lock. Shipped RTA (ready to assemble).

- Clearance from worksurface to valance is 24.25".
- Woodgrain runs horizontal on both the upper and lower back panels.

Z48S55H	15 x 48 x 54.4-54.9	150	207	36	\$1695	\$1752	\$1112	N/A
Z42S55H	15 x 42 x 54.4-54.9	150	188	31.50	\$1545	\$1608	\$1008	N/A
Z36S55H	15 x 36 x 54.4-54.9	125	167	27.26	\$1408	\$1464	\$912	N/A
Z30S55H	15 x 30 x 54.4-54.9	125	148	23	\$1273	\$1319	\$799	N/A

One fixed shelf and one adjustable shelf. Closed back features one grommet and flexible sweep for wire management. Doors lock. Shipped RTA (ready to assemble).

- Clearance from worksurface to valance is 24.25".
- Woodgrain runs horizontal on both the upper and lower back panels.

PIGEON-HOLE STORAGE

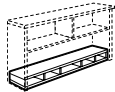
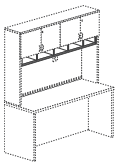

Horizontal Pigeon-Hole Storage

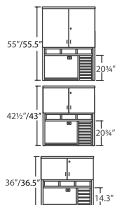
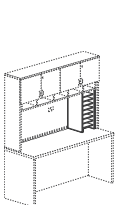

Vertical Pigeon-Hole Storage

MODEL#	DIMENSIONS	FREIGHT CLASS	WT/LBS.	CUBIC FT.	1" TOP	1.5" TOP	GLAZE ADD	HP ADD
ZHS84	12 x 82 x 5.66	70	49	3	\$840	N/A	N/A	N/A
ZHS72	12 x 70 x 5.66	70	49	3	\$756	N/A	N/A	N/A
ZHS71	12 x 69.6 x 5.66	70	49	3	\$756	N/A	N/A	N/A
ZHS66	12 x 63.9 x 5.66	70	46	2.80	\$715	N/A	N/A	N/A
ZHS60	12 x 58 x 5.66	70	42	2.50	\$683	N/A	N/A	N/A
ZHS48	12 x 45.9 x 5.66	70	33	2	\$511	N/A	N/A	N/A
ZHS42	12 x 40 x 5.66	85	29	2	\$479	N/A	N/A	N/A
ZHS36	12 x 33.9 x 5.66	85	26	2	\$450	N/A	N/A	N/A

For additional storage. Can be **top** or **bottom** mounted. For use inside hutch. Shipped RTA (ready to assemble).

- *Cannot be used on overstorage units.*
- Available in all standard laminate finishes (see page 113).

ZVS21	11.8 x 13.42 x 20.75	70	30	1.80	\$377	N/A	N/A	N/A
ZVS14	11.8 x 13.42 x 14.3	85	24	1.80	\$307	N/A	N/A	N/A

For use in conjunction with the horizontal pigeon-hole storage. Can be used **under** or **over** horizontal unit. Not freestanding. Shipped RTA (ready to assemble).

Vertical pigeon-hole shell - available in all standard laminate finishes (see page 113).

- Collator shelves - available in Black (**K**) or Brushed Cobalt (**T**) finish. Please specify.
Use Brushed Cobalt to match Silver finish handles.
- When used together with tackboard and hutch, reduce tackboard width by 12.5"

Required Specifications

Top finish Base/door finish*
Wall finish
Top/Edge Detail
Handles*

Optional Specifications

Glazing - Doors*
Grommet position
Key #
End filler cap

PIGEON-HOLE STORAGE

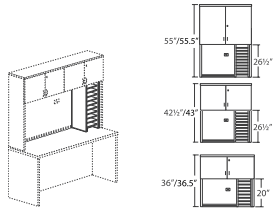

Vertical Pigeon-Hole Storage

MODEL#	DIMENSIONS	FREIGHT CLASS	WT/LBS.	CUBIC FT.	1" TOP	1.5" TOP	GLAZE ADD	HP ADD	
D x W x H									
ZVS26	11.8 x 13.42 x 25.4-25.9	70	36	1.80	\$452	N/A	N/A	N/A	
ZVS20	11.8 x 13.42 x 19-19.5	70	29	1.80	\$362	N/A	N/A	N/A	

- Used alone with a hutch. **Not freestanding.** Shipped easy to assemble in 1 carton.
- Vertical pigeon-hole shell - available in all standard laminate finishes (see page 113).
 - Collator shelves - available in Black (K) or Brushed Cobalt (T) finish. Please specify.
Use Brushed Cobalt to match Silver finish handles.
 - When used together with tackboard and hutch, reduce tackboard width by 12.5"
 - Removal of valance required.

TRANSITIONAL PIGEON-HOLE STORAGE

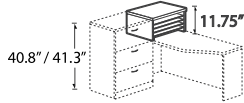

Transitional Pigeon-Hole Storage
11.75" H

MODEL#	DIMENSIONS	FREIGHT CLASS	WT/LBS.	CUBIC FT.	1" TOP	1.5" TOP	GLAZE ADD	HP ADD
Z24L12PH	24 x 24 x 11.25-11.75	65	63	2.70	\$747	\$823	N/A	N/A
Z20L12PH	24 x 20 x 11.25-11.75	70	56	2.70	\$659	\$725	N/A	N/A
Z16L12PH	24 x 16 x 11.25-11.75	65	46	1.60	\$603	\$660	N/A	N/A
Z24M12PH	20 x 24 x 11.25-11.75	70	55	2.70	\$659	\$725	N/A	N/A
Z20M12PH	20 x 20 x 11.25-11.75	70	48	2.70	\$585	\$639	N/A	N/A
Z16M12PH	20 x 16 x 11.25-11.75	65	40	1.60	\$530	\$576	N/A	N/A
Z24S12PH	16 x 24 x 11.25-11.75	65	43	1.60	\$607	\$663	N/A	N/A
Z20S12PH	16 x 20 x 11.25-11.75	65	38	1.60	\$533	\$578	N/A	N/A
Z16S12PH	16 x 16 x 11.25-11.75	70	33	1.60	\$499	\$537	N/A	N/A

- Designed to fit on top of returns and transition worksurface to match 40.8"/41.3" high storage modules. Pigeon-hole shell and four collator shelves. Shipped RTA (ready to assemble).
- Pigeon-Hole Shell - Available in all standard laminate finishes (page 113).
 - Collator Shelves - Available in Black (K) or Brushed Cobalt (T) finish. Please Specify.
Use Brushed Cobalt to match silver finish handles.

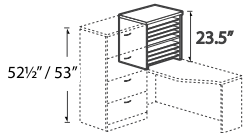

Transitional Pigeon-Hole Storage
23.5" H

Z24L23PH	24 x 24 x 23-23.5	60	101	2.70	\$1344	\$1420	N/A	N/A
Z20L23PH	24 x 20 x 23-23.5	60	88	2.70	\$1176	\$1239	N/A	N/A
Z16L23PH	24 x 16 x 23-23.5	65	76	2.70	\$1103	\$1160	N/A	N/A
Z24M23PH	20 x 24 x 23-23.5	60	87	2.70	\$1179	\$1242	N/A	N/A
Z20M23PH	20 x 20 x 23-23.5	65	76	2.70	\$1031	\$1085	N/A	N/A
Z16M23PH	20 x 16 x 23-23.5	60	64	1.60	\$948	\$994	N/A	N/A
Z24S23PH	16 x 24 x 23-23.5	65	74	2.70	\$1115	\$1171	N/A	N/A
Z20S23PH	16 x 20 x 23-23.5	65	65	2.70	\$974	\$1020	N/A	N/A
Z16S23PH	16 x 16 x 23-23.5	60	54	1.60	\$890	\$932	N/A	N/A

- Designed to fit on top of returns and transition worksurface to match 52.5"/53" high storage modules. Pigeon-hole shell and eight collator shelves. Shipped RTA (ready to assemble).
- Pigeon-Hole Shell - Available in all standard laminate finishes (page 113).
 - Collator Shelves - Available in Black (K) or Brushed Cobalt (T) finish. Please Specify.
Use Brushed Cobalt to match silver finish handles.

Required Specifications

- Top finish
- Wall finish
- Top/Edge Detail
- Shelf finish

Optional Specifications

- End filler cap
- Grommet

FLOATING SHELVES

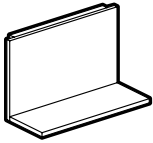

Floating Shelf - 20" H

MODEL#	DIMENSIONS D x W x H	FREIGHT CLASS	WT/LBS.	CUBIC FT.	1" TOP	1.5" TOP	GLAZE ADD	HP ADD
ZFS4220	14.25 x 42 x 20	70	55	2.75	\$610	\$648	N/A	N/A
ZFS3620	14.25 x 36 x 20	70	47	2.40	\$548	\$582	N/A	N/A
ZFS3020	14.25 x 30 x 20	70	39	2	\$466	\$496	N/A	N/A
ZFS2420	14.25 x 24 x 20	70	33	1.90	\$411	\$441	N/A	N/A

To match 71.9/72.4"H units. Standard with pre-mounted "J" bracket for wall mount applications. End cap required at the end of a run of floating shelves. End cap sold separately, see page 227.

• **NOTE:** Care should be taken to mount the units. Units should be mounted to wall studs using correct fasteners. Failure to do so may result in collapse of the unit and subsequent personal injury. **Fastening hardware not included.** Mounting hardware used should be based on wall material. Consult an installation professional for proper wall mounting.

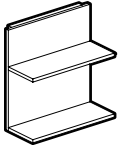

Double Floating Shelf - 32.5" H

ZF2S4232	14.25 x 42 x 32.5	65	85	3.30	\$870	\$908	N/A	N/A
ZF2S3632	14.25 x 36 x 32.5	65	73	2.90	\$779	\$813	N/A	N/A
ZF2S3032	14.25 x 30 x 32.5	65	60	2.50	\$664	\$694	N/A	N/A
ZF2S2432	14.25 x 24 x 32.5	70	50	2.40	\$588	\$618	N/A	N/A

To match 84.4/84.9"H units. Standard with pre-mounted "J" bracket for wall mount applications. End cap required at the end of a run of floating shelves. End cap sold separately, see page 227.

• **NOTE:** Care should be taken to mount the units. Units should be mounted to wall studs using correct fasteners. Failure to do so may result in collapse of the unit and subsequent personal injury. **Fastening hardware not included.** Mounting hardware used should be based on wall material. Consult an installation professional for proper wall mounting.

WALLS W/OVERHEAD STORAGE

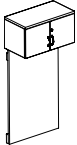

Wall w/Closed Storage - 66" H*

MODEL#	DIMENSIONS	FREIGHT CLASS	WT/LBS.	CUBIC FT.	1" TOP	1.5" TOP	GLAZE ADD	HP ADD
Z4266WS	16 x 42 x 65.5-66	85	122	8.26	\$1465	\$1528	\$515	N/A
Z3666WS	16 x 36 x 65.5-66	85	113	8.80	\$1233	\$1289	\$474	N/A
Z3066WS	16 x 30 x 65.5-66	85	97	7.50	\$1233	\$1269	\$424	N/A
Z2466WS	16 x 24 x 65.5-66	92.5	79	6.60	\$1088	\$1126	\$382	N/A

Standard with pre-mounted "J" bracket for wall mount applications. Doors lock. End cap required at the end of a run of wall units. End cap sold separately, see page 227.

• **NOTE:** Care should be taken to mount the units. Units should be mounted to wall studs using correct fasteners. Failure to do so may result in collapse of the unit and subsequent personal injury. **Mounting hardware not included.** Mounting hardware used should be based on wall material. Consult an installation professional for proper wall mounting.

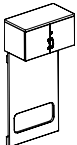

Wall w/Closed Storage - 66" H*

Z4266WSO	16 x 42 x 65.5-66	125	112	18.60	\$1562	\$1625	\$515	N/A
Z3666WSO	16 x 36 x 65.5-66	125	100	16.20	\$1421	\$1477	\$474	N/A
Z3066WSO	16 x 30 x 65.5-66	125	85	13.50	\$1239	\$1290	\$424	N/A
Z2466WSO	16 x 24 x 65.5-66	92.5	70	6.20	\$1099	\$1137	\$382	N/A

Standard with pre-mounted "J" bracket for wall mount applications. Doors lock. Large cutout provides direct access to wall for access to electrical. End cap required at the end of a run of wall units. End cap sold separately, see page 227.

• **NOTE:** Care should be taken to mount the units. Units should be mounted to wall studs using correct fasteners. Failure to do so may result in collapse of the unit and subsequent personal injury. **Mounting hardware not included.** Mounting hardware used should be based on wall material. Consult an installation professional for proper wall mounting.

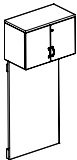

Wall w/Closed Storage - 72" H*

Z4272WS	16 x 42 x 71.9-72.4	85	134	10.20	\$1562	\$1641	\$590	N/A
Z3672WS	16 x 36 x 71.9-72.4	85	119	9.46	\$1505	\$1575	\$539	N/A
Z3072WS	16 x 30 x 71.9-72.4	85	102	8.10	\$1322	\$1380	\$483	N/A
Z2472WS	16 x 24 x 71.9-72.4	85	84	6.60	\$1159	\$1207	\$439	N/A

Standard with pre-mounted "J" bracket for wall mount applications. Doors lock. End cap required at the end of a run of wall units. End cap sold separately, see page 227.

• **NOTE:** Care should be taken to mount the units. Units should be mounted to wall studs using correct fasteners. Failure to do so may result in collapse of the unit and subsequent personal injury. **Mounting hardware not included.** Mounting hardware used should be based on wall material. Consult an installation professional for proper wall mounting.

Required Specifications

Top finish Base/door finish*
 Wall finish Handles*
 Top/Edge Detail
 Shelf finish

Optional Specifications

End filler cap
 Key #*
 Grommet position
 Glazed doors*

WALLS W/OVERHEAD STORAGE

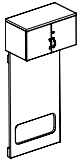

Wall w/Closed Storage - 72"H*

MODEL#	DIMENSIONS	FREIGHT CLASS	WT/LBS.	CUBIC FT.	1" TOP	1.5" TOP	GLAZE ADD	HP ADD	
D x W x H									
Z4272WSO	16 x 42 x 71.9-72.4	85	120	9.30	\$1578	\$1657	\$590	N/A	
Z3672WSO	16 x 36 x 71.9-72.4	85	105	8.66	\$1518	\$1588	\$539	N/A	
Z3072WSO	16 x 30 x 71.9-72.4	85	91	7.50	\$1333	\$1413	\$483	N/A	
Z2472WSO	16 x 24 x 71.9-72.4	92.5	74	6.20	\$1170	\$1218	\$439	N/A	

Standard with pre-mounted "J" bracket for wall mount applications. Doors lock. Large cutout provides direct access to wall for access to electrical. End cap required at the end of a run of wall units. End cap sold separately, see page 227.

• **NOTE:** Care should be taken to mount the units. Units should be mounted to wall studs using correct fasteners. Failure to do so may result in collapse of the unit and subsequent personal injury. **Mounting hardware not included.** Mounting hardware used should be based on wall material. Consult an installation professional for proper wall mounting.

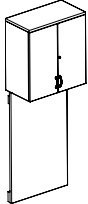

Wall w/Closed Storage - 84"H*

Z4284WS	16 x 42 x 84.4-84.9	85	134	10.20	\$1932	\$2011	\$819	N/A
Z3684WS	16 x 36 x 84.4-84.9	85	119	9.46	\$1835	\$1918	\$748	N/A
Z3084WS	16 x 30 x 84.4-84.9	85	102	8.10	\$1613	\$1671	\$664	N/A
Z2484WS	16 x 24 x 84.4-84.9	85	84	6.60	\$1421	\$1469	\$603	N/A

Standard with pre-mounted "J" bracket for wall mount applications. Doors lock. End cap required at the end of a run of wall units. End cap sold separately, see page 227.

• **NOTE:** Care should be taken to mount the units. Units should be mounted to wall studs using correct fasteners. Failure to do so may result in collapse of the unit and subsequent personal injury. **Mounting hardware not included.** Mounting hardware used should be based on wall material. Consult an installation professional for proper wall mounting.

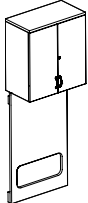

Wall w/Closed Storage - 84"H*

Z4284WSO	16 x 42 x 84.4-84.9	85	120	9.30	\$1946	\$2025	\$819	N/A
Z3684WSO	16 x 36 x 84.4-84.9	85	105	8.66	\$1848	\$1931	\$748	N/A
Z3084WSO	16 x 30 x 84.4-84.9	85	91	7.50	\$1625	\$1683	\$664	N/A
Z2484WSO	16 x 24 x 84.4-84.9	92.5	74	6.20	\$1430	\$1478	\$603	N/A

Standard with pre-mounted "J" bracket for wall mount applications. Doors lock. Large cutout provides direct access to wall for access to electrical. End cap required at the end of a run of wall units. End cap sold separately, see page 227.

• **NOTE:** Care should be taken to mount the units. Units should be mounted to wall studs using correct fasteners. Failure to do so may result in collapse of the unit and subsequent personal injury. **Mounting hardware not included.** Mounting hardware used should be based on wall material. Consult an installation professional for proper wall mounting.

WALLS W/FLOATING SHELVES

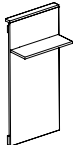

Wall w/Floating Shelf* - 66"H

MODEL#	DIMENSIONS	FREIGHT CLASS	WT/LBS.	CUBIC FT.	1" TOP	1.5" TOP	GLAZE ADD	HP ADD
ZF1S4266	14.25 x 42 x 65.5-66	70	117	7.50	\$1141	\$1179	N/A	N/A
ZF1S3666	14.25 x 36 x 65.5-66	70	103	6.60	\$994	\$1028	N/A	N/A
ZF1S3066	14.25 x 30 x 65.5-66	70	86	5.70	\$857	\$891	N/A	N/A
ZF1S2466	14.25 x 24 x 65.5-66	85	69	4.70	\$735	\$764	N/A	N/A

Standard with pre-mounted "J" bracket for wall mount applications. End cap required at the end of a run of floating shelves. End cap sold separately, see page 227.

• **NOTE:** Care should be taken to mount the units. Units should be mounted to wall studs using correct fasteners. Failure to do so may result in collapse of the unit and subsequent personal injury. **Fastening hardware not included.** Mounting hardware used should be based on wall material. Consult an installation professional for proper wall mounting.

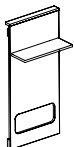

Wall w/Floating Shelf* - 66"H

ZF1S42660	14.25 x 42 x 65.5-66	85	110	7.50	\$1153	\$1191	N/A	N/A
ZF1S36660	14.25 x 36 x 65.5-66	85	97	6.60	\$1005	\$1039	N/A	N/A
ZF1S30660	14.25 x 30 x 65.5-66	85	81	5.70	\$864	\$898	N/A	N/A
ZF1S24660	14.25 x 24 x 65.5-66	85	66	4.70	\$740	\$769	N/A	N/A

Standard with pre-mounted "J" bracket for wall mount applications. Large cutout provides direct access to wall for access to electrical. End cap required at the end of a run of floating shelves. End cap sold separately, see page 227.

• **NOTE:** Care should be taken to mount the units. Units should be mounted to wall studs using correct fasteners. Failure to do so may result in collapse of the unit and subsequent personal injury. **Fastening hardware not included.** Mounting hardware used should be based on wall material. Consult an installation professional for proper wall mounting.

Required Specifications

Top finish Base/door finish*
 Wall finish Handles*
 Top/Edge Detail
 Shelf finish

Optional Specifications

End filler cap
 Grommet*

WALLS W/FLOATING SHELVES

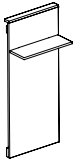

Wall w/Floating Shelf* - 72"H

MODEL#	DIMENSIONS D x W x H	FREIGHT CLASS	WT/LBS.	CUBIC FT.	1" TOP	1.5" TOP	GLAZE ADD	HP ADD
ZF1S4272	14.25 x 42 x 71.9-72.4	70	127	8	\$1201	\$1239	N/A	N/A
ZF1S3672	14.25 x 36 x 71.9-72.4	70	110	7.10	\$1049	\$1083	N/A	N/A
ZF1S3072	14.25 x 30 x 71.9-72.4	70	92	6.10	\$926	\$960	N/A	N/A
ZF1S2472	14.25 x 24 x 71.9-72.4	85	74	5	\$785	\$814	N/A	N/A

Standard with pre-mounted "J" bracket for wall mount applications. End cap required at the end of a run of floating shelves. End cap sold separately, see page 227.

• **NOTE:** Care should be taken to mount the units. Units should be mounted to wall studs using correct fasteners. Failure to do so may result in collapse of the unit and subsequent personal injury. **Fastening hardware not included.** Mounting hardware used should be based on wall material. Consult an installation professional for proper wall mounting.

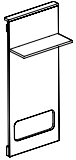

Wall w/Floating Shelf* - 72"H

ZF1S42720	14.25 x 42 x 71.9-72.4	70	120	8	\$1215	\$1253	N/A	N/A
ZF1S36720	14.25 x 36 x 71.9-72.4	85	104	7.10	\$1061	\$1095	N/A	N/A
ZF1S30720	14.25 x 30 x 71.9-72.4	85	87	6.10	\$938	\$972	N/A	N/A
ZF1S24720	14.25 x 24 x 71.9-72.4	85	71	5	\$790	\$819	N/A	N/A

Standard with pre-mounted "J" bracket for wall mount applications. Large cutout provides direct access to wall for access to electrical. End cap required at the end of a run of floating shelves. End cap sold separately, see page 227.

• **NOTE:** Care should be taken to mount the units. Units should be mounted to wall studs using correct fasteners. Failure to do so may result in collapse of the unit and subsequent personal injury. **Fastening hardware not included.** Mounting hardware used should be based on wall material. Consult an installation professional for proper wall mounting.

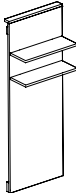

Wall w/Floating Shelves - 84"H

ZF2S4284	14.25 x 42 x 84.4-84.9	70	158	9.50	\$1411	\$1449	N/A	N/A
ZF2S3684	14.25 x 36 x 84.4-84.9	70	136	8.40	\$1215	\$1261	N/A	N/A
ZF2S3084	14.25 x 30 x 84.4-84.9	70	113	7.10	\$1074	\$1103	N/A	N/A
ZF2S2484	14.25 x 24 x 84.4-84.9	85	91	6.25	\$931	\$960	N/A	N/A

Standard with pre-mounted "J" bracket for wall mount applications. End cap required at the end of a run of floating shelves. End cap sold separately, see page 227.

• **NOTE:** Care should be taken to mount the units. Units should be mounted to wall studs using correct fasteners. Failure to do so may result in collapse of the unit and subsequent personal injury. **Fastening hardware not included.** Mounting hardware used should be based on wall material. Consult an installation professional for proper wall mounting.

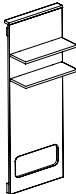

Wall w/Floating Shelves - 84"H

ZF2S42840	14.25 x 42 x 84.4-84.9	70	148	9.50	\$1423	\$1461	N/A	N/A
ZF2S36840	14.25 x 36 x 84.4-84.9	70	128	8.40	\$1232	\$1270	N/A	N/A
ZF2S30840	14.25 x 30 x 84.4-84.9	85	106	7.10	\$1166	\$1195	N/A	N/A
ZF2S24840	14.25 x 24 x 84.4-84.9	85	86	6.25	\$938	\$967	N/A	N/A

Standard with pre-mounted "J" bracket for wall mount applications. Large cutout provides direct access to wall for access to electrical. End cap required at the end of a run of floating shelves. End cap sold separately, see page 227.

• **NOTE:** Care should be taken to mount the units. Units should be mounted to wall studs using correct fasteners. Failure to do so may result in collapse of the unit and subsequent personal injury. **Fastening hardware not included.** Mounting hardware used should be based on wall material. Consult an installation professional for proper wall mounting.

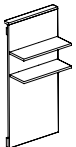

Wall w/Floating Shelves - 66"H

ZF2S4266	14.25 x 42 x 65.5-66	70	132	7.50	\$1177	\$1215	N/A	N/A
ZF2S3666	14.25 x 36 x 65.5-66	70	115	6.60	\$1021	\$1055	N/A	N/A
ZF2S3066	14.25 x 30 x 65.5-66	70	96	5.70	\$887	\$917	N/A	N/A
ZF2S2466	14.25 x 24 x 65.5-66	70	77	4.70	\$759	\$789	N/A	N/A

Standard with pre-mounted "J" bracket for wall mount applications. End cap required at the end of a run of floating shelves. End cap sold separately, see page 227.

• **NOTE:** Care should be taken to mount the units. Units should be mounted to wall studs using correct fasteners. Failure to do so may result in collapse of the unit and subsequent personal injury. **Fastening hardware not included.** Mounting hardware used should be based on wall material. Consult an installation professional for proper wall mounting.

Required Specifications

- Top finish
- Wall finish
- Top/Edge Detail
- Shelf finish

Optional Specifications

- End filler cap
- Grommet

WALLS W/FLOATING SHELVES

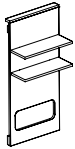

Wall w/Floating Shelves - 66"H

MODEL#	DIMENSIONS	FREIGHT CLASS	WT/LBS.	CUBIC FT.	1" TOP	1.5" TOP	GLAZE ADD	HP ADD
D x W x H								
ZF2S42660	14.25 x 42 x 65.5-66	70	125	7.50	\$1192	\$1230	N/A	N/A
ZF2S36660	14.25 x 36 x 65.5-66	70	109	6.60	\$1033	\$1067	N/A	N/A
ZF2S30660	14.25 x 30 x 65.5-66	70	91	5.70	\$899	\$929	N/A	N/A
ZF2S24660	14.25 x 24 x 65.5-66	70	74	4.70	\$766	\$796	N/A	N/A

Standard with pre-mounted "J" bracket for wall mount applications. Large cutout provides direct access to wall for access to electrical. End cap required at the end of a run of floating shelves. End cap sold separately, see page 227.

- **NOTE:** Care should be taken to mount the units. Units should be mounted to wall studs using correct fasteners. Failure to do so may result in collapse of the unit and subsequent personal injury. **Fastening hardware not included.** Mounting hardware used should be based on wall material. Consult an installation professional for proper wall mounting.

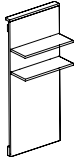

Wall w/Floating Shelves - 72"H

ZF2S4272	14.25 x 42 x 71.9-72.4	70	142	8	\$1239	\$1277	N/A	N/A
ZF2S3672	14.25 x 36 x 71.9-72.4	70	122	7.10	\$1077	\$1111	N/A	N/A
ZF2S3072	14.25 x 30 x 71.9-72.4	70	102	6.10	\$954	\$984	N/A	N/A
ZF2S2472	14.25 x 24 x 71.9-72.4	70	82	5	\$807	\$837	N/A	N/A

Standard with pre-mounted "J" bracket for wall mount applications. End cap required at the end of a run of floating shelves. End cap sold separately, see page 227.

- **NOTE:** Care should be taken to mount the units. Units should be mounted to wall studs using correct fasteners. Failure to do so may result in collapse of the unit and subsequent personal injury. **Fastening hardware not included.** Mounting hardware used should be based on wall material. Consult an installation professional for proper wall mounting.

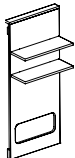

Wall w/Floating Shelves - 72"H

ZF2S42720	14.25 x 42 x 71.9-72.4	70	135	8	\$1253	\$1291	N/A	N/A
ZF2S36720	14.25 x 36 x 71.9-72.4	70	116	7.10	\$1091	\$1125	N/A	N/A
ZF2S30720	14.25 x 30 x 71.9-72.4	70	97	6.10	\$965	\$995	N/A	N/A
ZF2S24720	14.25 x 24 x 71.9-72.4	70	79	5	\$815	\$845	N/A	N/A

Standard with pre-mounted "J" bracket for wall mount applications. Large cutout provides direct access to wall for access to electrical. End cap required at the end of a run of floating shelves. End cap sold separately, see page 227.

- **NOTE:** Care should be taken to mount the units. Units should be mounted to wall studs using correct fasteners. Failure to do so may result in collapse of the unit and subsequent personal injury. **Fastening hardware not included.** Mounting hardware used should be based on wall material. Consult an installation professional for proper wall mounting.

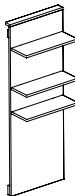

Wall w/Floating Shelves - 84"H

ZF3S4284	14.25 x 42 x 84.4-84.9	70	173	9.50	\$1447	\$1477	N/A	N/A
ZF3S3684	14.25 x 36 x 84.4-84.9	70	148	8.40	\$1253	\$1287	N/A	N/A
ZF3S3084	14.25 x 30 x 84.4-84.9	70	116	7.10	\$1102	\$1132	N/A	N/A
ZF3S2484	14.25 x 24 x 84.4-84.9	70	99	6.25	\$956	\$986	N/A	N/A

Standard with pre-mounted "J" bracket for wall mount applications. End cap required at the end of a run of floating shelves. End cap sold separately, see page 227.

- **NOTE:** Care should be taken to mount the units. Units should be mounted to wall studs using correct fasteners. Failure to do so may result in collapse of the unit and subsequent personal injury. **Fastening hardware not included.** Mounting hardware used should be based on wall material. Consult an installation professional for proper wall mounting.

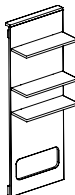

Wall w/Floating Shelves - 84"H

ZF3S42840	14.25 x 42 x 84.4-84.9	70	163	9.50	\$1462	\$1500	N/A	N/A
ZF3S36840	14.25 x 36 x 84.4-84.9	70	140	8.40	\$1267	\$1301	N/A	N/A
ZF3S30840	14.25 x 30 x 84.4-84.9	70	116	7.10	\$1196	\$1226	N/A	N/A
ZF3S24840	14.25 x 24 x 84.4-84.9	70	94	6.25	\$962	\$992	N/A	N/A

Standard with pre-mounted "J" bracket for wall mount applications. Large cutout provides direct access to wall for access to electrical. End cap required at the end of a run of floating shelves. End cap sold separately, see page 227.

- **NOTE:** Care should be taken to mount the units. Units should be mounted to wall studs using correct fasteners. Failure to do so may result in collapse of the unit and subsequent personal injury. **Fastening hardware not included.** Mounting hardware used should be based on wall material. Consult an installation professional for proper wall mounting.

Required Specifications

- Top finish
- Wall finish
- Top/Edge Detail
- Shelf finish

Optional Specifications

- End filler cap
- Grommet

WALL PANELS



Wall Panel - 66"H

MODEL#	DIMENSIONS D x W x H	FREIGHT CLASS	WT/LBS.	CUBIC FT.	1" TOP	1.5" TOP	GLAZE ADD	HP ADD
ZWHP4266	3.5 x 42 x 65.5-66	85	99	7.50	\$1011	\$1049	N/A	N/A
ZWHP3666	3.5 x 36 x 65.5-66	85	90	6.60	\$804	\$838	N/A	N/A
ZWHP3066	3.5 x 30 x 65.5-66	85	75	5.70	\$697	\$727	N/A	N/A
ZWHP2466	3.5 x 24 x 65.5-66	85	61	4.70	\$597	\$627	N/A	N/A

Standard with pre-mounted "J" bracket for wall mount applications. End cap required at the end of a run of floating shelves. End cap sold separately, see page 227.

- **NOTE:** Care should be taken to mount the units. Units should be mounted to wall studs using correct fasteners. Failure to do so may result in collapse of the unit and subsequent personal injury. **Fastening hardware not included.** Mounting hardware used should be based on wall material. Consult an installation professional for proper wall mounting.

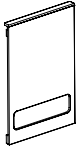

Wall Panel - 66"H

ZWHP42660	3.5 x 42 x 65.5-66	85	90	7.50	\$1026	\$1064	N/A	N/A
ZWHP36660	3.5 x 36 x 65.5-66	85	82	6.60	\$816	\$850	N/A	N/A
ZWHP30660	3.5 x 30 x 65.5-66	85	69	5.70	\$709	\$739	N/A	N/A
ZWHP24660	3.5 x 24 x 65.5-66	92.5	56	4.70	\$603	\$633	N/A	N/A

Standard with pre-mounted "J" bracket for wall mount applications. Large cutout provides direct access to wall for access to electrical. End cap required at the end of a run of floating shelves. End cap sold separately, see page 227.

- **NOTE:** Care should be taken to mount the units. Units should be mounted to wall studs using correct fasteners. Failure to do so may result in collapse of the unit and subsequent personal injury. **Fastening hardware not included.** Mounting hardware used should be based on wall material. Consult an installation professional for proper wall mounting.



Wall Panel - 72"H

ZWHP4272	3.5 x 42 x 71.9-72.4	85	113	8	\$988	\$1026	N/A	N/A
ZWHP3672	3.5 x 36 x 71.9-72.4	85	97	7.10	\$861	\$895	N/A	N/A
ZWHP3072	3.5 x 30 x 71.9-72.4	85	81	6.10	\$765	\$795	N/A	N/A
ZWHP2472	3.5 x 24 x 71.9-72.4	85	67	5	\$645	\$675	N/A	N/A

Standard with pre-mounted "J" bracket for wall mount applications. End cap required at the end of a run of floating shelves. End cap sold separately, see page 227.

- **NOTE:** Care should be taken to mount the units. Units should be mounted to wall studs using correct fasteners. Failure to do so may result in collapse of the unit and subsequent personal injury. **Fastening hardware not included.** Mounting hardware used should be based on wall material. Consult an installation professional for proper wall mounting.

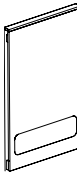

Wall Panel - 72"H

ZWHP42720	3.5 x 42 x 71.9-72.4	85	104	8	\$1003	\$1041	N/A	N/A
ZWHP36720	3.5 x 36 x 71.9-72.4	85	89	7.10	\$873	\$907	N/A	N/A
ZWHP30720	3.5 x 30 x 71.9-72.4	85	75	6.10	\$776	\$806	N/A	N/A
ZWHP24720	3.5 x 24 x 71.9-72.4	85	62	5	\$653	\$683	N/A	N/A

Standard with pre-mounted "J" bracket for wall mount applications. Large cutout provides direct access to wall for access to electrical. End cap required at the end of a run of floating shelves. End cap sold separately, see page 227.

- **NOTE:** Care should be taken to mount the units. Units should be mounted to wall studs using correct fasteners. Failure to do so may result in collapse of the unit and subsequent personal injury. **Fastening hardware not included.** Mounting hardware used should be based on wall material. Consult an installation professional for proper wall mounting.



Wall Panel - 84"H

ZWHP4284	3.5 x 42 x 84.4-84.9	85	128	9.50	\$1053	\$1091	N/A	N/A
ZWHP3684	3.5 x 36 x 84.4-84.9	85	111	8.40	\$928	\$962	N/A	N/A
ZWHP3084	3.5 x 30 x 84.4-84.9	85	92	7.10	\$827	\$857	N/A	N/A
ZWHP2484	3.5 x 24 x 84.4-84.9	85	75	6.25	\$713	\$743	N/A	N/A

Standard with pre-mounted "J" bracket for wall mount applications. End cap required at the end of a run of floating shelves. End cap sold separately, see page 227.

- **NOTE:** Care should be taken to mount the units. Units should be mounted to wall studs using correct fasteners. Failure to do so may result in collapse of the unit and subsequent personal injury. **Fastening hardware not included.** Mounting hardware used should be based on wall material. Consult an installation professional for proper wall mounting.

Required Specifications

Top finish
Wall finish
Top/Edge Detail

Optional Specifications

End filler cap
Grommet

WALL PANELS

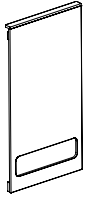

Wall Panel - 84"H

MODEL#	DIMENSIONS D x W x H	FREIGHT CLASS	WT/LBS.	CUBIC FT.	1" TOP	1.5" TOP	GLAZE ADD	HP ADD
ZWHP42840	3.5 x 42 x 84.4-84.9	85	119	9.50	\$1068	\$1106	N/A	N/A
ZWHP36840	3.5 x 36 x 84.4-84.9	85	103	8.40	\$940	\$974	N/A	N/A
ZWHP30840	3.5 x 30 x 84.4-84.9	85	92	7.10	\$836	\$866	N/A	N/A
ZWHP24840	3.5 x 24 x 84.4-84.9	92.5	70	6.25	\$721	\$751	N/A	N/A

Standard with pre-mounted "J" bracket for wall mount applications. Large cutout provides direct access to wall for access to electrical. End cap required at the end of a run of floating shelves. End cap sold separately, see page 227.

• **NOTE:** Care should be taken to mount the units. Units should be mounted to wall studs using correct fasteners. Failure to do so may result in collapse of the unit and subsequent personal injury. **Fastening hardware not included.** Mounting hardware used should be based on wall material. Consult an installation professional for proper wall mounting.

END FILLER CAPS



End Cap

MODEL#	DIMENSIONS	FREIGHT CLASS	WT/LBS.	CUBIC FT.	1" TOP	1.5" TOP	GLAZE ADD	HP ADD
ZEFC19	.75 x 2.5 x 17	70	1.50	.25	\$168	N/A	N/A	N/A

For ZFSxxxx 20"H floating shelf.



End Cap

ZEFC32	.75 x 2.5 x 30	300	2	2	\$274	N/A	N/A	N/A
--------	----------------	-----	---	---	--------------	-----	-----	-----

For ZF2Sxxxx 32.5"H floating shelf.



End Cap

ZEFC49	.75 x 2.5 x 47	250	3	1.20	\$359	N/A	N/A	N/A
--------	----------------	-----	---	------	--------------	-----	-----	-----

For Zxx66WS/Zxx66WSO 65.5/66"H walls with overhead.



End Cap

ZEFC52	.75 x 2.5 x 50	250	4	1.30	\$385	N/A	N/A	N/A
--------	----------------	-----	---	------	--------------	-----	-----	-----

For Zxx72WS/Zxx72WSO/Zxx84WS/Zxx84WSO 71.9/72.4"H or 84.4/84.9"H walls with overhead.



End Cap

ZEFC66	.75 x 2.5 x 64	300	4	4	\$470	N/A	N/A	N/A
--------	----------------	-----	---	---	--------------	-----	-----	-----

For ZF1Sxx66/ZF1Sxx66O/ZF2Sxx66/ZF2Sxx66O/ZWHPxx66/ZWHPxx66O 65.5/66"H wall panels, with or without shelves.

Required Specifications

Top finish
Wall finish
Top/Edge Detail

Optional Specifications

End filler cap
Grommet

END FILLER CAPS

MODEL# DIMENSIONS FREIGHT CLASS WT/LBS. CUBIC FT. 1" TOP 1.5" TOP GLAZE ADD HP ADD

D x W x H

ZEFC72	.75 x 2.5 x 70.5	300	4	4	\$507	N/A	N/A	N/A
--------	------------------	-----	---	---	--------------	-----	-----	-----



End Cap

For ZF1Sxx72/ZF1Sxx720/ZF2Sxx72/ZF2Sxx720/ZWHPxx72/ZWHPxx720 71.9/72.4"H wall panels, with or without shelves.

ZEFC84	.75 x 2.5 x 83	300	5	4.50	\$593	N/A	N/A	N/A
--------	----------------	-----	---	------	--------------	-----	-----	-----



End Cap

For ZF1Sxx84/ZF1Sxx840/ZF2Sxx84/ZF2Sxx840/ZWHPxx84/ZWHPxx840 84.4/84.9"H wall panels, with or without shelves.

Required Specifications

Finish

TACKBOARDS FOR HUTCHES

MODEL# DIMENSIONS FREIGHT CLASS WT/LBS. CUBIC FT. FABRIC GRADE LIST PRICE

D x W x H

TACKBOARD Notes: Tackboards can be upholstered in all of the following fabrics:

Grade 1: Jenny, Quilt, Terrace, Urban, Waterfall

Grade 2: Imprint, Lola

Grade 3: Anchorage, Merge

TACKBOARDS FOR HUTCHES - 23.5" / 24" HIGH

MODEL# DIMENSIONS FREIGHT CLASS WT/LBS. CUBIC FT. FABRIC GRADE LIST PRICE

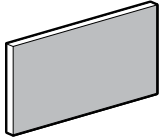

Tackboard

ZTB8217	.62 x 82 x 16.5-17	150	8.20	2	1	\$773
					2	\$930
					3	\$1112
					4	\$1329
					5	\$1527

For use on **Z84S23HN** hutch. Includes mounting screws.

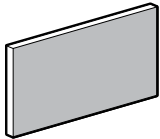

Tackboard

ZTB7017	.62 x 70 x 16.5-17	150	7	1.30	1	\$513
					2	\$619
					3	\$741
					4	\$882
					5	\$1016

For use on **Z72S23HN** hutch. Includes mounting screws.

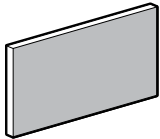

Tackboard

ZTB6917	.62 x 69 x 16.5-17	150	7	1.30	1	\$510
					2	\$616
					3	\$738
					4	\$877
					5	\$1006

For use on **Z71S23HN** hutch. Includes mounting screws.

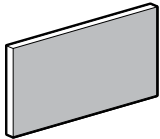

Tackboard

ZTB6417	.62 x 64 x 16.5-17	150	6.40	1.30	1	\$506
					2	\$609
					3	\$725
					4	\$864
					5	\$994

For use on **Z66S23HN** hutch. Includes mounting screws.

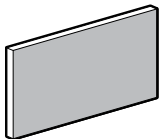

Tackboard

ZTB5817	.62 x 58 x 16.5-17	150	5.80	1.08	1	\$493
					2	\$593
					3	\$712
					4	\$848
					5	\$975

For use on **Z60S23HN** hutch. Includes mounting screws.

Required Specifications

Fabric

TACKBOARDS - 23.5" / 24" HIGH

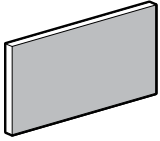

Tackboard

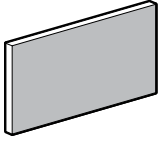

Tackboard

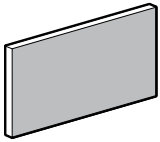

Tackboard

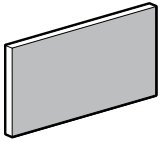

Tackboard

MODEL# DIMENSIONS FREIGHT CLASS WT/LBS. CUBIC FT. FABRIC GRADE LIST PRICE

	D x W x H					
ZTB4617	.62 x 46 x 16.5-17	150	4.60	.85	1	\$331
					2	\$400
					3	\$477
					4	\$566
					5	\$649

For use on **Z48S23HN** hutch. Includes mounting screws.

ZTB4017	.62 x 40 x 16.5-17	150	4	.85	1	\$318
					2	\$383
					3	\$458
					4	\$541
					5	\$623

For use on **Z42S23HN** hutch. Includes mounting screws.

ZTB3417	.62 x 34 x 16.5-17	150	3.40	.85	1	\$308
					2	\$373
					3	\$445
					4	\$523
					5	\$601

For use on **Z36S23HN** hutch. Includes mounting screws.

ZTB2817	.62 x 28 x 16.5-17	250	2.80	.85	1	\$295
					2	\$359
					3	\$428
					4	\$507
					5	\$582

For use on **Z30S23HN** hutch. Includes mounting screws.

TACKBOARDS FOR HUTCHES - 36" / 36.5" HIGH

FABRIC GRADE LIST PRICE

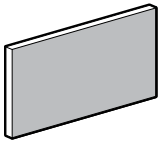

Tackboard

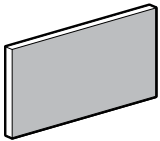

Tackboard

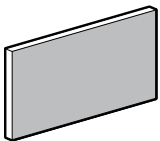

Tackboard

ZTB8216	.62 x 82 x 15-15.5	150	8.20	2	1	\$773
					2	\$930
					3	\$1112
					4	\$1329
					5	\$1527

For use on **Z84S36H and Z84S36HN** hutches. Includes mounting screws.

ZTB7016	.62 x 70 x 15-15.5	150	7	1.30	1	\$513
					2	\$619
					3	\$741
					4	\$882
					5	\$1016

For use on **Z72S36xxx** hutches. Includes mounting screws.

ZTB6916	.62 x 69.5 x 15-15.5	150	7	1.30	1	\$510
					2	\$616
					3	\$738
					4	\$877
					5	\$1006

For use on **Z71S36H and Z71S36HN** hutches. Includes mounting screws.

Required Specifications

Fabric

TACKBOARDS - 36" / 36.5" HIGH

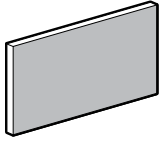

Tackboard

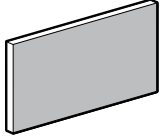

Tackboard

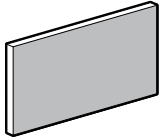

Tackboard

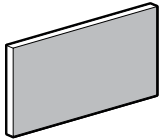

Tackboard

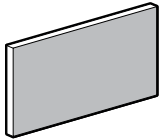

Tackboard

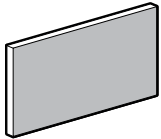

Tackboard

MODEL# DIMENSIONS FREIGHT CLASS WT/LBS. CUBIC FT. FABRIC GRADE LIST PRICE

D x W x H

ZTB6416	.62 x 64 x 15-15.5	150	6.40	1.30	1	\$506
					2	\$609
					3	\$725
					4	\$864
					5	\$994

For use on **Z66S36xxx** hutches. Includes mounting screws.

ZTB5816	.62 x 58 x 15-15.5	150	5.80	1.08	1	\$493
					2	\$593
					3	\$712
					4	\$848
					5	\$975

For use on **Z60S36xxx** hutches. Includes mounting screws.

ZTB4616	.62 x 46 x 15-15.5	150	4.60	.85	1	\$331
					2	\$400
					3	\$477
					4	\$566
					5	\$649

For use on **Z48S36H and Z48S36HN** hutches. Includes mounting screws.

ZTB4016	.62 x 40 x 15-15.5	150	4	.85	1	\$318
					2	\$383
					3	\$458
					4	\$541
					5	\$623

For use on **Z42S36H and Z42S36HN** hutch. Includes mounting screws.

ZTB3416	.62 x 34 x 15-15.5	150	3.40	.85	1	\$308
					2	\$373
					3	\$445
					4	\$523
					5	\$601

For use on **Z36S36H and Z36S36HN** hutch. Includes mounting screws.

ZTB2816	.62 x 28 x 15-15.5	250	2.80	.85	1	\$295
					2	\$359
					3	\$428
					4	\$507
					5	\$582

For use on **Z30S36H and Z30S36HN** hutch. Includes mounting screws.

Required Specifications

Fabric

TACKBOARDS - 42.4", 42.9" & 54.9", 55.4" HIGH

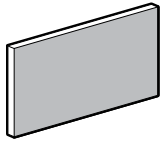

Tackboard

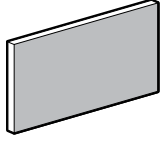

Tackboard

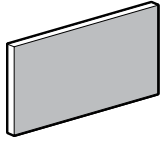

Tackboard

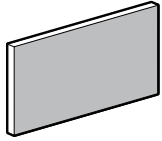

Tackboard

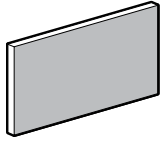

Tackboard

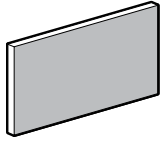

Tackboard

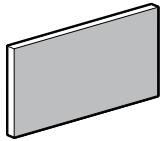

Tackboard

MODEL# DIMENSIONS FREIGHT CLASS WT/LBS. CUBIC FT. FABRIC GRADE LIST PRICE

	D x W x H					
ZTB8221	.62 x 82 x 20.5-21	150	12.80	2.30	1	\$941
					2	\$1127
					3	\$1353
					4	\$1615
					5	\$1855

For use on **Z84S42H, Z84S42HN, Z84S55H and Z84S55HN** hutches. Includes mounting screws.

ZTB7021	.62 x 70 x 20.5-21	125	11	1.50	1	\$633
					2	\$757
					3	\$908
					4	\$1081
					5	\$1244

For use on **Z72S42xxx and Z72S55xxx** hutches. Includes mounting screws.

ZTB6921	.62 x 69 x 20.5-21	125	10.70	1.50	1	\$620
					2	\$749
					3	\$895
					4	\$1067
					5	\$1226

For use on **Z71S42H, Z71S42HN, Z71S55H and Z71S55HN** hutches. Includes mounting screws.

ZTB6421	.62 x 64 x 20.5-21	125	10	1.50	1	\$586
					2	\$706
					3	\$848
					4	\$1008
					5	\$1158

For use on **Z66S42xxx and Z66S55xxx** hutches. Includes mounting screws.

ZTB5821	.62 x 58 x 20.5-21	125	9	1.50	1	\$582
					2	\$705
					3	\$842
					4	\$998
					5	\$1148

For use on **Z60S42xxx and Z60S55xxx** hutches. Includes mounting screws.

ZTB4621	.62 x 46 x 20.5-21	125	7.20	1	1	\$360
					2	\$435
					3	\$519
					4	\$616
					5	\$707

For use on **Z48S42H, Z48S42HN, Z48S55H and Z48S55HN** hutches. Includes mounting screws.

ZTB4021	.62 x 40 x 20.5-21	125	6.20	1	1	\$347
					2	\$419
					3	\$505
					4	\$595
					5	\$686

For use on **Z42S42H, Z42S42HN, Z42S55H and Z42S55HN** hutches. Includes mounting screws.

Required Specifications
Fabric

TACKBOARDS - 42.4", 42.9" & 54.9", 55.4" HIGH

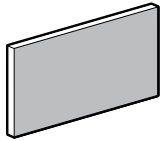

Tackboard

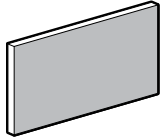

Tackboard

MODEL# DIMENSIONS FREIGHT CLASS WT/LBS. CUBIC FT. FABRIC GRADE LIST PRICE

MODEL#	DIMENSIONS	FREIGHT CLASS	WT/LBS.	CUBIC FT.	FABRIC GRADE	LIST PRICE	
ZTB3421	.62 x 34 x 20.5-21	150	5.30	1			
					D x W x H	1	\$343
					2	\$413	
					3	\$496	
					4	\$585	
5	\$674						

For use on **Z36S42H, Z36S42HN, Z36S55H and Z36S55HN** hutches. Includes mounting screws.

ZTB2821	.62 x 28 x 20.5-21	150	4.50	1		
					1	\$339
					2	\$408
					3	\$486
					4	\$578
5	\$662					

For use on **Z30S42H, Z30S42HN, Z30S55H and Z30S55HN** hutches. Includes mounting screws.

Required Specifications

Fabric

14" WALL-MOUNTED TACKBOARDS

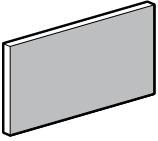

Wall Mounted Tackboard

MODEL#	DIMENSIONS D x W x H	FREIGHT CLASS	WT/LBS.	CUBIC FT.	FABRIC GRADE	LIST PRICE
ZWHT3014	1.25 x 30 x 13.5-14	150	4.70	1	1	\$333
					2	\$386
					3	\$443
					4	\$507
					5	\$581

For use under **Z30S200S/OSN/OSD/OSR/OSL/OSO/SOS** for a finished height of **65"/65.5"**. Standard with pre-mounted "J" bracket for wall mount applications.

• **NOTE:** Care should be taken to mount the units. Units should be mounted to wall studs using correct fasteners. Failure to do so may result in collapse of the unit and subsequent personal injury. **Mounting hardware not included.** Mounting hardware used should be based on wall material. Consult an installation professional for proper wall mounting.

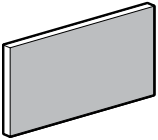

Wall Mounted Tackboard

ZWHT3614	1.25 x 36 x 13.5-14	150	5.60	1	1	\$367
					2	\$427
					3	\$487
					4	\$561
					5	\$642

For use under **Z36S200S/OSN/OSD/OSR/OSL/OSO/SOS** for a finished height of **65"/65.5"**. Standard with pre-mounted "J" bracket for wall mount applications.

• **NOTE:** Care should be taken to mount the units. Units should be mounted to wall studs using correct fasteners. Failure to do so may result in collapse of the unit and subsequent personal injury. **Mounting hardware not included.** Mounting hardware used should be based on wall material. Consult an installation professional for proper wall mounting.

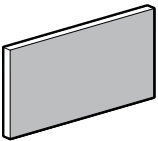

Wall Mounted Tackboard

ZWHT4214	1.25 x 42 x 13.5-14	125	6.50	1	1	\$430
					2	\$496
					3	\$569
					4	\$652
					5	\$748

For use under **Z42S200S/OSN/OSD/OSR/OSL/OSO/SOS** for a finished height of **65"/65.5"**. Standard with pre-mounted "J" bracket for wall mount applications.

• **NOTE:** Care should be taken to mount the units. Units should be mounted to wall studs using correct fasteners. Failure to do so may result in collapse of the unit and subsequent personal injury. **Mounting hardware not included.** Mounting hardware used should be based on wall material. Consult an installation professional for proper wall mounting.

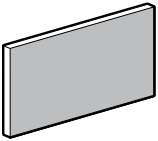

Wall Mounted Tackboard

ZWHT4814	1.25 x 48 x 13.5-14	125	7.50	1	1	\$464
					2	\$536
					3	\$614
					4	\$706
					5	\$810

For use under **Z48S200S/OSN/OSD/OSR/OSL/OSO/SOS** for a finished height of **65"/65.5"**. Standard with pre-mounted "J" bracket for wall mount applications.

• **NOTE:** Care should be taken to mount the units. Units should be mounted to wall studs using correct fasteners. Failure to do so may result in collapse of the unit and subsequent personal injury. **Mounting hardware not included.** Mounting hardware used should be based on wall material. Consult an installation professional for proper wall mounting.

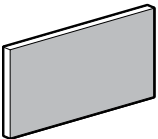

Wall Mounted Tackboard

ZWHT6014	1.25 x 60 x 13.5-14	150	9.30	1.80	1	\$578
					2	\$666
					3	\$765
					4	\$880
					5	\$1010

For use under **Z60S200S/OSN/OSD/OSR/OSL/OSO/SOS** for a finished height of **65"/65.5"**. Standard with pre-mounted "J" bracket for wall mount applications.

• **NOTE:** Care should be taken to mount the units. Units should be mounted to wall studs using correct fasteners. Failure to do so may result in collapse of the unit and subsequent personal injury. **Mounting hardware not included.** Mounting hardware used should be based on wall material. Consult an installation professional for proper wall mounting.

Required Specifications
Fabric

14" WALL-MOUNTED TACKBOARDS

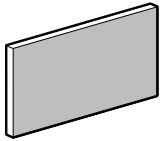

Wall Mounted Tackboard

MODEL#	DIMENSIONS	FREIGHT CLASS	WT/LBS.	CUBIC FT.	FABRIC GRADE	LIST PRICE
--------	------------	---------------	---------	-----------	--------------	------------

D x W x H						
ZWHT6614	1.25 x 66 x 13.5-14	150	10.30	1.80	1	\$614
					2	\$707
					3	\$812
					4	\$932
					5	\$1071

For use under **ZxxS200S/OSN/OSD/OSR/OSL/OSO/SOS** for a finished height of **65"/65.5"**. Standard with pre-mounted "J" bracket for wall mount applications.

• **NOTE:** Care should be taken to mount the units. Units should be mounted to wall studs using correct fasteners. Failure to do so may result in collapse of the unit and subsequent personal injury. **Mounting hardware not included.** Mounting hardware used should be based on wall material. Consult an installation professional for proper wall mounting.

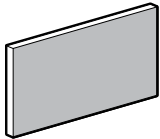

Wall Mounted Tackboard

ZWHT7214	1.25 x 72 x 13.5-14	125	11.20	1.80	1	\$673
					2	\$778
					3	\$892
					4	\$1027
					5	\$1178

For use under **ZxxS200S/OSN/OSD/OSR/OSL/OSO/SOS** for a finished height of **65"/65.5"**. Standard with pre-mounted "J" bracket for wall mount applications.

• **NOTE:** Care should be taken to mount the units. Units should be mounted to wall studs using correct fasteners. Failure to do so may result in collapse of the unit and subsequent personal injury. **Mounting hardware not included.** Mounting hardware used should be based on wall material. Consult an installation professional for proper wall mounting.

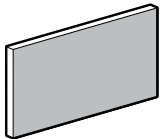

Wall Mounted Tackboard

ZWHT7814	1.25 x 78 x 13.5-14	125	12.10	1.80	1	\$710
					2	\$820
					3	\$943
					4	\$1079
					5	\$1242

For use under **ZxxS200S/OSN/OSD/OSR/OSL/OSO/SOS** for a finished height of **65"/65.5"**. Standard with pre-mounted "J" bracket for wall mount applications.

• **NOTE:** Care should be taken to mount the units. Units should be mounted to wall studs using correct fasteners. Failure to do so may result in collapse of the unit and subsequent personal injury. **Mounting hardware not included.** Mounting hardware used should be based on wall material. Consult an installation professional for proper wall mounting.

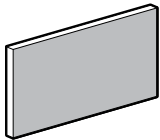

Wall Mounted Tackboard

ZWHT8414	1.25 x 84 x 13.5-14	125	13.10	1.80	1	\$767
					2	\$886
					3	\$1019
					4	\$1171
					5	\$1344

For use under **ZxxS200S/OSN/OSD/OSR/OSL/OSO/SOS** for a finished height of **65"/65.5"**. Standard with pre-mounted "J" bracket for wall mount applications.

• **NOTE:** Care should be taken to mount the units. Units should be mounted to wall studs using correct fasteners. Failure to do so may result in collapse of the unit and subsequent personal injury. **Mounting hardware not included.** Mounting hardware used should be based on wall material. Consult an installation professional for proper wall mounting.

18" WALL MOUNTED TACKBOARDS

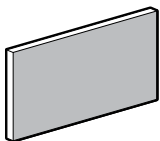

Wall Mounted Tackboard

MODEL#	DIMENSIONS	FREIGHT CLASS	WT/LBS.	CUBIC FT.	FABRIC GRADE	LIST PRICE
--------	------------	---------------	---------	-----------	--------------	------------

ZWHT3018	1.25 x 30 x 17.5-18	125	6	1	1	\$343
					2	\$399
					3	\$457
					4	\$525
					5	\$602

For use under **Z30S160S/OSN** for a finished height of **65"/65.5"**. Standard with pre-mounted "J" bracket for wall mount applications.

• **NOTE:** Care should be taken to mount the units. Units should be mounted to wall studs using correct fasteners. Failure to do so may result in collapse of the unit and subsequent personal injury. **Mounting hardware not included.** Mounting hardware used should be based on wall material. Consult an installation professional for proper wall mounting.

Required Specifications

Fabric

18" WALL MOUNTED TACKBOARDS

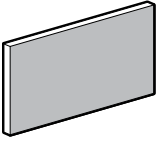

Wall Mounted Tackboard

MODEL#	DIMENSIONS D x W x H	FREIGHT CLASS	WT/LBS.	CUBIC FT.	FABRIC GRADE	LIST PRICE
ZWHT3618	1.25 x 36 x 17.5-18	125	7.20	1	1	\$381
					2	\$442
					3	\$506
					4	\$580
					5	\$667

For use under **Z36S160S/OSN** for a finished height of **65"/65.5"**. Standard with pre-mounted "J" bracket for wall mount applications.

- **NOTE:** Care should be taken to mount the units. Units should be mounted to wall studs using correct fasteners. Failure to do so may result in collapse of the unit and subsequent personal injury. **Mounting hardware not included.** Mounting hardware used should be based on wall material. Consult an installation professional for proper wall mounting.

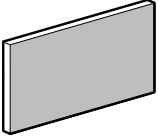

Wall Mounted Tackboard

ZWHT4218	1.25 x 42 x 17.5-18	100	8.40	1	1	\$442
					2	\$511
					3	\$585
					4	\$674
					5	\$773

For use under **Z42S160S/OSN** for a finished height of **65"/65.5"**. Standard with pre-mounted "J" bracket for wall mount applications.

- **NOTE:** Care should be taken to mount the units. Units should be mounted to wall studs using correct fasteners. Failure to do so may result in collapse of the unit and subsequent personal injury. **Mounting hardware not included.** Mounting hardware used should be based on wall material. Consult an installation professional for proper wall mounting.

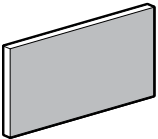

Wall Mounted Tackboard

ZWHT4818	1.25 x 48 x 17.5-18	100	9.60	1	1	\$481
					2	\$555
					3	\$639
					4	\$733
					5	\$841

For use under **Z48S160S/OSN** for a finished height of **65"/65.5"**. Standard with pre-mounted "J" bracket for wall mount applications.

- **NOTE:** Care should be taken to mount the units. Units should be mounted to wall studs using correct fasteners. Failure to do so may result in collapse of the unit and subsequent personal injury. **Mounting hardware not included.** Mounting hardware used should be based on wall material. Consult an installation professional for proper wall mounting.

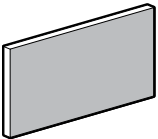

Wall Mounted Tackboard

ZWHT6018	1.25 x 60 x 17.5-18	125	12	1.80	1	\$591
					2	\$681
					3	\$785
					4	\$900
					5	\$1034

For use under **Z60S160S/OSN** for a finished height of **65"/65.5"**. Standard with pre-mounted "J" bracket for wall mount applications.

- **NOTE:** Care should be taken to mount the units. Units should be mounted to wall studs using correct fasteners. Failure to do so may result in collapse of the unit and subsequent personal injury. **Mounting hardware not included.** Mounting hardware used should be based on wall material. Consult an installation professional for proper wall mounting.

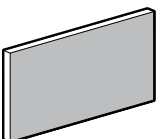

Wall Mounted Tackboard

ZWHT6618	1.25 x 66 x 17.5-18	125	13.20	1.80	1	\$630
					2	\$728
					3	\$837
					4	\$961
					5	\$1102

For use under **ZxxS160S/OSN** for a finished height of **65"/65.5"**. Standard with pre-mounted "J" bracket for wall mount applications.

- **NOTE:** Care should be taken to mount the units. Units should be mounted to wall studs using correct fasteners. Failure to do so may result in collapse of the unit and subsequent personal injury. **Mounting hardware not included.** Mounting hardware used should be based on wall material. Consult an installation professional for proper wall mounting.

Required Specifications
Fabric

18" WALL MOUNTED TACKBOARDS

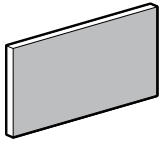

Wall Mounted Tackboard

MODEL#	DIMENSIONS	FREIGHT CLASS	WT./LBS.	CUBIC FT.	FABRIC GRADE	LIST PRICE
--------	------------	---------------	----------	-----------	--------------	------------

D x W x H						
ZWHT7218	1.25 x 72 x 17.5-18	100	14.40	1.80	1	\$692
					2	\$799
					3	\$915
					4	\$1053
					5	\$1208

For use under **ZxxS160S/OSN** for a finished height of **65"/65.5"**. Standard with pre-mounted "J" bracket for wall mount applications.

• **NOTE:** Care should be taken to mount the units. Units should be mounted to wall studs using correct fasteners. Failure to do so may result in collapse of the unit and subsequent personal injury. **Mounting hardware not included.** Mounting hardware used should be based on wall material. Consult an installation professional for proper wall mounting.

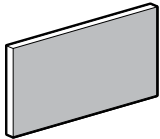

Wall Mounted Tackboard

ZWHT7818	1.25 x 78 x 17.5-18	100	15.60	1.80	1	\$729
					2	\$842
					3	\$965
					4	\$1111
					5	\$1273

For use under **ZxxS160S/OSN** for a finished height of **65"/65.5"**. Standard with pre-mounted "J" bracket for wall mount applications.

• **NOTE:** Care should be taken to mount the units. Units should be mounted to wall studs using correct fasteners. Failure to do so may result in collapse of the unit and subsequent personal injury. **Mounting hardware not included.** Mounting hardware used should be based on wall material. Consult an installation professional for proper wall mounting.

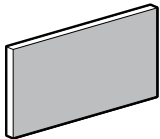

Wall Mounted Tackboard

ZWHT8418	1.25 x 84 x 17.5-18	100	16.80	1.80	1	\$789
					2	\$909
					3	\$1047
					4	\$1202
					5	\$1380

For use under **ZxxS160S/OSN** for a finished height of **65"/65.5"**. Standard with pre-mounted "J" bracket for wall mount applications.

• **NOTE:** Care should be taken to mount the units. Units should be mounted to wall studs using correct fasteners. Failure to do so may result in collapse of the unit and subsequent personal injury. **Mounting hardware not included.** Mounting hardware used should be based on wall material. Consult an installation professional for proper wall mounting.

21" WALL MOUNTED TACKBOARDS

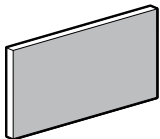

Wall Mounted Tackboard

MODEL#	DIMENSIONS	FREIGHT CLASS	WT./LBS.	CUBIC FT.	FABRIC GRADE	LIST PRICE
--------	------------	---------------	----------	-----------	--------------	------------

ZWHT3021	1.25 x 30 x 20.5-21	125	7	1	1	\$351
					2	\$408
					3	\$466
					4	\$535
					5	\$614

For use under **Z30S210S/OSN/OSD/OSR/OSL/OSO/SOS** for a finished height of **71.5"/72"**. Standard with pre-mounted "J" bracket for wall mount applications. For use under **Z30S330S/OSN** for a finished height of **84"/84.5"**

• **NOTE:** Care should be taken to mount the units. Units should be mounted to wall studs using correct fasteners. Failure to do so may result in collapse of the unit and subsequent personal injury. **Mounting hardware not included.** Mounting hardware used should be based on wall material. Consult an installation professional for proper wall mounting.

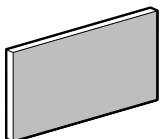

Wall Mounted Tackboard

ZWHT3621	1.25 x 36 x 20.5-21	100	8.40	1	1	\$388
					2	\$451
					3	\$514
					4	\$593
					5	\$680

For use under **Z36S210S/OSN/OSD/OSR/OSL/OSO/SOS** for a finished height of **71.5"/72"**. Standard with pre-mounted "J" bracket for wall mount applications. For use under **Z36S330S/OSN** for a finished height of **84"/84.5"**

• **NOTE:** Care should be taken to mount the units. Units should be mounted to wall studs using correct fasteners. Failure to do so may result in collapse of the unit and subsequent personal injury. **Mounting hardware not included.** Mounting hardware used should be based on wall material. Consult an installation professional for proper wall mounting.

Required Specifications

Fabric

21" WALL MOUNTED TACKBOARDS

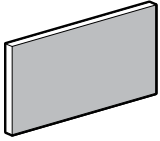

Wall Mounted Tackboard

MODEL#	DIMENSIONS D x W x H	FREIGHT CLASS	WT/LBS.	CUBIC FT.	FABRIC GRADE	LIST PRICE
ZWHT4221	1.25 x 42 x 20.5-21	100	9.80	1	1	\$448
					2	\$518
					3	\$595
					4	\$684
					5	\$785

For use under **Z42S210S/OSN/OSD/OSR/OSL/OSO/SOS** for a finished height of **71.5"/72"**. Standard with pre-mounted "J" bracket for wall mount applications. For use under **Z42S330S/OSN** for a finished height of **84"/84.5"**

• **NOTE:** Care should be taken to mount the units. Units should be mounted to wall studs using correct fasteners. Failure to do so may result in collapse of the unit and subsequent personal injury. **Mounting hardware not included.** Mounting hardware used should be based on wall material. Consult an installation professional for proper wall mounting.

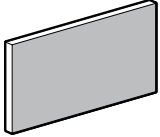

Wall Mounted Tackboard

ZWHT4821	1.25 x 48 x 20.5-21	92.5	11.20	1	1	\$488
					2	\$563
					3	\$647
					4	\$744
					5	\$854

For use under **Z48S210S/OSN/OSD/OSR/OSL/OSO/SOS** for a finished height of **71.5"/72"**. Standard with pre-mounted "J" bracket for wall mount applications. For use under **Z48S330S/OSN** for a finished height of **84"/84.5"**

• **NOTE:** Care should be taken to mount the units. Units should be mounted to wall studs using correct fasteners. Failure to do so may result in collapse of the unit and subsequent personal injury. **Mounting hardware not included.** Mounting hardware used should be based on wall material. Consult an installation professional for proper wall mounting.

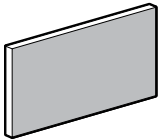

Wall Mounted Tackboard

ZWHT6021	1.25 x 60 x 20.5-21	125	14	1.80	1	\$604
					2	\$696
					3	\$801
					4	\$920
					5	\$1057

For use under **Z60S210S/OSN/OSD/OSR/OSL/OSO/SOS** for a finished height of **71.5"/72"**. Standard with pre-mounted "J" bracket for wall mount applications. For use under **Z60S330S/OSN** for a finished height of **84"/84.5"**

• **NOTE:** Care should be taken to mount the units. Units should be mounted to wall studs using correct fasteners. Failure to do so may result in collapse of the unit and subsequent personal injury. **Mounting hardware not included.** Mounting hardware used should be based on wall material. Consult an installation professional for proper wall mounting.

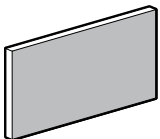

Wall Mounted Tackboard

ZWHT6621	1.25 x 66 x 20.5-21	100	15.40	1.80	1	\$641
					2	\$741
					3	\$850
					4	\$977
					5	\$1124

For use under **Z66S210S/OSN/OSD/OSR/OSL/OSO/SOS** for a finished height of **71.5"/72"**. Standard with pre-mounted "J" bracket for wall mount applications. For use under **Z66S330S/OSN** for a finished height of **84"/84.5"**

• **NOTE:** Care should be taken to mount the units. Units should be mounted to wall studs using correct fasteners. Failure to do so may result in collapse of the unit and subsequent personal injury. **Mounting hardware not included.** Mounting hardware used should be based on wall material. Consult an installation professional for proper wall mounting.

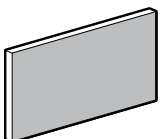

Wall Mounted Tackboard

ZWHT7221	1.25 x 72 x 20.5-21	100	16.80	1.80	1	\$704
					2	\$812
					3	\$932
					4	\$1071
					5	\$1232

For use under **Z72S210S/OSN/OSD/OSR/OSL/OSO/SOS** for a finished height of **71.5"/72"**. Standard with pre-mounted "J" bracket for wall mount applications. For use under **Z72S330S/OSN** for a finished height of **84"/84.5"**

• **NOTE:** Care should be taken to mount the units. Units should be mounted to wall studs using correct fasteners. Failure to do so may result in collapse of the unit and subsequent personal injury. **Mounting hardware not included.** Mounting hardware used should be based on wall material. Consult an installation professional for proper wall mounting.

Required Specifications
Fabric

21" WALL MOUNTED TACKBOARDS

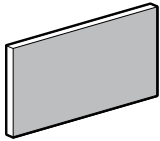

Wall Mounted Tackboard

MODEL#	DIMENSIONS	FREIGHT CLASS	WT./LBS.	CUBIC FT.	FABRIC GRADE	LIST PRICE
--------	------------	---------------	----------	-----------	--------------	------------

D x W x H						
ZWHT7821	1.25 x 78 x 20.5-21	92.5	18.20	1.80	1	\$740
					2	\$854
					3	\$982
					4	\$1128
					5	\$1296

For use under **Z78S210S/OSN/OSD/OSR/OSL/OSO/SOS** for a finished height of **71.5"/72"**. Standard with pre-mounted "J" bracket for wall mount applications. For use under **Z78S330S/OSN** for a finished height of **84"/84.5"**

• **NOTE:** Care should be taken to mount the units. Units should be mounted to wall studs using correct fasteners. Failure to do so may result in collapse of the unit and subsequent personal injury. **Mounting hardware not included.** Mounting hardware used should be based on wall material. Consult an installation professional for proper wall mounting.

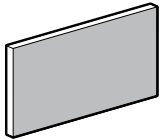

Wall Mounted Tackboard

ZWHT8421	1.25 x 84 x 20.5-21	92.5	19.60	1.80	1	\$806
					2	\$929
					3	\$1068
					4	\$1223
					5	\$1409

For use under **Z84S210S/OSN/OSD/OSR/OSL/OSO/SOS** for a finished height of **71.5"/72"**. Standard with pre-mounted "J" bracket for wall mount applications. For use under **Z84S330S/OSN** for a finished height of **84"/84.5"**

• **NOTE:** Care should be taken to mount the units. Units should be mounted to wall studs using correct fasteners. Failure to do so may result in collapse of the unit and subsequent personal injury. **Mounting hardware not included.** Mounting hardware used should be based on wall material. Consult an installation professional for proper wall mounting.

25" WALL MOUNTED TACKBOARDS

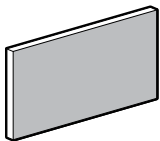

Wall Mounted Tackboard

MODEL#	DIMENSIONS	FREIGHT CLASS	WT./LBS.	CUBIC FT.	FABRIC GRADE	LIST PRICE
--------	------------	---------------	----------	-----------	--------------	------------

ZWHT3025	1.25 x 30 x 24.5-25	100	8.30	1	1	\$361
					2	\$419
					3	\$479
					4	\$548
					5	\$630

For use under **Z30S160S/OSN** for a finished height of **71.5"/72"**. Standard with pre-mounted "J" bracket for wall mount applications.

• **NOTE:** Care should be taken to mount the units. Units should be mounted to wall studs using correct fasteners. Failure to do so may result in collapse of the unit and subsequent personal injury. **Mounting hardware not included.** Mounting hardware used should be based on wall material. Consult an installation professional for proper wall mounting.

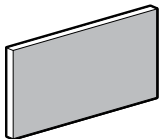

Wall Mounted Tackboard

ZWHT3625	1.25 x 36 x 24.5-25	92.5	10	1	1	\$400
					2	\$464
					3	\$532
					4	\$612
					5	\$699

For use under **Z36S160S/OSN** for a finished height of **71.5"/72"**. Standard with pre-mounted "J" bracket for wall mount applications.

• **NOTE:** Care should be taken to mount the units. Units should be mounted to wall studs using correct fasteners. Failure to do so may result in collapse of the unit and subsequent personal injury. **Mounting hardware not included.** Mounting hardware used should be based on wall material. Consult an installation professional for proper wall mounting.

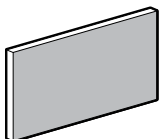

Wall Mounted Tackboard

ZWHT4225	1.25 x 42 x 24.5-25	92.5	11.70	1	1	\$464
					2	\$536
					3	\$614
					4	\$706
					5	\$810

For use under **Z42S160S/OSN** for a finished height of **71.5"/72"**. Standard with pre-mounted "J" bracket for wall mount applications.

• **NOTE:** Care should be taken to mount the units. Units should be mounted to wall studs using correct fasteners. Failure to do so may result in collapse of the unit and subsequent personal injury. **Mounting hardware not included.** Mounting hardware used should be based on wall material. Consult an installation professional for proper wall mounting.

Required Specifications

Fabric

25" WALL MOUNTED TACKBOARDS

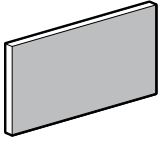

Wall Mounted Tackboard

MODEL#	DIMENSIONS D x W x H	FREIGHT CLASS	WT/LBS.	CUBIC FT.	FABRIC GRADE	LIST PRICE
ZWHT4825	1.25 x 48 x 24.5-25	85	13.30	1	1	\$504
					2	\$582
					3	\$669
					4	\$767
					5	\$882

For use under **Z48S160S/OSN** for a finished height of **71.5"/72"**. Standard with pre-mounted "J" bracket for wall mount applications.

• **NOTE:** Care should be taken to mount the units. Units should be mounted to wall studs using correct fasteners. Failure to do so may result in collapse of the unit and subsequent personal injury. **Mounting hardware not included.** Mounting hardware used should be based on wall material. Consult an installation professional for proper wall mounting.

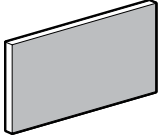

Wall Mounted Tackboard

ZWHT6025	1.25 x 60 x 24.5-25	100	16.70	1.80	1	\$621
					2	\$715
					3	\$823
					4	\$943
					5	\$1086

For use under **Z60S160S/OSN** for a finished height of **71.5"/72"**. Standard with pre-mounted "J" bracket for wall mount applications.

• **NOTE:** Care should be taken to mount the units. Units should be mounted to wall studs using correct fasteners. Failure to do so may result in collapse of the unit and subsequent personal injury. **Mounting hardware not included.** Mounting hardware used should be based on wall material. Consult an installation professional for proper wall mounting.

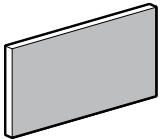

Wall Mounted Tackboard

ZWHT6625	1.25 x 66 x 24.5-25	92.5	18.30	1.80	1	\$661
					2	\$764
					3	\$876
					4	\$1005
					5	\$1155

For use under **ZxxS160S/OSN** for a finished height of **71.5"/72"**. Standard with pre-mounted "J" bracket for wall mount applications.

• **NOTE:** Care should be taken to mount the units. Units should be mounted to wall studs using correct fasteners. Failure to do so may result in collapse of the unit and subsequent personal injury. **Mounting hardware not included.** Mounting hardware used should be based on wall material. Consult an installation professional for proper wall mounting.

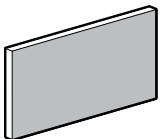

Wall Mounted Tackboard

ZWHT7225	1.25 x 72 x 24.5-25	92.5	20	1.80	1	\$725
					2	\$837
					3	\$960
					4	\$1103
					5	\$1267

For use under **ZxxS160S/OSN** for a finished height of **71.5"/72"**. Standard with pre-mounted "J" bracket for wall mount applications.

• **NOTE:** Care should be taken to mount the units. Units should be mounted to wall studs using correct fasteners. Failure to do so may result in collapse of the unit and subsequent personal injury. **Mounting hardware not included.** Mounting hardware used should be based on wall material. Consult an installation professional for proper wall mounting.

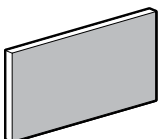

Wall Mounted Tackboard

ZWHT7825	1.25 x 78 x 24.5-25	85	21.70	1.80	1	\$763
					2	\$881
					3	\$1010
					4	\$1160
					5	\$1334

For use under **ZxxS160S/OSN** for a finished height of **71.5"/72"**. Standard with pre-mounted "J" bracket for wall mount applications.

• **NOTE:** Care should be taken to mount the units. Units should be mounted to wall studs using correct fasteners. Failure to do so may result in collapse of the unit and subsequent personal injury. **Mounting hardware not included.** Mounting hardware used should be based on wall material. Consult an installation professional for proper wall mounting.

Required Specifications

Fabric

25" WALL MOUNTED TACKBOARDS

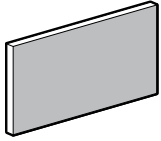

Wall Mounted Tackboard

MODEL#	DIMENSIONS	FREIGHT CLASS	WT./LBS.	CUBIC FT.	FABRIC GRADE	LIST PRICE
	D x W x H					
ZWHT8425	1.25 x 84 x 24.5-25	85	23.30	1.80	1	\$829
					2	\$955
					3	\$1096
					4	\$1261
					5	\$1448

For use under **ZxxS160S/OSN** for a finished height of **71.5"/72"**. Standard with pre-mounted "J" bracket for wall mount applications.

- **NOTE:** Care should be taken to mount the units. Units should be mounted to wall studs using correct fasteners. Failure to do so may result in collapse of the unit and subsequent personal injury. **Mounting hardware not included.** Mounting hardware used should be based on wall material. Consult an installation professional for proper wall mounting.

Required Specifications

Fabric

BOOKCASES

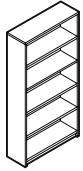

Bookcase - 72" High

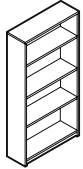

Bookcase - 65.5" High

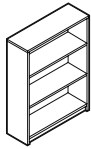

Bookcase - 48.5" High

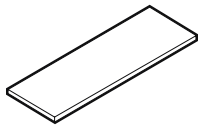

Bookcase Shelf

MODEL#	DIMENSIONS	FREIGHT CLASS	WT./LBS.	CUBIC FT.	1" TOP	1.5" TOP	GLAZE ADD	HP ADD
--------	------------	---------------	----------	-----------	--------	----------	-----------	--------

	D x W x H							
ZHBC72	12 x 36 x 71.9-72.4	125	176	23	\$1150	\$1217	N/A	N/A

One fixed shelf.

ZHBC65	12 x 36 x 65.5-66	125	156	21	\$1113	\$1179	N/A	N/A
--------	-------------------	-----	-----	----	---------------	---------------	-----	-----

One fixed shelf and two adjustable shelves.

ZHBC48	12 x 36 x 48.5-49	125	122	15.75	\$843	\$909	N/A	N/A
--------	-------------------	-----	-----	-------	--------------	--------------	-----	-----

Two adjustable shelves.

ZHSHELF	11 x 34 x .5-1	100	13	1.50	\$295	N/A	N/A	N/A
---------	----------------	-----	----	------	--------------	-----	-----	-----

Extra shelf for bookcases. 1" thick.

TABLE TOP BOOKCASES

NOTE: UNITS UNDER 30"W MUST BE SECURELY FASTENED TO THE WALL OR GANGED TO AN ADJACENT UNIT 30"W OR WIDER

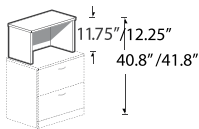

Table Top Bookcase 11.75"/12.25" High

Z36S12TN	16 x 36 x 11.25-11.75	100	44.91	5.25	\$336	\$403	N/A	N/A
Z30S12TN	16 x 30 x 11.25-11.75	100	39.33	4.30	\$308	\$366	N/A	N/A

To be placed **on top of 29"/29.5" high units to achieve 40.8"/41.8" final height** or placed on top of **40.8"/41.3" high units to achieve 52.5"/53.5" final height.**

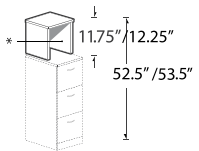

Table Top Bookcase 11.75"/12.25" High

Z21S12TN	16 x 21 x 11.25-11.75	100	28.87	3.10	\$258	\$304	N/A	N/A
Z18S12TN	16 x 18 x 11.25-11.75	92.5	27.13	2.70	\$247	\$289	N/A	N/A
Z16S12TN	16 x 16 x 11.25-11.75	92.5	24.57	2.40	\$235	\$273	N/A	N/A
Z15S12TN	16 x 15 x 11.25-11.75	92.5	24.34	2.30	\$225	\$258	N/A	N/A
Z12S12TN	16 x 12 x 11.25-11.75	92.5	21.55	1.90	\$213	\$242	N/A	N/A

To be placed **on top of 29"/29.5" high units to achieve 40.8"/41.8" final height** or placed on top of **40.8"/41.3" high units to achieve 52.5"/53.5" final height.**

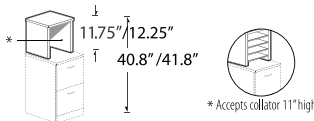

Table Top Bookcase 11.75"/12.25" High

Required Specifications

- Top finish
- Base finish
- Top/Edge Detail

Optional Specifications

- Collator (open shelf)

TABLE TOP BOOKCASES

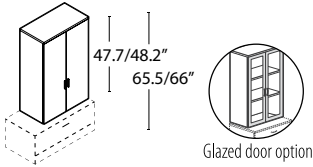

Closed Table Top Bookcase
47.7" High

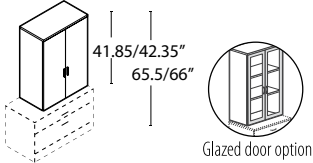

Closed Table Top Bookcase
41" High

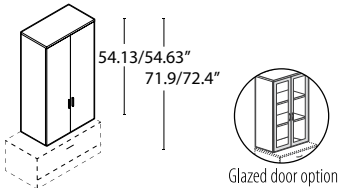

Closed Table Top Bookcase
54" High

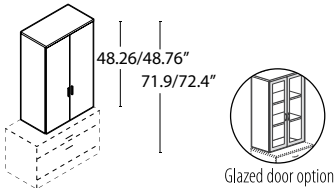

Closed Table Top Bookcase
48" High

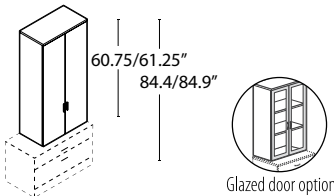

Closed Table Top Bookcase
61" High

MODEL#	DIMENSIONS D x W x H	FREIGHT CLASS	WT/LBS.	CUBIC FT.	1" TOP	1.5" TOP	GLAZE ADD	HP ADD
Z36S48T	36 x 16 x 47.7	125	149	20.25	\$1370	\$1437	\$1443	N/A
Z30S48T	30 x 16 x 47.7	125	130	17	\$1251	\$1309	\$1246	N/A

Designed to be placed **on top of 17.87"/18.37" high units to achieve 65.5"/66" final height.**
Laminate doors are standard. **Includes one adjustable shelf.** Standard with lock.

Z36S41T	36 x 16 x 41.85	125	128	17.75	\$1126	\$1193	\$1252	N/A
Z30S41T	30 x 16 x 41.85	125	111	15	\$1179	\$1237	\$1091	N/A

Designed to be placed **on top of 23.75"/24.25" high units to achieve 65.5"/66" final height.**
Laminate doors are standard. **Includes one adjustable shelf.** Standard with lock.

Z36S54T	36 x 16 x 54.13	125	163	22.75	\$1617	\$1684	\$1443	N/A
Z30S54T	30 x 16 x 54.13	125	142	19	\$1251	\$1309	\$1246	N/A

Designed to be placed **on top of 17.87"/18.37" high units to achieve 71.9"/72.4" final height.**
Laminate doors are standard. **Includes one adjustable shelf.** Standard with lock.

Z36S49T	36 x 16 x 48.26	125	141	20.25	\$1437	\$1504	\$952	N/A
Z30S49T	30 x 16 x 48.26	125	123	17.25	\$1289	\$1346	\$850	N/A

Designed to be placed **on top of 23.75"/24.25" high units to achieve 71.9"/72.4" final height.**
Laminate doors are standard. **Includes one adjustable shelf.** Standard with lock.

Z36S61T	36 x 16 x 60.75	125	176	25.25	\$1697	\$1764	\$1132	N/A
Z30S61T	30 x 16 x 60.75	125	153	21.25	\$1517	\$1574	\$1010	N/A

Designed to be placed **on top of 23.75"/24.25" high units to achieve 84.4"/84.9" final height.**
Laminate doors are standard. **Includes one adjustable shelf.** Standard with lock.

Required Specifications

Top finish
Base finish
Top/Edge Detail

Optional Specifications

Glazed doors

TABLE TOP BOOKCASES

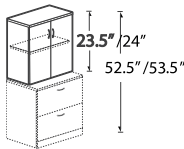

Table Top Bookcase 23.5"/24" High

MODEL#	DIMENSIONS D x W x H	FREIGHT CLASS	WT/LBS.	CUBIC FT.	1" TOP	1.5" TOP	GLAZE ADD	HP ADD
Z36S23T	16 x 36 x 23-23.5	100	87.45	9.50	\$804	\$871	\$792	N/A
Z30S23T	16 x 30 x 23-23.5	100	75.78	8	\$732	\$790	\$699	N/A

Designed to be placed **on top of 29"/29.5" high units to achieve 52.5"/53.5" final height.** DO NOT USE ON TOP OF 40.8"/41.3" HIGH UNITS. Laminate doors are standard. **Includes one adjustable shelf.** Standard with lock.

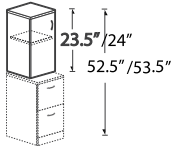

Table Top Bookcase with Door - LEFT 23.5"/24" High

Z21S23TL	16 x 21 x 23-23.5	92.5	58.83	5.75	\$573	\$618	\$432	N/A
Z18S23TL	16 x 18 x 23-23.5	92.5	54.65	5	\$552	\$590	\$395	N/A
Z16S23TL	16 x 16 x 23-23.5	92.5	46.71	4.50	\$490	\$528	\$386	N/A
Z15S23TL	16 x 15 x 23-23.5	92.5	46.06	4.20	\$465	\$498	\$348	N/A
Z12S23TL	16 x 12 x 23-23.5	92.5	40.77	3.50	\$434	\$463	\$314	N/A

Designed to be placed **on top of 29"/29.5" high units to achieve 52.5"/53.5" final height.** DO NOT USE ON TOP OF 40.8"/41.3" HIGH UNITS. Laminate door is standard. **Includes one adjustable shelf.** Standard with lock.

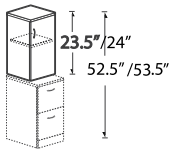

Table Top Bookcase with Door - RIGHT 23.5"/24" High

Z21S23TR	16 x 21 x 23-23.5	92.5	58.83	5.75	\$573	\$618	\$432	N/A
Z18S23TR	16 x 18 x 23-23.5	92.5	54.65	5	\$552	\$590	\$395	N/A
Z16S23TR	16 x 16 x 23-23.5	92.5	46.71	4.50	\$490	\$528	\$386	N/A
Z15S23TR	16 x 15 x 23-23.5	92.5	46.06	4.20	\$465	\$498	\$348	N/A
Z12S23TR	16 x 12 x 23-23.5	92.5	40.77	3.50	\$434	\$463	\$314	N/A

Designed to be placed **on top of 29"/29.5" high units to achieve 52.5"/53.5" final height.** DO NOT USE ON TOP OF 40.8"/41.3" HIGH UNITS. Laminate door is standard. **Includes one adjustable shelf.** Standard with lock.

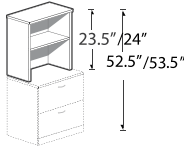

Table Top Bookcase 23.5"/24" High

Z36S23TN	16 x 36 x 23-23.5	125	69.06	9.50	\$526	\$593	N/A	N/A
Z30S23TN	16 x 30 x 23-23.5	125	60.33	8	\$483	\$540	N/A	N/A

Designed to be placed **on top of 29"/29.5" high units to achieve 52.5"/53.5" final height.** DO NOT USE ON TOP OF 40.8"/41.3" HIGH UNITS. **Includes one adjustable shelf.**

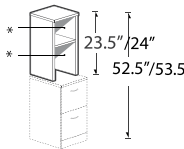

Table Top Bookcase 23.5"/24" High*

Z21S23TN	16 x 21 x 23-23.5	100	47.77	5.75	\$411	\$456	N/A	N/A
Z18S23TN	16 x 18 x 23-23.5	100	44.98	5	\$404	\$442	N/A	N/A
Z16S23TN	16 x 16 x 23-23.5	100	38.22	4.50	\$343	\$381	N/A	N/A
Z15S23TN	16 x 15 x 23-23.5	100	37	4.20	\$329	\$361	N/A	N/A
Z12S23TN	16 x 12 x 23-23.5	100	34.15	3.50	\$307	\$337	N/A	N/A

Designed to be placed **on top of 29"/29.5" high units to achieve 52.5"/53.5" final height.** DO NOT USE ON TOP OF 40.8"/41.3" HIGH UNITS. **Includes one adjustable shelf.**

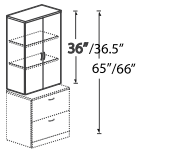

Table Top Bookcase with Doors 36"/36.5" High

Z36S36T	16 x 36 x 35.5-36	100	124.30	14.25	\$1033	\$1100	\$1021	N/A
Z30S36T	16 x 30 x 35.5-36	100	106.67	12	\$894	\$951	\$893	N/A

Designed to be placed **on top of 29"/29.5" high units to achieve 65"/66" final height.** Laminate doors are standard. **Includes two adjustable shelves.** Standard with lock.

Required Specifications

Top finish
Base finish
Top/Edge Detail

Optional Specifications

Collator*
Glazed doors

TABLE TOP BOOKCASES

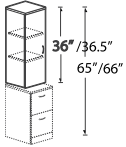

**Table Top Bookcase with Doors
36"/36.5" High - LEFT**

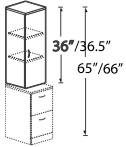

**Table Top Bookcase with Doors
36"/36.5" High - RIGHT**

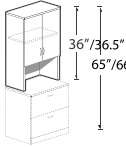

**Table Top Bookcase with Doors and
Cavity - 36"/36.5" High**

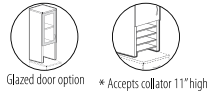
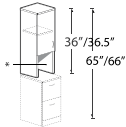

**Table Top Bookcase with Doors and*
Cavity - 36"/36.5" High - LEFT**

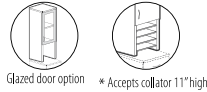
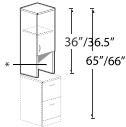

**Table Top Bookcase with Doors and*
Cavity - 36"/36.5" High - RIGHT**

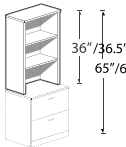

Table Top Bookcase 36"/36.5" High

MODEL#	DIMENSIONS	FREIGHT CLASS	WT/LBS.	CUBIC FT.	1" TOP	1.5" TOP	GLAZE ADD	HP ADD	
D x W x H									
Z21S36TL	16 x 21 x 35.5-36	100	82.99	8.75	\$732	\$778	\$561	N/A	
Z18S36TL	16 x 18 x 35.5-36	100	74.72	7.50	\$700	\$738	\$507	N/A	
Z16S36TL	16 x 16 x 35.5-36	92.5	67.82	6.75	\$640	\$678	\$499	N/A	
Z15S36TL	16 x 15 x 35.5-36	92.5	66.46	6.50	\$609	\$642	\$444	N/A	
Z12S36TL	16 x 12 x 35.5-36	92.5	59.30	5.25	\$565	\$594	\$400	N/A	

Designed to be placed **on top of 29"/29.5" high units to achieve 65"/66" final height.** Laminate door is standard.
Includes two adjustable shelves. Standard with lock.

Z21S36TR	16 x 21 x 35.5-36	100	82.99	8.75	\$732	\$778	\$561	N/A
Z18S36TR	16 x 18 x 35.5-36	100	74.72	7.50	\$700	\$738	\$507	N/A
Z16S36TR	16 x 16 x 35.5-36	92.5	67.82	6.75	\$640	\$678	\$499	N/A
Z15S36TR	16 x 15 x 35.5-36	92.5	66.46	6.50	\$609	\$642	\$444	N/A
Z12S36TR	16 x 12 x 35.5-36	92.5	59.30	5.25	\$565	\$594	\$400	N/A

Designed to be placed **on top of 29"/29.5" high units to achieve 65"/66" final height.** Laminate door is standard.
Includes two adjustable shelves. Standard with lock.

Z36S36TC	16 x 36 x 35.5-36	100	116.98	14.25	\$976	\$1043	\$902	N/A
Z30S36TC	16 x 30 x 35.5-36	100	100.58	12	\$845	\$903	\$786	N/A

Designed to be placed **on top of 29"/29.5" high units to achieve 65"/66" final height.** Laminate doors are standard.
Includes one adjustable shelf. Standard with lock.

Z21S36TCL	16 x 21 x 35.5-36	100	78.72	8.75	\$697	\$743	\$501	N/A
Z18S36TCL	16 x 18 x 35.5-36	100	71.07	7.50	\$672	\$714	\$451	N/A
Z16S36TCL	16 x 16 x 35.5-36	100	64.57	6.75	\$610	\$648	\$444	N/A
Z15S36TCL	16 x 15 x 35.5-36	100	63.42	6.50	\$586	\$618	\$394	N/A
Z12S36TCL	16 x 12 x 35.5-36	92.5	56.87	5.25	\$545	\$575	\$353	N/A

Designed to be placed **on top of 29"/29.5" high units to achieve 65"/66" final height.** Laminate door is standard.
Includes one adjustable shelf. Standard with lock.

Z21S36TCR	16 x 21 x 35.5-36	100	78.72	8.75	\$697	\$743	\$501	N/A
Z18S36TCR	16 x 18 x 35.5-36	100	71.07	7.50	\$672	\$714	\$451	N/A
Z16S36TCR	16 x 16 x 35.5-36	100	64.57	6.75	\$610	\$648	\$444	N/A
Z15S36TCR	16 x 15 x 35.5-36	100	63.42	6.50	\$586	\$618	\$394	N/A
Z12S36TCR	16 x 12 x 35.5-36	92.5	56.87	5.25	\$545	\$575	\$353	N/A

Designed to be placed **on top of 29"/29.5" high units to achieve 65"/66" final height.** Laminate door is standard.
Includes one adjustable shelf. Standard with lock.

Z36S36TN	16 x 36 x 35.5-36	125	95.31	14.25	\$694	\$763	N/A	N/A
Z30S36TN	16 x 30 x 35.5-36	125	82.38	12	\$591	\$649	N/A	N/A

Designed to be placed **on top of 29"/29.5" high units to achieve 65"/66" final height.** **Includes two adjustable shelves.**

Required Specifications

Top finish
Base finish
Top/Edge Detail

Optional Specifications

Collator*
Glazed doors

TABLE TOP BOOKCASES

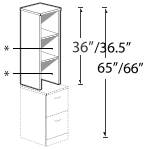

Table Top Bookcase 36"/36.5" High*

MODEL#	DIMENSIONS D x W x H	FREIGHT CLASS	WT/LBS.	CUBIC FT.	1" TOP	1.5" TOP	GLAZE ADD	HP ADD
Z21S36TN	16 x 21 x 35.5-36	125	65.62	8.75	\$537	\$583	N/A	N/A
Z18S36TN	16 x 18 x 35.5-36	125	59.68	7.50	\$523	\$565	N/A	N/A
Z16S36TN	16 x 16 x 35.5-36	100	56	6.75	\$463	\$501	N/A	N/A
Z15S36TN	16 x 15 x 35.5-36	100	53.74	6.50	\$448	\$481	N/A	N/A
Z12S36TN	16 x 12 x 35.5-36	125	48.85	6.25	\$418	\$447	N/A	N/A

Designed to be placed on top of 29"/29.5" high units to achieve 65"/66" final height. Includes two adjustable shelves.

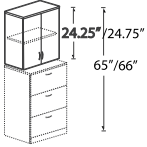

Table Top Bookcase with Doors 24.25"/24.75" High

Z36S24T	16 x 36 x 23.75-24.25	100	89.26	10	\$806	\$873	\$902	N/A
Z30S24T	16 x 30 x 23.75-24.25	100	77.47	8.25	\$736	\$793	\$786	N/A

Designed to be placed on top of 40.8"/41.3" high units to achieve 65"/66" final height. DO NOT USE ON TOP OF 29"/29.5 HIGH UNITS. Laminate doors are standard. Includes one adjustable shelf. Standard with lock.

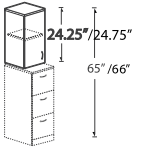

Table Top Bookcase with Door - LEFT 24.25"/24.75" High

Z21S24TL	16 x 21 x 23.75-24.25	100	59.24	6	\$573	\$619	\$501	N/A
Z18S24TL	16 x 18 x 23.75-24.25	92.5	56.11	5.25	\$553	\$591	\$451	N/A
Z16S24TL	16 x 16 x 23.75-24.25	92.5	48.13	4.60	\$491	\$529	\$444	N/A
Z15S24TL	16 x 15 x 23.75-24.25	92.5	46.35	4.30	\$466	\$499	\$394	N/A
Z12S24TL	16 x 12 x 23.75-24.25	85	44.32	3.60	\$435	\$464	\$353	N/A

Designed to be placed on top of 40.8"/41.3" high units to achieve 65"/66" final height. DO NOT USE ON TOP OF 29"/29.5 HIGH UNITS. Laminate door is standard. Includes one adjustable shelf. Standard with lock.

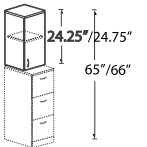

Table Top Bookcase with Door - RIGHT 24.25"/24.75" High

Z21S24TR	16 x 21 x 23.75-24.25	100	59.24	6	\$573	\$619	\$501	N/A
Z18S24TR	16 x 18 x 23.75-24.25	92.5	56.11	5.25	\$553	\$591	\$451	N/A
Z16S24TR	16 x 16 x 23.75-24.25	92.5	48.13	4.60	\$491	\$529	\$444	N/A
Z15S24TR	16 x 15 x 23.75-24.25	92.5	46.35	4.30	\$466	\$499	\$394	N/A
Z12S24TR	16 x 12 x 23.75-24.25	85	44.32	3.60	\$435	\$464	\$353	N/A

Designed to be placed on top of 40.8"/41.3" high units to achieve 65"/66" final height. DO NOT USE ON TOP OF 29"/29.5 HIGH UNITS. Laminate door is standard. Includes one adjustable shelf. Standard with lock.

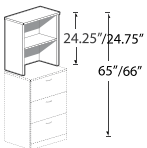

Table Top Bookcase 24.25"/24.75" High

Z36S24TN	16 x 36 x 23.75-24.25	125	70.11	10	\$526	\$595	N/A	N/A
Z30S24TN	16 x 30 x 23.75-24.25	125	61.38	8.25	\$483	\$541	N/A	N/A

Designed to be placed on top of 40.8"/41.3" high units to achieve 65"/66" final height. DO NOT USE ON TOP OF 29"/29.5 HIGH UNITS. Includes one adjustable shelf.

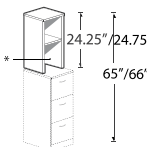

Table Top Bookcase* 24.25"/24.75" High

Z21S24TN	16 x 21 x 23.75-24.25	125	47.77	6	\$411	\$457	N/A	N/A
Z18S24TN	16 x 18 x 23.75-24.25	100	46.03	5.25	\$404	\$446	N/A	N/A
Z16S24TN	16 x 16 x 23.75-24.25	100	39.27	4.60	\$344	\$382	N/A	N/A
Z15S24TN	16 x 15 x 23.75-24.25	100	37.99	4.30	\$329	\$362	N/A	N/A
Z12S24TN	16 x 12 x 23.75-24.25	92.5	37.30	3.60	\$308	\$337	N/A	N/A

Designed to be placed on top of 40.8"/41.3" high units to achieve 65"/66" final height. DO NOT USE ON TOP OF 29"/29.5 HIGH UNITS. Includes one adjustable shelf.

Required Specifications

Top finish
Base finish
Top/Edge Detail

Optional Specifications

Collator*
Glazed doors

TABLE TOP BOOKCASES

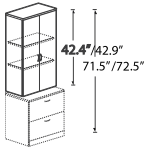

Glazed door option

Table Top Bookcase with Doors
42.4\"/>

MODEL#	DIMENSIONS D x W x H	FREIGHT CLASS	WT/LBS.	CUBIC FT.	1\"/>			
Z36S42T	16 x 36 x 41.9-42.4	100	137.40	16.75	\$1126	\$1193	\$1252	N/A
Z30S42T	16 x 30 x 41.9-42.4	100	119.06	14	\$983	\$1041	\$1091	N/A

Designed to be placed **on top of 29\"/>**

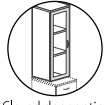
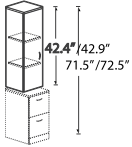

Glazed door option

Table Top Bookcase with Door - LEFT
42.4\"/>

Z21S42TL	16 x 21 x 41.9-42.4	300	119	70	\$798	\$844	\$693	N/A
Z18S42TL	16 x 18 x 41.9-42.4	85	117	8.75	\$766	\$804	\$623	N/A
Z16S42TL	16 x 16 x 41.9-42.4	300	112	62	\$691	\$729	\$617	N/A
Z15S42TL	16 x 15 x 41.9-42.4	250	109	54	\$655	\$687	\$542	N/A
Z12S42TL	16 x 12 x 41.9-42.4	250	105	49	\$609	\$639	\$489	N/A

Designed to be placed **on top of 29\"/>**

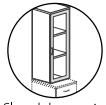
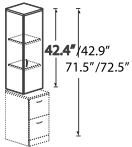

Glazed door option

Table Top Bookcase with Door - RIGHT
42.4\"/>

Z21S42TR	16 x 21 x 41.9-42.4	300	119	70	\$798	\$844	\$693	N/A
Z18S42TR	16 x 18 x 41.9-42.4	85	117	8.75	\$766	\$804	\$623	N/A
Z16S42TR	16 x 16 x 41.9-42.4	300	112	62	\$691	\$729	\$617	N/A
Z15S42TR	16 x 15 x 41.9-42.4	250	109	54	\$655	\$687	\$542	N/A
Z12S42TR	16 x 12 x 41.9-42.4	250	105	49	\$609	\$639	\$489	N/A

Designed to be placed **on top of 29\"/>**

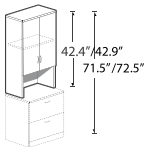

Glazed door option

Table Top Bookcase with Doors and Cavity
42.4\"/>

Z36S42TC	16 x 36 x 41.9-42.4	125	130.09	16.75	\$1091	\$1158	\$985	N/A
Z30S42TC	16 x 30 x 41.9-42.4	100	112.97	14	\$953	\$1011	\$857	N/A

Designed to be placed **on top of 29\"/>**

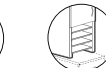
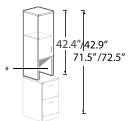

* Accepts collator 11\"/>

Table Top Bookcase with Door and* Cavity
42.4\"/>

Z21S42TCL	16 x 21 x 41.9-42.4	100	87.84	10	\$780	\$825	\$547	N/A
Z18S42TCL	16 x 18 x 41.9-42.4	100	79.83	8.75	\$749	\$787	\$492	N/A
Z16S42TCL	16 x 16 x 41.9-42.4	100	73.75	8	\$672	\$710	\$488	N/A
Z15S42TCL	16 x 15 x 41.9-42.4	100	70.71	7.50	\$640	\$672	\$429	N/A
Z12S42TCL	16 x 12 x 41.9-42.4	92.5	62.70	6	\$593	\$623	\$386	N/A

Designed to be placed **on top of 29\"/>**

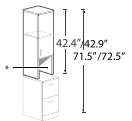

* Accepts collator 11\"/>

Table Top Bookcase with Door and* Cavity
42.4\"/>

Z21S42TCR	16 x 21 x 41.9-42.4	100	87.84	10	\$780	\$825	\$547	N/A
Z18S42TCR	16 x 18 x 41.9-42.4	100	79.83	8.75	\$749	\$787	\$492	N/A
Z16S42TCR	16 x 16 x 41.9-42.4	100	73.75	8	\$672	\$710	\$488	N/A
Z15S42TCR	16 x 15 x 41.9-42.4	100	70.71	7.50	\$640	\$672	\$429	N/A
Z12S42TCR	16 x 12 x 41.9-42.4	92.5	62.70	6	\$593	\$623	\$386	N/A

Designed to be placed **on top of 29\"/>**

Required Specifications

Top finish
Base finish
Top/Edge Detail

Optional Specifications

Collator*
Glazed doors

TABLE TOP BOOKCASES

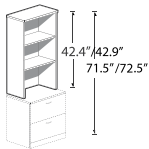
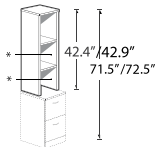
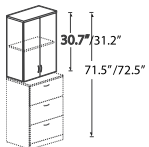

Table Top Bookcase
42.4"/42.9" High



* Accepts collator 11" high

Table Top Bookcase*
42.4"/42.9" High



Glazed door option

Table Top Bookcase with Doors
30.7"/31.2" High

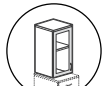
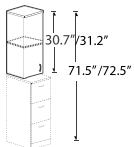

Glazed door option

Table Top Bookcase with Door
30.7"/31.2" High - LEFT

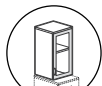
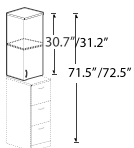

Glazed door option

Table Top Bookcase with Door
30.7"/31.2" High - RIGHT

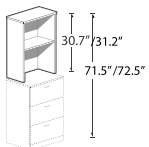

Table Top Bookcase
30.7"/31.2" High

MODEL#	DIMENSIONS D x W x H	FREIGHT CLASS	WT/LBS.	CUBIC FT.	1" TOP	1.5" TOP	GLAZE ADD	HP ADD
Z36S42TN	16 x 36 x 41.9-42.4	125	103.71	16.75	\$756	\$823	N/A	N/A
Z30S42TN	16 x 30 x 41.9-42.4	125	90.78	14	\$658	\$716	N/A	N/A

Designed to be placed **on top of 29"/29.5" high units to achieve 71.5"/72.5" final height.** DO NOT USE ON TOP OF 40.8"/41.3" HIGH UNITS. **Includes two adjustable shelves.** Standard with lock.

Z21S42TN	16 x 21 x 41.9-42.4	125	71.92	10	\$586	\$632	N/A	N/A
Z18S42TN	16 x 18 x 41.9-42.4	125	65.98	8.75	\$573	\$611	N/A	N/A
Z16S42TN	16 x 16 x 41.9-42.4	125	61.32	8	\$495	\$533	N/A	N/A
Z15S42TN	16 x 15 x 41.9-42.4	125	58.99	7.50	\$483	\$516	N/A	N/A
Z12S42TN	16 x 12 x 41.9-42.4	100	53.05	6	\$450	\$479	N/A	N/A

Designed to be placed **on top of 29"/29.5" high units to achieve 71.5"/72.5" final height.** DO NOT USE ON TOP OF 40.8"/41.3" HIGH UNITS. **Includes two adjustable shelves.** Standard with lock.

Z36S31T	16 x 36 x 30.2-30.7	100	104.19	12.25	\$886	\$953	\$985	N/A
Z30S31T	16 x 30 x 30.2-30.7	100	89.36	10.50	\$793	\$851	\$857	N/A

Designed to be placed **on top of 40.8"/41.8" high units to achieve 71.5"/72.5" final height.** Laminate doors are standard. **Includes one adjustable shelf.** Standard with lock.

Z21S31TL	16 x 21 x 30.2-30.7	100	69.88	7.50	\$634	\$680	\$547	N/A
Z18S31TL	16 x 18 x 30.2-30.7	92.5	65.22	6.50	\$580	\$618	\$492	N/A
Z16S31TL	16 x 16 x 30.2-30.7	92.5	59.18	5.75	\$553	\$591	\$488	N/A
Z15S31TL	16 x 15 x 30.2-30.7	92.5	56.15	5.50	\$528	\$560	\$429	N/A
Z12S31TL	16 x 12 x 30.2-30.7	92.5	50.39	4.40	\$492	\$522	\$386	N/A

Designed to be placed **on top of 40.8"/41.8" high units to achieve 71.5"/72.5" final height.** Laminate door is standard. **Includes one adjustable shelf.** Standard with lock.

Z21S31TR	16 x 21 x 30.2-30.7	100	69.88	7.50	\$634	\$680	\$547	N/A
Z18S31TR	16 x 18 x 30.2-30.7	92.5	65.22	6.50	\$580	\$618	\$492	N/A
Z16S31TR	16 x 16 x 30.2-30.7	92.5	59.18	5.75	\$553	\$591	\$488	N/A
Z15S31TR	16 x 15 x 30.2-30.7	92.5	56.15	5.50	\$528	\$560	\$429	N/A
Z12S31TR	16 x 12 x 30.2-30.7	92.5	50.39	4.40	\$492	\$522	\$386	N/A

Designed to be placed **on top of 40.8"/41.8" high units to achieve 71.5"/72.5" final height.** Laminate door is standard. **Includes one adjustable shelf.** Standard with lock.

Z36S31TN	16 x 36 x 30.2-30.7	125	79.56	12.25	\$577	\$644	N/A	N/A
Z30S31TN	16 x 30 x 30.2-30.7	125	68.73	10.50	\$520	\$577	N/A	N/A

Designed to be placed **on top of 40.8"/41.8" high units to achieve 71.5"/72.5" final height.** **Includes one adjustable shelf.**

Required Specifications

Top finish
Base finish
Top/Edge Detail

Optional Specifications

Collator*
Glazed doors

TABLE TOP BOOKCASES

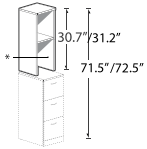

* Accepts collator 11\"/>

Table Top Bookcase*
30.7\"/>

MODEL#	DIMENSIONS D x W x H	FREIGHT CLASS	WT./LBS.	CUBIC FT.	1\"/>			
Z21S31TN	16 x 21 x 30.2-30.7	125	55.12	7.50	\$454	\$499	N/A	N/A
Z18S31TN	16 x 18 x 30.2-30.7	100	52.33	6.50	\$416	\$454	N/A	N/A
Z16S31TN	16 x 16 x 30.2-30.7	100	47.67	5.75	\$394	\$432	N/A	N/A
Z15S31TN	16 x 15 x 30.2-30.7	100	45.34	5.50	\$381	\$413	N/A	N/A
Z12S31TN	16 x 12 x 30.2-30.7	100	41.50	4.40	\$354	\$383	N/A	N/A

Designed to be placed **on top of 40.8\"/>**

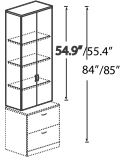

Glazed door option

Table Top Bookcase with Doors
54.9\"/>

Z36S55T	16 x 36 x 54.4-54.9	100	174.25	21.50	\$1370	\$1437	\$1443	N/A
Z30S55T	16 x 30 x 54.4-54.9	100	152.16	18	\$1251	\$1309	\$1246	N/A

Designed to be placed **on top of 29\"/>**

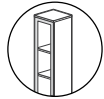
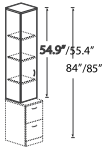

Glazed door option

Table Top Bookcase with Door - LEFT
54.9\"/>

Z21S55TL	16 x 21 x 54.4-54.9	100	116.26	13	\$972	\$1018	\$804	N/A
Z18S55TL	16 x 18 x 54.4-54.9	100	104.66	11.25	\$913	\$955	\$719	N/A
Z16S55TL	16 x 16 x 54.4-54.9	100	97.67	10	\$870	\$908	\$712	N/A
Z15S55TL	16 x 15 x 54.4-54.9	100	94.17	9.50	\$830	\$862	\$620	N/A
Z12S55TL	16 x 12 x 54.4-54.9	92.5	83.67	7.75	\$769	\$798	\$553	N/A

Designed to be placed **on top of 29\"/>**

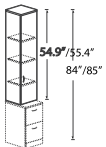

Glazed door option

Table Top Bookcase with Door - RIGHT
54.9\"/>

Z21S55TR	16 x 21 x 54.4-54.9	100	116.26	13	\$972	\$1018	\$804	N/A
Z18S55TR	16 x 18 x 54.4-54.9	100	104.66	11.25	\$913	\$955	\$719	N/A
Z16S55TR	16 x 16 x 54.4-54.9	100	97.67	10	\$870	\$908	\$712	N/A
Z15S55TR	16 x 15 x 54.4-54.9	100	94.17	9.50	\$830	\$862	\$620	N/A
Z12S55TR	16 x 12 x 54.4-54.9	92.5	83.67	7.75	\$769	\$798	\$553	N/A

Designed to be placed **on top of 29\"/>**

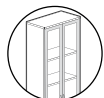
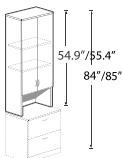

Glazed door option

Table Top Bookcase with Doors and Cavity
54.9\"/>

Z36S55TC	16 x 36 x 54.4-54.9	125	166.94	21.50	\$1334	\$1401	\$1257	N/A
Z30S55TC	16 x 30 x 54.4-54.9	100	146.06	18	\$1219	\$1277	\$1095	N/A

Designed to be placed **on top of 29\"/>**

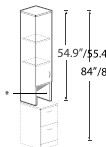

* Accepts collator 11\"/>

Table Top Bookcase with Door - LEFT and Cavity
54.9\"/>

Z21S55TCL	16 x 21 x 54.4-54.9	100	112	13	\$939	\$984	\$696	N/A
Z18S55TCL	16 x 18 x 54.4-54.9	100	101.01	11.25	\$885	\$923	\$625	N/A
Z16S55TCL	16 x 16 x 54.4-54.9	100	94.42	10	\$837	\$879	\$618	N/A
Z15S55TCL	16 x 15 x 54.4-54.9	100	91.12	9.50	\$799	\$832	\$545	N/A
Z12S55TCL	16 x 12 x 54.4-54.9	92.5	81.24	7.75	\$742	\$771	\$491	N/A

Designed to be placed **on top of 29\"/>**

Required Specifications

Top finish
Base finish
Top/Edge Detail

Optional Specifications

Collator*
Glazed doors

TABLE TOP BOOKCASES

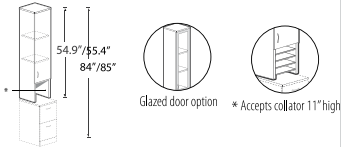

Table Top Bookcase with Door - RIGHT and Cavity - 54.9\"/>

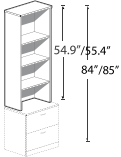

Table Top Bookcase 54.9\"/>

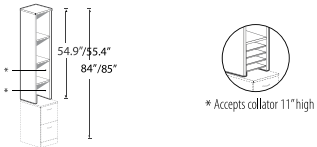

Table Top Bookcase* 54.9\"/>

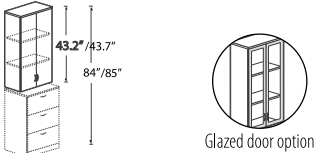

Table Top Bookcase with Doors 43.2\"/>



Table Top Bookcase with Door 43.2\"/>



Table Top Bookcase with Door 43.2\"/>

MODEL#	DIMENSIONS D x W x H	FREIGHT CLASS	WT/LBS.	CUBIC FT.	1" TOP	1.5" TOP	GLAZE ADD	HP ADD
Z21S55TCR	16 x 21 x 54.4-54.9	100	112	13	\$939	\$984	\$696	N/A
Z18S55TCR	16 x 18 x 54.4-54.9	100	101.01	11.25	\$885	\$923	\$625	N/A
Z16S55TCR	16 x 16 x 54.4-54.9	100	94.42	10	\$837	\$879	\$618	N/A
Z15S55TCR	16 x 15 x 54.4-54.9	100	91.12	9.50	\$799	\$832	\$545	N/A
Z12S55TCR	16 x 12 x 54.4-54.9	92.5	81.24	7.75	\$742	\$771	\$491	N/A

Designed to be placed **on top of 29\"/>**

Z36S55TN	16 x 36 x 54.4-54.9	125	129.96	21.50	\$912	\$979	N/A	N/A
Z30S55TN	16 x 30 x 54.4-54.9	125	114.93	18	\$849	\$906	N/A	N/A

Designed to be placed **on top of 29\"/>**

Z21S55TN	16 x 21 x 54.4-54.9	125	89.77	13	\$711	\$756	N/A	N/A
Z18S55TN	16 x 18 x 54.4-54.9	125	81.73	11.25	\$677	\$715	N/A	N/A
Z16S55TN	16 x 16 x 54.4-54.9	125	77.07	10	\$633	\$671	N/A	N/A
Z15S55TN	16 x 15 x 54.4-54.9	125	74.74	9.50	\$618	\$651	N/A	N/A
Z12S55TN	16 x 12 x 54.4-54.9	100	67.75	7.75	\$577	\$606	N/A	N/A

Designed to be placed **on top of 29\"/>**

Z36S43T	16 x 36 x 42.7-43.2	100	139.22	17	\$1151	\$1218	\$1257	N/A
Z30S43T	16 x 30 x 42.7-43.2	100	120.76	14.50	\$983	\$1041	\$1095	N/A

Designed to be placed **on top of 40.8\"/>**

Z21S43TL	16 x 21 x 42.7-43.2	100	93.62	10.25	\$815	\$860	\$696	N/A
Z18S43TL	16 x 18 x 42.7-43.2	100	84.94	9	\$780	\$818	\$625	N/A
Z16S43TL	16 x 16 x 42.7-43.2	100	78.42	8	\$699	\$737	\$618	N/A
Z15S43TL	16 x 15 x 42.7-43.2	92.5	75.16	7.50	\$658	\$690	\$545	N/A
Z12S43TL	16 x 12 x 42.7-43.2	92.5	66.48	6.25	\$610	\$640	\$491	N/A

Designed to be placed **on top of 40.8\"/>**

Z21S43TR	16 x 21 x 42.7-43.2	100	93.62	10.25	\$815	\$860	\$696	N/A
Z18S43TR	16 x 18 x 42.7-43.2	100	84.94	9	\$780	\$818	\$625	N/A
Z16S43TR	16 x 16 x 42.7-43.2	100	78.42	8	\$699	\$737	\$618	N/A
Z15S43TR	16 x 15 x 42.7-43.2	92.5	75.16	7.50	\$658	\$690	\$545	N/A
Z12S43TR	16 x 12 x 42.7-43.2	92.5	66.48	6.25	\$610	\$640	\$491	N/A

Designed to be placed **on top of 40.8\"/>**

Required Specifications

Top finish
Base finish
Top/Edge Detail

Optional Specifications

Collator*
Glazed doors

TABLE TOP BOOKCASES

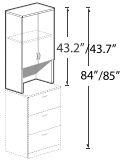

Glazed door option

Table Top Bookcase with Doors and Cavity - 43.2\"/>

MODEL#	DIMENSIONS	FREIGHT CLASS	WT/LBS.	CUBIC FT.	1\"/>			
Z36S43TC	16 x 36 x 42.7-43.2	125	131.91	17	\$1113	\$1180	\$989	N/A
Z30S43TC	16 x 30 x 42.7-43.2	125	114.67	14.50	\$974	\$1031	\$843	N/A

Designed to be placed **on top of 40.8\"/>**

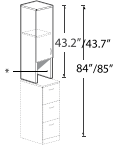

Glazed door option * Accepts collator 11\"/>

Table Top Bookcase with Door and Cavity - 43.2\"/>

Z21S43TCL	16 x 21 x 42.7-43.2	100	89.36	10.25	\$793	\$839	\$546	N/A
Z18S43TCL	16 x 18 x 42.7-43.2	100	81.29	9	\$761	\$799	\$491	N/A
Z16S43TCL	16 x 16 x 42.7-43.2	100	75.17	8	\$681	\$719	\$486	N/A
Z15S43TCL	16 x 15 x 42.7-43.2	100	72.11	7.50	\$642	\$674	\$428	N/A
Z12S43TCL	16 x 12 x 42.7-43.2	92.5	64.05	6.25	\$596	\$626	\$386	N/A

Designed to be placed **on top of 40.8\"/>**

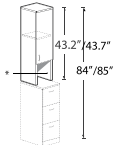

Glazed door option * Accepts collator 11\"/>

Table Top Bookcase with Door and Cavity - 43.2\"/>

Z21S43TCR	16 x 21 x 42.7-43.2	100	89.36	10.25	\$793	\$839	\$546	N/A
Z18S43TCR	16 x 18 x 42.7-43.2	100	81.29	9	\$761	\$799	\$491	N/A
Z16S43TCR	16 x 16 x 42.7-43.2	100	75.17	8	\$681	\$719	\$486	N/A
Z15S43TCR	16 x 15 x 42.7-43.2	100	72.11	7.50	\$642	\$674	\$428	N/A
Z12S43TCR	16 x 12 x 42.7-43.2	92.5	64.05	6.25	\$596	\$626	\$386	N/A

Designed to be placed **on top of 40.8\"/>**

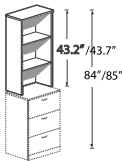
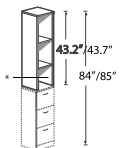

Table Top Bookcase 43.2\"/>

Z36S43TN	16 x 36 x 42.7-43.2	125	104.76	17	\$779	\$846	N/A	N/A
Z30S43TN	16 x 30 x 42.7-43.2	125	91.83	14.50	\$675	\$733	N/A	N/A

Designed to be placed **on top of 40.8\"/>**



* Accepts collator 11\"/>

Table Top Bookcase* 43.2\"/>

Z21S43TN	16 x 21 x 42.7-43.2	125	72.97	10.25	\$601	\$647	N/A	N/A
Z18S43TN	16 x 18 x 42.7-43.2	125	67.03	9	\$585	\$623	N/A	N/A
Z16S43TN	16 x 16 x 42.7-43.2	125	62.37	8	\$503	\$541	N/A	N/A
Z15S43TN	16 x 15 x 42.7-43.2	100	60.04	7.50	\$484	\$517	N/A	N/A
Z12S43TN	16 x 12 x 42.7-43.2	100	54.10	6.25	\$451	\$480	N/A	N/A

Designed to be placed **on top of 40.8\"/>**

Required Specifications

Top finish
Base finish
Top/Edge Detail

Optional Specifications

Collator**
Glazed doors*

END SHELVES

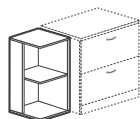

End Shelf - LEFT 29"/29.5" High*

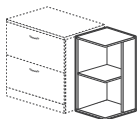

End Shelf - RIGHT 29"/29.5" High*

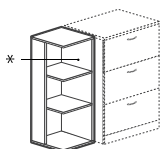

* Accepts collator 11" high

End Shelf - LEFT 40.8"/41.3" High**

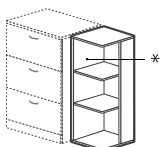

* Accepts collator 11" high

End Shelf - RIGHT 40.8"/41.3" High**

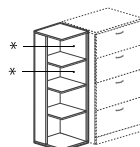

* Accepts collator 11" high

End Shelf - LEFT 52.5"/53" High**

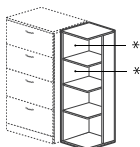

* Accepts collator 11" high

End Shelf - RIGHT 52.5"/53" High**

MODEL#	DIMENSIONS D x W x H	FREIGHT CLASS	WT/LBS.	CUBIC FT.	1" TOP	1.5" TOP	GLAZE ADD	HP ADD
Z24L2ESHL	24 x 24 x 29.5-30	70	99.75	4.75	\$667	\$724	N/A	\$131
Z20M2ESHL	20 x 20 x 29.5-30	70	76.65	3.75	\$553	\$596	N/A	\$84
Z16S2ESHL	16 x 16 x 29.5-30	65	53.55	2.25	\$470	\$508	N/A	\$84

For use at **LEFT end of 29"/29.5" H units. One adjustable shelf.** Shipped RTA (ready to assemble).

Z24L2ESHR	24 x 24 x 29.5-30	70	99.75	4.75	\$667	\$724	N/A	\$131
Z20M2ESHR	20 x 20 x 29.5-30	70	76.65	3.75	\$553	\$596	N/A	\$84
Z16S2ESHR	16 x 16 x 29.5-30	65	53.55	2.25	\$470	\$508	N/A	\$84

For use at **RIGHT end of 29"/29.5" H units. One adjustable shelf.** Shipped RTA (ready to assemble).

Z24L4ESHL	24 x 24 x 41.3-41.8	65	130.20	4.75	\$856	\$914	N/A	N/A
Z20M4ESHL	20 x 20 x 41.3-41.8	60	101	3.25	\$719	\$762	N/A	N/A
Z16S4ESHL	16 x 16 x 41.3-41.8	65	73.87	2.50	\$611	\$649	N/A	N/A

For use at **LEFT end of 40.8"/41.3" H units. Two adjustable shelves.** Shipped RTA (ready to assemble).

- Collator only available on **Z16S4ESHL**

Z24L4ESHR	24 x 24 x 41.3-41.8	65	130.20	4.75	\$856	\$914	N/A	N/A
Z20M4ESHR	20 x 20 x 41.3-41.8	60	101	3.25	\$719	\$762	N/A	N/A
Z16S4ESHR	16 x 16 x 41.3-41.8	65	73.87	2.50	\$611	\$649	N/A	N/A

For use at **RIGHT end of 40.8"/41.3" H units. Two adjustable shelves.** Shipped RTA (ready to assemble).

- Collator only available on **Z16S4ESHR**

Z24L5ESHL	24 x 24 x 53-53.5	60	162.75	4.75	\$1061	\$1118	N/A	N/A
Z20M5ESHL	20 x 20 x 53-53.5	60	125.69	4	\$875	\$918	N/A	N/A
Z16S5ESHL	16 x 16 x 53-53.5	65	91.35	3.25	\$738	\$780	N/A	N/A

For use at **LEFT end of 52.5"/53" H units. Three adjustable shelves.** Shipped RTA (ready to assemble).

- Collator only available on **Z16S5ESHL**

Z24L5ESHR	24 x 24 x 53-53.5	60	162.75	4.75	\$1061	\$1118	N/A	N/A
Z20M5ESHR	20 x 20 x 53-53.5	60	125.69	4	\$875	\$918	N/A	N/A
Z16S5ESHR	16 x 16 x 53-53.5	65	91.35	3.25	\$738	\$780	N/A	N/A

For use at **RIGHT end of 52.5"/53" H units. Three adjustable shelves.** Shipped RTA (ready to assemble).

- Collator only available on **Z16S5ESHR**

Required Specifications

Top finish
Base finish
Top/Edge Detail

Optional Specifications

Collator**
Glazed doors*

END SHELVES

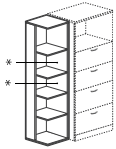

* Accepts collator 11" high

End Shelf - LEFT 65"/65.5" High

MODEL#	DIMENSIONS D x W x H	FREIGHT CLASS	WT/LBS.	CUBIC FT.	1" TOP	1.5" TOP	GLAZE ADD	HP ADD
Z24L6ESHL	24 x 24 x 65.5-66	60	196	6	\$1240	\$1298	N/A	N/A
Z20M6ESHL	20 x 20 x 65.5-66	60	152	5	\$1031	\$1074	N/A	N/A
Z16S6ESHL	16 x 16 x 65.5-66	65	111.30	4.25	\$880	\$918	N/A	N/A

For use at **LEFT end of 65"/65.5"H units. Four adjustable shelves.** Shipped RTA (ready to assemble).
 • Collator only available on **Z16S6ESHL**

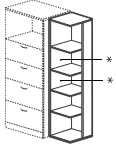

* Accepts collator 11" high

End Shelf - RIGHT 65"/65.5" High

Z24L6ESHR	24 x 24 x 65.5-66	60	196	6	\$1240	\$1298	N/A	N/A
Z20M6ESHR	20 x 20 x 65.5-66	60	152	5	\$1031	\$1074	N/A	N/A
Z16S6ESHR	16 x 16 x 65.5-66	65	111.30	4.25	\$880	\$918	N/A	N/A

For use at **RIGHT end of 65"/65.5"H units. Four adjustable shelves.** Shipped RTA (ready to assemble).
 • Collator only available on **Z16S6ESHR**

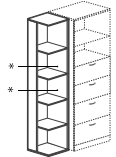

* Accepts collator 11" high

End Shelf - LEFT 71.5"/72" High

Z24L7ESHL	24 x 24 x 71.9-72.4	60	206.85	6.50	\$1302	\$1359	N/A	N/A
Z20M7ESHL	20 x 20 x 71.9-72.4	65	160.65	5.75	\$1087	\$1130	N/A	N/A
Z16S7ESHL	16 x 16 x 71.9-72.4	65	117.60	4.75	\$925	\$963	N/A	N/A

For use at **LEFT end of 71.5"/72"H units. Four adjustable shelves.** Shipped RTA (ready to assemble).
 • Collator only available on **Z16S7ESHL**

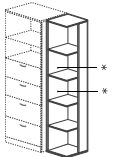

* Accepts collator 11" high

End Shelf - RIGHT 71.5"/72" High

Z24L7ESHR	24 x 24 x 71.9-72.4	60	206.85	6.50	\$1302	\$1359	N/A	N/A
Z20M7ESHR	20 x 20 x 71.9-72.4	65	160.65	5.75	\$1087	\$1130	N/A	N/A
Z16S7ESHR	16 x 16 x 71.9-72.4	65	117.60	4.75	\$925	\$963	N/A	N/A

For use at **RIGHT end of 71.5"/72"H units. Four adjustable shelves.** Shipped RTA (ready to assemble).
 • Collator only available on **Z16S7ESHR**

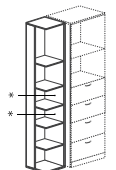

* Accepts collator 11" high

End Shelf - LEFT 84"/84.5" High

Z24L8ESHL	24 x 24 x 84.4-84.9	60	241.50	7.75	\$1494	\$1551	N/A	N/A
Z20M8ESHL	20 x 20 x 84.4-84.9	65	185.85	6.50	\$1246	\$1289	N/A	N/A
Z16S8ESHL	16 x 16 x 84.4-84.9	65	136.50	5.50	\$1058	\$1096	N/A	N/A

For use at **LEFT end of 84"/84.5"H units. Five adjustable shelves.** Shipped RTA (ready to assemble).
 • Collator only available on **Z16S8ESHL**

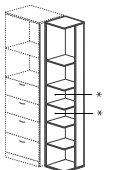

* Accepts collator 11" high

End Shelf - RIGHT 84"/84.5" High

Z24L8ESHR	24 x 24 x 84.4-84.9	60	241.50	7.75	\$1494	\$1551	N/A	N/A
Z20M8ESHR	20 x 20 x 84.4-84.9	65	185.85	6.50	\$1246	\$1289	N/A	N/A
Z16S8ESHR	16 x 16 x 84.4-84.9	65	136.50	5.50	\$1058	\$1096	N/A	N/A

For use at **RIGHT end of 84"/84.5"H units. Five adjustable shelves.** Shipped RTA (ready to assemble).
 • Collator only available on **Z16S8ESHR**

Required Specifications

Top finish
 Base finish
 Top/Edge Detail

Optional Specifications

Collator

TABLE TOP END SHELVES

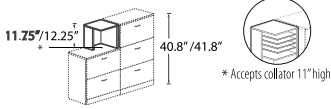

Table Top End Shelf - LEFT
11.75"/12.25" High

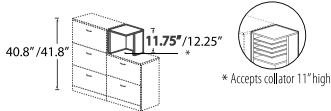

Table Top End Shelf - RIGHT
11.75"/12.25" High

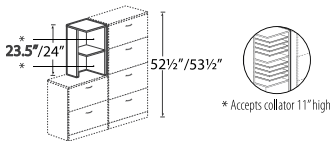

Table Top End Shelf - LEFT
23.5"/24" High

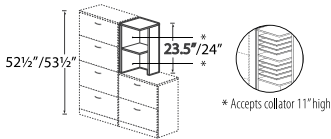

Table Top End Shelf - RIGHT
23.5"/24" High

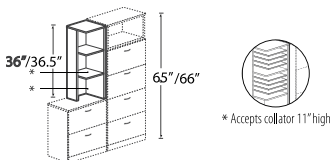

Table Top End Shelf - LEFT
36"/36.5" High

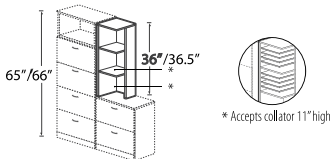

Table Top End Shelf - RIGHT
36"/36.5" High

MODEL#	DIMENSIONS D x W x H	FREIGHT CLASS	WT/LBS.	CUBIC FT.	1" TOP	1.5" TOP	GLAZE ADD	HP ADD
Z16S12DL	16 x 16 x 11.25-11.75	70	26	1.60	\$239	\$277	N/A	N/A

To be placed **on top of 29"/29.5" units**. For use at **LEFT end of 40.8"/41.8" H units**. Shipped RTA (ready to assemble).

Z16S12DR	16 x 16 x 11.25-11.75	70	26	1.60	\$239	\$277	N/A	N/A
----------	-----------------------	----	----	------	-------	-------	-----	-----

To be placed **on top of 29"/29.5" units**. For use at **RIGHT end of 40.8"/41.8" H units**. Shipped RTA (ready to assemble).

Z16S23DL	16 x 16 x 23-23.5	65	42	1.60	\$367	\$409	N/A	N/A
----------	-------------------	----	----	------	-------	-------	-----	-----

To be placed **on top of 29"/29.5" units**. For use at **LEFT end of 52.5"/53" H units**. Shipped RTA (ready to assemble).
One adjustable shelf.

Z16S23DR	16 x 16 x 23-23.5	65	42	1.60	\$367	\$409	N/A	N/A
----------	-------------------	----	----	------	-------	-------	-----	-----

To be placed **on top of 29"/29.5" units**. For use at **RIGHT end of 52.5"/53" H units**. Shipped RTA (ready to assemble).
One adjustable shelf.

Z16S36DL	16 x 16 x 35.5-36	70	62.84	2.80	\$511	\$549	N/A	N/A
----------	-------------------	----	-------	------	-------	-------	-----	-----

To be placed **on top of 29"/29.5" units**. For use at **LEFT end of 65"/65.5" H units**. Shipped RTA (ready to assemble).
Two adjustable shelves.

Z16S36DR	16 x 16 x 35.5-36	70	62.84	2.80	\$511	\$549	N/A	N/A
----------	-------------------	----	-------	------	-------	-------	-----	-----

To be placed **on top of 29"/29.5" units**. For use at **RIGHT end of 65"/65.5" H units**. Shipped RTA (ready to assemble).
Two adjustable shelves.

Required Specifications

Top finish
Base finish
Top/Edge Detail

Optional Specifications

Collator

TABLE TOP END SHELVES

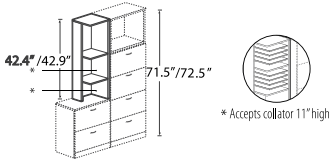

Table Top End Shelf - LEFT*
42.4\"/>

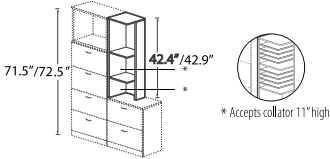

Table Top End Shelf - RIGHT*
42.4\"/>

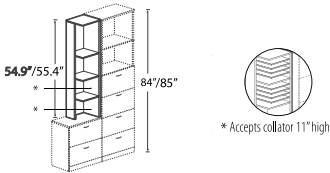

Table Top End Shelf - LEFT*
54.9\"/>

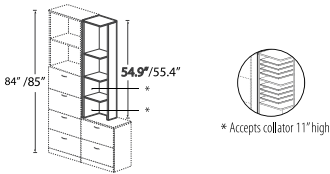

Table Top End Shelf - RIGHT*
54.9\"/>

MODEL#	DIMENSIONS	FREIGHT CLASS	WT/LBS.	CUBIC FT.	1" TOP	1.5" TOP	GLAZE ADD	HP ADD
Z16S42DL	16-36 x 16 x 41.9-42.4	65	70	2.80	\$552	\$590	N/A	N/A

To be placed **on top of 29\"/>**

Z16S42DR	16-36 x 16 x 41.9-42.4	65	70	2.80	\$552	\$590	N/A	N/A
----------	------------------------	----	----	------	-------	-------	-----	-----

To be placed **on top of 29\"/>**

Z16S55DL	16-36 x 16 x 54.4-54.9	60	89	2.80	\$681	\$723	N/A	N/A
----------	------------------------	----	----	------	-------	-------	-----	-----

To be placed **on top of 29\"/>**

Z16S55DR	16-36 x 16 x 54.4-54.9	60	89	2.80	\$681	\$723	N/A	N/A
----------	------------------------	----	----	------	-------	-------	-----	-----

To be placed **on top of 29\"/>**

Required Specifications

- Top finish
- Base finish
- Top/Edge Detail

Optional Specifications

- Collator

ACCESSORIES

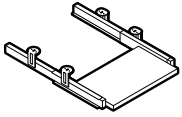

Pull-Out Keyboard

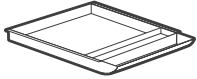

Pencil Drawer



L Bracket



LEFT
RIGHT
Skateboard

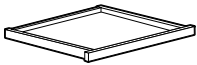

Center Drawer

MODEL#	DIMENSIONS D x W x H	FREIGHT CLASS	WT/LBS.	CUBIC FT.	LIST PRICE
APOKL28	17 x 28 x 3.5	85	13	.90	\$337
APOKL22	17 x 22 x 3.5	85	12	.90	\$305

APOKL28 will accommodate keyboard and mousepad. **APOKL28** will only fit on a single pedestal desk, freestanding table, or **Z42205C**.

W1518PDR	18 x 15 x 2.25	92.5	4	0.4	\$274
----------	----------------	------	---	-----	--------------

Black ABS plastic. Provides space for writing instruments and small items at the workspace. Attaches to underside of any 24"D and 30"D worksurface with included roller slides. Shipped RTA (ready to assemble).

MLB90	--	70	1	.01	\$60
-------	----	----	---	-----	-------------

Used to attach worksurfaces to end panels.

Z1425SKL (left)	13.9-36 x 25 x 3.2-3.7	100	13	1.50	\$137
---------------------------	------------------------	-----	----	------	--------------

Z1425SKR (right)	13.9-36 x 25 x 3.2-3.7	100	13	1.50	\$137
----------------------------	------------------------	-----	----	------	--------------

Mobile CPU holder designed to fit inside 'faux' pedestals of a single pedestal desk.

CD20	18 x 20 x 3	100	8	1	\$214
------	-------------	-----	---	---	--------------

Laminate drawer front is attached to a 4-sided frame. Recommended for use on small L-shaped units, and on 30" x 60" and 66" desks.

Required Specifications

Finish

zira boardroom + reception



Zira Boardroom + Reception

258

TOP AND BASE FINISHES

ACJ	Absolute Acajou	FCL	First Class
ASN	Asian Night	NBL	Noce Biondo
AWC	Avant Cherry	NGL	Noce Grigio
AWH	Avant Honey	NEL	Noce Leggero
BLK	Black	NML	Noce Medio
BZD	Blizzard	QTM	Quartered Mahogany
BRC	Brushed Cobalt	SBY	Sheer Beauty
CMB	Clear Maple	SOG	Storm Grey
CGY	Custom Grey	SDT	Stonedust
DES	Dark Espresso	WHE	Walnut Heights
DWT	Designer White	WHC	White Chocolate
FAS	Fashionista	WCR	Winter Cherry

BASE TRIM FINISHES

BRC	Brushed Cobalt
BLK	Black

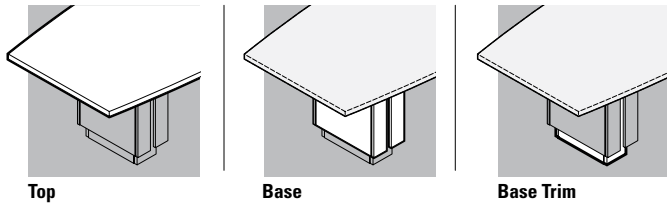

TOP THICKNESS/EDGE DETAIL



C3 1.5" top, standard **CR** 1.5" top, bicut edge **CF** 1.5" top, fluted edge

BASES

- 2 doors on base for wire management access from both sides

TOPS

- 96" tops are standard in one piece. All tops 120", 144" and 168" tops are standard in two equal size pieces. Woodgrain laminate finishes may NOT align where the two tops join. Tops 192" and larger are standard in 3 equal pieces.
- 96" tops are standard with **two bases**
- Tops 120", 144" and 168" are standard with **three bases**
- Tops 192" and larger are standard with **four bases**
- **Four** top shapes: **boat shaped, bow end, rectangular** and **racetrack**

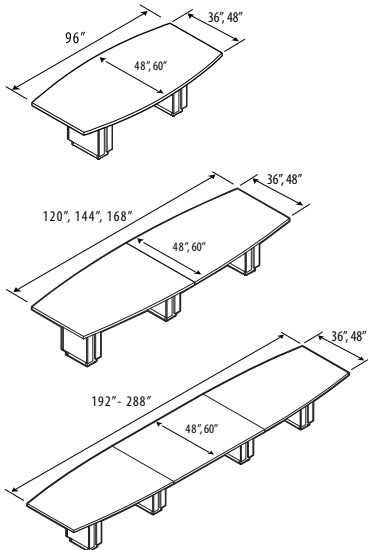

POWER BLOCK OPTIONS AND CUT-OUT LOCATIONS

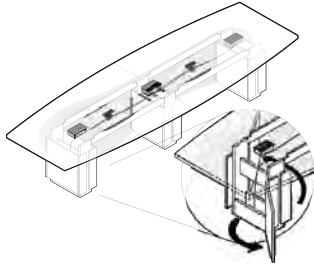

PRODUCT CODE DIAGRAM

PMSPPDM



PRTMCS401B
PRTMCS401T
PRTMCS401W
PRTMCS421B
PRTMCS421T
PRTMCS421W



PRTMCD602B
PRTMCD602T
PRTMCD602W
PRTMCD622B
PRTMCD622T
PRTMCD622W
PRTMCD642B
PRTMCD642T
PRTMCD642W



VILLA

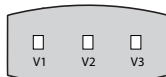

OASIS MINI A



OASIS MINI B



CUT-OUTS

- **Boardroom** and **collaborative** tables offer optional cut-outs for in-surface mounted power modules in three standard locations (left, center or right) as shown above for all table shapes excluding square boardroom tables. Order as **E1, M1, R1, T1, V1**, etc. **Add \$96** for each cut-out.
- Cut-out options for **square boardroom tables** in centered position only. Order as **E2, M2, R2, T2**, or **V2**. **Add \$96** for each cut-out.
- Cut-out options for **media tables** in position 1 only. Order as **E1, M1, R1, T1**, or **V1**. **Add \$96** for each cut-out.
- Select power block from **Productivity Solutions**, beginning on page 491.
- Match power block desired with cut-out code and location from above grid.
- Optional custom sized cut-out available in standard locations (left, center or right) for all table shapes. Submit appropriate form beginning on page 735 with order. **Add \$294** for each cut-out.

AUDIOVISUAL

Three components:
Multimedia Cart

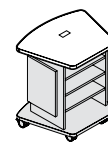
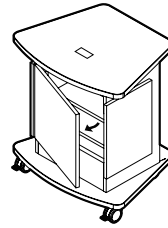

Top

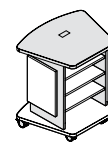

Base

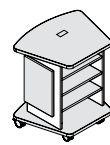

Base trim

Lectern

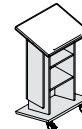
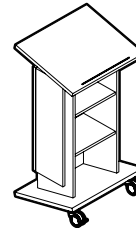

Top



Base

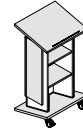

Base Trim

Visual Board

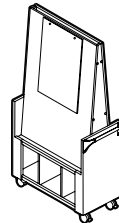

Lower Portion

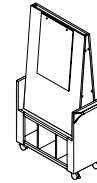

Push Bar & Casters

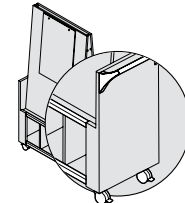

Visual Board

Multimedia Cart and Lectern:

- Available in all standard laminates
- Color of casters will match base trim
- Offered in the following **top thickness and edge details**:



A3 1.5" top, standard



AR 1" top, bicut edge



C3 1.5" top, standard



CR 1.5" top, bicut edge



CF 1.5" top, fluted edge

Visual Board:

- Available in all laminates listed above
- Push Bar available in Black (**BLK**) or Tungsten (**TUN**)
- Color of casters and aluminum trim will match push bar
- Visual Board comes standard in white color

BUFFET

Three components: **Buffet Carts, Buffets** and **Serving Carts**

- Top and/or base available in all laminates
- Push Bar on Buffet Carts and Serving Carts and Aluminum Trim on Open and Mixed Buffets available in Black (BLK) or Tungsten (TUN)
- Optional glazing available on Serving Carts with doors and Buffets with doors

Buffet Carts

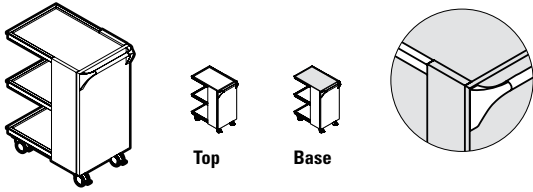

Serving Cart with Doors

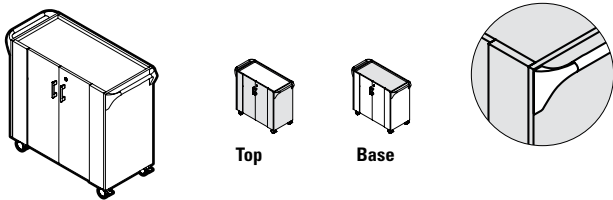

Serving Cart - Open

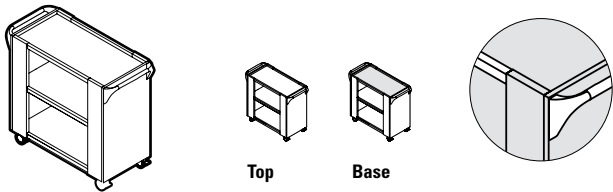

Buffet - Open

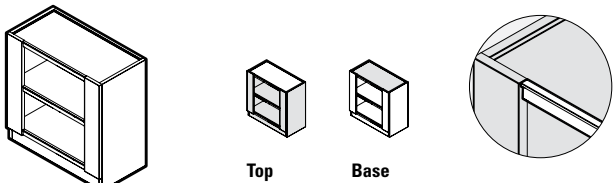

Buffet with Doors

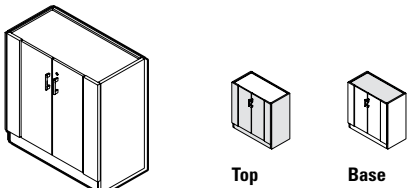

Buffet - Mixed

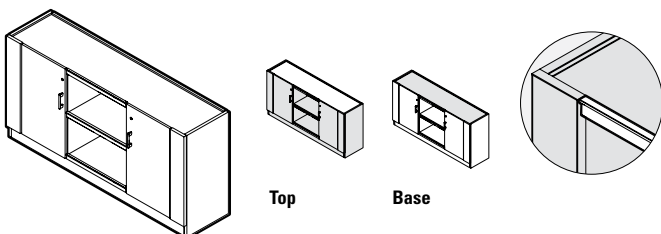

Glazing (Doors - Serving Cart and Buffets)



Z1 frosted glazing, Tungsten (TUN) frame Z2 frosted glazing, Black (BLK) frame

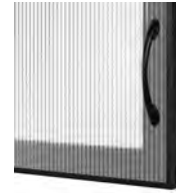

Z3 ribbed glazing, Tungsten (TUN) frame Z4 ribbed glazing, Black (BLK) frame

Handles

- Handles are standard on models with doors. Each handle is identified by the letters "HU", "HV", "HW", "HX", "HS", "HZ", "HO", "HQ", and "HR". To specify a handle, please specify the code after the model number.



HS Flared Silver



HV Square Edge Silver



HO Crescent Black



HW Flared Brass



HU Square Edge Black



HZ Dimpled Nickel



HX Flared Black



HQ Bar Silver



HR Bar Black

- Use the following for determining the size of a table and the number of chairs needed for a conference area. All estimates are based on an average chair width of 23" with a 4" clearance between chairs. Adjust accordingly for a different chair size.

Top Size	Rectangular	Bow End	Boat	Racetrack
48x96	6-8	6-8	6-8	6-8
48x120	8-10	8-10	8-10	8-10
48x144	10-12	10-12	10-12	10-12
48x168	12-14	12-14	12-14	12-14
48x192	14-16	14-16	14-16	14-16
48x216	16-18	16-18	16-18	16-18
48x240	18-20	18-20	18-20	18-20
48x264	20-22	20-22	20-22	20-22
48x288	22-24	22-24	22-24	22-24

BOARDROOM TABLES

MODEL#	DIMENSIONS	FREIGHT CLASS	WT/LBS.	CUBIC FT.	1" TOP	1.5" TOP	GLAZE ADD	HP ADD
D x W x H (1.5" TOP)								

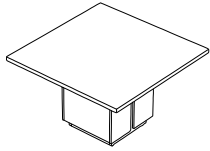

Boardroom Table - Square

Z3636SQ	36 x 36 x 30	85	129	10	N/A	\$2405	N/A	\$356
Z4242SQ	42 x 42 x 30	85	165.50	13.50	N/A	\$2738	N/A	\$488
Z4848SQ	48 x 48 x 30	85	190	14.24	N/A	\$2966	N/A	\$630
Z5454SQ	54 x 54 x 30	85	262	21.24	N/A	\$3318	N/A	\$799
Z6060SQ	60 x 60 x 30	85	300	22.74	N/A	\$3546	N/A	\$982

Square Table includes ONE BASE with wire access doors on each side of base. Shipped in 2 cartons.

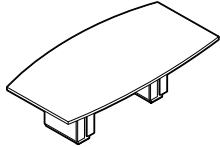

Boardroom Table - Boat Shaped

Z4896BE	48 x 96 x 30	70	342	21.95	N/A	\$3920	N/A	\$967
---------	--------------	----	-----	-------	-----	---------------	-----	--------------

Boat Shaped Table includes TWO BASES with wire access doors on each side of base and wire concealment runners between bases. Shipped in 3 cartons.

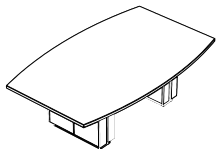

Boardroom Table - Boat Shaped

Z6096BE	60 x 96 x 30	85	432	35.39	N/A	\$6361	N/A	\$1571
---------	--------------	----	-----	-------	-----	---------------	-----	---------------

Boat Shaped Table includes TWO BASES with wire access doors on each side of base and wire concealment runners between bases. Shipped in 3 cartons.

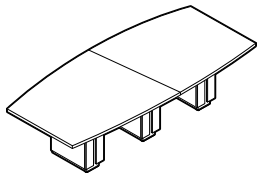

Boardroom Table - Boat Shaped

Z48120BE	48 x 120 x 30	70	452	23.48	N/A	\$5635	N/A	\$1208
Z48144BE	48 x 144 x 30	70	502	25.72	N/A	\$5690	N/A	\$1448
Z48168BE	48 x 168 x 30	85	557	37.25	N/A	\$7593	N/A	\$1831

Boat Shaped Table includes THREE BASES with wire access doors on each side of base and wire concealment runners between bases. Z48144BE and Z48120BE shipped in 4 cartons. Z48168BE shipped in 5 cartons.

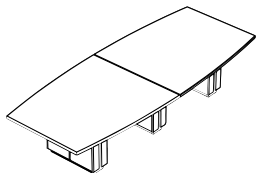

Boardroom Table - Boat Shaped

Z60120BE	60 x 120 x 30	85	599	48.50	N/A	\$9643	N/A	\$1961
Z60144BE	60 x 144 x 30	85	664.65	53.25	N/A	\$10321	N/A	\$2354
Z60168BE	60 x 168 x 30	85	741.30	58	N/A	\$11129	N/A	\$2745

Boat Shaped Table includes THREE BASES with wire access doors on each side of base and wire concealment runners between bases. Shipped in 5 cartons.

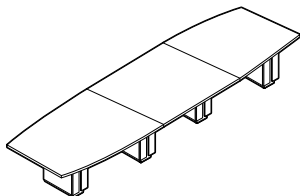

Boardroom Table - Boat Shaped

Z48192BE	48 x 192 x 30	70	688	45.66	N/A	\$9483	N/A	\$2091
Z48216BE	48 x 216 x 30	70	746	48.67	N/A	\$9929	N/A	\$2354
Z48240BE	48 x 240 x 30	70	803	51.68	N/A	\$10556	N/A	\$2614
Z48264BE	48 x 264 x 30	70	855	54.69	N/A	\$11181	N/A	\$2875
Z48288BE	48 x 288 x 30	70	906	57.69	N/A	\$11181	N/A	\$3136

Boat Shaped Table includes FOUR BASES with wire access doors on each side of base and wire concealment runners between bases. Shipped in 7 cartons.

Required Specifications

Top finish
Top/edge detail
Base finish
Base trim finish

Optional Specifications

HP laminate
Additional grommet

Accessories

Power block

BOARDROOM TABLES

MODEL# DIMENSIONS FREIGHT CLASS WT/LBS. CUBIC FT. 1"TOP 1.5" TOP GLAZE ADD HP ADD

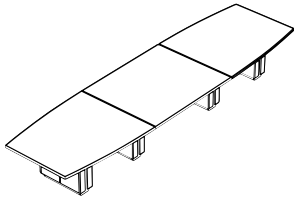

Boardroom Table - Boat Shaped

	D x W x H (1.5" TOP)								
Z60192BE	60 x 192 x 30	85	912.45	71.19	N/A	\$13999	N/A	\$3136	
Z60216BE	60 x 216 x 30	85	980.70	75.94	N/A	\$14784	N/A	\$3526	
Z60240BE	60 x 240 x 30	85	1062.60	80.98	N/A	\$15419	N/A	\$3920	
Z60264BE	60 x 264 x 30	85	1129.80	85.73	N/A	\$16031	N/A	\$4311	
Z60288BE	60 x 288 x 30	85	1198.05	90.49	N/A	\$17007	N/A	\$4704	

Boat Shaped Table includes FOUR BASES with wire access doors on each side of base and wire concealment runners between bases. Shipped in 7 cartons.

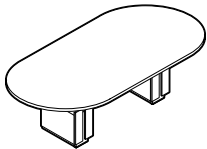

Boardroom Table - Racetrack

Z4896RTE	48 x 96 x 30	70	336	21.95	N/A	\$3811	N/A	\$967
----------	--------------	----	-----	-------	-----	--------	-----	-------

Racetrack Shaped Table includes TWO BASES with wire access doors on each side of base and wire concealment runners between bases. Shipped in 3 cartons.

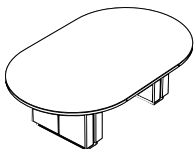

Boardroom Table - Racetrack

Z6096RTE	60 x 96 x 30	92.5	417	35.39	N/A	\$6361	N/A	\$1571
----------	--------------	------	-----	-------	-----	--------	-----	--------

Racetrack Shaped Table includes TWO BASES with wire access doors on each side of base and wire concealment runners between bases. Shipped in 3 cartons.

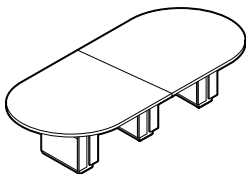

Boardroom Table - Racetrack

Z48120RTE	48 x 120 x 30	70	453	28.28	N/A	\$5299	N/A	\$1208
Z48144RTE	48 x 144 x 30	70	506	25.72	N/A	\$5648	N/A	\$1448
Z48168RTE	48 x 168 x 30	70	563	37.25	N/A	\$7639	N/A	\$1297

Racetrack Shaped Table includes THREE BASES with wire access doors on each side of base and wire concealment runners between bases. Z48144RTE and Z48120RTE shipped in 4 cartons. Z48168RTE shipped in 5 cartons.

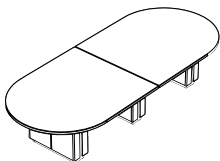

Boardroom Table - Racetrack

Z60120RTE	60 x 120 x 30	85	585.90	48.50	N/A	\$9643	N/A	\$1961
Z60144RTE	60 x 144 x 30	85	656.25	53.25	N/A	\$10321	N/A	\$2354
Z60168RTE	60 x 168 x 30	85	737.10	58	N/A	\$11129	N/A	\$2745

Racetrack Shaped Table includes THREE BASES with wire access doors on each side of base and wire concealment runners between bases. Shipped in 5 cartons.

Required Specifications

Top finish
Top/edge detail
Base finish
Base trim finish

Optional Specifications

HP laminate
Additional grommet

Accessories

Power block

BOARDROOM TABLES

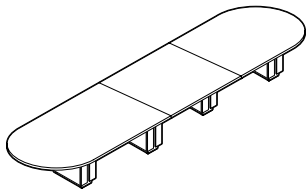

Boardroom Table - Racetrack

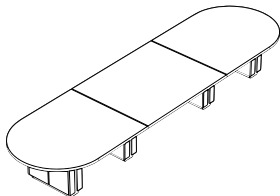

Boardroom Table - Racetrack

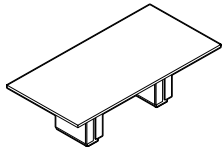

Boardroom Table - Rectangular

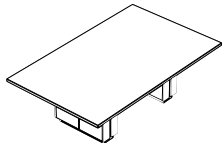

Boardroom Table - Rectangular

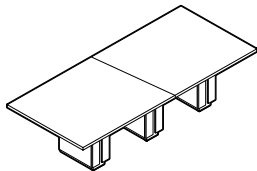

Boardroom Table - Rectangular

MODEL#	DIMENSIONS D x W x H (1.5" TOP)	FREIGHT CLASS	WT/LBS.	CUBIC FT.	1" TOP	1.5" TOP	GLAZE ADD	HP ADD
Z48192RTE	48 x 192 x 30	70	689	45.45	N/A	\$9530	N/A	\$2091
Z48216RTE	48 x 216 x 30	70	749	48.95	N/A	\$9974	N/A	\$2354
Z48240RTE	48 x 240 x 30	70	809	51.75	N/A	\$10601	N/A	\$2614
Z48264RTE	48 x 264 x 30	70	862	54.55	N/A	\$11227	N/A	\$2875
Z48288RTE	48 x 288 x 30	70	917	58.04	N/A	\$11227	N/A	\$3136

Racetrack Shaped Table includes FOUR BASES with wire access doors on each side of base and wire concealment runners between bases. Shipped in 7 cartons.

Z60192RTE	60 x 192 x 30	85	901.95	71.19	N/A	\$13999	N/A	\$3136
Z60216RTE	60 x 216 x 30	85	972.30	75.94	N/A	\$14784	N/A	\$3526
Z60240RTE	60 x 240 x 30	85	1057.35	80.98	N/A	\$15419	N/A	\$3920
Z60264RTE	60 x 264 x 30	85	1127.70	85.73	N/A	\$16031	N/A	\$4311
Z60288RTE	60 x 288 x 30	85	1198.05	90.49	N/A	\$17007	N/A	\$4704

Racetrack Shaped Table includes FOUR BASES with wire access doors on each side of base and wire concealment runners between bases. Shipped in 7 cartons.

Z4896REE	48 x 96 x 30	70	356	21.95	N/A	\$3900	N/A	\$967
----------	--------------	----	-----	-------	-----	---------------	-----	--------------

Rectangular Shaped Table includes TWO BASES with wire access doors on each side of base and wire concealment runners between bases. Shipped in 3 cartons.

Z6096REE	60 x 96 x 30	85	448	35.39	N/A	\$5831	N/A	\$1571
----------	--------------	----	-----	-------	-----	---------------	-----	---------------

Rectangular Shaped Table includes TWO BASES with wire access doors on each side of base and wire concealment runners between bases. Shipped in 3 cartons.

Z48120REE	48 x 120 x 30	70	472	23.48	N/A	\$5281	N/A	\$1208
Z48144REE	48 x 144 x 30	70	525	25.72	N/A	\$5653	N/A	\$1448
Z48168REE	48 x 168 x 30	70	583	37.25	N/A	\$7527	N/A	\$1831

Rectangular Shaped Table includes THREE BASES with wire access doors on each side of base and wire concealment runners between bases. Z48144REE and Z48120REE shipped in 4 cartons. Z48168REE shipped in 5 cartons.

Required Specifications

Top finish
Top/edge detail
Base finish
Base trim finish

Optional Specifications

HP laminate
Additional grommet

Accessories

Power block

BOARDROOM TABLES

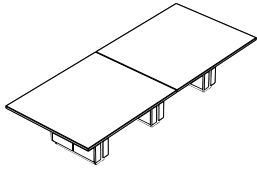

Boardroom Table - Rectangular

MODEL#	DIMENSIONS D x W x H (1.5" TOP)	FREIGHT CLASS	WT/LBS.	CUBIC FT.	1" TOP	1.5" TOP	GLAZE ADD	HP ADD
Z60120REE	60 x 120 x 30	85	618	48.50	N/A	\$8839	N/A	\$1961
Z60144REE	60 x 144 x 30	85	688	53.25	N/A	\$9460	N/A	\$2354
Z60168REE	60 x 168 x 30	85	769	58	N/A	\$10188	N/A	\$2745

Rectangular Shaped Table includes THREE BASES with wire access doors on each side of base and wire concealment runners between bases. Shipped in 5 cartons.

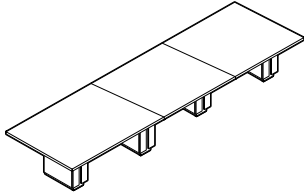

Boardroom Table - Rectangular

Z48192REE	48 x 192 x 30	70	708	45.45	N/A	\$9419	N/A	\$2091
Z48216REE	48 x 216 x 30	70	768	48.95	N/A	\$9864	N/A	\$2354
Z48240REE	48 x 240 x 30	70	828	51.75	N/A	\$10489	N/A	\$2614
Z48264REE	48 x 264 x 30	70	882	54.55	N/A	\$11117	N/A	\$2875
Z48288REE	48 x 288 x 30	70	936	58.04	N/A	\$11117	N/A	\$3136

Rectangular Shaped Table includes FOUR BASES with wire access doors on each side of base and wire concealment runners between bases. Shipped in 7 cartons.

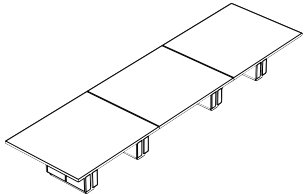

Boardroom Table - Rectangular

Z60192REE	60 x 192 x 30	85	941.85	71.12	N/A	\$12833	N/A	\$3136
Z60216REE	60 x 216 x 30	85	1003.80	75.94	N/A	\$13544	N/A	\$3526
Z60240REE	60 x 240 x 30	85	1088.85	80.98	N/A	\$14125	N/A	\$3920
Z60264REE	60 x 264 x 30	85	1159.20	85.73	N/A	\$14680	N/A	\$4311
Z60288REE	60 x 288 x 30	85	1229.55	90.49	N/A	\$15568	N/A	\$4704

Rectangular Shaped Table includes FOUR BASES with wire access doors on each side of base and wire concealment runners between bases. Shipped in 7 cartons.

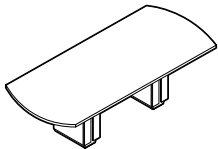

Boardroom Table - Bow End

Z4896BW	48 x 96 x 30	85	329	21.95	N/A	\$4039	N/A	\$967
---------	--------------	----	-----	-------	-----	---------------	-----	--------------

Bow End Table includes TWO BASES with wire access doors on each side of base and wire concealment runners between bases. Shipped in 3 cartons.

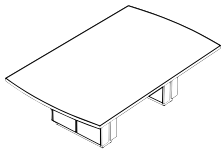

Boardroom Table - Bow End

Z6096BW	60 x 96 x 30	85	436	35.39	N/A	\$6361	N/A	\$1571
---------	--------------	----	-----	-------	-----	---------------	-----	---------------

Bow End Table includes TWO BASES with wire access doors on each side of base and wire concealment runners between bases. Shipped in 3 cartons.

Required Specifications

Top finish
Top/edge detail
Base finish
Base trim finish

Optional Specifications

HP laminate
Additional grommet

Accessories

Power block

BOARDROOM TABLES

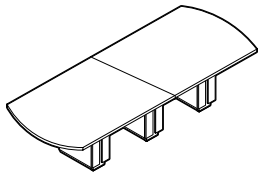

Boardroom Table - Bow End

MODEL#	DIMENSIONS D x W x H (1.5" TOP)	FREIGHT CLASS	WT/LBS.	CUBIC FT.	1" TOP	1.5" TOP	GLAZE ADD	HP ADD
Z48120BW	48 x 120 x 30	70	476	29.35	N/A	\$5378	N/A	\$1208
Z48144BW	48 x 144 x 30	70	513	25.72	N/A	\$5759	N/A	\$1448
Z48168BW	48 x 168 x 30	70	573	37.25	N/A	\$7560	N/A	\$1831

Bow End Table includes THREE BASES with wire access doors on each side of base and wire concealment runners between bases. Z48144BW and Z48120BW shipped in 4 cartons. Z48168BW shipped in 5 cartons.

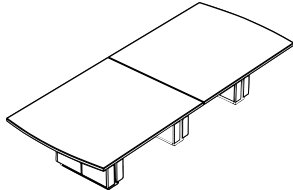

Boardroom Table - Bow End

Z60120BW	60 x 120 x 30	85	602	48.50	N/A	\$9643	N/A	\$1961
Z60144BW	60 x 144 x 30	85	673	53.25	N/A	\$10321	N/A	\$2354
Z60168BW	60 x 168 x 30	85	753	58	N/A	\$11129	N/A	\$2745

Bow End Table includes THREE BASES with wire access doors on each side of base and wire concealment runners between bases. Shipped in 5 cartons.

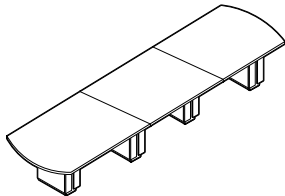

Boardroom Table - Bow End

Z48192BW	48 x 192 x 30	70	698	45.45	N/A	\$9454	N/A	\$2091
Z48216BW	48 x 216 x 30	70	758	48.95	N/A	\$9895	N/A	\$2354
Z48240BW	48 x 240 x 30	70	818	51.75	N/A	\$10522	N/A	\$2614
Z48264BW	48 x 264 x 30	70	872	54.55	N/A	\$11150	N/A	\$2875
Z48288BW	48 x 288 x 30	70	926	58.04	N/A	\$11150	N/A	\$3136

Bow End Table includes FOUR BASES with wire access doors on each side of base and wire concealment runners between bases. Shipped in 7 cartons.

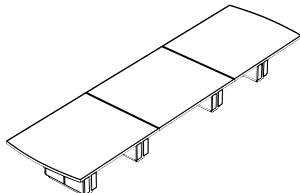

Boardroom Table - Bow End

Z60192BW	60 x 192 x 30	85	917.70	71.19	N/A	\$13999	N/A	\$3136
Z60216BW	60 x 216 x 30	85	988.05	75.94	N/A	\$14784	N/A	\$3526
Z60240BW	60 x 240 x 30	85	1073.10	80.98	N/A	\$15419	N/A	\$3920
Z60264BW	60 x 264 x 30	85	1143.45	85.73	N/A	\$16031	N/A	\$4311
Z60288BW	60 x 288 x 30	85	1213.80	90.49	N/A	\$17007	N/A	\$4704

Bow End Table includes FOUR BASES with wire access doors on each side of base and wire concealment runners between bases. Shipped in 7 cartons.

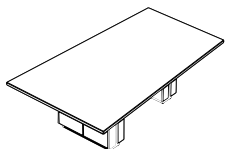

Boardroom Table - Wedge

Z6096WE	60 x 96 x 30	70	398	26.17	N/A	\$6361	N/A	\$1571
---------	--------------	----	-----	-------	-----	---------------	-----	---------------

Wedge Table includes TWO BASES with wire access doors on each side of base. Wedge tapers from 60" w to 48" w. Shipped in 3 cartons.

Required Specifications

Top finish
Top/edge detail
Base finish
Base trim finish

Optional Specifications

HP laminate
Additional grommet

Accessories

Power block

MEDIA TABLES

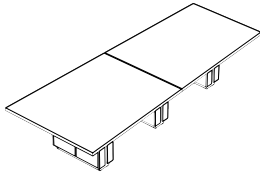

Boardroom Table - Wedge

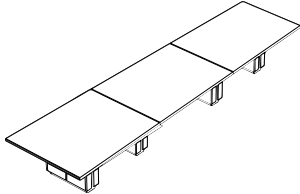

Boardroom Table - Wedge

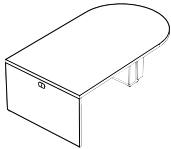

Media Table - D Island

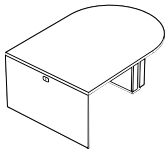

Media Table - D Island

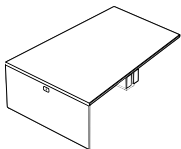

Media Table - D Wedge

MODEL#	DIMENSIONS D x W x H (1.5" TOP)	FREIGHT CLASS	WT/LBS.	CUBIC FT.	1" TOP	1.5" TOP	GLAZE ADD	HP ADD
Z60120WE	60 x 120 x 30	85	544.95	36.50	N/A	\$9643	N/A	\$1961
Z60144WE	60 x 144 x 30	70	603.75	39.50	N/A	\$10321	N/A	\$2354
Z60168WE	60 x 168 x 30	70	673.05	42.50	N/A	\$11129	N/A	\$2745

Wedge Table includes THREE BASES with wire access doors on each side of base. Wedge tapers from 60" w to 48" w. Shipped in 5 cartons.

Z60192WE	60 x 192 x 30	85	824.25	63.71	N/A	\$13999	N/A	\$3136
Z60216WE	60 x 216 x 30	85	884.10	68.25	N/A	\$14784	N/A	\$3526
Z60240WE	60 x 240 x 30	85	948.15	72.94	N/A	\$15419	N/A	\$3920
Z60264WE	60 x 264 x 30	85	1006.95	77.48	N/A	\$16031	N/A	\$4311
Z60288WE	60 x 288 x 30	85	1065.75	81.96	N/A	\$17007	N/A	\$4704

Wedge Table includes FOUR BASES with wire access doors on each side of base. Wedge tapers from 60" w to 48" w. Shipped in 7 cartons.

Z4860DMIL	48 x 60 x 30	70	267	17.69	N/A	\$3965	N/A	\$788
Z4872DMIL	48 x 72 x 30	70	298.20	19.67	N/A	\$4251	N/A	\$943
Z4884DMIL	48 x 84 x 30	70	326.55	21.44	N/A	\$4528	N/A	\$1101
Z4896DMIL	48 x 96 x 30	85	347.55	23.41	N/A	\$4795	N/A	\$1255

D Media Island includes ONE BASE with wire access doors on each side of base and wire concealment runners between the base and the end panel. Grommet centered at the top of the end panel for wire pass through. Shipped in 3 cartons.

Z6060DMIL	60 x 60 x 30	85	323.93	23.17	N/A	\$4756	N/A	\$982
Z6072DMIL	60 x 72 x 30	85	359.10	25.66	N/A	\$5094	N/A	\$1179
Z6084DMIL	60 x 84 x 30	85	397.95	27.90	N/A	\$5433	N/A	\$1376
Z6096DMIL	60 x 96 x 30	85	433.65	30.39	N/A	\$5754	N/A	\$1571

D Media Island includes ONE BASE with wire access doors on each side of base and wire concealment runners between the base and the end panel. Grommet centered at the top of the end panel for wire pass through. Shipped in 3 cartons.

Z6060WMIL	60 x 60 x 30	85	306.60	20.69	N/A	\$4756	N/A	\$982
Z6072WMIL	60 x 72 x 30	85	338.10	22.90	N/A	\$5094	N/A	\$1179
Z6084WMIL	60 x 84 x 30	85	374.85	25.42	N/A	\$5433	N/A	\$1376
Z6096WMIL	60 x 96 x 30	85	407.40	27.90	N/A	\$5754	N/A	\$1571

Wedge Media Island includes ONE BASE with wire access doors on each side of base and wire concealment runners between the base and the end panel. Grommet centered at the top of the end panel for wire pass through. Wedge tapers from 60" w to 48" w. Shipped in 3 cartons.

Required Specifications

Top finish
Top/edge detail
Base finish
Base trim finish

Optional Specifications

HP laminate
Additional grommet

Accessories

Power block

MEDIA TABLES

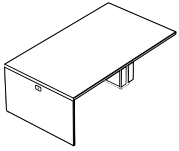

Media Table - Rectangular Island

MODEL#	DIMENSIONS D x W x H (1.5" TOP)	FREIGHT CLASS	WT/LBS.	CUBIC FT.	1" TOP	1.5" TOP	GLAZE ADD	HP ADD
Z4860RMIL	48 x 60 x 30	70	279.30	17.69	N/A	\$3651	N/A	\$788
Z4872RMIL	48 x 72 x 30	70	307.65	19.67	N/A	\$3913	N/A	\$943
Z4884RMIL	48 x 84 x 30	70	337.05	21.44	N/A	\$4163	N/A	\$1101
Z4896RMIL	48 x 96 x 30	70	357	23.41	N/A	\$4403	N/A	\$1255

Rectangular Media Island includes ONE BASE with wire access doors on each side of base and wire concealment runners between the base and the end panel. Grommet centered at the top of the end panel for wire pass through. Shipped in 3 cartons.

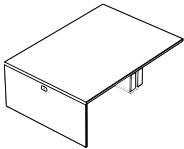

Media Table - Rectangular Island

Z6060RMIL	60 x 60 x 30	70	339.15	22.22	N/A	\$4368	N/A	\$982
Z6072RMIL	60 x 72 x 30	85	373.80	25.66	N/A	\$4677	N/A	\$1179
Z6084RMIL	60 x 84 x 30	85	414.75	27.90	N/A	\$4984	N/A	\$1376
Z6096RMIL	60 x 96 x 30	85	449.40	30.39	N/A	\$5276	N/A	\$1571

Rectangular Media Island includes ONE BASE with wire access doors on each side of base and wire concealment runners between the base and the end panel. Grommet centered at the top of the end panel for wire pass through. Shipped in 3 cartons.

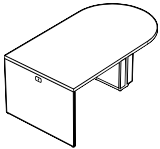

Media Table - D Island, 36" H

Z4860DMIM	48 x 60 x 36.5	70	291.90	19.19	N/A	\$4339	N/A	\$788
Z4872DMIM	48 x 72 x 36.5	70	321.30	21.17	N/A	\$4625	N/A	\$943
Z4884DMIM	48 x 84 x 36.5	70	349.65	22.90	N/A	\$4893	N/A	\$1101
Z4896DMIM	48 x 96 x 36.5	85	370.65	24.91	N/A	\$5166	N/A	\$1255

D Media Island includes ONE BASE with wire access doors on each side of base and wire concealment runners between the base and the end panel. Grommet centered at the top of the end panel for wire pass through. Shipped in 3 cartons.

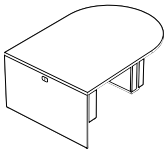

Media Table - D Island, 36" H

Z6060DMIM	60 x 60 x 36.5	85	352.28	25.42	N/A	\$5128	N/A	\$982
Z6072DMIM	60 x 72 x 36.5	85	386.40	27.66	N/A	\$5460	N/A	\$1179
Z6084DMIM	60 x 84 x 36.5	85	426.30	30.15	N/A	\$5800	N/A	\$1376
Z6096DMIM	60 x 96 x 36.5	85	462	32.63	N/A	\$6119	N/A	\$1571

D Media Island includes ONE BASE with wire access doors on each side of base and wire concealment runners between the base and the end panel. Grommet centered at the top of the end panel for wire pass through. Shipped in 3 cartons.

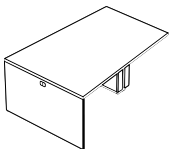

Media Table - D Wedge, 36" H

Z6060WMIM	60 x 60 x 36.5	85	331.80	22.16	N/A	\$5128	N/A	\$982
Z6072WMIM	60 x 72 x 36.5	85	364.35	24.67	N/A	\$5460	N/A	\$1179
Z6084WMIM	60 x 84 x 36.5	70	424.20	26.92	N/A	\$5800	N/A	\$1376
Z6096WMIM	60 x 96 x 36.5	85	424.20	29.40	N/A	\$6119	N/A	\$1571

Wedge Media Island includes ONE BASE with wire access doors on each side of base and wire concealment runners between the base and the end panel. Grommet centered at the top of the end panel for wire pass through. Wedge tapers from 60" w to 48" w. Shipped in 3 cartons.

Required Specifications

Top finish
Top/edge detail
Base finish
Base trim finish

Optional Specifications

HP laminate
Additional grommet

Accessories

Power block

MEDIA TABLES

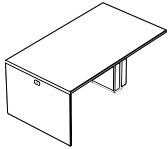

Media Table - Rectangular Island, 36”H

MODEL#	DIMENSIONS D x W x H (1.5" TOP)	FREIGHT CLASS	WT/LBS.	CUBIC FT.	1" TOP	1.5" TOP	GLAZE ADD	HP ADD
Z4860RMIM	48 x 60 x 36.5	70	301.35	19.19	N/A	\$3985	N/A	\$788
Z4872RMIM	48 x 72 x 36.5	70	330.75	21.17	N/A	\$4247	N/A	\$943
Z4884RMIM	48 x 84 x 36.5	70	360.15	22.90	N/A	\$4493	N/A	\$1101
Z4896RMIM	48 x 96 x 36.5	70	380.10	24.91	N/A	\$4742	N/A	\$1255

Rectangular Media Island includes ONE BASE with wire access doors on each side of base and wire concealment runners between the base and the end panel. Grommet centered at the top of the end panel for wire pass through. Shipped in 3 cartons.

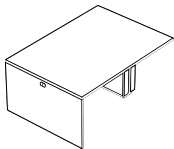

Media Table - Rectangular Island, 36”H

Z6060RMIM	60 x 60 x 36.5	85	367.50	25.42	N/A	\$4704	N/A	\$982
Z6072RMIM	60 x 72 x 36.5	85	402.15	27.66	N/A	\$5004	N/A	\$1179
Z6084RMIM	60 x 84 x 36.5	85	442.05	30.15	N/A	\$5315	N/A	\$1376
Z6096RMIM	60 x 96 x 36.5	85	477.75	32.63	N/A	\$5609	N/A	\$1571

Rectangular Media Island includes ONE BASE with wire access doors on each side of base and wire concealment runners between the base and the end panel. Grommet centered at the top of the end panel for wire pass through. Shipped in 3 cartons.

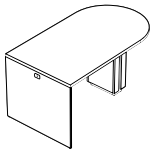

Media Table - D Island, 42”H

Z4860DMIH	48 x 60 x 42.5	70	312.90	20.69	N/A	\$4612	N/A	\$788
Z4872DMIH	48 x 72 x 42.5	70	342.30	22.66	N/A	\$4898	N/A	\$943
Z4884DMIH	48 x 84 x 42.5	70	371.70	24.40	N/A	\$5174	N/A	\$1101
Z4896DMIH	48 x 96 x 42.5	85	391.65	26.41	N/A	\$5440	N/A	\$1255

D Media Island includes ONE BASE with wire access doors on each side of base and wire concealment runners between the base and the end panel. Grommet centered at the top of the end panel for wire pass through. Shipped in 3 cartons.

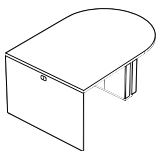

Media Table - D Island, 42”H

Z6060DMIH	60 x 60 x 42.5	85	378	27.40	N/A	\$5399	N/A	\$982
Z6072DMIH	60 x 72 x 42.5	85	413.70	29.91	N/A	\$5733	N/A	\$1179
Z6084DMIH	60 x 84 x 42.5	85	453.60	32.40	N/A	\$6080	N/A	\$1376
Z6096DMIH	60 x 96 x 42.5	85	488.25	34.88	N/A	\$6392	N/A	\$1571

D Media Island includes ONE BASE with wire access doors on each side of base and wire concealment runners between the base and the end panel. Grommet centered at the top of the end panel for wire pass through. Shipped in 3 cartons.

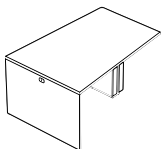

Media Table - Wedge, 42”H

Z6060WMIH	60 x 60 x 42.5	85	355	23.92	N/A	\$5399	N/A	\$982
Z6072WMIH	60 x 72 x 42.5	85	387	26.17	N/A	\$5733	N/A	\$1179
Z6084WMIH	60 x 84 x 42.5	85	424	28.65	N/A	\$6080	N/A	\$1376
Z6096WMIH	60 x 96 x 42.5	85	457	31.14	N/A	\$6392	N/A	\$1571

Wedge Media Island includes ONE BASE with wire access doors on each side of base and wire concealment runners between the base and the end panel. Grommet centered at the top of the end panel for wire pass through. Wedge tapers from 60”w to 48”w. Shipped in 3 cartons.

Required Specifications

Top finish
Top/edge detail
Base finish
Base trim finish

Optional Specifications

HP laminate
Additional grommet

Accessories

Power block

COLLABORATIVE TABLES

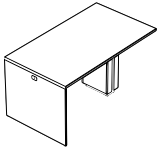

Media Table - Rectangular Island, 42" H

MODEL#	DIMENSIONS D x W x H (1.5" TOP)	FREIGHT CLASS	WT/LBS.	CUBIC FT.	1" TOP	1.5" TOP	GLAZE ADD	HP ADD
Z4860RMIH	48 x 60 x 42.5	70	324	20.69	N/A	\$4239	N/A	\$788
Z4872RMIH	48 x 72 x 42.5	70	353	22.66	N/A	\$4500	N/A	\$943
Z4884RMIH	48 x 84 x 42.5	70	382	24.40	N/A	\$4747	N/A	\$1101
Z4896RMIH	48 x 96 x 42.5	70	402	26.41	N/A	\$4991	N/A	\$1255

Rectangular Media Island includes ONE BASE with wire access doors on each side of base and wire concealment runners between the base and the end panel. Grommet centered at the top of the end panel for wire pass through. Shipped in 3 cartons.

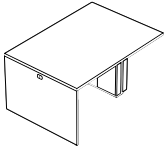

Media Table - Rectangular Island, 42" H

Z6060RMIH	60 x 60 x 42.5	85	394	27.40	N/A	\$4957	N/A	\$982
Z6072RMIH	60 x 72 x 42.5	85	429	29.91	N/A	\$5257	N/A	\$1179
Z6084RMIH	60 x 84 x 42.5	85	469	32.40	N/A	\$5571	N/A	\$1376
Z6096RMIH	60 x 96 x 42.5	85	504	34.88	N/A	\$5856	N/A	\$1571

Rectangular Media Island includes ONE BASE with wire access doors on each side of base and wire concealment runners between the base and the end panel. Grommet centered at the top of the end panel for wire pass through. Shipped in 3 cartons.

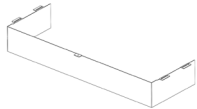

Media Table - Base Cover

Z60BEC	12.2 x 34.5 x 4.3	250	5	1.50	\$551			
Z48BEC	12.2 x 22.5 x 4.3	250	5	1.50	\$505			

For use on Zira Media Tables, but can be used on any Zira Boardroom table of corresponding width. Acts as a "cap" at the upper part of a base to hide any wire or power block that may be visible to users. Available in Black or Tungsten finish.

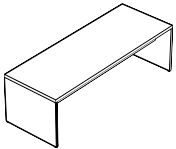

Collaborative Table - 29" H

Z367229BT	36 x 72 x 30	70	237	12.93	N/A	\$1961	N/A	\$709
Z368429BT	36 x 84 x 30	70	237	14.70	N/A	\$2280	N/A	\$828
Z369629BT	36 x 96 x 30	70	289	16.44	N/A	\$2472	N/A	\$943

Collaborative table with full end panels. Wire management runners span the length of the table between end panels. Shipped in 3 cartons.

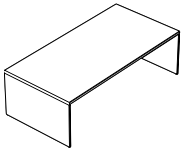

Collaborative Table - 29" H

Z487229BT	48 x 72 x 30	70	302	13.95	N/A	\$2464	N/A	\$943
Z488429BT	48 x 84 x 30	70	335	15.69	N/A	\$2654	N/A	\$1101
Z489629BT	48 x 96 x 30	70	360	17.43	N/A	\$2868	N/A	\$1255

Collaborative table with full end panels. Wire management runners span the length of the table between end panels. Shipped in 3 cartons.

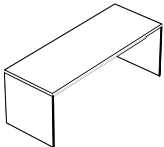

Collaborative Table - 36" H

Z367236BT	36 x 72 x 36.5	70	249	13.20	N/A	\$2034	N/A	\$709
Z368436BT	36 x 84 x 36.5	70	275	14.94	N/A	\$2360	N/A	\$828
Z369636BT	36 x 96 x 36.5	70	301	16.68	N/A	\$2549	N/A	\$943

Collaborative table with full end panels. Wire management runners span the length of the table between end panels. Shipped in 3 cartons.

Required Specifications

Top finish
Top/edge detail
Base finish
Base trim finish

Optional Specifications

HP laminate
Additional grommet

Accessories

Power block

COLLABORATIVE TABLES

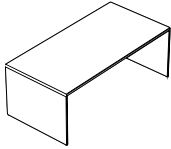

Collaborative Table - 36" H

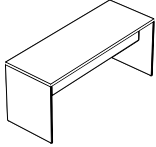

Collaborative Table - 42" H

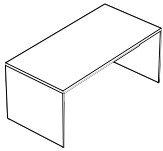

Collaborative Table - 42" H

MODEL#	DIMENSIONS D x W x H (1.5" TOP)	FREIGHT CLASS	WT/LBS.	CUBIC FT.	1" TOP	1.5" TOP	GLAZE ADD	HP ADD
Z487236BT	48 x 72 x 36.5	70	319	14.43	N/A	\$2555	N/A	\$943
Z488436BT	48 x 84 x 36.5	70	351	16.20	N/A	\$2752	N/A	\$1101
Z489636BT	48 x 96 x 36.5	70	376	17.93	N/A	\$2966	N/A	\$1255

Collaborative table with full end panels. Wire management runners span the length of the table between end panels. Shipped in 3 cartons.

Z367242BT	36 x 72 x 42.5	70	283	14.19	N/A	\$2276	N/A	\$709
Z368442BT	36 x 84 x 42.5	70	312	15.93	N/A	\$2627	N/A	\$828
Z369642BT	36 x 96 x 42.5	70	342	17.93	N/A	\$2842	N/A	\$943

Collaborative table with full end panels. Wire management runners span the length of the table between end panels. Shipped in 3 cartons.

Z487242BT	48 x 72 x 42.5	65	356	15.45	N/A	\$2816	N/A	\$943
Z488442BT	48 x 84 x 42.5	70	392	17.43	N/A	\$3032	N/A	\$1101
Z489642BT	48 x 96 x 42.5	70	421	19.19	N/A	\$3279	N/A	\$1255

Collaborative table with full end panels. Wire management runners span the length of the table between end panels. Shipped in 3 cartons.

Required Specifications

Top finish
Top/edge detail
Base finish
Base trim finish

Optional Specifications

HP laminate
Additional grommet

Accessories

Power block

ACCESSORIES

MODEL# DIMENSIONS FREIGHT CLASS WT/LBS. CUBIC FT. 1" TOP 1.5" TOP GLAZE ADD HP ADD

D x W x H (1.5" TOP)

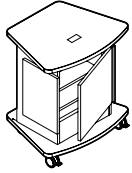

Multimedia Cart*

Z2822MCE	22.25 x 28 x 29.5	125	86	13.50	\$928	\$1001	N/A	\$184
----------	-------------------	-----	----	-------	--------------	---------------	-----	--------------

Multimedia cart features one non-locking hinged door on the back. Includes 3 fixed shelves, 1 grommet on top and 1 grommet in bottom panel for wire pass thru. 4 locking casters included.

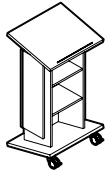

Lectern*

Z2444LEC	18 x 24 x 44.3	150	100	17	\$902	\$962	N/A	\$184
----------	----------------	-----	-----	----	--------------	--------------	-----	--------------

Features angled stand and storage with 2 fixed shelves. 2 locking casters included.

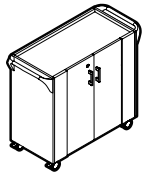

Serving Cart with Doors**

Z361836KD	18 x 36 x 36	125	150	20	\$1885	N/A	\$453	N/A
Z361829KD	18 x 36 x 29	125	113	16	\$1595	N/A	\$382	N/A

Cart features 2 doors with lock and 1 fixed height adjustable shelf. Top is recessed within side and end panels to act as a tray. Unique push handles are standard on both sides of the cart. 4 locking casters included.

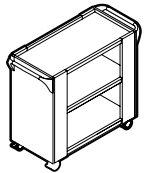

Serving Cart*

Z361836KO	18 x 36 x 36	125	121	20	\$2045	N/A	N/A	N/A
Z361829KO	18 x 36 x 29	125	108	16	\$1710	N/A	N/A	N/A

Cart features 1 fixed height adjustable shelf. Top is recessed within side and end panels to act as a tray. Decorative aluminum trim is standard on the lip of each shelf. Unique push handles are standard on both sides of the cart. 4 locking casters included.

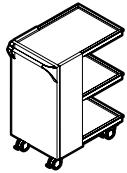

Buffet Cart*

Z261836BK	18 x 26 x 36	150	79	15	\$1944	N/A	N/A	\$184
-----------	--------------	-----	----	----	---------------	-----	-----	--------------

Cart features 1 fixed shelf. Top is recessed within side and end panels to act as a tray. Unique push handles are standard. Decorative aluminum trim is standard on the lip of each shelf. Locking casters included. Height aligns with 36" buffets.



Visual Board*

Z361872VB	18 x 36 x 72.4	100	187	19.25	\$2954	N/A	N/A	N/A
-----------	----------------	-----	-----	-------	---------------	-----	-----	-----

Angled visual board with paper pad on one side and dry erase board on the opposite side. Unique push handles are standard. Locking casters included. Decorative aluminum trim is standard on the lip of each shelf. Height aligns with 36" buffets. Shipped RTA (ready to assemble).

- *Wallmounted Visual Boards are available in Desk Accessories section.*

Required Specifications

Top finish Push bar finish*
 Base finish Handles
 Top/edge detail*
 Base trim finish (not Z3618xxKD)

Optional Specifications

HP laminate
 Glazed door (only Z3618xxKD)
 Key #***

ACCESSORIES

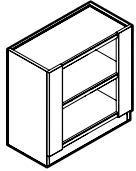

Buffet

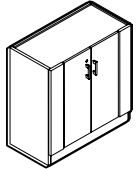

Buffet with Doors**

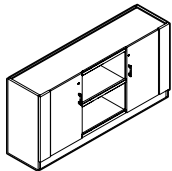

Buffet with Doors**

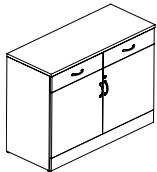

Buffet Credenza**

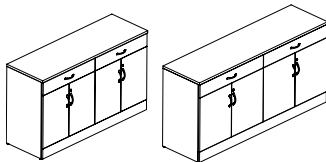

Buffet Credenza**

MODEL#	DIMENSIONS D x W x H (1.5" TOP)	FREIGHT CLASS	WT./LBS.	CUBIC FT.	1" TOP	1.5" TOP	GLAZE ADD	HP ADD
Z481836BO	18 x 48 x 36	125	152.50	22.50	\$1799	N/A	N/A	\$246
Z481829BO	18 x 48 x 29	125	135	18	\$1659	N/A	N/A	\$246
Z361836BO	18 x 36 x 36	125	126	18	\$1483	N/A	N/A	\$184
Z361829BO	18 x 36 x 29	100	112	14	\$1365	N/A	N/A	\$184

Buffet features 1 fixed height adjustable shelf. Top is recessed within side and end panels to act as a tray. Decorative aluminum trim is standard on the lip of each shelf.

Z481836BD	18 x 48 x 36	125	171	22.50	\$1872	N/A	\$398	\$246
Z481829BD	18 x 48 x 29	100	148	18	\$1672	N/A	\$454	\$246
Z361836BD	18 x 36 x 36	125	138.50	18	\$1664	N/A	\$453	\$184
Z361829BD	18 x 36 x 29	100	119	14	\$1399	N/A	\$382	\$184

Buffet features 2 doors with lock and 1 fixed height adjustable shelf. Top is recessed within side and end panels to act as a tray.

Z721836BU	18 x 72 x 36	125	242	33.50	\$2769	N/A	\$548	\$366
Z721829BU	18 x 72 x 29	125	211	27	\$2503	N/A	\$453	\$453
Z601836BU	18 x 60 x 36	125	188	28	\$2487	N/A	\$453	\$305
Z601829BU	18 x 60 x 29	125	163	22.50	\$2278	N/A	\$382	\$305

Buffet features 3 separate compartments. The two outer compartments come standard with locking doors and each features 1 fixed height adjustable shelf. The center compartment is open with 1 fixed height adjustable shelf. Decorative aluminum trim is standard on the lip of the open shelf. Top is recessed within side and end panels to act as a tray.

Z482036BD	20 x 48 x 36	100	199	24.70	\$2209	\$2338	\$953	\$415
-----------	--------------	-----	-----	-------	---------------	---------------	--------------	--------------

Buffet credenza with one locking storage compartment with two doors. Hinged doors cover one three-position height adjustable shelf. Two 6" drawers above storage compartment are non-locking.

Z722036BD	20 x 72 x 36	125	265	36.50	\$3203	\$3360	\$1902	\$668
Z602036BD	20 x 60 x 36	125	228	30.75	\$2777	\$2919	\$1747	\$542

Buffet credenza with two locking storage compartments side by side. Hinged doors cover 1 three-position height adjustable shelf. Two 6" drawers above storage compartment are non-locking.

Required Specifications

Top finish Top/edge detail*
 Base finish
 Handles
 Aluminum trim finish (only ZxxxxBO/BU)

Optional Specifications

HP laminate
 Glazed door**
 Key #***

Interconnecting Cables - Common Cable Lengths (in inches)

Female/Female	42FF-86 \$188	42FM-41 \$139
42FF-27 \$116	42FF-97 \$216	42FM-50 \$151
42FF-38 \$129	42FF-98 \$216	42FM-63 \$167
42FF-41 \$133	42FF-100 \$205	42FM-75 \$181
42FF-50 \$145	42FF-110 \$219	42FM-82 \$190
42FF-53 \$149		42FM-86 \$195
42FF-63 \$159	Female/Male	42FM-97 \$216
42FF-75 \$175	42FM-12 \$104	42FM-98 \$216
42FF-76 \$176	42FM-27 \$121	42FM-100 \$230
42FF-82 \$184	42FM-38 \$134	42FM-110 \$230

VILLA DAISYLINK OR OASIS MINI CABLE LENGTHS NEEDED FOR DAISY-CHAINING

Model #	Villa DaisyLink, Oasis Mini USB Oasis Mini A Oasis Mini B	Villa DaisyLink, Oasis Mini USB Oasis Mini A Oasis Mini B	Oasis Mini USB Oasis Mini A	Oasis Mini USB Oasis Mini A	Villa DaisyLink or Oasis Mini B	Villa DaisyLink or Oasis Mini B
Cutout Positions	V1, V3, M1, M3	V1, V3, M1, M3	M1, M2 & M3	M1, M2 & M3	V1, V2, V3, M1, M2, M3	V1, V2, V3, M1, M2, M3
Infeed Position	Left or Right	Center	Left or Right	Center	Left or Right	Center
Reference	Drawing 1A/1B	Drawing 2A/2B	Drawing 3	Drawing 4	Drawing 5	Drawing 6
Z4896BE Z4896RTE Z4896REE Z4896BW	(1) 42FF-53 SPECIFY INFEED	(1) 42FF-27 (1) 42FM-27 (1) DAISY-T SPECIFY INFEED	N/A	N/A	N/A	N/A
Z48120BE Z48120RTE Z48120REE Z48120BW	(1) 42FF-76 SPECIFY INFEED	(1) 42FF-38 (1) 42FM-38 (1) DAISY-T SPECIFY INFEED	(3) 42FF-41 SPECIFY INFEED	(3) 42FF-41 SPECIFY INFEED	(2) 42FF-41 SPECIFY INFEED	(2) 42FF-41 (1) 42FM-12 (1) DAISY-T SPECIFY INFEED
Z48144BE Z48144RTE Z48144REE Z48144BW	(1) 42FF-100 SPECIFY INFEED	(1) 42FF-50 (1) 42FM-50 (1) DAISY-T SPECIFY INFEED	(3) 42FF-53 SPECIFY INFEED	(3) 42FF-53 SPECIFY INFEED	(2) 42FF-53 SPECIFY INFEED	(2) 42FF-53 (1) 42FM-12 (1) DAISY-T SPECIFY INFEED
Z48168BE Z48168RTE Z48168REE Z48168BW	(1) 42FF-63 (1) 42FM-63 SPECIFY INFEED	1) 42FF-63 (1) 42FM-63 (1) DAISY-T SPECIFY INFEED	(3) 42FF-65 SPECIFY INFEED	(3) 42FF-65 SPECIFY INFEED	(2) 42FF-65 SPECIFY INFEED	(2) 42FF-65 (1) 42FM-12 (1) DAISY-T SPECIFY INFEED
Z48192BE Z48192RTE Z48192REE Z48192BW	(1) 42FF-75 (1) 42FM-75 SPECIFY INFEED	1) 42FF-75 (1) 42FM-75 (1) DAISY-T SPECIFY INFEED	(3) 42FF-77 SPECIFY INFEED	(3) 42FF-77 SPECIFY INFEED	(2) 42FF-77 SPECIFY INFEED	(2) 42FF-77 (1) 42FM-12 (1) DAISY-T SPECIFY INFEED
Z48216BE Z48216RTE Z48216REE Z48216BW	(1) 42FF-86 (1) 42FM-86 SPECIFY INFEED	1) 42FF-85 (1) 42FM-85 (1) DAISY-T SPECIFY INFEED	(3) 42FF-89 SPECIFY INFEED	(3) 42FF-89 SPECIFY INFEED	(2) 42FF-89 SPECIFY INFEED	(2) 42FF-89 (1) 42FM-12 (1) DAISY-T SPECIFY INFEED
Z48240BE Z48240RTE Z48240REE Z48240BW	(1) 42FF-98 (1) 42FM-98 SPECIFY INFEED	1) 42FF-97 (1) 42FM-97 (1) DAISY-T SPECIFY INFEED	(3) 42FF-101 SPECIFY INFEED	(3) 42FF-101 SPECIFY INFEED	(2) 42FF-101 SPECIFY INFEED	(2) 42FF-101 (1) 42FM-12 (1) DAISY-T SPECIFY INFEED
Z48264BE Z48264RTE Z48264REE Z48264BW	(1) 42FF-110 (1) 42FM-110 SPECIFY INFEED	(1) 42FF-110 (1) 42FM-110 (1) DAISY-T SPECIFY INFEED	(3) 42FF-113 SPECIFY INFEED	(3) 42FF-113 SPECIFY INFEED	(2) 42FF-113 SPECIFY INFEED	(2) 42FF-113 (1) 42FM-12 (1) DAISY-T SPECIFY INFEED
Z48288BE Z48288RTE Z48288REE Z48288BW	(1) 42FF-82 (2) 42FM-82 SPECIFY INFEED	(2) 42FF-41 (2) 42FM-41 (1) DAISY-T SPECIFY INFEED	(3) 42FF-63 (3) 42FM-63 SPECIFY INFEED	(3) 42FF-63 (3) 42FM-63 SPECIFY INFEED	(2) 42FF-63 (2) 42FM-63 SPECIFY INFEED	(2) 42FF-63 (2) 42FM-63 (1) DAISY-T SPECIFY INFEED

RECEPTION DESKS AND RETURNS

- Offered with **Straight** and **Bow** front
- Transactional tops available in 1" or 1 1/2" thick top with a variety of edge details
- Worksurface available in 1" thickness with A3 edge only

TOP AND BASE FINISHES

ACJ Absolute Acajou	FCL First Class
ASN Asian Night	NBL Noce Biondo
AWC Avant Cherry	NGL Noce Grigio
AWH Avant Honey	NEL Noce Leggero
BLK Black	NML Noce Medio
BZD Blizzard	QTM Quartered Mahogany
BRC Brushed Cobalt	SBY Sheer Beauty
CMB Clear Maple	SOG Storm Grey
CGY Custom Grey	SDT Stonedust
DES Dark Espresso	WHE Walnut Heights
DWT Designer White	WHC White Chocolate
FAS Fashionista	WCR Winter Cherry

Reception Desks:

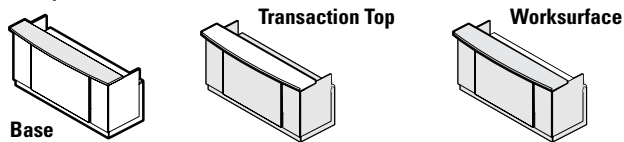

Reception Returns:

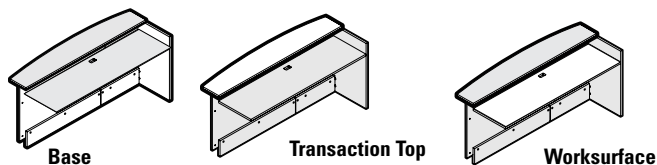

TRANSACTION TOP THICKNESS/EDGE DETAIL



A3 1" top, standard



AR 1" top, bicut edge

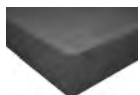

C3 1.5" top, standard



CR 1.5" top, bicut edge



CF 1.5" top, fluted edge

GLAZING (Center Panels)



Z1 frosted glazing, Tungsten (TUN) frame



Z2 frosted glazing, Black (BLK) frame



Z3 ribbed glazing, Tungsten (TUN) frame



Z4 ribbed glazing, Black (BLK) frame

GROMMETS - RECEPTION DESKS ONLY

- Two grommets are standard in position **AG1** and **AG3**
- Standard grommets can be removed at an upcharge
- Optional grommets available in **AG2**

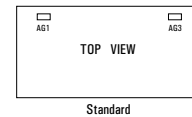
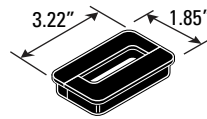

Standard

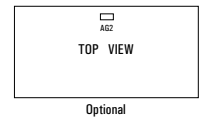

Optional

- Grommet hole dimensions are 3 1/4" wide x 1 7/8" deep.

POWER BLOCK

- A Power Block (model **PMSPDM**) may be ordered on transaction tops.
- A Power Block is a rectangular worksurface power/data module with one electrical duplex receptacle and two data (RJ45) receptacles. 9 foot black cord included. Power Block dimensions are 3 1/2" deep x 6 1/2" wide x 2 3/4" high.
- To purchase a Power Block, you must specify both the Power Block cut-out location and the Power Block model #. Order Power Block as PMSPDM, Add **\$330**. Power Blocks are available in standard worksurface locations (left, center or right). Order as E1, E2 or E3. Add **\$96**.

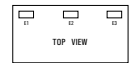

Power Block **PMSPDM** Add **\$330**

Specify location **E1, E2 or E3** Add **\$96**

TASK LIGHT

- Illuminates worksurface and optional glazed center panel
- Specify LED task light separately. Use PLED50 for 60", 66" and 72" wide reception units. Use PLED50 or PLED100 for 84" and 96" wide units. See page 452 for details.

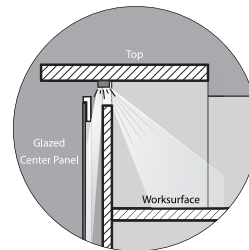

RECEPTION RETURNS - PIGEON

- Available in all laminates
- Worksurface available in 1" thickness with A3 edge only
- Collator shelves offered in Black (BLK) or Brushed Cobalt (BRC)
- One grommet is standard in position **AG3**
- Standard grommet can be removed at an upcharge
- Optional grommet available in position **AG2**, see upcharges above
- Power blocks are available in positions **E2 and E3**

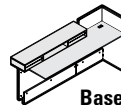

Base

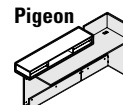

Pigeon

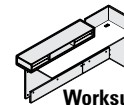

Worksurface

RECEPTION RETURNS - BOOKCASE

- Available in all laminates listed above
- Worksurface available in 1" thickness with A3 edge only
- One grommet is standard in position **AG2**
- Standard grommet can be removed at an upcharge
- Optional grommet available in position **AG3** for **54", 60" and 72" wide units only**
- Power blocks are available in positions **E2 and E3** for **54", 60" and 72" wide units only**

RECEPTION DESKS

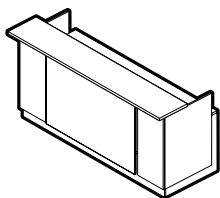

Reception Desk

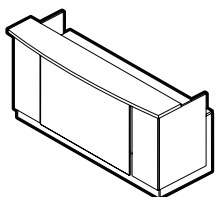

Reception Desk - Bow Front

MODEL#	DIMENSIONS D x W x H	FREIGHT CLASS	WT/LBS.	CUBIC FT.	1" TOP	1.5" TOP	GLAZE ADD	HP ADD
Z3096RDS	35.5 x 96 x 42.8-43.3	70	385	23.23	\$3581	\$3782	\$749	\$847
Z3084RDS	35.5 x 89.4 x 42.8-43.3	70	351	20.48	\$3182	\$3363	\$646	\$741
Z3072RDS	35.5 x 77.4 x 42.8-43.3	70	315	17.99	\$2935	\$3091	\$542	\$637
Z3066RDS	35.5 x 71.4 x 42.8-43.3	70	298	16.98	\$2788	\$2939	\$490	\$585
Z3060RDS	35.5 x 65.4 x 42.8-43.3	70	280	15.48	\$2657	\$2795	\$438	\$530
Z2496RDS	30 x 96 x 42.8-43.3	70	353	21.98	\$3375	\$3576	\$749	\$725
Z2484RDS	30 x 89.4 x 42.8-43.3	70	320	19.49	\$3008	\$3189	\$646	\$637
Z2472RDS	30 x 77.4 x 42.8-43.3	70	287	16.98	\$2770	\$2930	\$542	\$546
Z2466RDS	30 x 71.4 x 42.8-43.3	70	272	15.99	\$2625	\$2776	\$490	\$501
Z2460RDS	30 x 65.4 x 42.8-43.3	70	256	15	\$2502	\$2640	\$438	\$454

Z24xxRDS units are not freestanding; they must be connected to a return. Z30xxRDS units can be specified as freestanding. Standard with two grommets. Accommodates shells of all depths. Shipped RTA (ready to assemble) in 3 cartons.

- **Zxx96RDS** units feature a 90" w worksurface

Z3096RDB	35.5 x 96 x 42.8-43.3	70	382	23.23	\$3581	\$3782	\$749	\$847
Z3084RDB	35.5 x 89.4 x 42.8-43.3	70	348	20.48	\$3182	\$3363	\$646	\$741
Z3072RDB	35.5 x 77.4 x 42.8-43.3	70	312	17.99	\$2935	\$3091	\$542	\$637
Z3066RDB	35.5 x 71.4 x 42.8-43.3	70	295	16.98	\$2788	\$2939	\$490	\$585
Z3060RDB	35.5 x 65.4 x 42.8-43.3	70	277	15.99	\$2657	\$2795	\$438	\$530
Z2496RDB	30 x 96 x 42.8-43.3	70	350	21.98	\$3375	\$3556	\$749	\$725
Z2484RDB	30 x 89.4 x 42.8-43.3	70	317	19.49	\$3008	\$3189	\$646	\$637
Z2472RDB	30 x 77.4 x 42.8-43.3	70	284	16.98	\$2770	\$2930	\$542	\$546
Z2466RDB	30 x 71.4 x 42.8-43.3	70	269	15.99	\$2625	\$2776	\$490	\$501
Z2460RDB	30 x 65.4 x 42.8-43.3	70	253	15	\$2502	\$2640	\$438	\$454

Z24xxRDB units are not freestanding; they must be connected to a return. Z30xxRDB units can be specified as freestanding. Standard with two grommets. Accommodates shells of all depths. Shipped RTA (ready to assemble) in 3 cartons.

- **Zxx96RDB** units feature a 90" w worksurface

Required Specifications

Top finish
Top/edge detail
Base/surround finish
Transaction top finish

Optional Specifications

HP laminate
Additional grommet

Accessories

Power block

HIGH RECEPTION RETURNS

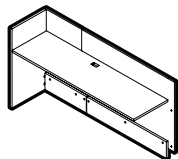

High Reception Return - LEFT

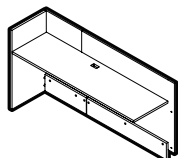

High Reception Return - LEFT

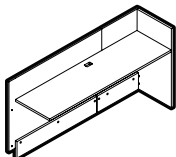

High Reception Return - RIGHT

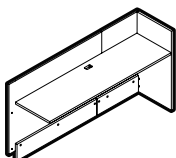

High Reception Return - RIGHT

MODEL#	DIMENSIONS D x W x H	FREIGHT CLASS	WT/LBS.	CUBIC FT.	1" TOP	1.5" TOP	GLAZE ADD	HP ADD
Z2472HRRL	25 x 75.7 x 39.8	70	151	8.2	\$1340	N/A	N/A	\$366
Z2460HRRL	25 x 63.7 x 39.8	70	131.2	7	\$1171	N/A	N/A	\$305
Z2454HRRL	25 x 57.7 x 39.8	70	120.9	5.75	\$1063	N/A	N/A	\$275
Z2448HRRL	25 x 51.7 x 39.8	70	110.9	5.25	\$987	N/A	N/A	\$246
Z2442HRRL	25 x 45.7 x 39.8	70	100.8	4.8	\$910	N/A	N/A	\$214
Z2436HRRL	25 x 39.7 x 39.8	70	90.7	4.3	\$832	N/A	N/A	\$184

Not freestanding. Grommet in worksurface. Shipped RTA (ready to assemble). Accommodates shells of all depths. Connecting hardware included. Widths and depths listed are outside dimensions including outside surrounds. Model numbers reflect the primary worksurface dimensions.

Z2072HRRL	20.9 x 75.7 x 39.8	70	139	8.2	\$1181	N/A	N/A	\$305
Z2060HRRL	20.9 x 63.7 x 39.8	70	121	7	\$1030	N/A	N/A	\$256
Z2054HRRL	20.9 x 57.7 x 39.8	70	111	5.75	\$929	N/A	N/A	\$229
Z2048HRRL	20.9 x 51.7 x 39.8	70	102	5.25	\$863	N/A	N/A	\$206
Z2042HRRL	20.9 x 45.7 x 39.8	70	92	4.8	\$792	N/A	N/A	\$180
Z2036HRRL	20.9 x 39.7 x 39.8	70	83	4.3	\$722	N/A	N/A	\$156

Not freestanding. Grommet in worksurface. Shipped RTA (ready to assemble). Accommodates shells of 20" depths. Connecting hardware included. Widths and depths listed are outside dimensions including outside surrounds. Model numbers reflect the primary worksurface dimensions.

Z2472HRRR	25 x 75.7 x 39.8	70	151	8.2	\$1340	N/A	N/A	\$366
Z2460HRRR	25 x 63.7 x 39.8	70	131.2	7	\$1171	N/A	N/A	\$305
Z2454HRRR	25 x 57.7 x 39.8	70	120.9	5.75	\$1063	N/A	N/A	\$275
Z2448HRRR	25 x 51.7 x 39.8	70	110.9	5.25	\$987	N/A	N/A	\$246
Z2442HRRR	25 x 45.7 x 39.8	70	100.8	4.8	\$910	N/A	N/A	\$214
Z2436HRRR	25 x 39.7 x 39.8	70	90.7	4.3	\$832	N/A	N/A	\$184

Not freestanding. Grommet in worksurface. Shipped RTA (ready to assemble). Accommodates shells of all depths. Connecting hardware included. Widths and depths listed are outside dimensions including outside surrounds. Model numbers reflect the primary worksurface dimensions.

Z2072HRRR	20.9 x 75.7 x 39.8	70	139	8.2	\$1181	N/A	N/A	\$305
Z2060HRRR	20.9 x 63.7 x 39.8	70	121	7	\$1030	N/A	N/A	\$256
Z2054HRRR	20.9 x 57.7 x 39.8	70	111	5.75	\$929	N/A	N/A	\$229
Z2048HRRR	20.9 x 51.7 x 39.8	70	102	5.25	\$863	N/A	N/A	\$206
Z2042HRRR	20.9 x 45.7 x 39.8	70	92	4.8	\$792	N/A	N/A	\$180
Z2036HRRR	20.9 x 39.7 x 39.8	70	83	4.3	\$722	N/A	N/A	\$156

Not freestanding. Grommet in worksurface. Shipped RTA (ready to assemble). Accommodates shells of 20" depths. Connecting hardware included. Widths and depths listed are outside dimensions including outside surrounds. Model numbers reflect the primary worksurface dimensions.

Required Specifications

Top finish
Top/edge detail
Base/surround finish

Optional Specifications

HP laminate
Additional grommet

Accessories

Power block

LOW RECEPTION RETURNS

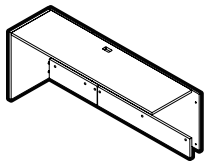

Low Reception Return - LEFT

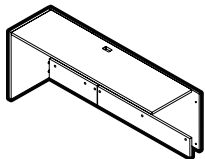

Low Reception Return - LEFT

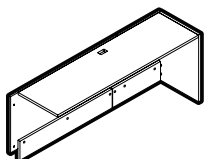

Low Reception Return - RIGHT

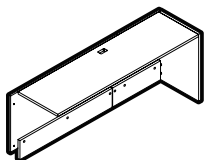

Low Reception Return - RIGHT

MODEL#	DIMENSIONS D x W x H	FREIGHT CLASS	WT/LBS.	CUBIC FT.	1" TOP	1.5" TOP	GLAZE ADD	HP ADD
Z2472LRRL	25 x 75.7 x 29.1	70	141	6.75	\$1302	N/A	N/A	\$366
Z2460LRRL	25 x 63.7 x 29.1	70	122	5.75	\$1124	N/A	N/A	\$305
Z2454LRRL	25 x 57.7 x 29.1	70	112.9	5.5	\$1029	N/A	N/A	\$275
Z2448LRRL	25 x 51.7 x 29.1	70	103.4	5	\$954	N/A	N/A	\$246
Z2442LRRL	25 x 45.7 x 29.1	70	94	4.5	\$877	N/A	N/A	\$214
Z2436LRRL	25 x 39.7 x 29.1	70	84.3	4	\$799	N/A	N/A	\$184

Not freestanding. Grommet in worksurface. Shipped RTA (ready to assemble). Accommodates shells of all depths. Connecting hardware included. Widths and depths listed are outside dimensions including outside surrounds. Model numbers reflect the primary worksurface dimensions.

Z2072LRRL	20.9 x 75.7 x 29.1	70	128.8	6.75	\$1145	N/A	N/A	\$305
Z2060LRRL	20.9 x 63.7 x 29.1	70	111.3	5.75	\$983	N/A	N/A	\$256
Z2054LRRL	20.9 x 57.7 x 29.1	70	102.8	5.5	\$900	N/A	N/A	\$229
Z2048LRRL	20.9 x 51.7 x 29.1	70	94.1	5	\$832	N/A	N/A	\$206
Z2042LRRL	20.9 x 45.7 x 29.1	70	85.3	4.5	\$763	N/A	N/A	\$180
Z2036LRRL	20.9 x 39.7 x 29.1	70	76.3	4	\$694	N/A	N/A	\$156

Not freestanding. Grommet in worksurface. Shipped RTA (ready to assemble). Accommodates shells of **20" depths**. Connecting hardware included. Widths and depths listed are outside dimensions including outside surrounds. Model numbers reflect the primary worksurface dimensions.

Z2472LRRR	25 x 75.7 x 29.1	70	141	6.75	\$1302	N/A	N/A	\$366
Z2460LRRR	25 x 63.7 x 29.1	70	122	5.75	\$1124	N/A	N/A	\$305
Z2454LRRR	25 x 57.7 x 29.1	70	112.9	5.5	\$1029	N/A	N/A	\$275
Z2448LRRR	25 x 51.7 x 29.1	70	103.4	5	\$954	N/A	N/A	\$246
Z2442LRRR	25 x 45.7 x 29.1	70	94	4.5	\$877	N/A	N/A	\$214
Z2436LRRR	25 x 39.7 x 29.1	70	84.3	4	\$799	N/A	N/A	\$184

Not freestanding. Grommet in worksurface. Shipped RTA (ready to assemble). Accommodates shells of all depths. Connecting hardware included. Widths and depths listed are outside dimensions including outside surrounds. Model numbers reflect the primary worksurface dimensions.

Z2072LRRR	20.9 x 75.7 x 29.1	70	128.8	6.75	\$1145	N/A	N/A	\$305
Z2060LRRR	20.9 x 63.7 x 29.1	70	111.3	5.75	\$983	N/A	N/A	\$256
Z2054LRRR	20.9 x 57.7 x 29.1	70	102.8	5.5	\$900	N/A	N/A	\$229
Z2048LRRR	20.9 x 51.7 x 29.1	70	94.1	5	\$832	N/A	N/A	\$206
Z2042LRRR	20.9 x 45.7 x 29.1	70	85.3	4.5	\$763	N/A	N/A	\$180
Z2036LRRR	20.9 x 39.7 x 29.1	70	76.3	4	\$694	N/A	N/A	\$156

Not freestanding. Grommet in worksurface. Shipped RTA (ready to assemble). Accommodates shells of **20" depths**. Connecting hardware included. Widths and depths listed are outside dimensions including outside surrounds. Model numbers reflect the primary worksurface dimensions.

Required Specifications

Top finish
Top/edge detail
Base/surround finish

Optional Specifications

HP laminate
Additional grommet

Accessories

Power block

TRANSACTIONAL RETURNS

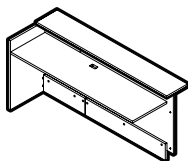

Transactional Return - LEFT

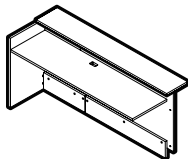

Transactional Return - LEFT

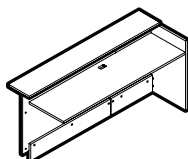

Transactional Return - RIGHT

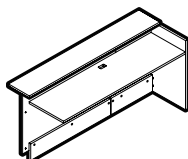

Transactional Return - RIGHT

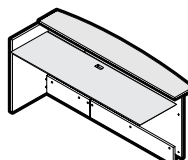

Transactional Return, Bow Front - LEFT

MODEL#	DIMENSIONS D x W x H	FREIGHT CLASS	WT/LBS.	CUBIC FT.	1" TOP	1.5" TOP	GLAZE ADD	HP ADD
Z2472TSRL	29.7 x 75.7 x 36.5-37	70	166	9.75	\$1593	\$1719	N/A	\$366
Z2460TSRL	29.7 x 63.7 x 36.5-37	70	144	8.75	\$1376	\$1484	N/A	\$305
Z2454TSRL	29.7 x 57.7 x 36.5-37	70	132	7.5	\$1250	\$1351	N/A	\$275
Z2448TSRL	29.7 x 51.7 x 36.5-37	70	121	7	\$1150	\$1238	N/A	\$246
Z2442TSRL	29.7 x 45.7 x 36.5-37	70	109	6.25	\$1055	\$1136	N/A	\$214
Z2436TSRL	29.7 x 39.7 x 36.5-37	70	96	5.5	\$956	\$1027	N/A	\$184

Not freestanding. Grommet in worksurface. Shipped RTA (ready to assemble). Accommodates shells of all depths. Connecting hardware included. Widths and depths listed are outside dimensions including transaction top overhang on the front and sides. Model numbers reflect the primary worksurface dimensions.

Z2072TSRL	25.6 x 75.7 x 36.5-37	70	153	8.25	\$1434	\$1560	N/A	\$305
Z2060TSRL	25.6 x 63.7 x 36.5-37	70	132	7.25	\$1231	\$1339	N/A	\$256
Z2054TSRL	25.6 x 57.7 x 36.5-37	70	120	6.25	\$1115	\$1216	N/A	\$229
Z2048TSRL	25.6 x 51.7 x 36.5-37	70	110	5.5	\$1023	\$1111	N/A	\$206
Z2042TSRL	25.6 x 45.7 x 36.5-37	70	100	5	\$931	\$1012	N/A	\$180
Z2036TSRL	25.6 x 39.7 x 36.5-37	70	89	4.4	\$845	\$916	N/A	\$156

Not freestanding. Grommet in worksurface. Shipped RTA (ready to assemble). Accommodates shells of 20" depths. Connecting hardware included. Widths and depths listed are outside dimensions including transaction top overhang on the front and sides. Model numbers reflect the primary worksurface dimensions.

Z2472TSRR	29.7 x 75.7 x 36.5-37	70	166	9.75	\$1593	\$1719	N/A	\$366
Z2460TSRR	29.7 x 63.7 x 36.5-37	70	144	8.75	\$1376	\$1484	N/A	\$305
Z2454TSRR	29.7 x 57.7 x 36.5-37	70	132	7.5	\$1250	\$1351	N/A	\$275
Z2448TSRR	29.7 x 51.7 x 36.5-37	70	121	7	\$1150	\$1238	N/A	\$246
Z2442TSRR	29.7 x 45.7 x 36.5-37	70	109	6.25	\$1055	\$1136	N/A	\$214
Z2436TSRR	29.7 x 39.7 x 36.5-37	70	96	5.5	\$956	\$1027	N/A	\$184

Not freestanding. Grommet in worksurface. Shipped RTA (ready to assemble). Accommodates shells of all depths. Connecting hardware included. Widths and depths listed are outside dimensions including transaction top overhang on the front and sides. Model numbers reflect the primary worksurface dimensions.

Z2072TSRR	25.6 x 75.7 x 36.5-37	70	153	8.25	\$1434	\$1560	N/A	\$305
Z2060TSRR	25.6 x 63.7 x 36.5-37	70	132	7.25	\$1231	\$1339	N/A	\$256
Z2054TSRR	25.6 x 57.7 x 36.5-37	70	120	6.25	\$1115	\$1216	N/A	\$229
Z2048TSRR	25.6 x 51.7 x 36.5-37	70	110	5.5	\$1023	\$1111	N/A	\$206
Z2042TSRR	25.6 x 45.7 x 36.5-37	70	100	5	\$931	\$1012	N/A	\$180
Z2036TSRR	25.6 x 39.7 x 36.5-37	70	89	4.4	\$845	\$916	N/A	\$156

Not freestanding. Grommet in worksurface. Shipped RTA (ready to assemble). Accommodates shells of 20" depths. Connecting hardware included. Widths and depths listed are outside dimensions including transaction top overhang on the front and sides. Model numbers reflect the primary worksurface dimensions.

Z2472TBRL	32.7 x 75.7 x 36.5-37	70	168.2	9.75	\$1593	\$1719	N/A	\$366
Z2460TBRL	32.7 x 63.7 x 36.5-37	70	145.3	8.5	\$1376	\$1484	N/A	\$305
Z2454TBRL	32.7 x 57.7 x 36.5-37	70	134.4	7.5	\$1250	\$1351	N/A	\$275
Z2448TBRL	32.7 x 51.7 x 36.5-37	70	122.2	7	\$1150	\$1238	N/A	\$246
Z2442TBRL	32.7 x 45.7 x 36.5-37	70	110.9	6.25	\$1055	\$1136	N/A	\$214
Z2436TBRL	32.7 x 39.7 x 36.5-37	70	98.4	5.5	\$956	\$1027	N/A	\$184

Not freestanding. Grommet in worksurface. Shipped RTA (ready to assemble). Accommodates shells of all depths. Connecting hardware included. Widths and depths listed are outside dimensions including transaction top overhang on the front and sides. Model numbers reflect the primary worksurface dimensions.

Required Specifications

Top finish
Base/surround finish
Transaction top finish

Optional Specifications

HP laminate
Additional grommet

Accessories

Power block

TRANSACTIONAL RETURNS

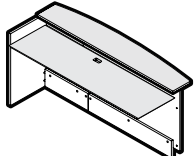

Transactional Return, Bow Front - LEFT

MODEL#	DIMENSIONS D x W x H	FREIGHT CLASS	WT/LBS.	CUBIC FT.	1" TOP	1.5" TOP	GLAZE ADD	HP ADD
Z2072TBRL	28.6 x 75.7 x 36.5-37	70	155.6	8.25	\$1434	\$1560	N/A	\$305
Z2060TBRL	28.6 x 63.7 x 36.5-37	70	134.2	7.5	\$1231	\$1339	N/A	\$256
Z2054TBRL	28.6 x 57.7 x 36.5-37	70	124	6.5	\$1115	\$1216	N/A	\$229
Z2048TBRL	28.6 x 51.7 x 36.5-37	70	112.6	6	\$1023	\$1111	N/A	\$206
Z2042TBRL	28.6 x 45.7 x 36.5-37	70	101.9	5.25	\$931	\$1012	N/A	\$180
Z2036TBRL	28.6 x 39.7 x 36.5-37	70	90.1	4.7	\$845	\$916	N/A	\$156

Not freestanding. Grommet in worksurface. Shipped RTA (ready to assemble). Accommodates shells of **20" depths**. Connecting hardware included. Widths and depths listed are outside dimensions including transaction top overhang on the front and sides. Model numbers reflect the primary worksurface dimensions.

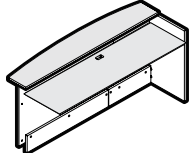

Transactional Return, Bow Front - RIGHT

Z2472TBRR	32.7 x 75.7 x 36.5-37	70	168.2	9.75	\$1593	\$1719	N/A	\$366
Z2460TBRR	32.7 x 63.7 x 36.5-37	70	145.3	8.5	\$1376	\$1484	N/A	\$305
Z2454TBRR	32.7 x 57.7 x 36.5-37	70	134.4	7.5	\$1250	\$1351	N/A	\$275
Z2448TBRR	32.7 x 51.7 x 36.5-37	70	122.2	7	\$1150	\$1238	N/A	\$246
Z2442TBRR	32.7 x 45.7 x 36.5-37	70	110.9	6.25	\$1055	\$1136	N/A	\$214
Z2436TBRR	32.7 x 39.7 x 36.5-37	70	98.4	5.5	\$956	\$1027	N/A	\$184

Not freestanding. Grommet in worksurface. Shipped RTA (ready to assemble). Accommodates shells of all depths. Connecting hardware included. Widths and depths listed are outside dimensions including transaction top overhang on the front and sides. Model numbers reflect the primary worksurface dimensions.

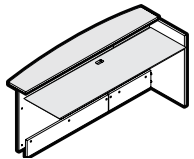

Transactional Return, Bow Front - RIGHT

Z2072TBRR	28.6 x 75.7 x 36.5-37	70	155.6	8.25	\$1434	\$1560	N/A	\$305
Z2060TBRR	28.6 x 63.7 x 36.5-37	70	134.2	7.5	\$1231	\$1339	N/A	\$256
Z2054TBRR	28.6 x 57.7 x 36.5-37	70	124	6.5	\$1115	\$1216	N/A	\$229
Z2048TBRR	28.6 x 51.7 x 36.5-37	70	112.6	6	\$1023	\$1111	N/A	\$206
Z2042TBRR	28.6 x 45.7 x 36.5-37	70	101.9	5.25	\$931	\$1012	N/A	\$180
Z2036TBRR	28.6 x 39.7 x 36.5-37	70	90.1	4.7	\$845	\$916	N/A	\$156

Not freestanding. Grommet in worksurface. Shipped RTA (ready to assemble). Accommodates shells of **20" depths**. Connecting hardware included. Widths and depths listed are outside dimensions including transaction top overhang on the front and sides. Model numbers reflect the primary worksurface dimensions.

Required Specifications

Top finish
Transaction top finish
Base/surround finish

Optional Specifications

HP laminate
Additional grommet

Accessories

Power block

PIGEON RECEPTION RETURNS

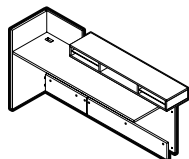

Pigeon Reception Return - LEFT*

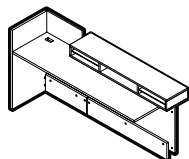

Pigeon Reception Return - LEFT*

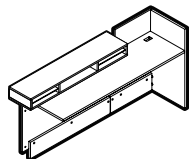

Pigeon Reception Return - RIGHT*

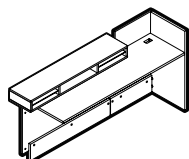

Pigeon Reception Return - RIGHT*

MODEL#	DIMENSIONS D x W x H	FREIGHT CLASS	WT/LBS.	CUBIC FT.	1" TOP	1.5" TOP	GLAZE ADD	HP ADD
Z2472PRRL	31 x 75.7 x 39.8	70	171.3	9.75	\$1805	N/A	N/A	\$366
Z2460PRRL	31 x 63.7 x 39.8	70	149	8.25	\$1586	N/A	N/A	\$305
Z2454PRRL	31 x 57.7 x 39.8	70	136.4	7.5	\$1475	N/A	N/A	\$275

Not freestanding. Grommet in worksurface. Shipped RTA (ready to assemble). Accommodates shells of all depths. Connecting hardware included. Widths and depths listed are outside dimensions including transaction top overhang on the front and sides. Model numbers reflect the primary worksurface dimensions.

Z2072PRRL	26.9 x 75.7 x 39.8	70	159	9.75	\$1650	N/A	N/A	\$305
Z2060PRRL	26.9 x 63.7 x 39.8	70	138.2	8.25	\$1444	N/A	N/A	\$256
Z2054PRRL	26.9 x 57.7 x 39.8	70	126.2	7.5	\$1342	N/A	N/A	\$229

Not freestanding. Grommet in worksurface. Shipped RTA (ready to assemble). Accommodates shells of 20" depths. Connecting hardware included. Widths and depths listed are outside dimensions including transaction top overhang on the front and sides. Model numbers reflect the primary worksurface dimensions.

Z2472PRRR	31 x 75.7 x 39.8	70	171.3	9.75	\$1805	N/A	N/A	\$366
Z2460PRRR	31 x 63.7 x 39.8	70	149	8.25	\$1586	N/A	N/A	\$305
Z2454PRRR	31 x 57.7 x 39.8	70	136.4	7.5	\$1475	N/A	N/A	\$275

Not freestanding. Grommet in worksurface. Shipped RTA (ready to assemble). Accommodates shells of all depths. Connecting hardware included. Widths and depths listed are outside dimensions including transaction top overhang on the front and sides. Model numbers reflect the primary worksurface dimensions.

Z2072PRRR	26.9 x 75.7 x 39.8	70	159	9.75	\$1650	N/A	N/A	\$305
Z2060PRRR	26.9 x 63.7 x 39.8	70	138.2	8.25	\$1444	N/A	N/A	\$256
Z2054PRRR	26.9 x 57.7 x 39.8	70	126.2	7.5	\$1342	N/A	N/A	\$229

Not freestanding. Grommet in worksurface. Shipped RTA (ready to assemble). Accommodates shells of 20" depths. Connecting hardware included. Widths and depths listed are outside dimensions including transaction top overhang on the front and sides. Model numbers reflect the primary worksurface dimensions.

Required Specifications

Top finish
Base/surround finish
Pigeon hole finish
Collator finish

Optional Specifications

HP laminate
Additional grommet

Accessories

Power block

BOOKCASE RETURNS

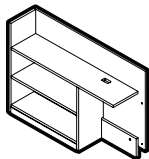

Bookcase Reception Return - LEFT

MODEL#	DIMENSIONS D x W x H	FREIGHT CLASS	WT/LBS.	CUBIC FT.	1" TOP	1.5" TOP	GLAZE ADD	HP ADD
Z1272BRRL	13.7 x 75.7 x 39.8	70	158	7.5	\$1443	N/A	N/A	\$184
Z1260BRRL	13.7 x 63.7 x 39.8	70	139	6.25	\$1276	N/A	N/A	\$156

Not freestanding. Grommet in worksurface. Shipped RTA (ready to assemble). Accommodates shells of all depths. Connecting hardware included. Widths and depths listed are outside dimensions including outside surrounds. Model numbers reflect the primary worksurface dimensions.

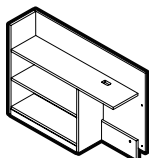

Bookcase Reception Return - LEFT

Z1254BRRL	13.7 x 57.7 x 39.8	65	131	5.75	\$1181	N/A	N/A	\$139
Z1248BRRL	13.7 x 51.7 x 39.8	70	114	5.25	\$1051	N/A	N/A	\$125
Z1242BRRL	13.7 x 45.7 x 39.8	65	106	4.6	\$988	N/A	N/A	\$110
Z1236BRRL	13.7 x 39.7 x 39.8	65	98	4.1	\$926	N/A	N/A	\$94

Not freestanding. Grommet in worksurface. Shipped RTA (ready to assemble). Accommodates shells of all depths. Connecting hardware included. Widths and depths listed are outside dimensions including outside surrounds. Model numbers reflect the primary worksurface dimensions.

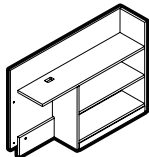

Bookcase Reception Return - RIGHT

Z1272BRRR	13.7 x 75.7 x 39.8	70	158	7.5	\$1443	N/A	N/A	\$184
Z1260BRRR	13.7 x 63.7 x 39.8	70	139	6.25	\$1276	N/A	N/A	\$156

Not freestanding. Grommet in worksurface. Shipped RTA (ready to assemble). Accommodates shells of all depths. Connecting hardware included. Widths and depths listed are outside dimensions including outside surrounds. Model numbers reflect the primary worksurface dimensions.

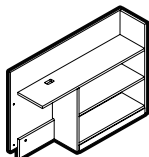

Bookcase Reception Return - RIGHT

Z1254BRRR	13.7 x 57.7 x 39.8	65	131	5.75	\$1181	N/A	N/A	\$139
Z1248BRRR	13.7 x 51.7 x 39.8	70	114	5.25	\$1051	N/A	N/A	\$125
Z1242BRRR	13.7 x 45.7 x 39.8	65	106	4.6	\$988	N/A	N/A	\$110
Z1236BRRR	13.7 x 39.7 x 39.8	65	98	4.1	\$926	N/A	N/A	\$94

Not freestanding. Grommet in worksurface. Shipped RTA (ready to assemble). Accommodates shells of all depths. Connecting hardware included. Widths and depths listed are outside dimensions including outside surrounds. Model numbers reflect the primary worksurface dimensions.

RECEPTION DESK VERTICAL STORAGE

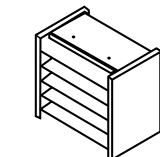

Reception Desk - Vertical Storage*

MODEL#	DIMENSIONS	FREIGHT CLASS	WT/LBS.	CUBIC FT.	1" TOP	1.5" TOP	GLAZE ADD	HP ADD
ZRDVS13	8.6 x 13.4 x 12.2	70	12.50	.80	\$237	N/A	N/A	N/A

Collator shelves.

Required Specifications

Top finish
Base/surround finish
Pigeon hole finish*
Collator finish*

Optional Specifications

HP laminate
Additional grommet

Accessories

Power block

GENERAL INFORMATION

- Comprehensive range of personal storage in a variety of sizes and configurations starting at 27.5"/28"H single column widths up to 66.5"/67"H triple column widths.
- Configurations include units with 1, 2, 3, 4, 6, 8 or 9 compartments depending on size.
- Lockers adapt to any space plan; in personal or shared work spaces, individually tailored to suit storage needs. Ideal for flex spaces or used to define space and used as barriers between work areas and to help guide workplace foot traffic flow.
- Available in two depths with door front in thermally fused laminate to add warmth and complement desking products or millwork.
- Multiple door pull options to match Global Desking series
- Units have internal drill points for optional ganging.
- Ships fully assembled.

CONSTRUCTION

- Tops are available in 1" or 1.5" thick thermally fused laminate tops with a variety of edge details
- Side panels utilize 1" thick material
- Shelves and backs utilize 11/16" thick material.
- Tops are sealed with Global's preferred edge in matching color. Woodgrain surfaces feature edging with matching printed woodgrain
- Constructed of 45 lb. density particleboard with high performance thermally fused laminate
- Virtually no loose hardware
- Leveling glides are standard

LOCKS

- Locks are standard on all lockers. Finish will coordinate with handles and/or aluminum doors.
- Please note that Flared Brass (HW) handle defaults to Black locks

SHIPPING

- Shipped assembled, 1 per carton, unless otherwise noted.

PRODUCT CODE BREAKDOWN:

- ZL**- indicates Zira locker
- ##** - 3rd & 4th position indicates height
- ##** - 5th & 6th position indicates width
- F** - indicates 18"D overall / **L** - indicates 24"D overall
- #** - 8th position indicates the number of columns side to side
- #** - 9th position indicates the number of rows top to bottom
- L** or **R** - indicates doors installed for left or right hand hinge

FINISH OPTIONS

- Must specify finish for top, case and doors separately

Thermally fused laminate finish options:

ACJ Absolute Acajou	FCL First Class
ASN Asian Night	NBL Noce Biondo
AWC Avant Cherry	NGL Noce Grigio
AWH Avant Honey	NEL Noce Leggero
BLK Black	NML Noce Medio
BZD Blizzard	QTM Quartered Mahogany
BRC Brushed Cobalt	SBY Sheer Beauty
CMB Clear Maple	SOG Storm Grey
CGY Custom Grey	SDT Stonedust
DES Dark Espresso	WHE Walnut Heights
DWT Designer White	WHC White Chocolate
FAS Fashionista	WCR Winter Cherry

Top Thickness/Edge Detail



A3 1" top, standard flat edge



AR 1" top, bicut edge



C3 1.5" top, standard flat edge



CR 1.5" top, bicut edge



CF 1.5" top, fluted edge

HANDLES

- To order handles, please specify corresponding code to image as below (**HS, HO, HW, HX, HV, HU, HQ, HZ, or HR**):



HS Flared Silver



HV Square Edge Silver



HO Crescent Black



HW Flared Brass



HU Square Edge Black



HZ Dimpled Nickel



HX Flared Black



HQ Bar Silver



HR Bar Black

INTERIOR SHELF AND HANGING OPTIONS

- Hooks and hat shelves are standard in certain units. See individual product description for details
- When standard, hat shelf is 11/16" thick and includes 9" of clearance.
- A chrome coat hook is affixed to the left or right side wall of the opening (based on left and right handed units) on single row lockers 40.5" and up, and on double row lockers 53.5"h and up.
- When standard, a chrome coat hook is affixed to the door.

GANGING

- **All units 12", 15" or 18" wide must be ganged to another locker or anchored to a fixed wall or adjacent cabinet for compliance with applicable ANSI/BIFMA X5.6 Storage standards.**
- Units ship factory ready for ganging and include pre-drills on cabinet interiors as well as the necessary hardware to connect unit to unit.

SINGLE COLUMN LOCKERS

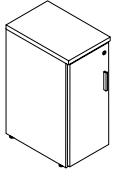

Left shown

One Column, One Row - 27.5/28" H

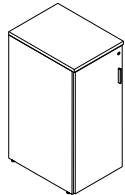

Left shown

One Column, One Row - 40.5/41" H

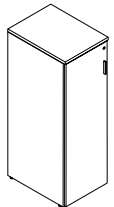

Left shown

One Column, One Row - 53.5/54" H

MODEL#	DIMENSIONS D x W x H	FREIGHT CLASS	WT/LBS.	CUBIC FT.	1" TOP	1.5" TOP
ZL2712F11L	18 x 12 x 27.5-28	92.5	52	5	\$702	\$720
ZL2712F11R	18 x 12 x 27.5-28	92.5	52	5	\$702	\$720

- Select suffix **(L)** for **left** hand / **(R)** for **right** hand opening.
- 12" wide lockers to be ganged or anchored for compliance with ANSI/BIFMA X5.6 storage standards.

ZL4012F11L	18 x 12 x 40.5-41	92.5	71	7.09	\$907	\$942
ZL4015F11L	18 x 15 x 40.5-41	100	74	8.75	\$980	\$1015
ZL4018F11L	18 x 18 x 40.5-41	100	86	10.25	\$1071	\$1106
ZL4012L11L	24 x 12 x 40.5-41	100	89	9.35	\$997	\$1032
ZL4015L11L	24 x 15 x 40.5-41	100	97	11.25	\$1088	\$1106
ZL4018L11L	24 x 18 x 40.5-41	125	105	13.25	\$1179	\$1218

ZL4012F11R	18 x 12 x 40.5-41	92.5	71	7.09	\$907	\$942
ZL4015F11R	18 x 15 x 40.5-41	100	74	8.75	\$980	\$1015
ZL4018F11R	18 x 18 x 40.5-41	100	86	10.25	\$1071	\$1106
ZL4012L11R	24 x 12 x 40.5-41	100	89	9.35	\$997	\$1032
ZL4015L11R	24 x 15 x 40.5-41	100	97	11.25	\$1088	\$1106
ZL4018L11R	24 x 18 x 40.5-41	125	105	13.25	\$1179	\$1218

- Select suffix **(L)** for **left** hand / **(R)** for **right** hand opening. Includes hat shelf and coat hook.
- 12", 15" or 18" wide lockers to be ganged or anchored for compliance with ANSI/BIFMA X5.6 storage standards.

ZL5312F11L	18 x 12 x 53.5-54	100	92	9.25	\$1161	\$1179
ZL5315F11L	18 x 15 x 53.5-54	100	101	11.25	\$1275	\$1309
ZL5318F11L	18 x 18 x 53.5-54	100	111	13	\$1399	\$1456
ZL5312L11L	24 x 12 x 53.5-54	100	115	12	\$1275	\$1309
ZL5315L11L	24 x 15 x 53.5-54	100	126	14.5	\$1366	\$1400
ZL5318L11L	24 x 18 x 53.5-54	100	136	17	\$1495	\$1546

ZL5312F11R	18 x 12 x 53.5-54	100	92	9.25	\$1161	\$1179
ZL5315F11R	18 x 15 x 53.5-54	100	101	11.25	\$1275	\$1309
ZL5318F11R	18 x 18 x 53.5-54	100	111	13	\$1399	\$1456
ZL5312L11R	24 x 12 x 53.5-54	100	115	12	\$1275	\$1309
ZL5315L11R	24 x 15 x 53.5-54	100	126	14.5	\$1366	\$1400
ZL5318L11R	24 x 18 x 53.5-54	100	136	17	\$1495	\$1546

- Select suffix **(L)** for **left** hand / **(R)** for **right** hand opening. Includes hat shelf and coat hook.
- 12", 15" or 18" wide lockers to be ganged or anchored for compliance with ANSI/BIFMA X5.6 storage standards.

Required Specifications

Top Finish
 Door Finish
 Top/Edge Detail
 Handles
 Base Finish

Optional Specifications

Key #

Accessories

SINGLE COLUMN LOCKERS

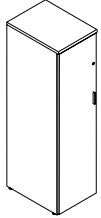

Left shown

One Column, One Row - 66.5/67" H

MODEL#	DIMENSIONS	FREIGHT CLASS	WT/LBS.	CUBIC FT.	1" TOP	1.5" TOP
D x W x H						
ZL6612F11L	18 x 12 x 66.5-67	100	111	11.5	\$1326	\$1349
ZL6615F11L	18 x 15 x 66.5-67	100	122	13.75	\$1422	\$1456
ZL6618F11L	18 x 18 x 66.5-67	125	127	16.25	\$1586	\$1620
ZL6612L11L	24 x 12 x 66.5-67	100	139	15	\$1473	\$1513
ZL6615L11L	24 x 15 x 66.5-67	100	151	18	\$1569	\$1620
ZL6618L11L	24 x 18 x 66.5-67	125	163	22	\$1717	\$1768
ZL6612F11R	18 x 12 x 66.5-67	100	111	11.5	\$1326	\$1349
ZL6615F11R	18 x 15 x 66.5-67	100	122	13.75	\$1422	\$1456
ZL6618F11R	18 x 18 x 66.5-67	125	127	16.25	\$1586	\$1620
ZL6612L11R	24 x 12 x 66.5-67	100	139	15	\$1473	\$1513
ZL6615L11R	24 x 15 x 66.5-67	100	151	18	\$1569	\$1620
ZL6618L11R	24 x 18 x 66.5-67	125	163	22	\$1717	\$1768

- Select suffix **(L)** for left hand / **(R)** for right hand opening. Includes hat shelf and coat hook.
- 12", 15" or 18" wide lockers to be ganged or anchored for compliance with ANSI/BIFMA X5.6 storage standards.

ONE COLUMN LOCKERS, TWO ROWS

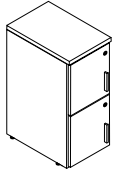

Left shown

One Column, Two Rows - 27.5/28" H

MODEL#	DIMENSIONS	FREIGHT CLASS	WT/LBS.	CUBIC FT.	1" TOP	1.5" TOP
ZL2712F12L	18 x 12 x 27.5-28	92.5	55	5	\$833	\$862
ZL2712F12R	18 x 12 x 27.5-28	92.5	55	5	\$833	\$862

- Select suffix **(L)** for left hand / **(R)** for right hand opening.
- 12" wide lockers to be ganged or anchored for compliance with ANSI/BIFMA X5.6 storage standards.

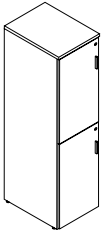

Left shown

One Column, Two Rows - 66.5/67" H

ZL6612F12L	18 x 12 x 66.5-67	100	112	11.5	\$1478	\$1508
ZL6618F12L	18 x 18 x 66.5-67	100	135	16.25	\$1727	\$1773
ZL6612L12L	24 x 12 x 66.5-67	100	140	15	\$1619	\$1654
ZL6618L12L	24 x 18 x 66.5-67	125	165	21.25	\$1881	\$1932
ZL6612F12R	18 x 12 x 66.5-67	100	112	11.5	\$1478	\$1508
ZL6618F12R	18 x 18 x 66.5-67	100	135	16.25	\$1727	\$1773
ZL6612L12R	24 x 12 x 66.5-67	100	140	15	\$1619	\$1654
ZL6618L12R	24 x 18 x 66.5-67	125	165	21.25	\$1881	\$1932

- Select suffix **(L)** for left hand / **(R)** for right hand opening. Includes coat hook in each opening
- 12" or 18" wide lockers to be ganged or anchored for compliance with ANSI/BIFMA X5.6 storage standards.

Required Specifications

Top Finish _____ Base Finish _____
 Door Finish _____
 Top/Edge Detail _____
 Handles _____

Optional Specifications

Key # _____

Accessories

ONE COLUMN LOCKERS, THREE ROWS

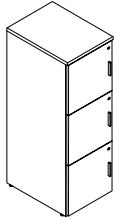

Left shown

One Column, Three Rows - 53.5/54" H

MODEL#	DIMENSIONS D x W x H	FREIGHT CLASS	WT/LBS.	CUBIC FT.	1" TOP	1.5" TOP
ZL5312F13L	18 x 12 x 53.5-54	92.5	96	9.25	\$1308	\$1337
ZL5318F13L	18 x 18 x 53.5-54	100	118	13.25	\$1563	\$1603
ZL5312L13L	24 x 12 x 53.5-54	100	121	12.25	\$1427	\$1462
ZL5318L13L	24 x 18 x 53.5-54	100	145	17.25	\$1694	\$1801
ZL5312F13R	18 x 12 x 53.5-54	92.5	96	9.25	\$1308	\$1337
ZL5318F13R	18 x 18 x 53.5-54	100	118	13.25	\$1563	\$1603
ZL5312L13R	24 x 12 x 53.5-54	100	121	12.25	\$1427	\$1462
ZL5318L13R	24 x 18 x 53.5-54	100	145	17.25	\$1694	\$1801

- Select suffix **(L)** for **left** hand / **(R)** for **right** hand.
- 12" or 18" wide lockers to be ganged or anchored for compliance with ANSI/BIFMA X5.6 storage standards.

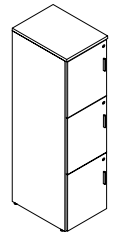

Left shown

One Column, Three Rows - 66.5/67" H

ZL6612F13L	18 x 12 x 66.5-67	92.5	115	11.5	\$1478	\$1508
ZL6618F13L	18 x 18 x 66.5-67	100	140	16.25	\$1750	\$1807
ZL6612L13L	24 x 12 x 66.5-67	100	144	15	\$1614	\$1649
ZL6618L13L	24 x 18 x 66.5-67	100	171	21.25	\$1909	\$1960
ZL6612F13R	18 x 12 x 66.5-67	92.5	115	11.5	\$1478	\$1508
ZL6618F13R	18 x 18 x 66.5-67	100	140	16.25	\$1750	\$1807
ZL6612L13R	24 x 12 x 66.5-67	100	144	15	\$1614	\$1649
ZL6618L13R	24 x 18 x 66.5-67	100	171	21.25	\$1909	\$1960

- Select suffix **(L)** for **left** hand / **(R)** for **right** hand opening.
- 12" or 18" wide lockers to be ganged or anchored for compliance with ANSI/BIFMA X5.6 storage standards.

ONE COLUMN LOCKERS, FOUR ROWS

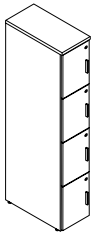

Left shown

One Column, Four Rows - 66.5/67" H

MODEL#	DIMENSIONS	FREIGHT CLASS	WT/LBS.	CUBIC FT.	1" TOP	1.5" TOP
ZL6612F14L	18 x 12 x 66.5-67	92.5	119	11.5	\$1642	\$1672
ZL6612L14L	24 x 12 x 66.5-67	100	149	15	\$1784	\$1819
ZL6612F14R	18 x 12 x 66.5-67	92.5	119	11.5	\$1642	\$1672
ZL6612L14R	24 x 12 x 66.5-67	100	149	15	\$1784	\$1819

- Select suffix **(L)** for **left** hand / **(R)** for **right** hand opening.
- 12" wide lockers to be ganged or anchored for compliance with ANSI/BIFMA X5.6 storage standards.

Required Specifications

Top Finish
 Door Finish
 Top/Edge Detail
 Handles

Optional Specifications

Key #

Accessories

TWO COLUMN LOCKERS, ONE ROW

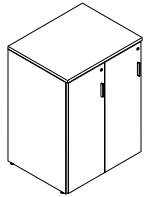

Left shown

Two Columns, One Row - 40.5/41" H

MODEL#	DIMENSIONS	FREIGHT CLASS	WT/LBS.	CUBIC FT.	1" TOP	1.5" TOP
D x W x H						
ZL4024F21L	18 x 24 x 40.5-41	100	118	13.25	\$1535	\$1591
ZL4030F21L	18 x 30 x 40.5-41	100	133	16.5	\$1659	\$1728
ZL4024L21L	24 x 24 x 40.5-41	100	149	17.25	\$1687	\$1750
ZL4030L21L	24 x 30 x 40.5-41	125	166	21.25	\$1818	\$1897
ZL4024F21R	18 x 24 x 40.5-41	100	118	13.25	\$1535	\$1591
ZL4030F21R	18 x 30 x 40.5-41	100	133	16.5	\$1659	\$1728
ZL4024L21R	24 x 24 x 40.5-41	100	149	17.25	\$1687	\$1750
ZL4030L21R	24 x 30 x 40.5-41	125	166	21.25	\$1818	\$1897

- Select suffix **(L)** for left hand / **(R)** for right hand opening. Includes coat hook in each opening

TWO COLUMN LOCKERS, TWO ROWS

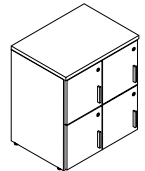

Left shown

Two Columns, Two Rows - 27.5/28" H

MODEL#	DIMENSIONS	FREIGHT CLASS	WT/LBS.	CUBIC FT.	1" TOP	1.5" TOP
ZL2724F22L	18 x 24 x 27.5-28	100	94	9.5	\$1427	\$1478
ZL2724F22R	18 x 24 x 27.5-28	100	94	9.5	\$1427	\$1478

- Select suffix **(L)** for left hand / **(R)** for right hand opening.

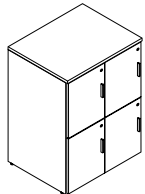

Left shown

Two Columns, Two Rows - 40.5/41" H

ZL4024F22L	18 x 24 x 40.5-41	100	125	13.25	\$1677	\$1728
ZL4030F22L	18 x 30 x 40.5-41	100	142	16.25	\$1818	\$1881
ZL4024L22L	24 x 24 x 40.5-41	100	158	17.25	\$1841	\$1904
ZL4030L22L	24 x 30 x 40.5-41	100	178	21.25	\$1993	\$2073
ZL4024F22R	18 x 24 x 40.5-41	100	125	13.25	\$1677	\$1728
ZL4030F22R	18 x 30 x 40.5-41	100	142	16.25	\$1818	\$1881
ZL4024L22R	24 x 24 x 40.5-41	100	158	17.25	\$1841	\$1904
ZL4030L22R	24 x 30 x 40.5-41	100	178	21.25	\$1993	\$2073

- Select suffix **(L)** for left hand / **(R)** for right hand opening.

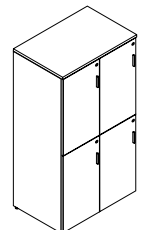

Left shown

Two Columns, Two Rows - 66.5/67" H

ZL6624F22L	18 x 24 x 66.5-67	100	187	21.25	\$2503	\$2554
ZL6636F22L	18 x 36 x 66.5-67	125	235	31	\$2939	\$3013
ZL6636L22L	24 x 36 x 66.5-67	125	283	40	\$3159	\$3250
ZL6624F22R	18 x 24 x 66.5-67	100	187	21.25	\$2503	\$2554
ZL6636F22R	18 x 36 x 66.5-67	125	235	31	\$2939	\$3013
ZL6636L22R	24 x 36 x 66.5-67	125	283	40	\$3159	\$3250

- Select suffix **(L)** for left hand / **(R)** for right hand opening. Includes coat hook in each opening and on each door.

Required Specifications

Top Finish _____ Base Finish _____
 Door Finish _____
 Top/Edge Detail _____
 Handles _____

Optional Specifications

Key # _____

Accessories

TWO COLUMN LOCKERS, THREE ROWS

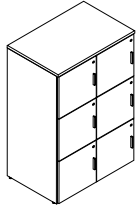

Left shown

Two Columns, Three Rows - 53.5/54" H

MODEL#	DIMENSIONS D x W x H	FREIGHT CLASS	WT/LBS.	CUBIC FT.	1" TOP	1.5" TOP
ZL5324F23L	18 x 24 x 53.5-54	100	163	17.25	\$2237	\$2294
ZL5330F23L	18 x 30 x 53.5-54	100	185	21.25	\$2429	\$2492
ZL5336F23L	18 x 36 x 53.5-54	100	207	25.25	\$2662	\$2741
ZL5324L23L	24 x 24 x 53.5-54	100	205	22.5	\$2447	\$2509
ZL5330L23L	24 x 30 x 53.5-54	100	230	27.5	\$2650	\$2730
ZL5336L23L	24 x 36 x 53.5-54	125	252	32.75	\$2887	\$2978
ZL5324F23R	18 x 24 x 53.5-54	100	163	17.25	\$2237	\$2294
ZL5330F23R	18 x 30 x 53.5-54	100	185	21.25	\$2429	\$2492
ZL5336F23R	18 x 36 x 53.5-54	100	207	25.25	\$2662	\$2741
ZL5324L23R	24 x 24 x 53.5-54	100	205	22.5	\$2447	\$2509
ZL5330L23R	24 x 30 x 53.5-54	100	230	27.5	\$2650	\$2730
ZL5336L23R	24 x 36 x 53.5-54	125	252	32.75	\$2887	\$2978

- Select suffix **(L)** for **left** hand / **(R)** for **right** hand.
- 12" or 18" wide lockers to be ganged or anchored for compliance with ANSI/BIFMA X5.6 storage standards.

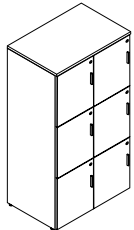

Left shown

Two Columns, Three Rows - 66.5/67" H

ZL6624F23L	18 x 24 x 66.5-67	100	194	21.25	\$2497	\$2548
ZL6630F23L	18 x 30 x 66.5-67	100	219	26	\$2712	\$2775
ZL6636F23L	18 x 36 x 66.5-67	125	246	31	\$2985	\$3064
ZL6624L23L	24 x 24 x 66.5-67	100	243	27.5	\$2730	\$2792
ZL6630L23L	24 x 30 x 66.5-67	100	271	33.75	\$2962	\$3036
ZL6636L23L	24 x 36 x 66.5-67	125	297	40	\$3228	\$3319
ZL6624F23R	18 x 24 x 66.5-67	100	194	21.25	\$2497	\$2548
ZL6630F23R	18 x 30 x 66.5-67	100	219	26	\$2712	\$2775
ZL6636F23R	18 x 36 x 66.5-67	125	246	31	\$2985	\$3064
ZL6624L23R	24 x 24 x 66.5-67	100	243	27.5	\$2730	\$2792
ZL6630L23R	24 x 30 x 66.5-67	100	271	33.75	\$2962	\$3036
ZL6636L23R	24 x 36 x 66.5-67	125	297	40	\$3228	\$3319

- Select suffix **(L)** for **left** hand / **(R)** for **right** hand.
- 12" or 18" wide lockers to be ganged or anchored for compliance with ANSI/BIFMA X5.6 storage standards.

TWO COLUMN LOCKERS, FOUR ROWS

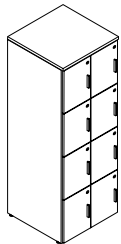

Left shown

Two Columns, Four Rows - 66.5/67" H

MODEL#	DIMENSIONS	FREIGHT CLASS	WT/LBS.	CUBIC FT.	1" TOP	1.5" TOP
ZL6624F24L	18 x 24 x 66.5-67	100	201	21.25	\$2826	\$2877
ZL6624L24L	24 x 24 x 66.5-67	100	252	27.5	\$3069	\$3138
ZL6624F24R	18 x 24 x 66.5-67	100	201	21.25	\$2826	\$2877
ZL6624L24R	24 x 24 x 66.5-67	100	252	27.5	\$3069	\$3138

- Select suffix **(L)** for **left** hand / **(R)** for **right** hand opening.

Required Specifications

Top Finish
Door Finish
Top/Edge Detail
Handles
Base Finish

Optional Specifications

Key #

Accessories

THREE COLUMN LOCKERS, ONE ROW

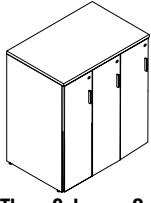

Left shown

Three Columns, One Row - 40.5/41" H

MODEL#	DIMENSIONS D x W x H	FREIGHT CLASS	WT/LBS.	CUBIC FT.	1" TOP	1.5" TOP
ZL4036F31L	18 x 36 x 40.5-41	100	165	19.5	\$2129	\$2209
ZL4036L31L	24 x 36 x 40.5-41	100	203	25.25	\$2305	\$2395
ZL4036F31R	18 x 36 x 40.5-41	100	165	19.5	\$2129	\$2209
ZL4036L31R	24 x 36 x 40.5-41	100	203	25.25	\$2305	\$2395

- Select suffix **(L)** for left hand / **(R)** for right hand opening. Includes coat hook in each opening

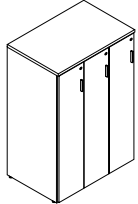

Left shown

Three Columns, One Row - 53.5/54" H

ZL5336F31L	18 x 36 x 53.5-54	100	215	25.25	\$2627	\$2707
ZL5336L31L	24 x 36 x 53.5-54	100	265	32.75	\$2882	\$2973
ZL5336F31R	18 x 36 x 53.5-54	100	215	25.25	\$2627	\$2707
ZL5336L31R	24 x 36 x 53.5-54	100	265	32.75	\$2882	\$2973

- Select suffix **(L)** for left hand / **(R)** for right hand opening. Includes hat shelf and coat hook in each opening.

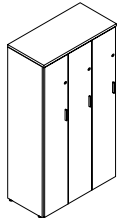

Left shown

Three Columns, One Row - 66.5/67" H

ZL6636F31L	18 x 36 x 66.5-67	100	258	31	\$2985	\$3059
ZL6636L31L	24 x 36 x 66.5-67	125	317	40	\$3267	\$3357
ZL6636F31R	18 x 36 x 66.5-67	100	258	31	\$2985	\$3059
ZL6636L31R	24 x 36 x 66.5-67	125	317	40	\$3267	\$3357

- Select suffix **(L)** for left hand / **(R)** for right hand opening. Includes hat shelf and coat hook in each opening.

THREE COLUMN LOCKERS, TWO ROWS

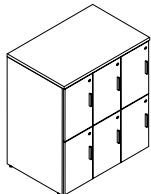

Left shown

Three Columns, Two Rows - 40.5/41" H

MODEL#	DIMENSIONS	FREIGHT CLASS	WT/LBS.	CUBIC FT.	1" TOP	1.5" TOP
ZL4036F32L	18 x 36 x 40.5-41	100	176	19.5	\$2339	\$2413
ZL4036L32L	24 x 36 x 40.5-41	100	218	25.25	\$2537	\$2627
ZL4036F32R	18 x 36 x 40.5-41	100	176	19.5	\$2339	\$2413
ZL4036L32R	24 x 36 x 40.5-41	100	218	25.25	\$2537	\$2627

- Select suffix **(L)** for left hand / **(R)** for right hand opening.

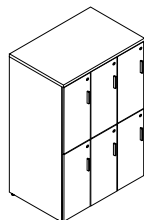

Left shown

Three Columns, Two Rows - 53.5/54" H

ZL5336F32L	18 x 36 x 53.5-54	100	219	25.25	\$3159	\$3233
ZL5336L32L	24 x 36 x 53.5-54	100	269	32.75	\$3392	\$3482
ZL5336F32R	18 x 36 x 53.5-54	100	219	25.25	\$3159	\$3233
ZL5336L32R	24 x 36 x 53.5-54	100	269	32.75	\$3392	\$3482

- Select suffix **(L)** for left hand / **(R)** for right hand opening. Includes coat hook in each opening and on each door.

Required Specifications

Top Finish _____ Base Finish _____
 Door Finish _____
 Top/Edge Detail _____
 Handles _____

Optional Specifications

Key # _____

Accessories

THREE COLUMN LOCKERS, TWO ROWS

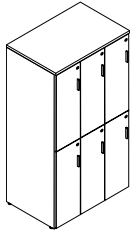

Left shown

Three Columns, Two Rows - 66.5/67" H

MODEL#	DIMENSIONS D x W x H	FREIGHT CLASS	WT/LBS.	CUBIC FT.	1" TOP	1.5" TOP
ZL6636F32L	18 x 36 x 66.5-67	100	262	31	\$3556	\$3630
ZL6636L32L	24 x 36 x 66.5-67	100	322	40	\$3833	\$3923
ZL6636F32R	18 x 36 x 66.5-67	100	262	31	\$3556	\$3630
ZL6636L32R	24 x 36 x 66.5-67	100	322	40	\$3833	\$3923

- Select suffix **(L)** for **left** hand / **(R)** for **right** hand opening. Includes coat hook in each opening and on each door.

THREE COLUMN LOCKERS, THREE ROWS

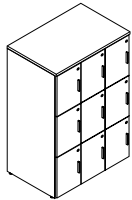

Left shown

Three Columns, Three Rows - 53.5/54" H

MODEL#	DIMENSIONS	FREIGHT CLASS	WT/LBS.	CUBIC FT.	1" TOP	1.5" TOP
ZL5336F33L	18 x 36 x 53.5-54	100	229	25.25	\$3154	\$3228
ZL5336L33L	24 x 36 x 53.5-54	100	283	32.75	\$3402	\$3493
ZL5336F33R	18 x 36 x 53.5-54	100	229	25.25	\$3154	\$3228
ZL5336L33R	24 x 36 x 53.5-54	100	283	32.75	\$3402	\$3493

- Select suffix **(L)** for **left** hand / **(R)** for **right** hand opening.

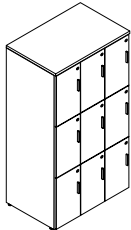

Left shown

Three Columns, Three Rows - 66.5/67" H

ZL6636F33L	18 x 36 x 66.5-67	100	272	31	\$3550	\$3624
ZL6636L33L	24 x 36 x 66.5-67	100	336	40	\$3850	\$3941
ZL6636F33R	18 x 36 x 66.5-67	100	272	31	\$3550	\$3624
ZL6636L33R	24 x 36 x 66.5-67	100	336	40	\$3850	\$3941

- Select suffix **(L)** for **left** hand / **(R)** for **right** hand opening.

Required Specifications

Top Finish _____ Base Finish _____
 Door Finish _____
 Top/Edge Detail _____
 Handles _____

Optional Specifications

Key # _____

Accessories

benching



Bridges II

292



bridges II

connect
share
achieve

Our desire was to develop an environment for collaborative teamwork which would facilitate connection, or bridging of people and ideas. A set of components which would even serve as a catalyst, inviting team members out of their cocooned comfort zones and encouraging them to engage, co-create. With Bridges II you can develop an environment of collaborative teamwork through workspace configuration that enhances line communication and bridges people with a spectrum of ideas and interfaces. Bridges II features a set of components that facilitate communication and streamline interaction through product that efficiently adapts and creatively configures. The product focuses on advancing engagement and collaborative creation through quick adaptations necessary to meet the needs of a fast paced and ever changing work environment. With flexible building components, Bridges II fits numerous applications, from boardrooms to multi-person workstations. It is easy to customize and reconfigure to fit specific requirements.

Features and Benefits

- High performance thermally fused laminate tops are 1" thick
- High pressure laminate tops are 1-1/16" thick
- Flat 3mm edge profile on all sides
- Worksurfaces provided with pilot holes for alignment
- Numerous Power/Data accessories
- Interconnected storage units can form a spine to create space division, storage, cable management and worksurface support
- Leg Options:
 - Height adjustable round legs
 - Fixed height rectangular legs



Rectangular Leg



Power Trough



Round Leg

GENERAL INFORMATION**Flexible Building components**

- Single leg tables (freestanding or mobile)
- Training Rooms
- Boardrooms
- Libraries
- 1 person general and private office
- 2 person workstation
- 3 person workstation
- 6+ person workstation
- Storage spine-based workstation

Easy to customize and reconfigure to fit specific requirements. From the facility manager's perspective, all workstations can be standardized to form a linear worksurface and power/data services, and their respective function or purpose can be governed by the type, quantity and placement of adjacent components like dividers, storage cabinets, shelves and accessories. These adjacent components can be easily reconfigured with minimal down time - without having to invite electrical and IT crews.

Compatible with various environments

- Clean, simple, elegant design language, with finishes suggesting comfortable, even domestic flavor. Understated to designer combinations, like anodized aluminum and white, give a hint of subtle sophistication.

Choice of **two functionally and visually different leg** supports

- Casters or levelers
- Height adjustable round legs
- Fixed height rectangular legs
- Optional anodized aluminum finish (Rectangular legs only). Refer to individual models for upcharge.

Various **power/data delivery** levels to choose from

- Wire basket to organize cable access under worksurfaces and storage units
- Vertical cable manager integrated into rectangular leg
- Worksurface edge-mounted power/data units (easy to reconfigure, plug into wall/floor outlets), or power troughs
- Single-sided and double-sided below worksurface power/data trough (desktop/floor standing computers and office equipment)
- Worksurface access door (access to below worksurface power outlets and data terminals)
- Above worksurface power/data trough provides immediate access for laptops, tablets and phones
- Storage integrated power/data unit
- Horizontal cable management under storage units with optional wire basket

Interconnected storage units can form a spine to create space division, storage, cable management and worksurface support. Storage leg can be configured to act as a ganging bracket.

- For environmental certifications, please visit globalfurnituregroup.com.

B BRIDGES II™ - NOTES

WORKSURFACES

- Standard in high performance thermally fused laminate. Optional high pressure (HP) laminate available.
- High performance thermally fused laminate tops are 1" thick particle board and have a flat 3mm edge profile on all sides
- High pressure (HP) laminate tops are 1-1/16" thick laminate particle board and have a flat 3mm edge profile on all sides
- Laminate surfaces offer a selection of matching + coordinating edgeband. Specify separately from the surface finish.



- Products specified with the high pressure laminate option are finished on the underside of the surface with a kraft paper backing.
- Doors and Drawer Fronts feature a matching 3mm edge. All other surfaces feature a matching self edge.

TABLES

- All multiple linear workstations are standard with levelers
- Tops square for flush surface-to-surface abutment and to accept desk mounted accessories
- Worksurfaces provided with pilot holes for alignment purposes

CODES

- This price list uses a numbering system with meaningful alphanumeric characters to create a simple-to-understand product number. This makes specifying the product much easier and more accurate.

Example of a worksurface:

Product code: BRTWS2472AWC + HP

BRT = Bridges II

WS = Type of Worksurface

2472 = Size: Depth x Width

AWC = High Pressure Laminate

HP = Finish

RECTANGULAR LEG

- For single and shared worksurface support
- Bridges II Rectangular legs are available with: Locking Casters (**BRTLCS**) or Levelers (**BRTLVS**)

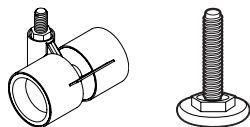

- Casters and Levelers **CANNOT** be retrofitted
- Levelers have a 2" height range, with 5/16" thread
- Levelers are available in Black only
- Casters are 45mm high with 8mm thread, available in White body / Grey tire combination only
- Leg frame is offered in 8 standard paint finishes and anodized aluminum finish
- Paint finish is a durable, environmentally friendly epoxy powder coating
- When anodized finish is selected, crossbeam is always White

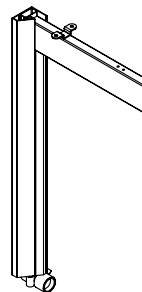

ROUND LEG

- For single and shared worksurface support
- Tubular steel legs are adjustable in 1" increments
- Height adjustment allows the user to easily set the height of a table
- Legs have a height adjustment of 24" - 32" in 1" increments with levelers and 27" - 35" with casters
- Bridges II Round legs are available with: Locking Casters (**BRTLCR**) or Levelers (**BRTLVR**)

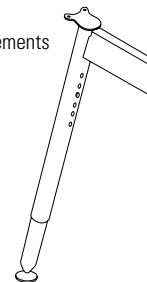
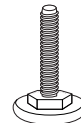

- Casters and Levelers CAN be retrofitted
- Levelers have a 1" height range, with 3/8-16" thread
- Levelers are available in Chrome only
- Casters available in Tungsten/Black combination only
- Casters are 3" diameter with an overall height of 3 3/4" with 3/8-16" thread
- Inner legs are available in Chrome only
- Leg frame is offered in 8 standard paint finishes
- Paint finish is a durable, environmentally friendly epoxy powder coating

FINISHES

Metal Frame Finishes:

BLK	Black
CHR	Charcoal
DWT	Designer White
FOG	Fog
NEV	Nevada
SIL	Silver
TPE	Taupe
TUN	Tungsten
ANO*	Anodized Aluminum - Upcharge applies. Refer to models for upcharge.

*ANO is a process, not a paint finish.

Laminate Top Finishes:

ACJ	Absolute Acajou
ASN	Asian Night
AWC	Avant Cherry
AWH	Avant Honey
BLK	Black - Coordinates with BLK Metal Frame Finish
BZD	Blizzard
BRC	Brushed Cobalt - Coordinates with TUN Metal Frame Finish
CMB	Clear Maple
CGY	Custom Grey - Coordinates with SIL Metal Frame Finish
DES	Dark Espresso
DWT	Designer White - Coordinates with DWT Metal Frame Finish
FAS	Fashionista
FCL	First Class
NBL	Noce Biondo
NGL	Noce Grigio
NEL	Noce Leggero
NML	Noce Medio
QTM	Quartered Mahogany
SBY	Sheer Beauty
SDT	Stonedust
SOG	Storm Grey - Coordinates with CHR Metal Frame Finish
STG	String - Coordinates with NEV Metal Frame Finish
WHE	Walnut Heights
WHC	White Chocolate
WCR	Winter Cherry

Edgeband Finishes:

AAE	Absolute Acajou
ASE	Asian Night
ACE	Avant Cherry
AHE	Avant Honey
BLK	Black
BRC	Brushed Cobalt
BZD	Blizzard
CHR	Charcoal (<i>use w/SOG</i>)
CGY	Custom Grey -
CME	Clear Maple
DEE	Dark Espresso
DWE	Designer White
FAS	Fashionista
FCL	First Class
NEV	Nevada (<i>use w/STG</i>)
QTM	Quartered Mahogany
SBY	Sheer Beauty
SIL	Silver
SDT	Stonedust
TPE	Taupe
WHE	Walnut Heights
CBE	White Chocolate
WCE	Winter Cherry

Chassis/Accent Finishes:

ACJ	Absolute Acajou
ASN	Asian Night
AWC	Avant Cherry
AWH	Avant Honey
BLK	Black - Coordinates with BLK Metal Frame Finish
BRC	Brushed Cobalt - Coordinates with TUN Metal Frame Finish
BZD	Blizzard
CGY	Custom Grey - Coordinates with SIL Metal Frame Finish
CMB	Clear Maple
DES	Dark Espresso
DWT	Designer White - Coordinates with DWT Metal Frame Finish
FAS	Fashionista
FCL	First Class
NBL	Noce Biondo
NGL	Noce Grigio
NEL	Noce Leggero
NML	Noce Medio
QTM	Quartered Mahogany
SBY	Sheer Beauty
SOG	Storm Grey - Coordinates with CHR Metal Frame Finish
SDT	Stonedust
STG	String - Coordinates with NEV Metal Frame Finish
WHC	White Chocolate
WHE	Walnut Heights
WCR	Winter Cherry

Metal Beam Finishes:

BLK	Black
CHR	Charcoal
DWT	Designer White
FOG	Fog
NEV	Nevada
SIL	Silver
TPE	Taupe
TUN	Tungsten

FABRIC TABLE DIVIDERS / SEAT PRIVACY PARTITIONS

Bridges II Fabric Table Dividers are available in: **Anchorage, Lola, Merge**

COLLABORATIVE SEATING

- All standard seating fabrics and grades apply.

30"W UNITS STORAGE CAPACITY CHART

Side to Side

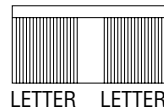

Side to Side Letter/Front to Back Legal

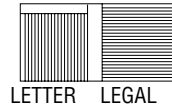
**36"W UNITS STORAGE CAPACITY CHART**

Side to Side Letter

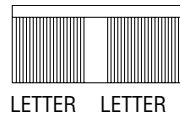

Side to Side Legal

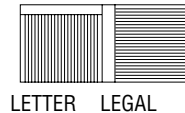

Side to Side Letter/Front to Back Legal

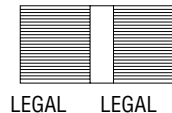

RECTANGULAR LEG PACKAGES

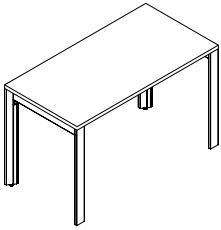

Single Line 1 Person Pod with Levelers

MODEL#	DIMENSIONS	FREIGHT CLASS	WT./LBS.	CUBIC FT.	LIST PRICE	HP ADD
	D x W x H					
BRTS1P2484L	24 x 84 x 29	70	75	4.92	\$1584	\$154
BRTS1P2478L	24 x 78 x 29	85	72	4.82	\$1538	\$148
BRTS1P2472L	24 x 72 x 29	85	69	4.73	\$1484	\$153
BRTS1P2466L	24 x 66 x 29	85	66	4.65	\$1468	\$136
BRTS1P2463L	24 x 62.5 x 29	85	63	4.57	\$1457	\$132
BRTS1P2460L	24 x 60 x 29	85	60	4.48	\$1441	\$131
BRTS1P2454L	24 x 54 x 29	85	57	4.4	\$1391	\$114
BRTS1P2451L	24 x 50.5 x 29	85	54	4.3	\$1353	\$109
BRTS1P2448L	24 x 48 x 29	85	51	4.2	\$1317	\$104
BRTS1P2442L	24 x 42 x 29	92.5	48	4.1	\$1260	\$85
BRTS1P2436L	24 x 36 x 29	92.5	45	4	\$1181	\$73
BRTS1P3084L	30 x 84 x 29	70	84	5.2	\$1661	\$165
BRTS1P3078L	30 x 78 x 29	70	81	5.1	\$1597	\$153
BRTS1P3072L	30 x 72 x 29	70	78	5.01	\$1559	\$151
BRTS1P3066L	30 x 66 x 29	70	75	4.9	\$1522	\$145
BRTS1P3063L	30 x 62.5 x 29	70	72	4.8	\$1510	\$140
BRTS1P3060L	30 x 60 x 29	85	69	4.73	\$1495	\$136
BRTS1P3054L	30 x 54 x 29	85	66	4.6	\$1461	\$113
BRTS1P3051L	30 x 50.5 x 29	85	63	4.5	\$1434	\$119
BRTS1P3048L	30 x 48 x 29	85	60	4.41	\$1410	\$114
BRTS1P3042L	30 x 42 x 29	85	57	4.3	\$1379	\$112
BRTS1P3036L	30 x 36 x 29	85	54	4.2	\$1274	\$77

Single Line Table Assemblies consist of one worksurface, two leg assemblies, and one supporting structural beam.

- Anodized Aluminum Leg - Add **\$154**. list upcharge

Required Specifications

Top finish
Edge finish
Metal finish (legs)
Beam finish

Optional Specifications

Anodized Aluminum Leg
HP laminate

RECTANGULAR LEG PACKAGES

MODEL#	DIMENSIONS	FREIGHT CLASS	WT/LBS.	CUBIC FT.	LIST PRICE	HP ADD
	D x W x H					
BRTS1P2484C	24 x 84 x 29	70	75	4.92	\$1661	\$154
BRTS1P2478C	24 x 78 x 29	85	72	4.82	\$1615	\$148
BRTS1P2472C	24 x 72 x 29	85	69	4.73	\$1571	\$145
BRTS1P2466C	24 x 66 x 29	85	66	4.65	\$1546	\$136
BRTS1P2463C	24 x 62.5 x 29	85	63	4.57	\$1533	\$132
BRTS1P2460C	24 x 60 x 29	85	60	4.48	\$1520	\$131
BRTS1P2454C	24 x 54 x 29	85	57	4.4	\$1468	\$114
BRTS1P2451C	24 x 50.5 x 29	85	54	4.3	\$1432	\$109
BRTS1P2448C	24 x 48 x 29	85	51	4.2	\$1394	\$104
BRTS1P2442C	24 x 42 x 29	92.5	48	4.1	\$1335	\$85
BRTS1P2436C	24 x 36 x 29	92.5	45	4	\$1261	\$73
BRTS1P3084C	30 x 84 x 29	70	84	5.2	\$1753	\$153
BRTS1P3078C	30 x 78 x 29	70	81	5.1	\$1674	\$153
BRTS1P3072C	30 x 72 x 29	70	78	5.01	\$1636	\$129
BRTS1P3066C	30 x 66 x 29	70	75	4.9	\$1600	\$145
BRTS1P3063C	30 x 62.5 x 29	70	72	4.8	\$1588	\$140
BRTS1P3060C	30 x 60 x 29	85	69	4.73	\$1572	\$136
BRTS1P3054C	30 x 54 x 29	85	66	4.6	\$1539	\$113
BRTS1P3051C	30 x 50.5 x 29	85	63	4.5	\$1512	\$119
BRTS1P3048C	30 x 48 x 29	85	60	4.41	\$1487	\$114
BRTS1P3042C	30 x 42 x 29	85	57	4.3	\$1458	\$112
BRTS1P3036C	30 x 36 x 29	85	54	4.2	\$1352	\$77

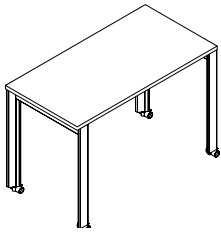

Single Line 1 Person Pod with Casters

Single Line Table Assemblies consist of one worksurface, two leg assemblies, and one supporting structural beam. 40mm white locking casters with grey tires; steel horizontal beams, aluminum legs.

- Anodized Aluminum Leg - Add **\$154**. list upcharge

Required Specifications

Top finish
Edge finish
Metal finish (legs)
Beam finish

Optional Specifications

Anodized Aluminum Leg
HP laminate

RECTANGULAR LEG PACKAGES

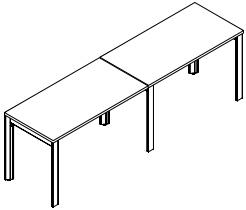

Single Line 2 Person Pod with Levelers

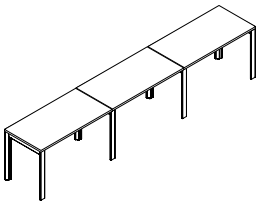

Single Line 3 Person Pod with Levelers

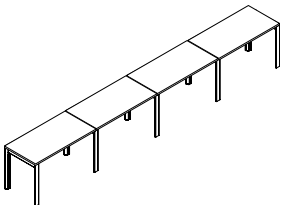

Single Line 4 Person Pod with Levelers

MODEL#	DIMENSIONS D x W x H	FREIGHT CLASS	WT/LBS.	CUBIC FT.	LIST PRICE	HP ADD
BRTS2P2484L	24 x 168 x 29	70	149	7.41	\$2775	\$306
BRTS2P2478L	24 x 156 x 29	70	140	7.27	\$2681	\$291
BRTS2P2472L	24 x 144 x 29	70	131	7.13	\$2598	\$283
BRTS2P2466L	24 x 132 x 29	70	122	6.95	\$2543	\$267
BRTS2P2460L	24 x 120 x 29	70	113	6.71	\$2488	\$260
BRTS2P2454L	24 x 108 x 29	70	104	6.45	\$2386	\$226
BRTS2P2448L	24 x 96 x 29	70	95	6.21	\$2240	\$203
BRTS2P3084L	30 x 168 x 29	70	173	8.25	\$2911	\$329
BRTS2P3078L	30 x 156 x 29	70	164	7.97	\$2783	\$303
BRTS2P3072L	30 x 144 x 29	70	155	7.69	\$2725	\$294
BRTS2P3066L	30 x 132 x 29	70	140	7.41	\$2633	\$283
BRTS2P3060L	30 x 120 x 29	70	131	7.13	\$2581	\$267
BRTS2P3054L	30 x 108 x 29	70	122	6.85	\$2507	\$226
BRTS2P3048L	30 x 96 x 29	70	113	6.57	\$2406	\$226

Single Line 2 Person workstation consists of two worksurfaces, three leg assemblies, and two supporting structural beams. One leg can be shared by 2 adjoining worksurfaces.

- Anodized Aluminum Leg - Add **\$228.** list upcharge

BRTS3P2484L	24 x 252 x 29	70	219	9.74	\$3969	\$457
BRTS3P2478L	24 x 234 x 29	70	206	9.53	\$3828	\$434
BRTS3P2472L	24 x 216 x 29	70	192	9.32	\$3701	\$423
BRTS3P2466L	24 x 198 x 29	70	179	9.11	\$3617	\$401
BRTS3P2460L	24 x 180 x 29	70	165	8.89	\$3539	\$368
BRTS3P2454L	24 x 162 x 29	70	152	8.68	\$3386	\$335
BRTS3P2448L	24 x 144 x 29	70	138	8.47	\$3165	\$301

BRTS3P3084L	30 x 252 x 29	65	263	11.59	\$4163	\$492
BRTS3P3078L	30 x 234 x 29	70	246	11.16	\$3970	\$454
BRTS3P3072L	30 x 216 x 29	70	229	10.72	\$3854	\$442
BRTS3P3066L	30 x 198 x 29	70	212	10.3	\$3743	\$423
BRTS3P3060L	30 x 180 x 29	70	195	9.87	\$3666	\$401
BRTS3P3054L	30 x 162 x 29	70	178	9.44	\$3557	\$335
BRTS3P3048L	30 x 144 x 29	70	161	9.01	\$3406	\$335

Single Line 3 Person workstation consists of three worksurfaces, four leg assemblies, and three supporting structural beams. One leg can be shared by 2 adjoining worksurfaces.

- Anodized Aluminum Leg - Add **\$305.** list upcharge

BRTS4P2484L	24 x 336 x 29	70	291	13.67	\$5157	\$610
BRTS4P2478L	24 x 312 x 29	70	273	13.18	\$4972	\$578
BRTS4P2472L	24 x 288 x 29	70	254	12.69	\$4832	\$571
BRTS4P2466L	24 x 264 x 29	70	236	12.2	\$4693	\$532
BRTS4P2460L	24 x 240 x 29	70	217	11.71	\$4585	\$516
BRTS4P2454L	24 x 216 x 29	70	199	11.22	\$4384	\$446
BRTS4P2448L	24 x 192 x 29	70	180	10.73	\$4089	\$401

BRTS4P3084L	30 x 336 x 29	65	345	14.87	\$5410	\$655
BRTS4P3078L	30 x 312 x 29	65	323	14.3	\$5155	\$600
BRTS4P3072L	30 x 288 x 29	70	301	13.73	\$5001	\$586
BRTS4P3066L	30 x 264 x 29	70	279	13.16	\$4854	\$561
BRTS4P3060L	30 x 240 x 29	70	257	12.59	\$4754	\$532
BRTS4P3054L	30 x 216 x 29	70	235	12.02	\$4605	\$446
BRTS4P3048L	30 x 192 x 29	70	213	11.45	\$4404	\$446

Single Line 4 Person workstation consists of four worksurfaces, five leg assemblies, and four supporting structural beams. One leg can be shared by 2 adjoining worksurfaces.

- Anodized Aluminum Leg - Add **\$382.** list upcharge

Required Specifications

Top finish
Edge finish
Metal finish (legs)
Beam finish

Optional Specifications

Anodized Aluminum Leg
HP laminate

RECTANGULAR LEG PACKAGES

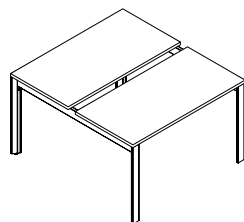

Back-to-Back 2 Person Pod with Levelers

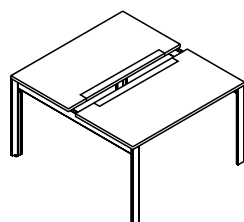

Back-to-Back 2 Person Pod with Access Door and Levelers

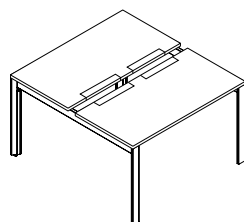

Back-to-Back 2 Person Pod with Access Doors and Levelers

MODEL#	DIMENSIONS D x W x H	FREIGHT CLASS	WT/LBS.	CUBIC FT.	LIST PRICE	HP ADD
BRTBAR2P2484L	50.5 x 84 x 29	70	146	9.4	\$2621	\$306
BRTBAR2P2478L	50.5 x 78 x 29	85	137	9.2	\$2526	\$291
BRTBAR2P2472L	50.5 x 72 x 29	85	128	9.02	\$2442	\$283
BRTBAR2P2466L	50.5 x 66 x 29	85	119	8.76	\$2386	\$267
BRTBAR2P2460L	50.5 x 60 x 29	85	110	8.56	\$2335	\$260
BRTBAR2P3084L	62.5 x 84 x 29	70	174	10.4	\$2699	\$329
BRTBAR2P3078L	62.5 x 78 x 29	70	163	9.8	\$2579	\$291
BRTBAR2P3072L	62.5 x 72 x 29	70	152	9.54	\$2496	\$291
BRTBAR2P3066L	62.5 x 66 x 29	70	141	9.25	\$2420	\$283
BRTBAR2P3060L	62.5 x 60 x 29	85	130	9	\$2368	\$267

Back-to-back 2 Person workstation consists of two worksurfaces, two back-to-back leg assemblies, and two supporting structural beams.

- Anodized Aluminum Leg - Add **\$154**. list upcharge

BRTBAR2PA2484L	50.5 x 84 x 29	70	146	9.4	\$2755	\$547
BRTBAR2PA2478L	50.5 x 78 x 29	85	137	9.2	\$2678	\$489
BRTBAR2PA2472L	50.5 x 72 x 29	85	128	9.02	\$2621	\$469
BRTBAR2PA2466L	50.5 x 66 x 29	85	119	8.76	\$2524	\$411
BRTBAR2PA2460L	50.5 x 60 x 29	85	110	8.56	\$2427	\$372
BRTBAR2PA3084L	62.5 x 84 x 29	70	174	10.4	\$3008	\$664
BRTBAR2PA3078L	62.5 x 78 x 29	70	163	9.8	\$2911	\$625
BRTBAR2PA3072L	62.5 x 72 x 29	70	152	9.54	\$2853	\$568
BRTBAR2PA3066L	62.5 x 66 x 29	70	141	9.25	\$2755	\$508
BRTBAR2PA3060L	62.5 x 60 x 29	85	130	9	\$2621	\$469

Back-to-back 2 Person workstation consists of two worksurfaces, two back-to-back leg assemblies, and two supporting structural beams. Anodized aluminum worksurface door provides access to power/data trough below worksurface. Worksurface with access doors CANNOT be combined with above worksurface power trough.

- Anodized Aluminum Leg - Add **\$154**. list upcharge

BRTBAR2PDA2484L	50.5 x 84 x 29	70	146	9.4	\$2973	\$586
BRTBAR2PDA2478L	50.5 x 78 x 29	85	137	9.2	\$2890	\$525
BRTBAR2PDA2472L	50.5 x 72 x 29	85	128	9.02	\$2827	\$504
BRTBAR2PDA2466L	50.5 x 66 x 29	85	119	8.76	\$2724	\$442
BRTBAR2PDA2460L	50.5 x 60 x 29	85	110	8.56	\$2620	\$399
BRTBAR2PDA3084L	62.5 x 84 x 29	70	174	10.4	\$3244	\$712
BRTBAR2PDA3078L	62.5 x 78 x 29	70	163	9.8	\$3140	\$670
BRTBAR2PDA3072L	62.5 x 72 x 29	70	152	9.54	\$3079	\$607
BRTBAR2PDA3066L	62.5 x 66 x 29	70	141	9.25	\$2973	\$542
BRTBAR2PDA3060L	62.5 x 60 x 29	85	130	9	\$2827	\$504

Back-to-back 2 Person workstation consists of two worksurfaces, two back-to-back leg assemblies, and two supporting structural beams. These tables feature dual access doors providing a central connection point for monitor lifts. Anodized aluminum worksurface door provides access to power/data trough below worksurface. Worksurface with access doors CANNOT be combined with above worksurface power trough.

- Anodized Aluminum Leg - Add **\$154**. list upcharge

Required Specifications

Top finish
Edge finish
Metal finish (legs)
Beam finish

Optional Specifications

Anodized Aluminum Leg
HP laminate

RECTANGULAR LEG PACKAGES

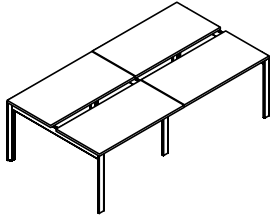

Back-to-Back 4 Person Pod with Levelers

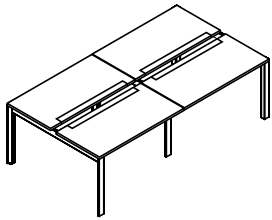

Back-to-Back 4 Person Pod with Access Door and Levelers

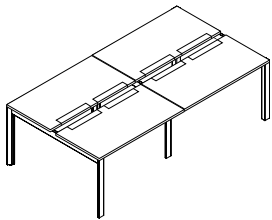

Back-to-Back 4 Person Pod with Access Door and Levelers

MODEL#	DIMENSIONS D x W x H	FREIGHT CLASS	WT/LBS.	CUBIC FT.	LIST PRICE	HP ADD
BRTBAR4P2484L	50.5 x 168 x 29	70	272	15.66	\$4693	\$610
BRTBAR4P2478L	50.5 x 156 x 29	70	256	15.2	\$4507	\$578
BRTBAR4P2472L	50.5 x 144 x 29	70	240	14.74	\$4339	\$561
BRTBAR4P2466L	50.5 x 132 x 29	70	224	14.28	\$4229	\$532
BRTBAR4P2460L	50.5 x 120 x 29	70	208	13.82	\$4120	\$516
BRTBAR4P3084L	62.5 x 168 x 29	70	333	16.86	\$4888	\$655
BRTBAR4P3078L	62.5 x 156 x 29	70	313	16.32	\$4631	\$600
BRTBAR4P3072L	62.5 x 144 x 29	70	293	15.78	\$4476	\$586
BRTBAR4P3066L	62.5 x 132 x 29	70	273	15.24	\$4330	\$561
BRTBAR4P3060L	62.5 x 120 x 29	70	253	14.7	\$4229	\$532

Back-to-back 4 Person workstation consists of four worksurfaces, two back-to-back outer leg assemblies, 1 back-to-back narrow leg assembly, and four supporting structural beams.

- Anodized Aluminum Leg - Add **\$228**. list upcharge

BRTBAR4PA2484L	50.5 x 168 x 29	70	272	15.66	\$4965	\$1091
BRTBAR4PA2478L	50.5 x 156 x 29	70	256	15.2	\$4810	\$972
BRTBAR4PA2472L	50.5 x 144 x 29	70	240	14.74	\$4693	\$933
BRTBAR4PA2466L	50.5 x 132 x 29	70	224	14.28	\$4499	\$819
BRTBAR4PA2460L	50.5 x 120 x 29	70	208	13.82	\$4305	\$742
BRTBAR4PA3084L	62.5 x 168 x 29	70	333	16.86	\$5430	\$1320
BRTBAR4PA3078L	62.5 x 156 x 29	70	313	16.32	\$5236	\$1243
BRTBAR4PA3072L	62.5 x 144 x 29	70	293	15.78	\$5122	\$1129
BRTBAR4PA3066L	62.5 x 132 x 29	70	273	15.24	\$4926	\$1012
BRTBAR4PA3060L	62.5 x 120 x 29	70	253	14.7	\$4656	\$933

Back-to-back 4 Person workstation consists of four worksurfaces, two back-to-back outer leg assemblies, 1 back-to-back narrow leg assembly, and four supporting structural beams. Anodized aluminum worksurface door provides access to power/data trough below worksurface. Worksurface with access doors CANNOT be combined with above worksurface power trough.

- Anodized Aluminum Leg - Add **\$228**. list upcharge

BRTBAR4PDA2484L	50.5 x 168 x 29	70	272	15.66	\$5357	\$1171
BRTBAR4PDA2478L	50.5 x 156 x 29	70	256	15.2	\$5189	\$1044
BRTBAR4PDA2472L	50.5 x 144 x 29	70	240	14.74	\$5063	\$1005
BRTBAR4PDA2466L	50.5 x 132 x 29	70	224	14.28	\$4857	\$875
BRTBAR4PDA2460L	50.5 x 120 x 29	70	208	13.82	\$4644	\$794
BRTBAR4PDA3084L	62.5 x 168 x 29	70	333	16.86	\$5860	\$1418
BRTBAR4PDA3078L	62.5 x 156 x 29	70	313	16.32	\$5649	\$1337
BRTBAR4PDA3072L	62.5 x 144 x 29	70	293	15.78	\$5525	\$1210
BRTBAR4PDA3066L	62.5 x 132 x 29	70	273	15.24	\$5315	\$1087
BRTBAR4PDA3060L	62.5 x 120 x 29	70	253	14.7	\$5024	\$1001

Back-to-back 4 Person workstation consists of four worksurfaces, two back-to-back outer leg assemblies, 1 back-to-back narrow leg assembly, and four supporting structural beams. These tables feature dual access doors providing a central connection point for monitor lifts. Anodized aluminum worksurface door provides access to power/data trough below worksurface. Worksurface with access doors CANNOT be combined with above worksurface power trough.

- Anodized Aluminum Leg - Add **\$228**. list upcharge

Required Specifications

Top finish
Edge finish
Metal finish (legs)
Beam finish

Optional Specifications

Anodized Aluminum Leg
HP laminate

RECTANGULAR LEG PACKAGES

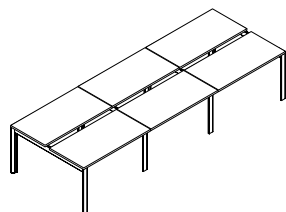

Back-to-Back 6 Person Pod with Levelers

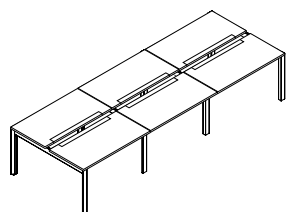

Back-to-Back 6 Person Pod with Access Door and Levelers

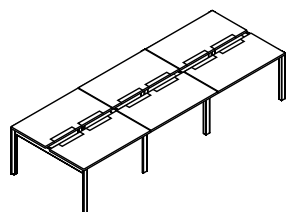

Back-to-Back 6 Person Pod with Access Door and Levelers

MODEL# DIMENSIONS FREIGHT CLASS WT/LBS. CUBIC FT. LIST PRICE HP ADD

	D x W x H						
BRTBAR6P2484L	50.5 x 252 x 29	70	434	22.88	\$6768	\$910	
BRTBAR6P2478L	50.5 x 234 x 29	70	409	22.1	\$6487	\$865	
BRTBAR6P2472L	50.5 x 216 x 29	70	359	21.32	\$6233	\$843	
BRTBAR6P2466L	50.5 x 198 x 29	70	329	20.54	\$6070	\$795	
BRTBAR6P2460L	50.5 x 180 x 29	70	308	19.76	\$5869	\$770	
BRTBAR6P3084L	62.5 x 252 x 29	70	493	24.53	\$7040	\$982	
BRTBAR6P3078L	62.5 x 234 x 29	70	462	23.75	\$6655	\$899	
BRTBAR6P3072L	62.5 x 216 x 29	70	431	22.86	\$6424	\$877	
BRTBAR6P3066L	62.5 x 198 x 29	70	400	21.97	\$6201	\$843	
BRTBAR6P3060L	62.5 x 180 x 29	70	369	21.08	\$6012	\$795	

Back-to-back 6 Person workstation consists of six worksurfaces, two back-to-back outer leg assemblies, two back-to-back narrow leg assemblies, and six supporting structural beams.

- Anodized Aluminum Leg - Add **\$305**. list upcharge

BRTBAR6PA2484L	50.5 x 252 x 29	70	434	22.88	\$7176	\$1633	
BRTBAR6PA2478L	50.5 x 234 x 29	70	409	22.1	\$6944	\$1458	
BRTBAR6PA2472L	50.5 x 216 x 29	70	359	21.32	\$6768	\$1399	
BRTBAR6PA2466L	50.5 x 198 x 29	70	329	20.54	\$6477	\$1225	
BRTBAR6PA2460L	50.5 x 180 x 29	70	308	19.76	\$6148	\$1107	
BRTBAR6PA3084L	62.5 x 252 x 29	70	493	24.53	\$7854	\$1980	
BRTBAR6PA3078L	62.5 x 234 x 29	70	462	23.75	\$7563	\$1865	
BRTBAR6PA3072L	62.5 x 216 x 29	70	431	22.86	\$7388	\$1690	
BRTBAR6PA3066L	62.5 x 198 x 29	70	400	21.97	\$7098	\$1516	
BRTBAR6PA3060L	62.5 x 180 x 29	70	369	21.08	\$6652	\$1399	

Back-to-back 6 Person workstation consists of six worksurfaces, two back-to-back outer leg assemblies, two back-to-back narrow leg assemblies, and six supporting structural beams. Anodized aluminum worksurface door provides access to power/data trough below worksurface. Worksurface with access doors CANNOT be combined with above worksurface power trough.

- Anodized Aluminum Leg - Add **\$305**. list upcharge

BRTBAR6PDA2484L	50.5 x 252 x 29	70	434	22.88	\$7742	\$1748	
BRTBAR6PDA2478L	50.5 x 234 x 29	70	409	22.1	\$7491	\$1566	
BRTBAR6PDA2472L	50.5 x 216 x 29	70	359	21.32	\$7303	\$1505	
BRTBAR6PDA2466L	50.5 x 198 x 29	70	329	20.54	\$6988	\$1256	
BRTBAR6PDA2460L	50.5 x 180 x 29	70	308	19.76	\$6632	\$1191	
BRTBAR6PDA3084L	62.5 x 252 x 29	70	493	24.53	\$8475	\$2128	
BRTBAR6PDA3078L	62.5 x 234 x 29	70	462	23.75	\$8158	\$2001	
BRTBAR6PDA3072L	62.5 x 216 x 29	70	431	22.86	\$7971	\$1813	
BRTBAR6PDA3066L	62.5 x 198 x 29	70	400	21.97	\$7656	\$1625	
BRTBAR6PDA3060L	62.5 x 180 x 29	70	369	21.08	\$7178	\$1502	

Back-to-back 6 Person workstation consists of six worksurfaces, two back-to-back outer leg assemblies, two back-to-back narrow leg assemblies, and six supporting structural beams. These tables feature dual access doors providing a central connection point for monitor lifts. Anodized aluminum worksurface door provides access to power/data trough below worksurface. Worksurface with access doors CANNOT be combined with above worksurface power trough.

- Anodized Aluminum Leg - Add **\$305**. list upcharge

Required Specifications

Top finish
Edge finish
Metal finish (legs)
Beam finish

Optional Specifications

Anodized Aluminum Leg
HP laminate

RECTANGULAR LEG PACKAGES

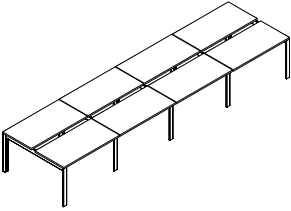

Back-to-Back 8 Person Pod with Levelers

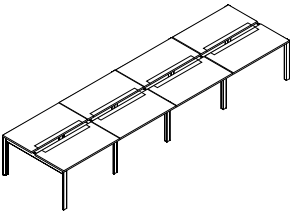

Back-to-Back 8 Person Pod with Access Door and Levelers

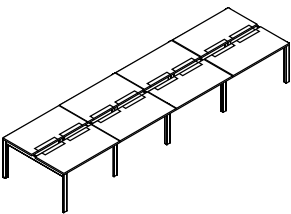

Back-to-Back 8 Person Pod with Access Door and Levelers

MODEL#	DIMENSIONS D x W x H	FREIGHT CLASS	WT./LBS.	CUBIC FT.	LIST PRICE	HP ADD
BRTBAR8P2484L	50.5 x 336 x 29	70	556	28.30	\$8842	\$1215
BRTBAR8P2478L	50.5 x 312 x 29	70	520	27.30	\$8470	\$1151
BRTBAR8P2472L	50.5 x 288 x 29	70	484	26.30	\$8128	\$1120
BRTBAR8P2466L	50.5 x 264 x 29	70	448	25.30	\$7912	\$1058
BRTBAR8P2460L	50.5 x 240 x 29	70	412	24.42	\$7732	\$1027
BRTBAR8P3084L	62.5 x 336 x 29	70	669	30.58	\$9190	\$1308
BRTBAR8P3078L	62.5 x 312 x 29	70	625	29.48	\$8678	\$1197
BRTBAR8P3072L	62.5 x 288 x 29	70	581	28.38	\$8370	\$1166
BRTBAR8P3066L	62.5 x 264 x 29	70	536	27.28	\$8074	\$1120
BRTBAR8P3060L	62.5 x 240 x 29	70	492	26.18	\$7871	\$1058

Back-to-back 8 Person workstation consists of eight worksurfaces, two back-to-back outer leg assemblies, three back-to-back narrow leg assemblies, and eight supporting structural beams.

- Anodized Aluminum Leg - Add **\$382**. list upcharge

BRTBAR8PA2484L	50.5 x 336 x 29	70	556	28.30	\$9383	\$2174
BRTBAR8PA2478L	50.5 x 312 x 29	70	520	27.30	\$9073	\$1941
BRTBAR8PA2472L	50.5 x 288 x 29	70	484	26.30	\$8842	\$1865
BRTBAR8PA2466L	50.5 x 264 x 29	70	448	25.30	\$8453	\$1633
BRTBAR8PA2460L	50.5 x 240 x 29	70	412	24.42	\$8106	\$1476
BRTBAR8PA3084L	62.5 x 336 x 29	70	669	30.58	\$10277	\$2639
BRTBAR8PA3078L	62.5 x 312 x 29	70	625	29.48	\$9886	\$2484
BRTBAR8PA3072L	62.5 x 288 x 29	70	581	28.38	\$9655	\$2252
BRTBAR8PA3066L	62.5 x 264 x 29	70	536	27.28	\$9268	\$2019
BRTBAR8PA3060L	62.5 x 240 x 29	70	492	26.18	\$8725	\$1865

Back-to-back 8 Person workstation consists of eight worksurfaces, two back-to-back outer leg assemblies, three back-to-back narrow leg assemblies, and eight supporting structural beams. Anodized aluminum worksurface door provides access to power/data trough below worksurface. Worksurface with access doors CANNOT be combined with above worksurface power trough.

- Anodized Aluminum Leg - Add **\$382**. list upcharge

BRTBAR8PDA2484L	50.5 x 336 x 29	70	556	28.30	\$10125	\$2336
BRTBAR8PDA2478L	50.5 x 312 x 29	70	520	27.30	\$9787	\$2086
BRTBAR8PDA2472L	50.5 x 288 x 29	70	484	26.30	\$9539	\$2005
BRTBAR8PDA2466L	50.5 x 264 x 29	70	448	25.30	\$9121	\$1754
BRTBAR8PDA2460L	50.5 x 240 x 29	70	412	24.42	\$8744	\$1587
BRTBAR8PDA3084L	62.5 x 336 x 29	70	669	30.58	\$11087	\$2636
BRTBAR8PDA3078L	62.5 x 312 x 29	70	625	29.48	\$10666	\$2671
BRTBAR8PDA3072L	62.5 x 288 x 29	70	581	28.38	\$10415	\$2422
BRTBAR8PDA3066L	62.5 x 264 x 29	70	536	27.28	\$10001	\$2166
BRTBAR8PDA3060L	62.5 x 240 x 29	70	492	26.18	\$9413	\$2005

Back-to-back 8 Person workstation consists of eight worksurfaces, two back-to-back outer leg assemblies, three back-to-back narrow leg assemblies, and eight supporting structural beams. These tables feature dual access doors providing a central connection point for monitor lifts. Anodized aluminum worksurface door provides access to power/data trough below worksurface. Worksurface with access doors CANNOT be combined with above worksurface power trough.

- Anodized Aluminum Leg - Add **\$382**. list upcharge

Required Specifications

Top finish
Edge finish
Metal finish (legs)
Beam finish

Optional Specifications

Anodized Aluminum Leg
HP laminate

RECTANGULAR LEG PACKAGES

MODEL# DIMENSIONS FREIGHT CLASS WT./LBS. CUBIC FT. LIST PRICE HP ADD

D x W x H

BRT36P2484C	24 x 84 x 36	70	120.68	6.42	\$3326	\$184
BRT36P2478C	24 x 78 x 36	70	114.16	6.13	\$3243	\$171
BRT36P2472C	24 x 72 x 36	70	107.64	5.83	\$3160	\$164
BRT36P2466C	24 x 66 x 36	70	101.12	5.62	\$3098	\$160
BRT36P2460C	24 x 60 x 36	70	94.60	5.41	\$3031	\$152
BRT36P2454C	24 x 54 x 36	70	88.08	5.19	\$2936	\$132
BRT36P2448C	24 x 48 x 36	70	81.56	4.98	\$2788	\$120
BRT36P2442C	24 x 42 x 36	70	76.04	4.76	\$2690	\$102
BRT36P2436C	24 x 36 x 36	70	68.52	4.55	\$2607	\$82

BRT36P3084C	30 x 84 x 36	70	148.11	7.32	\$3801	\$197
BRT36P3078C	30 x 78 x 36	70	139.96	6.95	\$3694	\$178
BRT36P3072C	30 x 72 x 36	70	131.81	6.59	\$3602	\$171
BRT36P3066C	30 x 66 x 36	70	123.66	6.32	\$3514	\$171
BRT36P3060C	30 x 60 x 36	70	115.51	6.06	\$3442	\$160
BRT36P3054C	30 x 54 x 36	70	107.36	5.79	\$3351	\$132
BRT36P3048C	30 x 48 x 36	70	99.21	5.53	\$3206	\$132
BRT36P3042C	30 x 42 x 36	70	91.06	5.26	\$3134	\$125
BRT36P3036C	30 x 36 x 36	70	83.91	5	\$3001	\$93

BRT36P3684C	36 x 84 x 36	70	161.97	8.91	\$4256	\$223
BRT36P3678C	36 x 78 x 36	70	152.82	8.50	\$4149	\$211
BRT36P3672C	36 x 72 x 36	70	144.67	8.10	\$4029	\$197
BRT36P3666C	36 x 66 x 36	70	135.52	7.79	\$3919	\$184
BRT36P3660C	36 x 60 x 36	70	126.37	7.48	\$3798	\$164
BRT36P3654C	36 x 54 x 36	70	118.22	7.18	\$3677	\$152
BRT36P3648C	36 x 48 x 36	70	109.07	6.87	\$3512	\$132
BRT36P3642C	36 x 42 x 36	70	99.92	6.56	\$3399	\$120

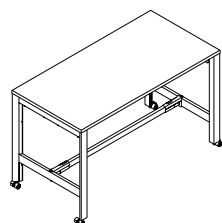

36"H Single Table with Casters

Single table assembly consists of one worksurface, two H leg assemblies, horizontal structural beams, and one bottom table beam. 40mm dia. locking casters with 8mm thread, white body and grey tires.

- 24"D tables include 3 horizontal structural beams. 30"/36"D tables include 4 horizontal structural beams.
- Anodized Aluminum Leg - Add **\$154.** list upcharge

BRT36P2484L	24 x 84 x 36	70	120.20	6.42	\$3216	\$184
BRT36P2478L	24 x 78 x 36	70	113.68	6.13	\$3137	\$171
BRT36P2472L	24 x 72 x 36	70	107.16	5.83	\$3050	\$164
BRT36P2466L	24 x 66 x 36	70	100.64	5.62	\$2991	\$160
BRT36P2460L	24 x 60 x 36	70	94.12	5.41	\$2921	\$152
BRT36P2454L	24 x 54 x 36	70	87.60	5.19	\$2826	\$132
BRT36P2448L	24 x 48 x 36	70	81.08	4.98	\$2678	\$120
BRT36P2442L	24 x 42 x 36	70	75.56	4.76	\$2581	\$102
BRT36P2436L	24 x 36 x 36	85	68.04	4.55	\$2497	\$82

BRT36P3084L	30 x 84 x 36	70	147.63	7.32	\$3691	\$197
BRT36P3078L	30 x 78 x 36	70	139.48	6.96	\$3586	\$178
BRT36P3072L	30 x 72 x 36	70	131.33	6.59	\$3493	\$171
BRT36P3066L	30 x 66 x 36	70	123.18	6.32	\$3407	\$171
BRT36P3060L	30 x 60 x 36	70	115.03	6.06	\$3332	\$160
BRT36P3054L	30 x 54 x 36	70	106.88	5.79	\$3240	\$132
BRT36P3048L	30 x 48 x 36	70	98.73	5.53	\$3098	\$132
BRT36P3042L	30 x 42 x 36	70	90.58	5.26	\$3024	\$125
BRT36P3036L	30 x 36 x 36	70	83.43	5	\$2893	\$93

BRT36P3684L	36 x 84 x 36	70	161.49	8.91	\$4150	\$223
BRT36P3678L	36 x 78 x 36	70	152.34	8.50	\$4039	\$211
BRT36P3672L	36 x 72 x 36	70	144.19	8.10	\$3922	\$197
BRT36P3666L	36 x 66 x 36	70	135.04	7.79	\$3808	\$184
BRT36P3660L	36 x 60 x 36	70	125.89	7.48	\$3690	\$164
BRT36P3654L	36 x 54 x 36	70	117.74	7.18	\$3566	\$152
BRT36P3648L	36 x 48 x 36	70	108.59	6.87	\$3406	\$132
BRT36P3642L	36 x 42 x 36	70	99.44	6.56	\$3291	\$120

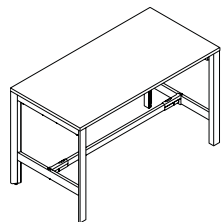

36"H Single Table with Levelers

Single table assembly consists of one worksurface, two H leg assemblies, horizontal structural beams, and one bottom table beam.

- 24"D tables include 3 horizontal structural beams. 30"/36"D tables include 4 horizontal structural beams.
- Anodized Aluminum Leg - Add **\$154.** list upcharge

Required Specifications

Top finish
Edge finish
Metal finish (legs)

Optional Specifications

Anodized Aluminum Leg
HP laminate

RECTANGULAR LEG PACKAGES

MODEL# DIMENSIONS FREIGHT CLASS WT./LBS. CUBIC FT. LIST PRICE HP ADD

D x W x H

BRT36A2484L	24 x 84 x 36	70	106.36	4.74	\$2600	\$184
BRT36A2478L	24 x 78 x 36	70	99.84	4.45	\$2523	\$171
BRT36A2472L	24 x 72 x 36	70	93.32	4.15	\$2437	\$164
BRT36A2466L	24 x 66 x 36	70	86.80	3.94	\$2378	\$160
BRT36A2460L	24 x 60 x 36	70	80.28	3.73	\$2307	\$152
BRT36A2454L	24 x 54 x 36	70	73.76	3.51	\$2211	\$132
BRT36A2448L	24 x 48 x 36	70	67.24	3.30	\$2065	\$120
BRT36A2442L	24 x 42 x 36	70	61.72	3.08	\$1968	\$102
BRT36A2436L	24 x 36 x 36	70	54.20	2.87	\$1884	\$82
BRT36A3084L	30 x 84 x 36	65	131.77	5.56	\$3040	\$197
BRT36A3078L	30 x 78 x 36	65	123.62	5.19	\$2933	\$178
BRT36A3072L	30 x 72 x 36	65	115.47	4.83	\$2841	\$171
BRT36A3066L	30 x 66 x 36	65	107.32	4.56	\$2754	\$171
BRT36A3060L	30 x 60 x 36	65	99.17	4.30	\$2678	\$160
BRT36A3054L	30 x 54 x 36	65	91.02	4.03	\$2588	\$132
BRT36A3048L	30 x 48 x 36	70	82.87	3.77	\$2445	\$132
BRT36A3042L	30 x 42 x 36	70	74.72	3.50	\$2370	\$125
BRT36A3036L	30 x 36 x 36	70	67.57	3.24	\$2240	\$93
BRT36A3684L	36 x 84 x 36	70	143.70	6.65	\$3405	\$223
BRT36A3678L	36 x 78 x 36	70	134.55	6.24	\$3293	\$211
BRT36A3672L	36 x 72 x 36	70	126.40	5.84	\$3175	\$197
BRT36A3666L	36 x 66 x 36	70	117.25	5.53	\$3063	\$184
BRT36A3660L	36 x 60 x 36	70	108.10	5.22	\$2944	\$164
BRT36A3654L	36 x 54 x 36	70	99.95	4.92	\$2821	\$152
BRT36A3648L	36 x 48 x 36	70	90.80	4.61	\$2658	\$132
BRT36A3642L	36 x 42 x 36	70	81.65	4.30	\$2545	\$120

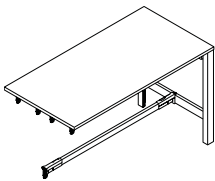

36" H Add-On with Levelers

Single table assembly consists of one worksurface, one H leg assembly, horizontal structural beams, and one bottom table beam.

- 24"D tables include 3 horizontal structural beams. 30"/36" D tables include 4 horizontal structural beams.
- Anodized Aluminum Leg - Add **\$77**. list upcharge

BRT42P2484C	24 x 84 x 42	70	122.58	6.98	\$3384	\$184
BRT42P2478C	24 x 78 x 42	70	116.06	6.69	\$3306	\$171
BRT42P2472C	24 x 72 x 42	70	109.54	6.39	\$3220	\$164
BRT42P2466C	24 x 66 x 42	70	103.02	6.18	\$3160	\$160
BRT42P2460C	24 x 60 x 42	70	96.50	5.97	\$3090	\$152
BRT42P2454C	24 x 54 x 42	70	89.98	5.75	\$2996	\$132
BRT42P2448C	24 x 48 x 42	70	83.46	5.54	\$2848	\$120
BRT42P2442C	24 x 42 x 42	85	77.94	5.32	\$2752	\$102
BRT42P2436C	24 x 36 x 42	85	70.42	5.11	\$2668	\$82
BRT42P3084C	30 x 84 x 42	70	150.01	7.92	\$3861	\$197
BRT42P3078C	30 x 78 x 42	70	141.86	7.55	\$3755	\$178
BRT42P3072C	30 x 72 x 42	70	133.71	7.19	\$3662	\$171
BRT42P3066C	30 x 66 x 42	70	125.56	6.92	\$3575	\$171
BRT42P3060C	30 x 60 x 42	70	117.41	6.66	\$3503	\$160
BRT42P3054C	30 x 54 x 42	70	109.26	6.39	\$3409	\$132
BRT42P3048C	30 x 48 x 42	70	101.11	6.13	\$3269	\$132
BRT42P3042C	30 x 42 x 42	70	92.96	5.86	\$3194	\$125
BRT42P3036C	30 x 36 x 42	70	85.81	5.60	\$3063	\$93
BRT42P3684C	36 x 84 x 42	70	163.87	9.69	\$4318	\$223
BRT42P3678C	36 x 78 x 42	70	154.72	9.28	\$4208	\$211
BRT42P3672C	36 x 72 x 42	70	146.57	8.88	\$4090	\$197
BRT42P3666C	36 x 66 x 42	70	137.42	8.57	\$3977	\$184
BRT42P3660C	36 x 60 x 42	70	128.27	8.26	\$3859	\$164
BRT42P3654C	36 x 54 x 42	70	120.12	7.96	\$3737	\$152
BRT42P3648C	36 x 48 x 42	85	110.97	7.65	\$3573	\$132
BRT42P3642C	36 x 42 x 42	85	101.82	7.34	\$3459	\$120

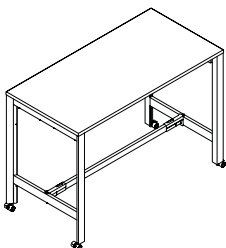

42" H Pod with Casters

Single table assembly consists of one worksurface, two H leg assemblies, horizontal structural beams and one bottom table beam. 40mm dia. locking casters with 8mm thread, white body and grey tires.

- 24"D tables include 3 horizontal structural beams. 30"/36" D tables include 4 horizontal structural beams.
- Anodized Aluminum Leg - Add **\$154**. list upcharge

Required Specifications

Top finish
Edge finish
Metal finish (legs)

Optional Specifications

Anodized Aluminum Leg
HP laminate

RECTANGULAR LEG PACKAGES

MODEL# DIMENSIONS FREIGHT CLASS WT./LBS. CUBIC FT. LIST PRICE HP ADD

D x W x H

BRT42P2484L	24 x 84 x 42	70	122.10	6.98	\$3277	\$184
BRT42P2478L	24 x 78 x 42	70	115.58	6.69	\$3197	\$171
BRT42P2472L	24 x 72 x 42	70	109.06	6.39	\$3112	\$164
BRT42P2466L	24 x 66 x 42	70	102.54	6.18	\$3050	\$160
BRT42P2460L	24 x 60 x 42	70	96.02	5.97	\$2984	\$152
BRT42P2454L	24 x 54 x 42	70	89.50	5.75	\$2887	\$132
BRT42P2448L	24 x 48 x 42	85	82.98	5.54	\$2739	\$120
BRT42P2442L	24 x 42 x 42	85	77.46	5.32	\$2642	\$102
BRT42P2436L	24 x 36 x 42	85	69.94	5.11	\$2559	\$82

BRT42P3084L	30 x 84 x 42	70	149.53	7.92	\$3756	\$197
BRT42P3078L	30 x 78 x 42	70	141.38	7.55	\$3649	\$178
BRT42P3072L	30 x 72 x 42	70	133.23	7.19	\$3557	\$171
BRT42P3066L	30 x 66 x 42	70	125.08	6.92	\$3470	\$171
BRT42P3060L	30 x 60 x 42	70	116.93	6.66	\$3396	\$160
BRT42P3054L	30 x 54 x 42	70	108.78	6.39	\$3304	\$132
BRT42P3048L	30 x 48 x 42	70	100.63	6.13	\$3163	\$132
BRT42P3042L	30 x 42 x 42	70	92.48	5.86	\$3088	\$125
BRT42P3036L	30 x 36 x 42	70	85.33	5.60	\$2958	\$93

BRT42P3684L	36 x 84 x 42	70	163.39	9.69	\$4211	\$223
BRT42P3678L	36 x 78 x 42	70	154.24	9.28	\$4100	\$211
BRT42P3672L	36 x 72 x 42	70	146.09	8.88	\$3981	\$197
BRT42P3666L	36 x 66 x 42	70	136.94	8.57	\$3871	\$184
BRT42P3660L	36 x 60 x 42	70	127.79	8.26	\$3750	\$164
BRT42P3654L	36 x 54 x 42	70	119.64	7.96	\$3628	\$152
BRT42P3648L	36 x 48 x 42	85	110.49	7.65	\$3464	\$132
BRT42P3642L	36 x 42 x 42	85	101.34	7.34	\$3353	\$120

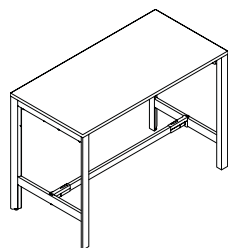

42" H Pod with Levelers

Single table assembly consists of one worksurface, two H leg assemblies, horizontal structural beams and one bottom table beam.

- 24"D tables include 3 horizontal structural beams. 30"/36"D tables include 4 horizontal structural beams.
- Anodized Aluminum Leg - Add **\$154**. list upcharge

BRT42A2484L	24 x 84 x 42	70	107.31	5.02	\$2631	\$184
BRT42A2478L	24 x 78 x 42	70	100.79	4.73	\$2551	\$171
BRT42A2472L	24 x 72 x 42	70	94.27	4.43	\$2470	\$164
BRT42A2466L	24 x 66 x 42	70	87.75	4.22	\$2406	\$160
BRT42A2460L	24 x 60 x 42	70	81.23	4.01	\$2339	\$152
BRT42A2454L	24 x 54 x 42	70	74.71	3.79	\$2243	\$132
BRT42A2448L	24 x 48 x 42	70	68.19	3.58	\$2097	\$120
BRT42A2442L	24 x 42 x 42	70	62.67	3.36	\$1910	\$102
BRT42A2436L	24 x 36 x 42	70	55.15	3.15	\$1832	\$82

BRT42A3084L	30 x 84 x 42	65	132.72	5.86	\$3071	\$197
BRT42A3078L	30 x 78 x 42	65	124.57	5.49	\$2964	\$178
BRT42A3072L	30 x 72 x 42	65	116.42	5.13	\$2870	\$171
BRT42A3066L	30 x 66 x 42	70	108.27	4.86	\$2785	\$171
BRT42A3060L	30 x 60 x 42	70	100.12	4.60	\$2712	\$160
BRT42A3054L	30 x 54 x 42	70	91.97	4.33	\$2620	\$132
BRT42A3048L	30 x 48 x 42	70	83.82	4.07	\$2477	\$132
BRT42A3042L	30 x 42 x 42	70	75.67	3.80	\$2403	\$125
BRT42A3036L	30 x 36 x 42	70	68.52	3.54	\$2271	\$93

BRT42A3684L	36 x 84 x 42	70	114.65	7.04	\$3432	\$223
BRT42A3678L	36 x 78 x 42	70	135.50	6.63	\$3326	\$211
BRT42A3672L	36 x 72 x 42	70	127.35	6.23	\$3205	\$197
BRT42A3666L	36 x 66 x 42	70	118.20	5.92	\$3095	\$184
BRT42A3660L	36 x 60 x 42	70	109.05	5.61	\$2973	\$164
BRT42A3654L	36 x 54 x 42	70	100.90	5.31	\$2852	\$152
BRT42A3648L	36 x 48 x 42	70	91.75	5	\$2689	\$132
BRT42A3642L	36 x 42 x 42	70	82.60	4.69	\$2574	\$120

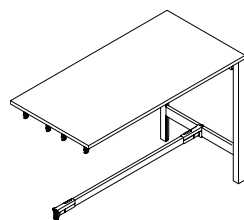

42" H Add-On with Levelers

Single table assembly consists of one worksurface, one H leg assembly, horizontal structural beams, and one bottom table beam.

- 24"D tables include 3 horizontal structural beams. 30"/36"D tables include 4 horizontal structural beams.
- Anodized Aluminum Leg - Add **\$77**. list upcharge

Required Specifications

Top finish
Edge finish
Metal finish (legs)

Optional Specifications

Anodized Aluminum Leg
HP laminate

ROUND LEG PACKAGES

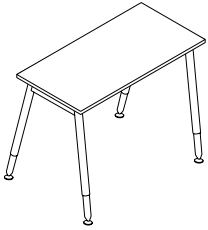

**Single Line 1 Person Pod with Levelers
Round Leg**

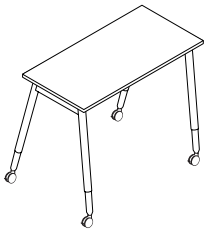

**Single Line 1 Person Pod with Casters
Round Leg**

MODEL#	DIMENSIONS D x W x H	FREIGHT CLASS	WT/LBS.	CUBIC FT.	LIST PRICE	HP ADD
BRTS1P2484LR	24 x 84 x 29	70	75	4.92	\$1632	\$154
BRTS1P2478LR	24 x 78 x 29	85	72	4.82	\$1584	\$148
BRTS1P2472LR	24 x 72 x 29	85	69	4.73	\$1543	\$145
BRTS1P2466LR	24 x 66 x 29	85	66	4.65	\$1514	\$136
BRTS1P2463LR	24 x 62.5 x 29	85	63	4.57	\$1502	\$132
BRTS1P2460LR	24 x 60 x 29	85	60	4.48	\$1487	\$131
BRTS1P2454LR	24 x 54 x 29	85	57	4.40	\$1457	\$94
BRTS1P2451LR	24 x 50.5 x 29	85	54	4.30	\$1399	\$88
BRTS1P2448LR	24 x 48 x 29	85	51	4.20	\$1364	\$104
BRTS1P2442LR	24 x 42 x 29	92.5	48	4.10	\$1307	\$65
BRTS1P2436LR	24 x 36 x 29	92.5	45	4	\$1263	\$46

BRTS1P3084LR	30 x 84 x 29	70	75	4.92	\$1668	\$165
BRTS1P3078LR	30 x 78 x 29	85	72	4.82	\$1606	\$153
BRTS1P3072LR	30 x 72 x 29	85	69	4.73	\$1566	\$129
BRTS1P3066LR	30 x 66 x 29	85	66	4.65	\$1531	\$145
BRTS1P3063LR	30 x 62.5 x 29	85	63	4.57	\$1520	\$140
BRTS1P3060LR	30 x 60 x 29	85	60	4.48	\$1505	\$115
BRTS1P3054LR	30 x 54 x 29	85	57	4.40	\$1468	\$114
BRTS1P3051LR	30 x 50.5 x 29	85	54	4.30	\$1443	\$119
BRTS1P3048LR	30 x 48 x 29	85	51	4.20	\$1397	\$114
BRTS1P3042LR	30 x 42 x 29	92.5	48	4.10	\$1369	\$112
BRTS1P3036LR	30 x 36 x 29	92.5	45	4	\$1225	\$81

Single Line Table Assemblies consist of one worksurface, two leg assemblies, and one supporting structural beam.

BRTS1P2484CR	24 x 84 x 29	70	75	4.92	\$1723	\$154
BRTS1P2478CR	24 x 78 x 29	85	72	4.82	\$1678	\$148
BRTS1P2472CR	24 x 72 x 29	85	69	4.73	\$1635	\$145
BRTS1P2466CR	24 x 66 x 29	85	66	4.65	\$1609	\$136
BRTS1P2463CR	24 x 62.5 x 29	85	63	4.57	\$1597	\$132
BRTS1P2460CR	24 x 60 x 29	85	60	4.48	\$1581	\$131
BRTS1P2454CR	24 x 54 x 29	85	57	4.40	\$1548	\$94
BRTS1P2451CR	24 x 50.5 x 29	85	54	4.30	\$1493	\$88
BRTS1P2448CR	24 x 48 x 29	85	51	4.20	\$1457	\$104
BRTS1P2442CR	24 x 42 x 29	92.5	48	4.10	\$1397	\$65
BRTS1P2436CR	24 x 36 x 29	92.5	45	4	\$1357	\$46

BRTS1P3084CR	30 x 84 x 29	70	75	4.92	\$1762	\$165
BRTS1P3078CR	30 x 78 x 29	85	72	4.82	\$1698	\$153
BRTS1P3072CR	30 x 72 x 29	85	69	4.73	\$1663	\$127
BRTS1P3066CR	30 x 66 x 29	85	66	4.65	\$1622	\$145
BRTS1P3063CR	30 x 62.5 x 29	85	63	4.57	\$1611	\$140
BRTS1P3060CR	30 x 60 x 29	85	60	4.48	\$1597	\$115
BRTS1P3054CR	30 x 54 x 29	85	57	4.40	\$1561	\$114
BRTS1P3051CR	30 x 50.5 x 29	85	54	4.30	\$1534	\$119
BRTS1P3048CR	30 x 48 x 29	85	51	4.20	\$1492	\$114
BRTS1P3042CR	30 x 42 x 29	92.5	48	4.10	\$1461	\$112
BRTS1P3036CR	30 x 36 x 29	92.5	45	4	\$1318	\$81

Single Line Table Assemblies consist of one worksurface, two leg assemblies, and one supporting structural beam. 40mm locking casters with grey tires; steel horizontal beams, aluminum legs.

Required Specifications

Top finish
Edge finish
Metal finish (legs)
Beam finish

Optional Specifications

Anodized Aluminum Leg
HP laminate

ROUND LEG PACKAGES

MODEL#	DIMENSIONS	FREIGHT CLASS	WT./LBS.	CUBIC FT.	LIST PRICE	HP ADD
--------	------------	---------------	----------	-----------	------------	--------

D x W x H

BRTS2P2484LR	24 x 168 x 29	70	149	7.41	\$2862	\$291
BRTS2P2478LR	24 x 156 x 29	70	140	7.27	\$2752	\$291
BRTS2P2472LR	24 x 144 x 29	70	131	7.13	\$2667	\$283
BRTS2P2466LR	24 x 132 x 29	70	122	6.95	\$2621	\$260
BRTS2P2460LR	24 x 120 x 29	70	113	6.71	\$2559	\$260
BRTS2P2454LR	24 x 108 x 29	70	104	6.45	\$2457	\$226
BRTS2P2448LR	24 x 96 x 29	70	95	6.21	\$2309	\$203

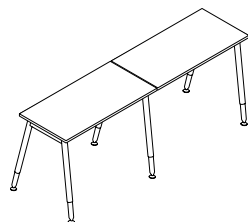

Single Line 2 Person Pod with Levelers Round Leg

BRTS2P3084LR	30 x 168 x 29	70	173	8.25	\$2922	\$329
BRTS2P3078LR	30 x 156 x 29	70	164	7.97	\$2794	\$303
BRTS2P3072LR	30 x 144 x 29	70	155	7.69	\$2716	\$294
BRTS2P3066LR	30 x 132 x 29	70	140	7.41	\$2643	\$283
BRTS2P3060LR	30 x 120 x 29	70	131	7.13	\$2594	\$267
BRTS2P3054LR	30 x 108 x 29	70	122	6.85	\$2521	\$226
BRTS2P3048LR	30 x 96 x 29	70	113	6.57	\$2420	\$226

Single Line 2 Person workstation consists of two worksurfaces, three leg assemblies, and two supporting structural beams. One leg can be shared by 2 adjoining worksurfaces.

BRTS3P2484LR	24 x 252 x 29	70	219	9.74	\$4061	\$457
BRTS3P2478LR	24 x 234 x 29	70	206	9.53	\$3921	\$434
BRTS3P2472LR	24 x 216 x 29	70	192	9.32	\$3793	\$423
BRTS3P2466LR	24 x 198 x 29	70	179	9.11	\$3712	\$401
BRTS3P2460LR	24 x 180 x 29	70	165	8.89	\$3630	\$388
BRTS3P2454LR	24 x 162 x 29	70	152	8.68	\$3479	\$335
BRTS3P2448LR	24 x 144 x 29	70	138	8.47	\$3259	\$301

BRTS3P3084LR	30 x 263 x 29	65	263	11.59	\$4176	\$492
BRTS3P3078LR	30 x 234 x 29	70	246	11.16	\$3984	\$454
BRTS3P3072LR	30 x 216 x 29	70	229	10.72	\$3869	\$442
BRTS3P3066LR	30 x 198 x 29	70	212	10.30	\$3758	\$423
BRTS3P3060LR	30 x 180 x 29	70	195	9.87	\$3682	\$401
BRTS3P3054LR	30 x 162 x 29	70	178	9.44	\$3572	\$335
BRTS3P3048LR	30 x 144 x 29	70	161	9.01	\$3420	\$335

Single Line 3 Person workstation consists of three worksurfaces, four leg assemblies, and three supporting structural beams. One leg can be shared by 2 adjoining worksurfaces.

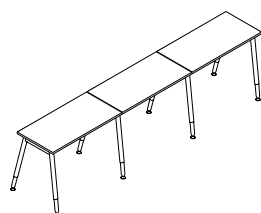

Single Line 3 Person Pod with Levelers Round Leg

BRTS4P2484LR	24 x 336 x 29	70	291	13.67	\$5276	\$610
BRTS4P2478LR	24 x 312 x 29	70	273	13.18	\$5089	\$578
BRTS4P2472LR	24 x 288 x 29	70	254	12.69	\$4920	\$561
BRTS4P2466LR	24 x 264 x 29	70	236	12.20	\$4810	\$532
BRTS4P2460LR	24 x 240 x 29	70	217	11.71	\$4686	\$532
BRTS4P2454LR	24 x 216 x 29	70	199	11.22	\$4499	\$446
BRTS4P2448LR	24 x 192 x 29	70	180	10.73	\$4158	\$446

BRTS4P3084LR	30 x 336 x 29	65	345	14.87	\$5430	\$655
BRTS4P3078LR	30 x 312 x 29	65	323	14.30	\$5176	\$600
BRTS4P3072LR	30 x 288 x 29	70	301	13.73	\$5020	\$586
BRTS4P3066LR	30 x 264 x 29	70	279	13.16	\$4871	\$561
BRTS4P3060LR	30 x 240 x 29	70	257	12.59	\$4770	\$532
BRTS4P3054LR	30 x 216 x 29	70	235	12.02	\$4624	\$446
BRTS4P3048LR	30 x 192 x 29	70	213	11.45	\$4422	\$446

Single Line 4 Person workstation consists of four worksurfaces, five leg assemblies, and four supporting structural beams. One leg can be shared by 2 adjoining worksurfaces.

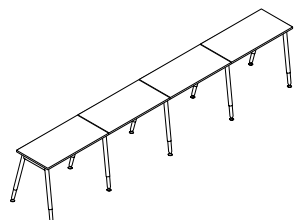

Single Line 4 Person Pod with Levelers Round Leg

Required Specifications

Top finish
Edge finish
Metal finish (legs)
Beam finish

Optional Specifications

Anodized Aluminum Leg
HP laminate

ROUND LEG PACKAGES

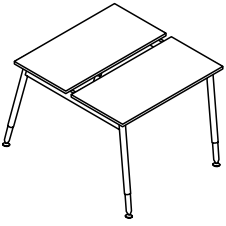

Back-to-Back 2 Person Pod with Levelers Round Leg

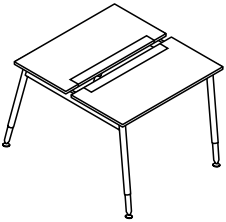

Back-to-Back 2 Person Pod with Access Door and Levelers, Round Leg

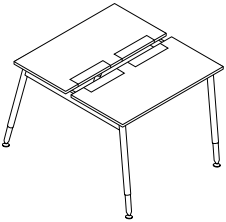

Back-to-Back 2 Person Pod with Access Door and Levelers, Round Leg

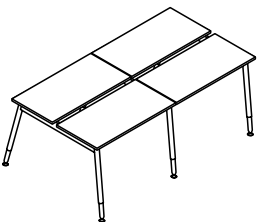

Back-to-Back 4 Person Pod with Levelers Round Leg

MODEL#	DIMENSIONS D x W x H	FREIGHT CLASS	WT./LBS.	CUBIC FT.	LIST PRICE	HP ADD
BRTBAR2P2484LR	50.5 x 84 x 29	70	146	9.40	\$2662	\$306
BRTBAR2P2478LR	50.5 x 78 x 29	85	137	9.20	\$2590	\$291
BRTBAR2P2472LR	50.5 x 72 x 29	85	128	9.02	\$2504	\$283
BRTBAR2P2466LR	50.5 x 66 x 29	85	119	8.76	\$2448	\$267
BRTBAR2P2460LR	50.5 x 60 x 29	85	110	8.56	\$2396	\$260
BRTBAR2P3084LR	62.5 x 84 x 29	70	174	10.40	\$2761	\$329
BRTBAR2P3078LR	62.5 x 78 x 29	70	163	9.80	\$2633	\$303
BRTBAR2P3072LR	62.5 x 72 x 29	70	152	9.54	\$2554	\$283
BRTBAR2P3066LR	62.5 x 66 x 29	70	141	9.25	\$2481	\$283
BRTBAR2P3060LR	62.5 x 60 x 29	85	130	9	\$2228	\$469

Back-to-back 2 Person workstation consists of two worksurfaces, two back-to-back leg assemblies, and two supporting structural beams.

BRTBAR2PA2484LR	50.5 x 84 x 29	70	146	9.40	\$2799	\$547
BRTBAR2PA2478LR	50.5 x 78 x 29	85	137	9.20	\$2739	\$489
BRTBAR2PA2472LR	50.5 x 72 x 29	85	128	9.02	\$2681	\$469
BRTBAR2PA2466LR	50.5 x 66 x 29	85	119	8.76	\$2584	\$411
BRTBAR2PA2460LR	50.5 x 60 x 29	85	110	8.56	\$2488	\$372
BRTBAR2PA3084LR	62.5 x 84 x 29	70	174	10.40	\$3032	\$664
BRTBAR2PA3078LR	62.5 x 78 x 29	70	163	9.80	\$2936	\$625
BRTBAR2PA3072LR	62.5 x 72 x 29	70	152	9.54	\$2874	\$568
BRTBAR2PA3066LR	62.5 x 66 x 29	70	141	9.25	\$2778	\$508
BRTBAR2PA3060LR	62.5 x 60 x 29	85	130	9	\$2643	\$469

Back-to-back 2 Person workstation consists of two worksurfaces, two back-to-back leg assemblies, and two supporting structural beams. Anodized aluminum worksurface door provides access to power/data trough below worksurface. Worksurface with access doors CANNOT be combined with above worksurface power trough.

BRTBAR2PDA2484LR	50.5 x 84 x 29	70	146	9.40	\$3019	\$588
BRTBAR2PDA2478LR	50.5 x 78 x 29	85	137	9.20	\$2958	\$524
BRTBAR2PDA2472LR	50.5 x 72 x 29	85	128	9.02	\$2892	\$504
BRTBAR2PDA2466LR	50.5 x 66 x 29	85	119	8.76	\$2790	\$440
BRTBAR2PDA2460LR	50.5 x 60 x 29	85	110	8.56	\$2687	\$402
BRTBAR2PDA3084LR	62.5 x 84 x 29	70	174	10.40	\$3270	\$712
BRTBAR2PDA3078LR	62.5 x 78 x 29	70	163	9.80	\$3166	\$670
BRTBAR2PDA3072LR	62.5 x 72 x 29	70	152	9.54	\$3100	\$611
BRTBAR2PDA3066LR	62.5 x 66 x 29	70	141	9.25	\$2998	\$546
BRTBAR2PDA3060LR	62.5 x 60 x 29	85	130	9	\$2851	\$505

Back-to-back 2 Person workstation consists of two worksurfaces, two back-to-back leg assemblies, and two supporting structural beams. These tables feature dual access doors providing a central connection point for monitor lifts. Anodized aluminum worksurface door provides access to power/data trough below worksurface. Worksurface with access doors CANNOT be combined with above worksurface power trough.

BRTBAR4P2484LR	50.5 x 168 x 29	70	272	15.66	\$4826	\$610
BRTBAR4P2478LR	50.5 x 156 x 29	70	256	15.20	\$4639	\$578
BRTBAR4P2472LR	50.5 x 144 x 29	70	240	14.74	\$4469	\$561
BRTBAR4P2466LR	50.5 x 132 x 29	70	224	14.28	\$4361	\$532
BRTBAR4P2460LR	50.5 x 120 x 29	70	208	13.82	\$4252	\$516
BRTBAR4P3084LR	62.5 x 168 x 29	70	333	16.86	\$4982	\$655
BRTBAR4P3078LR	62.5 x 156 x 29	70	313	16.32	\$4725	\$600
BRTBAR4P3072LR	62.5 x 144 x 29	70	293	15.78	\$4571	\$586
BRTBAR4P3066LR	62.5 x 132 x 29	70	273	15.24	\$4384	\$561
BRTBAR4P3060LR	62.5 x 120 x 29	70	253	14.70	\$4361	\$532

Back-to-back 4 Person workstation consists of four worksurfaces, three back-to-back outer leg assemblies, and four supporting structural beams.

Required Specifications

Top finish
Edge finish
Metal finish (legs)
Beam finish

Optional Specifications

Anodized Aluminum Leg
HP laminate

ROUND LEG PACKAGES

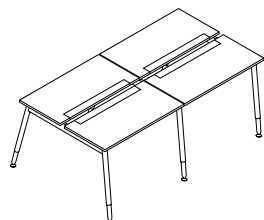

Back-to-Back 4 Person Pod with Access Door and Levelers, Round Leg

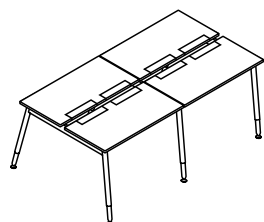

Back-to-Back 4 Person Pod with Access Door and Levelers, Round Leg

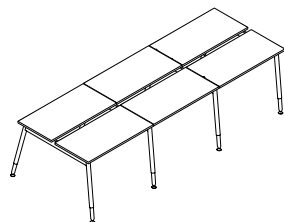

Back-to-Back 6 Person Pod with Levelers Round Leg

MODEL#	DIMENSIONS D x W x H	FREIGHT CLASS	WT/LBS.	CUBIC FT.	LIST PRICE	HP ADD
BRTBAR4PA2484LR	50.5 x 168 x 29	70	272	15.66	\$4965	\$1091
BRTBAR4PA2478LR	50.5 x 156 x 29	70	256	15.20	\$4810	\$972
BRTBAR4PA2472LR	50.5 x 144 x 29	70	240	14.74	\$4693	\$933
BRTBAR4PA2466LR	50.5 x 132 x 29	70	224	14.28	\$4499	\$819
BRTBAR4PA2460LR	50.5 x 120 x 29	70	208	13.82	\$4305	\$742
BRTBAR4PA3084LR	62.5 x 168 x 29	70	333	16.86	\$5430	\$1320
BRTBAR4PA3078LR	62.5 x 156 x 29	70	313	16.32	\$5236	\$1243
BRTBAR4PA3072LR	62.5 x 144 x 29	70	293	15.78	\$5122	\$1129
BRTBAR4PA3066LR	62.5 x 132 x 29	70	273	15.24	\$4926	\$1012
BRTBAR4PA3060LR	62.5 x 120 x 29	70	253	14.70	\$4656	\$933

Back-to-back 4 Person workstation consists of four worksurfaces, three back-to-back outer leg assemblies, and four supporting structural beams. Anodized aluminum worksurface door provides access to power/data trough below worksurface. Worksurface with access doors CANNOT be combined with above worksurface power trough.

BRTBAR4PDA2484LR	50.5 x 168 x 29	70	272	15.66	\$5498	\$1171
BRTBAR4PDA2478LR	50.5 x 156 x 29	70	256	15.20	\$5331	\$1045
BRTBAR4PDA2472LR	50.5 x 144 x 29	70	240	14.74	\$5205	\$1004
BRTBAR4PDA2466LR	50.5 x 132 x 29	70	224	14.28	\$5089	\$879
BRTBAR4PDA2460LR	50.5 x 120 x 29	70	208	13.82	\$4788	\$795
BRTBAR4PDA3084LR	62.5 x 168 x 29	70	333	16.86	\$5958	\$1421
BRTBAR4PDA3078LR	62.5 x 156 x 29	70	313	16.32	\$5749	\$1337
BRTBAR4PDA3072LR	62.5 x 144 x 29	70	293	15.78	\$5623	\$1210
BRTBAR4PDA3066LR	62.5 x 132 x 29	70	273	15.24	\$5498	\$1001
BRTBAR4PDA3060LR	62.5 x 120 x 29	70	253	14.70	\$5164	\$1004

Back-to-back 4 Person workstation consists of four worksurfaces, three back-to-back outer leg assemblies, and four supporting structural beams. These tables feature dual access doors providing a central connection point for monitor lifts. Anodized aluminum worksurface door provides access to power/data trough below worksurface. Worksurface with access doors CANNOT be combined with above worksurface power trough.

BRTBAR6P2484LR	50.5 x 252 x 29	70	434	22.88	\$6969	\$910
BRTBAR6P2478LR	50.5 x 234 x 29	70	409	22.10	\$6690	\$865
BRTBAR6P2472LR	50.5 x 216 x 29	70	359	21.32	\$6435	\$843
BRTBAR6P2466LR	50.5 x 198 x 29	70	329	20.54	\$6270	\$795
BRTBAR6P2460LR	50.5 x 180 x 29	70	308	19.76	\$6110	\$783
BRTBAR6P3084LR	62.5 x 252 x 29	70	493	24.53	\$7215	\$968
BRTBAR6P3078LR	62.5 x 234 x 29	70	462	23.75	\$6818	\$899
BRTBAR6P3072LR	62.5 x 216 x 29	70	431	22.86	\$6585	\$877
BRTBAR6P3066LR	62.5 x 198 x 29	70	400	21.97	\$6363	\$843
BRTBAR6P3060LR	62.5 x 180 x 29	70	369	21.08	\$6213	\$795

Back-to-back 6 Person workstation consists of six worksurfaces, four back-to-back outer leg assemblies, and six supporting structural beams.

Required Specifications

Top finish
Edge finish
Metal finish (legs)
Beam finish

Optional Specifications

Anodized Aluminum Leg
HP laminate

ROUND LEG PACKAGES

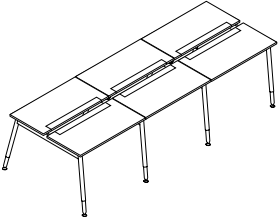

Back-to-Back 6 Person Pod with Access Door and Levelers, Round Leg

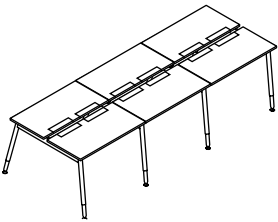

Back-to-Back 6 Person Pod with Access Door and Levelers, Round Leg

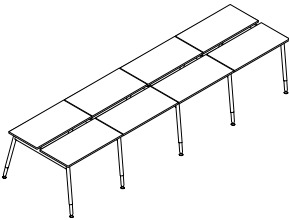

Back-to-Back 8 Person Pod with Levelers Round Leg

MODEL#	DIMENSIONS D x W x H	FREIGHT CLASS	WT/LBS.	CUBIC FT.	LIST PRICE	HP ADD
BRTBAR6PA2484LR	50.5 x 252 x 29	70	434	22.88	\$7376	\$1633
BRTBAR6PA2478LR	50.5 x 234 x 29	70	409	22.10	\$7143	\$1458
BRTBAR6PA2472LR	50.5 x 216 x 29	70	359	21.32	\$6969	\$1399
BRTBAR6PA2466LR	50.5 x 198 x 29	70	329	20.54	\$6677	\$1225
BRTBAR6PA2460LR	50.5 x 180 x 29	70	308	19.76	\$6387	\$1107
BRTBAR6PA3084LR	62.5 x 252 x 29	70	493	24.53	\$8016	\$1980
BRTBAR6PA3078LR	62.5 x 234 x 29	70	462	23.75	\$7726	\$1865
BRTBAR6PA3072LR	62.5 x 216 x 29	70	431	22.86	\$7551	\$1690
BRTBAR6PA3066LR	62.5 x 198 x 29	70	400	21.97	\$7260	\$1516
BRTBAR6PA3060LR	62.5 x 180 x 29	70	369	21.08	\$6853	\$1399

Back-to-back 6 Person workstation consists of six worksurfaces, four back-to-back leg assemblies, and six supporting structural beams. Anodized aluminum worksurface door provides access to power/data trough below worksurface. Worksurface with access doors CANNOT be combined with above worksurface power trough.

BRTBAR6PDA2484LR	50.5 x 252 x 29	70	434	22.88	\$7959	\$1752
BRTBAR6PDA2478LR	50.5 x 234 x 29	70	409	22.10	\$7706	\$1565
BRTBAR6PDA2472LR	50.5 x 216 x 29	70	359	21.32	\$7519	\$1502
BRTBAR6PDA2466LR	50.5 x 198 x 29	70	329	20.54	\$7202	\$1318
BRTBAR6PDA2460LR	50.5 x 180 x 29	70	308	19.76	\$6894	\$1190
BRTBAR6PDA3084LR	62.5 x 252 x 29	70	493	24.53	\$8648	\$2128
BRTBAR6PDA3078LR	62.5 x 234 x 29	70	462	23.75	\$8334	\$1999
BRTBAR6PDA3072LR	62.5 x 216 x 29	70	431	22.86	\$8148	\$1813
BRTBAR6PDA3066LR	62.5 x 198 x 29	70	400	21.97	\$7830	\$1630
BRTBAR6PDA3060LR	62.5 x 180 x 29	70	369	21.08	\$7395	\$1501

Back-to-back 6 Person workstation consists of six worksurfaces, four back-to-back leg assemblies, and six supporting structural beams. These tables feature dual access doors providing a central connection point for monitor lifts. Anodized aluminum worksurface door provides access to power/data trough below worksurface. Worksurface with access doors CANNOT be combined with above worksurface power trough.

BRTBAR8P2484LR	50.5 x 336 x 29	70	556	28.30	\$9127	\$1197
BRTBAR8P2478LR	50.5 x 312 x 29	70	520	27.30	\$8741	\$1151
BRTBAR8P2472LR	50.5 x 288 x 29	70	484	26.30	\$8399	\$1120
BRTBAR8P2466LR	50.5 x 264 x 29	70	448	25.30	\$8181	\$1058
BRTBAR8P2460LR	50.5 x 240 x 29	70	412	24.42	\$7964	\$1027
BRTBAR8P3084LR	62.5 x 336 x 29	70	669	30.58	\$9422	\$1308
BRTBAR8P3078LR	62.5 x 312 x 29	70	625	29.48	\$8910	\$1197
BRTBAR8P3072LR	62.5 x 288 x 29	70	581	28.38	\$8601	\$1166
BRTBAR8P3066LR	62.5 x 264 x 29	70	536	27.28	\$8307	\$1120
BRTBAR8P3060LR	62.5 x 240 x 29	70	492	26.18	\$8106	\$1058

Back-to-back 8 Person workstation consists of eight worksurfaces, five back-to-back leg assemblies, and eight supporting structural beams.

Required Specifications

Top finish
Edge finish
Metal finish (legs)
Beam finish

Optional Specifications

Anodized Aluminum Leg
HP laminate

ROUND LEG PACKAGES

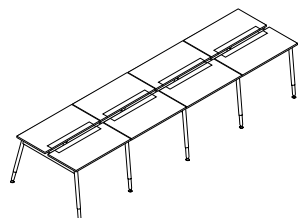

Back-to-Back 8 Person Pod with Access Door and Levelers, Round Leg

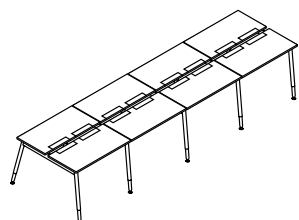

Back-to-Back 8 Person Pod with Access Door and Levelers, Round Leg

MODEL#	DIMENSIONS D x W x H	FREIGHT CLASS	WT/LBS.	CUBIC FT.	LIST PRICE	HP ADD
BRTBAR8PA2484LR	50.5 x 336 x 29	70	556	28.30	\$9655	\$2174
BRTBAR8PA2478LR	50.5 x 312 x 29	70	520	27.30	\$9345	\$1941
BRTBAR8PA2472LR	50.5 x 288 x 29	70	484	26.30	\$9113	\$1865
BRTBAR8PA2466LR	50.5 x 264 x 29	70	448	25.30	\$8725	\$1633
BRTBAR8PA2460LR	50.5 x 240 x 29	70	412	24.42	\$8336	\$1476
BRTBAR8PA3084LR	62.5 x 336 x 29	70	669	30.58	\$10509	\$2639
BRTBAR8PA3078LR	62.5 x 312 x 29	70	625	29.48	\$10119	\$2484
BRTBAR8PA3072LR	62.5 x 288 x 29	70	581	28.38	\$9886	\$2252
BRTBAR8PA3066LR	62.5 x 264 x 29	70	536	27.28	\$9500	\$2019
BRTBAR8PA3060LR	62.5 x 240 x 29	70	492	26.18	\$8957	\$1865

Back-to-back 8 Person workstation consists of eight worksurfaces, five back-to-back leg assemblies, and eight supporting structural beams. Anodized aluminum worksurface door provides access to power/data trough below worksurface. Worksurface with access doors CANNOT be combined with above worksurface power trough.

BRTBAR8PDA2484LR	50.5 x 336 x 29	70	556	28.30	\$10415	\$2336
BRTBAR8PDA2478LR	50.5 x 312 x 29	70	520	27.30	\$10081	\$2085
BRTBAR8PDA2472LR	50.5 x 288 x 29	70	484	26.30	\$9832	\$1999
BRTBAR8PDA2466LR	50.5 x 264 x 29	70	448	25.30	\$9413	\$1754
BRTBAR8PDA2460LR	50.5 x 240 x 29	70	412	24.42	\$8995	\$1587
BRTBAR8PDA3084LR	62.5 x 336 x 29	70	669	30.58	\$11336	\$2835
BRTBAR8PDA3078LR	62.5 x 312 x 29	70	625	29.48	\$10916	\$2671
BRTBAR8PDA3072LR	62.5 x 288 x 29	70	581	28.38	\$10666	\$2422
BRTBAR8PDA3066LR	62.5 x 264 x 29	70	536	27.28	\$10251	\$2169
BRTBAR8PDA3060LR	62.5 x 240 x 29	70	492	26.18	\$9664	\$2001

Back-to-back 8 Person workstation consists of eight worksurfaces, five back-to-back leg assemblies, and eight supporting structural beams. These tables feature dual access doors providing a central connection point for monitor lifts. Anodized aluminum worksurface door provides access to power/data trough below worksurface. Worksurface with access doors CANNOT be combined with above worksurface power trough.

RETURNS

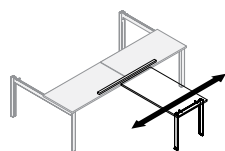

Rail Sliding Table Kit - Rectangular Legs

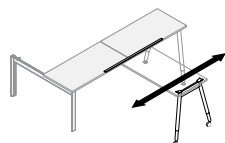

Rail Sliding Table Kit - Round Legs

BRTSLDT72C	72 x 48 x 29	92.5	28.50	2.40	\$779	N/A
BRTSLDT72CR	72 x 48 x 29	92.5	28.50	2.40	\$779	N/A

Includes leg, leg support, sliding bracket hardware, 72" rail and hardware to secure table. **Worksurface not included.** Legs are for 24" d worksurfaces. 40mm dia. locking casters with 8mm thread, white body and grey tires. Maximum length of sliding table surface is 48". **Cannot be used on single line pods with rectangular legs.**

- Anodized Aluminum Leg - Add **\$56.** list upcharge

Includes leg, leg support, sliding bracket hardware, 72" rail and hardware to secure table. **Worksurface not included.** Legs are for 24" d worksurfaces. 3" dia. locking casters are standard. Maximum length of sliding table surface is 48".

Required Specifications

Top finish
Edge finish
Metal finish (legs)
Beam finish

Optional Specifications

Anodized Aluminum Leg
HP laminate

MEETING TABLES

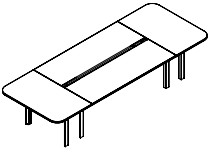

Boardroom Table with Rectangular Leg and Levelers

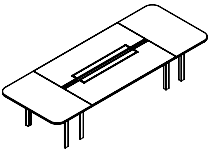

Boardroom Table with Rectangular Leg, Access Door and Levelers

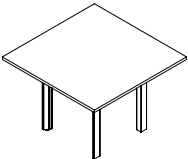

Square Meeting Table with Rectangular Legs

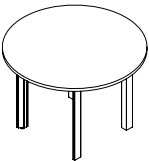

Round Meeting Table with Rectangular Legs

MODEL#	DIMENSIONS D x W x H	FREIGHT CLASS	WT./LBS.	CUBIC FT.	LIST PRICE	HP ADD
BRTBRDP276L	52.5 x 276 x 29	70	474	23.42	\$8481	\$1062
BRTBRDP240L	52.5 x 240 x 29	70	408	22.64	\$8156	\$994
BRTBRDP204L	52.5 x 204 x 29	70	340	20.74	\$6610	\$783
BRTBRDP180L	52.5 x 180 x 29	70	308	19.82	\$6391	\$736
BRTBRDP132L	52.5 x 132 x 29	70	228	15.02	\$4754	\$504
BRTBRDP120L	52.5 x 120 x 29	85	210	14.56	\$4642	\$481

Boardroom Table assemblies consist of 2 or more back-to-back tables with end tables on either side. Inset support legs, levelers. Worksurfaces, supporting structure and connecting hardware included.

- Anodized Aluminum Leg - Add **\$305** list upcharge
- BRTBRDP276L consists of (6) 24" x 72" back-to-back tables and (2) 30" x 50.5" end tables
- BRTBRDP240L consists of (6) 24" x 60" back-to-back tables and (2) 30" x 50.5" end tables
- BRTBRDP204L consists of (4) 24" x 72" back-to-back tables and (2) 30" x 50.5" end tables
- BRTBRDP180L consists of (4) 24" x 60" back-to-back tables and (2) 30" x 50.5" end tables
- BRTBRDP132L consists of (2) 24" x 72" back-to-back tables and (2) 30" x 50.5" end tables
- BRTBRDP120L consists of (2) 24" x 60" back-to-back tables and (2) 30" x 50.5" end tables

BRTBRDPA276L	52.5 x 276 x 29	70	474	23.42	\$9016	\$1621
BRTBRDPA240L	52.5 x 240 x 29	70	408	22.64	\$8706	\$1026
BRTBRDPA204L	52.5 x 204 x 29	70	340	20.74	\$6963	\$845
BRTBRDPA180L	52.5 x 180 x 29	70	308	19.82	\$6577	\$961
BRTBRDPA132L	52.5 x 132 x 29	70	228	15.02	\$4892	\$689
BRTBRDPA120L	52.5 x 120 x 29	85	210	14.56	\$4697	\$591

Boardroom Table assemblies consist of 2 or more back-to-back tables with end tables on either side. Inset support legs, levelers. Worksurfaces, supporting structure and connecting hardware included.

- Anodized Aluminum Leg - Add **\$305** list upcharge
- BRTBRDPA276L consists of (6) 24" x 72" back-to-back tables and (2) 30" x 50.5" end tables
- BRTBRDPA240L consists of (6) 24" x 60" back-to-back tables and (2) 30" x 50.5" end tables
- BRTBRDPA204L consists of (4) 24" x 72" back-to-back tables and (2) 30" x 50.5" end tables
- BRTBRDPA180L consists of (4) 24" x 60" back-to-back tables and (2) 30" x 50.5" end tables
- BRTBRDPA132L consists of (2) 24" x 72" back-to-back tables and (2) 30" x 50.5" end tables
- BRTBRDPA120L consists of (2) 24" x 60" back-to-back tables and (2) 30" x 50.5" end tables

BRTSQ42L	42 x 42 x 29	70	85	4.20	\$1468	\$160
BRTSQ42C	42 x 42 x 29	70	85	4.20	\$1546	\$160

3mm edging. Select BRTSQ42L for levelers or BRTSQ42C for casters.

- Anodized Aluminum Leg - Add **\$154** list upcharge

BRTR42L	42 x 42 x 29	70	65	3.90	\$1468	\$160
BRTR42C	42 x 42 x 29	70	65	3.90	\$1546	\$160

3mm edging. Select BRTR42L for levelers or BRTR42C for casters.

- Anodized Aluminum Leg - Add **\$154** list upcharge

Required Specifications

Top finish
Edge finish
Metal finish (legs)
Beam finish

Optional Specifications

HP laminate
Anodized aluminum leg
Table-edge mounted power module (Meeting Tables)

Below worksurface power trough with power distribution module (Meeting Tables)

LEG ASSEMBLIES

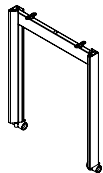

Single Rectangular Leg Assembly with Casters

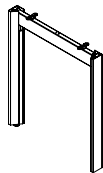

Single Rectangular Leg Assembly with Levelers

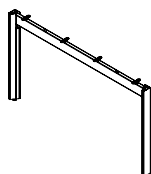

Back-to-Back Rectangular Leg Assembly with Levelers

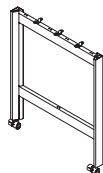

Single H Leg Assembly with Casters

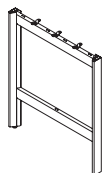

Single H Leg Assembly with Levelers

MODEL#	DIMENSIONS	FREIGHT CLASS	WT./LBS.	CUBIC FT.	LIST PRICE	HP ADD
--------	------------	---------------	----------	-----------	------------	--------

D x W x H

BRTSL24C	24 x 2.5 x 28	150	8	1.34	\$523	N/A
BRTSL30C	30 x 2.5 x 28	150	8	1.41	\$527	N/A
BRTSL36C	36 x 2.5 x 28	150	8	1.81	\$642	N/A

Two single leg assemblies combined with support beams form the structure of the Bridges II series Single Table. One leg can be shared by two adjoining worksurfaces. 40mm white locking casters with grey tires; steel horizontal beams, aluminum legs.

- Anodized Aluminum Leg - Add **\$77** list upcharge

BRTSL24L	24 x 2.5 x 28	150	8	1.34	\$473	N/A
BRTSL30L	30 x 2.5 x 28	150	8	1.34	\$493	N/A
BRTSL36L	36 x 2.5 x 28	125	9	1.50	\$434	N/A

Two single leg assemblies combined with support beams form the structure of the Bridges II series Single Table or Single Line tables. One leg can be shared by two adjoining worksurfaces. Leveling glides; steel horizontal beams, aluminum legs.

- Anodized Aluminum Leg - Add **\$77** list upcharge
- Please specify two beams when using BRTSL36L.

BRTBA34L	34 x 2.5 x 28	150	10	2.47	\$469	N/A
BRTBA51L	50.5 x 2.5 x 28	150	12	2.96	\$508	N/A
BRTBA63L	62.5 x 2.5 x 28	150	13	3.21	\$530	N/A

Two double leg assemblies combined with support beams form the structure of the Bridges II series Back-to-Back Table. One double leg can be shared by four adjoining worksurfaces. Leveling glides; steel horizontal beams, aluminum legs.

- Anodized Aluminum Leg - Add **\$77** list upcharge

BRTHL3624C	24 x 2.5 x 35	100	14	1.68	\$673	N/A
BRTHL3630C	30 x 2.5 x 35	100	16	1.76	\$711	N/A
BRTHL3636C	36 x 2.5 x 35	125	18	2.26	\$805	N/A

BRTHL4224C	24 x 2.5 x 41	125	15	1.96	\$703	N/A
BRTHL4230C	30 x 2.5 x 41	100	17	2.06	\$742	N/A
BRTHL4236C	36 x 2.5 x 41	125	19	2.65	\$833	N/A

Two single leg assemblies combined with support beams form the structure of the Bridges II series Single Line Tables. One leg can be shared by two adjoining worksurfaces. 40mm white locking casters with grey tires; steel horizontal beams, aluminum legs. For proper installation, the following beams are required:

- 24"D legs - 4 beams (3 under the surface and one at the bottom)
- 30"D/36"D legs - 5 beams (4 under the surface and one at the bottom)
- Anodized Aluminum Leg - Add **\$77** list upcharge

BRTHL3624L	24 x 2.5 x 35	100	14	1.68	\$619	N/A
BRTHL3630L	30 x 2.5 x 35	100	16	1.76	\$657	N/A
BRTHL3636L	36 x 2.5 x 35	125	18	2.26	\$751	N/A

BRTHL4224L	24 x 2.5 x 41	125	15	1.96	\$648	N/A
BRTHL4230L	30 x 2.5 x 41	100	17	2.06	\$688	N/A
BRTHL4236L	36 x 2.5 x 41	125	19	2.65	\$780	N/A

Two single leg assemblies combined with support beams form the structure of the Bridges II series Single Line Tables. One leg can be shared by two adjoining worksurfaces. For proper installation, the following beams are required:

- 24"D legs - 4 beams (3 under the surface and one at the bottom)
- 30"D/36"D legs - 5 beams (4 under the surface and one at the bottom)
- Anodized Aluminum Leg - Add **\$77** list upcharge

Required Specifications

Metal finish (legs)

Optional Specifications

Anodized aluminum leg

LEG ASSEMBLIES

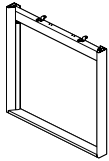

Single Loop Leg

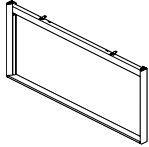

Back-to-Back Loop Leg



120° Rectangular Corner Leg Kit

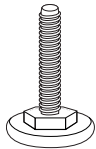

Leveler for Rectangular Leg Table

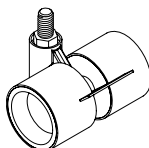

Caster for Rectangular Leg Table



Single Table Round Leg Assembly

MODEL#	DIMENSIONS	FREIGHT CLASS	WT./LBS.	CUBIC FT.	LIST PRICE	HP ADD
--------	------------	---------------	----------	-----------	------------	--------

D x W x H

BRTSLL24L	24 x 2.5 x 28	92.5	11	1.01	\$446	N/A
BRTSLL30L	30 x 2.5 x 28	92.5	13.75	1.26	\$478	N/A
BRTSLL36L	36 x 2.5 x 28	92.5	16.50	1.51	\$512	N/A

Two single leg assemblies combined with support beams form the structure of the Bridges II series Single Line tables. One leg can be shared by two adjoining worksurfaces. Leveling glides; steel horizontal beams, aluminum legs.

- Anodized Aluminum Leg - Add **\$77** list upcharge

BRTBALL51L	50.5 x 2.5 x 28	92.5	23.14	2.12	\$619	N/A
BRTBALL63L	62.5 x 2.5 x 28	92.5	28.64	2.62	\$647	N/A

Two back-to-back leg assemblies form the structure of the Bridges II series Single Line Back-to-Back Table. One double leg can be shared by four adjoining worksurfaces. Leveling glides; steel horizontal beams, aluminum legs.

- Anodized Aluminum Leg - Add **\$77** list upcharge

BRT120L42	34 x 2.5 x 28	250	6.60	2.80	\$896	N/A
-----------	---------------	-----	------	------	--------------	-----

One 120° corner leg kit combined with two single or double leg assemblies and support beams form the structure of the Bridges II 120° Tables. 120° corner leg kit includes one corner leg and adjacent, telescopic beams to support BRTWAC120xxxx or BRTWAC120xxxxA 120° worksurfaces. Telescopic horizontal beams allow single or double leg assemblies to be positioned either under the worksurface (end of a run) or to be shared by adjoining worksurfaces. Levelers, steel horizontal beams, aluminum legs.

- Anodized Aluminum Leg - Add **\$46** list upcharge

BRTLVS	1 x 1 x 2.5	70	.03	.01	\$11	N/A
--------	-------------	----	-----	-----	-------------	-----

5/16" thread with black base. Leveler has 2" adjustment range. Casters and levelers on Rectangular legs cannot be interchanged on site.

BRTLCS	2.6 x 2.7 x 2.5	70	.06	.01	\$35	N/A
--------	-----------------	----	-----	-----	-------------	-----

Locking. 40mm diameter with 8mm thread, white body, light grey tires. Casters and levelers on Rectangular legs cannot be interchanged on site.

BRTSL	24 x 3 x 28	125	8	1.25	\$415	N/A
-------	-------------	-----	---	------	--------------	-----

Two single table leg assemblies combined with a single beam form the supporting structure of the Bridges II series Single Line Table. One leg can be shared by two adjoining worksurfaces. Leveling Glides are standard. Locking casters are available on single tables. Specify BRTLCCR

Required Specifications

Top finish
Edge finish
Metal finish (legs)

Optional Specifications

Anodized Aluminum Leg
HP laminate

LEG ASSEMBLIES

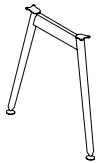

**Single Table Round Leg Assembly,
Fixed Height**

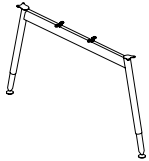

Double Table Round Leg Assembly

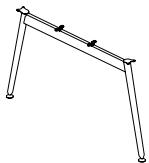

**Double Table Round Leg Assembly,
Fixed Height**

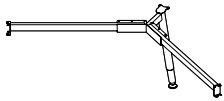

120° Round Corner Leg Assembly

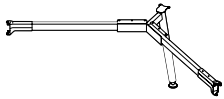

120° Fixed Height Corner Leg Assembly

MODEL#	DIMENSIONS	FREIGHT CLASS	WT/LBS.	CUBIC FT.	LIST PRICE	HP ADD
--------	------------	---------------	---------	-----------	------------	--------

D x W x H

BRTFSL	24 x 2.5 x 28	150	5	.97	\$355	N/A
--------	---------------	-----	---	-----	--------------	-----

Two single table leg assemblies combined with a single beam form the supporting structure of the Bridges II series Single Line Table. One leg can be shared by two adjoining worksurfaces. Leveling glides are standard.

BRTDL	50 x 3 x 28	150	12	2.81	\$538	N/A
-------	-------------	-----	----	------	--------------	-----

Two double table leg assemblies combined with two single beams form the supporting structure of the Bridges II series Back-to-Back Tables. One leg can be shared by two adjoining worksurfaces. Leveling glides are standard.

BRTFDL	50 x 2.5 x 28	250	8	2.03	\$483	N/A
--------	---------------	-----	---	------	--------------	-----

Two double table leg assemblies combined with two single beams form the supporting structure of the Bridges II series Back-to-Back Tables. One leg can be shared by two adjoining worksurfaces. Leveling glides are standard.

BRTCRL42	16 x 18 x 28	92.5	15	1.50	\$829	N/A
----------	--------------	------	----	------	--------------	-----

Provides support for worksurfaces connected at 120°. Single leg and beam assembly for 120° worksurface planning. Works with BRTWAC120xxxx or BRTWAC120xxxxA 120° worksurfaces. For a single application, two BRTSL (single legs) must be added. To join a back-to-back table application, leg assembly will join to existing pod.

- When joining to an existing table, the beam extends to reach the shared leg.

BRTFCRL42	16 x 18 x 28	92.5	13	1.50	\$770	N/A
-----------	--------------	------	----	------	--------------	-----

Provides support for worksurfaces connected at 120°, supported by fixed height legs. Single leg and beam assembly for 120° worksurface planning. Works with BRTWAC120xxxx or BRTWAC120xxxxA 120° worksurfaces. For a single application, two BRTFSL (single legs) must be added. To join a back-to-back table application, leg assembly will join to existing pod.

- When joining to an existing table, the beam extends to reach the shared leg.

Required Specifications

Metal finish (legs)

LEG ASSEMBLIES

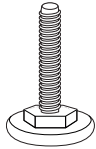

Leveler for Round Leg Table

MODEL#	DIMENSIONS D x W x H	FREIGHT CLASS	WT./LBS.	CUBIC FT.	LIST PRICE	HP ADD
BRTLVR	2.13 x 2.13 x 2	70	.20	.01	\$11	N/A

3/8" thread with black base. Leveler has 1" height adjustment range. Field retrofitable on round leg.



Caster for Round Leg Table

BRTLCR	1.5 x 3 x 3.75	70	.30	.01	\$35	N/A
--------	----------------	----	-----	-----	-------------	-----

Locking. 3" diameter with 3/8" -16 threaded stem. Field retrofitable on round leg.

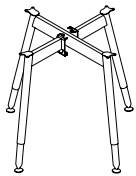

Round Table Leg Assembly

BRTRL	24 x 24 x 28	125	16	2.33	\$853	N/A
-------	--------------	-----	----	------	--------------	-----

Four leg assembly. Leveling Glides are standard. Locking casters are available. Specify (4) BRTLCR. Maximum table diameter is 42". Includes all connecting hardware.

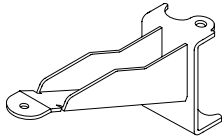

Leg Support Cantilever

BRTLSC	2 x 9 x 5	70	.50	.01	\$148	N/A
--------	-----------	----	-----	-----	--------------	-----

Provides stability for leg supports.

Required Specifications
Metal Finish (legs)

Optional Specifications
Casters (BRTRL)

BEAM APPLICATIONS

D x W x H

Table supporting structures - BEAMS

Legs are connected with supporting beams. There is one beam for a single line of tables while two beams connect back-to-back table structures. Adjustable clamps at either end of the beam can be adjusted to accommodate the following applications in both single table as well as back-to-back table configurations.

STANDARD TABLE BEAM**Single table beam application (1)**

Designed to bridge two legs to form support for a single table, or for two back-to-back worksurfaces. Adjustable clamps at either end of the beam are pushed all the way in to allow both table legs to be tucked under the worksurface.

**End of run table beam application (2)**

Supports one table leg assembly tucked under the worksurface (one adjustable clamp pushed all the way in), while the other table leg assembly can be shared between two adjacent worksurfaces (adjustable clamp pulled out to extend the beam).

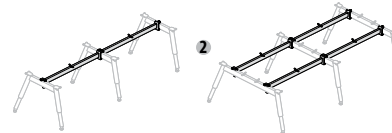
**Interconnecting table beam application (3)**

Supports both table leg assemblies extended to support adjacent worksurfaces on either side. Adjustable clamps at either end of the beam are pushed all the way in to allow both table legs to be tucked under the worksurface. Single table beam application supports single table leg assemblies with legs on both sides tucked under the worksurface.

**TELESCOPIC TABLE BEAM (4)**

Supports a return connected perpendicularly to a 24" or 30" deep primary worksurface. The Telescopic beam is connected to a single or back-to-back leg on one side and to any-worksurface supporting beam on the opposite side. Telescopic beam clamp allows the table leg to be tucked under the worksurface or shared between two adjacent worksurfaces.

**STORAGE TABLE BEAM (5)**

The Storage beam is connected to a single or back-to-back leg on one side and to the worksurface on the opposite side - thus saving one leg assembly. Assembly worksurface is connected to storage units with included storage brackets. Storage table beam's flexibility allows for a single table application (with the table leg tucked in under the worksurface) as well as for a double table installation (two adjacent tables supported by a shared leg in the middle and two storage cabinets at the opposite ends).

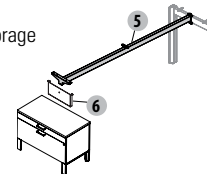
**STORAGE TABLE BEAM ADAPTER (6)**

Connects to a storage table beam. This assembly allows a worksurface to be supported by a leg on one side and a spine (formed by interconnected storage cabinets) on the opposite side.

BEAMS	MODEL#	DIMENSIONS	FREIGHT CLASS	WT/LBS.	CUBIC FT.	LIST PRICE
	BRTSB84C	1 x 79 x 2	60	8.02	.15	\$318
	BRTSB78C	1 x 73 x 2	60	7.38	.12	\$311
	BRTSB72C	1 x 67 x 2	60	6.74	.09	\$302
	BRTSB66C	1 x 61 x 2	60	6.09	.08	\$290
	BRTSB63C	1 x 57.5 x 2	60	5.72	.08	\$286
	BRTSB60C	1 x 55 x 2	60	5.45	.07	\$280
	BRTSB54C	1 x 49 x 2	60	4.86	.06	\$269
	BRTSB51C	1 x 45.5 x 2	60	4.81	.05	\$262
	BRTSB48C	1 x 43 x 2	60	4.60	.05	\$251
	BRTSB42C	1 x 37 x 2	60	3.59	.04	\$241
	BRTSB36C	1 x 31 x 2	60	3.31	.03	\$238
	BRTSB30C	1 x 25 x 2	60	2.70	.02	\$237
	BRTSB24C	1 x 19 x 2	60	2.03	.01	\$230
	BRTSB15C	1 x 10 x 2	70	1.28	.01	\$184

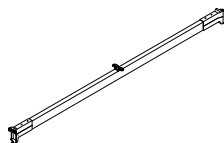
**Standard Table Beam**

Standard Table Beam bridges two legs to form support for a single table, or two back-to-back worksurfaces. Adjustable clamps at either end of the beam accommodate **standard table beam, end of run and interconnecting table beam applications**. Adjustable brackets ship attached to the beam. Specify Standard Table Beam size corresponding nominally to the worksurface length. Includes all hardware necessary to connect to legs. Powder coated steel beam and aluminum cast clamps.

Required Specifications

Metal Finish

BEAMS

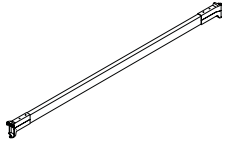

Bottom Table Beam

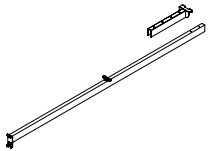

Telescopic Table Beam

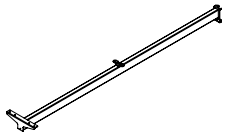

Storage Table Beam

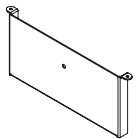

Storage Table Beam Adapter

MODEL#	DIMENSIONS D x W x H	FREIGHT CLASS	WT./LBS.	CUBIC FT.	LIST PRICE
BRTBB84C	1 x 79 x 2	60	10.32	.15	\$358
BRTBB78C	1 x 73 x 2	60	9.68	.12	\$349
BRTBB72C	1 x 67 x 2	60	9.04	.09	\$338
BRTBB66C	1 x 61 x 2	60	8.40	.09	\$326
BRTBB60C	1 x 55 x 2	60	7.75	.08	\$315
BRTBB54C	1 x 49 x 2	60	7.11	.07	\$303
BRTBB48C	1 x 43 x 2	60	6.74	.07	\$281
BRTBB42C	1 x 37 x 2	60	5.83	.06	\$269
BRTBB36C	1 x 31 x 2	60	5.19	.05	\$266

Bottom table beam connects to the lower cross beam on the 36" and 42" high "H" leg to create the footrest. One beam required for each table. Cannot be used as a substitute for the standard table beam. Specify bottom table beam that corresponds to the worksurface length. Includes all hardware necessary to connect to "H" leg. Powder coated steel beam and aluminum cast clamps.

BRTTB84C	1 x 96.5 x 2	60	10.32	.15	\$488
BRTTB78C	1 x 90.5 x 2	60	9.68	.12	\$479
BRTTB72C	1 x 84.5 x 2	60	9.04	.09	\$469
BRTTB66C	1 x 78.5 x 2	60	8.40	.09	\$458
BRTTB60C	1 x 72.5 x 2	60	7.75	.08	\$447
BRTTB54C	1 x 66.5 x 2	60	7.11	.07	\$431
BRTTB48C	1 x 60.5 x 2	60	6.74	.07	\$407
BRTTB42C	1 x 54.5 x 2	60	5.83	.06	\$391
BRTTB36C	1 x 48.5 x 2	60	5.19	.05	\$367

Provides support for a worksurface connected perpendicularly to a run of primary tables. Can be adjusted to accommodate 24" and 30" primary worksurfaces. One end of the beam is attached to a Leg Assembly while the other end is secured, off module to the perpendicular Standard Table Beam, End of Run or Interconnecting Beam. Specify Telescopic Table Beam size corresponding nominally to the return worksurface length.

BRTSTB84C	1 x 80.75 x 2	60	8.64	.09	\$350
BRTSTB78C	1 x 74.75 x 2	60	7.99	.08	\$341
BRTSTB72C	1 x 68.75 x 2	60	7.35	.08	\$329
BRTSTB66C	1 x 62.75 x 2	60	6.74	.07	\$318
BRTSTB60C	1 x 54.75 x 2	60	5.85	.06	\$302
BRTSTB54C	1 x 50.75 x 2	60	5.43	.05	\$280
BRTSTB48C	1 x 44.75 x 2	60	4.78	.05	\$266
BRTSTB42C	1 x 38.75 x 2	60	4.16	.04	\$262
BRTSTB36C	1 x 32.75 x 2	60	3.50	.03	\$251

Allows a worksurface to be supported by a leg on one side and storage tower(s) or spine of 21" and 25" interconnected storage units on the opposite side. Specify Storage Table Beam size corresponding nominally to the worksurface length. Includes all hardware necessary to connect the storage beam to the legs and worksurface.

BRTSA21	1 x 15.2 x 6.5	60	2.15	.05	\$120
BRTSA25	1 x 15.2 x 2.75	60	4.30	.02	\$103

Allows a worksurface to be supported by a leg on one side and storage spine on the opposite side. A typical storage spine is formed by series of Interconnected 21" or 25" storage cabinets of corresponding depth. The 21" or 25" adaptors provide structural support, acting as supports between the top of the storage cabinet spine and the bottom of the perpendicular worksurfaces. The flexible leg/beam/adaptor assembly arrangement allows the leg to be tucked in under the worksurface or to be shared by two adjacent worksurfaces. Specify Storage Beam nominally 18" shorter than worksurfaces for storage spine support application. Specify BRTSA21 or BRTSA25 depending on height of storage units forming the spine. Includes all hardware necessary to connect the adapter to the beam, worksurface and storage spine.

Required Specifications

Metal Finish

WORKSURFACES

MODEL# DIMENSIONS FREIGHT CLASS WT/LBS. CUBIC FT. LIST PRICE HP ADD

D x W x H

BRTWS2484	24 x 84 x 1	60	55	1.80	\$499	\$154
BRTWS2478	24 x 78 x 1	60	51	1.70	\$460	\$148
BRTWS2472	24 x 72 x 1	60	47	1.54	\$431	\$145
BRTWS2466	24 x 66 x 1	60	43	1.41	\$411	\$136
BRTWS2463	24 x 62.5 x 1	65	39	1.41	\$404	\$138
BRTWS2460	24 x 60 x 1	60	39	1.30	\$394	\$131
BRTWS2454	24 x 54 x 1	65	35	1.20	\$355	\$115
BRTWS2451	24 x 50.5 x 1	65	31	1.06	\$359	\$115
BRTWS2448	24 x 48 x 1	65	31	1.06	\$300	\$104
BRTWS2442	24 x 42 x 1	60	28	.90	\$251	\$85
BRTWS2436	24 x 36 x 1	60	23	.71	\$192	\$65
BRTWS3084	30 x 84 x 1	60	69	2.24	\$537	\$165
BRTWS3078	30 x 78 x 1	60	64	2.10	\$483	\$153
BRTWS3072	30 x 72 x 1	65	59	2	\$455	\$151
BRTWS3066	30 x 66 x 1	60	54	1.80	\$427	\$145
BRTWS3063	30 x 62.5 x 1	65	49	1.77	\$417	\$140
BRTWS3060	30 x 60 x 1	65	49	1.77	\$411	\$136
BRTWS3054	30 x 54 x 1	60	44	1.44	\$383	\$115
BRTWS3051	30 x 50.5 x 1	65	39	1.41	\$377	\$120
BRTWS3048	30 x 48 x 1	65	39	1.41	\$355	\$115
BRTWS3042	30 x 42 x 1	60	34	1.12	\$334	\$112
BRTWS3036	30 x 36 x 1	65	30	1.06	\$238	\$81
BRTWS3663	36 x 62.5 x 1	65	53	1.94	\$625	\$162
BRTWS3651	36 x 50.5 x 1	65	43	1.71	\$556	\$93

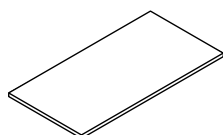

Rectangular Worksurface

Flat 3 mm edge profile on all sides.

BRTWSAA2484	24 x 84 x 1	60	51	1.70	\$594	\$289
BRTWSAA2478	24 x 78 x 1	60	47	1.54	\$563	\$258
BRTWSA2472	24 x 72 x 1	60	47	1.54	\$517	\$238
BRTWSA2466	24 x 66 x 1	60	43	1.41	\$480	\$206
BRTWSA2460	24 x 60 x 1	60	39	1.30	\$442	\$187
BRTWSA2454	24 x 54 x 1	65	35	1.20	\$392	\$179
BRTWSA2448	24 x 48 x 1	65	31	1.06	\$355	\$160
BRTWSA2442	24 x 42 x 1	60	28	.90	\$315	\$140
BRTWSAA3084	30 x 84 x 1	60	64	2.10	\$706	\$349
BRTWSAA3078	30 x 78 x 1	65	59	2	\$665	\$327
BRTWSA3072	30 x 72 x 1	65	59	2	\$615	\$285
BRTWSA3066	30 x 66 x 1	60	54	1.80	\$577	\$256
BRTWSA3060	30 x 60 x 1	65	49	1.77	\$517	\$238
BRTWSA3054	30 x 54 x 1	60	44	1.44	\$469	\$216
BRTWSA3048	30 x 48 x 1	65	39	1.41	\$420	\$187
BRTWSA3042	30 x 42 x 1	60	34	1.12	\$372	\$168

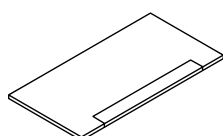

Rectangular Worksurface with Access Door

Flat 3 mm edge profile on all sides. Worksurfaces 42" to 72" w have one access door. 78" w and 84" w worksurfaces have two access doors. Access door is offset 13.5" from either side of work surface. Anodized aluminum work surface door provides access to power/data trough below work surface. Work surface with access doors CANNOT be combined with above work surface power trough.

BRTWBE2451R	24 x 50.5 x 1	65	31	1.06	\$355	\$115
BRTWBE2463R	24 x 62.5 x 1	65	39	1.41	\$411	\$136
BRTWBE3051R	30 x 50.5 x 1	65	39	1.41	\$383	\$115
BRTWBE3063R	30 x 62.5 x 1	65	49	1.77	\$427	\$145

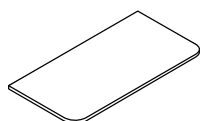

Rectangular Boardroom Table Top Extension, Round Corners

Flat 3 mm edge profile on all sides. Boardroom table extensions convert existing 24" or 30" deep back-to-back Bridges table assembly into a boardroom table. 24" and 30" d rectangular top with round corner can only be supported by 34" double leg and extension beams. *No freestanding and mobile application.*

Required Specifications

Top finish
Edge finish

Optional Specifications

HP laminate

WORKSURFACES

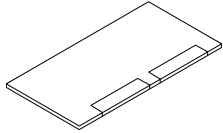

Rectangular Worksurface with 2 Access Doors

MODEL#	DIMENSIONS D x W x H	FREIGHT CLASS	WT./LBS.	CUBIC FT.	LIST PRICE	HP ADD
BRTWSAA2484	24 x 84 x 1	60	51	1.70	\$594	\$289
BRTWSAA2478	24 x 78 x 1	60	47	1.54	\$563	\$258
BRTWSAA2472	24 x 72 x 1	60	43	1.41	\$556	\$257
BRTWSAA2466	24 x 66 x 1	60	39	1.30	\$517	\$226
BRTWSAA2460	24 x 60 x 1	65	35	1.20	\$476	\$203
BRTWSAA3084	30 x 84 x 1	60	64	2.10	\$706	\$349
BRTWSAA3078	30 x 78 x 1	65	59	2	\$665	\$327
BRTWSAA3072	30 x 72 x 1	60	54	1.80	\$659	\$308
BRTWSAA3066	30 x 66 x 1	65	49	1.77	\$622	\$272
BRTWSAA3060	30 x 60 x 1	60	44	1.44	\$556	\$257

Flat 3 mm edge profile on all sides. Access doors are offset 10" (60" worksurfaces) and 13.5" (worksurfaces 66" and wider) from either side of worksurface. Anodized aluminum worksurface doors provide access to power/data trough below worksurface. Worksurfaces with access doors CANNOT be combined with above worksurface power troughs. Dimension between doors is 8" for 60" and 66" surfaces, 20" for 78", and 26" for 84".

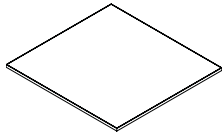

Meeting Table Top

BRTWS2451	24 x 50.5 x 1	65	31	1.06	\$359	\$115
BRTWS3051	30 x 50.5 x 1	65	39	1.41	\$377	\$120
BRTWS3651	36 x 50.5 x 1	65	43	1.71	\$556	\$93
BRTWS4251	42 x 50.5 x 1	65	48	1.93	\$615	\$165
BRTWS4851	48 x 50.5 x 1	65	52	2.07	\$699	\$183
BRTWS5151	50.5 x 50.5 x 1	65	55	2.12	\$748	\$173
BRTWS5451	54 x 50.5 x 1	65	59	2.19	\$808	\$226
BRTWS6051	60 x 50.5 x 1	65	63	2.26	\$919	\$231
BRTWS2463	24 x 62.5 x 1	65	39	1.41	\$404	\$138
BRTWS3063	30 x 62.5 x 1	65	49	1.77	\$417	\$140
BRTWS3663	36 x 62.5 x 1	65	53	1.94	\$625	\$162
BRTWS4263	42 x 62.5 x 1	65	57	2.07	\$748	\$196
BRTWS4863	48 x 62.5 x 1	65	61	2.13	\$898	\$227
BRTWS5463	54 x 62.5 x 1	65	63	2.21	\$1009	\$255
BRTWS6063	60 x 62.5 x 1	65	67	2.34	\$1124	\$279

Can create convenient, flexible extension of the back-to-back Bridges table assembly. Worksurfaces provided with pilot holes for alignment purposes.

- Meeting table top 50.5" long side matches 24" deep back-to-back Bridges table assembly
- Meeting table top 62.5" long side matches 30" deep back-to-back Bridges table assembly

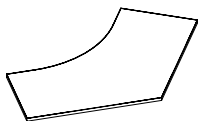

120° Worksurface

BRTWAC120424224	24 x 42 x 1	65	31	1.06	\$886	\$291
BRTWAC120424230	30 x 42 x 1	65	39	1.41	\$965	\$295

5-sided worksurface can be used for a single, freestanding table, can form a pod of two or three tables, or can be combined with rectangular worksurfaces to create a larger workstation.

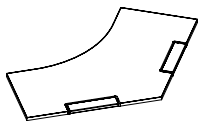

120° Worksurface with Access Door

BRTWAC120A424224	24 x 42 x 1	65	31	1.06	\$943	\$316
BRTWAC120A424230	30 x 42 x 1	65	39	1.41	\$1019	\$395

5-sided worksurface can be used for a single, freestanding table, can form a pod of two or three tables, or can be combined with rectangular worksurfaces to create a larger workstation. Access door is offset 13.5" from either side of worksurface. Anodized aluminum worksurface door provides access to power/data trough below worksurface. Worksurface with access doors CANNOT be combined with above worksurface power trough.

Required Specifications

Top finish
Edge finish

Optional Specifications

HP laminate

WORKSURFACES

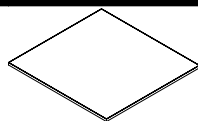

Rectangular Meeting Table Top*

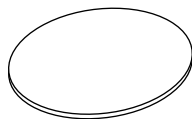

Round Meeting Table Top*

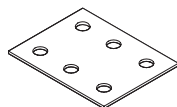

Flat Bracket

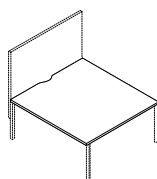

Display Wall Table Top w/Scoop*

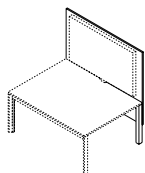

Monitor Facing Double Workstation**

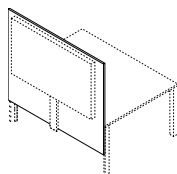

Monitor Facing Back of Double Workstation**

MODEL# DIMENSIONS FREIGHT CLASS WT./LBS. CUBIC FT. LIST PRICE HP ADD

	D x W x H					
BRTMT5151	50.5 x 50.5 x 1	65	55	2.12	\$703	\$392

50.5"long side matches 24"d back-to-back table assembly.

BRTMTR42	42 x 42 x 1	65	40	1.76	\$469	\$119
----------	-------------	----	----	------	--------------	--------------

BHBF01	4 x 3	70	.50	.01	\$22	
--------	-------	----	-----	-----	-------------	--

Constructed of cold rolled steel. May be used to ensure alignment of neighboring worksurfaces.

BRTWS6051SCP	60 x 50.5 x 1	60	75	1.75	\$899	\$228
BRTWS5451SCP	54 x 50.5 x 1	60	68	1.58	\$794	\$222
BRTWS4863SCP	48 x 62.5 x 1	60	75	1.74	\$880	\$223

BRTWS6063SCP	60 x 62.5 x 1	60	93	2.17	\$1100	\$272
BRTWS5463SCP	54 x 62.5 x 1	60	84	1.95	\$992	\$249
BRTWS4863SCP	48 x 62.5 x 1	60	75	1.74	\$880	\$223

Display wall mounts to the end of back-to-back table assembly supported by rectangular legs. As opposed to two separate back-to-back worksurfaces, the display wall table top provides one continuous, uninterrupted surface with a scoop cutout next to the display wall (the scoop facilitates cable passage from below the table). Table top 50.5" w side matches 24" d back-to-back table assemblies. Meeting table tops 62.5" w side matches 30" d back-to-back table assemblies.

BRTTVF63	4 x 62.5 x 52	100	74	7.52	\$1757	
BRTTVF51	4 x 50.5 x 52	92.5	62	6.08	\$1663	

Display wall faces the double workstation; facilitates seated presentation area. Includes laminate board, TV/display brackets (black), mounting hardware, vertical cable manager (black). Slim (22mm) bracket capable of supporting displays/TVs up to 50" (resp. 62") wide, up to 80lbs. When installed, top of the 52" x 50.5" (resp. 62.5") wide board reaches 65.5"h. 1" LP laminate board with 3mm edging. Specify **WHB** to add HP white, dry-erase marker board laminate on non-display board surface and standard HP laminate on the opposite side. Display wall mounts to the end of back-to-back table assembly supported by rectangular legs or back-to-back table structure with BRTWSxxxxSCP Display Wall Table Top with Scoop.

- Included vertical cable manager passes through the gap between 2 back-to-back worksurfaces. Should you need one continuous, uninterrupted surface specify BRTWSxxxxSCP Display Wall Table Top with Scoop.
- Add **\$1036** for white, dry erase on 51" w model, and **\$1383** for 63" w

BRTTVBK63	4 x 62.5 x 52	100	74	7.52	\$1757	
BRTTVBK51	4 x 50.5 x 52	92.5	62	6.08	\$1663	

Display wall support board mounts to end of back-to-back table assembly supported by rectangular legs. Display faces back of the double workstation (combine with collaborative seating). Includes laminate board, TV/display brackets (black), mounting hardware, vertical cable manager (black). Slim (22mm) bracket capable of supporting displays/TVs up to 50" (resp. 62") wide, up to 80lbs. When installed, top of the 52" x 50.5" (resp. 62.5") wide board reaches 65.5"h. 1" LP laminate board with 3mm edging. Specify **WHB** to add HP white, dry-erase marker board laminate on non-display board surface and standard HP laminate on the opposite side. Display wall mounts to the end of back-to-back table assembly supported by rectangular legs or back-to-back table structure with BRTWSxxxxSCP Display Wall Table Top with Scoop.

- Add **\$1036** for white, dry erase on 51" w model, and **\$1383** for 63" w

Required Specifications

Top finish
Edge finish

Optional Specifications

HP laminate

POWER DELIVERY / CABLE MANAGEMENT

D x W x H

At the basic level, table and floor based office equipment is serviced by a wall or floor power supply. As the operation grows, there might be a need to organize excessive cable clutter.

Wire Basket (1) connects to the underside of worksurfaces with sprig brackets, and cables are simply dropped and coiled into them. *Wire Basket is not to be used with power troughs.*

Cable Snake (2) Installed in proximity of floor monument to manage vertical cable clutter.

Table clamped, single circuit **Desk Top Power Data Modules (3)** deliver services to desk height, while tapping into wall or floor power supply. Again, the excessive cables can be managed with Cable Trays.

Ceiling pole **BRTCPP (4)** manages power and data cables between ceiling and above or below worksurface power troughs.

Above and Below Worksurface Power/Data Troughs (5) can be installed between back-to-back tables for extended below and above desk height power/data distribution. 8 wire, 4-circuit system. (2 + 2 circuit configuration)

NOTE: Specify **BRTHH58 (8)** to distribute power from double-sided, back-to-back below worksurface power trough to a single-sided, below worksurface power trough at the end of a table run.

Leg shroud (9) attaches to 34" w legs and manages power floor feed, as well as data cables from floor monument.

Single Sided Power/Data Troughs (6) can be installed to the underside of a single table.

Storage power/data box BRTVCM (7) attaches to storage units and provides access to one duplex/data terminal on top storage surface. Integrated single circuit module can be plugged to floor monument under the storage or to a wall outlet

4-2-2 Wiring Schematic

8-Wire Shared Neutral

"2 + 2" - 2 Utility Circuits, 2 Dedicated

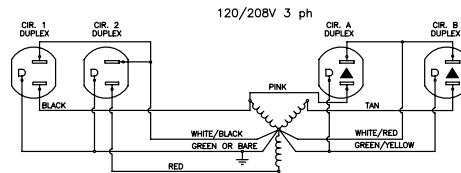
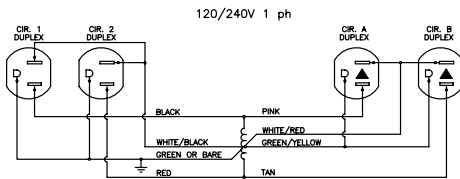

8 Wires

4 Lines (12 ga.)
2 Neutrals (10 ga.)
2 Grounds (12 ga.)

4 Circuits

2 Utility circuits
2 Dedicated Circuits

Receptacles

Duplex - Up to 12 duplex receptacles per circuit
(Up to 48 per infeed)

Specifications

System rated for connection to a grounded 120/240 V single phase, 20A, 60Hz or 120/208 V, 3 phase, 20A, 60Hz branch circuit for U.S. and 15A if product is marked with a C-UL Mark. Outlets rated 15A max.

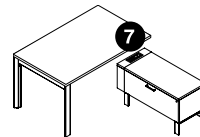
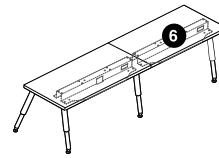
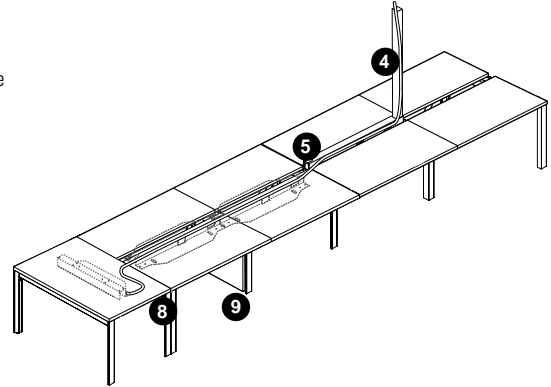
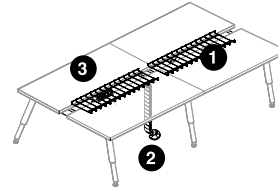

POWER DELIVERY / CABLE MANAGEMENT

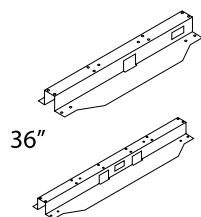

42" - 72"

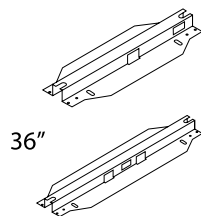
Below Worksurface Single Power/Data Trough

42" - 72"

Below Worksurface Double Power/Data Trough

MODEL# DIMENSIONS FREIGHT CLASS WT/LBS. CUBIC FT. LIST PRICE

D x W x H

MODEL#	DIMENSIONS	FREIGHT CLASS	WT/LBS.	CUBIC FT.	LIST PRICE
BRTEETB84SKIT	11.6 x 78.34 x 2.5	100	12	1.31	\$1129
BRTEETB78SKIT	11.6 x 72.34 x 2.5	100	11	1.21	\$1081
BRTEETB72SKIT	11.6 x 66.34 x 2.5	100	9.80	1.11	\$703
BRTEETB66SKIT	11.6 x 60.34 x 2.5	100	8.90	1.01	\$680
BRTEETB60SKIT	11.6 x 54.34 x 2.5	100	8	.91	\$655
BRTEETB54SKIT	11.6 x 48.34 x 2.5	100	7.10	.81	\$642
BRTEETB48SKIT	11.6 x 42.34 x 2.5	100	6.20	.71	\$615
BRTEETB42SKIT	11.6 x 36.34 x 2.5	100	5.30	.61	\$568
BRTEETB36SKIT	11.6 x 30.34 x 2.5	125	4.50	.59	\$517

Formed steel trough is secured below a single table worksurface; outlets are facing the rear worksurface edge. Cannot be used on back-to-back tables. Specify Duplex receptacles separately. *Covers for duplex openings are not supplied.* 36" trough can house one duplex and 42-72" trough can house two duplexes. Specify jumpers between tables separately. Base feed entry at either end and not suitable for ceiling feed. Each trough provides one opening at 1.37" x 2.68" for terminal plate (not supplied). One terminal plate can accommodate up to 4 data/communication terminals (jacks). Data/comm plate spacer BRTPDS available to accommodate larger cable-to-terminal bending radius.

- BRTEETB36SKIT through BRTEETB72SKIT consist of one single sided steel trough, Power Distribution housing, mounting brackets and one charcoal grey extruded Data/Communication cable manager.
- BRTEETB78SKIT and BRTEETB84SKIT consist of two single-sided steel troughs, two Power Distribution Housings, mounting brackets and two charcoal grey extruded Data/Communication cable managers.
- BRTEETB78SKIT includes (1) BRTEETB36SKIT, (1) BRTEETB42SKIT and (1) JUMPER
- BRTEETB84SKIT includes (2) BRTEETB42SKIT and (1) JUMPER
- For 120° table applications, please specify BRTEETB36SKIT single trough kit for tables with BRTWAC120xx and BRTWAC120Axx worksurfaces. BRTEHH28 may be used as usual.
- Specify duplex receptacles separately
- Each trough includes one black BRTPDS Data/Comm spacer, extending the depth behind the Data/Comm opening by 0.6". White (BRTPDSW) and Silver (BRTPDSS). Data/Comm spacers are available as a special order for **\$59** list, see BRTPDS.

BRTEETB84DKIT	8.5 x 78.3 x 2.5	92.5	9.80	.96	\$1458
BRTEETB78DKIT	8.5 x 72.3 x 2.5	92.5	9	.88	\$1437
BRTEETB72DKIT	8.5 x 66.3 x 2.5	92.5	8.30	.81	\$847
BRTEETB66DKIT	8.5 x 60.3 x 2.5	92.5	7.50	.74	\$829
BRTEETB60DKIT	8.5 x 54.3 x 2.5	92.5	6.80	.66	\$800
BRTEETB54DKIT	8.5 x 48.3 x 2.5	92.5	6	.59	\$779
BRTEETB48DKIT	8.5 x 42.3 x 2.5	92.5	5.30	.52	\$761
BRTEETB42DKIT	8.5 x 36.3 x 2.5	92.5	4.50	.44	\$730
BRTEETB36DKIT	8.5 x 30.3 x 2.5	92.5	3.80	.37	\$712

Formed steel trough is secured below worksurface; outlets between back-to-back stations supported by double table legs. Cannot be used on single table assemblies. Specify Duplex receptacles separately. *Covers for duplex openings are not supplied.* 36" trough can house one duplex per side and 42-72" trough can house two duplexes per side. Specify jumpers between tables separately. Ceiling feed entry through slots at either end; base feed entry at either end. Each trough provides one opening at 1.37" x 2.68" (one per side) for data/communication terminal plates. A single terminal plate (not supplied) can accommodate up to 4 data/communication plates. Data/comm plate spacer BRTPDS available to accommodate larger cable-to-terminal bending radius.

- BRTEETB36DKIT through BRTEETB72DKIT consist of one double-sided steel trough, Power Distribution housing, mounting brackets and one charcoal grey extruded Data/Communication cable manager.
- BRTEETB78DKIT and BRTEETB84DKIT consist of two double-sided steel troughs, two Power Distribution Housings, mounting brackets and two charcoal grey extruded Data/Communication cable managers.
- BRTEETB78DKIT includes (1) BRTEETB36DKIT, (1) BRTEETB42DKIT and (1) JUMPER
- BRTEETB84DKIT includes (2) BRTEETD42SKIT and (1) JUMPER
- For back-to-back 120° table applications, please specify BRTEETB42DKIT double trough kit for tables with BRTWAC120xx and BRTWAC120Axx worksurfaces. BRTEHH28 may be used as usual.
- Specify duplex receptacles separately
- Each trough includes one black BRTPDS Data/Comm spacer, extending the depth behind the Data/Comm opening by 0.6". White (BRTPDSW) and Silver (BRTPDSS). Data/Comm spacers are available as a special order for **\$59** list, see BRTPDS.

Required Specifications

Metal Finish (Power/Data Troughs)

ELECTRICAL COMPONENTS

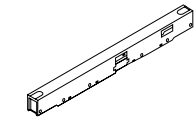

36"

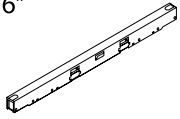

42" - 72"

Above Worksurface Power Trough

MODEL#	DIMENSIONS D x W x H	FREIGHT CLASS	WT/LBS.	CUBIC FT.	LIST PRICE
BRTEETA84KIT	2.5 x 84 x 3.5	65	9.49	.42	\$1265
BRTEETA78KIT	2.5 x 78 x 3.5	65	8.81	.39	\$1217
BRTEETA72KIT	2.5 x 71.9 x 3.5	65	8.12	.36	\$800
BRTEETA66KIT	2.5 x 65.9 x 3.5	65	7.45	.33	\$790
BRTEETA60KIT	2.5 x 59.9 x 3.5	65	6.77	.30	\$730
BRTEETA54KIT	2.5 x 53.9 x 3.5	65	6.09	.27	\$712
BRTEETA48KIT	2.5 x 47.9 x 3.5	65	5.41	.24	\$674
BRTEETA42KIT	2.5 x 41.9 x 3.5	65	4.73	.21	\$634
BRTEETA36KIT	2.5 x 35.9 x 3.5	65	4.06	.18	\$586

Formed steel trough is secured between back-to-back stations. Cannot be used on single table assemblies. Specify Duplex receptacles separately. *Covers for duplex openings are not supplied.* 36" trough side. **Specify jumpers between tables separately.** Ceiling feed entry through can house one duplex per side and 42-72" trough can house two duplexes per slots at either end; base feed entry at either end. Each trough provides two openings at 1.37" x 2.68" (one per side) for data/communication terminal plates. A single terminal plate (not supplied) can accommodate up to 4 data/comm plates. Data/comm plate spacer BRTPDS available to accommodate larger cable-to-terminal bending radius.

- BRTEETA36KIT through BRTEETA72KIT consist of one double-sided steel trough, Power Distribution Housing, mounting brackets and one charcoal grey extruded Data/Communication cable manager.
- BRTEETA78KIT and BRTEETA84KIT consist of two double-sided steel troughs, two Power Distribution Housings, mounting brackets and two charcoal grey extruded Data/Communication cable managers.
- BRTEETA78KIT includes (1) BRTEETA36KIT, (1) BRTEETA42KIT and (1) JUMPER
- BRTEETA84KIT includes (2) BRTEETA42KIT and (1) JUMPER
- Specify above worksurface power trough end cap BRTEETEC to finish open ends of the power trough
- Each trough includes one black BRTPDS Data/Comm spacer, extending the depth behind the Data/Comm opening by 0.6". White (BRTPDSW) and Silver (BRTPDSS). Data/Comm spacers are available as a special order for **\$59** list, see BRTPDS.

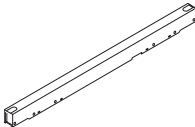

Back-to-Back Storage Tower Gap Filler Kit

BRTEST15KIT	15.5 x 2.5 x 3.5	65	2	.08	\$527
BRTEST24KIT	24 x 2.5 x 3.5	70	2.50	.12	\$572
BRTEST30KIT	31 x 2.5 x 3.5	70	3.50	.16	\$610
BRTEST48KIT	48 x 2.5 x 3.5	70	4	.24	\$673

Consists of a formed sheet metal cover and four brackets which allow the cover to be mounted at either above worksurface power trough level or below worksurface power trough level. Versatile brackets secure the cover trough at corners, to the bottom of back-to-back worksurface supported by either shared 51" or 63" legs or storage beam and storage towers.

- Note: the back-to-back storage tower gap filler is not compatible with single, freestanding tables.
- The BRTEST15kit and BRTEST24kit cover the gap between two back-to-back BRTT5024x or BRTT5030x storage towers
- The BRTEST30kit and BRTEST48kit cover the gap between two pairs of back-to-back BRTT5024x or BRTT5030x storage towers



Above Worksurface Power Trough

BRTEETEC	.5 x 2.25 x 3	70	.10	.01	\$11
----------	---------------	----	-----	-----	-------------

Covers the end of the worksurface power trough. Specify two per linear trough assembly. White finish only.

Required Specifications

Metal Finish (Power/Data Troughs)

ELECTRICAL COMPONENTS

MODEL# DIMENSIONS FREIGHT CLASS WT./LBS. CUBIC FT. LIST PRICE

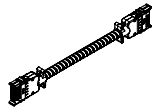

Housing to Housing Harness

D x W x H

BRTEHH28	.5 x 28 x 2	70	1	1.17	\$179
BRTEHH40	.5 x 40.5 x 2	70	1.10	1.25	\$191
BRTEHH44	.5 x 44.5 x 2	70	1.5	1.17	\$206
BRTEHH52	.5 x 52.5 x 2	300	2.0	1.17	\$217
BRTEHH58	.5 x 58.5 x 2	300	2.2	1.17	\$226
BRTEHH76	.5 x 76.5 x 2	250	2.8	1.17	\$252

Distributes power between Power Distribution Housings.

- BRTEHH28 distributes power between back-to-back or single sided troughs in a straight run.
- BRTEHH40 distributes power from back-to-back to single sided power troughs
- BRTEHH44 distributes power between back-to-back power troughs separated by (1) pair of storage cabinets without wardrobes. Specify BRTEST15KIT separately.
- BRTEHH52 distributes power from back-to-back power troughs separated by (1) pair of storage cabinets with wardrobes. Specify BRTEST24KIT separately.
- BRTEHH58 distributes power from back-to-back power troughs separated by (2) pairs of storage cabinets without wardrobes. Specify BRTEST30KIT separately.
- BRTEHH58 also distributes power from double-sided, back-to-back below worksurface power troughs to a single sided, below worksurface power trough at the end of a table run.
- BRTEHH76 distributes power from back-to-back power troughs separated by (2) pairs of storage cabinets with wardrobes. Specify BRTEST48KIT separately.

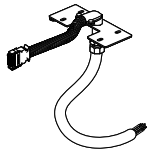

Base Feed

BRTEBF	6 x 4 x 72	250	4	2	\$542
BRTEBF120	6 x 4 x 120	250	6	2	\$755
BRTEBF144	6 x 4 x 144	150	8	2	\$812

Provides single power entry from floor or wall located building power supply. Connects to Power Distribution Housing. Must be hard wired to the building power supply by a licensed electrician.

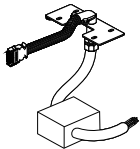

Base Feed - New York Electrical

BRTEBFK	6 x 4 x 100	250	4	2	\$851
---------	-------------	-----	---	---	--------------

Provides single power entry from floor or wall located building power supply. Connects to Power Distribution Housing. Must be hard wired to the building power supply by a licensed electrician.



Ceiling Pole

BRTCPP	1.5 x 4.75 x 99	65	13	.48	\$294
--------	-----------------	----	----	-----	--------------

Brings ceiling feed conduit and data cables from the ceiling down to Power Troughs at desk height. Accommodates 10' ceiling heights. Two part construction allows power/data conduit lay-in. Attaches to a junction between two adjacent Power Troughs in back-to-back applications only. Not for use on single sided Bridges II troughs. Includes mounting hardware and ceiling bezel. Painted Finish.

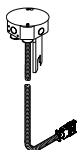

Ceiling Feed

BRTECF120	6 x 6 x 120	250	5	2	\$476
BRTECF144	6 x 6 x 144	250	5	2	\$530

Provides single power entry from ceiling, through ceiling pole into Power Trough, into Power Distribution Module. An 8 wire (4 circuit) metal conduit harness with included metal junction box for hard wiring to the building power supply above ceiling tile. Must be hard wired to the building power supply by a licensed electrician. Ceiling Pole not included.

Required Specifications

Metal Finish (BRTCPP)

ELECTRICAL COMPONENTS

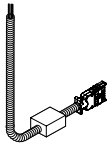

Ceiling Feed - New York Electrical

MODEL#	DIMENSIONS D x W x H	FREIGHT CLASS	WT./LBS.	CUBIC FT.	LIST PRICE
BRTECFK120	6 x 6 x 120	250	5	2	\$712
BRTECFK144	6 x 6 x 144	250	5	2	\$790

Provides single power entry from ceiling, through ceiling pole into Power Trough, into Power Distribution Module. An 8 wire (4 circuit) metal conduit harness with included metal junction box for hard wiring to the building power supply above ceiling tile. Must be hard wired to the building power supply by a licensed electrician. Ceiling Pole not included.

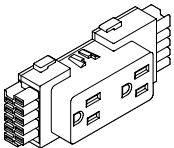

Duplex Receptacles

BRTE8D1	1.25 x 4.63 x 2	70	.10	.01	\$42
BRTE8D2	1.25 x 4.63 x 2	70	.10	.01	\$42
BRTE8DA	1.25 x 4.63 x 2	70	.10	.01	\$42
BRTE8DB	1.25 x 4.63 x 2	70	.10	.01	\$42
BRTE8DXW1	1.25 x 4.63 x 2	70	.10	.01	\$59
BRTE8DXW2	1.25 x 4.63 x 2	70	.10	.01	\$59
BRTE8DXWA	1.25 x 4.63 x 2	70	.10	.01	\$59
BRTE8DXWB	1.25 x 4.63 x 2	70	.10	.01	\$59

Snaps into Power Distribution Housing. Up to 13 duplex receptacles per circuit XW identifies white color plastic, all others standard in black.

- BRTE8D1 / BRTE8DXW1 - Circuit #1 (utility circuit)
- BRTE8D2 / BRTE8DXW2 - Circuit #2 (utility circuit)
- BRTE8DA / BRTE8DXWA - Circuit A (dedicated circuit)
- BRTE8DB / BRTE8DXWB - Circuit B (dedicated circuit)

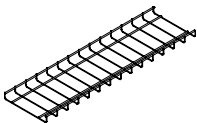

Power/Data Cable Basket

BRTCB76KIT	8 x 34 x 1	70	1.56	.15	\$263
BRTCB70	8 x 70 x 1	100	3.22	.34	\$191
BRTCB64	8 x 64 x 1	92.5	2.94	.29	\$178
BRTCB58	8 x 58 x 1	92.5	2.66	.26	\$172
BRTCB52	8 x 52 x 1	100	2.39	.24	\$162
BRTCB46	8 x 46 x 1	92.5	2.16	.21	\$153
BRTCB40	8 x 40 x 1	70	1.80	.18	\$145
BRTCB34	8 x 34 x 1	70	1.56	.15	\$139
BRTCB28	8 x 28 x 1	70	1.20	.13	\$123
BRTCB22	8 x 22 x 1	70	1.01	.10	\$115
BRTCB16	8 x 16 x 1	70	.73	.07	\$108
BRTCB8	8 x 8 x 1	70	.36	.03	\$97

Shallow, 8" wide basket manages cable excess and serves to manage cords and cables. It can be easily unclipped from spring steel brackets (included) to rearrange cable connections from below worksurface. Spring steel brackets can suspend the Cable Basket below storage cabinet's bottom where it keeps the cords and cables off the floor and manages them under storage cabinets along the horizontal plane - between floor monuments and Storage Vertical Cable Manager, for example. Tall storage cabinet's legs provide easy access to the Cable Basket where it can easily be unclipped from spring steel brackets to rearrange cable connections. Steel wire construction, chrome finish baskets; black spring steel hanging brackets, fasteners.

- Wide Cable Baskets can span under several storage cabinets. Specify Cable Basket a min. 8" shorter than the storage cabinet spine assembly.

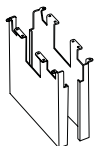

34" Leg Shroud

BRTDLSHS34	5 x 30 x 29	92.5	62	5.25	\$539
------------	-------------	------	----	------	--------------

A two part steel enclosure creates 5" deep and 30" wide cable management cavity between 34" rectangular table legs. Hides floor power feeds as well as data/communication cables rising from floor monuments to the underside of Bridges II tables. Secures to BRTBA34L rectangular leg and to underside of worksurfaces. Specify powder coat finish.

Required Specifications
Metal Finish (BRTDLSHS34)

ELECTRICAL COMPONENTS

**Cable Snake**

MODEL#	DIMENSIONS D x W x H	FREIGHT CLASS	WT./LBS.	CUBIC FT.	LIST PRICE
--------	-------------------------	---------------	----------	-----------	------------

BRTCS	2 x 8 x 30	70	3	.19	\$152
-------	------------	----	---	-----	--------------

Flexible cable management trough. Two pathways within the snake, one for data/communication and one for routing power cables. Translucent White finish only.

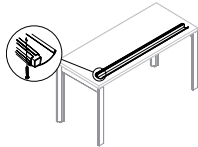
**Wire Manager**

BRTCM43	46 x 5 x 3	92.5	8	.67	\$62
BRTCM55	58 x 5 x 3	92.5	9	.85	\$72

Replacement wire manager can be added. Wire Manager neatly organizes and stores electrical and communication cables. Two lengths: 46" for tops 60" and under; 58" for tops 72". Black Plastic only.

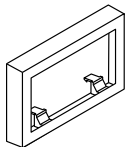
**Data/Comm Spacer**

BRTPDS	.6 x 4.75 x 2.04	70	.10	.01	\$59
BRTPDSW	.6 x 4.75 x 2.04	70	.10	.01	\$59
BRTPDSS	.6 x 4.75 x 2.04	70	.10	.01	\$59

Data/Comm plate spacer extends the depth behind data/comm jacks by 0.6" in order to accommodate larger data/comm cable bending radius. BRTPDS is Black, BRTPDSW is White and BRTPDSS is Silver.

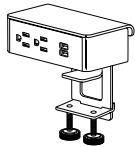
**Duo Module**

BRED50	3.2 x 5.5 x 1.8	70	2.50	.14	\$386
--------	-----------------	----	------	-----	--------------

The duo power module is completely integrated with a mounting clamp to attach to the edge of a worksurface. Provides two outlets and two 2.1 amp USB ports. White face plate, outlets and bracket; 72" long three-prong black cord, silver body.

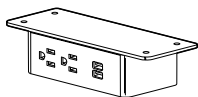
**Duo Under Module**

BREDU51	2.8 x 5.5 x 1.8	70	2.50	.14	\$335
---------	-----------------	----	------	-----	--------------

The duo under power module comes with a thin flush mounting bracket to attach to the underside of a worksurface or above worksurface shelves. Provides two outlets and two 2.1 amp USB ports. White face plate, outlets and brackets; 72" long three-prong black cord, silver body.

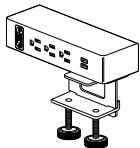
**Trio Plus Module**

BRETP53	3.2 x 8 x 1.8	70	2.50	.14	\$436
---------	---------------	----	------	-----	--------------

The trio plus power module is completely integrated with a mounting clamp to attach to the edge of a worksurface or above worksurface shelves. Provides three outlets and two 2.1 amp USB ports and an adapter kit containing blank cover, HDMI, RJ45 or VGA adapter brackets. Note: HDMI, RJ45 and VGA connectors are not included. White face plate, outlets, adapters and brackets; 72" long three-prong black cord.

ELECTRICAL COMPONENTS

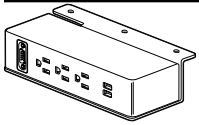

Trio Plus Under Module

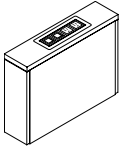

Vertical Cable Manager*

MODEL#	DIMENSIONS	FREIGHT CLASS	WT./LBS.	CUBIC FT.	LIST PRICE
--------	------------	---------------	----------	-----------	------------

	D x W x H				
BRETPU54	2.8 x 8 x 1.8	70	2.50	.14	\$406

The trio plus under power module comes with a thin flush mounting bracket to attach to the underside of a worksurface. Provides three outlets and two 2.1 amp USB ports and an adapter kit containing blank cover, HDMI, RJ45 or VGA adapter brackets. Note: HDMI, RJ45 and VGA connectors are not included. White face plate, outlets, adapters and brackets; 72" long three-prong black cord.

BRTVCM2118	18 x 6 x 21	92.5	14	1.31	\$1069
BRTVCM2518	18 x 6 x 25	92.5	17	1.56	\$1091
BRTVCM2124	24 x 6 x 21	100	17	1.75	\$1129
BRTVCM2524	24 x 6 x 25	92.5	22	2.08	\$1147

Facilitates power/data transfer from a floor monument under storage cabinets. The units can join other 18" or 24" deep storage units to form a storage spine. Removable top with a Below worksurface Power/Data Module provides easy access. Optional cable basket suspends off storage unit's bottom and manages cables along the horizontal plane. 1" top, unfinished cut-out edges. Universal connecting hardware included. Below Worksurface Power/Data Module included. Provides power - two outlets; 72"L 3-prong power cord. White face plate, outlets and coupler & jack adapters; anodized aluminum bracket supports; thumb screws, black cord. Provides data - two coupler/jack ports; includes Voice/Data Adapter Kit to accept various couplers & jacks (Not Included).

Required Specifications

- Top finish*
- Edge finish*
- Chassis finish*

ACCESSORIES / TABLE DIVIDERS MODEL# DIMENSIONS FREIGHT CLASS WT./LBS. CUBIC FT. LIST PRICE

- 9mm thick panels offered in 9 finishes
- Made from 100% PET (polyester) fiber with a high content (50%) of post-recycled material, free of added chemicals, binders and adhesives
- Lightweight panels are tackable, impact and tear resistant, bacteria resistant, moisture resistant, and installation friendly
- Variation in fiber mix and color are inherent to the character of the product

BRACKET/EXTRUSION FINISH

- BLK Black
- CHR Charcoal
- DWT Designer White
- FOG Fog
- NEV Nevada
- SIL Silver
- TPE Taupe
- TUN Tungsten
- ANO Anodized Aluminum - upcharge applies. *Available on select models only. Refer to model for availability and upcharge.*

FELT COLORS

- BLK Black MTS Mist
- BRI Brick PWT Pewter
- DEN Denim SHR Shamrock
- GPH Graphite WHT White
- HVT Harvest

FELT DIVIDERS MODEL# DIMENSIONS FREIGHT CLASS WT./LBS. CUBIC FT. LIST PRICE

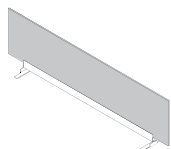

Back-to-Back Parallel Felt Divider

BRTAFDD84	7.5 x 81 x 16.88	125	6.30	1	\$710
BRTAFDD78	7.5 x 75 x 16.88	125	5.90	.92	\$677
BRTAFDD72	7.5 x 69 x 16.88	125	5.40	.85	\$645
BRTAFDD66	7.5 x 63 x 16.88	125	5	.77	\$611
BRTAFDD60	7.5 x 57 x 16.88	125	4.60	.70	\$577
BRTAFDD54	7.5 x 51 x 16.88	125	4.10	.63	\$546
BRTAFDD48	7.5 x 45 x 16.88	125	3.70	.55	\$384
BRTAFDD42	7.5 x 39 x 16.88	125	3.20	.48	\$340
BRTAFDD36	7.5 x 33 x 16.88	125	2.80	.41	\$305

Secures between two back-to-back tables; provides privacy, divides space. 9mm felt material is tackable. Installed divider measures 15.7" from the top of the worksurface. Available in 9 PET felt colors. Please specify. Brackets and extrusion available in all standard Bridges II paint finishes. 36"- 72" wide dividers include 2 support brackets. 78" and 84" wide dividers include 3.

- Anodized Aluminum extrusion - Add **\$164** list upcharge

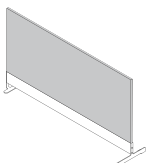

Perpendicular Side to Side Off Module Felt Divider

BRTAFPPD30M	6.5 x 30.24 x 16.85	100	2.60	.27	\$289
BRTAFPPD24M	6.5 x 24.24 x 16.85	100	2.10	.22	\$256

Secures off module to front and back edges of a table; provides privacy, divides space. 9mm felt material is tackable. 24M and 30M kits are designed to be installed on tables with **recessed** legs (round legs, 34" rectangular legs). Cannot be installed at the end of a run. Installed divider measures 15.7" from the top of the worksurface. Available in 9 PET felt colors. Please specify. Brackets and extrusion available in all standard Bridges II paint finishes.

- Anodized Aluminum extrusion - Add **\$164** list upcharge

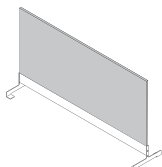

Perpendicular Side to Side Felt Divider

BRTAFPPD63S	6.5 x 62.81 x 16.85	100	4.20	.46	\$600
BRTAFPPD51S	6.5 x 50.81 x 16.85	100	4.20	.46	\$535
BRTAFPPD30S	6.5 x 30.24 x 16.85	92.5	2.70	.27	\$296
BRTAFPPD24S	6.5 x 24.24 x 16.85	92.5	2.30	.22	\$263

Secures to the front edge of both worksurfaces, regardless of type of leg support - supporting brackets can straddle over shared leg; provides privacy, divides space. 9mm felt material is tackable. Cannot be installed at the end of a run. Installed divider measures 15.7" from the top of the worksurface. Available in 9 PET felt colors. Please specify. Brackets and extrusion available in all standard Bridges II paint finishes.

- Anodized Aluminum extrusion - Add **\$164** list upcharge

Required Specifications

- Felt color
- Bracket/extrusion finish

Optional Specifications

- Anodized extrusion

FELT DIVIDERS

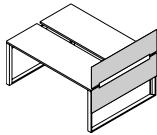
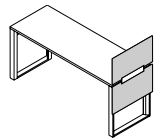

End of Run Felt Divider & Modesty Kit*

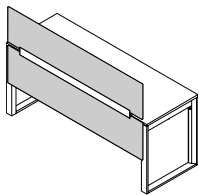

Felt Divider & Modesty Panel Kit*

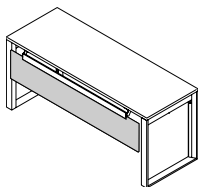

Felt Modesty Panel

MODEL#	DIMENSIONS D x W x H	FREIGHT CLASS	WT/LBS.	CUBIC FT.	LIST PRICE
BRTAFEDN24	4.05 x 25.46 x 30.68	250	3.3	1.12	\$443
BRTAFEDN30	4.05 x 31.46 x 30.68	250	3.98	1.29	\$497
BRTAFEDN51	4.05 x 50.56 x 30.68	150	6.22	1.46	\$912
BRTAFEDN63	4.05 x 62.56 x 30.68	150	7.57	1.63	\$1039

Secures to the side bottom of a single or back-to-back table; provides privacy above and below the worksurface. 9mm felt material is tackable. Installed divider measures 15.7" from the top of the worksurface and 15" below the worksurface. Kit includes two felt dividers, support extrusion and left and right brackets. Available in 9 PET felt colors. Please specify. Brackets and extrusion available in all standard Bridges II paint finishes.

BRTAFDSN84	4.05 x 78 x 30.68	125	9.24	1.2	\$1241
BRTAFDSN78	4.05 x 72 x 30.68	125	8.57	1.11	\$1182
BRTAFDSN72	4.05 x 69 x 30.68	125	7.89	1.02	\$1124
BRTAFDSN66	4.05 x 63 x 30.68	125	7.21	0.93	\$979
BRTAFDSN60	4.05 x 57 x 30.68	125	6.54	0.84	\$935
BRTAFDSN54	4.05 x 51 x 30.68	125	5.87	0.74	\$878
BRTAFDSN48	4.05 x 45 x 30.68	125	5.19	0.65	\$726

Secures to the rear bottom of a single table; provides privacy above and below the worksurface. 9mm felt material is tackable. Installed divider measures 15.7" from the top of the worksurface and 15" below the worksurface. Kit includes two felt dividers, support extrusion and left and right brackets. Available in 9 PET felt colors. Please specify. Brackets and extrusion available in all standard Bridges II paint finishes.

- 66" - 84" dividers require 3 support brackets and cannot be used with worksurfaces that have a single access door.

BRTAFMPSN84	4.17 x 77.75 x 13.82	65	31.12	1.2	\$530
BRTAFMPSN78	4.17 x 71.75 x 13.82	65	28.72	1.11	\$502
BRTAFMPSN72	4.17 x 65.75 x 13.82	65	26.32	1.02	\$476
BRTAFMPSN66	4.17 x 59.75 x 13.82	65	23.92	0.93	\$449
BRTAFMPSN60	4.17 x 53.75 x 13.82	65	21.51	0.84	\$423
BRTAFMPSN54	4.17 x 47.75 x 13.82	65	19.11	0.74	\$405
BRTAFMPSN48	4.17 x 41.75 x 13.82	65	16.71	0.65	\$297

Secures to the rear bottom of a single table; provides privacy below the worksurface. 9mm felt material is tackable. Installed divider measures 15" below the worksurface. Kit includes felt modesty, support extrusion and left and right brackets. Available in 9 PET felt colors. Please specify. Brackets and extrusion available in all standard Bridges II paint finishes.

- 66" - 84" dividers require 3 support brackets and cannot be used with worksurfaces that have a single access door.

Required Specifications

Felt color
Bracket/extrusion finish

TABLE DIVIDERS

MODEL# DIMENSIONS FREIGHT CLASS WT./LBS. CUBIC FT. LIST PRICE

D x W x H

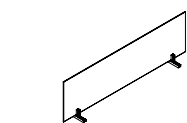

36" - 72"

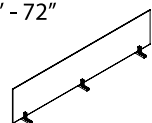

78" - 84"

Table Divider - Glass

BRTAGDD84	.25 x 81 x 16	60	29	.18	\$868
BRTAGDD78	.25 x 75 x 16	60	27	.17	\$819
BRTAGDD72	.25 x 69 x 16	60	25	.16	\$703
BRTAGDD66	.25 x 63 x 16	60	23	.14	\$655
BRTAGDD60	.25 x 57 x 16	60	21	.13	\$604
BRTAGDD54	.25 x 51 x 16	60	18	.11	\$577
BRTAGDD48	.25 x 45 x 16	60	16	.10	\$530
BRTAGDD42	.25 x 39 x 16	60	14	.09	\$489
BRTAGDD36	.25 x 33 x 16	60	12	.07	\$442

Secures between two back-to-back tables; provides privacy, divides space. Installed divider measures 15.7" from the top of the worksurface. 36" - 72" wide dividers include 2 support brackets. 78" and 84" wide dividers include 3. Frosted tempered glass. Satin chrome lower bracket, upper is available in all standard Bridges II paint finishes.

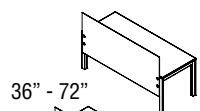

36" - 72"

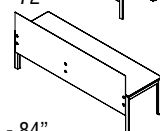

78" - 84"

Parallel Table Divider - Glass

BRTAGDS84	.25 x 81 x 32	60	55	.35	\$1655
BRTAGDS78	.25 x 75 x 32	60	51	.33	\$1573
BRTAGDS72	.25 x 69 x 32	60	47	.30	\$1317
BRTAGDS66	.25 x 63 x 32	60	43	.28	\$1238
BRTAGDS60	.25 x 57 x 32	60	39	.25	\$1158
BRTAGDS54	.25 x 51 x 32	60	35	.23	\$1081
BRTAGDS48	.25 x 45 x 32	60	31	.20	\$1000
BRTAGDS42	.25 x 39 x 32	60	27	.18	\$921
BRTAGDS36	.25 x 33 x 32	60	23	.15	\$844

Secures to the rear edge of a single table; provides privacy, divides space while not obstructing available light. 36" - 72" wide dividers include 2 support brackets. 78" and 84" wide dividers include 3. Frosted tempered glass. Satin chrome lower bracket, upper is available in all standard Bridges II paint finishes.

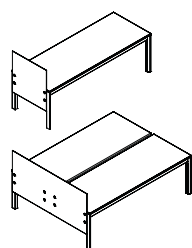

Perpendicular End of Run Divider - Glass

BRTAGED63	.25 x 62.5 x 32	60	35	.23	\$1735
BRTAGED51	.25 x 50.5 x 32	60	31	.20	\$1573
BRTAGED30	.25 x 30 x 32	60	27	.18	\$882
BRTAGED24	.25 x 24 x 32	60	23	.15	\$805

Secures to the rear edge of a single or double back-to-back table; provides privacy, divides space while not obstructing available light. Installed divider reaches 15.7" from the top of the worksurface and 15" below the worksurface. Rounded front top corner of 24" and 30" deep glass dividers. 51" and 63" glass dividers for back-to-back tables have both top corners rounded. 24" and 30" wide dividers include 2 support brackets; 51" and 63" wide dividers include 3. Frosted tempered glass. Satin chrome lower bracket, upper is available in all standard Bridges II paint finishes.

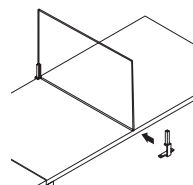

Shared Perpendicular Side to Side Divider, Middle - Glass, Rounded Corners

BRTAGPPD24M	.25 x 24 x 16	60	9	.06	\$505
BRTAGPPD30M	.25 x 30 x 16	60	11.25	.07	\$531

Provides privacy, divides space while not obstructing available light. 24M and 30M kits are designed to be installed on tables with **recessed** legs (round legs, 34" rectangular legs). 24" and 30" kits consist of a wide rear bracket, narrow front bracket (white powder coated steel), tempered glass with **rounded** top corners (acid etched on one side), bracket-fitting gaskets and mounting screws securing the brackets to the underside of the worksurface. Satin chrome lower bracket, upper is available in all standard Bridges II paint finishes.

Required Specifications

Bracket finish

TABLE DIVIDERS

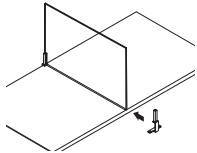

Shared Perpendicular Side to Side Divider, Middle - Glass, Square Corners

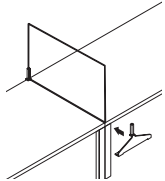

Shared Perpendicular Side to Side Divider, Seam - Glass, Rounded Corners

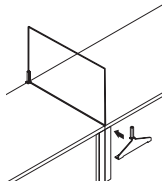

Shared Perpendicular Side to Side Divider, Seam - Glass, Square Corners

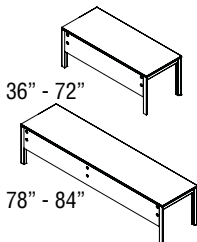

Modesty Panel - Glass

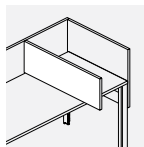

Perpendicular Laminate Side to Side Divider - Extended*

MODEL#	DIMENSIONS D x W x H	FREIGHT CLASS	WT/LBS.	CUBIC FT.	LIST PRICE
BRTAGPPD24MQ	.25 x 24 x 16	60	9	.06	\$505
BRTAGPPD30MQ	.25 x 30 x 16	60	11.25	.07	\$531

Provides privacy, divides space while not obstructing available light. 24M and 30M kits are designed to be installed on tables with **recessed** legs (round legs, 34" rectangular legs). 24" and 30" kits consist of a wide rear bracket, narrow front bracket (white powder coated steel), tempered glass with **square** top corners (acid etched on one side), bracket-fitting gaskets and mounting screws securing the brackets to the underside of the worksurface. Brackets are available in all standard Bridges II paint finishes.

BRTAGPPD24S	.25 x 24 x 16	60	9	.05	\$505
BRTAGPPD30S	.25 x 30 x 16	60	11.25	.07	\$531

Provides privacy, divides space while not obstructing available light. 24S and 30S kits are designed to be installed in the middle or over a seam of two adjacent worksurfaces supported by a shared, full depth **rectangular** leg. 24S and 30S kits consist of two wide rear brackets, wide front bracket, tempered glass with **rounded** top corners (acid etched on one side), bracket-fitting gaskets and mounting screws securing the brackets to the underside of the worksurface. Brackets are available in all standard Bridges II paint finishes.

BRTAGPPD24SQ	.25 x 24 x 16	60	9	.05	\$505
BRTAGPPD30SQ	.25 x 30 x 16	60	11.25	.07	\$531

Provides privacy, divides space while not obstructing available light. 24S and 30S kits are designed to be installed in the middle or over a seam of two adjacent worksurfaces supported by a shared, full depth **rectangular** leg. 24S and 30S kits consist of two wide rear brackets, wide front bracket, tempered glass with **square** top corners (acid etched on one side), bracket-fitting gaskets and mounting screws securing the brackets to the underside of the worksurface. Brackets are available in all standard Bridges II paint finishes.

BRTAGMPS84	.25 x 77.75 x 13.25	60	24	.14	\$1081
BRTAGMPS78	.25 x 71.75 x 13.25	60	22	.13	\$1042
BRTAGMPS72	.25 x 65.75 x 13.25	60	20	.12	\$824
BRTAGMPS66	.25 x 59.75 x 13.25	60	19	.11	\$784
BRTAGMPS60	.25 x 53.75 x 13.25	60	17	.10	\$744
BRTAGMPS54	.25 x 47.75 x 13.25	60	15	.09	\$706
BRTAGMPS48	.25 x 41.75 x 13.25	60	11	.06	\$667
BRTAGMPS42	.25 x 35.75 x 13.25	60	11	.06	\$625
BRTAGMPS36	.25 x 29.75 x 13.25	60	9	.05	\$587

Secures to the rear edge of a single table, between table legs; provides privacy. Installed divider reaches 15" below the worksurface. 36" - 72" wide modesty panels include 2 mounting brackets. 78" and 84" wide modesty panels include 3 mounting brackets. Tempered glass, acid etched on one side (similar to frosted), and satin chrome disc fasteners. Brackets are available in all standard Bridges II paint finishes.

BRTLPE36	.75 x 36 x 16	60	11	.25	\$301
BRTLPE30	.75 x 30 x 16	60	9	.21	\$262

Protrudes by 6" beyond the front worksurface edge for added privacy. Secures off-module or on-module to the front and back edge of worksurface, regardless of type of leg support - supporting brackets can straddle over shared leg. 3/4" LP PVC edge boards. Brackets are available in all standard Bridges II paint finishes.

- Specify BRTLPE30 for 24" d worksurfaces and BRTLPE36 for 30" d worksurfaces

Required Specifications

Chassis/Accent Finish (Laminate Dividers)
Bracket finish
Edge finish*

TABLE DIVIDERS

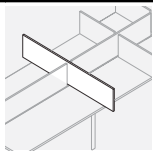

Perpendicular Laminate Side to Side Double Divider - Extended

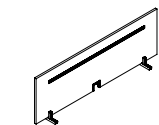

36" - 72"

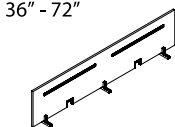

78" - 84"

Table Divider - Laminate

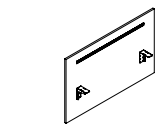

36" - 72"

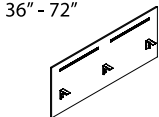

78" - 84"

High Table Divider - Laminate

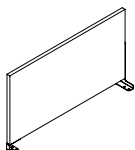

High Perpendicular Side-to-Side Divider - Laminate

MODEL#	DIMENSIONS	FREIGHT CLASS	WT/LBS.	CUBIC FT.	LIST PRICE
--------	------------	---------------	---------	-----------	------------

D x W x H

BRTLDPSE75	.75 x 75 x 16	60	22	.52	\$538
BRTLDPSE63	.75 x 63 x 16	60	18	.44	\$483

Protrudes by 6" beyond the front worksurface edge for added privacy. Installs on-module, between two BRTLPPD dividers. It is secured to the front edge of both worksurfaces, regardless of type of leg support - supporting brackets can straddle over shared leg. Brackets are available in all standard Bridges II paint finishes. 3/4" LP PVC edge boards.

- Can ONLY be installed on-module between two BRTLPPD dividers.
- Specify BRTLDPSE63 for 24"d back-to-back worksurfaces and BRTLDPSE75 for 30"d back-to-back worksurfaces

BRTLPPD84	.75 x 81 x 16	60	24	.56	\$654
BRTLPPD78	.75 x 75 x 16	60	23	.52	\$632
BRTLPPD72	.75 x 69 x 16	60	21	.47	\$504
BRTLPPD66	.75 x 63 x 16	60	19	.43	\$472
BRTLPPD60	.75 x 57 x 16	60	17	.39	\$450
BRTLPPD54	.75 x 51 x 16	60	15	.35	\$431
BRTLPPD48	.75 x 45 x 16	60	14	.31	\$407
BRTLPPD42	.75 x 39 x 16	60	12	.27	\$379
BRTLPPD36	.75 x 33 x 16	60	10	.22	\$344

Secures between two back-to-back tables; provides privacy, divides space. Installed divider measures 15.7" from the top of the worksurface. 36" - 72" wide dividers include 2 support brackets and one pass-through grommet. 78" and 84" wide dividers include 3 support brackets and 2 pass-through grommets. 3/4" PVC edged boards. Integrated anodized aluminum accessory rail, white cut out and rail trims. Brackets are available in all standard Bridges II paint finishes.

- Please refer to the **Compatibility Guide** on page 368 to determine available accessories

BRTLPPDS84	.75 x 81 x 32	60	50	1.16	\$1023
BRTLPPDS78	.75 x 75 x 32	60	47	1.08	\$982
BRTLPPDS72	.75 x 69 x 32	60	43	1	\$803
BRTLPPDS66	.75 x 63 x 32	60	40	.91	\$761
BRTLPPDS60	.75 x 57 x 32	60	36	.83	\$718
BRTLPPDS54	.75 x 51 x 32	60	32	.75	\$664
BRTLPPDS48	.75 x 45 x 32	60	29	.66	\$632
BRTLPPDS42	.75 x 39 x 32	60	25	.56	\$589
BRTLPPDS36	.75 x 33 x 32	60	22	.50	\$482

Installed on one side only. Secures to the back of a single table; provides privacy, divides space. Installed divider measures 15.7" from the top of the worksurface and 15" below the worksurface. 36" - 72" wide dividers include 2 support brackets. 78" and 84" wide dividers include 4 support brackets. 3/4" self edged boards. Integrated anodized aluminum accessory rail, white cut out and rail trims. Brackets are available in all standard Bridges II paint finishes. Integrated modesty panel.

- Please refer to the **Compatibility Guide** on page 368 to determine available accessories

BRTLPPD24	.75 x 24 x 16	60	7	.16	\$239
BRTLPPD30	.75 x 30 x 16	60	9	.20	\$260

Secures off-module to front and back edges of a table; provides privacy, divides space. Can be installed anywhere along worksurface or over the seam of two adjacent worksurfaces. Cannot be installed at the end of a run. Installed divider measures 15.7" from the top of the worksurface. 3/4" self edged boards. Brackets are available in all standard Bridges II paint finishes.

Required Specifications

Chassis/Accent finish
Bracket finish
Edge finish

TABLE DIVIDERS

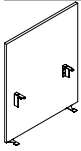

Perpendicular End of Run Divider, Laminate*

MODEL#	DIMENSIONS D x W x H	FREIGHT CLASS	WT/LBS.	CUBIC FT.	LIST PRICE
BRTLPE24	.75 x 24 x 32	60	7	.16	\$380
BRTLPE30	.75 x 30 x 32	60	9	.20	\$407
BRTLPE51	.75 x 50.5 x 32	60	15	.35	\$642
BRTLPE63	.75 x 62.5 x 32	60	19	.43	\$728

Secures to the side edge of a table; provides privacy, divides space. Installed divider measures 15.7" from the top of the worksurface and 15" below the worksurface. Integrated modesty panel. 3/4" self edged boards. Brackets are available in all standard Bridges II paint finishes. For Rectangular leg only.

- BRTLPE51 divider matches 24" deep back-to-back assemblies
- BRTLPE63 divider matches 30" deep back-to-back assemblies

MODESTY PANEL

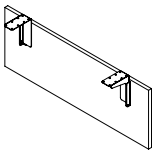

Laminate Modesty Panel*

MODEL#	DIMENSIONS	FREIGHT CLASS	WT/LBS.	CUBIC FT.	LIST PRICE
BRTMPS84	.75 x 78.5 x 14	60	22	.51	\$577
BRTMPS78	.75 x 72.5 x 14	60	20	.47	\$556
BRTMPS72	.75 x 66.5 x 14	60	19	.43	\$537
BRTMPS66	.75 x 60.5 x 14	60	17	.40	\$517
BRTMPS60	.75 x 54.5 x 14	60	16	.36	\$499
BRTMPS54	.75 x 48.5 x 14	60	14	.32	\$480
BRTMPS48	.75 x 42.5 x 14	60	13	.29	\$459
BRTMPS42	.75 x 36.5 x 14	60	11	.25	\$442
BRTMPS36	.75 x 30.5 x 14	60	9	.21	\$420

Secures to the back edge of a table; provides privacy, divides space. Installed divider measures 15" below the worksurface. 3/4" self edged boards. Flips down for easy access to underside of worksurface. Brackets are available in all standard Bridges II paint finishes.

Required Specifications

Chassis/Accent finish
Edge finish
Bracket finish

ACCESSORIES

MODEL# DIMENSIONS FREIGHT CLASS WT./LBS. CUBIC FT. LIST PRICE

D x W x H

BRTPEG24	.75 x 24 x 14	60	6	.14	\$247
BRTPEG24H21	.75 x 24 x 20.5	60	9	.21	\$286
BRTPEG24H27	.75 x 24 x 26.5	60	12	.26	\$334
BRTPEG30	.75 x 30 x 14	60	8	.18	\$266
BRTPEG30H21	.75 x 30 x 20.5	60	12	.26	\$304
BRTPEG30H27	.75 x 30 x 26.5	60	15	.33	\$354
BRTPEG51	.75 x 50.5 x 14	60	13	.30	\$431
BRTPEG51H21	.75 x 50.5 x 20.5	60	20	.43	\$522
BRTPEG51H27	.75 x 50.5 x 26.5	60	26	.56	\$604
BRTPEG63	.75 x 62.5 x 14	60	16	.38	\$469
BRTPEG63H21	.75 x 62.5 x 20.5	60	25	.53	\$558
BRTPEG63H27	.75 x 62.5 x 26.5	60	32	.69	\$642

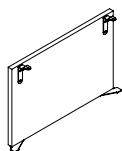

Laminate End of Run Gable*

Perpendicular end of a run gable. Secures to the side edge of a table/tables and legs; provides privacy, divides space. ¾" self edged boards. Brackets are available in all standard Bridges II paint finishes. **For Rectangular leg only.**

- BRTPEG24, 30, 51 and 63 measure 15" below worksurface
- BRTPEGxxH21 lines up with the bottom of storage cabinets
- BRTPEGxxH27 reaches down 1" from the floor (creates full panel look)

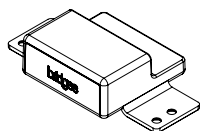
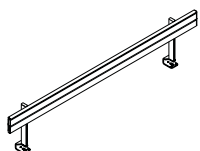

Table End Gap Filler

BRTTEGF	4.5 x 2.5 x 1	70	.03	.01	\$16
---------	---------------	----	-----	-----	-------------

Injection molded block fills the gap finishing the end of back-to-back table assemblies. Secures to the bottom of two back-to-back worksurfaces. Injection molded resin, white.



Single Table Accessory Rail

BRLBST84	2.95 x 81 x 13.5	70	10.24	.61	\$548
BRLBST78	2.95 x 75 x 13.5	70	9.69	.56	\$532
BRLBST72	2.95 x 69 x 13.5	70	9.15	.52	\$516
BRLBST66	2.95 x 63 x 13.5	70	8.61	.48	\$499
BRLBST60	2.95 x 57 x 13.5	70	8.07	.43	\$482
BRLBST54	2.95 x 51 x 13.5	70	7.52	.39	\$472
BRLBST48	2.95 x 45 x 13.5	70	6.98	.35	\$455
BRLBST42	2.95 x 39 x 13.5	70	6.44	.30	\$439
BRLBST36	2.95 x 33 x 13.5	65	5.90	.26	\$417

Table mounted accessory rail. Compatible with standard accessories. Includes end caps and mounting hardware.

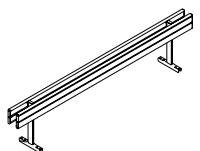

Back-To-Back Accessory Rail

BRLBB2B84	7.50 x 81 x 13.5	65	17.69	.74	\$904
BRLBB2B78	7.50 x 75 x 13.5	65	16.61	.69	\$871
BRLBB2B72	7.50 x 69 x 13.5	65	15.52	.63	\$839
BRLBB2B66	7.50 x 63 x 13.5	65	14.44	.58	\$807
BRLBB2B60	7.50 x 57 x 13.5	65	13.36	.53	\$775
BRLBB2B54	7.50 x 51 x 13.5	65	12.27	.48	\$752
BRLBB2B48	7.50 x 45 x 13.5	65	11.19	.42	\$718
BRLBB2B42	7.50 x 39 x 13.5	65	10.10	.37	\$686
BRLBB2B36	7.50 x 33 x 13.5	65	9.02	.32	\$646

Table mounted accessory rail. Compatible with standard accessories. Includes end caps and mounting hardware.

Required Specifications

Chassis/Accent finish*

Edge finish*

Bracket finish*

FRAMED DIVIDERS

D x W x H

Single Table Or Single Table Row Application; 16" and 30" high dividers

Table Mounted Framed Divider for single table or single table row; recessed 1.5" at both ends, mounted to the table with 0.6" gap at the back.
 BRTMFD/BRTMLD 36" (33" actual) - 66" (63" actual) dividers have 2 mounting brackets.
 BRTMFD/BRTMLD 72" (69" actual) - 84" (81" actual) dividers have 3 mounting brackets.

Perpendicular Single Table End of Run Framed Divider;
 BREFD/BRELD 24" (21" actual for 24" deep worksurfaces),
 BREFD/BRELD 30" (27" actual for 30" deep worksurfaces),
 BREFD/BRELD 36" (33" actual for 36" deep worksurfaces),

Two brackets secure the divider to the side edge of work surface. Flush with rear edge, 3" recessed from front work surface edge.

Perpendicular Shared Framed Divider;
 BRSEFD/BRSLD 24" (21" actual for 24" deep worksurfaces),
 BRSEFD/BRSLD 30" (27" actual for 30" deep worksurfaces),
 BRSEFD/BRSLD 36" (33" actual for 36" deep worksurfaces),

Single bracket secures the divider to the rear edge of worksurface; Can be mounted off-module or over the seam of two adjacent worksurfaces. Flush with the rear edge, 3" recessed from front worksurface edge.

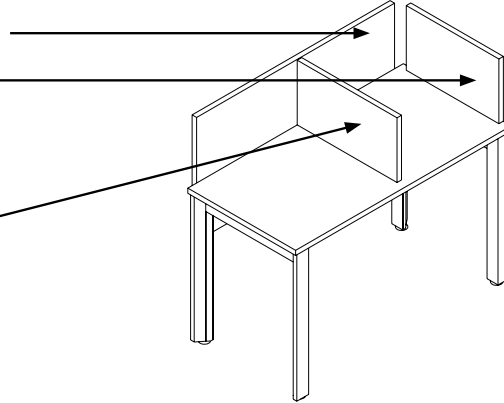

Back-To-Back Table Application; 16" dividers

Perpendicular Back 2 Back Parallel Framed Divider secured between two back-to-back tables; recessed 1.5" at both ends; 0.6" gap between the divider and work surfaces.
 BRPFD/BRPLD 36" (33" actual) - 66" (63" actual) dividers have 2 mounting brackets.
 BRPFD/BRPLD 72" (69" actual) - 84" (81" actual) dividers have 3 mounting brackets.

Perpendicular Shared Frame Back 2 Back Framed Divider;
 BRSEFD/BRSDLD 51" (45" actual for 24" deep back-to-back work surfaces)
 BRSEFD/BRSDLD 63" (57" actual for 30" deep back-to-back work surfaces).
 One bracket secures the divider through the gap between work surfaces; two brackets locate top of the divider between two adjacent Parallel dividers.
 NOTE: cannot be used on its own without the two Parallel dividers.
 3" recessed from front worksurface edges.

Perpendicular Back-To-Back End of Run Framed Divider;
 BREDFD/BREDLD 51" (45" actual for 24" deep back-to-back worksurfaces)
 BREDFD/BREDLD 63" (57" actual for 30" deep back-to-back worksurfaces).
 Three brackets secure the divider to both side edges of worksurfaces.
 3" recessed from front worksurface edges.

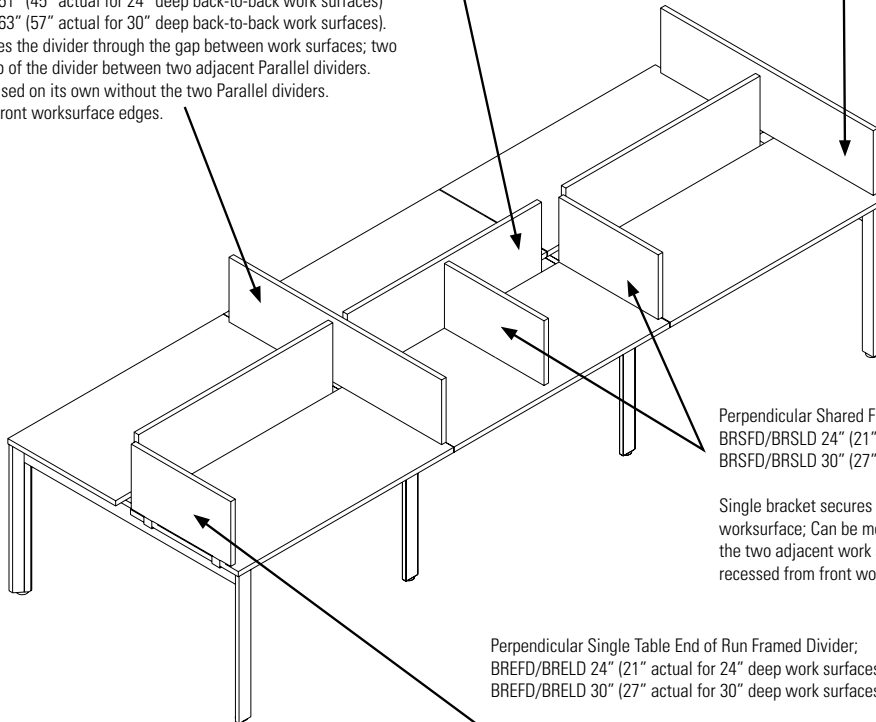

Perpendicular Shared Framed Divider;
 BRSEFD/BRSLD 24" (21" actual for 24" deep work surfaces).
 BRSEFD/BRSLD 30" (27" actual for 30" deep work surfaces).

Single bracket secures the divider to the rear edge of worksurface; Can be mounted off-module or over the seam of the two adjacent work surfaces. Flush with the rear edge, 3" recessed from front work surfaces edge.

Perpendicular Single Table End of Run Framed Divider;
 BREFD/BRELD 24" (21" actual for 24" deep work surfaces).
 BREFD/BRELD 30" (27" actual for 30" deep work surfaces).

Two brackets secure the divider to the side edge of work surface. Flush with the rear edge, 3" recessed from front work surface edge.

Required Specifications

Top finish
 Edge finish
 Metal finish (legs)

Optional Specifications

Anodized Aluminum Leg
 HP laminate

FRAMED DIVIDERS

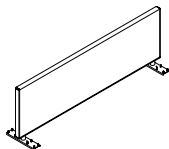

**Back-to-Back Parallel Framed Divider
Fabric**

MODEL#	DIMENSIONS D x W x H	FREIGHT CLASS	WT/LBS.	CUBIC FT.	LIST PRICE
BRPFD84	1.25 x 81 x 16	70	32	1.95	\$907
BRPFD78	1.25 x 75 x 16	70	28	1.81	\$861
BRPFD72	1.25 x 69 x 16	70	24	1.57	\$850
BRPFD66	1.25 x 63 x 16	85	20	1.53	\$817
BRPFD60	1.25 x 57 x 16	92.5	15	1.39	\$770
BRPFD54	1.25 x 51 x 16	92.5	13	1.25	\$649
BRPFD48	1.25 x 45 x 16	85	11	.75	\$615
BRPFD42	1.25 x 39 x 16	100	9	.97	\$534
BRPFD36	1.25 x 33 x 16	100	8	.83	\$522

Secures to the underside of the worksurface. Fabric divider is tackable and always railroaded. Installed divider measures 15.7" from top of worksurface. 36" to 54" dividers include 2 support brackets. 60" to 84" dividers include 3 support brackets. Brackets are available in all standard Bridges II paint finishes.

- 60" - 84" dividers require 3 support brackets and cannot be used with worksurfaces that have a single access door

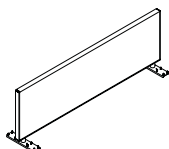

Back-to-Back Parallel Framed Divider

MODEL#	DIMENSIONS D x W x H	FREIGHT CLASS	WT/LBS.	CUBIC FT.	LIST PRICE	HP ADD	DE ADD	DM ADD
BRPLD84	1.25 x 81 x 16	70	32	2.25	\$637	\$321	\$729	\$1848
BRPLD78	1.25 x 75 x 16	70	28	2.08	\$626	\$290	\$730	\$1840
BRPLD72	1.25 x 69 x 16	70	24	1.92	\$619	\$260	\$729	\$1826
BRPLD66	1.25 x 63 x 16	85	20	1.75	\$598	\$270	\$608	\$1660
BRPLD60	1.25 x 57 x 16	92.5	15	1.58	\$577	\$223	\$616	\$1551
BRPLD54	1.25 x 51 x 16	92.5	13	1.42	\$482	\$196	\$644	\$1578
BRPLD48	1.25 x 45 x 16	85	11	1.25	\$414	\$149	\$288	\$756
BRPLD42	1.25 x 39 x 16	100	9	1.08	\$367	\$119	\$245	\$652
BRPLD36	1.25 x 33 x 16	100	8	.92	\$349	\$109	\$219	\$575

Secures to the underside of the worksurface. Divider infill can be specified in low pressure laminate (**LP**), high pressure laminate (**HP**), dry erase whiteboard (**DE**) or dry erase magnetic whiteboard (**DM**). Installed divider measures 15.7" from top of worksurface. 36" to 54" dividers include 2 support brackets. 60" to 84" dividers include 3 support brackets. Brackets are available in all standard Bridges II paint finishes.

- 60" - 84" dividers require 3 support brackets and cannot be used with worksurfaces that have a single access door

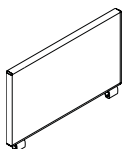

**Perpendicular Single Table End of Run
Framed Divider, Fabric**

MODEL#	DIMENSIONS D x W x H	FREIGHT CLASS	WT/LBS.	CUBIC FT.	LIST PRICE
BREFD36	1.25 x 33 x 16	85	12	.92	\$460
BREFD30	1.25 x 27 x 16	85	11	.75	\$416
BREFD24	1.25 x 21 x 16	70	9	.58	\$404

Connects to the perpendicular end of a single or back-to-back table. Fabric divider is tackable and always railroaded. Installed divider measures 15.7" from top of worksurface. Divider comes with 2 support brackets. Two brackets secure the divider to the side edge of worksurface. Flush with the rear edge, 3" recessed from front worksurface edge. Brackets are available in all standard Bridges II paint finishes.

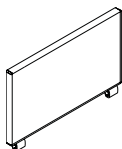

**Perpendicular Single Table End of Run
Framed Divider, Laminate**

MODEL#	DIMENSIONS D x W x H	FREIGHT CLASS	WT/LBS.	CUBIC FT.	LIST PRICE	HP ADD	DE ADD	DM ADD
BRELD36	1.25 x 33 x 16	70	20	.92	\$301	\$110	\$219	\$341
BRELD30	1.25 x 27 x 16	65	17	.75	\$291	\$97	\$167	\$262
BRELD24	1.25 x 21 x 16	65	14	.58	\$261	\$81	\$151	\$229

Connects to the perpendicular end of a single or back-to-back table. Divider infill can be specified in low pressure laminate (**LP**), high pressure laminate (**HP**), dry erase whiteboard (**DE**) or dry erase magnetic whiteboard (**DM**). Installed divider measures 15.7" from top of worksurface. Divider comes with 2 support brackets. Two brackets secure the divider to the side edge of worksurface. Flush with the rear edge, 3" recessed from front worksurface edge. When dry erase magnetic whiteboard (**DM**) is specified it is applied user side **ONLY** and dry erase whiteboard (**DE**) is applied on the opposite side. Brackets are available in all standard Bridges II paint finishes.

Required Specifications

Fabric
Finish
Bracket finish

SHARED FRAMED DIVIDERS

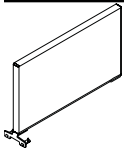

Perpendicular Shared Framed Divider, Fabric

MODEL#	DIMENSIONS D x W x H	FREIGHT CLASS	WT/LBS.	CUBIC FT.	LIST PRICE
BRSFD36	1.25 x 33 x 16	85	12	.92	\$449
BRSFD30	1.25 x 27 x 16	85	11	.75	\$404
BRSFD24	1.25 x 21 x 16	70	9	.58	\$392

Connects anywhere along and between worksurfaces to divide space and create privacy. Divider is fastened under the worksurface flush to the back of the table and recessed 3" from the front edge on the user side. Fabric divider is tackable and always railroaded. Installed divider measures 15.7" from top of worksurface. Divider comes with a support bracket at the back and a spacer plate with double sided adhesive at the front. Brackets are available in all standard Bridges II paint finishes.

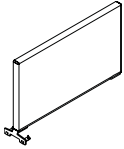

Perpendicular Shared Framed Divider, Laminate

					LIST PRICE	HP ADD	DE ADD	DM ADD
BRSLD36	1.25 x 33 x 16	70	20	.92	\$301	\$110	\$178	\$626
BRSLD30	1.25 x 27 x 16	65	17	.75	\$281	\$97	\$135	\$557
BRSLD24	1.25 x 21 x 16	65	14	.58	\$261	\$72	\$114	\$416

Connects anywhere along and between worksurfaces to divide space and create privacy. Divider is fastened under the worksurface flush to the back of the table and recessed 3" from the front edge on the user side. Divider infill can be specified in low pressure laminate (**LP**), high pressure laminate (**HP**), dry erase whiteboard (**DE**) or dry erase magnetic whiteboard (**DM**). Installed divider measures 15.7" from top of worksurface. Divider comes with a support bracket at the back and a spacer plate with double sided adhesive at the front. Brackets are available in all standard Bridges II paint finishes.

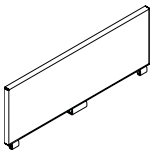

Perpendicular Back-to-Back End of Run Framed Divider, Fabric

					LIST PRICE
BREDFD63	1.25 x 57 x 16	85	21	1.58	\$711
BREDFD51	1.25 x 45 x 16	85	18	1.25	\$627

Connects to the end of run on a back-to-back tables to create privacy. Divider is fastened under the worksurface and recessed 3" from the user edge on either side. Fabric divider is tackable and always railroaded. Installed divider measures 15.7" from top of worksurface. Divider comes with 1 large and 2 small support brackets. Brackets are available in all standard Bridges II paint finishes.

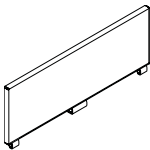

Perpendicular Back-to-Back End of Run Framed Divider, Laminate

					LIST PRICE	HP ADD	DE ADD	DM ADD
BREDLD63	1.25 x 57 x 16	70	32	1.58	\$522	\$223	\$510	\$929
BREDLD51	1.25 x 45 x 16	70	26	1.25	\$424	\$147	\$243	\$444

Connects to the end of run on a back-to-back tables to create privacy. Divider is fastened under the worksurface and recessed 3" from the user edge on either side. Divider infill can be specified in low pressure laminate (**LP**), high pressure laminate (**HP**), dry erase whiteboard (**DE**) or dry erase magnetic whiteboard (**DM**). Installed divider measures 15.7" from top of worksurface. Divider comes with 1 large and 2 small support brackets. When dry erase magnetic whiteboard (DM) is specified it is applied user side ONLY and dry erase whiteboard (DE) is applied on the opposite side. Brackets are available in all standard Bridges II paint finishes.

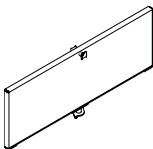

Perpendicular Back-to-Back Shared Framed Divider, Fabric

					LIST PRICE
BRSDFD63	1.25 x 57 x 16	85	20	1.58	\$675
BRSDFD51	1.25 x 45 x 16	85	17	1.25	\$590

Connects between parallel framed dividers for back-to-back tables to divide space and create privacy. Divider is fastened under the worksurface and recessed 3" from the user edge on either side. Fabric divider is tackable and always railroaded. Installed divider measures 15.7" from top of worksurface. Divider comes with 1 center support bracket, 2 spacer plates with adhesive and 2 top spacer clamps. Brackets are available in all standard Bridges II paint finishes.

- Cannot be used on its own without the two parallel dividers

Required Specifications

Fabric
Finish
Bracket finish

SHARED FRAMED DIVIDERS

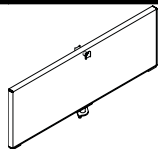

Perpendicular Back-to-Back Shared Framed Divider, Laminate*

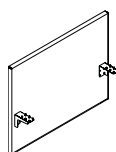

Table Mounted Framed Divider, Fabric*

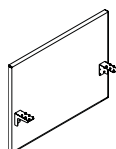

Table Mounted Framed Divider, Laminate*



Ceiling Pole for Wellness Screens

MODEL#	DIMENSIONS D x W x H	FREIGHT CLASS	WT/LBS.	CUBIC FT.	LIST PRICE			
					LIST PRICE	HP ADD	DE ADD	DM ADD
BRSDLD63	1.25 x 57 x 16	70	32	1.58	\$500	\$214	\$502	\$1707
BRSDLD51	1.25 x 45 x 16	70	26	1.25	\$405	\$147	\$233	\$833

Connects between parallel framed dividers for back-to-back tables to divide space and create privacy. Divider is fastened under the worksurface and recessed 3" from the user edge on either side. Divider infill can be specified in low pressure laminate (LP), high pressure laminate (HP), dry erase whiteboard (DE) or dry erase magnetic whiteboard (DM). Installed divider measures 15.7" from top of worksurface. Divider comes with 1 center support bracket, 2 spacer plates with adhesive and 2 top spacer clamps. Brackets are available in all standard Bridges II paint finishes.

- Cannot be used on its own without the two parallel dividers

					LIST PRICE			
BRTMFD84	1.25 x 81 x 30	70	43	4.22	\$1029			
BRTMFD78	1.25 x 75 x 30	70	40	3.91	\$957			
BRTMFD72	1.25 x 69 x 30	70	37	3.59	\$921			
BRTMFD66	1.25 x 63 x 30	85	33	3.28	\$890			
BRTMFD60	1.25 x 57 x 30	92.5	30	2.97	\$783			
BRTMFD54	1.25 x 51 x 30	92.5	27	2.66	\$698			
BRTMFD48	1.25 x 45 x 30	85	25	2.34	\$627			
BRTMFD42	1.25 x 39 x 30	100	22	2.03	\$557			
BRTMFD36	1.25 x 33 x 30	100	20	1.90	\$473			

Parallel divider for single tables. Fabric divider is tackable and always railroaded. Fastens to the underside of the worksurface. 0.6" gap between worksurface and divider allows for cable pass thru. Installed divider reaches 15.7" up and 15" down from top of worksurface. 36" to 66" dividers include 2 support brackets. 72" to 84" dividers include 3 support brackets. Brackets are available in all standard Bridges II paint finishes.

- 72" - 84" dividers require 3 support brackets and cannot be used with worksurfaces that have a single access door

					LIST PRICE	HP ADD	DE ADD	DM ADD
BRTMLD84	1.25 x 81 x 30	70	83	4.22	\$1302	\$427	\$1318	\$2848
BRTMLD78	1.25 x 75 x 30	70	77	3.91	\$1282	\$429	\$1318	\$2848
BRTMLD72	1.25 x 69 x 30	70	71	3.59	\$648	\$288	\$1772	\$3461
BRTMLD66	1.25 x 63 x 30	85	66	3.28	\$619	\$290	\$1779	\$3470
BRTMLD60	1.25 x 57 x 30	92.5	60	2.97	\$598	\$205	\$1787	\$3470
BRTMLD54	1.25 x 51 x 30	92.5	54	2.66	\$568	\$205	\$1685	\$3278
BRTMLD48	1.25 x 45 x 30	85	48	2.34	\$548	\$205	\$695	\$1557
BRTMLD42	1.25 x 39 x 30	100	42	2.03	\$527	\$205	\$704	\$1452
BRTMLD36	1.25 x 33 x 30	100	38	1.90	\$508	\$205	\$385	\$1126

Parallel divider for single tables. Divider infill can be specified in low pressure laminate (LP), high pressure laminate (HP), dry erase whiteboard (DE) or dry erase magnetic whiteboard (DM) user side only. Fastens to the underside of the worksurface. 0.6" gap between worksurface and divider allows for cable pass thru. Installed divider reaches 15.7" up and 15" down from top of worksurface. 36" to 66" dividers include 2 support brackets. 72" to 84" dividers include 3 support brackets. Brackets are available in all standard Bridges II paint finishes.

- 72" - 84" dividers require 3 support brackets and cannot be used with worksurfaces that have a single access door

BRTADPCPP	1.5 x 4.75 x 99	65	13	.48	\$624
-----------	-----------------	----	----	-----	--------------

Brings ceiling feed conduit and data cables from the ceiling down to Power Troughs at desk height. Accommodates 10' ceiling heights. Two part construction allows power/data conduit lay-in. Attaches to a junction between two adjacent Power Troughs in back-to-back applications only. Not for use on single sided Bridges II troughs. Includes mounting hardware and ceiling bezel. Painted Finish.

- Screens must be specified 6" shorter than the nominal worksurface dimension in order to accommodate this ceiling feed.

Required Specifications

Fabric
Finish
Bracket finish*

BACK-TO-BACK WELLNESS SCREENS

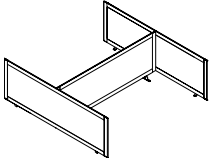

24" H Back-to-Back Wellness Screen

MODEL#	DIMENSIONS D x W x H	FREIGHT CLASS	WT./LBS.	CUBIC FT.	LIST PRICE
BRTADP5136H24	50.50 x 36 x 24.63	150	33	6.31	\$1632
BRTADP5142H24	50.50 x 42 x 24.63	150	34.50	7.36	\$1664
BRTADP5148H24	50.50 x 48 x 24.63	150	36	8.42	\$1699
BRTADP5154H24	50.50 x 54 x 24.63	250	37.50	9.47	\$1733
BRTADP5160H24	50.50 x 60 x 24.63	250	39	10.52	\$1766
BRTADP5166H24	50.50 x 66 x 24.63	250	40.50	11.57	\$1801
BRTADP5172H24	50.50 x 72 x 24.63	250	42	12.63	\$1833
BRTADP5178H24	50.50 x 78 x 24.63	250	43.50	13.68	\$1868
BRTADP5184H24	50.50 x 84 x 24.63	250	45	14.73	\$1902
BRTADP6336H24	62.50 x 36 x 24.63	150	46.50	7.81	\$1764
BRTADP6342H24	62.50 x 42 x 24.63	150	48	9.11	\$1796
BRTADP6348H24	62.50 x 48 x 24.63	150	49.50	10.42	\$1832
BRTADP6354H24	62.50 x 54 x 24.63	150	51	11.72	\$1865
BRTADP6360H24	62.50 x 60 x 24.63	150	52.50	13.02	\$1898
BRTADP6366H24	62.50 x 66 x 24.63	250	54	14.32	\$1933
BRTADP6372H24	62.50 x 72 x 24.63	250	55	15.63	\$1967
BRTADP6378H24	62.50 x 78 x 24.63	250	57.35	16.93	\$2001
BRTADP6384H24	62.50 x 84 x 24.63	250	58.50	18.23	\$2035

Powder coated aluminum frame, translucent ribbed polycarbonate. Includes all hardware to connect. Brackets are painted steel. Side dividers extend 6.25" from the front edge of each surface. Center divider sits over the gap between the worksurface allowing for cable pass-through to trough. Gap for each side is approximately 1". Width and depth are nominal sizes representing the sizes of the Bridges configuration. Allow for .25" overhang at the sides and 6.25" at the front. Frame and hardware available in all Bridges paint finishes. End trim cap is only available in Charcoal (CHR).

- **BRTADP51xxH24 are for configurations with 24" deep surfaces.**
- **BRTADP63xxH24 are for configurations with 30" deep surfaces.**

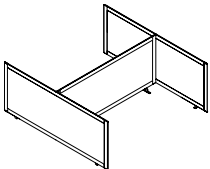

30" H Back-to-Back Wellness Screen

BRTADP5136H30	50.50 x 36 x 30.63	150	35.50	6.31	\$1808
BRTADP5142H30	50.50 x 42 x 30.63	150	37	7.36	\$1848
BRTADP5148H30	50.50 x 48 x 30.63	150	38.50	8.42	\$1885
BRTADP5154H30	50.50 x 54 x 30.63	150	40	9.47	\$1928
BRTADP5160H30	50.50 x 60 x 30.63	250	41.50	10.52	\$1966
BRTADP5166H30	50.50 x 66 x 30.63	250	43	11.57	\$2007
BRTADP5172H30	50.50 x 72 x 30.63	250	44.50	12.63	\$2044
BRTADP5178H30	50.50 x 78 x 30.63	250	46	13.68	\$2083
BRTADP5184H30	50.50 x 84 x 30.63	250	47.50	14.73	\$2123
BRTADP6336H30	62.50 x 36 x 30.63	125	49	7.81	\$2032
BRTADP6342H30	62.50 x 42 x 30.63	150	50.50	9.11	\$2071
BRTADP6348H30	62.50 x 48 x 30.63	150	52	10.42	\$2110
BRTADP6354H30	62.50 x 54 x 30.63	150	53.50	11.72	\$2149
BRTADP6360H30	62.50 x 60 x 30.63	150	55	13.02	\$2188
BRTADP6366H30	62.50 x 66 x 30.63	250	56.50	14.32	\$2228
BRTADP6372H30	62.50 x 72 x 30.63	250	58	15.63	\$2266
BRTADP6378H30	62.50 x 78 x 30.63	250	59.50	16.93	\$2306
BRTADP6384H30	62.50 x 84 x 30.63	250	61	18.23	\$2345

Powder coated aluminum frame, translucent ribbed polycarbonate. Includes all hardware to connect. Brackets are painted steel. Side dividers extend 6.25" from the front edge of each surface. Center divider sits over the gap between the worksurface allowing for cable pass-through to trough. Gap for each side is approximately 1". Width and depth are nominal sizes representing the sizes of the Bridges configuration. Allow for .25" overhang at the sides and 6.25" at the front. Frame and hardware available in all Bridges paint finishes. End trim cap is only available in Charcoal (CHR).

- **BRTADP51xxH30 are for configurations with 24" deep surfaces.**
- **BRTADP63xxH30 are for configurations with 30" deep surfaces.**

Required Specifications

Frame finish

BACK-TO-BACK WELLNESS SCREENS

MODEL# DIMENSIONS FREIGHT CLASS WT/LBS. CUBIC FT. LIST PRICE

D x W x H

BRTADPE5136H24	50.50 x 36 x 24.63	150	26.35	6.31	\$1106
BRTADPE5142H24	50.50 x 42 x 24.63	250	27.85	7.36	\$1139
BRTADPE5148H24	50.50 x 48 x 24.63	250	29.35	8.42	\$1173
BRTADPE5154H24	50.50 x 54 x 24.63	250	30.85	9.47	\$1205
BRTADPE5160H24	50.50 x 60 x 24.63	250	32.35	10.52	\$1241
BRTADPE5166H24	50.50 x 66 x 24.63	250	33.85	11.57	\$1275
BRTADPE5172H24	50.50 x 72 x 24.63	250	35.35	12.63	\$1312
BRTADPE5178H24	50.50 x 78 x 24.63	250	36.85	13.68	\$1344
BRTADPE5184H24	50.50 x 84 x 24.63	250	38.35	14.73	\$1377

BRTADPE6336H24	62.50 x 36 x 24.63	150	39.85	7.81	\$1172
BRTADPE6342H24	62.50 x 42 x 24.63	150	41.35	9.11	\$1204
BRTADPE6348H24	62.50 x 48 x 24.63	150	42.85	10.42	\$1239
BRTADPE6354H24	62.50 x 54 x 24.63	250	44.35	11.72	\$1274
BRTADPE6360H24	62.50 x 60 x 24.63	250	45.85	13.02	\$1308
BRTADPE6366H24	62.50 x 66 x 24.63	250	47.35	14.32	\$1344
BRTADPE6372H24	62.50 x 72 x 24.63	250	48.85	15.63	\$1375
BRTADPE6378H24	62.50 x 78 x 24.63	250	50.35	16.93	\$1410
BRTADPE6384H24	62.50 x 84 x 24.63	250	51.85	18.23	\$1445

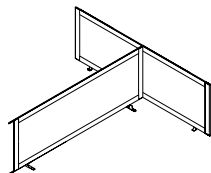

24" H Back-to-Back Wellness Screen Extension Kit

Intended to always connect to Back-to-Back Divider Screen Kit. Powder coated aluminum frame, translucent ribbed polycarbonate. Includes all hardware to connect. Brackets are painted steel. Side dividers extend 6.25" from the front edge of each surface. Center divider sits over the gap between the worksurface allowing for cable pass-through to trough. Gap for each side is approximately 1". Width and depth are nominal sizes representing the sizes of the Bridges configuration. Allow for .25" overhang at the sides and 6.25" at the front. Frame and hardware available in all Bridges paint finishes. End trim cap is only available in Charcoal (CHR).

- **BRTADPE51xxH24 are for configurations with 24" deep surfaces.**
- **BRTADPE63xxH24 are for configurations with 30" deep surfaces.**

BRTADPE5136H30	50.50 x 36 x 30.63	150	28.85	6.31	\$1215
BRTADPE5142H30	50.50 x 42 x 30.63	150	30.35	7.36	\$1254
BRTADPE5148H30	50.50 x 48 x 30.63	250	31.85	8.42	\$1294
BRTADPE5154H30	50.50 x 54 x 30.63	250	33.35	9.47	\$1335
BRTADPE5160H30	50.50 x 60 x 30.63	250	34.85	10.52	\$1372
BRTADPE5166H30	50.50 x 66 x 30.63	250	36.35	11.57	\$1412
BRTADPE5172H30	50.50 x 72 x 30.63	250	37.85	12.63	\$1452
BRTADPE5178H30	50.50 x 78 x 30.63	250	39.35	13.68	\$1489
BRTADPE5184H30	50.50 x 84 x 30.63	250	40.85	14.73	\$1529

BRTADPE6336H30	62.50 x 36 x 30.63	150	42.35	7.81	\$1292
BRTADPE6342H30	62.50 x 42 x 30.63	150	43.85	9.11	\$1333
BRTADPE6348H30	62.50 x 48 x 30.63	150	45.35	10.42	\$1371
BRTADPE6354H30	62.50 x 54 x 30.63	250	46.85	11.72	\$1410
BRTADPE6360H30	62.50 x 60 x 30.63	250	48.35	13.02	\$1449
BRTADPE6366H30	62.50 x 66 x 30.63	250	49.85	14.32	\$1488
BRTADPE6372H30	62.50 x 72 x 30.63	250	51.35	15.63	\$1529
BRTADPE6378H30	62.50 x 78 x 30.63	250	52.85	16.93	\$1566
BRTADPE6384H30	62.50 x 84 x 30.63	250	54.35	18.23	\$1606

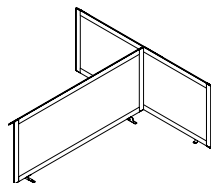

30" H Back-to-Back Wellness Screen Extension Kit

Intended to always connect to Back-to-Back Divider Screen Kit. Powder coated aluminum frame, translucent ribbed polycarbonate. Includes all hardware to connect. Brackets are painted steel. Side dividers extend 6.25" from the front edge of each surface. Center divider sits over the gap between the worksurface allowing for cable pass-through to trough. Gap for each side is approximately 1". Width and depth are nominal sizes representing the sizes of the Bridges configuration. Allow for .25" overhang at the sides and 6.25" at the front. Frame and hardware available in all Bridges paint finishes. End trim cap is only available in Charcoal (CHR).

- **BRTADPE51xxH30 are for configurations with 24" deep surfaces.**
- **BRTADPE63xxH30 are for configurations with 30" deep surfaces.**

Required Specifications

Frame finish

SINGLE TABLE WELLNESS SCREENS

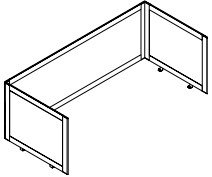

24" H Single Table Wellness Screen

MODEL#	DIMENSIONS D x W x H	FREIGHT CLASS	WT./LBS.	CUBIC FT.	LIST PRICE
BRTADP2436H24	31.75 x 36 x 24.63	125	26.55	3.97	\$1126
BRTADP2442H24	31.75 x 42 x 24.63	125	28.10	4.63	\$1162
BRTADP2448H24	31.75 x 48 x 24.63	150	29.65	5.29	\$1194
BRTADP2454H24	31.75 x 54 x 24.63	150	31.20	5.95	\$1229
BRTADP2460H24	31.75 x 60 x 24.63	150	32.75	6.61	\$1263
BRTADP2466H24	31.75 x 66 x 24.63	150	34.30	7.28	\$1295
BRTADP2472H24	31.75 x 72 x 24.63	150	35.85	7.94	\$1331
BRTADP2478H24	31.75 x 78 x 24.63	150	37.40	8.60	\$1366
BRTADP2484H24	31.75 x 84 x 24.63	150	38.95	9.26	\$1399
BRTADP3036H24	37.75 x 36 x 24.63	100	40.50	4.72	\$1205
BRTADP3042H24	37.75 x 42 x 24.63	125	42.05	5.51	\$1241
BRTADP3048H24	37.75 x 48 x 24.63	125	43.60	6.29	\$1275
BRTADP3054H24	37.75 x 54 x 24.63	150	42.15	7.08	\$1312
BRTADP3060H24	37.75 x 60 x 24.63	150	46.70	7.87	\$1344
BRTADP3066H24	37.75 x 66 x 24.63	150	48.25	8.65	\$1377
BRTADP3072H24	37.75 x 72 x 24.63	150	49.80	9.44	\$1412
BRTADP3078H24	37.75 x 78 x 24.63	150	51.35	10.22	\$1446
BRTADP3084H24	37.75 x 84 x 24.63	150	52.90	11.01	\$1481

Powder coated aluminum frame, translucent ribbed polycarbonate. Includes all hardware to connect. Brackets are painted steel. Side dividers extend 6.25" from the front edge of each surface. Back divider extends over the back edge of the worksurface by 1.5", allowing for cable pass-through to trough. Width and depth are nominal sizes representing the sizes of the Bridges configuration. Allow for .25" overhang at the sides, 1.5" at the back, and 6.25" at the front. Frame and hardware available in all Bridges paint finishes. End trim cap is only available in Charcoal (CHR).

- **BRTADP24xxH24 are for configurations with 24" deep surfaces.**
- **BRTADP30xxH24 are for configurations with 30" deep surfaces.**

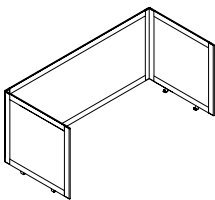

30" H Single Table Wellness Screen

BRTADP2436H30	31.75 x 36 x 30.63	125	28.85	3.97	\$1263
BRTADP2442H30	31.75 x 42 x 30.63	125	30.40	4.63	\$1304
BRTADP2448H30	31.75 x 48 x 30.63	125	31.95	5.29	\$1344
BRTADP2454H30	31.75 x 54 x 30.63	150	33.50	5.95	\$1382
BRTADP2460H30	31.75 x 60 x 30.63	150	35.05	6.61	\$1422
BRTADP2466H30	31.75 x 66 x 30.63	150	36.60	7.28	\$1460
BRTADP2472H30	31.75 x 72 x 30.63	150	38.15	7.94	\$1500
BRTADP2478H30	31.75 x 78 x 30.63	150	39.70	8.60	\$1538
BRTADP2484H30	31.75 x 84 x 30.63	150	41.25	9.26	\$1578
BRTADP3036H30	37.75 x 36 x 30.63	100	42.80	4.72	\$1340
BRTADP3042H30	37.75 x 42 x 30.63	100	44.35	5.51	\$1382
BRTADP3048H30	37.75 x 48 x 30.63	125	45.90	6.29	\$1421
BRTADP3054H30	37.75 x 54 x 30.63	125	47.45	7.08	\$1457
BRTADP3060H30	37.75 x 60 x 30.63	125	49	7.87	\$1496
BRTADP3066H30	37.75 x 66 x 30.63	150	50.55	8.65	\$1537
BRTADP3072H30	37.75 x 72 x 30.63	150	52.10	9.44	\$1573
BRTADP3078H30	37.75 x 78 x 30.63	150	53.65	10.22	\$1615
BRTADP3084H30	37.75 x 84 x 30.63	150	55.20	11.01	\$1655

Powder coated aluminum frame, translucent ribbed polycarbonate. Includes all hardware to connect. Brackets are painted steel. Side dividers extend 6.25" from the front edge of each surface. Back divider extends over the back edge of the worksurface by 1.5", allowing for cable pass-through to trough. Width and depth are nominal sizes representing the sizes of the Bridges configuration. Allow for .25" overhang at the sides, 1.5" at the back, and 6.25" at the front. Frame and hardware available in all Bridges paint finishes. End trim cap is only available in Charcoal (CHR).

- **BRTADP24xxH30 are for configurations with 24" deep surfaces.**
- **BRTADP30xxH30 are for configurations with 30" deep surfaces.**

Required Specifications

Frame finish

SINGLE TABLE WELLNESS SCREENS

MODEL# DIMENSIONS FREIGHT CLASS WT/LBS. CUBIC FT. LIST PRICE

D x W x H

BRTADPE2436H24	31.75 x 36 x 24.63	150	21.05	3.97	\$845
BRTADPE2442H24	31.75 x 42 x 24.63	150	22.60	4.63	\$928
BRTADPE2448H24	31.75 x 48 x 24.63	150	24.15	5.29	\$963
BRTADPE2454H24	31.75 x 54 x 24.63	150	25.70	5.95	\$996
BRTADPE2460H24	31.75 x 60 x 24.63	150	27.25	6.61	\$1029
BRTADPE2466H24	31.75 x 66 x 24.63	250	28.80	7.28	\$1064
BRTADPE2472H24	31.75 x 72 x 24.63	250	30.35	7.94	\$1098
BRTADPE2478H24	31.75 x 78 x 24.63	250	31.90	8.60	\$1132
BRTADPE2484H24	31.75 x 84 x 24.63	250	33.45	9.26	\$1164

BRTADPE3036H24	37.75 x 36 x 24.63	125	35	4.72	\$879
BRTADPE3042H24	37.75 x 42 x 24.63	125	36.55	5.51	\$960
BRTADPE3048H24	37.75 x 48 x 24.63	125	38.10	6.29	\$996
BRTADPE3054H24	37.75 x 54 x 24.63	150	39.65	7.08	\$1029
BRTADPE3060H24	37.75 x 60 x 24.63	150	41.20	7.87	\$1064
BRTADPE3066H24	37.75 x 66 x 24.63	150	42.75	8.65	\$1096
BRTADPE3072H24	37.75 x 72 x 24.63	150	44.30	9.44	\$1129
BRTADPE3078H24	37.75 x 78 x 24.63	150	45.85	10.01	\$1164
BRTADPE3084H24	37.75 x 84 x 24.63	150	47.40	10.01	\$1198

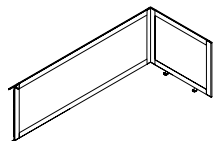

24" H Single Table Wellness Screen Extension Kit

Intended to always connect to Single Table Divider Screen Kit. Powder coated aluminum frame, translucent ribbed polycarbonate. Includes all hardware to connect. Brackets are painted steel. Side dividers extend 6.25" from the front edge of each surface. Back divider extends over the back edge of the worksurface by 1.5", allowing for cable pass-through to trough. Width and depth are nominal sizes representing the sizes of the Bridges configuration. Allow for .25" overhang at the sides, 1.5" at the back, and 6.25" at the front. Frame and hardware available in all Bridges paint finishes. End trim cap is only available in Charcoal (CHR).

- **BRTADPE24xxH24 are for configurations with 24" deep surfaces.**
- **BRTADPE30xxH24 are for configurations with 30" deep surfaces.**

BRTADPE2436H30	31.75 x 36 x 30.63	150	22.85	3.97	\$930
BRTADPE2442H30	31.75 x 42 x 30.63	150	24.40	4.63	\$1018
BRTADPE2448H30	31.75 x 48 x 30.63	150	25.95	5.29	\$1056
BRTADPE2454H30	31.75 x 54 x 30.63	150	27.50	5.95	\$1095
BRTADPE2460H30	31.75 x 60 x 30.63	150	29.05	6.61	\$1136
BRTADPE2466H30	31.75 x 66 x 30.63	150	30.60	7.28	\$1173
BRTADPE2472H30	31.75 x 72 x 30.63	150	32.15	7.94	\$1212
BRTADPE2478H30	31.75 x 78 x 30.63	250	33.70	8.60	\$1251
BRTADPE2484H30	31.75 x 84 x 30.63	250	35.25	9.26	\$1291

BRTADPE3036H30	37.75 x 36 x 30.63	125	36.80	4.72	\$968
BRTADPE3042H30	37.75 x 42 x 30.63	125	38.35	5.51	\$1056
BRTADPE3048H30	37.75 x 48 x 30.63	125	39.90	6.29	\$1095
BRTADPE3054H30	37.75 x 54 x 30.63	150	41.45	7.08	\$1133
BRTADPE3060H30	37.75 x 60 x 30.63	150	43	7.87	\$1173
BRTADPE3066H30	37.75 x 66 x 30.63	150	44.55	8.65	\$1212
BRTADPE3072H30	37.75 x 72 x 30.63	150	46.10	9.44	\$1250
BRTADPE3078H30	37.75 x 78 x 30.63	150	47.65	10.22	\$1291
BRTADPE3084H30	37.75 x 84 x 30.63	150	49.20	11.01	\$1328

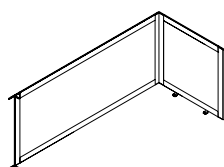

30" H Single Table Wellness Screen Extension Kit

Intended to always connect to Single Table Divider Screen Kit. Powder coated aluminum frame, translucent ribbed polycarbonate. Includes all hardware to connect. Brackets are painted steel. Side dividers extend 6.25" from the front edge of each surface. Back divider extends over the back edge of the worksurface by 1.5", allowing for cable pass-through to trough. Width and depth are nominal sizes representing the sizes of the Bridges configuration. Allow for .25" overhang at the sides, 1.5" at the back, and 6.25" at the front. Frame and hardware available in all Bridges paint finishes. End trim cap is only available in Charcoal (CHR).

- **BRTADPE24xxH30 are for configurations with 24" deep surfaces.**
- **BRTADPE30xxH30 are for configurations with 30" deep surfaces.**

Required Specifications

Frame finish

BACK-TO-BACK FELT DIVIDER SCREENS

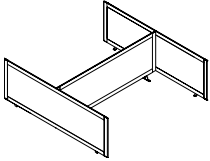

24" H Back-to-Back Felt Divider Screen

MODEL#	DIMENSIONS D x W x H	FREIGHT CLASS	WT/LBS.	CUBIC FT.	LIST PRICE
BRTADF5136H24	50.50 x 36 x 24.60	150	28	6.31	\$1287
BRTADF5142H24	50.50 x 42 x 24.60	150	29.50	7.36	\$1309
BRTADF5148H24	50.50 x 48 x 24.60	150	31	8.42	\$1335
BRTADF5154H24	50.50 x 54 x 24.60	250	32.50	9.47	\$1356
BRTADF5160H24	50.50 x 60 x 24.60	250	34	10.52	\$1385
BRTADF5166H24	50.50 x 66 x 24.60	250	35.50	11.57	\$1410
BRTADF5172H24	50.50 x 72 x 24.60	250	37	12.63	\$1435
BRTADF5178H24	50.50 x 78 x 24.60	250	38.50	13.68	\$1462
BRTADF5184H24	50.50 x 84 x 24.60	250	40	14.73	\$1509
BRTADF6336H24	62.50 x 36 x 24.60	150	41.50	7.81	\$1385
BRTADF6342H24	62.50 x 42 x 24.60	150	43	9.11	\$1410
BRTADF6348H24	62.50 x 48 x 24.60	150	44.50	10.42	\$1435
BRTADF6354H24	62.50 x 54 x 24.60	150	46	11.72	\$1460
BRTADF6360H24	62.50 x 60 x 24.60	150	47.50	13.02	\$1484
BRTADF6366H24	62.50 x 66 x 24.60	250	49	14.32	\$1509
BRTADF6372H24	62.50 x 72 x 24.60	250	50.50	15.63	\$1534
BRTADF6378H24	62.50 x 78 x 24.60	250	52	16.93	\$1559
BRTADF6384H24	62.50 x 84 x 24.60	250	53.50	18.23	\$1608

Provides privacy in an open plan environment. Powder coated aluminum frame with 9mm felt. Includes all hardware to connect. Brackets are painted steel. Side dividers extend 6.25" from the front edge of each surface. Center divider sits over the gap between the worksurface allowing for cable pass-through to trough. Gap for each side is approximately 1". Width and depth are nominal sizes representing the sizes of the Bridges configuration. Allow for .25" overhang at the sides and 6.25" at the front. Frame and hardware available in all Bridges paint finishes. End trim cap is only available in Charcoal (CHR). 9mm PET felt material is tackable and available in 9 colors.

- **BRTAPF51xxH24 are for configurations with 24" deep surfaces.**
- **BRTAPF63xxH24 are for configurations with 30" deep surfaces.**

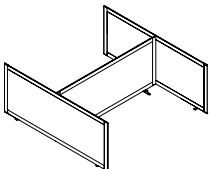

30" H Back-to-Back Felt Divider Screen

BRTADF5136H30	50.50 x 36 x 30.60	150	30.50	6.31	\$1282
BRTADF5142H30	50.50 x 42 x 30.60	150	32	7.36	\$1306
BRTADF5148H30	50.50 x 48 x 30.60	150	33.50	8.42	\$1329
BRTADF5154H30	50.50 x 54 x 30.60	150	35	9.47	\$1352
BRTADF5160H30	50.50 x 60 x 30.60	250	36.50	10.52	\$1375
BRTADF5166H30	50.50 x 66 x 30.60	250	38	11.57	\$1397
BRTADF5172H30	50.50 x 72 x 30.60	250	39.50	12.63	\$1422
BRTADF5178H30	50.50 x 78 x 30.60	250	41	13.68	\$1447
BRTADF5184H30	50.50 x 84 x 30.60	250	42.50	14.73	\$1500
BRTADF6336H30	62.50 x 36 x 30.60	125	44	7.81	\$1440
BRTADF6342H30	62.50 x 42 x 30.60	150	45.50	9.11	\$1462
BRTADF6348H30	62.50 x 48 x 30.60	150	47	10.42	\$1484
BRTADF6354H30	62.50 x 54 x 30.60	150	48.50	11.72	\$1507
BRTADF6360H30	62.50 x 60 x 30.60	150	50	13.02	\$1531
BRTADF6366H30	62.50 x 66 x 30.60	250	51.50	14.32	\$1555
BRTADF6372H30	62.50 x 72 x 30.60	250	53	15.63	\$1578
BRTADF6378H30	62.50 x 78 x 30.60	250	54.50	16.93	\$1601
BRTADF6384H30	62.50 x 84 x 30.60	250	56	18.23	\$1655

Provides privacy in an open plan environment. Powder coated aluminum frame with 9mm felt. Includes all hardware to connect. Brackets are painted steel. Side dividers extend 6.25" from the front edge of each surface. Center divider sits over the gap between the worksurface allowing for cable pass-through to trough. Gap for each side is approximately 1". Width and depth are nominal sizes representing the sizes of the Bridges configuration. Allow for .25" overhang at the sides and 6.25" at the front. Frame and hardware available in all Bridges paint finishes. End trim cap is only available in Charcoal (CHR). 9mm PET felt material is tackable and available in 9 colors.

- **BRTADF51xxH30 are for configurations with 24" deep surfaces.**
- **BRTADF63xxH30 are for configurations with 30" deep surfaces.**

Required Specifications

Frame finish
Felt finish

BACK-TO-BACK FELT DIVIDER SCREENS

MODEL# DIMENSIONS FREIGHT CLASS WT/LBS. CUBIC FT. LIST PRICE

D x W x H

BRTADFE5136H24	50.50 x 36 x 24.60	150	23.35	6.31	\$877
BRTADFE5142H24	50.50 x 42 x 24.60	250	24.85	7.36	\$902
BRTADFE5148H24	50.50 x 48 x 24.60	250	26.35	8.42	\$927
BRTADFE5154H24	50.50 x 54 x 24.60	250	27.85	9.47	\$952
BRTADFE5160H24	50.50 x 60 x 24.60	250	29.35	10.52	\$976
BRTADFE5166H24	50.50 x 66 x 24.60	250	30.85	11.57	\$1001
BRTADFE5172H24	50.50 x 72 x 24.60	250	32.35	12.63	\$1026
BRTADFE5178H24	50.50 x 78 x 24.60	250	33.85	13.68	\$1052
BRTADFE5184H24	50.50 x 84 x 24.60	250	35.35	14.73	\$1102

BRTADFE6336H24	62.50 x 36 x 24.60	150	36.85	7.81	\$924
BRTADFE6342H24	62.50 x 42 x 24.60	150	38.35	9.11	\$949
BRTADFE6348H24	62.50 x 48 x 24.60	150	39.85	10.42	\$975
BRTADFE6354H24	62.50 x 54 x 24.60	250	41.35	11.72	\$999
BRTADFE6360H24	62.50 x 60 x 24.60	250	42.85	13.02	\$1025
BRTADFE6366H24	62.50 x 66 x 24.60	250	44.35	14.32	\$1049
BRTADFE6372H24	62.50 x 72 x 24.60	250	45.85	15.63	\$1075
BRTADFE6378H24	62.50 x 78 x 24.60	250	47.35	16.93	\$1099
BRTADFE6384H24	62.50 x 84 x 24.60	250	48.85	18.23	\$1149

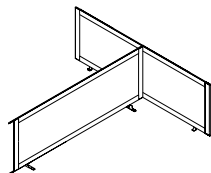

24" H Back-to-Back Felt Divider Screen Extension Kit

Provides an extension to privacy in an open plan environment. Intended to always connect to Back-to-Back Divider Screen Kit. Powder coated aluminum frame with 9mm felt. Includes all hardware to connect. Brackets are painted steel. Side dividers extend 6.25" from the front edge of each surface. Center divider sits over the gap between the worksurface allowing for cable pass-through to trough. Gap for each side is approximately 1". Width and depth are nominal sizes representing the sizes of the Bridges configuration. Allow for .25" overhang at the sides and 6.25" at the front. Frame and hardware available in all Bridges paint finishes. End trim cap is only available in Charcoal (CHR). 9mm PET felt material is tackable and available in 9 colors.

- **BRTADFE51xxH24 are for configurations with 24" deep surfaces.**
- **BRTADFE63xxH24 are for configurations with 30" deep surfaces.**

BRTADFE5136H30	50.50 x 36 x 30.60	150	25.85	6.31	\$875
BRTADFE5142H30	50.50 x 42 x 30.60	150	27.35	7.36	\$898
BRTADFE5148H30	50.50 x 48 x 30.60	250	28.85	8.42	\$922
BRTADFE5154H30	50.50 x 54 x 30.60	250	30.35	9.47	\$945
BRTADFE5160H30	50.50 x 60 x 30.60	250	31.85	10.52	\$968
BRTADFE5166H30	50.50 x 66 x 30.60	250	33.35	11.57	\$992
BRTADFE5172H30	50.50 x 72 x 30.60	250	34.85	12.63	\$1015
BRTADFE5178H30	50.50 x 78 x 30.60	250	36.35	13.68	\$1038
BRTADFE5184H30	50.50 x 84 x 30.60	250	37.85	14.73	\$1092

BRTADFE6336H30	62.50 x 36 x 30.60	150	39.35	7.81	\$921
BRTADFE6342H30	62.50 x 42 x 30.60	150	40.85	9.11	\$944
BRTADFE6348H30	62.50 x 48 x 30.60	150	42.35	10.42	\$967
BRTADFE6354H30	62.50 x 54 x 30.60	250	43.85	11.72	\$990
BRTADFE6360H30	62.50 x 60 x 30.60	250	45.35	13.02	\$1014
BRTADFE6366H30	62.50 x 66 x 30.60	250	46.85	14.32	\$1037
BRTADFE6372H30	62.50 x 72 x 30.60	250	48.35	15.63	\$1060
BRTADFE6378H30	62.50 x 78 x 30.60	250	49.85	16.93	\$1083
BRTADFE6384H30	62.50 x 84 x 30.60	250	51.35	18.23	\$1136

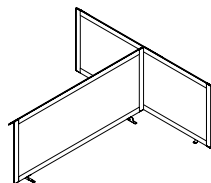

30" H Back-to-Back Felt Divider Screen Extension Kit

Provides an extension to privacy in an open plan environment. Intended to always connect to Back-to-Back Divider Screen Kit. Powder coated aluminum frame with 9mm felt. Includes all hardware to connect. Brackets are painted steel. Side dividers extend 6.25" from the front edge of each surface. Center divider sits over the gap between the worksurface allowing for cable pass-through to trough. Gap for each side is approximately 1". Width and depth are nominal sizes representing the sizes of the Bridges configuration. Allow for .25" overhang at the sides and 6.25" at the front. Frame and hardware available in all Bridges paint finishes. End trim cap is only available in Charcoal (CHR). 9mm PET felt material is tackable and available in 9 colors.

- **BRTADFE51xxH30 are for configurations with 24" deep surfaces.**
- **BRTADFE63xxH30 are for configurations with 30" deep surfaces.**

Required Specifications

Frame finish
Felt finish

SINGLE TABLE FELT DIVIDER SCREENS

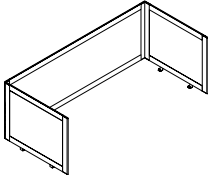

24" H Single Table Felt Divider Screen

MODEL#	DIMENSIONS D x W x H	FREIGHT CLASS	WT./LBS.	CUBIC FT.	LIST PRICE
BRTADF2436H24	31.50 x 36 x 24.60	125	22.55	3.94	\$937
BRTADF2442H24	31.50 x 42 x 24.60	125	24.10	4.59	\$961
BRTADF2448H24	31.50 x 48 x 24.60	150	25.65	5.25	\$986
BRTADF2454H24	31.50 x 54 x 24.60	150	27.20	5.91	\$1010
BRTADF2460H24	31.50 x 60 x 24.60	150	28.75	6.56	\$1037
BRTADF2466H24	31.50 x 66 x 24.60	150	30.30	7.22	\$1061
BRTADF2472H24	31.50 x 72 x 24.60	150	31.85	7.88	\$1086
BRTADF2478H24	31.50 x 78 x 24.60	150	33.40	8.53	\$1111
BRTADF2484H24	31.50 x 84 x 24.60	150	34.95	9.19	\$1160
BRTADF3036H24	37.75 x 36 x 24.60	100	36.50	4.72	\$968
BRTADF3042H24	37.75 x 42 x 24.60	125	38.05	5.51	\$995
BRTADF3048H24	37.75 x 48 x 24.60	125	39.60	6.29	\$1019
BRTADF3054H24	37.75 x 54 x 24.60	150	41.15	7.08	\$1044
BRTADF3060H24	37.75 x 60 x 24.60	150	41.70	7.87	\$1069
BRTADF3066H24	37.75 x 66 x 24.60	150	44.25	8.65	\$1095
BRTADF3072H24	37.75 x 72 x 24.60	150	45.80	9.44	\$1117
BRTADF3078H24	37.75 x 78 x 24.60	150	47.35	10.22	\$1142
BRTADF3084H24	37.75 x 84 x 24.60	150	48.90	11.01	\$1193

Provides privacy in an open plan environment. Powder coated aluminum frame with 9mm felt. Includes all hardware to connect. Brackets are painted steel. Side dividers extend 6.237" from the front edge of each surface. Back divider extends over the back edge of the worksurface by 1.5", allowing for cable pass-through to trough. Width and depth are nominal sizes representing the sizes of the Bridges configuration. Allow for .25" overhang at the sides, 1.5" at the back, and 6.237" at the front. Frame and hardware available in all Bridges paint finishes. End trim cap is only available in Charcoal (CHR). 9mm PET felt material is tackable and available in 9 colors.

- **BRTADF24xxH24 are for configurations with 24" deep surfaces.**
- **BRTADF30xxH24 are for configurations with 30" deep surfaces.**

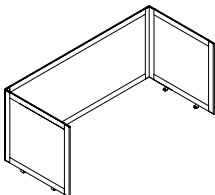

30" H Single Table Felt Divider Screen

BRTADF2436H30	31.50 x 36 x 30.60	125	24.85	3.97	\$930
BRTADF2442H30	31.50 x 42 x 30.60	125	26.40	4.59	\$954
BRTADF2448H30	31.50 x 48 x 30.60	125	27.95	5.25	\$976
BRTADF2454H30	31.50 x 54 x 30.60	150	29.50	5.91	\$999
BRTADF2460H30	31.50 x 60 x 30.60	150	31.05	6.56	\$1022
BRTADF2466H30	31.50 x 66 x 30.60	150	32.60	7.22	\$1045
BRTADF2472H30	31.50 x 72 x 30.60	150	34.14	7.88	\$1069
BRTADF2478H30	31.50 x 78 x 30.60	150	34.70	8.53	\$1092
BRTADF2484H30	31.50 x 84 x 30.60	150	37.25	9.19	\$1147
BRTADF3036H30	37.75 x 36 x 30.60	100	38.80	4.72	\$975
BRTADF3042H30	37.75 x 42 x 30.60	100	40.35	5.51	\$998
BRTADF3048H30	37.75 x 48 x 30.60	125	41.90	6.29	\$1021
BRTADF3054H30	37.75 x 54 x 30.60	125	43.45	7.08	\$1044
BRTADF3060H30	37.75 x 60 x 30.60	125	45	7.87	\$1069
BRTADF3066H30	37.75 x 66 x 30.60	150	46.55	8.65	\$1092
BRTADF3072H30	37.75 x 72 x 30.60	150	48.10	9.44	\$1114
BRTADF3078H30	37.75 x 78 x 30.60	150	49.65	10.22	\$1137
BRTADF3084H30	37.75 x 84 x 30.60	150	51.20	11.01	\$1191

Provides privacy in an open plan environment. Powder coated aluminum frame with 9mm felt. Includes all hardware to connect. Brackets are painted steel. Side dividers extend 6.237" from the front edge of each surface. Back divider extends over the back edge of the worksurface by 1.5", allowing for cable pass-through to trough. Width and depth are nominal sizes representing the sizes of the Bridges configuration. Allow for .25" overhang at the sides, 1.5" at the back, and 6.237" at the front. Frame and hardware available in all Bridges paint finishes. End trim cap is only available in Charcoal (CHR). 9mm PET felt material is tackable and available in 9 colors.

- **BRTADF24xxH30 are for configurations with 24" deep surfaces.**
- **BRTADF30xxH30 are for configurations with 30" deep surfaces.**

Required Specifications

Frame finish
Felt finish

SINGLE TABLE FELT DIVIDER SCREENS

MODEL# DIMENSIONS FREIGHT CLASS WT/LBS. CUBIC FT. LIST PRICE

D x W x H

BRTADFE2436H24	31.50 x 36 x 24.60	150	18.55	3.94	\$709
BRTADFE2442H24	31.50 x 42 x 24.60	150	20.10	4.59	\$776
BRTADFE2448H24	31.50 x 48 x 24.60	150	21.65	5.25	\$802
BRTADFE2454H24	31.50 x 54 x 24.60	150	23.20	5.91	\$827
BRTADFE2460H24	31.50 x 60 x 24.60	150	24.75	6.56	\$852
BRTADFE2466H24	31.50 x 66 x 24.60	250	26.30	7.22	\$877
BRTADFE2472H24	31.50 x 72 x 24.60	250	27.85	7.88	\$902
BRTADFE2478H24	31.50 x 78 x 24.60	250	29.40	8.53	\$927
BRTADFE2484H24	31.50 x 84 x 24.60	250	30.95	9.19	\$976

BRTADFE3036H24	37.75 x 36 x 24.60	125	32.50	4.72	\$735
BRTADFE3042H24	37.75 x 42 x 24.60	125	34.05	5.51	\$803
BRTADFE3048H24	37.75 x 48 x 24.60	125	35.60	6.29	\$829
BRTADFE3054H24	37.75 x 54 x 24.60	150	37.15	7.08	\$853
BRTADFE3060H24	37.75 x 60 x 24.60	150	38.70	7.87	\$879
BRTADFE3066H24	37.75 x 66 x 24.60	150	40.25	8.65	\$904
BRTADFE3072H24	37.75 x 72 x 24.60	150	41.80	9.44	\$929
BRTADFE3078H24	37.75 x 78 x 24.60	150	43.35	10.01	\$954
BRTADFE3084H24	37.75 x 84 x 24.60	150	44.90	10.01	\$1004

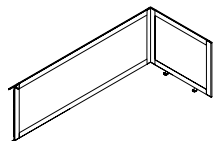

24" H Single Table Felt Divider Screen Extension Kit

Provides an extension for privacy in an open plan environment. Intended to always connect to Single Table Divider Screen Kit. Powder coated aluminum frame with 9mm felt. Includes all hardware to connect. Brackets are painted steel. Side dividers extend 6.237" from the front edge of each surface. Back divider extends over the back edge of the worksurface by 1.5", allowing for cable pass-through to trough. Width and depth are nominal sizes representing the sizes of the Bridges configuration. Allow for .25" overhang at the sides, 1.5" at the back, and 6.237" at the front. Frame and hardware available in all Bridges paint finishes. End trim cap is only available in Charcoal (CHR). 9mm PET felt material is tackable and available in 9 colors.

- **BRTADFE24xxH24 are for configurations with 24" deep surfaces.**
- **BRTADFE30xxH24 are for configurations with 30" deep surfaces.**

BRTADFE2436H30	31.50 x 36 x 30.60	150	20.35	3.94	\$743
BRTADFE2442H30	31.50 x 42 x 30.60	150	21.90	4.59	\$811
BRTADFE2448H30	31.50 x 48 x 30.60	150	23.45	5.25	\$833
BRTADFE2454H30	31.50 x 54 x 30.60	150	25	5.91	\$857
BRTADFE2460H30	31.50 x 60 x 30.60	150	26.55	6.56	\$880
BRTADFE2466H30	31.50 x 66 x 30.60	150	28.10	7.22	\$904
BRTADFE2472H30	31.50 x 72 x 30.60	150	29.65	7.88	\$927
BRTADFE2478H30	31.50 x 78 x 30.60	250	31.20	8.53	\$949
BRTADFE2484H30	31.50 x 84 x 30.60	250	32.75	9.19	\$1004

BRTADFE3036H30	37.75 x 36 x 30.60	125	34.30	4.72	\$770
BRTADFE3042H30	37.75 x 42 x 30.60	125	35.85	5.51	\$842
BRTADFE3048H30	37.75 x 48 x 30.60	125	37.40	6.29	\$865
BRTADFE3054H30	37.75 x 54 x 30.60	150	38.95	7.08	\$890
BRTADFE3060H30	37.75 x 60 x 30.60	150	40.50	7.87	\$913
BRTADFE3066H30	37.75 x 66 x 30.60	150	42.05	8.65	\$937
BRTADFE3072H30	37.75 x 72 x 30.60	150	43.60	9.44	\$960
BRTADFE3078H30	37.75 x 78 x 30.60	150	45.15	10.22	\$983
BRTADFE3084H30	37.75 x 84 x 30.60	150	46.70	11.01	\$1037

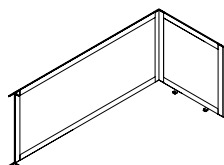

30" H Single Table Felt Divider Screen Extension Kit

Provides an extension for privacy in an open plan environment. Intended to always connect to Single Table Divider Screen Kit. Powder coated aluminum frame with 9mm felt. Includes all hardware to connect. Brackets are painted steel. Side dividers extend 6.237" from the front edge of each surface. Back divider extends over the back edge of the worksurface by 1.5", allowing for cable pass-through to trough. Width and depth are nominal sizes representing the sizes of the Bridges configuration. Allow for .25" overhang at the sides, 1.5" at the back, and 6.237" at the front. Frame and hardware available in all Bridges paint finishes. End trim cap is only available in Charcoal (CHR). 9mm PET felt material is tackable and available in 9 colors.

- **BRTADFE24xxH30 are for configurations with 24" deep surfaces.**
- **BRTADFE30xxH30 are for configurations with 30" deep surfaces.**

Required Specifications

Frame finish
Felt finish

BACK-TO-BACK GLASS DIVIDER SCREENS

MODEL#	DIMENSIONS D x W x H	FREIGHT CLASS	WT./LBS.	CUBIC FT.	LIST PRICE	FRST ADD
BRTADG5136H24	50.50 x 36 x 24.60	150	28	6.31	\$1446	\$442
BRTADG5142H24	50.50 x 42 x 24.60	150	29.50	7.36	\$2243	\$455
BRTADG5148H24	50.50 x 48 x 24.60	150	31	8.42	\$2295	\$461
BRTADG5154H24	50.50 x 54 x 24.60	250	32.50	9.47	\$2347	\$475
BRTADG5160H24	50.50 x 60 x 24.60	250	34	10.52	\$2398	\$481
BRTADG5166H24	50.50 x 66 x 24.60	250	35.50	11.57	\$2449	\$494
BRTADG5172H24	50.50 x 72 x 24.60	250	37	12.63	\$2502	\$508
BRTADG5178H24	50.50 x 78 x 24.60	250	38.50	13.68	\$2554	\$513
BRTADG5184H24	50.50 x 84 x 24.60	250	40	14.73	\$2606	\$525
BRTADG6336H24	62.50 x 36 x 24.60	150	41.50	7.81	\$2398	\$481
BRTADG6342H24	62.50 x 42 x 24.60	150	43	9.11	\$2444	\$494
BRTADG6348H24	62.50 x 48 x 24.60	150	44.50	10.42	\$2502	\$508
BRTADG6354H24	62.50 x 54 x 24.60	150	46	11.72	\$2548	\$513
BRTADG6360H24	62.50 x 60 x 24.60	150	47.50	13.02	\$2606	\$525
BRTADG6366H24	62.50 x 66 x 24.60	250	49	14.32	\$2657	\$533
BRTADG6372H24	62.50 x 72 x 24.60	250	50.50	15.63	\$2703	\$546
BRTADG6378H24	62.50 x 78 x 24.60	250	52	16.93	\$2761	\$558
BRTADG6384H24	62.50 x 84 x 24.60	250	53.50	18.23	\$2807	\$566

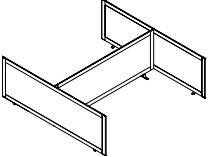

24" H Back-to-Back Glass Divider Screen

Provides privacy in an open plan environment. Easy to clean table mounted partitions. Powder coated aluminum frame with 4mm clear (CLR) glass. Includes all hardware to connect. Brackets are painted steel. Side dividers extend 6.25" from the front edge of each surface. Center divider sits over the gap between the worksurface allowing for cable pass-through to trough. Gap for each side is approximately 1". Width and depth are nominal sizes representing the sizes of the Bridges configuration. Allow for .25" overhang at the sides and 6.25" at the front. Frame and hardware available in all Bridges paint finishes. End trim cap is only available in Charcoal (CHR). **Add 20% upcharge for frosted glass (FRST).**

- **BRTADG51xxH24 are for configurations with 24" deep surfaces.**
- **BRTADG63xxH24 are for configurations with 30" deep surfaces.**

BRTADG5136H30	50.50 x 36 x 30.60	150	30.50	6.31	\$2315	\$467
BRTADG5142H30	50.50 x 42 x 30.60	150	32	7.36	\$2373	\$481
BRTADG5148H30	50.50 x 48 x 30.60	150	33.50	8.42	\$2418	\$488
BRTADG5154H30	50.50 x 54 x 30.60	150	35	9.47	\$2477	\$500
BRTADG5160H30	50.50 x 60 x 30.60	250	36.50	10.52	\$2528	\$508
BRTADG5166H30	50.50 x 66 x 30.60	250	38	11.57	\$2580	\$520
BRTADG5172H30	50.50 x 72 x 30.60	250	39.50	12.63	\$2612	\$525
BRTADG5178H30	50.50 x 78 x 30.60	250	41	13.68	\$2690	\$539
BRTADG5184H30	50.50 x 84 x 30.60	250	42.50	14.73	\$2741	\$553
BRTADG6336H30	62.50 x 36 x 30.60	125	44	7.81	\$2599	\$525
BRTADG6342H30	62.50 x 42 x 30.60	150	45.50	9.11	\$2651	\$533
BRTADG6348H30	62.50 x 48 x 30.60	150	47	10.42	\$2703	\$546
BRTADG6354H30	62.50 x 54 x 30.60	150	48.50	11.72	\$2761	\$558
BRTADG6360H30	62.50 x 60 x 30.60	150	50	13.02	\$2813	\$566
BRTADG6366H30	62.50 x 66 x 30.60	250	51.50	14.32	\$2857	\$578
BRTADG6372H30	62.50 x 72 x 30.60	250	53	15.63	\$2898	\$583
BRTADG6378H30	62.50 x 78 x 30.60	250	54.50	16.93	\$2968	\$598
BRTADG6384H30	62.50 x 84 x 30.60	250	56	18.23	\$3027	\$611

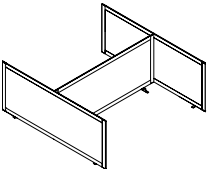

30" H Back-to-Back Glass Divider Screen

Provides privacy in an open plan environment. Easy to clean table mounted partitions. Powder coated aluminum frame with 4mm clear (CLR) glass. Includes all hardware to connect. Brackets are painted steel. Side dividers extend 6.25" from the front edge of each surface. Center divider sits over the gap between the worksurface allowing for cable pass-through to trough. Gap for each side is approximately 1". Width and depth are nominal sizes representing the sizes of the Bridges configuration. Allow for .25" overhang at the sides and 6.25" at the front. Frame and hardware available in all Bridges paint finishes. End trim cap is only available in Charcoal (CHR). **Add 20% upcharge for frosted glass (FRST).**

- **BRTADG51xxH30 are for configurations with 24" deep surfaces.**
- **BRTADG63xxH30 are for configurations with 30" deep surfaces.**

Required specifications
Frame finish

Optional specifications
Frosted glass (FRST)

BACK-TO-BACK GLASS DIVIDER SCREENS

MODEL# DIMENSIONS FREIGHT CLASS WT/LBS. CUBIC FT. LIST PRICE FRST ADD

D x W x H

BRTADGE5136H24	50.50 x 36 x 24.60	150	23.35	6.31	\$1446	\$292
BRTADGE5142H24	50.50 x 42 x 24.60	250	24.85	7.36	\$1499	\$306
BRTADGE5148H24	50.50 x 48 x 24.60	250	26.35	8.42	\$1549	\$313
BRTADGE5154H24	50.50 x 54 x 24.60	250	27.85	9.47	\$1602	\$325
BRTADGE5160H24	50.50 x 60 x 24.60	250	29.35	10.52	\$1654	\$333
BRTADGE5166H24	50.50 x 66 x 24.60	250	30.85	11.57	\$1705	\$345
BRTADGE5172H24	50.50 x 72 x 24.60	250	32.35	12.63	\$1757	\$358
BRTADGE5178H24	50.50 x 78 x 24.60	250	33.85	13.68	\$1808	\$365
BRTADGE5184H24	50.50 x 84 x 24.60	250	35.35	14.73	\$1861	\$378

BRTADGE6336H24	62.50 x 36 x 24.60	150	36.85	7.81	\$1549	\$313
BRTADGE6342H24	62.50 x 42 x 24.60	150	38.35	9.11	\$1602	\$325
BRTADGE6348H24	62.50 x 48 x 24.60	150	39.85	10.42	\$1654	\$333
BRTADGE6354H24	62.50 x 54 x 24.60	250	41.35	11.72	\$1705	\$345
BRTADGE6360H24	62.50 x 60 x 24.60	250	42.85	13.02	\$1749	\$350
BRTADGE6366H24	62.50 x 66 x 24.60	250	44.35	14.32	\$1808	\$365
BRTADGE6372H24	62.50 x 72 x 24.60	250	45.85	15.63	\$1861	\$378
BRTADGE6378H24	62.50 x 78 x 24.60	250	47.35	16.93	\$1907	\$383
BRTADGE6384H24	62.50 x 84 x 24.60	250	48.85	18.23	\$1965	\$396

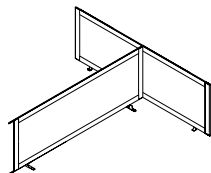

**24" H Back-to-Back Glass Divider
Screen Extension Kit**

Provides an extension to privacy in an open plan environment. Easy to clean table mounted partitions. Intended to always connect to Back-to-Back Divider Screen Kit. Powder coated aluminum frame with 4mm clear (CLR) glass. Includes all hardware to connect. Brackets are painted steel. Side dividers extend 6.25" from the front edge of each surface. Center divider sits over the gap between the worksurface allowing for cable pass-through to trough. Gap for each side is approximately 1". Width and depth are nominal sizes representing the sizes of the Bridges configuration. Allow for .25" overhang at the sides and 6.25" at the front. Frame and hardware available in all Bridges paint finishes. End trim cap is only available in Charcoal (CHR). **Add 20%** upcharge for frosted glass (FRST).

- **BRTADGE51xxH24 are for configurations with 24" deep surfaces.**
- **BRTADGE63xxH24 are for configurations with 30" deep surfaces.**

BRTADGE5136H30	50.50 x 36 x 30.60	150	25.85	6.31	\$1531	\$313
BRTADGE5142H30	50.50 x 42 x 30.60	150	27.35	7.36	\$1575	\$319
BRTADGE5148H30	50.50 x 48 x 30.60	250	28.85	8.42	\$1627	\$333
BRTADGE5154H30	50.50 x 54 x 30.60	250	30.35	9.47	\$1686	\$338
BRTADGE5160H30	50.50 x 60 x 30.60	250	31.85	10.52	\$1737	\$350
BRTADGE5166H30	50.50 x 66 x 30.60	250	33.35	11.57	\$1796	\$365
BRTADGE5172H30	50.50 x 72 x 30.60	250	34.85	12.63	\$1822	\$371
BRTADGE5178H30	50.50 x 78 x 30.60	250	36.35	13.68	\$1894	\$383
BRTADGE5184H30	50.50 x 84 x 30.60	250	37.85	14.73	\$1952	\$396

BRTADGE6336H30	62.50 x 36 x 30.60	150	39.35	7.81	\$1627	\$333
BRTADGE6342H30	62.50 x 42 x 30.60	150	40.85	9.11	\$1686	\$338
BRTADGE6348H30	62.50 x 48 x 30.60	150	42.35	10.42	\$1737	\$350
BRTADGE6354H30	62.50 x 54 x 30.60	250	43.85	11.72	\$1790	\$365
BRTADGE6360H30	62.50 x 60 x 30.60	250	45.35	13.02	\$1841	\$371
BRTADGE6366H30	62.50 x 66 x 30.60	250	46.85	14.32	\$1894	\$383
BRTADGE6372H30	62.50 x 72 x 30.60	250	48.35	15.63	\$1932	\$391
BRTADGE6378H30	62.50 x 78 x 30.60	250	49.85	16.93	\$2004	\$403
BRTADGE6384H30	62.50 x 84 x 30.60	250	51.35	18.23	\$2055	\$416

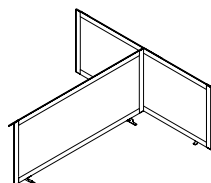

**30" H Back-to-Back Glass Divider
Screen Extension Kit**

Provides an extension to privacy in an open plan environment. Easy to clean table mounted partitions. Intended to always connect to Back-to-Back Divider Screen Kit. Powder coated aluminum frame with 4mm clear (CLR) glass. Includes all hardware to connect. Brackets are painted steel. Side dividers extend 6.25" from the front edge of each surface. Center divider sits over the gap between the worksurface allowing for cable pass-through to trough. Gap for each side is approximately 1". Width and depth are nominal sizes representing the sizes of the Bridges configuration. Allow for .25" overhang at the sides and 6.25" at the front. Frame and hardware available in all Bridges paint finishes. End trim cap is only available in Charcoal (CHR). **Add 20%** upcharge for frosted glass (FRST).

- **BRTADGE51xxH30 are for configurations with 24" deep surfaces.**
- **BRTADGE63xxH30 are for configurations with 30" deep surfaces.**

Required specifications

Frame finish

Optional specifications

Frosted glass (FRST)

SINGLE TABLE GLASS DIVIDER SCREENS

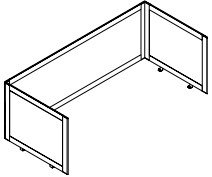

24" H Single Table Glass Divider Screen

MODEL#	DIMENSIONS D x W x H	FREIGHT CLASS	WT./LBS.	CUBIC FT.	LIST PRICE	FRST ADD
BRTADG2436H24	31.50 x 36 x 24.60	125	22.55	3.94	\$1582	\$319
BRTADG2442H24	31.50 x 42 x 24.60	125	24.10	4.59	\$1633	\$333
BRTADG2448H24	31.50 x 48 x 24.60	150	25.65	5.25	\$1686	\$338
BRTADG2454H24	31.50 x 54 x 24.60	150	27.20	5.91	\$1737	\$350
BRTADG2460H24	31.50 x 60 x 24.60	150	28.75	6.56	\$1790	\$365
BRTADG2466H24	31.50 x 66 x 24.60	150	30.30	7.22	\$1841	\$371
BRTADG2472H24	31.50 x 72 x 24.60	150	31.85	7.88	\$1894	\$383
BRTADG2478H24	31.50 x 78 x 24.60	150	33.40	8.53	\$1945	\$391
BRTADG2484H24	31.50 x 84 x 24.60	150	34.95	9.19	\$1997	\$403
BRTADG3036H24	37.75 x 36 x 24.60	100	36.50	4.72	\$1686	\$338
BRTADG3042H24	37.75 x 42 x 24.60	125	38.05	5.51	\$1732	\$350
BRTADG3048H24	37.75 x 48 x 24.60	125	39.60	6.29	\$1790	\$365
BRTADG3054H24	37.75 x 54 x 24.60	125	41.15	7.08	\$1835	\$371
BRTADG3060H24	37.75 x 60 x 24.60	150	41.70	7.87	\$1887	\$383
BRTADG3066H24	37.75 x 66 x 24.60	150	44.25	8.65	\$1939	\$391
BRTADG3072H24	37.75 x 72 x 24.60	150	45.80	9.44	\$1990	\$403
BRTADG3078H24	37.75 x 78 x 24.60	150	47.35	10.22	\$2041	\$409
BRTADG3084H24	37.75 x 84 x 24.60	150	48.90	11.01	\$2094	\$423

Provides privacy in an open plan environment. Easy to clean table mounted partitions. Powder coated aluminum frame with 4mm clear (CLR) glass. Includes all hardware to connect. Brackets are painted steel. Side dividers extend 6.237" from the front edge of each surface. Back divider extends over the back edge of the worksurface by 1.5", allowing for cable pass-through to trough. Width and depth are nominal sizes representing the sizes of the Bridges configuration. Allow for .25" overhang at the sides, 1.5" at the back, and 6.237" at the front. Frame and hardware available in all Bridges paint finishes. End trim cap is only available in Charcoal (CHR). 9mm PET felt material is tackable and available in 9 colors.

- **BRTADG24xxH24 are for configurations with 24" deep surfaces.**
- **BRTADG30xxH24 are for configurations with 30" deep surfaces.**

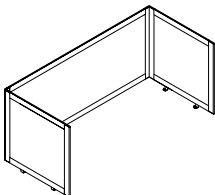

30" H Single Table Glass Divider Screen

BRTADG2436H30	31.50 x 36 x 30.60	125	24.85	3.97	\$1654	\$333
BRTADG2442H30	31.50 x 42 x 30.60	125	26.40	4.59	\$1699	\$345
BRTADG2448H30	31.50 x 48 x 30.60	125	27.95	5.25	\$1749	\$350
BRTADG2454H30	31.50 x 54 x 30.60	150	29.50	5.91	\$1808	\$365
BRTADG2460H30	31.50 x 60 x 30.60	150	31.05	6.56	\$1861	\$378
BRTADG2466H30	31.50 x 66 x 30.60	150	32.60	7.22	\$1919	\$391
BRTADG2472H30	31.50 x 72 x 30.60	150	34.14	7.88	\$1945	\$391
BRTADG2478H30	31.50 x 78 x 30.60	150	34.70	8.53	\$2016	\$409
BRTADG2484H30	31.50 x 84 x 30.60	150	37.25	9.19	\$2074	\$416
BRTADG3036H30	37.75 x 36 x 30.60	100	38.80	4.72	\$1749	\$350
BRTADG3042H30	37.75 x 42 x 30.60	100	40.35	5.51	\$1808	\$365
BRTADG3048H30	37.75 x 48 x 30.60	125	41.90	6.29	\$1861	\$378
BRTADG3054H30	37.75 x 54 x 30.60	125	43.45	7.08	\$1907	\$383
BRTADG3060H30	37.75 x 60 x 30.60	125	45	7.87	\$1965	\$396
BRTADG3066H30	37.75 x 66 x 30.60	150	46.55	8.65	\$2016	\$409
BRTADG3072H30	37.75 x 72 x 30.60	150	48.10	9.44	\$2055	\$416
BRTADG3078H30	37.75 x 78 x 30.60	150	49.65	10.22	\$2127	\$429
BRTADG3084H30	37.75 x 84 x 30.60	150	51.20	11.01	\$2172	\$436

Provides privacy in an open plan environment. Easy to clean table mounted partitions. Powder coated aluminum frame with 4mm clear (CLR) glass. Includes all hardware to connect. Brackets are painted steel. Side dividers extend 6.237" from the front edge of each surface. Back divider extends over the back edge of the worksurface by 1.5", allowing for cable pass-through to trough. Width and depth are nominal sizes representing the sizes of the Bridges configuration. Allow for .25" overhang at the sides, 1.5" at the back, and 6.237" at the front. Frame and hardware available in all Bridges paint finishes. End trim cap is only available in Charcoal (CHR). **Add 20% upcharge for frosted glass (FRST).**

- **BRTADG24xxH30 are for configurations with 24" deep surfaces.**
- **BRTADG30xxH30 are for configurations with 30" deep surfaces.**

Required specifications
Frame finish

Optional specifications
Frosted glass (FRST)

SINGLE TABLE GLASS DIVIDER SCREENS

MODEL# DIMENSIONS FREIGHT CLASS WT/LBS. CUBIC FT. LIST PRICE FRST ADD

D x W x H

BRTADGE2436H24	31.50 x 36 x 24.60	150	18.55	3.94	\$1136	\$228
BRTADGE2442H24	31.50 x 42 x 24.60	150	20.10	4.59	\$1239	\$255
BRTADGE2448H24	31.50 x 48 x 24.60	150	21.65	5.25	\$1283	\$261
BRTADGE2454H24	31.50 x 54 x 24.60	150	23.20	5.91	\$1336	\$274
BRTADGE2460H24	31.50 x 60 x 24.60	150	24.75	6.56	\$1388	\$280
BRTADGE2466H24	31.50 x 66 x 24.60	250	26.30	7.22	\$1440	\$292
BRTADGE2472H24	31.50 x 72 x 24.60	250	27.85	7.88	\$1491	\$300
BRTADGE2478H24	31.50 x 78 x 24.60	250	29.40	8.53	\$1544	\$313
BRTADGE2484H24	31.50 x 84 x 24.60	250	30.95	9.19	\$1595	\$325

BRTADGE3036H24	37.75 x 36 x 24.60	125	32.50	4.72	\$1187	\$241
BRTADGE3042H24	37.75 x 42 x 24.60	125	34.05	5.51	\$1291	\$261
BRTADGE3048H24	37.75 x 48 x 24.60	125	35.60	6.29	\$1341	\$274
BRTADGE3054H24	37.75 x 54 x 24.60	150	37.15	7.08	\$1394	\$280
BRTADGE3060H24	37.75 x 60 x 24.60	150	38.70	7.87	\$1446	\$292
BRTADGE3066H24	37.75 x 66 x 24.60	150	40.25	8.65	\$1499	\$306
BRTADGE3072H24	37.75 x 72 x 24.60	150	41.80	9.44	\$1549	\$313
BRTADGE3078H24	37.75 x 78 x 24.60	150	43.35	10.01	\$1602	\$325
BRTADGE3084H24	37.75 x 84 x 24.60	150	44.90	10.01	\$1654	\$333

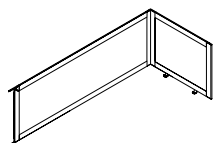
**24" H Single Table Glass Divider Screen Extension Kit**

Provides an extension for privacy in an open plan environment. Intended to always connect to Single Table Divider Screen Kit. Easy to clean table mounted partitions. Powder coated aluminum frame with 4mm clear (CLR) glass. Includes all hardware to connect. Brackets are painted steel. Side dividers extend 6.237" from the front edge of each surface. Back divider extends over the back edge of the worksurface by 1.5", allowing for cable pass-through to trough. Width and depth are nominal sizes representing the sizes of the Bridges configuration. Allow for .25" overhang at the sides, 1.5" at the back, and 6.237" at the front. Frame and hardware available in all Bridges paint finishes. End trim cap is only available in Charcoal (CHR). **Add 20%** upcharge for frosted glass (FRST).

- **BRTADGE24xxH24 are for configurations with 24" deep surfaces.**
- **BRTADGE30xxH24 are for configurations with 30" deep surfaces.**

BRTADGE2436H30	31.50 x 36 x 30.60	150	20.35	3.94	\$1187	\$241
BRTADGE2442H30	31.50 x 42 x 30.60	150	21.90	4.59	\$1291	\$261
BRTADGE2448H30	31.50 x 48 x 30.60	150	23.45	5.25	\$1341	\$274
BRTADGE2454H30	31.50 x 54 x 30.60	150	25	5.91	\$1400	\$286
BRTADGE2460H30	31.50 x 60 x 30.60	150	26.55	6.56	\$1452	\$292
BRTADGE2466H30	31.50 x 66 x 30.60	150	28.10	7.22	\$1511	\$306
BRTADGE2472H30	31.50 x 72 x 30.60	150	29.65	7.88	\$1537	\$313
BRTADGE2478H30	31.50 x 78 x 30.60	250	31.20	8.53	\$1608	\$325
BRTADGE2484H30	31.50 x 84 x 30.60	250	32.75	9.19	\$1666	\$338

BRTADGE3036H30	37.75 x 36 x 30.60	125	34.30	4.72	\$1246	\$255
BRTADGE3042H30	37.75 x 42 x 30.60	125	35.85	5.51	\$1341	\$274
BRTADGE3048H30	37.75 x 48 x 30.60	125	37.40	6.29	\$1400	\$286
BRTADGE3054H30	37.75 x 54 x 30.60	150	38.95	7.08	\$1452	\$292
BRTADGE3060H30	37.75 x 60 x 30.60	150	40.50	7.87	\$1511	\$306
BRTADGE3066H30	37.75 x 66 x 30.60	150	42.05	8.65	\$1557	\$313
BRTADGE3072H30	37.75 x 72 x 30.60	150	43.60	9.44	\$1589	\$319
BRTADGE3078H30	37.75 x 78 x 30.60	150	45.15	10.22	\$1666	\$338
BRTADGE3084H30	37.75 x 84 x 30.60	150	46.70	11.01	\$1719	\$345

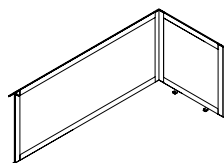
**30" H Single Table Glass Divider Screen Extension Kit**

Provides an extension for privacy in an open plan environment. Intended to always connect to Single Table Divider Screen Kit. Easy to clean table mounted partitions. Powder coated aluminum frame with 4mm clear (CLR) glass. Includes all hardware to connect. Brackets are painted steel. Side dividers extend 6.237" from the front edge of each surface. Back divider extends over the back edge of the worksurface by 1.5", allowing for cable pass-through to trough. Width and depth are nominal sizes representing the sizes of the Bridges configuration. Allow for .25" overhang at the sides, 1.5" at the back, and 6.237" at the front. Frame and hardware available in all Bridges paint finishes. End trim cap is only available in Charcoal (CHR). **Add 20%** upcharge for frosted glass (FRST).

- **BRTADGE24xxH30 are for configurations with 24" deep surfaces.**
- **BRTADGE30xxH30 are for configurations with 30" deep surfaces.**

Required specifications

Frame finish

Optional specifications

Frosted glass (FRST)

STORAGE

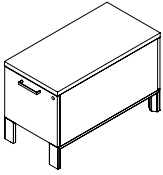

File Pedestal

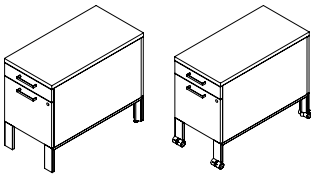

Box/File Pedestal

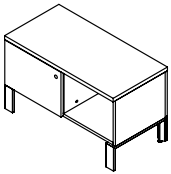

Sliding Door Storage

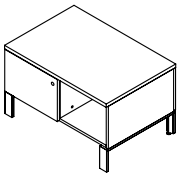

Shared Sliding Door Storage

MODEL#	DIMENSIONS D x W x H	FREIGHT CLASS	WT./LBS.	CUBIC FT.	LIST PRICE	HP ADD
BRT21BF18L	18 x 15.5 x 21	70	58	3.39	\$855	\$63
BRT21BF24L	24 x 15.5 x 21	85	64	4.52	\$994	\$63
BRT21BF30L	30 x 15.5 x 21	85	72	5.65	\$1091	\$82
BRT21BF18C	18 x 15.5 x 21	70	58	3.39	\$855	\$63
BRT21BF24C	24 x 15.5 x 21	85	64	4.52	\$1069	\$63
BRT21BF30C	30 x 15.5 x 21	85	72	5.65	\$1166	\$82

Can join with other 21" h storage units of corresponding depth to form a spine or slide out on casters to serve as an additional worksurface. One file drawer. Fits under table beams even with optional seat cushion. Optional cable basket suspends off storage unit's bottom and manages cables and data cables under storage spine. (Leveler models only.) 1" top; metal handles; powder coated aluminum or anodized aluminum legs. Specify "L" models for levelers or "C" models for 40mm white/grey locking casters.

- Anodized Aluminum Leg - Add **\$85** list upcharge
- 18" deep storage components will not accept legal size paper

BRT25BF18L	18 x 15.5 x 25	70	69	3.89	\$972	\$63
BRT25BF24L	24 x 15.5 x 25	85	74	5.02	\$1129	\$63
BRT25BF30L	30 x 15.5 x 25	85	82	6.15	\$1225	\$82
BRT25BF18C	18 x 15.5 x 25	70	69	3.89	\$1050	\$63
BRT25BF24C	24 x 15.5 x 25	85	74	5.02	\$1204	\$63
BRT25BF30C	30 x 15.5 x 25	85	82	6.15	\$1302	\$82

Can join with other 25" h storage units of corresponding depth to form a spine or slide out on casters to serve as an additional worksurface. One box drawer, one file drawer. Optional cable basket suspends off storage unit's bottom and manages cables and data cables under storage spine. (Leveler models only.) 1" top; metal handles; powder coated aluminum or anodized aluminum legs. Specify "L" models for levelers or "C" models for 40mm white/grey locking casters. Black pencil tray included.

- Anodized Aluminum Leg - Add **\$85** list upcharge
- 18" deep storage components will not accept legal size paper

BRT21LS30L	18 x 30 x 21	100	53	6.56	\$933	\$82
BRT21LS36L	18 x 36 x 21	125	60	7.87	\$1032	\$82
BRT21LS42L	18 x 42 x 21	125	67	9.18	\$1129	\$82

Can join with other 21" h storage units of corresponding depth to form a spine. Optional 15.5" x 18" cushion. Storage compartment internal height: 12.36" Sliding door locks on left side. Optional cable basket suspends off storage unit's bottom and manages cables along the horizontal plane. 1" top; metal handles; powder coated aluminum or anodized aluminum legs.

- Anodized Aluminum Leg - Add **\$85** list upcharge
- 18" deep storage components will not accept legal size paper

BRT21LSS30L	24 x 30 x 21	125	69	8.75	\$1302	\$82
BRT21LSS36L	24 x 36 x 21	125	78	10.50	\$1418	\$103
BRT21LSS42L	24 x 42 x 21	125	87	12.25	\$1534	\$120

Offers two 11" deep storage compartments on either side. For use beside a table assembly, between two adjacent workstations. Can join with other 21" h, 24" d storage units to form a spine. Optional 15.5" x 18" cushion. Storage compartment internal height: 12.36" Sliding door locks on left side. Optional cable basket suspends off storage unit's bottom and manages cables along the horizontal plane. 1" top; metal handles; powder coated aluminum or anodized aluminum legs.

- Anodized Aluminum Leg - Add **\$85** list upcharge

Required Specifications

Metal finish
Top finish
Chassis finish
Drawer/door front finish

Edge finish

Optional Specifications

Anodized Aluminum Leg
HP laminate (tops only)
Cable Basket

STORAGE

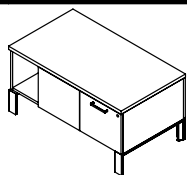

Shared File/Open Storage*

MODEL#	DIMENSIONS	FREIGHT CLASS	WT./LBS.	CUBIC FT.	LIST PRICE	HP ADD
--------	------------	---------------	----------	-----------	------------	--------

	D x W x H					
BRT21LSO42L	24 x 42 x 21	100	124	14	\$1747	\$140

Offers storage compartments on either side. For use between two adjacent workstations. Can join with other 21" h, 24" d storage units to form a spine or serve as an additional return worksurface or ad-hoc guest seating with optional 15.5" x 18" cushion. One locking file drawer, One open compartment per side. Storage compartment internal height without shelf: 12.36". Optional cable basket suspends off storage unit's bottom and manages cables along the horizontal plane. 1" top; metal handles; powder coated aluminum or anodized aluminum legs.

- Anodized Aluminum Leg - Add **\$85** list upcharge

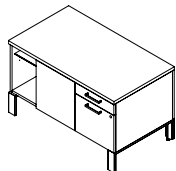

Shared Storage Unit*

BRT25LBF042L	24 x 42 x 25	100	154	16.66	\$2194	\$120
--------------	--------------	-----	-----	-------	--------	-------

Offers storage compartments on either side. For use between two adjacent workstations. Can join with other 25" h, 24" d storage units to form a spine or serve as an additional return worksurface or ad-hoc guest seating with optional 15.5" x 18" cushion. One locking file drawer, One open compartment per side. Storage compartment internal height without shelf: 12.36". Optional cable basket suspends off storage unit's bottom and manages cables along the horizontal plane. 1" top; metal handles; powder coated aluminum or anodized aluminum legs. Black pencil tray included.

- Anodized Aluminum Leg - Add **\$85** list upcharge
- 25" high Bridges storage should not be used under back-to-back Bridges table applications using Below Worksurface Trough. Storage will not fit under the trough.

MODULAR STORAGE

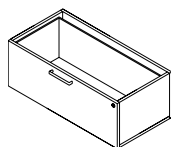

21" H Lateral File Drawer, No Top

MODEL#	DIMENSIONS	FREIGHT CLASS	WT./LBS.	CUBIC FT.	LIST PRICE	HP ADD
--------	------------	---------------	----------	-----------	------------	--------

BRT21F3018U	18 x 30 x 13	92.5	47	4.06	\$1009	n/a
BRT21F3618U	18 x 36 x 13	92.5	51	4.88	\$1115	n/a
BRT21F4218U	18 x 42 x 13	100	56	5.69	\$1294	n/a
BRT21F3024U	24 x 30 x 13	100	51	5.42	\$1033	n/a
BRT21F3624U	24 x 36 x 13	100	55	6.5	\$1151	n/a
BRT21F4224U	24 x 42 x 13	125	60	7.58	\$1353	n/a

Fits below Bridges II tables. Can join with other 21" h storage units of corresponding depth to form a spine. Floor clearance allows for installation of optional cable basket to manage cords and data cables under storage spine. One file drawer. **Top and legs to be ordered separately.** Metal handles.

- 18" deep storage components will not accept legal size paper

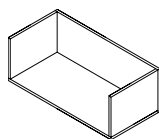

21" H Open Storage, No Top

BRT21LO3018U	18 x 30 x 13	125	25	4.06	\$318	n/a
BRT21LO3618U	18 x 36 x 13	150	29	4.88	\$473	n/a
BRT21LO4218U	18 x 42 x 13	150	32	5.69	\$514	n/a
BRT21LO3024U	24 x 30 x 13	150	29	5.42	\$330	n/a
BRT21LO3624U	24 x 36 x 13	150	33	6.5	\$492	n/a
BRT21LO4224U	24 x 42 x 13	150	36	7.58	\$534	n/a

Open storage unit with no top. Positioned beside a Bridges II table assembly or between two adjacent workstations. Can join with other 21" h storage units to form a spine. Floor clearance allows for installation of optional cable basket to manage cords and data cables under storage spine. One box opening. **Top and legs to be ordered separately.**

Required Specifications

Metal finish*	
Top finish*	Edge finish*
Chassis finish	
Drawer/door front finish	

Optional Specifications

Anodized Aluminum Leg*
HP laminate* (tops only)
Cable Basket
Cushion (BRT21LSO42L)

MODULAR STORAGE

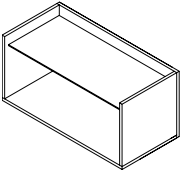

25" H Open Storage, Glass Shelf, No Top

MODEL#	DIMENSIONS D x W x H	FREIGHT CLASS	WT./LBS.	CUBIC FT.	LIST PRICE	HP ADD
BRT25L03018U	18 x 30 x 17	125	40	5.31	\$470	n/a
BRT25L03618U	18 x 36 x 17	125	46	6.38	\$645	n/a
BRT25L04218U	18 x 42 x 17	125	52	7.44	\$666	n/a
BRT25L03024U	24 x 30 x 17	125	44	7.08	\$501	n/a
BRT25L03624U	24 x 36 x 17	150	50	8.5	\$670	n/a
BRT25L04224U	24 x 42 x 17	150	56	9.92	\$699	n/a

Positioned usually beside a table assembly or between two adjacent workstations. Can join with other 25" h storage units to form a storage spine. Floor clearance allows for installation of optional cable basket to manage cords and data cables under storage spine. One box opening with glass shelf. **Top and legs to be ordered separately.**

- 25" high Bridges storage should not be used under back-to-back Bridges table applications using Below Worksurface Trough. Storage will not fit under the trough.

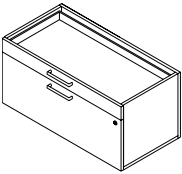

Lateral Box/File Storage, No Top*

BRT25LBF3018U	18 x 30 x 17	92.5	58	5.31	\$1210	n/a
BRT25LBF3618U	18 x 36 x 17	85	78	6.38	\$1405	n/a
BRT25LBF4218U	18 x 42 x 17	100	68	7.44	\$1496	n/a
BRT25LBF3024U	24 x 30 x 17	100	62	7.08	\$1258	n/a
BRT25LBF3624U	24 x 36 x 17	100	82	8.5	\$1461	n/a
BRT25LBF4224U	24 x 42 x 17	125	72	9.92	\$1557	n/a

Positioned usually beside a table assembly or between two adjacent workstations. Can join with other 25" h storage units to form a storage spine. Floor clearance allows for installation of optional cable basket to manage cords and data cables under storage spine. One locking file drawer, one box drawer. **Top and legs to be ordered separately.** Metal handles. Black pencil tray included.

- 18" deep storage components will not accept legal size paper
- 25" high Bridges storage should not be used under back-to-back Bridges table applications using Below Worksurface Trough. Storage will not fit under the trough.

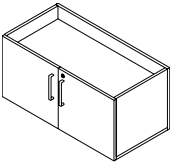

25" H Storage Cabinet, No Top*

BRT25L2D3018U	18 x 30 x 17	125	39	5.31	\$896	n/a
BRT25L2D3618U	18 x 36 x 17	125	45	6.38	\$962	n/a
BRT25L2D4218U	18 x 42 x 17	125	54	7.44	\$1001	n/a
BRT25L2D3024U	24 x 30 x 17	125	43	7.08	\$1042	n/a
BRT25L2D3624U	24 x 36 x 17	150	49	8.5	\$1136	n/a
BRT25L2D4224U	24 x 42 x 17	150	58	9.92	\$1183	n/a

Positioned usually beside a table assembly or between two adjacent workstations. Can join with other 25" h storage units to form a storage spine. Floor clearance allows for installation of optional cable basket to manage cords and data cables under storage spine. Two lockable doors, glass shelf included. **Top and legs to be ordered separately.** Storage compartment internal height is 16.5". Metal handles.

- 25" high Bridges storage should not be used under back-to-back Bridges table applications using Below Worksurface Trough. Storage will not fit under the trough.

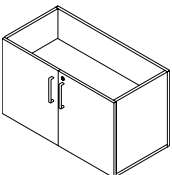

29" H Storage Cabinet, No Top*

BRT29L2D3018U	18 x 30 x 21	125	49	6.56	\$1022	n/a
BRT29L2D3618U	18 x 36 x 21	125	55	7.88	\$1067	n/a
BRT29L2D4218U	18 x 42 x 21	125	64	9.19	\$1114	n/a
BRT29L2D3024U	24 x 30 x 21	125	53	8.75	\$1199	n/a
BRT29L2D3624U	24 x 36 x 21	150	59	10.5	\$1253	n/a
BRT29L2D4224U	24 x 42 x 21	150	68	12.25	\$1281	n/a

Positioned usually beside a table assembly or between two adjacent workstations. Units are level with Bridges tops and can join other 29" h storage units to form a credenza or serve as an additional return worksurface. Floor clearance allows for installation of optional cable basket to manage cords and data cables under storage spine. Two lockable doors, glass shelf included. **Top and legs to be ordered separately.** Storage compartment internal height is 20.5". Metal handles.

- 25" high Bridges storage should not be used under back-to-back Bridges table applications using Below Worksurface Trough. Storage will not fit under the trough.

Required Specifications

Chassis finish
Drawer/door front finish*

Optional Specifications

Cable Basket

MODULAR STORAGE

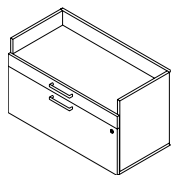

29" H Box/File/Open Storage, No Top

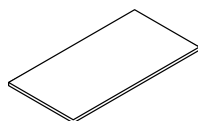

Worksurface for Modular Storage*

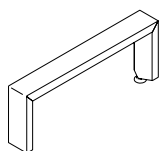

Modular Storage Leg**

MODEL#	DIMENSIONS	FREIGHT CLASS	WT/LBS.	CUBIC FT.	LIST PRICE	HP ADD
--------	------------	---------------	---------	-----------	------------	--------

D x W x H						
BRT29LOBF3018U	18 x 30 x 21	92.5	70	6.56	\$1424	n/a
BRT29LOBF3618U	18 x 36 x 21	100	78	7.88	\$1606	n/a
BRT29LOBF4218U	18 x 42 x 21	100	86	9.19	\$1765	n/a
BRT29LOBF3024U	24 x 30 x 21	100	74	8.75	\$1482	n/a
BRT29LOBF3624U	24 x 36 x 21	125	82	10.52	\$1671	n/a
BRT29LOBF4224U	24 x 42 x 21	125	90	12.25	\$1835	n/a

Positioned beside a table assembly or between two adjacent workstations. Units are level with Bridges tops and can join other 29" h storage units to form a credenza or serve as an additional return worksurface. Floor clearance allows for installation of optional cable basket to manage cords and data cables under storage spine. One locking file drawer, one box drawer and one open compartment. **Top and legs to be ordered separately.** Storage compartment internal height: 3.9". Metal handles. Black pencil tray included.

- 18" deep storage components will not accept legal size paper

BRTWU1830	18 x 30 x 1	60	15	0.5	\$179	\$63
BRTWU1836	18 x 36 x 1	60	18	0.59	\$204	\$69
BRTWU1842	18 x 42 x 1	60	21	0.68	\$268	\$91
BRTWU1860	18 x 60 x 1	65	29	0.97	\$423	\$124
BRTWU1866	18 x 66 x 1	65	32	1.1	\$444	\$140
BRTWU1872	18 x 72 x 1	65	35	1.2	\$462	\$152
BRTWU1878	18 x 78 x 1	65	38	1.3	\$489	\$160
BRTWU1884	18 x 84 x 1	65	41	1.4	\$536	\$168
BRTWU1890	18 x 90 x 1	65	44	1.5	\$557	\$173
BRTWU1896	18 x 96 x 1	65	47	1.6	\$580	\$181

BRTWU2430	24 x 30 x 1	60	20	0.65	\$187	\$57
BRTWU2436	24 x 36 x 1	60	24	0.78	\$208	\$71
BRTWU2442	24 x 42 x 1	60	28	0.9	\$274	\$90
BRTWU2460	24 x 60 x 1	60	39	1.3	\$432	\$142
BRTWU2466	24 x 66 x 1	60	43	1.41	\$450	\$147
BRTWU2472	24 x 72 x 1	60	47	1.54	\$470	\$38
BRTWU2478	24 x 78 x 1	60	51	1.7	\$504	\$161
BRTWU2484	24 x 84 x 1	60	55	1.8	\$546	\$170
BRTWU2490	24 x 90 x 1	60	59	1.9	\$568	\$175
BRTWU2496	24 x 96 x 1	60	63	2	\$590	\$184

Flat 3mm profile on all sides. Worksurface provided with pilot holes for alignment purposes. Worksurfaces can be used for each modular unit or can span two to three units.

BRT18LEGL	18 x 2.5 x 8	150	8	1.34	\$68	n/a
BRT24LEGL	24 x 2.5 x 8	150	8	1.34	\$75	n/a

Two single legs form the structure of the Bridges II series modular storage. A single leg can be used at the end of each modular storage unit or can be used to support where two modular units meet. Leveling glides, steel frame, aluminum legs.

- Anodized Aluminum leg - Add **\$36** list upcharge

Required Specifications

Top finish*
Edge finish
Chassis finish
Metal finish**

Optional Specifications

HP laminate* (tops only)
Anodized Aluminum Leg**
Cable Basket (storage unit)

STORAGE

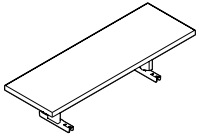

Center Mount Shelf*

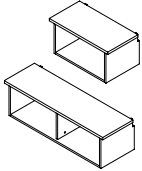
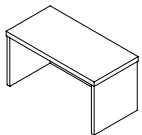
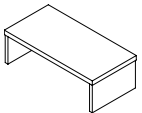

Table Mounted End Shelf*



Single Sided Elevated Table Shelf*

MODEL#	DIMENSIONS	FREIGHT CLASS	WT./LBS.	CUBIC FT.	LIST PRICE	HP ADD
--------	------------	---------------	----------	-----------	------------	--------

	D x W x H					
BRTCMS36	12 x 36 x 6.75	100	15.20	1.69	\$372	n/a
BRTCMS30	12 x 30 x 6.75	100	12.60	1.41	\$262	n/a

Open, shared center mount shelf “floats” 6.75” above the gap formed by two back-to-back worksurfaces. Accepts BRTESSBBIN Elevated Shelf Binder Bin - The 30”w shelf accommodates two; 36”w shelf accommodates up to three. Shelves overhang the support structure by 6” on either side. Aluminum/die cast structure attaches to the underside of both worksurfaces.

- Not compatible with BRTEETA Above Worksurface Power Trough and Worksurfaces with Access Doors
- Anodized Aluminum support structure - Add **\$85** list upcharge

BRTTES24	15.5 x 24 x 15	100	29	3.22	\$722	\$63
BRTTES30	15.5 x 30 x 15	100	34	4.03	\$790	\$71
BRTTES51	15.5 x 50.5 x 15	100	57	6.79	\$1302	\$129
BRTTES63	15.5 x 62.5 x 15	100	68	8.40	\$1430	\$167

Single or double open shelf/extended worksurface. Secured to the end of single or back-to-back Bridges table. All mounting hardware included. Storage compartment internal height: 13.25”. 1” top.

BRTSTS0824	12 x 24 x 8	92.5	14	1.33	\$256	\$82
BRTSTS0830	12 x 30 x 8	100	16	1.66	\$294	\$82
BRTSTS0851	12 x 50.5 x 8	100	25	2.80	\$469	\$120
BRTSTS0863	12 x 62.5 x 8	100	28	3.47	\$530	\$179

BRTSTS1324	12 x 24 x 13	100	18	2.16	\$277	\$82
BRTSTS1330	12 x 30 x 13	125	21	2.70	\$315	\$82
BRTSTS1351	12 x 50.5 x 13	125	32	4.55	\$469	\$120
BRTSTS1363	12 x 62.5 x 13	125	38	5.64	\$547	\$160

BRTSTS1624	12 x 24 x 16	125	19	2.66	\$315	\$82
BRTSTS1630	12 x 30 x 16	100	29	3.33	\$372	\$82
BRTSTS1651	12 x 50.5 x 16	150	33	5.61	\$547	\$140
BRTSTS1663	12 x 62.5 x 16	150	39	6.94	\$625	\$179

Secured perpendicularly to the single or back-to-back Bridges table. Integrated anodized aluminum accessory rail. White cut out and accessory rail trims. Optional Elevated Shelf Binder Bin (BRTESSBBIN) rests on top surface for enhanced privacy. 8”h provides additional storage space without obstructing view and reaches 16” module height when combined w/8”h Binder shelf. Internal height: 6.6”. 16”h lines up with top of 16” table dividers (15.8”). Specify 12” narrower shared elevated shelf immediately adjacent to the perpendicular elevated shelf. Internal height: 14.6”.

- Please refer to the **Compatibility Guide** on page 368 to determine available accessories

Required Specifications

Top finish
Edge finish
Chassis/Accent Finish

Optional Specifications

HP laminate (tops only)
Elevated Shelf Binder Bin

STORAGE

MODEL#	DIMENSIONS	FREIGHT CLASS	WT./LBS.	CUBIC FT.	LIST PRICE	HP ADD
--------	------------	---------------	----------	-----------	------------	--------

D x W x H

BRTBTS0836	12 x 36 x 8	100	16	2	\$392	\$82
BRTBTS0842	12 x 42 x 8	100	19	2.33	\$431	\$82
BRTBTS0848	12 x 48 x 8	125	21	2.66	\$469	\$120
BRTBTS0854	12 x 54 x 8	125	23	3	\$489	\$140
BRTBTS0860	12 x 60 x 8	125	26	3.33	\$547	\$160
BRTBTS0866	12 x 66 x 8	125	28	3.66	\$586	\$179
BRTBTS0872	12 x 72 x 8	125	30	4	\$625	\$179
BRTBTS0878	12 x 78 x 8	125	32	4.33	\$664	\$198
BRTBTS0884	12 x 84 x 8	125	35	4.66	\$703	\$216

BRTBTS1336	12 x 36 x 13	125	22	3.25	\$469	\$103
BRTBTS1342	12 x 42 x 13	125	25	3.79	\$530	\$103
BRTBTS1348	12 x 48 x 13	125	28	4.33	\$568	\$140
BRTBTS1354	12 x 54 x 13	125	30	4.87	\$625	\$140
BRTBTS1360	12 x 60 x 13	150	33	5.86	\$664	\$140
BRTBTS1366	12 x 66 x 13	150	36	6.45	\$680	\$238
BRTBTS1372	12 x 72 x 13	125	39	6.50	\$779	\$198
BRTBTS1378	12 x 78 x 13	150	42	7.04	\$838	\$198
BRTBTS1384	12 x 84 x 13	150	44	7.58	\$896	\$216

BRTBTS1636	12 x 36 x 16	125	25	4	\$489	\$82
BRTBTS1642	12 x 42 x 16	125	28	4.66	\$547	\$120
BRTBTS1648	12 x 48 x 16	150	31	5.33	\$604	\$120
BRTBTS1654	12 x 54 x 16	150	34	6	\$642	\$160
BRTBTS1660	12 x 60 x 16	150	38	6.66	\$703	\$160
BRTBTS1666	12 x 66 x 16	150	41	7.33	\$761	\$160
BRTBTS1672	12 x 72 x 16	150	44	8	\$819	\$179
BRTBTS1678	12 x 78 x 16	150	47	8.66	\$855	\$198
BRTBTS1684	12 x 84 x 16	150	50	9.33	\$917	\$216

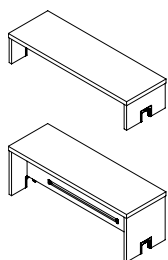

Shared Elevated Table Shelf

Rests on back-to-back Bridges tables. Cut outs in both supporting side gables allow placement over above worksurface power/data troughs. Integrated anodized aluminum accessory rail. White cut out and accessory rail trims. Three heights available. 8" h provides additional storage space without obstructing view; reaches 16" module height when combined w/8" h Binder shelf. Internal height: 6.6". 16" h lines up with top of 16" table dividers (15.8"). Specify 12" narrower shared elevated shelf immediately adjacent to the perpendicular elevated shelf. Internal height: 14.6". Optional Elevated Shelf Binder Bin (BRTESBBIN) rests on top surface for enhanced privacy. 1" top.

- Please refer to the **Compatibility Guide** on page 368 to determine available accessories

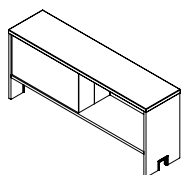

Table Supported Shared Overhead

BRTBAS048	12 x 48 x 21	125	54	7	\$779	\$120
-----------	--------------	-----	----	---	-------	-------

One compartment per side. White magnetic back wall. Lines up with 50" h floor standing storage. Fits over the gap between two parallel back-to-back Bridges tables. Fits over worksurface power/data trough. Storage compartment internal height: 12.8". Optional Elevated Shelf Binder Bin (BRTESBBIN) rests on top surface for enhanced privacy. 1" top.

- Please refer to the **Compatibility Guide** on page 368 to determine available accessories

Required Specifications

Top finish
Edge finish
Chassis/accent finish

Optional Specifications

HP laminate (tops only)
Elevated Shelf Binder Bin

STORAGE

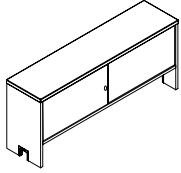

Shared Elevated Overhead*

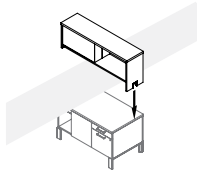

45" High Shared Storage Divider**

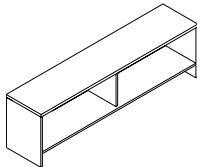

Open Single Sided Storage

MODEL#	DIMENSIONS D x W x H	FREIGHT CLASS	WT./LBS.	CUBIC FT.	LIST PRICE	HP ADD
BRTBASL36	16 x 36 x 21	250	23.50	6.56	\$2250	\$151
BRTBASL42	16 x 42 x 21	250	27.50	7.65	\$2407	\$184
BRTBASL48	16 x 48 x 21	250	31.40	8.75	\$2533	\$217
BRTBASL54	16 x 54 x 21	250	35.30	9.84	\$2725	\$228
BRTBASL60	16 x 60 x 21	250	35.30	9.84	\$2873	\$235
BRTBASL66	16 x 66 x 21	250	43.20	12.03	\$3242	\$275
BRTBASL72	16 x 72 x 21	250	47.10	13.12	\$3413	\$307
BRTBASL78	16 x 78 x 21	250	51	14.21	\$3592	\$330
BRTBASL84	16 x 84 x 21	250	55	15.31	\$3639	\$455

Two compartments facing in opposite direction with locking, sliding laminate doors. Storage compartment internal height: 12.25". Shared elevated overhead fits over the gap between two parallel Bridges back-to-back tables. Integrated anodized aluminum accessory rail below the storage compartments. Fits over Above Worksurface Power/Data Troughs. Elevated Shelf Binder Bins DO NOT work with this overhead. 1" top.

- Note: In order to prevent duplex outlet and worksurface access door interference, please specify Overhead of the same width as the supporting worksurface.
- To prevent interference with Ceiling feed pole, please specify Overhead 6" shorter in width corresponding with the length of the supporting worksurface.
- Please refer to the **Compatibility Guide** on page 368 to determine available accessories

BRTSDS48	12 x 48 x 16	92.5	54	5.33	\$625	\$120
----------	--------------	------	----	------	--------------	--------------

Divides side-to-side workstations. Two shared, open shelves. One compartment per side. White magnetic back wall. Rests on top of shared 25" box/file/open and back-to-back worksurface. Top of unit is 15.7" from the top of the worksurface. Storage compartment internal height: 12.8". Optional Elevated Shelf Binder Bin (BRTEBBIN) rests on top surface for enhanced privacy. 1" top, white powder-coated steel central partition and backs.

BRT21HO3616	16 x 36 x 21	100	81	9	\$1121	\$151
BRT21HO4216	16 x 42 x 21	100	81	9	\$1203	\$173
BRT21HO4816	16 x 48 x 21	250	31.40	8.75	\$1283	\$197
BRT21HO5416	16 x 54 x 21	250	35.30	9.84	\$1363	\$222
BRT21HO6016	16 x 60 x 21	250	35.30	9.84	\$1452	\$247
BRT21HO6616	16 x 66 x 21	250	43.20	12.03	\$1545	\$270
BRT21HO7216	16 x 72 x 21	250	47.10	13.12	\$1602	\$306
BRT21HO7816	16 x 78 x 21	250	51	14.21	\$1723	\$318
BRT21HO8416	16 x 84 x 21	250	55	15.31	\$1792	\$343

Table supported single sided open storage. Storage compartment internal height: 14". 1" top.

- Cannot be used in conjunction with above worksurface power trough.
- To prevent duplex outlet and worksurface access door interference, please specify Overhead of the same width of the supporting worksurface.
- To prevent interference with ceiling feed pole, please specify Overhead 6" shorter in width corresponding with the length of the supporting worksurface.
- Please refer to the **Compatibility Guide** on page 368 to determine available accessories

Required Specifications

Top finish
Edge finish
Chassis finish*
Drawer/door front finish*

Optional Specifications

HP laminate (tops only)
Elevated Shelf Binder Bin**

STORAGE

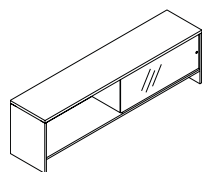

Double Sided Storage, Glass Door

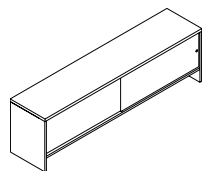

Double Sided Storage, Laminate Door*

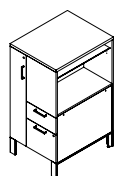

50" H Storage Tower w/Coat Storage*

MODEL#	DIMENSIONS	FREIGHT CLASS	WT/LBS.	CUBIC FT.	LIST PRICE	HP ADD
--------	------------	---------------	---------	-----------	------------	--------

D x W x H

BRT21GDS3616	16 x 36 x 21	92.5	94	9	\$2288	\$145
BRT21GDS4216	16 x 42 x 21	92.5	111	10.50	\$2396	\$173
BRT21GDS4816	16 x 48 x 21	100	117	12	\$2448	\$198
BRT21GDS5416	16 x 54 x 21	92.5	143	13.50	\$3167	\$222
BRT21GDS6016	16 x 60 x 21	92.5	155	15	\$3223	\$247
BRT21GDS6616	16 x 66 x 21	92.5	167	16.50	\$3437	\$269
BRT21GDS7216	16 x 72 x 21	100	177	18	\$3513	\$294
BRT21GDS7816	16 x 78 x 21	100	188	19.50	\$3659	\$317
BRT21GDS8416	16 x 84 x 21	100	196	21	\$3894	\$343

Table supported double sided open storage with sliding glass doors and recessed pull. Fits over the gap between two parallel Bridges II back-to-back tables. Storage compartment internal height: 14". 1" top.

- Cannot be used in conjunction with above worksurface power trough.
- To prevent duplex outlet and worksurface access door interference, please specify Overhead of the same width of the supporting worksurface.
- To prevent interference with ceiling feed pole, please specify Overhead 6" shorter in width corresponding with the length of the supporting worksurface.
- Please refer to the **Compatibility Guide** on page 368 to determine available accessories

BRT21LDS3616	16 x 36 x 21	92.5	106	9	\$2249	\$149
BRT21LDS4216	16 x 42 x 21	85	126	10.50	\$2391	\$173
BRT21LDS4816	16 x 48 x 21	92.5	134	12	\$2441	\$197
BRT21LDS5416	16 x 54 x 21	85	162	13.50	\$3047	\$222
BRT21LDS6016	16 x 60 x 21	92.5	176	15	\$3100	\$247
BRT21LDS6616	16 x 66 x 21	92.5	190	16.50	\$3309	\$270
BRT21LDS7216	16 x 72 x 21	92.5	203	18	\$3359	\$294
BRT21LDS7816	16 x 78 x 21	92.5	216	19.50	\$3484	\$317
BRT21LDS8416	16 x 84 x 21	92.5	227	21	\$3694	\$343

Table supported double sided open storage with sliding laminate doors and recessed pull. Fits over the gap between two parallel Bridges II back-to-back tables. Storage compartment internal height: 14". 1" top.

- Cannot be used in conjunction with above worksurface power trough.
- To prevent duplex outlet and worksurface access door interference, please specify Overhead of the same width of the supporting worksurface.
- To prevent interference with ceiling feed pole, please specify Overhead 6" shorter in width corresponding with the length of the supporting worksurface.
- Please refer to the **Compatibility Guide** on page 368 to determine available accessories

BRTTW5024L	24 x 24 x 50	100	142	16.66	\$2116	\$140
BRTTW5024R	24 x 24 x 50	100	142	16.66	\$2116	\$140
BRTTW5030L	30 x 24 x 50	125	163	20.83	\$2348	\$140
BRTTW5030R	30 x 24 x 50	125	163	20.83	\$2348	\$140

Provides storage and privacy at the end of a table. Box + file drawers, open compartment with adjustable glass shelf (50"h); coat storage with hinged door. Specify Left or Right handed. Capable of supporting worksurface on one side. Built-in threaded inserts to secure dedicated worksurface supporting beam. Open side storage compartment internal height: 19.6". Optional cable basket suspends off storage unit's bottom and manages cables along the horizontal plane. 1" top; metal handles; powder-coated aluminum or anodized aluminum legs. Black pencil tray included.

- Anodized Aluminum Leg - Add \$85 list upcharge

Required Specifications

Top finish
Chassis finish
Drawer/door front finish
Metal finish (legs)

Edge finish

Optional Specifications

Anodized aluminum leg*
HP laminate
E-Lock*

STORAGE

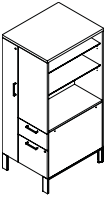

66" H Storage Tower with Coat Storage

MODEL#	DIMENSIONS D x W x H	FREIGHT CLASS	WT/LBS.	CUBIC FT.	LIST PRICE	HP ADD
BRTTW6624L	24 x 24 x 66	125	170	22	\$2805	\$181
BRTTW6624R	24 x 24 x 66	125	170	22	\$2805	\$181
BRTTW6630L	30 x 24 x 66	125	195	27.50	\$3112	\$183
BRTTW6630R	30 x 24 x 66	125	195	27.50	\$3112	\$219

Provides storage and privacy at the end of a table. Box + file drawers, open compartment with 2 adjustable glass shelves (66"h); coat storage with hinged door and 2 shelves. Specify Left or Right handed. Capable of supporting worksurface on one side. Built-in threaded inserts to secure dedicated worksurface supporting beam. Open side storage compartment internal height: 35.6". Optional cable basket suspends off storage unit's bottom and manages cables along the horizontal plane. 1" top; metal handles; powder-coated aluminum or anodized aluminum legs. Black pencil tray included.

- Anodized Aluminum Leg - Add **\$85** list upcharge

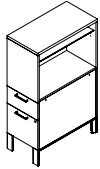

50" H Storage Tower

BRTT5024L	24 x 15.5 x 50	100	88	10.76	\$1572	\$103
BRTT5024R	24 x 15.5 x 50	100	88	10.76	\$1572	\$103
BRTT5030L	30 x 15.5 x 50	125	101	13.45	\$1730	\$120
BRTT5030R	30 x 15.5 x 50	125	101	13.45	\$1730	\$120

Provides storage and privacy at the end of a table. Box + file drawers, open compartment with adjustable glass shelf (50"h). Specify Left or Right handed. Capable of supporting worksurface on one side. Built-in threaded inserts to secure dedicated worksurface supporting beam. Open side storage compartment internal height: 19.6". Optional cable basket suspends off storage unit's bottom and manages cables along the horizontal plane. 1" top; metal handles; powder-coated aluminum or anodized aluminum legs. Black pencil tray included.

- Anodized Aluminum Leg - Add **\$85** list upcharge

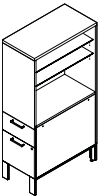

66" H Storage Tower

BRTT6624L	24 x 15.5 x 66	100	106	12.91	\$2085	\$131
BRTT6624R	24 x 15.5 x 66	100	106	12.91	\$2085	\$131
BRTT6630L	30 x 15.5 x 66	125	121	16.14	\$2292	\$159
BRTT6630R	30 x 15.5 x 66	125	121	16.14	\$2292	\$159

Provides storage and privacy at the end of a table. Box + file drawers, open compartment with 2 adjustable glass shelves (66"h). Specify Left or Right handed. Capable of supporting worksurface on one side. Built-in threaded inserts to secure dedicated worksurface supporting beam. Open side storage compartment internal height: 35.6". Optional cable basket suspends off storage unit's bottom and manages cables along the horizontal plane. 1" top; metal handles; powder-coated aluminum or anodized aluminum legs. Black pencil tray included.

- Anodized Aluminum Leg - Add **\$85** list upcharge

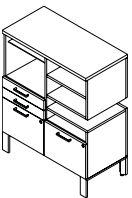

Cantilever Storage*

BRTCS45BBFFL	18 x 36 x 45	92.5	256	24	\$2859	\$149
BRTCS45BBFFR	18 x 36 x 45	92.5	256	24	\$2859	\$149

Provides storage and privacy anywhere along the length of the bench. The middle opening of the cabinet allows the upper portion to cantilever above the worksurface. 2 locking file drawers. 2 pencil drawers (not locking). Open compartment with adjustable glass shelf, internal dimension of 15.9". Three fixed open compartments; two above worksurfaces (6.7" interior dimension), one below (3.7" interior dimension). Specify Left or Right handed. Optional cable basket suspends off storage unit's bottom and manages cables along the horizontal plane. 1" top; metal handles; powder-coated aluminum or anodized aluminum legs.

- Anodized Aluminum Leg - Add **\$85** list upcharge

Required Specifications

Top finish
Edge finish
Chassis finish
Drawer/door front finish

Optional Specifications

Anodized aluminum leg
E-Lock*
HP laminate

STORAGE

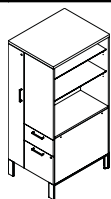
**66" H Storage Tower with Coat Storage**

MODEL#	DIMENSIONS	FREIGHT CLASS	WT/LBS.	CUBIC FT.	LIST PRICE	HP ADD
--------	------------	---------------	---------	-----------	------------	--------

D x W x H

BRTTW6624L	24 x 24 x 66	125	170	22	\$2805	\$181
BRTTW6624R	24 x 24 x 66	125	170	22	\$2805	\$181
BRTTW6630L	30 x 24 x 66	125	195	27.50	\$3112	\$183
BRTTW6630R	30 x 24 x 66	125	195	27.50	\$3112	\$219

Provides storage and privacy at the end of a table. Box/File drawers, open compartment with 2 adjustable shelves (66" h); coat storage with hinged door and 2 shelves. Specify Left or Right handed. Capable of supporting worksurface on one side. Built-in threaded inserts to secure dedicated worksurface supporting beam. Open side storage compartment internal height: 35.6". Optional cable basket suspends off storage unit's bottom and manages cables along the horizontal plane. 1" top; metal handles; powder-coated aluminum or anodized aluminum legs. Black pencil tray included.

- Anodized Aluminum Leg - Add **\$85** list upcharge

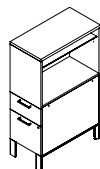
**50" H Storage Tower**

BRTT5024L	24 x 15.5 x 50	100	88	10.76	\$1572	\$103
BRTT5024R	24 x 15.5 x 50	100	88	10.76	\$1572	\$103
BRTT5030L	30 x 15.5 x 50	125	101	13.45	\$1730	\$120
BRTT5030R	30 x 15.5 x 50	125	101	13.45	\$1730	\$120

Provides storage and privacy at the end of a table. Box/File drawers, open compartment with adjustable shelf (50" h). Specify Left or Right handed. Capable of supporting worksurface on one side. Built-in threaded inserts to secure dedicated worksurface supporting beam. Open side storage compartment internal height: 19.6". Optional cable basket suspends off storage unit's bottom and manages cables along the horizontal plane. 1" top; metal handles; powder-coated aluminum or anodized aluminum legs. Black pencil tray included.

- Anodized Aluminum Leg - Add **\$85** list upcharge

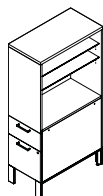
**66" H Storage Tower**

BRTT6624L	24 x 15.5 x 66	100	106	12.91	\$2085	\$131
BRTT6624R	24 x 15.5 x 66	100	106	12.91	\$2085	\$131
BRTT6630L	30 x 15.5 x 66	125	121	16.14	\$2292	\$159
BRTT6630R	30 x 15.5 x 66	125	121	16.14	\$2292	\$159

Provides storage and privacy at the end of a table. Box/File drawers, open compartment with 2 adjustable glass shelves (66" h). Specify Left or Right handed. Capable of supporting worksurface on one side. Built-in threaded inserts to secure dedicated worksurface supporting beam. Open side storage compartment internal height: 35.6". Optional cable basket suspends off storage unit's bottom and manages cables along the horizontal plane. 1" top; metal handles; powder-coated aluminum or anodized aluminum legs. Black pencil tray included.

- Anodized Aluminum Leg - Add **\$85** list upcharge

**Cantilever Storage***

BRTCS45BBFFL	18 x 36 x 45	92.5	256	24	\$2859	\$149
BRTCS45BBFFR	18 x 36 x 45	92.5	256	24	\$2859	\$149

Provides storage and privacy anywhere along the length of the bench. The middle opening of the cabinet allows the upper portion to cantilever above the worksurface. 2 locking file drawers. 2 pencil drawers (not locking). Open compartment with adjustable glass shelf, internal dimension of 15.9". Three fixed open compartments; two above worksurfaces (6.7" interior dimension), one below (3.7" interior dimension). Specify Left or Right handed. Optional cable basket suspends off storage unit's bottom and manages cables along the horizontal plane. 1" top; metal handles; powder-coated aluminum or anodized aluminum legs.

- Anodized Aluminum Leg - Add **\$85** list upcharge

Required Specifications

Top finish
Edge finish
Chassis finish
Drawer/door front finish

Optional Specifications

Anodized aluminum leg
E-Lock*
HP laminate

STORAGE

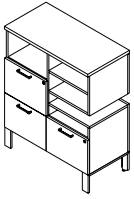

Cantilever Storage*

MODEL#	DIMENSIONS	FREIGHT CLASS	WT/LBS.	CUBIC FT.	LIST PRICE	HP ADD
--------	------------	---------------	---------	-----------	------------	--------

D x W x H

BRTCS45FFFOL	18 x 36 x 45	92.5	256	24	\$2929	\$149
BRTCS45FFFOR	18 x 36 x 45	92.5	256	24	\$2929	\$149

Provides storage and privacy anywhere along the length of the bench. The middle opening of the cabinet allows the upper portion to cantilever above the worksurface. 3 locking file drawers with 2 locks. Open compartment (10.3" interior dimension). Three fixed open compartments; two above worksurfaces (6.7" interior dimension), one below (3.7" interior dimension). Specify Left or Right handed. Optional cable basket suspends off storage unit's bottom and manages cables along the horizontal plane. 1" top; metal handles; powder-coated aluminum or anodized aluminum legs.

- Anodized Aluminum Leg - Add **\$85** list upcharge

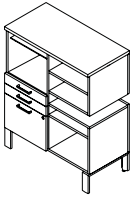

Cantilever Storage*

BRTCS45BBFOL	18 x 36 x 45	92.5	256	24	\$2797	\$149
BRTCS45BBFOR	18 x 36 x 45	92.5	256	24	\$2797	\$149

Provides storage and privacy anywhere along the length of the bench. The middle opening of the cabinet allows the upper portion to cantilever above the worksurface. Locking file drawer. 2 pencil drawers (not locking). Open compartment (10.3" interior dimension) with adjustable glass shelf. 4 fixed open compartments; two above worksurfaces (6.7" interior dimension), two below (lower 12.2" interior dimension; upper 3.3" interior dimension). Specify Left or Right handed. Optional cable basket suspends off storage unit's bottom and manages cables along the horizontal plane. 1" top; metal handles; powder-coated aluminum or anodized aluminum legs.

- Anodized Aluminum Leg - Add **\$85** list upcharge

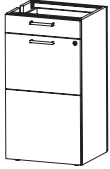

Pier Storage, Box/File

BRTDS2B2F	16 x 18 x 36	125	85	14	\$1752	n/a
-----------	--------------	-----	----	----	---------------	-----

Supports side-by-side divider with Box/File on opposite sides for side-by-side application. Two lockable file drawers, two box drawers. Black pencil tray included.

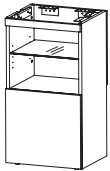

Pier Storage, Open w/Glass Shelves

BRTDSOP	16 x 18 x 36	150	75	14	\$1165	n/a
---------	--------------	-----	----	----	---------------	-----

Supports side-by-side divider with Box/File on opposite sides for side-by-side application. Storage compartment internal height without adjustable shelf: 15"

Required Specifications

Top finish*
Edge finish*
Chassis finish
Drawer/door front finish

Optional Specifications

Anodized aluminum leg*

ACCESSORIES

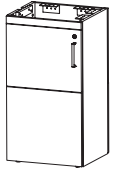
**Pier Storage, Door w/Glass Shelves**

MODEL#	DIMENSIONS	FREIGHT CLASS	WT/LBS.	CUBIC FT.	GRADE	LIST	GRADE	LIST
BRTDS2D	D x W x H 16 x 18 x 36	150	79	14		\$1565	n/a	

Supports side-by-side divider with hinged, lockable door on opposite sides for side-by-side application. Storage compartment internal height without adjustable shelf: 15"

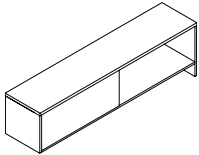
**Side-by-Side Storage, Open***

BRT21PHDO4216	16 x 42 x 21	100	96	10.50		\$1014	\$173
BRT21PHDO4816	16 x 48 x 21	100	100	12		\$1077	\$201
BRT21PHDO5416	16 x 54 x 21	100	124	13.50		\$1181	\$222
BRT21PHDO6016	16 x 60 x 21	100	134	15		\$1248	\$247
BRT21PHDO6616	16 x 66 x 21	100	144	16.50		\$1353	\$268
BRT21PHDO7216	16 x 72 x 21	100	152	18		\$1425	\$294

Pier and table supported side-by-side double-sided open storage. Divides space and provides storage anywhere along bench or table. Storage compartment internal height: 14". 1" top.

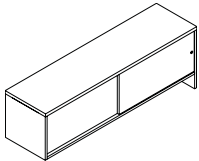
**Side-by-Side Storage, Laminate Doors***

BRT21PLDS4216	16 x 42 x 21	92.5	126	11		\$2347	\$173
BRT21PLDS4816	16 x 48 x 21	92.5	134	12		\$2397	\$198
BRT21PLDS5416	16 x 54 x 21	92.5	162	14		\$3007	\$222
BRT21PLDS6016	16 x 60 x 21	92.5	176	15		\$3060	\$247
BRT21PLDS6616	16 x 66 x 21	92.5	190	17		\$3267	\$270
BRT21PLDS7216	16 x 72 x 21	92.5	203	18		\$3317	\$294

Pier and table supported side-by-side double-sided storage with sliding laminate doors and recessed pull. Divides space and provides storage anywhere along bench or table. Storage compartment internal height: 14". 1" top.

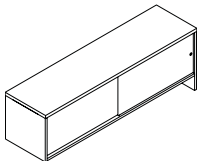
**Side-by-Side Storage, Glass Doors***

BRT21PGDS4216	16 x 42 x 21	92.5	110	10.50		\$2370	\$171
BRT21PGDS4816	16 x 48 x 21	100	116	12		\$2423	\$197
BRT21PGDS5416	16 x 54 x 21	92.5	141	13.50		\$3142	\$222
BRT21PGDS6016	16 x 60 x 21	92.5	153	15		\$3198	\$245
BRT21PGDS6616	16 x 66 x 21	92.5	165	16.50		\$3412	\$269
BRT21PGDS7216	16 x 72 x 21	100	175	18		\$3489	\$295

Pier and table supported side-by-side double-sided storage with sliding glass doors and recessed pull. Divides space and provides storage anywhere along bench or table. Storage compartment internal height: 14". 1" top.

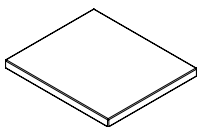
**Cushion****

BRTC	18 x 15.5 x 1.25	150	2	.41	1	\$255	7	\$493
					2	\$291	8	\$533
					3	\$319	9	\$579
					4	\$351	10	\$690
					5	\$400	11	\$782
					6	\$446	12	\$880

Optional seat cushion may be added to any storage component. Available in all Global seating fabrics.

• When added to 25"h storage units, unit will NOT fit under any table with a beam

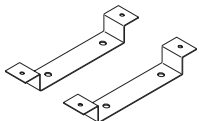
**Glide Tray Adapter**

GAGTA01	2 x 9 x 2.5	70	.50	.03		\$115		
---------	-------------	----	-----	-----	--	--------------	--	--

Accommodates the placement of sliding keyboard mechanisms and CPU holders below the cross beam of Bridges tables. Attaches to Glide Tracks of all Productivity Solutions Keyboard Mechanisms and Sliding CPU holders. Mounting hardware included. Available in black only.

• Cannot be used with GACPU01. See Productivity Solutions for compatible keyboard mechanisms and sliding CPU holder.

Required Specifications

Fabric**
Metal finish (hanging bracket)
Beam finish*

ACCESSORIES

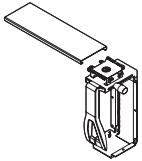

CPU Holder on Glide Track

MODEL#	DIMENSIONS D x W x H	FREIGHT CLASS	WT./LBS.	CUBIC FT.	LIST PRICE
GACPU02	9.2 x 11.7 x 18.5	92.5	12.60	1.15	\$252

Accepts tower CPUs with a width range of 12.5" to 22.5" and width range of 3.5" to 9.3". Soft touch knob for side clamp adjustment and bayonet lance for vertical height adjustment. 12" glide track mounted and 360° swivel for easy access to rear of CPU. Manufactured from steel and engineered resin, providing rugged durability and support. Available in black only.

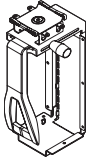

Fixed Mount CPU Holder

GACPU01	9.2 x 11.7 x 18.5	125	9	1.15	\$228
---------	-------------------	-----	---	------	--------------

Fully adjustable clamping mechanism to accept tower CPUs with a height range of 12.5" to 22.5" and width range of 3.5" to 9.3". Soft touch knob for side clamp adjustment and bayonet lance for vertical height adjustment. Mounts directly to underside of desk surface. CPU Holder can also be mounted directly to an upright desk leg surface or wall via side mounting holes. Manufactured from Steel and Engineered Resin, providing rugged durability and support. Available in black only.

- Not compatible with GAGTA01

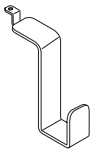

Hanging Bracket

BRTHB	3.3 x 1.5 x 3.5	70	.20	.01	\$32
-------	-----------------	----	-----	-----	-------------

A formed steel bracket hooks over Bridges II table leg. Can be secured either on the inner or outer side of the leg. Specify frame finish.

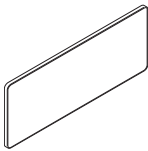

Whiteboard

BRTWB0924	0.5 x 24 x 8.5	70	1	.56	\$255
-----------	----------------	----	---	-----	--------------

White dry-erase marker board surface on white powder coated steel backer. Fits 16" tall Bridges II dividers and single-sided shelves. White dry-erase surface attaches magnetically to the steel backer. When removed, the steel backer can be used as a magnetic board. Please refer to the **Compatibility Guide** (page 368) to determine available accessories.

- Available in Tungsten (TUN) or Designer White (DWT) Only

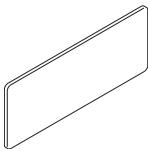

Tackboard*

BRTTB0924	0.5 x 24 x 8.5	70	1	.56	\$255
-----------	----------------	----	---	-----	--------------

Grey tackboard surface on white powder coated steel backer. Fits 16" tall Bridges II dividers and single-sided shelves. Please refer to the **Compatibility Guide** (page 368) to determine available accessories.

- Available in Tungsten (TUN) or Designer White (DWT) Only

Required Specifications

Metal finish
Fabric*

MONITOR ARMS

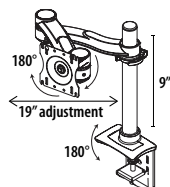
**Single Screen Double Extension Arm**

MODEL#	DIMENSIONS D x W x H	FREIGHT CLASS	WT/LBS.	CUBIC FT.	LIST PRICE
GAMCSSDE	-- x -- x --	125	7.50	1.09	\$571

Double extension allows 19" of horizontal back and forth movement. Arm folds back to post for more desk space. Displays are able to tilt 180°, swing 180° side-to-side and rotate from landscape to portrait. Minor assembly required.

- To use arm in conjunction with below worksurface power troughs, thru-surface mount must be used. Cannot be clamp mounted when using power troughs.

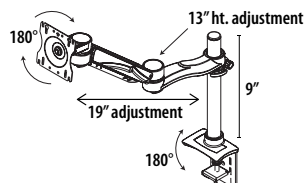
**Single Screen Double Extension Arm with Height Adjustment**

GAMCSSDEH	-- x -- x --	125	8.20	1.09	\$685
-----------	--------------	-----	------	------	--------------

Counterbalanced arm provides an additional 13" of height adjustment. Double extension allows 19" of horizontal back and forth movement. Easy to use Allen wrench allows user to adjust the counterbalance mechanism for easy movement of the monitor. Displays are able to tilt 180°, swing 180° side-to-side and rotate from landscape to portrait. Cable manager comes on extension arm and hides all cables. Minor assembly required.

- To use arm in conjunction with below worksurface power troughs, thru-surface mount must be used. Cannot be clamp mounted when using power troughs.

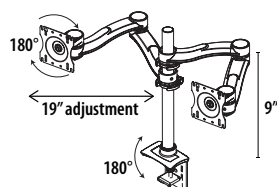
**Dual Screen Double Extension Arm**

GAMCDSDE	-- x -- x --	100	10.70	1.09	\$1006
----------	--------------	-----	-------	------	---------------

For dual monitor applications. Double extension arms allow 19" of horizontal back and forth movement. Easy to use Allen wrench allows user to adjust the counterbalance mechanism for easy movement of the monitor. Displays are able to tilt 180°, swing 180° side-to-side and rotate from landscape to portrait. Minor assembly required.

- To use arm in conjunction with below worksurface power troughs, thru-surface mount must be used. Cannot be clamp mounted when using power troughs.

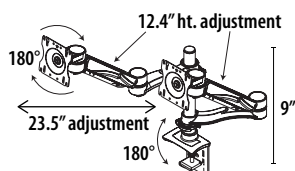
**Dual Screen Double Extension Arm with Height Adjustment**

GAMCDSDEH	-- x -- x --	92.5	12.2	1.09	\$1247
-----------	--------------	------	------	------	---------------

For dual monitor applications. Counterbalanced arms provide an additional 13" of height adjustment. Double extension arms allow 19" of horizontal back and forth movement. Easy to use Allen wrench allows user to adjust the counterbalance mechanism for easy movement of the monitor. Displays are able to tilt 180°, swing 180° side-to-side and rotate from landscape to portrait. Cable manager comes on extension arm and hides all cables. Minor assembly required.

- To use arm in conjunction with below worksurface power troughs, thru-surface mount must be used. Cannot be clamp mounted when using power troughs.

ACCESSORIES

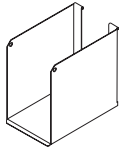

Binder Bin

MODEL#	DIMENSIONS D x W x H	FREIGHT CLASS	WT./LBS.	CUBIC FT.	LIST PRICE
BABB01	10.25 x 4 x 9	100	2	.21	\$70

Load bar/accessory rail mounted metal binder bin.

- Please refer to the **Compatibility Guide** on page 368 to determine compatible storage components

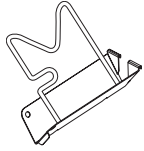

Flip Sorter

BAFS01	9.25 x 2.75 x 9.25	70	.06	.14	\$54
--------	--------------------	----	-----	-----	-------------

Load bar/accessory rail mounted metal flip sorter. Comes with chrome wire.

- Please refer to the **Compatibility Guide** on page 368 to determine compatible storage components

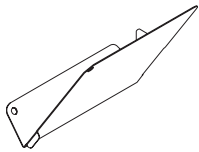

Slant Sorter

BASS01L (Left)	10.25 x 5 x 9.5	70	1	.28	\$44
BASS01R (Right)	10.25 x 5 x 9.5	70	1	.28	\$44

Load bar/accessory rail mounted metal slant sorter.

- Please refer to the **Compatibility Guide** on page 368 to determine compatible storage components

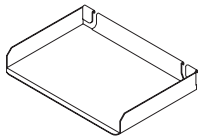

Letter/Legal Tray

BALTO1 (Letter)	9.25 x 13.5 x 2	70	.05	.15	\$58
BALTO1LGL (Legal)	9.25 x 15 x 2	70	.05	.15	\$71

Load bar/accessory rail mounted metal letter or legal tray.

- Please refer to the **Compatibility Guide** on page 368 to determine compatible storage components

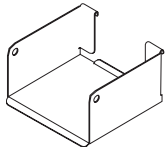

Media Bin

BAMB01	5.25 x 5.75 x 3	70	.08	.05	\$58
--------	-----------------	----	-----	-----	-------------

Load bar/accessory rail mounted metal media bin.

- Please refer to the **Compatibility Guide** on page 368 to determine compatible storage components

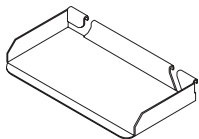

Utility Tray

BAUT01	3.75 x 5.75 x 3	70	.05	.02	\$38
--------	-----------------	----	-----	-----	-------------

Load bar/accessory rail mounted metal utility tray.

- Please refer to the **Compatibility Guide** on page 368 to determine compatible storage components

Required Specifications

Fabric (Cushion)
Metal Finish (hanging bracket, whiteboard, tackboard)

ACCESSORIES

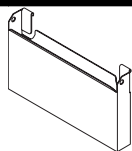
**Mail Box**

MODEL#	DIMENSIONS	FREIGHT CLASS	WT/LBS.	CUBIC FT.	LIST PRICE
--------	------------	---------------	---------	-----------	------------

D x W x H

BAPP01	2.75 x 16 x 9	100	2	.25	\$88
--------	---------------	-----	---	-----	-------------

Load bar/accessory rail mounted metal mail box.

- Please refer to the **Compatibility Guide** on page 368 to determine compatible storage components

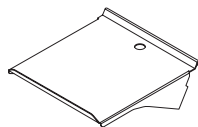
**Telephone Holder**

BATH01	10 x 9 x 2	125	2	.26	\$85
--------	------------	-----	---	-----	-------------

Load bar/accessory rail mounted metal telephone holder.

- Please refer to the **Compatibility Guide** on page 368 to determine compatible storage components

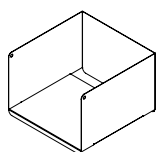
**Elevated Shelf Binder Bin**

BRTESBBIN	12 x 12 x 8	100	6	.66	\$181
-----------	-------------	-----	---	-----	--------------

Load bar/accessory rail mounted elevated shelf binder bin.

- Please refer to the **Compatibility Guide** on page 368 to determine compatible storage components

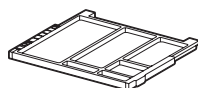
**Pencil Drawer**

PEEPD	15 x 22.5 x 1.5	250	2	0.7	\$164
-------	-----------------	-----	---	-----	--------------

Provides storage for writing instruments and small items at the worksurface. Attaches to underside of worksurface with drawer slides (included). Black ABS plastic only.

ACCESSORIES

D x W x H

ACCESSORIES COMPATIBILITY GUIDE

	DIVIDERS: BRTLPPD BRTLPS BR2AFD BR2AHD	Elevated Shelves BRTSTS08 BRTBTS08 8" high	Elevated Shelves BRTSTS13 BRTBTS13 13" high	Elevated Shelves BRTSTS16 BRTBTS16 16" high	Shared Overhead BRTBAS048 12" deep	Shared Overhead with slid- ing doors BRTBASS 16" deep
Binder Bin BABB01	yes	no	no	yes	no	no
Flip Sorter BAFS01	yes	no	yes	no	no	no
Slant Sorter BASS01	yes	no	yes	no	no	no
Letter Tray BALT01	yes	yes	yes	yes	yes	yes
Media Bin BAMB01	yes	yes	yes	yes	yes	yes
Utility Tray BAUT01	yes	yes	yes	yes	yes	yes
Mail Box BAPP01	yes	no	no	yes	no	no
Phone Holder BVATH01	yes	yes	yes	yes	yes	yes
Elevated Shelf Binder Bin BRTEBBIN	no	no	no	no	yes	no
Tackboard BRTTB	yes	no	no	yes	no	no
Whiteboard BRTWB	yes	no	no	yes	no	no

COLLABORATIVE SEATING**D x W x H**

Bridges collaborative seating collection consists of seating, privacy screens, tables, tablets and power. It is a versatile modular furniture series which can be configured into many space planning scenarios, including corner, in-line, open concept, traditional reception, as well as secluded seating with high privacy partitions.

Furniture pieces can be used as stand alone items or can be mechanically linked together to form a variety of seating configurations.

Seat and backrest can be integrated with Bridges tables.

Corner tables and in-line 6" table modules double as power delivery centers.

Dedicated seat backrests feature dual USB charging port.

Some inline 6" table modules are furnished with grommets to support tablets.

Legs are available in standard Bridges metal painted finishes and anodized aluminum finish.

Bridges Collaborative Seating upholstery features a single stitch, thick white thread around the edges. The white, wide stitch along with crisp corners are part of its distinctive personality. In order to achieve crisp edges and to minimize "pillow" effect caused by taut fabric, the upholstery material has been applied deliberately loose, which may over time, produce puckering of the upholstery surface material. This can be easily corrected by stretching the fabric by hand or during vacuuming.

In order to efficiently utilize fabric yield, all 60" seats and backs feature a seam in the middle. The double stitch seam is sewn with a thin thread, closely matching the upholstery material in color.

Some complicated fabric patterns prevent pattern matching and will be upholstered without the seam at the discretion of the factory.

Should you require no middle seam by cutting into the roll, please specify "NO SEAM" at time of your order.

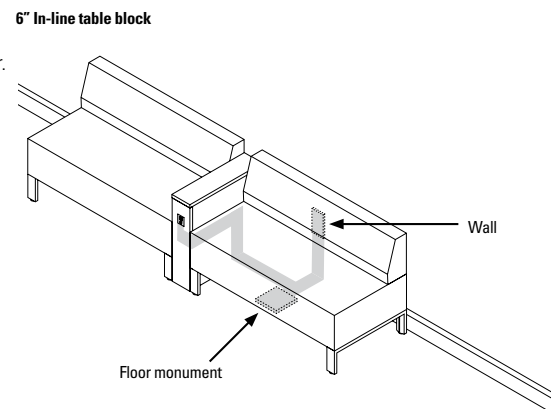
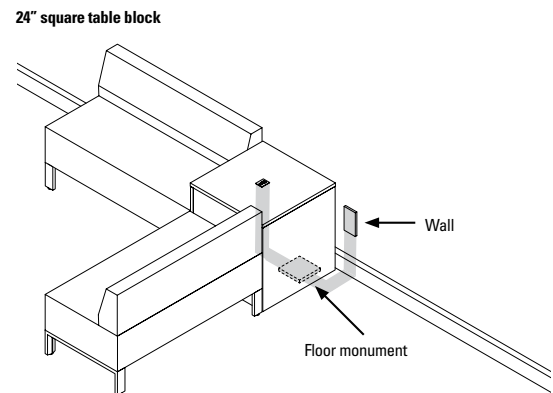
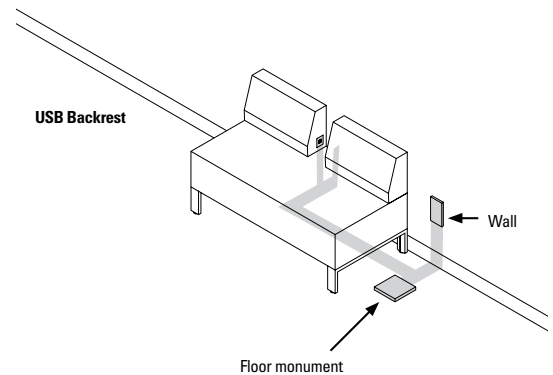

B BRIDGES II™

COLLABORATIVE SEATING

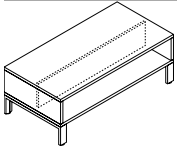

Low Table*

MODEL#	DIMENSIONS D x W x H	FREIGHT CLASS	WT/LBS.	CUBIC FT.	LIST PRICE	HP ADD
BRTST2460F	24 x 60 x 17	150	83.60	14.17	\$880	\$326
BRTST2448F	24 x 48 x 17	125	69	11.33	\$787	\$237
BRTST2424F	24 x 24 x 17	125	40.70	5.67	\$556	\$97

Freestanding 17”h table. Central partition divides space under top surface into two 11” deep compartments. All LP chassis w/ HP or LP top (3mm edging). Bridges storage aluminum leg.

- Anodized Aluminum Leg - Add **\$74.** list upcharge
- To convert to mobile - Add an **M** at the end of the product code. Add **\$35.** list upcharge.

COLLABORATIVE SEATING

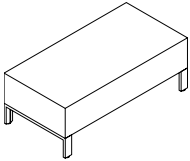

Lounge Seat

					GRADE	LIST	GRADE	LIST
BRTSE60NB	24 x 60 x 17	250	47	14.17	1	\$1659	7	\$2225
					2	\$1743	8	\$2421
					3	\$1807	9	\$2572
					4	\$1901	10	\$2741
					5	\$2039	11	\$3084
					6	\$2101	12	\$3454
BRTSE48NB	24 x 48 x 17	250	36.90	11.33	1	\$1433	7	\$1888
					2	\$1502	8	\$2045
					3	\$1553	9	\$2164
					4	\$1630	10	\$2300
					5	\$1737	11	\$2577
					6	\$1789	12	\$2870
BRTSE24NB	24 x 24 x 17	150	22.70	5.57	1	\$787	7	\$1072
					2	\$831	8	\$1170
					3	\$863	9	\$1246
					4	\$911	10	\$1330
					5	\$979	11	\$1501
					6	\$1010	12	\$1686

Fully upholstered armless lounge seat with metal base. Seats can be freestanding or linked with optional interlocking bracket kit.

- Anodized Aluminum Leg - Add **\$74** list upcharge

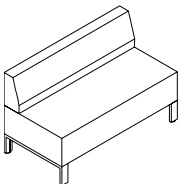

Lounge Seat, Full Backrest

BRTSE6060B	24 x 60 x 29	250	70	24.17	1	\$2649	7	\$3666
					2	\$2797	8	\$4018
					3	\$2912	9	\$4288
					4	\$3084	10	\$4590
					5	\$3327	11	\$5214
					6	\$3443	12	\$5878
BRTSE4848B	24 x 48 x 29	250	55.50	19.33	1	\$2286	7	\$3076
					2	\$2401	8	\$3350
					3	\$2491	9	\$3562
					4	\$2625	10	\$3797
					5	\$2817	11	\$4282
					6	\$2905	12	\$4797
BRTSE2424B	24 x 24 x 29	250	33	9.57	1	\$1239	7	\$1749
					2	\$1315	8	\$1925
					3	\$1373	9	\$2061
					4	\$1458	10	\$2213
					5	\$1580	11	\$2525
					6	\$1638	12	\$2855

Fully upholstered armless lounge seat with full backrest and metal base. Backrests are permanently secured to the seats and cannot be reconfigured on site. Seats can be freestanding or linked with optional interlocking bracket kit.

- Anodized Aluminum Leg - Add **\$74** list upcharge

Required Specifications

Top finish* Edge finish*
 Chassis finish*
 Fabric
 Metal Finish (legs)

Optional Specifications

Anodized Aluminum Leg
 HP laminate*

COLLABORATIVE SEATING

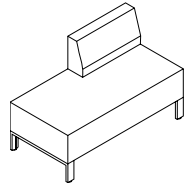

Lounge Seat, 24" Offset Backrest

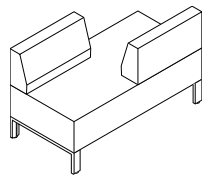

Lounge Seat, Two 24" Offset Backrests

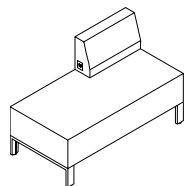

Lounge Seat, 21" USB Backrest

MODEL#	DIMENSIONS	FREIGHT CLASS	WT./LBS.	CUBIC FT.	GRADE	LIST	GRADE	LIST
D x W x H								
BRTSE2448BL	24 x 48 x 29	250	46.10	19.33	1	\$1884	7	\$2563
					2	\$1987	8	\$2800
					3	\$2063	9	\$2980
					4	\$2175	10	\$3179
					5	\$2339	11	\$3596
					6	\$2416	12	\$4038
BRTSE2448BR (shown)	24 x 48 x 29	250	46.10	19.33	1	\$1884	7	\$2563
					2	\$1987	8	\$2800
					3	\$2063	9	\$2980
					4	\$2175	10	\$3179
					5	\$2339	11	\$3596
					6	\$2416	12	\$4038
BRTSE2448BODL (shown)	24 x 48 x 29	250	46.10	19.33	1	\$2336	7	\$3241
					2	\$2468	8	\$3554
					3	\$2570	9	\$3794
					4	\$2724	10	\$4065
					5	\$2940	11	\$4618
					6	\$3043	12	\$5206
BRTSE2448BODR	24 x 48 x 29	250	46.10	19.33	1	\$2336	7	\$3241
					2	\$2468	8	\$3554
					3	\$2570	9	\$3794
					4	\$2724	10	\$4065
					5	\$2940	11	\$4618
					6	\$3043	12	\$5206
BRTSE2148EBL	24 x 48 x 29	250	33	9.67	1	\$2184	7	\$2863
					2	\$2287	8	\$3100
					3	\$2363	9	\$3280
					4	\$2475	10	\$3479
					5	\$2639	11	\$3896
					6	\$2716	12	\$4338
BRTSE2148EBR (shown)	24 x 48 x 29	250	46.10	19.33	1	\$2184	7	\$2863
					2	\$2287	8	\$3100
					3	\$2363	9	\$3280
					4	\$2475	10	\$3479
					5	\$2639	11	\$3896
					6	\$2716	12	\$4338

Fully upholstered armless lounge seat with one backrest and metal base. Specify backrest as either left or right side. Backrests are permanently secured to the bench and cannot be reconfigured on site. Seats can be freestanding or linked with optional interlocking bracket kit.

- Anodized Aluminum Leg - Add \$74 list upcharge

Fully upholstered armless lounge seat with two offset backrests and metal base. Specify either left or right backrest configuration. Backrests are permanently secured to the bench and cannot be reconfigured on site. Seats can be freestanding or linked with optional interlocking bracket kit.

- Anodized Aluminum Leg - Add \$74 list upcharge

Fully upholstered armless lounge seat with one backrest and metal base. 21" w backrest comes with embedded dual USB port in its side. Note: The side mounted power/USB outlets always point to the center of the seat. Each USB outlet offers 2 amps. AC/DC transformer plugs into the wall or floor monument (approx. 4' long cable available from the bottom of the seat). Transformer power consumption: 0.68 amps. Specify either left or right backrest configuration. Backrests are permanently secured to the bench and cannot be reconfigured on site. Seats can be freestanding or linked with optional interlocking bracket kit. White USB outlets.

- Anodized Aluminum Leg - Add \$74 list upcharge

Required Specifications

Fabric
Metal Finish (legs)

Optional Specifications

Anodized Aluminum Leg

COLLABORATIVE SEATING

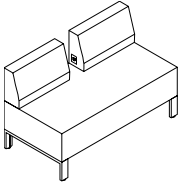

Lounge Seat, Two 21" USB Backrests

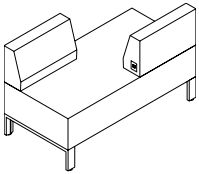

Lounge Seat, Two Offset USB Backrests

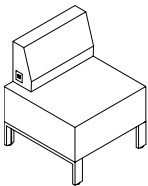

Lounge Seat, 21" USB Backrest

MODEL#	DIMENSIONS D x W x H	FREIGHT CLASS	WT/LBS.	CUBIC FT.	GRADE	LIST	GRADE	LIST
BRTSE2148E2B	24 x 48 x 29	250	57	19.33	1	\$2934	7	\$3838
					2	\$3066	8	\$4151
					3	\$3165	9	\$4392
					4	\$3319	10	\$4660
					5	\$3536	11	\$5213
					6	\$3641	12	\$5803

Fully upholstered armless lounge seat with two backrests and metal base. Both 21" w backrests come with embedded dual USB port in its side. Note: The side mounted power/USB outlets always point to the center of the seat. Each USB outlet offers 2 amps. AC/DC transformer plugs into the wall or floor monument (approx. 52" long cable available from the bottom of the seat). Transformer power consumption: 0.68 amps. Backrests are permanently secured to the bench and cannot be reconfigured on site. Seats can be freestanding or linked with optional interlocking bracket kit. White USB outlets.

- Anodized Aluminum Leg - Add **\$74** list upcharge

BRTSE2148EBODL (shown)	24 x 48 x 29	250	57	19.33	1	\$2934	7	\$3838
					2	\$3066	8	\$4151
					3	\$3165	9	\$4392
					4	\$3319	10	\$4660
					5	\$3536	11	\$5213
					6	\$3641	12	\$5803

BRTSE2148EBODR	24 x 48 x 29	250	57	19.33	1	\$2934	7	\$3838
					2	\$3066	8	\$4151
					3	\$3165	9	\$4392
					4	\$3319	10	\$4660
					5	\$3536	11	\$5213
					6	\$3641	12	\$5803

Fully upholstered armless lounge seat with two offset backrests and metal base. Both 21" w backrests come with embedded dual USB port in its side. Note: The side mounted power/USB outlets always point to the center of the seat. Each USB outlet offers 2 amps. AC/DC transformer plugs into the wall or floor monument (approx. 52" long cable available from the bottom of the seat). Transformer power consumption: 0.68 amps. Specify either left or right backrest configuration. Backrests are permanently secured to the bench and cannot be reconfigured on site. Seats can be freestanding or linked with optional interlocking bracket kit. White USB outlets.

- Anodized Aluminum Leg - Add **\$74** list upcharge

BRTSE2124EBL	24 x 24 x 29	250	46.10	19.33	1	\$1538	7	\$2049
					2	\$1614	8	\$2225
					3	\$1673	9	\$2360
					4	\$1757	10	\$2512
					5	\$1879	11	\$2824
					6	\$1939	12	\$3154

BRTSE2124EBR (shown)	24 x 24 x 29	250	46.10	19.33	1	\$1538	7	\$2049
					2	\$1614	8	\$2225
					3	\$1673	9	\$2360
					4	\$1757	10	\$2512
					5	\$1879	11	\$2824
					6	\$1939	12	\$3154

Fully upholstered armless lounge seat with one backrest and metal base. 21" w backrest comes with embedded dual USB port in its side. Note: Each USB outlet offers 2 amps. AC/DC transformer plugs into the wall or floor monument (approx. 52" long cable available from the bottom of the seat). Transformer power consumption: 0.68 amps. Specify either left or right. Backrests are permanently secured to the bench and cannot be reconfigured on site. Seats can be freestanding or linked with optional interlocking bracket kit. White USB outlets.

- Anodized Aluminum Leg - Add **\$74** list upcharge

Required Specifications

Fabric
Metal Finish (legs)

Optional Specifications

Anodized Aluminum Leg

COLLABORATIVE SEATING

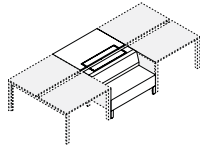

Integrated Lounge Seat, Single-Sided

MODEL#	DIMENSIONS	FREIGHT CLASS	WT./LBS.	CUBIC FT.	GRADE	LIST	GRADE	LIST	
BRTSINT60S	24 x 60 x 29	125	155	24.17					
					D x W x H				
					1	\$5294	7	\$6289	
					2	\$5422	8	\$6641	
					3	\$5535	9	\$6914	
					4	\$5709	10	\$7216	
5	\$5952	11	\$7838						
6	\$6068	12	\$8501						
BRTSINT48S	24 x 48 x 29	100	182	19.33	1	\$5065	7	\$5856	
					2	\$5181	8	\$6130	
					3	\$5271	9	\$6343	
					4	\$5406	10	\$6577	
					5	\$5596	11	\$7062	
					6	\$5685	12	\$7579	

Fully upholstered armless lounge seat with full width backrest and metal legs integrated into Bridges 62.5" d back-to-back linear table assembly. The single-sided kit consists of 24" x 48" or 24" x 60" seat, full width back, three-sided below worksurface enclosure, 6" d worksurface module with access door, 30" x 48" or 30" x 60" w worksurface with access door and supporting hardware. The seat module accommodates continuation of power and data distribution services below worksurfaces (specify Below Worksurface Power Trough and power components separately). The 6" d worksurface module with access door provides access to Below Worksurface Power Trough. Backrests are permanently secured to the bench and cannot be reconfigured on site. Tables not included.

• **Only compatible with back-to-back 30" d worksurfaces (62.5" total depth) supported by Bridges rectangular legs.** Not compatible with round legs, 24" d worksurfaces; not compatible with single line table assemblies 24" and 30" d. The kit cannot be used at the end of a table run, nor can it be used as a standalone, freestanding configuration. It must always be supported by back-to-back table assemblies on either side

- Anodized Aluminum Leg - Add **\$74** list upcharge
- High pressure laminate - Add **\$266** list upcharge

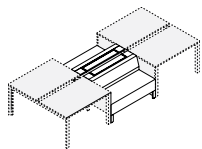

Integrated Lounge Seat, Double-Sided

BRTSINT60D	24 x 60 x 29	125	155	24.17				
					1	\$6873	7	\$7890
					2	\$7021	8	\$8242
					3	\$7136	9	\$8512
					4	\$7308	10	\$8814
					5	\$7551	11	\$9438
6	\$7668	12	\$10103					
BRTSINT48D	24 x 48 x 29	100	182	19.33	1	\$6148	7	\$6938
					2	\$6263	8	\$7212
					3	\$6353	9	\$7424
					4	\$6487	10	\$7659
					5	\$6679	11	\$8144
					6	\$6768	12	\$8659

Fully upholstered armless lounge bench with full backrests and metal legs integrated into Bridges 62.5" d back-to-back linear table assembly. The double-sided kit consists of two 24" x 48" or 24" x 60" seats, full width backs, three-sided below worksurface enclosures, 6" d worksurface modules with access doors and supporting hardware. The seat module accommodates continuation of power and data distribution services below worksurfaces (specify Below Worksurface Power Trough and power components separately). The 6" d worksurface module with access door provides access to Below Worksurface Power Trough. Backrests are permanently secured to the bench and cannot be reconfigured on site. Tables not included.

• **Only compatible with back-to-back 30" d worksurfaces (62.5" total depth) supported by Bridges rectangular legs.** Not compatible with round legs, 24" d worksurfaces; not compatible with single line table assemblies 24" and 30" d. The kit cannot be used at the end of a table run, nor can it be used as a standalone, freestanding configuration. It must always be supported by back-to-back table assemblies on either side.

- Anodized Aluminum Leg - Add **\$74** list upcharge
- High pressure laminate - Add **\$266** list upcharge

Required Specifications

Fabric
Laminate finish (enclosure)
Edge finish (enclosure)
Metal finish (legs)

Optional Specifications

Anodized Aluminum Leg
HP laminate (enclosure)

SEATING PARTITIONS

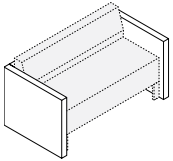

Seat Partitions

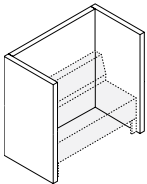

Seat Privacy Partitions

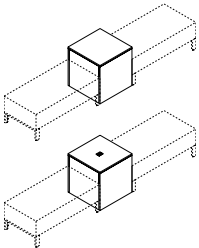

Square Table Block*

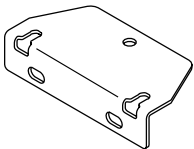

Square Table Block Ganging Bracket Kit

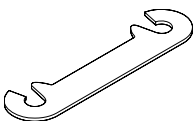

Ganging Bracket Kit

MODEL#	DIMENSIONS D x W x H	FREIGHT CLASS	WT./LBS.	CUBIC FT.	LIST PRICE
BRTPP2448L1	28.7 x 53 x 25	300	41	22.01	\$1941
BRTPP2424L1	28.7 x 29 x 25	250	32	12.04	\$1452

Fully upholstered 2.5" thick, 3-part, low level partition kit wraps around 24" or 48" bridges seat. The seat front is recessed by 2.5". The kit is secured to seats on-site (brackets connecting seat legs to the inner side of the partition are included). Upholstered kits consist of 2" hollow core boards, 1/4" foam, fabric, levelers and connecting hardware. Note: Seats and backrests are not included.

BRTPP2448L2	28.7 x 53 x 50	400	41	44.01	\$2813
BRTPP2424L2	28.7 x 29 x 50	300	32	24.08	\$2199

Fully upholstered 2.5" thick, 3-part, two tier partition kit wraps around 24" or 48" bridges seat. The 50"h assembly provides seated visual privacy. 2.5" thick upholstered partitions improve acoustic privacy for focused time away from the team or for a quiet phone call. Recessed seat extends the partition at the front by 2.5" for enhanced sense of privacy. The kit is secured to seats on-site (brackets connecting seat legs to the inner side of the partition are included). Upholstered kits consist of 2" hollow core boards, 1/4" foam, fabric, levelers and connecting hardware. Note: Seats and backrests are not included.

BRTS2424B	24 x 24 x 25	250	32	12.04	\$619	\$90
BRTS2424BP	24 x 24 x 25	125	59.30	8.33	\$1231	\$90

Freestanding 24" square table block serves as a visual anchor whenever a bridges seat needs to turn a corner or split into 2, 3 or 4 directions. BRTS2424BP can be positioned directly over a floor monument, which will supply power to the top-mounted power module. This option includes 24"x 24" block chassis and flush-mounted Duo power module (two outlets and two 2.1 amp USB ports, white face plate, outlets and bezel, 72" long three prong black cord). The square table block can function as a self-supporting, freestanding unit or it can be secured permanently to adjacent bridges seats with optional interconnecting brackets listed below. 2 Square Table Ganging Bracket Kits included.

BRTSTBG	2.4 x 5 x 1.1	70	.05	.01	\$47	n/a
---------	---------------	----	-----	-----	-------------	-----

Two square table block ganging brackets connect seat legs permanently to the side of the 24" square table block on site. The kit employs machine screws connecting legs to seats, and ships with wood screws which provide permanent connection to the square table block. Includes 2 brackets and screws. Black powdercoat finish.

BRTSTSB	1.3 x 6 x .1	70	.03	.01	\$21	n/a
---------	--------------	----	-----	-----	-------------	-----

Two ganging brackets connect seat temporarily to adjacent in-line seat or 24"d bridges storage. Black powdercoat finish.

Required Specifications

Fabric

COLLABORATIVE SEATING

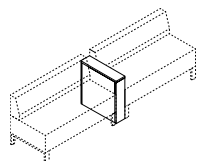

Inline 6" Block

BRTS2406B

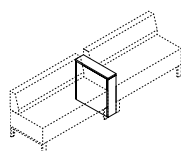

Inline table - no power module or swivel arm

MODEL#	DIMENSIONS D x W x H	FREIGHT CLASS	WT/LBS.	CUBIC FT.	LIST PRICE	HP ADD
BRTS2406B	24 x 6 x 25	92.5	21	2.08	\$531	\$47
BRTS2406BP	24 x 6 x 25	92.5	23.30	2.08	\$1144	\$47
BRTS2406B2P	24 x 6 x 25	92.5	24.30	2.08	\$1758	\$47
BRTS2406BT	24 x 6 x 25	85	25.60	2.08	\$1014	\$47
BRTS2406BPT	24 x 6 x 25	92.5	24.30	2.08	\$1627	\$47

Multifunctional inline 6" table block divides seating areas, serves as a utility surface, can support tablet arms, lamps, and double as a power delivery center. It is permanently secured between two bridge seats and cannot be placed at the end of a run. Two Square Table Block Ganging Brackets (BRTSTBG) connect seat legs permanently to the side of the in-line table block on site. The included kit employs machine screws connecting legs to seats and ships with wood screws, which provide permanent connection to the in-line 6" block. Black powdercoat finish. The chassis is available without power module, with one power module or with two vertically embedded power modules. Vertical panel flush-mounted Duo module provides two outlets and two 2.1 amp USB ports; 72" cord exits through the bottom and plugs into a floor monument under seats, white face plate and bezel. 2 Square Table Ganging Bracket Kits included.

- BRTS2406BT and BRTS2406BPT include 9.5" x 14.5" swivel tablet. If top is specified in high pressure laminate, tablet will also be manufactured in high pressure laminate.

BRTS2406BP

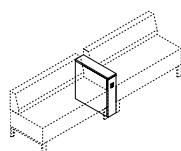

Inline table w/front power module

BRTS2406B2P

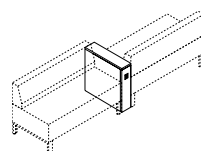

Inline table w/front and rear power module

BRTS2406BT

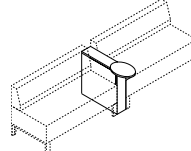

Inline table w/swivel tablet arm

BRTS2406BPT

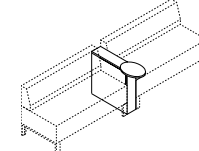

Inline table w/front power module and swivel tablet arm

Required Specifications

Top finish*
Edge finish*
Chassis/Accent finish*

Optional Specifications

HP laminate* (top only)



Divide is a modular desk-mounted panel system that can be retro installed on many Global Desks. The panels can be vertically stacked to provide varying degrees of privacy. The panels are available in laminate or fabric tackboards as well as glazed panels that allow light to pass through. Divide's off-desk accessories help to organize paperwork and free up the workspace. Divide is offered in many laminate and fabric color options to complement any office environment.



Features and Benefits

- Available as fabric, glazed or laminate partitioning panels in an array of heights and widths
- Easy to specify: choose the desired panel height and width and its corresponding height divide post(s)
- A built-in paper management rail (on fabric and glazed panels) is designed to accommodate off-desk accessories for workspace organization.
- Laminate panels offer an optional wire access cutout at the bottom of each panel (order as SCP2)
- Laminate transaction tops are offered in various shapes and sizes, and are standard as either 1" thick or 1.5" thick to match
- All Adaptabilities, Genoa, and Zira laminate colors are offered as well as a wide variety of fabrics

GENERAL INFORMATION

- Divide is a desk mounted panel system that can be field installed at any time on many Global desks
- Vertical stacking of varying heights provides semi-private to private work areas
- Designed for use on the Adaptabilities, Genoa, and Zira laminate desk series', and may be retrofitted onto non-Global square edged product if necessary.
- Panels are available in 12", 18", 24" and 36" heights and can be stacked to produce heights of 24", 30", 36" and 42" for a virtually limitless variety of configurations
- Progressive, desk mounted partition system consisting of three major categories:
 - Divide posts - to support the partitions
 - Partitioning screens - a variety of widths and heights to create personalized privacy; offered in laminate, glaze or select fabrics
 - Transaction tops - laminate tops ideal for creating reception stations
- For environmental certifications, please visit globalfurnituregroup.com
- Model numbers reflect total width of panel and posts

DIVIDE POSTS

- Available in 6 standard heights:
 - 12" high - to create **semi-private** spaces and to support Transaction Tops
 - 18" high - to create **semi-private** spaces and to support Transaction Tops
 - 24" high - to create **semi-private** spaces
 - 30" high - to create **semi-private** spaces
 - 36" high - to create **private** spaces and to match the height of 36" high hutches and/or 65" high Adaptabilities, Genoa and Zira cabinets
 - 42" high - to create **private** spaces and to match the height of 42" high hutches and/or 72" high Zira cabinets
- Posts are field installed. Each plate divider includes: 1 post mounting plate, 1 threaded rod, 3 cover strips and 1 top cap plus mounting hardware (wcontains 8 screws, 1 washer, 1 locking nut). 2 divide posts are required per partitioning panel.
- Available in Black (**BLK**) or Tungsten (**TUN**) finish, please specify.

PARTITIONING SCREENS

- Available in 4 standard heights: 12", 18", 24" and 36" and can be used in combinations to create systems consisting of 12", 18", 24", 30", 36" and 42" heights.
- Available in 3 materials:
 - **Laminate:** available in all laminate colors used on Adaptabilities, Genoa and Zira (see right). Accent edging at top and bottom is Black (**BLK**) only. Optional wire access scoop cut-out is offered, centered at the bottom of the panel - order as **SCP2** after model #. Woodgrain direction is horizontal for all sizes.
 - **Glazed:** choice of **ribbed** or **frosted** glazing. Frosted material is 3mm thick Acrylic P95; Ribbed material is 10mm thick multiwall UV protected polycarbonate. Top and bottom rail are optional in Black (**BLK**) or Tungsten (**TUN**) finish, please specify. Top rail is designed to accommodate off-desk accessories. Glazed panels are also available with 4" raised bottom for pass-through option.
 - **Fabric:** available in all Grade 1, 2, 3 and 4 panel fabrics and select seating fabrics only (see right). Top and bottom rail optional in Black (**BLK**) or Tungsten (**TUN**), finish please specify. Top rail is designed to accommodate off-desk accessories.
- Filler panels are included with each Divide panel. To be used between two posts in a straight run from worksurface to worksurface.
- Special width panels are available in laminate or glazed material options only. For pricing, contact Specials.

TRANSACTION TOPS

- Tops are available in 1" or 1.5" thick thermally fused laminate
- Tops are sealed with Global's preferred edging in matching color
- Woodgrain surfaces feature edging in matching printed woodgrain
- Transaction tops are available with optional edges at no upcharge. Please specify (see right column).

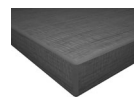

A3 1" top, standard

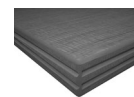

AR 1" top, bicut edge

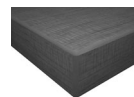

C3 1.5" top, standard



CR 1.5" top, bicut edge

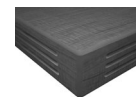

CF 1.5" top, fluted edge

- Includes all necessary flat mounting plates and joining plates.
- Features pre-drilled locating holes to allow for quick alignment with the divide post
- Available with a radius cut on one or both ends (each radius adds a 6" overhang).
- Woodgrain surfaces feature edging with matching printed woodgrain
- Products specified with the high pressure laminate option are finished on the underside of the surface with a kraft paper backing.

LAMINATE AND EDGE FINISHES (laminate panels and transaction tops)

ACJ	Absolute Acajou	FCL	First Class
ASN	Asian Night	NBL	Noce Biondo
AWC	Avant Cherry	NGL	Noce Grigio
AWH	Avant Honey	NEL	Noce Leggero
BLK	Black	NML	Noce Medio
BZD	Blizzard	QTM	Quartered Mahogany
BRC	Brushed Cobalt	SBY	Sheer Beauty
CMB	Clear Maple	SOG	Storm Grey
CGY	Custom Grey	SDT	Stonedust
DES	Dark Espresso	WHE	Walnut Heights
DWT	Designer White	WHC	White Chocolate
FAS	Fashionista	WCR	Winter Cherry

FABRICS (fabric screens)

Fabric screens can be upholstered in the following fabrics only:

- Anchorage
- Imprint
- Lola
- Merge

D DIVIDE™ - NOTES

PLEASE NOTE:

- Divide screens cannot be centered between two back to back worksurfaces.
- Screens must be installed on one worksurface or the other.
- Divide cannot be used with Adaptabilities reception units.
- When panels are mounted on a 30" deep worksurface from Adaptabilities, Genoa or Zira, please specify 29" wide panel

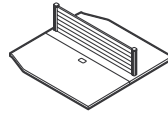

Correct Installation

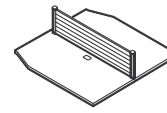

Incorrect Installation

HOW TO ORDER DIVIDE SCREENS

example: DTB 1236 GN31

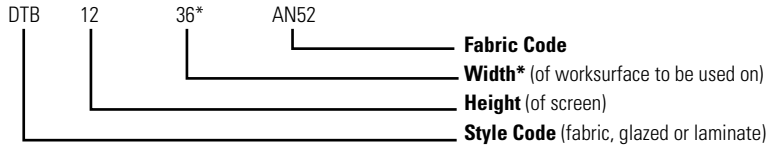

*NOTE: Number denotes width of worksurface to use - please see dimensions in price book for actual dimensions of the screen.

PARTS AND COMPONENTS

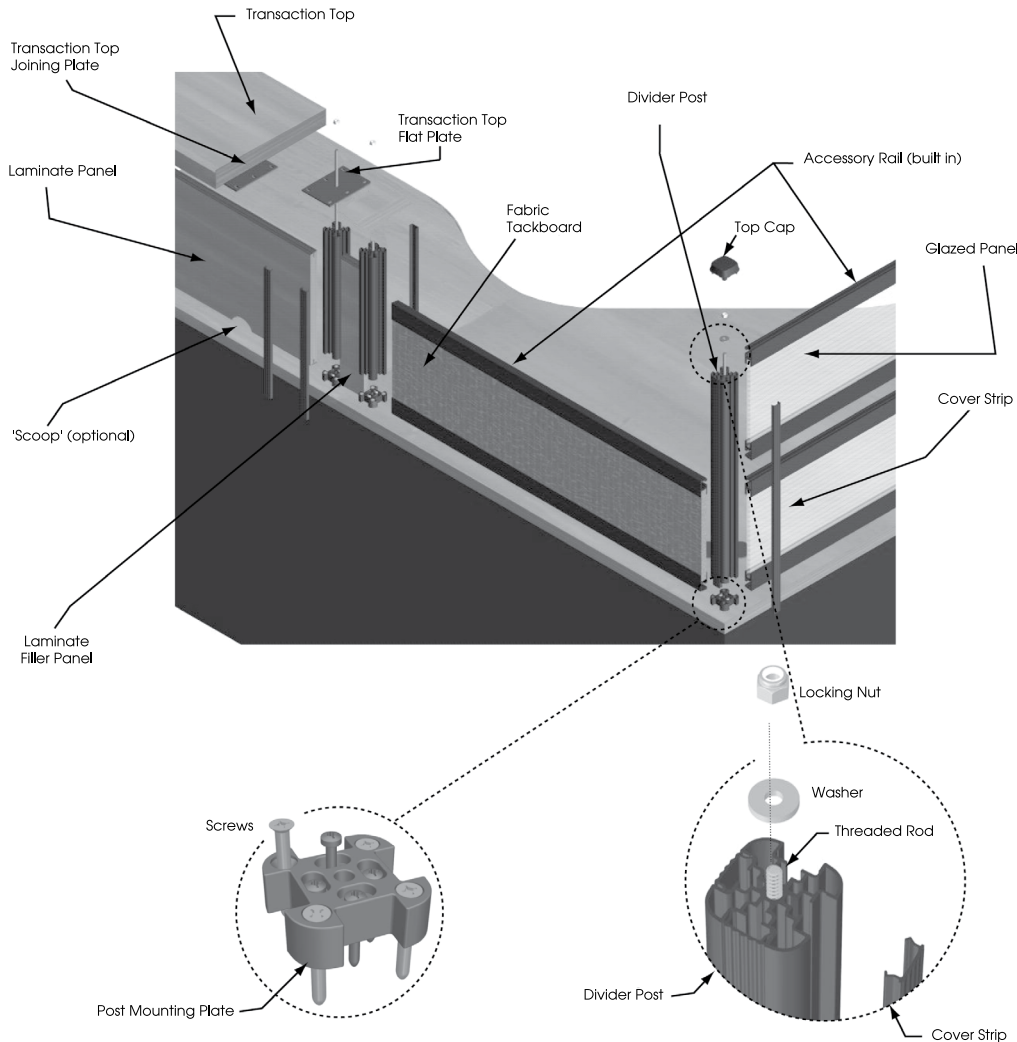

INSTALLATION IS AS SIMPLE AS 1...2...3

- 1) Attach the threaded **Post Mounting Plate** with enclosed screws to the top side of the worksurface.
- 2) **Divider Post** is bolted to the Mounting Plate.
- 3) **Top Cap** is attached to the top of the Divide Post.

12”H System

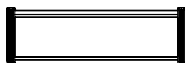

12” panel



12” raised panel

18”H System



18” panel

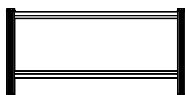

18” raised panel

24”H System



24” panel



24” raised panel

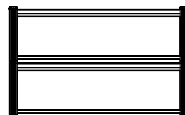

(2) 12” panels

30”H System

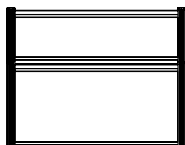

12” panel + 18” panel

36”H System

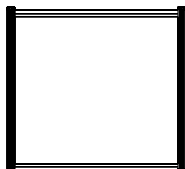

36” panel

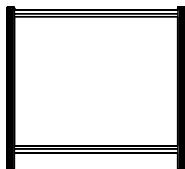

36” raised panel

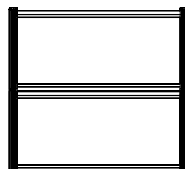

(2) 18” panels

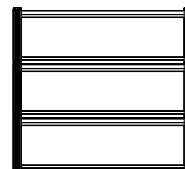

(3) 12” panels

42”H System

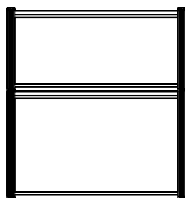

18” panel + 24” panel

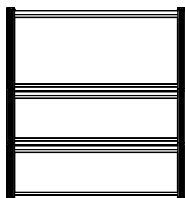

(1) 18” panel
(2) 12” panels

FABRIC PANELS

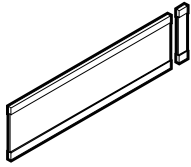

Fabric Panel - 12" High

MODEL#	DIMENSIONS D x W x H	FREIGHT CLASS	WT/LBS.	CUBIC FT.	GR.1	GR.2	GR.3	GR.4	GR.5
DTB1220	.68 x 14.8 x 12	92.5	3	.30	\$270	\$303	\$330	\$370	\$421
DTB1224	.68 x 18.9 x 12	85	4	.30	\$282	\$315	\$340	\$374	\$430
DTB1229	.68 x 24.5 x 12	92.5	4	.40	\$299	\$335	\$359	\$399	\$449
DTB1230	.68 x 24.8 x 12	85	5	.40	\$299	\$335	\$359	\$399	\$449
DTB1236	.68 x 30.8 x 12	85	5	.40	\$332	\$366	\$390	\$426	\$478
DTB1242	.68 x 36.8 x 12	85	6	.50	\$386	\$420	\$444	\$478	\$534
DTB1248	.68 x 42.8 x 12	92.5	7	.60	\$418	\$450	\$476	\$509	\$564
DTB1260	.68 x 54.8 x 12	85	9	.70	\$447	\$481	\$507	\$543	\$597
DTB1266	.68 x 60.8 x 12	85	10	.80	\$472	\$505	\$532	\$566	\$620
DTB1272	.68 x 66.8 x 12	85	11	.80	\$502	\$536	\$562	\$596	\$650

Features built-in accessory rail. Includes matching filler panel. Ships 1 set per carton. **Specify DTB1229 for panels placed along the depth side of a 30" deep worksurface.**

- Top and bottom rail optional in Black (**BLK**) or Tungsten (**TUN**) finish, please specify.
- *Model # depicts size of worksurface to be used on - see NOTES on page 378 for additional ordering information.*
- When specifying a Grade 1, 2, 3, 4 or 5 seating fabric, please note fabric pattern will run horizontally
- Divide Post **MUST** be ordered separately. Two posts are required per panel.

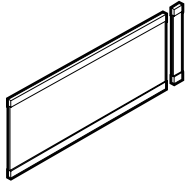

Fabric Panel - 18" High

DTB1820	.68 x 14.8 x 18	85	4	.30	\$299	\$335	\$359	\$399	\$449
DTB1824	.68 x 18.9 x 18	85	5	.40	\$314	\$346	\$372	\$405	\$460
DTB1829	.68 x 24.5 x 18	85	6	.50	\$332	\$366	\$390	\$426	\$478
DTB1830	.68 x 24.8 x 18	85	6	.50	\$332	\$366	\$390	\$426	\$478
DTB1836	.68 x 30.8 x 18	92.5	7	.60	\$386	\$420	\$444	\$478	\$534
DTB1842	.68 x 36.8 x 18	92.5	8	.70	\$422	\$455	\$479	\$513	\$566
DTB1848	.68 x 42.8 x 18	85	10	.80	\$447	\$481	\$507	\$543	\$597
DTB1860	.68 x 54.8 x 18	85	12	.90	\$472	\$505	\$532	\$566	\$620
DTB1866	.68 x 60.8 x 18	85	14	1	\$502	\$536	\$562	\$596	\$650
DTB1872	.68 x 66.8 x 18	85	14	1.10	\$562	\$596	\$622	\$658	\$712

Features built-in accessory rail. Includes matching filler panel. Ships 1 set per carton. **Specify DTB1829 for panels placed along the depth side of a 30" deep worksurface.**

- Top and bottom rail optional in Black (**BLK**) or Tungsten (**TUN**) finish, please specify.
- *Model # depicts size of worksurface to be used on - see NOTES on page 378 for additional ordering information.*
- When specifying a Grade 1, 2, 3, 4 or 5 seating fabric, please note fabric pattern will run horizontally
- Divide Post **MUST** be ordered separately. Two posts are required per panel.

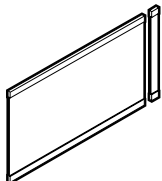

Fabric Panel - 24" High

DTB2420	.68 x 14.8 x 24	92.5	4	.40	\$332	\$366	\$390	\$426	\$478
DTB2424	.68 x 18.9 x 24	100	4	.50	\$332	\$366	\$390	\$426	\$478
DTB2429	.68 x 24.5 x 24	92.5	6	.60	\$386	\$420	\$444	\$478	\$534
DTB2430	.68 x 24.8 x 24	92.5	6	.60	\$386	\$420	\$444	\$478	\$534
DTB2436	.68 x 30.8 x 24	92.5	7	.70	\$418	\$450	\$476	\$509	\$564
DTB2442	.68 x 36.8 x 24	92.5	8	.80	\$447	\$481	\$507	\$543	\$597
DTB2448	.68 x 42.8 x 24	92.5	9	.90	\$472	\$505	\$532	\$566	\$620
DTB2460	.68 x 54.8 x 24	92.5	11	1.10	\$502	\$536	\$562	\$596	\$650
DTB2466	.68 x 60.8 x 24	92.5	12	1.20	\$562	\$596	\$622	\$658	\$712
DTB2472	.68 x 66.8 x 24	92.5	14	1.40	\$611	\$645	\$672	\$705	\$761

Features built-in accessory rail. Includes matching filler panel. Ships 1 set per carton. **Specify DTB2429 for panels placed along the depth side of a 30" deep worksurface.**

- Top and bottom rail optional in Black (**BLK**) or Tungsten (**TUN**) finish, please specify.
- *Model # depicts size of worksurface to be used on - see NOTES on page 378 for additional ordering information.*
- When specifying a Grade 1, 2, 3, 4 or 5 seating fabric, please note fabric pattern will run horizontally
- Divide Post **MUST** be ordered separately. Two posts are required per panel.

Required Specifications

Fabric
Rail Finish

FABRIC PANELS

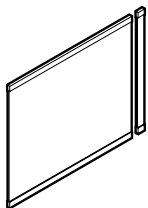

Fabric Panel - 36" High*

MODEL#	DIMENSIONS	FREIGHT CLASS	WT/LBS.	CUBIC FT.	GR.1	GR.2	GR.3	GR.4	GR.5	
D x W x H										
DTB3620	.68 x 14.8 x 36	92.5	6	.60	\$409	\$435	\$455	\$485	\$528	
DTB3624	.68 x 18.9 x 36	92.5	7	.70	\$409	\$435	\$455	\$485	\$528	
DTB3629	.68 x 24.5 x 36	92.5	9	.90	\$552	\$578	\$598	\$628	\$671	
DTB3630	.68 x 24.8 x 36	92.5	9	.90	\$552	\$578	\$598	\$628	\$671	
DTB3636	.68 x 30.8 x 36	92.5	10	1	\$623	\$650	\$670	\$700	\$743	
DTB3642	.68 x 36.8 x 36	92.5	12	1.20	\$668	\$694	\$714	\$744	\$787	
DTB3648	.68 x 42.8 x 36	92.5	14	1.30	\$779	\$805	\$825	\$855	\$898	
DTB3660	.68 x 54.8 x 36	92.5	17	1.60	\$908	\$934	\$954	\$984	\$1027	
DTB3666	.68 x 60.8 x 36	92.5	19	1.80	\$1012	\$1039	\$1059	\$1089	\$1132	
DTB3672	.68 x 66.8 x 36	92.5	21	1.90	\$1070	\$1096	\$1116	\$1146	\$1189	

Features built-in accessory rail. Includes matching filler panel. Ships 1 set per carton. **Specify DTB3629 for panels placed along the depth side of a 30" deep worksurface.**

- Top and bottom rail optional in Black (BLK) or Tungsten (TUN) finish, please specify.
- Model # depicts size of worksurface to be used on - see NOTES on page 378 for additional ordering information.
- When specifying a Grade 1, 2, 3, 4 or 5 seating fabric, please note fabric pattern will run horizontally
- Divide Post **MUST** be ordered separately. Two posts are required per panel.

GLAZED PANELS

LIST PRICE

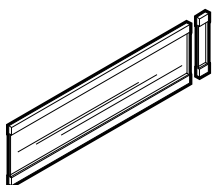

Glazed Panel - 12" High**

DGP1220	.68 x 14.8 x 12	125	2	.30	\$265
DGP1224	.68 x 18.9 x 12	92.5	3	.30	\$282
DGP1229	.68 x 24.5 x 12	125	3	.40	\$335
DGP1230	.68 x 24.8 x 12	92.5	4	.40	\$335
DGP1236	.68 x 30.8 x 12	92.5	4	.40	\$389
DGP1242	.68 x 36.8 x 12	92.5	5	.50	\$442
DGP1248	.68 x 42.8 x 12	100	5	.60	\$522
DGP1260	.68 x 54.8 x 12	92.5	7	.70	\$611
DGP1266	.68 x 60.8 x 12	100	7	.80	\$668
DGP1272	.68 x 66.8 x 12	92.5	8	.80	\$723

Features built-in accessory rail. Includes matching filler panel. Ships 1 set per carton. **Specify DGP1229 for panels placed along the depth side of a 30" deep worksurface.**

- Top and bottom rail optional in Black (BLK) or Tungsten (TUN) finish, please specify.
- Model # depicts size of worksurface to be used on - see NOTES on page 378 for additional ordering information.
- Divide Post **MUST** be ordered separately. Two posts are required per panel.
- Glazing is available in Frosted (GF) or Ribbed (RG).

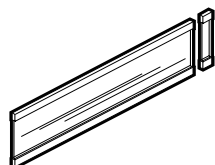

Glazed Panel - 12" High, Raised**

DRGP1220	.68 x 14.8 x 12	60	2	.02	\$236
DRGP1224	.68 x 18.9 x 12	60	3	.03	\$274
DRGP1229	.68 x 24.5 x 12	60	3	.03	\$322
DRGP1230	.68 x 24.8 x 12	60	4	.03	\$322
DRGP1236	.68 x 30.8 x 12	60	4	.04	\$377
DRGP1242	.68 x 36.8 x 12	60	5	.05	\$427
DRGP1248	.68 x 42.8 x 12	60	5	.05	\$507
DRGP1260	.68 x 54.8 x 12	60	7	.07	\$600
DRGP1266	.68 x 60.8 x 12	60	7	.07	\$655
DRGP1272	.68 x 66.8 x 12	60	8	.08	\$711

4" gap at bottom. Features built-in accessory rail. Includes matching filler panel. Ships 1 set per carton. Raised glazed panels to be offered on the lower level only. **Specify DRGP1229 for panels placed along the depth side of a 30" deep worksurface.**

- Top and bottom rail optional in Black (BLK) or Tungsten (TUN) finish, please specify.
- Model # depicts size of worksurface to be used on - see NOTES on page 378 for additional ordering information.
- Divide Post **MUST** be ordered separately. Two posts are required per panel.
- Glazing is available in Frosted (GF) or Ribbed (RG).

Required Specifications

- Fabric*
- Glaze**
- Rail Finish

GLAZED PANELS

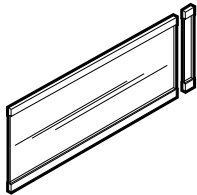

Glazed Panel - 18" High

MODEL#	DIMENSIONS D x W x H	FREIGHT CLASS	WT/LBS.	CUBIC FT.	LIST PRICE
DGP1820	.68 x 14.8 x 18	92.5	3	.30	\$296
DGP1824	.68 x 18.9 x 18	125	3	.40	\$320
DGP1829	.68 x 24.5 x 18	100	4	.50	\$374
DGP1830	.68 x 24.8 x 18	100	4	.50	\$374
DGP1836	.68 x 30.8 x 18	100	5	.60	\$432
DGP1842	.68 x 36.8 x 18	125	5	.70	\$482
DGP1848	.68 x 42.8 x 18	125	6	.80	\$578
DGP1860	.68 x 54.8 x 18	100	8	.90	\$691
DGP1866	.68 x 60.8 x 18	100	8	1	\$747
DGP1872	.68 x 66.8 x 18	100	9	1.10	\$807

Features built-in accessory rail. Includes matching filler panel. Ships 1 set per carton. **Specify DGP1829 for panels placed along the depth side of a 30" deep worksurface.**

- Top and bottom rail optional in Black (**BLK**) or Tungsten (**TUN**) finish, please specify.
- *Model # depicts size of worksurface to be used on - see NOTES on page 378 for additional ordering information.*
- Divide Post **MUST** be ordered separately. Two posts are required per panel.
- Glazing is available in Frosted (**GF**) or Ribbed (**RG**).

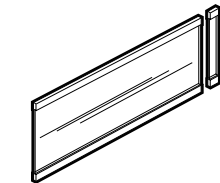

Glazed Panel - 18" High, Raised

DRGP1820	.68 x 14.8 x 18	60	3	.03	\$274
DRGP1824	.68 x 18.9 x 18	60	3	.04	\$310
DRGP1829	.68 x 24.5 x 18	60	4	.05	\$359
DRGP1830	.68 x 24.8 x 18	60	4	.05	\$359
DRGP1836	.68 x 30.8 x 18	60	5	.06	\$422
DRGP1842	.68 x 36.8 x 18	60	5	.06	\$470
DRGP1848	.68 x 42.8 x 18	60	6	.07	\$563
DRGP1860	.68 x 54.8 x 18	60	8	.09	\$673
DRGP1866	.68 x 60.8 x 18	100	8	1	\$729
DRGP1872	.68 x 66.8 x 18	100	9	1.10	\$790

4" gap at bottom. Features built-in accessory rail. Includes matching filler panel. Ships 1 set per carton. Raised glazed panels to be offered on the lower level only. **Specify DRGP1829 for panels placed along the depth side of a 30" deep worksurface.**

- Top and bottom rail optional in Black (**BLK**) or Tungsten (**TUN**) finish, please specify.
- *Model # depicts size of worksurface to be used on - see NOTES on page 378 for additional ordering information.*
- Divide Post **MUST** be ordered separately. Two posts are required per panel.
- Glazing is available in Frosted (**GF**) or Ribbed (**RG**).

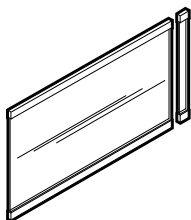

Glazed Panel - 24" High

DGP2420	.68 x 14.8 x 24	125	3	.40	\$320
DGP2424	.68 x 18.9 x 24	100	4	.50	\$358
DGP2429	.68 x 24.5 x 24	125	4	.60	\$429
DGP2430	.68 x 24.8 x 24	100	5	.60	\$429
DGP2436	.68 x 30.8 x 24	125	5	.70	\$495
DGP2442	.68 x 36.8 x 24	125	6	.80	\$562
DGP2448	.68 x 42.8 x 24	125	7	.90	\$660
DGP2460	.68 x 54.8 x 24	100	9	1.10	\$801
DGP2466	.68 x 60.8 x 24	100	10	1.20	\$874
DGP2472	.68 x 66.8 x 24	125	10	1.40	\$940

Features built-in accessory rail. Includes matching filler panel. Ships 1 set per carton. **Specify DGP2429 for panels placed along the depth side of a 30" deep worksurface.**

- Top and bottom rail optional in Black (**BLK**) or Tungsten (**TUN**) finish, please specify.
- *Model # depicts size of worksurface to be used on - see NOTES on page 378 for additional ordering information.*
- Divide Post **MUST** be ordered separately. Two posts are required per panel.
- Glazing is available in Frosted (**GF**) or Ribbed (**RG**).

Required Specifications

- Glaze
- Rail finish

GLAZED PANELS

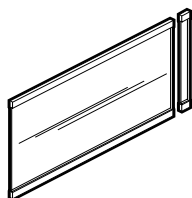

Glazed Panel - 24" High, Raised

MODEL#	DIMENSIONS D x W x H	FREIGHT CLASS	WT/LBS.	CUBIC FT.	LIST PRICE
DRGP2420	.68 x 14.8 x 24	60	3	.04	\$310
DRGP2424	.68 x 18.9 x 24	60	4	.05	\$348
DRGP2429	.68 x 24.5 x 24	60	4	.06	\$415
DRGP2430	.68 x 24.8 x 24	60	5	.06	\$415
DRGP2436	.68 x 30.8 x 24	60	5	.07	\$483
DRGP2442	.68 x 36.8 x 24	60	6	.08	\$550
DRGP2448	.68 x 42.8 x 24	60	7	.09	\$642
DRGP2460	.68 x 54.8 x 24	100	9	1.10	\$785
DRGP2466	.68 x 60.8 x 24	100	10	1.20	\$857
DRGP2472	.68 x 66.8 x 24	125	10	1.30	\$926

4" gap at bottom. Features built-in accessory rail. Includes matching filler panel. Ships 1 set per carton. Raised glazed panels to be offered on the lower level only. **Specify DRGP2429 for panels placed along the depth side of a 30" deep work surface.**

- Top and bottom rail optional in Black (BLK) or Tungsten (TUN) finish, please specify.
- Model # depicts size of work surface to be used on - see NOTES on page 378 for additional ordering information.
- Divide Post **MUST** be ordered separately. Two posts are required per panel.
- Glazing is available in Frosted (GF) or Ribbed (RG).

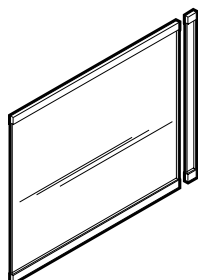

Glazed Panel - 36" High

DGP3620	.68 x 14.8 x 36	125	4	.60	\$389
DGP3624	.68 x 18.9 x 36	150	4	.70	\$429
DGP3629	.68 x 24.5 x 36	150	5	.90	\$512
DGP3630	.68 x 24.8 x 36	125	6	.90	\$512
DGP3636	.68 x 30.8 x 36	125	7	1	\$604
DGP3642	.68 x 36.8 x 36	125	8	1.20	\$691
DGP3648	.68 x 42.8 x 36	125	9	1.30	\$807
DGP3660	.68 x 54.8 x 36	125	11	1.60	\$974
DGP3666	.68 x 60.8 x 36	125	12	1.80	\$1061
DGP3672	.68 x 66.8 x 36	125	13	1.90	\$1145

Features built-in accessory rail. Includes matching filler panel. Ships 1 set per carton. **Specify DGP3629 for panels placed along the depth side of a 30" deep work surface.**

- Top and bottom rail optional in Black (BLK) or Tungsten (TUN) finish, please specify.
- Model # depicts size of work surface to be used on - see NOTES on page 378 for additional ordering information.
- Divide Post **MUST** be ordered separately. Two posts are required per panel.
- Glazing is available in Frosted (GF) or Ribbed (RG).

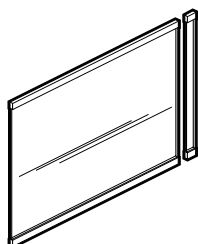

Glazed Panel - 36" High, Raised

DRGP3620	.68 x 14.8 x 36	60	4	.06	\$377
DRGP3624	.68 x 18.9 x 36	60	4	.07	\$415
DRGP3629	.68 x 24.5 x 36	60	5	.08	\$501
DRGP3630	.68 x 24.8 x 36	60	6	.08	\$501
DRGP3636	.68 x 30.8 x 36	125	7	1	\$593
DRGP3642	.68 x 36.8 x 36	125	8	1.10	\$673
DRGP3648	.68 x 42.8 x 36	125	9	1.30	\$790
DRGP3660	.68 x 54.8 x 36	125	11	1.60	\$950
DRGP3666	.68 x 60.8 x 36	125	12	1.70	\$1036
DRGP3672	.68 x 66.8 x 36	125	13	1.90	\$1122

4" gap at bottom. Features built-in accessory rail. Includes matching filler panel. Ships 1 set per carton. Raised glazed panels to be offered on the lower level only. **Specify DRGP3629 for panels placed along the depth side of a 30" deep work surface.**

- Top and bottom rail optional in Black (BLK) or Tungsten (TUN) finish, please specify.
- Model # depicts size of work surface to be used on - see NOTES on page 378 for additional ordering information.
- Divide Post **MUST** be ordered separately. Two posts are required per panel.
- Glazing is available in Frosted (GF) or Ribbed (RG).

Required Specifications

Glaze
Rail finish

LAMINATE PANELS

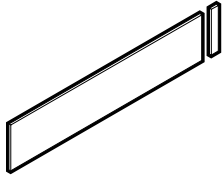

Laminate Panel - 12" High

MODEL#	DIMENSIONS D x W x H	FREIGHT CLASS	WT/LBS.	CUBIC FT.	LIST PRICE
DLP1220	.68 x 14.8 x 12	70	5	.30	\$88
DLP1224	.68 x 18.9 x 12	70	5	.30	\$104
DLP1229	.68 x 24.5 x 12	70	7	.40	\$131
DLP1230	.68 x 24.8 x 12	70	7	.40	\$131
DLP1236	.68 x 30.8 x 12	70	8	.40	\$144
DLP1242	.68 x 36.8 x 12	70	10	.50	\$164
DLP1248	.68 x 42.8 x 12	70	11	.60	\$184
DLP1260	.68 x 54.8 x 12	70	14	.70	\$199
DLP1266	.68 x 60.8 x 12	70	16	.80	\$219
DLP1272	.68 x 66.8 x 12	70	17	.80	\$247

Includes matching filler panel. Scoop option (**SCP2**) available, **Add \$42**. Ships 1 set per carton. **Specify DLP1229 for panels placed along the depth side of a 30" deep worksurface.**

- Model # depicts size of worksurface to be used on - see NOTES on page 378 for additional ordering information.
- Divide Post **MUST** be ordered separately. Two posts are required per panel.
- Accent edging at top and bottom Black (**BLK**) only.

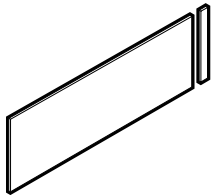

Laminate Panel - 18" High

DLP1820	.68 x 14.8 x 18	65	7	.30	\$106
DLP1824	.68 x 18.9 x 18	70	8	.40	\$120
DLP1829	.68 x 24.5 x 18	70	10	.50	\$142
DLP1830	.68 x 24.8 x 18	70	10	.50	\$142
DLP1836	.68 x 30.8 x 18	70	12	.60	\$161
DLP1842	.68 x 36.8 x 18	70	15	.70	\$184
DLP1848	.68 x 42.8 x 18	70	17	.80	\$213
DLP1860	.68 x 54.8 x 18	65	21	.90	\$233
DLP1866	.68 x 60.8 x 18	65	23	1	\$256
DLP1872	.68 x 66.8 x 18	65	25	1.10	\$282

Includes matching filler panel. Scoop option (**SCP2**) available, **Add \$42**. Ships 1 set per carton. **Specify DLP1829 for panels placed along the depth side of a 30" deep worksurface.**

- Model # depicts size of worksurface to be used on - see NOTES on page 378 for additional ordering information.
- Divide Post **MUST** be ordered separately. Two posts are required per panel.
- Accent edging at top and bottom Black (**BLK**) only.

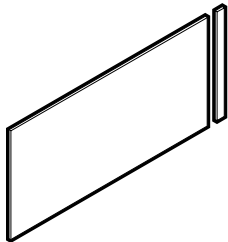

Laminate Panel - 24" High

DLP2420	.68 x 14.8 x 24	65	9	.40	\$120
DLP2424	.68 x 18.9 x 24	70	11	.50	\$130
DLP2429	.68 x 24.5 x 24	70	13	.60	\$161
DLP2430	.68 x 24.8 x 24	70	13	.60	\$161
DLP2436	.68 x 30.8 x 24	65	16	.70	\$178
DLP2442	.68 x 36.8 x 24	65	19	.80	\$207
DLP2448	.68 x 42.8 x 24	65	22	.90	\$236
DLP2460	.68 x 54.8 x 24	65	28	1.10	\$265
DLP2466	.68 x 60.8 x 24	65	30	1.20	\$295
DLP2472	.68 x 66.8 x 24	65	33	1.40	\$323

Includes matching filler panel. Scoop option (**SCP2**) available, **Add \$42**. Ships 1 set per carton. **Specify DLP2429 for panels placed along the depth side of a 30" deep worksurface.**

- Model # depicts size of worksurface to be used on - see NOTES on page 378 for additional ordering information.
- Divide Post **MUST** be ordered separately. Two posts are required per panel.
- Accent edging at top and bottom Black (**BLK**) only.

Required Specifications

Laminate finish. Note: woodgrain finishes are horizontal on all sizes.

LAMINATE PANELS

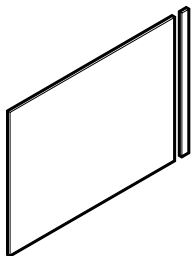

Laminate Panel - 36" High*

MODEL#	DIMENSIONS	FREIGHT CLASS	WT/LBS.	CUBIC FT.	LIST PRICE
--------	------------	---------------	---------	-----------	------------

D x W x H					
DLP3620	.68 x 14.8 x 36	70	13	.60	\$146
DLP3624	.68 x 18.9 x 36	65	16	.70	\$161
DLP3629	.68 x 24.5 x 36	70	20	.90	\$197
DLP3630	.68 x 24.8 x 36	70	20	.90	\$197
DLP3636	.68 x 30.8 x 36	65	24	1	\$227
DLP3642	.68 x 36.8 x 36	65	28	1.20	\$262
DLP3648	.68 x 42.8 x 36	65	33	1.30	\$295
DLP3660	.68 x 54.8 x 36	65	41	1.60	\$339
DLP3666	.68 x 60.8 x 36	65	45	1.80	\$374
DLP3672	.68 x 66.8 x 36	65	50	1.90	\$411

Includes matching filler panel. Scoop option (**SCP2**) available, **Add \$42**. Ships 1 set per carton. **Specify DLP3629 for panels placed along the depth side of a 30" deep worksurface.**

- Model # depicts size of worksurface to be used on - see *NOTES* on page 378 for additional ordering information.
- Divide Post **MUST** be ordered separately. Two posts are required per panel.
- Accent edging at top and bottom Black (**BLK**) only.

DIVIDE POSTS



Divide Post

MODEL#	DIMENSIONS	FREIGHT CLASS	WT/LBS.	CUBIC FT.	LIST PRICE
--------	------------	---------------	---------	-----------	------------

DPOST12	1.68 x 1.68 x 12	70	2	.10	\$121
DPOST18	1.68 x 1.68 x 18	70	2	.10	\$164
DPOST24	1.68 x 1.68 x 24	60	3	.10	\$214
DPOST30	1.68 x 1.68 x 30	60	4	.10	\$296
DPOST36	1.68 x 1.68 x 36	70	4	.20	\$339
DPOST42	1.68 x 1.68 x 42	65	5	.20	\$377

For supporting panels. Includes one post mounting plate, one top cap, three cover strips, threaded rod and all mounting hardware. Installation templates are supplied with each project. Available in Black (**BLK**) or Tungsten (**TUN**), please specify.

- Requires 2 divide posts per panel
- Divide post is mounted 1.063" from worksurface edge.



Post-to-Wall Filler Strip

DFS12	1.43 x .75 x 12	150	2	.50	\$67
DFS18	1.43 x .75 x 18	150	2	.50	\$67
DFS24	1.43 x .75 x 24	150	2	.50	\$67
DFS30	1.43 x .75 x 30	150	2	.50	\$71
DFS36	1.43 x .75 x 36	150	2	.50	\$71
DFS42	1.43 x .75 x 42	150	3	.60	\$71

Used to fill gap between divide post and an adjacent wall, wardrobe unit, or hutch. Ships 1 per carton. Black only.

Required Specifications

Laminate finish*. Note: woodgrain finishes are horizontal on all sizes.

TRANSACTION TOPS

D x W x H

- To order a radius end on one side of a transaction top, add the suffix "D" to the model number (ex. DATT30D). Add a **15% upcharge**.
- To order a radius end on both sides of a transaction top, add the suffix "DD" to the model number (ex. DATT30DD). Add a **20% upcharge**.
- Each radius end adds a 6" overhang per side (see illustrations below).

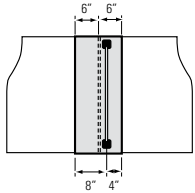

Transaction top is offset 6" from edge of worksurface in both directions.

Transaction top is offset 4" from the center of divider post towards the inside and 8" towards the outside.

Transaction Top Offset

- 4" from the center of the Divider Post to the inside of worksurface
- 8" from the center of the Divider Post to the outside of worksurface

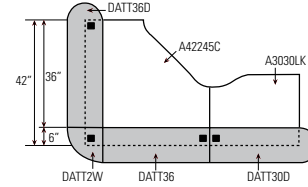

Two Way Connector Transaction Top (DATT2W/DCTT2W)

Use with a corner worksurface to link transaction tops together.

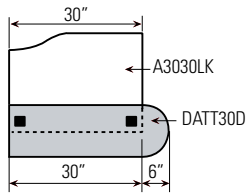

Radius End Transaction Top - one side

Add suffix "D" to model number for radius end on one side.

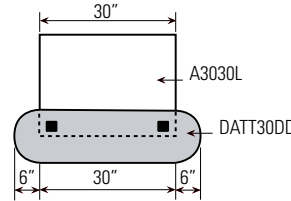

Radius End Transaction Top - two sides

Add suffix "DD" to model number for radius end on both sides.

STRAIGHT TRANSACTION TOPS

MODEL# DIMENSIONS FREIGHT CLASS WT./LBS. CUBIC FT. LIST PRICE

DATT14	12 x 14 x 1	65	7	.30	\$264
DATT18	12 x 18 x 1	70	8	.40	\$264
DATT20	12 x 20 x 1	70	9	.50	\$264
DATT23	12 x 23 x 1	70	10	.50	\$300
DATT24	12 x 24 x 1	70	10	.50	\$300
DATT29	12 x 29 x 1	70	12	.60	\$321
DATT30	12 x 30 x 1	70	12	.60	\$321
DATT36	12 x 36 x 1	70	14	.70	\$339
DATT42	12 x 42 x 1	70	16	.80	\$358
DATT48	12 x 48 x 1	70	18	.90	\$358
DATT54	12 x 54 x 1	70	21	1	\$404
DATT60	12 x 60 x 1	70	23	1.10	\$404
DATT66	12 x 66 x 1	70	25	1.20	\$451
DATT72	12 x 72 x 1	70	27	1.30	\$451



Straight Transaction Top - 1" thick

12" deep x 1" thick top. Includes all necessary Flat Plates, Joining Plates and screws. Thickness matches Adaptabilities, Genoa, Halton and Zira Series worksurfaces. Ships 1 set per carton.

- Add "D" to model number for radius end on one side, ADD **15% upcharge**.
- Add "DD" to model number for radius end on both sides, ADD **20% upcharge**.
- Each radius adds 6" overhang per side.

Required Specifications

Laminate Finish
Edge Detail

Optional Specifications

Radius End

TRANSACTION TOPS

MODEL# DIMENSIONS FREIGHT CLASS WT/LBS. CUBIC FT. LIST PRICE

D x W x H

DCTT14	12 x 14 x 1.5	60	9	.30	\$367
DCTT18	12 x 18 x 1.5	65	11	.40	\$367
DCTT20	12 x 14.8 x 1.5	65	12	.50	\$367
DCTT23	12 x 23 x 1.5	65	14	.50	\$426
DCTT24	12 x 18.9 x 1.5	65	14	.50	\$426
DCTT29	12 x 24.5 x 1.5	65	17	.60	\$453
DCTT30	12 x 30 x 1.5	65	17	.60	\$453
DCTT36	12 x 36 x 1.5	65	20	.70	\$475
DCTT42	12 x 42 x 1.5	65	23	.80	\$475
DCTT48	12 x 48 x 1.5	65	26	.90	\$475
DCTT54	12 x 54 x 1.5	65	29	1	\$540
DCTT60	12 x 60 x 1.5	65	32	1.10	\$540
DCTT66	12 x 66 x 1.5	65	35	1.20	\$591
DCTT72	12 x 72 x 1.5	65	38	1.30	\$591



Straight Transaction Top - 1½" thick

12" deep x 1½" thick top. Includes all necessary Flat Plates, Joining Plates and screws. Thickness matches Zira worksurfaces. Ships 1 set per carton.

- Add "D" to model number for radius end on one side, ADD **15% upcharge**.
- Add "DD" to model number for radius end on both sides, ADD **20% upcharge**.
- Each radius adds 6" overhang per side.

GALLERY CORNER TRANSACTION TOPS

MODEL# DIMENSIONS FREIGHT CLASS WT/LBS. CUBIC FT. LIST PRICE



Gallery Corner Transaction Top - 1" thick

DA1GC36	36 x 36 x 1	125	32	5	\$806
DA1GC42	42 x 42 x 1	150	38	6.50	\$806

One piece corner top to be used on 36" and 42" 5-sided corners. Cut-out maximizes use of worksurface space allowing for computer screen. Includes all necessary Flat Plates, Joining Plates and screws. Thickness matches Adaptabilities, Genoa, Halton and Zira Series worksurfaces. Ships 1 set per carton.

- Woodgrain runs in one direction.



Gallery Corner Transaction Top - 1½" thick

DC1GC36	36 x 36 x 1.5	100	43	5	\$1003
DC1GC42	42 x 42 x 1.5	125	50	6.50	\$1003

One piece corner top to be used on 36" and 42" 5-sided corners. Cut-out maximizes use of worksurface space allowing for computer screen. Includes all necessary Flat Plates, Joining Plates and screws. Thickness matches Zira worksurfaces. Ships 1 set per carton.

- Woodgrain runs in one direction.

2 PIECE GALLERY CORNER TRANSACTION TOPS

MODEL# DIMENSIONS FREIGHT CLASS WT/LBS. CUBIC FT. LIST PRICE



2 Piece Gallery Corner Transaction Top - 1" thick

DA2GC36	36 x 36 x 1	70	29	1.90	\$572
DA2GC42	42 x 42 x 1	70	33	1.90	\$572

Two piece corner top to be used on 36" and 42" 5-sided corners. Cut-out maximizes use of worksurface space allowing for computer screen. Includes all necessary Flat Plates, Joining Plates and screws. Thickness matches Adaptabilities, Genoa, Halton and Zira Series worksurfaces. Ships 1 set per carton.

- Woodgrain runs in two directions.

Required Specifications

Laminate Finish
Edge Detail

Optional Specifications

Radius End (DCTT models)

2 PIECE GALLERY CORNER TRANSACTION TOPS



2 Piece Gallery Corner Transaction Top - 1½" thick

MODEL#	DIMENSIONS	FREIGHT CLASS	WT/LBS.	CUBIC FT.	LIST PRICE
	D x W x H				
DC2GC36	36 x 36 x 1.5	70	39	1.90	\$768
DC2GC42	42 x 42 x 1.5	65	45	1.90	\$768

Two piece corner top to be used on 36" and 42" 5-sided corners. Cut-out maximizes use of worksurface space allowing for computer screen. Includes all necessary Flat Plates, Joining Plates and screws. Thickness matches Zira worksurfaces. Ships 1 set per carton.

- Woodgrain runs in two directions.

2-WAY CONNECTOR TRANSACTION TOPS

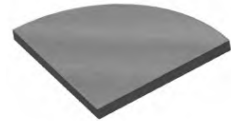

2-Way Connector Transaction Top - 1" thick

MODEL#	DIMENSIONS	FREIGHT CLASS	WT/LBS.	CUBIC FT.	LIST PRICE
DATT2W	12 x 12 x 1	70	6	.30	\$361

Used as a corner piece to link two transaction tops. Deduct 6" from each side adjoining the corner piece. Includes all necessary Flat Plates, Joining Plates and screws. Thickness matches Adaptabilities, Genoa, Halton and Zira Series worksurfaces. Ships 1 set per carton.

- Woodgrain runs diagonally.

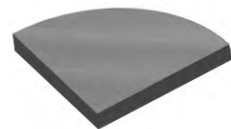

2-Way Connector Transaction Top - 1½" thick

DCTT2W	12 x 12 x 1.5	65	7	.30	\$422
--------	---------------	----	---	-----	--------------

Used as a corner piece to link two transaction tops. Deduct 6" from each side adjoining the corner piece. Includes all necessary Flat Plates, Joining Plates and screws. Thickness matches Zira worksurfaces. Ships 1 set per carton.

- Woodgrain runs diagonally.

4-WAY CONNECTOR TRANSACTION TOPS

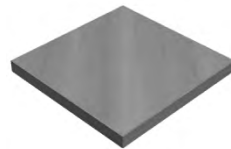

4-Way Connector Transaction Top - 1" thick

DATT4W	12 x 12 x 1	65	8	.30	\$385
--------	-------------	----	---	-----	--------------

Used as a corner piece to link four transaction tops. Deduct 6" from each side adjoining the corner piece. Includes all necessary Flat Plates, Joining Plates and screws. Thickness matches Adaptabilities, Genoa, Halton and Zira Series worksurfaces. Ships 1 set per carton.

- Woodgrain runs diagonally.

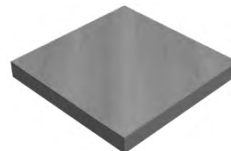

4-Way Connector Transaction Top - 1½" thick

DCTT4W	12 x 12 x 1.5	60	10	.30	\$494
--------	---------------	----	----	-----	--------------

Used as a corner piece to link four transaction tops. Deduct 6" from each side adjoining the corner piece. Includes all necessary Flat Plates, Joining Plates and screws. Thickness matches Zira worksurfaces. Ships 1 set per carton.

- Woodgrain runs diagonally.

Required Specifications

- Laminate Finish
- Edge Detail

personal storage



Sidebar Storage

456

S SIDEBAR STORAGE - NOTES



Sidebar storage is well suited to the modern workplace. Fun, unique and functional storage items provide personal touches to the workspace all while maintaining a practical appeal.

Features and Benefits

- All surfaces are 1" thick, constructed of 45 lb. density particle board covered on both sides with high performance thermally fused laminate.
- Surfaces available in four detail options.
- Tapered feet feature adjustable glides and can be painted in Black (BLK) or Tungsten (TTU).
- Tiered storage enhances the visuals of any office setting



Foot options



Stack-on storage



Low credenza storage with cushion

GENERAL INFORMATION

- SideBar is a great complement to Bungee & Bungee SL training tables as well as Zira Desking.
- High pressure tops are available on all SideBar laminates at an extended lead time – please refer to model # for availability and pricing.
- For environmental certifications, please visit globalfurnituregroup.com

CONSTRUCTION

- Tops are 1" thick, available in a variety of edge details
- All finishes feature edging in matching color (i.e. wood grain surfaces feature edging with matching printed wood grain)
- High pressure tops are available in all SideBar laminate finishes at an extended lead time. Please see model # for availability and pricing
- Products specified with the high pressure laminate option are finished on the underside of the surface with a kraft paper backing.

STORAGE

- Tops of all storage units are 1" thick, available in a variety of edge details
- Drawer and open cavity heights are built on a common module of 13.5". In open cavities, this height accommodates standard size binders.
- All lateral files feature a foolproof interlock device
- 75 lb. box – 150 lb. file drawer weight capacity with full height sides. Pencil tray included in box drawer.
- All storage is standard with handles unless otherwise noted
- All drawers are locking unless otherwise noted
- All shelves are fixed

CONSTRUCTION

- Constructed of 45 lb. density particleboard covered on both sides with high performance thermally fused laminate
- Levelling glides are standard on all floor units
- Premium full extension progressive ball bearing slides on file drawers and box drawers
- All drawer fronts are edge banded on all four sides

FEET

- Levelers adjust up to 1".
- Storage unit feet will coordinate with handle finish (brass handles will default to Black [BLK] feet).
- If no handle selection is available, legs and feet are available in Tungsten (**TTU**) or Black (**TBL**)

LOCKS

- Locks are standard on all storage modules unless otherwise noted. Lock finish will coordinate with handle finish (brass handles will default to Black [BK] locks).

SHIPPING

- Most items are shipped assembled, 1 per carton, unless otherwise noted. Items are easy to assemble

S SIDEBAR STORAGE - NOTES

1. SPECIFY MODEL NUMBER

2. SPECIFY FINISH

Top/Base/Door, Drawer and Cabinet Finishes:

ACJ	Absolute Acajou	FCL	First Class
ASN	Asian Night	NBL	Noce Biondo
AWC	Avant Cherry	NGL	Noce Grigio
AWH	Avant Honey	NEL	Noce Leggero
BLK	Black	NML	Noce Medio
BZD	Blizzard	QTM	Quartered Mahogany
BRC	Brushed Cobalt	SBY	Sheer Beauty
CMB	Clear Maple	SDT	Stonedust
CGY	Custom Grey	SOG	Storm Grey
DES	Dark Espresso	WHE	Walnut Heights
DWT	Designer White	WHC	White Chocolate
FAS	Fashionista	WCR	Winter Cherry

Edge:

AB	Split color edge with Black Trim
AS	Split color edge with Silver Trim
A3	Standard edge
AR	Bicut edge

Feet:

Storage Feet are available in Tungsten (**TTU**) or Black (**TBL**).

3. SPECIFY OPTIONS

EDGE OPTIONS



A3 - square corner, standard edge

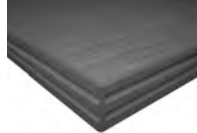

AR - square corner, bicut edge



AS - square corner, Silver



AB - square corner, Black

HANDLES

- Handles are standard on most drawers/storage modules. All other drawers, including mobile and hanging pedestals, can be ordered with a choice of nine handle options to be **factory installed**. Each handle is identified by the letters "**HU**", "**HV**", "**HW**", "**HX**", "**HS**", "**HZ**", "**HO**", "**HQ**", and "**HR**". To specify a handle, please specify the code after the model number. To order a handle as an option, please specify the code when ordering. List Price is **\$47**.



HS Flared Silver



HV Square Edge Silver



HO Crescent Black



HW Flared Brass



HU Square Edge Black



HZ Dimpled Nickel



HX Flared Black



HQ Bar Silver



HR Bar Black

MOBILE PEDESTAL



Mobile Pedestal*

MODEL#	DIMENSIONS D x W x H	FREIGHT CLASS	WT/LBS.	CUBIC FT.	LIST PRICE	HP ADD
S1619MP	19 x 16 x 25	85	76	6	\$989	n/a
S1623MP	23 x 16 x 25	92.5	82	7	\$1028	n/a

Box/File drawers on fully progressive ball bearing slides, accommodate letter and legal size hanging files. Pedestal top is inset within side panels. Includes counterweight to prevent tipping. Drawers are locking. Handles are standard. Only front casters are locking.

- File drawer construction is for accommodating hanging files and NOT for stacking material on the drawer bottom.

MOBILE PEDESTAL

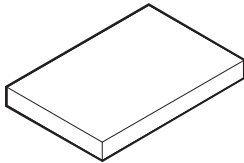

Cushion for Mobile Pedestals**

MODEL#	DIMENSIONS	FREIGHT CLASS	WT/LBS.	CUBIC FT.	GRADE	LIST	GRADE	LIST
CU1517	17 x 15 x 1.5	125	6	.90	1	\$145	7	\$414
					2	\$188	8	\$507
					3	\$217	9	\$579
					4	\$263	10	\$657
					5	\$325	11	\$820
					6	\$357	12	\$998
CU1520	20 x 15 x 1.5	70	1	1	1	\$156	7	\$423
					2	\$196	8	\$517
					3	\$226	9	\$588
					4	\$273	10	\$667
					5	\$336	11	\$831
					6	\$365	12	\$1008

Cushion attaches with Velcro strips.

- CU1517 for use on S1619MP. CU1520 for use on S1623MP.

Required Specifications

- Top finish*
- Drawer front finish*
- Handles*
- Fabric**

S SIDEBAR STORAGE

STORAGE

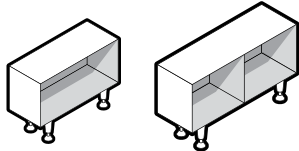

30" w

36" w

Low Bookcase

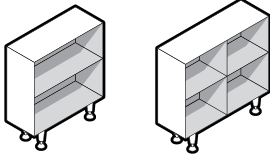

30" w

36" w

2 High Bookcase

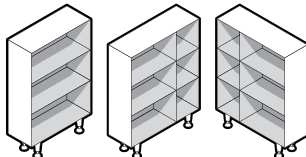

30" w

36" w - left

36" w - right

3 High Bookcase

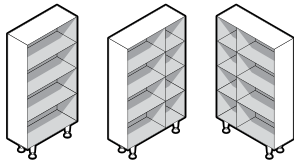

30" w

36" w - left

36" w - right

4 High Bookcase

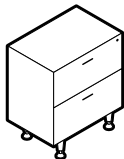

2 High Lateral File

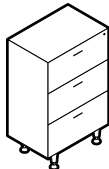

3 High Lateral File

MODEL#	DIMENSIONS	FREIGHT CLASS	WT/LBS.	CUBIC FT.	LIST PRICE	HP ADD
--------	------------	---------------	---------	-----------	------------	--------

D x W x H

S3012A0	12 x 30 x 22.85	125	49	7	\$618	n/a
S3612A0	12 x 36 x 22.85	125	61	8.25	\$715	n/a

Open bookcases accommodate binders in every cavity. One fixed shelf. 36" w units feature a fixed vertical divider.

S3012D0	12 x 30 x 36.35	125	77	10.50	\$853	n/a
S3612D0	12 x 36 x 36.35	125	94	12.50	\$989	n/a

Open bookcases accommodate binders in every cavity. Two fixed shelves. 36" w units feature a fixed vertical divider. Matches Tier 2.

S3012F0	12 x 30 x 49.85	125	102	14	\$1028	n/a
S3612FOL	12 x 36 x 49.85	125	127	16.50	\$1218	n/a
S3612FOR	12 x 36 x 49.85	125	127	16.50	\$1218	n/a

Open bookcases accommodate binders in every cavity. Three fixed shelves. 36" w units feature a fixed vertical divider. Matches Tier 3.

S3012H0	12 x 30 x 63.35	125	129	17.50	\$1218	n/a
S3612HOL	12 x 36 x 63.35	125	161	20.75	\$1467	n/a
S3612HOR	12 x 36 x 63.35	125	161	20.75	\$1467	n/a

Open bookcases accommodate binders in every cavity. Four fixed shelves. 36" w units feature a fixed vertical divider. Matches Tier 4.

S3020DZ	20 x 30 x 36.35	100	142	16.50	\$1668	n/a
S3024DZ	24 x 30 x 36.35	125	149	19.50	\$1760	n/a
S3620DZ	20 x 36 x 36.35	125	153	19.50	\$1805	n/a
S3624DZ	24 x 36 x 36.35	125	168	23.35	\$1902	n/a

Two file drawers. Handles are standard. Lock secures all drawers. Front-to-back and side-to-side letter/legal filing capability. Matches Tier 2.

- Lateral file drawer construction is for accommodating hanging files and NOT for stacking material on the drawer bottom.

S3020FZ	20 x 30 x 49.85	100	191	22	\$2051	n/a
S3024FZ	24 x 30 x 49.85	125	198	26	\$2158	n/a
S3620FZ	20 x 36 x 49.85	125	203	26	\$2223	n/a
S3624FZ	24 x 36 x 49.85	125	221	31	\$2340	n/a

Three file drawers. Handles are standard. Lock secures all drawers. Front-to-back and side-to-side letter/legal filing capability. Matches Tier 3.

- Lateral file drawer construction is for accommodating hanging files and NOT for stacking material on the drawer bottom.

Required Specifications

Top finish
Top/edge detail
Base finish
Drawer Front Finish (Units w/doors)

Handles
Leg Finish (Bookcases only)
Shelf Finish (Open Units)

STORAGE

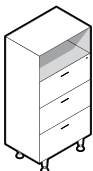

3 High Lateral File - Open

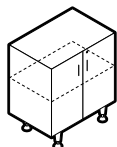

2 High Storage Cabinet

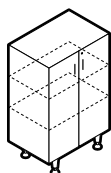

3 High Storage Cabinet

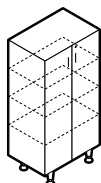

4 High Storage Cabinet

MODEL#	DIMENSIONS	FREIGHT CLASS	WT/LBS.	CUBIC FT.	LIST PRICE	HP ADD
--------	------------	---------------	---------	-----------	------------	--------

D x W x H

S3020HZ	20 x 30 x 63.35	100	239	27.50	\$2524	n/a
S3024HZ	24 x 30 x 63.35	125	246	32.50	\$2645	n/a
S3620HZ	20 x 36 x 63.35	125	253	32.75	\$2733	n/a
S3624HZ	24 x 36 x 63.35	125	275	38.75	\$2868	n/a

Three file drawers. Handles are standard. Lock secures all drawers. Front-to-back and side-to-side letter/legal filing capability. Matches Tier 4.

- Lateral file drawer construction is for accommodating hanging files and NOT for stacking material on the drawer bottom.

S3020DX	20 x 30 x 36.35	125	122	16.50	\$1295	n/a
S3024DX	24 x 30 x 36.35	125	139	19.50	\$1395	n/a
S3620DX	20 x 36 x 36.35	125	151	19.50	\$1519	n/a
S3624DX	24 x 36 x 36.35	125	173	23	\$1656	n/a

Laminate doors are standard. Handles are standard. Two fixed shelves. Standard with lock. Matches Tier 2.

S3020FX	20 x 30 x 49.85	125	167	22	\$1605	n/a
S3024FX	24 x 30 x 49.85	125	190	26	\$1732	n/a
S3620FX	20 x 36 x 49.85	100	209	23.75	\$1902	n/a
S3624FX	24 x 36 x 49.85	125	238	30.75	\$2082	n/a

Laminate doors are standard. Handles are standard. Three fixed shelves. Standard with lock. Matches Tier 3.

S3020HX	20 x 30 x 63.35	125	212	27.50	\$1923	n/a
S3024HX	24 x 30 x 63.35	125	241	32.50	\$2086	n/a

Laminate doors are standard. Handles are standard. Includes four fixed shelves. Standard with lock. Matches Tier 4.

Required Specifications

Top finish
 Top/edge detail
 Base finish
 Door / Drawer Front Finish

Handles

S SIDEBAR STORAGE

LOW CREDENZAS

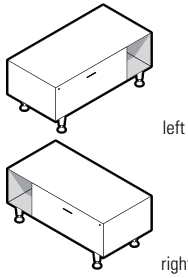

Low Credenza - Lateral Drawer

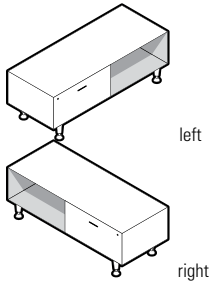

Low Credenza - Lateral Drawer

MODEL#	DIMENSIONS D x W x H	FREIGHT CLASS	WT./LBS.	CUBIC FT.	LIST PRICE	HP ADD
S4220ASL	20 x 42 x 22.85	125	110	15	\$1245	\$200
S4224ASL	24 x 42 x 22.85	125	123	17.50	\$1335	\$234
S4820ASL	20 x 48 x 22.85	125	121	17	\$1347	\$234
S4824ASL	24 x 48 x 22.85	125	136	20	\$1440	\$264
S4220ASR	20 x 42 x 22.85	125	110	15	\$1245	\$200
S4224ASR	24 x 42 x 22.85	125	123	17.50	\$1335	\$234
S4820ASR	20 x 48 x 22.85	125	121	17	\$1347	\$234
S4824ASR	24 x 48 x 22.85	125	136	20	\$1440	\$264

Lateral file drawer is standard on one side, open cavity on the other. Handles are standard. Specify left or right handed. Standard with lock. Front-to-back and side-to-side letter/legal filing capability.

- 42" w cabinet has a 30" w lateral drawer.
- 48" w cabinet has a 36" w lateral drawer.
- Lateral file drawer construction is for accommodating hanging files and NOT for stacking material on the drawer bottom.

S6020ASL	20 x 60 x 22.85	125	138	21	\$1484	\$299
S6024ASL	24 x 60 x 22.85	125	156	24.75	\$1588	\$331
S7220ASL	20 x 72 x 22.85	125	159	20.75	\$1656	\$331
S7224ASL	24 x 72 x 22.85	125	179	25	\$1764	\$396
S6020ASR	20 x 60 x 22.85	125	138	21	\$1484	\$299
S6024ASR	24 x 60 x 22.85	125	156	24.75	\$1588	\$331
S7220ASR	20 x 72 x 22.85	125	159	20.75	\$1656	\$331
S7224ASR	24 x 72 x 22.85	125	179	25	\$1764	\$396

Lateral file drawer is standard on one side, open cavity on the other. Specify left or right handed. Standard with lock. Front-to-back and side-to-side letter/legal filing capability.

- 60" w cabinet has a 30" w lateral drawer.
- 72" w cabinet has a 36" w lateral drawer.
- Lateral file drawer construction is for accommodating hanging files and NOT for stacking material on the drawer bottom.

MEDIUM CREDENZAS

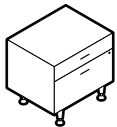

Medium Credenza - Box/File

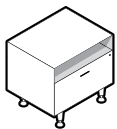

Medium Credenza w/Lateral File

MODEL#	DIMENSIONS	FREIGHT CLASS	WT./LBS.	CUBIC FT.	LIST PRICE	HP ADD
S3020BZ	20 x 30 x 29.6	100	113	13.75	\$1322	\$167
S3024BZ	24 x 30 x 29.6	125	126	16.25	\$1407	\$167
S3620BZ	20 x 36 x 29.6	125	128	16.25	\$1446	\$167
S3624BZ	24 x 36 x 29.6	100	142	16.75	\$1532	\$200

Wide box and lateral file. Handles are standard. Lock secures both drawers.

- Lateral file drawer construction is for accommodating hanging files and NOT for stacking material on the drawer bottom.

S3020BY	20 x 30 x 29.6	100	116	13.75	\$1255	\$167
S3024BY	24 x 30 x 29.6	100	131	16.25	\$1354	\$167
S3620BY	20 x 36 x 29.6	100	132	16.25	\$1382	\$167
S3624BY	24 x 36 x 29.6	100	149	16.75	\$1484	\$200

Open cavity and lateral file. Handles are standard. Standard with lock.

- Lateral file drawer construction is for accommodating hanging files and NOT for stacking material on the drawer bottom.

Required Specifications

Top finish
Top/edge detail
Base finish
Door/drawer front finish

Handles

Optional Specifications

HP laminate

MEDIUM CRENZAS

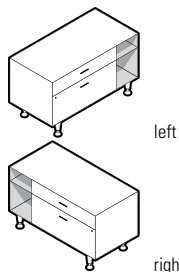

Medium Credenza - Box/Lateral File

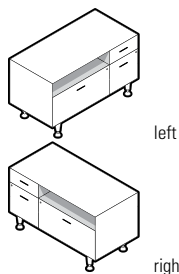

Medium Credenza - Mixed Drawers

MODEL#	DIMENSIONS D x W x H	FREIGHT CLASS	WT/LBS.	CUBIC FT.	LIST PRICE	HP ADD
S4220BSL	20 x 42 x 29.6	125	142	18.75	\$1564	\$200
S4224BSL	24 x 42 x 29.6	125	160	22	\$1668	\$234
S4820BSL	20 x 48 x 29.6	125	155	21.25	\$1695	\$234
S4824BSL	24 x 48 x 29.6	125	173	25	\$1805	\$264
S4220BSR	20 x 42 x 29.6	125	142	18.75	\$1564	\$200
S4224BSR	24 x 42 x 29.6	125	160	22	\$1668	\$234
S4820BSR	20 x 48 x 29.6	125	155	21.25	\$1695	\$234
S4824BSR	24 x 48 x 29.6	125	173	25	\$1805	\$264

Wide box and lateral file is standard on one side, open cavity with fixed shelf on the other. Handles are standard. Specify left or right handed. Standard with lock. Front-to-back and side-to-side letter/legal filing capability.

- 42" w credenza has a 30" w box/lateral file
- 48" w credenza has a 36" w box/lateral file
- Lateral file drawer construction is for accommodating hanging files and NOT for stacking material on the drawer bottom.

S4220BQL	20 x 42 x 29.6	100	165	18.75	\$1989	\$200
S4224BQL	24 x 42 x 29.6	100	184	22	\$2112	\$234
S4820BQL	20 x 48 x 29.6	100	179	21.25	\$2116	\$234
S4824BQL	24 x 48 x 29.6	100	184	22	\$2112	\$264
S4220BQR	20 x 42 x 29.6	100	165	18.75	\$1989	\$200
S4224BQR	24 x 42 x 29.6	100	184	22	\$2112	\$234
S4820BQR	20 x 48 x 29.6	100	179	21.25	\$2116	\$234
S4824BQR	24 x 48 x 29.6	100	184	22	\$2112	\$264

Box/file is standard on one side, open cavity and lateral file on the other side. Specify left or right handed. Handles are standard. Standard with locks. Front-to-back and side-to-side letter/legal filing capability.

- 42" w credenza has a 30" w lateral drawer
- 48" w credenza has a 36" w lateral drawer
- Lateral file drawer construction is for accommodating hanging files and NOT for stacking material on the drawer bottom.

Required Specifications

Top finish
Top/edge detail
Base finish
Door/drawer front finish

Handles

Optional Specifications

HP laminate

S SIDEBAR STORAGE

STACK-ON STORAGE

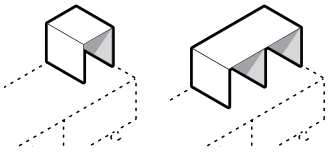

Stack-On Bookcases

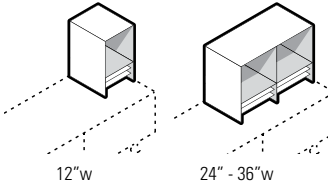

Stack-On Bookcase w/Collators**

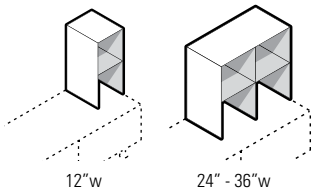

Stack-On Bookcases

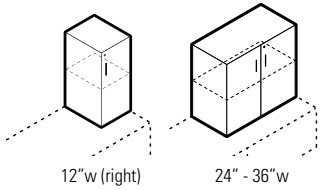

Stack-On Storage Cabinet*

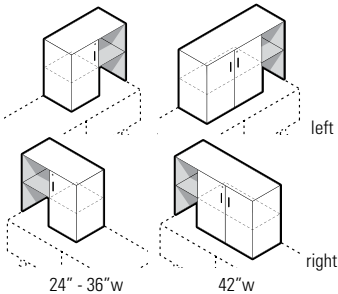

Stack-On Mixed Storage Cabinet*

MODEL#	DIMENSIONS D x W x H	FREIGHT CLASS	WT/LBS.	CUBIC FT.	LIST PRICE	HP ADD
S1214A0	14.3 x 12 x 13.5	92.5	23	2.20	\$247	n/a
S2414A0	14.3 x 24 x 13.5	100	37	4	\$375	n/a
S3014A0	14.3 x 30 x 13.5	100	41	5	\$415	n/a
S3614A0	14.3 x 36 x 13.5	125	46	5.90	\$453	n/a

Designed to be placed on top of credenzas. Open cavity. Unit rests directly on credenza top.
 • Sxx14A0 Stack-On bookcases add 1 tier when placed on any storage unit.

S1214B0	14.3 x 12 x 20.25	92.5	35	3.10	\$356	n/a
S2414B0	14.3 x 24 x 20.25	92.5	59	5.75	\$586	n/a
S3014B0	14.3 x 30 x 20.25	100	68	7	\$656	n/a
S3614B0	14.3 x 36 x 20.25	100	77	8.50	\$754	n/a

Designed to be placed on top credenzas. Open cavity with collator below. Unit rests directly on credenza top.
 • Sxx14B0 Stack-On bookcases add 1.5 tiers when placed on any storage unit.

S1214D0	14.3 x 12 x 27	92.5	41	4	\$401	n/a
S2414D0	14.3 x 24 x 27	100	68	7.50	\$630	n/a
S3014D0	14.3 x 30 x 27	100	76	9.25	\$691	n/a
S3614D0	14.3 x 36 x 27	125	85	11	\$767	n/a

Designed to be placed on top of credenzas. Open cavities with fixed shelf. Unit rests directly on credenza top.
 • Sxx14D0 Stack-On bookcases add 2 tiers when placed on any storage unit.

S1215DTL	15 x 12 x 27	92.5	47	4.20	\$526	n/a
S1215DTR	15 x 12 x 27	92.5	47	4.20	\$526	n/a
S2415DT	15 x 24 x 27	92.5	79	7.75	\$880	n/a
S3015DT	15 x 30 x 27	100	91	9.50	\$964	n/a
S3615DT	15 x 36 x 27	100	103	11.25	\$1075	n/a

Designed to be placed on top of credenzas. Laminate doors are standard. Includes fixed shelf. For 12" w units specify left or right handed. Handles are standard. Standard with locks. Unit rests directly on credenza top.
 • Sxx15DT/DTL/DTR Stack-On storage cabinets add 2 tiers when placed on any storage unit.

S2415DNL	15 x 24 x 27	100	73	7.75	\$754	n/a
S3015DNL	15 x 30 x 27	100	83	9.50	\$828	n/a
S3615DNL	15 x 36 x 27	100	94	11.25	\$925	n/a
S4215DNL	15 x 42 x 27	100	117	13	\$1183	n/a
S2415DNR	15 x 24 x 27	100	73	7.75	\$754	n/a
S3015DNR	15 x 30 x 27	100	83	9.50	\$828	n/a
S3615DNR	15 x 36 x 27	100	94	11.25	\$925	n/a
S4215DNR	15 x 42 x 27	100	117	13	\$1183	n/a

Designed to be placed on top of credenzas. Laminate doors are standard on one side with one fixed shelf. Open cavity with one fixed shelf on the other side. Specify left or right handed. Handles are standard. Standard with locks. Unit rests directly on credenza top.
 • Sxx15DNL/DNR Stack-On mixed storage cabinets add 2 tiers when placed on any storage unit.

Required Specifications

Top finish
 Top/edge detail
 Base finish
 Door/drawer front finish*

Handles*
 Collator finish**

STACK-ON STORAGE

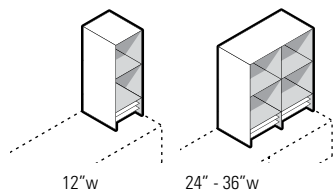

Stack-On Bookcase w/Collators

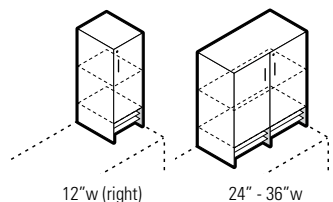

Stack-On Closed Storage* Cabinet w/Collators

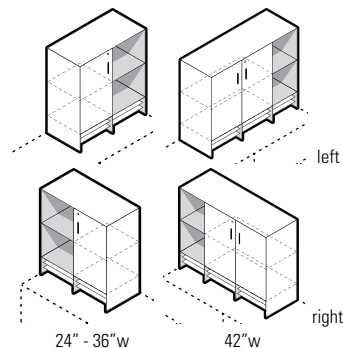

Stack-On Mixed Storage* Cabinet w/Collators

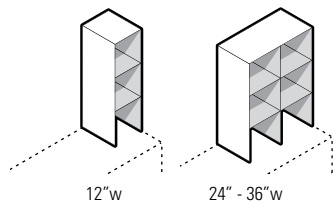

Stack-On Bookcases

MODEL#	DIMENSIONS	FREIGHT CLASS	WT/LBS.	CUBIC FT.	LIST PRICE	HP ADD
--------	------------	---------------	---------	-----------	------------	--------

	D x W x H					
S1214EO	14.3 x 12 x 33.75	92.5	53	5	\$520	n/a
S2414EO	14.3 x 24 x 33.75	100	90	9.25	\$859	n/a
S3014EO	14.3 x 30 x 33.75	100	102	11.25	\$951	n/a
S3614EO	14.3 x 36 x 33.75	100	115	13.25	\$1079	n/a

Designed to be placed on top of credenzas. Open cavities with one fixed shelf and collator below. Unit rests directly on credenza top.

- Sxx14EO Stack-On bookcases add 2.5 tiers when placed on any storage unit.

S1215ETL	15 x 12 x 33.75	92.5	59	5.25	\$643	n/a
S1215ETR	15 x 12 x 33.75	92.5	59	5.25	\$643	n/a
S2415ET	15 x 24 x 33.75	92.5	102	9.50	\$1101	n/a
S3015ET	15 x 30 x 33.75	100	117	11.75	\$1218	n/a
S3615ET	15 x 36 x 33.75	100	133	14	\$1382	n/a

Designed to be placed on top of credenzas. Laminate doors are standard with one fixed shelf and collator below. For 12" w units specify left or right handed. Handles are standard. Standard with locks. Unit rests directly on credenza top.

- Sxx15ET/ETL/ETR Stack-On storage cabinets add 2.5 tiers when placed on any storage unit.

S2415ENL	15 x 24 x 33.75	92.5	96	9.50	\$977	n/a
S3015ENL	15 x 30 x 33.75	100	110	11.75	\$1087	n/a
S3615ENL	15 x 36 x 33.75	100	124	14	\$1231	n/a
S4215ENL	15 x 42 x 33.75	100	154	16	\$1536	n/a

S2415ENR	15 x 24 x 33.75	92.5	96	9.50	\$977	n/a
S3015ENR	15 x 30 x 33.75	100	110	11.75	\$1087	n/a
S3615ENR	15 x 36 x 33.75	100	124	14	\$1231	n/a
S4215ENR	15 x 42 x 33.75	100	154	16	\$1536	n/a

Designed to be placed on top of credenzas. Laminate doors are standard on one side with one fixed shelf. Open cavities on the other side, with one fixed shelf and collator below. Specify left or right handed. Handles are standard. Standard with locks. Unit rests directly on credenza top.

- Sxx15ENL/ENR Stack-On mixed storage cabinets add 2.5 tiers when placed on any storage unit.

S1214FO	14.3 x 12 x 40.5	100	59	6	\$560	n/a
S2414FO	14.3 x 24 x 40.5	100	98	10.75	\$873	n/a
S3014FO	14.3 x 30 x 40.5	100	110	13.25	\$956	n/a
S3614FO	14.3 x 36 x 40.5	125	123	15.75	\$1061	n/a

Designed to be placed on top of credenzas. Open cavities with two fixed shelves. Unit rests directly on credenza top.

- Sxx14FO Stack-On bookcases add 3 tiers when placed on any storage unit.

Required Specifications

Top finish
Top/edge detail
Base finish
Door/drawer front finish*

Handles*
Collator finish

S SIDEBAR STORAGE

STACK-ON STORAGE

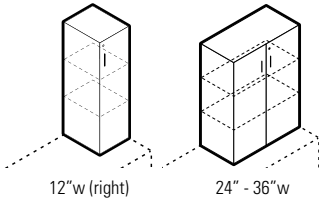

Stack-On Storage Cabinet

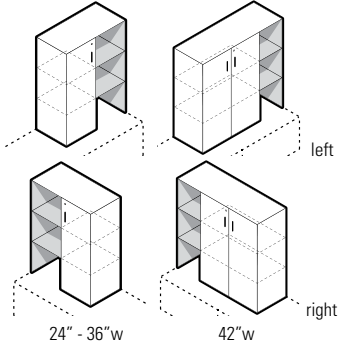

Stack-On Mixed Storage Cabinet

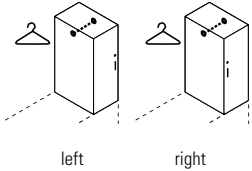

Stack-On Wardrobe Cabinet

MODEL#	DIMENSIONS	FREIGHT CLASS	WT/LBS.	CUBIC FT.	LIST PRICE	HP ADD
--------	------------	---------------	---------	-----------	------------	--------

	D x W x H					
S1215FTL	15 x 12 x 40.5	92.5	68	6.25	\$715	n/a
S1215FTR	15 x 12 x 40.5	92.5	68	6.25	\$715	n/a
S2415FT	15 x 24 x 40.5	92.5	116	11.25	\$1193	n/a
S3015FT	15 x 30 x 40.5	100	132	14	\$1308	n/a
S3615FT	15 x 36 x 40.5	100	150	16.50	\$1458	n/a

Designed to be placed on top of credenzas. Laminate doors are standard, with two fixed shelves. Handles are standard. Standard with locks. Unit rests directly on credenza top.

- Sxx15FT/FTL/FTR Stack-On storage cabinets add 3 tiers when placed on any storage unit.

S2415FNL	15 x 24 x 40.5	100	107	11.25	\$1034	n/a
S3015FNL	15 x 30 x 40.5	100	121	14	\$1132	n/a
S3615FNL	15 x 36 x 40.5	100	137	16.50	\$1264	n/a
S4215FNL	15 x 42 x 40.5	100	171	19	\$1616	n/a

S2415FNR	15 x 24 x 40.5	100	107	11.25	\$1034	n/a
S3015FNR	15 x 30 x 40.5	100	121	14	\$1132	n/a
S3615FNR	15 x 36 x 40.5	100	137	16.50	\$1264	n/a
S4215FNR	15 x 42 x 40.5	100	171	19	\$1616	n/a

Designed to be placed on top of credenzas. Laminate doors are standard on one side, with two fixed shelves. Open cavities on the other side, with two fixed shelves. Specify left or right handed. Handles are standard. Standard with locks. Unit rests directly on credenza top.

- Sxx15FNL/FNR Stack-On mixed storage cabinets add 3 tiers when placed on any storage unit.

S1224FTL	24 x 12 x 40.5	100	83	9.50	\$845	n/a
S1224FTR	24 x 12 x 40.5	100	83	9.50	\$845	n/a

Designed to be placed on top of credenzas. Laminate doors are standard. Includes hanging rod. Specify left or right handed. Handles are standard. Standard with locks. Unit rests directly on credenza top.

- S1224FTL/FTR Stack-On wardrobe cabinets add 3 tiers when placed on any storage unit.

Required Specifications

Top finish
Top/edge detail
Base finish
Door/drawer front finish

Handles

wellness solutions



Wellness Solutions

402

LAMINATE PANELS	MODEL#	DIMENSIONS	FREIGHT CLASS	WT/LBS.	CUBIC FT.	LIST PRICE
		D x W x H				
<ul style="list-style-type: none"> • Surface mounted wellness guard provides a physical divider • Acrylic glazing is clear and support rails are painted Designer White (DWT). • Kit includes all hardware to install on an existing surface • Aluminum extruded posts 						
			Laminate Finishes (for GCBMSGxxxxLP):			
			ACJ	Absolute Acajou	DES	Dark Espresso
			ASN	Asian Night	DWT	Designer White
			AWC	Avant Cherry	QTM	Quartered Mahogany
			AWH	Avant Honey	SOG	Storm Grey
			BLK	Black	WHE	Walnut Heights
			BRC	Brushed Cobalt	WHC	White Chocolate
			CMB	Clear Maple	WCR	Winter Cherry

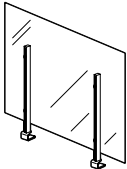
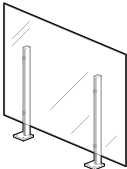
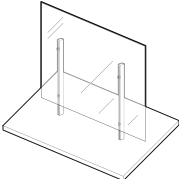
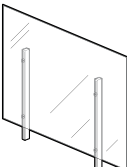
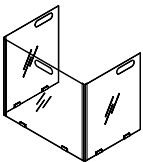
WELLNESS SCREENS	MODEL#	DIMENSIONS	FREIGHT CLASS	WT/LBS.	CUBIC FT.	LIST PRICE
		D x W x H				
 <p>Wellness Screen - Clamp Mount</p>	GCTCSG3636LP	3 x 36 x 36	300	20.20	2.92	\$608
	GCTCSG3648LP	3 x 48 x 36	300	22.80	3.98	\$756
	GCTCSG3636W	3 x 36 x 36	300	20.20	2.92	\$624
	GCTCSG3648W	3 x 48 x 36	300	22.80	3.98	\$773
	Includes clamp mount brackets, for use with existing worksurface or transaction top. Select model ending in LP for tops up to 1-1/8" thick or W for tops up to 1 1/2" thick					
 <p>Wellness Screen - Surface Mount</p>	GCBMSG3636LP	5 x 36 x 36	300	20.20	2.92	\$608
	GCBMSG3648LP	5 x 48 x 36	300	22.80	3.98	\$756
	Includes flat face surface mounting brackets, for use with existing worksurface or transaction top.					
 <p>Wellness Screen - Freestanding*</p>	GCBMSG3636LP	12 x 36 x 36	250	28.45	2.92	\$674
	GCBMSG3648LP	12 x 48 x 36	250	34.17	3.98	\$867
	12"D, board mounted. Available in all standard Global laminate finishes.					
 <p>Wellness Screen - Under Mount</p>	GCAMSG3636LP	2 x 36 x 36	300	20.20	2.92	\$497
	GCAMSG3648LP	2 x 48 x 36	300	22.80	3.98	\$646
	No mounting hardware included; drilling required. For use with existing worksurface or transaction top.					
 <p>Wellness Screen - Tri-Fold</p>	Sold individually:					
	GCFSGS1618-1	15 x 18 x 15.75	150	5.15	0.97	\$493
	GCFSGA1923-1	15.75 x 23 x 19	92.5	7.30	0.67	\$566
	Sold in packs of 5:					
GCFSGS1618-5	15 x 18 x 15.75	150	25.75	4.86	\$2353	
GCFSGA1923-5	15.75 x 23 x 19	92.5	36.50	3.37	\$2727	
	Self-supported tri-fold wellness screens create a physical divider. Lightweight and foldable for easy transport or storage. Acrylic glazing is 3mm with clear finish. Includes non-marring base bumpers and integrated handles.					
	<ul style="list-style-type: none"> • Models ending in -1 are a single unit, individually packed • Models ending in -5 are a bundle of 5 units, bulk packed. 					

Required Specifications
Finish*

FREESTANDING DIVIDERS - FELT	MODEL#	DIMENSIONS	FREIGHT CLASS	WT/LBS.	CUBIC FT.	LIST PRICE
------------------------------	--------	------------	---------------	---------	-----------	------------

D x W x H

- Divide space with flexibility.
- Lightweight and easy to clean partitions
- Minimal footprint for storage
- Fluted solid white polypropylene screens are surrounded by a 0.5" x 2.5" powder coated aluminum frame in Designer White (**DWT**) or Tungsten (**TUN**)
- Charcoal soft touch radius end trim
- 7" panel opening at panel bottom for easy cleaning and cable pass-through
- Includes all connecting hardware and 1" leveling glide
- Stations are 60" wide by 42" deep by 66" high.

MODEL#	DIMENSIONS	FREIGHT CLASS	WT/LBS.	CUBIC FT.	LIST PRICE
--------	------------	---------------	---------	-----------	------------

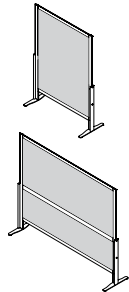

Felt Screen - Flat Feet

GCUPFSF5442	20 x 42 x 51.75	400	21.8	25.16	\$787
GCUPFSF5448	20 x 48 x 51.75	400	22.54	28.75	\$800
GCUPFSF5460	20 x 60 x 51.75	400	24.03	35.94	\$981
GCUPFSF6042	20 x 42 x 57.75	400	22.57	28.07	\$806
GCUPFSF6048	20 x 48 x 57.75	400	23.3	32.08	\$812
GCUPFSF6060	20 x 60 x 57.75	400	24.87	40.1	\$994
GCUPFSF7242	20 x 42 x 69.75	400	24.06	33.91	\$986
GCUPFSF7248	20 x 48 x 69.75	400	24.88	38.75	\$999
GCUPFSF7260	20 x 60 x 69.75	400	29.79	48.44	\$1252

Provides privacy and room separation. PET felt screen with steel flat feet. 60" wide divider has a crossbar in the middle.

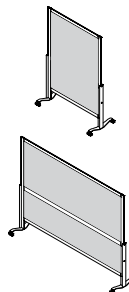

Felt Screen - Casters

GCUPMSF5442	20 x 42 x 52.05	400	22.98	25.3	\$1064
GCUPMSF5448	20 x 48 x 52.05	400	23.72	28.92	\$1077
GCUPMSF5460	20 x 60 x 52.05	400	25.21	36.15	\$1246
GCUPMSF6042	20 x 42 x 58.05	400	23.75	28.22	\$1084
GCUPMSF6048	20 x 48 x 58.05	400	24.51	32.25	\$1097
GCUPMSF6060	20 x 60 x 58.05	400	26.05	40.31	\$1265
GCUPMSF7242	20 x 42 x 70.05	400	25.24	34.05	\$1258
GCUPMSF7248	20 x 48 x 70.05	400	26.06	38.92	\$1265
GCUPMSF7260	20 x 60 x 70.05	400	30.97	48.65	\$1499

Provides privacy and room separation. PET felt screen with steel feet with casters. 60" wide divider has a crossbar in the middle.

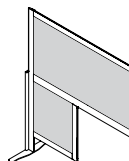

Shared Divider Felt Screen

GCUPSHF5448	20 x 48 x 53.57	400	18.06	29.76	\$657
GCUPSHF5454	20 x 54 x 53.57	400	18.8	33.48	\$747
GCUPSHF6048	20 x 48 x 59.57	400	18.84	33.09	\$702
GCUPSHF6054	20 x 54 x 59.57	400	19.6	37.23	\$922

Provides privacy and divides space for workstations. Divider stands on the floor and sits on the worksurface. Has no mechanical connection to any surface. Lightweight and easy to clean and move. PET felt screen with steel flat foot. 60" wide divider has a crossbar in the middle. Extends 24" from the worksurface. Sits 24" or 30" above worksurface.

Required Specifications

Frame/ foot finish
PET felt

FREESTANDING DIVIDERS - GLASS

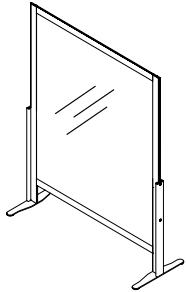

Glass Screen - Flat Feet

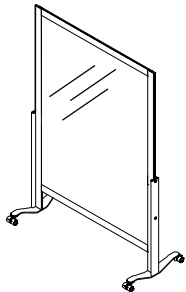

Glass Screen - Casters

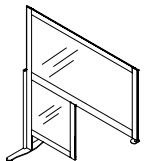

Shared Divider Glass Screen

MODEL#	DIMENSIONS D x W x H	FREIGHT CLASS	WT/LBS.	CUBIC FT.	LIST PRICE
GCUPFSG5424	20 x 24 x 51.75	250	30.83	14.38	\$896
GCUPFSG5430	20 x 30 x 51.75	300	34.95	17.97	\$974
GCUPFSG5436	20 x 36 x 51.75	300	39.07	21.56	\$1050
GCUPFSG5442	20 x 42 x 51.75	300	43.19	25.16	\$1128
GCUPFSG5448	20 x 48 x 51.75	300	47.31	28.75	\$1206
GCUPFSG5460	20 x 60 x 51.75	300	55.56	35.94	\$1360
GCUPFSG6024	20 x 24 x 57.75	250	33.11	16.04	\$950
GCUPFSG6030	20 x 30 x 57.75	300	37.74	20.05	\$1034
GCUPFSG6036	20 x 36 x 57.75	300	42.36	24.06	\$1119
GCUPFSG6042	20 x 42 x 57.75	300	46.99	28.07	\$1204
GCUPFSG6048	20 x 48 x 57.75	300	51.61	32.08	\$1290
GCUPFSG6060	20 x 60 x 57.75	300	60.86	40.1	\$1459

Provides privacy and room separation. Lightweight and easy to clean and move. Aluminum frame, clear glass screen with steel flat feet.

- For frosted glass (**FRST**), add 20%.

GCUPMSG5424	20 x 24 x 52.05	250	31.99	14.46	\$1284
GCUPMSG5430	20 x 30 x 52.05	300	36.11	18.07	\$1361
GCUPMSG5436	20 x 36 x 52.05	300	40.24	21.69	\$1438
GCUPMSG5442	20 x 42 x 52.05	300	44.36	25.3	\$1515
GCUPMSG5448	20 x 48 x 52.05	300	48.48	28.92	\$1592
GCUPMSG5460	20 x 60 x 52.05	300	56.72	36.15	\$1747
GCUPMSG6024	20 x 24 x 58.05	250	34.28	16.13	\$1337
GCUPMSG6030	20 x 30 x 58.05	300	38.9	20.16	\$1422
GCUPMSG6036	20 x 36 x 58.05	300	43.53	24.19	\$1506
GCUPMSG6042	20 x 42 x 58.05	300	48.15	28.22	\$1591
GCUPMSG6048	20 x 48 x 58.05	300	52.78	32.25	\$1676
GCUPMSG6060	20 x 60 x 58.05	300	62.03	40.31	\$1846

Provides privacy and room separation. Lightweight and easy to clean and move. Aluminum frame, clear glass screen with steel flat feet.

- For frosted glass (**FRST**), add 20%.

GCUPSHG5448	20 x 48 x 53.57	300	36.17	29.76	\$989
GCUPSHG5454	20 x 54 x 53.57	300	38.51	33.48	\$1034
GCUPSHG6048	20 x 48 x 59.57	300	40.52	33.09	\$1070
GCUPSHG6054	20 x 54 x 59.57	300	43.36	37.23	\$1122

Provides privacy and divides space for workstations. Divider stands on the floor and sits on the worksurface. Has no mechanical connection to any surface. Lightweight and easy to clean and move. Aluminum frame, clear glass screen with steel flat foot. Extends 24" from the worksurface. Sits 24" or 30" above worksurface.

- For frosted glass (**FRST**), add 20%.

Required Specifications

Frame/foot finish

Optional Specifications

Frosted glass (FRST)

LINKING PANELS	MODEL#	DIMENSIONS	FREIGHT CLASS	WT./LBS.	CUBIC FT.	LIST PRICE
----------------	--------	------------	---------------	----------	-----------	------------

D x W x H

- Segmented panels offer a thermally fused laminate lower and high pressure upper pressed on a lightweight core
- Minimal footprint for storage
- Easy to connect
- Easy to reconfigure
- Easy to clean
- Panels available in Designer White (**DWT**) or Absolute Acajou (**ACJ**) laminates
- Frames available in Designer White (**DWT**) or Tungsten (**TUN**)
- Width options: 36", 42", 48", 60" wide
- 66" high
- 1.3" thick.

LINKING PANELS - SEGMENTED	MODEL#	DIMENSIONS	FREIGHT CLASS	WT./LBS.	CUBIC FT.	LIST PRICE
----------------------------	--------	------------	---------------	----------	-----------	------------

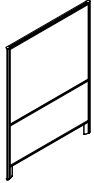

Segmented Linking Panel*

DLSP6636	1.3 x 36 x 66	92.5	35	3	\$845
DLSP6642	1.3 x 42 x 66	92.5	41	3.46	\$869
DLSP6648	1.3 x 48 x 66	92.5	47	3.93	\$886
DLSP6660	1.3 x 60 x 66	85	59	4.90	\$1360

Segmented panels offer a thermally fused laminate lower and high pressure upper pressed on a lightweight core. Minimal footprint for storage. Laminate core available in Designer White (**DWT**) or Absolute Acajou (**ACJ**). Aluminum extrusion comes in powder coated paint finish in Designer White (**DWT**) or Absolute Acajou (**ACJ**). Comes complete with hinge kits and levelers on both legs.

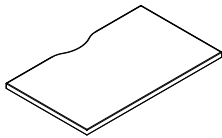

Worksurface, for Segmented Panel**

DLSPWS1830SCPLP	18 x 30 x 1	60	15	.50	\$197
-----------------	-------------	----	----	-----	--------------

Straight rectangular laminate worksurface, non handed, can be interchanged on site, and features a scoop for cable pass-through. Available in Designer White (**DWT**) or Absolute Acajou (**ACJ**). Edging available in Designer White (**DWE**) or Absolute Acajou (**ACJ**).

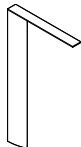

Worksurface Off-Module Cantilever*

DLSPHOMC	12 x 3 x 21	100	4	.42	\$154
----------	-------------	-----	---	-----	--------------

Installs on horizontal rails of panels to provide worksurface support. Frees up space under the worksurface. Powder coated paint finish in Designer White (**DWT**) or Tungsten (**TUN**).

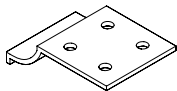

Worksurface Bracket*

DLSPHBRKT	3 x 2.25 x 0.75	70	.10	.05	\$14
-----------	-----------------	----	-----	-----	-------------

Extruded aluminum bracket that is bolted to the underside of the worksurface. Bracket supports worksurface at any location along the middle rail of the panel. Includes mounting hardware. Powder coated paint finish in Designer White (**DWT**) or Tungsten (**TUN**).

Required Specifications

- Frame finish*
- Laminate finish**

LAMINATE LINKING PANELS	MODEL#	DIMENSIONS	FREIGHT CLASS	WT./LBS.	CUBIC FT.	LIST PRICE
-------------------------	--------	------------	---------------	----------	-----------	------------

D x W x H

- Laminate linking panels provide privacy.
- Standard height of 54" or 66", width in 6" increments from 24" to 60".
- Aluminum extrusion comes in powder coated paint finish: Designer White (**DWT**) or Tungsten (**TUN**).
- Laminate core offered in Designer White (**DWT**) or Absolute Acajou (**ACJ**).
- Edge banded to match laminate finish.
- Panels come complete with hinge kits

Planning Diagrams

- When supported on one side (by 90° turn, supporting "T" legs or wall mounting), panels can run two long OR a maximum of 8'.
- When supported on both sides (by 90° turn, supporting "T" legs or wall mounting), panels can run three long OR a maximum of 13'.

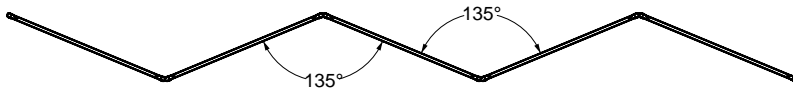
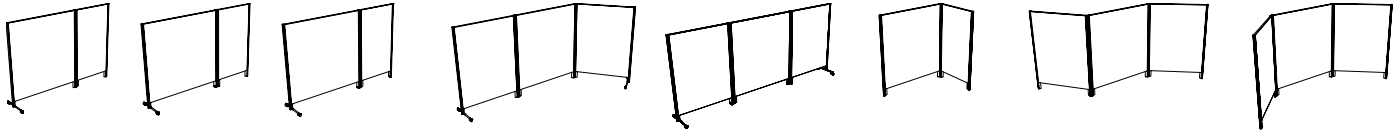

For longer, unsupported runs, panels must maintain a 135° angle (or less) to remain stable.

LAMINATE LINKING PANELS	MODEL#	DIMENSIONS	FREIGHT CLASS	WT./LBS.	CUBIC FT.	LIST PRICE
-------------------------	--------	------------	---------------	----------	-----------	------------

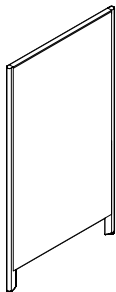

Laminate Panel - Leveler/Leveler

DPL5424	1.3 x 24 x 54	92.5	18	1.62	\$642	
DPL5430	1.3 x 30 x 54	92.5	23	2.08	\$712	
DPL5436	1.3 x 36 x 54	92.5	27	2.47	\$783	
DPL5442	1.3 x 42 x 54	92.5	32	2.85	\$853	
DPL5448	1.3 x 48 x 54	92.5	37	3.25	\$923	
DPL5454	1.3 x 54 x 54	92.5	42	3.63	\$995	
DPL5460	1.3 x 60 x 54	92.5	47	4.02	\$1065	
DPL6624	1.3 x 24 x 66	92.5	23	2.04	\$729	
DPL6630	1.3 x 30 x 66	92.5	29	2.52	\$806	
DPL6636	1.3 x 36 x 66	92.5	35	3	\$883	
DPL6642	1.3 x 42 x 66	92.5	41	3.46	\$960	
DPL6648	1.3 x 48 x 66	92.5	47	3.93	\$1039	
DPL6654	1.3 x 54 x 66	92.5	53	4.40	\$1117	
DPL6660	1.3 x 60 x 66	92.5	59	4.90	\$1193	

Levelers on both legs.

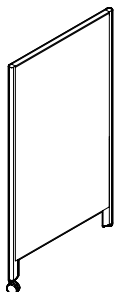

Laminate Panel - Caster/Leveler

DPLSCH5424	1.3 x 24 x 54	92.5	18	1.62	\$769	
DPLSCH5430	1.3 x 30 x 54	92.5	23	2.08	\$844	
DPLSCH5436	1.3 x 36 x 54	92.5	27	2.47	\$918	
DPLSCH5442	1.3 x 42 x 54	92.5	32	2.85	\$992	
DPLSCH5448	1.3 x 48 x 54	92.5	37	3.25	\$1065	
DPLSCH5454	1.3 x 54 x 54	92.5	42	3.63	\$1139	
DPLSCH5460	1.3 x 60 x 54	92.5	47	4.02	\$1213	
DPLSCH6624	1.3 x 24 x 66	92.5	23	2.04	\$855	
DPLSCH6630	1.3 x 30 x 66	92.5	29	2.52	\$938	
DPLSCH6636	1.3 x 36 x 66	92.5	35	3	\$1020	
DPLSCH6642	1.3 x 42 x 66	92.5	41	3.46	\$1100	
DPLSCH6648	1.3 x 48 x 66	92.5	47	3.93	\$1180	
DPLSCH6654	1.3 x 54 x 66	92.5	53	4.40	\$1292	
DPLSCH6660	1.3 x 60 x 66	92.5	59	4.90	\$1344	

Single locking caster on one leg, leveler on the other.

Required Specifications

- Frame finish
- Laminate finish

LAMINATE LINKING PANELS

MODEL#	DIMENSIONS	FREIGHT CLASS	WT./LBS.	CUBIC FT.	LIST PRICE
D x W x H					
DPLDF5424	1.3 x 24 x 54	65	40.2	1.62	\$757
DPLDF5430	1.3 x 30 x 54	65	47.6	2.08	\$811
DPLDF5436	1.3 x 36 x 54	70	54.9	2.47	\$863
DPLDF5442	1.3 x 42 x 54	70	62.3	2.85	\$917
DPLDF5448	1.3 x 48 x 54	70	69.6	3.25	\$968
DPLDF5454	1.3 x 54 x 54	70	77	3.63	\$1022
DPLDF5460	1.3 x 60 x 54	70	84.3	4.02	\$1075
DPLDF6624	1.3 x 24 x 66	65	48.6	2.04	\$821
DPLDF6630	1.3 x 30 x 66	65	57.9	2.52	\$878
DPLDF6636	1.3 x 36 x 66	70	67.3	3	\$937
DPLDF6642	1.3 x 42 x 66	70	76.6	3.46	\$994
DPLDF6648	1.3 x 48 x 66	70	85.9	3.93	\$1052
DPLDF6654	1.3 x 54 x 66	70	95.2	4.40	\$1110
DPLDF6660	1.3 x 60 x 66	70	104.5	4.90	\$1169

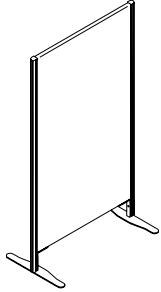

Laminate Panel - Flat Feet

Flat foot on both legs. Freestanding.

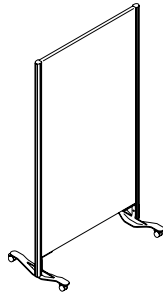

Laminate Panel - Double Casters

DPLMN5424	1.3 x 24 x 54	65	18	1.62	\$803
DPLMN5430	1.3 x 30 x 54	65	23	2.08	\$873
DPLMN5436	1.3 x 36 x 54	65	27	2.47	\$944
DPLMN5442	1.3 x 42 x 54	70	32	2.85	\$1012
DPLMN5448	1.3 x 48 x 54	70	37	3.25	\$1083
DPLMN5454	1.3 x 54 x 54	70	42	3.63	\$1153
DPLMN5460	1.3 x 60 x 54	70	47	4.02	\$1221
DPLMN6624	1.3 x 24 x 66	65	23	2.04	\$890
DPLMN6630	1.3 x 30 x 66	65	29	2.52	\$965
DPLMN6636	1.3 x 36 x 66	65	35	3	\$1043
DPLMN6642	1.3 x 42 x 66	70	41	3.46	\$1121
DPLMN6648	1.3 x 48 x 66	70	47	3.93	\$1197
DPLMN6654	1.3 x 54 x 66	70	53	4.40	\$1273
DPLMN6660	1.3 x 60 x 66	70	59	4.90	\$1351

Double locking caster base on both legs. Freestanding.

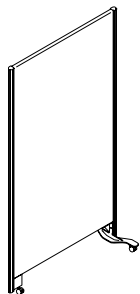

Laminate Panel - Single Caster/Double Casters

DPLDCMN5424	1.3 x 24 x 54	65	18	1.62	\$755
DPLDCMN5430	1.3 x 30 x 54	70	23	2.08	\$825
DPLDCMN5436	1.3 x 36 x 54	70	27	2.47	\$889
DPLDCMN5442	1.3 x 42 x 54	70	32	2.85	\$957
DPLDCMN5448	1.3 x 48 x 54	70	37	3.25	\$1023
DPLDCMN5454	1.3 x 54 x 54	70	42	3.63	\$1087
DPLDCMN5460	1.3 x 60 x 54	70	47	4.02	\$1158
DPLDCMN6624	1.3 x 24 x 66	65	23	2.04	\$834
DPLDCMN6630	1.3 x 30 x 66	70	29	2.52	\$909
DPLDCMN6636	1.3 x 36 x 66	70	35	3	\$982
DPLDCMN6642	1.3 x 42 x 66	70	41	3.46	\$1055
DPLDCMN6648	1.3 x 48 x 66	70	47	3.93	\$1127
DPLDCMN6654	1.3 x 54 x 66	70	53	4.40	\$1201
DPLDCMN6660	1.3 x 60 x 66	70	59	4.90	\$1256

Single locking caster on one leg and double locking caster base on the other. Freestanding.

Required Specifications

- Frame finish
- Laminate finish

LAMINATE PANELS

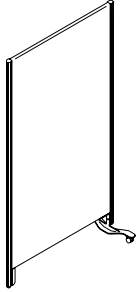

**Laminate Panel -
Leveler/Double Caster**

MODEL#	DIMENSIONS D x W x H	FREIGHT CLASS	WT./LBS.	CUBIC FT.	LIST PRICE
DPLDCHN5424	1.3 x 24 x 54	65	18	1.62	\$712
DPLDCHN5430	1.3 x 30 x 54	70	23	2.08	\$775
DPLDCHN5436	1.3 x 36 x 54	70	27	2.47	\$845
DPLDCHN5442	1.3 x 42 x 54	70	32	2.85	\$911
DPLDCHN5448	1.3 x 48 x 54	70	37	3.25	\$976
DPLDCHN5454	1.3 x 54 x 54	70	42	3.63	\$1044
DPLDCHN5460	1.3 x 60 x 54	70	47	4.02	\$1111
DPLDCHN6624	1.3 x 24 x 66	65	23	2.04	\$790
DPLDCHN6630	1.3 x 30 x 66	70	29	2.52	\$865
DPLDCHN6636	1.3 x 36 x 66	70	35	3	\$937
DPLDCHN6642	1.3 x 42 x 66	70	41	3.46	\$1008
DPLDCHN6648	1.3 x 48 x 66	70	47	3.93	\$1083
DPLDCHN6654	1.3 x 54 x 66	70	53	4.40	\$1158
DPLDCHN6660	1.3 x 60 x 66	70	59	4.90	\$1230

Leveler on one leg and double locking caster base on the other. Freestanding.

LINKING PANEL ACCESSORIES



Wall Connection

MODEL#	DIMENSIONS	FREIGHT CLASS	WT./LBS.	CUBIC FT.	LIST PRICE
DPLWA54	2 x 2 x 54	70	2.3	0.13	\$167
DPLWA66	2 x 2 x 66	65	3.5	0.15	\$190

Connects linking panels to walls. Available in Designer White (**DWT**) or Tungsten (**TUN**) paint finish. Kit consists of vertical extrusion, charcoal PVC cover and hinge kits.

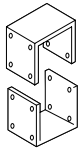

Expanding Kit

DPLEKIT	2 x 2 x 3	70	1	.05	\$291
---------	-----------	----	---	-----	--------------

Connects two linking panels in a straight line. This kit will accommodate any special width by overlapping the panels. Available in Designer White (**DWT**) or Tungsten (**TUN**) paint finish. Kit consists of a top and bottom bracket and all necessary hardware.

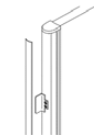

Door and Door Catch Kit

DPDC01	1.3 x 3 x 6	60	2	.05	\$183
--------	-------------	----	---	-----	--------------

Converts any linking panel into a door. Available in Designer White (**DWT**) or Tungsten (**TUN**) paint finish. Kit consists of striker plate, two hinge kits, single caster foot assembly and 1" caster.

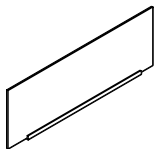

PET Felt Over Panel

DPLOP24	1.05 x 24 x 16.8	70	1.74	.39	\$151
DPLOP30	1.05 x 30 x 16.8	150	2.20	.49	\$179
DPLOP36	1.05 x 36 x 16.8	150	2.67	.59	\$209
DPLOP42	1.05 x 42 x 16.8	150	3.14	.70	\$231
DPLOP48	1.05 x 48 x 16.8	150	3.60	.80	\$345
DPLOP54	1.05 x 54 x 16.8	150	4.07	.90	\$373
DPLOP60	1.05 x 60 x 16.8	150	4.53	1.01	\$404

For laminate panels. Sits atop laminate panel and bridges the gap between the 66"H laminate linking panel and top of the consultation booth. Available in Designer White (**DWT**) or Tungsten (**TUN**) paint finish. Kit contains aluminum extrusion and felt insert.

Required Specifications

Finish

acoustic solutions



Priva

460



Softpod

463



Priva acoustic pods provide a place for personal privacy, focus and online collaboration, away from the noise of the open office. Integrated ventilation and low-voltage LED lighting are motion-sensor activated to reduce energy consumption. The tempered glass entrance door, in combination with optional glass back panel, reduces the sense of confinement. Interior carpet flooring is comprised of eco-friendly nylon fiber, solution dyed with a polypropylene backing.

A laptop shelf, two AC outlets and two USB-A charging ports support the range of today's electronic and communication devices. The exterior is available in a variety of laminate finishes to coordinate with other furnishings. The interior can be finished in laminate or PET, for industry-leading sound absorption. Hinge and handle trim is available in Black or anodized Silver. Mechanical fasteners to affix the pod to the floor are available.



Features and Benefits

- Quiet and private
- Plug-and-play
- Internal frame is comprised of 14-gauge steel beams
- Easily clean high touch surfaces
- Slim, modern design
- Optional PET interior for greater acoustic properties
- Fixed touch-down shelf with power unit
- Special retractable casters enable Priva to be relocated easily



Two AC outlets and two USB-A charging ports, plus laminate touch-down shelf



Easy to clean

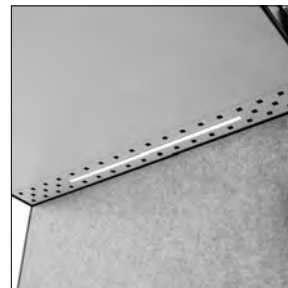

Ventilation fan and LED lights

GENERAL INFORMATION

- Priva is the culmination of 2 years of research and development of an acoustic phone booth that inhibits sound transmission between the interior and exterior creating a private room-in-room for workplace applications.
- Assembles in less than 90 minutes. Once complete, simply plug in and get to work!
- Priva has been tested and complies with all BIFMA mechanical tests.
- For environmental certification, please visit globalfurnituregroup.com.

CONSTRUCTION

- Exterior is clad in 3/4" thermally fused laminate with a 10mm tempered glass door and glass (POD1G) or laminate back panel (POD1L).
- Exterior corner details are made of extruded aluminum
- Internal frame is comprised of 14 gauge steel beams
- Interior is clad in PET (recommended for greater acoustic properties)
- Laminate interior is optional.
- Pod ceiling is Designer White laminate
- Interior carpet flooring is comprised of eco-friendly nylon fiber, solution dyed with a polypropylene backing.
- Laminate touch-down shelf is standard in Designer White (DWT) laminate.

DIMENSIONS

- Exterior: 44" w x 38" d x 88" h
- Interior: 36" w x 36" d x 80" h
- Door: 32" w x 88" h
- Shelf: 24" w x 8" d x 40" h

Exterior Dimensions

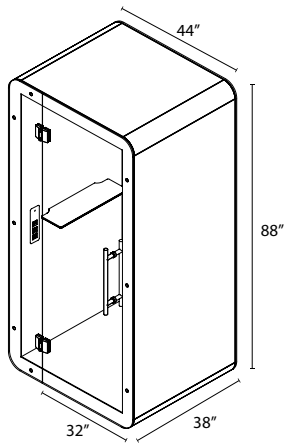

Interior Dimensions - Side View

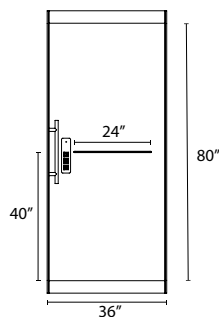

Interior Dimensions - Front View

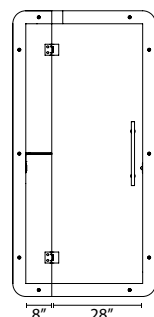

POWER + CONNECTIVITY

- Two AC outlets and two charging USB-A ports, coupled with an occupancy sensor controlling two 12V DC fans and an LED light circuit, ensure comfort in even the smallest of enclosed spaces, while keeping power consumption at a minimum.
- One 10 foot power cord with 3-prong plug

ACOUSTIC RATINGS

- NIC-36, STI .24

AIRFLOW SPECIFICATIONS

- CFM 55

FINISHES

Exterior Finishes:

- ACJ Absolute Acajou
- ASN Asian Night
- BLK Black
- BRC Brushed Cobalt
- CMB Clear Maple
- DES Dark Espresso
- DWT Designer White
- FAS Fashionista
- FCL First Class
- NBL Noce Biondo
- NGL Noce Grigio
- NEL Noce Leggero
- NML Noce Medio
- SBY Sheer Beauty
- SOG Storm Grey
- WHE Walnut Heights
- WHC White Chocolate
- WCR Winter Cherry

Exterior Frame Finishes

- BK Black
- CR Charcoal
- DW Designer White
- TU Tungsten

Interior Finishes - select Laminate or PET

- | | | | |
|--------------|--|--------------------|--|
| PET: | | Laminate: | |
| GPH Graphite | | BLK Black | |
| MTS Mist | | DWT Designer White | |
| PWT Pewter | | SOG Storm Grey | |

Hardware Finishes (Handle + Hinge)

- BK Black
 - SI Silver
- Interior Finish (Laminate or PET)

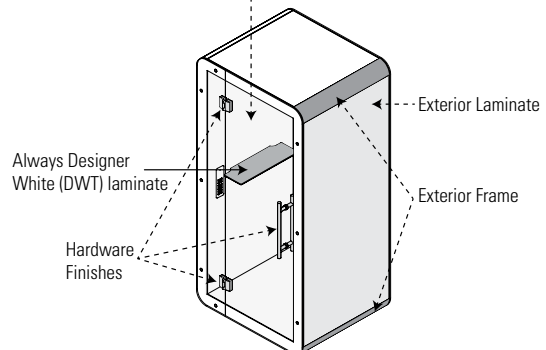

SINGLE USER POD MODEL# DIMENSIONS FREIGHT CLASS WT/LBS. CUBIC FT. LIST PRICE

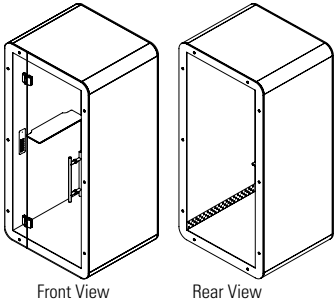

	D x W x H				
POD1G	38 x 44 x 88	65	1323	44.80	\$25441

Single User Pod - Glass Back Panel

Acoustic pod includes laminate exterior with aluminum frame. PET interior provides acoustic privacy. Laminate interior optional for easy cleaning. Door is 10mm tempered glass with a **glass back panel**.

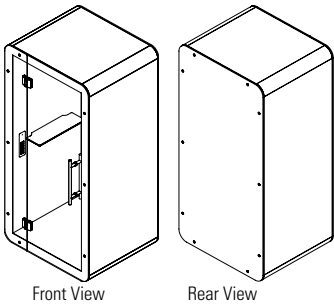

POD1L	38 x 44 x 88	65	1323	44.80	\$25441
-------	--------------	----	------	-------	----------------

Single User Pod - Laminate Back Panel

Acoustic pod includes laminate exterior with aluminum frame. PET interior provides acoustic privacy. Laminate interior optional for easy cleaning. Door is 10mm tempered glass with a **laminate back panel**.

Required specifications

- Exterior laminate finish
- Exterior frame finish
- Hardware finish
- Interior finish



Introducing **Softpod** - where flexibility meets focus.

Softpod™ responds to the changing landscape of today's workplace, providing an alternative to conventional workstations and cubicles. As an adjunct to collaborative and community spaces, Softpod supports activities that require individual focus and engagement. Softpod facilitates hybrid schedules that require unassigned workspaces as people move between the office and home.

Features and Benefits

- Freestanding hexagon shape allows for on/off grid 120-degree planning
- Single, standalone (private) workspace or "pod" that can be loosely fit in a floorplan
- PET felt + aluminum construction
- Simple kit of parts makes it easy to specify with quick fulfillment + installation
- Panels are comprised of two layers of recycled sound-absorbing PET felt
- Easily clean high touch surfaces
- User can easily add/remove privacy + accessory elements
- Casual storage options and accessories support hybrid schedules
- Pods can be equipped with power and data solutions

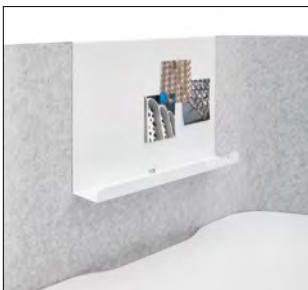

Hanging shelf with dry erase board



Under worksurface casual storage unit



Optional coat/bag hook

GENERAL INFORMATION

- Available as 3, 4 and 5-sided pods in a range of colors.
- Easy to specify and install.
- Easily add, subtract or rearrange each Softpod workstation without having to take anything apart
- High and low pressure laminate work surfaces are durable and easy to clean. Choose from a range of finishes to suit your style.
- Softpod panels can be specified in a range of color options to suit a range of styles. The inner and outer panel sides can be specified in different colors to offer visual appeal or to help workers identify groups or individual work areas within open spaces.
- PET felt panels and internal aluminum framework can be recycled.
- For environmental certifications, please visit globalfurnituregroup.com.

WORKSURFACES

- Standard in high performance thermally fused laminate. Optional high pressure (HP) laminate available.
- High performance thermally fused laminate tops are 1" thick particle board and have a flat 3mm edge profile on all sides
- High pressure (HP) laminate tops are 1-1/16" thick laminate particle board and have a flat 3mm edge profile on all sides
- Laminate surfaces offer a selection of matching + coordinating edgeband. Specify separately from the surface finish.



- Products specified with the high pressure laminate option are finished on the underside of the surface with a kraft paper backing.

FINISHES

Metal Leg Finishes:

CHR	Charcoal
DWT	Designer White

PET Felt Colors

BLK	Black
BRI	Brick
DEN	Denim
GPH	Graphite
HVT	Harvest
MTS	Mist
PWT	Pewter
SHR	Shamrock
WHT	White

LAMINATE FINISHES (thermally fused and high pressure laminates):

ACJ	Absolute Acajou	FCL	First Class
ASN	Asian Night	NBL	Noce Biondo
AWC	Avant Cherry	NGL	Noce Grigio
AWH	Avant Honey	NEL	Noce Leggero
BLK	Black	NML	Noce Medio
BRC	Brushed Cobalt	QTM	Quartered Mahogany
CMB	Clear Maple	SBY	Sheer Beauty
CGY	Custom Grey	SOG	Storm Grey
DES	Dark Espresso	WHE	Walnut Heights
DWT	Designer White	WHC	White Chocolate
FAS	Fashionista	WCR	Winter Cherry

EDGE FINISHES (Laminate Surfaces Only)

AAE	Absolute Acajou	FCL	First Class
ASE	Asian Night	NBL	Noce Biondo
ACE	Avant Cherry	NGL	Noce Grigio
AHE	Avant Honey	NEL	Noce Leggero
BLK	Black	NML	Noce Medio
BRC	Brushed Cobalt	QTM	Quartered Mahogany
CHR	Charcoal (use w/SOG)	SBY	Sheer Beauty
CME	Clear Maple	SIL	Silver
CGY	Custom Grey	TPE	Taupe
DEE	Dark Espresso	WHE	Walnut Heights
DWE	Designer White	CBE	White Chocolate
FAS	Fashionista	WCE	Winter Cherry

Divider:

- PET felt / aluminum composition
- Channel edge allows for add-on privacy

PET Felt features:

- Tackable acoustic material
- Soft form capability

Electrical:

- Simple interconnect / direct plug-in
- Hard wire formats

Storage:

- Solution based

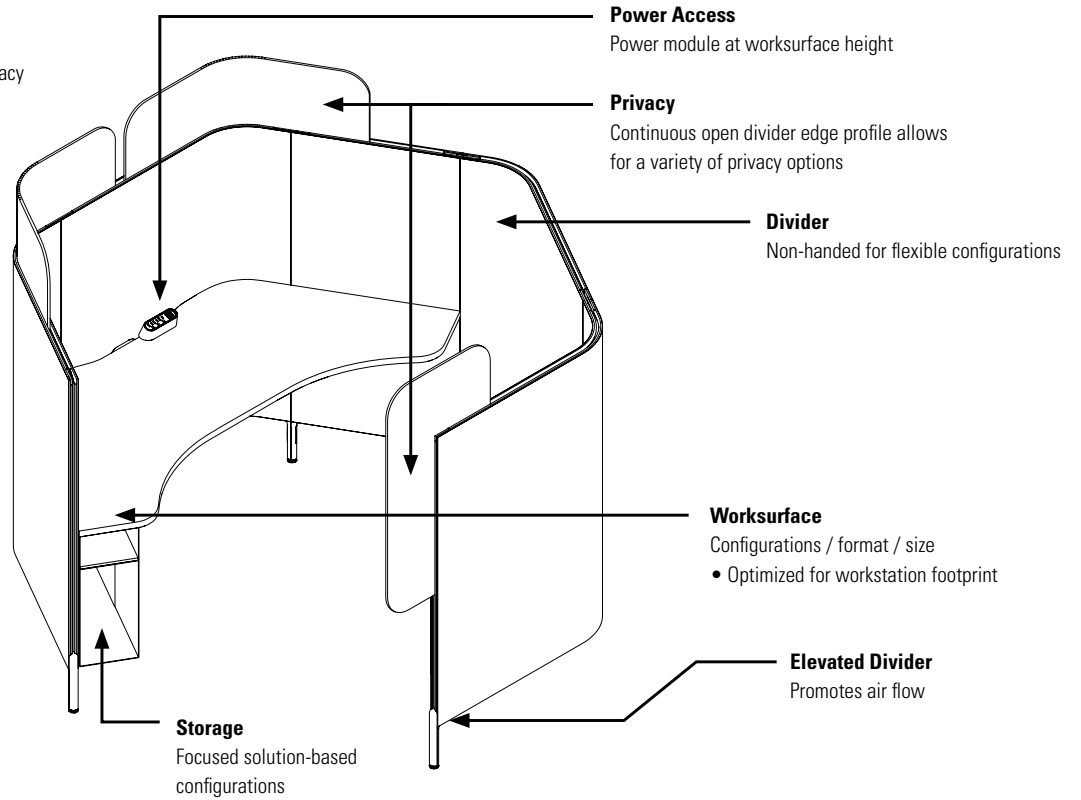

S SOFTPOD - STATEMENT OF LINE

softPODs

HX3P5472SW
softPOD with 3 Dividers
and Worksurface

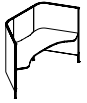

HX4P5472SW
softPOD with 4 Dividers
and Worksurface



HX4P5472L/RW
softPOD with 4 Dividers and
Wraparound Worksurface

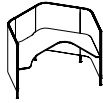

HX5P5472SW
softPOD with 5 Dividers
and Worksurface

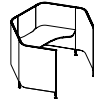

HX5P5472L/RW
softPOD with 5 Dividers and
Wraparound Worksurface



HXP5430AP
Single J-divider



Extensions

HXPAEFE
End PET Felt Extension
Divider Add-on

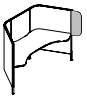

HXPACFE
Corner PET Felt Extension
Divider Add-on

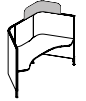

HXPATCFE
Top Corner PET Felt
Extension Divider Add-on

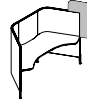

Electrical

BRED50
Duo Module



BRET53
Trio Plus Module

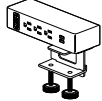

HXEUWC
Under Worksurface
Edge USB charger



GAADG
Access Door
Module

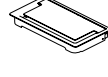

GAADCT
Access Door Module
with Cable Tray

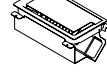

PMDSA10
ModPower
Starter Unit



PMDEA3
ModPower Middle
Mounted Unit



PMDEA3
ModPower End
Mounted Unit

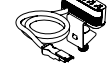

PMDCLIPS
ModPower cable
management clips



PMDJ36BK
ModPower
interconnecting jumper



PSDPC22W
Slim Desktop Power
Module, 2 Duplex



PSDPC32W
Slim Desktop Power
Module, 3 Duplex



HXEPK
Station 2-Circuit
Power Kit



HXECS
Cable Shroud



HXEPRJ
Station to Station
Jumper



HXECF
Ceiling Feed

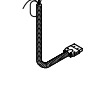

HXEBF
Base Feed

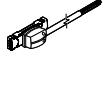

HXECFP
Ceiling Feed Pole



HXEPGK
Divider Grommet
Kit



HXEPGCS
Divider Grommet
Connector / Spacer

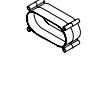

Accessories

LINLAMPS
LED Single Arm
Lamp



LINLAMPD
LED Double Arm
Lamp



RNDLAMPS
LED Single Arm
Lamp



RNDLAMPD
LED Double Arm
Lamp



HXAHS
Hanging Shelf

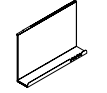

HXAHSWB
Hanging Shelf with
Dry Erase Board

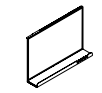

HXARWS
Rear Wall Shelf



HXACHS
Coat/Bag Hook
for Dividers



HXACHT
Coat/Bag Hook
for Dividers Edge



HXABH
Under Surface
Bag Hook



HXNP
Name Plate

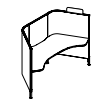

Storage

HXSCSO
Under Worksurface
Casual Storage Unit

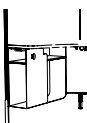

FFPO
Pantry Storage

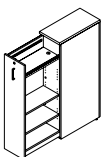

FOOTPRINT

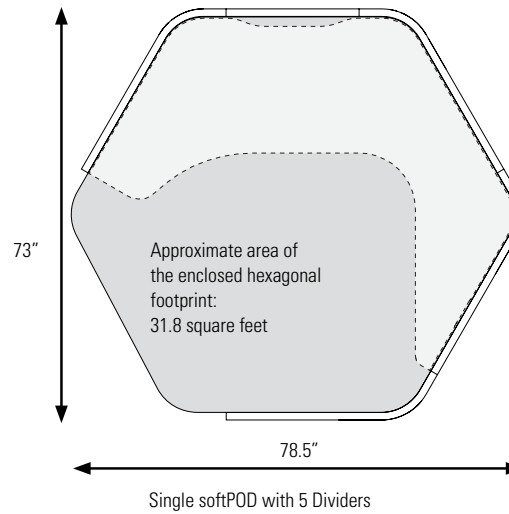
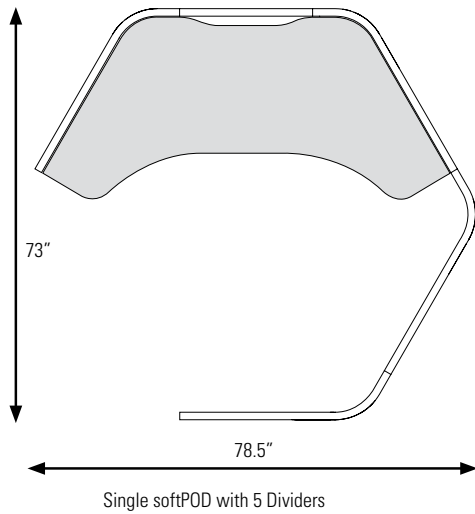
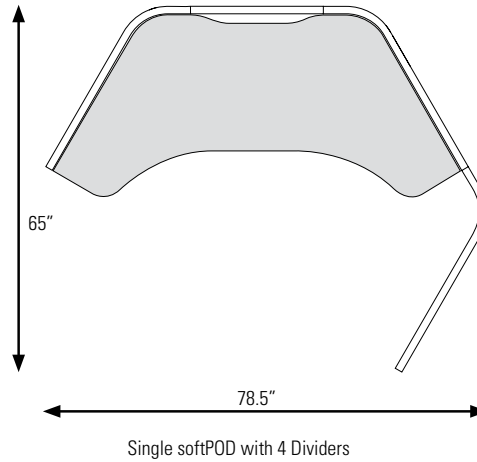
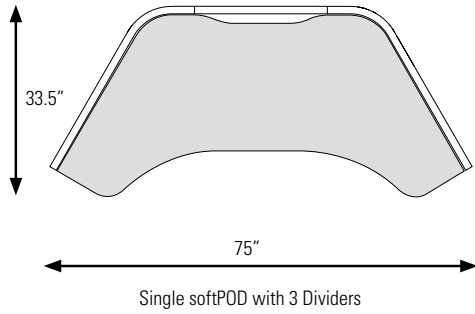

OFF GRID PLANNING

The flexible format of softPOD offers a variety of planning options and encourages off grid layouts. From a single or cluster of softPODs this versatile system adapts to your needs.

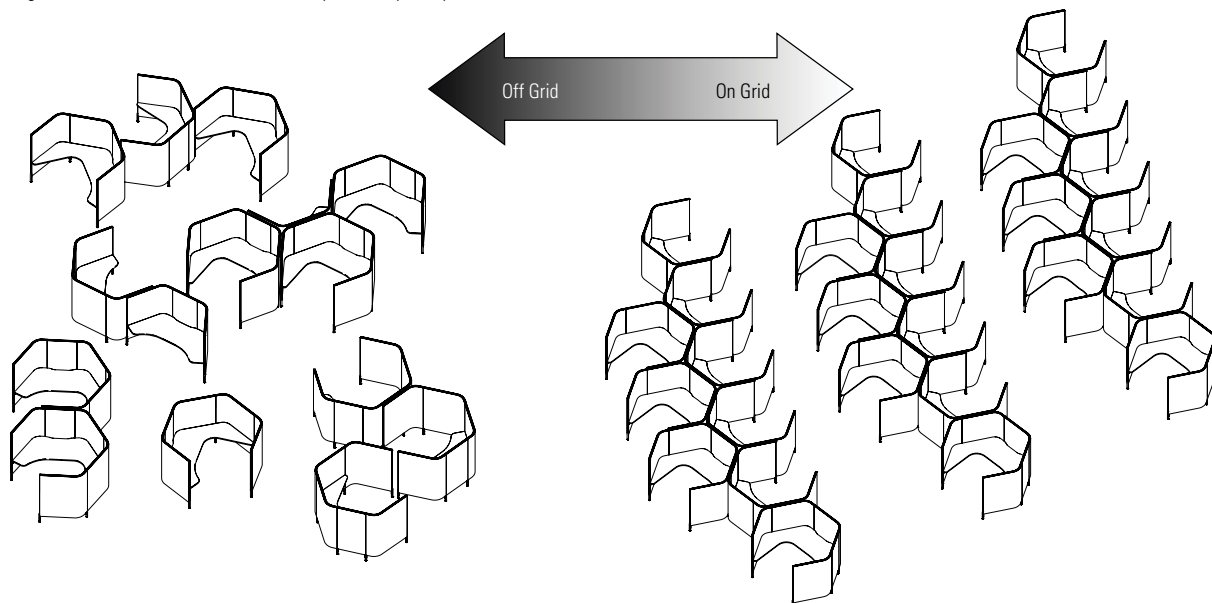

OFF GRID PLANNING

Agile

The freestanding, single softPOD can flex to support any number of employees in a hybrid work environment. The pods can be easily reconfigured and adjusted as needs change. Its small kit of parts and thoughtfully designed features make it easy to specify and keep inventory counts low. Easy to specify and keep inventory counts low.

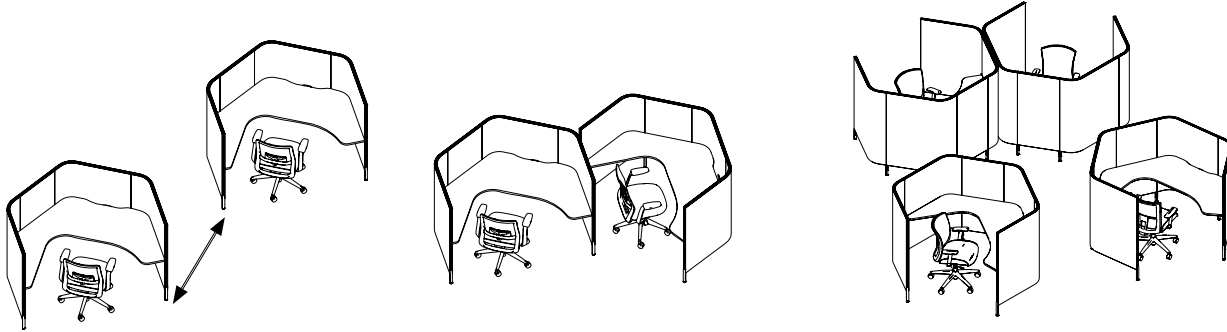

Scalable

The adaptable dividers give the ability to address the level of privacy needed on a station by station basis.

softPOD PRIVACY

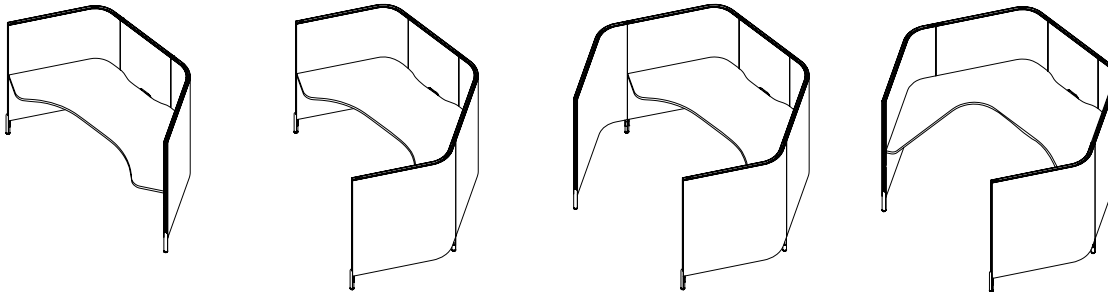

Extensions - PRIVACY

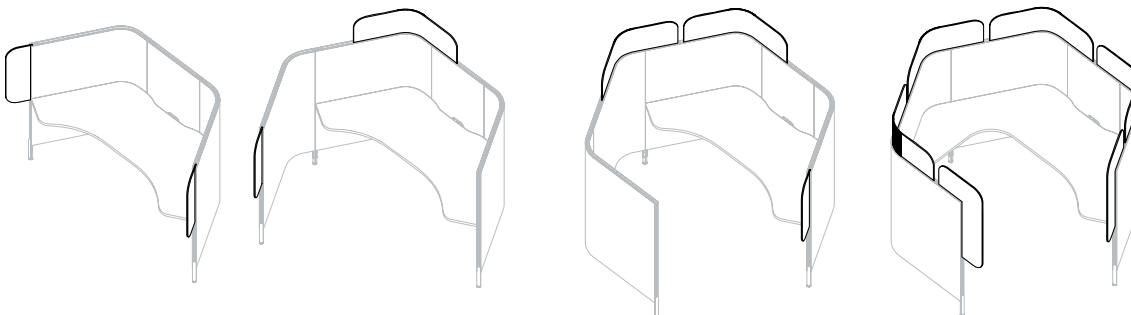

POWER CONNECTIONS

Plug In

Simple casual wire - Direct plug-in or hard wired.

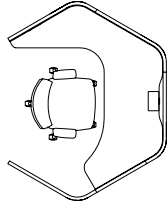

Daisy Chain Interconnect System

Plug-in power supply and interlinked, pre-determined, universal modules. If specified, one module is shipped with the station and interconnected on site.

Integrating additional station (C) requires disconnecting A from B and plugging in the C on site.

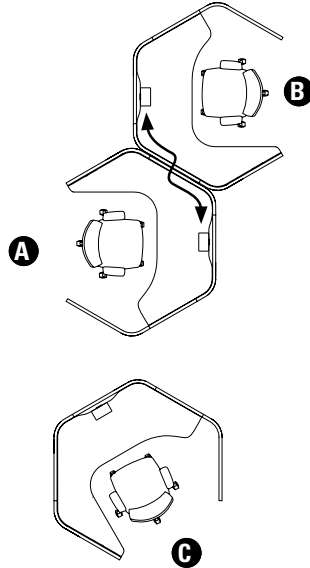

Dual Circuit Power

Outlets mounted below worksurfaces.

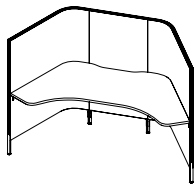
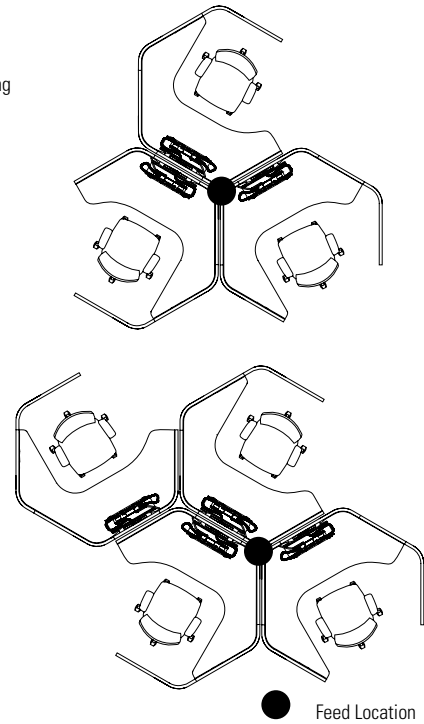

Single Pod with 3 Dividers

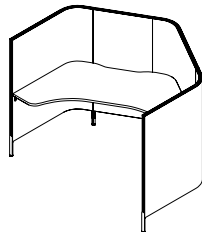

Single Pod with 4 Dividers

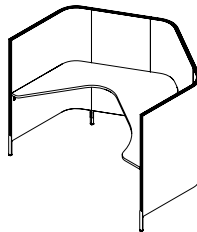

Single Pod with 4 Dividers and Wrap Around Surface

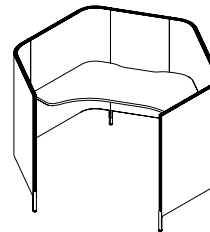

Single Pod with 5 Dividers

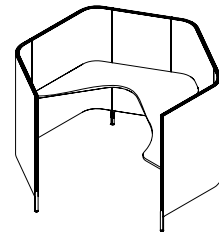

Single Pod with 5 Dividers and Wrap Around Surface

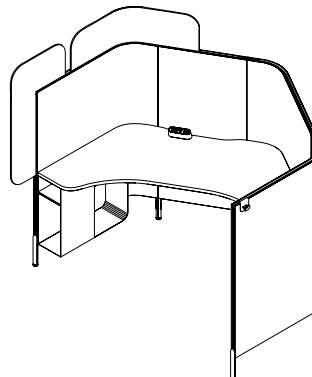
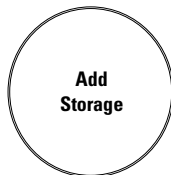
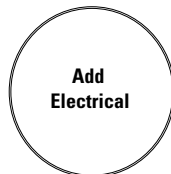

SPACE PLANNING

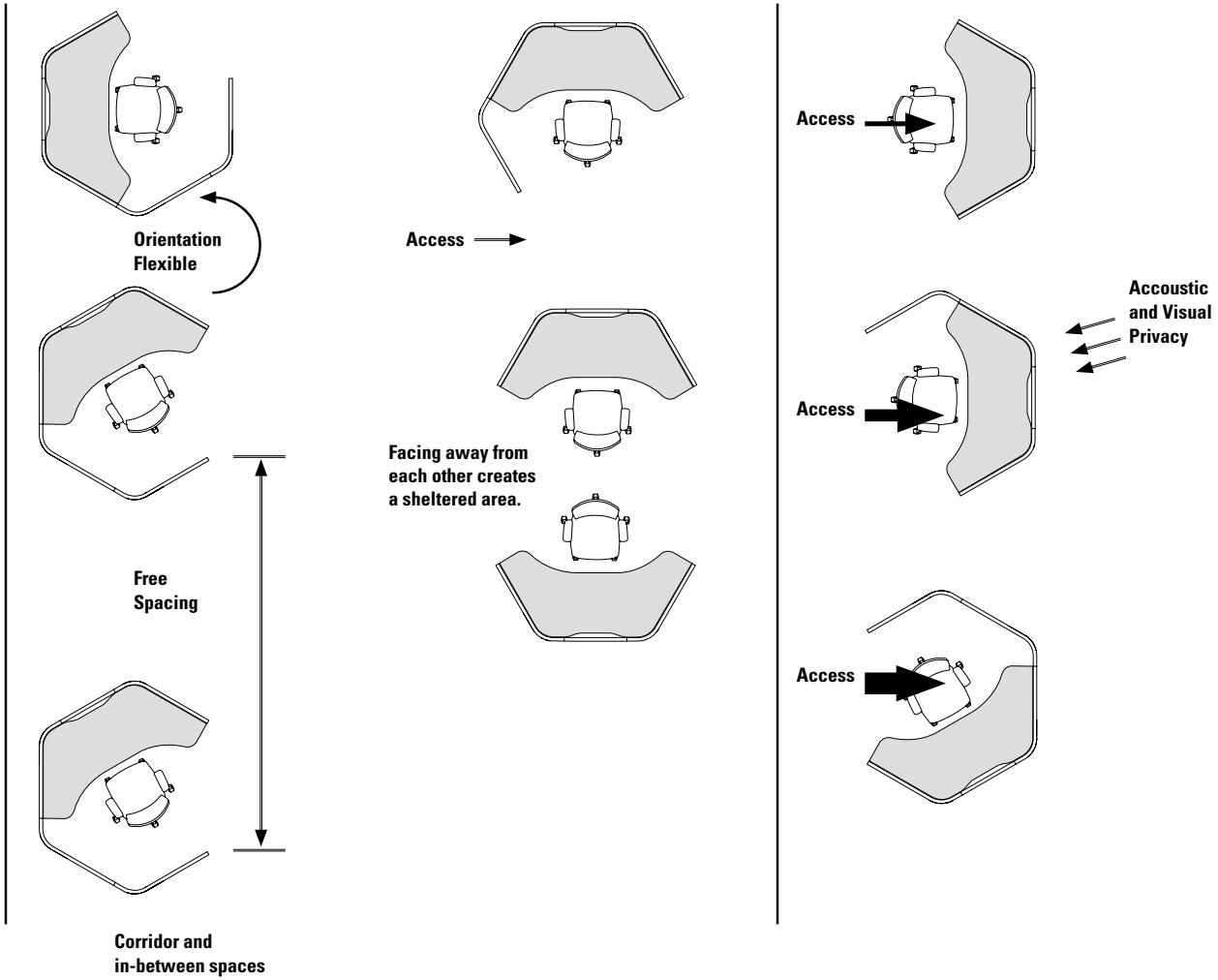

POD FORMATS

Align units in cluster plan
Option unit type & orientation

(A) Worksurfaces must have opposing alignment

Flat and curved dividers are non-handed and symmetrical. The addition of the legs determines if the j-dividers becomes LEFT handed or RIGHT handed. Any j-divider can be configured and reconfigured LEFT or RIGHT.

Maximum 4 unit cluster per 2 circuits

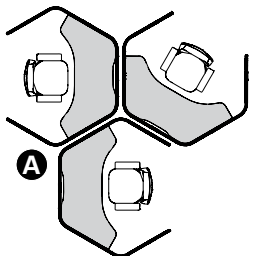

Power/ data is delivered through screen walls via grommet

Grommet tethers units together

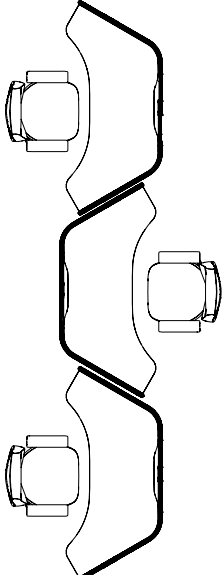
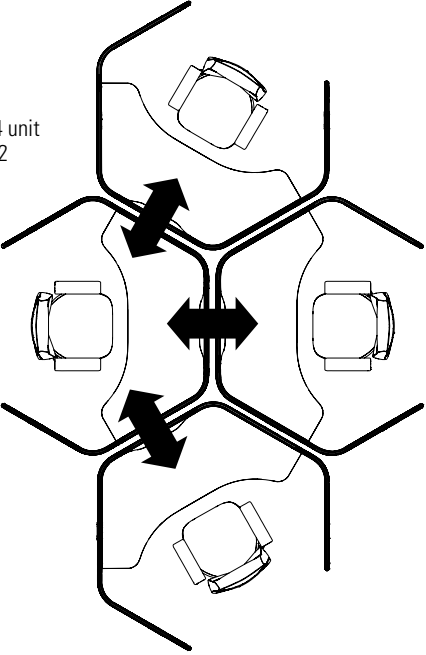
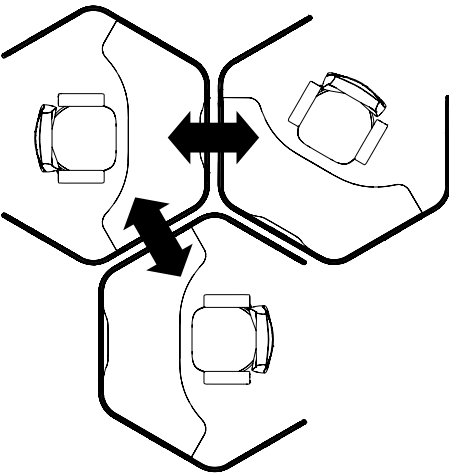

Density Touchdown

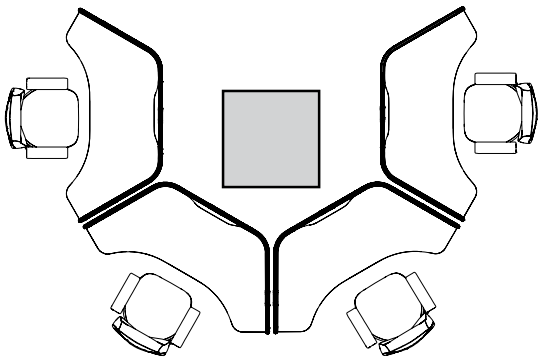
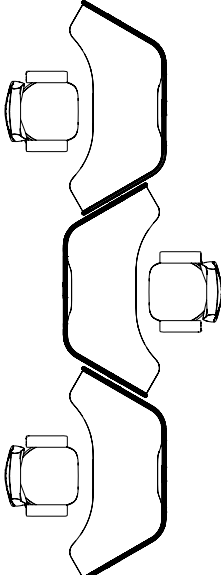

Around Column

PLANNING FOR SINGLE SOFTPOD WITH 4 DIVIDERS

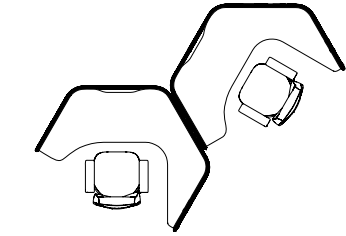

Cluster of 2 softPODs

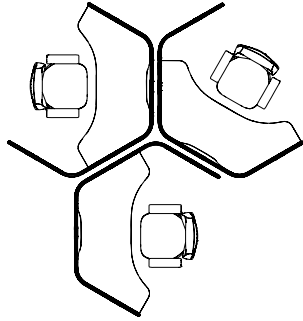
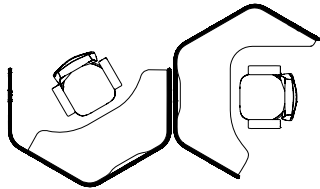
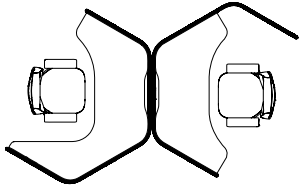

Cluster of 3 softPODs

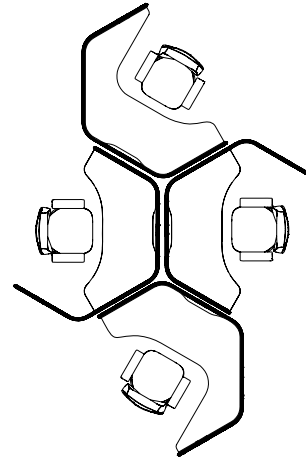
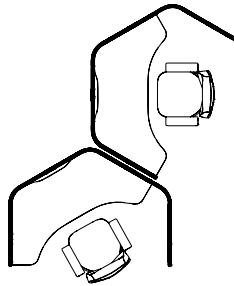

Cluster of 4 softPODs

PLANNING FOR SINGLE SOFTPOD WITH 5 DIVIDERS - CENTER

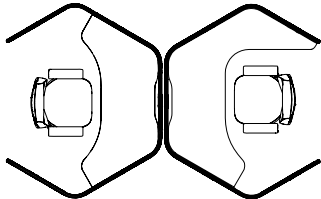

Cluster of 2 softPODs

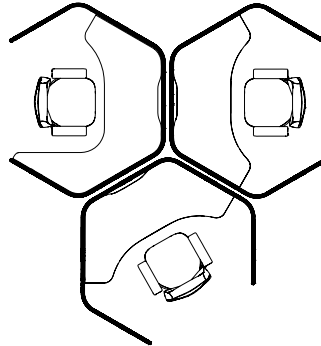
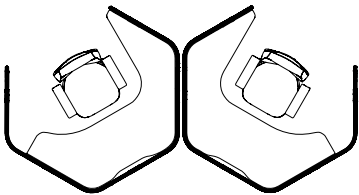
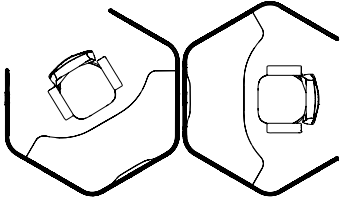

Cluster of 3 softPODs

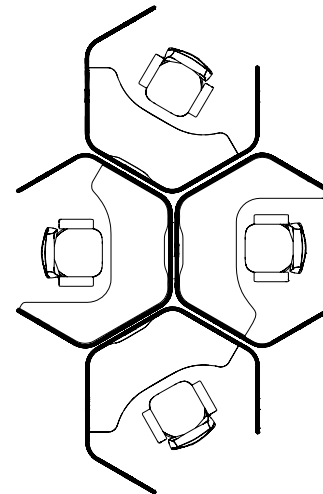
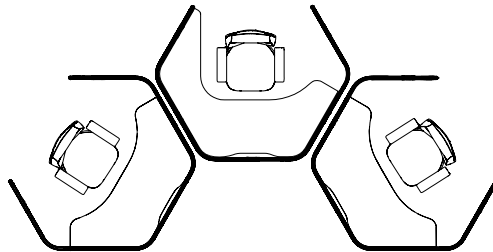

Cluster of 4 softPODs

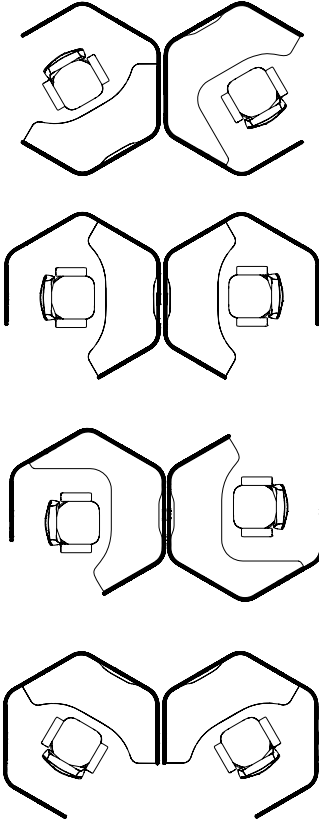
PLANNING FOR SINGLE SOFTPOD WITH 5 DIVIDERS, LEFT/RIGHT

Cluster of 2 softPODs

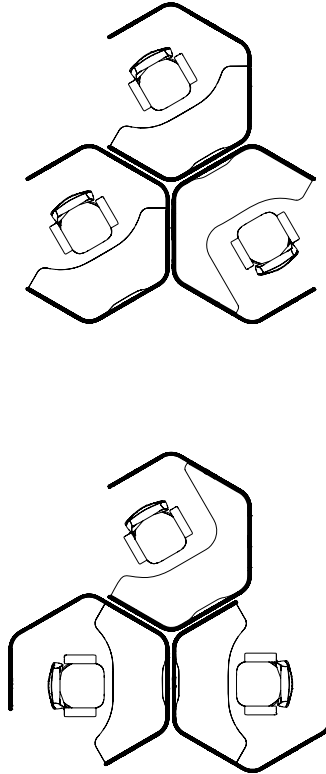

Cluster of 3 softPODs

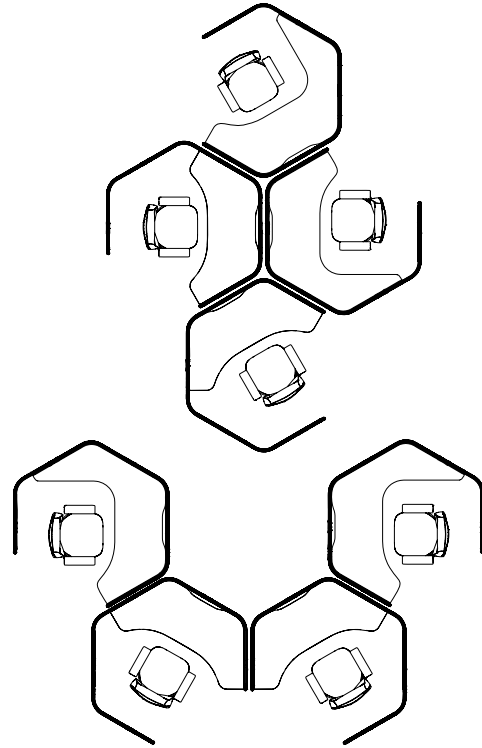

Cluster of 4 softPODs

PRIVACY EXTENSIONS

Flexible privacy extensions can be added to any softPOD workstation to adjust the level of privacy based on the user's needs.

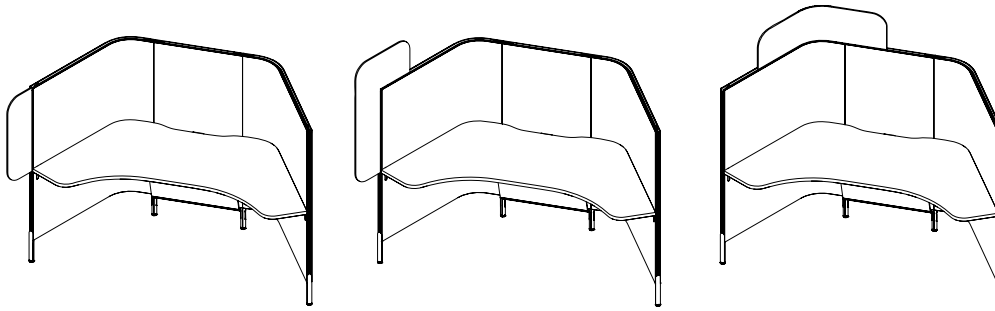

User added PRIVACY

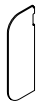
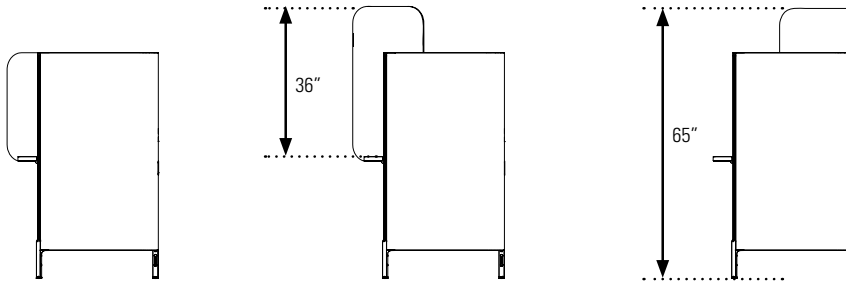

**End PET Felt
Extension Divider
Add-on**

Height: 25.5"
Depth: 9mm
Width: 9.5"
PET Felt
- solid



**Top Corner PET
Felt Extension
Divider Add-on**

Height: 37"
Depth: 9mm
Width: 19.5"
PET Felt
- solid
- perforated



**Corner PET Felt
Extension Divider
Add-on**

Height: 11.5"
Depth: 9mm
Width: 38.5"
PET Felt
- solid
- perforated

PRIVACY EXTENSIONS

PET Felt - Solid

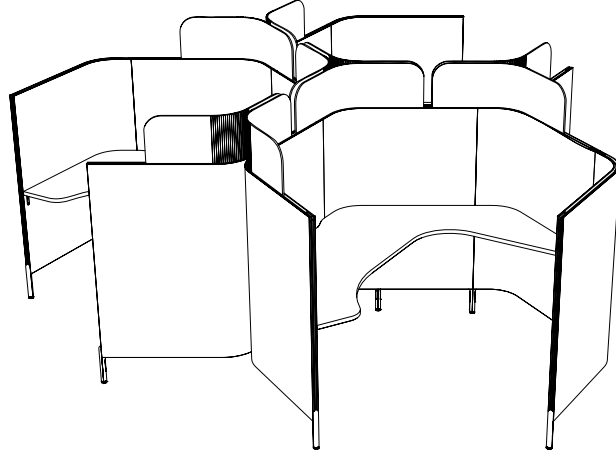
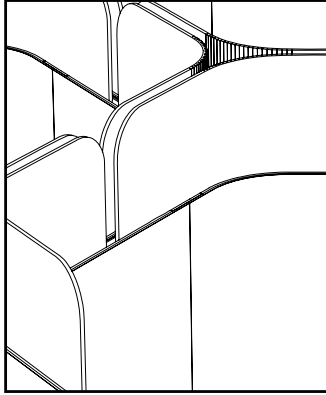

PET Felt - Perforated

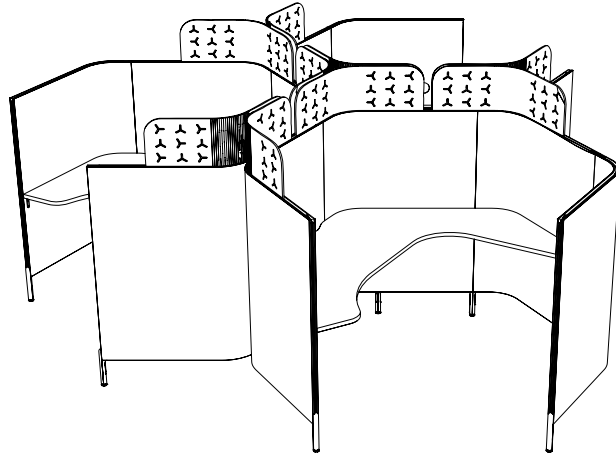
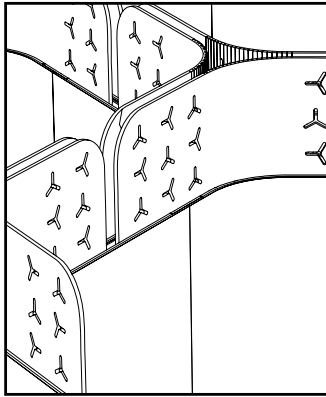

PET FELT COLOR PROGRAMMING

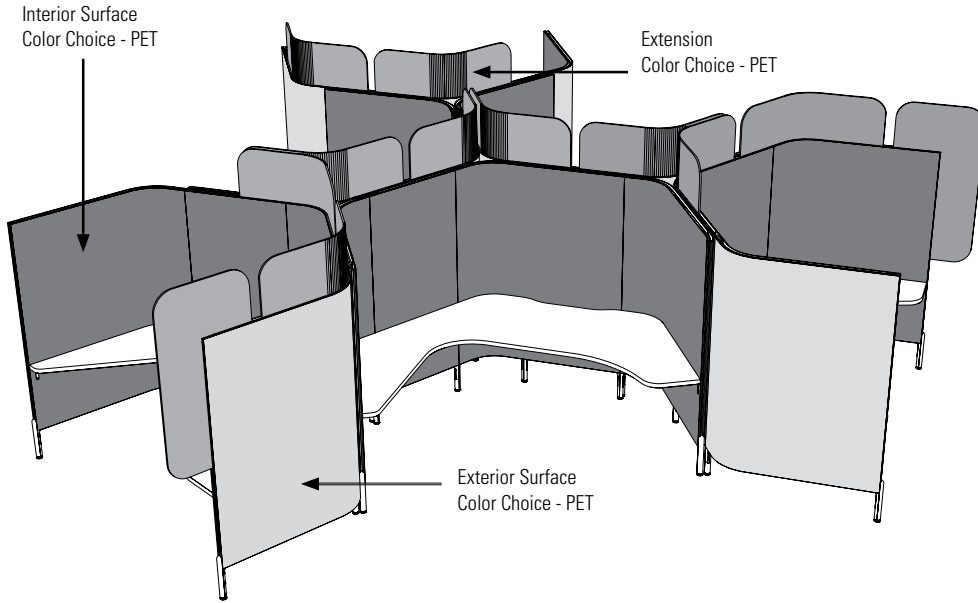

WORKSURFACE DIMENSIONS AND GRAIN DIRECTION

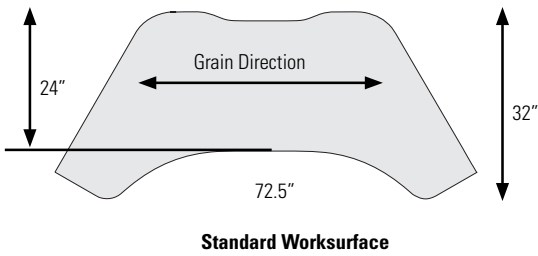

- A single worksurface to be used within softPOD dividers.
- The surface is non handed with pre-determined mounting points.

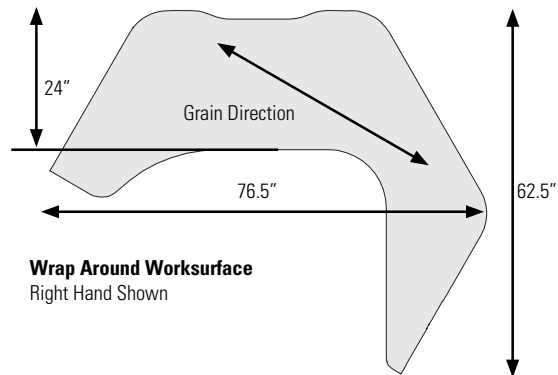

- A single wrap around worksurface to be used within softPOD dividers.
- The surface is handed L -left or R -right with pre-determined mounting points.
- Compatible only with 4 or 5 divider station configurations.

GROMMET LOCATIONS

GAADDCT/
GAADCTPD

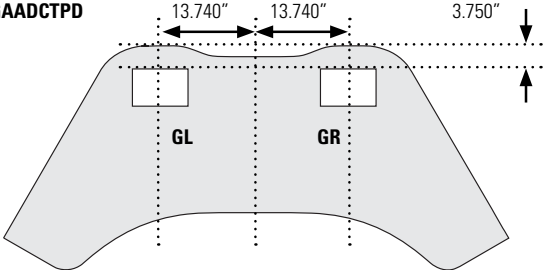

GAADDCT/
GAADCTPD

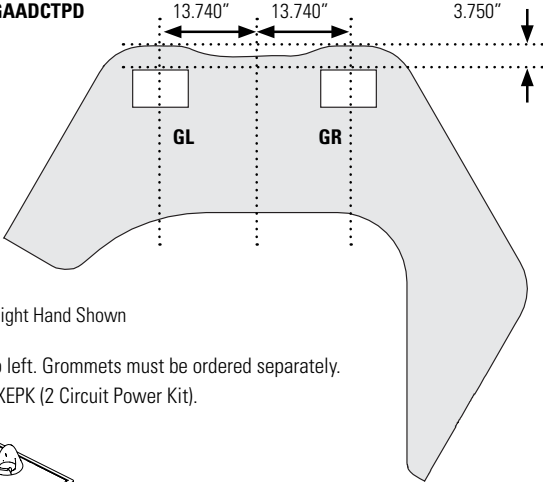

- Grommet cut-out option for GAADS series and Mod Power. TR -top right or TL -top left. Grommets must be ordered separately.
- GAAD grommet is not available in combination with HXECS (Cable Shroud) and HXEPK (2 Circuit Power Kit).

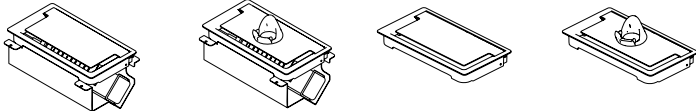

ELECTRICAL

- Power and data lines can enter softPOD via floor, ceiling, or through grommet in the divider. The grommet opening is built into every softPOD divider at a specific location, but it is covered by an on-site removable PET plug.
- A grommet on a single softPOD can also facilitate cable access to a wall outlet.
- Grommets installed on specific dividers facilitate passage of wires through softPOD dividers into adjacent softPODs.
- Orientation of worksurfaces plays an important role when planning softPOD cluster layouts with the need to pass cables between individual softPODs as the cables are best hidden underneath.
- Worksurfaces must have opposing alignment.
- Align units in cluster plan
- Option unit type & orientation.

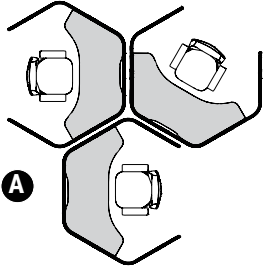

(A) Worksurfaces must have opposing alignment.

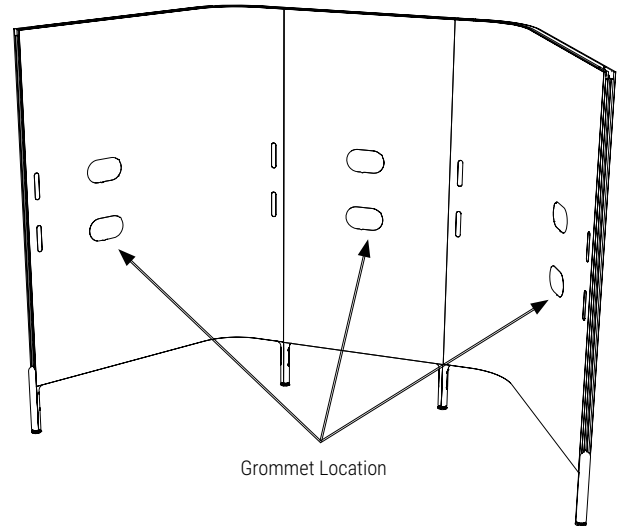

- Ceiling pole attaches to the divider grommet under worksurface.
- Location of the ceiling pole on the inside of the softPOD is determined by the contoured recess at the back of worksurface.
- White dots below indicate possible ceiling feed pole location within the Pod (must be at the same location as worksurface contoured recess).
- Grey dots indicate possible Ceiling fee pole location outside of the POD (because cables pass through the divider grommets and under the worksurface).
- Black arrows indicate possible power and data cable passage between soft-PODs (because cables pass through the divider grommet under the worksurface, through the second divider grommet and into the adjacent softPOD, under worksurface).
- In either case, the cables enter or exit the softPOD through the divider grommet.

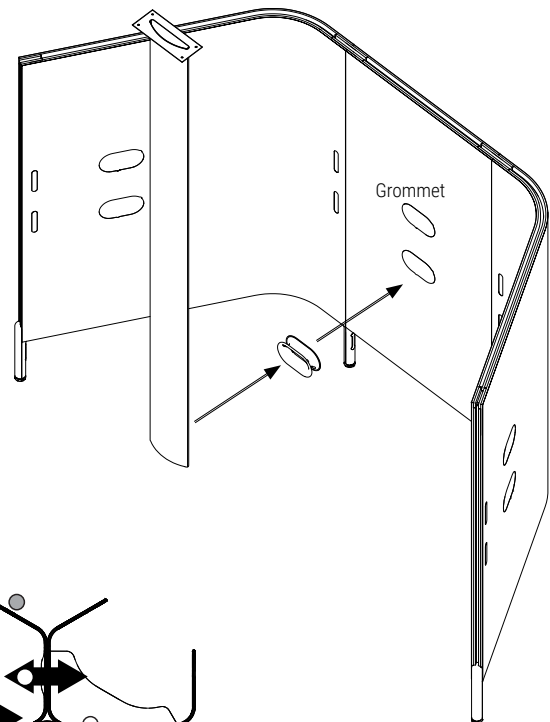

Recommended
Maximum 4 unit
cluster per 2 circuits.

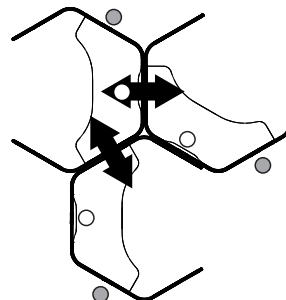
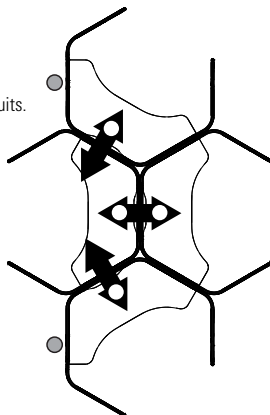

● Ceiling Feed Pole Location

ELECTRICAL OPTIONS

Direct Plug In

- Direct or floor monument outlet plug-in

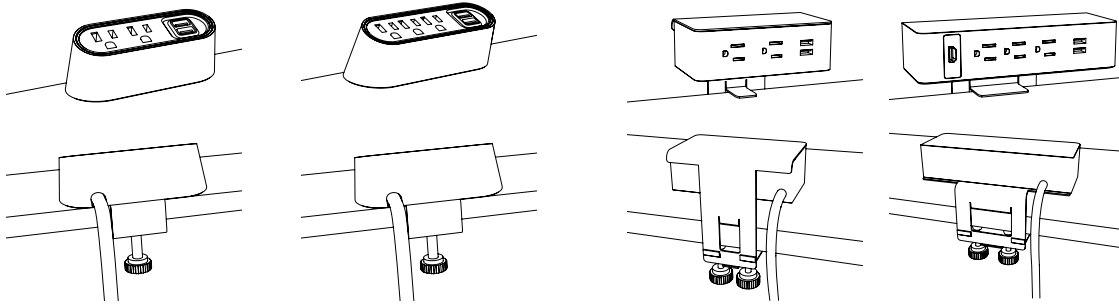

Grommet Application

- In surface.

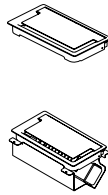
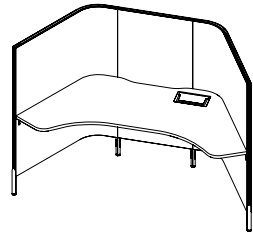

Grommet Application

- In surface Daisy Chain.

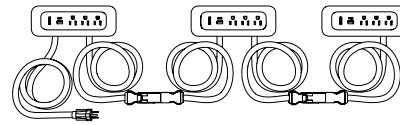
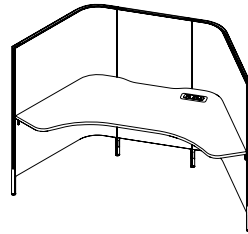

Daisy Chain Interconnect System

- Direct or floor monument outlet plug-in

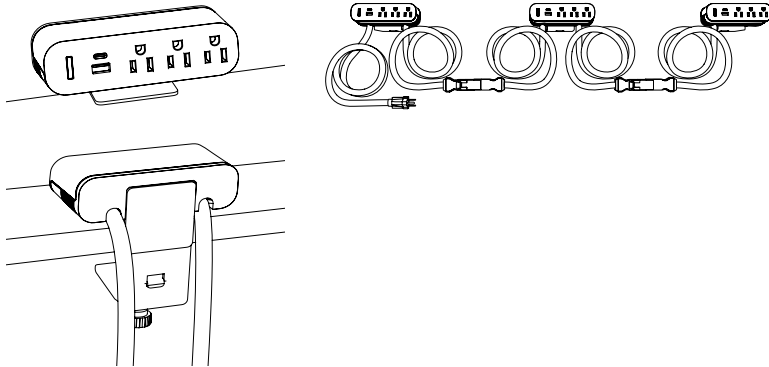

Dual Circuit Power

- Hardwired

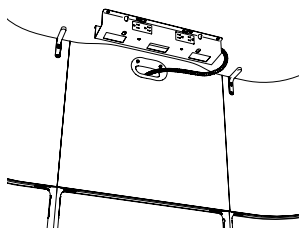
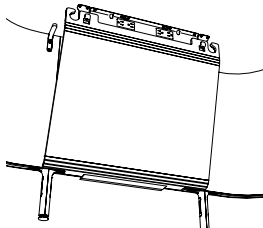

Floor Feed

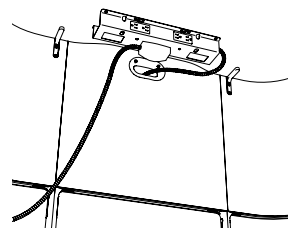

Ceiling Feed

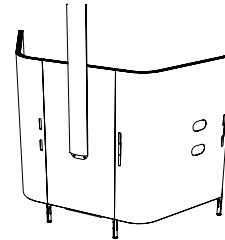

ELECTRICAL

2 Circuit, 4 Wire Power Distribution

The 4-wire, 2-circuit electrical components are housed in a metal trough, mounted under worksurface, immediately adjacent to the worksurface contoured recess.

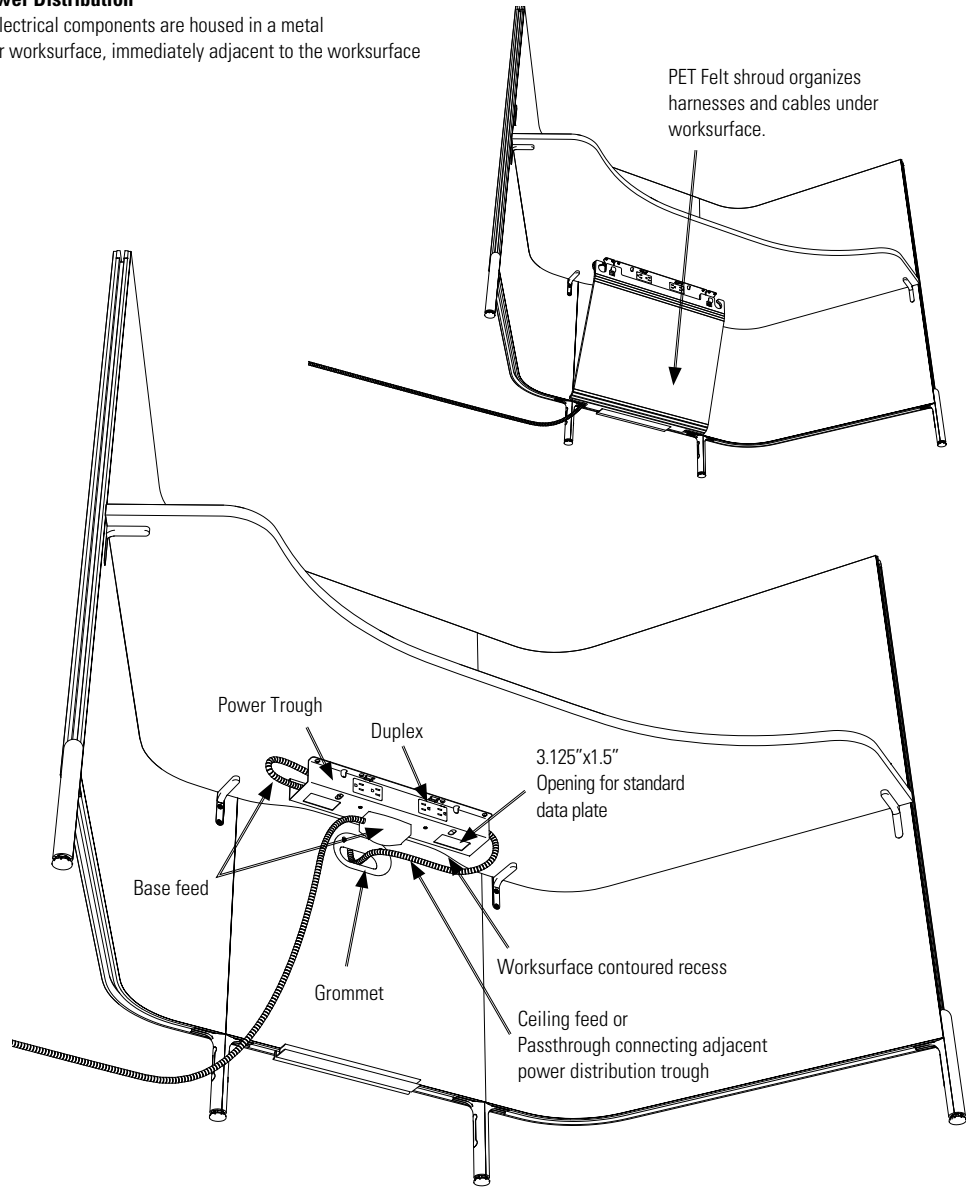

STORAGE

Hook

For hanging small items like earphones.

Shelf

PET Felt liner with rear hole to direct power cords for charging.

Rear Access

Tuck valuable items out of sight

Bag Drop

Area for storing personal items.

Pantry Storage

Multifunction, customizable storage

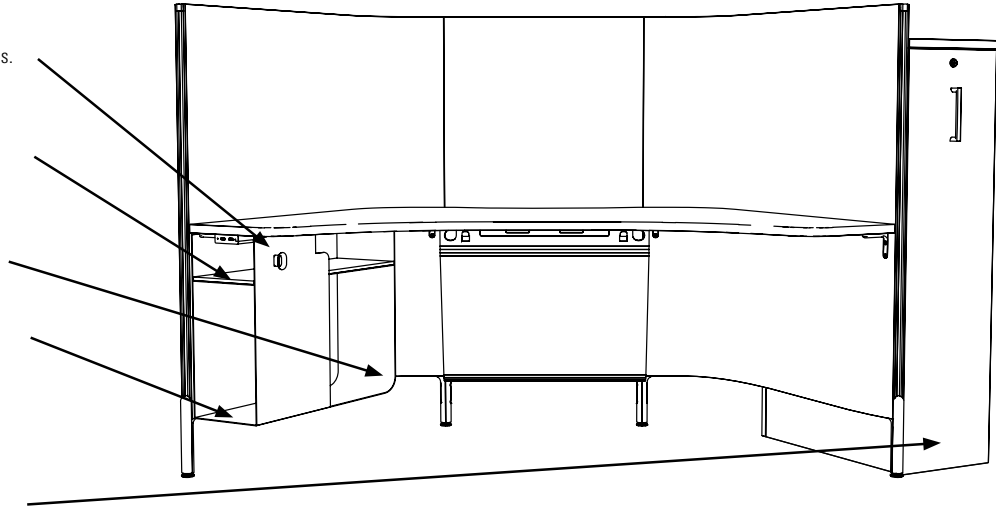

ACCESSORIES

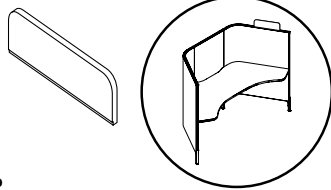

HXNP

Name Plate

Height: 3.5"

Depth: 0.5"

Width: 11"

- Two sided white dry erase surface.

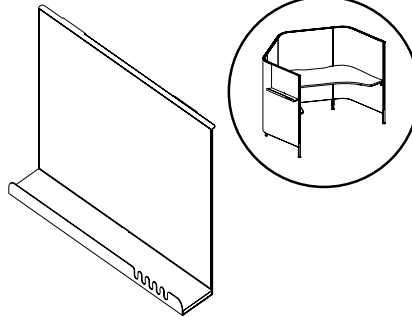

HXAHS

Hanging Shelf

Height: 16"

Depth: 3"

Width: 23.5"

- Optional dry erase board available

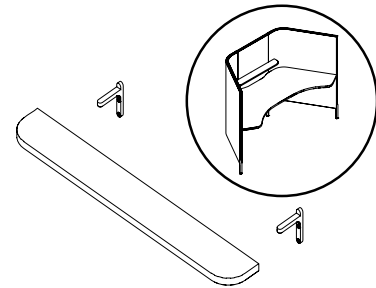

HXARWS

Rear Wall Shelf

Height: 3/4"

Depth: 4.5"

Width: 32.5"

- Laminate

NOTE : Not compatible with Ceiling Feed Pole or any monitor mounts.

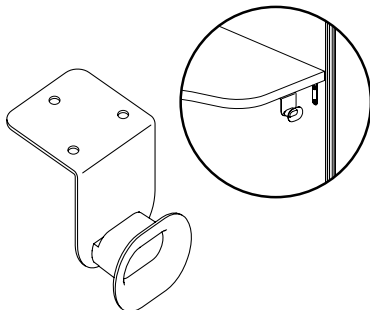

HXABG

Under Surface Bag Hook

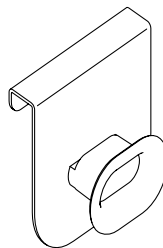

HXACHT

Coat, Bag Hook for horizontal divider edge

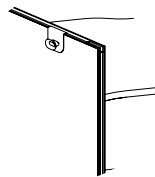

HXACHS

Coat, Bag Hook for Dividers

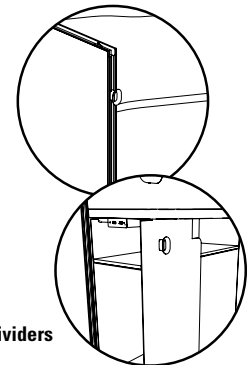

SOFTPODS AND EXTENSIONS MODEL# DIMENSIONS FREIGHT CLASS WT/LBS. CUBIC FT. LIST PRICE HP ADD

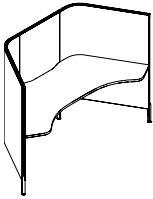

SoftPOD w/3 Dividers and Worksurface

MODEL#	DIMENSIONS D x W x H	FREIGHT CLASS	WT/LBS.	CUBIC FT.	LIST PRICE	HP ADD
HX3P5472SW	30 x 72 x 54	70	141	22.92	\$4056	\$533

Complete 3 divider pod consisting of one straight back divider, two side j-dividers and one standard worksurface. Installed pod measures 54”h from the floor, 25” from top of surface and has a clearance of 6-3/8” at floor level.

- Dividers are surfaced with tackable PET felt. Interior PET felt color may be different than the outer.
- The divider perimeter reveal trim accepts privacy extensions and is made of polypropylene available only in Charcoal (CHR).
- Worksurface choice of thermally fused or high pressure laminate with PVC edge.
- Metal legs are powder coated paint, available in Charcoal (CHR) or Designer White (DWT).
- Complete pod includes all connecting hardware, tubular legs and supporting brackets.
- Extensions, electrical, storage and accessories are specified separately.

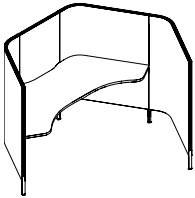

SoftPOD w/4 Dividers and Worksurface

HX4P5472SW	65 x 72 x 54	125	170	25.41	\$5092	\$533
------------	--------------	-----	-----	-------	--------	-------

Complete 4 divider pod consisting of one straight back divider, three side j-dividers and one standard worksurface. Installed pod measures 54”h from the floor, 25” from top of surface and has a clearance of 6-3/8” at floor level.

- Dividers are surfaced with tackable PET felt. Interior PET felt color may be different than the outer.
- The divider perimeter reveal trim accepts privacy extensions and is made of polypropylene available only in Charcoal (CHR).
- Worksurface choice of thermally fused or high pressure laminate with PVC edge.
- Metal legs are powder coated paint, available in Charcoal (CHR) or Designer White (DWT).
- Complete pod includes all connecting hardware, tubular legs and supporting brackets.
- J-divider may be installed on the left or right.
- Extensions, electrical, storage and accessories are specified separately.

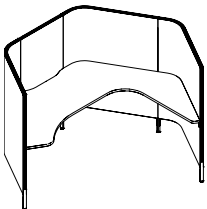

right shown

SoftPOD w/4 Dividers and Wraparound Worksurface

Left:						
HX4P5472LW	65 x 72 x 54	125	185	25.41	\$5543	\$751
Right:						
HX4P5472RW	65 x 72 x 54	125	185	25.41	\$5543	\$751

Complete 4 divider pod consisting of one straight back divider, three side j-dividers and one standard wraparound worksurface. Installed pod measures 54”h from the floor, 25” from top of surface and has a clearance of 6-3/8” at floor level.

- Dividers are surfaced with tackable PET felt. Interior PET felt color may be different than the outer.
- The divider perimeter reveal trim accepts privacy extensions and is made of polypropylene available only in Charcoal (CHR).
- Worksurface choice of thermally fused or high pressure laminate with PVC edge.
- Metal legs are powder coated paint, available in Charcoal (CHR) or Designer White (DWT).
- Complete pod includes all connecting hardware, tubular legs and supporting brackets.
- Extensions, electrical, storage and accessories are specified separately.

Required specifications

PET felt interior finish
 PET felt exterior finish
 Laminate finish
 Edge finish / Leg finish

Optional specifications

HP laminate
 Grommet option

Accessories

Keyboard tray
 Power block

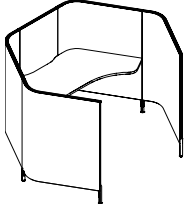
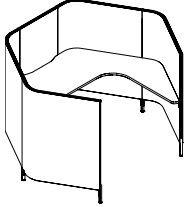
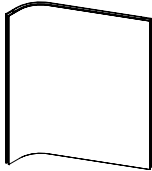
WORKSURFACES	MODEL#	DIMENSIONS	FREIGHT CLASS	WT/LBS.	CUBIC FT.	LIST PRICE	HP ADD		
 <p>SoftPOD w/5 Dividers and Worksurface</p>	D x W x H								
	HX5P5472SW	65 x 72 x 54	125	198	25.41	\$6218	\$534		
<p>Complete 5 divider pod consisting of one straight back divider, four side j-dividers and one standard workspace. Installed pod measures 54" h from the floor, 25" from top of surface and has a clearance of 6-3/8" at floor level.</p> <ul style="list-style-type: none"> • Dividers are surfaced with tackable PET felt. Interior PET felt color may be different than the outer. • The divider perimeter reveal trim accepts privacy extensions and is made of polypropylene available only in Charcoal (CHR). • Worksurface choice of thermally fused or high pressure laminate with PVC edge. • Metal legs are powder coated paint, available in Charcoal (CHR) or Designer White (DWT). • Complete pod includes all connecting hardware, tubular legs and supporting brackets. • J-dividers can be installed both on left or right side or one on each side. • Extensions, electrical, storage and accessories are specified separately. 									
 <p>SoftPOD w/5 Dividers and Wraparound Worksurface</p> <p style="text-align: right;"><i>right shown</i></p>	Left:								
	HX5P5472LW	65 x 72 x 54	100	213.36	25.41	\$6604	\$750		
		Right:							
		HX5P5472RW	65 x 72 x 54	100	213.36	25.41	\$6604	\$750	
<p>Complete 5 divider pod consisting of one straight back divider, four side j-dividers and one standard wraparound workspace. Installed pod measures 54" h from the floor, 25" from top of surface and has a clearance of 6-3/8" at floor level.</p> <ul style="list-style-type: none"> • Dividers are surfaced with tackable PET felt. Interior PET felt color may be different than the outer. • The divider perimeter reveal trim accepts privacy extensions and is made of polypropylene available only in Charcoal (CHR). • Worksurface choice of thermally fused or high pressure laminate with PVC edge. • Metal legs are powder coated paint, available in Charcoal (CHR) or Designer White (DWT). • Complete pod includes all connecting hardware, tubular legs and supporting brackets. • J-divider may be installed on the left or right. • Extensions, electrical, storage and accessories are specified separately. 									
 <p>Single J-divider</p>	HXP5430AP								
		6 x 30 x 54	300	28.3	16.17	\$1161			
<p><i>To be ordered as an add-on to a previously ordered 3-divider or 4-divider pod. A single divider is curved; non-handed; symmetrical along the horizontal axis. J-dividers are surfaced with PET felt. Interior PET felt color may be different than the outer. Installed pod measures 54" h from the floor, 25" from top of surface and has a clearance of 6-3/8" at floor level.</i></p> <ul style="list-style-type: none"> • The divider perimeter reveal trim accepts privacy extensions and is made of polypropylene available only in Charcoal (CHR). • J-divider comes complete with top connector kit, shared leg kit and trim. • If a single J-divider is ordered as an add-on to a previous order, the PET felt finish may or may not match based on dyelot and fading. • J-divider is not freestanding. 									

Required specifications

PET felt interior finish
 PET felt exterior finish
 Laminate finish
 Edge finish / Leg finish

Optional specifications

HP laminate
 Grommet option

Accessories

Keyboard tray
 Power block

EXTENSIONS MODEL# DIMENSIONS FREIGHT CLASS WT/LBS. CUBIC FT. LIST PRICE

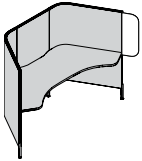

End PET Felt Extension Divider Add-on

	D x W x H					
HXPAEFE	0.35 x 9.3 x 25.4	70	0.63	0.05		\$56

Designed to add 8.7" of additional depth privacy at the end of the divider. Fits into the base perimeter reveal and placement is user oriented.

- PET felt divider surface is tackable.
- *Not available with perforated pattern.*

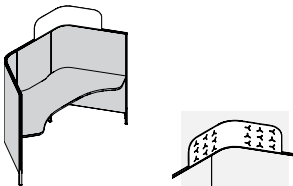

Corner PET Felt Extension Divider Add-on

HXPACFE	0.35 x 38.3 x 11.69	70	1.16	0.09		\$99
HXPACFEP	0.35 x 38.3 x 11.69	70	1.16	0.09		\$296

Designed to add 11.1" of additional height privacy at the top corner of the divider. Fits into the divider perimeter reveal and placement is user oriented. Pod with Corner PET Felt Extension Divider Add-on installed measures 65" from floor, 36" from top of work surface.

- PET felt divider surface is tackable.
- Perforated pattern option available, shown with "P" at the end of the code.

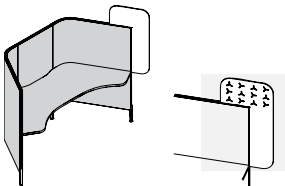

Top Corner PET Felt Extension Divider Add-on



HXPATCFE	0.35 x 19.5 x 37.1	70	1.25	0.15		\$108
HXPATCFEP	0.35 x 19.5 x 37.1	70	1.25	0.15		\$258

Designed to add 8.7" of additional height privacy at the top of the divider and 11.1" depth at the end of the divider. Fits into the divider perimeter reveal and placement is user oriented. Pod with Corner PET Felt Extension Divider Add-on installed measures 65" from floor, 36" from top of work surface.

- PET felt divider surface is tackable.
- Perforated pattern option available, shown with "P" at the end of the code.

Required specifications

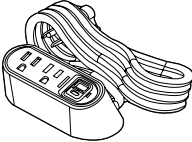
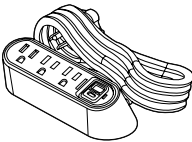
PET felt color

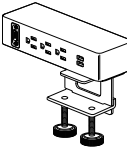
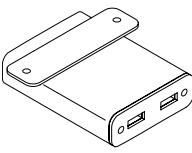
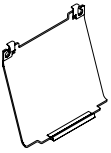
POWER/DATA	MODEL#	DIMENSIONS D x W x H	FREIGHT CLASS	WT/LBS.	CUBIC FT.	LIST PRICE
 <p>DPC Slim Desktop 2 Power/USB-A and -C</p>	PSDPC22W	2.25 x 4.88 x 2.25	60	2.5	0.05	\$307
<p>Desktop power center with two 15A tamper resistant power receptacles, one USB-A port and one USB-C port (provides 3.1A). 10' cord with molded plug. Includes three mounting options: a screw-in mounting plate for forward facing outlets; under surface mount bracket; or a clamp mounting kit for 0.5"-1.5" thick surfaces. Gloss White body with Grey face.</p>						
 <p>DPC Slim Desktop 3 Power/USB-A and -C</p>	PSDPC32W	2.25 x 6 x 2.25	60	2.6	0.05	\$405
<p>Desktop power center with three 15A tamper resistant power receptacles, one USB-A port and one USB-C port (provides 3.1A). 10' cord with molded plug. Includes three mounting options: a screw-in mounting plate for forward facing outlets; under surface mount bracket; or a clamp mounting kit for 0.5"-1.5" thick surfaces. Gloss White body with Grey face.</p>						
 <p>Duo Module</p>	BRED50	3.2 x 5.5 x 1.8	70	2.5	0.14	\$386
<p>The duo power module is completely integrated with a mounting clamp to attach to the edge of a worksurface. Provides two outlets and two 2.1 amp USB ports. White face plate, outlets and bracket; 72" long three-prong black cord, silver body.</p>						
 <p>Trio Plus Module</p>	BRETP53	3.2 x 8 x 1.8	70	2.5	0.14	\$436
<p>The trio plus power module is completely integrated with a mounting clamp to attach to the edge of a worksurface or above worksurface shelves. Provides three outlets and two 2.1 amp USB ports and an adapter kit containing blank cover, HDMI, RJ45 or VGA adapter brackets. Note: HDMI, RJ45 and VGA connectors are not included. White face plate, outlets, adapters and brackets; 72" long three-prong black cord.</p>						
 <p>Under Worksurface/Edge USB Charger</p>	HXEUWC	4 x 3 x 1	70	0.31	0.01	\$512
<p>Under surface table-mounted module with dual USB-A & -C charging ports. Consists of one 15 watt USB-C charging outlet and one 2.1 amp USB-A charging outlet. Unit has white housing, white powder coated mounting bracket and white electrical cord.</p>						
 <p>Cable Shroud*</p>	HXECS	9.73 x 23.5 x 20.85	70	1.62	2.87	\$106
<p>Secures to the bottom of the worksurface and clips to the bottom of straight section of any divider. Includes all connecting hardware. Specify PET felt color.</p>						

Required specifications
 PET felt color*

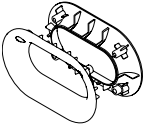
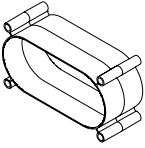
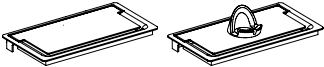
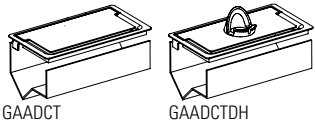
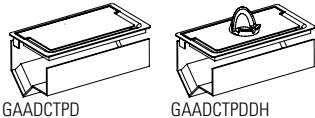
POWER/DATA	MODEL#	DIMENSIONS D x W x H	FREIGHT CLASS	WT/LBS.	CUBIC FT.	LIST PRICE
 <p>Divider Grommet Kit*</p>	HXEPPGK	2.75 x 5.5 x 3.25	70	0.27	0.02	\$41
	<p>Facilitates passage of wires through any softPOD divider. Can be located either below or above the worksurface. Installed on site; no need to order special dividers. Powder coated die-cast aluminum divider grommet - specify Charcoal (CHR) or White (DWT). Can be installed on a single panel or to connect two panels when used in conjunction with the Divider Grommet Connector/Spacer.</p>					
 <p>Divider Grommet Connector/Spacer</p>	HXEPPGCS	2.75 x 5.5 x 3.25	70	0.04	0.01	\$19
	<p>Converts any divider grommet kit into a connector. Clamps two dividers together through the divider grommet opening. Can be located above or below the worksurface at pre-determined locations. Specify with the Divider Grommet Kit or use with the Divider Grommet Kit included in the Station 2-Circuit Power Kit. Made of injection molded ABS in Charcoal (CHR).</p>					
 <p>GAADG GAADGDH</p> <p>Access Door Module</p>	GAADG	5.54 x 10.09 x 1.08	--	2	0.04	\$90
	GAADGDH	5.54 x 10.09 x 1.08	--	2	0.04	\$97
<p>Soft close door is set back from edge to allow for cable pass thru when closed. Available in all standard base finishes. GAADGDH includes device holder for most mobile phones or tablets. Holder is only available in White. SoftPOD can only accommodate one grommet per worksurface.</p>						
 <p>GAADCT GAADCTDH</p> <p>Access Door Module w/Cable Tray</p>	GAADCT	5.54 x 10.09 x 5.07	--	4	0.19	\$145
	GAADCTDH	5.54 x 10.09 x 5.07	--	4	0.19	\$153
<p>Soft close door is set back from edge to allow for cable pass thru when closed. Cable tray comes standard with one telecom knockout and platform to mount a power bar. Sides are open for easy access. Available in all standard base finishes. GAADCTDH includes device holder for most mobile phones or tablets. Holder is only available in White. SoftPOD can only accommodate one grommet per worksurface.</p>						
 <p>GAADCTPD GAADCTPDDH</p> <p>Access Door Module w/Cable Tray and Power Bar</p>	GAADCTPD	5.54 x 10.09 x 6.96	--	4	0.20	\$307
	GAADCTPDDH	5.54 x 10.09 x 6.96	--	4	0.20	\$316
<p>Soft close door is set back from edge to allow for cable pass thru when closed. Cable tray comes standard with one telecom knockout and platform to mount a powerbar. Power bar with 3 simplex and 2 USB, CSA Certified. Sides are open for easy access. Available in all standard base finishes. GAADCTPDDH includes device holder for most mobile phones or tablets. Holder is only available in White. SoftPOD can only accommodate one grommet per worksurface.</p>						

Required specifications
Grommet finish*

POWER/DATA	MODEL#	DIMENSIONS	FREIGHT CLASS	WT./LBS.	CUBIC FT.	LIST PRICE
------------	--------	------------	---------------	----------	-----------	------------

D x W x H

- Connect up to four units from a single infeed, delivering AC power and USB charging to the table tops.
- Starter modules include 10' corded infeed with three prong NEMA plug.
- Touch safe easy to use connectors from module to module with added latch to prevent unintended separation.
- Each module features three tamper-resistant receptacles, USB-A and USB-C charging ports.
- Overall maximum length joined together not to exceed 48.5 feet per infeed.
- UL listed to **UL962A SD**, the standard for furniture power distribution units on portable/movable workspace tables.
- Certified to CSA standard **C22.2 No. 203-16**.
- On-surface modules come with a clamp mount that will accommodate any material from 0.5" to 1.5" thick; additional brackets are also included for alternate screw in mounting options that can accommodate vertical or horizontal positions.

On Surface

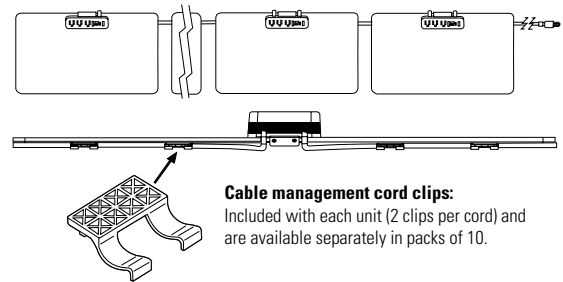

Cable management cord clips:
Included with each unit (2 clips per cord) and are available separately in packs of 10.

MODPOWER DAISY-CHAIN SOLUTION	MODEL#	DIMENSIONS	FREIGHT CLASS	WT./LBS.	CUBIC FT.	LIST PRICE
-------------------------------	--------	------------	---------------	----------	-----------	------------

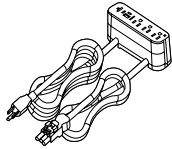

ModPower On-Surface Starter Unit*

PMDSA10MG	1.75 x 6.13 x 2.5	150	4.33	1	\$551
PMDSA10WH	1.75 x 6.13 x 2.5	150	4.33	1	\$551

Includes infeed, one 10' cord with NEMA plug and one 3' connector cord. Unit is equipped with three 15A tamper-resistant receptacles, one USB-A and one USB-C charging ports, and a circuit breaker. Includes edge clamp and three other mounting methods. Four cable management cord clips included. Available in Magnesium (**MG**) or White (**WH**) finish as indicated by last characters of model number. UL Listed: UL 962A.

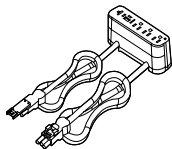

ModPower On-Surface Middle Unit*

PMDCA3MG	1.75 x 6.13 x 2.5	250	3.33	1	\$521
PMDCA3WH	1.75 x 6.13 x 2.5	250	3.33	1	\$521

Includes two 3' connector cords. Unit is equipped with three 15A rated 12A tamper-resistant receptacles, one USB-A and one USB-C charging ports, and a circuit breaker. Includes edge clamp and three other mounting methods. Four cable management cord clips included. Available in Magnesium (**MG**) or White (**WH**) finish as indicated by last characters of model number. UL Listed: UL 962A.

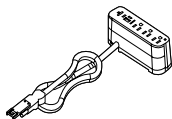

ModPower On-Surface End Unit*

PMDEA3MG	1.75 x 6.13 x 2.5	250	2.75	1	\$459
PMDEA3WH	1.75 x 6.13 x 2.5	250	2.75	1	\$459

Includes one 3' connector cord. Unit is equipped with three 15A rated 12A tamper-resistant receptacles, one USB-A and one USB-C charging ports, and a circuit breaker. Includes edge clamp and three other mounting methods. Two cable management cord clips included. Available in Magnesium (**MG**) or White (**WH**) finish as indicated by last characters of model number. UL Listed: UL 962A.

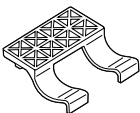

ModPower Cable Management Clips

PMDCLIPS	2.5 x 2.6 x .6	70	0.03	0.02	\$92
----------	----------------	----	------	------	-------------

Package of 10 clips.

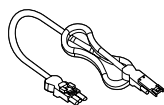

ModPower Interconnecting Jumper

PMDJ36BK	-- x 36 x --	70	1.38	0.09	\$308
----------	--------------	----	------	------	--------------

Interconnection jumper cord to add an additional 3' of cord length between in-surface and on-surface ModPower units. 3' cord with male and female connector. Package of 2 jumpers. UL Listed: UL 962A.

ELECTRICAL

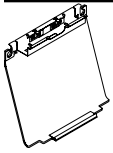

Station 2-Circuit Power Kit*

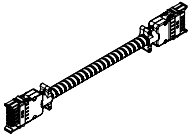

Station to Station Jumper

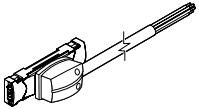

Base Feed

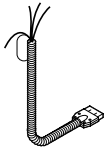

Ceiling Feed



Ceiling Pole**

MODEL#	DIMENSIONS D x W x H	FREIGHT CLASS	WT./LBS.	CUBIC FT.	LIST PRICE
HXEPK11	9.73 x 23.5 x 20.85	300	3.92	2.76	\$434
HXEPK12	9.73 x 23.5 x 20.85	300	3.92	2.76	\$434
HXEPK22	9.73 x 23.5 x 20.85	300	3.92	2.76	\$434

Station 2-Circuit power kit consists of two duplexes, trough, cable shroud and divider grommet. Accommodates up to two standard data plates (data plates not included). Accommodates center mount single or dual screen monitor arm. Facilitates 2-circuit power delivery. Facilitates power connection between stations. Specify Station to Station Jumper. Specify duplex circuit #1, #2 or combination of #1+2. Ceiling or base feed not included - specify separately. Trough is powder coated metal in Charcoal (CHR). Includes all connecting hardware, supporting brackets and through divider grommet.

HXEPPJ	2 x 60 x 2	60	5	0.13	\$168
--------	------------	----	---	------	--------------

Facilitates power connection between stations (through divider grommet, under the worksurface).

HXEBF	2 x 72 x 2	60	5.6	0.06	\$367
-------	------------	----	-----	------	--------------

Provides single power entry from floor into 2-Circuit Power Kit under worksurface. 6' long liquid tight whip plugs into the side of the left or right duplex. Must be hard wired to the building power supply by a licensed electrician. Base feed jumper included.

HXECF	2 x 144 x 2	60	5.6	0.06	\$249
-------	-------------	----	-----	------	--------------

Ceiling feed plugs into side of left or right duplex mounted within the 2-Circuit Power Kit. 10' long metal conduit, ready to be hardwired to building power supply. Strain relief fitting provided; junction box is not included. To be used with HXECFP - Ceiling Feed Pole.

HXECFP	1.5 x 6 x 116	85	5.49	0.38	\$210
--------	---------------	----	------	------	--------------

Manages power and data cables between ceiling and worksurface. Aluminum extrusion with PVC cover secures to the divider grommet and passes below worksurface through the worksurface contoured recess. Includes mounting hardware and ceiling bezel. Hardware for securing the pole above ceiling tile is not included. Specify paint finish. Ceiling Feed HXECF must be ordered separately. PVC cover is standard in Charcoal (CHR). Cover can be removed to access cabling inside.

Required specifications

PET felt color*
Paint finish**

STORAGE	MODEL#	DIMENSIONS	FREIGHT CLASS	WT/LBS.	CUBIC FT.	LIST PRICE	HP ADD
---------	--------	------------	---------------	---------	-----------	------------	--------

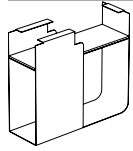

Under Worksurface Casual Storage Unit*

D x W x H
 HXSCSO 24 x 8 x 21 150 20.18 4.22 **\$456** n/a

Open storage with shelf; extension at the back provides side compartment. Sheet metal construction with PET felt liner. 24"D. Secures to bottom of worksurface. Order coat hook HXACHS, attaches to either left or right side of storage unit (sold separately).

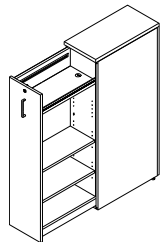

Left (NL) shown

Pantry Storage**

FFPO1224H54NL	24 x 12 x 54	70	138	9	\$2551	\$29
FFPO1230H54NL	30 x 12 x 54	85	153	11	\$2673	\$29
FFPO1236H54NL	36 x 12 x 54	92.5	167	14	\$2796	\$40
FFPO1224H54NR	24 x 12 x 54	70	138	9	\$2551	\$29
FFPO1230H54NR	30 x 12 x 54	85	153	11	\$2673	\$29
FFPO1236H54NR	36 x 12 x 54	92.5	167	14	\$2796	\$40
FFPO1824H54NL	24 x 18 x 54	92.5	166	14	\$2956	\$40
FFPO1830H54NL	30 x 18 x 54	92.5	182	17	\$3090	\$51
FFPO1836H54NL	36 x 18 x 54	100	197	20	\$3223	\$57
FFPO1824H54NR	24 x 18 x 54	92.5	166	14	\$2956	\$40
FFPO1830H54NR	30 x 18 x 54	92.5	182	17	\$3090	\$51
FFPO1836H54NR	36 x 18 x 54	100	197	20	\$3223	\$57

The pull out cabinet serves as a multifunctional, customizable storage unit that both defines space and enhances privacy in an open plan environment. Internal organization consists of two fixed shelves on the top and bottom. The two middle shelves are adjustable. Two accessory rails (each 18.25" long) are standard and will accept metal accessories (sold separately - see previous page). Interior cabinet shelves and back are standard in Designer White. Cabinet shell, drawer and top can be specified in any standard laminate. FFPOxxxx will not allow binders.

- For Dry-erase marker board, specify **DE** and add **\$392**. If specified, the dry-erase marker laminate will be applied to the external surface of the pull-out drawer side wall.

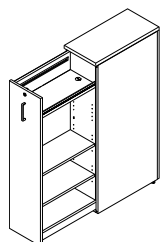

Left (NL) shown

Pantry Storage - w/USB**

FFPO1224H54NLUSB	24 x 12 x 54	70	138	9	\$3126	\$29
FFPO1230H54NLUSB	30 x 12 x 54	85	153	11	\$3248	\$29
FFPO1236H54NLUSB	36 x 12 x 54	92.5	167	14	\$3370	\$40
FFPO1224H54NRUSB	24 x 12 x 54	70	138	9	\$3126	\$29
FFPO1230H54NRUSB	30 x 12 x 54	85	153	11	\$3248	\$29
FFPO1236H54NRUSB	36 x 12 x 54	92.5	167	14	\$3370	\$40
FFPO1824H54NLUSB	24 x 18 x 54	92.5	166	14	\$3530	\$40
FFPO1830H54NLUSB	30 x 18 x 54	92.5	182	17	\$3665	\$51
FFPO1836H54NLUSB	36 x 18 x 54	100	197	20	\$3798	\$57
FFPO1824H54NRUSB	24 x 18 x 54	92.5	166	14	\$3530	\$40
FFPO1830H54NRUSB	30 x 18 x 54	92.5	182	17	\$3665	\$51
FFPO1836H54NRUSB	36 x 18 x 54	100	197	20	\$3798	\$57

The pull out cabinet serves as a multifunctional, customizable storage unit that both defines space and enhances privacy in an open plan environment. Internal organization consists of two fixed shelves on the top and bottom. Top shelf comes with grey felt surface and grommet which allows for cable passage from the USB outlet (located below the top shelf). A 2-prong power cord exits the cabinet through the floor at the back. The two middle shelves are adjustable. Two accessory rails (each 18.25" long) are standard and will accept metal accessories (sold separately - see previous page). Interior cabinet shelves and back are standard in Designer White. Cabinet shell, drawer and top can be specified in any standard laminate. FFPOxxxx will not allow binders.

- For Dry-erase marker board, specify **DE** and add **\$392**. If specified, the dry-erase marker laminate will be applied to the external surface of the pull-out drawer side wall.

Required specifications
 Paint finish*
 Laminate finish**

TASK LIGHTING

D x W x H

Mounting Options for Voyage and Revo Lights:

- Freestanding Base (**FS**)
- Freestanding Base with USB charge port (**FSUSB**) - Add **\$104**.
- Surface Mount (**SM**)
- Clamp Mount (**CM**)

REVO + VOYAGE

MODEL# DIMENSIONS FREIGHT CLASS WT/LBS. CUBIC FT. LIST PRICE



Voyage - Single Arm

LINLAMPS	6 x 6 x 14.1	60	2.66	.01	\$672
----------	--------------	----	------	-----	--------------

Fully articulating body with single arm. 6' power cord. Touch and hold dimming capability, with auto shut-off after 10 hours. Brightness adjustment from 100% to 15%. 18 fractional LEDs, 337 lumens, 3500K color temperature. 85 CRI. 94% post consumer recyclability by weight. Available in Black (BLK), White (WHT) and Silver (SLV). Mounting accessories sold separately (see above). Optional integrated USB port in base (**FSUSB**) allows for charging of mobile devices. UL Listed: UL 1153:2014.

- Occupancy Sensor (**OS**) - Add **\$78**

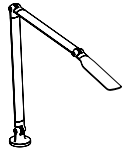

Voyage - Double Arm

LINLAMPD	6 x 6 x 21.6	60	2.66	.01	\$688
----------	--------------	----	------	-----	--------------

Fully articulating body with double arm. 6' power cord. Touch and hold dimming capability, with auto shut-off after 10 hours. Brightness adjustment from 100% to 15%. 18 fractional LEDs, 337 lumens, 3500K color temperature. 85 CRI. 94% post consumer recyclability by weight. Available in Black (BLK), White (WHT) and Silver (SLV). Mounting accessories sold separately (see above). Optional integrated USB port in base (**FSUSB**) allows for charging of mobile devices. UL Listed: UL 1153:2014.

- Occupancy Sensor (**OS**) - Add **\$78**

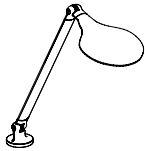

Revo - Single Arm

RNDLAMPS	6 x 6 x 14.1	60	2.66	.01	\$672
----------	--------------	----	------	-----	--------------

Fully articulating body with single arm. 6' power cord. Touch and hold dimming capability, with auto shut-off after 10 hours. Brightness adjustment from 100% to 15%. 18 fractional LEDs, 294 lumens, 3500K color temperature. 85 CRI. 94% post consumer recyclability by weight. Available in Black (BLK), White (WHT) and Silver (SLV). Mounting accessories sold separately (see above). Optional integrated USB port in base (**FSUSB**) allows for charging of mobile devices. UL Listed: UL 1153:2014.

- Occupancy Sensor (**OS**) - Add **\$78**

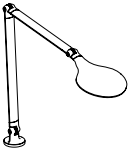

Revo - Double Arm

RNDLAMPD	6 x 6 x 21.6	60	2.66	.01	\$688
----------	--------------	----	------	-----	--------------

Fully articulating body with double arm. 6' power cord. Touch and hold dimming capability, with auto shut-off after 10 hours. Brightness adjustment from 100% to 15%. 18 fractional LEDs, 294 lumens, 3500K color temperature. 85 CRI. 94% post consumer recyclability by weight. Available in Black (BLK), White (WHT) and Silver (SLV). Mounting accessories sold separately (see above). Optional integrated USB port in base (**FSUSB**) allows for charging of mobile devices. UL Listed: UL 1153:2014.



- Occupancy Sensor (**OS**) - Add **\$78**

Required Specifications

- Finish
- Mount

Optional Specifications

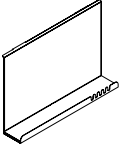
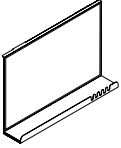
- Occupancy Sensor

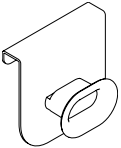
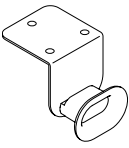
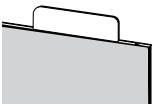
ACCESSORIES	MODEL#	DIMENSIONS	FREIGHT CLASS	WT/LBS.	CUBIC FT.	LIST PRICE	HP ADD
 <p>Hanging Shelf*</p>		D x W x H					
	HXAHS	3 x 23.5 x 16	150	8.8	1.91	\$145	n/a
<p>Suspends from the divider's top reveal. Installed board measures 16" from top; 9" from top of worksurface. Shelf is painted metal, tray insert is PET felt. Magnetic.</p>							
 <p>Hanging Shelf w/Dry Erase Board*</p>		D x W x H					
	HXAHSWB	3 x 23.5 x 16	150	9.57	1.91	\$555	n/a
<p>Suspends from the divider's top reveal. Installed board measures 16" from top; 9" from top of worksurface. White surface, painted metal frame, tray insert is PET felt. Magnetic.</p>							
 <p>Rear Wall Shelf**</p>		D x W x H					
	HXARWS	4.5 x 32.25 x 0.75	250	2.8	1.13	\$148	\$41
<p>3/4" laminate shelf; non-handed, with pre-determined mounting points. 2.5" front radii. <i>Not compatible with Ceiling Feed Pole or any monitor mounts.</i></p>							
 <p>Coat/Bag Hook for Dividers*</p>		D x W x H					
	HXACHS	0.75 x 1.25 x 2	70	0.05	0.01	\$42	n/a
<p>Can be installed anywhere along the divider perimeter reveal or either side of the Under Surface Casual Storage Unit. Made of die-cast aluminum; plug insert is PET felt.</p>							
 <p>Coat/Bag Hook for Divider Edge*</p>		D x W x H					
	HXACHT	0.75 x 1.25 x 2	70	0.23	0.01	\$49	n/a
<p>Can be installed anywhere along the divider perimeter reveal or either or both sides of any divider. Made of die-cast aluminum with steel brackets; plug insert is PET felt.</p>							
 <p>Under Surface Bag Hook*</p>		D x W x H					
	HXABH	0.75 x 1.25 x 2	70	0.18	0.01	\$46	n/a
<p>Can be secured to the bottom of worksurface. Made of die-cast aluminum with steel brackets; plug insert is PET felt.</p>							
 <p>Name Plate</p>		D x W x H					
	HXNP	0.5 x 10.75 x 3.625	70	0.26	0.01	\$84	n/a
<p>Sits inside the divider top reveal. Two-sided white dry erase surface laminated to 1/2" PET felt. Can be mounted horizontally or vertically.</p>							

Required specifications

Paint finish*
Laminate finish**

Optional Specifications

HP laminate**



Productivity Solutions™ by Global is a comprehensive series of ergonomically sound products, naturally connecting people with technology to enhance comfort and productivity. Designed to Fit you and your technology and fully integrate with Global Furniture Group products to create complete office solutions that meet the needs of today's diverse workplaces.

Designed with human capabilities and comfort in mind, Productivity Solutions by Global provide a good Fit for today's workers and meet or exceed ergonomics standards, guidelines and ANSI/BIFMA standards for performance, durability and safety.

FIT = Move + Match + Support



Monitor Arms



Power/Data Module



Lift n Lock Keyboard Tray



Foli Electric Height Adjustable Table



Manual Height Adjustable Desk

Features and Benefits

- Foli Height Adjustable Table with 18.4" height range
- Manual Height Adjustable Table has counterbalanced spring mechanism
- 4 keyboard support mechanisms
- 5 keyboard trays
- New monitor arm options
- Wire management and power/data options
- Meets ANSI-BIFMA, Greenguard Indoor Air Quality, Greenguard Gold Certified
- Height Adjustable Tables are BIFMA level 2 certified

MANUAL HEIGHT ADJUSTABLE TABLES

- Manually operated height adjustable tables with counterbalanced spring mechanism
- Exceptional ergonomic alternative to traditional desking
- Sit-Stand design promotes increased circulation, improving performance and comfort
- Can be used alone or in conjunction with Global desks.

Please note: Global desks are 1" or 1.5" thick.

- Meets ANSI/BIFMA requirements

TOP FINISHES

ACJ Absolute Acajou	FCL First Class
ASN Asian Night	NBL Noce Biondo
AWC Avant Cherry	NGL Noce Grigio
AWH Avant Honey	NEL Noce Leggero
BLK Black	NML Noce Medio
BZD Blizzard	QTM Quartered Mahogany
BRC Brushed Cobalt	SBY Sheer Beauty
CMB Clear Maple	SOG Storm Grey
CGY Custom Grey	SDT Stonedust
DES Dark Espresso	WHE Walnut Heights
DWT Designer White	WHC White Chocolate
FAS Fashionista	WCR Winter Cherry

CONSTRUCTION

- 1" thick tops constructed of 45 lb. density particle board with high performance thermally fused laminate

DIMENSIONS

- When designing workstations, leave 1" clearance on either side to prevent finger pinch

EDGE

- Preferred matching edge

BASE

- Heavy duty steel formed legs with radius detail are available in Black only
- Easy to reach tension control supports loads up to 100 lbs.
- Environmentally friendly, recyclable epoxy powder coating provides a durable finish. Black only.
- Black plastic leveling glides offer 0.5" adjustability

GROMMETS

- Grommets available in standard worksurface locations (left, center or right)
- Order as: **AG1, AG2 or AG3. Add \$96.**

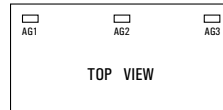

- Grommet hole dimensions are 3 1/4" wide x 1 7/8" deep

MECHANISM

- Counterbalanced height adjustable base supports weights up to 100 lbs.
- Height range from floor to underside of modesty shroud is 17" when surface height is 26"
- 7 year warranty

SHIPPING

- Shipped RTA (Ready to Assemble)
- Easy to assemble with Phillips or Robertson screwdriver

	MODEL#	DIMENSIONS D x W x H	FREIGHT CLASS	WT/LBS.	CUBIC FT.	LIST PRICE	
<p>Rectangular Table</p>	Rectangular Tops:						
		HTM3058T	30 x 58 x 1	70	50	2.50	\$553
		HTM3046T	30 x 46 x 1	70	40	2	\$463
		HTM2458T	24 x 58 x 1	70	40	2	\$424
		HTM2446T	24 x 46 x 1	70	32	1.50	\$394
		Base:					
	KEZLIFT	24 x 34.5 x 26-46	70	88	5.40	\$2961	

Paddle activated height adjustable base. Height adjustable from 26" to 46". Keyboard tray and mechanism not necessary

- **Specify base separately from top**

Required Specifications
Top Finish

FOLI ELECTRIC HEIGHT ADJUSTABLE TABLES

D x W x H

- Electric height adjustment allows for easy movement from sitting to standing and back throughout the day. Foli's work surface moves with you and your work without interruption.
- Foli offers a universal freestanding design and finish options to easily integrate with existing Global workstation configurations, becoming a natural part of your office space
- Whether in a private or general office, touch-down space, collaborative area or home office, Foli supports a more active and healthy work style
- Can be used alone or in conjunction with Global desks. Please note Global desks are 1" or 1.5" thick.

TOP FINISHES

ACJ	Absolute Acajou	FCL	First Class
ASN	Asian Night	NBL	Noce Biondo
AWC	Avant Cherry	NGL	Noce Grigio
AWH	Avant Honey	NEL	Noce Leggero
BLK	Black	NML	Noce Medio
BZD	Blizzard	QTM	Quartered Mahogany
BRC	Brushed Cobalt	SBY	Sheer Beauty
CMB	Clear Maple	SOG	Storm Grey
CGY	Custom Grey	SDT	Stonedust
DES	Dark Espresso	WHE	Walnut Heights
DWT	Designer White	WHC	White Chocolate
FAS	Fashionista	WCR	Winter Cherry

EDGE

- Preferred matching edge

CONSTRUCTION

- Tops are 1" thick, constructed of 45 lb. density particle board covered on both sides with high performance thermally fused laminate. Optional high pressure laminate tops are 1-1/16" thick.
- Steel constructed leg tubing, feet and cross bar
- 108" 3-prong power cord
- Table frame designed with 3.15" x 2.35" rectangular outer leg with large tubing facing down
- "T" leg, flat foot design with adjustable glides
- Expandable cross bars for table widths of 48", 54", 60", 66" and 72"
- Available table depths of 23" and 29"
- Products specified with the high pressure laminate option are finished on the underside of the surface with a kraft paper backing.
- **Caution:** to meet BIFMA standards for performance and stability, appropriate base size must be specified with corresponding top sizes identified.

BASE

- 3-stage steel constructed leg tubing, feet and cross bar
- Dual motors are concealed within column.
- Provides height adjustment from 22.6" to 48.6" (26" adjustability with 1" top)
- Leveling glides offer 1" adjustability
- Operates at 1.3" per second
- Lifts 265 lbs.
- Shadow power draw 0.5 watts
- Base available in a Silver powder coated finish, will never mar during adjustment
- Open front cross bar to accommodate articulating keyboard platforms.
- Easy to use, push button controller with digital readout.
- Anti-collision feature standard

GROMMETS

- Grommets available in standard table top locations (left, center or right). Order as: **AG1, AG2 or AG3 - Add \$96.**
- Return tops: cut-out available in center only (**AG2**)
- Grommet hole dimensions are 3 1/4" wide x 1 7/8" deep.
- Grommets may be placed at non-standard locations. Order as: **AGS - Add \$96.** A drawing must be supplied with vertical and horizontal dimensions to the center of the cut-out (as in drawing below). Please refer to CUSTOM GROMMET LOCATION FORM in the back reference section.

Grommet hole dimensions:

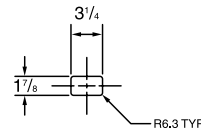

Grommet:

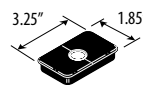

Grommet Locations:

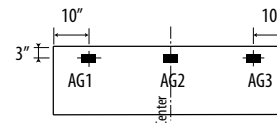

POWER BLOCK

- A power block (model **PMSPDM**) may be installed on all Foli tables
- The power block module includes one electrical duplex receptacle and two data (RJ45) receptacles. 9' Black cord with NEMA plug. Power block dimensions are 6.5" W x 3.5" D x 2.75" H.
- Power block cutout dimensions are 2.75" D x 6" W.
- Specify the power block cut-out location when ordering the table. The power block is ordered separately. Order power block separately as **PMSPDM, Add \$330.** Power blocks are available in standard worksurface locations (left, center or right). Specify **E1, E2 or E3 cutout location. Add \$96.**
- Return tops: cut-out available in center only (**E2**)

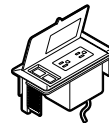

Power Block **PMSPDM. Add \$330**

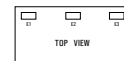

Specify location **E1, E2 or E3. Add \$96**

SHIPPING

- Shipped unassembled in 1 carton
- Easy to assemble.

FOLI ELECTRIC HEIGHT ADJUSTABLE TABLES

MODEL# DIMENSIONS FREIGHT CLASS WT/LBS. CUBIC FT. LIST PRICE HP ADD

D x W x H

Rectangular Tops:

PHAT2970T	29 x 70 x 1	65	70	2.6	\$587	\$294
PHAT2964T	29 x 64 x 1	65	64	2.4	\$560	\$280
PHAT2958T	29 x 58 x 1	65	59	2.2	\$536	\$268
PHAT2952T	29 x 52 x 1	65	52	2	\$525	\$263
PHAT2946T	29 x 46 x 1	65	44	1.8	\$512	\$256
PHAT2370T	23 x 70 x 1	65	57	2.1	\$583	\$292
PHAT2364T	23 x 64 x 1	65	52	1.9	\$538	\$269
PHAT2358T	23 x 58 x 1	65	47	1.8	\$513	\$257
PHAT2352T	23 x 52 x 1	65	46	1.6	\$462	\$231
PHAT2346T	23 x 46 x 1	60	44	1.4	\$431	\$216

Base:

PH3T6601	10 x -- x 26.8	65	67	2.83	\$1255	n/a
----------	----------------	----	----	------	---------------	-----



Top

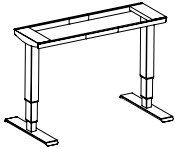

Base

Foli Rectangular Table

All table frames are easy to assemble with few parts. Lifts 220 lbs. Base manufactured so that leg paint will never mar during height adjustment. Leg assembly tubing, feet and upper structure assemblies constructed of steel. Table frame designed with 3.15" x 2.36" rectangular outer leg with the large tube facing down. Flat foot design with adjustable glides. I-profile crossbars that are expandable in fixed steps to create a variety of size table widths. Height range is 22.6" to 48.6" (26" adjustability with 1" top). Operates at 1.3" per second. Shadow power draw is 0.5 watts. Maximum power draw is 1.5A. Base finish in Silver powder coat only.

- **Specify base separately from top**
- **Recommended torque range for installing all fasteners is 3-5 foot pounds and should not be exceeded. In addition, no impact drivers or high-torque equipment are to be used for any fasteners included in the table assembly kits, as this creates a high risk for damage that is not covered under warranty. The use of hand tools is highly recommended.**

Return Tops:

PHAR2947T	29 x 47 x 1	65	44	1.8	\$512	\$256
PHAR2941T	29 x 41 x 1	65	41	1.6	\$507	\$254
PHAR2935T	29 x 35 x 1	65	35	1.4	\$507	\$254
PHAR2347T	23 x 47 x 1	60	44	1.4	\$431	\$216
PHAR2341T	23 x 41 x 1	65	32	1.2	\$411	\$206
PHAR2335T	23 x 35 x 1	65	27	1.1	\$372	\$186

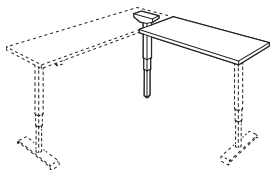

Return Kit

Third Leg Kit:

PH3TLK6601	10 x -- x 26.8	85	19	1.3	\$861	n/a
------------	----------------	----	----	-----	--------------	-----

Third leg kit to be used with a Foli freestanding table to create an electric height adjustable L station. Post leg with return kit replaces one of the T-legs on freestanding table; the T-leg from the freestanding table is then moved to support one side of the return top. Cross bar is included to connect and support the return top to the freestanding table top. May be configured for left or right hand returns. All three legs plug into the freestanding table's controller and the three motors will electronically synchronize. The overall footprint with a return kit is not to exceed 72"W x 72"D. The 48"W return kit is only to be used with a 24"D primary table. 36" and 42"W return kits may be used with either 24"D or 30"D primary tables.

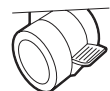

1.5" Dual Wheel Casters

P79100014	- x - x 1.5	60	2	0.4	\$77	N/A
-----------	-------------	----	---	-----	-------------	-----

Pack of four casters, two locking and two non-locking. Interchangeable on site with levelers on Foli electric height adjustable table PHATxxxx models only.

- **Cannot be used with Third Leg Kit**

Required Specifications

Top Finish

Optional Specifications

High Pressure Laminate
Grommet

P PRODUCTIVITY SOLUTIONS™ BY GLOBAL

PET FELT PANELS

- 9mm thick panels offered in 9 finishes
- Made from 100% PET (polyester) fiber with a high content (50%) of post-recycled material, free of added chemicals, binders and adhesives
- Lightweight panels are tackable, impact and tear resistant, bacteria resistant, moisture resistant, and installation friendly
- Variation in fiber mix and color are inherent to the character of the product
- Clamps are included. Available in satin anodized finish only.
- Privacy screen clamps for use on 1" surfaces only.

FELT COLORS

BLK	Black	MTS	Mist
BRI	Brick	PWT	Pewter
DEN	Denim	SHR	Shamrock
GPH	Graphite	WHT	White
HVT	Harvest		

PET FELT PRIVACY SCREENS

MODEL#	DIMENSIONS D x W x H	FREIGHT CLASS	WT./LBS.	CUBIC FT.	LIST PRICE
PT9PP3013-1	.36 x 30 x 12.5	250	2.12	.57	\$180
PT9PP3613-1	.36 x 36 x 12.5	250	2.38	.69	\$190
PT9PP4213-1	.36 x 42 x 12.5	250	2.63	.80	\$255
PT9PP4813-1	.36 x 48 x 12.5	250	3.31	.91	\$264
PT9PP5413-1	.36 x 54 x 12.5	250	3.57	1.03	\$330
PT9PP6013-1	.36 x 60 x 12.5	250	3.82	1.14	\$340
PT9PP6613-1	.36 x 66 x 12.5	250	4.50	1.25	\$405
PT9PP7213-1	.36 x 72 x 12.5	250	4.76	1.36	\$415
PT9PP7813-1	.36 x 78 x 12.5	250	5.01	1.48	\$424

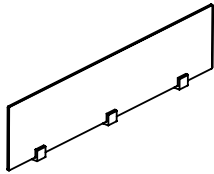

PET Felt Privacy Screen - 1 pk.

PET Felt Privacy Screen available in 9 finishes, please specify. 2, 3 or 4 clamps are included depending on screen size. Clamps available in satin anodized finish only. Privacy screen clamps for use on 1" surfaces only.

- Up to 42" w - 2 clamps per panel
- 48"-60" w - 3 clamps per panel
- 66"-78" w - 4 clamps per panel

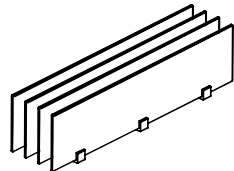

PET Felt Privacy Screen - 4 pk.

PT9PP3013-4	0.36 x 30 x 12.5	85	7.64	.60	\$679
PT9PP3613-4	0.36 x 36 x 12.5	85	8.56	.71	\$719
PT9PP4213-4	0.36 x 42 x 12.5	92.5	9.48	.83	\$971
PT9PP4813-4	0.36 x 48 x 12.5	85	11.90	.98	\$1008
PT9PP5413-4	0.36 x 54 x 12.5	92.5	12.80	1.09	\$1263
PT9PP6013-4	0.36 x 60 x 12.5	92.5	13.80	1.20	\$1296
PT9PP6613-4	0.36 x 66 x 12.5	85	16.20	1.32	\$1548
PT9PP7213-4	0.36 x 72 x 12.5	92.5	17.10	1.43	\$1584
PT9PP7813-4	0.36 x 78 x 12.5	92.5	18	1.54	\$1616

PET Felt Privacy Screen available in 9 finishes, please specify. 2, 3 or 4 clamps are included depending on screen size. Clamps available in satin anodized finish only. Privacy screen clamps for use on 1" surfaces only.

- Up to 42" w - 2 clamps per panel
- 48"-60" w - 3 clamps per panel
- 66"-78" w - 4 clamps per panel

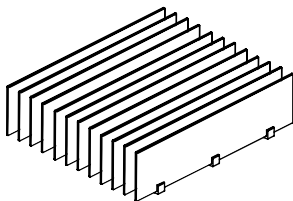

PET Felt Privacy Screen - 12 pk.

PT9PP3013-12	0.36 x 30 x 12.5	92.5	21.60	1.92	\$1994
PT9PP3613-12	0.36 x 36 x 12.5	92.5	24.30	2.26	\$2101
PT9PP4213-12	0.36 x 42 x 12.5	60	26.90	.80	\$2847
PT9PP4813-12	0.36 x 48 x 12.5	92.5	33.80	3.05	\$2951
PT9PP5413-12	0.36 x 54 x 12.5	92.5	36.40	3.39	\$3711
PT9PP6013-12	0.36 x 60 x 12.5	92.5	39	3.72	\$3803
PT9PP6613-12	0.36 x 66 x 12.5	92.5	45.90	4.18	\$4550
PT9PP7213-12	0.36 x 72 x 12.5	92.5	48.50	4.51	\$4642
PT9PP7813-12	0.36 x 78 x 12.5	92.5	51.10	4.85	\$4736

PET Felt Privacy Screen available in 9 finishes, please specify. 2, 3 or 4 clamps are included depending on screen size. Clamps available in satin anodized finish only. Privacy screen clamps for use on 1" surfaces only.

- Up to 42" w - 2 clamps per panel
- 48"-60" w - 3 clamps per panel
- 66"-78" w - 4 clamps per panel

Required Specifications

Finish

PET FELT MODESTY PANELS

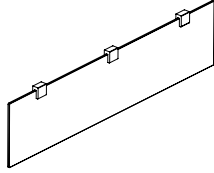

PET Felt Modesty Panel - 1 pk.

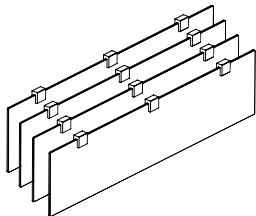

PET Felt Modesty Panel - 4 pk.

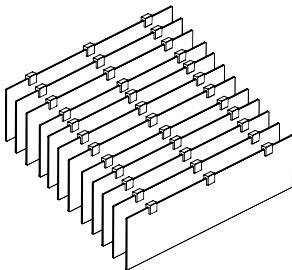

PET Felt Modesty Panel - 12 pk.

MODEL# DIMENSIONS FREIGHT CLASS WT/LBS. CUBIC FT. LIST PRICE

	D x W x H				
PT9MP3013-1	.36 x 30 x 12.5	250	2.12	.57	\$159
PT9MP3613-1	.36 x 36 x 12.5	250	2.38	.69	\$168
PT9MP4213-1	.36 x 42 x 12.5	250	2.63	.80	\$222
PT9MP4813-1	.36 x 48 x 12.5	250	3.31	.91	\$231
PT9MP5413-1	.36 x 54 x 12.5	250	3.57	1.03	\$300
PT9MP6013-1	.36 x 60 x 12.5	250	3.82	1.14	\$307
PT9MP6613-1	.36 x 66 x 12.5	250	4.50	1.25	\$360
PT9MP7213-1	.36 x 72 x 12.5	250	4.76	1.36	\$372
PT9MP7813-1	.36 x 78 x 12.5	250	5.01	1.48	\$381

PET Felt Modesty Panel available in 9 finishes, please specify. 2, 3 or 4 clamps are included depending on screen size. Clamps available in satin anodized finish only. **Specify a nominal size 6" shorter than worksurface size.**

- Up to 42"w - 2 clamps per panel
- 48"-60"w - 3 clamps per panel
- 66"-78"w - 4 clamps per panel

PT9MP3013-4	0.36 x 30 x 12.5	85	7.64	.60	\$594
PT9MP3613-4	0.36 x 36 x 12.5	85	8.56	.71	\$632
PT9MP4213-4	0.36 x 42 x 12.5	92.5	9.48	.83	\$841
PT9MP4813-4	0.36 x 48 x 12.5	85	11.90	.98	\$878
PT9MP5413-4	0.36 x 54 x 12.5	92.5	12.80	1.09	\$1133
PT9MP6013-4	0.36 x 60 x 12.5	92.5	13.80	1.20	\$1166
PT9MP6613-4	0.36 x 66 x 12.5	85	16.20	1.32	\$1373
PT9MP7213-4	0.36 x 72 x 12.5	92.5	17.10	1.43	\$1410
PT9MP7813-4	0.36 x 78 x 12.5	92.5	18	1.54	\$1443

PET Felt Modesty Panel available in 9 finishes, please specify. 2, 3 or 4 clamps are included depending on screen size. Clamps available in satin anodized finish only. **Specify a nominal size 6" shorter than worksurface size.**

- Up to 42"w - 2 clamps per panel
- 48"-60"w - 3 clamps per panel
- 66"-78"w - 4 clamps per panel

PT9MP3013-12	0.36 x 30 x 12.5	92.5	21.60	1.92	\$1732
PT9MP3613-12	0.36 x 36 x 12.5	92.5	24.30	2.26	\$1840
PT9MP4213-12	0.36 x 42 x 12.5	92.5	26.90	2.60	\$2456
PT9MP4813-12	0.36 x 48 x 12.5	92.5	33.80	3.05	\$2559
PT9MP5413-12	0.36 x 54 x 12.5	92.5	36.40	3.39	\$3318
PT9MP6013-12	0.36 x 60 x 12.5	92.5	39	3.72	\$3410
PT9MP6613-12	0.36 x 66 x 12.5	92.5	45.90	4.18	\$4026
PT9MP7213-12	0.36 x 72 x 12.5	92.5	48.50	4.51	\$4120
PT9MP7813-12	0.36 x 78 x 12.5	92.5	51.10	4.85	\$4212

PET Felt Modesty Panel available in 9 finishes, please specify. 2, 3 or 4 clamps are included depending on screen size. Clamps available in satin anodized finish only. **Specify a nominal size 6" shorter than worksurface size.**

- Up to 42"w - 2 clamps per panel
- 48"-60"w - 3 clamps per panel
- 66"-78"w - 4 clamps per panel

Required Specifications

Finish

PET TRI-FOLD SCREENS	MODEL#	DIMENSIONS	FREIGHT CLASS	WT/LBS.	CUBIC FT.	LIST PRICE
		D x W x H				
<ul style="list-style-type: none"> • 9mm thick panels offered in 9 finishes • Made from 100% PET (polyester) fiber with a high content (50%) of post-recycled material, free of added chemicals, binders and adhesives • Lightweight panels are tackable, impact and tear resistant, bacteria resistant, moisture resistant, and installation friendly • Variation in fiber mix and color are inherent to the character of the product. 	FELT COLORS					
		BLK	Black	MTS	Mist	
		BRI	Brick	PWT	Pewter	
		DEN	Denim	SHR	Shamrock	
		GPH	Graphite	WHT	White	
		HVT	Harvest			

PET TRI-FOLD SCREENS	MODEL#	DIMENSIONS	FREIGHT CLASS	WT/LBS.	CUBIC FT.	LIST PRICE
		D x W x H				

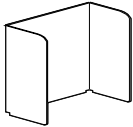

PET Felt Desktop Partition

PSDTP3224	15.5 x 31.5 x 23.5	85	7	0.5	\$306
-----------	--------------------	----	---	-----	--------------

Lightweight freestanding desktop partition. Move wherever you need to provide a focus space. 9mm thick PET Felt, no hardware connections. Folds flat for storage when not in use. Ships in two pieces with a puzzle-like joint. Easy to assemble.

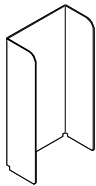

PET Felt Floor Partition

PSFSP3260	15.5 x 31.5 x 60	92.5	13	1.2	\$692
-----------	------------------	------	----	-----	--------------

Lightweight freestanding floor partition. Move wherever you need to provide a focus space. 9mm thick PET Felt, no hardware connections. Folds flat for storage when not in use. Ships in two pieces with a puzzle-like joint. Easy to assemble.

Required Specifications
Finish

G7 MONITOR ARMS

MODEL#

DIMENSIONS

FREIGHT CLASS

WT/LBS.

CUBIC FT.

LIST PRICE

D x W x H

- Free up valuable space on surfaces
- Attach to any standard surface with flush edge with clamp that tightens from the desktop.
- Can be placed through standard Global grommets for mounting.
- Clamps on worksurfaces .50" to 2.625" thick
- Built-in cable management on arm and at the back of the base.
- Quick connect option is standard with hole patterns to meet Video Electronics Standards Association (VESA) standards (75mm x 75mm or 100mm x 100mm)
- Available finishes: Black (**BLK**), Designer White (**DWT**), Tungsten (**TUN**).

G7 MONITOR ARMS

MODEL#

DIMENSIONS

FREIGHT CLASS

WT/LBS.

CUBIC FT.

LIST PRICE

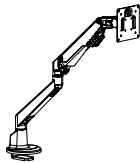

G7 Monitor Arm, Single

PSMA1	5.5 x -- x 21	85	6.6	0.47	\$350
-------	---------------	----	-----	------	--------------

For use with monitors weighing 4.4 to 19.8 lbs. Adjustable counterbalance provides free floating fingertip control. Maximum 20.5" extension from rear of the desk to back of monitor, folds to 4.5". Monitor can rotate for portrait or landscape viewing with -90° to 45° tilt adjustment. 180° lockout function. Maximum monitor width of 34". Some assembly required.

- Available in Black (**BLK**), Designer White (**DWT**) and Tungsten (**TUN**).
- Also accommodates mini slide arm, **PSMS**.

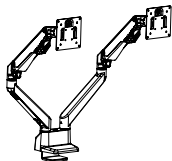

G7 Monitor Arm, Double

PSMA2	5.5 x -- x 21	85	11.44	0.8	\$580
-------	---------------	----	-------	-----	--------------

For use with monitors weighing 4.4 to 19.8 lbs. Adjustable counterbalance provides free floating fingertip control. Maximum 20.5" extension from rear of the desk to back of monitor, folds to 4.5". Monitor can rotate for portrait or landscape viewing with -90° to 45° tilt adjustment. 180° lockout function. Maximum monitor width of 34" (per arm). Some assembly required.

- Available in Black (**BLK**), Designer White (**DWT**) and Tungsten (**TUN**).
- Also accommodates mini slide arm, **PSMS**.

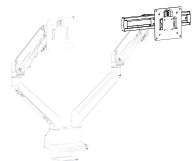

G7 Mini Slide Monitor Arm

PSMS	6 x 11 x 4.5	92.5	3.3	0.29	\$115
------	--------------	------	-----	------	--------------

For use with **PSMA1** and **PSMA2** monitor arms only. Provides 9" of lateral adjustment for the monitor and allows for better positioning when used side by side. Some assembly required. Loading capacity of 13.2 lbs. Quick release VESA plate.

- Available in Black (**BLK**), Designer White (**DWT**) and Tungsten (**TUN**).
- If for **PSMA1**, order (1)
- If for **PSMA2**, order (2)

Required Specifications

Finish

MONITOR ARMS	MODEL#	DIMENSIONS D x W x H	FREIGHT CLASS	WT./LBS.	CUBIC FT.	LIST PRICE
--------------	--------	-------------------------	---------------	----------	-----------	------------

- Free up valuable space on surfaces
- Attach to any standard surface with flush edge by a desk clamp or through a grommet. Grommets above support panels cannot be used for mounting. Mounting hardware included.
- Clamps on worksurfaces 1/2" to 2 5/8" thick
- 9" vertical height adjustment on 12" post
- For use in grommets up to 3.5" wide
- Built-in cable management
- Quick connect option is standard with hole patterns to meet Video Electronics Standards Association (VESA) standards (75mm x 75mm or 100mm x 100mm)
- Monitor arm components are 100% recycled aluminum die cast material, providing stability and durability
- Available finishes: Silver (**SIL**) standard; Black (**BLK**) and White (**WTE**).

MONITOR ARMS, SINGLE SCREEN	MODEL#	DIMENSIONS	FREIGHT CLASS	WT./LBS.	CUBIC FT.	LIST PRICE
-----------------------------	--------	------------	---------------	----------	-----------	------------

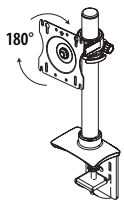

Single Screen Pole Position

MON1SPP	-- x -- x --	150	5.80	1.20	\$338
---------	--------------	-----	------	------	--------------

No extension arms. Minor assembly required. Supports 20 lb. load capacity. No maximum monitor width.

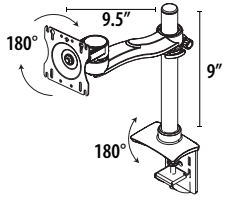

Single Screen Single Extension Arm

MON1SSE	-- x -- x --	150	6.20	1.20	\$456
---------	--------------	-----	------	------	--------------

9.5" horizontal reach from center of pole to front of monitor mounting plate. Displays are able to tilt 180°, swing 180° side-to-side and rotate from landscape to portrait. Minor assembly required. Supports 20 lb. load capacity. No maximum monitor width.

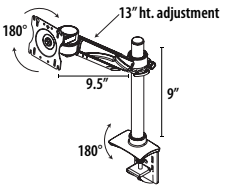

Single Screen Single Extension Arm with Height Adjustment

MON1SSEH	-- x -- x --	125	7.20	1.10	\$583
----------	--------------	-----	------	------	--------------

Counterbalanced arm provides an additional 13" of height adjustment. Easy to use Allen wrench allows user to adjust the counterbalance mechanism for easy movement of the monitor. 9.5" horizontal reach from center of pole to front of monitor mounting plate. Displays are able to tilt 180°, swing 180° side-to-side and rotate from landscape to portrait. Minor assembly required. Supports 20 lb. load capacity. No maximum monitor width.

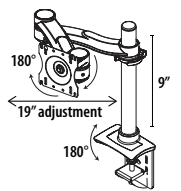

Single Screen Double Extension Arm

MON1SDE	-- x -- x --	125	7.50	1.20	\$569
---------	--------------	-----	------	------	--------------

Double extension allows 19" of horizontal back and forth movement. Arm folds back to post for more desk space. Displays are able to tilt 180°, swing 180° side-to-side and rotate from landscape to portrait. Minor assembly required. Supports 20 lb. load capacity. No maximum monitor width.

Required Specifications
Finish

MONITOR ARMS

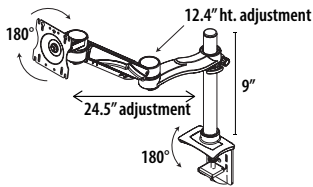

Single Screen Double Extension Arm w/Height Adjustment

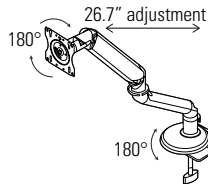

Single Screen Double Extension Arm - Light Duty

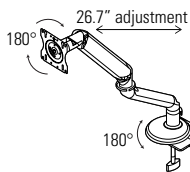

Single Screen Double Extension Arm - Medium Duty

MODEL# DIMENSIONS FREIGHT CLASS WT/LBS. CUBIC FT. LIST PRICE

MODEL#	D x W x H	FREIGHT CLASS	WT/LBS.	CUBIC FT.	LIST PRICE
MON1SDEH	29.3 x 9.5 x 12.5	125	8.20	1.10	\$684

Counterbalanced arm provides an additional 12.4" of height adjustment. Double extension allows 24.5" of horizontal back and forth movement. Easy to use Allen wrench allows user to adjust the counterbalance mechanism for easy movement of the monitor. Displays are able to tilt 180°, swing 180° side-to-side and rotate from landscape to portrait. Cable manager comes on extension arm and hides all cables. Minor assembly required. Supports 20 lb. load capacity. No maximum monitor width.

M7750LD	5.5 x -- x --	100	10.34	1.12	\$782
---------	---------------	-----	-------	------	-------

For use with monitors weighing 5 to 20 lbs. Adjustable counterbalance provides free floating fingertip control. Maximum of 26.7" extension from rear of desk to back of monitor; folds to 4.5". Monitor can rotate 180° for portrait or landscape viewing with -90° to 45° tilt adjustment. Integral monitor weight adjustment gauge. Aluminum die cast construction. VESA plate edge clamp and grommet mount included. Silver finish. Some assembly required. Supports 20 lb. load capacity. No maximum monitor width.

• Also available in **Black finish** #M7750LDB or **White finish** #M7750LDW.

M7755MD	5.5 x -- x --	100	10.34	1.12	\$834
---------	---------------	-----	-------	------	-------

For use with monitors weighing 10 to 30 lbs. Adjustable counterbalance provides free floating fingertip control. Maximum of 26.7" extension from rear of desk to back of monitor; folds to 4.5". Monitor can rotate 180° for portrait or landscape viewing with -90° to 45° tilt adjustment. Integral monitor weight adjustment gauge. Aluminum die cast construction. VESA plate edge clamp and grommet mount included. Silver finish. Some assembly required. Supports 20 lb. load capacity. No maximum monitor width. • Also available in **Black finish** #M7755MDB or **White finish** #M7755MDW.

MONITOR ARMS, DUAL SCREEN

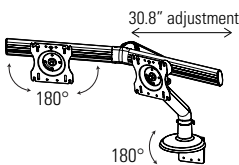

Dual Screen Double Extension Arm

MODEL# DIMENSIONS FREIGHT CLASS WT/LBS. CUBIC FT. LIST PRICE

M7760DSS	26 x 8.4-30.75 x 24.4	92.5	14.75	1.3	\$1081
----------	-----------------------	------	-------	-----	--------

For use with monitors weighing 6 to 28 lbs. total and maximum width of 24" diagonal. Adjustable counterbalance provides free floating fingertip control. Maximum of 30.8" extension from rear of desk to back of monitor; folds to 8.4". Monitor can rotate 180° for portrait or landscape viewing with -90° to 45° tilt adjustment. Integral monitor weight adjustment gauge. Aluminum die cast construction. VESA plate edge clamp and grommet mount included. Silver finish. Some assembly required. Supports 20 lb. load capacity. No maximum monitor width.

• Also available in **Black finish** #M7760DSB or **White finish** #M7760DSW.

Required Specifications

Finish

MONITOR ARMS, DUAL SCREEN

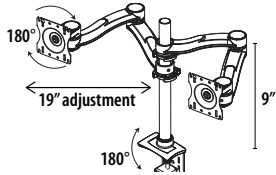

Dual Screen Double Extension Arm

MODEL#	DIMENSIONS D x W x H	FREIGHT CLASS	WT/LBS.	CUBIC FT.	LIST PRICE
MON2SDE	-- x -- x 12.5	100	10.70	1.20	\$1006

For dual monitor applications. 32" maximum monitor width. Supports a 20lb. load capacity per screen. Double extension arms reach out up to 19". Top of mounting pole is 12.5" from worksurface. Easy to use Allen wrench allows user to adjust the counterbalance mechanism for easy movement of the monitor. Displays are able to tilt 180°, swing 180° side-to-side and rotate from landscape to portrait. Minor assembly required.

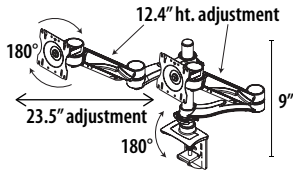

Dual Screen Double Extension Arm with Height Adjustment

MON2SDEH	-- x -- x 12.5	150	6	1.20	\$1247
----------	----------------	-----	---	------	---------------

For dual monitor applications. 35" maximum monitor width. Supports a 20 lb. load capacity per screen. Counterbalanced arms provide an additional 12.4" of height adjustment. Double extension arms reach out up to 23.5". Easy to use Allen wrench allows user to adjust the counterbalance mechanism for easy movement of the monitor. Both arms can be set at the same height. Displays are able to tilt 180°, swing 180° side-to-side and rotate from landscape to portrait. Cable manager comes on extension arm and hides all cables. Minor assembly required. Supports 20 lb. load capacity.

MONITOR ARMS, QUAD SCREEN

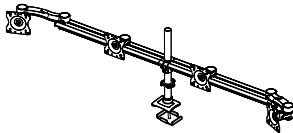

Parabolic Quad Screen Beam Mount

MODEL#	DIMENSIONS	FREIGHT CLASS	WT/LBS.	CUBIC FT.	LIST PRICE
MONQSBM	-- x -- x --	65	18.30	.70	\$1630

Supports four monitors. Two outside single extension arms tilt 180° and swing 180° side-to-side. All displays can be rotated from landscape to portrait. Beam is 63.9"w. Minor assembly required. Supports 20 lb. load capacity. 21" maximum monitor width. Bracket for grommet mount only included.

Required Specifications
Finish

SIT-STAND WORKSTATIONS

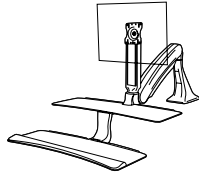

Single Screen Sit-Stand Workstation with Keyboard Tray and Shelf

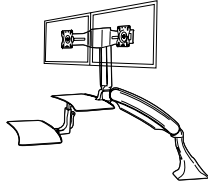

Dual Screen Sit-Stand Workstation with Keyboard Tray and Shelf

MODEL#	DIMENSIONS	FREIGHT CLASS	WT/LBS.	CUBIC FT.	LIST PRICE
--------	------------	---------------	---------	-----------	------------

	D x W x H				
M6011WS	28 x -- x --	125	36	4.8	\$3314

Desktop edge (rear, side or corner) or grommet mount on 24" or 30" deep worksurfaces. Transition between seated and standing positions, HFES compliant. Over 22" of gas assisted height adjustment plus independent height adjustable mechanism for the keyboard tray. Additional 9.5" of independent counterbalance height adjustment for the monitor. 45° of tilt and 90° of portrait to landscape rotation. Monitor weight limit from 5 to 25 lbs. Silver/Grey (SG) finish. Assembly required.

- Also available in **Black/Black (B/B) finish** #M6011WSBB or **White/Grey (WG) finish** #M6011WSWG.

M6021WS	28 x -- x --	100	42	4.8	\$3670
---------	--------------	-----	----	-----	---------------

Desktop edge (rear, side or corner) or grommet mount on 24" or 30" deep worksurfaces. Transition between seated and standing positions, HFES compliant. Over 22" of gas assisted height adjustment plus independent height adjustable mechanism for the keyboard tray. Additional 9.5" of independent counterbalance height adjustment for the monitor. 45° of tilt and 90° of portrait to landscape rotation. Accommodates most 24" monitors weighing up to 8 lbs. each and offers independent screen adjustments. Silver/Grey (SG) finish. Assembly required.

- Also available in **Black/Black (B/B) finish** #M6021WSBB or **White/Grey (WG) finish** #M6021WSWG.

Required Specifications

Finish

KEYBOARD MECHANISMS

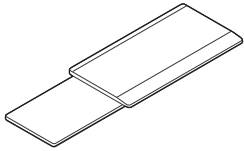

Tray with Sliding Mouse Support

MODEL#	DIMENSIONS D x W x H	FREIGHT CLASS	WT./LBS.	CUBIC FT.	LIST PRICE
KT01	10.5 x 21.3 x 2	70	7	.40	\$277

Mouse surface slides below support for left or right mouse positioning. Keyboard surface is 21”w x 11”d. Mouse surface extends 9” beyond the side of the tray. Compatible with all Global keyboard mechanisms. ABS plastic tray and sliding mouse tray.

- **Specify mechanism separately (see next page)**

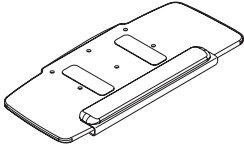

27” HDPE Tray

KT27M02	11.5 x 27.5 x .38	70	6	.40	\$377
---------	-------------------	----	---	-----	--------------

Allows mouse to be easily positioned at the same height as, and to the left or right of, the keyboard. Palm rest is easily removable. Includes anti-slip strips. High Density Polyethylene (HDPE) surface material. SSU palm rest. Compatible with all Global keyboard mechanisms.

- **Specify mechanism separately (see next page)**

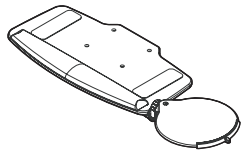

Tray with Height Adjustable Mouse Support - Black

KTMT03	11.5 x 23 x 2.8	100	5.80	.60	\$385
--------	-----------------	-----	------	-----	--------------

Low profile tray with highly adjustable Mouse Support that allows the user to position the mouse surface according to their needs and preferences. Mouse support features include: height adjustment, swivel and tilt. User can easily mount on left or right side of keyboard tray, easily swivel and adjust the height position to maintain neutral postures, and independently adjust the mouse surface tilt so mouse stays on the support when the keyboard tray is tilted. Compatible with all Global keyboard mechanisms. Palm rest is easily removable. Includes Mouse Fence with Cable Manager and anti-slip strips. Keyboard tray is 20.5”w x 11”d and mouse support is 11” in diameter. Tray support material is a compact phenolic panel; mouse tray in ABS plastic. Plug-in gel-feel foam palm rest.

- **Specify mechanism separately (see next page)**

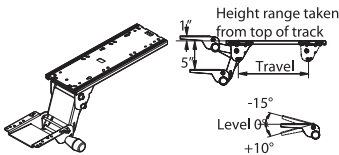

Soft Touch Keyboard Support Mechanism

KSM01-21	23.8 x 9 x 4.3	85	9.20	.70	\$275
KSM01-18	19.7 x 7.4 x 3.6	85	7.60	.60	\$275
KSM01-12	13 x 5 x 2.4	85	5.10	.40	\$275

Soft Touch knob for simultaneous height and tilt adjustment. Spring-assist mechanism. Compatible with all Global keyboard mechanisms. Good for single users who do not adjust their keyboard often.

- KSM01-21 requires 21.75” of depth clearance under the surface for installation.
- KSM01-18 requires 18” of depth clearance under the surface for installation.
- KSM01-12 requires 12” of depth clearance under the surface for installation.
- **Specify keyboard tray separately (see previous page)**

KEYBOARD MECHANISMS

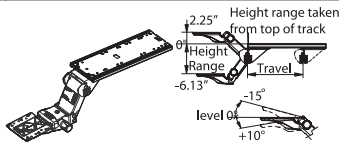

Lift-N-Lock Keyboard Support Mechanism

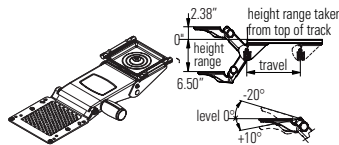

Slim Fit Keyboard Support Mechanism

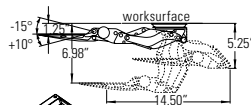

Trackless Keyboard Support Mechanism

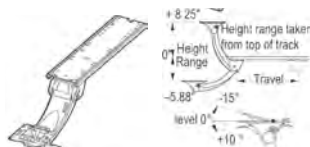

Lift-N-Lock Sit-Stand Mechanism

MODEL# DIMENSIONS FREIGHT CLASS WT./LBS. CUBIC FT. LIST PRICE

	D x W x H				
KSM02-21	23.8 x 9 x 9.7	85	9.70	.70	\$361
KSM02-18	19.7 x 7.4 x 8.2	85	8	.60	\$361
KSM02-12	13 x 5 x 5.4	85	5.40	.40	\$361

Knobless height adjustment and independent tilt adjustment. Locks automatically into position with release of tray. Compatible with all Global keyboard mechanisms. Good for single users who frequently change positions or for multiple users.

- KSM02-21 requires 21.75" of depth clearance under the surface for installation.
- KSM02-18 requires 18" of depth clearance under the surface for installation.
- KSM02-12 requires 12" of depth clearance under the surface for installation.
- **Specify keyboard tray separately (see previous page)**

Black:					
KSFK-21	17.5 x 7.5 x 4.75	70	9	.60	\$361
KSFK-18	17.5 x 7.5 x 4.75	70	8.30	.50	\$361
KSFK-12	17.5 x 7.5 x 4.75	85	7.30	.50	\$361

Warm White:					
KSFK-21-W	17.5 x 7.5 x 4.75	85	9	0.7	\$429

Super slim profile accommodates leg clearance requirements of more users. Knobless height adjustment and independent tilt adjustment. Height and depth indicators together in dashboard. Compatible with all Global keyboard mechanisms. Good for single users who frequently change positions and for multiple users. Swivels 360°.

- KSFK-21 requires 21.75" of depth clearance under the surface for installation.
- KSFK-18 requires 18" of depth clearance under the surface for installation.
- KSFK-12 requires 12" of depth clearance under the surface for installation.
- **Specify keyboard tray separately (see previous page)**

Black:					
KSTRKLS-B	14.5 x 7.5 x 5.25	70	6	0.3	\$506

Super slim profile trackless keyboard mechanism designed to fit worksurfaces such as height adjustable tables and benching systems, where space is limited and conventional track mounted keyboard mechanisms will not fit. Knobless height adjustment and independent tilt adjustment. Compatible with all Global keyboard trays.

- **Specify keyboard tray separately (see previous page)**

KSM03-21	23.8 x 9 x 9.7	85	11.80	.90	\$579
KSM03-18	19.7 x 7.4 x 8	85	9.70	.70	\$579
KSM03-12	13 x 5 x 5.3	85	6.50	.50	\$579

Ergonomic support for both seated and standing positions. Curved neck allows user closer access to the desk. Compatible with all Global keyboard mechanisms. Recommended for single users who alternate between sitting and standing.

- KSM03-21 requires 21.75" of depth clearance under the surface for installation.
- KSM03-18 requires 18" of depth clearance under the surface for installation.
- KSM03-12 requires 12" of depth clearance under the surface for installation.
- **Specify keyboard tray separately (see previous page)**

CPU ACCESSORIES

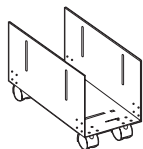

CPU Holder on Casters

MODEL#	DIMENSIONS D x W x H	FREIGHT CLASS	WT./LBS.	CUBIC FT.	LIST PRICE
PCPU-HC	15 x 5 x 10.37	70	8	.45	\$190

Adjusts 5" - 9" in width. Front locking casters. Assembly hardware included. Height without CPU is 10.4". Depth without CPU is 15". Black only.

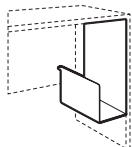

Power Park CPU Holder

PCPU-HO	15 x 5-11 x 18	92.5	11.50	1.06	\$166
---------	----------------	------	-------	------	--------------

Desk mounted CPU Holder. Adjusts 5" - 11" in width. Mounting hardware included. Height without CPU is 18". Depth without CPU is 15". Black only.



CPU Holder on Glide Track

PCPU-GT	-- x -- x --	100	12.60	1.40	\$412
---------	--------------	-----	-------	------	--------------

Accepts tower CPUs with widths from 3.5" to 9.3" and heights from 12.5" to 22.5". 17" glide track and 360° swivel for easy access to rear of CPU. Steel and engineered resin construction.

TASK LIGHTING

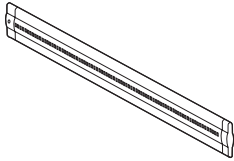

LED Task Light

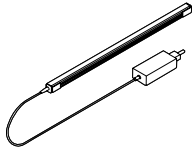

Starter LED Task Light

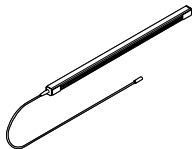

Add-On LED Task Light

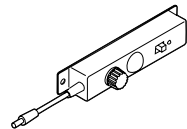

Occupancy Sensor

MODEL# DIMENSIONS FREIGHT CLASS WT/LBS. CUBIC FT. LIST PRICE

D x W x H

PLED30	1.5 x 15.5 x .5	150	2	.50	\$494
PLED50	1.5 x 23.5 x .5	150	2	.50	\$569
PLED100	1.5 x 43.5 x .5	125	3	.50	\$660

Energy efficient LED. Ultra slim design. Suitable for hanging under hutch or wallhung units. 6' power cord. UL listed: UL 153.

PLEDS240	0.94 x 22.9 x .79	70	2.5	0.13	\$243
PLEDS360	0.94 x 33.5 x .79	70	2.8	0.16	\$280
PLEDS480	0.94 x 45.5 x .79	70	3.2	0.21	\$311

Undercabinet slim profile LED linear light fixture with lens and On/Off switch. May be used as stand-alone or extended with add-on section below (PLEDAxxx). Plug-in power supply with 72" cord length plus 78" DC cable. Includes magnetic mounting brackets for both steel and laminate units; for laminate units, additional mounting plates are required and included. Light enclosure in clear anodizing finish. Color temperature cool white 4000K. Lifespan rated 30,000 hours. UL listed: UL 153.

	PLEDS240	PLEDS360	PLEDS480
Nominal size	24"W	36"W	48"W
Number of LEDs	36	54	72
Total light output (lumens)	580	780	1150
Power input per light (watts)	9	13.5	18

PLEDA240	0.94 x 22.9 x .79	70	2.5	0.13	\$199
PLEDA360	0.94 x 33.5 x .79	70	2.8	0.16	\$236
PLEDA480	0.94 x 45.5 x .79	70	3.2	0.21	\$267

Undercabinet slim profile LED linear add-on light fixture with lens. Daisy chain unit with 39" linking cable, no power supply. Add-on units can only be linked up to a total of 48 watts per power supply; this is equivalent to 10 feet of nominal length of light per power supply. Includes magnetic mounting brackets for both steel and laminate units; for laminate units, additional mounting plates are required and included. Light enclosure in clear anodizing finish. Color temperature cool white 4000K. Lifespan rated 30,000 hours. UL listed: UL 153.

	PLEDA240	PLEDA360	PLEDA480
Nominal size	24"W	36"W	48"W
Number of LEDs	36	54	72
Total light output (lumens)	580	780	1150
Power input per light (watts)	9	13.5	18

PLEDOS	0.93 x 4.4 x 1.3	70	0.40	0.01	\$98
--------	------------------	----	------	------	-------------

Inline add-on controller for dimming and occupancy sensor. UL listed: UL153.

Required Specifications

Finish
Mount

Optional Specifications

Occupancy Sensor

TASK LIGHTING	MODEL#	DIMENSIONS	FREIGHT CLASS	WT/LBS.	CUBIC FT.	LIST PRICE
D x W x H						
Mounting Options for Voyage and Revo Lights: Freestanding Base (FS) Freestanding Base with USB charge port (FSUSB) - Add \$104 . Surface Mount (SM) Clamp Mount (CM)						

REVO + VOYAGE	MODEL#	DIMENSIONS	FREIGHT CLASS	WT/LBS.	CUBIC FT.	LIST PRICE
---------------	--------	------------	---------------	---------	-----------	------------

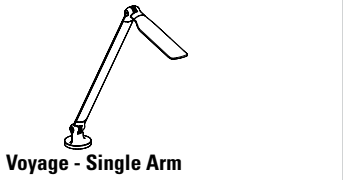

LINLAMPS	6 x 6 x 14.1	60	2.66	.01	\$672	
Fully articulating body with single arm. 6' power cord. Touch and hold dimming capability, with auto shut-off after 10 hours. Brightness adjustment from 100% to 15%. 18 fractional LEDs, 337 lumens, 3500K color temperature. 85 CRI. 94% post consumer recyclability by weight. Available in Black (BLK), White (WHT) and Silver (SLV). Mounting accessories sold separately (see above). Optional integrated USB port in base (FSUSB) allows for charging of mobile devices. UL listed: UL 1153:2014. <ul style="list-style-type: none"> • Occupancy Sensor (OS) - Add \$78 						

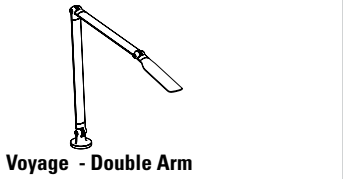

LINLAMPD	6 x 6 x 21.6	60	2.66	.01	\$688	
Fully articulating body with double arm. 6' power cord. Touch and hold dimming capability, with auto shut-off after 10 hours. Brightness adjustment from 100% to 15%. 18 fractional LEDs, 337 lumens, 3500K color temperature. 85 CRI. 94% post consumer recyclability by weight. Available in Black (BLK), White (WHT) and Silver (SLV). Mounting accessories sold separately (see above). Optional integrated USB port in base (FSUSB) allows for charging of mobile devices. UL listed: UL 1153:2014. <ul style="list-style-type: none"> • Occupancy Sensor (OS) - Add \$78 						

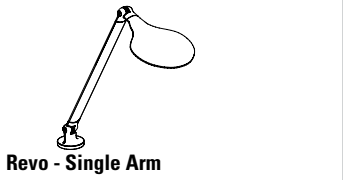

RNDLAMPS	6 x 6 x 14.1	60	2.66	.01	\$672	
Fully articulating body with single arm. 6' power cord. Touch and hold dimming capability, with auto shut-off after 10 hours. Brightness adjustment from 100% to 15%. 18 fractional LEDs, 294 lumens, 3500K color temperature. 85 CRI. 94% post consumer recyclability by weight. Available in Black (BLK), White (WHT) and Silver (SLV). Mounting accessories sold separately (see above). Optional integrated USB port in base (FSUSB) allows for charging of mobile devices. UL listed: UL 1153:2014. <ul style="list-style-type: none"> • Occupancy Sensor (OS) - Add \$78 						

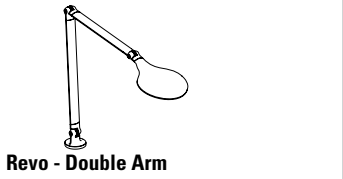

RNDLAMPD	6 x 6 x 21.6	60	2.66	.01	\$688	
Fully articulating body with double arm. 6' power cord. Touch and hold dimming capability, with auto shut-off after 10 hours. Brightness adjustment from 100% to 15%. 18 fractional LEDs, 294 lumens, 3500K color temperature. 85 CRI. 94% post consumer recyclability by weight. Available in Black (BLK), White (WHT) and Silver (SLV). Mounting accessories sold separately (see above). Optional integrated USB port in base (FSUSB) allows for charging of mobile devices. UL listed: UL 1153:2014. <ul style="list-style-type: none"> • Occupancy Sensor (OS) - Add \$78 						

Required Specifications

Finish
Mount

Optional Specifications

Occupancy Sensor

POWER/DATA

MODEL# DIMENSIONS FREIGHT CLASS WT/LBS. CUBIC FT. LIST PRICE



Cable Snake

	D x W x H				
PCSN01	2 x 3 x 31.25	92.5	2.10	.20	\$135

Flexible cable management. Provides access to power/data from floor to underside of worksurface where it attaches. Two pathways within Cable Snake. Silver (SIL) plastic only.

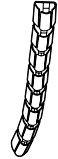

Cable Snake Extension

PCSN01E	- x - x -	92.5	2.1	0.2	\$108
---------	-----------	------	-----	-----	--------------

Extension kit to use with cable snake PCSN01. Additional 8 links extend cable snake up to 49" in length. Ideal for height adjustable tables. Silver plastic only.

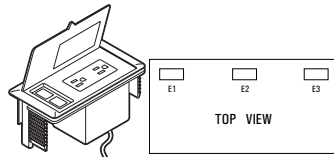

Power/Data Block

PMSpDM	3.5 x 6.5 x 2.75	70	2	.10	\$330
--------	------------------	----	---	-----	--------------

Worksurface power and data module. Two power receptacles and two data receptacles. 9' black cord included. Specify position and add \$96 for cut-out in worksurface. See diagram E1/E2/E3 for specification location. Black only. Cut-out dimensions: 5.95" x 2.75".

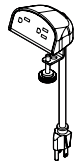

Mini Adapt Power Module

PEUTEM	3 x 3.8 x 2	70	1	.18	\$221
--------	-------------	----	---	-----	--------------

Two power receptacles. Attaches to edge of table or desk through grommet hole. 6' black cord. Black only.

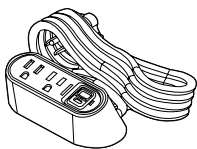

DPC Slim Desktop 2 Power/USB-A and -C

PSDPC22W	2.25 x 4.88 x 2.25	60	2.5	0.5	\$307
----------	--------------------	----	-----	-----	--------------

Desktop power center with two 15A tamper resistant power receptacles, one USB-A port and one USB-C port (provides 3.1A). 10' cord with molded plug. Includes three mounting options: a screw-in mounting plate for forward facing outlets; under surface mount bracket; or a clamp mounting kit for 0.5"-1.5" thick surfaces. Gloss White body with Grey face. UL listed: UL 962A.

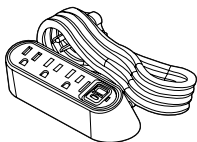

DPC Slim Desktop 3 Power/USB-A and -C

PSDPC32W	2.25 x 6 x 2.25	60	2.6	0.5	\$405
----------	-----------------	----	-----	-----	--------------

Desktop power center with three 15A tamper resistant power receptacles, one USB-A port and one USB-C port (provides 3.1A). 10' cord with molded plug. Includes three mounting options: a screw-in mounting plate for forward facing outlets; under surface mount bracket; or a clamp mounting kit for 0.5"-1.5" thick surfaces. Gloss White body with Grey face. UL listed: UL 962A.

POWER / DATA

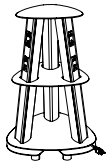

Isle Power Tower

MODEL#	DIMENSIONS D x W x H	FREIGHT CLASS	WT./LBS.	CUBIC FT.	LIST PRICE
PTISL96GB	18 x 18 x 25.5	92.5	68	6.50	\$3760
PTISL96GW	18 x 18 x 25.5	92.5	68	6.50	\$3760
PTISL96SP	18 x 18 x 25.5	92.5	68	6.50	\$3760

Includes three standard duplexes each with (2) 110V power outlets, and three USB A+C duplexes each with (2) 110V power outlets, (1) 55W USB-C power delivery port and (1) 1.5A, 5V USB-A port; total of (12) 110V power outlets, (3) USB-C and (3) USB-A ports. 9' cord with molded plug.

Available in Gloss Black (**GB**), Gloss White (**GW**) and Silver Pearl (**SP**) as indicated by last letter of model number.

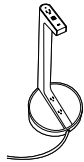

Vesta Portable Power Tower

PPVST3WF	12 x 12 x 28.25	250	10	4.30	\$1580
----------	-----------------	-----	----	------	---------------

Includes three 110V power outlets (one on top, two on base), two USB-A and one USB-C charging ports. 10' cord with plug. Matte White finish with Fog inserts.

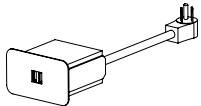

Cove Mini - Charging USB

COV-SM-U-_-108	--	70	1.5	.25	\$378
----------------	----	----	-----	-----	--------------

Retrofits into any AG or POG grommet cutout (grommet cover must be removed). Includes two 2.1 AMP USB charging ports. Requires 2" clearance below the worksurface. 9' black cord. UL listed: UL 962A.

- This unit utilizes the entire grommet, eliminating available wire pass thru
- Replace _ with **B** for **Black**
- Replace _ with **S** for **Silver**

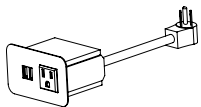

Cove Mini - Power & Charging USB

COV-SM-1U-_-108	--	70	1.5	.25	\$402
-----------------	----	----	-----	-----	--------------

Retrofits into any AG or POG grommet cutout (grommet cover must be removed). Includes one power outlet and two 2.1 AMP USB charging ports. Requires 2" clearance below the worksurface. 9' black cord. UL listed: UL 962A.

- This unit utilizes the entire grommet, eliminating available wire pass thru
- Replace _ with **B** for **Black**
- Replace _ with **S** for **Silver**

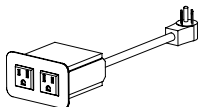

Cove Mini - Power

COV-SM-2-_-108	--	70	1.5	.25	\$249
----------------	----	----	-----	-----	--------------

Retrofits into any AG or POG grommet cutout (grommet cover must be removed). Includes two power outlets. Requires 2" clearance below the worksurface. 9' black cord. UL listed: UL 962A.

- This unit utilizes the entire grommet, eliminating available wire pass thru
- Replace _ with **B** for **Black**
- Replace _ with **S** for **Silver**

Required Specifications

Finish

POWER / DATA

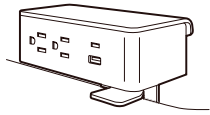

Clamp Mount 2 Power/USB-A&C

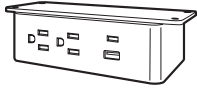

Under Mount 2 Power/USB-A&C



Clamp Mount 3 Power/USB-A&C

MODEL#	DIMENSIONS	FREIGHT CLASS	WT/LBS.	CUBIC FT.	LIST PRICE
--------	------------	---------------	---------	-----------	------------

D x W x H

PS3525057	3.2 x 5.5 x 3	60	3.01	0.2	\$500
PS3525002	3.2 x 5.5 x 3	60	3.01	0.2	\$500

Ashley Duo clamp mount power module with two 15 amp 120 Volt AC receptacles; 2.4 amp USB-A port and 60 watt USB-C power delivery port, 10' power cord with molded plug, UL listed: UL 962A. Clamp accommodates worksurfaces 0.5" to 1.5" thick; fastened with thumb screws.

- PS3525057 - White module with Silver bracket.
- PS3525002 - Black module with Silver bracket

PS3526057	2.8 x 5.5 x 1.8	60	3.2	0.2	\$500
PS3526002	2.8 x 5.5 x 1.8	60	3.2	0.2	\$500

Ashley Duo under mount power module with two 15 amp 120 Volt AC receptacles; 2.4 amp USB-A port and 60 watt USB-C power delivery port, 10' power cord with molded plug, UL listed: UL 962A. Mountable under most worksurfaces. Installation template provided.

- PS3526057 - White module with Silver bracket
- PS3526002 - Black module with Silver bracket.

PS305217	3.2 x 5.5 x 3	60	3.01	0.2	\$575
PS305212	3.2 x 5.5 x 3	60	3.01	0.2	\$575

Ashley Trio clamp mount power module with three 15-amp 120 Volt AC receptacles; 2.4-amp USB-A port and 60 watt USB-C power delivery port, 10' power cord with molded plug, and an adapter kit containing blank cover, HDMI, RJ45 or VGA adapter brackets. NOTE: HDMI, RJ45 and VGA connectors are not included. UL listed: UL 962A. Clamp accommodates worksurfaces 0.5" to 1.5" thick; fastened with thumb screws.

- PS305217 - White module with Silver bracket.
- PS305212 - Black module with Silver bracket

Required Specifications

Finish

POWER/DATA



Single Sided Recessed Power Block

MODEL#	DIMENSIONS D x W x H	FREIGHT CLASS	WT/LBS.	CUBIC FT.	LIST PRICE
PRTMCS401B	4.22 x 10.78 x 4.86	100	4.3	0.51	\$456
PRTMCS401T	4.22 x 10.78 x 4.86	100	4.3	0.51	\$456
PRTMCS401W	4.22 x 10.78 x 4.86	100	4.3	0.51	\$456

Single-sided recessed power block with **one regular duplex and one telecom knockout on top; one power duplex on bottom**. 10' power cord with straight plug. Specify telecom options separately, see page 463. Available in Black (**B**), Tungsten (**T**) or Designer White (**W**) as indicated by the last letter of model number. Duplexes always Grey. Corresponding cut-out options are **R1, R2** or **R3**. Units are not approved for daisy chaining. UL listed: UL 1363.



Single Sided Recessed Power Block - USB-A + USB-C

PRTMCS421B	4.22 x 10.78 x 4.86	100	4.3	0.51	\$599
PRTMCS421T	4.22 x 10.78 x 4.86	100	4.3	0.51	\$599
PRTMCS421W	4.22 x 10.78 x 4.86	100	4.3	0.51	\$599

Single-sided recessed power block with **one power/USB-A/USB-C duplex and one telecom knockout on top; one power duplex on bottom**. USB-A port charges max 2.4 amps at 5V and USB-C port charges max 3 amps at 5V. 10' power cord with straight plug. Specify telecom options separately, see page 463. Available in Black (**B**), Tungsten (**T**) or Designer White (**W**) as indicated by the last letter of model number. Duplexes always Grey (duplex with USB ports is glossy finish). Corresponding cut-out options are **R1, R2** or **R3**. Units are not approved for daisy chaining. UL listed: UL 1363.



Double Sided Recessed Power Block

PRTMCD602B	6.22 x 10.78 x 4.86	92.5	5.9	0.51	\$521
PRTMCD602T	6.22 x 10.78 x 4.86	92.5	5.9	0.51	\$521
PRTMCD602W	6.22 x 10.78 x 4.86	92.5	5.9	0.51	\$521

Double-sided recessed power block with **two regular power duplexes and two telecom knockouts on top; one power duplex on bottom**. 10' power cord with straight plug. Specify telecom options separately, see page 463. Available in Black (**B**), Tungsten (**T**) or Designer White (**W**) as indicated by last letter of model number. Duplexes always Grey. Corresponding cut-out options are **T1, T2** or **T3**. Units are not approved for daisy chaining. UL listed: UL 1363.



Double Sided Recessed Power Block - USB-A + USB-C

PRTMCD622B	6.22 x 10.78 x 4.86	92.5	6.1	0.51	\$656
PRTMCD622T	6.22 x 10.78 x 4.86	92.5	6.1	0.51	\$656
PRTMCD622W	6.22 x 10.78 x 4.86	92.5	6.1	0.51	\$656

Double-sided recessed power block with **one regular power duplex, one power/USB-A/USB-C duplex and two telecom knockouts on top; one power duplex on bottom**. USB-A port charges max 2.4 amps at 5V and USB-C port charges max 3 amps at 5V. 10' power cord with straight plug. Specify telecom options separately, see page 463. Available in Black (**B**), Tungsten (**T**) or Designer White (**W**) as indicated by last letter of model number. Duplexes always Grey (duplex with USB ports is glossy finish). Corresponding cut-out options are **T1, T2** or **T3**. Units are not approved for daisy chaining. UL listed: UL 1363.







Double Sided Recessed Power Block - USB-A + USB-C

PRTMCD642B	6.22 x 10.78 x 4.86	85	6.3	0.51	\$790
PRTMCD642T	6.22 x 10.78 x 4.86	85	6.3	0.51	\$790
PRTMCD642W	6.22 x 10.78 x 4.86	85	6.3	0.51	\$790

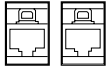
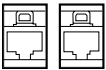
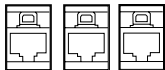
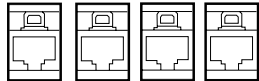
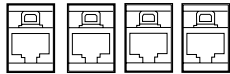
Double-sided recessed power block with **two power/USB-A/USB-C duplexes and two telecom knockouts on top; one power duplex on bottom**. USB-A port charges max 2.4 amps at 5V and USB-C port charges max 3 amps at 5V. 10' power cord with straight plug. Specify telecom options separately, see page 463. Available in Black (**B**), Tungsten (**T**) or Designer White (**W**) as indicated by last letter of model number. Duplexes always Grey (duplex with USB ports is glossy finish). Corresponding cut-out options are **T1, T2** or **T3**. Units are not approved for daisy chaining. UL listed: UL 1363.

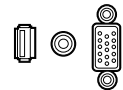
Required Specifications
Finish

TELECOM PLATES	MODEL#	DIMENSIONS D x W x H	FREIGHT CLASS	WT/LBS.	CUBIC FT.	LIST PRICE
 <p>Telecom Plate - 2 x 6</p>	PTEL01	- x - x -	70	0.01	0.05	\$164
	Includes 2 x RJ45 cat 6 data. Black telecom plate. To be hardwired by data contractor.					
 <p>Telecom Plate - 2 x 6</p>	PTEL12	- x - x -	70	1	0.01	\$207
	Grey telecom plate with (2) RJ45 cat 6 data jacks. To be hardwired by data contractor.					
 <p>Telecom Plate - 3 x 6</p>	PTEL02	- x - x -	70	0.01	0.05	\$222
	Includes 2 x RJ45 cat 6 data and 1 RJ11 cat phone. Black telecom plate. To be hardwired by data contractor.					
 <p>Telecom Plate - 4 x 6</p>	PTEL03	- x - x -	70	0.01	0.05	\$340
	Includes 4 x RJ45 cat 6 data. Black telecom plate. To be hardwired by data contractor.					
 <p>Telecom Plate - 4 x 6</p>	PTEL13	- x - x -	70	1	0.01	\$375
	Grey telecom plate with (4) RJ45 cat 6 data jacks. To be hardwired by data contractor.					
 <p>Telecom Plate - 3TSV</p>	PTEL04	- x - x -	70	0.01	0.05	\$290
	Includes 1 x RJ45 cat 6 data, mini stereo and 15 pin HD VGA. Black telecom plate. To be hardwired by data contractor.					
 <p>Telecom Plate - 3SVH</p>	PTEL05	- x - x -	70	0.01	0.05	\$401
	Includes mini stereo, 15 pin HD VGA and HDMI. Black telecom plate.					
 <p>Telecom Plate - SVH</p>	PTEL14	2 x 3.25 x -	70	1	0.01	\$483
	Grey telecom plate with mini stereo, 15 pin HD VGA with female to male connector cable and HDMI with female to female connector cable.					
 <p>Telecom Plate - 1 USB-C, 1 USB-A</p>	PTEL08	- x - x -	70	1	0.01	\$176
	Grey telecom plate with (1) USB-C port w/20" male pigtail and (1) USB-A port w/72" pigtail; requires powered USB transformer #PUSBTRSF ordered separately.					

Required Specifications

Finish

TELECOM PLATES

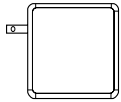

Powered USB Transformer



Telecom Plate - 2 USB-A



Telecom Plate - 2 RJ45, 1 HDMI

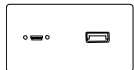

Telecom Plate - 1 HDMI, 1 USB-A



Telecom Plate - 1 HDMI

MODEL#	DIMENSIONS	FREIGHT CLASS	WT/LBS.	CUBIC FT.	LIST PRICE
--------	------------	---------------	---------	-----------	------------

D x W x H

PUSBTRSF	- x - x -	70	1	0.01	\$117
----------	-----------	----	---	------	--------------

Powered USB transformer, 25w, 100-240 VAC, 5-9VDC (1) USB-C and (2) USB-A female ports - provides power for PTEL08.

PTEL09	- x - x -	70	1	0.01	\$236
--------	-----------	----	---	------	--------------

Grey telecom plate with (2) USB-A ports each 2/72" patchcord.

PTEL10	- x - x -	70	1	0.01	\$485
--------	-----------	----	---	------	--------------

Grey telecom plate with (2) RJ45 cat 6 data connectors, (1) HDMI w/36" male pigtail; female/female gender changer included.

PTEL11	- x - x -	70	1	0.01	\$386
--------	-----------	----	---	------	--------------

Grey telecom plate with (1) HDMI female/female w/36" patchcord and (1) USB-A with 72" patchcord.

PTEL15	- x - x -	70	1	0.10	\$445
--------	-----------	----	---	------	--------------

Grey telecom plate with (1) HDMI female/female with 36" patchcord.

POWER SOLUTIONS FOR FLEXIBLE SPACES MODEL# DIMENSIONS FREIGHT CLASS WT./LBS. CUBIC FT. LIST PRICE

- Perfect for training areas, meeting rooms, in-office workstations and more; Code compliant that allows users to optimize any space providing convenient power access.
- Connect up to four units from a single infeed, delivering AC power and USB charging to the table tops.
- Two styles are available: in-surface modules or on-surface modules.
- Starter modules include 10' corded infeed with three prong NEMA plug.
- Touch safe easy to use connectors from module to module with added latch to prevent unintended separation.
- Each module features three tamper-resistant receptacles, USB-A and USB-C charging ports.
- Overall maximum length joined together not to exceed 48.5 feet per infeed.
- UL listed to **UL962A SD**, the standard for furniture power distribution units on portable/movable workspace tables.
- Certified to CSA standard **C22.2 No. 203-16**.
- When ordering in-surface modules be sure to select corresponding cut-out options when specifying tables. Specify **MPS** for a single centered cut-out on the approach side of the table or **MPD** for two cut-outs in the left and right hand positions. Upcharge will apply per cut-out. Cut-outs are available on the following series: **2gether tables, Bungee rectangular fixed and flip-top tables, Bungee SL tables, ConnectTables, Edventure study carrels and Zook rectangular and flip-top tables**. Surface must be a minimum of 0.5" to a maximum of 1.5" thick for proper mounting of the units.
- On-surface modules come with a clamp mount that will accommodate any material from 0.5" to 1.5" thick; additional brackets are also included for alternate screw in mounting options that can accommodate vertical or horizontal positions.
- In-surface cut-out dimensions: 7.15" x 2.25".

In Surface

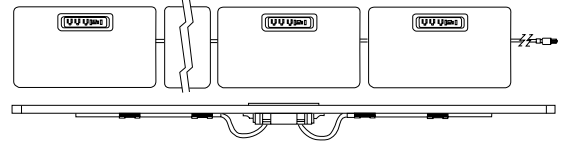

On Surface

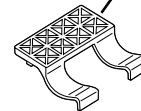
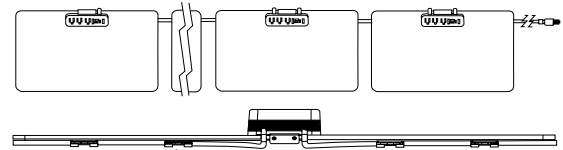

Cable management cord clips:
Included with each unit (2 clips per cord) and are available separately in packs of 10.

MODPOWER DAISY-CHAIN SOLUTION MODEL# DIMENSIONS FREIGHT CLASS WT./LBS. CUBIC FT. LIST PRICE

D x W x H

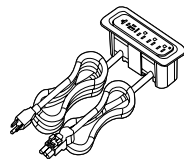

ModPower In-Surface Starter Unit

PMDSF10MG	2.75 x 7.63 x 2.63	250	3.44	1	\$521
PMDSF10WH	2.75 x 7.63 x 2.63	250	3.44	1	\$521

Includes infeed, one 10' cord with NEMA plug and one 3' connector cord. Unit is equipped with three 15A tamper-resistant receptacles, one USB-A and one USB-C charging ports, and a circuit breaker. Four cable management cord clips included. Specify corresponding cut-out code when ordering table: single centered cut-out (**MPS**) or two cut-outs in left and right positions (**MPD**). Available in Magnesium (**MG**) or White (**WH**) finish as indicated by last characters of model number. UL listed: UL 962A.

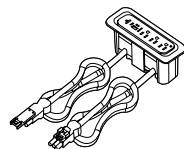

ModPower In-Surface Middle Unit

PMDCF3MG	2.75 x 7.63 x 2.63	250	2.44	1	\$490
PMDCF3WH	2.75 x 7.63 x 2.63	250	2.44	1	\$490

Includes two 3' connector cords. Unit is equipped with three 15A rated 12A tamper-resistant receptacles, one USB-A and one USB-C charging ports, and a circuit breaker. Four cable management cord clips included. Specify corresponding cut-out code when ordering table: single centered cut-out (**MPS**) or two cut-outs in left and right positions (**MPD**). Available in Magnesium (**MG**) or White (**WH**) finish as indicated by last characters of model number. UL listed: UL 962A.

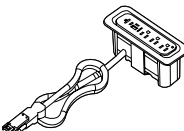

ModPower In-Surface End Unit

PMDEF3MG	2.75 x 7.63 x 2.63	70	1.85	1	\$429
PMDEF3WH	2.75 x 7.63 x 2.63	70	1.85	1	\$429

Includes one 3' connector cord. Unit is equipped with three 15A rated 12A tamper-resistant receptacles, one USB-A and one USB-C charging ports, and a circuit breaker. Two cable management cord clips included. Specify corresponding cut-out code when ordering table: single centered cut-out (**MPS**) or two cut-outs in left and right positions (**MPD**). Available in Magnesium (**MG**) or White (**WH**) finish as indicated by last characters of model number. UL listed: UL 962A.

MODPOWER MODULES

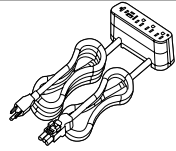

ModPower On-Surface Starter Unit

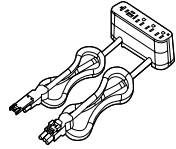

ModPower On-Surface Middle Unit

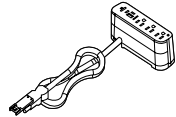

ModPower On-Surface End Unit

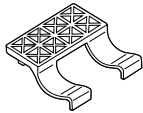

ModPower Cable Management Clips

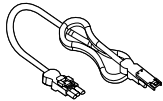

ModPower Interconnecting Jumper

MODEL#	DIMENSIONS D x W x H	FREIGHT CLASS	WT/LBS.	CUBIC FT.	LIST PRICE
PMDSA10MG	1.75 x 6.13 x 2.5	150	4.33	1	\$551
PMDSA10WH	1.75 x 6.13 x 2.5	150	4.33	1	\$551

Includes infeed, one 10' cord with NEMA plug and one 3' connector cord. Unit is equipped with three 15A tamper-resistant receptacles, one USB-A and one USB-C charging ports, and a circuit breaker. Includes edge clamp and three other mounting methods. Four cable management cord clips included. Available in Magnesium (**MG**) or White (**WH**) finish as indicated by last characters of model number. UL listed: UL 962A.

PMDCA3MG	1.75 x 6.13 x 2.5	250	3.33	1	\$521
PMDCA3WH	1.75 x 6.13 x 2.5	250	3.33	1	\$521

Includes two 3' connector cords. Unit is equipped with three 15A rated 12A tamper-resistant receptacles, one USB-A and one USB-C charging ports, and a circuit breaker. Includes edge clamp and three other mounting methods. Four cable management cord clips included. Available in Magnesium (**MG**) or White (**WH**) finish as indicated by last characters of model number. UL listed: UL 962A.

PMDEA3MG	1.75 x 6.13 x 2.5	250	2.75	1	\$459
PMDEA3WH	1.75 x 6.13 x 2.5	250	2.75	1	\$459

Includes one 3' connector cord. Unit is equipped with three 15A rated 12A tamper-resistant receptacles, one USB-A and one USB-C charging ports, and a circuit breaker. Includes edge clamp and three other mounting methods. Two cable management cord clips included. Available in Magnesium (**MG**) or White (**WH**) finish as indicated by last characters of model number. UL listed: UL 962A.

PMDCLIPS	2.5 x 2.6 x .6	70	0.03	0.02	\$92
----------	----------------	----	------	------	-------------

Package of 10 clips.

PMDJ36BK	-- x 36 x --	70	1.38	0.09	\$308
----------	--------------	----	------	------	--------------

Interconnection jumper cord to add an additional 3' of cord length between in-surface and on-surface ModPower units. 3' cord with male and female connector. Package of 2 jumpers. UL listed: UL 962A.

Required Specifications

Finish

OFFICE ACCESSORIES

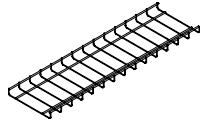

Power/Data Cable Basket

MODEL# DIMENSIONS FREIGHT CLASS WT/LBS. CUBIC FT. LIST PRICE

	D x W x H				
BRTCB76KIT	8 x 34 x 1	70	1.56	0.15	\$263
BRTCB70	8 x 70 x 1	100	3.22	0.34	\$191
BRTCB64	8 x 64 x 1	92.5	2.94	0.29	\$178
BRTCB58	8 x 58 x 1	92.5	2.66	0.26	\$172
BRTCB52	8 x 52 x 1	100	2.39	0.24	\$162
BRTCB46	8 x 46 x 1	92.5	2.16	0.21	\$153
BRTCB40	8 x 40 x 1	70	1.8	0.18	\$145
BRTCB34	8 x 34 x 1	70	1.56	0.15	\$139
BRTCB28	8 x 28 x 1	70	1.2	0.13	\$123
BRTCB22	8 x 22 x 1	70	1.01	0.1	\$115
BRTCB16	8 x 16 x 1	70	0.73	0.07	\$108
BRTCB8	8 x 8 x 1	70	0.36	0.03	\$97

Shallow, 8" wide basket manages cable excess and serves to manage cords and cables. It can be easily unclipped from spring steel brackets (included) to rearrange cable connections from below worksurface. Spring steel brackets can suspend the Cable Basket below the worksurface where it keeps the cords and cables off the floor and manages them along the horizontal plane - between floor monuments and Storage Vertical Cable Manager, for example. Tall storage cabinet's legs provide easy access to the Cable Basket where it can easily be unclipped from spring steel brackets to rearrange cable connections. Steel wire construction, chrome finish baskets; black spring steel hanging brackets, fasteners.

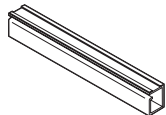

Wire Manager

PEWM5.5	2 x 66 x 2	70	.60	.10	\$198
PEWM5	2 x 60 x 2	70	.60	.10	\$166
PEWM4.5	2 x 54 x 2	70	.50	.10	\$148
PEWM4	2 x 48 x 2	70	.50	.10	\$135
PEWM3.5	2 x 42 x 2	70	.40	.10	\$116
PEWM3	2 x 36 x 2	70	.40	.10	\$104
PEWM2.5	2 x 30 x 2	70	.30	.10	\$85
PEWM2	2 x 24 x 2	70	.30	.10	\$70
PEWM1.5	2 x 18 x 2	70	.20	.10	\$55
PEWM1	2 x 12 x 2	70	.20	.10	\$40

Plastic tray flexes to receive and hold electrical and data wires. Quickly attaches with two strips of double-sided tape. Black (**BLK**) only.



Vertical Wire Manager

PEVWM	2 x 22 x 2	70	.30	.10	\$68
-------	------------	----	-----	-----	-------------

From underside of worksurface to bottom panel. Capable of holding electrical and data wires in a vertical position. Black (**BLK**) only. Attaches with two strips of double-sided tape.

Required Specifications

Finish

OFFICE ACCESSORIES



Coat Tree

MODEL#	DIMENSIONS D x W x H	FREIGHT CLASS	WT/LBS.	CUBIC FT.	LIST PRICE
PCOS2	25 x 25 x 60	300	8	4.67	\$501
PCOS3	25 x 25 x 60	300	8	4.67	\$501

Square tube metal frame, complete with four Chrome double hooks. Adjustable glides. 60" high. Ships UPS. 3 per carton

- PCOS2 is finished in Black. PCOS3 is finished in Chrome.



Coat Tree*

PCT	25 x 25 x 65	250	6	3	\$642
-----	--------------	-----	---	---	--------------

Square tube. Complete with four satin brass double hooks. 65" high. Available in the following finishes: Absolute (AAM), Black (BKM), Cherry (ACM), Cherry Latte (CLM), Cocoa Vanilla (CVM), English Oak (EOM), Fruitwood (TFM), Honey (AHM), Gray (HGM), Mahogany (TMM), Maple (AVM), Medium Walnut (MWM), Night (ASM), Sandy Beach (SBM), Walnut (TWM), White (WHM) and Winter Cherry (WCM). Ships UPS. 1 per carton.

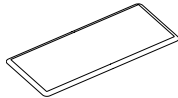

Anti-Fatigue Mat

PAFM3018	29.4 x 17.63 x .75	85	4.4	0.3	\$172
PAFM4820	48 x 20 x .75	85	7.7	0.59	\$276

Polyurethane anti-fatigue mat offers increased comfort and helps reduce strain while standing. Tapered, no-curl edges prevent tripping hazards. Anti-slip backing is suitable for low pile carpet or hard flooring. Black only.

Required Specifications

Finish*

BOARDROOM ACCESSORIES **MODEL#** **DIMENSIONS** **FREIGHT CLASS** **WT./LBS.** **CUBIC FT.** **LIST PRICE**

D x W x H

CONFERENCE CABINET NOTES

- Visual boards feature a self edge all around.
- Available finishes:
 ACJ Absolute Acajou
 BLK Black
 QTM Quartered Mahogany

ASN	Asian Night	AWC	Avant Cherry	AWH	Avant Honey
BRC	Brushed Cobalt	DES	Dark Espresso	DWT	Designer White
SOG	Storm Grey	WHC	White Chocolate	WCR	Winter Cherry

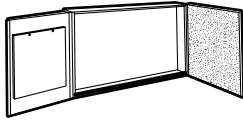

Visual Board*

Includes white board and two side opening doors containing cork board on right door and 50-sheet paper writing pad on left door. Marker board can be used for projection. Set of 4 dry markers and eraser included.

- **NOTE:** Care should be taken to mount the units. Units should be mounted to wall studs using correct fasteners. Failure to do so may result in collapse of the unit and subsequent personal injury. **Mounting hardware not included.** Mounting hardware used should be based on wall material. Consult an installation professional for proper wall mounting.

GVB4848	4 x 48 x 48	85	122	9.25	\$1695
AVB4848	4 x 48 x 48	70	135	9	\$1650

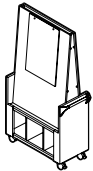

Visual Board*

Angled visual board with paper pad on one side and dry erase board on the opposite side. Unique push handles are standard. Locking casters included. Decorative aluminum trim is standard on the lip of each shelf. Height aligns with 36" buffets. Shipped RTA (ready to assemble).

Z361872VB	36 x 18 x 72	250	187	38.50	\$2954
-----------	--------------	-----	-----	-------	---------------

PENCIL DRAWERS **MODEL#** **DIMENSIONS** **FREIGHT CLASS** **WT./LBS.** **CUBIC FT.** **LIST PRICE**

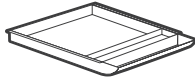

Pencil Drawer

Black ABS plastic. Provides space for writing instruments and small items at the workspace. Attaches to underside of any 24"D and 30"D worksurface with included roller slides. Shipped RTA (ready to assemble).

- May be used with all casegoods.

W1624PDR	16 x 24 x 2.25	92.5	5	.50	\$362
W1518PDR	18 x 15 x 2.25	92.5	4	.40	\$274

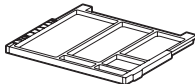



Pencil Drawer

Provides storage for writing instruments and small items at the worksurface. Attaches to underside of worksurface with drawer slides (included). Black ABS plastic only.

PEEPD	15 x 22.5 x 1.5	250	2	0.7	\$164
-------	-----------------	-----	---	-----	--------------

Required Specifications

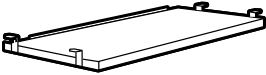
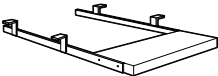
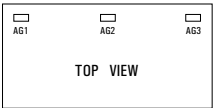
Laminate finish

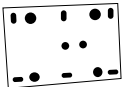
KEYBOARD DRAWERS		MODEL#	DIMENSIONS	FREIGHT CLASS	WT./LBS.	CUBIC FT.	LIST PRICE
 <p>Keyboard Shelf</p>		KS20	D x W x H 11 x 20 x 3.5	92.5	10	1	\$265
		Pull-out laminate shelf. Specify finish from list available in each series. • Not available on StreamLINE or Adaptabilities Series - see page 41 for comparable Adaptabilities option.					
 <p>Keyboard Drawer</p>		MPOKL	11 x 24 x 3.5	92.5	10	1	\$274
		Pull-out laminate drawer. Specify finish from list available in each series. • Not available on StreamLINE or Adaptabilities Series - see page 41 for comparable Adaptabilities option.					
ACCESSORIES		MODEL#	DIMENSIONS	FREIGHT CLASS	WT./LBS.	CUBIC FT.	LIST PRICE
 <p>Wire Manager Grommet</p>		AG1	1.875 d x 3.25 w	100	--	--	\$96
		AG2					
		AG3					
	Rectangular black surface mount that can be factory installed in any worksurface. Indicate position - left (AG1), center (AG2) or right (AG3). See individual Series Notes for further details. To order a grommet cover only, please specify GEN160-UN - \$25 list each.						
 <p>L Bracket</p>		MLB90	4.5 x 1.5	70	1	.01	\$60
		Used to attach worksurfaces to end panels. Black only.					
 <p>Flat Bracket</p>		CST318	4.5 x 3	70	1	.01	\$56
		Used as a mending plate to give additional worksurface support. Black only.					

CENTER DRAWERS	MODEL#	DIMENSIONS	FREIGHT CLASS	WT./LBS.	CUBIC FT.	LIST PRICE
----------------	--------	------------	---------------	----------	-----------	------------

CENTER DRAWER NOTES

• Center drawers must be dealer or end user installed. Drawers do not fill entire center space opening. Approximate kneespace widths are:

30" x 60" DP	25½"	30" x 66" DP	31½"
30" x 72" DP	37½"	30" x 66"/20" x 40" L	22½"
30" x 66"/24" x 48" L	24½"	36" x 72"/24" x 48" L	30½"

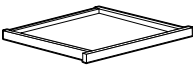
 <p>Center Drawer*</p>		CD20	18 x 20 x 3	100	8	1	\$214
		Laminate drawer front is attached to a 4-sided frame. Recommended for use on small L-shaped units, and on 30" x 60" and 66" desks.					

Required Specifications

Finish*

HANDLES

MODEL# DIMENSIONS FREIGHT CLASS WT/LBS. CUBIC FT. LIST PRICE



Silver Handle (HV)

MODEL#	D x W x H	FREIGHT CLASS	WT/LBS.	CUBIC FT.	LIST PRICE
GEN225-SIL	-- x 5 x --	70	1	.01	\$34

Silver finish, square edge handle style. **For use on pedestals and all lateral files.**

- This handle has a measurement of 96mm center to center.
- Drawer handles on this page are for purchase. Installation is done by the customer. To purchase as a factory installed option on **Zira** desks, credenzas and returns, see series notes for option code and price.



Matte Black Handle (HU)

GEN225-BLK	-- x 5 x --	70	1	.01	\$34
------------	-------------	----	---	-----	------

Black matte finish, square edge handle style. **For use on pedestals and all lateral files.**

- This handle has a measurement of 96mm center to center.
- Drawer handles on this page are for purchase. Installation is done by the customer. To purchase as a factory installed option on **Zira** desks, credenzas and returns, see series notes for option code and price.



Flared Brass Handle (HW)

GEN217	-- x 5.25 x --	70	1	.01	\$34
--------	----------------	----	---	-----	------

Satin brass finish, flared handle style. **For use on pedestals and all lateral files.**

- This handle has a measurement of 96mm center to center.
- Drawer handles on this page are for purchase. Installation is done by the customer. To purchase as a factory installed option on **Zira** desks, credenzas and returns, see series notes for option code and price.



Flared Black Handle (HX)

GEN165	-- x 5.25 x --	70	1	.01	\$34
--------	----------------	----	---	-----	------

Black matte finish, flared handle style **For use on pedestals and all lateral files.**

- This handle has a measurement of 96mm center to center.
- Drawer handles on this page are for purchase. Installation is done by the customer. To purchase as a factory installed option on **Zira** desks, credenzas and returns, see series notes for option code and price.



Flared Silver Handle (HS)

GEN189-HS	-- x 4.5 x --	70	1	.01	\$34
-----------	---------------	----	---	-----	------

Silver finish, flared handle style. **For use on pedestals and all lateral files.**

- This handle has a measurement of 96mm center to center.
- Drawer handles on this page are for purchase. Installation is done by the customer. To purchase as a factory installed option on **Zira** desks, credenzas and returns, see series notes for option code and price.



Dimpled Nickel Handle (HZ)

GEN190	-- x 4.9 x --	70	1	.01	\$34
--------	---------------	----	---	-----	------

Nickel matte finish, dimpled handle style. **For use on pedestals and all lateral files.**

- This handle has a measurement of 96mm center to center.
- Drawer handles on this page are for purchase. Installation is done by the customer. To purchase as a factory installed option on **Zira** desks, credenzas and returns, see series notes for option code and price.



Crescent Black Handle (H0)

GEN256	-- x 4.75 x --	70	1	.01	\$34
--------	----------------	----	---	-----	------

Black matte finish, crescent handle style **For use on pedestals and all lateral files.**

- This handle has a measurement of 96mm center to center.
- Drawer handles on this page are for purchase. Installation is done by the customer. To purchase as a factory installed option on **Zira desks, credenzas and returns only**, see series notes for option code and price.

Required Specifications

Finish (Drawers)



HANDLES	MODEL#	DIMENSIONS	FREIGHT CLASS	WT/LBS.	CUBIC FT.	LIST PRICE
 <p>Bar Silver Handle (HQ)</p>		D x W x H				
	CS0003-SIL	-- x 4.6 x --	70	1	.01	\$34
<p>Silver finish, bar handle style For use on pedestals and all lateral files.</p> <ul style="list-style-type: none"> • This handle has a measurement of 96mm center to center. • Drawer handles on this page are for purchase. Installation is done by the customer. To purchase as a factory installed option on Zira desks, credenzas and returns only, see series notes for option code and price. 						
 <p>Bar Black Handle (HR)</p>		D x W x H				
	CS0003-BLK	-- x 4.6 x --	70	1	.01	\$34
<p>Black finish, bar handle style For use on pedestals and all lateral files.</p> <ul style="list-style-type: none"> • This handle has a measurement of 96mm center to center. • Drawer handles on this page are for purchase. Installation is done by the customer. To purchase as a factory installed option on Zira desks, credenzas and returns only, see series notes for option code and price. 						
 <p>Bridges II Handle</p>		D x W x H				
	BRH1	-- x 6.375 x --	70	1	.01	\$35
<p>Silver Finish, square edged handle style. For use on all pedestals and storage cabinets with handles.</p> <ul style="list-style-type: none"> • This handle has a measurement of 128mm center to center. • Drawer handles on this page are for purchase. Installation is done by the customer. To purchase as a factory installed option on Bridges II pedestals and cabinets only, see series notes for option code and price. 						

table power
+
technology solutions



T TABLE POWER + TECHNOLOGY SOLUTIONS™ - NOTES

- Global is pleased to offer a range of sophisticated electrical and technology options for training and conference tables.
- Worksurface cut-outs for units must be specified separately, please see appropriate product note pages for details.
- Daisy chaining is generally defined as having multiple power units connect to one another from a single electrical infeed source.
- The daisy-chain units below utilize a 4-wire, 2 circuit system (when hardwired by a licensed electrician to a building power source) or can run a single circuit (when utilizing the 42AP1-72 plug and play infeed).
- The following maximums are to National Electric Code (NEC) – some local codes vary from NEC code – it is the customer's responsibility to follow all applicable local codes and guidelines.

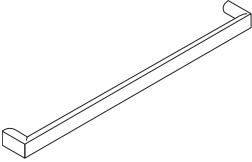
Product	Max units per circuit
Villa I	8 units per circuit
Villa II	4 units per circuit
Villa USB	8 units per circuit
Oasis Mini A	3 units per circuit
Oasis Mini B	3 units per circuit

Electrical System

4-2 Wiring Schematic
 4-Wire Shared Neutral
 Complies with National Electric Code
 UL Listed
 All circuits rated for 20 AMP

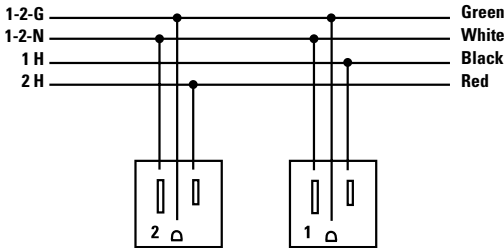

VILLA I, VILLA II AND VILLA USB DETAILS

- Each Villa unit is available two ways. Corded units includes three-prong plugs to connect directly into a standard outlet. DaisyLink kits can be specified separately to daisy-chain multiple units off of a single infeed. Infeeds are specified separately.
- Villa I units include two power outlets and either two knockouts or two data ports included, **all accessible at the surface**.
- Villa II units include two power outlets and either two knockouts for data or two data ports included accessible at the surface. Another two power outlets are **accessible below the surface**.
- Villa USB includes two power outlets, two 2.1 AMP charging USB ports and either two data knockouts or two data ports included, **all accessible at the surface**.

OASIS MINI DETAILS

- Each Oasis Mini (except for Chicago Mini Oasis) is available two ways. Corded units includes three-prong plugs to connect directly into a standard outlet. DaisyLink units must have interconnecting cords specified separately to daisy-chain multiple units off of a single infeed. Infeeds are specified separately.
- Oasis Mini A units includes six power outlets and two telecom plate knockouts
- Oasis Mini B units includes four power outlets and three telecom plate knockouts
- Oasis Mini USB units include six power outlets, two 2.1 AMP charging USB ports and one telecom plate knockouts

TELECOM PLATE DETAILS

- Telecom plates are for use on Oasis Mini units only, providing a means to provide different types of telephone, data and audio visual connections to the worksurface. For every telecom plate knockout on a Oasis Mini unit, please specify one telecom plate. If telecom plates are not required, it is recommended blank telecom plates are specified - see page 484 for details.

EXAMPLE LAYOUTS - TRAINING TABLES

- Single Power Block Kits Available on training tables 36" – 72" (**must specify V2 cut-out on table**):
- Each single block kit includes 1 Power Block and 1 Grommet Cover, 1 Female/Female Interconnecting Cable and 1 Female/Male Interconnecting Cable. Cable clamps for management of these cables are also included.

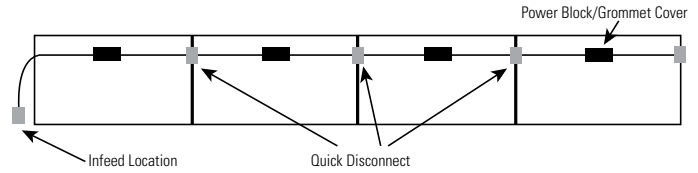

- Double Power Block Kits Available on 60", 66" and 72" (**must specify V1 and V3 cut-out on table**):
- Each double block kit includes 2 Power Blocks and 2 Grommet Covers, 2 Female/Female Interconnecting Cable and 1 Female/Male Interconnecting Cable. Cable clamps for management of these cables are also included.

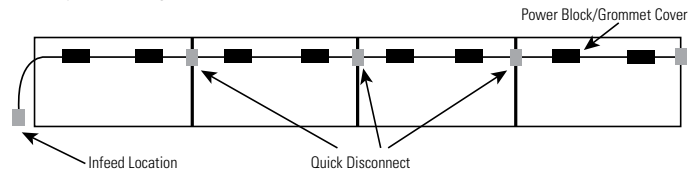

VILLA CUT-OUTS

- Optional Villa cut-out available in standard worksurface locations (left, center or right) **for Rectangular Tables**. Order as: **V1, V2 or V3**. **Add \$96 for each cut-out**.
- Villa cut-outs may be placed at non-standard locations. Please contact customer service.

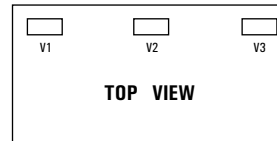

OASIS MINI CUT-OUTS

- Optional Oasis Mini cut-out available in standard worksurface locations (left, center or right) **for Rectangular Tables**. Order as: **M1, M2 or M3**. **Add \$96 for each cut-out**.
- Oasis Mini cut-outs may be placed at non-standard locations. Please contact customer care.
- **Oasis Mini is only available on Zira Boardroom Tables**

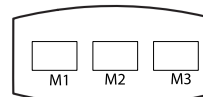

VILLA I, CENTER POSITION- DAISYLINK KITS

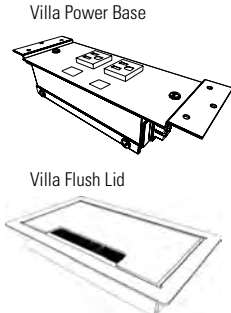

Data Knockouts, No Data Ports

MODEL#	DIMENSIONS	FREIGHT CLASS	WT./LBS.	CUBIC FT.	LIST PRICE
--------	------------	---------------	----------	-----------	------------

D x W x H

VIF-41-DKO_72SK	--	70	9	.45	\$496
VIF-41-DKO_66SK	--	70	9	.45	\$496
VIF-41-DKO_60SK	--	70	9	.45	\$496
VIF-41-DKO_54K	--	70	9	.45	\$496
VIF-41-DKO_48K	--	70	9	.45	\$496
VIF-41-DKO_42K	--	70	9	.45	\$496
VIF-41-DKO_36K	--	70	9	.45	\$496

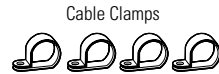

Includes **one power block** with **two power receptacles** and two knockouts for data, grommet cover, one female/female interconnecting cable, one female/male interconnecting cable and four cable clamps. **V2 cut-out must be specified on training table** (see product notes section for more details and cut-out upcharge). **Power Infeed required and sold separate** (see page 485). For multiple circuit configurations, please contact customer service. UL listed: UL 183 and CSA Certified.

- Replace _ with **B** for **Black**
- Replace _ with **S** for **Silver Pearl**
- Villa DaisyLink kits are not recommended for use on 2gether tables or Zira Boardroom Tables

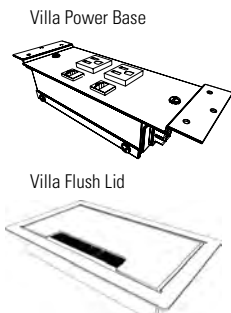

Data Knockouts, Data Ports Included

VIF-41-D-_72SK	--	70	9	.45	\$648
VIF-41-D-_66SK	--	70	9	.45	\$648
VIF-41-D-_60SK	--	70	9	.45	\$648
VIF-41-D-_54K	--	70	9	.45	\$648
VIF-41-D-_48K	--	70	9	.45	\$648
VIF-41-D-_42K	--	70	9	.45	\$648
VIF-41-D-_36K	--	70	9	.45	\$648



Includes **one power block** with **two power receptacles** and **two RJ45** Cat 6 Data, grommet cover, one female/female interconnecting cable, one female/male interconnecting cable and four cable clamps. **V2 cut-out must be specified on training table** (see product notes section for more details and cut-out upcharge). **Power Infeed required and sold separate** (see page 485). For multiple circuit configurations, please contact customer service. UL listed: UL 183 and CSA Certified.

- Replace _ with **B** for **Black**
- Replace _ with **S** for **Silver Pearl**
- Villa DaisyLink kits are not recommended for use on 2gether tables or Zira Boardroom Tables

Required Specifications

Finish
Power Infeed
Cut-out location

T TABLE POWER + TECHNOLOGY SOLUTIONS

VILLA I, CENTER POSITION- DAISYLINK KITS

MODEL# DIMENSIONS FREIGHT CLASS WT./LBS. CUBIC FT. LIST PRICE

D x W x H

VIF-41-UDKO_-36K	--	70	10	.45	\$679
VIF-41-UDKO_-42K	--	70	10	.45	\$679
VIF-41-UDKO_-48K	--	70	10	.45	\$679
VIF-41-UDKO_-54K	--	70	10	.45	\$679
VIF-41-UDKO_60SK	--	70	10	.45	\$679
VIF-41-UDKO_66SK	--	70	10	.45	\$679
VIF-41-UDKO_72SK	--	70	10	.45	\$679

Villa Power Base

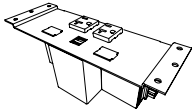

Villa Flush Lid



42 FF Cable



42 FM Cable



Cable Clamps

Villa I USB Data Knockouts, No Data Ports

Includes **one power block with two power receptacles, two 2.1 AMP USB charging ports** and two knockouts for data, grommet cover, one female/female interconnecting cable, one female/male interconnecting cable and four cable clamps. **V2 cut-out must be specified on training table** (see product notes section for more details and cut-out upcharge). **Power Infeed required and sold separate** (see page 485). For multiple circuit configurations, please contact customer service.

UL listed: UL 183 and CSA Certified.

- Replace _ with **B** for **Black**
- Replace _ with **S** for **Silver Pearl**
- Villa DaisyLink kits are not recommended for use on 2gether tables or Zira Boardroom Tables
- Not compatible with Terina tables or Junction wire managers (JNECxx)

VIF-41-UD_-36K	--	70	10	.45	\$831
VIF-41-UD_-42K	--	70	10	.45	\$831
VIF-41-UD_-48K	--	70	10	.45	\$831
VIF-41-UD_-54K	--	70	10	.45	\$831
VIF-41-UD_60SK	--	70	10	.45	\$831
VIF-41-UD_66SK	--	70	10	.45	\$831
VIF-41-UD_72SK	--	70	10	.45	\$831

Villa Power Base

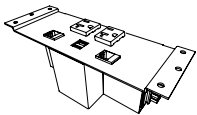

Villa Flush Lid



Villa I USB Data Knockouts, Data Ports Included

Includes **one power block with two power receptacles, two 2.1 AMP USB charging ports** and two RJ45 Cat 6 for data, grommet cover, one female/female interconnecting cable, one female/male interconnecting cable and four cable clamps. **V2 cut-out must be specified on training table** (see product notes section for more details and cut-out upcharge). **Power Infeed required and sold separate** (see page 485). For multiple circuit configurations, please contact customer service.

UL listed: UL 183 and CSA Certified.

- Replace _ with **B** for **Black**
- Replace _ with **S** for **Silver Pearl**
- Villa DaisyLink kits are not recommended for use on 2gether tables or Zira Boardroom Tables
- Not compatible with Terina tables or Junction wire managers (JNECxx)

Required Specifications

Finish
Power Infeed
Cutout location

VILLA II, CENTER POSITION - DAISYLINK KITS

Villa II Power Base

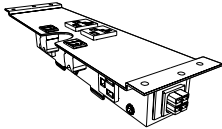

Villa II Flush Lid



Data Knockouts, No Data Ports

MODEL#	DIMENSIONS	FREIGHT CLASS	WT/LBS.	CUBIC FT.	LIST PRICE
	D x W x H				
VIF2-41-DKO_72SK	--	65	12	.45	\$585
VIF2-41-DKO_66SK	--	65	12	.45	\$585
VIF2-41-DKO_60SK	--	65	12	.45	\$585
VIF2-41-DKO_54K	--	65	12	.45	\$585
VIF2-41-DKO_48K	--	65	12	.45	\$585
VIF2-41-DKO_42K	--	65	12	.45	\$585
VIF2-41-DKO_36K	--	65	12	.45	\$585

42 FF Cable



42 FM Cable



Cable Clamps



Includes **one power block** with **four power receptacles** (two worksurface accessible, two below worksurface) and two knockouts for data, grommet cover, one female/female interconnecting cable, one female/male interconnecting cable and four cable clamps. **V2 cut-out must be specified on training table** (see product notes section for more details and cut-out upcharge). **Power Infeed required and sold separate** (see page 485). For multiple circuit configurations, please contact customer service. UL listed: UL 183 and CSA Certified.

- Replace _ with **B** for **Black**
- Replace _ with **S** for **Silver Pearl**
- Villa DaisyLink kits are not recommended for use on 2gether tables or Zira Boardroom Tables

VIF2-41-D_-72SK	--	65	12	.45	\$740
VIF2-41-D_-66SK	--	65	12	.45	\$740
VIF2-41-D_-60SK	--	65	12	.45	\$740
VIF2-41-D_-54K	--	65	12	.45	\$740
VIF2-41-D_-48K	--	65	12	.45	\$740
VIF2-41-D_-42K	--	65	12	.45	\$740
VIF2-41-D_-36K	--	65	12	.45	\$740

Villa II Power Base

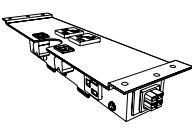

Villa II Flush Lid



Data Knockouts, Data Ports Included

42 FF Cable



42 FM Cable



Cable Clamps



Includes **one power block** with **four power receptacles** (two worksurface accessible, two below worksurface) and **two RJ45 Cat 6 Data**, grommet cover, one female/female interconnecting cable, one female/male interconnecting cable and four cable clamps. **V2 cut-out must be specified on training table** (see product notes section for more details and cut-out upcharge). **Power Infeed required and sold separate** (see page 485). For multiple circuit configurations, please contact customer service. UL listed: UL 183 and CSA Certified.

- Replace _ with **B** for **Black**
- Replace _ with **S** for **Silver Pearl**
- Villa DaisyLink kits are not recommended for use on 2gether tables or Zira Boardroom Tables

Required Specifications

Finish
Power Infeed
Cutout location

T TABLE POWER + TECHNOLOGY SOLUTIONS

VILLA I, LEFT & RIGHT POSITION - DAISYLINK KITS MODEL# DIMENSIONS FREIGHT CLASS WT/LBS. CUBIC FT. LIST PRICE

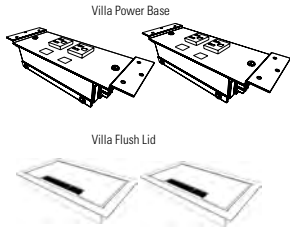

Data Knockouts, No Data Ports

MODEL#	DIMENSIONS D x W x H	FREIGHT CLASS	WT/LBS.	CUBIC FT.	LIST PRICE
GL-VIF41KO_72DK	--	60	18	.23	\$924
GL-VIF41KO_66DK	--	60	18	.23	\$924
GL-VIF41KO_60DK	--	60	18	.23	\$924

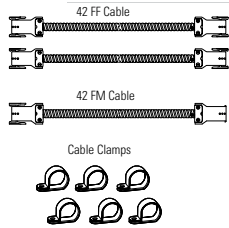

Includes **two power blocks** with **two power receptacles** and two knockouts for data in each block, two grommet covers, two female/female interconnecting cables, one female/male interconnecting cable and 6 cable clamps. **V1 & V3 cut-outs must be specified on training table** (see product notes section for more details and cut-out upcharge). **Power Infeed required and sold separate** (see page 485). For multiple circuit configurations, please contact customer service. UL listed: UL 183 and CSA Certified.

- Replace _ with **B** for **Black**
- Replace _ with **S** for **Silver Pearl**
- Villa DaisyLink kits are not recommended for use on 2gether tables or Zira Boardroom Tables

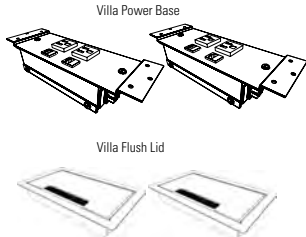

Data Knockouts, Data Ports Included

GL-VIF41D_72DK	--	60	18	.23	\$955
GL-VIF41D_66DK	--	60	18	.23	\$955
GL-VIF41D_60DK	--	60	18	.23	\$955

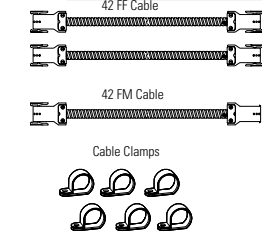

Includes **two power blocks** with **two power receptacles** and **two RJ45** Cat 6 data in each block, two grommet covers, two female/female interconnecting cables, one female/male interconnecting cable and 6 cable clamps. **V1 & V3 cut-outs must be specified on training table** (see product notes section for more details and cut-out upcharge). **Power Infeed required and sold separate** (see page 485). For multiple circuit configurations, please contact customer service. UL listed: UL 183 and CSA Certified.

- Replace _ with **B** for **Black**
- Replace _ with **S** for **Silver Pearl**
- Villa DaisyLink kits are not recommended for use on 2gether tables or Zira Boardroom tables

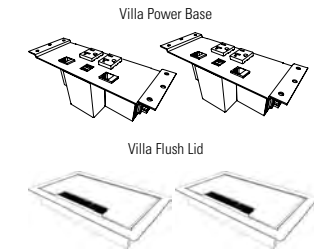

Villa I USB

GL-VIF41UKO_72DK	--	60	23	.23	\$1294
GL-VIF41UKO_66DK	--	60	23	.23	\$1294
GL-VIF41UKO_60DK	--	60	23	.23	\$1294

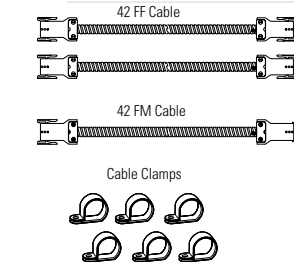

Includes **two power blocks** with **two power receptacles**, **two 2.1 AMP USB charging ports** and two knockouts for data, grommet cover, two female/female interconnecting cables, one female/male interconnecting cable and four cable clamps. **V1 & V3 cut-outs must be specified on training table** (see product notes section for more details and cut-out upcharge). **Power Infeed required and sold separate** (see page 485). For multiple circuit configurations, please contact customer service. UL listed: UL 183 and CSA Certified.

- Replace _ with **B** for **Black**
- Replace _ with **S** for **Silver Pearl**
- Villa DaisyLink kits are not recommended for use on 2gether tables or Zira Boardroom Tables
- Not compatible with Terina tables or Junction wire managers (JNECxx)

Required Specifications

- Finish
- Power infeed
- Cut-out location

VILLA II, LEFT & RIGHT POSITION - DAISYLINK KITS **MODEL#** **DIMENSIONS** **FREIGHT CLASS** **WT/LBS.** **CUBIC FT.** **LIST PRICE**

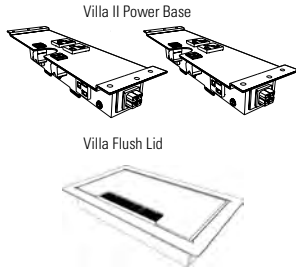

Data Knockouts, No Data Ports

	D x W x H				
GLVIF241KO_72DK	--	60	22	.23	\$986
GLVIF241KO_66DK	--	60	22	.23	\$986
GLVIF241KO_60DK	--	60	22	.23	\$986

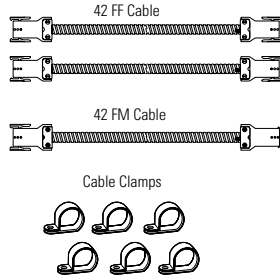

Includes **two power blocks** with **four power receptacles** (two worksurface accessible, two below worksurface) and two knockouts for data in each block, two grommet covers, two female/female interconnecting cables, one female/male interconnecting cable and 6 cable clamps. **V1 & V3 cut-outs must be specified on training table** (see product notes section for more details and cut-out upcharge). **Power Infeed required and sold separate** (see page 485). For multiple circuit configurations, please contact customer service. UL listed: UL 183 and CSA Certified.

- Replace _ with **B** for **Black**
- Replace _ with **S** for **Silver Pearl**
- Villa DaisyLink kits are not recommended for use on 2gether tables or Zira Boardroom Tables

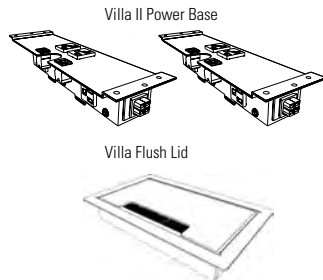

Data Knockouts, Data Ports Included

GL-VIF241D_72DK	--	60	22	.23	\$1294
GL-VIF241D_66DK	--	60	22	.23	\$1294
GL-VIF241D_60DK	--	60	22	.23	\$1294

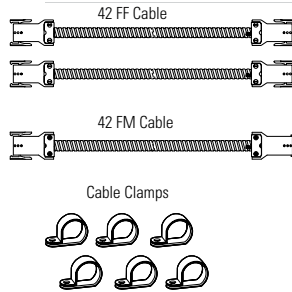

Includes **two power blocks** with **four power receptacles** (two worksurface accessible, two below worksurface) and **two RJ45 Cat 6** data in each block, two grommet covers, two female/female interconnecting cables, one female/male interconnecting cable and 6 cable clamps. **V1 & V3 cut-outs must be specified on training table** (see product notes section for more details and cut-out upcharge). **Power Infeed required and sold separate** (see page 485). For multiple circuit configurations, please contact customer service. UL listed: UL 183 and CSA Certified.

- Replace _ with **B** for **Black**
- Replace _ with **S** for **Silver Pearl**
- Villa DaisyLink kits are not recommended for use on 2gether tables or Zira Boardroom Tables

Required Specifications

- Finish
- Power Infeed
- Cut-out location

T TABLE POWER + TECHNOLOGY SOLUTIONS

VILLA I - CORDED UNITS

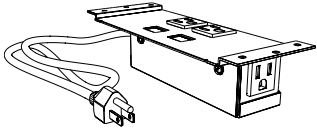

Data Knockouts, No Data Ports

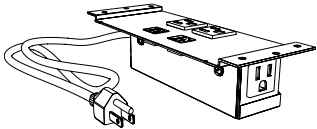

Data Knockouts, Data Ports Included

MODEL#	DIMENSIONS D x W x H	FREIGHT CLASS	WT/LBS.	CUBIC FT.	LIST PRICE
VIL-C-DKO-_-108	3.25 x 8.75 x 2.25	100	4	.45	\$249
VIL-C-DKO-_-72	3.25 x 8.75 x 2.25	100	4	.45	\$249

Villa I with 3-prong plug. Includes **two power receptacles** and two knockouts for data. A third convenience receptacle is provided below the worksurface. **V1, V2 or V3 cut-out(s) must be specified on training table** (see product notes section for more details and cut-out upcharge). **Grommet cover is required and sold separate** (see page 481). UL listed: UL 962A and CUL listed.

- Replace _ with **B** for **Black**
- Replace _ with **S** for **Silver Pearl**
- Compatible with Zira Collaborative tables
- -108 models include a 108" long cord. -72 models include a 72" long cord.

VIL-C-D-_-108	3.25 x 8.75 x 2.25	100	4	.45	\$402
VIL-C-D-_-72	3.25 x 8.75 x 2.25	100	4	.45	\$402

Villa I with 3-prong plug. Includes **two power receptacles** and **two RJ45** Cat 6 data. A third convenience receptacle is provided below the worksurface. **V1, V2 or V3 cut-out(s) must be specified on training table** (see product notes section for more details and cut-out upcharge). **Grommet cover is required and sold separate** (see page 481). UL listed: UL 962A and CUL listed.

- Replace _ with **B** for **Black**
- Replace _ with **S** for **Silver Pearl**
- Compatible with Zira Collaborative tables

VILLA II - CORDED UNITS

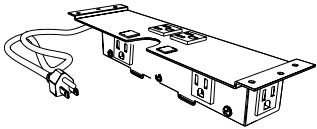

Data Knockouts, No Data Ports

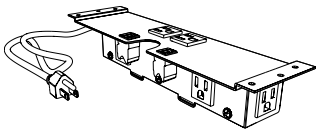

Data Knockouts, Data Ports Included

MODEL#	DIMENSIONS	FREIGHT CLASS	WT/LBS.	CUBIC FT.	LIST PRICE
VIL2-C2-DKO_-108	3.25 x 11 x 2.25	85	6	.45	\$340
VIL2-C2-DKO_-72	3.25 x 11 x 2.25	85	6	.45	\$340

Villa II with 3-prong plug. Includes **four power receptacles** (two worksurface accessible, two below worksurface) and two knockouts for data. A fifth convenience receptacle is provided below the worksurface. **V1, V2 or V3 cut-out(s) must be specified on training table** (see product notes section for more details and cut-out upcharge). **Grommet cover is required and sold separate** (see below). UL listed: UL 962A and CUL listed.

- Replace _ with **B** for **Black**
- Replace _ with **S** for **Silver Pearl**
- Not compatible with Zira Collaborative tables

VIL2-C2-D-_-108	3.25 x 11 x 2.25	85	6	.45	\$496
VIL2-C2-D-_-72	3.25 x 11 x 2.25	85	6	.45	\$496

Villa II with 3-prong plug. Includes **four power receptacles** (two worksurface accessible, two below worksurface) and **two RJ45** Cat 6 data. A fifth convenience receptacle is provided below the worksurface. **V1, V2 or V3 cut-out(s) must be specified on training table** (see product notes section for more details and cut-out upcharge). **Grommet cover is required and sold separate** (see below). UL listed: UL 962A and CUL listed.

- Replace _ with **B** for **Black**
- Replace _ with **S** for **Silver Pearl**
- Not compatible with Zira Collaborative tables

Required Specifications

Finish
Power Infeed
Cutout location

VILLA DAISYLINK

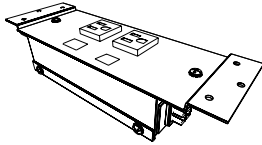

Villa I, DaisyLink

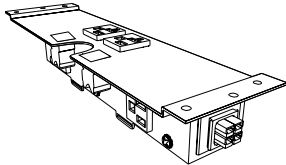

Villa II, DaisyLink

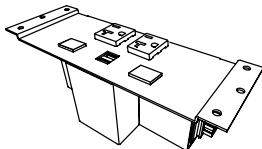

Villa USB, DaisyLink

MODEL#	DIMENSIONS	FREIGHT CLASS	WT/LBS.	CUBIC FT.	LIST PRICE
--------	------------	---------------	---------	-----------	------------

D x W x H

VIL-4-1-DKO-__	--	100	4	.45	\$218
----------------	----	-----	---	-----	-------

Villa I for use in hardwire or DaisyLink applications. Includes **two power receptacles** and **two knockouts for data in each block**. **V1, V2 or V3 cut-out(s) must be specified on table** (see product notes section for more details and cut-out upcharge). **Power infeed required and sold separate** (see page 485). *Please see our **Daisy-Chain guide** on page 486 for appropriate cable lengths and important notes.* **Grommet cover is required and sold separate** (see page 481). UL listed: UL 183 and CSA Certified.

- Replace __ with **B** for **Black** or **S** for **Silver Pearl**
- Villa DaisyLink kits are not recommended for use on 2gether tables.
- Not compatible with Zira Collaborative tables.
- Intended for use on Zira Boardroom tables, Kadin and Swap tables

VIL2-4-1-DKO-__	--	85	6	.45	\$310
-----------------	----	----	---	-----	-------

Villa II for use in hardwire or DaisyLink applications. Includes **four power receptacles (two worksurface accessible, two below worksurface)** and **two knockouts for data in each block**. **V1, V2 or V3 cut-out(s) must be specified on table** (see product notes section for more details and cut-out upcharge). **Power infeed and connecting cables sold separate** (see page 485). *Please see our **Daisy-Chain guide** on page 486 for appropriate cable lengths and important notes.* **Grommet cover is required and sold separate** (see page 481). UL listed: UL 183 and CSA Certified.

- Replace __ with **B** for **Black** or **S** for **Silver Pearl**
- Villa DaisyLink kits are not recommended for use on 2gether tables.
- Not compatible with Zira Collaborative tables.
- Intended for use on Zira Boardroom tables, Kadin and Swap tables

VIL-4-1-U-DKO-__	--	85	6	.45	\$402
------------------	----	----	---	-----	-------

Villa USB for use in hardwire or DaisyLink applications. Includes **two power receptacles, two 2.1 AMB USB charging ports, and two knockouts for data in each block**. **V1, V2 or V3 cut-out(s) must be specified on table** (see product notes section for more details and cut-out upcharge). **Power infeed and connecting cables sold separate** (see page 485). *Please see our **Daisy-Chain guide** on page 486 for appropriate cable lengths and important notes.* **Grommet cover is required and sold separate** (see page 481). UL listed: UL 183 and CSA Certified.

- Replace __ with **B** for **Black** or **S** for **Silver Pearl**
- Villa DaisyLink kits are not recommended for use on 2gether tables
- Not compatible with Zira Collaborative tables, Terina tables or Junction wire managers (JNECxx)
- Intended for use on Zira Boardroom tables, Kadin and Swap tables

VILLA GROMMET COVERS

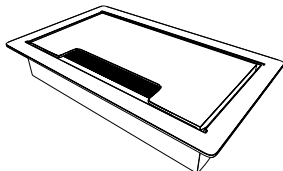

Villa Grommet Cover

MODEL#	DIMENSIONS	FREIGHT CLASS	WT/LBS.	CUBIC FT.	LIST PRICE
--------	------------	---------------	---------	-----------	------------

VIL-GROM-F-__	3.5 x 5.75 x .94	70	1	.08	\$126
---------------	------------------	----	---	-----	-------

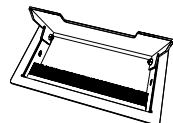

Powder coated flush metal grommet to be used with Villa I and Villa II **corded** series power blocks. Cut-outs in tables must be specified separately. **V1, V2 or V3 cut-out(s) must be specified on training table** (see product notes section for more details and cut-out upcharge). **Grommet cover remains open while in use.**

- **Cannot be used with PMSPDM.**
- Replace __ with **B** for **Black** or **S** for **Silver Pearl**

Required Specifications

Finish
Power Infeed
Cutout location

T TABLE POWER + TECHNOLOGY SOLUTIONS

OASIS MINI

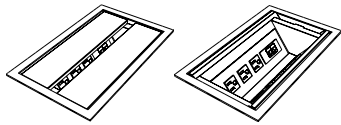

Oasis Mini A, Corded

MODEL#	DIMENSIONS D x W x H	FREIGHT CLASS	WT./LBS.	CUBIC FT.	LIST PRICE
OAM-A-PC-__	15 x 9 x 5.25	92.5	16	1.53	\$1826

Mini Oasis A unit. 15" Trough with six power receptacles, two telecom plate cut-outs (**telecom plates sold separate**, see page 484) and two 108" 3-prong plugs. **M1, M2 or M3 cut-out(s) must be specified on conference table** (see product notes section for more details and cut-out upcharge). Cut-out dimensions: 14.12" x 8.25". UL Listed: UL 962A.

- **Cannot be daisy-chained.**
- Replace _ with **B** for **Black**
- Replace _ with **S** for **Silver Pearl**

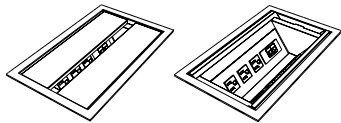

Oasis Mini A, DaisyLink Version

OAM-A-PC-4-1-__	15 x 9 x 5.25	92.5	16	1.53	\$2091

For hardwire and daisy chain applications. Mini Oasis A unit. 15" Trough with six power receptacles, two telecom plate cut-outs (**telecom plates sold separate**, see page 484). **Power infeed sold separate** (see page 485). **M1, M2 or M3 cut-out(s) must be specified on conference table** (see product notes section for more details and cut-out upcharge). For multiple circuit configurations, please contact customer service. *Please see our **Daisy-Chain guide** on page 486 for appropriate cable lengths and important notes.* UL Listed: UL 183.

- Replace _ with **B** for **Black**
- Replace _ with **S** for **Silver Pearl**

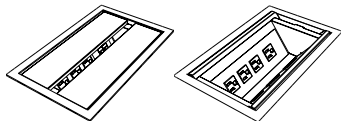

Oasis Mini B, Corded

OAM-B-PC-__	15 x 9 x 5.25	92.5	16	1.53	\$1826

Mini Oasis B unit. 15" Trough with four power receptacles, three telecom plate cut-outs (**telecom plates sold separate**, see page 484) and one 108" 3-prong plug. **M1, M2 or M3 cut-out(s) must be specified on conference table** (see product notes section for more details and cut-out upcharge). UL Listed: UL 962A.

- **Cannot be daisy-chained.**
- Replace _ with **B** for **Black**
- Replace _ with **S** for **Silver Pearl**

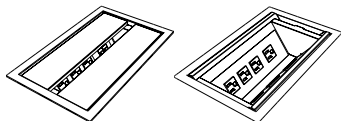

Oasis Mini B, DaisyLink Version

OAM-B-PC-4-1-__	15 x 9 x 5.25	92.5	16	1.53	\$2091

For hardwire and daisy chain applications. Mini Oasis B unit. 15" Trough with four power receptacles, three telecom plate cut-outs (**telecom plates sold separate**, see page 484). **Power infeed sold separate** (see page 485). **M1, M2 or M3 cut-out(s) must be specified on conference table** (see product notes section for more details and cut-out upcharge). For multiple circuit configurations, please contact customer service. *Please see our **Daisy-Chain guide** on page 486 for appropriate cable lengths and important notes.* UL Listed: UL 183.

- Replace _ with **B** for **Black**
- Replace _ with **S** for **Silver Pearl**

Required Specifications

Finish
Power Infeed
Cut-out location

OASIS MINI

MODEL#	DIMENSIONS	FREIGHT CLASS	WT/LBS.	CUBIC FT.	LIST PRICE
--------	------------	---------------	---------	-----------	------------

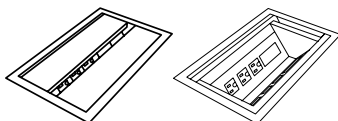

Oasis Mini USB, Corded

	D x W x H				
OAM-U-PC-__	15 x 9 x 5.25	92.5	16	1.53	\$2044

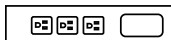
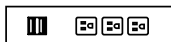

Mini Oasis USB unit. 15" trough with six power receptacles, two 2.1 AMP USB charging ports and one telecom plate cut-out (**telecom plates sold separate**, see page 484) and two 108" 3-prong plugs. **M1, M2 or M3 cut-out(s) must be specified on conference table** (see product notes section for more details and cut-out upcharge). UL Listed: UL 962A.

- **Cannot be daisy-chained.**
- Replace _ with **B** for **Black**
- Replace _ with **S** for **Silver Pearl**

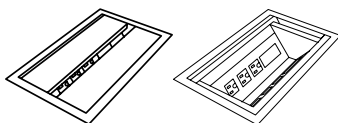

Oasis Mini USB, DaisyLink Version

OAM-U-PC-4-1-__	15 x 9 x 5.25	92.5	16	1.53	\$2307
-----------------	---------------	------	----	------	---------------

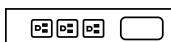
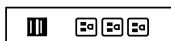

For hardware and daisy chain applications. Mini Oasis USB unit. 15" trough with six power receptacles, two 2.1 AMP USB charging ports and one telecom plate cut-out (**telecom plates sold separate**, see page 484). **Power infeed sold separate** (see page 485). **M1, M2 or M3 cut-out(s) must be specified on conference table** (see product notes section for more details and cut-out upcharge). For multiple circuit configurations, please contact customer service. *Please see our **Daisy-Chain guide** on page 486 for appropriate cable lengths and important notes.* UL Listed: UL 183.

- Replace _ with **B** for **Black**
- Replace _ with **S** for **Silver Pearl**

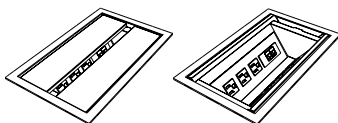

Oasis Mini, Chicago Code

GL-OAMPD_P72HW	15 x 9 x 5.25	92.5	16	1.53	\$2490
----------------	---------------	------	----	------	---------------

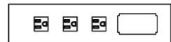
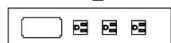

Mini Oasis for Chicago code includes electrical trough with (2) separate hardwire inserts. Each insert includes (3) simplex outlets and (1) telecom plate cut-out (**telecom plates sold separate**, see page 484). **M1, M2 or M3 cut-out(s) must be specified on conference table** (see product notes section for more details and cut-out upcharge). Each component is UL Listed: UL 962A.

- **Cannot be daisy-chained.**
- Replace _ with **B** for **Black**
- Replace _ with **S** for **Silver Pearl**

Required Specifications



- Finish
- Power Infeed
- Cut-out location

T TABLE POWER + TECHNOLOGY SOLUTIONS

TOP TELECOM PLATES

D x W x H





NOT COMPATIBLE WITH VILLA UNITS

TOP TELECOM PLATE	MODEL	CONFIGURATION	LIST PRICE
	A-__-A-B	Telecom plate with RJ11 Cat 3 Phone and RJ45 Cat 6 Data	\$108
	A-__-B-B	(2) RJ45 Cat 6 Connectors	\$141
	A-__-B-B-B	(3) RJ45 Cat 6 Connectors	\$206
	A-__-B-B-B-B	(4) RJ45 Cat 6 Connectors	\$274
	A-__-B-C51-L	RJ45 Cat 6 Data, Mini-Stereo Inline and 15 pin HD VGA Female/Female with 72" patch cord attached.	\$244
	A-__-B-B-C51	(2) RJ45 Cat 6 Data and (1) 15 pin HD VGA Female/Female with 72" patch cord attached.	\$254
	A-__-A-B-102	RJ11 Cat 3 phone, RJ45 Cat 6 Data and USB with 72" patch cord attached.	\$244
	A-__-B	RJ45 Cat 6 Data	\$76
	A-__-C51-L	Mini Stereo Inline and 15 pin HD VGA Female/Female with 72" patch cord attached.	\$191
	A-__-CRDMINDER	Cordminder Plate - 2 5/8" holes and 1 7/8" holes	\$43
	A-__-C45-C51-L	HDMI Female/Female with 36" patch cord attached. Mini Stereo Inline and 15 Pin HD VGA Female/Female with 72" patch cord attached.	\$333



Required Specifications

- Finish
- Power Infeed
- Cut-out location

TOP TELECOM PLATES

		D x W x H	
TOP TELECOM PLATE	MODEL	CONFIGURATION	LIST PRICE
	A-__-C45	HDMI Female/Female with 36" patch cord attached.	\$164
	A-__-A-B-B	(1) RJ11 Cat 3 Phone and (2) RJ45 Cat 6 data.	\$178
	A-__	Blank telecom plate	\$27
	A-__-102	USB with 72" patch cord attached.	\$76
	A-__-C51	15 pin HD VGA Female/Female with 72" patch cord attached.	\$123
<ul style="list-style-type: none"> • Replace __ with BL for Black • Replace __ with GR for Grey 			

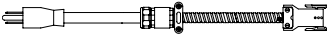
POWER INFEEDS

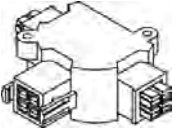
	42AP1-72	--	--	--	--	\$245
Plug and Play Infeed	Single Circuit 20 AMP Power Infeed with 72" 3-prong plug. Provides single power entry from floor or wall mounted standard power supply. Connects to Oasis Mini or Villa units that require a separate infeed. UL Listed: UL 1286.					
	42SB2-108	--	--	--	--	\$203
	42SB2-72	--	--	--	--	\$158
	42SB2-36	--	--	--	--	\$115
Multi-Circuit Hardwire Power Infeed	Multi-Circuit Hardwire Infeed (up to 20 AMPS per circuit), two circuits. Provides single power entry from floor or wall located building power supply. Connects to Oasis Mini or Villa units that require a power infeed. TO BE HARDWIRED BY A LICENSED ELECTRICIAN. UL Listed: UL 183.					
	DAISY-T	--	70	1	1	\$187
3 Way Power Splitter	Daisy-T power manager includes two male and one female connection. For use in splitting a power source two ways. UL Listed: UL 183.					

Required Specifications

Finish
Power Infeed
Cut-out location

T TABLE POWER + TECHNOLOGY SOLUTIONS

TOP TELECOM PLATES



Interconnecting Cables

	D x W x H
42FF-__	
Female/Female	
42FM-__	
Female/Male	

UL Listed: UL 183 and CSA Certified. For appropriate quantity and sizes, please refer to the chart on the next page.

Interconnecting Cables - Common Cable Lengths (in inches)

Female/Female

42FF-27	\$116
42FF-38	\$129
42FF-41	\$133
42FF-50	\$145
42FF-53	\$149
42FF-63	\$159
42FF-65	\$163
42FF-75	\$175
42FF-76	\$176
42FF-77	\$177
42FF-82	\$184
42FF-85	\$187
42FF-86	\$188
42FF-89	\$193

42FF-97	\$216
42FF-98	\$216
42FF-100	\$205
42FF-101	\$208
42FF-103	\$208
42FF-110	\$219
42FF-113	\$225

Female/Male

42FM-12	\$104
42FM-27	\$121
42FM-38	\$134
42FM-41	\$139
42FM-50	\$151
42FM-63	\$167
42FM-75	\$181
42FM-82	\$190
42FM-85	\$164
42FM-86	\$195
42FM-97	\$216
42FM-98	\$216
42FM-100	\$230
42FM-110	\$230

DRAWING 1A - OASIS MINI A & OASIS MINI USB

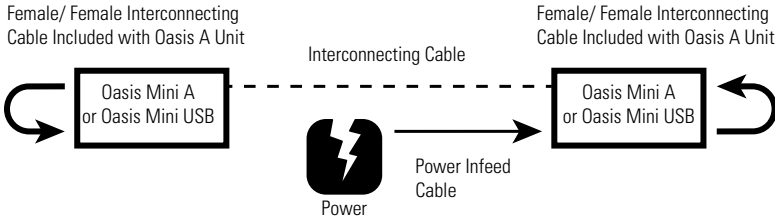

DRAWING 1B - OASIS MINI B

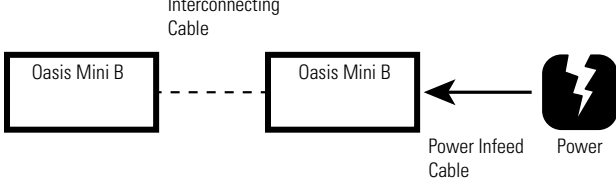

DRAWING 2A - OASIS MINI A & OASIS MINI USB

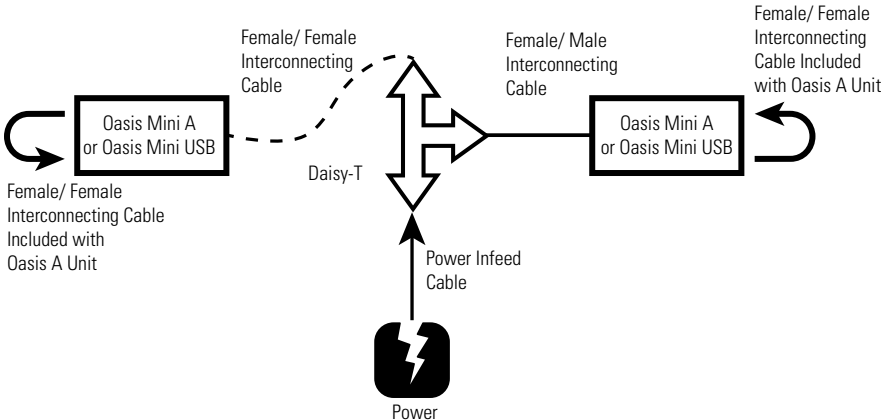

DRAWING 2B - OASIS MINI B

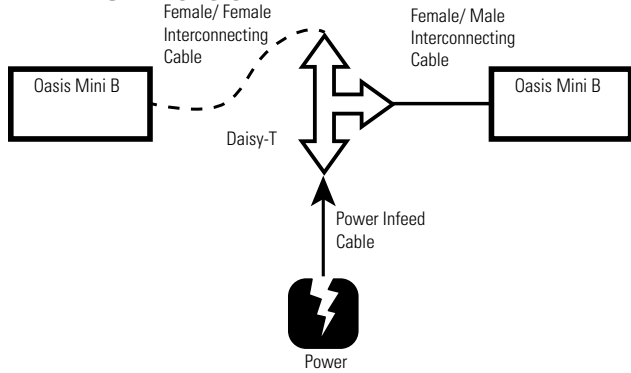

DRAWING 3 - OASIS MINI A & OASIS MINI USB

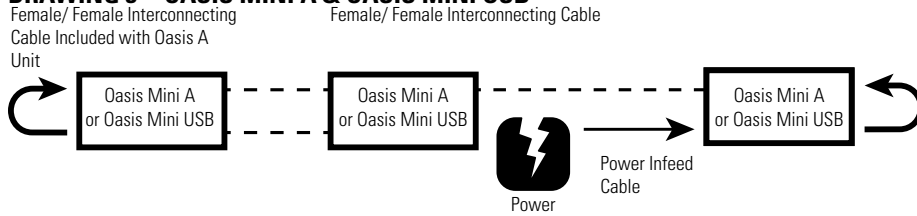

DRAWING 4 - OASIS MINI A & OASIS MINI USB

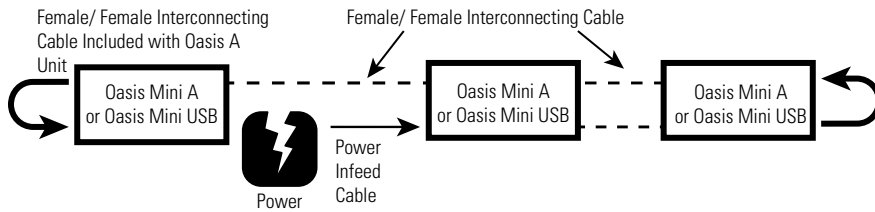

DRAWING 5 - OASIS MINI B

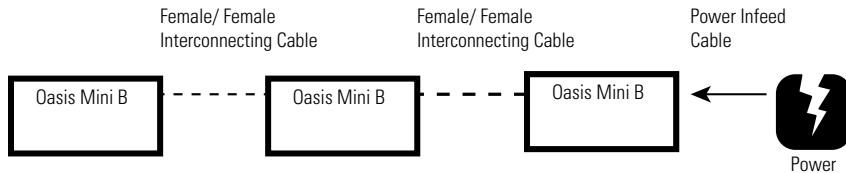

DRAWING 6 - OASIS MINI B

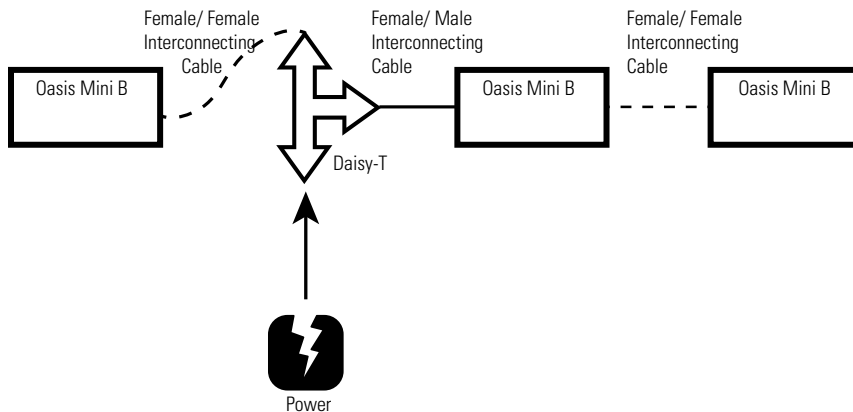

OASIS MINI A, B & USB CABLE LENGTHS NEEDED FOR DAISY-CHAINING

Model #	Villa DaisyLink, Oasis Mini USB Oasis Mini A Oasis Mini B	Villa DaisyLink, Oasis Mini USB Oasis Mini A Oasis Mini B	Oasis Mini USB Oasis Mini A	Oasis Mini USB Oasis Mini A	Villa DaisyLink or Oasis Mini B	Villa DaisyLink or Oasis Mini B
Cut-out Positions	V1, V3, M1, M3	V1, V3, M1, M3	M1, M2 & M3	M1, M2 & M3	V1, V2, V3, M1, M2, M3	V1, V2, V3, M1, M2, M3
Infeed Position	Left or Right	Center	Left or Right	Center	Left or Right	Center
Reference	Drawing 1A/1B	Drawing 2A/2B	Drawing 3	Drawing 4	Drawing 5	Drawing 6
Z4896BE Z4896RTE Z4896REE Z4896BW	(1) 42FF-53 SPECIFY INFEED	(1) 42FF-27 (1) 42FM-27 (1) DAISY-T SPECIFY INFEED	N/A	N/A	N/A	N/A
Z48120BE Z48120RTE Z48120REE Z48120BW	(1) 42FF-76 SPECIFY INFEED	(1) 42FF-38 (1) 42FM-38 (1) DAISY-T SPECIFY INFEED	(3) 42FF-41 SPECIFY INFEED	(3) 42FF-41 SPECIFY INFEED	(2) 42FF-41 SPECIFY INFEED	(2) 42FF-41 (1) 42FM-12 (1) DAISY-T SPECIFY INFEED
Z48144BE Z48144RTE Z48144REE Z48144BW	(1) 42FF-100 SPECIFY INFEED	(1) 42FF-50 (1) 42FM-50 (1) DAISY-T SPECIFY INFEED	(3) 42FF-53 SPECIFY INFEED	(3) 42FF-53 SPECIFY INFEED	(2) 42FF-53 SPECIFY INFEED	(2) 42FF-53 (1) 42FM-12 (1) DAISY-T SPECIFY INFEED
Z48168BE Z48168RTE Z48168REE Z48168BW	(1) 42FF-63 (1) 42FM-63 SPECIFY INFEED	1) 42FF-63 (1) 42FM-63 (1) DAISY-T SPECIFY INFEED	(3) 42FF-65 SPECIFY INFEED	(3) 42FF-65 SPECIFY INFEED	(2) 42FF-65 SPECIFY INFEED	(2) 42FF-65 (1) 42FM-12 (1) DAISY-T SPECIFY INFEED
Z48192BE Z48192RTE Z48192REE Z48192BW	(1) 42FF-75 (1) 42FM-75 SPECIFY INFEED	1) 42FF-75 (1) 42FM-75 (1) DAISY-T SPECIFY INFEED	(3) 42FF-77 SPECIFY INFEED	(3) 42FF-77 SPECIFY INFEED	(2) 42FF-77 SPECIFY INFEED	(2) 42FF-77 (1) 42FM-12 (1) DAISY-T SPECIFY INFEED
Z48216BE Z48216RTE Z48216REE Z48216BW	(1) 42FF-86 (1) 42FM-86 SPECIFY INFEED	1) 42FF-85 (1) 42FM-85 (1) DAISY-T SPECIFY INFEED	(3) 42FF-89 SPECIFY INFEED	(3) 42FF-89 SPECIFY INFEED	(2) 42FF-89 SPECIFY INFEED	(2) 42FF-89 (1) 42FM-12 (1) DAISY-T SPECIFY INFEED
Z48240BE Z48240RTE Z48240REE Z48240BW	(1) 42FF-98 (1) 42FM-98 SPECIFY INFEED	1) 42FF-97 (1) 42FM-97 (1) DAISY-T SPECIFY INFEED	(3) 42FF-101 SPECIFY INFEED	(3) 42FF-101 SPECIFY INFEED	(2) 42FF-101 SPECIFY INFEED	(2) 42FF-101 (1) 42FM-12 (1) DAISY-T SPECIFY INFEED
Z48264BE Z48264RTE Z48264REE Z48264BW	(1) 42FF-110 (1) 42FM-110 SPECIFY INFEED	(1) 42FF-110 (1) 42FM-110 (1) DAISY-T SPECIFY INFEED	(3) 42FF-113 SPECIFY INFEED	(3) 42FF-113 SPECIFY INFEED	(2) 42FF-113 SPECIFY INFEED	(2) 42FF-113 (1) 42FM-12 (1) DAISY-T SPECIFY INFEED
Z48288BE Z48288RTE Z48288REE Z48288BW	(1) 42FF-82 (2) 42FM-82 SPECIFY INFEED	(2) 42FF-41 (2) 42FM-41 (1) DAISY-T SPECIFY INFEED	(3) 42FF-63 (3) 42FM-63 SPECIFY INFEED	(3) 42FF-63 (3) 42FM-63 SPECIFY INFEED	(2) 42FF-63 (2) 42FM-63 SPECIFY INFEED	(2) 42FF-63 (2) 42FM-63 (1) DAISY-T SPECIFY INFEED

tables and accessories

café, meeting and conference

Boardroom.....	492	Kadin.....	642
Collaborative Spaces.....	545	Swap.....	651

training

2gether.....	490	Edventure.....	591
Bungee.....	513	FreeFit.....	599
Bungee SL.....	530	Junction.....	635
Connectables.....	572	Terina.....	696
Duet.....	588	Zook.....	700

reception and occasional

Citi.....	712	River+ tables.....	721
Drift tables.....	716	Sirena tables.....	724
Lite Lift II.....	720	Wind.....	725
Occasional tables.....	714	Work tables.....	726

GENERAL INFORMATION

- 2gether is a series of multi-purpose flip-top tables for collaboration, classroom, training and conference applications.
- “Easy Touch” mechanism allows you to flip the tables up or down with maximum ease
- Adjustable leveling casters provide smooth mobility
- Offset “Y” sculpted legs allow for parallel space-saving table nesting, to minimize footprint required for storage
- Optional modesty panels with integrated wire troughs are available
- Grommets are available on 24” deep worksurfaces
- Available sizes: 18”D x 60”W, 24”D x 60”W and 72”W
- Shipped easy to assemble. Each component is packaged individually; legs are shipped 1 per carton.
- For environmental certifications, please visit globalfurnituregroup.com

WORKSURFACES

- 1” thick tops are constructed of 45 lb. density particleboard with high performance thermally fused laminate

CONSTRUCTION

- “Easy touch” lever located at both sides of table for flip-top operation from either side
- Global’s preferred matching edge
- Tops are pre-drilled with threaded steel inserts
- Tops 60” and 72” wide feature a built-in support bar
- 14.25” high optional articulating modesty panel attaches to underside of flip-top
- Bumpers on legs and undercarriage prevent tables from being damaged while nested
- Grommets optional on 24” deep tops only
- Champagne base finish
- Products specified with the high pressure laminate option are finished on the underside of the surface with a kraft paper backing.

LAMINATE FINISHES

ACJ	Absolute Acajou	FCL	First Class
ASN	Asian Night	NBL	Noce Biondo
AWC	Avant Cherry	NGL	Noce Grigio
AWH	Avant Honey	NEL	Noce Leggero
BLK	Black	NML	Noce Medio
BZD	Blizzard	QTM	Quartered Mahogany
BRC	Brushed Cobalt	SBY	Sheer Beauty
CMB	Clear Maple	SOG	Storm Grey
CGY	Custom Grey	SDT	Stonedust
DES	Dark Espresso	WHE	Walnut Heights
DWT	Designer White	WHC	White Chocolate
FAS	Fashionista	WCR	Winter Cherry

GANGING PLATES

- Ganging plates are available for ganging adjoining tables together.
- Ganging plates are black epoxy coated steel plates with two thumbscrews

GROMMETS

- Available only on 24” deep worksurfaces
- Additional grommets available in standard worksurface locations (left, center or right). Order as: **AG1, AG2 or AG3. Add \$96**
- Grommet hole dimensions are 3 ¼” wide x 1 7/8” deep.

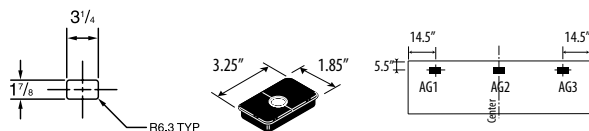

- Grommets may be placed at non-standard locations. Order as: **AGS - Add \$96** A drawing must be supplied with vertical and horizontal dimensions to the center of the cut-out (as in drawing above). Please refer to CUSTOM GROMMET LOCATION FORM in the back reference section.

POWER BLOCK

- Available only on 24” deep worksurfaces
- A Power Block is a rectangular worksurface power/data module with one electrical duplex receptacle and two data (RJ45) receptacles. 9’ black cord included. Power Block dimensions are 3 ½” deep x 6 ½” wide x 2 ¾” high.
- A Power Block (model **PMSPDM**) may be ordered for **24” Deep Tables** in place of standard grommets.
- To purchase a Power Block, you must specify both the Power Block cut-out location and the Power Block model #. Order Power Block as **PMSPDM, Add \$330**. Power Blocks are available in standard worksurface locations (left, center or right). Order as **E1, E2 or E3. Add \$96**.

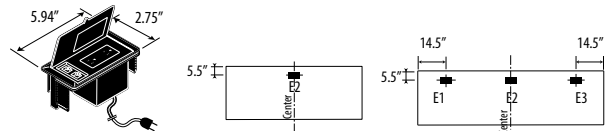

For 48”w units For 60” and 72”w units.
Power Block **PMSPDM, Add \$330** Specify location **E1, E2 or E3, Add \$96**

VILLA CUT-OUTS

- Available only on 24” deep worksurfaces
- A Villa Power Block is available for daisy-chaining or corded for use on individual tables (see page 475 for Villa details). Villa Power Block dimensions vary by model. Villa cutout dimensions are 3” deep x 5 ¼” wide.
- Villa DaisyLink **kits** are not for use on 2gether tables.
- A Villa cutout may be ordered for 24” Deep Tables. Order as **V1, V2 or V3, Add \$96 for each cutout**.
- Order Villa Power Block and Villa Grommet Cover separately, see page 475 for pricing and details

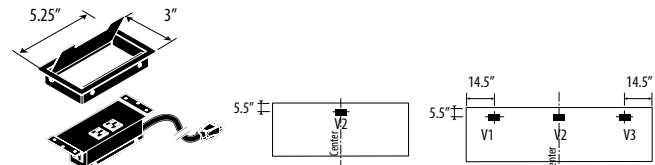

For 48”w units For 60” and 72”w units.

MODPOWER DAISY CHAIN SOLUTION

- Add flexible power and USB charging to 2gether tables. Connect up to four units with a single corded infeed with NEMA plug.
- ModPower units are sold separately, refer to Productivity Solutions page 465.
- Begin run with a starter unit which includes a corded infeed. Add additional middle or end units as required. Middle and end units are equipped with connecting cables.
- To be used with rectangular tables **IT2460RX** and **IT2472RX** only.
- On-surface modules clamp on or screw mount to the table tops.
- In-surface modules require table top cut-outs for mounting. Specify cut-out option:
 - **MPS** for a single cut-out to accommodate one ModPower in-surface unit (cut-out will be centered on the approach side). **Add \$96**
 - **MPD** for two cut-outs in the left and right positions, 15” from ends to center of unit on approach side. **Add \$192**.

RECTANGULAR TOP **MODEL#** **DIMENSIONS** **FREIGHT CLASS** **WT/LBS.** **CUBIC FT.** **LIST PRICE** **HP ADD**

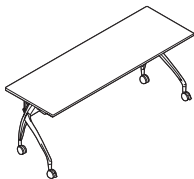

Rectangular Table - Flip-Top

	D x W x H						
IT2472RX	24 x 72 x 29	92.5	97.20	8.68	\$2237	\$274	
IT2460RX	24 x 60 x 29	92.5	86	7.68	\$2092	\$242	
IT1860RX	18 x 60 x 29	92.5	75	6.98	\$2014	\$214	

Easy touch flip-top table on 4 adjustable leveling casters, 2 locking. Easy touch lever located at both ends of the table allows for activation on either side of the table; offset Y leg accommodates in-line nesting for space-saving storage. Wire management channel included. Champagne finish leg, black casters. Optional articulating modesty panel available.

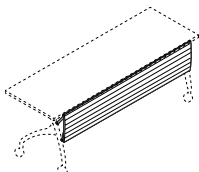

Modesty Panel

IT72MP	2.75 x 63 x 14.25	125	13.20	2	\$328		
IT60MP	2.75 x 51 x 14.25	125	11.40	1.60	\$302		

Articulating modesty for use with flip-top 2gether tables. Champagne finish.

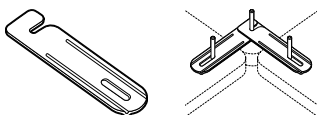

Ganging Connector

CNGFP	5 x 2.5 x 1.13	70	.20	.10	\$69		
-------	----------------	----	-----	-----	-------------	--	--

Black epoxy coated 13 gauge steel with 2 thumbscrews included. Used to connect tabletops together for additional stability or for connecting freestanding tops together. Holes with steel inserts are located in the corner of all tops to accommodate this plate. **Sold individually.**

Required Specifications
Top Finish

Accessories
Modesty Panel

B BOARDROOM TABLES



Sturdy and economically priced, Global boardroom tables are excellent choices. All tables are made from thermally fused, high performance laminate and are easy to maintain.

Choose from four attractive table edges: Bullnose, T-mold, Self-edge, or Built-up Self-edge. Available in a variety of colors, all edge options are durable and wear-resistant.

Table tops are offered in five shapes - rectangular, racetrack, boat-shaped, square and round, and a variety of bases including slab, drum and arch. Add to this an impressive variety of laminate finishes that may be mixed and matched and you'll find Global can satisfy any and every business need.

From small meeting rooms to large boardrooms, from traditional to contemporary, Global's incredible range of table components, shapes, sizes and colors will enhance any office decor.

Features and Benefits

- One-piece tops can be cut to 2 pieces for an upcharge
- Tables 96" to 144" in length special ordered with two piece tops must have a third base
- All tops are premarked as to base location
- All tops are 1 1/8" thick - a 1/4" built-up self edge is available on all models
- Tops and bases boxed as appropriate
- Custom finish laminate tables available as special order
- Bullnose edges available in Black or Grey
- T-Mold edge available in Black, Grey or coordinating laminate finish.
- Self-edge and built-up self edge available in same color as laminate finish.
- All edges available on all tables

GENERAL INFORMATION

- All tables are 29" high
- Tops are thermally fused laminate with 45 lb. density particle board core.
- Multiple base styles available in thermally fused laminate or metal.
- Tables 144" or less are standard in one piece. All tops over 144" are standard in two pieces.
- Five top shapes: rectangular, racetrack, boat, square and round and four edge options: self edge, bullnose, T-mold or built-up self edge.
- For environmental certifications, please visit globalfurnituregroup.com

CONSTRUCTION

- All tables are 29" high. Tops are made of 45 lb. density particle board covered on both sides with high performance, thermally fused laminate. Table width is nominal.
- All tables with cross bases use Blum fasteners
- Round and square tops up to 60" dia. are 1" thick; all other tops are 1.125" thick.
- Tops with BU edge have a 1.75" built-up self edge.
- Tops are crated and bases boxed or crated as appropriate
- Table tops of 144" or less in length are standard as one piece. 1 piece tops can be cut to 2 piece tops, **Add \$289**; however, an additional base will be required. Tables 96" to 144" in length special ordered with 2 piece tops **must** have a third base.
- All tops are **PRE-MARKED** as to base location, and the slot and hook assembly method (on selected tables) allows for easy installation.
- All racetrack, boat and rectangular tables 144" and under are standard with two drum, slab, arch, 2-legged, or tubular bases and are priced accordingly. For 3 bases, **Add \$506** list per table for a drum, and **add \$333** list per table for the slab. Arch base tables will require a special 3" thick slab at a list price of **\$448** per table. **Add \$430** list per table for 2-legged base, and **add \$448** list per table for tubular.
- Custom size tables are priced at next size table price, not to exceed width or length. Example: 44" x 108" would be priced at the 48" x 120" price. Contact Customer Care for pricing of tables over 48" in width. Custom tables **less** than the smallest size must be quoted.
- Products specified with the high pressure laminate option are finished on the underside of the surface with a kraft paper backing.

EDGE OPTIONS

- Self, built-up, bullnose and T-mold edges are available on all models. Corners of rectangular, square and boat shaped tables ordered with T-mold or bullnose will be rounded.
- **Bullnose** edge is available in Black (BK) or Grey (GR) only.
- **T-mold** edge is available in Black (BK), Grey (GR) or coordinating laminate finish (ME)
- **Self edge and built-up** edges are same color as laminate finish.

METAL BASE FINISHES

- Available on all round and square GCARxx, GTCRxx, GCRRxx, GCASxx, GTCSxx, and GCRSxx tables.

Paint finishes

TBL	Black	TIN	Ink
TBZ	Buzz Blue	TKA	Kalua
TCC	Cactus	TLA	Latte
TCR	Carrot	TMO	Mocha
TIV	Cloud	TNE	Nevada
TDW	Designer White	TSN	Sand
TDJ	Dijon	TSR	Scarlet
TEG	Eggplant	TSH	Shadow
TFO	Fog	TOA	Toast
TFR	Frost	TTU	Tungsten

Plated finishes - upcharge applies

CHM	Polished Chrome	BCH	Brushed Chrome
ACO	Antique Copper	SBR	Satin Brass

LAMINATE FINISHES

ACJ	Absolute Acajou	FCL	First Class
ASN	Asian Night	NBL	Noce Biondo
AWC	Avant Cherry	NGL	Noce Grigio
AWH	Avant Honey	NEL	Noce Leggero
BLK	Black	NML	Noce Medio
BZD	Blizzard	QTM	Quartered Mahogany
BRC	Brushed Cobalt	SBY	Sheer Beauty
CMB	Clear Maple	SOG	Storm Grey
CGY	Custom Grey	SDT	Stonedust
DES	Dark Espresso	WHE	Walnut Heights
DWT	Designer White	WCH	White Chocolate
FAS	Fashionista	WCR	Winter Cherry

- Fashionista (FAS), First Class (FCL), Sheer Beauty (SBY) + White Chocolate (WCH) not available on 10 & 12 foot tables. Must be cut in two pieces and specify third base.
- Fashionista (FAS), First Class (FCL), Sheer Beauty (SBY) + White Chocolate (WCH) not available on 20', 22' & 24' tables. Tables must be quoted to be in three pieces with appropriate bases. Please contact Customer Care.
- The above laminate finishes are available in **High Pressure**. Upcharge varies by model.
- Tables in woodgrain finishes over 12' in length will not have a perfect match of grain at the center where the two halves meet.
- All tables with Drum Bases & Pedestal require approx. 125 lb. of sand in each base for adequate stability. Sand is not included with Drum Bases.
- If other than a Global standard laminate finish is preferred, contact your customer care Representative. Information needed includes the name of the laminate manufacturer, color name, number and model of table. You will then be given a quote for this special order.

BASE SIZE CHART (Table width is nominal)

Round or Square Tops:

Top	Slab	Drum	Arch	Cross	4 Leg	Trumpet	4 Tube
36"	n/a	n/a	n/a	n/a	32"	24"	30"
42"	n/a	18"	n/a	30"	32"	24"	30"
48"	n/a	24"	n/a	30"	32"	n/a	30"
60"	n/a	30"	n/a	36"	n/a	n/a	n/a

Rectangular, Boat or Racetrack Tops:

Top	Slab	Drum	Arch	Cross	2 Leg	Trumpet	2/3 Tube
36" x 72"	24"	18"	24"	n/a	32"	n/a	30"
48" x 96"	28"	18"	28"	n/a	32"	n/a	30"
48" x 120"	28"	24"	28"	n/a	32"	n/a	30"
48" x 144"	28"	24"	28"	n/a	32"	n/a	30"

GROMMETS

- Grommets available in standard table top locations (left, center or right).
- Order as: **AG1, AG2 or AG3. Add \$96.**
- Grommet hole dimensions are 3 1/4" wide x 1 7/8" deep.

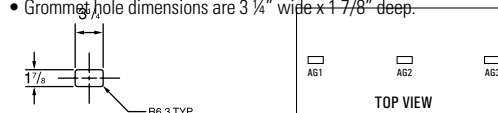

- Actual grommet locations will vary according to base selection.

POWER BLOCK

- A Power Block (model **PMSpDM**) may be ordered on all worksurfaces.
- A Power Block is a rectangular worksurface power/data module with one electrical duplex receptacle and two data (RJ45) receptacles. 9' black cord included. Power Block dimensions are 3 1/2" deep x 6 1/2" wide x 2 3/4" high.
- Actual Power Block locations vary according to base selection. The locations will be left (AG1, E1), center (AG2, E2), and right (AG3, E3). **Example:** 8' table with drum base does not have a modesty panel, so the grommet (AG2) and power block (E2) can be perfectly centered in the table. An 8' table with a slab base has the modesty panel, so the grommet (AG2) and power block (E2) will be offset alongside the modesty panel.

B BOARDROOM TABLES

- To purchase a Power Block, you must specify both the Power Block cut-out location and the Power Block model #. Order Power Block as **PMSPPM, Add \$330**. Power Blocks are available in standard worksurface locations (left, center or right). Order as **E1, E2 or E3. Add \$96**.

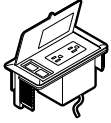

Power Block **PMSPPM - Add \$330** Specify location **E1, E2 or E3 - Add \$96**

TABLE NOTES - ESTIMATED CAPACITY

- Use the following for determining the size of a round table and the number of chairs needed for a conference area. All estimates are based on an average chair width of 23" with a 4" clearance between chairs. Adjust accordingly for a different chair size.

Top Size	Round	Square	Rectangular	Boat	Racetrack	Elliptical
30x30	3	3	N/A	N/A	N/A	N/A
36x36	4	4	N/A	N/A	N/A	N/A
42x42	4	4	N/A	N/A	N/A	N/A
48x48	4	4	N/A	N/A	N/A	N/A
60x60	5	6	N/A	N/A	N/A	N/A
30x60	N/A	N/A	4-6	4-6	4-6	4
36x72	N/A	N/A	4-6	4-6	4-6	4
44x84	N/A	N/A	6-8	6-8	6-8	6
48x96	N/A	N/A	6-8	6-8	6-8	6
48x120	N/A	N/A	8-10	8-10	8-10	8
48x144	N/A	N/A	10-12	10-12	10-12	10
48x168	N/A	N/A	12-14	12-14	12-14	12
48x192	N/A	N/A	14-16	14-16	14-16	14
48x216	N/A	N/A	16-18	16-18	16-18	16
48x240	N/A	N/A	18-20	18-20	18-20	18
48x264	N/A	N/A	20-22	20-22	20-22	20
48x288	N/A	N/A	22-24	22-24	22-24	22

BASE OPTIONS

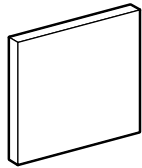

slab

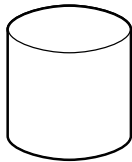

drum

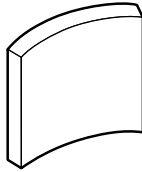

arch

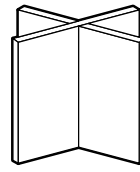

cross

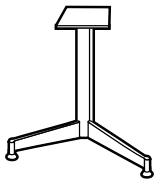

2-leg



4-leg

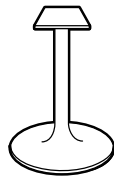

trumpet

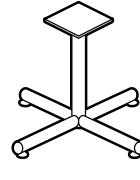

tube

EDGE OPTIONS

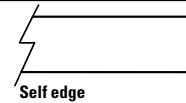

Self edge

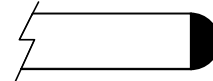

Bullnose

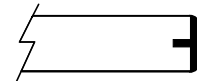

T-mold

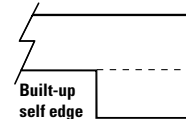

Built-up self edge

TABLE TOP STYLES

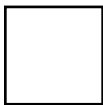

Square

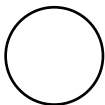

Round



Racetrack

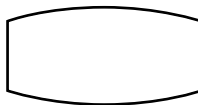

Boat



Rectangular

ROUND TOP - DRUM BASE

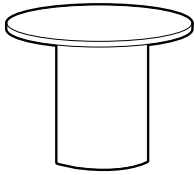

	MODEL#	DIMENSIONS	FRT. CLASS	WT./LBS.	CUBIC FT.	LIST PRICE	HP ADD		
		D x W x H							
self edge	G42CZ	42 x 42 x 29	92.5	89	8.50	\$915		\$461	
bullnose edge	G42CZBN	42 x 42 x 29	92.5	86	8.50	\$915		\$461	
T-mold edge	G42CZTM	42 x 42 x 29	92.5	90	8.50	\$915		\$461	
built-up self edge	G42CZBU	42 x 42 x 29	92.5	96	9.40	\$1016		\$510	
self edge	G48CZ	48 x 48 x 29	125	106	13.60	\$1059		\$532	
bullnose edge	G48CZBN	48 x 48 x 29	100	117	13.60	\$1059		\$532	
T-mold edge	G48CZTM	48 x 48 x 29	100	121	13.60	\$1059		\$532	
built-up self edge	G48CZBU	48 x 48 x 29	100	133	14.90	\$1180		\$591	
self edge	G60CZ	60 x 60 x 29	100	171	21	\$1327		\$665	
bullnose edge	G60CZBN	60 x 60 x 29	100	171	21	\$1327		\$665	
T-mold edge	G60CZTM	60 x 60 x 29	100	171	21	\$1327		\$665	
built-up self edge	G60CZBU	60 x 60 x 29	125	174	23.20	\$1560		\$781	

• All Drum Bases require approx. 125 lb. of sand in each base for adequate stability. Sand is not included.

ROUND TOP - CROSS BASE

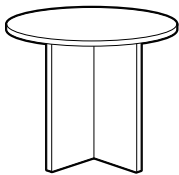

self edge	G42CH	42 x 42 x 29	70	97	5	\$852		\$428	
bullnose edge	G42CHBN	42 x 42 x 29	70	94	5	\$852		\$428	
T-mold edge	G42CHTM	42 x 42 x 29	70	98	5	\$852		\$428	
built-up self edge	G42CHBU	42 x 42 x 29	70	104	5.70	\$915		\$461	
self edge	G48CH	48 x 48 x 29	70	101	6	\$992		\$496	
bullnose edge	G48CHBN	48 x 48 x 29	70	112	6	\$992		\$496	
T-mold edge	G48CHTM	48 x 48 x 29	70	116	6	\$992		\$496	
built-up self edge	G48CHBU	48 x 48 x 29	70	128	6.60	\$1138		\$571	
self edge	G60CH	60 x 60 x 29	70	174	9	\$1271		\$637	
bullnose edge	G60CHBN	60 x 60 x 29	125	64	9	\$1271		\$637	
T-mold edge	G60CHTM	60 x 60 x 29	125	64	9	\$1271		\$637	
built-up self edge	G60CHBU	60 x 60 x 29	70	190	9.70	\$1497		\$751	

ROUND TOP - 4 LEG BASE



	MODEL#	DIMENSIONS	FRT. CLASS	WT./LBS.	CUBIC FT.	LIST PRICE	HP ADD	CHM/BCH	ACO/SBR
self edge	GCAR36	36 x 36 x 29	250	48	13	\$617	\$309	\$92	\$332
bullnose edge	GCAR36BN	36 x 36 x 29	150	55	13	\$617	\$309	\$92	\$332
T-mold edge	GCAR36TM	36 x 36 x 29	250	48	13	\$617	\$309	\$92	\$332
built-up self edge	GCAR36BU	36 x 36 x 29	150	68	13	\$686	\$346	\$92	\$332
self edge	GCAR42	42 x 42 x 29	150	59	14	\$736	\$369	\$92	\$332
bullnose edge	GCAR42BN	42 x 42 x 29	150	68	14	\$736	\$369	\$92	\$332
T-mold edge	GCAR42TM	42 x 42 x 29	150	61	14	\$736	\$369	\$92	\$332
built-up self edge	GCAR42BU	42 x 42 x 29	150	78	14	\$813	\$408	\$92	\$332
self edge	GCAR48	48 x 48 x 29	150	72	15	\$863	\$434	\$92	\$332
bullnose edge	GCAR48BN	48 x 48 x 29	150	83	15	\$863	\$434	\$92	\$332
T-mold edge	GCAR48TM	48 x 48 x 29	150	87	15	\$863	\$434	\$92	\$332
built-up self edge	GCAR48BU	48 x 48 x 29	125	99	15	\$958	\$482	\$92	\$332

Required Specifications

Top finish
Base finish
Edge color, if applicable

B BOARDROOM TABLES

ROUND TOP - TRUMPET BASE

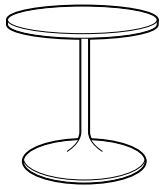

	MODEL#	DIMENSIONS	FRT. CLASS	WT/LBS.	CUBIC FT.	LIST PRICE	HP ADD	BCH/CHM	ACO/SBR
D x W x H									
self edge	GTCR36	36 x 36 x 29	250	54	19	\$863	\$434	\$89	\$363
bullnose edge	GTCR36BN	36 x 36 x 29	250	61	18	\$863	\$434	\$89	\$363
T-mold edge	GTCR36TM	36 x 36 x 29	250	54	18	\$863	\$434	\$89	\$363
built-up self edge	GTCR36BU	36 x 36 x 29	150	74	18	\$958	\$482	\$89	\$363
self edge	GTCR42	42 x 42 x 29	150	77	19	\$968	\$486	\$89	\$363
bullnose edge	GTCR42BN	42 x 42 x 29	250	74	19	\$968	\$486	\$89	\$363
T-mold edge	GTCR42TM	42 x 42 x 29	150	78	19	\$968	\$486	\$89	\$363
built-up self edge	GTCR42BU	42 x 42 x 29	150	84	19	\$1078	\$542	\$89	\$363

ROUND TOP - TUBULAR BASE



	MODEL#	DIMENSIONS	FRT. CLASS	WT/LBS.	CUBIC FT.	LIST PRICE	HP ADD	BCH/CHM	ACO/SBR
self edge	GCRR36	36 x 36 x 29	250	50	18	\$744	\$373	\$92	\$398
bullnose edge	GCRR36BN	36 x 36 x 29	250	57	19	\$744	\$373	\$92	\$398
T-mold edge	GCRR36TM	36 x 36 x 29	250	50	19	\$744	\$373	\$92	\$398
built-up self edge	GCRR36BU	36 x 36 x 29	250	70	19	\$830	\$415	\$92	\$398
self edge	GCRR42	42 x 42 x 29	250	61	19	\$863	\$434	\$92	\$398
bullnose edge	GCRR42BN	42 x 42 x 29	250	70	19	\$863	\$434	\$92	\$398
T-mold edge	GCRR42TM	42 x 42 x 29	250	63	19	\$863	\$434	\$92	\$398
built-up self edge	GCRR42BU	42 x 42 x 29	150	80	19	\$958	\$482	\$92	\$398
self edge	GCRR48	48 x 48 x 29	250	74	20	\$992	\$496	\$92	\$398
bullnose edge	GCRR48BN	48 x 48 x 29	150	85	20	\$992	\$496	\$92	\$398
T-mold edge	GCRR48TM	48 x 48 x 29	150	89	20	\$992	\$496	\$92	\$398
built-up self edge	GCRR48BU	48 x 48 x 29	150	101	20	\$1099	\$551	\$92	\$398

SQUARE TOP - DRUM BASE

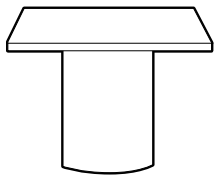

						LIST PRICE	HP ADD
self edge	G42SZ	42 x 42 x 29	100	89	9	\$915	\$461
bullnose edge	G42SZBN	42 x 42 x 29	100	89	9	\$915	\$461
T-mold edge	G42SZTM	42 x 42 x 29	100	89	9	\$915	\$461
built-up self edge	G42SZBU	42 x 42 x 29	92.5	106	9.40	\$1016	\$510
self edge	G48SZ	48 x 48 x 29	100	121	13.40	\$1059	\$532
bullnose edge	G48SZBN	48 x 48 x 29	100	121	13.40	\$1059	\$532
T-mold edge	G48SZTM	48 x 48 x 29	100	121	13.60	\$1059	\$532
built-up self edge	G48SZBU	48 x 48 x 29	100	133	14.90	\$1180	\$591
self edge	G60SZ	60 x 60 x 29	100	171	21	\$1327	\$665
bullnose edge	G60SZBN	60 x 60 x 29	100	171	21	\$1327	\$665
T-mold edge	G60SZTM	60 x 60 x 29	100	171	21	\$1327	\$665
built-up self edge	G60SZBU	60 x 60 x 29	125	174	23.20	\$1560	\$781

• All Drum Bases require approx. 125 lb. of sand in each base for adequate stability. Sand is not included.

SQUARE TOP - CROSS BASE

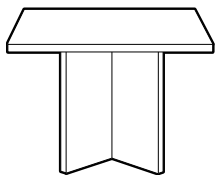

						LIST PRICE	HP ADD
self edge	G42SH	42 x 42 x 29	70	97	5	\$852	\$428
bullnose edge	G42SHBN	42 x 42 x 29	70	97	5	\$852	\$428
T-mold edge	G42SHTM	42 x 42 x 29	70	97	5	\$852	\$428
built-up self edge	G42SHBU	42 x 42 x 29	70	114	5.70	\$915	\$461
self edge	G48SH	48 x 48 x 29	70	116	6	\$992	\$496
bullnose edge	G48SHBN	48 x 48 x 29	70	116	6	\$992	\$496
T-mold edge	G48SHTM	48 x 48 x 29	70	116	6	\$992	\$496
built-up self edge	G48SHBU	48 x 48 x 29	70	122	6.40	\$1138	\$571
self edge	G60SH	60 x 60 x 29	125	64	9	\$1271	\$637
bullnose edge	G60SHBN	60 x 60 x 29	125	64	9	\$1271	\$637
T-mold edge	G60SHTM	60 x 60 x 29	125	64	9	\$1271	\$637
built-up self edge	G60SHBU	60 x 60 x 29	125	64	9.70	\$1497	\$751

Required Specifications

Top finish
Base finish
Edge color, if applicable

Optional Specifications

HP laminate

SQUARE TOP - 4 LEG BASE



	MODEL#	DIMENSIONS	FRT. CLASS	WT/LBS.	CUBIC FT.	LIST PRICE	HP ADD	BCH/CHM	ACO/SBR	
		D x W x H								
self edge	GCAS36	36 x 36 x 29	150	63	13	\$617	\$309	\$92	\$332	
bullnose edge	GCAS36BN	36 x 36 x 29	150	63	13	\$617	\$309	\$92	\$332	
T-mold edge	GCAS36TM	36 x 36 x 29	150	63	13	\$617	\$309	\$92	\$332	
built-up self edge	GCAS36BU	36 x 36 x 29	150	67	13	\$686	\$346	\$92	\$332	
self edge	GCAS42	42 x 42 x 29	150	71	14	\$736	\$369	\$92	\$332	
bullnose edge	GCAS42BN	42 x 42 x 29	150	78	14	\$736	\$369	\$92	\$332	
T-mold edge	GCAS42TM	42 x 42 x 29	150	78	14	\$736	\$369	\$92	\$332	
built-up self edge	GCAS42BU	42 x 42 x 29	125	86	14	\$813	\$408	\$92	\$332	

SQUARE TOP - TRUMPET BASE



self edge	GTCS36	36 x 36 x 29	250	69	18	\$863	\$434	\$89	\$363
bullnose edge	GTCS36BN	36 x 36 x 29	250	69	18	\$863	\$434	\$89	\$363
T-mold edge	GTCS36TM	36 x 36 x 29	250	69	18	\$863	\$434	\$89	\$363
built-up self edge	GTCS36BU	36 x 36 x 29	150	76	18	\$958	\$482	\$89	\$363
self edge	GTCS42	42 x 42 x 29	150	77	19	\$968	\$486	\$89	\$363
bullnose edge	GTCS42BN	42 x 42 x 29	150	77	19	\$968	\$486	\$89	\$363
T-mold edge	GTCS42TM	42 x 42 x 29	150	77	19	\$968	\$486	\$89	\$363
built-up self edge	GTCS42BU	42 x 42 x 29	150	84	19	\$1078	\$542	\$89	\$363

SQUARE TOP - TUBULAR BASE



self edge	GCRS36	36 x 36 x 29	250	65	18	\$744	\$373	\$92	\$398
bullnose edge	GCRS36BN	36 x 36 x 29	250	65	18	\$744	\$373	\$92	\$398
T-mold edge	GCRS36TM	36 x 36 x 29	250	65	18	\$744	\$373	\$92	\$398
built-up self edge	GCRS36BU	36 x 36 x 29	250	69	18	\$830	\$415	\$92	\$398
self edge	GCRS42	42 x 42 x 29	250	73	19	\$863	\$434	\$92	\$398
bullnose edge	GCRS42BN	42 x 42 x 29	150	80	19	\$863	\$434	\$92	\$398
T-mold edge	GCRS42TM	42 x 42 x 29	150	80	19	\$863	\$434	\$92	\$398
built-up self edge	GCRS42BU	42 x 42 x 29	150	88	19	\$958	\$482	\$92	\$398

Required Specifications

Top finish
Base finish
Edge color, if applicable

Optional Specifications

HP laminate

B BOARDROOM TABLES

RECTANGULAR TOP - SLAB BASE

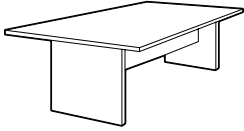

		MODEL#	DIMENSIONS	FREIGHT CLASS	WT/LBS.	CUBIC FT.	LIST PRICE	HP ADD
		D x W x H						
5 foot	self edge	GCT5RX	30 x 60 x 29	70	131	6	\$1074	\$538
	bullnose edge	GCT5RXBN	30 x 60 x 60	70	131	6	\$1074	\$538
	T-mold edge	GCT5RXTM	30 x 60 x 29	70	131	6	\$1074	\$538
	built-up self edge	GCT5RXBU	30 x 60 x 29	70	134	7	\$1187	\$594
6 foot	self edge	GCT6RX	36 x 72 x 29	70	174	11.38	\$1203	\$603
	bullnose edge	GCT6RXBN	36 x 72 x 29	70	174	11.38	\$1203	\$603
	T-mold edge	GCT6RXTM	36 x 72 x 29	70	174	11.38	\$1203	\$603
	built-up self edge	GCT6RXBU	36 x 72 x 29	85	177	13.32	\$1341	\$672
7 foot	self edge	GCT7RX	44 x 84 x 29	85	199	14.94	\$1549	\$776
	bullnose edge	GCT7RXBN	44 x 84 x 29	85	199	14.94	\$1549	\$776
	T-mold edge	GCT7RXTM	44 x 84 x 84	85	199	14.94	\$1549	\$776
	built-up self edge	GCT7RXBU	44 x 84 x 84	92.5	203	17.93	\$1748	\$875
8 foot	self edge	GCT8WRX	48 x 96 x 29	70	218	11.29	\$1549	\$776
	bullnose edge	GCT8WRXBN	48 x 96 x 29	70	218	11.29	\$1549	\$776
	T-mold edge	GCT8WRXTM	48 x 96 x 29	70	218	11.29	\$1549	\$776
	built-up self edge	GCT8WRXBU	48 x 96 x 29	70	249	13.53	\$1748	\$875
10 foot	self edge	GCT10WRX2	48 x 120 x 29	70	272	13.53	\$1795	\$900
	bullnose edge	GCT10WRX2BN	48 x 120 x 29	70	272	13.53	\$1795	\$900
	T-mold edge	GCT10WRX2TM	48 x 120 x 29	70	272	13.53	\$1795	\$900
	built-up self edge	GCT10WRX2BU	48 x 120 x 29	70	291	16.20	\$2124	\$1062
12 foot	self edge	GCT12WRX2	48 x 144 x 29	70	309	15.54	\$2105	\$1055
	bullnose edge	GCT12WRX2BN	48 x 144 x 29	70	309	15.54	\$2105	\$1055
	T-mold edge	GCT12WRX2TM	48 x 144 x 29	70	309	15.54	\$2105	\$1055
	built-up self edge	GCT12WRX2BU	48 x 144 x 29	70	348	18.77	\$2472	\$1237
14 foot	self edge	GCT14WRX2	48 x 168 x 29	70	419	22.50	\$3044	\$1524
	bullnose edge	GCT14WRX2BN	48 x 168 x 29	70	419	22.50	\$3044	\$1524
	T-mold edge	GCT14WRX2TM	48 x 168 x 29	65	419	18	\$3044	\$1524
	built-up self edge	GCT14WRX2BU	48 x 168 x 29	70	425	20	\$3398	\$1701
16 foot	self edge	GCT16WRX2	48 x 192 x 29	70	460	22.72	\$3172	\$1588
	bullnose edge	GCT16WRX2BN	48 x 192 x 29	70	460	22.72	\$3172	\$1588
	T-mold edge	GCT16WRX2TM	48 x 192 x 29	70	460	22.70	\$3172	\$1588
	built-up self edge	GCT16WRX2BU	48 x 192 x 29	70	466	27.20	\$3542	\$1772
18 foot	self edge	GCT18WRX2	48 x 216 x 29	70	521	24.60	\$3948	\$1976
	bullnose edge	GCT18WRX2BN	48 x 216 x 29	70	521	24.60	\$3948	\$1976
	T-mold edge	GCT18WRX2TM	48 x 216 x 29	70	521	24.60	\$3948	\$1976
	built-up self edge	GCT18WRX2BU	48 x 216 x 29	70	528	29.80	\$4425	\$2216
20 foot	self edge	GCT20WRX2	48 x 240 x 29	70	572	26.60	\$4011	\$2007
	bullnose edge	GCT20WRX2BN	48 x 240 x 29	70	572	26.60	\$4011	\$2007
	T-mold edge	GCT20WRX2TM	48 x 240 x 29	70	572	26.60	\$4011	\$2007
	built-up self edge	GCT20WRX2BU	48 x 240 x 29	70	580	32.50	\$4489	\$2246
22 foot	self edge	GCT22WRX2	48 x 264 x 29	70	612	28.90	\$4655	\$2328
	bullnose edge	GCT22WRX2BN	48 x 264 x 29	70	612	28.90	\$4655	\$2328
	T-mold edge	GCT22WRX2TM	48 x 264 x 29	70	612	28.90	\$4655	\$2328
	built-up self edge	GCT22WRX2BU	48 x 264 x 29	70	620	35.10	\$5141	\$2572
24 foot	self edge	GCT24WRX2	48 x 288 x 29	70	673	31.20	\$4786	\$2396
	bullnose edge	GCT24WRX2BN	48 x 288 x 29	70	673	31.20	\$4786	\$2396
	T-mold edge	GCT24WRX2TM	48 x 288 x 29	70	673	31.20	\$4786	\$2396
	built-up self edge	GCT24WRX2BU	48 x 288 x 29	70	682	37.70	\$5295	\$2650

- All tops over 144" are standard in two pieces. Woodgrain laminate finishes will NOT align where the two tops join.
- All tops 168", 192", 216" and 240" are SHIPPED WITH 3 SLAB BASES.
- All tops 264" and 288" are SHIPPED WITH 4 SLAB BASES.

Required Specifications

Top finish
Base finish
Edge color, if applicable

Optional Specifications

Grommet
HP laminate

Accessories

Power Block

RECTANGULAR TOP - DRUM BASE

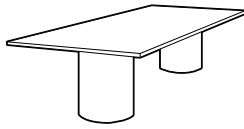

		MODEL#	DIMENSIONS	FREIGHT CLASS	WT./LBS.	CUBIC FT.	LIST PRICE	HP ADD
		D x W x H						
6 foot	self edge	GCT6RZ	36 x 72 x 29	100	154	17.50	\$1626	\$814
	bullnose edge	GCT6RZBN	36 x 72 x 29	100	167	17.50	\$1626	\$814
	T-mold edge	GCT6RZTM	36 x 72 x 29	100	167	17.50	\$1626	\$814
	built-up self edge	GCT6RZBU	36 x 72 x 29	100	177	18.80	\$1819	\$911
7 foot	self edge	GCT7RZ	44 x 84 x 29	125	196	29.04	\$1883	\$943
	bullnose edge	GCT7RZBN	44 x 84 x 29	125	196	29.04	\$1883	\$943
	T-mold edge	GCT7RZTM	44 x 84 x 29	125	196	29.04	\$1883	\$943
	built-up self edge	GCT7RZBU	44 x 84 x 29	125	199	31.66	\$2075	\$1039
8 foot	self edge	GCT8WRZ	48 x 96 x 29	125	219	31.82	\$1883	\$943
	bullnose edge	GCT8WRZBN	48 x 96 x 29	125	219	31.82	\$1883	\$943
	T-mold edge	GCT8WRZTM	48 x 96 x 29	125	219	31.82	\$1883	\$943
	built-up self edge	GCT8WRZBU	48 x 96 x 29	125	250	35.18	\$2075	\$1039
10 foot	self edge	GCT10WRZ2	48 x 120 x 29	100	295	33	\$2206	\$1104
	bullnose edge	GCT10WRZ2BN	48 x 120 x 29	100	295	33	\$2206	\$1104
	T-mold edge	GCT10WRZ2TM	48 x 120 x 29	100	295	33.02	\$2206	\$1104
	built-up self edge	GCT10WRZ2BU	48 x 120 x 29	100	314	35.72	\$2432	\$1217
12 foot	self edge	GCT12WRZ2	48 x 144 x 29	100	328	35.10	\$2466	\$1234
	bullnose edge	GCT12WRZ2BN	48 x 144 x 29	100	328	35.10	\$2466	\$1234
	T-mold edge	GCT12WRZ2TM	48 x 144 x 29	250	97	35.10	\$2466	\$1234
	built-up self edge	GCT12WRZ2BU	48 x 144 x 29	250	367	96	\$2737	\$1371
14 foot	self edge	GCT14WRZ2	48 x 168 x 29	92.5	441	39	\$3304	\$1654
	bullnose edge	GCT14WRZ2BN	48 x 168 x 29	92.5	441	39	\$3304	\$1654
	T-mold edge	GCT14WRZ2TM	48 x 168 x 29	92.5	441	39	\$3304	\$1654
	built-up self edge	GCT14WRZ2BU	48 x 168 x 29	92.5	447	42	\$3664	\$1834
16 foot	self edge	GCT16WRZ2	48 x 192 x 29	92.5	482	42.50	\$3433	\$1718
	bullnose edge	GCT16WRZ2BN	48 x 192 x 29	92.5	482	42.50	\$3433	\$1718
	T-mold edge	GCT16WRZ2TM	48 x 192 x 29	92.5	482	42.50	\$3433	\$1718
	built-up self edge	GCT16WRZ2BU	48 x 192 x 29	92.5	488	47	\$3788	\$1897
18 foot	self edge	GCT18WRZ2	48 x 216 x 29	100	523	54.40	\$4464	\$2233
	bullnose edge	GCT18WRZ2BN	48 x 216 x 29	100	523	54.40	\$4464	\$2233
	T-mold edge	GCT18WRZ2TM	48 x 216 x 29	100	523	54.40	\$4464	\$2233
	built-up self edge	GCT18WRZ2BU	48 x 216 x 29	100	550	59	\$5018	\$2511
20 foot	self edge	GCT20WRZ2	48 x 240 x 29	100	564	66.20	\$4529	\$2266
	bullnose edge	GCT20WRZ2BN	48 x 240 x 29	100	564	66.20	\$4529	\$2266
	T-mold edge	GCT20WRZ2TM	48 x 240 x 29	100	564	66.20	\$4529	\$2266
	built-up self edge	GCT20WRZ2BU	48 x 240 x 29	100	572	70.60	\$5084	\$2545
22 foot	self edge	GCT22WRZ2	48 x 264 x 29	100	604	68.20	\$5044	\$2523
	bullnose edge	GCT22WRZ2BN	48 x 264 x 29	100	604	68.20	\$5044	\$2523
	T-mold edge	GCT22WRZ2TM	48 x 264 x 29	100	604	68.20	\$5044	\$2523
	built-up self edge	GCT22WRZ2BU	48 x 264 x 29	100	612	73.68	\$5635	\$2819
24 foot	self edge	GCT24WRZ2	48 x 288 x 29	100	646	70.20	\$5175	\$2590
	bullnose edge	GCT24WRZ2BN	48 x 288 x 29	100	646	70.20	\$5175	\$2590
	T-mold edge	GCT24WRZ2TM	48 x 288 x 29	100	646	70.20	\$5175	\$2590
	built-up self edge	GCT24WRZ2BU	48 x 288 x 29	100	655	76.80	\$5756	\$2880

- All Drum Bases require approx. 125 lb. of sand in each base for adequate stability. Sand is not included.
- All tops over 144" are standard in two pieces. Woodgrain laminate finishes will NOT align where the two tops join.
- All tops 168", 192" and 216" are SHIPPED WITH 3 DRUM BASES.
- All tops 240", 264" and 288" are SHIPPED WITH 4 DRUM BASES.

Required Specifications

Top finish
Base finish
Edge color, if applicable

Optional Specifications

Grommet
HP laminate

Accessories

Power Block

B BOARDROOM TABLES

RECTANGULAR TOP - ARCH BASE

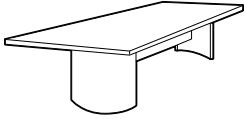

		MODEL#	DIMENSIONS	FREIGHT CLASS	WT/LBS.	CUBIC FT.	LIST PRICE	HP ADD
		D x W x H						
5 foot	self edge	GCT5RA	30 x 60 x 29	85	131	9	\$1430	\$717
	bullnose edge	GCT5RABN	30 x 60 x 29	85	131	9	\$1430	\$717
	T-mold edge	GCT5RATM	30 x 60 x 29	85	131	9	\$1430	\$717
	built-up self edge	GCT5RABU	30 x 60 x 29	85	134	10	\$1625	\$814
6 foot	self edge	GCT6RA	36 x 72 x 29	125	157	24.64	\$1496	\$750
	bullnose edge	GCT6RABN	36 x 72 x 29	125	157	24.64	\$1496	\$750
	T-mold edge	GCT6RATM	36 x 72 x 29	70	157	8.24	\$1496	\$750
	built-up self edge	GCT6RABU	36 x 72 x 29	100	167	17.96	\$1777	\$889
7 foot	self edge	GCT7RA	44 x 84 x 29	92.5	203	19.43	\$1820	\$912
	bullnose edge	GCT7RABN	44 x 84 x 29	92.5	203	19.43	\$1820	\$912
	T-mold edge	GCT7RATM	44 x 84 x 29	92.5	203	19.43	\$1820	\$912
	built-up self edge	GCT7RABU	44 x 84 x 29	100	206	20.90	\$2060	\$1033
8 foot	self edge	GCT8WRA	48 x 96 x 29	100	220	22.40	\$1820	\$912
	bullnose edge	GCT8WRABN	48 x 96 x 29	100	220	22.40	\$1820	\$912
	T-mold edge	GCT8WRATM	48 x 96 x 29	100	220	22.40	\$1820	\$912
	built-up self edge	GCT8WRABU	48 x 96 x 29	92.5	251	23.89	\$2060	\$1033
10 foot	self edge	GCT10WRA	48 x 120 x 29	70	274	16.95	\$2076	\$1041
	bullnose edge	GCT10WRABN	48 x 120 x 29	70	274	16.95	\$2076	\$1041
	T-mold edge	GCT10WRATM	48 x 120 x 29	70	274	16.95	\$2076	\$1041
	built-up self edge	GCT10WRABU	48 x 120 x 29	70	293	18.92	\$2448	\$1227
12 foot	self edge	GCT12WRA	48 x 144 x 29	70	311	19.94	\$2400	\$1201
	bullnose edge	GCT12WRABN	48 x 144 x 29	70	311	19.94	\$2400	\$1201
	T-mold edge	GCT12WRATM	48 x 144 x 29	70	311	19.94	\$2400	\$1201
	built-up self edge	GCT12WRABU	48 x 144 x 29	70	350	21.92	\$2801	\$1402
14 foot	self edge	GCT14WRA	48 x 168 x 29	70	423	26	\$3692	\$1848
	bullnose edge	GCT14WRABN	48 x 168 x 29	70	423	26	\$3692	\$1848
	T-mold edge	GCT14WRATM	48 x 168 x 29	70	423	26	\$3692	\$1848
	built-up self edge	GCT14WRABU	48 x 168 x 29	70	429	28	\$4114	\$2058
16 foot	self edge	GCT16WRA	48 x 192 x 29	70	474	30	\$3884	\$1944
	bullnose edge	GCT16WRABN	48 x 192 x 29	70	474	30	\$3884	\$1944
	T-mold edge	GCT16WRATM	48 x 192 x 29	70	474	30	\$3884	\$1944
	built-up self edge	GCT16WRABU	48 x 192 x 29	70	480	32	\$4342	\$2173
18 foot	self edge	GCT18WRA	48 x 216 x 29	70	525	31.92	\$4786	\$2396
	bullnose edge	GCT18WRABN	48 x 216 x 29	70	525	31.92	\$4786	\$2396
	T-mold edge	GCT18WRATM	48 x 216 x 29	70	525	31.92	\$4786	\$2396
	built-up self edge	GCT18WRABU	48 x 216 x 29	70	532	33.89	\$5349	\$2676
20 foot	self edge	GCT20WRA	48 x 240 x 29	70	576	33.89	\$4855	\$2428
	bullnose edge	GCT20WRABN	48 x 240 x 29	70	576	33.89	\$4855	\$2428
	T-mold edge	GCT20WRATM	48 x 240 x 29	70	576	33.89	\$4855	\$2428
	built-up self edge	GCT20WRABU	48 x 240 x 29	70	584	35.93	\$5399	\$2702
22 foot	self edge	GCT22WRA	48 x 264 x 29	70	626	36.89	\$5427	\$2716
	bullnose edge	GCT22WRABN	48 x 264 x 29	70	626	36.89	\$5427	\$2716
	T-mold edge	GCT22WRATM	48 x 264 x 29	70	626	36.89	\$5427	\$2716
	built-up self edge	GCT22WRABU	48 x 264 x 29	70	634	37.90	\$6068	\$3036
24 foot	self edge	GCT24WRA	48 x 288 x 29	70	678	40	\$5558	\$2780
	bullnose edge	GCT24WRABN	48 x 288 x 29	70	678	40	\$5558	\$2780
	T-mold edge	GCT24WRATM	48 x 288 x 29	70	678	40	\$5558	\$2780
	built-up self edge	GCT24WRABU	48 x 288 x 29	70	687	42	\$6193	\$3099

- All tops over 144" are standard in two pieces. Woodgrain laminate finishes will NOT align where the two tops join.
- All tops 168", 192", 216" and 240" are SHIPPED WITH 2 ARCH BASES AND 1 SLAB BASE.
- All tops 264" and 288" are SHIPPED WITH 2 ARCH BASES AND 2 SLAB BASES.

Required Specifications

Top finish
Base finish
Edge color, if applicable

Optional Specifications

Grommet
HP laminate

Accessories

Power Block

RECTANGULAR TOP - 2 LEG BASE

	MODEL#	DIMENSIONS	FREIGHT CLASS	WT./LBS.	CUBIC FT.	LIST PRICE	HP ADD
		D x W x H					
5 foot	self edge	GCT5R	30 x 60 x 29	125	88	13	\$1263 \$634
	bullnose edge	GCT5RBN	30 x 60 x 29	125	88	13	\$1263 \$634
	T-mold edge	GCT5RTM	30 x 60 x 29	125	88	13	\$1263 \$634
	built-up self edge	GCT5RBU	30 x 60 x 29	125	91	14	\$1410 \$708
6 foot	self edge	GCT6R	36 x 72 x 29	125	115	15	\$1407 \$705
	bullnose edge	GCT6RBN	36 x 72 x 29	92.5	152	15	\$1407 \$705
	T-mold edge	GCT6RTM	36 x 72 x 29	92.5	152	15	\$1407 \$705
	built-up self edge	GCT6RBU	36 x 72 x 29	92.5	162	16	\$1562 \$782
7 foot	self edge	GCT7R	44 x 84 x 29	100	155	17	\$1626 \$814
	bullnose edge	GCT7RBN	44 x 84 x 29	100	155	17	\$1626 \$814
	T-mold edge	GCT7RTM	44 x 84 x 29	100	155	17	\$1626 \$814
	built-up self edge	GCT7RBU	44 x 84 x 29	100	158	19.02	\$1821 \$912
8 foot	self edge	GCT8WR	48 x 96 x 29	92.5	194	19.04	\$1626 \$814
	bullnose edge	GCT8WRBN	48 x 96 x 29	100	180	19.02	\$1626 \$814
	T-mold edge	GCT8WRM	48 x 96 x 29	100	180	19.02	\$1626 \$814
	built-up self edge	GCT8WRBU	48 x 96 x 29	92.5	211	21	\$1821 \$912
10 foot	self edge	GCT10WR	48 x 120 x 29	92.5	214	20.93	\$2258 \$1131
	bullnose edge	GCT10WRBN	48 x 120 x 29	92.5	237	21	\$2258 \$1131
	T-mold edge	GCT10WRM	48 x 120 x 29	92.5	237	21	\$2258 \$1131
	built-up self edge	GCT10WRBU	48 x 120 x 29	125	256	34.37	\$2526 \$1264
12 foot	self edge	GCT12WR	48 x 144 x 29	92.5	270	23	\$2541 \$1272
	bullnose edge	GCT12WRBN	48 x 144 x 29	85	270	21	\$2541 \$1272
	T-mold edge	GCT12WRM	48 x 144 x 29	92.5	270	22.90	\$2541 \$1272
	built-up self edge	GCT12WRBU	48 x 144 x 29	85	309	24.91	\$2830 \$1419
14 foot	self edge	GCT14WR	48 x 168 x 29	100	326	34	\$2914 \$1460
	bullnose edge	GCT14WRBN	48 x 168 x 29	100	326	34	\$2914 \$1460
	T-mold edge	GCT14WRM	48 x 168 x 29	100	326	34	\$2914 \$1460
	built-up self edge	GCT14WRBU	48 x 168 x 29	100	332	38	\$3220 \$1612
16 foot	self edge	GCT16WR	48 x 192 x 29	100	367	38	\$3044 \$1524
	bullnose edge	GCT16WRBN	48 x 192 x 29	100	367	38	\$3044 \$1524
	T-mold edge	GCT16WRM	48 x 192 x 29	100	367	38	\$3044 \$1524
	built-up self edge	GCT16WRBU	48 x 192 x 29	100	373	40	\$3297 \$1651
18 foot	self edge	GCT18WR	48 x 216 x 29	92.5	408	40	\$3627 \$1816
	bullnose edge	GCT18WRBN	48 x 216 x 29	92.5	408	40	\$3627 \$1816
	T-mold edge	GCT18WRM	48 x 216 x 29	92.5	408	40	\$3627 \$1816
	built-up self edge	GCT18WRBU	48 x 216 x 29	100	416	42	\$4044 \$2025
20 foot	self edge	GCT20WR	48 x 240 x 29	92.5	449	42	\$3756 \$1880
	bullnose edge	GCT20WRBN	48 x 240 x 29	92.5	449	42	\$3756 \$1880
	T-mold edge	GCT20WRM	48 x 240 x 29	92.5	449	42	\$3756 \$1880
	built-up self edge	GCT20WRBU	48 x 240 x 29	92.5	457	44	\$4167 \$2086
22 foot	self edge	GCT22WR	48 x 264 x 29	92.5	489	44	\$4140 \$2073
	bullnose edge	GCT22WRBN	48 x 264 x 29	92.5	489	44	\$4140 \$2073
	T-mold edge	GCT22WRM	48 x 264 x 29	92.5	489	44	\$4140 \$2073
	built-up self edge	GCT22WRBU	48 x 264 x 29	92.5	497	46	\$4662 \$2332
24 foot	self edge	GCT24WR	48 x 288 x 29	92.5	531	46	\$4268 \$2135
	bullnose edge	GCT24WRBN	48 x 288 x 29	92.5	531	46	\$4268 \$2135
	T-mold edge	GCT24WRM	48 x 288 x 29	92.5	531	46	\$4268 \$2135
	built-up self edge	GCT24WRBU	48 x 288 x 29	92.5	540	48	\$4772 \$2387

- All tops over 144" are standard in two pieces. Woodgrain laminate finishes will NOT align where the two tops join.
- All tops 120", 144", and 168" are SHIPPED WITH 3 LEG BASES.
- All tops 192" are SHIPPED WITH 4 LEG BASES.
- All tops 216", 240", 264" and 288" are SHIPPED WITH 6 LEG BASES.

Required Specifications

Top finish
Base finish
Edge color, if applicable

Optional Specifications

Grommet
HP laminate

Accessories

Power Block

B BOARDROOM TABLES

RECTANGULAR TOP - TUBULAR BASE



	MODEL#	DIMENSIONS	FREIGHT CLASS	WT/LBS.	CUBIC FT.	LIST PRICE	HP ADD	
	D x W x H							
5 foot	self edge	GCR5R	30 x 60 x 29	150	94	21	\$1303	\$654
	bullnose edge	GCR5RBN	30 x 60 x 29	150	94	21	\$1303	\$654
	T-mold edge	GCR5RTM	30 x 60 x 29	150	94	21	\$1303	\$654
	built-up self edge	GCR5RBU	30 x 60 x 29	150	97	23	\$1454	\$731
6 foot	self edge	GCR6R	36 x 72 x 29	150	107	23	\$1447	\$725
	bullnose edge	GCR6RBN	36 x 72 x 29	150	107	23	\$1447	\$725
	T-mold edge	GCR6RTM	36 x 72 x 29	150	107	23	\$1447	\$725
	built-up self edge	GCR6RBU	36 x 72 x 29	150	117	25	\$1610	\$806
7 foot	self edge	GCR7R	44 x 84 x 29	125	161	25	\$1667	\$834
	bullnose edge	GCR7RBN	44 x 84 x 29	125	161	25	\$1667	\$834
	T-mold edge	GCR7RTM	44 x 84 x 29	125	161	25	\$1667	\$834
	built-up self edge	GCR7RBU	44 x 84 x 29	125	164	27	\$1865	\$933
8 foot	self edge	GCR8WR	48 x 96 x 29	125	177	27	\$1667	\$834
	bullnose edge	GCR8WRBN	48 x 96 x 29	125	177	27	\$1667	\$834
	T-mold edge	GCR8WRTM	48 x 96 x 29	125	177	27	\$1667	\$834
	built-up self edge	GCR8WRBU	48 x 96 x 29	125	208	29	\$1865	\$933
10 foot	self edge	GCR10WR	48 x 120 x 29	125	221	28.92	\$2281	\$1142
	bullnose edge	GCR10WRBN	48 x 120 x 29	125	221	28.92	\$2281	\$1142
	T-mold edge	GCR10WRTM	48 x 120 x 29	125	221	29	\$2281	\$1142
	built-up self edge	GCR10WRBU	48 x 120 x 29	125	239	32	\$2560	\$1281
12 foot	self edge	GCR12WR	48 x 144 x 29	100	270	30.96	\$2570	\$1287
	bullnose edge	GCR12WRBN	48 x 144 x 29	100	270	30.96	\$2570	\$1287
	T-mold edge	GCR12WRTM	48 x 144 x 29	100	270	30.96	\$2570	\$1287
	built-up self edge	GCR12WRBU	48 x 144 x 29	100	293	33.89	\$2869	\$1436
14 foot	self edge	GCR14WR	48 x 168 x 29	125	330	50	\$2952	\$1479
	bullnose edge	GCR14WRBN	48 x 168 x 29	125	330	50	\$2952	\$1479
	T-mold edge	GCR14WRTM	48 x 168 x 29	125	330	50	\$2952	\$1479
	built-up self edge	GCR14WRBU	48 x 168 x 29	125	336	54	\$3260	\$1631
16 foot	self edge	GCR16WR	48 x 192 x 29	125	371	54	\$3082	\$1542
	bullnose edge	GCR16WRBN	48 x 192 x 29	125	371	54	\$3082	\$1542
	T-mold edge	GCR16WRTM	48 x 192 x 29	125	371	54	\$3082	\$1542
	built-up self edge	GCR16WRBU	48 x 192 x 29	125	377	58	\$3384	\$1695
18 foot	self edge	GCR18WR	48 x 216 x 29	125	412	56	\$3651	\$1827
	bullnose edge	GCR18WRBN	48 x 216 x 29	125	412	56	\$3651	\$1827
	T-mold edge	GCR18WRTM	48 x 216 x 29	125	412	56	\$3651	\$1827
	built-up self edge	GCR18WRBU	48 x 216 x 29	125	419	60	\$4077	\$2042
20 foot	self edge	GCR20WR	48 x 240 x 29	125	453	58	\$3780	\$1894
	bullnose edge	GCR20WRBN	48 x 240 x 29	125	453	58	\$3780	\$1894
	T-mold edge	GCR20WRTM	48 x 240 x 29	125	453	58	\$3780	\$1894
	built-up self edge	GCR20WRBU	48 x 240 x 29	125	461	62	\$4214	\$2108
22 foot	self edge	GCR22WR	48 x 264 x 29	100	493	60	\$4206	\$2104
	bullnose edge	GCR22WRBN	48 x 264 x 29	100	493	60	\$4206	\$2104
	T-mold edge	GCR22WRTM	48 x 264 x 29	100	493	60	\$4206	\$2104
	built-up self edge	GCR22WRBU	48 x 264 x 29	125	501	64	\$4697	\$2352
24 foot	self edge	GCR24WR	48 x 288 x 29	100	535	62	\$4338	\$2171
	bullnose edge	GCR24WRBN	48 x 288 x 29	100	535	62	\$4338	\$2171
	T-mold edge	GCR24WRTM	48 x 288 x 29	100	535	62	\$4338	\$2171
	built-up self edge	GCR24WRBU	48 x 288 x 29	100	544	66	\$4821	\$2413

- All tops over 144" are standard in two pieces. Woodgrain laminate finishes will NOT align where the two tops join.
- All tops 120", 144", and 168" are SHIPPED WITH 3 TUBULAR BASES.
- All tops 192" are SHIPPED WITH 4 TUBULAR BASES.
- All tops 216", 240", 264" and 288" are SHIPPED WITH 6 TUBULAR BASES.

Required Specifications

Top finish
Base finish
Edge color, if applicable

Optional Specifications

Grommet
HP laminate

Accessories

Power Block

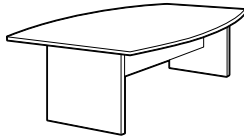
BOAT TOP - SLAB BASE

	MODEL#	DIMENSIONS	FREIGHT CLASS	WT./LBS.	CUBIC FT.	LIST PRICE	HP ADD
		D x W x H					
5 foot	self edge	GCT5BX	30 x 60 x 29	70	131	6	\$1074 \$538
	bullnose edge	GCT5BXBN	30 x 60 x 29	70	131	6	\$1074 \$538
	T-mold edge	GCT5BXTM	30 x 60 x 29	70	131	7	\$1074 \$538
	built-up self edge	GCT5BXBU	30 x 60 x 29	125	114	17	\$1187 \$594
6 foot	self edge	GCT6BX	36 x 72 x 29	70	138	7.60	\$1203 \$603
	bullnose edge	GCT6BXBN	36 x 72 x 29	70	138	7.60	\$1203 \$603
	T-mold edge	GCT6BXTM	36 x 72 x 29	70	147	7.60	\$1203 \$603
	built-up self edge	GCT6BXBU	36 x 72 x 29	70	157	8.90	\$1341 \$672
7 foot	self edge	GCT7BX	44 x 84 x 29	70	199	9.94	\$1549 \$776
	bullnose edge	GCT7BXBN	44 x 84 x 29	70	199	9.94	\$1549 \$776
	T-mold edge	GCT7BXTM	44 x 84 x 29	70	199	9.94	\$1549 \$776
	built-up self edge	GCT7BXBU	44 x 84 x 29	70	203	11.95	\$1748 \$875
8 foot	self edge	GCT8WBX	48 x 96 x 29	70	218	11.29	\$1549 \$776
	bullnose edge	GCT8WBXBN	48 x 96 x 29	70	218	11.29	\$1549 \$776
	T-mold edge	GCT8WBXTM	48 x 96 x 29	70	218	11.29	\$1549 \$776
	built-up self edge	GCT8WBXBU	48 x 96 x 29	70	218	13.53	\$1748 \$875
10 foot	self edge	GCT10WBX2	48 x 120 x 29	70	249	13.53	\$1795 \$900
	bullnose edge	GCT10WBX2BN	48 x 120 x 29	70	249	13.53	\$1795 \$900
	T-mold edge	GCT10WBX2TM	48 x 120 x 29	70	249	13.53	\$1795 \$900
	built-up self edge	GCT10WBX2BU	48 x 120 x 29	70	294	16.20	\$2124 \$1062
12 foot	self edge	GCT12WBX2	48 x 144 x 29	70	308	15.54	\$2105 \$1055
	bullnose edge	GCT12WBX2BN	48 x 144 x 29	70	308	15.54	\$2105 \$1055
	T-mold edge	GCT12WBX2TM	48 x 144 x 29	70	308	15.54	\$2105 \$1055
	built-up self edge	GCT12WBX2BU	48 x 144 x 29	70	338	18.83	\$2472 \$1237
14 foot	self edge	GCT14WBX2	48 x 168 x 29	65	419	18	\$3044 \$1524
	bullnose edge	GCT14WBX2BN	48 x 168 x 29	65	419	18	\$3044 \$1524
	T-mold edge	GCT14WBX2TM	48 x 168 x 29	65	419	18	\$3044 \$1524
	built-up self edge	GCT14WBX2BU	48 x 168 x 29	65	425	16	\$3398 \$1701
16 foot	self edge	GCT16WBX2	48 x 192 x 29	70	460	22.70	\$3172 \$1588
	bullnose edge	GCT16WBX2BN	48 x 192 x 29	70	460	22.70	\$3172 \$1588
	T-mold edge	GCT16WBX2TM	48 x 192 x 29	70	460	22.70	\$3172 \$1588
	built-up self edge	GCT16WBX2BU	48 x 192 x 29	70	466	27.20	\$3542 \$1772
18 foot	self edge	GCT18WBX2	48 x 216 x 29	70	521	24.60	\$3948 \$1976
	bullnose edge	GCT18WBX2BN	48 x 216 x 29	70	521	24.60	\$3948 \$1976
	T-mold edge	GCT18WBX2TM	48 x 216 x 29	70	521	24.60	\$3948 \$1976
	built-up self edge	GCT18WBX2BU	48 x 216 x 29	70	528	29.80	\$4425 \$2216
20 foot	self edge	GCT20WBX2	48 x 240 x 29	70	572	26.60	\$4011 \$2007
	bullnose edge	GCT20WBX2BN	48 x 240 x 29	70	572	26.60	\$4011 \$2007
	T-mold edge	GCT20WBX2TM	48 x 240 x 29	70	572	26.60	\$4011 \$2007
	built-up self edge	GCT20WBX2BU	48 x 240 x 29	70	580	32.50	\$4489 \$2246
22 foot	self edge	GCT22WBX2	48 x 264 x 29	70	612	28.90	\$4655 \$2328
	bullnose edge	GCT22WBX2BN	48 x 264 x 29	70	612	28.90	\$4655 \$2328
	T-mold edge	GCT22WBX2TM	48 x 264 x 29	70	612	28.90	\$4655 \$2328
	built-up self edge	GCT22WBX2BU	48 x 264 x 29	70	620	35.10	\$5141 \$2572
24 foot	self edge	GCT24WBX2	48 x 288 x 29	70	673	31.20	\$4786 \$2396
	bullnose edge	GCT24WBX2BN	48 x 288 x 29	70	673	31.20	\$4786 \$2396
	T-mold edge	GCT24WBX2TM	48 x 288 x 29	70	673	31.20	\$4786 \$2396
	built-up self edge	GCT24WBX2BU	48 x 288 x 29	70	682	37.70	\$5295 \$2650

- All tops over 144" are standard in two pieces. Woodgrain laminate finishes will NOT align where the two tops join.
- All tops 168", 192", 216" and 240" are SHIPPED WITH 3 SLAB BASES.
- All tops 264" and 288" are SHIPPED WITH 4 SLAB BASES.

Required Specifications

Top finish
Base finish
Edge color, if applicable

Optional Specifications

Grommet
HP laminate

Accessories

Power Block

B BOARDROOM TABLES

BOAT TOP - DRUM BASE

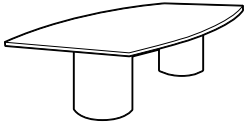

		MODEL#	DIMENSIONS	FREIGHT CLASS	WT/LBS.	CUBIC FT.	LIST PRICE	HP ADD
			D x W x H					
6 foot	self edge	GCT6BZ	36 x 72 x 29	100	162	17.50	\$1626	\$814
	bullnose edge	GCT6BZBN	36 x 72 x 29	100	153	17.50	\$1626	\$814
	T-mold edge	GCT6BZTM	36 x 72 x 29	100	162	17.50	\$1626	\$814
	built-up self edge	GCT6BZBU	36 x 72 x 29	100	172	18.90	\$1819	\$911
7 foot	self edge	GCT7BZ	44 x 84 x 29	92.5	196	19.40	\$1846	\$925
	bullnose edge	GCT7BZBN	44 x 84 x 29	92.5	196	19.40	\$1846	\$925
	T-mold edge	GCT7BZTM	44 x 84 x 29	92.5	196	19.40	\$1846	\$925
	built-up self edge	GCT7BZBU	44 x 84 x 29	100	199	21.20	\$2075	\$1039
8 foot	self edge	GCT8WBZ	48 x 96 x 29	92.5	219	21.20	\$1883	\$943
	bullnose edge	GCT8WBZBN	48 x 96 x 29	92.5	219	21.20	\$1883	\$943
	T-mold edge	GCT8WBZTM	48 x 96 x 29	92.5	219	21.20	\$1883	\$943
	built-up self edge	GCT8WBZBU	48 x 96 x 29	92.5	250	23.50	\$2075	\$1039
10 foot	self edge	GCT10WBZ2	48 x 120 x 29	100	272	33.30	\$2206	\$1104
	bullnose edge	GCT10WBZ2BN	48 x 120 x 29	100	272	33.30	\$2206	\$1104
	T-mold edge	GCT10WBZ2TM	48 x 120 x 29	100	272	33.22	\$2206	\$1104
	built-up self edge	GCT10WBZ2BU	48 x 120 x 29	100	317	35.70	\$2432	\$1217
12 foot	self edge	GCT12WBZ2	48 x 144 x 29	100	327	35.30	\$2466	\$1234
	bullnose edge	GCT12WBZ2BN	48 x 144 x 29	100	327	35.30	\$2466	\$1234
	T-mold edge	GCT12WBZ2TM	48 x 144 x 29	100	327	35.30	\$2466	\$1234
	built-up self edge	GCT12WBZ2BU	48 x 144 x 29	100	357	38.40	\$2737	\$1371
14 foot	self edge	GCT14WBZ2	48 x 168 x 29	92.5	441	39	\$3304	\$1654
	bullnose edge	GCT14WBZ2BN	48 x 168 x 29	92.5	441	39	\$3304	\$1654
	T-mold edge	GCT14WBZ2TM	48 x 168 x 29	92.5	441	39	\$3304	\$1654
	built-up self edge	GCT14WBZ2BU	48 x 168 x 29	92.5	447	42	\$3664	\$1834
16 foot	self edge	GCT16WBZ2	48 x 192 x 29	92.5	482	42.52	\$3433	\$1718
	bullnose edge	GCT16WBZ2BN	48 x 192 x 29	92.5	482	42.52	\$3433	\$1718
	T-mold edge	GCT16WBZ2TM	48 x 192 x 29	92.5	482	42.52	\$3433	\$1718
	built-up self edge	GCT16WBZ2BU	48 x 192 x 29	92.5	488	47	\$3788	\$1897
18 foot	self edge	GCT18WBZ2	48 x 216 x 29	100	523	54.40	\$4464	\$2233
	bullnose edge	GCT18WBZ2BN	48 x 216 x 29	100	523	54.40	\$4464	\$2233
	T-mold edge	GCT18WBZ2TM	48 x 216 x 29	100	523	54.40	\$4464	\$2233
	built-up self edge	GCT18WBZ2BU	48 x 216 x 29	100	550	59	\$5018	\$2511
20 foot	self edge	GCT20WBZ2	48 x 240 x 29	100	564	66.20	\$4529	\$2266
	bullnose edge	GCT20WBZ2BN	48 x 240 x 29	100	564	66.20	\$4529	\$2266
	T-mold edge	GCT20WBZ2TM	48 x 240 x 29	100	564	66.20	\$4529	\$2266
	built-up self edge	GCT20WBZ2BU	48 x 240 x 29	100	572	70.60	\$5084	\$2545
22 foot	self edge	GCT22WBZ2	48 x 264 x 29	100	604	68.20	\$5044	\$2523
	bullnose edge	GCT22WBZ2BN	48 x 264 x 29	100	604	68.20	\$5044	\$2523
	T-mold edge	GCT22WBZ2TM	48 x 264 x 29	100	604	68.20	\$5044	\$2523
	built-up self edge	GCT22WBZ2BU	48 x 264 x 29	100	612	73.68	\$5635	\$2819
24 foot	self edge	GCT24WBZ2	48 x 288 x 29	100	646	70.20	\$5175	\$2590
	bullnose edge	GCT24WBZ2BN	48 x 288 x 29	100	646	70.20	\$5175	\$2590
	T-mold edge	GCT24WBZ2TM	48 x 288 x 29	100	646	70.20	\$5175	\$2590
	built-up self edge	GCT24WBZ2BU	48 x 288 x 29	100	655	76.80	\$5756	\$2880

- All Drum Bases require approx. 125 lb. of sand in each base for adequate stability. Sand is not included.
- All tops over 144" are standard in two pieces. Woodgrain laminate finishes will NOT align where the two tops join.
- All tops 168", 192" and 216" are SHIPPED WITH 3 DRUM BASES.
- All tops 240", 264" and 288" are SHIPPED WITH 4 DRUM BASES.

Required Specifications

Top finish
Base finish
Edge color, if applicable

Optional Specifications

Grommet
HP laminate

Accessories

Power Block

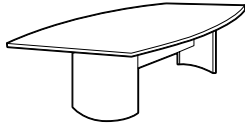
BOAT TOP - ARCH BASE

	MODEL#	DIMENSIONS	FREIGHT CLASS	WT./LBS.	CUBIC FT.	LIST PRICE	HP ADD
		D x W x H					
5 foot	self edge	GCT5BA	30 x 60 x 29	85	131	9	\$1430 \$717
	bullnose edge	GCT5BABN	30 x 60 x 29	85	131	9	\$1430 \$717
	T-mold edge	GCT5BATM	30 x 60 x 29	85	131	9	\$1430 \$717
	built-up self edge	GCT5BABU	30 x 60 x 29	85	134	10	\$1625 \$814
6 foot	self edge	GCT6BA	36 x 72 x 29	85	152	11	\$1496 \$750
	bullnose edge	GCT6BABN	36 x 72 x 29	85	152	11	\$1496 \$750
	T-mold edge	GCT6BATM	36 x 72 x 29	85	152	11	\$1496 \$750
	built-up self edge	GCT6BABU	36 x 72 x 29	85	162	12	\$1777 \$889
7 foot	self edge	GCT7BA	44 x 84 x 29	70	203	12.96	\$1820 \$912
	bullnose edge	GCT7BABN	44 x 84 x 29	70	203	12.96	\$1820 \$912
	T-mold edge	GCT7BATM	44 x 84 x 29	70	203	12.96	\$1820 \$912
	built-up self edge	GCT7BABU	44 x 84 x 29	85	206	13.98	\$2060 \$1033
8 foot	self edge	GCT8WBA	48 x 96 x 29	70	228	14.97	\$1820 \$912
	bullnose edge	GCT8WBABN	48 x 96 x 29	85	220	14.97	\$1820 \$912
	T-mold edge	GCT8WBATM	48 x 96 x 29	85	220	14.97	\$1820 \$912
	built-up self edge	GCT8WBABU	48 x 96 x 29	85	220	15.96	\$2060 \$1033
10 foot	self edge	GCT10WBA	48 x 120 x 29	85	251	16.96	\$2076 \$1041
	bullnose edge	GCT10WBABN	48 x 120 x 29	85	251	16.95	\$2076 \$1041
	T-mold edge	GCT10WBATM	48 x 120 x 29	85	251	16.95	\$2076 \$1041
	built-up self edge	GCT10WBABU	48 x 120 x 29	70	296	18.92	\$2448 \$1227
12 foot	self edge	GCT12WBA	48 x 144 x 29	70	306	20	\$2400 \$1201
	bullnose edge	GCT12WBABN	48 x 144 x 29	70	310	19.94	\$2400 \$1201
	T-mold edge	GCT12WBATM	48 x 144 x 29	70	310	19.94	\$2400 \$1201
	built-up self edge	GCT12WBABU	48 x 144 x 29	70	340	21.89	\$2801 \$1402
14 foot	self edge	GCT14WBA	48 x 168 x 29	70	423	25.93	\$3692 \$1848
	bullnose edge	GCT14WBABN	48 x 168 x 29	70	423	25.93	\$3692 \$1848
	T-mold edge	GCT14WBATM	48 x 168 x 29	70	423	25.93	\$3692 \$1848
	built-up self edge	GCT14WBABU	48 x 168 x 29	70	429	27.90	\$4114 \$2058
16 foot	self edge	GCT16WBA	48 x 192 x 29	70	474	29.94	\$3884 \$1944
	bullnose edge	GCT16WBABN	48 x 192 x 29	70	474	29.94	\$3884 \$1944
	T-mold edge	GCT16WBATM	48 x 192 x 29	70	474	29.94	\$3884 \$1944
	built-up self edge	GCT16WBABU	48 x 192 x 29	70	480	31.92	\$4342 \$2173
18 foot	self edge	GCT18WBA	48 x 216 x 29	70	525	31.92	\$4786 \$2396
	bullnose edge	GCT18WBABN	48 x 216 x 29	70	525	31.92	\$4786 \$2396
	T-mold edge	GCT18WBATM	48 x 216 x 29	70	525	31.92	\$4786 \$2396
	built-up self edge	GCT18WBABU	48 x 216 x 29	70	532	33.89	\$5349 \$2676
20 foot	self edge	GCT20WBA	48 x 240 x 29	70	576	33.89	\$4855 \$2428
	bullnose edge	GCT20WBABN	48 x 240 x 29	70	576	33.89	\$4855 \$2428
	T-mold edge	GCT20WBATM	48 x 240 x 29	70	576	33.89	\$4855 \$2428
	built-up self edge	GCT20WBABU	48 x 240 x 29	70	584	35.93	\$5399 \$2702
22 foot	self edge	GCT22WBA	48 x 264 x 29	70	626	36.89	\$5427 \$2716
	bullnose edge	GCT22WBABN	48 x 264 x 29	70	626	36.89	\$5427 \$2716
	T-mold edge	GCT22WBATM	48 x 264 x 29	70	626	36.89	\$5427 \$2716
	built-up self edge	GCT22WBABU	48 x 264 x 29	70	634	37.90	\$6068 \$3036
24 foot	self edge	GCT24WBA	48 x 288 x 29	70	678	40	\$5558 \$2780
	bullnose edge	GCT24WBABN	48 x 288 x 29	70	678	40	\$5558 \$2780
	T-mold edge	GCT24WBATM	48 x 288 x 29	70	678	40	\$5558 \$2780
	built-up self edge	GCT24WBABU	48 x 288 x 29	65	687	25.10	\$6193 \$3099

- All tops over 144" are standard in two pieces. Woodgrain laminate finishes will NOT align where the two tops join.
- All tops 168", 192", 216" and 240" are SHIPPED WITH 2 ARCH BASES AND 1 SLAB BASE.
- All tops 264" and 288" are SHIPPED WITH 2 ARCH BASES AND 2 SLAB BASES.

Required Specifications

Top finish
Base finish
Edge color, if applicable

Optional Specifications

Grommet
HP laminate

Accessories

Power Block

B BOARDROOM TABLES

BOAT TOP - 2 LEG BASE



	MODEL#	DIMENSIONS	FREIGHT CLASS	WT/LBS.	CUBIC FT.	LIST PRICE	HP ADD
D x W x H							
5 foot	self edge	GCT5B	30 x 60 x 29	125	88	13	\$1263 \$634
	bullnose edge	GCT5BBN	30 x 60 x 29	125	88	13	\$1263 \$634
	T-mold edge	GCT5BTM	30 x 60 x 29	125	88	13	\$1263 \$634
	built-up self edge	GCT5BBU	30 x 60 x 29	125	91	14	\$1410 \$708
6 foot	self edge	GCT6B	36 x 72 x 29	100	123	15	\$1407 \$705
	bullnose edge	GCT6BBN	36 x 72 x 29	125	114	15	\$1407 \$705
	T-mold edge	GCT6BTM	36 x 72 x 29	100	123	15	\$1407 \$705
	built-up self edge	GCT6BBU	36 x 72 x 29	100	133	16	\$1562 \$782
7 foot	self edge	GCT7B	44 x 84 x 29	100	155	16.98	\$1626 \$814
	bullnose edge	GCT7BBN	44 x 84 x 29	100	155	16.98	\$1626 \$814
	T-mold edge	GCT7BTM	44 x 84 x 29	100	155	16.98	\$1626 \$814
	built-up self edge	GCT7BBU	44 x 84 x 29	100	158	18.98	\$1821 \$912
8 foot	self edge	GCT8WB	48 x 96 x 29	100	188	19	\$1626 \$814
	bullnose edge	GCT8WBBN	48 x 96 x 29	100	180	19	\$1626 \$814
	T-mold edge	GCT8WBTM	48 x 96 x 29	100	180	18.98	\$1626 \$814
	built-up self edge	GCT8WBBU	48 x 96 x 29	100	180	21	\$1821 \$912
10 foot	self edge	GCT10WB	48 x 120 x 29	92.5	214	21	\$2258 \$1131
	bullnose edge	GCT10WBBN	48 x 120 x 29	92.5	214	20.98	\$2258 \$1131
	T-mold edge	GCT10WBTM	48 x 120 x 29	92.5	214	20.93	\$2258 \$1131
	built-up self edge	GCT10WBBU	48 x 120 x 29	92.5	259	22.93	\$2526 \$1264
12 foot	self edge	GCT12WB	48 x 144 x 29	92.5	265	22.80	\$2541 \$1272
	bullnose edge	GCT12WBBN	48 x 144 x 29	92.5	269	22.69	\$2541 \$1272
	T-mold edge	GCT12WBTM	48 x 144 x 29	92.5	269	22.69	\$2541 \$1272
	built-up self edge	GCT12WBBU	48 x 144 x 29	92.5	299	25.69	\$2832 \$1419
14 foot	self edge	GCT14WB	48 x 168 x 29	100	326	34	\$2914 \$1460
	bullnose edge	GCT14WBBN	48 x 168 x 29	100	326	34	\$2914 \$1460
	T-mold edge	GCT14WBTM	48 x 168 x 29	100	326	34	\$2914 \$1460
	built-up self edge	GCT14WBBU	48 x 168 x 29	100	332	38	\$3220 \$1612
16 foot	self edge	GCT16WB	48 x 192 x 29	100	367	38	\$3044 \$1524
	bullnose edge	GCT16WBBN	48 x 192 x 29	100	367	38	\$3044 \$1524
	T-mold edge	GCT16WBTM	48 x 192 x 29	100	367	38	\$3044 \$1524
	built-up self edge	GCT16WBBU	48 x 192 x 29	100	373	40	\$3297 \$1651
18 foot	self edge	GCT18WB	48 x 216 x 29	92.5	408	40	\$3627 \$1816
	bullnose edge	GCT18WBBN	48 x 216 x 29	92.5	408	40	\$3627 \$1816
	T-mold edge	GCT18WBTM	48 x 216 x 29	92.5	408	40	\$3627 \$1815
	built-up self edge	GCT18WBBU	48 x 216 x 29	100	416	42	\$4044 \$2025
20 foot	self edge	GCT20WB	48 x 240 x 29	92.5	449	42	\$3756 \$1880
	bullnose edge	GCT20WBBN	48 x 240 x 29	92.5	449	42	\$3756 \$1880
	T-mold edge	GCT20WBTM	48 x 240 x 29	92.5	449	42	\$3756 \$1880
	built-up self edge	GCT20WBBU	48 x 240 x 29	92.5	457	44	\$4167 \$2086
22 foot	self edge	GCT22WB	48 x 264 x 29	92.5	489	44	\$4140 \$2073
	bullnose edge	GCT22WBBN	48 x 264 x 29	92.5	489	44	\$4140 \$2073
	T-mold edge	GCT22WBTM	48 x 264 x 29	92.5	489	44	\$4140 \$2073
	built-up self edge	GCT22WBBU	48 x 264 x 29	92.5	497	46	\$4662 \$2332
24 foot	self edge	GCT24WB	48 x 288 x 29	92.5	531	46	\$4268 \$2135
	bullnose edge	GCT24WBBN	48 x 288 x 29	92.5	531	46	\$4268 \$2135
	T-mold edge	GCT24WBTM	48 x 288 x 29	92.5	531	46	\$4268 \$2135
	built-up self edge	GCT24WBBU	48 x 288 x 29	92.5	540	48	\$4772 \$2387

- All tops over 144" are standard in two pieces. Woodgrain laminate finishes will NOT align where the two tops join.
- All tops 120", 144", and 168" are SHIPPED WITH 3 LEG BASES.
- All tops 192" are SHIPPED WITH 4 LEG BASES.
- All tops 216", 240", 264" and 288" are SHIPPED WITH 6 LEG BASES.

Required Specifications

Top finish
Base finish
Edge color, if applicable

Optional Specifications

Grommet
HP laminate

Accessories

Power Block

BOAT TOP - TUBULAR BASE

	MODEL#	DIMENSIONS	FREIGHT CLASS	WT/LBS.	CUBIC FT.	LIST PRICE	HP ADD
	D x W x H						
5 foot	self edge	GCR5B	30 x 60 x 29	150	94	21	\$1303 \$654
	bullnose edge	GCR5BBN	30 x 60 x 29	150	94	21	\$1303 \$654
	T-mold edge	GCR5BTM	30 x 60 x 29	150	94	21	\$1303 \$654
	built-up self edge	GCR5BBU	30 x 60 x 29	150	97	23	\$1454 \$731
6 foot	self edge	GCR6B	36 x 72 x 29	150	107	23	\$1447 \$725
	bullnose edge	GCR6BBN	36 x 72 x 29	150	107	23	\$1447 \$725
	T-mold edge	GCR6BTM	36 x 72 x 29	150	107	23	\$1447 \$725
	built-up self edge	GCR6BBU	36 x 72 x 29	150	117	25	\$1610 \$806
7 foot	self edge	GCR7B	44 x 84 x 29	125	161	25	\$1667 \$834
	bullnose edge	GCR7BBN	44 x 84 x 29	125	161	25	\$1667 \$834
	T-mold edge	GCR7BTM	44 x 84 x 29	125	161	25	\$1667 \$834
	built-up self edge	GCR7BBU	44 x 84 x 29	150	164	29	\$1865 \$933
8 foot	self edge	GCR8WB	48 x 96 x 29	125	184	27	\$1667 \$834
	bullnose edge	GCR8WBBN	48 x 96 x 29	125	177	27	\$1667 \$834
	T-mold edge	GCR8WBTM	48 x 96 x 29	125	177	27	\$1667 \$834
	built-up self edge	GCR8WBBU	48 x 96 x 29	125	208	29	\$1865 \$933
10 foot	self edge	GCR10WB	48 x 120 x 29	125	221	29	\$2281 \$1142
	bullnose edge	GCR10WBBN	48 x 120 x 29	125	221	29	\$2281 \$1142
	T-mold edge	GCR10WBTM	48 x 120 x 29	125	221	29	\$2281 \$1142
	built-up self edge	GCR10WBBU	48 x 120 x 29	125	239	32	\$2560 \$1436
12 foot	self edge	GCR12WB	48 x 144 x 29	100	270	31	\$2570 \$1287
	bullnose edge	GCR12WBBN	48 x 144 x 29	100	270	31	\$2570 \$1287
	T-mold edge	GCR12WBTM	48 x 144 x 29	100	270	30.78	\$2570 \$1287
	built-up self edge	GCR12WBBU	48 x 144 x 29	100	293	34	\$2869 \$1436
14 foot	self edge	GCR14WB	48 x 168 x 29	125	330	50	\$2952 \$1479
	bullnose edge	GCR14WBBN	48 x 168 x 29	125	330	50	\$2952 \$1479
	T-mold edge	GCR14WBTM	48 x 168 x 29	125	330	50	\$2952 \$1479
	built-up self edge	GCR14WBBU	48 x 168 x 29	125	336	54	\$3260 \$1631
16 foot	self edge	GCR16WB	48 x 192 x 29	125	371	54	\$3082 \$1542
	bullnose edge	GCR16WBBN	48 x 192 x 29	125	371	54	\$3082 \$1542
	T-mold edge	GCR16WBTM	48 x 192 x 29	125	371	54	\$3082 \$1542
	built-up self edge	GCR16WBBU	48 x 192 x 29	125	377	58	\$3384 \$1695
18 foot	self edge	GCR18WB	48 x 216 x 29	125	412	56	\$3651 \$1827
	bullnose edge	GCR18WBBN	48 x 216 x 29	125	412	56	\$3651 \$1827
	T-mold edge	GCR18WBTM	48 x 216 x 29	125	412	56	\$3651 \$1827
	built-up self edge	GCR18WBBU	48 x 216 x 29	125	419	60	\$4077 \$2042
20 foot	self edge	GCR20WB	48 x 240 x 29	125	453	58	\$3780 \$1894
	bullnose edge	GCR20WBBN	48 x 240 x 29	125	453	58	\$3780 \$1894
	T-mold edge	GCR20WBTM	48 x 240 x 29	125	453	58	\$3780 \$1894
	built-up self edge	GCR20WBBU	48 x 240 x 29	125	461	62	\$4214 \$2108
22 foot	self edge	GCR22WB	48 x 264 x 29	100	493	60	\$4206 \$2104
	bullnose edge	GCR22WBBN	48 x 264 x 29	100	493	60	\$4206 \$2104
	T-mold edge	GCR22WBTM	48 x 264 x 29	100	493	60	\$4206 \$2104
	built-up self edge	GCR22WBBU	48 x 264 x 29	125	501	64	\$4697 \$2352
24 foot	self edge	GCR24WB	48 x 288 x 29	100	535	62	\$4338 \$2171
	bullnose edge	GCR24WBBN	48 x 288 x 29	100	535	62	\$4338 \$2171
	T-mold edge	GCR24WBTM	48 x 288 x 29	100	535	62	\$4338 \$2171
	built-up self edge	GCR24WBBU	48 x 288 x 29	100	544	66	\$4821 \$2413

- All tops over 144" are standard in two pieces. Woodgrain laminate finishes will NOT align where the two tops join.
- All tops 120", 144", and 168" are SHIPPED WITH 3 TUBULAR BASES.
- All tops 192" are SHIPPED WITH 4 TUBULAR BASES.
- All tops 216", 240", 264" and 288" are SHIPPED WITH 6 TUBULAR BASES.

Required Specifications

Top finish
Base finish
Edge color, if applicable

Optional Specifications

Grommet
HP laminate

Accessories

Power Block

B BOARDROOM TABLES

RACETRACK TOP - SLAB BASE

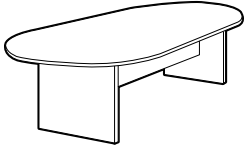

	MODEL#	DIMENSIONS	FREIGHT CLASS	WT/LBS.	CUBIC FT.	LIST PRICE	HP ADD
D x W x H							
5 foot	self edge	GRT5X	30 x 60 x 29	70	131	6	\$1074 \$538
	bullnose edge	GRT5XBN	30 x 60 x 29	70	131	6	\$1074 \$538
	T-mold edge	GRT5XTM	30 x 60 x 29	70	131	6	\$1074 \$538
	built-up self edge	GRT5XBU	30 x 60 x 29	70	134	7	\$1187 \$594
6 foot	self edge	GRT6X	36 x 72 x 29	70	135	7.60	\$1203 \$603
	bullnose edge	GRT6XBN	36 x 72 x 29	70	143	7.60	\$1203 \$603
	T-mold edge	GRT6XTM	36 x 72 x 29	70	143	7.60	\$1203 \$603
	built-up self edge	GRT6XBU	36 x 72 x 29	70	160	8.90	\$1341 \$672
7 foot	self edge	GRT7X	44 x 84 x 29	70	199	9.94	\$1549 \$776
	bullnose edge	GRT7XBN	44 x 84 x 29	70	199	9.97	\$1549 \$776
	T-mold edge	GRT7XTM	44 x 84 x 29	70	199	9.94	\$1549 \$776
	built-up self edge	GRT7XBU	44 x 84 x 29	70	203	11.95	\$1748 \$875
8 foot	self edge	GRT8WX	48 x 96 x 29	70	216	11.29	\$1549 \$776
	bullnose edge	GRT8WXBN	48 x 96 x 29	70	218	11.29	\$1549 \$776
	T-mold edge	GRT8WXTM	48 x 96 x 29	70	216	11.29	\$1549 \$776
	built-up self edge	GRT8WXBU	48 x 96 x 29	70	242	13.53	\$1748 \$875
10 foot	self edge	GRT10WX2	48 x 120 x 29	70	280	13.53	\$1795 \$900
	bullnose edge	GRT10WX2BN	48 x 120 x 29	70	266	13.53	\$1795 \$900
	T-mold edge	GRT10WX2TM	48 x 120 x 29	70	256	13.53	\$1795 \$900
	built-up self edge	GRT10WX2BU	48 x 120 x 29	70	289	16.20	\$2124 \$1062
12 foot	self edge	GRT12WX2	48 x 144 x 29	70	210	12.54	\$2105 \$1055
	bullnose edge	GRT12WX2BN	48 x 144 x 29	65	307	12.54	\$2105 \$1055
	T-mold edge	GRT12WX2TM	48 x 144 x 29	65	307	12.54	\$2105 \$1055
	built-up self edge	GRT12WX2BU	48 x 144 x 29	70	340	18.83	\$2472 \$1237
14 foot	self edge	GRT14WX2	48 x 168 x 29	65	419	18	\$3044 \$1524
	bullnose edge	GRT14WX2BN	48 x 168 x 29	65	419	18	\$3044 \$1524
	T-mold edge	GRT14WX2TM	48 x 168 x 29	65	419	18	\$3044 \$1524
	built-up self edge	GRT14WX2BU	48 x 168 x 29	70	425	20	\$3398 \$1701
16 foot	self edge	GRT16WX2	48 x 192 x 29	70	460	22.70	\$3172 \$1588
	bullnose edge	GRT16WX2BN	48 x 192 x 29	70	460	22.70	\$3172 \$1588
	T-mold edge	GRT16WX2TM	48 x 192 x 29	70	460	22.70	\$3172 \$1588
	built-up self edge	GRT16WX2BU	48 x 192 x 29	70	466	27.20	\$3542 \$1772
18 foot	self edge	GRT18WX2	48 x 216 x 29	70	521	24.60	\$3948 \$1976
	bullnose edge	GRT18WX2BN	48 x 216 x 29	70	521	24.60	\$3948 \$1976
	T-mold edge	GRT18WX2TM	48 x 216 x 29	70	521	24.60	\$3948 \$1976
	built-up self edge	GRT18WX2BU	48 x 216 x 29	70	528	29.80	\$4425 \$2216
20 foot	self edge	GRT20WX2	48 x 240 x 29	70	572	26.60	\$4011 \$2007
	bullnose edge	GRT20WX2BN	48 x 240 x 29	70	572	26.60	\$4011 \$2007
	T-mold edge	GRT20WX2TM	48 x 240 x 29	70	572	26.60	\$4011 \$2007
	built-up self edge	GRT20WX2BU	48 x 240 x 29	70	580	32.50	\$4489 \$2246
22 foot	self edge	GRT22WX2	48 x 264 x 29	70	612	28.90	\$4655 \$2328
	bullnose edge	GRT22WX2BN	48 x 264 x 29	70	612	28.90	\$4655 \$2328
	T-mold edge	GRT22WX2TM	48 x 264 x 29	70	612	28.90	\$4655 \$2328
	built-up self edge	GRT22WX2BU	48 x 264 x 29	70	620	35.10	\$5141 \$2572
24 foot	self edge	GRT24WX2	48 x 288 x 29	70	673	31.20	\$4786 \$2396
	bullnose edge	GRT24WX2BN	48 x 288 x 29	70	673	31.20	\$4786 \$2396
	T-mold edge	GRT24WX2TM	48 x 288 x 29	70	673	31.20	\$4786 \$2396
	built-up self edge	GRT24WX2BU	48 x 288 x 29	70	682	37.70	\$5295 \$2650

- All tops over 144" are standard in two pieces. Woodgrain laminate finishes will NOT align where the two tops join.
- All tops 168", 192", 216" and 240" are SHIPPED WITH 3 SLAB BASES.
- All tops 264" and 288" are SHIPPED WITH 4 SLAB BASES.

Required Specifications

Top finish
Base finish
Edge color, if applicable

Optional Specifications

Grommet
HP laminate

Accessories

Power Block

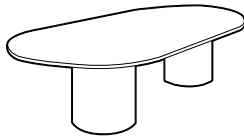
RACETRACK TOP - DRUM BASE

	MODEL#	DIMENSIONS	FREIGHT CLASS	WT/LBS.	CUBIC FT.	LIST PRICE	HP ADD
		D x W x H					
6 foot	self edge	GRT6Z	36 x 72 x 29	100	150	17.50	\$1626 \$814
	bullnose edge	GRT6ZBN	36 x 72 x 29	100	158	17.50	\$1626 \$814
	T-mold edge	GRT6ZTM	36 x 72 x 29	100	158	17.50	\$1626 \$814
	built-up self edge	GRT6ZBU	36 x 72 x 29	100	175	18.80	\$1819 \$911
7 foot	self edge	GRT7Z	44 x 84 x 29	92.5	196	19.40	\$1883 \$943
	bullnose edge	GRT7ZBN	44 x 84 x 29	92.5	196	19.40	\$1883 \$943
	T-mold edge	GRT7ZTM	44 x 84 x 29	92.5	196	19.40	\$1883 \$943
	built-up self edge	GRT7ZBU	44 x 84 x 29	100	199	21.20	\$2075 \$1039
8 foot	self edge	GRT8WZ	48 x 96 x 29	92.5	217	21.26	\$1883 \$943
	bullnose edge	GRT8WZBN	48 x 96 x 29	92.5	219	21.26	\$1883 \$943
	T-mold edge	GRT8WZTM	48 x 96 x 29	92.5	217	21.26	\$1883 \$943
	built-up self edge	GRT8WZBU	48 x 96 x 29	92.5	243	23.50	\$2075 \$942
10 foot	self edge	GRT10WZ2	48 x 120 x 29	100	313	33.14	\$2206 \$1104
	bullnose edge	GRT10WZ2BN	48 x 120 x 29	100	289	33.14	\$2206 \$1104
	T-mold edge	GRT10WZ2TM	48 x 120 x 29	100	279	33.14	\$2206 \$1104
	built-up self edge	GRT10WZ2BU	48 x 120 x 29	100	312	35.70	\$2432 \$1217
12 foot	self edge	GRT12WZ2	48 x 144 x 29	100	329	35.14	\$2466 \$1234
	bullnose edge	GRT12WZ2BN	48 x 144 x 29	150	326	58.70	\$2466 \$1234
	T-mold edge	GRT12WZ2TM	48 x 144 x 29	100	326	35.14	\$2466 \$1234
	built-up self edge	GRT12WZ2BU	48 x 144 x 29	100	359	38.32	\$2737 \$1234
14 foot	self edge	GRT14WZ2	48 x 168 x 29	92.5	478	44.44	\$3304 \$1654
	bullnose edge	GRT14WZ2BN	48 x 168 x 29	92.5	441	39	\$3304 \$1654
	T-mold edge	GRT14WZ2TM	48 x 168 x 29	92.5	441	39	\$3304 \$1654
	built-up self edge	GRT14WZ2BU	48 x 168 x 29	92.5	447	42	\$3664 \$1834
16 foot	self edge	GRT16WZ2	48 x 192 x 29	92.5	478	42.50	\$3433 \$1718
	bullnose edge	GRT16WZ2BN	48 x 192 x 29	92.5	482	42.50	\$3433 \$1718
	T-mold edge	GRT16WZ2TM	48 x 192 x 29	92.5	482	42.50	\$3433 \$1718
	built-up self edge	GRT16WZ2BU	48 x 192 x 29	92.5	488	47	\$3788 \$1897
18 foot	self edge	GRT18WZ2	48 x 216 x 29	100	523	54.40	\$4464 \$2233
	bullnose edge	GRT18WZ2BN	48 x 216 x 29	100	523	54	\$4464 \$2233
	T-mold edge	GRT18WZ2TM	48 x 216 x 29	100	523	54.40	\$4464 \$2233
	built-up self edge	GRT18WZ2BU	48 x 216 x 29	100	550	59	\$5018 \$2511
20 foot	self edge	GRT20WZ2	48 x 240 x 29	100	564	66.20	\$4529 \$2266
	bullnose edge	GRT20WZ2BN	48 x 240 x 29	100	564	66.20	\$4529 \$2266
	T-mold edge	GRT20WZ2TM	48 x 240 x 29	100	564	66.20	\$4529 \$2266
	built-up self edge	GRT20WZ2BU	48 x 240 x 29	100	572	70.60	\$5084 \$2545
22 foot	self edge	GRT22WZ2	48 x 264 x 29	100	604	68.20	\$5044 \$2523
	bullnose edge	GRT22WZ2BN	48 x 264 x 29	100	604	68.20	\$5044 \$2523
	T-mold edge	GRT22WZ2TM	48 x 264 x 29	100	604	68.20	\$5044 \$2523
	built-up self edge	GRT22WZ2BU	48 x 264 x 29	100	612	73.70	\$5635 \$2819
24 foot	self edge	GRT24WZ2	48 x 288 x 29	100	646	70.20	\$5175 \$2590
	bullnose edge	GRT24WZ2BN	48 x 288 x 29	100	646	70.20	\$5175 \$2590
	T-mold edge	GRT24WZ2TM	48 x 288 x 29	100	646	70.20	\$5175 \$2590
	built-up self edge	GRT24WZ2BU	48 x 288 x 29	100	655	76.80	\$5756 \$2880

- All Drum Bases require approx. 125 lb. of sand in each base for adequate stability. Sand is not included.
- All tops over 144" are standard in two pieces. Woodgrain laminate finishes will NOT align where the two tops join.
- All tops 168", 192" and 216" are SHIPPED WITH 3 DRUM BASES.
- All tops 240", 264" and 288" are SHIPPED WITH 4 DRUM BASES.

Required Specifications

Top finish
Base finish
Edge color, if applicable

Optional Specifications

Grommet
HP laminate

Accessories

Power Block

B BOARDROOM TABLES

RACETRACK TOP - ARCH BASE

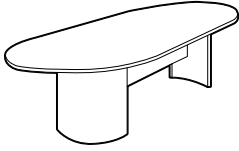

	MODEL#	DIMENSIONS	FREIGHT CLASS	WT/LBS.	CUBIC FT.	LIST PRICE	HP ADD
D x W x H							
5 foot	self edge	GRT5A	30 x 60 x 29	85	131	9	\$1430 \$717
	bullnose edge	GRT5ABN	30 x 60 x 29	85	131	9	\$1430 \$717
	T-mold edge	GRT5ATM	30 x 60 x 29	85	131	9	\$1430 \$717
	built-up self edge	GRT5ABU	30 x 60 x 29	85	134	10	\$1625 \$814
6 foot	self edge	GRT6A	36 x 72 x 29	85	140	11	\$1496 \$750
	bullnose edge	GRT6ABN	36 x 72 x 29	85	148	11	\$1496 \$750
	T-mold edge	GRT6ATM	36 x 72 x 29	85	148	11	\$1496 \$750
	built-up self edge	GRT6ABU	36 x 72 x 29	85	165	12	\$1777 \$889
7 foot	self edge	GRT7A	44 x 84 x 29	70	203	12.93	\$1820 \$912
	bullnose edge	GRT7ABN	44 x 84 x 29	70	203	12.93	\$1820 \$912
	T-mold edge	GRT7ATM	44 x 84 x 29	70	203	12.93	\$1820 \$912
	built-up self edge	GRT7ABU	44 x 84 x 29	85	206	13.95	\$2060 \$1033
8 foot	self edge	GRT8WA	48 x 96 x 29	85	218	14.94	\$1820 \$912
	bullnose edge	GRT8WABN	48 x 96 x 29	92.5	236	22.40	\$1820 \$912
	T-mold edge	GRT8WATM	48 x 96 x 29	85	218	14.94	\$1820 \$912
	built-up self edge	GRT8WABU	48 x 96 x 29	70	244	15.93	\$2060 \$1033
10 foot	self edge	GRT10WA	48 x 120 x 29	70	268	16.95	\$2076 \$1041
	bullnose edge	GRT10WABN	48 x 120 x 29	70	268	16.95	\$2076 \$1041
	T-mold edge	GRT10WATM	48 x 120 x 29	70	268	16.95	\$2076 \$1041
	built-up self edge	GRT10WABU	48 x 120 x 29	70	291	18.92	\$2448 \$1227
12 foot	self edge	GRT12WA	48 x 144 x 29	85	309	24.94	\$2400 \$1201
	bullnose edge	GRT12WABN	48 x 144 x 29	65	309	11.98	\$2400 \$1201
	T-mold edge	GRT12WATM	48 x 144 x 29	100	309	33.29	\$2400 \$1201
	built-up self edge	GRT12WABU	48 x 144 x 29	70	342	21.95	\$2801 \$1402
14 foot	self edge	GRT14WA	48 x 168 x 29	70	423	26	\$3692 \$1848
	bullnose edge	GRT14WABN	48 x 168 x 29	70	423	26	\$3692 \$1848
	T-mold edge	GRT14WATM	48 x 168 x 29	70	423	26	\$3692 \$1848
	built-up self edge	GRT14WABU	48 x 168 x 29	70	429	28	\$4114 \$2058
16 foot	self edge	GRT16WA	48 x 192 x 29	70	474	30	\$3884 \$1944
	bullnose edge	GRT16WABN	48 x 192 x 29	70	474	29.94	\$3884 \$1944
	T-mold edge	GRT16WATM	48 x 192 x 29	70	474	29.94	\$3884 \$1944
	built-up self edge	GRT16WABU	48 x 192 x 29	70	480	31.92	\$4342 \$2173
18 foot	self edge	GRT18WA	48 x 216 x 29	70	525	31.92	\$4786 \$2396
	bullnose edge	GRT18WABN	48 x 216 x 29	70	525	31.92	\$4786 \$2396
	T-mold edge	GRT18WATM	48 x 216 x 29	70	525	31.92	\$4786 \$2396
	built-up self edge	GRT18WABU	48 x 216 x 29	70	532	33.89	\$5349 \$2676
20 foot	self edge	GRT20WA	48 x 240 x 29	70	576	33.89	\$4855 \$2428
	bullnose edge	GRT20WABN	48 x 240 x 29	70	576	33.89	\$4855 \$2428
	T-mold edge	GRT20WATM	48 x 240 x 29	70	576	33.89	\$4855 \$2428
	built-up self edge	GRT20WABU	48 x 240 x 29	70	584	35.93	\$5399 \$2702
22 foot	self edge	GRT22WA	48 x 264 x 29	70	626	36.89	\$5427 \$2716
	bullnose edge	GRT22WABN	48 x 264 x 29	70	626	36.89	\$5427 \$2716
	T-mold edge	GRT22WATM	48 x 264 x 29	70	626	36.89	\$5427 \$2716
	built-up self edge	GRT22WABU	48 x 264 x 29	70	634	37.90	\$6068 \$3036
24 foot	self edge	GRT24WA	48 x 288 x 29	70	678	39.88	\$5558 \$2780
	bullnose edge	GRT24WABN	48 x 288 x 29	70	678	39.88	\$5558 \$2780
	T-mold edge	GRT24WATM	48 x 288 x 29	70	678	39.88	\$5558 \$2780
	built-up self edge	GRT24WABU	48 x 288 x 29	70	687	41.92	\$6193 \$3099

- All tops over 144" are standard in two pieces. Woodgrain laminate finishes will NOT align where the two tops join.
- All tops 168", 192", 216" and 240" are SHIPPED WITH 2 ARCH BASES AND 1 SLAB BASE.
- All tops 264" and 288" are SHIPPED WITH 2 ARCH BASES AND 2 SLAB BASES.

Required Specifications

Top finish
Base finish
Edge color, if applicable

Optional Specifications

Grommet
HP laminate

Accessories

Power Block

RACETRACK TOP - 2 LEG BASE

	MODEL#	DIMENSIONS	FREIGHT CLASS	WT/LBS.	CUBIC FT.	LIST PRICE	HP ADD
		D x W x H					
5 foot	self edge	GRT5	30 x 60 x 29	125	88	13	\$1263 \$634
	bullnose edge	GRT5BN	30 x 60 x 29	125	88	13	\$1263 \$634
	T-mold edge	GRT5TM	30 x 60 x 29	125	88	13	\$1263 \$634
	built-up self edge	GRT5BU	30 x 60 x 29	125	91	14	\$1410 \$708
6 foot	self edge	GRT6	36 x 72 x 29	125	111	15	\$1407 \$705
	bullnose edge	GRT6BN	36 x 72 x 29	125	119	15	\$1407 \$705
	T-mold edge	GRT6TM	36 x 72 x 29	125	119	15	\$1407 \$705
	built-up self edge	GRT6BU	36 x 72 x 29	100	136	16	\$1562 \$782
7 foot	self edge	GRT7	44 x 84 x 29	100	155	17	\$1626 \$814
	bullnose edge	GRT7BN	44 x 84 x 29	100	155	17	\$1626 \$814
	T-mold edge	GRT7TM	44 x 84 x 29	100	155	17	\$1626 \$814
	built-up self edge	GRT7BU	44 x 84 x 29	100	158	19	\$1821 \$912
8 foot	self edge	GRT8W	48 x 96 x 29	100	178	19	\$1626 \$814
	bullnose edge	GRT8WBN	48 x 96 x 29	100	180	19	\$1626 \$814
	T-mold edge	GRT8WTM	48 x 96 x 29	100	178	19	\$1626 \$814
	built-up self edge	GRT8WBU	48 x 96 x 29	100	204	21	\$1821 \$912
10 foot	self edge	GRT10W	48 x 120 x 29	300	39	21	\$2258 \$1131
	bullnose edge	GRT10WBN	48 x 120 x 29	92.5	231	21	\$2258 \$1131
	T-mold edge	GRT10WTM	48 x 120 x 29	92.5	221	21	\$2258 \$1131
	built-up self edge	GRT10WBU	48 x 120 x 29	92.5	254	23	\$2526 \$1264
12 foot	self edge	GRT12W	48 x 144 x 29	92.5	271	23	\$2541 \$1272
	bullnose edge	GRT12WBN	48 x 144 x 29	92.5	268	23	\$2541 \$1272
	T-mold edge	GRT12WTM	48 x 144 x 29	92.5	268	23	\$2541 \$1272
	built-up self edge	GRT12WBU	48 x 144 x 29	92.5	301	25.90	\$2832 \$1419
14 foot	self edge	GRT14W	48 x 168 x 29	100	326	34	\$2914 \$1460
	bullnose edge	GRT14WBN	48 x 168 x 29	100	326	34	\$2914 \$1460
	T-mold edge	GRT14WTM	48 x 168 x 29	100	326	34	\$2914 \$1460
	built-up self edge	GRT14WBU	48 x 168 x 29	100	332	38	\$3220 \$1612
16 foot	self edge	GRT16W	48 x 192 x 29	100	367	38	\$3044 \$1524
	bullnose edge	GRT16WBN	48 x 192 x 29	100	367	38	\$3044 \$1524
	T-mold edge	GRT16WTM	48 x 192 x 29	100	367	38	\$3044 \$1524
	built-up self edge	GRT16WBU	48 x 192 x 29	100	368	40	\$3297 \$1651
18 foot	self edge	GRT18W	48 x 216 x 29	92.5	408	40	\$3627 \$1816
	bullnose edge	GRT18WBN	48 x 216 x 29	92.5	408	40	\$3627 \$1816
	T-mold edge	GRT18WTM	48 x 216 x 29	92.5	408	40	\$3627 \$1816
	built-up self edge	GRT18WBU	48 x 216 x 29	100	416	42	\$4044 \$2025
20 foot	self edge	GRT20W	48 x 240 x 29	92.5	449	42	\$3756 \$1880
	bullnose edge	GRT20WBN	48 x 240 x 29	92.5	449	42	\$3756 \$1880
	T-mold edge	GRT20WTM	48 x 240 x 29	92.5	449	42	\$3756 \$1880
	built-up self edge	GRT20WBU	48 x 240 x 29	92.5	457	44	\$4167 \$2086
22 foot	self edge	GRT22W	48 x 264 x 29	92.5	489	44	\$4140 \$2073
	bullnose edge	GRT22WBN	48 x 264 x 29	92.5	489	44	\$4140 \$2073
	T-mold edge	GRT22WTM	48 x 264 x 29	92.5	489	44	\$4140 \$2073
	built-up self edge	GRT22WBU	48 x 264 x 29	92.5	497	46	\$4662 \$2332
24 foot	self edge	GRT24W	48 x 288 x 29	92.5	531	46	\$4268 \$2135
	bullnose edge	GRT24WBN	48 x 288 x 29	92.5	531	46	\$4268 \$2135
	T-mold edge	GRT24WTM	48 x 288 x 29	92.5	531	46	\$4268 \$2135
	built-up self edge	GRT24WBU	48 x 288 x 29	92.5	540	48	\$4772 \$2387

- All tops over 144" are standard in two pieces. Woodgrain laminate finishes will NOT align where the two tops join.
- All tops 120", 144", and 168" are SHIPPED WITH 3 LEG BASES.
- All tops 192" are SHIPPED WITH 4 LEG BASES.
- All tops 216", 240", 264" and 288" are SHIPPED WITH 6 LEG BASES.

Required Specifications

Top finish
Base finish
Edge color, if applicable

Optional Specifications

Grommet
HP laminate

Accessories

Power Block

B BOARDROOM TABLES

RACETRACK TOP - TUBULAR BASE



		MODEL#	DIMENSIONS	FREIGHT CLASS	WT/LBS.	CUBIC FT.	LIST PRICE	HP ADD
		D x W x H						
5 foot	self edge	GRT5R	30 x 60 x 29	150	94	21	\$1303	\$654
	bullnose edge	GRT5RBN	30 x 60 x 29	150	94	21	\$1303	\$654
	T-mold edge	GRT5RTM	30 x 60 x 29	150	94	21	\$1303	\$654
	built-up self edge	GRT5RBU	30 x 60 x 29	150	97	23	\$1454	\$731
6 foot	self edge	GRT6R	36 x 72 x 29	150	107	23	\$1447	\$725
	bullnose edge	GRT6RBN	36 x 72 x 29	150	107	23	\$1447	\$725
	T-mold edge	GRT6RTM	36 x 72 x 29	150	107	23	\$1447	\$725
	built-up self edge	GRT6RBU	36 x 72 x 29	150	117	25	\$1610	\$806
7 foot	self edge	GRT7R	44 x 84 x 29	125	161	25	\$1667	\$834
	bullnose edge	GRT7RBN	44 x 84 x 29	125	161	25	\$1667	\$834
	T-mold edge	GRT7RTM	44 x 84 x 29	125	161	25	\$1667	\$834
	built-up self edge	GRT7RBU	44 x 84 x 29	125	164	27	\$1865	\$933
8 foot	self edge	GRT8WR	48 x 96 x 29	125	175	27	\$1667	\$834
	bullnose edge	GRT8WRBN	48 x 96 x 29	125	177	27	\$1667	\$834
	T-mold edge	GRT8WRTM	48 x 96 x 29	125	175	27	\$1667	\$834
	built-up self edge	GRT8WRBU	48 x 96 x 29	125	176	29	\$1865	\$933
10 foot	self edge	GRT10WR	48 x 120 x 29	125	221	29	\$2281	\$1142
	bullnose edge	GRT10WRBN	48 x 120 x 29	125	221	29	\$2281	\$1142
	T-mold edge	GRT10WRTM	48 x 120 x 29	125	221	29	\$2281	\$1142
	built-up self edge	GRT10WRBU	48 x 120 x 29	125	239	32	\$2560	\$1281
12 foot	self edge	GRT12WR	48 x 144 x 29	100	270	31	\$2570	\$1287
	bullnose edge	GRT12WRBN	48 x 144 x 29	100	270	31	\$2570	\$1287
	T-mold edge	GRT12WRTM	48 x 144 x 29	100	270	30.9	\$2570	\$1287
	built-up self edge	GRT12WRBU	48 x 144 x 29	100	301	34	\$2869	\$1436
14 foot	self edge	GRT14WR	48 x 168 x 29	125	330	50	\$2952	\$1479
	bullnose edge	GRT14WRBN	48 x 168 x 29	125	330	50	\$2952	\$1479
	T-mold edge	GRT14WRTM	48 x 168 x 29	125	330	50	\$2952	\$1479
	built-up self edge	GRT14WRBU	48 x 168 x 29	125	326	54	\$3260	\$1631
16 foot	self edge	GRT16WR	48 x 192 x 29	125	371	54	\$3082	\$1542
	bullnose edge	GRT16WRBN	48 x 192 x 29	125	371	54	\$3082	\$1542
	T-mold edge	GRT16WRTM	48 x 192 x 29	125	371	54	\$3082	\$1542
	built-up self edge	GRT16WRBU	48 x 192 x 29	125	377	58	\$3384	\$1695
18 foot	self edge	GRT18WR	48 x 216 x 29	125	412	56	\$3651	\$1827
	bullnose edge	GRT18WRBN	48 x 216 x 29	125	412	56	\$3651	\$1827
	T-mold edge	GRT18WRTM	48 x 216 x 29	125	412	56	\$3651	\$1827
	built-up self edge	GRT18WRBU	48 x 216 x 29	125	419	60	\$4077	\$2042
20 foot	self edge	GRT20WR	48 x 240 x 29	125	453	58	\$3780	\$1894
	bullnose edge	GRT20WRBN	48 x 240 x 29	125	453	58	\$3780	\$1894
	T-mold edge	GRT20WRTM	48 x 240 x 29	125	453	58	\$3780	\$1894
	built-up self edge	GRT20WRBU	48 x 240 x 29	125	461	62	\$4214	\$2108
22 foot	self edge	GRT22WR	48 x 264 x 29	100	493	60	\$4206	\$2104
	bullnose edge	GRT22WRBN	48 x 264 x 29	100	493	60	\$4206	\$2104
	T-mold edge	GRT22WRTM	48 x 264 x 29	100	493	60	\$4206	\$2104
	built-up self edge	GRT22WRBU	48 x 264 x 29	125	501	64	\$4697	\$2352
24 foot	self edge	GRT24WR	48 x 288 x 29	100	535	62	\$4338	\$2171
	bullnose edge	GRT24WRBN	48 x 288 x 29	100	535	62	\$4338	\$2171
	T-mold edge	GRT24WRTM	48 x 288 x 29	100	535	62	\$4338	\$2171
	built-up self edge	GRT24WRBU	48 x 288 x 29	100	544	66	\$4821	\$2413

- All tops over 144" are standard in two pieces. Woodgrain laminate finishes will NOT align where the two tops join.
- All tops 120", 144", and 168" are SHIPPED WITH 3 TUBULAR BASES.
- All tops 192" are SHIPPED WITH 4 TUBULAR BASES.
- All tops 216", 240", 264" and 288" are SHIPPED WITH 6 TUBULAR BASES.

Required Specifications

Top finish
Base finish
Edge color, if applicable

Optional Specifications

Grommet
HP laminate

Accessories

Power Block

BUNGEE™ TABLES



Bungee is a series of freestanding tables and accessories designed for classrooms, training rooms, boardrooms and any other multi-functional space that may require frequent configurations. Tables are sold complete with legs and Bungee cords so they may quickly and easily be connected together without searching for tools or worrying about loose parts.

Bungee tables feature rounded corners with a unique “bubble molding” that is engineered to compress under the tension of the Bungee cords. The compressed molding creates a seal that serves to locate and align interconnected tables while also providing a soft and forgiving edge.

Choose from a variety of top shapes and laminate finishes to create your individual style. In addition, most tables offer a choice of tapered legs or spider legs in a Tungsten or Black finish with adjustable levelers or optional casters. Optional modesty panels, grommets, wire management and power blocks further enhance your workspace.



Flip-Top tables can be nested and easily stored by activating the single hand release mechanism from the left or right side.

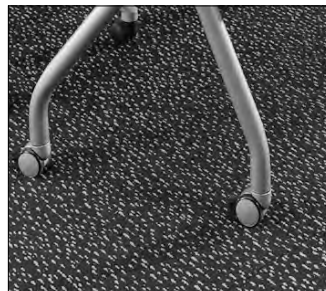

Optional locking casters are available in Tungsten or Black (standard on Flip-Top models).

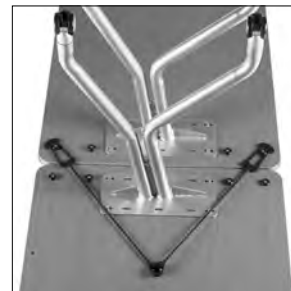

Bungee cords are utilized to quickly and easily reconfigure tables

Features and Benefits

- Bungee tables are complete with Top, Legs and Bungee cords
- Bungee cords provide a fast and easy method of reconfiguring tables without requiring a tool
- Tops are 1” thick and are offered in a variety of shapes and sizes
- Legs are offered in tapered or spider design in a Tungsten or Black finish.
- Levelers on legs are standard.
- Laminate modesty panels and filler modesty inserts help conceal wires and enhance visual appeal
- Wire management tracks neatly contain wires, using two separate channels for data and voice wires
- Optional grommets or power blocks offer technological flexibility
- Models with handles feature a bow handle in Silver or Black Nickel finish
- Metal feet are height adjustable and offered in Black or Tungsten finish
- Boardrooms were never easier to specify - table “sets” and accessories such as AV Cabinets and Credenza Buffets are specified with one model number

B BUNGEE™ TABLES - NOTES

GENERAL INFORMATION

- Bungee is a series of freestanding tables and accessories designed for classrooms, training rooms, boardrooms and any other multifunctional space that requires frequent reconfigurations.
- Bungee tables come complete with a work top, a set of legs and built-in Bungee cord connectors
- Bungee cords allow the movement and reconfiguration of tables without a risk of damage or losing loose parts
- High pressure tops are available in all Bungee laminate finishes at an extended lead time - please see model # for pricing.
- Unique “bubble molding” edging is specially engineered to create a secure seal to align interconnected tables.
- Bungee products have been tested and comply with all mechanical tests.
- For environmental certifications, please visit globalfurnituregroup.com

CONSTRUCTION

- Tops are 1” thick. Modesty panels are 11/16” thick.
- All components are made of 45 lb. commercial density particle board, covered on both sides with high performance, thermally fused laminate.
- Tops 54” and over feature a built-in support bar.
- Products specified with the high pressure laminate option are finished on the underside of the surface with a kraft paper backing.

w

BUNGEE CORDS

- Bungee cords are patented elastic devices designed to provide a rapid, no-tool method of attaching tables of the same depth.
- The elastic nature of cords allows two connected tables to be moved around without risk of damage to the table top or connecting hardware.
- Bungee cords are included with all freestanding tables and carry a lifetime warranty.

EDGE DETAIL

- Bungee comes with a choice of four edge styles (check model for edge availability):



A3 - square corner, standard edge



AR - square corner, bicut edge



AS - square corner, Silver



AB - square corner, Black



BS - rounded corner, Silver



BB - rounded corner, Black

- **BB/BS** - Bungee Bubble Edge: unique “bubble” molding is engineered to compress under the tension of the Bungee cords, creating a seal that serves to locate and align interconnected tables.
- **AB/AS** - Split color PVC edge: edge matches split color aesthetic of the bubble edge, but allows for 90 degree corners and a cleaner look.
- **A3** - Global’s preferred edge. Coordinates well with Adaptabilities and Zira 1” tops.
- **AR** - Bicut edge. Coordinates well with Zira 1” tops.
- **NOTE:** Trapezoid tables can only be specified with Bubble Edge (Rounded Corners).
- **NOTE:** Boardroom Table sets allow for all edge types but **ONLY** with rounded corners (when AS/AB/A3/AR are selected, the table will be produced with rounded corners).

LEGS

- Tables feature two styles of legs - Tapered leg or Spider leg. Legs on fixed tables offer glides or casters. Adjusts 3mm-10mm in height.
- For legs and glides in Tungsten, specify (**TTU**).
- For legs and glides in Black, specify (**TBL**).
- For legs and casters in Tungsten, specify (**TTC**).
- For legs and casters in Black, specify (**TBC**).



Tapered Leg



Spider Leg

HANDLES

- Metal handles are standard on all drawers and doors. Handles are offered in two finishes: Silver (**HS**) or Black Nickel (**HT**), please specify
- Handle finish will match leg finish.



bow handle, Silver finish (**HS**)



bow handle, Black Nickel finish (**HT**)

FEET

- Metal feet are standard on all cabinets. Feet adjust 3/4” in height.
- Feet are available in Tungsten Finish (**TTU**) or Black Finish (**BLK**).



TTU - Tungsten



BLK - Black Nickel

MODESTY PANELS

- Panels are 9.5” high, recessed 3/4” from the back and inset 7” from the sides.
- Available in all Bungee laminate finishes.
- Edge available in Silver finish (**SI**) or Black finish (**BK**). Please specify.

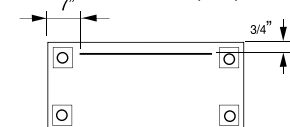
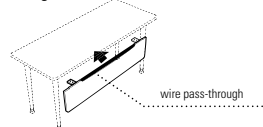

FILLER MODESTY PANELS

- Used to fill the space between two modesty panels when two tables are linked together. Helps conceal wires and enhance visual appeal.
- Reversible - Black on one side, Silver on the other.

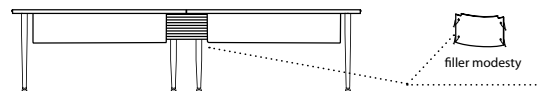

WIRE MANAGEMENT

- Wire management tracks are mounted to the underside of the worksurface. Available in 5” and 22” track lengths.
- 5” track includes one wire clamp; 22” track includes two wire clamps.
- Data and voice wires can be routed separately using two separate channels on each clamp.
- Available in Black only.

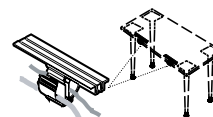

5” Wire Management Track

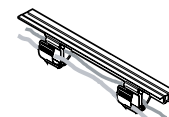

22” Wire Management Track

1. SPECIFY MODEL NUMBER

2. SPECIFY FINISH

LAMINATE FINISHES

ACJ	Absolute Acajou	FCL	First Class
ASN	Asian Night	NBL	Noce Biondo
AWC	Avant Cherry	NGL	Noce Grigio
AWH	Avant Honey	NEL	Noce Leggero
BLK	Black	NML	Noce Medio
BZD	Blizzard	QTM	Quartered Mahogany
BRC	Brushed Cobalt	SBY	Sheer Beauty
CMB	Clear Maple	SOG	Storm Grey
CGY	Custom Grey	SDT	Stonedust
DES	Dark Espresso	WHE	Walnut Heights
DWT	Designer White	WHC	White Chocolate
FAS	Fashionista	WCR	Winter Cherry

Edge:

BB	Bungee bubble edge with Black trim
BS	Bungee bubble edge with Silver trim
AB	Split color edge with Black trim
AS	Split color edge with Silver trim
A3	Matching edge
AR	Matching bicut edge

Legs with Glides:

TBL	Black
TTU	Tungsten

Legs with Casters:

TBC	Black
TTC	Tungsten

Handles:

HS	Silver
HT	Black Nickel

Modesty Panel Edge:

SI	Silver
BK	Black Nickel

Feet:

BLK	Black Nickel	TTU	Tungsten
-----	--------------	-----	----------

3. SPECIFY OPTIONS

GROMMETS

- Optional Grommets available in standard worksurface locations (left, center or right) for **Rectangular Tops 48" and up**. Order as: **AG1, AG2 or AG3 - Add \$96**
- Additional grommets are available in **center position only** for **Rectangular Tops (36", 42" and 48") and Trapezoid Tables**. Order as **AG2 - Add \$96**.
- Grommet hole dimensions are 3 1/4" wide x 1 7/8" deep.
- Grommets may be placed at non-standard locations. Order as: **AGS - Add \$96**. A drawing must be supplied with vertical and horizontal dimensions to the center of the cut-out (as in drawing above). Please refer to CUSTOM GROMMET LOCATION FORM in the back reference section.

Grommet hole dimensions

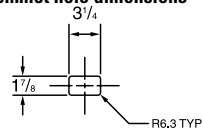

Grommet

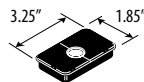

Rectangular Tops

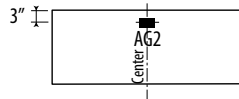

For 36" and 42" wide units

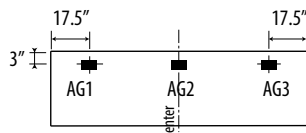

For 48", 60" and 72" wide units



Trapezoid Tables

Grommet Location - AG2...Add \$96

POWER BLOCK

- A Power Block is a rectangular worksurface power/data module with one electrical duplex receptacle and two data (RJ45) receptacles. 9' black cord included. Power Block dimensions are 3 1/2" deep x 6 1/2" wide x 2 3/4" high.
- A Power Block (model **PMSPDM**) may be ordered for **Rectangular Tables 60" and up** in place of standard grommets. Order as **E1, E2 or E3 - Add \$96**.
- Additional Power Blocks are available in **center position only** for **Rectangular Tops (36", 42" and 48") and Trapezoid Tables**. Order as **E2 - Add \$96**.
- To purchase a Power Block, you must specify both the Power Block cut-out location and the Power Block model #. Order Power Block as **PMSPDM, Add \$330**.
- Power Blocks are available in standard worksurface locations (left, center or right). Order as **E1, E2 or E3. Add \$96**.
- See above for examples of placement.**



Power Block **PMSPDM** Add \$330

Rectangular Tops

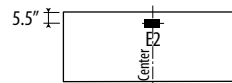

For 36", 42" and 48" wide units

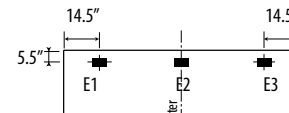

For 60" and 72" wide units

VILLA CUTOUTS

- Optional Villa cutout available in standard worksurface locations (left, center or right) for **Rectangular Tables 60" and up**. Order as: **V1, V2 or V3 - Add \$96 for each cutout**.
- Additional power block cutouts are available in **center position only** for **Rectangular Tops (36", 42" and 48") and Trapezoid Tables**. Order as **V2 - Add \$96**.
- Villa cutouts may be placed at non-standard locations. Please contact customer care.
- To purchase a Villa Power Block, you must specify both the Villa Power Block cutout location and the Power Block model #. Please see page 475 for Villa models.

Rectangular Tops

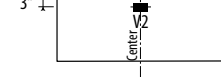

For 36", 42" and 48" wide units

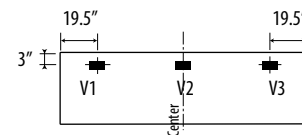

For 60" and 72" wide units

MODPOWER DAISY CHAIN SOLUTION

- Add flexible power and USB charging to Bungee rectangular tables. Connect up to four units with a single corded infeed with NEMA plug.
- ModPower units are sold separately, refer to Productivity Solutions page 465.
- Begin run with a starter unit which includes a corded infeed. Add additional middle or end units as required. Middle and end units are equipped with connecting cables.
- On-surface modules clamp on or screw mount to the table tops.
- In-surface modules require table top cut-outs for mounting. Specify cut-out option:
 - **MPS** for a single cut-out to accommodate one ModPower in-surface unit (cut-out will be centered on the approach side) for **42" to 72" wide non-flip tables and 48" to 72" wide flip tables. Add \$96**
 - **MPD** for two cut-outs in the left and right positions, 18.25" from ends to center of unit on approach side for **60", 66" and 72" wide rectangular tables. Add \$192.**

B BUNGEE™ TABLES

CONNECTING CONDITIONS

- Bungee cords allow for fast and easy reconfiguring of tables whenever needed. Due to the elastic nature of the Bungee cord, two tables connected with Bungee cords can be moved around without risk of damage to the table top or the connecting hardware.
- Connecting tables is simple and intuitive. Tools are not required and there are no loose parts that may be misplaced.
- Bungee cords connect tables of the same depth in all directions.
- Rectangular Tables 48" and longer connect in both Straight and "L" configurations. Rectangular Tables 36" and 42" connect in Straight configurations only.

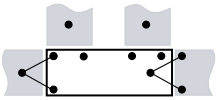
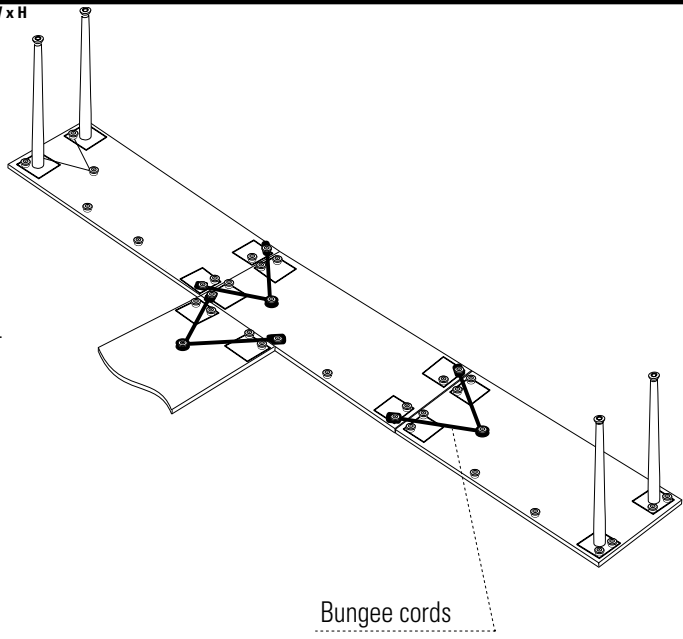

Rectangular Tables

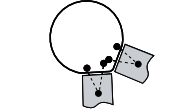

Round Wedge Tables

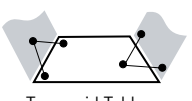

Trapezoid Tables

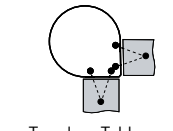

Teardrop Tables

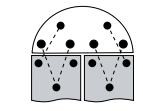

Half Moon Tables

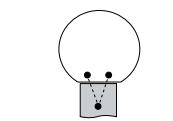

Flat Round Tables

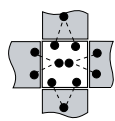

Square Tables



Keystone Tables

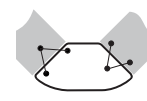

Wedge Tables

SAMPLE TABLE CONFIGURATIONS

- The following table configurations can be created using Bungee Boardroom Table Sets only.

Meeting/Boardroom Table

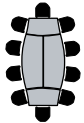

Meeting/Boardroom Table



Training

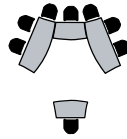

Lecture / AV Presentations

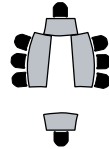

Small Teaming Stations



Large Teaming Stations



Meeting/Boardroom Table

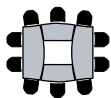

Training

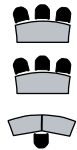

FLIP TOP TABLE NESTING DIAGRAM

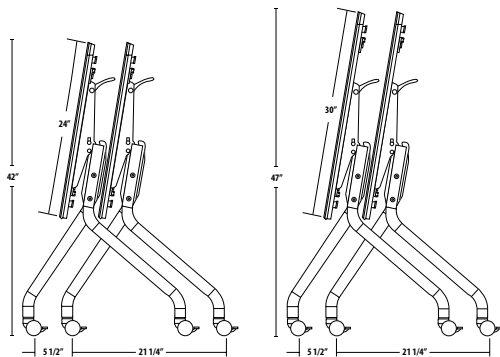

RECTANGULAR TABLES

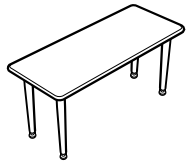
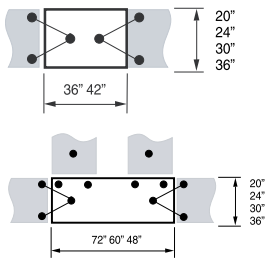

Rectangular Table - Tapered Legs

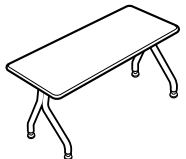
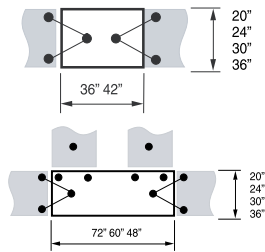

Rectangular Table - Spider Legs

MODEL#	DIMENSIONS D x W x H	FREIGHT CLASS	WT/LBS.	CUBIC FT.	LIST PRICE	HP ADD
B2036REF	20 x 36 x 28.7	92.5	59	5.26	\$874	\$178
B2042REF	20 x 42 x 28.7	92.5	62	5.76	\$906	\$236
B2048REF	20 x 48 x 28.7	92.5	67	6	\$940	\$236
B2060REF	20 x 60 x 28.7	92.5	74	7	\$1064	\$324
B2072REF	20 x 72 x 28.7	92.5	81	7.26	\$1167	\$367
B2436REF	24 x 36 x 28.7	92.5	65	5.76	\$925	\$178
B2442REF	24 x 42 x 28.7	92.5	69	6	\$956	\$236
B2448REF	24 x 48 x 28.7	92.5	72	6.5	\$988	\$236
B2460REF	24 x 60 x 28.7	92.5	82	7.26	\$1141	\$353
B2472REF	24 x 72 x 28.7	92.5	91	8	\$1232	\$548
B3036REF	30 x 36 x 28.7	100	70	7.26	\$913	\$332
B3042REF	30 x 42 x 28.7	92.5	78	7.5	\$956	\$367
B3048REF	30 x 48 x 28.7	92.5	81	7.5	\$982	\$353
B3060REF	30 x 60 x 28.7	92.5	92	8.26	\$1141	\$441
B3072REF	30 x 72 x 28.7	92.5	102	9	\$1250	\$548
B3642REF	36 x 42 x 28.7	150	83	15	\$1048	\$353
B3648REF	36 x 48 x 28.7	92.5	91	8	\$1150	\$334
B3660REF	36 x 60 x 28.7	92.5	103	9	\$1250	\$415
B3672REF	36 x 72 x 28.7	92.5	116	10	\$1397	\$526

Freestanding table includes four tapered legs with levellers and Bungee cords. Each table can be "Bungee-tied" to other tables of the same depth. Shipped RTA (ready to assemble). Modesty panels available, see page 521.

- **Tables 48" and longer connect in both Straight and "L" configurations**
- **Tables 36" and 42" connect in Straight configurations only.**
- Available with optional locking casters, specify option "TBC" or "TTC".

B2036RES	20 x 36 x 28.7	100	57	6.76	\$982	\$178
B2042RES	20 x 42 x 28.7	100	60	7.26	\$1015	\$236
B2048RES	20 x 48 x 28.7	100	65	7.5	\$1048	\$236
B2060RES	20 x 60 x 28.7	100	72	8.5	\$1181	\$324
B2072RES	20 x 72 x 28.7	100	79	8.76	\$1290	\$367
B2436RES	24 x 36 x 28.7	100	62	7.26	\$1039	\$178
B2442RES	24 x 42 x 28.7	150	64	15	\$1064	\$236
B2448RES	24 x 48 x 28.7	125	71	10	\$1105	\$236
B2460RES	24 x 60 x 28.7	125	80	10.76	\$1250	\$353
B2472RES	24 x 72 x 28.7	125	89	11.26	\$1354	\$548
B3036RES	30 x 36 x 28.7	125	72	10.26	\$1064	\$332
B3042RES	30 x 42 x 28.7	125	80	10.5	\$1097	\$367
B3048RES	30 x 48 x 28.7	125	83	10.5	\$1132	\$404
B3060RES	30 x 60 x 28.7	100	94	11.26	\$1290	\$404
B3072RES	30 x 72 x 28.7	100	104	12	\$1383	\$549

Freestanding table includes two spider legs with levellers and Bungee cords. Each table can be "Bungee-tied" to other tables of the same depth. Shipped RTA (ready to assemble). Modesty panels available, see page 521.

- **Tables 48" and longer connect in both Straight and "L" configurations**
- **Tables 36" and 42" connect in Straight configurations only.**
- Available with optional locking casters, specify option "TBC" or "TTC".

Required Specifications

Top finish
Edge
Leg finish

Optional Specifications

Casters
Grommet
Modesty Panel
High Pressure Laminate

Accessories

Power Block

B BUNGEE™ TABLES

TRAPEZOID TABLES

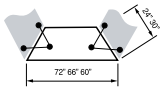

Trapezoid Table - Tapered Legs

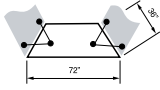
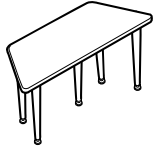

Trapezoid Table - Tapered Legs

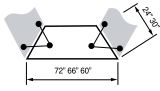
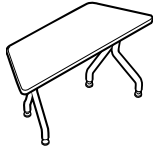

Trapezoid Table - Spider Legs

MODEL#	DIMENSIONS	FREIGHT CLASS	WT/LBS.	CUBIC FT.	LIST PRICE	HP ADD
--------	------------	---------------	---------	-----------	------------	--------

D x W x H						
B2460TRF	24 x 60 x 28.7	100	71	7.5	\$1048	\$353
B2466TRF	24 x 66 x 28.7	100	74	8	\$1075	\$548
B2472TRF	24 x 72 x 28.7	100	78	8.26	\$1155	\$548
B3060TRF	30 x 60 x 28.7	100	78	8.5	\$1120	\$404
B3066TRF	30 x 66 x 28.7	100	81	9.5	\$1167	\$548
B3072TRF	30 x 72 x 28.7	100	85	9.5	\$1240	\$548

Freestanding table includes four tapered legs with levelers and Bungee cords. Each table can be "Bungee-tied" to other tables of the same depth. Shipped RTA (ready to assemble). Modesty panels available, see page 521.

- Available with bubble edge (BB or BS) only.

B3672TRF	36 x 72 x 28.7	100	91	10.5	\$1431	\$526
----------	----------------	-----	----	------	---------------	--------------

Freestanding table includes five tapered legs with levelers and Bungee cords. Each table can be "Bungee-tied" to other tables of the same depth. Shipped RTA (ready to assemble). Modesty panels available, see page 521.

- Available with bubble edge (BB or BS) only.
- Available with optional locking casters, specify option "TBC" or "TTC".

B2060TRS	20 x 60 x 28.7	125	67	8.76	\$1132	\$324
B2066TRS	20 x 66 x 28.7	125	68	9	\$1167	\$367
B2072TRS	20 x 72 x 28.7	125	74	9.26	\$1213	\$367
B2460TRS	24 x 60 x 28.7	125	69	9.26	\$1167	\$353
B2466TRS	24 x 66 x 28.7	125	72	9.76	\$1213	\$548
B2472TRS	24 x 72 x 28.7	125	76	10	\$1264	\$548
B3060TRS	30 x 60 x 28.7	125	79	11.5	\$1254	\$404
B3066TRS	30 x 66 x 28.7	125	83	12.5	\$1301	\$548
B3072TRS	30 x 72 x 28.7	125	87	12.5	\$1372	\$548

Freestanding table includes two spider legs with levelers and Bungee cords. Each table can be "Bungee-tied" to other tables of the same depth. Shipped RTA (ready to assemble). Modesty panels available, see page 521.

- Available with bubble edge (BB or BS) only.
- Available with optional locking casters, specify option "TBC" or "TTC".

KEYSTONE TABLES

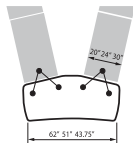
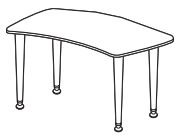

Keystone Table - Tapered Legs

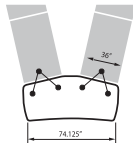
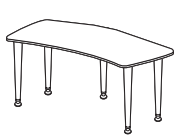

Keystone Table - Tapered Legs

B30KSF	30 x 62 x 28.7	150	69	15.2	\$1112	\$441
B24KSF	24 x 51 x 28.7	150	60	13	\$1029	\$296
B20KSF	20 x 43.75 x 28.7	150	58	13	\$1016	\$236

Freestanding table includes four tapered legs with levelers and Bungee cords. Each table can be "Bungee-tied" to other tables of 24" and 30" depth. Shipped RTA (ready to assemble). Modesty panels or Filler Modestys are NOT available.

B36KSF	36 x 74.13 x 28.7	150	84	16.8	\$1373	\$621
--------	-------------------	-----	----	------	---------------	--------------

Freestanding table includes five tapered legs with levelers and Bungee cords. Each table can be "Bungee-tied" to other tables of 24" and 30" depth. Shipped RTA (ready to assemble). Modesty panels or Filler Modestys are NOT available.

Required Specifications

Top finish
Edge
Leg finish

Optional Specifications

Grommet
Casters
Modesty panel (Trapezoid Tables only)
HP laminate

Accessories

Power block

KEYSTONE TABLES

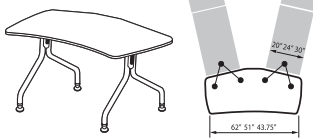

Keystone Table - Spider Legs

MODEL#	DIMENSIONS D x W x H	FREIGHT CLASS	WT/LBS.	CUBIC FT.	LIST PRICE	HP ADD
B30KSS	30 x 62 x 28.7	150	77	15.2	\$1298	\$439
B24KSS	24 x 51 x 28.7	150	66	13	\$1208	\$274
B20KSS	20 x 43.75 x 28.7	150	64	13	\$1187	\$236

Freestanding table includes two spider legs with levelers and Bungee cords. Each table can be "Bungee-tied" to other tables of 24" and 30" depth. Shipped RTA (ready to assemble). Modesty panels or Filler Modestys are NOT available.

- Available with optional locking casters, specify option "TBC" or "TTC".

WEDGE TABLES

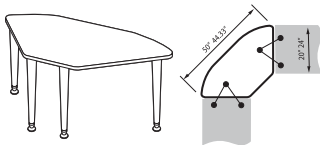

Wedge Table - Tapered Legs

B24WEF	24 x 63 x 28.7	150	54	13.2	\$1076	\$295
B20WEF	20 x 57 x 28.7	150	46	10.2	\$985	\$236

Freestanding table includes four tapered legs with levelers and Bungee cords. Each table can be "Bungee-tied" to other tables of the same depth. Shipped RTA (ready to assemble). Modesty panels are NOT available.

- Available with optional locking casters, specify option "TBC" or "TTC".

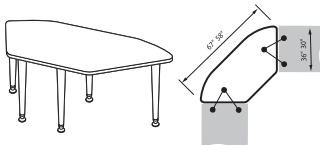

Wedge Table - Tapered Legs

B36WEF	36 x 80 x 28.7	150	84	18.8	\$1465	\$526
B30WEF	30 x 70 x 28.7	150	70	14.4	\$1298	\$367

Freestanding table includes five tapered legs with levelers and Bungee cords. Each table can be "Bungee-tied" to other tables of the same depth. Shipped RTA (ready to assemble). Modesty panels are NOT available.

- Available with optional locking casters, specify option "TBC" or "TTC".

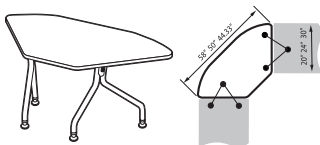

Wedge Table - Spider Legs

B30WES	30 x 70 x 28.7	150	73	14.4	\$1286	\$370
B24WES	24 x 63 x 28.7	150	62	13.2	\$1201	\$295
B20WES	20 x 57 x 28.7	150	52	10.2	\$1112	\$236

Freestanding table includes two spider legs with levelers and Bungee cords. Each table can be "Bungee-tied" to other tables of the same depth. Shipped RTA (ready to assemble). Modesty panels are NOT available.

- Available with optional locking casters, specify option "TBC" or "TTC".

HALF MOON TABLES

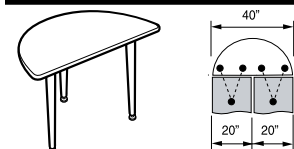

Half Moon Table - Tapered Legs

B2040HMF	20 x 40 x 28.7	100	49	6	\$692	\$236
----------	----------------	-----	----	---	--------------	--------------

Freestanding table includes three tapered legs with levelers and Bungee cords. Each table can be "Bungee-tied" to other tables of the same depth. Shipped RTA (ready to assemble). Modesty panels or Filler Modestys are NOT available.

- Available with optional locking casters, specify option "TBC" or "TTC".

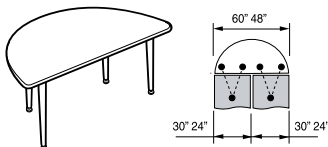

Half Moon Table - Tapered Legs

B2448HMF	24 x 48 x 28.7	100	69	7.76	\$900	\$236
B3060HMF	30 x 60 x 28.7	100	81	8.5	\$956	\$404

Freestanding table includes four tapered legs with levelers and Bungee cords. Each table can be "Bungee-tied" to other tables of the same depth. Shipped RTA (ready to assemble). Modesty panels or Filler Modestys are NOT available.

- Available with optional locking casters, specify option "TBC" or "TTC".

Required Specifications

Top finish
Edge
Leg finish

Optional Specifications

Casters
HP laminate

Accessories

Power Block (position 2 only)

B BUNGEE™ TABLES

HALF MOON TABLES

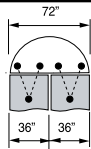
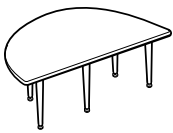

Half Moon Table - Tapered Legs

MODEL#	DIMENSIONS D x W x H	FREIGHT CLASS	WT./LBS.	CUBIC FT.	LIST PRICE	HP ADD
B3672HMF	36 x 72 x 28.7	100	110	11.5	\$1346	\$526

Freestanding table includes five tapered legs with levellers and Bungee cords. Each table can be "Bungee-tied" to other tables of the same depth. Shipped RTA (ready to assemble). Modesty panels or Filler Modestys are NOT available.

- Available with optional locking casters, specify option "TBC" or "TTC".

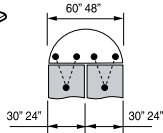
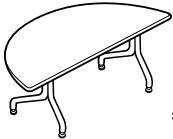

Half Moon Table - Spider Legs

B2448HMS	24 x 48 x 28.7	125	67	9.26	\$1023	\$236
B3060HMS	30 x 60 x 28.7	125	83	11.5	\$1097	\$404

Freestanding table includes two spider legs with levellers and Bungee cords. Each table can be "Bungee-tied" to other tables of the same depth. Shipped RTA (ready to assemble). Modesty panels or Filler Modestys are NOT available.

- Available with optional locking casters, specify option "TBC" or "TTC".

SQUARE TABLES

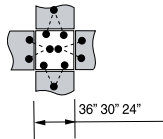
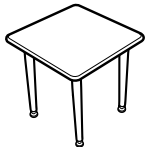

Square Table - Tapered Legs

B2424SQF	24 x 24 x 28.7	92.5	55	4.6	\$856	\$151
B3030SQF	30 x 30 x 28.7	100	65	7.5	\$874	\$223
B3636SQF	36 x 36 x 28.7	100	78	8	\$999	\$265

Freestanding table includes four tapered legs with levellers and Bungee cords. Each table can be "Bungee-tied" to other tables of the same depth. Shipped RTA (ready to assemble). Modesty panels available, see page 521.

- Available with optional locking casters, specify option "TBC" or "TTC".

ROUND WEDGE TABLES

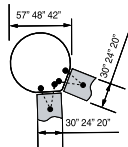

Round Wedge 120° Table

B2042RWF	20 x 42 x 28.7	100	76	8.26	\$956	\$513
B2448RWF	24 x 48 x 28.7	125	85	10.76	\$982	\$513
B3057RWF	30 x 57 x 28.7	100	102	12	\$1167	\$731

Freestanding table includes four tapered legs with levellers and Bungee cords. Each table can be "Bungee-tied" to other tables of the same depth. Shipped RTA (ready to assemble). Modesty panels or Filler Modestys are NOT available.

- Available with bubble edge (BB or BS) only.
- Available with optional locking casters, specify option "TBC" or "TTC".

TEARDROP TABLES

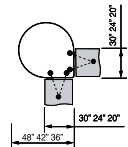

Teardrop 90° Table

B2036TDF	20 x 36 x 28.7	100	71	8	\$900	\$332
B2442TDF	24 x 42 x 28.7	100	81	8.5	\$982	\$513
B3048TDF	30 x 48 x 28.7	100	91	11	\$1079	\$477

Freestanding table includes four tapered legs with levellers and Bungee cords. Each table can be "Bungee-tied" to other tables of the same depth. Shipped RTA (ready to assemble). Modesty panels or Filler Modestys are NOT available.

- Available with bubble edge (BB or BS) only.
- Available with optional locking casters, specify option "TBC" or "TTC".

Required Specifications

Top finish
Edge
Leg finish

Optional Specifications

Casters
High Pressure Laminate

FLAT ROUND TABLES

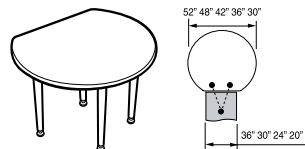

Flat Round Table*

MODEL#	DIMENSIONS D x W x H	FREIGHT CLASS	WT/LBS.	CUBIC FT.	LIST PRICE	HP ADD
B2030FRF	20 x 30 x 28.7	100	56	6	\$874	\$296
B2036FRF	20 x 36 x 28.7	100	66	7.26	\$874	\$332
B2436FRF	24 x 36 x 28.7	100	64	7.26	\$874	\$332
B2442FRF	24 x 42 x 28.7	100	76	8.26	\$1039	\$513
B3042FRF	30 x 42 x 28.7	100	74	8	\$1039	\$513
B3048FRF	30 x 48 x 28.7	100	88	11	\$1039	\$469
B3648FRF	36 x 48 x 28.7	125	85	11	\$1150	\$731
B3652FRF	36 x 52 x 28.7	100	93	11	\$1150	\$731

Freestanding table includes four tapered legs with levellers and Bungee cords. Each table can be "Bungee-tied" to other tables of the same depth. Shipped RTA (ready to assemble). Modesty panels or Filler Modestys are NOT available.

- Available with bubble edge (BB or BS) only.
- Available with optional locking casters, specify option "TBC" or "TTC".

MODESTY PANELS

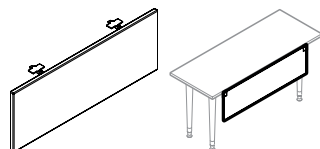

Modesty Panel

BX36QMP	.69 x 21 x 9.6	250	3	1.3	\$114	N/A
BX42QMP	.69 x 27 x 9.6	250	4	1.4	\$120	N/A
BX48QMP	.69 x 33 x 9.6	250	4	1.6	\$127	N/A
BX60QMP	.69 x 45 x 9.6	250	5	2.1	\$138	N/A
BX66QMP	.69 x 51 x 9.6	250	6	2.4	\$144	N/A
BX72QMP	.69 x 57 x 9.6	250	7	2.6	\$151	N/A

For use on **Rectangular** and **Square** Tables. Includes hinged mounting bracket. Available in all Bungee laminate finishes. Edge available in Silver finish (SI) or Black finish (BK).

- Modesty panel model number indicates the width of table to be used on.

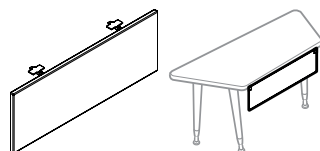

Modesty Panel

BXM60QMP	.69 x 27 x 9.6	300	4	2.1	\$120	N/A
BXM66QMP	.69 x 33 x 9.6	300	4	2.4	\$127	N/A
BXM72QMP	.69 x 39 x 9.6	300	5	2.6	\$132	N/A
BXL60QMP	.69 x 21 x 9.6	300	3	2.1	\$118	N/A
BXL66QMP	.69 x 27 x 9.6	300	4	2.4	\$120	N/A
BXL72QMP	.69 x 33 x 9.6	300	4	2.6	\$127	N/A

For use on **Trapezoid** Tables. Includes hinged mounting bracket. Intended for use on the short side of the table; may be used on long side but leaves a larger gap. Available in all Bungee laminate finishes. Edge available in Silver finish (SI) or Black finish (BK).

- Modesty panel model number indicates the width of table to be used on.
- Specify **BXM** models for 24" D tables and **BXL** models for 30" D tables.

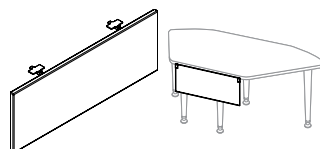

Modesty Panel

BXWQMP	.69 x 27 x 9.6	250	4	1.5	\$120	N/A
--------	----------------	-----	---	-----	--------------	-----

For use on **Wedge** Tables. Includes hinged mounting bracket. Intended for use on the short side of the table. Available in all Bungee laminate finishes. Edge available in Silver finish (SI) or Black finish (BK).

Required Specifications

Top finish
Edge
Leg finish*

Optional Specifications

Casters*
HP laminate*

B BUNGEE™ TABLES

FILLER MODESTY PANELS



Filler Modesty Panel - Straight

MODEL#	DIMENSIONS D x W x H	FREIGHT CLASS	WT/LBS.	CUBIC FT.	LIST PRICE	HP ADD
BSFMS	.25 x 21 x 9	70	1	0.03	\$125	N/A

Used to fill the space between two **square** modesty panels where tables are linked in a straight configuration. Available in Silver (**SI**) or Black (**BK**). Please specify.



Filler Modesty Panel - Straight to Wedge

BSWFM	9 x 19.6 x .25	70	1	1.5	\$135	N/A
-------	----------------	----	---	-----	--------------	-----

Used to fill the space between a straight modesty panel and a wedge table. Use for regular wedge table - tapered legs and flip-top wedge - spider legs. Available in Silver (**SI**) or Black (**BK**). Please specify.

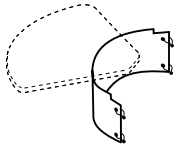

Filler Modesty Panel - Inside Curve

B23IFMS	.06 x 23 x 9	250	3	1.5	\$150	N/A
B29IFMS	.06 x 29 x 9	250	3	1.5	\$150	N/A
B30IFMS	.06 x 30 x 9	70	3	0.15	\$150	N/A

Used to fill the space (inside curve) between two modesty panels where tables are linked at an angle or curve. Use for the inside curve of Round Wedge Tables, Teardrop Tables, or Trapezoid Tables. Available in Silver (**SI**) or Black (**BK**). Please specify.

- Use model **B23IFMS** for Trapezoid Tables inside curve only.
- Use model **B29IFMS** for Teardrop Tables inside curve only.
- Use model **B30IFMS** for Round Wedge Tables inside curve only.

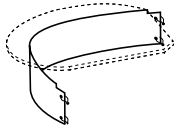

Filler Modesty Panel - Outside Curve

B56S	.06 x 56 x 9	250	4	1.5	\$215	N/A
B62S	.06 x 62 x 9	250	4	1.5	\$233	N/A
B71S	.06 x 71 x 9	250	4	1.5	\$281	N/A

Used to fill the space (outside curve) between two modesty panels where tables are linked at an angle or curve. Use for Teardrop Tables only (**B2036TDF**, **B2442TDF** and **B3048TDF**). Available in Silver (**SI**) or Black (**BK**). Please specify.

- Use model **B56S** for **B2036TDF** Teardrop Tables outside curve only.
- Use model **B62S** for **B2442TDF** Teardrop Tables outside curve only.
- Use model **B71S** for **B3048TDF** Teardrop Tables outside curve only.

Required Specifications

Finish

WIRE MANAGEMENT

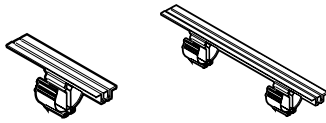

Wire Management - 5" /22" Track

MODEL#	DIMENSIONS D x W x H	FREIGHT CLASS	WT/LBS.	CUBIC FT.	LIST PRICE	HP ADD
BWMS5	2 x 5 x 3.5	70	1	.10	\$17	N/A
BWMD22	2 x 22 x 3.5	70	1	.10	\$24	N/A

Retrofittable track mounts to the underside of worksurface. Includes wire clamp that can route data and voice wires separately. Black only.

- For a 5" track, order model **BWMS5** - includes one wire clamp.
- For a 22" track, order model **BWMD22** - includes two wire clamps.

BOARDROOM TABLE SETS

11 Foot Configurations

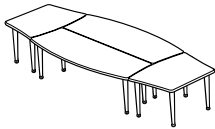

Boardroom Table Set - 11 foot

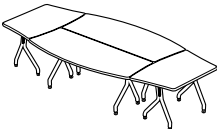

Boardroom Table Set - 11 foot

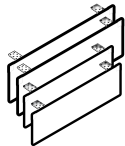

Modesty Panel Set for Boardroom Table

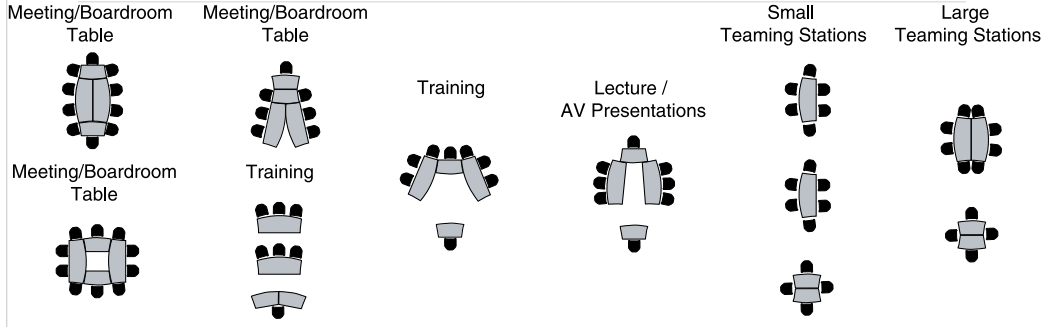

BK132F	60 x 132 x 28.7	70	290	19.25	\$4220	\$1606
--------	-----------------	----	-----	-------	---------------	---------------

Set includes four freestanding tables with **tapered legs** and Bungee cords for tool free ganging. Leg finish or legs with casters optional, see page 514 . Shipped easy to assemble in 6 cartons. Modesty panel set available, order **BXK132QMP**.

- Due to the unique geometry of the tables, all edge types will feature rounded corners.

BK132S	60 x 132 x 28.7	85	290	22.25	\$4735	\$1606
--------	-----------------	----	-----	-------	---------------	---------------

Set includes four freestanding tables with **spider legs** and Bungee cords for tool free ganging. Leg finish or legs with casters optional, see page 514 . Shipped easy to assemble in 6 cartons. Modesty panel set available, order **BXK132QMP**.

- Due to the unique geometry of the tables, all edge types will feature rounded corners.

BXK132QMP	.69 x 45 x 9.6	92.5	13	1.10	\$464	N/A
-----------	----------------	------	----	------	--------------	-----

For use on **11 foot Boardroom Table Set**. Includes mounting bracket and wire access sweep. Available in all Bungee laminate finishes.

Required Specifications

- Top finish
- Edge
- Leg finish

Optional Specifications

- Casters
- Grommet
- Modesty panel
- HP laminate

B BUNGEE™ TABLES

BOARDROOM TABLE SETS

13/15 Foot Configurations

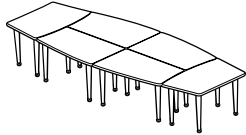

Boardroom Table Set - 13 and 15 foot

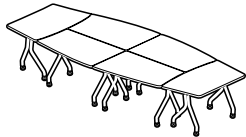

Boardroom Table Set - 13 and 15 foot

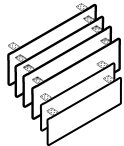

Modesty Panel Set for Boardroom Table

MODEL#	DIMENSIONS D x W x H	FREIGHT CLASS	WT/LBS.	CUBIC FT.	LIST PRICE	HP ADD
Meeting/Boardroom Table	Lecture / AV Presentations	Training			Small Teaming Stations	Large Teaming Stations
Meeting/Boardroom Table	Lecture / AV Presentations	Meeting/Boardroom Table	Training		Small Teaming Stations	
BK156F	60 x 156 x 28.7	85	374	26.25	\$6212	\$2037
BK180F	60 x 180 x 28.7	85	420	29.75	\$6769	\$2327

Set includes six freestanding tables with **tapered legs** and Bungee cords for tool free ganging. Leg finish or legs with casters optional, see page 514 . Shipped easy to assemble in 9 cartons. Modesty panel set available, order **BK156QMP/ BK180QMP**.

- Due to the unique geometry of the tables, all edge types will feature rounded corners.

BK156S	60 x 156 x 28.7	85	374	28.75	\$6409	\$2037
BK180S	60 x 180 x 28.7	85	420	32.50	\$6949	\$2327

Set includes six freestanding tables with **spider legs** and Bungee cords for tool free ganging. Leg finish or legs with casters optional, see page 514 . Shipped easy to assemble in 9 cartons. Modesty panel set available, order **BK156QMP/ BK180QMP**.

- Due to the unique geometry of the tables, all edge types will feature rounded corners.

BXK156QMP	.69 x 33 x 9.6	125	20	2.9	\$785	N/A
BXK180QMP	.69 x 45 x 9.6	125	25	3.2	\$752	N/A

For use on **13 & 15 foot Boardroom Table Set**. Includes mounting bracket and wire access sweep.

Available in all Bungee laminate finishes. Edge available in Silver finish (**SI**) or Black finish (**BK**).

- Use model **BXK156QMP** for **BK156F/S** Boardroom Table Set.
- Use model **BXK180QMP** for **BK180F/S** Boardroom Table Set.

Required Specifications

Top finish
Edge
Leg + caster finish

Optional Specifications

Grommet
Modesty panel
HP laminate

Accessories

Power block

RECTANGULAR TABLE - FLIP TOP

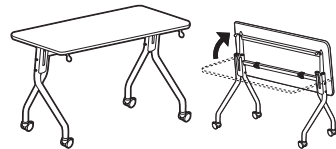
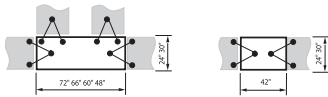

Flip-Top Rectangular Table - Spider Legs

MODEL#	DIMENSIONS	FREIGHT CLASS	WT/LBS.	CUBIC FT.	LIST PRICE	HP ADD
	D x W x H					
BX2442RES	24 x 42 x 29.2	250	66	20.75	\$1554	\$233
BX2448RES	24 x 48 x 29.2	250	72	23.5	\$1575	\$233
BX2460RES	24 x 60 x 29.2	250	84	29	\$1612	\$290
BX2466RES	24 x 66 x 29.2	250	97	31.75	\$1626	\$347
BX2472RES	24 x 72 x 29.2	250	102	34.75	\$1656	\$347
BX3042RES	30 x 42 x 29.2	250	73	25.5	\$1554	\$290
BX3048RES	30 x 48 x 29.2	250	73	28.75	\$1575	\$290
BX3060RES	30 x 60 x 29.2	250	94	35.75	\$1618	\$360
BX3066RES	30 x 66 x 29.2	250	106	39.25	\$1635	\$432
BX3072RES	30 x 72 x 29.2	250	112	42.5	\$1671	\$432

Table features a flip-top worksurface for ease of storage. Single hand release mechanism can be activated from left or right side of the table. Tables can be nested when folded. Each table can be "Bungee-tied" to other tables of the same depth. Folding modesty panels available, see next page.

- **Tables 48" and longer connect in both Straight and "L" configurations**
- **Standard with locking casters**
- **Due to hardware placement, tables placed in back-to-back configurations will not be able to be "Bungee-tied" together.**

TRAPEZOID TABLES - FLIP TOP

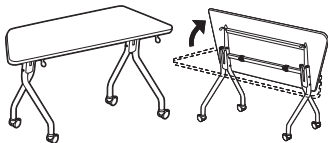
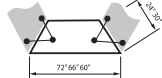

Flip-Top Trapezoid Table - Spider Legs

BX2460TRS	24 x 60 x 29.2	150	112	28	\$1457	\$290
BX2466TRS	24 x 66 x 29.2	250	112	31	\$1481	\$347
BX2472TRS	24 x 72 x 29.2	250	112	33	\$1502	\$347
BX3060TRS	30 x 60 x 29.2	250	112	35.5	\$1489	\$360
BX3066TRS	30 x 66 x 29.2	250	112	39	\$1510	\$432
BX3072TRS	30 x 72 x 29.2	250	112	42.5	\$1532	\$432

Table features a flip-top worksurface for ease of storage. Single hand release mechanism can be activated from left or right side of the table. Tables can be nested when folded. Each table can be "Bungee-tied" to other tables of the same depth. Folding modesty panels available, see next page.

- **Available with bubble edge (BB or BS) only.**
- **Standard with locking casters**

KEYSTONE TABLES - FLIP TOP

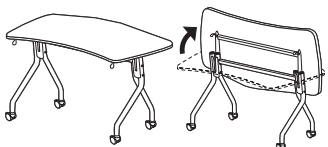

Flip-Top Keystone Table - Spider Legs

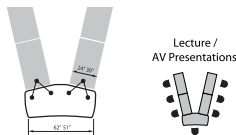

BX24KSS	24 x 51 x 29.2	125	112	16.5	\$1449	\$290
BX30KSS	30 x 62 x 29.2	125	112	16.5	\$1510	\$432

Table features a flip-top worksurface for ease of storage. Single hand release mechanism can be activated from left or right side of the table. Tables can be nested when folded. Each table can be "Bungee-tied" to other tables of the same depth.

- **Modesty panels or Filler Modestys are NOT available.**
- **Standard with locking casters**

Required Specifications

Top finish
Edge
Leg + caster finish

Optional Specifications

Grommet
Modesty panel
HP laminate

Accessories

Power block

B BUNGEE™ TABLES

WEDGE TABLES - FLIP TOP

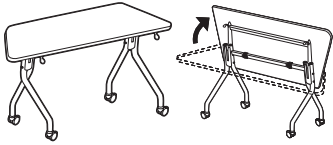

Flip-Top Wedge Table - Spider Legs

MODEL#	DIMENSIONS D x W x H	FREIGHT CLASS	WT/LBS.	CUBIC FT.	LIST PRICE	HP ADD
BX24WES	24 x 63 x 29	60	76	33	\$1825	\$415
BX30WES	30 x 70 x 29.2	250	84	33	\$1855	\$415

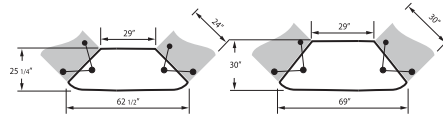
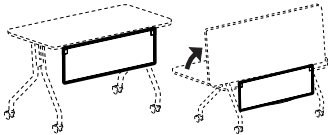

Table features a flip-top worksurface for ease of storage. Single hand release mechanism can be activated from left or right side of the table. Tables can be nested when folded. Each table can be "Bungee-tied" to other tables of the same depth. Folding modesty panels available, see below.

- Standard with locking casters

MODESTY PANELS - FLIP TOP



Modesty Panel

BX36QMP	.69 x 21 x 9.6	250	3	1.3	\$114	N/A
BX42QMP	.69 x 27 x 9.6	250	4	1.4	\$120	N/A
BX48QMP	.69 x 33 x 9.6	250	4	1.6	\$127	N/A
BX60QMP	.69 x 45 x 9.6	250	5	2.1	\$138	N/A
BX66QMP	.69 x 51 x 9.6	250	6	2.4	\$144	N/A
BX72QMP	.69 x 57 x 9.6	250	7	2.6	\$151	N/A

For use on **Flip Top Rectangular Tables**. Includes hinged mounting bracket. Available in all Bungee laminate finishes. Edge available in Silver finish (**SI**) or Black finish (**BK**).

- Modesty panel model number indicates the width of table to be used on.

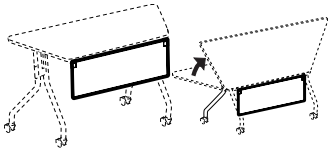

Modesty Panel

BXM60QMP	.69 x 27 x 9.6	300	4	2.1	\$120	N/A
BXM66QMP	.69 x 33 x 9.6	300	4	2.4	\$127	N/A
BXM72QMP	.69 x 39 x 9.6	300	5	2.6	\$132	N/A
BXL60QMP	.69 x 21 x 9.6	300	3	2.1	\$118	N/A
BXL66QMP	.69 x 27 x 9.6	300	4	2.4	\$120	N/A
BXL72QMP	.69 x 33 x 9.6	300	4	2.6	\$127	N/A

For use on **Flip Top Trapezoid Tables**. Includes hinged mounting bracket. Intended for use on the short side of the table; may be used on long side but leaves a larger gap. Available in all Bungee laminate finishes. Edge available in Silver finish (**SI**) or Black finish (**BK**).

- Modesty panel model number indicates the width of table to be used on.
- Specify **BXM** models for 24" D tables and **BXL** models for 30" D tables.

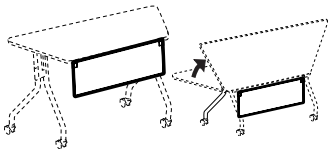

Modesty Panel

BXWQMP	.69 x 27 x 9.6	250	4	1.5	\$120	N/A
--------	----------------	-----	---	-----	--------------	-----

For use on **Flip Top Wedge Tables**. Includes hinged mounting bracket. Intended for use on the short side of the table. Available in all Bungee laminate finishes. Edge available in Silver finish (**SI**) or Black finish (**BK**).

- Modesty panel model number indicates the width of table to be used on.

Required Specifications

Top finish
Edge
Leg + caster finish

Optional Specifications

Grommet
Modesty panel
HP laminate

Accessories

Power block

BOARDROOM TABLE SET - FLIP TOP

MODEL#

DIMENSIONS

FREIGHT CLASS

WT/LBS.

CUBIC FT.

LIST PRICE

HP ADD

D x W x H

4 pc. Configurations

Meeting/Boardroom Table



Meeting/Boardroom Table



Training



Lecture / AV Presentations



Small Teaming Stations



Large Teaming Stations



Meeting/Boardroom Table



Training



BXK132S

60 x 132 x 29.2

250

352

151.25

\$5962

\$1641



Boardroom Table Set - 4pc. Flip Top

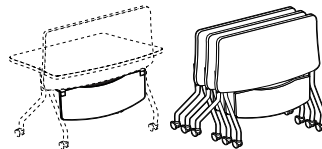

Set includes four freestanding tables with **spider legs** and Bungee cords for tool free ganging. Only legs with casters available, see page 514 for finish choices. All tables feature a flip top worksurface for ease of storage. Single hand release mechanism can be activated from left or right side of table. Tables can be nested when folded. Shipped in 4 cartons. Modesty panel set available, order **BXK132QMP**.

• Due to the unique geometry of the tables, all edge types will feature rounded corners.

BXK132QMP

.69 x 45 x 9.6

150

13

2.5

\$464

N/A

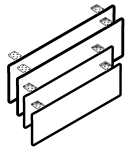

Square Modesty Panel Set for 4pc. Flip Top Table

For use on **4 pc. flip top table kits**. Modesty panels flip down for storage. Features black wire access sweep. Available in all Bungee laminate finishes. Edge available in Silver finish (**SI**) or Black finish (**BK**).

Required Specifications

- Top finish
- Edge
- Leg + caster finish

Optional Specifications

- HP laminate

B BUNGEE™ TABLES

MODESTY PANEL SETS

6 pc. Configurations

MODEL#	DIMENSIONS D x W x H	FREIGHT CLASS	WT/LBS.	CUBIC FT.	LIST PRICE	HP ADD

BXK156S	60 x 156 x 29.2	250	452	181.75	\$8826	\$1894
BXK180S	60 x 180 x 29.2	250	507	209.50	\$9040	\$2179

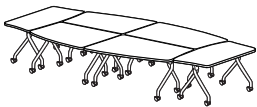

Boardroom Table Set - 6pc. Flip Top

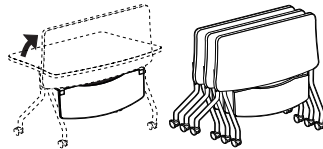

Set includes six freestanding tables with **spider legs** and Bungee cords for tool free ganging. Only legs with casters available, see page 514 for finish choices. All tables feature a flip top worksurface for ease of storage. Single hand release mechanism can be activated from left or right side of table. Tables can be nested when folded. Shipped in 6 cartons. Modesty panel set available, order **BXK156QMP/ BXK180QMP**.

• **Due to the unique geometry of the tables, all edge types will feature rounded corners.**

BXK156QMP	.69 x 33 x 9.6	125	20	2.9	\$785	N/A
BXK180QMP	.69 x 45 x 9.6	125	25	3.2	\$752	N/A

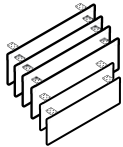

Square Modesty Panel Set for 6 pc. Flip Top Table

For use on **6 pc. flip top table kits**. Modesty panels flip down for storage. Features black wire access sweep. Available in all Bungee laminate finishes. Edge available in Silver finish (**SI**) or Black finish (**BK**).

Required Specifications

Top finish
Edge
Leg + caster finish

Optional Specifications

Grommet

Accessories

Power block

ACCESSORIES

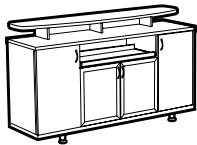

Credenza Buffet

MODEL#	DIMENSIONS D x W x H	FREIGHT CLASS	WT./LBS.	CUBIC FT.	LIST PRICE	HP ADD
B2072BUF	20 x 72 x 42	100	305	37.50	\$3681	\$543

Pull-out shelf. Top transaction shelf is edged with bubble molding. Side storage compartments feature a laminate door and one adjustable shelf each. Center storage features frosted aluminum doors with one adjustable shelf. Leveler feet are standard.

- Some assembly required.



Audio/Visual Cabinet

B249072AV	24 x 90 x 72	92.5	530	52.52	\$6068	\$548
-----------	--------------	------	-----	-------	--------	-------

Top pigeon holes and center adjustable shelf accommodate electronic equipment, CDs and other media. Bottom storage compartments feature laminate doors and one adjustable shelf. Side storage towers feature frosted aluminum doors with three adjustable shelves each. Accommodates TVs up to 58" w x 34" h x 24" d.

- Some assembly required.



Lectern

B44LEC	17 x 22 x 44	250	36	12.50	\$925	\$178
--------	--------------	-----	----	-------	-------	-------

Features angled stand with pencil ledge. Locking casters. **Specify CS or CK.**

Required Specifications

Top finish
Edge
Leg finish

Optional Specifications

Grommet

Accessories

Power block

B BUNGEE SL™ - NOTES



BUNGEE SL - a completely new product line to complement and coordinate with the Bungee Training Tables series. Bungee SL takes the popular aesthetic of the Bungee series and allows tables to be specified in shared leg and permanent applications - great for training, teaming and academic areas. Bungee SL tops and legs are sold separately, increasing the flexibility of the product in the future and allows for space saving in areas where real estate is a premium.

For greater flexibility, specify **Power and Data Management Troughs** for the BUNGEE SL table series. Add Global's proprietary 4-wire power kits and create inexpensive and versatile training, benching, academic and meeting areas. Front panels are available in Laminate or Aluminum. A center spine version allows for inexpensive double-sided applications.

Features and Benefits

- Tops are 1" thick with a choice of four edges: BB/BS - Bungee bubble edge, AB/AS - split color edge, A3 - matching edge and AR - Bicut edge.
- Legs are offered in Tapered or Spider design in a Tungsten or Black finish. Levelers are standard
- Power and data management troughs are sold separately and are meant to be used on BUNGEE SL only.



Tapered leg with levelers, offered in Tungsten or Black finish.



Optional power and data management troughs for Bungee SL. Center spine shown.



Shared leg, back-to-back tables with center spine trough.

GENERAL INFORMATION

- Introducing **BUNGEE SL** - a completely new product line to complement and coordinate with the top selling Bungee Training Tables series.
- Bungee SL takes the popular aesthetic of the Bungee series and allows tables to be specified in shared leg and permanent applications - great for benching, training, teaming and academic areas.
- Bungee SL tops and legs are sold separately, increasing the flexibility of the product in the future and allows for space saving in areas where real estate is a premium.
- High pressure tops are available in all BUNGEE SL laminates at an extended lead time - please refer to model # for pricing.
- For environmental certifications, please visit globalfurnituregroup.com

CONSTRUCTION

- Tops are 1" thick
- All laminate components are made of 45 lb. density particleboard with high performance thermally fused laminate.
- Tops 60" and over feature a built-in support bar. The support bar is 10" from the **approach** side, and clearance to the bottom of the support bar is 27" from the floor.
- **BUNGEE CORDS ARE NOT INCLUDED AND ARE NOT COMPATIBLE WITH BUNGEE SL TOPS**
- Products specified with the high pressure laminate option are finished on the underside of the surface with a kraft paper backing.

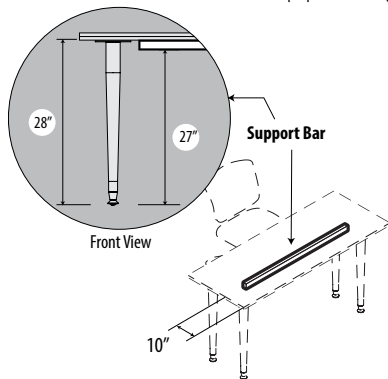

EDGE DETAIL

- Bungee SL comes with a choice of four edge styles:



A3 - square corner, standard edge



AR - square corner, bicut edge



AS - square corner, Silver



AB - square corner, Black



BS - rounded corner, Silver



BB - rounded corner, Black

- **BB/BS** - Bungee Bubble Edge: unique "bubble" molding found on original Bungee
- **AB/AS** - Split color PVC edge: edge matches split color aesthetic of the bubble edge, but allows for 90 degree corners and a cleaner look.
- **A3** - Global's preferred edge. Coordinates well with Adaptabilities and Zira 1" tops.
- **AR** - Bicut edge. Coordinates well with Zira 1" tops.

LEGS

- Two leg styles are available - Tapered and Spider leg. Available in Black (**TBL**) or Tungsten (**TTU**) finish. Levelers are standard; casters are not available for Bungee SL legs. Levelers adjust 3mm - 10mm in height.

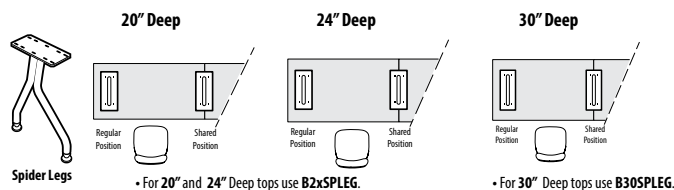

MODESTY PANELS

- See **POWER AND DATA MANAGEMENT TROUGHS** - page 537
- For modesty panels without power and data management, please see **Bungee modesty panels**, found on page 547

WIRE MANAGEMENT / POWER OPTIONS

- **TO UTILIZE BUNGEE SL TO THE FULLEST EXTENT, SPECIFY POWER AND DATA MANAGEMENT TROUGH (SEE PAGE 537).**
- For basic wire management, see details on page 547.

1. SPECIFY MODEL NUMBER

2. SPECIFY FINISH

Laminate Finishes:

ACJ	Absolute Acajou	NBL	Noce Biondo
ASN	Asian Night	NGL	Noce Grigio
AWC	Avant Cherry	NEL	Noce Leggero
AWH	Avant Honey	NML	Noce Medio
BLK	Black	QTM	Quartered Mahogany
BRC	Brushed Cobalt	SBY	Sheer Beauty
BZD	Blizzard	SDT	Stonedust
CMB	Clear Maple	SOG	Storm Grey
CGY	Custom Grey	WHE	Walnut Heights
DES	Dark Espresso	WHC	White Chocolate
DWT	Designer White	WCR	Winter Cherry
FAS	Fashionista		

Edge:

BB	Bungee bubble edge with Black trim
BS	Bungee bubble edge with Silver trim
AB	Split color edge with Black trim
AS	Split color edge with Silver trim
A3	Matching edge
AR	Matching bicut edge

Legs:

TBL	Black
TTU	Tungsten

3. SPECIFY OPTIONS

GROMMETS

- Optional Grommets available in standard worksurface locations (left, center or right) for **rectangular tops 48" and up**. Order as: **AG1, AG2 or AG3 - Add \$96**
- Optional grommets are available in **center position only** for **rectangular tops (36" and 42")**, **keystone**, **half moon** and **wedge tops**. Order as **AG2 - Add \$96**.
- Grommet hole dimensions are 3.25" wide x 1.875" deep.
- Grommets may be placed at non-standard locations. Order as: **AGS - Add \$96**. A drawing must be supplied with vertical and horizontal dimensions to the center of the cut-out (as in drawing below). Please refer to CUSTOM GROMMET LOCATION FORM in the back reference section.

Grommet hole dimensions

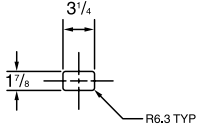

Grommet

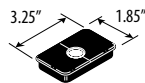

Keystone

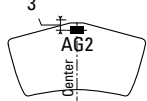

Half Moon

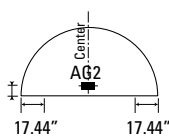

Wedge



Rectangular Tops

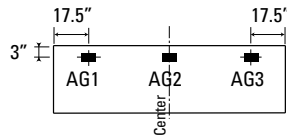
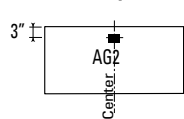

For 36" and 42" wide units

For 48", 60" and 72" wide units

Rectangular Tops

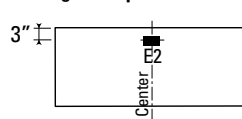

For 36", 42" and 48" wide units

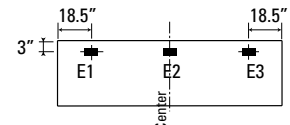

For 60" and 72" wide units

VILLA POWER BLOCK (CORDED VERSION ONLY)

- A Villa power block (corded) is available in four options (see page 544 for Villa Corded details). Villa power block (corded) dimensions vary by model. Villa cutout dimensions are 3"D x 5.25"W.
- A Villa cutout may be ordered for **rectangular tops 48" and up**. Order as: **V1, V2 or V3 - Add \$96 for each cutout**.
- A Villa cutout may be ordered in the **center position only** for **rectangular tops (36" and 42")**, **keystone** and **half moon tops**. Order as: **V2 - Add \$96**.
- Order Villa Power Block and Villa Grommet Cover separately, see page 544 for pricing and details.

Keystone

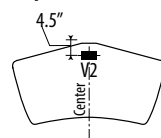

Half Moon

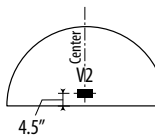

Villa Power Block

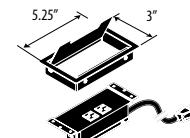

Rectangular Tops

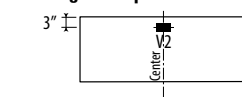

For 36", 42" and 48" wide units

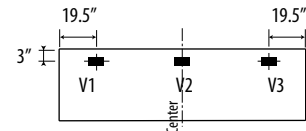

For 60" and 72" wide units

POWER BLOCK

- A Power Block is a rectangular worksurface power/data module with one electrical duplex receptacle and two data (RJ45) receptacles. 9' black cord included. Power block dimensions are 3.5"D x 6.5"W x 2.75"H. Power block cutout dimensions are 2.75"D x 6"W.
- A power block cutout (model **PMSPPDM**) may be ordered for **rectangular tops (48" and up)** in place of standard grommets. Order as **E1, E2 or E3. Add \$96**.
- A power block cutout (model **PMSPPDM**) may be ordered in the **center position only** for **rectangular tops (36" and 42")**, **keystone** and **half moon tops**. Order as **E2. Add \$96**.
- To purchase a power block, you must specify both the power block cut-out location and the power block model #. Order power block separately as **PMSPPDM, Add \$330**.

Keystone

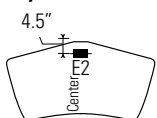

Half Moon

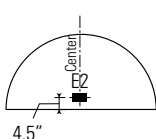

Power Block

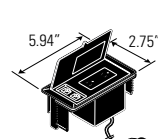

MODPOWER DAISY CHAIN SOLUTION

- Add flexible power and USB charging to Bungee SL rectangular tables. Connect up to four units with a single corded infeed with NEMA plug.
- ModPower units are sold separately, refer to Productivity Solutions page 465.
- Begin run with a starter unit which includes a corded infeed. Add additional middle or end units as required. Middle and end units are equipped with connecting cables.
- On-surface modules clamp on or screw mount to the table tops.
- In-surface modules require table top cut-outs for mounting. Specify cut-out option:
 - **MPS** for a single cut-out to accommodate one ModPower in-surface unit (cut-out will be centered on the approach side) for **42" to 72" wide rectangular tables. Add \$96**
 - **MPD** for two cut-outs in the left and right positions, 18.25" from ends to center of unit on approach side for **60", 66" and 72" wide rectangular tables. Add \$192**.

TOPS WITH SQUARE CORNERS (A3, AR OR AB/AS EDGE)	MODEL#	DIMENSIONS	FREIGHT CLASS	WT/LBS.	CUBIC FT.	LIST PRICE	HP ADD
---	--------	------------	---------------	---------	-----------	------------	--------

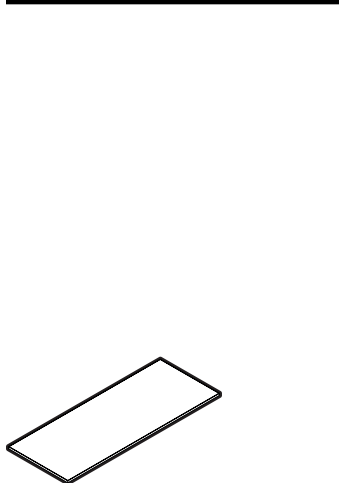

Rectangular Top - Square Corners

	D x W x H						
BS3072REC	30 x 72 x 1	70	60	4	\$575	\$494	
BS3060REC	30 x 60 x 1	70	53	3.4	\$480	\$411	
BS3048REC	30 x 48 x 1	70	46	2.7	\$295	\$331	
BS3042REC	30 x 42 x 1	70	42	2.4	\$287	\$290	
BS3036REC	30 x 36 x 1	70	38	2.1	\$229	\$250	
BS2472REC	24 x 72 x 1	70	51	3.3	\$503	\$396	
BS2460REC	24 x 60 x 1	70	44	2.8	\$439	\$331	
BS2448REC	24 x 48 x 1	70	37	2.3	\$251	\$264	
BS2442REC	24 x 42 x 1	70	33	2	\$237	\$234	
BS2436REC	24 x 36 x 1	70	29	1.8	\$224	\$200	
BS2072REC	20 x 72 x 1	85	43	2.9	\$467	\$331	
BS2060REC	20 x 60 x 1	70	37	2.4	\$396	\$278	
BS2048REC	20 x 48 x 1	70	30	2	\$236	\$234	
BS2042REC	20 x 42 x 1	70	27	1.8	\$218	\$200	
BS2036REC	20 x 36 x 1	70	24	1.5	\$205	\$200	

Rectangular 1" thick worksurface with **Square Corners**. Can accept Tapered (B29TPLEG) or Spider Legs (B2XSPLEG / B30SPLEG) in "end of run" or shared leg positions. Tops 60" and up include a built-in support bar. Shipped RTA (ready to assemble). Compatible with **power and data management troughs** (see page 537) or standard modesty panels (see page 573).

- For worksurfaces to be used as a return, please see Return Tops.
- Legs sold separately.

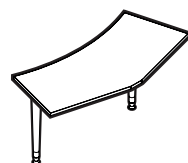

Keystone Top - Square Corners

BS30KSF	30.5 x 62.75 x 28.7	150	37	7.2	\$1112	\$494
BS24KSF	28.75 x 52 x 28.7	150	29	5.6	\$1029	\$361
BS20KSF	27.75 x 44 x 28.7	150	25	4.8	\$1016	\$299

1" thick worksurface with **Square Corners**. Includes (2) Tapered legs. *Not available with Spider Legs*. Connects to other tops of 20", 24" or 30" depths. Shipped RTA (ready to assemble). Modesty panels or filler panels are NOT available.

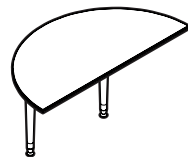

Half Moon Top - Square Corners

BS3060HMF	29.75 x 59.4 x 28.7	150	36	6.6	\$956	\$411
BS2448HMF	24 x 48.2 x 28.7	150	24	4.6	\$900	\$264

1" thick worksurface with **Square Corners**. Includes (2) Tapered legs. *Not available with Spider Legs*. Connects to other tables equaling the same length. Shipped RTA (ready to assemble). Modesty panels or filler panels are NOT available.

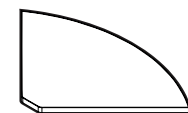

90° Wedge Top - Square Corners

BS24WE	26.8 x 26.8 x 1	92.5	15	1.5	\$278	\$234
BS20WE	22.8 x 22.8 x 1	100	10	1.2	\$205	\$200

1" thick worksurface with **Square Corners**. Can accept Tapered (B29TPLEG) or Spider Legs (B2XSPLEG / B30SPLEG) in shared positions only. Shipped RTA (ready to assemble). Accepts filler modesty panels.

- Legs sold separately.

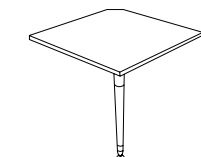

90° Corner - Square Corners

BS30CN	33.2 x 33.2 x 28.7	125	36	2.50	\$624	\$194
--------	--------------------	-----	----	------	-------	-------

Connects to 30" Deep Rectangular Tables. Includes (1) Tapered leg. *Not available with Spider Legs*.

Required Specifications

Top Finish
Top / Edge Detail

Optional Specifications

Grommet
Power/Data Management Troughs -
(Rectangular tops only)
Modesty Panel (Rectangular tops only)

HP Laminate

Accessories

Power Block
Villa Power Block (Corded)

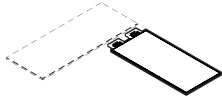

Rectangular Return Tops - Square Corners

MODEL#	DIMENSIONS D x W x H	FREIGHT CLASS	WT./LBS.	CUBIC FT.	LIST PRICE	HP ADD
BS3054RRE	30 x 54 x 1	70	50	3.1	\$314	\$372
BS3048RRE	30 x 48 x 1	70	46	2.7	\$295	\$331
BS3042RRE	30 x 42 x 1	70	42	2.4	\$287	\$290
BS3036RRE	30 x 36 x 1	70	38	2.1	\$229	\$250
BS2454RRE	24 x 54 x 1	70	40	2.5	\$272	\$299
BS2448RRE	24 x 48 x 1	70	37	2.3	\$251	\$264
BS2442RRE	24 x 42 x 1	70	33	2	\$237	\$234
BS2436RRE	24 x 36 x 1	70	29	1.8	\$224	\$200
BS2054RRE	20 x 54 x 1	70	33	2.2	\$258	\$250
BS2048RRE	20 x 48 x 1	70	30	2	\$236	\$223
BS2042RRE	20 x 42 x 1	70	27	1.8	\$218	\$200
BS2036RRE	20 x 36 x 1	70	24	1.5	\$205	\$167

Rectangular 1" thick worksurface with **Square Corners**. Includes two flat brackets to attach to another worksurface on one end. Can accept Tapered (B29TPLEG) or Spider Legs (B2XSPLEG / B30SPLEG) on the other end. 54" tops include a built-in support bar. Shipped RTA (ready to assemble). Compatible with standard modesty panels (see page 555).

- For worksurfaces to be used as a main surface, please see Rectangular Tops.
- Legs sold separately.

TOPS WITH ROUNDED CORNERS (BB/BS EDGES ONLY)

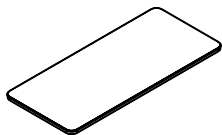

Rectangular Top - Rounded Corners

BB3072REC	30 x 72 x 1	85	59	4	\$737	\$494
BB3060REC	30 x 60 x 1	70	52	3.4	\$616	\$411
BB3048REC	30 x 48 x 1	70	45	2.7	\$375	\$331
BB3042REC	30 x 42 x 1	70	41	2.4	\$367	\$290
BB3036REC	30 x 36 x 1	70	37	2.1	\$296	\$250
BB2472REC	24 x 72 x 1	70	50	3.3	\$646	\$396
BB2460REC	24 x 60 x 1	70	43	2.8	\$562	\$331
BB2448REC	24 x 48 x 1	70	36	2.3	\$319	\$264
BB2442REC	24 x 42 x 1	70	32	2	\$305	\$234
BB2436REC	24 x 36 x 1	70	28	1.8	\$287	\$200
BB2072REC	20 x 72 x 1	85	42	2.9	\$599	\$331
BB2060REC	20 x 60 x 1	70	36	2.4	\$507	\$278
BB2048REC	20 x 48 x 1	85	29	2	\$302	\$234
BB2042REC	20 x 42 x 1	85	26	1.8	\$278	\$200
BB2036REC	20 x 36 x 1	70	23	1.5	\$260	\$200

Rectangular 1" thick worksurface with **Rounded Corners**. Can accept Tapered (B29TPLEG) or Spider Legs (B2XSPLEG / B30SPLEG) in "end of run" or shared leg positions. Tops 60" and up include a built-in support bar. Shipped RTA (ready to assemble). Compatible with **power and data management troughs** (see page 537) or standard modesty panels (see page 555).

- For worksurfaces to be used as a return, please see Return Tops
- Legs sold separately.

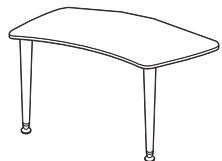

Keystone Top - Rounded Corners

BB30KSF	30.5 x 62.75 x 28.7	150	36	7.2	\$1112	\$494
BB24KSF	28.75 x 52 x 28.7	150	28	5.6	\$1029	\$361
BB20KSF	27.75 x 44 x 28.7	150	24	4.8	\$1016	\$299

1" thick worksurface with **Rounded Corners**. Includes (2) Tapered legs. *Not available with Spider Legs*. Connects to other tops of 20", 24" or 30" depths. Shipped RTA (ready to assemble). Modesty panels or filler panels are NOT available.

Required Specifications

Top Finish
Top / Edge Detail

Optional Specifications

Grommet
Power/Data Management Troughs -
(Rectangular tops only)
Modesty Panel

HP Laminare

Accessories

Power Block
Villa Power Block (Corded)

MODEL# DIMENSIONS FREIGHT CLASS WT/LBS. CUBIC FT. LIST PRICE HP ADD

D x W x H

BB3060HMF	29.75 x 59.4 x 28.7	150	35	6.6	\$956	\$411
BB2448HMF	24 x 48.2 x 28.7	150	23	4.6	\$900	\$264

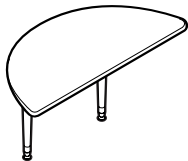

Half Moon Top - Rounded Corners

1" thick worksurface with **Rounded Corners**. Includes (2) Tapered legs. *Not available with Spider Legs*. Connects to other tables equaling the same length. Shipped RTA (ready to assemble). Modesty panels or filler panels are NOT available.



90° Wedge Top - Rounded Corners

BB24WE	26.8 x 26.8 x 1	100	14	1.5	\$356	\$234
BB20WE	22.8 x 22.8 x 1	125	9	1.2	\$260	\$200

1" thick worksurface with **Rounded Corners**. Can accept Tapered (B29TPLEG) or Spider Legs (B2XSPLEG / B30SPLEG) in shared positions only. Shipped RTA (ready to assemble). Accepts filler modesty panels.

- Legs sold separately.

BB3054RRE	30 x 54 x 1	70	50	3.06	\$403	\$372
BB3048RRE	30 x 48 x 1	70	46	2.75	\$375	\$331
BB3042RRE	30 x 42 x 1	70	42	2.44	\$367	\$290
BB3036RRE	30 x 36 x 1	70	38	2.13	\$296	\$250

BB2454RRE	24 x 54 x 1	70	40	2.54	\$347	\$299
BB2448RRE	24 x 48 x 1	70	37	2.28	\$319	\$264
BB2442RRE	24 x 42 x 1	70	33	2.03	\$305	\$234
BB2436RRE	24 x 36 x 1	70	29	1.77	\$287	\$200

BB2054RRE	20 x 54 x 1	70	33	2.2	\$329	\$250
BB2048RRE	20 x 48 x 1	70	30	1.97	\$302	\$223
BB2042RRE	20 x 42 x 1	70	27	1.75	\$278	\$200
BB2036RRE	20 x 36 x 1	70	24	1.53	\$260	\$167

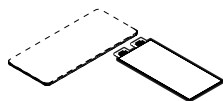

Rectangular Return Tops - Rounded Corners

Rectangular 1" thick worksurface with **Rounded Corners**. Includes two flat brackets to attach to another worksurface on one end. Can accept Tapered (B29TPLEG) or Spider Legs (B2XSPLEG / B30SPLEG) on the other end. 54" tops include a built-in support bar. Shipped RTA (ready to assemble). Compatible with standard modesty panels (see page 573).

- For worksurfaces to be used as a main surface, please see Rectangular Tops
- Legs sold separately.

BB30CN	33.17 x 33.17 x 28.7	125	36	2.50	\$671	\$194
--------	----------------------	-----	----	------	--------------	--------------

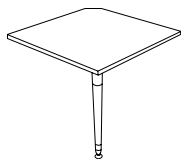

90° Corner - Rounded Corners

Connects to 30" Deep Rectangular Tables. Includes (1) Tapered leg. *Not available with Spider Legs*.

B30SPLEG	25 x 6 x 27.7	150	16	2.9	\$403	
----------	---------------	-----	----	-----	--------------	--



Spider Legs for 30"D Tables

Spider leg with levers. Shipped/sold one per carton. **Tops sold separately.**

- Available in Tungsten (TTU) or Black (TBL). Please specify.
- **To be used with 30"D tops only**

Required Specifications

Top Finish
Top / Edge Detail

Optional Specifications

Grommet
Filler Modesty Panel (Wedge Tops only)
Modesty Panel (Rectangular Return Tops)
HP Laminate

Accessories

Power Block
Villa Power Block (Corded)

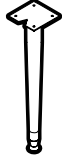
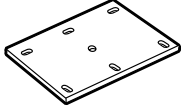
	MODEL#	DIMENSIONS	FREIGHT CLASS	WT/LBS.	CUBIC FT.	LIST PRICE
 <p>Spider Legs for 20" & 24" D Tables</p>		D x W x H				
	B2XSPLEG	20 x 6 x 27.7	125	14	2.2	\$348
<p>Spider leg with levellers. Shipped/sold one per carton. Tops sold separately.</p> <ul style="list-style-type: none"> • Available in Tungsten (TTU) or Black (TBL). Please specify. • To be used with 20" & 24" deep tops only 						
 <p>Tapered Leg</p>						
	B29TPLEG	6 x 6 x 27.7	85	11	0.8	\$165
<p>Tapered leg with levellers for tables of all depths. Shipped/sold one per carton. Tops sold separately.</p> <ul style="list-style-type: none"> • Available in Tungsten (TTU) or Black (TBL). Please specify. 						
 <p>Flat Bracket</p>						
	B6PLT	6 x 6 x .25	70	2	0.1	\$57
<p>To be used as a mending plate for Bungee SL. Black only. Shipped/sold one per pack.</p>						

Required Specifications

Leg Finish

GENERAL INFORMATION

- Power and Data Management Troughs for the **BUNGEE SL** table series. Add Global's proprietary 4-wire power kits and create inexpensive and versatile training, benching, academic and meeting areas.
- Front panels are available in aluminum. A center spine version allows for inexpensive double-sided applications.
- **POWER AND DATA MANAGEMENT TROUGHS** are sold separately and are meant to be used on **BUNGEE SL only**.
- **POWER AND DATA MANAGEMENT TROUGHS** accept Global's 4-wire power kit in addition to numerous data, phone and other multimedia wires.
- Filler modesty panels conceal wiring in spaces not covered by troughs.
- For environmental certifications, please visit globalfurnituregroup.com

FINISHES

LAMINATE:

ACJ Absolute Acajou	FCL First Class
ASN Asian Night	NBL Noce Biondo
AWC Avant Cherry	NGL Noce Grigio
AWH Avant Honey	NEL Noce Leggero
BLK Black	NML Noce Medio
BZD Blizzard	QTM Quartered Mahogany
BRC Brushed Cobalt	SBY Sheer Beauty
CMB Clear Maple	SOG Storm Grey
CGY Custom Grey	SDT Stonedust
DES Dark Espresso	WHE Walnut Heights
DWT Designer White	WHC White Chocolate
FAS Fashionista	WCR Winter Cherry

Aluminum Face Panel, Trough, Filler Panels and End Caps:

Black (BLK) Tungsten (TUN)

LAMINATE FACE PANEL (LFP)

- Laminate face panel (LFP) on the approach side is 11/16" thick. LFP height is 13".
- Rear access panel is 1/4" thick laminate. Rear panel height is 7.25".
- LFP and rear panel swing up to allow wire access and feature a flexible sweep at the top.
- All laminate components are made of 45 lb. commercial density particle board, covered on both sides with high performance, thermally fused laminate.
- The trough portion of the unit is made of a heavy duty aluminum extrusion to allow wire systems (including Global's 4-Wire System) to lie within the bottom.
- **LFP is available in Black (BLK) laminate only.**
- Aluminum trough available in Tungsten (TUN) or Black (BLK) finish, please specify.
- Rear access panel is finished in Black (BLK) laminate.
- End Caps (JBEC) sold separately

side view

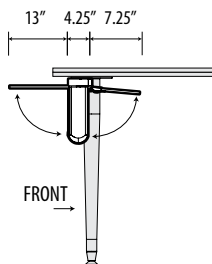

Tops, legs and end caps not included

CENTER SPINE (CS)

- 1/4" thick laminate panels on both sides of the unit. Panel height is 7.25".
- Both panels swing up to allow wire access and feature a flexible sweep at the top.
- All laminate components are made of 45 lb. commercial density particle board, covered on both sides with high performance, thermally fused laminate.
- The trough portion of the unit is made of a heavy duty aluminum extrusion to allow wire systems (like Global's 4-Wire System) to lie within the bottom.
- Aluminum trough available in Tungsten (TUN) or Black (BLK) finish, please specify (rear access panel is finished in Brushed Cobalt (BRC) laminate when TUN is specified, or both access panels are finished in Black (BLK) laminate when BLK is specified).
- End Caps (JBEC) sold separately.



Tops, legs and end caps not included

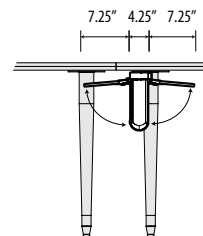

B BUNGEE SL™ POWER/DATA MANAGEMENT TROUGHS - NOTES

FILLER MODESTY PANELS

- Used to fill the space between two power and data management troughs and conceal wiring from the approach side
- Straight Filler allows for use in straight configurations between two rectangular tables with power and data management troughs
- Curved Filler allows for use at curve with 90° wedge tables between two rectangular tables with power and data management troughs
- Available in Silver (SI) or Black (BK) finish. Please specify.

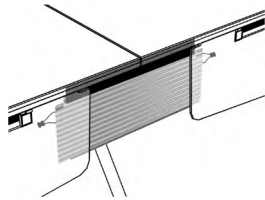

Straight Filler Modesty Panel

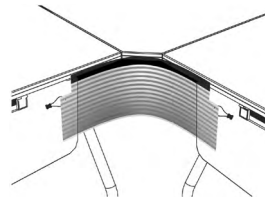

Curved Filler Modesty Panel

END CAPS

- Plastic end caps with decorative insert. Required for beginning and end of runs.
- Cap can be notched in field to allow wire infeed pass through.
- Charcoal finish only.



WIRE MANAGEMENT

- Two wire manager clamps are included within all power and data management troughs.
- Attached to the unit, they can slide from side to side to accommodate wiring systems
- Data, voice, multi-media and power can be routed separately using channels on each wire manager.
- Additional wire manager clamps are available to retrofit.
- Available in black only.

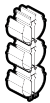

GLOBAL 4-WIRE POWER SYSTEM

- Global's proprietary power system comes with everything you need to power your **BUNGEE SL** layouts. Kits coordinate to the size of the table being used and fit snugly into the bottom of the power and data management trough.
- Single duplex kits come with one duplex – centered on the wiring harness. Duplexes are 6" wide.
- Double duplex kits come with two duplexes – 11" of wiring on each side of the harness allows for flexibility between connections. Duplexes are 6" wide.
- One end of the harness kit features a female connection, while the opposite end features a male connection for a quick and easy connect/disconnect
- Actual kit length is 1" longer than nominal
- Must be hardwired using infeeds (specified separately) by a licensed electrician
- All conduits are enclosed in a black nylon sleeve to reduce visibility
- All duplexes and connectors are plastic. Black only.
- **8 DUPLEXES PER CIRCUIT MAXIMUM** – maximums are to National Electric Code (NEC) – some local codes vary from NEC code – it is the customer's responsibility to follow all applicable local codes and guidelines.

ELECTRICAL SYSTEM

- 4-2 Wiring Schematic
- 4-Wire Shared Neutral
- Complies with National Electric Code
- UL Listed
- All circuits rated for 20 AMP

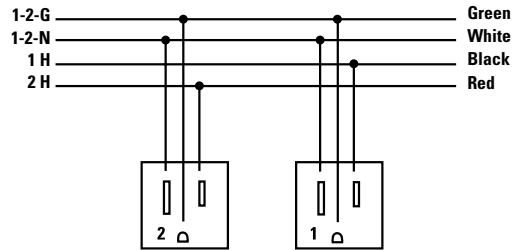

PRODUCT

MAX UNITS PER CIRCUIT

P42S	8 units per circuit
P42D	4 units per circuit

POWER/DATA MANAGEMENT TROUGH PLACEMENT

Single Table - AFP

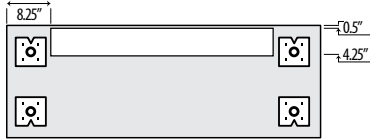

Shared Leg Table - AFP:

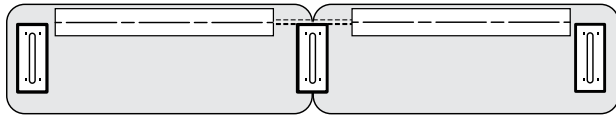
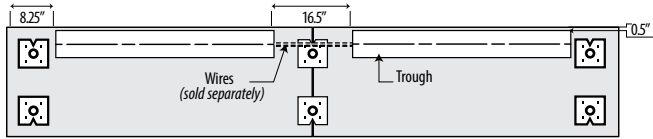

CS

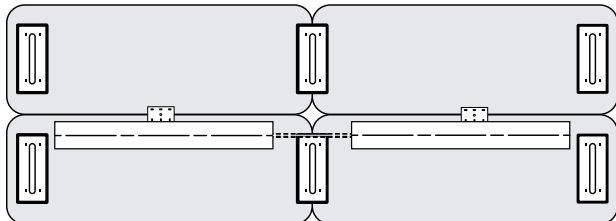
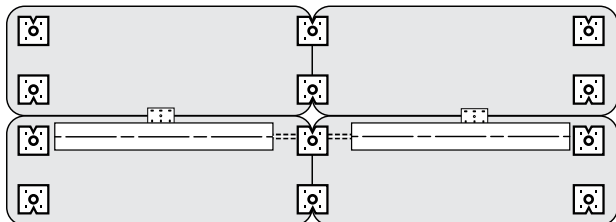
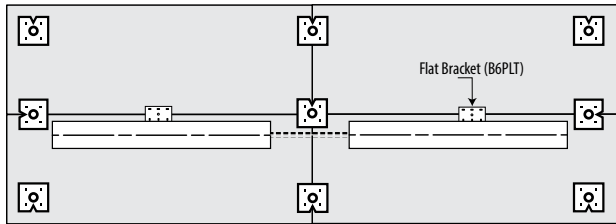

GLOBAL 4-WIRE POWER TO POWER/DATA MANAGEMENT TROUGH:

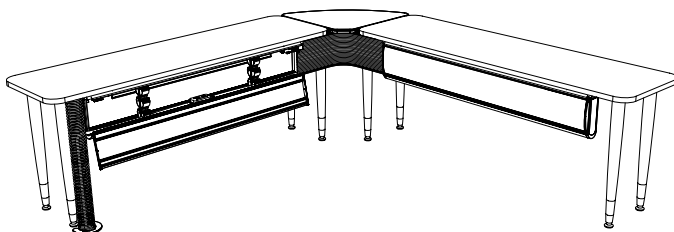

Bungee SL with AFP Power/Data Management Trough - 90° Corner Application

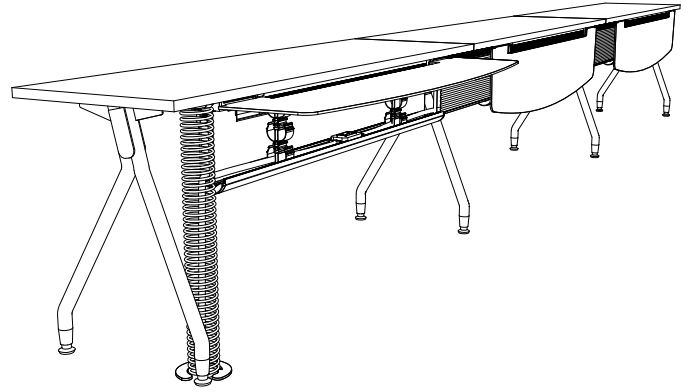

Bungee SL with LFP Power/Data Management Trough - Single Sided Straight Run

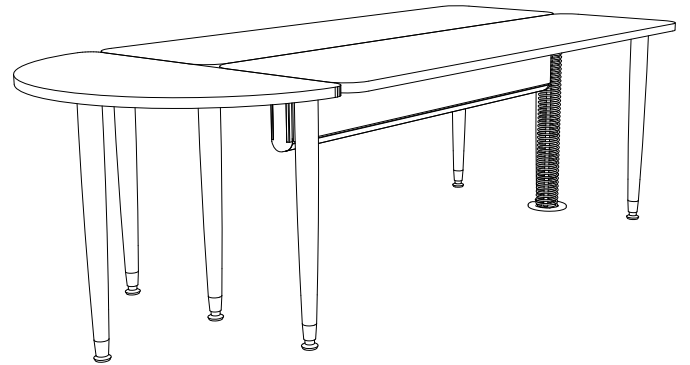

Bungee SL with CS Power/Data Management Trough - Back to Back Application (shown with power snake)

UTILIZING POWER BLOCKS AND GROMMETS WITH POWER/DATA MANAGEMENT TROUGH

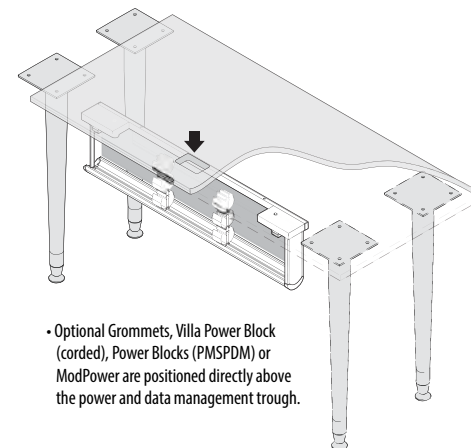

• Optional Grommets, Villa Power Block (corded), Power Blocks (PMSPDM) or ModPower are positioned directly above the power and data management trough.



Grommet



Power Block



Villa Coded

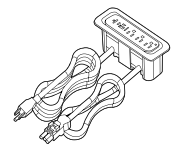

ModPower

B BUNGEE SL™ POWER/DATA MANAGEMENT TROUGHS

MODEL# DIMENSIONS FREIGHT CLASS WT/LBS. CUBIC FT. LIST PRICE

D x W x H

JB72L	4.25 x 55.75 x 10	125	23	2.9	\$857
JB60L	4.25 x 43.75 x 10	125	18	2.3	\$767
JB48L	4.25 x 31.75 x 10	100	14	1.7	\$667
JB42L	4.25 x 25.75 x 10	100	12	1.5	\$618
JB36L	4.25 x 19.75 x 10	100	10	1.2	\$566

Trough w/Laminate Face Panel (LFP)

For use on rectangular Bungee SL surfaces only. Out-facing laminate panel swings up to allow wire access and features flexible sweep at the top. In-facing laminate panel swings up to allow wire access and features flexible sweep at the top. Black wire management clamps included.

- To fill the gap between two power/data management trough (LFP) modules in a straight run, a single filler modesty panel (JBFSFM) is recommended.
- To fill the gap between two power/data management trough (LFP) modules at 90°, a corner filler modesty panel (JBCFM) is recommended.
- Model # corresponds to the size table power/data management trough will fit on (i.e. JB72L will fit a 72" wide table).
- Laminate panels are Black - no finish options available.



JB72C	4.25 x 55.75 x 10	100	19	2.20	\$774
JB60C	4.25 x 43.75 x 10	100	15	1.80	\$729
JB48C	4.25 x 31.75 x 10	100	12	1.30	\$617
JB42C	4.25 x 25.75 x 10	100	10	1.10	\$575
JB36C	4.25 x 19.75 x 10	60	8	.08	\$532

Trough w/Center Spine (CS)

For use on rectangular Bungee SL surfaces only in back-to-back applications only. Two laminate panels swing up to allow wire access and feature flexible sweep at the top. Black wire management clamps included.

- To fill the gap between two power/data management trough (CS) modules in a straight run, two filler modesty panels (JBFSFM) are recommended to conceal wiring from both sides.
- Model # corresponds to the size table power/data management trough will fit on (i.e. JB72C will fit a 72" wide table).
- Laminate panels are Black - no finish options available.

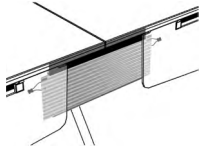

Straight Filler Modesty Panel

Straight filler modesty is used to fill the space between two power/data management trough modules where tables are linked in a straight configuration.

- In center spine applications, two straight filler modesty panels should be specified to cover cabling and wires from both sides.
- Filler modesty panels are reversible with Black (BK) finish on one side and Silver (SI) finish on the opposite side.

JBFSFM	0.25 x 22.5 x 9	70	1.60	.04	\$187
--------	-----------------	----	------	-----	--------------

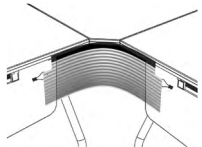

Curved Filler Modesty Panel*

Curved filler modesty is used to fill the space between two power/data management troughs where tables are linked at a 90° curve.

- For interior curves only.
- Filler modesty panels are reversible with Black (BK) finish on one side and Silver (SI) finish on the opposite side.

JBCFM	0.25 x 22.5 x 9	70	1.80	.05	\$223
-------	-----------------	----	------	-----	--------------

Optional Specifications

4-Wire Power System

ACCESSORIES



End Cap

MODEL#	DIMENSIONS	FREIGHT CLASS	WT/LBS.	CUBIC FT.	LIST PRICE
--------	------------	---------------	---------	-----------	------------

	D x W x H				
JBEC	3 x 8 x 1	70	1	.15	\$46

Plastic end cap to be snapped into place at the end of power/data management troughs. To be specified for the beginning and end of runs for a finished look. Charcoal finish only.

- Plastic cap can be notched in the field to allow infeed or data cable pass-through.

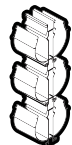

Wire Management Clamp

JBWM2	2.5 x 6 x 1.75	70	1	.01	\$168
-------	----------------	----	---	-----	--------------

Wire management track with double wire clamp - triple height. Can be affixed to the underside of worksurface using double-sided tape (supplied) or retrofit into power/data management trough modules. Black finish only.

- Recommended for use at 90° corners.
- Retrofitting requires disassembly of power/data management trough modules.

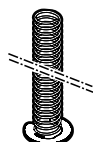

Power Snake

JBPS	4 x 4 x 34	100	2	.25	\$160
------	------------	-----	---	-----	--------------

Attaches to the underside of worksurface with supplied wood screws. Used to organize and channel wires from the power/data management trough down to the floor infeed. Black finish only.

B BUNGEE SL™ POWER/DATA MANAGEMENT TROUGHS

4-WIRE POWER SYSTEM

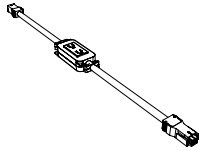

Single Duplex Kit

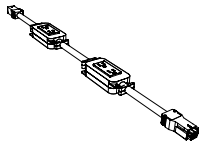

Double Duplex Kit



Power Harness Jumper

MODEL#	DIMENSIONS	FREIGHT CLASS	WT/LBS.	CUBIC FT.	LIST PRICE
--------	------------	---------------	---------	-----------	------------

D x W x H

Circuit 1:

P42S-72-1	73 x 2 x 2	60	3.19	.10	\$195
P42S-60-1	61 x 2 x 2	60	2.82	.09	\$178
P42S-48-1	49 x 2 x 2	60	2.44	.08	\$164
P42S-42-1	43 x 2 x 2	60	2.26	.07	\$156
P42S-36-1	37 x 2 x 2	60	2.07	.06	\$149

Circuit 2:

P42S-72-2	73 x 2 x 2	60	3.19	.10	\$195
P42S-60-2	61 x 2 x 2	60	2.82	.09	\$178
P42S-48-2	49 x 2 x 2	60	2.44	.08	\$164
P42S-42-2	43 x 2 x 2	60	2.26	.07	\$156
P42S-36-2	37 x 2 x 2	60	2.07	.06	\$149

Single Duplex Kit includes one black plastic duplex connected to harnesses. Male connection (IN) on one side with female connection (OUT) on the opposite for easy connect and disconnect. Conduit is wrapped in black nylon sleeve. Actual length is 1" longer than nominal.

- Model # corresponds to the size table power/data management trough will fit on (i.e. P42S-48 will fit a JB48A, JB48L or JB48C module).
- Infeed required for connection to building power. Sold separately (next page).

Circuit 1:

P42D-72-1	2 x 73 x 2	60	3.01	.10	\$226
P42D-60-1	2 x 61 x 2	65	2.63	.09	\$208
P42D-48-1	2 x 49 x 2	65	2.26	.08	\$194
P42D-42-1	2 x 43 x 2	65	2.07	.07	\$187
P42D-36-1	2 x 37 x 2	70	1.88	.06	\$178

Circuit 2:

P42D-72-2	2 x 73 x 2	60	3.01	.10	\$226
P42D-60-2	2 x 61 x 2	65	2.63	.09	\$208
P42D-48-2	2 x 49 x 2	65	2.26	.08	\$194
P42D-42-2	2 x 43 x 2	65	2.07	.07	\$187
P42D-36-2	2 x 37 x 2	70	1.88	.06	\$178

Double Duplex Kit includes two black plastic duplexes connected to harnesses. Male connection (IN) on one side with female connection (OUT) on the opposite for easy connect and disconnect. Conduit is wrapped in black nylon sleeve. Actual length is 1" longer than nominal.

- Both duplexes on the kit will be assigned to the same circuit.
- Model # corresponds to the size table power/data management trough will fit on (i.e. P42D-48 will fit a JB48A, JB48L or JB48C module).
- Infeed required for connection to building power. Sold separately (below).

P42J-72	2 x 73 x 2	60	3	.10	\$176
P42J-60	2 x 61 x 2	60	2.73	.09	\$157
P42J-48	2 x 49 x 2	65	2.35	.08	\$139
P42J-42	2 x 43 x 2	60	2.16	.07	\$129
P42J-36	2 x 37 x 2	70	1.98	.06	\$120
P42J-18	2 x 19 x 2	70	1.41	.04	\$93

Male connection (IN) on one side with female connection (OUT) on the opposite for easy connect and disconnect. Conduit is wrapped in black nylon sleeve. Actual length is 1" longer than nominal.

- Use P42J-18 between two power/data management troughs separated by Bungee SL wedge, keystone or half moon tables
- Use all other sizes to jump between power kits on power/data management troughs that are NOT powered (i.e. use a P42J-60 as a pass-through on a 60" wide non-powered table between POWERED power/data management trough modules).

4-WIRE POWER SYSTEM

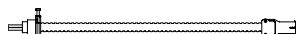

72" Multi-circuit Hardwire Infeed

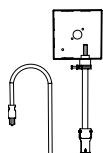

Single-circuit 3-Prong Infeed

MODEL#	DIMENSIONS	FREIGHT CLASS	WT./LBS.	CUBIC FT.	LIST PRICE
--------	------------	---------------	----------	-----------	------------

	D x W x H				
P42HW-72	1 x 72 x 1	70	6.50	.30	\$193

72" Multi-circuit Hardwire Infeed (up to 20 AMPS per circuit), two circuits. Provides single power entry from floor or wall located building power supply. Conduit is wrapped in black nylon sleeve.

- Connects P42S or P42D kits. **Power circuit 1, circuit 2 or a mix.**
- **TO BE HARDWIRED BY LICENSED ELECTRICIAN.** UL listed.
- Where Liquid Tight conduit is required, specify P42HW-72L

P42TP-120	8 x 4 x 2	70	6.10	.30	\$239
P42TP-72	8 x 4 x 4	60	4.50	.15	\$218

Hardwire junction box included (to be mounted on underside of table). Provides single power entry from floor or wall located building power supply. Conduit is wrapped in black nylon sleeve. Allows for quick and easy disconnection from the wall. Available in 72" or 120" overall lengths.

- Connects P42S or P42D kits. **Power circuit 1 only.**
- **TO BE HARDWIRED BY LICENSED ELECTRICIAN.** UL listed.

B BUNGEE SL™ POWER/DATA MANAGEMENT TROUGHS

POWER BLOCK

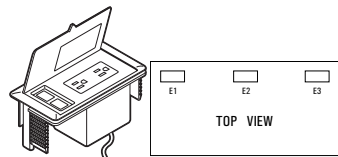

Power/Data Block

MODEL#	DIMENSIONS D x W x H	FREIGHT CLASS	WT./LBS.	CUBIC FT.	LIST PRICE
PMSPDM	3.5 x 6.5 x 2.75	70	2	.10	\$330

Worksurface power and data module. Two power receptacles and two data receptacles. 9' cord. Specify position and **add \$96** for cut-out in worksurface. See diagram E1/E2/E3 for specification location. Black (**BLK**) only.

VILLA I SERIES CORDED UNITS

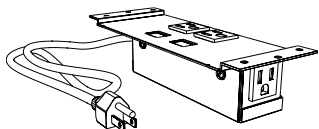

Data Knockouts, No Data Ports

VIL-C-DKO-_-108	3.25 x 8.75 x 2.25	100	4	.45	\$249
VIL-C-DKO-_-72	3.25 x 8.75 x 2.25	100	4	.45	\$249

Villa I with 3-prong plug. Includes **two power receptacles** and two knockouts for data. A third convenience receptacle is provided below the worksurface. **V1, V2 or V3 cutout(s) must be specified on training table** (see product notes section for more details and cutout upcharge). **Grommet cover is required and sold separate** (see below). UL/CUL listed.

- Replace _ with **B** for **Black**
- Replace _ with **S** for **Silver Pearl**

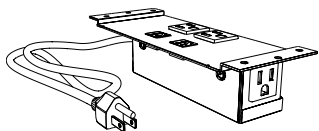

Data Knockouts, Data Ports Included

VIL-C-D-_-108	3.25 x 8.75 x 2.25	100	4	.45	\$402
VIL-C-D-_-72	3.25 x 8.75 x 2.25	100	4	.45	\$402

Villa I with 3-prong plug. Includes **two power receptacles** and **two RJ45 Cat 6** data. A third convenience receptacle is provided below the worksurface. **V1, V2 or V3 cutout(s) must be specified on training table** (see product notes section for more details and cutout upcharge). **Grommet cover is required and sold separate** (see below). UL/CUL listed.

- Replace _ with **B** for **Black**
- Replace _ with **S** for **Silver Pearl**

VILLA GROMMET COVERS

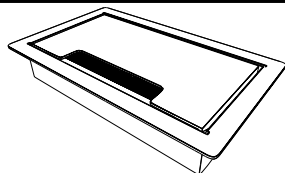

Villa Grommet Cover

VIL-GROM-F-__	3.5 x 5.75 x .94	70	1	.08	\$126
---------------	------------------	----	---	-----	--------------

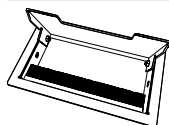

Powder coated flush metal grommet to be used with Villa I **corded** series power blocks. Cutouts in tables must be specified separately. **V1, V2 or V3 cutout(s) must be specified on training table** (see product notes section for more details and cutout upcharge). **Grommet cover remains open while in use.**

- **Cannot be used with PMSPDM.**
- Replace _ with **B** for **Black**
- Replace _ with **S** for **Silver Pearl**

Required Specifications

Face panel and box finish - BLK or TUN



Bring people together. Collaborative Spaces™ fosters teamwork through adaptable environments that can transform at a moment's notice or evolve over time. Optimize existing spaces with individual pieces or create new ones with the full range of mobile team carts, work tables and accessories. Scale up, scale down, create a space for the way you work.

Collaborative Spaces' range of laptop tables can transform any area into a productive workspace. Hospitality carts to support team meetings in relaxed settings, with all the essentials to keep the team fueled up.

Create learning hubs with large workshop and collaboration tables and shelf carts for all the resources they require to get their ideas out into the world. Collaborative Spaces is designed to withstand demanding environments in education.

Features and Benefits

- Tables offered with small (1.5") or large (9") radius corners
- Tables are available with glides or casters
- Media units and power accessories provide means for hybrid collaboration
- Accessories like undersurface bag hooks and trays for bag drops keep items out of the way and off the floor.
- PET felt screens provide privacy and noise reduction while dividing space. PET felt screens clip onto shelf carts with included brackets.
- Laptop shelves and media trays can be added to media carts.
- Wire management accessories at the leg and undersurface hide excess cables.
- Undersurface power modules can be positioned anywhere along the table edge.



Optional recessed power tray



Optional steel mesh tray keeps bags and other personal items off the floor



Cart mounted PET Felt privacy panel

GENERAL INFORMATION

- Collaborative Spaces™ includes a range of products that complement each other.
- Series includes collaboration and workshop tables in three heights: 29", 36" and 42"; occasional tables, laptop tables, team carts, and a variety of accessories.
- Aluminum beams provide strength and rigidity for long term use.
- Combine elements to demark space, absorb ambient noise and afford visual privacy.
- PET felt wire manager hangs from underside of worksurface to organize wires.
- Collaborative Spaces' robust aluminum framework supports high-traffic applications and is 100% recyclable.
- For environmental certifications, please visit globalfurnituregroup.com.

CONSTRUCTION

- All tables are standard in high performance thermally fused laminate. Optional high pressure (HP) laminate available.
- High performance thermally fused laminate tops are 1" thick particle board and have a flat 3mm edge profile on all sides
- High pressure (HP) laminate tops are 1-1/16" thick laminate particle board and have a flat 3mm edge profile on all sides
- Laminate surfaces offer a selection of matching + coordinating edgeband. Specify separately from the surface finish.



- Products specified with the high pressure laminate option are finished on the underside of the surface with a kraft paper backing.
- Grommet location must be specified at the time of order or it will default to a no grommet option.
- Power modules and grommets are not included and must be specified separately.
- Table legs and bases are painted aluminum finish.
- Tables are shipped knocked down and must be assembled on site.
- Corner radius for small radius table tops is 1.5".
- Corner radius for large radius tables tops is 9".
- Top end overhang for large tables is 10.5"
- Worksurface support beams and footrests (where applicable) are centered for tables 18" and 24" deep.
- Worksurface support beams and footrests (where applicable) are 9" from the outside table edges for tables 30" deep.
- Worksurface support beams and footrests (where applicable) are 12" from the outside table edges for tables 36 to 48" deep.
- The top of footrests on café height tables is 8.4" above the floor.
- The top of footrests on bar height tables is 14.4" above the floor.
- Cart shelf load capacities : 120 lbs. for 42" wide (Hospitality Cart), 140 lbs. for 48" wide and 175 lbs. for 60" wide.

HOW TO SPECIFY:

Example: SCTWSL2472:

SC	Spaces Collaborative	<i>Other Options:</i>	C Cafe height table - 36"
W	Work height table - 29"		B Bar height table - 42"
S	Small radius - 1.5"		L Large radius - 9"
L	Levelers		C Casters, available in Black (BLK) or Grey (GRC)
24	Depth		
72	Width		
LP	Low pressure laminate		HP - High pressure laminate

FINISHES

Metal Finishes:

BLK	Black
BZD	Blizzard
CHR	Charcoal
DWT	Designer White
INK	Ink
NEV	Nevada
SIL	Silver
SDT	Stonedust
TPE	Taupe
TUN	Tungsten

Laminate Finishes (thermally fused and high pressure laminates):

ACJ	Absolute Acajou
ASN	Asian Night
AWC	Avant Cherry
AWH	Avant Honey
BLK	Black
BZD	Blizzard
BRC	Brushed Cobalt - Coordinates with TUN edgeband finish
CGY	Custom Grey - Coordinates with SIL edgeband finish
CMB	Clear Maple
DES	Dark Espresso
DWT	Designer White
FAS	Fashionista
FCL	First Class
NBL	Noce Biondo
NGL	Noce Grigio
NEL	Noce Leggero
NML	Noce Medio
QTM	Quartered Mahogany
SBY	Sheer Beauty
SDT	Stonedust
SOG	Storm Grey - Coordinates with CHR edgeband finish
STG	String - Coordinates with NEV edgeband finish
WHC	White Chocolate
WHE	Walnut Heights
WCR	Winter Cherry

Edgeband Finishes:

AAE	Absolute Acajou	NGL	Noce Grigio
ASE	Asian Night	NEL	Noce Leggero
ACE	Avant Cherry	NML	Noce Medio
AHE	Avant Honey	NEV	Nevada (use w/STG)
BLK	Black	QTM	Quartered Mahogany
BRC	Brushed Cobalt	SBY	Sheer Beauty
BZD	Blizzard	SIL	Silver
CHR	Charcoal (use w/SOG)	SDT	Stonedust
CME	Clear Maple	TPE	Taupe
DEE	Dark Espresso	TUN	Tungsten (use w/BRC)
DWE	Designer White	WHE	Walnut Heights
FAS	Fashionista	CBE	White Chocolate
FCL	First Class	WCE	Winter Cherry
NBL	Noce Biondo		

Caster Finish:

BLK	Black
GRC	Grey

PET Felt Colors

BLK	Black
BRI	Brick
DEN	Denim
GPH	Graphite
HVT	Harvest
MTS	Mist
PWT	Pewter
SHR	Shamrock
WHT	White

POWER ACCESSORY CUT-OUT LOCATIONS

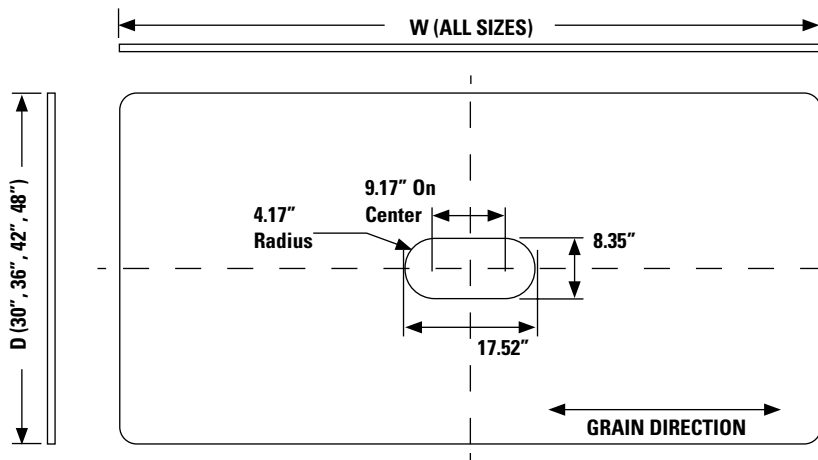

NOTES:

1. **O2, OS** cut-out for SCTAPT + SCTAPR power accessories.
2. Cut-out not available for 18" and 24" deep tables.
3. Cut-out position **O2** available only.
4. These rules apply to both small and large radius table tops. Small radius top shown.

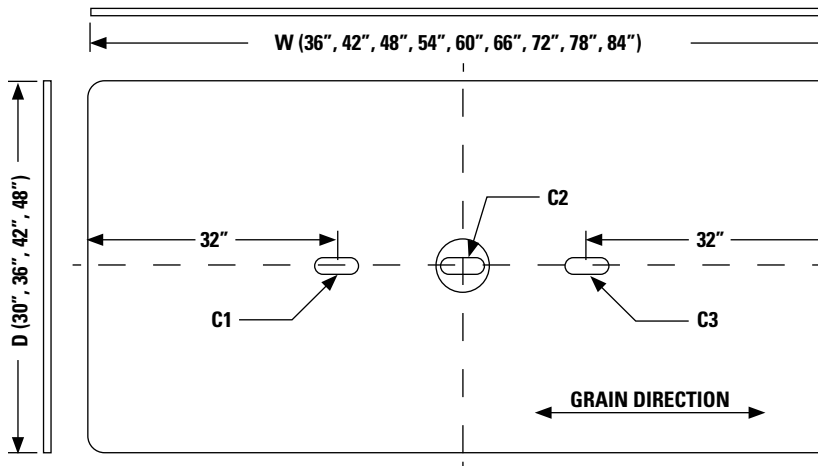

NOTES:

1. **C1, C2, C3, CS** cut-out for SCTAPS + SCTAPR power accessories.
2. Cut-out not available for 18" and 24" deep tables.
3. **C2** cut-outs available on all table widths.
4. **C1** and **C3** cut-outs only available on 90" + 96"w tables.
5. These rules apply to both small and large radius table tops. Small radius top shown.

COLLABORATION TABLES - 29"H

MODEL#	DIMENSIONS D x W x H	FREIGHT CLASS	WT/LBS.	CUBIC FT.	LIST PRICE	HP ADD
SCTWD1836	18 x 36 x 29	70	35.54	2.33	\$713	\$84
SCTWD1842	18 x 42 x 29	70	38.52	2.52	\$741	\$102
SCTWD1848	18 x 48 x 29	70	47.05	2.71	\$820	\$116
SCTWD1854	18 x 54 x 29	70	50.88	2.9	\$857	\$130
SCTWD1860	18 x 60 x 29	70	54.7	3.08	\$889	\$195
SCTWD1866	18 x 66 x 29	70	58.52	3.27	\$931	\$218
SCTWD1872	18 x 72 x 29	70	62.34	3.46	\$973	\$236
SCTWD2436	24 x 36 x 29	85	41.51	3.11	\$764	\$116
SCTWD2442	24 x 42 x 29	85	45.49	3.36	\$801	\$135
SCTWD2448	24 x 48 x 29	70	55.02	3.61	\$885	\$153
SCTWD2454	24 x 54 x 29	70	59.83	3.86	\$936	\$171
SCTWD2460	24 x 60 x 29	70	64.65	4.11	\$973	\$254
SCTWD2466	24 x 66 x 29	70	69.46	4.36	\$1024	\$282
SCTWD2472	24 x 72 x 29	70	74.27	4.61	\$1070	\$310
SCTWD3036	30 x 36 x 29	85	47.47	3.89	\$815	\$144
SCTWD3042	30 x 42 x 29	85	52.45	4.2	\$862	\$166
SCTWD3048	30 x 48 x 29	85	62.98	4.51	\$954	\$190
SCTWD3054	30 x 54 x 29	85	68.78	4.83	\$1010	\$213
SCTWD3060	30 x 60 x 29	85	74.59	5.14	\$1056	\$319
SCTWD3066	30 x 66 x 29	85	80.4	5.45	\$1112	\$351
SCTWD3072	30 x 72 x 29	60	86.2	2.76	\$1167	\$384

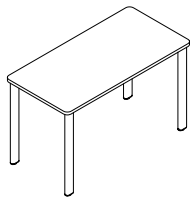

**Core Collaboration Table, 29"H,
Small Radius, Levelers**

Consists of four individual legs and one surface with a small 1.5" radius at each corner.

- Worksurface choice of thermally fused or high pressure laminate with PVC edge.
- Legs are painted extruded aluminum. Levelers have 1" adjustment for leveling.
- Tables from 48" to 72" include a center worksurface support beam.
- Center worksurface support beam eliminates the possibility of a power accessory cut-out.

Required specifications

Laminate finish
Edge finish
Paint finish

Optional specifications

HP laminate

Accessories

Table leg cable organizer,
PET felt modesty panel,
Table mounted bag hook,
Nik power modules, PET felt wire manager

COLLABORATION TABLES - 29"H

MODEL#	DIMENSIONS	FREIGHT CLASS	WT./LBS.	CUBIC FT.	LIST PRICE	HP ADD
D x W x H						
SCTWWSL1836	18 x 36 x 29	70	40.05	2.33	\$1088	\$88
SCTWWSL1842	18 x 42 x 29	70	43.65	2.52	\$1158	\$102
SCTWWSL1848	18 x 48 x 29	70	50.15	2.71	\$1380	\$116
SCTWWSL1854	18 x 54 x 29	70	53.75	2.9	\$1413	\$129
SCTWWSL1860	18 x 60 x 29	70	57.34	3.08	\$1468	\$144
SCTWWSL1866	18 x 66 x 29	70	60.93	3.27	\$1500	\$158
SCTWWSL1872	18 x 72 x 29	70	64.52	3.46	\$1575	\$171
SCTWWSL1878	18 x 78 x 29	70	68.12	3.65	\$1607	\$185
SCTWWSL1884	18 x 84 x 29	70	71.71	3.83	\$1639	\$199
SCTWWSL1890	18 x 90 x 29	70	75.31	4.02	\$1760	\$213
SCTWWSL1896	18 x 96 x 29	70	78.9	4.21	\$1788	\$231
SCTWWSL2436	24 x 36 x 29	85	43.05	3.11	\$1172	\$116
SCTWWSL2442	24 x 42 x 29	85	46.65	3.36	\$1250	\$135
SCTWWSL2448	24 x 48 x 29	85	53.15	3.61	\$1477	\$153
SCTWWSL2454	24 x 54 x 29	85	56.75	3.86	\$1519	\$171
SCTWWSL2460	24 x 60 x 29	85	60.34	4.11	\$1584	\$190
SCTWWSL2466	24 x 66 x 29	85	63.93	4.36	\$1621	\$208
SCTWWSL2472	24 x 72 x 29	85	67.52	4.61	\$1704	\$227
SCTWWSL2478	24 x 78 x 29	85	71.12	4.86	\$1741	\$250
SCTWWSL2484	24 x 84 x 29	85	74.71	5.11	\$1778	\$269
SCTWWSL2490	24 x 90 x 29	85	78.31	5.36	\$1908	\$287
SCTWWSL2496	24 x 96 x 29	85	81.9	5.61	\$1945	\$305
SCTWWSL3036	30 x 36 x 29	92.5	46.05	3.89	\$1408	\$143
SCTWWSL3042	30 x 42 x 29	92.5	49.65	4.2	\$1533	\$167
SCTWWSL3048	30 x 48 x 29	85	56.15	4.51	\$1797	\$190
SCTWWSL3054	30 x 54 x 29	85	59.75	4.83	\$1843	\$213
SCTWWSL3060	30 x 60 x 29	85	63.34	5.14	\$1940	\$241
SCTWWSL3066	30 x 66 x 29	85	66.93	5.45	\$1987	\$263
SCTWWSL3072	30 x 72 x 29	85	70.52	5.76	\$2121	\$287
SCTWWSL3078	30 x 78 x 29	85	74.12	6.08	\$2190	\$310
SCTWWSL3084	30 x 84 x 29	92.5	77.71	6.7	\$2237	\$333
SCTWWSL3090	30 x 90 x 29	85	81.31	6.39	\$2459	\$356
SCTWWSL3096	30 x 96 x 29	85	84.9	7.01	\$2505	\$380

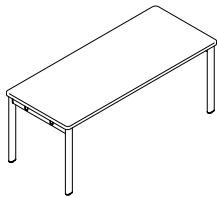

Standard Collaboration Table, 29"H, Small Radius, Levelers

Consists of two leg assemblies, worksurface support beams, and worksurface with a small 1.5" radius at each corner.

- Worksurface choice of thermally fused or high pressure laminate with PVC edge.
- Legs are painted extruded aluminum. Levelers have 1" adjustment for leveling.
- Cut-outs for power modules are limited to specific sizes/configurations, please see "Power Accessory Cut-out Locations".
- 18" and 24" deep tables feature one worksurface support beam.
- 30" deep tables feature two worksurface support beams.

Required specifications

Laminate finish
Edge finish
Paint finish

Optional specifications

HP laminate
Power accessory cut-out

Accessories

Table leg cable organizer,
PET felt modesty panel,
Table mounted bag hook,
Nik power modules, PET felt wire manager

COLLABORATION TABLES - 36" CAFE HEIGHT

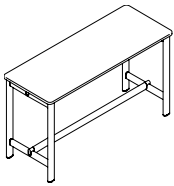

For 18" and 24"D surfaces

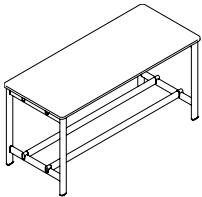

For 30"D tables, 36" to 72"W

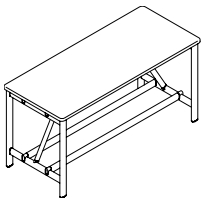

For 30"D tables, 78" to 96"W

Café Height Collaboration Table, 36"H, Small Radius, Levelers

MODEL#	DIMENSIONS D x W x H	FREIGHT CLASS	WT/LBS.	CUBIC FT.	LIST PRICE	HP ADD
SCTCSL1836	18 x 36 x 36	70	50.14	2.33	\$1547	\$88
SCTCSL1842	18 x 42 x 36	70	54.34	2.52	\$1658	\$102
SCTCSL1848	18 x 48 x 36	65	61.46	2.71	\$1880	\$111
SCTCSL1854	18 x 54 x 36	65	65.66	2.9	\$1908	\$130
SCTCSL1860	18 x 60 x 36	65	69.87	3.08	\$1996	\$139
SCTCSL1866	18 x 66 x 36	65	74.07	3.27	\$2024	\$157
SCTCSL1872	18 x 72 x 36	65	78.28	3.46	\$2144	\$171
SCTCSL1878	18 x 78 x 36	65	82.48	3.65	\$2176	\$186
SCTCSL1884	18 x 84 x 36	65	86.69	3.83	\$2204	\$204
SCTCSL1890	18 x 90 x 36	65	90.9	4.02	\$2417	\$213
SCTCSL1896	18 x 96 x 36	65	95.1	4.21	\$2445	\$231
SCTCSL2436	24 x 36 x 36	70	67.83	3.11	\$1658	\$116
SCTCSL2442	24 x 42 x 36	70	74.58	3.36	\$1778	\$135
SCTCSL2448	24 x 48 x 36	65	84.23	3.61	\$2005	\$153
SCTCSL2454	24 x 54 x 36	65	90.98	3.86	\$2042	\$171
SCTCSL2460	24 x 60 x 36	65	97.73	4.11	\$2135	\$190
SCTCSL2466	24 x 66 x 36	65	104.48	4.36	\$2172	\$213
SCTCSL2472	24 x 72 x 36	65	111.23	4.61	\$2301	\$227
SCTCSL2478	24 x 78 x 36	65	117.98	4.86	\$2338	\$250
SCTCSL2484	24 x 84 x 36	65	124.73	5.11	\$2375	\$269
SCTCSL2490	24 x 90 x 36	65	131.48	5.36	\$2593	\$287
SCTCSL2496	24 x 96 x 36	65	138.23	5.61	\$2635	\$301
SCTCSL3036	30 x 36 x 36	70	86.09	3.89	\$2079	\$144
SCTCSL3042	30 x 42 x 36	65	95.44	4.2	\$2288	\$166
SCTCSL3048	30 x 48 x 36	65	107.7	4.51	\$2519	\$194
SCTCSL3054	30 x 54 x 36	65	117.05	4.83	\$2565	\$218
SCTCSL3060	30 x 60 x 36	65	126.41	5.14	\$2718	\$241
SCTCSL3066	30 x 66 x 36	65	135.76	5.45	\$2764	\$264
SCTCSL3072	30 x 72 x 36	65	145.11	5.76	\$2991	\$283
SCTCSL3078	30 x 78 x 36	65	156.91	6.08	\$3209	\$310
SCTCSL3084	30 x 84 x 36	65	166.26	6.7	\$3255	\$333
SCTCSL3090	30 x 90 x 36	65	175.62	6.39	\$3658	\$356
SCTCSL3096	30 x 96 x 36	65	184.97	7.01	\$3704	\$380

Consists of two leg assemblies, worksurface support beam(s), footrest(s), and one worksurface with a small 1.5" radius at each corner.

- Worksurface choice of thermally fused or high pressure laminate with PVC edge.
- Legs are painted extruded aluminum. Levelers have 1" adjustment for leveling.
- Cut-outs for power modules are limited to specific sizes/configurations, please see "Power Accessory Cut-out Locations".
- 18" and 24" deep tables feature one worksurface support beam and one footrest.
- 30" deep tables feature two worksurface support beams and two footrests.
- 30" deep tables 78" wide and greater include a reinforcement cantilever for added stability.

Required specifications

Laminate finish
Edge finish
Paint finish

Optional specifications

HP laminate
Power accessory cut-out

Accessories

Table leg cable organizer,
PET felt modesty panel,
Table mounted bag hook,
Nik power modules, PET felt wire manager

COLLABORATION TABLES - 42" BAR HEIGHT

MODEL#	DIMENSIONS	FREIGHT CLASS	WT/LBS.	CUBIC FT.	LIST PRICE	HP ADD
D x W x H						
SCTBSL1836	18 x 36 x 42	65	70.28	3.11	\$1672	\$83
SCTBSL1842	18 x 42 x 42	65	77.02	3.36	\$1783	\$97
SCTBSL1848	18 x 48 x 42	65	86.68	3.61	\$2000	\$116
SCTBSL1854	18 x 54 x 42	65	93.43	3.86	\$2033	\$130
SCTBSL1860	18 x 60 x 42	65	100.18	4.11	\$2116	\$144
SCTBSL1866	18 x 66 x 42	65	106.93	4.36	\$2149	\$157
SCTBSL1872	18 x 72 x 42	65	113.68	4.61	\$2269	\$171
SCTBSL1878	18 x 78 x 42	65	120.43	4.86	\$2297	\$185
SCTBSL1884	18 x 84 x 42	65	127.18	5.11	\$2329	\$199
SCTBSL1890	18 x 90 x 42	65	133.93	5.36	\$2538	\$212
SCTBSL1896	18 x 96 x 42	65	140.67	5.61	\$2570	\$227
SCTBSL2436	24 x 36 x 42	65	52.58	2.33	\$1783	\$116
SCTBSL2442	24 x 42 x 42	65	56.79	2.52	\$1903	\$130
SCTBSL2448	24 x 48 x 42	65	63.9	2.71	\$2130	\$153
SCTBSL2454	24 x 54 x 42	65	68.11	2.9	\$2167	\$171
SCTBSL2460	24 x 60 x 42	65	72.31	3.08	\$2260	\$190
SCTBSL2466	24 x 66 x 42	65	76.52	3.27	\$2297	\$208
SCTBSL2472	24 x 72 x 42	65	80.72	3.46	\$2422	\$231
SCTBSL2478	24 x 78 x 42	65	84.93	3.65	\$2463	\$246
SCTBSL2484	24 x 84 x 42	65	89.13	3.83	\$2500	\$269
SCTBSL2490	24 x 90 x 42	65	93.34	4.02	\$2718	\$287
SCTBSL2496	24 x 96 x 42	65	97.55	4.21	\$2755	\$306
SCTBSL3036	30 x 36 x 42	65	88.53	3.89	\$2204	\$139
SCTBSL3042	30 x 42 x 42	65	97.89	4.2	\$2408	\$167
SCTBSL3048	30 x 48 x 42	65	110.14	4.51	\$2644	\$190
SCTBSL3054	30 x 54 x 42	65	117.05	4.83	\$2690	\$213
SCTBSL3060	30 x 60 x 42	65	126.41	5.14	\$2843	\$236
SCTBSL3066	30 x 66 x 42	65	135.76	5.45	\$2889	\$260
SCTBSL3072	30 x 72 x 42	65	145.11	5.76	\$3112	\$287
SCTBSL3078	30 x 78 x 42	65	159.35	6.08	\$3334	\$310
SCTBSL3084	30 x 84 x 42	65	168.71	6.7	\$3380	\$333
SCTBSL3090	30 x 90 x 42	65	178.06	6.39	\$3783	\$356
SCTBSL3096	30 x 96 x 42	65	187.41	7.01	\$3829	\$380

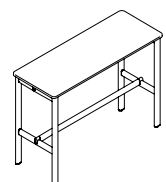

For 18" and 24"D surfaces

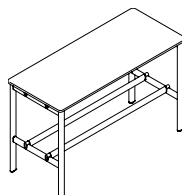

For 30"D tables, 36" to 72"W

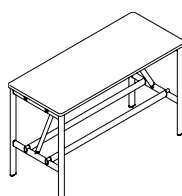

For 30"D tables, 78" to 96"W

Bar Height Collaboration Table, 42"H, Small Radius, Levelers

Consists of two leg assemblies, worksurface support beam(s), footrest(s), and one worksurface with a small 1.5" radius at each corner.

- Worksurface choice of thermally fused or high pressure laminate with PVC edge.
- Legs are painted extruded aluminum. Levelers have 1" adjustment for leveling.
- Cut-outs for power modules are limited to specific sizes/configurations, please see "Power Accessory Cut-out Locations".
- 18" and 24" deep tables feature one worksurface support beam and one footrest.
- 30" deep tables feature two worksurface support beams and two footrests.
- 30" deep tables 78" wide and greater include a reinforcement cantilever for added stability.

Required specifications

Laminate finish
Edge finish
Paint finish

Optional specifications

HP laminate
Power accessory cut-out

Accessories

Table leg cable organizer,
PET felt modesty panel,
Table mounted bag hook,
Nik power modules, PET felt wire manager

WORKSHOP TABLES - 29" H

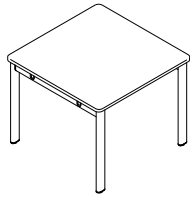

**Workshop Table, 29" H,
Small Radius, Levelers**

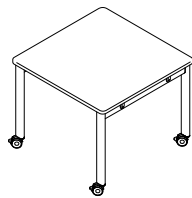

**Workshop Table, 29" H,
Small Radius, Casters***

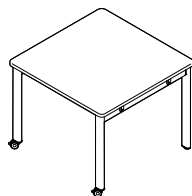

**Workshop Table, 29" H,
Small Radius, Casters/Levelers***

MODEL#	DIMENSIONS D x W x H	FREIGHT CLASS	WT./LBS.	CUBIC FT.	LIST PRICE	HP ADD
SCTSWSL3636	36 x 36 x 29	70	79.31	4.67	\$1496	\$171
SCTSWSL3642	36 x 42 x 29	70	88.73	5.04	\$1681	\$204
SCTSWSL3648	36 x 48 x 29	70	101.24	5.42	\$1899	\$226
SCTSWSL3654	36 x 54 x 29	70	110.76	5.79	\$1950	\$259
SCTSWSL3660	36 x 60 x 29	70	120.27	6.17	\$2056	\$287
SCTSWSL4242	42 x 42 x 29	70	99.72	5.88	\$1713	\$237
SCTSWSL4248	42 x 48 x 29	70	113.52	6.32	\$1991	\$269
SCTSWSL4254	42 x 54 x 29	70	124.41	6.76	\$2051	\$301
SCTSWSL4260	42 x 60 x 29	70	135.31	7.19	\$2167	\$333
SCTSWSL4848	48 x 48 x 29	70	125.8	7.22	\$2098	\$301
SCTSWSL4854	48 x 54 x 29	70	138.07	7.72	\$2163	\$342
SCTSWSL4860	48 x 60 x 29	70	150.35	8.22	\$2283	\$384

Consists of two leg assemblies, two worksurface support beams, and one worksurface with a small 1.5" radius at each corner.

- Worksurface choice of thermally fused or high pressure laminate with PVC edge.
- Legs are painted extruded aluminum. Levelers have 1" adjustment for leveling.
- Cut-outs for power modules are limited to specific sizes/configurations, please see "Power Accessory Cut-out Locations".

SCTSWSC3636	36 x 36 x 29	70	79.4	4.67	\$1760	\$171
SCTSWSC3642	36 x 42 x 29	70	88.92	5.04	\$1889	\$204
SCTSWSC3648	36 x 48 x 29	70	101.33	5.42	\$2107	\$227
SCTSWSC3654	36 x 54 x 29	70	110.85	5.79	\$2158	\$259
SCTSWSC3660	36 x 60 x 29	70	120.36	6.17	\$2264	\$287
SCTSWSC4242	42 x 42 x 29	70	99.81	5.88	\$1977	\$232
SCTSWSC4248	42 x 48 x 29	70	113.61	6.32	\$2200	\$268
SCTSWSC4254	42 x 54 x 29	70	124.5	6.76	\$2260	\$304
SCTSWSC4260	42 x 60 x 29	70	135.4	7.19	\$2375	\$334
SCTSWSC4848	48 x 48 x 29	70	125.89	7.22	\$2301	\$306
SCTSWSC4854	48 x 54 x 29	70	138.16	7.72	\$2371	\$342
SCTSWSC4860	48 x 60 x 29	70	150.44	8.22	\$2491	\$384

Consists of two leg assemblies, two worksurface support beams, and one worksurface with a small 1.5" radius at each corner.

- Worksurface choice of thermally fused or high pressure laminate with PVC edge.
- Legs are painted extruded aluminum. Casters are lockable, in a choice of two finishes - Black (**BLK**) or Grey (**GRC**).
- Cut-outs for power modules are limited to specific sizes/configurations, please see "Power Accessory Cut-out Locations".

SCTSWSX3636	36 x 36 x 29	70	79.36	4.67	\$1625	\$172
SCTSWSX3642	36 x 42 x 29	70	88.87	5.04	\$1760	\$199
SCTSWSX3648	36 x 48 x 29	70	101.29	5.42	\$2005	\$227
SCTSWSX3654	36 x 54 x 29	70	110.8	5.79	\$2056	\$259
SCTSWSX3660	36 x 60 x 29	70	120.31	6.17	\$2163	\$287
SCTSWSX4242	42 x 42 x 29	70	99.77	5.88	\$1848	\$231
SCTSWSX4248	42 x 48 x 29	70	113.56	6.32	\$2098	\$264
SCTSWSX4254	42 x 54 x 29	70	124.46	6.76	\$2158	\$301
SCTSWSX4260	42 x 60 x 29	70	135.36	7.19	\$2269	\$333
SCTSWSX4848	48 x 48 x 29	70	125.71	7.22	\$2200	\$305
SCTSWSX4854	48 x 54 x 29	70	137.99	7.72	\$2269	\$343
SCTSWSX4860	48 x 60 x 29	70	150.27	8.22	\$2389	\$380

Consists of one leg assembly with casters, one leg assembly with levelers, two worksurface support beams, and one worksurface with a small 1.5" radius at each corner.

- Worksurface choice of thermally fused or high pressure laminate with PVC edge.
- Legs are painted extruded aluminum. Casters are lockable, in a choice of two finishes - Black (**BLK**) or Grey (**GRC**). Levelers have 1" adjustment for leveling.
- Cut-outs for power modules are limited to specific sizes/configurations, please see "Power Accessory Cut-out Locations".

Required specifications

Laminate finish
Edge finish
Paint finish
Caster finish*

Optional specifications

HP laminate
Grommet option

Accessories

Table leg cable organizer
Table mounted bag hook
Nik power modules
PET felt wire manager

LARGE COLLABORATION TABLES - 29"H	MODEL#	DIMENSIONS	FREIGHT CLASS	WT/LBS.	CUBIC FT.	LIST PRICE	HP ADD
-----------------------------------	--------	------------	---------------	---------	-----------	------------	--------

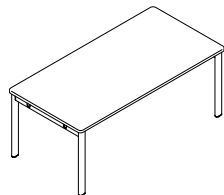

Large Collaboration Table, 29"H, Small Radius, Levelers

D x W x H							
SCTLWLSL3666	36 x 66 x 29	70	129.78	6.54	\$2112	\$314	
SCTLWLSL3672	36 x 72 x 29	70	139.3	6.92	\$2255	\$343	
SCTLWLSL3678	36 x 78 x 29	70	148.81	7.29	\$2329	\$371	
SCTLWLSL3684	36 x 84 x 29	70	158.32	7.67	\$2380	\$403	
SCTLWLSL3690	36 x 90 x 29	70	167.84	8.04	\$2612	\$430	
SCTLWLSL3696	36 x 96 x 29	70	177.35	8.42	\$2667	\$458	
SCTLWLSL4266	42 x 66 x 29	70	146.21	7.63	\$2227	\$366	
SCTLWLSL4272	42 x 72 x 29	70	127.1	8.07	\$2375	\$403	
SCTLWLSL4278	42 x 78 x 29	70	168	8.51	\$2459	\$435	
SCTLWLSL4284	42 x 84 x 29	70	178.89	8.94	\$2519	\$468	
SCTLWLSL4290	42 x 90 x 29	70	189.79	9.38	\$2760	\$500	
SCTLWLSL4296	42 x 96 x 29	70	200.68	9.82	\$2820	\$532	
SCTLWLSL4866	48 x 66 x 29	70	162.63	8.72	\$2352	\$422	
SCTLWLSL4872	48 x 72 x 29	70	174.91	9.22	\$2510	\$458	
SCTLWLSL4878	48 x 78 x 29	70	187.18	9.72	\$2598	\$495	
SCTLWLSL4884	48 x 84 x 29	70	199.46	10.22	\$2667	\$533	
SCTLWLSL4890	48 x 90 x 29	70	211.74	10.72	\$2913	\$574	
SCTLWLSL4896	48 x 96 x 29	70	224.01	11.22	\$2982	\$611	

Consists of two leg assemblies, two worksurface support beams, and one worksurface with a small 1.5" radius at each corner.

- Worksurface choice of thermally fused or high pressure laminate with PVC edge.
- Legs are painted extruded aluminum. Levelers have 1" adjustment for leveling.
- Cut-outs for power modules are limited to specific sizes/configurations, please see "Power Accessory Cut-out Locations".

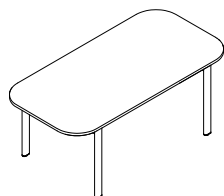

Large Collaboration Table, 29"H, Large Radius, Levelers

SCTLWLL3666	36 x 66 x 29	70	123.52	6.54	\$2056	\$315	
SCTLWLL3672	36 x 72 x 29	70	133.03	6.92	\$2112	\$342	
SCTLWLL3678	36 x 78 x 29	70	142.55	7.29	\$2218	\$370	
SCTLWLL3684	36 x 84 x 29	70	152.06	7.67	\$2269	\$403	
SCTLWLL3690	36 x 90 x 29	70	161.57	8.04	\$2413	\$430	
SCTLWLL3696	36 x 96 x 29	70	171.09	8.42	\$2487	\$458	
SCTLWLL4266	42 x 66 x 29	70	139.94	7.63	\$2172	\$370	
SCTLWLL4272	42 x 72 x 29	70	150.84	8.07	\$2232	\$403	
SCTLWLL4278	42 x 78 x 29	70	161.73	8.51	\$2348	\$435	
SCTLWLL4284	42 x 84 x 29	70	172.63	8.94	\$2408	\$467	
SCTLWLL4290	42 x 90 x 29	70	183.52	9.38	\$2556	\$500	
SCTLWLL4296	42 x 96 x 29	70	194.42	9.82	\$2616	\$533	
SCTLWLL4866	48 x 66 x 29	70	156.37	8.72	\$2297	\$421	
SCTLWLL4872	48 x 72 x 29	70	168.64	9.22	\$2366	\$459	
SCTLWLL4878	48 x 78 x 29	70	180.92	9.72	\$2487	\$495	
SCTLWLL4884	48 x 84 x 29	70	193.2	10.22	\$2556	\$532	
SCTLWLL4890	48 x 90 x 29	70	205.48	10.72	\$2713	\$570	
SCTLWLL4896	48 x 96 x 29	70	217.75	11.22	\$2801	\$612	

Consists of two leg assemblies, two worksurface support beams, and one worksurface with a large 9" radius at each corner with 10.5" overhang on each end.

- Worksurface choice of thermally fused or high pressure laminate with PVC edge.
- Legs are painted extruded aluminum. Levelers have 1" adjustment for leveling.
- Cut-outs for power modules are limited to specific sizes/configurations, please see "Power Accessory Cut-out Locations".
- Large radius tables are not compatible with SCTAMxx and SCTAMTx Media Units.

Required specifications

Laminate finish
Edge finish
Paint finish

Optional specifications

HP laminate
Power accessory cut-out

Accessories

Collaboration table media unit,
Table leg cable organizer,
Table mounted bag hook,
Nik power modules, PET felt wire manager

LARGE COLLABORATION TABLES - 29"H

MODEL# DIMENSIONS FREIGHT CLASS WT/LBS. CUBIC FT. LIST PRICE HP ADD

D x W x H

SCTLWSC3666	36 x 66 x 29	70	129.87	6.54	\$2320	\$315
SCTLWSC3672	36 x 72 x 29	70	139.39	6.92	\$2463	\$343
SCTLWSC3678	36 x 78 x 29	70	148.9	7.29	\$2538	\$370
SCTLWSC3684	36 x 84 x 29	70	158.41	7.67	\$2588	\$403
SCTLWSC3690	36 x 90 x 29	70	167.93	8.04	\$2820	\$430
SCTLWSC3696	36 x 96 x 29	70	177.44	8.42	\$2875	\$459
SCTLWSC4266	42 x 66 x 29	70	146.3	7.63	\$2436	\$365
SCTLWSC4272	42 x 72 x 29	70	157.19	8.07	\$2584	\$403
SCTLWSC4278	42 x 78 x 29	70	168.09	8.51	\$2667	\$435
SCTLWSC4284	42 x 84 x 29	70	178.98	8.94	\$2727	\$468
SCTLWSC4290	42 x 90 x 29	70	189.88	9.38	\$2968	\$500
SCTLWSC4296	42 x 96 x 29	70	200.77	9.82	\$2792	\$537
SCTLWSC4866	48 x 66 x 29	70	162.72	8.72	\$2561	\$421
SCTLWSC4872	48 x 72 x 29	70	175	9.22	\$2718	\$458
SCTLWSC4878	48 x 78 x 29	70	187.27	9.22	\$2806	\$495
SCTLWSC4884	48 x 84 x 29	70	199.55	10.22	\$2875	\$533
SCTLWSC4890	48 x 90 x 29	70	211.83	10.72	\$3121	\$574
SCTLWSC4896	48 x 96 x 29	70	224.1	11.22	\$3190	\$611

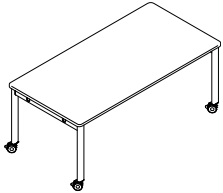

Large Collaboration Table, 29"H, Small Radius, Casters*

- Consists of two leg assemblies, two worksurface support beams, and one worksurface with a small 1.5" radius at each corner.
- Worksurface choice of thermally fused or high pressure laminate with PVC edge.
 - Legs are painted extruded aluminum. Casters are lockable, in a choice of two finishes - Black (**BLK**) or Grey (**GRC**).
 - Cut-outs for power modules are limited to specific sizes/configurations, please see "Power Accessory Cut-out Locations".

SCTLWLC3666	36 x 66 x 29	70	123.61	6.54	\$2264	\$315
SCTLWLC3672	36 x 72 x 29	70	133.12	6.92	\$2320	\$343
SCTLWLC3678	36 x 78 x 29	70	142.64	7.29	\$2426	\$371
SCTLWLC3684	36 x 84 x 29	70	152.15	7.67	\$2477	\$403
SCTLWLC3690	36 x 90 x 29	70	161.66	8.04	\$2621	\$430
SCTLWLC3696	36 x 96 x 29	70	171.18	8.42	\$2695	\$458
SCTLWLC4266	42 x 66 x 29	70	140.03	7.63	\$2380	\$370
SCTLWLC4272	42 x 72 x 29	70	150.93	8.07	\$2440	\$403
SCTLWLC4278	42 x 78 x 29	70	161.82	8.51	\$2556	\$435
SCTLWLC4284	42 x 84 x 29	70	172.72	8.94	\$2616	\$468
SCTLWLC4290	42 x 90 x 29	70	183.62	9.38	\$2764	\$500
SCTLWLC4296	42 x 96 x 29	70	194.51	9.82	\$2848	\$532
SCTLWLC4866	48 x 66 x 29	70	156.46	8.72	\$2505	\$421
SCTLWLC4872	48 x 72 x 29	70	168.73	9.22	\$2575	\$458
SCTLWLC4878	48 x 78 x 29	70	181.01	9.72	\$2695	\$495
SCTLWLC4884	48 x 84 x 29	70	193.29	10.22	\$2764	\$533
SCTLWLC4890	48 x 90 x 29	70	205.57	10.72	\$2922	\$569
SCTLWLC4896	48 x 96 x 29	70	217.84	11.22	\$3010	\$611

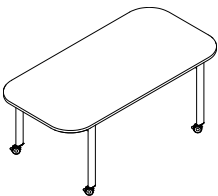

Large Collaboration Table, 29"H, Large Radius, Casters

- Consists of two leg assemblies, two worksurface support beams, and one worksurface with a large 9" radius at each corner with 10.5" overhang on each end.
- Worksurface choice of thermally fused or high pressure laminate with PVC edge.
 - Legs are painted extruded aluminum. Casters are lockable, in a choice of two finishes - Black (**BLK**) or Grey (**GRC**).
 - Cut-outs for power modules are limited to specific sizes/configurations, please see "Power Accessory Cut-out Locations".
 - *Large radius tables are not compatible with SCTAMxx and SCTAMTx Media Units.*

Required specifications

Laminate finish
Edge finish
Paint finish
Caster finish

Optional specifications

HP laminate
Grommet option

Accessories

Collaboration table media unit*, Table leg cable organizer, PET felt modesty panel, Table mounted bag hook, Nik power modules, PET felt wire manager

WORKSHOP TABLES - 36"H

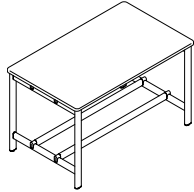

Café Height Workshop Table, 36"H
Small Radius, Levelers

MODEL#	DIMENSIONS	FREIGHT CLASS	WT/LBS.	CUBIC FT.	LIST PRICE	HP ADD
D x W x H						
SCTSCSL3636	36 x 36 x 36	70	96.82	5.67	\$2200	\$171
SCTSCSL3642	36 x 42 x 36	70	107.56	6.21	\$2413	\$203
SCTSCSL3648	36 x 48 x 36	70	121.2	6.75	\$2658	\$227
SCTSCSL3654	36 x 54 x 36	70	131.93	7.29	\$2709	\$259
SCTSCSL3660	36 x 60 x 36	70	142.67	7.83	\$2871	\$287
SCTSCSL4242	42 x 42 x 36	70	119.68	7.05	\$2473	\$236
SCTSCSL4248	42 x 48 x 36	70	134.7	7.65	\$2774	\$268
SCTSCSL4254	42 x 54 x 36	70	146.81	8.26	\$2834	\$301
SCTSCSL4260	42 x 60 x 36	70	158.93	8.86	\$3005	\$333
SCTSCSL4848	48 x 48 x 36	70	148.2	8.56	\$2913	\$305
SCTSCSL4854	48 x 54 x 36	70	161.7	9.22	\$2982	\$343
SCTSCSL4860	48 x 60 x 36	70	175.2	9.89	\$3158	\$380

Consists of two leg assemblies, two worksurface support beams, dual footrests and one worksurface with a small 1.5" radius at each corner.

- Worksurface choice of thermally fused or high pressure laminate with PVC edge.
- Legs are painted extruded aluminum. Levelers have 1" adjustment for leveling.
- Cut-outs for power modules are limited to specific sizes/configurations, please see "Power Accessory Cut-out Locations".

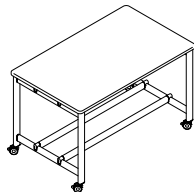

Café Height Workshop Table, 36"H
Small Radius, Casters*

SCTSCSC3636	36 x 36 x 36	70	96.66	5.67	\$2440	\$172
SCTSCSC3642	36 x 42 x 36	70	107.39	6.21	\$2653	\$199
SCTSCSC3648	36 x 48 x 36	70	107.39	6.21	\$2894	\$231
SCTSCSC3654	36 x 54 x 36	70	131.77	7.29	\$2950	\$254
SCTSCSC3660	36 x 60 x 36	70	142.5	7.83	\$3107	\$287
SCTSCSC4242	42 x 42 x 36	70	119.51	7.05	\$2764	\$232
SCTSCSC4248	42 x 48 x 36	70	134.53	7.65	\$3014	\$264
SCTSCSC4254	42 x 54 x 36	70	146.65	8.26	\$3075	\$300
SCTSCSC4260	42 x 60 x 36	70	158.77	8.86	\$3241	\$334
SCTSCSC4848	48 x 48 x 36	70	148.03	8.56	\$3153	\$306
SCTSCSC4854	48 x 54 x 36	70	161.53	9.22	\$3218	\$347
SCTSCSC4860	48 x 60 x 36	70	175.03	9.89	\$3394	\$384

Consists of two leg assemblies, two worksurface support beams, dual footrests and one worksurface with a small 1.5" radius at each corner.

- Worksurface choice of thermally fused or high pressure laminate with PVC edge.
- Legs are painted extruded aluminum. Casters are lockable, in a choice of two finishes - Black (**BLK**) or Grey (**GRC**).
- Cut-outs for power modules are limited to specific sizes/configurations, please see "Power Accessory Cut-out Locations".

Required specifications

Laminate finish
Edge finish
Paint finish
Caster finish*

Optional specifications

HP laminate
Grommet option

Accessories

Collaboration table media unit, Table leg cable organizer, PET felt modesty panel, Wire mesh storage tray, Table mounted bag hook, Nik power modules, PET felt wire manager

LARGE COLLABORATION TABLES - 36"

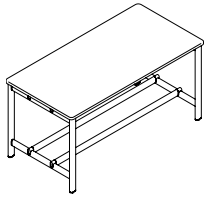

For 66" and 72"W tables

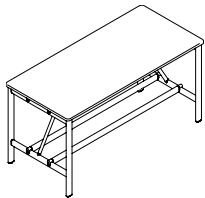

For 78" to 96"W tables

Large Café Height Collaboration Table, 36"H, Small Radius, Levelers*

MODEL#	DIMENSIONS D x W x H	FREIGHT CLASS	WT/LBS.	CUBIC FT.	LIST PRICE	HP ADD
SCTLCSL3666	36 x 66 x 36	70	153.4	8.38	\$2922	\$315
SCTLCSL3672	36 x 72 x 36	70	164.14	8.92	\$3153	\$343
SCTLCSL3678	36 x 78 x 36	70	177.32	9.46	\$3385	\$370
SCTLCSL3684	36 x 84 x 36	70	188.05	10	\$3436	\$402
SCTLCSL3690	36 x 90 x 36	70	198.79	10.54	\$3848	\$426
SCTLCSL3696	36 x 96 x 36	70	209.52	11.08	\$3899	\$458
SCTLCSL4266	42 x 66 x 36	70	171.05	9.47	\$3065	\$366
SCTLCSL4272	42 x 72 x 36	70	183.17	10.07	\$3301	\$403
SCTLCSL4278	42 x 78 x 36	70	197.73	10.67	\$3538	\$435
SCTLCSL4284	42 x 84 x 36	70	209.84	11.28	\$3598	\$467
SCTLCSL4290	42 x 90 x 36	70	221.96	11.88	\$4019	\$500
SCTLCSL4296	42 x 96 x 36	70	234.08	12.49	\$4079	\$533
SCTLCSL4866	48 x 66 x 36	70	188.69	10.56	\$3227	\$417
SCTLCSL4872	48 x 72 x 36	70	202.19	11.22	\$3473	\$458
SCTLCSL4878	48 x 78 x 36	70	218.14	11.89	\$3713	\$496
SCTLCSL4884	48 x 84 x 36	70	231.63	12.56	\$3783	\$532
SCTLCSL4890	48 x 90 x 36	70	245.13	13.22	\$4209	\$569
SCTLCSL4896	48 x 96 x 36	70	258.63	13.89	\$4274	\$611

Consists of two leg assemblies, two worksurface support beams, dual footrests, and one worksurface with a small 1.5" radius at each corner.

- Worksurface choice of thermally fused or high pressure laminate with PVC edge.
- Legs are painted extruded aluminum. Levelers have 1" adjustment for leveling.
- Cut-outs for power modules are limited to specific sizes/configurations, please see "Power Accessory Cut-out Locations".
- Tables 78" wide and greater include a reinforcement cantilever for added stability.

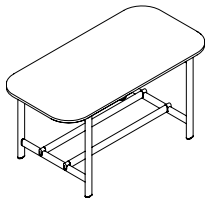

For 66" and 72"W tables

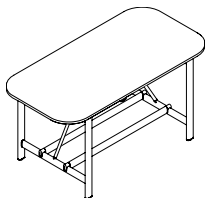

For 78" to 96"W tables

Large Café Height Collaboration Table, 36"H, Large Radius, Levelers

SCTLCLL3666	36 x 66 x 36	70	143.48	8.38	\$2815	\$315
SCTLCLL3672	36 x 72 x 36	70	154.21	8.92	\$2866	\$347
SCTLCLL3678	36 x 78 x 36	70	164.95	9.46	\$3028	\$371
SCTLCLL3684	36 x 84 x 36	70	175.68	10	\$3084	\$398
SCTLCLL3690	36 x 90 x 36	70	186.42	10.54	\$3315	\$426
SCTLCLL3696	36 x 96 x 36	70	199.6	11.08	\$3542	\$458
SCTLCLL4266	42 x 66 x 36	70	161.12	9.47	\$2959	\$366
SCTLCLL4272	42 x 72 x 36	70	173.24	10.07	\$3019	\$398
SCTLCLL4278	42 x 78 x 36	70	185.36	10.67	\$3186	\$430
SCTLCLL4284	42 x 84 x 36	70	197.47	11.28	\$3246	\$467
SCTLCLL4290	42 x 90 x 36	70	209.59	11.88	\$3482	\$505
SCTLCLL4296	42 x 96 x 36	70	224.15	12.49	\$3297	\$537
SCTLCLL4866	48 x 66 x 36	70	178.77	10.56	\$3116	\$422
SCTLCLL4872	48 x 72 x 36	125	688	99	\$3186	\$458
SCTLCLL4878	48 x 78 x 36	125	726	107	\$3362	\$495
SCTLCLL4884	48 x 84 x 36	70	219.26	12.56	\$3426	\$537
SCTLCLL4890	48 x 90 x 36	70	232.76	13.22	\$3676	\$570
SCTLCLL4896	48 x 96 x 36	70	248.71	13.89	\$3917	\$611

Consists of two leg assemblies, two worksurface support beams, dual footrests, and one worksurface with a large 9" radius at each corner with 10.5" overhang on each end.

- Worksurface choice of thermally fused or high pressure laminate with PVC edge.
- Legs are painted extruded aluminum. Levelers have 1" adjustment for leveling.
- Cut-outs for power modules are limited to specific sizes/configurations, please see "Power Accessory Cut-out Locations".
- Tables 78" wide and greater include a reinforcement cantilever for added stability.
- *Large radius tables are not compatible with SCTAMxx and SCTAMTx Media Units.*

Required specifications

Laminate finish
Edge finish
Paint finish

Optional specifications

HP laminate
Power accessory cut-out

Accessories

Collaboration table media unit*, Table leg cable organizer, PET felt modesty panel, Wire mesh storage tray, Table mounted bag hook, Nik power modules, PET felt wire manager

LARGE COLLABORATION TABLES - 36"

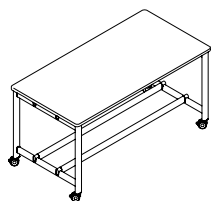

For 66" and 72"W tables

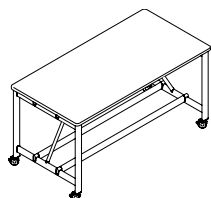

For 78" to 96"W tables

Large Café Height Collaboration Table, 36"H, Small Radius, Casters*

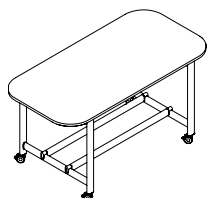

For 66" and 72"W tables

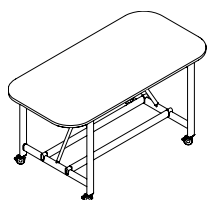

For 78" to 96"W tables

Large Café Height Collaboration Table, 36"H, Large Radius, Casters

MODEL#	DIMENSIONS	FREIGHT CLASS	WT./LBS.	CUBIC FT.	LIST PRICE	HP ADD
D x W x H						
SCTLCSC3666	36 x 66 x 36	70	153.24	8.38	\$3163	\$314
SCTLCSC3672	36 x 72 x 36	70	163.97	8.92	\$3394	\$343
SCTLCSC3678	36 x 78 x 36	70	177.15	9.46	\$3621	\$370
SCTLCSC3684	36 x 84 x 36	70	187.89	10	\$3676	\$399
SCTLCSC3690	36 x 90 x 36	70	198.62	10.54	\$4084	\$430
SCTLCSC3696	36 x 96 x 36	70	209.36	11.08	\$4139	\$454
SCTLCSC4266	42 x 66 x 36	70	170.88	9.47	\$3301	\$366
SCTLCSC4272	42 x 72 x 36	70	183	10.07	\$3542	\$398
SCTLCSC4278	42 x 78 x 36	70	197.56	10.67	\$3778	\$431
SCTLCSC4284	42 x 84 x 36	70	209.68	11.28	\$3838	\$468
SCTLCSC4290	42 x 90 x 36	70	221.8	11.88	\$4255	\$500
SCTLCSC4296	42 x 96 x 36	70	233.91	12.41	\$4315	\$533
SCTLCSC4866	48 x 66 x 36	70	188.53	10.56	\$3463	\$422
SCTLCSC4872	48 x 72 x 36	70	202.03	11.22	\$3709	\$458
SCTLCSC4878	48 x 78 x 36	70	217.97	11.89	\$3954	\$496
SCTLCSC4884	48 x 84 x 36	70	231.47	12.56	\$4019	\$537
SCTLCSC4890	48 x 90 x 36	70	244.97	13.22	\$4445	\$574
SCTLCSC4896	48 x 96 x 36	70	258.47	13.89	\$4514	\$611

Consists of two leg assemblies, two worksurface support beams, dual footrests, and one worksurface with a small 1.5" radius at each corner.

- Worksurface choice of thermally fused or high pressure laminate with PVC edge.
- Legs are painted extruded aluminum. Casters are lockable, in a choice of two finishes - Black (BLK) or Grey (GRC).
- Cut-outs for power modules are limited to specific sizes/configurations, please see "Power Accessory Cut-out Locations".
- Tables 78" wide and greater include a reinforcement cantilever for added stability.

SCTLCLC3666	36 x 66 x 36	70	143.31	8.38	\$3051	\$315
SCTLCLC3672	36 x 72 x 36	70	154.05	8.92	\$3107	\$343
SCTLCLC3678	36 x 78 x 36	70	164.78	9.46	\$3264	\$375
SCTLCLC3684	36 x 84 x 36	70	175.52	10	\$3320	\$398
SCTLCLC3690	36 x 90 x 36	70	186.25	10.54	\$3551	\$431
SCTLCLC3696	36 x 96 x 36	70	199.43	11.08	\$3778	\$459
SCTLCLC4266	42 x 66 x 36	70	160.96	9.47	\$3195	\$366
SCTLCLC4272	42 x 72 x 36	70	173.07	10.07	\$3255	\$398
SCTLCLC4278	42 x 78 x 36	70	185.19	10.67	\$3422	\$435
SCTLCLC4284	42 x 84 x 36	70	197.31	11.28	\$3482	\$468
SCTLCLC4290	42 x 90 x 36	70	209.43	11.88	\$3723	\$500
SCTLCLC4296	42 x 96 x 36	70	223.98	12.49	\$3959	\$532
SCTLCLC4866	48 x 66 x 36	70	178.6	10.56	\$3195	\$417
SCTLCLC4872	48 x 72 x 36	70	192.1	11.22	\$3255	\$458
SCTLCLC4878	48 x 78 x 36	70	205.6	11.89	\$3422	\$495
SCTLCLC4884	48 x 84 x 36	70	219.1	12.56	\$3482	\$533
SCTLCLC4890	48 x 90 x 36	70	232.6	13.22	\$3723	\$574
SCTLCLC4896	48 x 96 x 36	70	248.54	12.89	\$4158	\$611

Consists of two leg assemblies, two worksurface support beams, dual footrests, and one worksurface with a large 9" radius at each corner with 10.5" overhang on each end.

- Worksurface choice of thermally fused or high pressure laminate with PVC edge.
- Legs are painted extruded aluminum. Casters are lockable, in a choice of two finishes - Black (BLK) or Grey (GRC).
- Cut-outs for power modules are limited to specific sizes/configurations, please see "Power Accessory Cut-out Locations".
- Tables 78" wide and greater include a reinforcement cantilever for added stability.
- Large radius tables are not compatible with SCTAMxx and SCTAMTxx Media Units.

Required specifications

Laminate finish
Edge finish
Paint finish
Caster finish

Optional specifications

HP laminate
Power accessory cut-out

Accessories

Collaboration table media unit*, Table leg cable organizer, PET felt modesty panel, Wire mesh storage tray, Table mounted bag hook, Nik power modules, PET felt wire manager

LARGE COLLABORATION TABLES - 42"

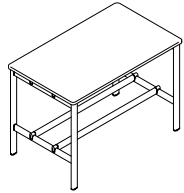

**Bar Height Workshop Table, 42"H
Small Radius, Levelers**

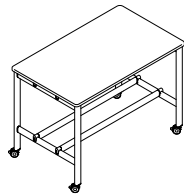

**Bar Height Workshop Table, 42"H
Small Radius, Casters***

MODEL#	DIMENSIONS D x W x H	FREIGHT CLASS	WT/LBS.	CUBIC FT.	LIST PRICE	HP ADD
SCTSBSL3636	36 x 36 x 42	70	99.27	5.67	\$2325	\$171
SCTSBSL3642	36 x 42 x 42	70	110	6.21	\$2538	\$199
SCTSBSL3648	36 x 48 x 42	70	123.64	6.75	\$2778	\$232
SCTSBSL3654	36 x 54 x 42	70	134.38	7.29	\$2834	\$254
SCTSBSL3660	36 x 60 x 42	70	145.11	7.83	\$2991	\$287
SCTSBSL4242	42 x 42 x 42	70	122.12	7.05	\$2649	\$231
SCTSBSL4248	42 x 48 x 42	70	137.14	7.65	\$2899	\$268
SCTSBSL4254	42 x 54 x 42	70	149.26	8.26	\$2959	\$301
SCTSBSL4260	42 x 60 x 42	70	161.38	8.86	\$3125	\$334
SCTSBSL4848	48 x 48 x 42	70	150.64	8.56	\$3038	\$305
SCTSBSL4854	48 x 54 x 42	70	164.14	9.22	\$3107	\$343
SCTSBSL4860	48 x 60 x 42	70	177.64	9.89	\$3278	\$385

Consists of two leg assemblies, two worksurface support beams, dual footrests and one worksurface with a small 1.5" radius at each corner.

- Worksurface choice of thermally fused or high pressure laminate with PVC edge.
- Legs are painted extruded aluminum. Levelers have 1" adjustment for leveling.
- Cut-outs for power modules are limited to specific sizes/configurations, please see "Power Accessory Cut-out Locations".

SCTSBSL3636	36 x 36 x 42	70	99.1	5.67	\$2491	\$172
SCTSBSL3642	36 x 42 x 42	70	109.84	6.21	\$2704	\$199
SCTSBSL3648	36 x 48 x 42	70	123.48	6.75	\$2945	\$231
SCTSBSL3654	36 x 54 x 42	70	134.21	7.29	\$3000	\$255
SCTSBSL3660	36 x 60 x 42	70	144.95	7.83	\$3158	\$287
SCTSBSL4242	42 x 42 x 42	70	121.95	7.05	\$2815	\$232
SCTSBSL4248	42 x 48 x 42	70	136.98	7.65	\$3065	\$264
SCTSBSL4254	42 x 54 x 42	70	149.09	8.26	\$3125	\$301
SCTSBSL4260	42 x 60 x 42	70	161.21	8.86	\$3292	\$333
SCTSBSL4848	48 x 48 x 42	70	150.47	8.56	\$3204	\$306
SCTSBSL4854	48 x 54 x 42	70	163.97	9.22	\$3274	\$342
SCTSBSL4860	48 x 60 x 42	70	177.47	9.89	\$3445	\$384

Consists of two leg assemblies, two worksurface support beams, dual footrests and one worksurface with a small 1.5" radius at each corner.

- Worksurface choice of thermally fused or high pressure laminate with PVC edge.
- Legs are painted extruded aluminum. Casters are lockable, in a choice of two finishes - Black (**BLK**) or Grey (**GRC**).
- Cut-outs for power modules are limited to specific sizes/configurations, please see "Power Accessory Cut-out Locations".

Required specifications

Laminate finish
Edge finish
Paint finish
Caster finish*

Optional specifications

HP laminate
Power accessory cut-out

Accessories

Collaboration table media unit, Table leg cable organizer, PET felt modesty panel, Wire mesh storage tray, Table mounted bag hook, Nik power modules, PET felt wire manager

LARGE COLLABORATION TABLES - 42"

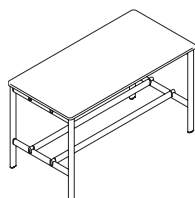

For 66" and 72"W tables

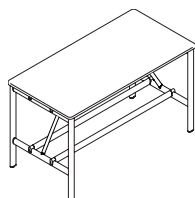

For 78" to 96"W tables

Large Bar Height Collaboration Table, 42"H, Small Radius, Levelers*

MODEL#	DIMENSIONS D x W x H	FREIGHT CLASS	WT/LBS.	CUBIC FT.	LIST PRICE	HP ADD
SCTLBSL3666	36 x 66 x 42	70	155.85	8.38	\$3047	\$315
SCTLBSL3672	36 x 72 x 42	70	166.58	8.92	\$3278	\$343
SCTLBSL3678	36 x 78 x 42	70	179.76	9.46	\$3533	\$370
SCTLBSL3684	36 x 84 x 42	70	190.5	10	\$3584	\$403
SCTLBSL3690	36 x 90 x 42	70	201.23	10.54	\$3996	\$430
SCTLBSL3696	36 x 96 x 42	70	211.97	11.08	\$4047	\$458
SCTLBSL4266	42 x 66 x 42	70	173.49	9.47	\$3186	\$365
SCTLBSL4272	42 x 72 x 42	70	185.61	10.07	\$3426	\$399
SCTLBSL4278	42 x 78 x 42	70	200.17	10.67	\$3690	\$431
SCTLBSL4284	42 x 84 x 42	70	212.29	11.28	\$3750	\$468
SCTLBSL4290	42 x 90 x 42	70	224.41	11.88	\$4167	\$500
SCTLBSL4296	42 x 96 x 42	70	236.52	12.49	\$4227	\$533
SCTLBSL4866	48 x 66 x 42	70	191.14	10.56	\$3348	\$421
SCTLBSL4872	48 x 72 x 42	70	204.64	11.22	\$3593	\$458
SCTLBSL4878	48 x 78 x 42	70	220.58	11.89	\$3866	\$496
SCTLBSL4884	48 x 84 x 42	70	234.08	12.56	\$3931	\$537
SCTLBSL4890	48 x 90 x 42	70	247.58	13.22	\$4357	\$574
SCTLBSL4896	48 x 96 x 42	70	261.08	13.89	\$4426	\$612

Consists of two leg assemblies, two worksurface support beams, dual footrests, and one worksurface with a small 1.5" radius at each corner.

- Worksurface choice of thermally fused or high pressure laminate with PVC edge.
- Legs are painted extruded aluminum. Levelers have 1" adjustment for leveling.
- Cut-outs for power modules are limited to specific sizes/configurations, please see "Power Accessory Cut-out Locations".
- Tables 78" wide and greater include a reinforcement cantilever for added stability.

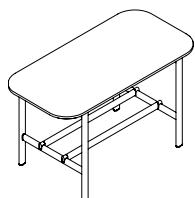

For 66" and 90"W tables

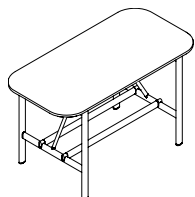

For 96"W tables

Large Bar Height Collaboration Table, 42"H, Large Radius, Levelers

SCTLBLL3666	36 x 66 x 42	70	145.92	8.38	\$2940	\$310
SCTLBLL3672	36 x 72 x 42	70	156.66	8.92	\$2991	\$343
SCTLBLL3678	36 x 78 x 42	70	167.39	9.46	\$3306	\$370
SCTLBLL3684	36 x 84 x 42	70	178.13	10	\$3357	\$245
SCTLBLL3690	36 x 90 x 42	70	188.86	10.54	\$3588	\$278
SCTLBLL3696	36 x 96 x 42	70	202.04	11.08	\$3663	\$458
SCTLBLL4266	42 x 66 x 42	70	163.57	9.47	\$3079	\$366
SCTLBLL4272	42 x 72 x 42	70	175.68	10.07	\$3139	\$399
SCTLBLL4278	42 x 78 x 42	70	187.8	10.67	\$3459	\$282
SCTLBLL4284	42 x 84 x 42	70	199.92	11.28	\$3519	\$315
SCTLBLL4290	42 x 90 x 42	70	212.04	11.88	\$3760	\$347
SCTLBLL4296	42 x 96 x 42	70	226.6	12.49	\$3843	\$537
SCTLBLL4866	48 x 66 x 42	70	181.21	10.56	\$3241	\$417
SCTLBLL4872	48 x 72 x 42	70	194.71	11.22	\$3306	\$458
SCTLBLL4878	48 x 78 x 42	70	208.21	11.89	\$3639	\$338
SCTLBLL4884	48 x 84 x 42	70	221.71	12.56	\$3704	\$380
SCTLBLL4890	48 x 90 x 42	70	235.21	13.22	\$3950	\$421
SCTLBLL4896	48 x 96 x 42	70	251.15	13.89	\$4042	\$611

Consists of two leg assemblies, two worksurface support beams, dual footrests, and one worksurface with a large 9" radius at each corner with 10.5" overhang on each end.

- Worksurface choice of thermally fused or high pressure laminate with PVC edge.
- Legs are painted extruded aluminum. Levelers have 1" adjustment for leveling.
- Cut-outs for power modules are limited to specific sizes/configurations, please see "Power Accessory Cut-out Locations".
- Tables 96" wide and greater include a reinforcement cantilever for added stability.
- Large radius tables are not compatible with SCTAMxx and SCTAMTx Media Units.

Required specifications

Laminate finish
Edge finish
Paint finish

Optional specifications

HP laminate
Power accessory cut-out

Accessories

Collaboration table media unit*, Table leg cable organizer, PET felt modesty panel, Wire mesh storage tray, Table mounted bag hook, Nik power modules, PET felt wire manager

LARGE COLLABORATION TABLES - 42"

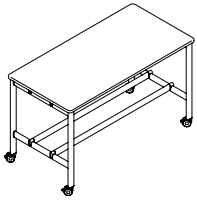

For 66" and 72"W tables

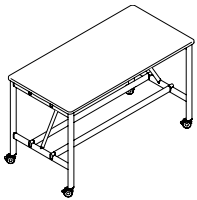

For 78" to 96"W tables

Large Bar Height Collaboration Table, 42"H, Small Radius, Casters*

MODEL#	DIMENSIONS D x W x H	FREIGHT CLASS	WT/LBS.	CUBIC FT.	LIST PRICE	HP ADD
SCTLBSC3666	36 x 66 x 42	70	155.68	8.38	\$3213	\$315
SCTLBSC3672	36 x 72 x 42	70	166.42	8.92	\$3445	\$343
SCTLBSC3678	36 x 78 x 42	70	179.6	9.46	\$3700	\$370
SCTLBSC3684	36 x 84 x 42	70	190.33	10	\$3750	\$403
SCTLBSC3690	36 x 90 x 42	70	201.07	10.54	\$4163	\$430
SCTLBSC3696	36 x 96 x 42	70	211.8	11.08	\$4213	\$459
SCTLBSC4266	42 x 66 x 42	70	173.33	9.47	\$3352	\$366
SCTLBSC4272	42 x 72 x 42	70	185.45	10.07	\$3593	\$398
SCTLBSC4278	42 x 78 x 42	70	200	10.67	\$3857	\$431
SCTLBSC4284	42 x 84 x 42	70	212.12	11.28	\$3917	\$463
SCTLBSC4290	42 x 90 x 42	70	224.24	11.88	\$4334	\$500
SCTLBSC4296	42 x 96 x 42	70	236.36	12.49	\$4394	\$532
SCTLBSC4866	48 x 66 x 42	70	190.97	10.56	\$3514	\$422
SCTLBSC4872	48 x 72 x 42	70	204.47	11.22	\$3760	\$458
SCTLBSC4878	48 x 78 x 42	70	220.41	11.89	\$4033	\$495
SCTLBSC4884	48 x 84 x 42	70	233.91	12.56	\$4098	\$537
SCTLBSC4890	48 x 90 x 42	70	247.41	13.22	\$4524	\$574
SCTLBSC4896	48 x 96 x 42	70	260.91	13.89	\$4593	\$607

Consists of two leg assemblies, two worksurface support beams, dual footrests, and one worksurface with a small 1.5" radius at each corner.

- Worksurface choice of thermally fused or high pressure laminate with PVC edge.
- Legs are painted extruded aluminum. Casters are lockable, in a choice of two finishes - Black (BLK) or Grey (GRC).
- Cut-outs for power modules are limited to specific sizes/configurations, please see "Power Accessory Cut-out Locations".
- Tables 78" wide and greater include a reinforcement cantilever for added stability.

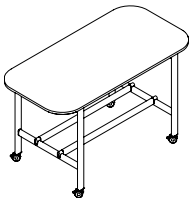

For 66" and 90"W tables

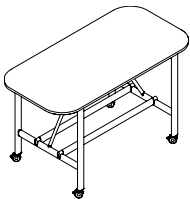

For 96"W tables

Large Bar Height Collaboration Table, 42"H, Large Radius, Casters

SCTLBLC3666	36 x 66 x 42	70	145.75	8.38	\$3102	\$315
SCTLBLC3672	36 x 72 x 42	70	156.49	8.92	\$3158	\$342
SCTLBLC3678	36 x 78 x 42	70	167.23	9.46	\$3315	\$375
SCTLBLC3684	36 x 84 x 42	70	177.96	10	\$3371	\$398
SCTLBLC3690	36 x 90 x 42	70	188.7	10.54	\$3602	\$431
SCTLBLC3696	36 x 96 x 42	70	201.87	11.08	\$3829	\$459
SCTLBLC4266	42 x 66 x 42	70	163.4	9.47	\$3246	\$366
SCTLBLC4272	42 x 72 x 42	70	175.52	10.07	\$3306	\$398
SCTLBLC4278	42 x 78 x 42	70	187.63	10.67	\$3473	\$435
SCTLBLC4284	42 x 84 x 42	70	199.75	11.28	\$3533	\$467
SCTLBLC4290	42 x 90 x 42	70	211.87	11.88	\$3774	\$500
SCTLBLC4296	42 x 96 x 42	70	226.43	12.49	\$4010	\$532
SCTLBLC4866	48 x 66 x 42	70	181.04	10.56	\$3408	\$417
SCTLBLC4872	48 x 72 x 42	70	197.54	11.22	\$3473	\$458
SCTLBLC4878	48 x 78 x 42	70	208.04	11.89	\$3649	\$495
SCTLBLC4884	48 x 84 x 42	70	221.54	12.56	\$3718	\$532
SCTLBLC4890	48 x 90 x 42	70	235.04	13.22	\$3963	\$575
SCTLBLC4896	48 x 96 x 42	70	250.98	13.89	\$4209	\$611

Consists of two leg assemblies, two worksurface support beams, dual footrests, and one worksurface with a large 9" radius at each corner with 10.5" overhang on each end.

- Worksurface choice of thermally fused or high pressure laminate with PVC edge.
- Legs are painted extruded aluminum. Casters are lockable, in a choice of two finishes - Black (BLK) or Grey (GRC).
- Cut-outs for power modules are limited to specific sizes/configurations, please see "Power Accessory Cut-out Locations".
- Tables 96" wide and greater include a reinforcement cantilever for added stability.
- Large radius tables are not compatible with SCTAMxx and SCTAMTx Media Units.

Required specifications

Laminate finish
Edge finish
Paint finish
Caster finish

Optional specifications

HP laminate
Power accessory cut-out

Accessories

Collaboration table media unit*, Table leg cable organizer, PET felt modesty panel, Wire mesh storage tray, Table mounted bag hook, Nik power modules, PET felt wire manager

ACCESSORIES MODEL# DIMENSIONS FREIGHT CLASS WT./LBS. CUBIC FT. LIST PRICE HP ADD

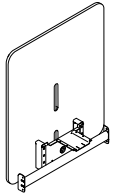

Collaboration Table Media Unit*

	D x W x H						
SCTAM36	11.25 x 36 x 43	150	46.28	10.08	\$907	n/a	
SCTAM42	11.25 x 42 x 43	150	52.5	11.76	\$930	n/a	
SCTAM48	11.25 x 48 x 43	150	58.83	13.44	\$1001	n/a	

Can be affixed to all small radius tables of the same nominal width. User side is thermally fused laminate to accept TV mounts. Side facing away from users features a tackable PET panel affixed to the thermally fused laminate with a 0.5" inset.

- Worksurface available in thermally fused laminate only.
- PET felt available in all standard finishes.
- Brackets and reinforcement bar is painted metal.
- *TV mount not included.*
- Units 36" wide can accept TV's up to 40", not exceeding 50 lbs.
- Units 42" wide can accept TV's up to 43", not exceeding 50 lbs.
- Units 48" wide can accept TV's up to 55", not exceeding 50 lbs.

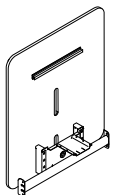

Collaboration Table Media Unit* with TV Mount

SCTAMT36	11.25 x 36 x 43	150	47.58	10.08	\$1141	n/a	
SCTAMT42	11.25 x 42 x 43	150	53.8	11.76	\$1164	n/a	
SCTAMT48	11.25 x 48 x 43	150	60.13	13.44	\$1235	n/a	

Can be affixed to all small radius tables of the same nominal width. User side is thermally fused laminate and includes a TV mount. Side facing away from users features a tackable PET panel affixed to the thermally fused laminate with a 0.5" inset.

- Worksurface available in thermally fused laminate only.
- PET felt backer available in all standard finishes.
- Brackets and reinforcement bar is painted metal.
- Units 36" wide can accept TV's up to 40", not exceeding 50 lbs.
- Units 42" wide can accept TV's up to 43", not exceeding 50 lbs.
- Units 48" wide can accept TV's up to 55", not exceeding 50 lbs.



Table Leg Cable Organizer

SCTAL23	2.21 x 2.965 x 23	70	0.6	0.09	\$41	n/a	
---------	-------------------	----	-----	------	-------------	-----	--

Organizer snaps on to any leg to manage wires vertically. Black only.

Required specifications

- Laminate finish
- Felt finish*
- Paint finish

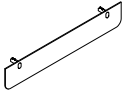
ACCESSORIES	MODEL#	DIMENSIONS D x W x H	FREIGHT CLASS	WT./LBS.	CUBIC FT.	LIST PRICE	HP ADD
	SCTAP36	4.75 x 33 x 11	70	1.78	1	\$92	n/a
	SCTAP42	4.75 x 39 x 11	70	1.99	1.18	\$99	n/a
	SCTAP48	4.75 x 45 x 11	300	2.14	1.36	\$99	n/a
	SCTAP54	4.75 x 51 x 11	300	2.38	1.54	\$104	n/a
	SCTAP60	4.75 x 57 x 11	300	2.53	1.72	\$125	n/a
	SCTAP66	4.75 x 63 x 11	300	2.68	1.9	\$130	n/a
	SCTAP72	4.75 x 69 x 11	300	2.87	2.09	\$135	n/a
	SCTAP78	4.75 x 75 x 11	300	3.05	2.27	\$139	n/a
	SCTAP84	4.75 x 81 x 11	300	3.23	2.45	\$153	n/a
	SCTAP90	4.75 x 87 x 11	300	3.41	2.63	\$167	n/a
	SCTAP96	4.75 x 93 x 11	300	3.59	2.81	\$181	n/a

PET Felt Modesty Panel*

PET felt modesty panel with metal brackets for use on Core, Standard and Workshop tables.

- Specify matching nominal width to table.
- Modesty panels 36" to 54" include two brackets.
- Modesty panels 60" to 90" include three brackets.
- Modesty panels 96" include four brackets.
- PET felt available in standard finishes.

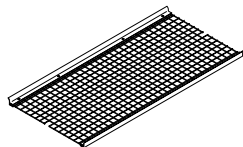

Wire Mesh Storage Tray

SCTAT4848	22 x 42 x 1.6	100	7.85	0.98	\$247	n/a
SCTAT4854	22 x 48 x 1.6	100	8.97	1.1	\$278	n/a
SCTAT4860	22 x 54 x 1.6	100	10.09	1.22	\$315	n/a
SCTAT4866	22 x 60 x 1.6	100	11.19	1.34	\$357	n/a
SCTAT4872	22 x 66 x 1.6	100	12.29	1.47	\$476	n/a
SCTAT4878	22 x 72 x 1.6	100	13.4	1.59	\$489	n/a
SCTAT4884	22 x 78 x 1.6	100	14.52	1.71	\$505	n/a
SCTAT4890	22 x 84 x 1.6	100	15.62	1.83	\$583	n/a
SCTAT4896	22 x 90 x 1.6	100	16.72	1.96	\$600	n/a

Steel storage tray is attached between dual stretchers on tables 48"d x 48"w and larger.

- Specify matching nominal width to table.
- Cannot be combined with SCTAM/SCTAMT media units on tables with casters larger than 78"w.

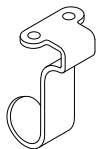
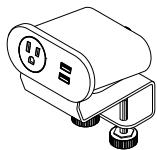

Table-mounted Bag Hook**

SCTAH	0.65 x 1.5 x 3.5	70	0.3	0.01	\$20	n/a
-------	------------------	----	-----	------	-------------	-----

Steel hook for use on Collaborative tables. Specify standard metal paint finish. Maximum capacity of 10 lbs.



Nik Edge/Clamp Mount Power Module

SCTAPEA	2.10 x 6 x 3.7	60	4	0.03	\$570	n/a
SCTAPEB	2.10 x 6 x 3.7	60	4	0.03	\$542	n/a
SCTAPEC	2.10 x 6 x 3.7	60	4	0.03	\$630	n/a
SCTAPED	2.10 x 6 x 3.7	60	4	0.03	\$746	n/a
SCTAPEE	2.10 x 6 x 3.7	60	4	0.03	\$556	n/a

Black with black receptacles, 10ft cord. Specify configuration, last letter of the code represents the following:

- A = 1 AC, 1 USB-A 1.5A charge port, 1 USB-A 2.4A quick charge port
- B = 2 AC
- C = 2 AC, 1 USB-A 1.5A charge port, 1 USB-A 2.4A quick charge port
- D = 1 AC, 1 USB-A 1.5A charge port, 1 USB-A 2.4A quick charge port, 1 60W USB-C charge port
- E = 3 AC

Required specifications

PET felt finish*
Paint finish**

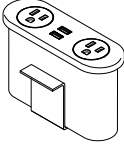
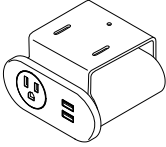
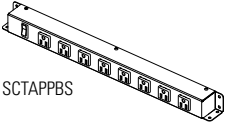
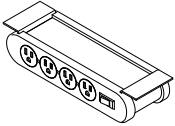
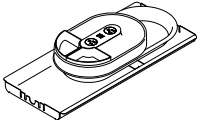
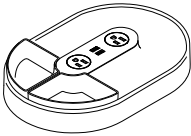
ACCESSORIES	MODEL#	DIMENSIONS D x W x H	FREIGHT CLASS	WT/LBS.	CUBIC FT.	LIST PRICE	HP ADD
 <p>Nik In-Surface Power Module</p>	SCTAPSC	2.10 x 6 x 3.7	60	4	0.03	\$639	n/a
	SCTAPSD	2.10 x 6 x 3.7	60	4	0.03	\$797	n/a
	SCTAPSE	2.10 x 6 x 3.7	60	4	0.03	\$561	n/a
<p>Black with black receptacles, 10ft cord. Corresponding cut-out option is C1, C2 or C3 (where applicable). Specify configuration, last letter of the code represents the following:</p> <ul style="list-style-type: none"> • C = 2 AC, 1 USB-A 1.5A charge port, 1 USB-A 2.4A quick charge port • D = 1 AC, 1 USB-A 1.5A charge port, 1 USB-A 2.4A quick charge port, 1 60W USB-C charge port • E = 3 AC 							
 <p>Nik Below Surface Power Module</p>	SCTAPBA	2.10 x 6 x 3.7	60	4	0.03	\$445	n/a
	SCTAPBB	2.10 x 6 x 3.7	60	4	0.03	\$403	n/a
	SCTAPBC	2.10 x 6 x 3.7	60	4	0.03	\$473	n/a
	SCTAPBD	2.10 x 6 x 3.7	60	4	0.03	\$584	n/a
	SCTAPBE	2.10 x 6 x 3.7	60	4	0.03	\$413	n/a
<p>Black with black receptacles, 10ft cord. Specify configuration, last letter of the code represents the following:</p> <ul style="list-style-type: none"> • A = 1 AC, 1 USB-A 1.5A charge port, 1 USB-A 2.4A quick charge port • B = 2 AC • C = 2 AC, 1 USB-A 1.5A charge port, 1 USB-A 2.4A quick charge port • D = 1 AC, 1 USB-A 1.5A charge port, 1 USB-A 2.4A quick charge port, 1 60W USB-C charge port • E = 3 AC 							
 <p>SCTAPPBS</p>  <p>SCTAPPBD</p> <p>Below Surface Power Bar</p>	SCTAPPBS	1.95 x 21 x 1.95	60	2.7	0.06	\$343	n/a
	SCTAPPBD	4 x 10.6 x 2.3	60	2.7	0.06	\$843	n/a
<p>Available in black only.</p> <ul style="list-style-type: none"> • Single (SCTAPPBS) includes 8 outlets on a single side • Double (SCTAPPBD) includes 4 outlets on each side of the bar. Built-in circuit breaker. 							
 <p>Collaborative Spaces Power Tray</p>	SCTAPTC	10.51 x 23.26 x 4.53	85	7.73	0.64	\$950	n/a
	SCTAPTD	10.51 x 23.26 x 4.53	85	7.73	0.64	\$1107	n/a
	SCTAPTE	10.51 x 23.26 x 4.53	85	7.73	0.64	\$871	n/a
<p>Black plastic power tray with removable grey accessory trays. Top tray is offset for cable storage underneath. Recessed tray sits 3.7" below surface to keep cables out of sight. 10ft. cord. Corresponding cut-out option is O2 (where applicable). Specify configuration, last letter of the code represents the following:</p> <ul style="list-style-type: none"> • C = 2 AC, 1 USB-A 1.5A charge port, 1 USB-A 2.4A quick charge port • D = 1 AC, 1 USB-A 1.5A charge port, 1 USB-A 2.4A quick charge port, 1 60W USB-C charge port • E = 3 AC 							
 <p>Collaborative Spaces Organizer Tray</p>	SCTAOTC	8.32 x 12.40 x 4.28	70	1.5	0.26	\$709	n/a
	SCTAOTD	8.32 x 12.40 x 4.28	70	1.5	0.26	\$862	n/a
	SCTAOTE	8.32 x 12.40 x 4.28	70	1.5	0.26	\$630	n/a
<p>Black plastic power tray with removable grey accessory trays. 10ft. cord. Corresponding cut-out option is C1, C2 or C3 (where applicable). Specify configuration, last letter of the code represents the following:</p> <ul style="list-style-type: none"> • C = 2 AC, 1 USB-A 1.5A charge port, 1 USB-A 2.4A quick charge port • D = 1 AC, 1 USB-A 1.5A charge port, 1 USB-A 2.4A quick charge port, 1 60W USB-C charge port • E = 3 AC 							

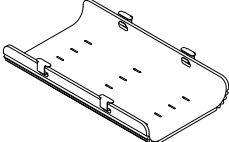
ACCESSORIES	MODEL#	DIMENSIONS	FREIGHT CLASS	WT./LBS.	CUBIC FT.	LIST PRICE	HP ADD
 <p>Collaborative Spaces Recessed Power Tray</p>		D x W x H					
	SCTAPRC	10.51 x 23.26 x 6.4	125	6.06	0.91	\$843	n/a
	SCTAPRD	10.51 x 23.26 x 6.4	125	6.06	0.91	\$996	n/a
	SCTAPRE	10.51 x 23.26 x 6.4	125	6.06	0.91	\$764	n/a
<p>Black plastic power tray. Recessed tray sits 3.7" below surface to keep cables out of sight. 10ft. cord. Corresponding cut-out option is O2 (where applicable). Specify configuration, last letter of the code represents the following:</p> <ul style="list-style-type: none"> • C = 2 AC, 1 USB-A 1.5A charge port, 1 USB-A 2.4A quick charge port • D = 1 AC, 1 USB-A 1.5A charge port, 1 USB-A 2.4A quick charge port, 1 60W USB-C charge port • E = 3 AC 							
 <p>Collaborative Spaces PET Felt* Wire Manager</p>	SCTACT	26 x 11 x 4	70	1.1	0.66	\$97	n/a
	<p>PET Felt Wire Manager hangs from four brackets under the surface. Includes Black painted metal brackets. PET felt available in standard finishes.</p>						

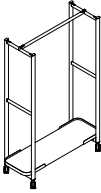
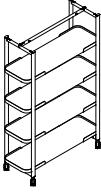
TEAM CARTS	MODEL#	DIMENSIONS	FREIGHT CLASS	WT./LBS.	CUBIC FT.	LIST PRICE	HP ADD
 <p>Coat Rack Cart</p>	SCCR1848	18 x 48 x 72	300	56.82	36.04	\$2202	n/a
	SCCR1860	18 x 60 x 72	300	62.77	45.05	\$2272	n/a
<p>Cart includes side rails for compatible accessories and a single top rail for hanging coats, jackets, etc.</p> <ul style="list-style-type: none"> • Shelf available in thermally fused laminate. • Painted aluminum frame available in standard paint finishes. • 48" w cart shelf has a capacity of 140 lbs., evenly distributed. • 60" w cart shelf has a capacity of 175 lbs., evenly distributed • Casters are lockable, in a choice of two finishes - Black (BLK) or Grey (GRC). 							
 <p>Shelf Cart*</p>	SCCS1848	18 x 48 x 72	250	123.88	36.04	\$4119	n/a
	<p>Cart includes four fixed shelves with metal trim detail. Vertical rails accept PET privacy panels (sold separately) to create space division within open areas.</p> <ul style="list-style-type: none"> • Horizontal top rail accepts compatible accessories. • Shelf available in thermally fused laminate. • Painted aluminum frame available in standard paint finishes. • Each shelf has a capacity of 140 lbs., evenly distributed. • Casters are lockable, in a choice of two finishes - Black (BLK) or Grey (GRC). 						

Required specifications

PET felt finish*
 Laminate finish Edge finish
 Paint finish Caster finish

Accessories

PET privacy panel (*shelf cart only*)
 Accessory cup
 Hook for team cart
 Laptop shelf (*coat rack cart only*)

TEAM CARTS	MODEL#	DIMENSIONS	FREIGHT CLASS	WT./LBS.	CUBIC FT.	LIST PRICE	HP ADD
------------	--------	------------	---------------	----------	-----------	------------	--------

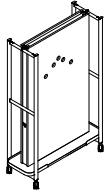

Media Cart

	D x W x H						
SCCMPE1848	18 x 48 x 72	150	171.42	36.04	\$4257	n/a	
SCCMPE1860	18 x 60 x 72	150	214.23	45.05	\$4778	n/a	
SCCMNE1848	18 x 48 x 72	150	170.92	36.04	\$4049	n/a	
SCCMNE1860	18 x 60 x 72	150	213.73	45.05	\$4569	n/a	

Cart includes includes a bottom shelf and thermally fused laminate TV board. Short side panels feature small cut-out for wire pass through and hook for wire management.

- Side rails accept compatible accessories.
- Shelf available in thermally fused laminate.
- Back panel is removable for access to cavity for cable management. Back panel is whiteboard laminate.
- SCCMEP models include a power bar (SCCAMP) mounted internally.
- SCCMNE models do not include any power.
- Units 48" wide can accept TV's up to 55", not exceeding 50lbs.
- Units 60" wide can accept TV's up to 60", not exceeding 50lbs.
- Painted aluminum frame available in standard paint finishes
- Casters are lockable, in a choice of two finishes - Black (**BLK**) or Grey (**GRC**).
- Note: TV mount included. *TV and video conferencing units are not included.*

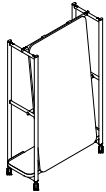

Single-Sided Whiteboard Cart

SCCSW1848	18 x 48 x 72	250	106.37	36.04	\$3647	n/a	
SCCSW1860	18 x 60 x 72	150	191.07	45.05	\$4276	n/a	

Cart includes one fixed shelf with metal trim detail, accessible from behind whiteboard. Front of vertical whiteboard panel is whiteboard only.

- Side rails accept compatible accessories.
- Back of vertical whiteboard panel is Designer White laminate (DWT) with Designer White edging (DWE).
- Shelf available in thermally fused laminate.
- Painted aluminum frame available in standard paint finishes.
- Casters are lockable, in a choice of two finishes - Black (**BLK**) or Grey (**GRC**).

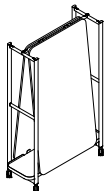

Double-Sided Whiteboard Cart

SCCDW1848	18 x 48 x 72	150	153.96	36.04	\$4918	n/a	
SCCDW1860	18 x 60 x 72	150	191.07	45.05	\$6088	n/a	

Cart includes one fixed shelf with metal trim detail, accessible from behind whiteboard. Front of vertical whiteboard panels is whiteboard only.

- Side rails accept compatible accessories.
- Back of vertical whiteboard panel is Designer White laminate (DWT) with Designer White edging (DWE).
- Shelf available in thermally fused laminate.
- Painted aluminum frame available in standard paint finishes.
- Casters are lockable, in a choice of two finishes - Black (**BLK**) or Grey (**GRC**).

Required specifications

Laminate finish
Edge finish
Paint finish
Caster finish

Accessories

Concealed power unit (SCCMNExxxx only)
Media tray (SCCMPExxxx/MNExxxx only)
Accessory cup

Hook for team cart
Laptop shelf

TEAM CARTS

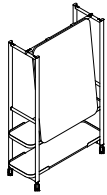

Combo Whiteboard Cart

MODEL#	DIMENSIONS D x W x H	FREIGHT CLASS	WT./LBS.	CUBIC FT.	LIST PRICE	HP ADD
SCCCW1848	18 x 48 x 72	250	115.66	36.04	\$3937	n/a
SCCCW1860	18 x 60 x 72	250	150.33	45.05	\$4524	n/a

Cart includes two fixed shelves with metal trim detail, accessible from behind whiteboard. Bottom shelf is accessible from both sides of cart; top shelf accessible from behind write board. Front of vertical whiteboard panel is whiteboard only.

- Side rails accept compatible accessories.
- Back of vertical whiteboard panel is Designer White laminate (DWT) with Designer White edging (DWE).
- Shelves available in thermally fused laminate.
- Painted aluminum frame available in standard paint finishes.
- 48" w cart shelf has a capacity of 140 lbs., evenly distributed.
- 60" w cart shelf has a capacity of 175 lbs., evenly distributed
- Casters are lockable, in a choice of two finishes - Black (**BLK**) or Grey (**GRC**).

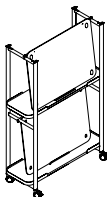

Removable Whiteboard Cart

SCCRW1848	18 x 48 x 72	150	188	42.05	\$6071	n/a
SCCRW1860	18 x 60 x 72	150	245.61	52.56	\$6932	n/a

Cart includes two fixed shelves with spacers for removable whiteboards. Includes five lightweight removable whiteboard panels.

- One whiteboard can be stored at the top and four at the bottom.
- Cart accepts five lightweight removable whiteboard panels maximum.
- Whiteboards feature whiteboard front; back in Designer White laminate (DWT) with Designer White edging (DWE).
- Hanging bracket finish matches the cart frame finish.
- Shelves available in thermally fused laminate.
- Side rails accept compatible accessories.
- Painted aluminum frame available in standard paint finishes.
- Casters are lockable, in a choice of two finishes - Black (**BLK**) or Grey (**GRC**).

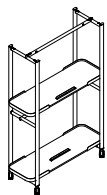

Empty Removable Whiteboard Cart

SCCEW1848	18 x 48 x 72	300	82.31	42.05	\$2973	n/a
SCCEW1860	18 x 60 x 72	250	105.7	52.56	\$3145	n/a

Cart includes two fixed shelves with spacers for removable whiteboards.

- Cart accepts five lightweight removable whiteboard panels maximum.
- One whiteboard can be stored at the top and four at the bottom.
- To order Removable Whiteboard, specify SCCAWB3336 for the 48" wide cart and SCCAWB3348 for the 60" wide cart.
- Hanging bracket finish matches the cart frame finish.
- Shelves available in thermally fused laminate.
- Side rails accept compatible accessories.
- Painted aluminum frame available in standard paint finishes.
- Casters are lockable, in a choice of two finishes - Black (**BLK**) or Grey (**GRC**).

Required specifications

Laminate finish
Edge finish
Paint finish
Caster finish

Accessories

Accessory cup
Hook for team cart
Whiteboard
Laptop shelf

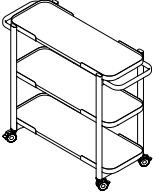
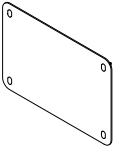
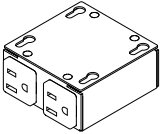
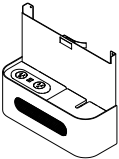
TEAM CARTS	MODEL#	DIMENSIONS	FREIGHT CLASS	WT./LBS.	CUBIC FT.	LIST PRICE	HP ADD
 <p>Hospitality Cart*</p>	D x W x H						
	SCHC2233	22 x 43 x 41	150	81.31	15.39	\$3214	n/a
	SCHC2239	22 x 49 x 41	150	95	17.96	\$3346	n/a
		<p>Cart includes three fixed shelves with metal trim.</p> <ul style="list-style-type: none"> • Surfaces available in thermally fused laminate. • Legs and handles are painted aluminum available in standard paint finishes. • 33" w cart shelf has a capacity of 120 lbs., evenly distributed. • 39" w cart shelf has a capacity of 140 lbs., evenly distributed • Casters are lockable, in a choice of two finishes - Black (BLK) or Grey (GRC). • Note: size is inclusive of handles, shelf sizing is approximately 10" shorter. 					
TEAM CART ACCESSORIES	MODEL#	DIMENSIONS	FREIGHT CLASS	WT./LBS.	CUBIC FT.	LIST PRICE	HP ADD
 <p>Cart Mounted PET Felt Privacy Panels**</p>	SCCAPP3248	0.5 x 48 x 32	85	4.16	0.32	\$271	n/a
	SCCAPP3260	0.5 x 60 x 32	85	5.16	0.4	\$401	n/a
		<p>Lightweight removable PET Felt panels, specify SCCAPP3248 for the 48" w cart and SCCAPP3260 for the 60" w cart.</p> <ul style="list-style-type: none"> • Snaps onto (SCCEWxxxx) vertical rails at various shelf heights to create space division and privacy. • Cover caps painted metal finish should be specified to match the cart finish. • PET felt available in standard finishes. 					
 <p>Concealed Power Unit</p>	SCCAMP	3 x 3 x 1.5	70	0.5	0.01	\$305	n/a
			<p>Provided inside SCCMEPxxxx media units, can be added to SCCNMExxxx in field. Includes two AC outlets. 10ft cord.</p> <ul style="list-style-type: none"> • Compatible with Mobile Media Carts only. • Black (BLK) finish only. 				
 <p>Media Tray**</p>	SCCAMT	5.60 x 14.57 x 13.80	70	12	0.65	\$676	n/a
	SCCAMTPC	5.60 x 14.57 x 13.80	70	12	0.65	\$1315	n/a
	SCCAMTPD	5.60 x 14.57 x 13.80	70	12	0.65	\$1473	n/a
	SCCAMTPE	5.60 x 14.57 x 13.80	70	12	0.65	\$1237	n/a
			<p>Attaches to the front of the SCCMEPxxxx/SCCNMExxxx to provide a wire catch, wireless receiver area and easily accessible power at the front of the media carts</p> <ul style="list-style-type: none"> • Compatible with Mobile Media Carts only. • Tray is painted metal with a PET Felt insert. PET felt available in standard finishes. • SCCAMT is empty and has no power capabilities. • Specify configuration, last letter of the code represents the following • C = 2 AC, 1 USB-A 1.5A charge port, 1 USB-A 2.4A quick charge port • D = 1 AC, 1 USB-A 1.5A charge port, 1 USB-A 2.4A quick charge port, 1 60W USB-C charge port • E = 3 AC 				

Required specifications

- Laminate finish / Edge finish*
- Paint finish*
- Caster finish*
- PET Felt finish**

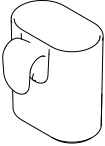
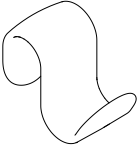
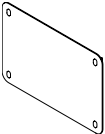
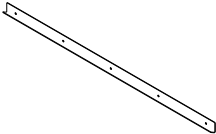
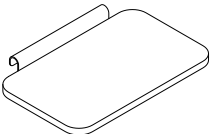
TEAM CART ACCESSORIES	MODEL#	DIMENSIONS D x W x H	FREIGHT CLASS	WT/LBS.	CUBIC FT.	LIST PRICE	HP ADD
 Accessory Cup	SCCAC	3 x 3 x 1.5	70	0.15	0.02	\$14	n/a
	Hangs onto any team cart horizontal top or side rail. Black (BLK) finish only.						
 Hook for Team Cart	SCCAH	3 x 3 x 1.5	70	0.1	0.01	\$10	n/a
	Hangs onto any team cart horizontal top or side rail. Black (BLK) finish only. Maximum capacity of 10lbs.						
 Whiteboard¹	SCCAWB3336	0.50 x 36 x 33	60	17.62	0.34	\$608	n/a
	SCCAWB3348	0.50 x 48 x 33	400	23.32	46	\$752	n/a
	Lightweight removable whiteboard panels. Specify SCCAWB3336 for the 48" w cart and SCCAWB3348 for the 60" w cart. <ul style="list-style-type: none"> • Back of whiteboard is Designer White (DWT) with Designer White edging (DWE). • Cover caps painted metal finish should be specified to match the cart finish. • Horizontal and vertical mounting on wall rail(s). 						
 Whiteboard Wall Rail	SCCAWBR36	1 x 36 x 2	70	1.27	0.04	\$62	n/a
	SCCAWBR48	1 x 48 x 2	70	1.71	0.05	\$77	n/a
	SCCAWBR72	1 x 72 x 2	60	2.54	0.08	\$121	n/a
	SCCAWBR96	1 x 96 x 2	60	3.42	0.11	\$149	n/a
	Wall rail for whiteboards. Accepts SCCAWBxxxx. Metal extrusion in Black (BLK) only.						
 Laptop Shelf*	SCCAL51219	12 x 19 x 3	65	11.07	0.4	\$295	n/a
	Laminate laptop shelf with dual bracket. Can be flipped vertically to store when cart is not in use. <ul style="list-style-type: none"> • Shelf available in thermally fused laminate. • Bracket included is painted metal finish and should be specified to match the cart finish. 						

Required specifications

- Laminate finish*
- Edge finish*
- Paint finish*1

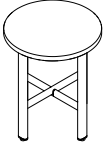
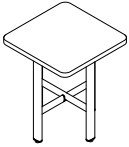
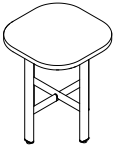
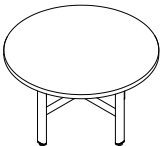
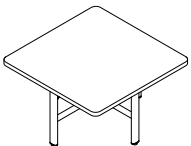
OCCASIONAL TABLES	MODEL#	DIMENSIONS	FREIGHT CLASS	WT/LBS.	CUBIC FT.	LIST PRICE	HP ADD																					
 <p>Occasional Side Table, Round Top</p>	D x W x H																											
	SCOR1818	18 x 18 x 21	150	18.52	3.94	\$667	n/a																					
	SCOR2424	24 x 24 x 21	250	26.53	7.01	\$785	n/a																					
<p>Includes leg assembly, cross beams and one worksurface.</p> <ul style="list-style-type: none"> • Surface available in thermally fused laminate. • Legs and cross beam are painted aluminum available in standard paint finishes. 																												
 <p>Occasional Side Table, Square Top</p>	<table border="1"> <tr> <td>SCOC1818</td> <td>18 x 18 x 21</td> <td>150</td> <td>21.12</td> <td>3.94</td> <td>\$667</td> <td>n/a</td> </tr> <tr> <td>SCOC2424</td> <td>24 x 24 x 21</td> <td>150</td> <td>31.2</td> <td>7.01</td> <td>\$785</td> <td>n/a</td> </tr> </table>							SCOC1818	18 x 18 x 21	150	21.12	3.94	\$667	n/a	SCOC2424	24 x 24 x 21	150	31.2	7.01	\$785	n/a							
	SCOC1818	18 x 18 x 21	150	21.12	3.94	\$667	n/a																					
SCOC2424	24 x 24 x 21	150	31.2	7.01	\$785	n/a																						
<p>Includes leg assembly, cross beams and one worksurface with a small 1.5" radius at each corner.</p> <ul style="list-style-type: none"> • Surface available in thermally fused laminate. • Legs and cross beam are painted aluminum available in standard paint finishes. 																												
 <p>Occasional Side Table, Square Top, Larger Radius</p>	<table border="1"> <tr> <td>SCOCL1818</td> <td>18 x 18 x 21</td> <td>150</td> <td>21.12</td> <td>3.94</td> <td>\$667</td> <td>n/a</td> </tr> <tr> <td>SCOCL2424</td> <td>24 x 24 x 21</td> <td>150</td> <td>31.2</td> <td>7.01</td> <td>\$785</td> <td>n/a</td> </tr> </table>							SCOCL1818	18 x 18 x 21	150	21.12	3.94	\$667	n/a	SCOCL2424	24 x 24 x 21	150	31.2	7.01	\$785	n/a							
	SCOCL1818	18 x 18 x 21	150	21.12	3.94	\$667	n/a																					
SCOCL2424	24 x 24 x 21	150	31.2	7.01	\$785	n/a																						
<p>Includes leg assembly, cross beams and one worksurface with a larger 9" radius at each corner.</p> <ul style="list-style-type: none"> • Surface available in thermally fused laminate. • Legs and cross beam are painted aluminum available in standard paint finishes. 																												
 <p>Occasional Coffee Table, Round Top</p>	<table border="1"> <tr> <td>SCOCR2424</td> <td>24 x 24 x 17</td> <td>150</td> <td>25.55</td> <td>5.67</td> <td>\$760</td> <td>n/a</td> </tr> <tr> <td>SCOCR3030</td> <td>30 x 30 x 17</td> <td>150</td> <td>35.76</td> <td>8.86</td> <td>\$901</td> <td>n/a</td> </tr> <tr> <td>SCOCR3636</td> <td>36 x 36 x 17</td> <td>250</td> <td>48.13</td> <td>12.76</td> <td>\$1071</td> <td>n/a</td> </tr> </table>							SCOCR2424	24 x 24 x 17	150	25.55	5.67	\$760	n/a	SCOCR3030	30 x 30 x 17	150	35.76	8.86	\$901	n/a	SCOCR3636	36 x 36 x 17	250	48.13	12.76	\$1071	n/a
	SCOCR2424	24 x 24 x 17	150	25.55	5.67	\$760	n/a																					
	SCOCR3030	30 x 30 x 17	150	35.76	8.86	\$901	n/a																					
SCOCR3636	36 x 36 x 17	250	48.13	12.76	\$1071	n/a																						
<p>Includes leg assembly, cross beams and one worksurface.</p> <ul style="list-style-type: none"> • Surface available in thermally fused laminate. • Legs and cross beam are painted aluminum available in standard paint finishes. 																												
 <p>Occasional Coffee Table, Square Top</p>	<table border="1"> <tr> <td>SCOCS2424</td> <td>24 x 24 x 17</td> <td>150</td> <td>30.22</td> <td>5.67</td> <td>\$760</td> <td>n/a</td> </tr> <tr> <td>SCOCS3030</td> <td>30 x 30 x 17</td> <td>150</td> <td>43.1</td> <td>8.86</td> <td>\$901</td> <td>n/a</td> </tr> </table>							SCOCS2424	24 x 24 x 17	150	30.22	5.67	\$760	n/a	SCOCS3030	30 x 30 x 17	150	43.1	8.86	\$901	n/a							
	SCOCS2424	24 x 24 x 17	150	30.22	5.67	\$760	n/a																					
SCOCS3030	30 x 30 x 17	150	43.1	8.86	\$901	n/a																						
<p>Includes leg assembly, cross beams and one worksurface with a small 1.5" radius at each corner.</p> <ul style="list-style-type: none"> • Surface available in thermally fused laminate. • Legs and cross beam are painted aluminum available in standard paint finishes. 																												

Required specifications

- Laminate finish
- Edge finish
- Paint finish

OCCASIONAL TABLES

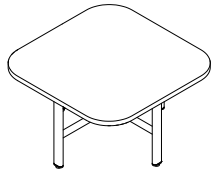

Occasional Coffee Table, Square Top, Larger Radius

MODEL#	DIMENSIONS D x W x H	FREIGHT CLASS	WT/LBS.	CUBIC FT.	LIST PRICE	HP ADD
SCOCSL2424	18 x 18 x 21	150	29.11	5.67	\$760	n/a
SCOCSL3030	24 x 24 x 21	150	41.99	8.86	\$901	n/a

Includes leg assembly, cross beams and one worksurface with a larger 9" radius at each corner.

- Surface available in thermally fused laminate.
- Legs and cross beam are painted aluminum available in standard paint finishes.

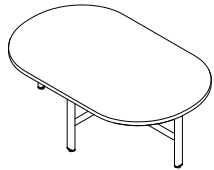

Occasional Coffee Table, Racetrack Top



SCOCC2442	24 x 42 x 17	150	42.78	9.93	\$955	n/a
SCOCC3048	30 x 48 x 17	150	57.13	14.18	\$1137	n/a

Includes leg assembly, cross beams and one racetrack worksurface.

- Surface available in thermally fused laminate.
- Legs and cross beam are painted aluminum available in standard paint finishes.

Required specifications

- Laminate finish
- Edge finish
- Paint finish

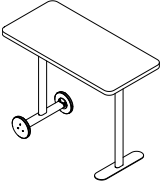
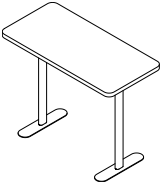
LAPTOP TABLES	MODEL#	DIMENSIONS	FREIGHT CLASS	WT/LBS.	CUBIC FT.	LIST PRICE	HP ADD
 <p>Laptop Table, Racetrack Top, Wheel and Foot Base</p>		D x W x H					
	SCLCC1633	16 x 33 x 26	250	25.6	6.51	\$1181	n/a
 <p>Laptop Table, Racetrack Top, Foot Base</p>							
	SCLCB1633	16 x 33 x 26	250	23.85	6.51	\$713	n/a
 <p>Laptop Table, Rectangular Top, Wheel and Foot Base</p>							
	SCLTC1633	16 x 33 x 26	150	27.64	6.51	\$1181	n/a
 <p>Laptop Table, Rectangular Top, Foot Base</p>							
	SCLTB1633	16 x 33 x 26	250	25.88	6.51	\$713	n/a

Includes leg assembly and two wheels with rubber trim, one leg assembly with a foot, and one racetrack surface.

- Two bag hooks included, one on the exterior of each leg, mounted just under the surface for easy access.
- Each bag hook accepts up to 10 lbs. and is painted to match the legs.
- Legs, beams and hook are painted aluminum available in standard paint finishes.
- Wheel insert is painted to match the legs and beams.
- Surface available in thermally fused laminate.

Includes two leg assemblies with a foot and one racetrack surface.

- Two bag hooks included, one on the exterior of each leg, mounted just under the surface for easy access.
- Each bag hook accepts up to 10 lbs. and is painted to match the legs.
- Legs, beams and hook are painted aluminum available in standard paint finishes.
- Surface available in thermally fused laminate.

Includes leg assembly and two wheels with rubber trim, one leg assembly with a foot, and one rectangular surface with a small 1.5" radius at each corner.

- Two bag hooks included, one on the exterior of each leg, mounted just under the surface for easy access.
- Each bag hook accepts up to 10 lbs. and is painted to match the legs.
- Legs, beams and hooks are painted aluminum available in standard paint finishes.
- Wheel insert is painted to match the legs and beams.
- Surface available in thermally fused laminate.

Includes two leg assemblies with a foot and one rectangular surface with a small 1.5" radius at each corner.

- Two bag hooks included, one on the exterior of each leg, mounted just under the surface for easy access.
- Each bag hook accepts up to 10 lbs. and is painted to match the legs.
- Legs, beams and hook are painted aluminum available in standard paint finishes.
- Surface available in thermally fused laminate.

Required specifications

Laminate finish
Edge finish
Paint finish

Optional specifications

HP laminate
Power accessory cut-out

Accessories

Table leg cable organizer,
PET felt modesty panel,
Table mounted bag hook,
Nik power modules, PET felt wire manager



ConnectTABLES® provides solutions for a variety of day-to-day work environments. Designed as easy-to-use linking or freestanding tables, ConnectTABLES is limited only by your imagination.

Open Conference

Many ConnectTABLES® tops can be assembled to be freestanding. When combined with locking casters and the flip top "T" leg, the result is easy storage and complete portability.

Meeting Rooms

ConnectTABLES® modular units will provide quick and affordable answers for all sizes and shapes of rooms and applications.

Educational and Training Rooms

ConnectTABLES® table tops configure easily into temporary or permanent educational applications.

Features and Benefits

- Optional, easy-to-use thumbscrews allow installation without tools.
- Optional zinc-plated steel ganging hardware connects free standing tops without moving "T" Leg position.
- Optional modesty panel wire management unit available.
- Casters will not affect table height when used in conjunction with or in place of glides.
- Optional Black grommets for convenient wire management can be ordered "factory installed".
- Tops are 1" thick and constructed of 45 lb. density particleboard.
- Optional casters available with or without manual locks provide mobility.
- ConnectTABLES® tops are available in all Global laminate finishes with three leg and two edge color options.



T Leg with leveling glides



Modesty Panel

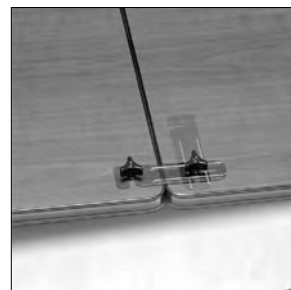

Optional ganging connector

GENERAL INFORMATION

- ConnecTABLES® is an affordable and highly flexible system of modular tables. Designed as easy-to-use linking or freestanding tables, ConnecTABLES adapts to most every requirement: seminar or training room, meeting room, personal workstations, educational, conferencing and team cluster workgroups.
- ConnecTABLES have nine basic top shapes available in various sizes.
- ConnecTABLES edges **do not match** any other Global product in either color or style.
- For environmental certifications, please visit globalfurnituregroup.com.

WORKSURFACES

- Tops are 1" thick, made of 45 lb. density particle board covered on both sides with high performance thermally fused laminate. Optional high pressure laminate tops are 1-1/16" thick.
- Laminate finishes are available in High Pressure. Contact Customer Care for a quote.
- If other than a Global standard laminate finish is preferred, contact Customer Care. Information needed includes the name of the laminate manufacturer, color name, number and model of table. You will then be given a quote for this special order.
- **ConnecTABLES® edges do not match any other Global product in either color or style.**
- Products specified with the high pressure laminate option are finished on the underside of the surface with a kraft paper backing.

CONSTRUCTION

- Some components can stand alone when the "T" base is set in the freestanding position. When the "T" base is in the linking position, all the components can be used in grouping configurations (clusters).
- Optional wire grommets not available on 45° wedge and the 60° triangle.
- Rectangular tops 54" in length and longer are supplied with a 16" gauge steel support channel. Top is pre-drilled for placement.
- Shipped RTA (ready to assemble). Quick and easy to assemble.
- Special width tops are available. Use next size up.
- Adjustable levelers offer up to 1" adjustability.
- Elliptical column cover, glides, casters, thumbscrews and endcaps available in Black only.
- Must specify top, edge, and "T" base color with each order.

LEGS

- "T" leg is coated with environmentally friendly, recyclable paint electrostatically applied epoxy powder coating for a very durable finish in three colors as specified below. Only the bottom horizontal portion of the painted leg is visible.
- Black plastic leveling glides offer 1" adjustability.
- Two black plastic elliptical column caps cover each leg column.
- Casters will not affect table height when used in conjunction with or in place of glides.
- Casters can facilitate mobility in installations which need to be moved frequently.

LAMINATE FINISHES

ACJ	Absolute Acajou	FCL	First Class
ASN	Asian Night	NBL	Noce Biondo
AWC	Avant Cherry	NGL	Noce Grigio
AWH	Avant Honey	NEL	Noce Leggero
BLK	Black	NML	Noce Medio
BZD	Blizzard	QTM	Quartered Mahogany
BRC	Brushed Cobalt	SBY	Sheer Beauty
CMB	Clear Maple	SOG	Storm Grey
CGY	Custom Grey	SDT	Stonedust
DES	Dark Espresso	WHE	Walnut Heights
DWT	Designer White	WHC	White Chocolate
FAS	Fashionista	WCR	Winter Cherry

EDGE COLORS

Black (BK) Grey (GR)

LEG COLORS

Black (TBL) Shadow (TSH)
 Tungsten (TTU) Chrome (CHM) - optional on foot only, upcharge applies

GROMMETS

- Optional Grommets available in standard worksurface locations (left, center or right) **for Rectangular Tables**. Order as: **AG1, AG2 or AG3. Add \$96**
- Grommet hole dimensions are 3 1/4" wide x 1 7/8" deep.

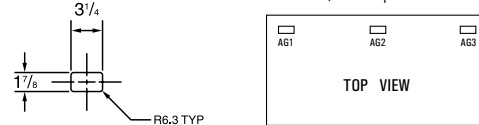

- Grommets may be placed at non-standard locations. Order as: **AGS - Add \$96**. A drawing must be supplied with vertical and horizontal dimensions to the center of the cut-out (as in drawing above). Please refer to CUSTOM GROMMET LOCATION FORM in the back reference section.
- If adding **Cove mini power block** to **AG** cut-out, cannot use with modesties.

POWER BLOCK

- An individually corded power block (model **PMSPDM**) may be ordered on all worksurfaces. Units cannot be daisy chained and cannot be used with modesties.
- Power block is configured with one electrical duplex receptacle and two data (RJ45) receptacles. 9' black cord included. Power block dimensions are 3.5" deep x 6.5" wide x 2.75" high.
- To purchase a power block, you must specify both the power block cut-out location and the power block model #. Order power block as **PMSPDM. Add \$330**. Power Blocks are available in standard worksurface locations (left, center or right). Order as **E1, E2 or E3. Add \$96**.

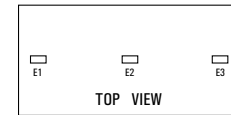

Power Block **PMSPDM, Add \$330**

Specify location **E1, E2 or E3, Add \$96**.

EXAMPLES OF GROMMET AND POWER BLOCK POSITIONS

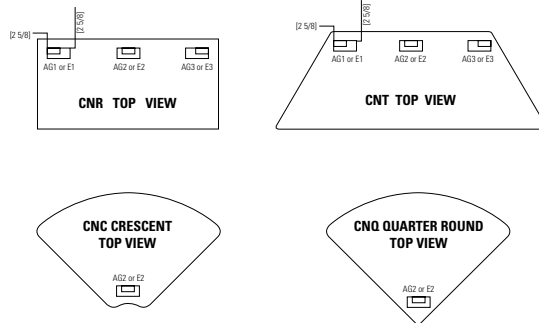

MODPOWER DAISY CHAIN SOLUTION

- Add flexible power and USB charging to ConnecTables rectangular tables. Connect up to four units with a single corded infeed with NEMA plug.
- ModPower units are sold separately, refer to Productivity Solutions page 465.
- Begin run with a starter unit which includes a corded infeed. Add additional middle or end units as required. Middle and end units are equipped with connecting cables.
- On-surface modules clamp on or screw mount to the table tops.
- In-surface modules require table top cut-outs for mounting. Specify cut-out option:
 - **MPS** for a single cut-out to accommodate one ModPower in-surface unit (cut-out will be centered on the approach side) for **30" to 72" wide rectangular tables. Add \$96**
 - **MPD** for two cut-outs in the left and right positions, 18.25" from ends to center of unit on approach side for **60", 66" and 72" wide rectangular tables. Add \$192**.

C CONNECTABLES® - NOTES

VILLA CUTOUTS

- Optional Villa cutout available in standard worksurface locations (left, center or right) for **Rectangular Tables**. Order as: **V1, V2 or V3** - Add \$96 for each cutout.
- Villa cutouts may be placed at non-standard locations. Please contact customer care.

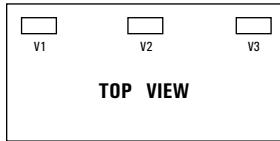

TOP & EDGE OPTIONS

- ConnectTABLES® have nine basic top shapes available in various sizes. All top shapes have a variety of straight or curved edges which are referred to as **Working (W)**, **Connecting (C) or End (E) edges**. Edges can also have a combination of edge types as shown.

*cannot freestand

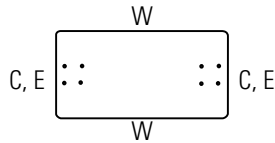

Rectangle

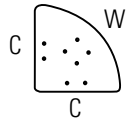

Quarter Round*

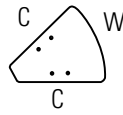

45° Wedge*

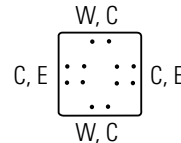

Square

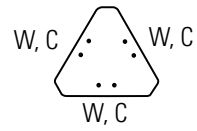

60° Triangle*

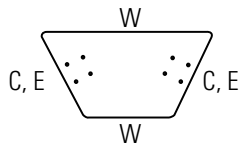

Trapezoid

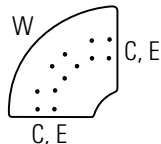

90° Crescent

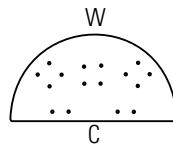

Half Round

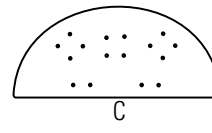

Extended Half Round*

Working Edge (1) - Edges designated with the letter "W" indicate that this is a **working** or sitting edge. These edges can be connected with optional ganging hardware in free-standing applications.

Connecting Edge (2) - Edges designated with the letter "C" indicate that this is a **connecting** edge. These edges can be connected to any other connecting edge of equal width, regardless of the top shape or size.

End Edge (3) - Edges designated with the letter "E" indicate that this is an **end** edge or an edge that can finish a run of tops. If a top has two end edges it can be freestanding. 90° crescent tops can be freestanding if the optional center leg is added.

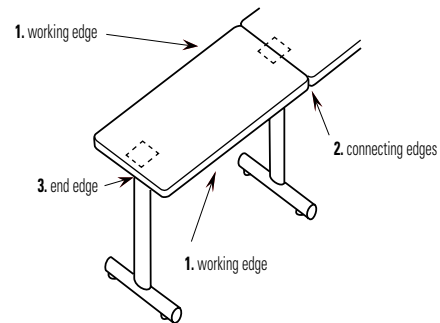

FREESTANDING AND CONNECTING CONDITIONS

Freestanding tables are defined as any one worksurface supported by two or more legs;

connecting tables are defined as more than one work surface supported by a single leg at each point of connection. The rule for determining the quantity of legs of an open configuration is the number of worksurfaces plus one (**See Figure 1**).

On closed configurations, the number of legs is equal to the number of worksurfaces (**See Figure 2**). There are some exceptions, such as when optional third legs are used on quarter round or 90° crescent shapes.

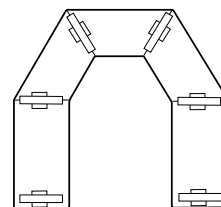

Figure 1. Open Configuration
Number of Surfaces = 5
Number of Legs = 6

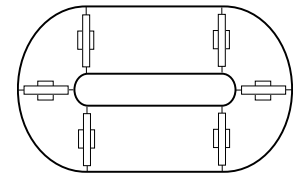

Figure 2. Closed Configuration
Number of Surfaces = 6
Number of Legs = 6

FREESTANDING CONDITIONS

- All square, rectangle and trapezoid shapes are able to act as freestanding tables (**Figure 3**).
- When Trapezoid tops are freestanding, legs must be on the outer left and right sides (**Figure 4**).
- 90° crescent work surfaces have provision for an optional third center leg for additional stability when heavy loads are applied to the outside edge. They can also be used as freestanding tables when a third leg is added (**Figure 5**).
- All freestanding tables can be connected with optional ganging hardware.
- Freestanding tables can be ganged with connected tables in some cases, providing that the number and size of connected tables is easily movable (**Figure 6**).
- **DO NOT DRAG TABLES WHEN RE-CONFIGURING.**

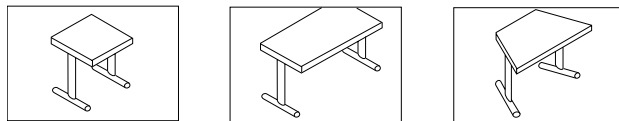
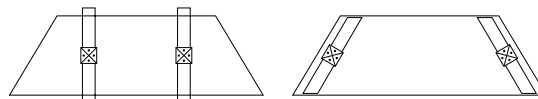

Figure 3 - Freestanding Tables



Incorrect Correct

Figure 4 - Trapezoid Tops

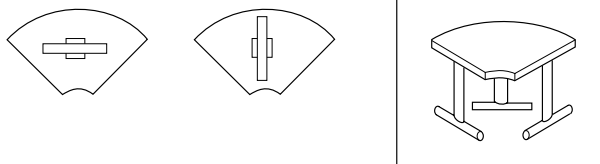

Figure 5 - Adding a Third Leg

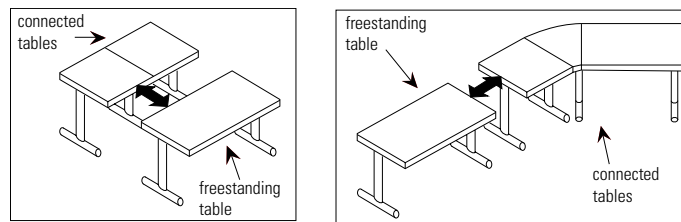

Figure 6 - Ganging with Connected Tables

CONNECTING CONDITIONS

- Any two worksurfaces of equal depth (24"D, 30"D or 36"D) can be connected with one leg, at the connecting or end edges (**Figure 8**).
- Half round work surfaces can be used in the following ways: They must be of equal width when connected to each other (**Figure 7**) or the connecting shapes must be equal to half the width of the connecting half round (**Figure 8**).
- ConnectABLES® is designed with the leg to be fastened parallel to connecting edges, but in some cases you may wish to fasten legs at 90° to connecting edges. This could allow for increased leg or knee clearance, depending on the intended use (**Figure 9**).
- Quarter round and 90° crescent work surfaces have provision for an optional third leg for additional stability when heavy loads are applied to the outside edge. For quarter round work surfaces, it is recommended that configuration "A" be used since the outside end of the center leg in configuration "B" is almost flush with the outside edge of the worksurface. If configuration "B" is installed against a wall or where there will be no traffic flow, then configuration "B" can be used.

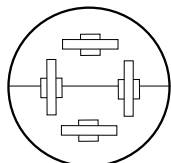

Figure 7

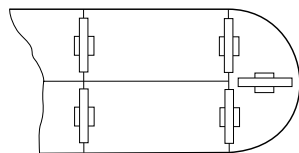

Figure 8

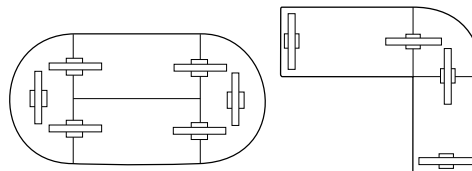
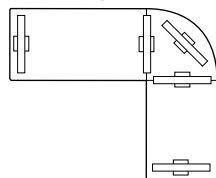
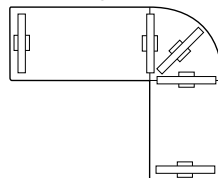

Figure 9 - 90° Leg Connections



Configuration A



Configuration B

C CONNECTABLES® - PUTTING IT ALL TOGETHER

Legs are fastened to worksurfaces utilizing a steel-to-steel connection. Each leg comes equipped with four ¼" x 7/8" machine screws. Screws are inserted through the four oval shaped holes only. Do not use wood screws! When fastening legs to work surfaces, hand thread screws into position to prevent any cross threading. When all screws have been hand threaded, tighten firmly with screwdriver to secure. Optional thumbscrews can be used in place of machine screws. Thumbscrews eliminate the need for a screwdriver, whether assembling or disassembling tables. **Do not use power tools for assembly of legs.**

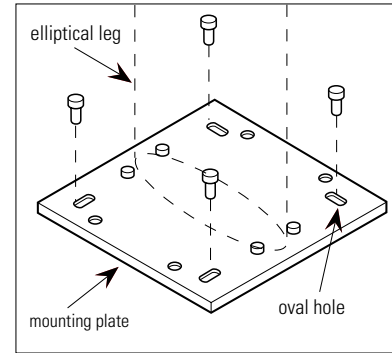

FREESTANDING TABLES

1. Turn work surface upside-down on clean floor. (You may want to use carton from packaging as a protective assembly surface to protect the top from scratching.)
2. Position leg mounting plate holes over threaded steel inserts in top.
3. Fasten each leg to top with four ¼" x 7/8" screws.
4. Turn table right-side up.
5. Level table by adjusting glides.

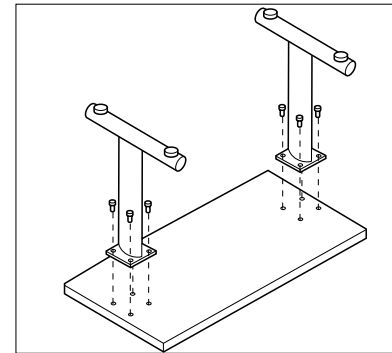

CONNECTING TABLES

1. Determine approximate location of desired configuration in room and turn work surfaces upside-down on floor. (Remember you are working in reverse.)
2. Position leg mounting plate so it is centered over the connecting edge of the first work surface. Fasten leg with two ¼" x 7/8" screws.
3. Repeat step 2 and 3 on the opposite edge of the first work surface.
4. Turn table right-side up.
5. Turn table right-side up and fasten to the previous top from the underside.
6. To add additional work surfaces repeat step 6.
7. When all the tops have been connected, level complete configuration by adjusting glides.

Note: Use the same procedures as above when using optional thumb screws.

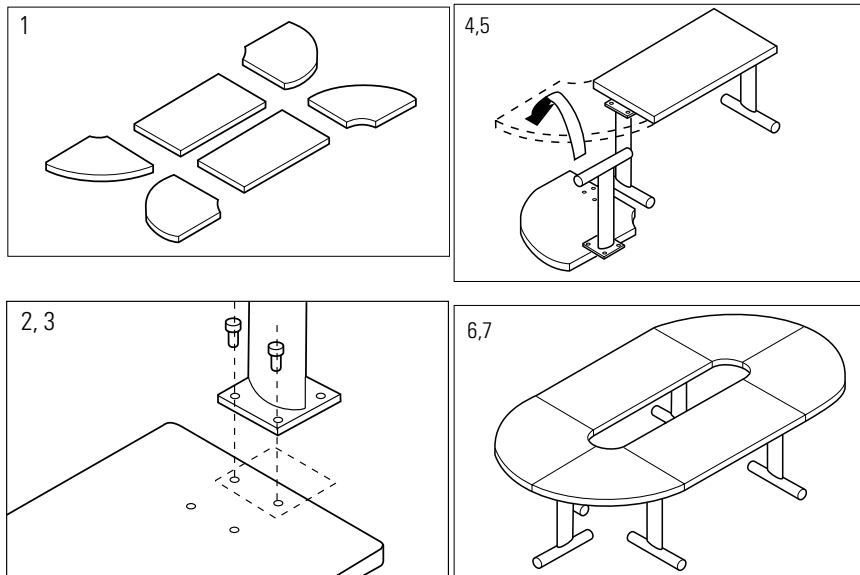

OPTIONAL CASTERS

1. Turn work surface upside-down on floor.
2. Remove existing glide if previously installed.
3. Fasten caster to T-leg by threading caster stem into base of T-leg and secure by tightening lock nut.
4. If casters are used in combination with gliders, level table by adjusting glides.

Note: Casters are available in locking or non-locking styles.

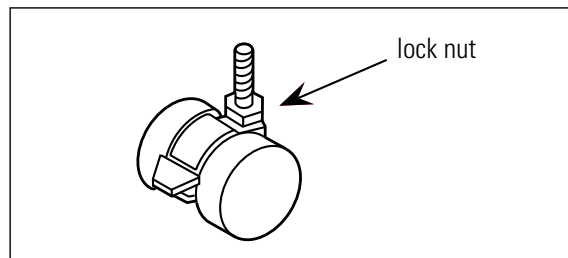
**OPTIONAL GANGING HARDWARE**

1. Optional ganging hardware should be used when quick and frequent reconfigurations are required.
2. Turn work surfaces to be ganged upside-down on floor.
3. Remove ganging hardware from package. Holes with steel inserts are located in the corner of tops.
4. Fasten ganging hardware to each work surface with supplied thumb screws.
5. Projected arm from ganging hardware can pivot out of the way when not in use.

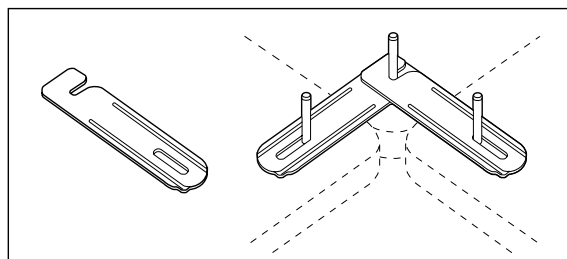

SQUARE TOPS

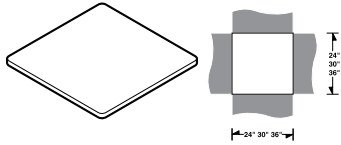

Square Top

MODEL#	DIMENSIONS	FREIGHT CLASS	WT/LB.	CUBIC FT.	LIST PRICE	HP ADD
	D x W x H					
CNS2424	24 x 24 x 1	70	18	1	\$431	\$216
CNS3030	30 x 30 x 1	70	27	1.56	\$525	\$264
CNS3636	36 x 36 x 1	70	39	2	\$563	\$283

T-mold edging. Predrilled with threaded steel inserts for freestanding and linking installations.

RECTANGULAR TOPS

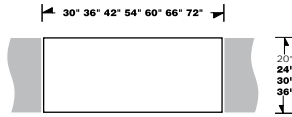

Rectangle Top

MODEL #	DIMENSIONS	FREIGHT CLASS	WT/LB.	CUBIC FT.	LIST PRICE	HP ADD
CNR2030	20 x 30 x 1	70	22	1.25	\$312	\$158
CNR2036	36 x 20 x 1	60	22.5	0.46	\$346	\$174
CNR2042	20 x 42 x 1	70	31	1.75	\$372	\$187
CNR2048	20 x 48 x 1	70	35	2	\$414	\$209
CNRU2054	20 x 54 x 1	60	33.75	0.69	\$513	\$259
CNRU2060	20 x 60 x 1	65	37.5	1.4	\$552	\$278
CNRU2066	20 x 66 x 1	60	41.25	0.84	\$597	\$302
CNRU2072	20 x 72 x 1	60	45	1	\$637	\$319
CNR2430	24 x 30 x 1	70	22	1.25	\$312	\$158
CNR2436	24 x 36 x 1	70	26	1.5	\$346	\$174
CNR2442	24 x 42 x 1	70	31	1.75	\$372	\$187
CNR2448	24 x 48 x 1	70	35	2	\$414	\$209
CNRU2454	24 x 54 x 1	70	42	2.34	\$513	\$259
CNRU2460	24 x 60 x 1	70	47	2.5	\$552	\$278
CNRU2466	24 x 66 x 1	70	52	2.8	\$597	\$302
CNRU2472	24 x 72 x 1	70	57	3	\$637	\$319
CNR3036	30 x 36 x 1	70	33	1.88	\$414	\$209
CNR3042	30 x 42 x 1	70	38	2.19	\$451	\$226
CNR3048	30 x 48 x 1	70	44	2.5	\$477	\$241
CNRU3054	30 x 54 x 1	70	52	2.8	\$590	\$296
CNRU3060	30 x 60 x 1	70	59	3.13	\$634	\$318
CNRU3066	30 x 66 x 1	70	64	3.44	\$677	\$341
CNRU3072	30 x 72 x 1	70	70	3.75	\$721	\$362
CNR3642	36 x 42 x 1	60	52.5	1.6	\$597	\$302
CNR3648	36 x 48 x 1	60	60	1.8	\$653	\$328
CNRU3654	36 x 54 x 1	60	70	2	\$789	\$396
CNRU3660	36 x 60 x 1	60	78	2.2	\$875	\$441
CNRU3666	36 x 66 x 1	60	87	2.4	\$958	\$482
CNRU3672	36 x 72 x 1	60	94	2.6	\$1043	\$524

T-mold edging. Predrilled with threaded steel inserts for freestanding and linking installations. **Tops 54" and longer are standard with a 16 gauge steel support channel.**

TRAPEZOID TOPS

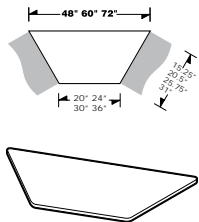

Trapezoid Top

MODEL #	DIMENSIONS	FREIGHT CLASS	WT/LB.	CUBIC FT.	LIST PRICE	HP ADD
CNT2048	17.5 x 48 x 1	60	26.25	0.55	\$435	\$219
CNT2060	17.5 x 60 x 1	65	44	1.85	\$522	\$263
CNT2448	20.5 x 48 x 1	92.5	21	2	\$435	\$219
CNT2460	20.5 x 60 x 1	65	44	1.85	\$522	\$263
CNT3060	25.75 x 60 x 1	92.5	35	3.13	\$571	\$287
CNT3072	25.75 x 72 x 1	60	66	2.2	\$637	\$319
CNT3660	31 x 60 x 1	60	66	2.2	\$814	\$409
CNT3672	31 x 72 x 1	65	79.2	3.5	\$971	\$488

T-mold edging. Predrilled with threaded steel inserts for freestanding and linking installations.

Required Specifications

Top Finish
Edge Finish

Optional Specifications

Grommet

Accessories

Power Block

90° CRESCENT TOPS

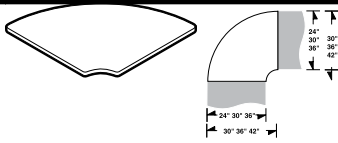

90° Crescent Top

MODEL#	DIMENSIONS	FREIGHT CLASS	WT/LBS.	CUBIC FT.	LIST PRICE	HP ADD
	D x W x H					
CNC2430	30 x 30 x 1	85	20	1.56	\$455	\$228
CNC3036	36 x 36 x 1	85	30	2.25	\$645	\$323
CNC3642	42 x 42 x 1	70	50	3.15	\$885	\$444

T-mold edging. Predrilled with threaded steel inserts for freestanding and linking installations.

- **CNC2430** for use with 24" deep tops
- **CNC3036** for use with 30" deep tops
- **CNC3642** for use with 36" deep tops
- **CNC2430** does not require a center leg

QUARTER ROUND TOPS

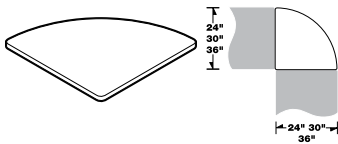

Quarter Round Top

MODEL #	DIMENSIONS	FREIGHT CLASS	WT/LB.	CUBIC FT.	LIST PRICE	HP ADD
CNQ2424	24 x 24 x 1	85	14	1	\$287	\$145
CNQ3030	30 x 30 x 1	85	21	1.56	\$347	\$175
CNQ3636	36 x 36 x 1	60	45	1.3	\$492	\$247

T-mold edging. Predrilled with threaded steel inserts for **linking installations ONLY**.

45° WEDGE TOPS

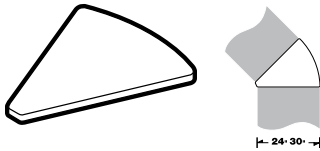

45° Wedge Top

MODEL #	DIMENSIONS	FREIGHT CLASS	WT/LB.	CUBIC FT.	LIST PRICE	HP ADD
CNW2424	24 x 24 x 1	92.5	10	1	\$307	\$156
CNW3030	30 x 30 x 1	100	14	1.56	\$373	\$187

T-mold edging. Predrilled with threaded steel inserts for **linking installations ONLY**.

THREE WAY CONNECTOR TOPS

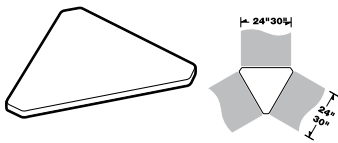

Three Way Connector Top

MODEL #	DIMENSIONS	FREIGHT CLASS	WT/LB.	CUBIC FT.	LIST PRICE	HP ADD
CNY2424	24 x 24 x 1	85	13	1	\$287	\$145
CNY3030	30 x 30 x 1	92.5	18	1.56	\$347	\$175

T-mold edging. Predrilled with threaded steel inserts for **linking installations ONLY**.

HALF ROUND TOPS

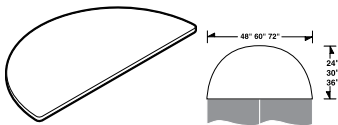

Half Round Top

MODEL #	DIMENSIONS	FREIGHT CLASS	WT/LB.	CUBIC FT.	LIST PRICE	HP ADD
CNHFS2448	24 x 48 x 1	70	36	2	\$438	\$220
CNHFS3060	30 x 60 x 1	70	56	3.13	\$567	\$286
CNHFS3672	36 x 72 x 1	65	81	3.3	\$971	\$488

T-mold edging. Predrilled with threaded steel inserts for freestanding and linking installations.

- *Requires three legs for freestanding*

EXTENDED HALF ROUND TOPS

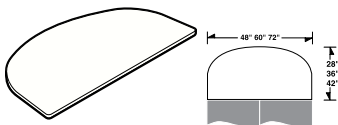

Extended Half Round Top

MODEL #	DIMENSIONS	FREIGHT CLASS	WT/LB.	CUBIC FT.	LIST PRICE	HP ADD
CNHE24	28 x 48 x 1	65	50	1.88	\$536	\$269
CNHE30	36 x 60 x 1	65	75	2.87	\$745	\$375
CNHE36	42 x 72 x 1	65	102	3.88	\$1185	\$594

T-mold edging. Predrilled with threaded steel inserts for **linking installations ONLY**.

Required Specifications

Top Finish
Edge Finish

Optional Specifications

Grommet

Accessories

Power Block

MODESTY PANELS

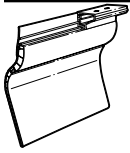

Modesty Panel

MODEL#	DIMENSIONS D x W x H	FREIGHT CLASS	WT./LBS.	CUBIC FT.	LIST PRICE
CNCA2430	2.75 x 35 x 11.75	150	2.8	0.5	\$255
CNCA3036	2.75 x 43 x 11.75	150	3.3	0.6	\$297
CNCA3642	2.75 x 53 x 11.75	150	3.9	0.7	\$389

For use with **CNC crescent tops**. 11 3/4" high, Black plastic, attractive ribbed design. Includes two fold-away installation clips and flexible privacy strips. Connects to predrilled holes in table top.

- *Can not be used when worksurface tops are attached to flip top legs.*

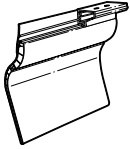

Modesty Panel

CNOA2424	2.75 x 27 x 11.75	150	2.2	0.4	\$218
CNOA3030	2.75 x 35 x 11.75	150	2.8	0.5	\$255
CNOA3636	2.75 x 44 x 11.75	150	3.3	0.6	\$297

For use with **CNQ quarter round tops**. 11 3/4" high, Black plastic, attractive ribbed design. Includes two fold-away installation clips and flexible privacy strips. Connects to predrilled holes in table top.

- *Can not be used when worksurface tops are attached to flip top legs.*

CNRA2030	2.75 x 29 x 11.75	150	2.8	0.5	\$218
CNRA2036	2.75 x 35 x 11.75	150	3.3	0.6	\$255
CNRA2042	2.75 x 41 x 11.75	150	3.9	0.7	\$297
CNRA2048	2.75 x 47 x 11.75	150	4.4	0.8	\$337
CNRA2054	2.75 x 53 x 11.75	150	5	0.9	\$389
CNRA2060	2.75 x 59 x 11.75	150	5.5	1	\$422
CNRA2066	2.75 x 65 x 11.75	150	6.1	1.1	\$463
CNRA2072	2.75 x 71 x 11.75	150	6.6	1.2	\$505

CNRA2430	2.75 x 29 x 11.75	150	2.8	0.5	\$218
CNRA2436	2.75 x 35 x 11.75	150	3.3	0.6	\$255
CNRA2442	2.75 x 41 x 11.75	150	3.9	0.7	\$297
CNRA2448	2.75 x 47 x 11.75	150	4.4	0.8	\$337
CNRA2454	2.75 x 53 x 11.75	150	5	0.9	\$389
CNRA2460	2.75 x 59 x 11.75	150	5.5	1	\$422
CNRA2466	2.75 x 65 x 11.75	150	6.1	1.1	\$463
CNRA2472	2.75 x 71 x 11.75	150	6.6	1.2	\$505

CNRA3036	2.75 x 35 x 11.75	150	3.3	0.6	\$255
CNRA3042	2.75 x 41 x 11.75	150	3.9	0.7	\$297
CNRA3048	2.75 x 47 x 11.75	150	4.4	0.8	\$337
CNRA3054	2.75 x 53 x 11.75	150	5	0.9	\$389
CNRA3060	2.75 x 59 x 11.75	150	5.5	1	\$422
CNRA3066	2.75 x 65 x 11.75	150	6.1	1.1	\$463
CNRA3072	2.75 x 71 x 11.75	150	6.6	1.2	\$505

CNRA3642	2.75 x 41 x 11.75	150	3.9	0.7	\$297
CNRA3648	2.75 x 47 x 11.75	150	4.4	0.8	\$337
CNRA3654	2.75 x 53 x 11.75	150	5	0.9	\$389
CNRA3660	2.75 x 59 x 11.75	150	5.5	1	\$422
CNRA3666	2.75 x 65 x 11.75	150	6.1	1.1	\$463
CNRA3672	2.75 x 71 x 11.75	150	6.6	1.2	\$505

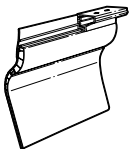

Modesty Panel

For use with **CNR/CNRU rectangular tops**. 11 3/4" high, Black plastic, attractive ribbed design. Includes two fold-away installation clips and flexible privacy strips. Connects to predrilled holes in table top.

- *Can not be used when worksurface tops are attached to flip top legs.*

Required Specifications

Top Finish
Edge Finish

Optional Specifications

Grommet

Accessories

Power Block

MODESTY PANELS

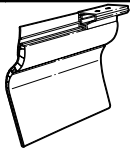

Modesty Panel

MODEL# DIMENSIONS FREIGHT CLASS WT/LBS. CUBIC FT. LIST PRICE

D x W x H

CNSA2424	2.75 x 23 x 11.75	150	2.2	0.4	\$174
CNSA3030	2.75 x 29 x 11.75	150	2.8	0.5	\$218
CNSA3636	2.75 x 35 x 11.75	150	3.3	0.6	\$255

For use with **long side of CNS square tops**. 11 3/4" high, Black plastic, attractive ribbed design. Includes two fold-away installation clips and flexible privacy strips. Connects to predrilled holes in table top.

- *Can not be used when worksurface tops are attached to flip top legs.*

CNTA2048L	20 x 43	150	4.4	0.8	\$297
CNTA2060L	2.750 x 55	150	5.5	1.2	\$389

CNTA2448L	2.75 x 43 x 11.75	150	4.4	0.8	\$297
CNTA2460L	2.75 x 55 x 11.75	150	5.5	1.2	\$389

CNTA3060L	2.75 x 55 x 11.75	150	5.5	1.2	\$389
CNTA3072L	2.75 x 67 x 11.75	150	6.6	1.4	\$463

CNTA3660L	2.75 x 55 x 11.75	150	5.5	1.2	\$389
CNTA3672L	2.75 x 67 x 11.75	150	6.6	1.4	\$463

For use with **long side of CNT trapezoid tops**. 11 3/4" high, Black plastic, attractive ribbed design. Includes two fold-away installation clips and flexible privacy strips. Connects to predrilled holes in table top.

- *Can not be used when worksurface tops are attached to flip top legs.*

CNTA2048S	20 x 24	150	2.2	0.4	\$174
CNTA2060S	20 x 36	150	2.8	0.5	\$255

CNTA2448S	2.75 x 23 x 11.75	150	2.2	0.4	\$174
CNTA2460S	2.75 x 35 x 11.75	150	2.2	0.4	\$255

CNTA3060S	2.75 x 29 x 11.75	150	2.8	0.5	\$218
CNTA3072S	2.75 x 41 x 11.75	150	2.8	0.5	\$297

CNTA3660S	2.75 x 23 x 11.75	150	3.3	0.6	\$174
CNTA3672S	2.75 x 35 x 11.75	150	3.3	0.6	\$255

For use with **short side of CNT trapezoid tops**. 11 3/4" high, Black plastic, attractive ribbed design. Includes two fold-away installation clips and flexible privacy strips. Connects to predrilled holes in table top.

- *Can not be used when worksurface tops are attached to flip top legs.*

CNWA2424	2.75 x 17 x 11.75	150	2.2	0.4	\$135
CNWA3030	2.75 x 22 x 11.75	150	2.8	0.5	\$174

For use with **CNW wedge tops**. 11 3/4" high, Black plastic, attractive ribbed design. Includes two fold-away installation clips and flexible privacy strips. Connects to predrilled holes in table top.

- *Can not be used when worksurface tops are attached to flip top legs.*

CNYA2424	2.75 x 22 x 11.75	150	2.2	0.4	\$164
CNYA3030	2.75 x 27 x 11.75	150	2.8	0.5	\$199

For use with **CNY triangle tops**. 11 3/4" high, Black plastic, attractive ribbed design. Includes two fold-away installation clips and flexible privacy strips. Connects to predrilled holes in table top.

- *Can not be used when worksurface tops are attached to flip top legs.*

Modesty Panel

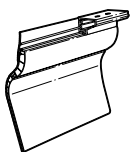

Modesty Panel

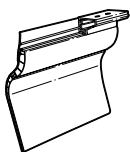

Modesty Panel

Required Specifications

Top Finish
Edge Finish

Optional Specifications

Grommet

Accessories

Power Block

WIRE MANAGEMENT UNITS

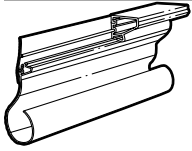

Wire Management Unit

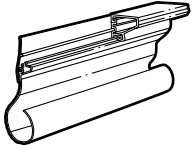

Wire Management Unit

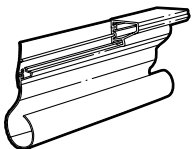

Wire Management Unit

MODEL#	DIMENSIONS D x W x H	FREIGHT CLASS	WT./LBS.	CUBIC FT.	LIST PRICE
CNCB2430	2.75 x 35 x 6	70	1.5	0.5	\$193
CNCB3036	2.75 x 43 x 6	70	1.8	0.6	\$215
CNCB3642	2.75 x 53 x 6	250	2.1	0.7	\$279

For use with **CNC crescent tops**. 6" high, Black plastic, attractive ribbed design. Includes two fold-away installation clips and flexible privacy strips. Connects to predrilled holes in table top. Can be used with or without wire management grommet.

- *Cannot be used when worksurface tops are attached to flip top legs.*

CNQB2424	2.75 x 27 x 6	70	1.2	0.4	\$162
CNQB3030	2.75 x 35 x 6	70	1.5	0.5	\$193
CNQB3636	2.75 x 44 x 6	70	1.8	0.6	\$248

For use with **CNQ quarter round tops**. 6" high, Black plastic, attractive ribbed design. Includes two fold-away installation clips and flexible privacy strips. Connects to predrilled holes in table top. Can be used with or without wire management grommet.

- *Cannot be used when worksurface tops are attached to flip top legs.*

CNRB2030	2.75 x 29 x 6	70	1.5	0.5	\$162
CNRB2036	2.75 x 35 x 6	70	1.8	0.6	\$193
CNRB2042	2.75 x 41 x 6	250	2.1	0.7	\$215
CNRB2048	2.75 x 47 x 6	250	2.4	0.8	\$297
CNRB2054	2.75 x 53 x 6	250	2.7	0.9	\$312
CNRB2060	2.75 x 59 x 6	250	3	1	\$312
CNRB2066	2.75 x 65 x 6	250	3.3	1.1	\$312
CNRB2072	2.75 x 71 x 6	250	3.6	1.2	\$422
CNRB2430	2.75 x 29 x 6	70	1.5	0.5	\$162
CNRB2436	2.75 x 35 x 6	70	1.8	0.6	\$193
CNRB2442	2.75 x 41 x 6	250	2.1	0.7	\$215
CNRB2448	2.75 x 47 x 6	250	2.4	0.8	\$297
CNRB2454	2.75 x 53 x 6	250	2.7	0.9	\$312
CNRB2460	2.75 x 59 x 6	250	3	1	\$312
CNRB2466	2.75 x 65 x 6	250	3.3	1.1	\$312
CNRB2472	2.75 x 71 x 6	250	3.6	1.2	\$422
CNRB3036	2.75 x 35 x 6	70	1.8	0.6	\$193
CNRB3042	2.75 x 41 x 6	250	2.1	0.7	\$215
CNRB3048	2.75 x 47 x 6	250	2.4	0.8	\$248
CNRB3054	2.75 x 53 x 6	250	2.7	0.9	\$279
CNRB3060	2.75 x 59 x 6	250	3	1	\$312
CNRB3066	2.75 x 65 x 6	250	3.3	1.1	\$368
CNRB3072	2.75 x 71 x 6	250	3.6	1.2	\$422
CNRB3642	2.75 x 41 x 6	250	2.1	0.7	\$215
CNRB3648	2.75 x 47 x 6	250	2.4	0.8	\$279
CNRB3654	2.75 x 53 x 6	250	2.7	0.9	\$279
CNRB3660	2.75 x 59 x 6	250	3	1	\$312
CNRB3666	2.75 x 65 x 6	250	3.3	1.1	\$312
CNRB3672	2.75 x 71 x 6	250	3.6	1.2	\$422

For use with **CNR/CNRU rectangular tops**. 6" high, Black plastic, attractive ribbed design. Includes two fold-away installation clips and flexible privacy strips. Connects to predrilled holes in table top. Can be used with or without wire management grommet.

- *Cannot be used when worksurface tops are attached to flip top legs.*

Required Specifications

Top Finish
Edge Finish

Optional Specifications

Grommet

Accessories

Power Block

WIRE MANAGEMENT UNITS

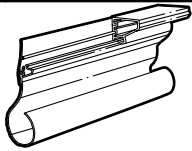

Wire Management Unit

MODEL# DIMENSIONS FREIGHT CLASS WT/LBS. CUBIC FT. LIST PRICE

	D x W x H				
CNSB2424	2.75 x 23 x 6	70	1.8	0.4	\$129
CNSB3030	2.75 x 29 x 6	70	1.5	0.5	\$162
CNSB3636	2.75 x 35 x 6	70	1.8	0.6	\$193

For use with **CNS square tops**. 6" high, Black plastic, attractive ribbed design. Includes two fold-away installation clips and flexible privacy strips. Connects to predrilled holes in table top. Can be used with or without wire management grommet.

- *Cannot be used when worksurface tops are attached to flip top legs.*

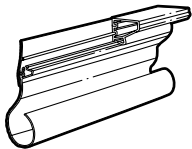

Wire Management Unit

CNTB2048L	0 x 43	250	2.4	0.8	\$215
CNTB2060L	0 x 55	250	3	1	\$279
CNTB2448L	2.75 x 43 x 6	250	2.4	0.8	\$215
CNTB2460L	2.75 x 55 x 6	250	3	1	\$279
CNTB3060L	2.75 x 55 x 6	250	3	1	\$279
CNTB3072L	2.75 x 67 x 6	250	3.6	1.2	\$389
CNTB3660L	2.75 x 55 x 6	250	3	1	\$279
CNTB3672L	2.75 x 67 x 6	250	3.6	1.2	\$389

For use with **long side of CNT trapezoid tops**. 6" high, Black plastic, attractive ribbed design. Includes two fold-away installation clips and flexible privacy strips. Connects to predrilled holes in table top. Can be used with or without wire management grommet.

- *Cannot be used when worksurface tops are attached to flip top legs.*

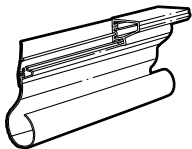

Wire Management Unit

CNTB2048S	0 x 24	70	1.2	0.4	\$129
CNTB2060S	0 x 36	70	1.5	0.5	\$193
CNTB2448S	2.75 x 23 x 6	70	1.2	0.4	\$129
CNTB2460S	2.75 x 35 x 6	70	1.2	0.4	\$193
CNTB3060S	2.75 x 29 x 6	70	1.5	0.5	\$162
CNTB3072S	2.75 x 41 x 6	70	1.5	0.5	\$215
CNTB3660S	2.75 x 23 x 6	70	1.8	0.6	\$129
CNTB3672S	2.75 x 35 x 6	70	1.8	0.6	\$193

For use with **short side of CNT trapezoid tops**. 6" high, Black plastic, attractive ribbed design. Includes two fold-away installation clips and flexible privacy strips. Connects to predrilled holes in table top. Can be used with or without wire management grommet.

- *Can not be used when worksurface tops are attached to flip top legs.*

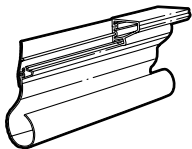

Wire Management Unit

CNWB2424	2.75 x 17 x 6	70	1.2	0.4	\$106
CNWB3030	2.75 x 22 x 6	70	1.5	0.5	\$129

For use with **CNW wedge tops**. 6" high, Black plastic, attractive ribbed design. Includes two fold-away installation clips and flexible privacy strips. Connects to predrilled holes in table top. Can be used with or without wire management grommet.

- *Cannot be used when worksurface tops are attached to flip top legs.*

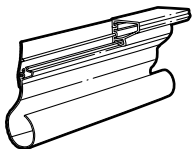

Wire Management Unit

CNYB2424	2.75 x 22 x 6	70	1.2	0.4	\$129
CNYB3030	2.75 x 27 x 6	70	1.5	0.5	\$162

For use with **CNY triangle tops**. 6" high, Black plastic, attractive ribbed design. Includes two fold-away installation clips and flexible privacy strips. Connects to predrilled holes in table top. Can be used with or without wire management grommet.

- *Cannot be used when worksurface tops are attached to flip top legs.*

Required Specifications

Top Finish
Edge Finish

Optional Specifications

Grommet

Accessories

Power Block

MODESTY PANEL WITH WIRE MANAGEMENT

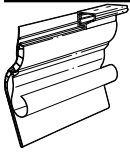

Modesty Panel with Wire Management

MODEL#	DIMENSIONS D x W x H	FREIGHT CLASS	WT./LBS.	CUBIC FT.	LIST PRICE
CNCC2430	2.75 x 35 x 11.75	100	4.3	0.5	\$279
CNCC3036	2.75 x 43 x 11.75	100	5.1	0.6	\$317
CNCC3642	2.75 x 53 x 11.75	100	6	0.7	\$411

For use with **CNC crescent tops**. 11 3/4" high, Black plastic, attractive ribbed design. Includes two fold-away installation clips and flexible privacy strips. Connects to predrilled holes in table top. Can be used with or without wire management grommet.

- *Can not be used when worksurface tops are attached to flip top legs.*

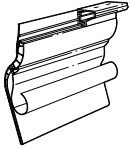

Modesty Panel with Wire Management

CNQC2424	2.75 x 27 x 11.75	100	3.4	0.4	\$233
CNQC3030	2.75 x 35 x 11.75	100	4.3	0.5	\$279
CNQC3636	2.75 x 44 x 11.75	100	5.1	0.6	\$317

For use with **CNC quarter round tops**. 11 3/4" high, Black plastic, attractive ribbed design. Includes two fold-away installation clips and flexible privacy strips. Connects to predrilled holes in table top. Can be used with or without wire management grommet.

- *Can not be used when worksurface tops are attached to flip top legs.*

CNRC2030	2.75 x 29 x 11.75	100	4.3	0.5	\$233
CNRC2036	2.75 x 35 x 11.75	100	5.1	0.6	\$279
CNRC2042	2.75 x 41 x 11.75	100	6	0.7	\$317
CNRC2048	2.75 x 47 x 11.75	100	6.8	0.8	\$369
CNRC2054	2.75 x 53 x 11.75	100	7.7	0.9	\$411
CNRC2060	2.75 x 59 x 11.75	100	8.5	1	\$456
CNRC2066	2.75 x 65 x 11.75	100	9.4	1.1	\$493
CNRC2072	2.75 x 71 x 11.75	100	10.2	1.2	\$522
CNRC2430	2.75 x 29 x 11.75	100	4.3	0.5	\$233
CNRC2436	2.75 x 35 x 11.75	100	5.1	0.6	\$279
CNRC2442	2.75 x 41 x 11.75	100	6	0.7	\$317
CNRC2448	2.75 x 47 x 11.75	100	6.8	0.8	\$369
CNRC2454	2.75 x 53 x 11.75	100	7.7	0.9	\$411
CNRC2460	2.75 x 59 x 11.75	100	8.5	1	\$456
CNRC2466	2.75 x 65 x 11.75	100	9.4	1.1	\$493
CNRC2472	2.75 x 71 x 11.75	100	10.2	1.2	\$522
CNRC3036	2.75 x 35 x 11.75	100	5.1	0.6	\$279
CNRC3042	2.75 x 41 x 11.75	100	6	0.7	\$317
CNRC3048	2.75 x 47 x 11.75	100	6.8	0.8	\$369
CNRC3054	2.75 x 53 x 11.75	100	7.7	0.9	\$411
CNRC3060	2.75 x 59 x 11.75	100	8.5	1	\$456
CNRC3066	2.75 x 65 x 11.75	100	9.4	1.1	\$493
CNRC3072	2.75 x 71 x 11.75	100	10.2	1.2	\$522
CNRC3642	2.75 x 41 x 11.75	100	6	0.7	\$317
CNRC3648	2.75 x 47 x 11.75	100	6.8	0.8	\$369
CNRC3654	2.75 x 53 x 11.75	100	7.7	0.9	\$411
CNRC3660	2.75 x 59 x 11.75	100	8.5	1	\$456
CNRC3666	2.75 x 65 x 11.75	100	9.4	1.1	\$493
CNRC3672	2.75 x 71 x 11.75	100	10.2	1.2	\$522

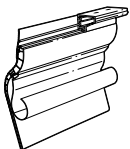

Modesty Panel with Wire Management

For use with **CNR/CNRU rectangular tops**. 11 3/4" high, Black plastic, attractive ribbed design. Includes two fold-away installation clips and flexible privacy strips. Connects to predrilled holes in table top. Can be used with or without wire management grommet.

- *Can not be used when worksurface tops are attached to flip top legs.*

Required Specifications

Top Finish
Leg Finish
Edge Finish

Optional Specifications

Grommet

Accessories

Power Block

MODESTY PANEL WITH WIRE MANAGEMENT

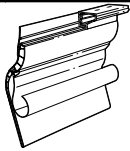

Modesty Panel with Wire Management

MODEL# DIMENSIONS FREIGHT CLASS WT/LBS. CUBIC FT. LIST PRICE

D x W x H

CNSC2424	2.75 x 23 x 11.75	100	3.5	0.4	\$193
CNSC3030	2.75 x 29 x 11.75	100	4.3	0.5	\$233
CNSC3636	2.75 x 35 x 11.75	100	5.1	0.6	\$279

For use with **CNC square tops**. 11 3/4" high, Black plastic, attractive ribbed design. Includes two fold-away installation clips and flexible privacy strips. Connects to predrilled holes in table top. Can be used with or without wire management grommet.

- *Can not be used when worksurface tops are attached to flip top legs.*

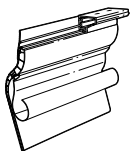

Modesty Panel with Wire Management

CNTC2048L	2.75 x 43 x 11.75	100	6.8	0.8	\$317
CNTC2060L	2.75 x 55 x 11.75	100	8.5	1	\$411
CNTC2448L	2.75 x 43 x 11.75	100	6.8	0.8	\$317
CNTC2460L	2.75 x 55 x 11.75	100	8.5	1	\$411
CNTC3060L	2.75 x 55 x 11.75	100	8.5	1	\$411
CNTC3072L	2.75 x 67 x 11.75	100	10.2	1.2	\$493
CNTC3660L	2.75 x 55 x 11.75	100	8.5	1	\$411
CNTC3672L	2.75 x 67 x 11.75	100	10.2	1.2	\$493

For use with **long side of CNT trapezoid tops**. 11 3/4" high, Black plastic, attractive ribbed design. Includes two fold-away installation clips and flexible privacy strips. Connects to predrilled holes in table top. Can be used with or without wire management grommet.

- *Can not be used when worksurface tops are attached to flip top legs.*

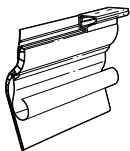

Modesty Panel with Wire Management

CNTC2048S	2.75 x 23 x 11.75	100	3.4	0.4	\$193
CNTC2060S	2.75 x 35 x 11.75	100	3.5	0.5	\$279
CNTC2448S	2.75 x 23 x 11.75	100	3.4	0.4	\$193
CNTC2460S	2.75 x 35 x 11.75	100	3.4	0.4	\$279
CNTC3060S	2.75 x 29 x 11.75	100	4.3	0.5	\$233
CNTC3072S	2.75 x 41 x 11.75	100	4.3	0.5	\$317
CNTC3660S	2.75 x 23 x 11.75	100	5.1	0.6	\$193
CNTC3672S	2.75 x 35 x 11.75	100	5.1	0.6	\$279

For use with **short side of CNT trapezoid tops**. 11 3/4" high, Black plastic, attractive ribbed design. Includes two fold-away installation clips and flexible privacy strips. Connects to predrilled holes in table top. Can be used with or without wire management grommet.

- *Can not be used when worksurface tops are attached to flip top legs.*

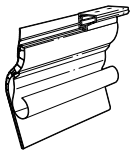

Modesty Panel with Wire Management

CNWC2424	2.75 x 17 x 11.75	100	3.4	0.4	\$158
CNWC3030	2.75 x 22 x 11.75	100	4.3	0.5	\$193

For use with **CNW wedge tops**. 11 3/4" high, Black plastic, attractive ribbed design. Includes two fold-away installation clips and flexible privacy strips. Connects to predrilled holes in table top. Can be used with or without wire management grommet.

- *Can not be used when worksurface tops are attached to flip top legs.*

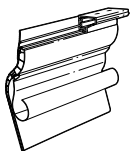

Modesty Panel with Wire Management

CNYC2424	2.75 x 22 x 11.75	100	3.4	0.4	\$193
CNYC3030	2.75 x 27 x 11.75	100	4.3	0.5	\$233

For use with **CNY triangle tops**. 11 3/4" high, Black plastic, attractive ribbed design. Includes two fold-away installation clips and flexible privacy strips. Connects to predrilled holes in table top. Can be used with or without wire management grommet.

- *Can not be used when worksurface tops are attached to flip top legs.*

Required Specifications

Top Finish
Leg Finish
Edge Finish

Optional Specifications

Grommet

Accessories

Power Block

T LEGS

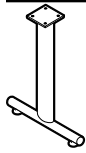

"T" Leg

MODEL#	DIMENSIONS D x W x H	FREIGHT CLASS	WT/LBS.	CUBIC FT.	LIST PRICE
GCNTLEG18	5.25 x 17.1 x 27.63	125	15	2.1	\$294
GCNTLG18P	5.25 x 17.1 x 27.63	100	17	2.1	\$578

18" long with plastic elliptical column cover, leveling glides and end caps. **For assembly with 20" tops.**

- For a single leg, order **GCNTLEG18**.
- For a pair of legs (set of 2), order **GCNTLG18P**.
- Chrome (CHM) is available (on foot only). **Add \$96** list for model GCNTLEG18 and **\$186** list for model GCNTLG18P.

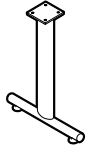

"T" Leg

GCNTLEG24	5.25 x 20.8 x 27.63	150	9	2.1	\$294
GCNTLG24P	5.25 x 20.8 x 27.63	100	17	2.1	\$578

20" long with plastic elliptical column cover, leveling glides and end caps. **For assembly with 24" tops.**

- For a single leg, order **GCNTLEG24**.
- For a pair of legs (set of 2), order **GCNTLG24P**.
- Chrome (CHM) is available (on foot only). **Add \$96** list for model GCNTLEG24 and **\$186** list for model GCNTLG24P.

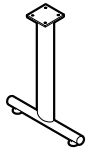

"T" Leg

GCNTLEG30	5.25 x 27.25 x 27.63	250	10	2.6	\$317
GCNTLG30P	5.25 x 27.25 x 27.63	125	19	2.6	\$630

26" long with plastic elliptical column cover, leveling glides and end caps. **For assembly with 30" tops.**

- For a single leg, order **GCNTLEG30**.
- For a pair of legs (set of 2), order **GCNTLG30P**.
- Chrome (CHM) is available (on foot only). **Add \$96** list for model GCNTLEG30 and **\$186** list for model GCNTLG30P.

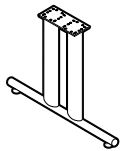

"T" Leg

GCNTLEG36	5.75 x 33.25 x 27.63	150	14	3.3	\$637
GCNTLG36P	5.25 x 33.25 x 27.63	100	27	3.3	\$1262

32" long with double post plastic elliptical column cover, leveling glides and end caps. **For assembly with 36" tops.**

- For a single leg, order **GCNTLEG36**.
- For a pair of legs (set of 2), order **GCNTLG36P**.
- Chrome (CHM) is available (on foot only). **Add \$96** list for model GCNTLEG36 and **\$186** list for model GCNTLG36P.

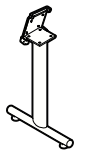

Flip Top "T" Leg

CNTFLEG24	1.75 x 20.8 x 28	150	10	2.4	\$547
-----------	------------------	-----	----	-----	--------------

20" long with plastic elliptical column cover, leveling glides and end caps. **For assembly with 24" deep rectangular and square tops only.** Hinged plate with locking mechanism to lock in open or closed position. Cannot be installed with thumbscrews.

- *Can not be used when modesty panels and wire management are attached to worksurface tops.*
- List Price is per **each leg**.
- Chrome (CHM) is available (on foot only). **Add \$96** list.

Required Specifications

Leg Finish

T LEGS

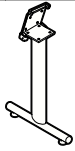

Flip Top "T" Leg

MODEL#	DIMENSIONS	FREIGHT CLASS	WT./LBS.	CUBIC FT.	LIST PRICE
--------	------------	---------------	----------	-----------	------------

D x W x H

CNTFLEG30	1.75 x 27.25 x 28	150	14	3	\$578
-----------	-------------------	-----	----	---	-------

26" long with plastic elliptical column cover, leveling glides and end caps. **For assembly with 30" deep rectangular and square tops only.** Hinged plate with locking mechanism to lock in open or closed position. Cannot be installed with thumbscrews.

- Can not be used when modesty panels and wire management are attached to worksurface tops.
- List Price is per **each leg**.
- Chrome (CHM) is available (on foot only). **Add \$96 list**

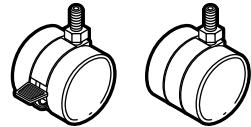

Casters

CNCP	- x - x 1.5	70	0.8	0.05	\$63
------	-------------	----	-----	------	------

Set of (2) 1½" dual wheel casters, one locking. Suggested for hard floor surfaces and industrial carpeting. Casters are fully interchangeable with glides. Black only.

- For use with *ConnecTABLES* units only.
- Casters **DO NOT** affect table height.

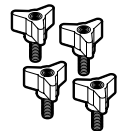

Thumbscrews

CNTS	1.25 x 1.25 x 1.5	70	0.04	0.02	\$40
------	-------------------	----	------	------	------

Triangular thumbscrew with ¾" steel thread. Set of 4. Can be used in place of factory supplied screws to allow installation of "T" legs to tops without tools. Black only.

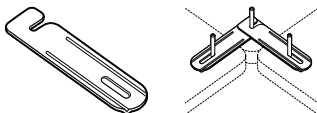

Ganging Connector

CNGFP	5 x 2.5 x 1.13	70	0.2	0.1	\$69
-------	----------------	----	-----	-----	------

Black epoxy coated 13 gauge steel with 2 thumbscrews included. Used to connect tabletops together for additional stability or for connecting freestanding tops together. Holes with steel inserts are located in the corner of all tops to accommodate this plate. **Sold individually.**

Required Specifications

Leg Finish



Duet tables are multi-purpose stacking tables that offer optimum space utilization and flexibility. Their personality and simple design make them ideal for use in any learning or training environment at post-secondary and adult levels. Temporarily and easily convert auditoriums and other spaces into examination and seminar spaces. They can be partnered with stacking chairs such as Duet or Popcorn in matching or complementary colors (stacking chairs can be found in the Multi-Purpose section of the Seating price list).

The one-piece molded top and modesty are gently contoured providing an eased edge with an elegant waterfall transition from top to modesty.

Tops are available in a wide array of colors in 0.5" thick polypropylene. Polypropylene material offers strength and ease of cleaning with a slightly textured surface to offer scratch resistance.

Features and Benefits

- One-piece molded top and modesty are 0.5" thick polypropylene.
- Tables are rated 250 lbs. capacity.
- Surface includes factory installed metal inserts for solid and secure connection to the sled frame.
- 0.5" diameter solid steel rod sled frame.
- Bumpers on the underside for protection when stacking.
- Model with ADA width compliant frame is available.
- Shipped fully assembled.



One-piece top and modesty.



Stacks 5 high on floor or 20 high on dolly.

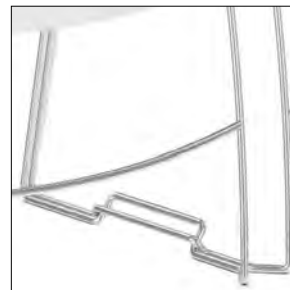

Ganging frame to keep tables evenly aligned.

GENERAL INFORMATION

- Duet tables are multi-purpose stacking tables ideal for auditoriums, seminars or any learning or training environment.
- Lightweight and easy to handle whether stacking for storage or setting up a room.
- Made of durable materials to withstand more demanding environments.
- Shipped fully assembled. Packaged 4 per carton.
- Global products are in compliance with stringent emission guidelines set out by the Greenguard Environmental Institute under the standards for low emitting products and materials. www.greenguard.org.
- Covered by Global's Lifetime Warranty.
- For environmental certifications, please visit globalfurnituregroup.com

WORKSURFACES

- Top and modesty are a one-piece injection molded design in 0.5" thick polypropylene.
- Available in a wide array of colors (see right column "FINISHES") to complement any space or to define sections by color.
- One-piece molded top and modesty are contoured providing an eased user edge, with an elegant waterfall transition from top to modesty.

26"W x 18"D x 9.75"H

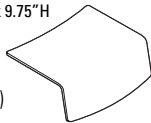

CONSTRUCTION

- Surface includes molded in threaded inserts to provide a secure metal-to-metal connection to the sled frame.
- Bumpers are included on the underside of top and inside modesty to protect surfaces when stacking.

FRAME

- 0.5" diameter solid steel rod sled frame.
- Available in a durable Chrome finish.
- Model with ganging frame keeps tables evenly positioned and aligned. No tools or fasteners required for ganging; the frames simply interlock.
- Model with ADA compliant frame is also available. The frame is 33" wide and the polypropylene top/modesty remain a constant size.
- Tables are standard without glides and are suitable for carpet, rubber or cork flooring.
- Glide options are available (see right column "GLIDES"). Glides must be chosen to best suit flooring type and site conditions. Upcharges apply.

DOLLY

- For space saving storage and transport.
- Constructed from 1.5" x 0.5" steel tubing with heavy duty casters (two locking) and a removable handle.
- Dolly can stack up to 20 tables.
- Stacking height on dolly is up to 68".

FINISHES

BZB	Buzz Blue	FRO	Frost
CCT	Cactus	INK	Ink
CRO	Carrot	LAB	Latte
IVC	Cloud	BLK	Night
DJN	Dijon	SND	Sand
EGP	Eggplant	SAR	Scarlet
FOG	Fog	SHW	Shadow

GLIDES

- CG** Clear polycarbonate (for carpet, rubber or concrete flooring). Height added to table: 0.18". **Add \$18/set.**
- SG** Glides with stainless steel pads (for carpet or rubber flooring). Height added to table: 0.17". **Add \$34/set.**
- FG** Glides with felt pads (for vinyl, cork or laminate flooring). Height added to table: 0.24". **Add \$34/set.**
- RG** Glides with rubber pads (for vinyl, hardwood, laminate, stone or ceramic flooring). Height added to table: 0.16". **Add \$34/set.**

SPECIFICATIONS

- Specifications marked with an * are applicable to only those products which have the * symbol beside the product name.

EXAMPLE DUET TABLE ORDER CODE:

Duet stacking table, polypropylene surface in Latte, clear polycarbonate glides

DTS1828P	-LAB	-CG
Model #	Surface finish	Glides

D DUET™ TABLES

STACKING TABLES

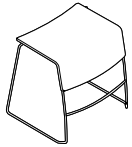

Stacking Table*

MODEL#	DIMENSIONS D x W x H	FREIGHT CLASS	WT./LBS.	CUBIC FT.	LIST PRICE
DTS1828P	25 x 29 x 28	150	26	17.75	\$516

One-piece polypropylene top and modesty with Chrome frame. Shipped fully assembled, 4 per carton.

- Price shown is per table. It is recommended to order in multiples of 4.
- Please be sure to select the appropriate glide (see previous page) for the flooring surface, as scratches could occur.
- Worksurface is 18" D x 28" W

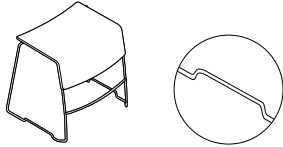

Stacking Table, Ganging Frame*

DTS1828PG	25 x 30.75 x 28	150	26	17.75	\$550
-----------	-----------------	-----	----	-------	--------------

One-piece polypropylene top and modesty with Chrome ganging frame.

Shipped fully assembled, 4 per carton.

- Price shown is per table. It is recommended to order in multiples of 4.
- Please be sure to select the appropriate glide (see previous page) for the flooring surface, as scratches could occur.
- Worksurface is 18" D x 28" W

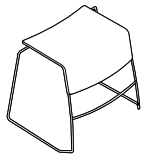

Stacking Table, 32" Wide*

DTA1832P	25 x 33 x 28	150	26	17.75	\$583
----------	--------------	-----	----	-------	--------------

ADA (American with Disabilities Act) compliant. 33" wide. One-piece polypropylene top and modesty with Chrome frame. Underside clearance is 27.1"H (extra height if glides are selected). Stacks up to 5 high on floor only; dolly does not accommodate. Shipped fully assembled, 4 per carton.

- Price shown is per table. It is recommended to order in multiples of 4.
- Please be sure to select the appropriate glide (see previous page) for the flooring surface, as scratches could occur.
- Worksurface is 18" D x 32" W

DOLLY



Dolly

MODEL #	DIMENSIONS	FREIGHT CLASS	WT./LB.	CUBIC FT.	LIST PRICE
DTD20	29.5 x 63 x 38.5	250	50	21	\$749

For use with tables DTS1828P and DTS1828PG. Can stack up to 20 tables. Black only. Removable handle for storage. Shipped fully assembled in 1 carton.

Required Specifications
Finish

Optional Specifications
Grommet

Accessories
Power Block



Edventure is a value series collection that offers a range of teacher desks, student desks and study carrels for more traditional learning environments. Designed to withstand daily rigorous use, traditional style meets modern performance.

Tops are available in a wide array of finishes in 1" thick thermally fused laminate or 1 1/16" high pressure laminate with matching or complementary 2mm PVC edgebanding. Edventure's color palette also includes nine new bold finishes available on select components in high pressure laminate only.

Mobile teacher desks offer versatility with storage options for educators on the move.

Single and connecting study carrels create quiet work areas with optional power and data to stay connected.

Features and Benefits

- Tops are 1" thick thermally fused laminate or 1 1/16" high pressure laminate.
- Tops are constructed of 45 lb. density particle board.
- Matching or complementary 2mm PVC edgebanding.
- Surfaces include factory installed metal inserts for solid and secure leg connections.
- H-leg design on teacher and student desks.
- Teacher's desk includes modesty panel and is available with or without casters.
- Teacher's desk with left or right hand box/box/file pedestal available on casters only.
- Study carrel features curved side panels for seated privacy with a 29"H worksurface.
- Easy to assemble.



H-legs with cross bar.



Mobile teacher desk with modesty panel.



Freestanding and add-on study carrels.

GENERAL INFORMATION

- Edventure series is an affordable collection of teacher desks, student desks and study carrels with personal storage options, that bring a traditional element to the classroom.
- Simple and elegant design respects space requirements to accommodate various teaching styles.
- Edventure series is a high achiever, built to withstand the most demanding environments.
- Shipped easy to assemble.
- For environmental certifications, please visit globalfurnituregroup.com

WORKSURFACES

- Tops are available in 1" thick thermally fused laminate or 1 1/16" thick high pressure laminate.
- Available in an array of finishes in both thermally fused laminate or high pressure laminate.
- Products specified with the high pressure laminate option are finished on the underside of the surface with a kraft paper backing.

CONSTRUCTION

- Top core is made of 45 lb. density particle board.
- Surfaces include factory installed metal inserts for solid and secure leg connections.

EDGE DETAIL

- Global's preferred 2mm PVC edgebanding is standard.
- Edgebanding may be specified in a matching or a complementary finish for tops in standard Global laminates.

LEGS

- H-legs are 28" high and constructed from 2" x 2" square tubing with a 1" x 2" rectangular cross bar and adjustable leveling glides.
- Available in Black (**TBL**), Buzz Blue (**TBZ**), Cactus (**TCC**), Carrot (**TCR**), Cloud (**TIV**), Designer White (**TDW**), Dijon (**TDJ**), Eggplant (**TEG**), Fog (**TFO**), Frost (**TFR**), Ink (**TIN**), Kalua (**TKA**), Latte (**TLA**), Mocha (**TMO**), Nevada (**TNE**), Sand (**TSN**), Scarlet (**TSR**), Shadow (**TSH**), Toast (**TOA**) or Tungsten (**TTU**) painted finishes, Sandtex finish applied.

CASTERS

- Teacher desks are available with locking casters. See models ending in C.
- Casters are 3.5" high overall.

MODESTY PANELS

- 12"H modesty panel is included with teacher desks.
- Available in an array of finishes (see 594) in thermally fused laminate with matching edges only.

SPECIFICATIONS

- Specifications marked with an * are applicable to only those products which have the* symbol beside the product name.

STUDY CARRELS

- The study carrel features a 29" high worksurface and curved side panels for privacy.
- Freestanding (starter) and add-on models are available. Legs and privacy panels are shared between adjoining add-on carrels.
- The back panel is inset to hide connecting fasteners from user's view. The inset back also creates a wire drop for the optional LED task light cord.
- Carrels with an optional shelf are available. See models ending in **S**.
- Optional LED task light is available for carrel with shelf, see page 596
- Optional Cove Daisylink system is available to bring power, USB charging or data to the carrel surface for desktop access, see 598

GROMMETS

- Optional grommets are available in standard worksurface locations (left, center or right) for **teacher desks** and **study carrels**. Order as: **AG1, AG2** or **AG3**. **Add \$96**.
- Grommet hole dimensions are 3.25"W x 1.875"D
 - ENSTxxxx, ENAC2924/3524, ENFC3024/3624 models - **AG2** option only
 - ENFC6024/7224, ENFC5924/7124 models - **AG1 and AG3** option only

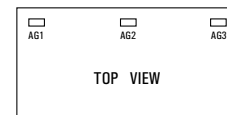
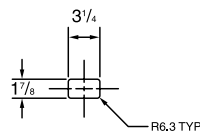

POWER BLOCK

- A power block is a rectangular worksurface power/data module with one electrical duplex receptacle and two data (RJ45) receptacles. 9' Black cord included. Power block dimensions are 6.5"W x 3.5"D x 2.75"H. Units cannot be daisy-chained.
 - ENSTxxxx, ENAC2924/3524, ENFC3024/3624 models - **E2** option only
 - ENFC6024/7224, ENFC5924/7124 models - **E1 and E3** option only

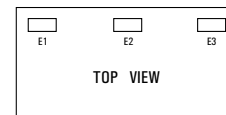
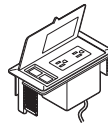

Power block **PMSPDM**. **Add \$330**. Specify location **E1, E2** or **E3**. **Add \$96**.

VILLA CUTOUTS

- Optional Villa cutout available in standard worksurface locations (left, center or right) for Rectangular tables. Order as: **V1, V2 or V3 - Add \$96 for each cutout.**
 - ENSTxxxx, ENAC2924/3524, ENFC3024/3624 models - **V2** option only
 - ENFC6024/7224, ENFC5924/7124 models - **V1 and V3** option only

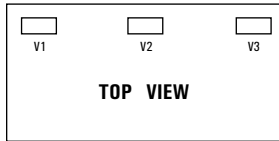

COVE DAISYLINK COMPONENTS

- A daisy-chain power solution with a unique “no particular order” feature, making installation or reconfiguration easy.
- Cove Daisylink modules must be ordered separately and are available for study carrels only.
- Specify the cut-out for Cove Daisylink modules when ordering the study carrels; order the Cove kits (modules and jumpers) and infeed separately.
- When **CV** cut-out is specified on 29”, 30”, 35” and 36” study carrels, **one** cut-out in the center position is included. **Add \$96.** When **CV** cut-out is specified on 59”, 60”, 71” and 72” study carrels, **two** cut-outs in the left and right positions are included. **Add \$192.**
- For Cove Daisylink components, see 598
- Maximum of 9 Cove modules per each infeed.

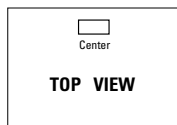

29”, 30”, 35” and 36” study carrels

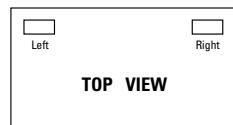

59”, 60”, 71” and 72” study carrels

MODPOWER DAISY CHAIN SOLUTION

- Add flexible power and USB charging to Edventure study carrels. Connect up to four units with a single corded infeed with NEMA plug.
- ModPower units are sold separately, refer to Productivity Solutions on page 465.
- Begin run with a starter unit which includes a corded infeed. Add additional middle or end units as required. Middle and end units are equipped with connecting cables.
- On-surface modules clamp on or screw mount to the table tops.
- In-surface modules require table top cut-outs for mounting. Specify cut-out option:
 - **MPS** for a single cut-out to accommodate one ModPower in-surface unit (cut-out will be centered on the back edge of surface) for **29” to 72” wide study carrels.** **Add \$96**
 - **MPD** for two cut-outs in the left and right positions, 15” from ends to center of unit on the back edge of surface for **59” to 72” wide study carrels.** **Add \$192.**

FINISHES

Thermally Fused or High Pressure Laminate Tops

ACJ	Absolute Acajou	FCL	First Class
ASN	Asian Night	NBL	Noce Biondo
AWC	Avant Cherry	NGL	Noce Grigio
AWH	Avant Honey	NEL	Noce Leggero
BLK	Black	NML	Noce Medio
BZD	Blizzard	QTM	Quartered Mahogany
BRC	Brushed Cobalt	SBY	Sheer Beauty
CMB	Clear Maple	SOG	Storm Grey
CGY	Custom Grey	SDT	Stonedust
DES	Dark Espresso	WHE	Walnut Heights
DWT	Designer White	WHC	White Chocolate
FAS	Fashionista	WCR	Winter Cherry

Leg finishes

TBL	Black	TIN	Ink
TBZ	Buzz Blue	TKA	Kalua
TCC	Cactus	TLA	Latte
TCR	Carrot	TMO	Mocha
TIV	Cloud	TNE	Nevada
TDW	Designer White	TSN	Sand
TDJ	Dijon	TSR	Scarlet
TEG	Eggplant	TSH	Shadow
TFO	Fog	TOA	Toast
TFR	Frost	TTU	Tungsten

Note: Modesty panel available in thermally fused laminate finishes only. Modesty panel and pedestal edging will match thermally fused laminate finish specified.

2mm Thick Edgebanding

AAE	Absolute Acajou	FCL	First Class
ASE	Asian Night	FOG	Fog
ACE	Avant Cherry	LAB	Latte
AHE	Avant Honey	NBL	Noce Biondo
BLK	Black	NGL	Noce Grigio
BRC	Brushed Cobalt	NEL	Noce Leggero
BZB	Buzz Blue	NML	Noce Medio
BZD	Blizzard	QTM	Quartered Mahogany
CCT	Cactus	SAR	Scarlet
CRO	Carrot	SBY	Sheer Beauty
CME	Clear Maple	SHW	Shadow
CGY	Custom Grey	SDT	Stonedust
DEE	Dark Espresso	SOG	Storm Grey
DWE	Designer White	WHE	Walnut Heights
DJN	Dijon	CBE	White Chocolate
FAS	Fashionista	WCE	Winter Cherry

TO SPECIFY:

1. SPECIFY MODEL NUMBER

2. SPECIFY THE FOLLOWING:

FOR TEACHER AND STUDENT DESKS:

- Top finish
- Optional HP laminate
- Edge finish (top only)
- Modesty finish if applicable
- Pedestal finish if applicable
- Leg finish
- Optional AG grommet or cut-out for PMS/SDM, if applicable
- Optional key alike or select number (#100-120) applicable with teacher's desks with pedestals

FOR STUDY CARRELS:

- Top surface finish (shelf, if applicable, will be in the same finish)
- Optional HP laminate
- Edge finish
- Leg finish
- Surround finish (side and back panels)
- Optional cut-out(s) for Cove Daisylink or ModPower components

EXAMPLE ADVENTURE ORDER CODES:

Teacher desk

ENTD7230	-ACJ	-HPL	-AAE	-TTU	-ACJ
Model #	Top finish	High pressure laminate	Edge finish	Leg finish	Modesty panel finish

Study carrel

ENFC3024	-ACJ	-HPL	-AAE	-TTU	-ACJ	-CV
Model #	Top finish	High pressure laminate	Top edge finish	Leg finish	Surround finish	Cut-out for Cove

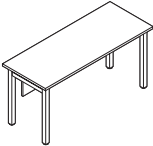
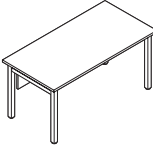
TEACHER DESKS	MODEL#	DIMENSIONS	FREIGHT CLASS	WT/LBS.	CUBIC FT.	LIST PRICE	HP ADD
 <p>Teacher Desk, 24\"</p>	D x W x H						
	ENTD4824	24 x 48 x 29	70	74	4.6	\$1071	\$169
	ENTD5424	24 x 54 x 29	70	80	4.7	\$1084	\$194
	ENTD6024	24 x 60 x 29	70	86	4.9	\$1100	\$207
12\"H modesty panel included. Shipped easy to assemble in 2 cartons.							
 <p>Teacher Desk, 30\"</p>	ENTD6030	30 x 60 x 29	70	96	6.4	\$1170	\$224
	ENTD6630	30 x 66 x 29	70	103	6.6	\$1210	\$273
	ENTD7230	30 x 72 x 29	70	110	6.8	\$1250	\$292
	12\"H modesty panel included. Shipped easy to assemble in 2 cartons.						

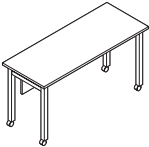
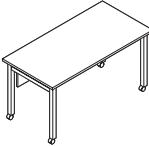
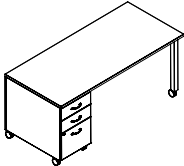
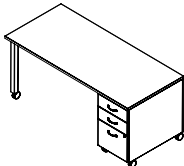
MOBILE TEACHER DESKS	MODEL #	DIMENSIONS	FREIGHT CLASS	WT/LB.	CUBIC FT.	LIST PRICE	HP ADD	
 <p>Mobile Teacher Desk, 24\"</p>	ENTD4824C	24 x 48 x 29	70	75	4.6	\$1242	\$169	
	ENTD5424C	24 x 54 x 29	70	81	4.7	\$1257	\$182	
	ENTD6024C	24 x 60 x 29	70	87	4.9	\$1273	\$196	
	12\"H modesty panel included. Shipped easy to assemble in 2 cartons.							
 <p>Mobile Teacher Desk, 30\"</p>	ENTD6030C	30 x 60 x 29	70	98	5.4	\$1343	\$209	
	12\"H modesty panel included. Shipped easy to assemble in 2 cartons.							
 <p>Mobile Teacher Desk, BBF - Left*</p>	ET6024BBFLC	24 x 60 x 29	85	155	12.37	\$2385	\$195	
	ET6624BBFLC	24 x 66 x 29	85	161	12.57	\$2428	\$209	
	ET7224BBFLC	24 x 72 x 29	85	167	12.75	\$2474	\$223	
	ET6030BBFLC	30 x 60 x 29	85	193	14.67	\$2521	\$209	
	ET6630BBFLC	30 x 66 x 29	85	201	14.85	\$2565	\$255	
	ET7230BBFLC	30 x 72 x 29	85	210	15.06	\$2610	\$274	
	Inset 12\"H modesty panel and flush left hand locking box/box/file pedestal included. Top box drawer is non-locking. Shipped easy to assemble (BBF pedestal is fully assembled) in 3 cartons.							
	 <p>Mobile Teacher Desk, BBF - Right*</p>	ET6024BBFRC	24 x 60 x 29	85	155	12.37	\$2385	\$195
		ET6624BBFRC	24 x 66 x 29	85	161	12.57	\$2428	\$209
		ET7224BBFRC	24 x 72 x 29	85	167	12.75	\$2474	\$223
ET6030BBFRC		30 x 60 x 29	85	193	14.67	\$2521	\$209	
ET6630BBFRC		30 x 66 x 29	85	201	14.85	\$2565	\$255	
ET7230BBFRC		30 x 72 x 29	85	210	15.06	\$2610	\$274	
Inset 12\"H modesty panel and flush right hand locking box/box/file pedestal included. Top box drawer is non-locking. Shipped easy to assemble (BBF pedestal is fully assembled) in 3 cartons.								

Required specifications

- Top finish
- Edge finish
- Leg finish
- Modesty finish
- Pedestal finish*

Optional specifications

- HP laminate
- AG grommet or cut-out for PMSPDM*
- Key alike/select key*

STUDENT DESK

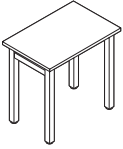

Student Desk**

MODEL#	DIMENSIONS	FREIGHT CLASS	WT/LBS.	CUBIC FT.	LIST PRICE	HP ADD
ENST3020	20 x 30 x 29	85	49	3.9	\$543	\$115

Shipped easy to assemble in 2 cartons.

FREESTANDING OR STARTER STUDY CARRELS

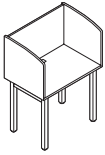

Freestanding/Starter Study Carrel*

MODEL #	DIMENSIONS	FREIGHT CLASS	WT/LB.	CUBIC FT.	LIST PRICE	HP ADD	CUT-OUT ADD
ENFC3024	24 x 30 x 50	70	89	4.44	\$1045	\$119	\$96
ENFC3624	24 x 36 x 50	70	97.5	4.72	\$1091	\$139	\$96
ENFC6024	24 x 60 x 50	70	115	5.8	\$1272	\$207	\$96
ENFC7224	24 x 72 x 50	70	123.5	6.34	\$1359	\$238	\$96

Features a 29" high worksurface with curved side privacy panels. Shown with optional cut-out. Bring power and USB charging to the user with Cove Daisylink components, see 598. Shipped easy to assemble in 2 cartons.

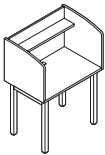

Freestanding/Starter Study Carrel w/Shelf*

ENFC3024S	24 x 30 x 50	70	93	4.44	\$1098	\$138	\$96
ENFC3624S	24 x 36 x 50	70	102.5	4.72	\$1150	\$160	\$96
ENFC6024S	24 x 60 x 50	70	122	5.8	\$1363	\$246	\$96
ENFC7224S	24 x 72 x 50	70	131.5	6.34	\$1465	\$281	\$96

Features a 29" high worksurface with curved side privacy panels. Shown with optional cut-out. Shelf is 6" deep and accepts optional LED task light. Bring power and USB charging to the user with Cove Daisylink components, see 598. Shipped easy to assemble in 2 cartons.

ADD-ON STUDY CARRELS

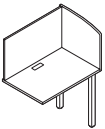

Add-On Study Carrel*

MODEL #	DIMENSIONS	FREIGHT CLASS	WT/LB.	CUBIC FT.	LIST PRICE	HP ADD	CUT-OUT ADD
ENAC2924	24 x 29 x 50	85	63	4.4	\$785	\$119	\$96
ENAC3524	24 x 35 x 50	70	71.5	4.67	\$830	\$139	\$96
ENAC5924	24 x 59 x 50	70	89	5.75	\$1016	\$207	\$96
ENAC7124	24 x 71 x 50	70	97.5	6.3	\$1104	\$238	\$96

Features a 29" high worksurface with curved side privacy panels. Shown with optional cut-out. Bring power and USB charging to the user with Cove Daisylink components, see 598. Shipped easy to assemble in 2 cartons.

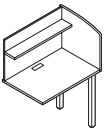

Add-On Study Carrel w/Shelf*

ENAC2924S	24 x 29 x 50	70	67	4.4	\$835	\$138	\$96
ENAC3524S	24 x 35 x 50	70	76.5	4.67	\$888	\$160	\$96
ENAC5924S	24 x 59 x 50	70	96	5.75	\$1110	\$246	\$96
ENAC7124S	24 x 59 x 50	70	105.5	6.3	\$1210	\$281	\$96

Features a 29" high worksurface with curved side privacy panels. Shown with optional cut-out. Shelf is 6" deep and accepts optional LED task light. Bring power and USB charging to the user with Cove Daisylink components, see 598. Clearance from worksurface to shelf is 14". Shipped easy to assemble in 2 cartons.

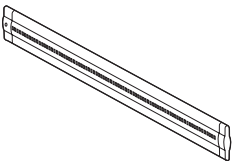

LED Task Light

PLED30	1.5 x 15.5 x .5	150	2	.50	\$494
PLED50	1.5 x 23.5 x .5	150	2	.50	\$569
PLED100	1.5 x 43.5 x .5	125	3	.50	\$660

Energy efficient LED. Ultra slim design. Suitable for mounting on the underside of the shelf of a study carrel. 6' power cord.

Required specifications

Top finish*
Edge finish*
Leg finish*
Surround finish*

Optional specifications

HP laminate*
Cut-out for Cove Daisylink modules*

Accessories

Cove Daisylink modules*
LED task lights*

COVE DAISYLINK COMPONENTS

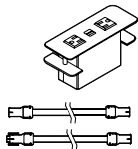

Single Power/USB for 29"/30" Carrels

MODEL#	DIMENSIONS D x W x H	FREIGHT CLASS	WT/LBS.	CUBIC FT.	LIST PRICE
ECV2PU30B	2 x 30 x -	60	4.5	0.5	\$640
ECV2PU30S	2 x 30 x -	60	4.5	0.5	\$640

Cove single desktop module with two power outlets and two 2.1A USB charging ports. Includes four cable clamps, one 14" female/male connecting cable and one 14" female/female connecting cable. Connecting cables will daisy-chain modules between two 30" wide starter carrels, one 30" wide starter carrel and one 29" wide add-on carrel, or two 29" wide add-on carrels. Available in Black **(B)** or Silver **(S)** - indicated by last letter of the model number. Infeed to be ordered separately.

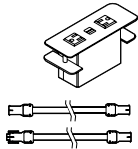

Single Power/USB for 35"/36" Carrels

ECV2PU36B	2 x 36 x -	60	4.6	0.5	\$644
ECV2PU36S	2 x 36 x -	60	4.6	0.5	\$644

Cove single desktop module includes two power outlets and two 2.1A USB charging ports. Includes four cable clamps, one 17" female/male connecting cable and one 17" female/female connecting cable. Connecting cables will daisy-chain modules between two 36" wide starter carrels, one 36" wide starter carrel and one 35" wide add-on carrel, or two 35" wide add-on carrels. Available in Black **(B)** or Silver **(S)** - indicated by last letter of the model number. Infeed to be ordered separately.

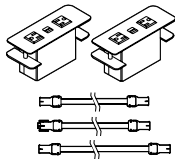

Double Power/USB for 59"/60" Carrels

ECV2PU60B	2 x 60 x -	60	4.6	0.5	\$1182
ECV2PU60S	2 x 60 x -	60	4.6	0.5	\$1182

Cove double desktop modules - each module includes two power outlets and two 2.1A USB charging ports. Includes four cable clamps, one 12" female/male connecting cable, one 12" female/female connecting cable and one 26" female/female interconnecting cable. Connecting cables will daisy-chain modules between two 60" wide starter carrels, one 60" wide starter carrel and one 59" wide add-on carrel, or two 59" wide add-on carrels. Available in Black **(B)** or Silver **(S)** - indicated by last letter of the model number.

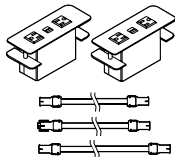

Double Power/USB for 71"/72" Carrels

ECV2PU72B	2 x 72 x -	60	4.6	0.5	\$1202
ECV2PU72S	2 x 72 x -	60	4.6	0.5	\$1202

Cove double desktop modules - each module includes two power outlets and two 2.1A USB charging ports. Includes four cable clamps, one 15" female/male connecting cable, one 15" female/female connecting cable and one 31" female/female interconnecting cable. Connecting cables will daisy-chain modules between two 72" wide starter carrels, one 72" wide starter carrel and one 71" wide add-on carrel, or two 71" wide add-on carrels. Available in Black **(B)** or Silver **(S)** - indicated by last letter of the model number.

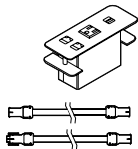

Single Power/Data/USB for 29"/30" Carrels

ECVPUD30B	2 x 30 x -	60	4.6	0.5	\$602
ECVPUD30S	2 x 30 x -	60	4.6	0.5	\$602

Cove single desktop module includes one power outlet, two data knockouts and two 2.1A USB charging ports. Includes four cable clamps, one 14" female/male connecting cable and one 14" female/female connecting cable. Data/telecom options to be ordered separately. Connecting cables will daisy-chain modules between two 30" wide starter carrels, one 30" wide starter carrel and one 29" wide add-on carrel, or two 29" wide add-on carrels. Available in Black **(B)** or Silver **(S)** - indicated by last letter of the model number. Infeed to be ordered separately.

Required specifications

Paint finish, case*
Laminate finish**
Edge finish (ENMST1824 only)
Trim finish (ENLS182 only)

Optional specifications

Key alike*
HP laminate (ENMST1824 only)

COVE DAISYLINK COMPONENTS

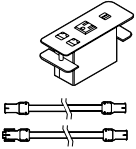

Single Power/Data/USB for 35"/36" Carrels

MODEL#	DIMENSIONS D x W x H	FREIGHT CLASS	WT/LBS.	CUBIC FT.	LIST PRICE
ECVPUD36B	2 x 36 x -	60	4.60	0.5	\$609
ECVPUD36S	2 x 36 x -	60	4.60	0.5	\$609

Cove single desktop module includes one power outlet, two data knockouts and two 2.1A USB charging ports. Includes four cable clamps, one 17" female/male connecting cable and one 17" female/female connecting cable. Data/telecom options to be ordered separately. Connecting cables will daisy-chain modules between two 36" wide starter carrels, one 36" wide starter carrel and one 35" wide add-on carrel, or two 35" wide add-on carrels. Available in Black (B) or Silver (S) - indicated by last letter of the model number. Infeed to be ordered separately.

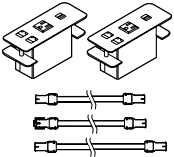

Double Power/Data/USB for 59"/60" Carrels

ECVPUD60B	2 x 60 x -	60	4.6	0.5	\$1112
ECVPUD60S	2 x 60 x -	60	4.6	0.5	\$1112

Cove double desktop modules - each module includes one power outlet, two data knockouts and two 2.1A USB charging ports. Includes four cable clamps, one 12" female/male connecting cable, one 12" female/female connecting cable and one 26" female/female interconnecting cable. Data/telecom options to be ordered separately. Connecting cables will daisy-chain modules between two 60" wide starter carrels, one 60" wide starter carrel and one 59" wide add-on carrel, or two 59" wide add-on carrels. Available in Black (B) or Silver (S) - indicated by last letter of the model number. Infeed to be ordered separately.

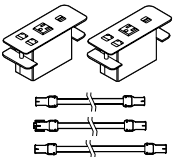

Double Power/Data/USB for 71"/72" Carrels

ECVPUD72B	2 x 72 x -	60	4.6	0.5	\$1123
ECVPUD72S	2 x 72 x -	60	4.6	0.5	\$1123

Cove double desktop modules - each module includes one power outlet, two data knockouts and two 2.1A USB charging ports. Includes four cable clamps, one 15" female/male connecting cable, one 15" female/female connecting cable and one 31" female/female interconnecting cable. Data/telecom options to be ordered separately. Connecting cables will daisy-chain modules between two 72" wide starter carrels, one 72" wide starter carrel and one 71" wide add-on carrel, or two 71" wide add-on carrels. Available in Black (B) or Silver (S) - indicated by last letter of the model number. Infeed to be ordered separately.

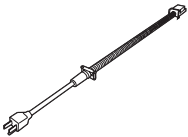

Single-Circuit Corded Infeed, 72"

42AP1-72	72"W	70	1	1.80	\$245
----------	------	----	---	------	--------------

72" corded infeed to start a run of Cove Daisylink modules. Maximum of 9 Cove modules per each infeed (Cove double counts as two modules).

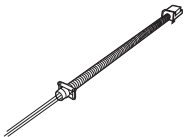

Multi-Circuit Power Hardwire Infeed, 72"

42SB2-72	72"W	70	1	1.80	\$158
----------	------	----	---	------	--------------

Hardwire infeed to start a run of Cove Daisylink modules. Maximum of 9 Cove modules per each infeed (Cove double counts as two modules). Certified electrician required for installation.

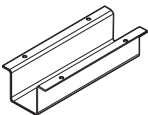

Jumper Guards - Set of 4

ENCVG12	5 x 12 x 3.1	85	14	1.1	\$141
---------	--------------	----	----	-----	--------------

Metal channel to protect jumper connection to Cove Daisylink module. Black only. Mounts directly to the underside of surface.

Required specifications

Top finish*
Edge finish*
Leg finish*
Surround finish*

Optional specifications

HP laminate*
Cut-out for Cove Daisylink modules*

Accessories

Cove Daisylink modules*
LED task lights*



FreeFit offers a universal freestanding design with finish options on bases and surfaces that allow you to easily integrate with existing Global workstation configurations, becoming a part of your workspace. With two concealed motors on each base, FreeFit adjusts at 1.5" per second while emitting just 44db. Select from two table ranges – standard range accommodates most users, while extended range meets BIFMA ergonomics guidelines accommodating an extensive array of user needs.

Features and Benefits

- Tops are 1" thick thermally fused laminate or 1 1/16" high pressure laminate
- Tops are constructed of 45 lb. density particle board
- Worksurfaces are sold separate from the base
- Steel constructed leg tubing, feet and cross bar
- Table frames include expandable width upper cross bars
- Standard up/down handset. Optional digital readout handset.



Add a 3rd leg kit to create an electric height adjustable L station.

GENERAL INFORMATION

- FreeFit Height Adjustable Tables allow for easy movement from sitting to standing and back throughout the day.
- FreeFit offers a universal freestanding design with finish options on the bases and surfaces that allow you to easily integrate with existing Global workstation configurations, becoming a part of your office space.
- Can be used alone or in conjunction with Global desks. Please note Global desks are 1" or 1.5" thick
- For environmental certifications, please visit globalfurnituregroup.com

ORDERING GUIDELINES

CODES

The price list uses a numbering system with meaningful alphanumeric characters to create a simple to understand product number. This makes specifying the product much easier and more accurate.

SPECIFICATION EXAMPLE OF A HEIGHT ADJUSTABLE TABLE:

Ordered as components, please order:

1. BASE

PRODUCT CODE: **FT** - FreeFit
5 - Standard Range Legs
2 - Leg Quantity
SF - Small Frame
24 - Depth

OPTIONS:

Frame Style: **5** - Standard Range Frame 27.5" to 47"
6 - Extended Range Frame 22.5" to 48.5"

Leg Quantity: **1** - 1 leg for return kit
2 - 2 leg table kit
4 - 4 leg table kit

Frame Size: **BF** - Base Frame, for 30" to 42" wide tables
SF - Small Frame, for 48" to 60" wide tables
LF - Large Frame, for 66" to 84" wide tables

Worksurface Depth: **24** - For 23" deep worksurfaces
30 - For 29" and 35" deep worksurfaces

Leg Style: **CL** - C-shaped table leg
TL - T-shaped table leg

Controller Style: **S** - Standard controller
D - Display controller, add \$47 list (\$94 list for back-to-back benching and media tables).

Base Finish: BLK Black
DWT Designer White
TUN Tungsten

2. TOP

PRODUCT CODE: **FTWR2436**

Top: **LP** - Low Pressure laminate, 1" thick
HP - High Pressure laminate, 1-1/16" thick

Top Finish Laminate: Select Color

Top PVC Edge Finish: Select Color

3. ACCESSORIES

PRODUCT CODE: **FTAEC12**

Base Finish: BLK Black
CHR Charcoal
DWT Designer White
FOG Fog
NEV Nevada
SIL Silver
TPE Taupe
TUN Tungsten

CONSTRUCTION

- Table frames feature 3.15" x 1.97" rectangular outer leg with larger tube attached to the foot.
- Open base design with ample room for chair and user's legs
- Flat foot design includes ½" adjustable glides
- Table frames include expandable width upper cross bars.
- Open base design has no lower crossbars.
- All table frames are easy to assemble with few parts.
- Tables are designed so that the paint will never mar on the leg during operation.
- Steel construction of the leg assembly tubing, feet and upper structure assemblies.
- Powder coat finishes for bases are offered in Black (BLK), Charcoal (CHR), Designer White (DWT), Fog (FOG), Nevada (NEV), Silver (SIL), Taupe (TPE) or Tungsten (TUN).
- All standard Global laminate finishes are available.
- Sizes of tops are "nominal." Unless otherwise stated, actual depth is 1" less and actual width is 2" less than "nominal" size.
- All bases lift 350 lbs on two leg tables.
- Operates at 1.5" per second.
- 108" 3-prong power cord
- Standard Range Frame adjusts from 27.5" to 47" including the worksurface.
- Extended Range Frame adjusts from 22.5" to 48.5" including the worksurface.
- Worksurfaces and troughs are sold separate from the base.
- 1" thick tops constructed of 45 lb. density particle board with high performance thermally fused laminate.
- Laminate surfaces offer a selection of matching + coordinating edgeband. Specify separately from the surface finish.
- Products specified with the high pressure laminate option are 1-1/16" thick and finished on the underside of the surface with a kraft paper backing.
- Worksurface sizes are "nominal". Main worksurface sizes are 1" less in depth and 2" less in width.
- Steel constructed leg tubing, feet and cross bar.
- Back-to-back benching kits feature a pad foot with ½" adjustable glides
- Foot on single sided benching is 3.55"W x 1"H (with glides fully recessed).
- **Caution:** to meet BIFMA standards for performance and stability, appropriate base size must be specified with corresponding top sizes identified.
- All products meet or exceed ANSI-BIFMA X5.5-2014 and 7.1 VOC. and CSA-C22.2 No. 6809, CAN/CGSB-44.228-2008.
- **All components** are UL 962 listed.

STANDARD RANGE COLUMNS

The 2-part lifting column is a perfect choice for a wide range of different desk applications in the office.

- Compact design where guide and actuator functions are an integrated unit
- Reinforced column and optimized motor housing design for extra strength and stability
- Max. load 800 N per column
- Max. speed 1.5"/second unloaded
- Standard installation dimension 25.4"
- Standard stroke length 19.7"
- Weight: Approximately 14.3 lbs. per column
- Column dimensions: 1.97" x 3.15" (outer profile) and 1.71" x 2.89" (inner profile)
- Motor housing dimensions: 6.97" x 3.82" x 1.81"
- Low noise level
- No visible gliding pads
- Standard Range Tables have 2-stages and feature an adjustment range of 27.5" – 45.5" (18" travel).

EXTENDED RANGE COLUMNS

The 3-part construction ensures a short installation dimension combined with a long stroke length making the Extended Range Column the optimum choice no matter the height of the person using it. The middle profile of the column moves synchronously so the profiles are always in the same height optimizing the desk design and the stability.

- Compact design where guide and actuator functions are an integrated unit
- Reinforced column and optimized motor housing design for extra strength and stability

- Max. thrust 1200 N per column (12 mm spindle pitch)
- Max. speed 1.5"/second unloaded
- Installation dimension: 22" / 20.4" (BIFMA)
- Stroke length: 25.6" / 26.2" (BIFMA)
- Weight: 17.2 lbs. per column
- Column dimensions: 1.97" x 3.15" (outer profile), 1.71" x 2.89" (middle profile), 1.46" x 2.64" (inner profile)
- Low noise level
- No visible gliding pads

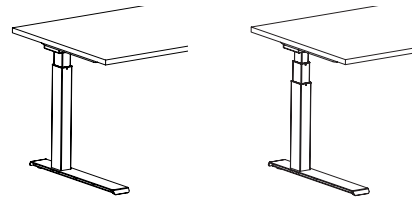

Standard range (2 stage)

Extended range (3-stage)

FOOT TYPE

- FreeFit offers two foot styles, either a "T" or "C".
- Feet offered in two lengths: 22.75" and 28".
- Foot offers a recessed connection for the column and connects from the bottom with 4 bolts.
- Adjustable glides are standard

DESK MOUNT FRAME

- Can be specified in three lengths:
 Base Frame (**BF**) for tables 30" - 42" long (nominal dimensions)
 Short Frame (**SF**) for tables 48" - 60" long (nominal dimensions)
 Long Frame (**LF**) for tables 66" - 84" long (nominal dimensions)
- All metal parts are Black
- Cantilever length: 21.7"
- Central or off-center placement of columns (T-desk or C-desk)
- Includes all connecting hardware

CONTROL BOX

- Two leg tables come standard with a 200 W Control Box
 - Mains voltage 120 VAC, 60 Hz
 - Ultra-compact; 8.25" long
 - Lightweight control box; weight is approximately 1 lb.
- Three Leg Tables come standard with a 300 W Control Box
 - can be connected up to 4 columns
 - Mains voltage 100-240 VAC, 50-60 Hz (universal)
 - Ultra-compact; 10.5" long
 - Lightweight control box; weight is approximately 1.1 lbs.
- Common features for the (200 W and 300 W):
- Ultra-low; only 1.5" high
- Environment: Operation Storage
 - Ambient temperature: 5 to 40 °C -10 to +50 °C
 - Relative humidity: 20 to 80 % at 30 °C 20 to 80 % at 30 °C
 - Atmospheric pressure: 700 to 1060 hPa 700 to 1060 hPa
- Compact high-power SMPS (Switch Mode Power Supply)
- Color: Black
- Protection against overload (EOP), by individual current limitation
- The control box is designed with a soft start/stop function
- Autodetection of the number and type of columns connected
- Cable grooves at the bottom to optimise cable management
- White plugs for easy recognition when mounting/dismounting
- PVC-Free™
- Low standby power consumption – only 0.1 W.
- Exchangeable standard mains cable

STANDARD HANDSET

- Features Bluetooth® connection, two favorite positions and an LED reminder to prompt users to change position.
- Controller is activated by tilting the desk panel in the same direction as the desk is intended to drive.
- Pulsating orange and green LED lights remind users to change positions.
- Using the integrated Bluetooth® and downloading the Desk Control App, users can also be reminded via notifications on their computer or smart devices.
- Black only. Black cable with RJ45 modular plug. 63" long.
- PVC-Free™, featuring ZERO™. Very low power consumption in standby mode.
- Approved according to EN 60335-1 and UL962

DISPLAY HANDSET

- Features Bluetooth® connection, four favorite positions, a display to guide users, and a light strip to prompt users to change position.
- Controller is activated by tilting the desk panel in the same direction as the desk is intended to drive.
- Display controller features a modern, discreet design with a glossy surface and integrated display to ensure a clean and minimalist design.
- The display provides guidance to users when operating the desk.
- Via pulsating orange and green lights, the light strip reminds users to change positions.
- Using the integrated Bluetooth® and downloading the Desk Control App, users can also be reminded via notifications on their computer or smart devices.
- Black only. Black cable with RJ45 modular plug. 63" long.
- PVC-Free™, featuring ZERO™. Very low power consumption in standby mode.
- Approved according to EN 60335-1 and UL962
- Specify **(D)**, add **\$59** list (**\$117** list for back-to-back benching and media tables).
- A basic handset without Bluetooth® capabilities is available and must be purchased separately, replacing the **S** or **D** handset in the field. See 619 for details and pricing.

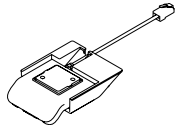

Standard handset (**S**)

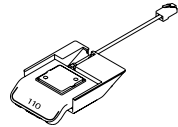

Display handset (**D**)

ANTI-COLLISION SENSOR

- Features enhanced Anti-Collision protection which can limit material damage to a desk or an object if a collision occurs during driving of the desk.
- The sensor is a compact plug-in adapter based on gyroscope-technology, and it detects even slight tilting of the desk when the desk is driving up or down.
- Upon detected tilting, the system stops and drives in the opposite direction to avoid collision and damage to the desk or the object.
- The sensor can detect both hard and soft obstacles.
- The Anti-Collision Sensor is standard on all desks.
- Reacts to angle changes bigger than 0.7° per second
- Just plug it in – no mounting required
- ZERO™ power capable
- PVC-Free™

BATTERY BOX

- A high-performance lithium-Ion battery with a capacity of 2.15 Ah.
- On a full charge the table can cycle from 35 to 45 stroke lengths based upon the range of column selected and load on the table.
- Compact unit for easy handling and installation
- Battery alarm (audio) when charging is needed
- Battery charging indicator (LED light bars) indicating the capacity level
- Thermal switch protection, overcurrent protection
- Color: black
- Battery capacity: 2.15 Ah / 52 Wh
- Nominal voltage: 24 V DC
- Discharge current: 9 A (max)
- Maximum charging voltage: 40 V DC
- Charging current: 0.5 A
- Weight: 1.32 lbs.

USAGE

- Ambient temperature: 41 to 104 °C
- Storage temperature: 32 to 113 °C

Approved according to:

- EN 62133 (Battery safety testing)
- UL 1642 (Lithium cells, standard test)
- UN 38.3 (transportation of Lithium batteries)
- UL 2054 (Household and commercial batteries)
- EN 60335-1 with CBH Advanced

GROMMET WITH ACCESS DOOR OPTIONS FOR FREEFIT BENCHING

- Access door option is specified by first selecting a grommet position left or right of center, use code GL or GR, add \$83 list (see diagram on next page for specific position).
- Access doors are specified separately, using the code + list pricing below.
- Available in Black (**BLK**), Designer White (**DWT**) or Tungsten (**TUN**) paint finishes
- Device holder is only available in white plastic.
- CSA certified power bar includes (3) outlets and (2) charging USB ports (2.1 amp).

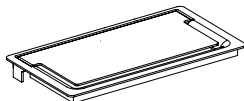

Standard Access Door (**GAADG**). Add **\$90**.

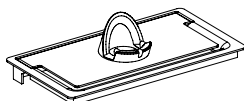

Access Door with Device Holder (**GAADGDH**). Add **\$97**.

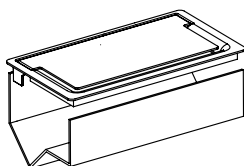

Access Door with Cable Tray (**GAADCT**). Add **\$145**.

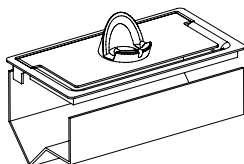

Access Door with Cable Tray & Device Holder (**GAADCTDH**). Add **\$153**.

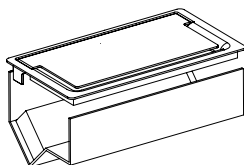

Access Door with Cable Tray & Power Bar (**GAADCTPD**). Add **\$307**.

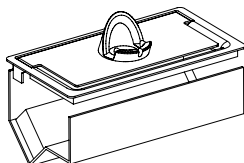

Access Door with Cable Tray, Power Bar & Device Holder (**GAADCTPDDH**). Add **\$316**.

ACCESS DOOR CUT-OUT DIMENSIONS

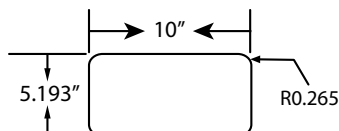

FINISHES

Laminate Top Finishes:

- ACJ Absolute Acajou
- ASN Asian Night
- AWC Avant Cherry
- AWH Avant Honey
- BLK Black - Coordinates with BLK Metal Frame Finish
- BZD Blizzard
- BRC Brushed Cobalt - Coordinates with TUN Metal Frame Finish
- CMB Clear Maple
- CGY Custom Grey
- DES Dark Espresso
- DWT Designer White - Coordinates with DWT Metal Frame Finish
- FAS Fashionista
- FCL First Class
- NBL Noce Biondo
- NGL Noce Grigio
- NEL Noce Leggero
- NML Noce Medio
- QTM Quartered Mahogany
- SBY Sheer Beauty
- SDT Stonedust
- SOG Storm Grey
- STG String
- WHE Walnut Heights
- WHC White Chocolate
- WCR Winter Cherry

Base Finishes

- BLK Black
- CHR Charcoal
- DWT Designer White
- FOG Fog
- NEV Nevada
- SIL Silver
- TPE Taupe
- TUN Tungsten

Edgeband Finishes:

- AAE Absolute Acajou
- ASE Asian Night
- ACE Avant Cherry
- AHE Avant Honey
- BLK Black
- BZD Blizzard
- BRC Brushed Cobalt
- CHR Charcoal (*use w/SOG*)
- CME Clear Maple
- DES Dark Espresso
- DEE Dark Espresso
- DWE Designer White
- FAS Fashionista
- FCL First Class
- NBL Noce Biondo
- NGL Noce Grigio
- NEL Noce Leggero
- NML Noce Medio
- NEV Nevada (*use w/STG*)
- QTM Quartered Mahogany
- SBY Sheer Beauty
- SIL Silver
- SDT Stonedust
- TPE Taupe
- WHE Walnut Heights
- CBE White Chocolate
- WCE Winter Cherry

CUT-OUT LOCATIONS

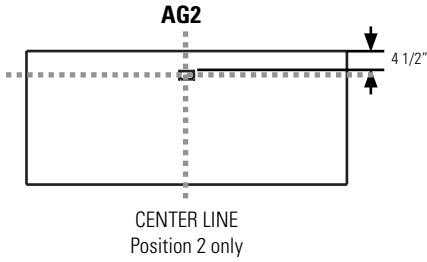

Rectangular Worksurfaces: 46", 52" & 58"
End of Run Table Top: 51"
Rectangular Return/Extension Return Worksurface: All sizes

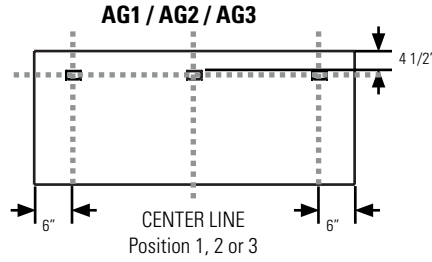

Rectangular Worksurfaces: 64", 70", 76", & 82"
End of Run Table Top: 63"

Access Door grommet in left position (GL)

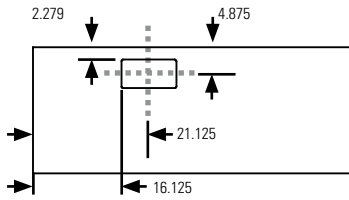

Access Door grommet in right position (GR)

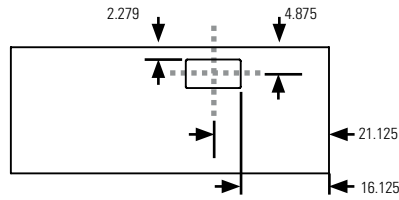

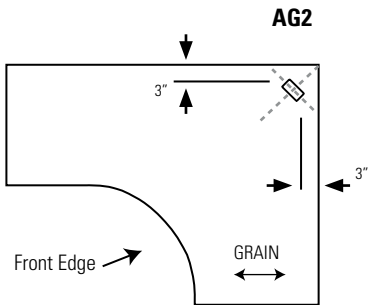

Select one or the other; both options are not available in one surface.
Rectangular Worksurfaces: 46" - 82"
End of Run Table Top: 51" & 63"

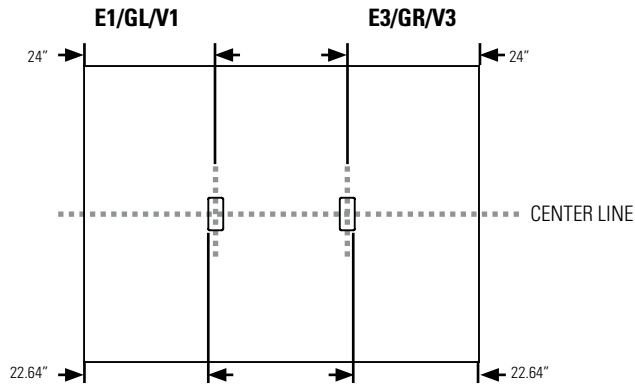

90° Corner Table Tops
Extended 90° Corner Table Tops



Media Table Tops

WORKSURFACES	MODEL#	DIMENSIONS	FREIGHT CLASS	WT/LBS.	CUBIC FT.	LIST PRICE	HP ADD									
 <p>Rectangular Worksurfaces</p>		D x W x H														
	FTWR2328	23 x 28 x 1	70	20	1.16	\$225	\$68									
	FTWR2334	23 x 34 x 1	70	24	1.40	\$249	\$76									
	FTWR2340	23 x 40 x 1	70	28	1.64	\$319	\$104									
	FTWR2346	23 x 46 x 1	70	31	1.84	\$427	\$128									
	FTWR2352	23 x 52 x 1	70	36	2.08	\$457	\$145									
	FTWR2358	23 x 58 x 1	70	40	2.32	\$510	\$162									
	FTWR2364	23 x 64 x 1	70	44	2.56	\$534	\$168									
	FTWR2370	23 x 70 x 1	85	48	3.80	\$577	\$179									
	FTWR2376	23 x 76 x 1	70	52	3.03	\$582	\$185									
	FTWR2382	23 x 82 x 1	70	56	3.27	\$629	\$193									
	FTWR2928	29 x 28 x 1	70	25	1.46	\$261	\$83									
	FTWR2934	29 x 34 x 1	70	30	1.76	\$305	\$96									
	FTWR2940	29 x 40 x 1	70	35	2.06	\$427	\$132									
	FTWR2946	29 x 46 x 1	70	40	2.32	\$509	\$145									
	FTWR2952	29 x 52 x 1	70	45	2.62	\$521	\$145									
	FTWR2958	29 x 58 x 1	70	50	2.92	\$532	\$168									
	FTWR2964	29 x 64 x 1	70	55	3.22	\$555	\$181									
	FTWR2970	29 x 70 x 1	70	60	3.52	\$582	\$186									
	FTWR2976	29 x 76 x 1	70	65	3.83	\$609	\$192									
	FTWR2982	29 x 82 x 1	70	71	4.13	\$677	\$211									
	FTWR3528	35 x 28 x 1	70	30	1.76	\$270	\$86									
	FTWR3534	35 x 34 x 1	70	35	2	\$317	\$99									
	FTWR3540	35 x 40 x 1	70	40	2.50	\$444	\$138									
	FTWR3546	35 x 46 x 1	70	48	2.80	\$578	\$145									
	FTWR3552	35 x 52 x 1	70	54	3.16	\$640	\$164									
	FTWR3558	35 x 58 x 1	70	60	3.52	\$712	\$179									
	FTWR3564	35 x 64 x 1	70	67	3.89	\$776	\$198									
	FTWR3570	35 x 70 x 1	70	73	4.25	\$844	\$213									
	FTWR3576	35 x 76 x 1	70	79	4.62	\$906	\$230									
	FTWR3582	35 x 82 x 1	70	85	4.98	\$976	\$245									
		Rectangular worksurfaces are non-handed and can be interchanged on site. For 23" deep worksurfaces, use FT52xx24 or FT62xx24. For 29" deep worksurfaces, use FT52xx30 or FT62xx30. For 35" deep worksurfaces, use FT52xx30 or FT62xx30.														
		<ul style="list-style-type: none"> • 35" deep worksurfaces cannot be used with Back-to-Back bases. • For back-to-back bases, please use the following chart: <table border="0" style="width: 100%; margin-top: 5px;"> <tr> <td>FTWR(23/29)46, FT54BSF/FT64BSF</td> <td>FTWR(23/29)64, FT54BLF/FT64BLF</td> </tr> <tr> <td>FTWR(23/29)52, FT54BSF/FT64BSF</td> <td>FTWR(23/29)72, FT54BLF/FT64BLF</td> </tr> <tr> <td>FTWR(23/29)58, FT54BSF/FT64BSF</td> <td>FTWR(23/29)76, FT54BLF/FT64BLF</td> </tr> <tr> <td></td> <td>FTWR(23/29)82, FT54BLF/FT64BLF</td> </tr> </table> 							FTWR(23/29)46, FT54BSF/FT64BSF	FTWR(23/29)64, FT54BLF/FT64BLF	FTWR(23/29)52, FT54BSF/FT64BSF	FTWR(23/29)72, FT54BLF/FT64BLF	FTWR(23/29)58, FT54BSF/FT64BSF	FTWR(23/29)76, FT54BLF/FT64BLF		FTWR(23/29)82, FT54BLF/FT64BLF
	FTWR(23/29)46, FT54BSF/FT64BSF	FTWR(23/29)64, FT54BLF/FT64BLF														
	FTWR(23/29)52, FT54BSF/FT64BSF	FTWR(23/29)72, FT54BLF/FT64BLF														
FTWR(23/29)58, FT54BSF/FT64BSF	FTWR(23/29)76, FT54BLF/FT64BLF															
	FTWR(23/29)82, FT54BLF/FT64BLF															
 <p>Media Table Top</p>	FTWMR5460	54 x 60 x 1	70	96	5.63	\$850	\$328									
	FTWMR5466	54 x 66 x 1	70	106	6.19	\$927	\$360									
	FTWMR5472	54 x 72 x 1	70	115	6.75	\$1004	\$394									
	FTWMR5478	54 x 78 x 1	70	125	7.31	\$1078	\$427									
	FTWMR5484	54 x 84 x 1	70	135	7.88	\$1155	\$459									
	FTWMR5490	54 x 90 x 1	70	144	8.44	\$1235	\$492									
	FTWMR5496	54 x 96 x 1	70	154	9	\$1312	\$524									
	FTWMR6060	60 x 60 x 1	70	107	6.25	\$931	\$366									
	FTWMR6066	60 x 66 x 1	70	118	6.88	\$1018	\$403									
	FTWMR6072	60 x 72 x 1	70	128	7.50	\$1102	\$439									
	FTWMR6078	60 x 78 x 1	70	139	8.13	\$1187	\$473									
	FTWMR6084	60 x 84 x 1	70	150	8.75	\$1271	\$510									
	FTWMR6090	60 x 90 x 1	70	160	9.38	\$1357	\$547									
	FTWMR6096	60 x 96 x 1	70	171	10	\$1440	\$583									
		For tables FTWMR5460 and 6060, use FTM5B2BSF standard range or FTM6B2BSF extended range base. For all other tables, use FTM5B2BLF standard range or FTM6B2BLF extended range base														

Required specifications

Top finish
Edge finish

Optional specifications

HP laminate
Grommet

WORKSURFACES

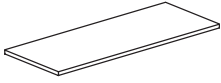

Rectangular Return Worksurfaces

MODEL#	DIMENSIONS D x W x H	FREIGHT CLASS	WT/LBS.	CUBIC FT.	LIST PRICE	HP ADD
FTWRR2329	23 x 29 x 1	70	20	1.16	\$272	\$68
FTWRR2335	23 x 35 x 1	70	24	1.40	\$368	\$81
FTWRR2341	23 x 41 x 1	70	28	1.64	\$406	\$107
FTWRR2347	23 x 47 x 1	70	32	1.88	\$427	\$128
FTWRR2353	23 x 53 x 1	70	36	2.12	\$457	\$145
FTWRR2359	23 x 59 x 1	70	40	2.36	\$503	\$162
FTWRR2929	29 x 29 x 1	70	25	1.46	\$340	\$84
FTWRR2935	29 x 35 x 1	70	30	1.76	\$503	\$97
FTWRR2941	29 x 41 x 1	70	35	2.06	\$503	\$136
FTWRR2947	29 x 47 x 1	70	40	2.36	\$509	\$145
FTWRR2953	29 x 53 x 1	70	46	2.67	\$521	\$145
FTWRR2959	29 x 59 x 1	70	51	2.97	\$607	\$168

Rectangular return worksurfaces are non-handed and can be interchanged on site. Includes two flat brackets for connection. For use with FT51SR/LR or FT61SR/LR. To determine the appropriate return base, use the following chart:

Main Surface	Return Surface	Return Base
FTWR23xx	FTWRR(23/29)29	FT51/61SR
FTWR23xx	FTWRR(23/29)35	FT51/61SR
FTWR23xx	FTWRR(23/29)41	FT51/61SR
FTWR23xx	FTWRR(23/29)47	FT51/61LR
FTWR23xx	FTWRR(23/29)53	FT51/61LR
FTWR23xx	FTWRR(23/29)59	FT51/61LR
FTWR29xx	FTWRR(23/29)29	FT51/61SR
FTWR29xx	FTWRR(23/29)35	FT51/61SR
FTWR29xx	FTWRR(23/29)41	FT51/61LR
FTWR29xx	FTWRR(23/29)47	FT51/61LR
FTWR29xx	FTWRR(23/29)53	FT51/61LR
FTWR29xx	FTWRR(23/29)59	FT51/61LR

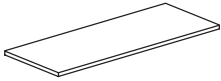

Rectangular End of Run Worksurfaces

FTWR2351	23 x 51 x 1	70	40	2.02	\$498	\$162
FTWR2362	23 x 62 x 1	70	44	2.50	\$523	\$168
FTWR2951	29 x 51 x 1	70	50	2.54	\$523	\$168
FTWR2962	29 x 62 x 1	70	55	3.15	\$535	\$270

Rectangular return worksurfaces are non-handed and can be interchanged on site.

- For 23" deep worksurfaces, use with FT52xx24 or FT62xx24.
- For 29" deep worksurfaces, use with FT52xx30 or FT62xx30.
- For back-to-back bases, please use the following chart:
 FTWR(23/29)51, FT52BSF24/30 or FT62BSF24/30
 FTWR(23/29)62, FT52BLF24/30 or FT62BLF24/30

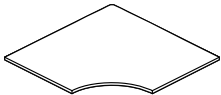

90° Corner Worksurface

FTWCC234023	40 x 40 x 1	60	80	1.5	\$827	\$83
FTWCC234623	46 x 46 x 1	60	95	2	\$851	\$85
FTWCC235223	52 x 52 x 1	70	80	4.69	\$987	\$85
FTWCC235823	58 x 58 x 1	70	100	5.84	\$1263	\$128
FTWCC294029	40 x 40 x 1	60	80	1.5	\$827	\$83
FTWCC294629	46 x 46 x 1	70	63	3.67	\$838	\$86
FTWCC295229	52 x 52 x 1	70	80	4.69	\$987	\$103
FTWCC295829	58 x 58 x 1	70	100	5.84	\$1263	\$128

For tables that connect with 23" deep worksurfaces, use with FT539FS24CL or FT639FS24CL. For tables that connect with 29" deep worksurfaces, use with FT539FS30CL or FT639FS30CL.

Required specifications

Top finish
Edge finish

Optional specifications

HP laminate
Grommet

EXTENDED CORNER WORKSURFACES

MODEL# DIMENSIONS FREIGHT CLASS WT/LBS. CUBIC FT. LIST PRICE HP ADD

D x W x H

FTWEC23584023	58 x 40 x 1	60	115	2.6	\$1114	\$281
FTWEC23644023	64 x 40 x 1	60	127	2.8	\$1238	\$311
FTWEC23704023	70 x 40 x 1	60	138	3.1	\$1353	\$343
FTWEC23764023	76 x 40 x 1	60	150	3.3	\$1445	\$359
FTWEC23824023	82 x 40 x 1	60	162	3.6	\$1533	\$384
FTWEC23584623	58 x 46 x 1	60	115	2.55	\$1164	\$292
FTWEC23644623	64 x 46 x 1	60	127	2.81	\$1294	\$326
FTWEC23704623	70 x 46 x 1	60	138	3.07	\$1415	\$358
FTWEC23764623	76 x 46 x 1	60	150	3.34	\$1510	\$378
FTWEC23824623	82 x 46 x 1	60	162	3.6	\$1602	\$403
FTWEC23585223	58 x 52 x 1	60	130	2.88	\$1198	\$304
FTWEC23645223	64 x 52 x 1	60	143	3.18	\$1333	\$337
FTWEC23705223	70 x 52 x 1	60	156	3.48	\$1457	\$368
FTWEC23765223	76 x 52 x 1	60	170	3.77	\$1555	\$389
FTWEC23825223	82 x 52 x 1	60	183	4.07	\$1648	\$415
FTWEC23645823	64 x 58 x 1	60	160	3.54	\$1372	\$345
FTWEC23705823	70 x 58 x 1	60	174	3.88	\$1501	\$379
FTWEC23765823	76 x 58 x 1	60	189	4.21	\$1602	\$402
FTWEC23825823	82 x 58 x 1	60	204	4.54	\$1698	\$431

FTWEC29584029	58 x 40 x 1	60	115	2.2	\$1159	\$291
FTWEC29644029	64 x 40 x 1	60	127	2.4	\$1290	\$322
FTWEC29704029	70 x 40 x 1	60	138	2.7	\$1407	\$356
FTWEC29764029	76 x 40 x 1	60	150	2.9	\$1502	\$373
FTWEC29824029	82 x 40 x 1	60	162	3.1	\$1593	\$401
FTWEC29584629	58 x 46 x 1	60	115	2.55	\$1212	\$305
FTWEC29644629	64 x 46 x 1	60	127	2.81	\$1346	\$338
FTWEC29704629	70 x 46 x 1	60	138	3.07	\$1471	\$373
FTWEC29764629	76 x 46 x 1	60	150	3.34	\$1570	\$391
FTWEC29824629	82 x 46 x 1	60	152	3.6	\$1665	\$418
FTWEC29585229	58 x 52 x 1	60	130	2.88	\$1248	\$316
FTWEC29645229	64 x 52 x 1	60	143	3.18	\$1385	\$350
FTWEC29705229	70 x 52 x 1	60	156	3.48	\$1516	\$382
FTWEC29765229	76 x 52 x 1	60	170	3.77	\$1616	\$403
FTWEC29825229	82 x 52 x 1	60	183	4.07	\$1716	\$432
FTWEC29645829	64 x 58 x 1	60	160	3.54	\$1427	\$360
FTWEC29705829	70 x 58 x 1	60	174	3.88	\$1562	\$393
FTWEC29765829	76 x 58 x 1	60	189	4.21	\$1665	\$417
FTWEC29825829	82 x 58 x 1	60	204	4.54	\$1766	\$444

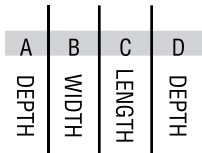
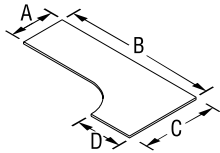

Ext. 90° Corner Worksurface, Left

For tables that connect with 23" deep (A and D) worksurfaces, use with FT539F(S/L)24CL or FT539F(S/L)24CL bases. For tables that connect with 29" deep (A and D) worksurfaces, use with FT539F(S/L)30CL or FT639F(S/L)30CL bases. Must use with FTWRExxx return surfaces only.

Required specifications

Top finish
Edge finish

Optional specifications

HP laminate
Grommet

MODEL# DIMENSIONS FREIGHT CLASS WT/LBS. CUBIC FT. LIST PRICE HP ADD

D x W x H

FTWEC23405823	58 x 40 x 1	60	115	2.6	\$1114	\$281
FTWEC23406423	64 x 40 x 1	60	127	2.8	\$1238	\$311
FTWEC23407023	70 x 40 x 1	60	138	3.1	\$1353	\$343
FTWEC23407623	76 x 40 x 1	60	150	3.3	\$1445	\$359
FTWEC23408223	82 x 40 x 1	60	162	3.6	\$1533	\$384
FTWEC23465823	58 x 46 x 1	60	115	2.55	\$1164	\$292
FTWEC23466423	64 x 46 x 1	60	127	2.81	\$1294	\$326
FTWEC23467023	70 x 46 x 1	60	138	3.07	\$1415	\$358
FTWEC23467623	76 x 46 x 1	60	150	3.34	\$1510	\$378
FTWEC23468223	82 x 46 x 1	60	162	3.6	\$1602	\$403
FTWEC23525823	58 x 52 x 1	60	130	2.88	\$1198	\$304
FTWEC23526423	64 x 52 x 1	60	143	3.18	\$1333	\$337
FTWEC23527023	70 x 52 x 1	60	156	3.48	\$1457	\$368
FTWEC23527623	76 x 52 x 1	60	170	3.77	\$1555	\$389
FTWEC23528223	82 x 52 x 1	60	183	4.07	\$1648	\$415
FTWEC23586423	64 x 58 x 1	60	160	3.54	\$1372	\$345
FTWEC23587023	70 x 58 x 1	60	174	3.88	\$1501	\$379
FTWEC23587623	76 x 58 x 1	60	189	4.21	\$1602	\$402
FTWEC23588223	82 x 58 x 1	60	204	4.54	\$1698	\$431

FTWEC29405829	58 x 40 x 1	60	115	2.2	\$1159	\$291
FTWEC29406429	64 x 40 x 1	60	127	2.4	\$1290	\$322
FTWEC29407029	70 x 40 x 1	60	138	2.7	\$1407	\$356
FTWEC29407629	76 x 40 x 1	60	127	2.4	\$1502	\$373
FTWEC29408229	82 x 40 x 1	60	162	3.1	\$1593	\$401
FTWEC29465829	58 x 46 x 1	60	115	2.55	\$1212	\$305
FTWEC29466429	64 x 46 x 1	60	127	2.81	\$1346	\$338
FTWEC29467029	70 x 46 x 1	60	138	3.07	\$1471	\$373
FTWEC29467629	76 x 46 x 1	60	150	3.34	\$1570	\$391
FTWEC29468229	82 x 46 x 1	60	162	3.6	\$1665	\$418
FTWEC29525829	58 x 52 x 1	60	130	2.88	\$1248	\$316
FTWEC29526429	64 x 52 x 1	60	143	3.18	\$1385	\$350
FTWEC29527029	70 x 52 x 1	60	156	3.48	\$1516	\$382
FTWEC29527629	76 x 52 x 1	60	170	3.77	\$1616	\$403
FTWEC29528229	82 x 52 x 1	60	183	4.07	\$1716	\$432
FTWEC29586429	64 x 58 x 1	60	160	3.54	\$1427	\$360
FTWEC29587029	70 x 58 x 1	60	174	3.88	\$1562	\$393
FTWEC29587629	76 x 58 x 1	60	189	4.21	\$1665	\$417
FTWEC29588229	82 x 58 x 1	60	204	4.54	\$1766	\$444

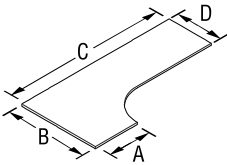

Ext. 90° Corner Worksurface, Right

For tables that connect with 23" deep (A and D) worksurfaces, use with FT539F(S/L)24CL or FT539F(S/L)24CL bases. For tables that connect with 29" deep (A and D) worksurfaces, use with FT539F(S/L)30CL or FT639F(S/L)30CL bases. Must use with FTWRExxxx return surfaces only.

FTWRE2324	23 x 24 x 1	70	16	0.96	\$211	\$68
FTWRE2330	23 x 30 x 1	70	20	1.2	\$229	\$68
FTWRE2336	23 x 36 x 1	70	25	1.44	\$255	\$81
FTWRE2924	29 x 24 x 1	70	21	1.21	\$250	\$74
FTWRE2930	29 x 30 x 1	70	26	1.51	\$266	\$84
FTWRE2936	29 x 36 x 1	70	31	1.81	\$308	\$97

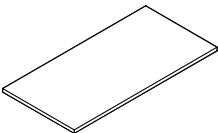

Rectangular Extension**
Return Worksurface

Worksurfaces to be used only with Extended 90° Corner Worksurfaces.

- FTWRE23 to be used with FTWEC23xxxx23
- FTWRE29 to be used with FTWEC29xxxx29

Required specifications

Top finish
Edge finish

Optional specifications

HP laminate
Grommet

BASES

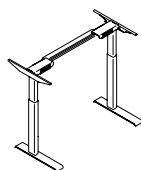

Standard Range Base*

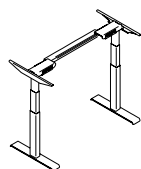

Extended Range Base*

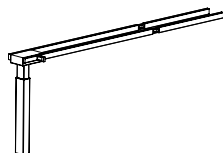

Standard Range Return Kit

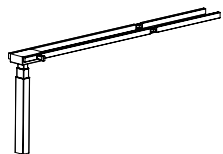

Extended Range Return Kit

MODEL# DIMENSIONS FREIGHT CLASS WT/LBS. CUBIC FT. LIST PRICE

D x W x H

FT52BF24	24 x 30-42 x 27.5-47	60	67	1.47	\$1255
FT52SF24	24 x 48-60 x 27.5-47	60	67	1.47	\$1382
FT52LF24	24 x 66-84 x 27.5-47	60	67	1.47	\$1388
FT52BF30	30-36 x 30-42 x 27.5-47	60	67	1.47	\$1265
FT52SF30	30-36 x 48-60 x 27.5-47	60	67	1.47	\$1392
FT52LF30	30-36 x 66-84 x 27.5-47	60	67	1.47	\$1398

Kit includes one beam, two cantilevers, two standard range columns, and two C or T styled feet. **BF** indicates base frame for 30" to 42" tables. **SF** indicates small frame for 48" to 60" tables. **LF** indicates large frame: 66" to 84" tables. For 23" deep worksurfaces, use 24" leg. For 29" and 35" deep worksurface, use 30" leg. For enhanced collision detection, an Anti Collision Desk Sensor is included with every base. Standard up/down controller with 2 memory positions, reminder settings + Bluetooth capability is standard - specify **(S)**. For a Display controller with height readout, 4 memory positions, reminder settings + Bluetooth capabilities, specify **(D)**, add **\$59** list. Specify paint finish: Black (**BLK**), Charcoal (**CHR**), Designer White (**DWT**), Fog (**FOG**), Nevada (**NEV**), Silver (**SIL**), Taupe (**TPE**), Tungsten (**TUN**). UL Listed: UL 962.

FT62BF24	24 x 30-42 x 22.5-48.5	60	67	1.47	\$1341
FT62SF24	24 x 48-60 x 22.5-48.5	60	67	1.47	\$1473
FT62LF24	24 x 66-84 x 22.5-48.5	60	67	1.47	\$1480
FT62BF30	30-36 x 30-42 x 22.5-48.5	60	67	1.47	\$1351
FT62SF30	30-36 x 48-60 x 22.5-48.5	60	67	1.47	\$1485
FT62LF30	30-36 x 66-84 x 22.5-48.5	60	67	1.47	\$1489

Kit includes one beam, two cantilevers, two extended range columns, and two C or T styled feet. **BF** indicates base frame for 30" to 42" tables. **SF** indicates small frame for 48" to 60" tables. **LF** indicates large frame: 66" to 84" tables. For 23" deep worksurfaces, use 24" leg. For 29" and 35" deep worksurface, use 30" leg. For enhanced collision detection, an Anti Collision Desk Sensor is included with every base. Standard up/down controller with 2 memory positions, reminder settings + Bluetooth capability is standard - specify **(S)**. For a Display controller with height readout, 4 memory positions, reminder settings + Bluetooth capabilities, specify **(D)**, add **\$59** list. Specify paint finish: Black (**BLK**), Charcoal (**CHR**), Designer White (**DWT**), Fog (**FOG**), Nevada (**NEV**), Silver (**SIL**), Taupe (**TPE**), Tungsten (**TUN**). UL Listed: UL 962.

FT51SRNL	-- x 24-48 x 27.5-47	60	61	1.47	\$846
FT51LRNL	-- x 54-72 x 27.5-47	60	61	1.47	\$863

Kit includes one beam, one cantilever, one standard range columns, and one pad foot. See chart on 606 to determine whether SR or LR kit is required. For 23" deep worksurfaces, use 24" return. For 29" and 35" deep worksurface, use 30" return. Specify paint finish: Black (**BLK**), Charcoal (**CHR**), Designer White (**DWT**), Fog (**FOG**), Nevada (**NEV**), Silver (**SIL**), Taupe (**TPE**), Tungsten (**TUN**). UL Listed: UL 962.

- When using the return kit for a 23"d return and a 29"/35" deep desk, a new foot must be ordered separately. See FTFOOT24TL/CL (619) for specification information.

FT61SRNL	-- x 24-48 x 22.5-48.5	60	61	1.47	\$890
FT61LRNL	-- x 54-72 x 22.5-48.5	60	61	1.47	\$908

Kit includes one beam, one cantilever, one standard range columns, and one pad foot. See chart on 606 to determine whether SR or LR kit is required. For 23" deep worksurfaces, use 24" return. For 29" and 35" deep worksurface, use 30" return. Specify paint finish: Black (**BLK**), Charcoal (**CHR**), Designer White (**DWT**), Fog (**FOG**), Nevada (**NEV**), Silver (**SIL**), Taupe (**TPE**), Tungsten (**TUN**). UL Listed: UL 962.

- When using the return kit for a 23"d return and a 29"/35" deep desk, a new foot must be ordered separately. See FTFOOT24TL/CL (619) for specification information.

Required specifications

Base finish
Leg style*

Optional specifications

Digital handset

BASES

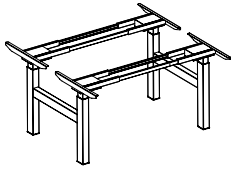

Back-to-Back Standard Range Base

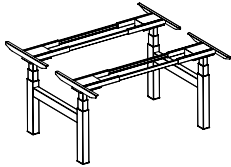

Back-to-Back Extended Range Base

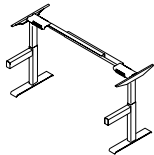

Standard Range Single Frame

MODEL#	DIMENSIONS D x W x H	FREIGHT CLASS	WT/LBS.	CUBIC FT.	LIST PRICE
FT54BSFNL	24 x -- x 27.5-47	60	123	2.94	\$3080
FT54BLFNL	24 x -- x 27.5-47	60	123	2.94	\$3089

Back-to-back height adjustable bases includes four height adjustable columns with pad feet, two sets of cross rails for surface support and two short beams to attach the columns back-to-back. Combine with surfaces & trough kits (sold separately) to create a complete workstation. For 50.5" depth, use two x 23" deep worksurfaces. For 62.5" depth, use two x 29" deep worksurfaces. **30" or larger depth worksurfaces cannot be used with Back to Back bases.** Duplex receptacles are not included, please specify separately. For enhanced collision detection, an Anti Collision Desk Sensor is included with every base. Standard up/down controller with 2 memory positions, reminder settings + Bluetooth capability is standard - specify **(S)**. For a Display controller with height readout, 4 memory positions, reminder settings + Bluetooth capabilities, specify **(D)**, add **\$117** list. Specify paint finish: Black **(BLK)**, Charcoal **(CHR)**, Designer White **(DWT)**, Fog **(FOG)**, Nevada **(NEV)**, Silver **(SIL)**, Taupe **(TPE)**, Tungsten **(TUN)**. UL Listed: UL 962.

FT64BSFNL	10 x -- x 22.5-48.5	60	123	2.94	\$3253
FT64BLFNL	10 x -- x 22.5-48.5	60	123	2.94	\$3264

Back-to-back height adjustable bases includes four height adjustable columns with pad feet, two sets of cross rails for surface support and two short beams to attach the columns back-to-back. Combine with surfaces & trough kits (sold separately) to create a complete workstation. For 50.5" depth, use two x 23" deep worksurfaces. For 62.5" depth, use two x 29" deep worksurfaces. **30" or larger depth worksurfaces cannot be used with Back to Back bases.** Duplex receptacles are not included, please specify separately. For enhanced collision detection, an Anti Collision Desk Sensor is included with every base. Standard up/down controller with 2 memory positions, reminder settings + Bluetooth capability is standard - specify **(S)**. For a Display controller with height readout, 4 memory positions, reminder settings + Bluetooth capabilities, specify **(D)**, add **\$117** list. Specify paint finish: Black **(BLK)**, Charcoal **(CHR)**, Designer White **(DWT)**, Fog **(FOG)**, Nevada **(NEV)**, Silver **(SIL)**, Taupe **(TPE)**, Tungsten **(TUN)**. UL Listed: UL 962.

FT52BSF24	24 x -- x 27.5-47	60	72	1.47	\$1741
FT52BLF24	24 x -- x 27.5-47	60	72	1.47	\$1751
FT52BSF30	30 x -- x 27.5-47	60	72	1.47	\$1806
FT52BLF30	30 x -- x 27.5-47	60	72	1.47	\$1816

Single sided height adjustable bases includes two height adjustable columns with "T" feet, one set of cross rails for surface support and two short beams to attach the columns to a trough kit. Combine with single surfaces & trough kits (sold separately) to create a complete workstation. Use 23" deep worksurfaces with FT52BSF24 + FT52BLF24. Use 29" deep worksurfaces with FT52BSF30 + FT52BLF30. **30" or larger depth worksurfaces cannot be used with benching bases.** Duplex receptacles are not included, please specify separately. For enhanced collision detection, an Anti Collision Desk Sensor is included with every base. Standard up/down controller with 2 memory positions, reminder settings + Bluetooth capability is standard - specify **(S)**. For a Display controller with height readout, 4 memory positions, reminder settings + Bluetooth capabilities, specify **(D)**, add **\$117** list. Specify paint finish: Black **(BLK)**, Charcoal **(CHR)**, Designer White **(DWT)**, Fog **(FOG)**, Nevada **(NEV)**, Silver **(SIL)**, Taupe **(TPE)**, Tungsten **(TUN)**. UL Listed: UL 962.

Required specifications

Base finish
Leg style*

Optional specifications

Digital handset

BASES

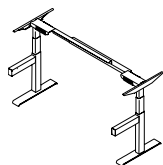

Extended Range Single Frame

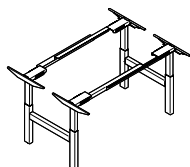

Standard Range Media Table Base

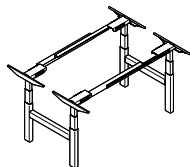

Extended Range Media Table Base

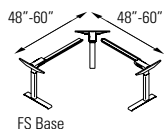

FS Base

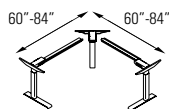

FL Base

Standard Range 90° Base, Equal Sides

MODEL# DIMENSIONS FREIGHT CLASS WT./LBS. CUBIC FT. LIST PRICE

D x W x H

FT62BSF24	24 x -- x 22.5-48.5	60	72	1.47	\$1887
FT62BLF24	24 x -- x 22.5-48.5	60	72	1.47	\$1892
FT62BSF30	30 x -- x 22.5-48.5	60	72	1.47	\$1897
FT62BLF30	30 x -- x 22.5-48.5	60	72	1.47	\$1903

Single sided height adjustable bases includes two height adjustable columns with "T" feet, one set of cross rails for surface support and two short beams to attach the columns to a trough kit. Combine with single surfaces & trough kits (sold separately) to create a complete workstation. Use 23" deep worksurfaces with FT62BSF24 + FT62BLF24. Use 29" deep worksurfaces with FT62BSF30 + FT62BLF30. **30" or larger depth worksurfaces cannot be used with benching bases.** Duplex receptacles are not included, please specify separately. For enhanced collision detection, an Anti Collision Desk Sensor is included with every base. Standard up/down controller with 2 memory positions, reminder settings + Bluetooth capability is standard - specify **(S)**. For a Display controller with height readout, 4 memory positions, reminder settings + Bluetooth capabilities, specify **(D)**, add **\$117** list. Specify paint finish: Black **(BLK)**, Charcoal **(CHR)**, Designer White **(DWT)**, Fog **(FOG)**, Nevada **(NEV)**, Silver **(SIL)**, Taupe **(TPE)**, Tungsten **(TUN)**. UL Listed: UL 962.

FTM5B2BSF	54-60 x 60 x 27.5-47	60	123	2.94	\$3080
FTM5B2BLF	54-60 x 60 x 27.5-47	60	123	2.94	\$3089

Kit includes two beams, four cantilevers, four standard range columns and two controllers. SF indicates small base for 60" sided tables. LF indicates large base for 66" to 84" sided tables. For enhanced collision detection, an Anti Collision Desk Sensor is included with every base. Standard up/down controller with 2 memory positions, reminder settings + Bluetooth capability is standard - specify **(S)**. For a Display controller with height readout, 4 memory positions, reminder settings + Bluetooth capabilities, specify **(D)**, add **\$117** list. Specify paint finish: Black **(BLK)**, Charcoal **(CHR)**, Designer White **(DWT)**, Fog **(FOG)**, Nevada **(NEV)**, Silver **(SIL)**, Taupe **(TPE)**, Tungsten **(TUN)**. UL Listed: UL 962.

FTM6B2BSF	54-60 x 60 x 22.5-48.5	60	123	2.94	\$3253
FTM6B2BLF	54-60 x 60 x 22.5-48.5	60	123	2.94	\$3264

Kit includes two beams, four cantilevers, four extended range columns and two controllers. SF indicates small base for 60" sided tables. LF indicates large base for 66" to 84" sided tables. For enhanced collision detection, an Anti Collision Desk Sensor is included with every base. Standard up/down controller with 2 memory positions, reminder settings + Bluetooth capability is standard - specify **(S)**. For a Display controller with height readout, 4 memory positions, reminder settings + Bluetooth capabilities, specify **(D)**, add **\$117** list. Specify paint finish: Black **(BLK)**, Charcoal **(CHR)**, Designer White **(DWT)**, Fog **(FOG)**, Nevada **(NEV)**, Silver **(SIL)**, Taupe **(TPE)**, Tungsten **(TUN)**. UL Listed: UL 962.

FT539FS24CL	54-60 x 42-60 x 27.5-47	60	101	1.47	\$2011
FT539FS30CL	54-60 x 42-60 x 27.5-47	60	101	1.47	\$2023
FT539FL24CL	66-84 x 66-84 x 27.5-47	60	101	1.47	\$2047
FT539FL30CL	66-84 x 66-84 x 27.5-47	60	101	1.47	\$2030

Kit includes two equal length beams, three cantilevers, one standard range corner column, two standard range columns, and two C styled feet. **FS** indicates small base for 54" to 60" sided tables. **FL** indicates large base: 66" to 84" sided tables. For 23" deep worksurfaces, use 24" CL leg. For 29" and 35" deep worksurface, use 30" CL leg. For enhanced collision detection, an Anti Collision Desk Sensor is included with every base.

Standard up/down controller with 2 memory positions, reminder settings + Bluetooth capability is standard - specify **(S)**. For a Display controller with height readout, 4 memory positions, reminder settings + Bluetooth capabilities, specify **(D)**, add **\$59** list. Specify paint finish: Black **(BLK)**, Charcoal **(CHR)**, Designer White **(DWT)**, Fog **(FOG)**, Nevada **(NEV)**, Silver **(SIL)**, Taupe **(TPE)**, Tungsten **(TUN)**. UL Listed: UL 962.

- When using a 23" d return with the FT539FS30CL/LF30CL a 24" foot must be ordered separately. See FTFOOT24TL/CL (619) for specification information.

Required specifications

Base finish

Optional specifications

Digital handset

BASES

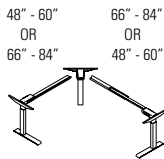

Standard Range 90° Base, Unequal Sides

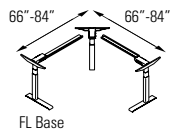
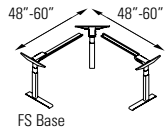

Extended Range 90° Base, Equal Sides*

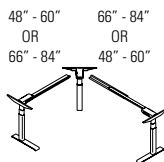

Extended Range 90° Base, Unequal Sides*

MODEL#	DIMENSIONS D x W x H	FREIGHT CLASS	WT/LBS.	CUBIC FT.	LIST PRICE
FT539FSL24CL	66-84 x 42-60 x 27.5-47	60	101	1.47	\$2030
FT539FSL30CL	66-84 x 42-60 x 27.5-47	60	101	1.47	\$2040

Kit includes two beams (one small, one large), three cantilevers, one standard range corner column, two standard range columns, and two C styled feet. For 23" deep worksurfaces, use 24" CL leg. For 29" and 35" deep worksurface, use 30" CL leg. For enhanced collision detection, an Anti Collision Desk Sensor is included with every base.

Standard up/down controller with 2 memory positions, reminder settings + Bluetooth capability is standard - specify **(S)**. For a Display controller with height readout, 4 memory positions, reminder settings + Bluetooth capabilities, specify **(D)**, add **\$59** list. Specify paint finish: Black **(BLK)**, Charcoal **(CHR)**, Designer White **(DWT)**, Fog **(FOG)**, Nevada **(NEV)**, Silver **(SIL)**, Taupe **(TPE)**, Tungsten **(TUN)**. UL Listed: UL 962.

- When using a 23"d return with the FT539FSL30CL a 24" foot must be ordered separately. See FTFOOT24TL/CL (619) for specification information.

FT639FS24CL	48-60 x 42-60 x 22.5-48.5	60	101	1.47	\$2148
FT639FS30CL	48-60 x 42-60 x 22.5-48.5	60	101	1.47	\$2159
FT639FL24CL	66-84 x 66-84 x 22.5-48.5	60	101	1.47	\$2184
FT639FL30CL	66-84 x 66-84 x 22.5-48.5	60	101	1.47	\$2195

Kit includes two equal length beams, three cantilevers, one extended range corner column, two extended range columns, and two C styled feet. **FS** indicates small base for 54" to 60" sided tables. **FL** indicates large base: 66" to 84" sided tables. For 23" deep worksurfaces, use 24" CL leg. For 29" and 35" deep worksurface, use 30" CL leg. For enhanced collision detection, an Anti Collision Desk Sensor is included with every base.

Standard up/down controller with 2 memory positions, reminder settings + Bluetooth capability is standard - specify **(S)**. For a Display controller with height readout, 4 memory positions, reminder settings + Bluetooth capabilities, specify **(D)**, add **\$59** list. Specify paint finish: Black **(BLK)**, Charcoal **(CHR)**, Designer White **(DWT)**, Fog **(FOG)**, Nevada **(NEV)**, Silver **(SIL)**, Taupe **(TPE)**, Tungsten **(TUN)**. UL Listed: UL 962.

- When using a 23"d return with the FT639FS30CL/LF30CL a 24" foot must be ordered separately. See FTFOOT24TL/CL (619) for specification information.

FT639FSL24CL	48-84 x 48-60 x 22.5-48.5	60	101	1.47	\$2166
FT639FSL30CL	48-84 x 48-60 x 22.5-48.5	60	101	1.47	\$2177

Kit includes two beams (one small, one large), three cantilevers, one extended range corner column, two extended range columns, and two C styled feet. For 23" deep worksurfaces, use 24" CL leg. For 29" and 35" deep worksurface, use 30" CL leg. For enhanced collision detection, an Anti Collision Desk Sensor is included with every base.

Standard up/down controller with 2 memory positions, reminder settings + Bluetooth capability is standard - specify **(S)**. For a Display controller with height readout, 4 memory positions, reminder settings + Bluetooth capabilities, specify **(D)**, add **\$59** list. Specify paint finish: Black **(BLK)**, Charcoal **(CHR)**, Designer White **(DWT)**, Fog **(FOG)**, Nevada **(NEV)**, Silver **(SIL)**, Taupe **(TPE)**, Tungsten **(TUN)**. UL Listed: UL 962.

- When using a 23"d return with the FT639FSL30CL a 24" foot must be ordered separately. See FTFOOT24TL/CL (619) for specification information.

Required specifications

Top finish
Base finish
Foot style
Foot configuration

Optional specifications

HP laminate
Digital handset
Grommet
Insulation type

Accessories

Keyboard tray
Power block

LAMINATE LEG SHROUDS

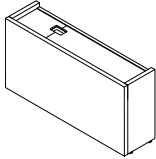

Laminate Leg Shroud, for C-Leg - Left**

MODEL# DIMENSIONS FREIGHT CLASS WT/LBS. CUBIC FT. LIST PRICE

D x W x H

FTB23L	9 x 23 x 18	65	47	2	\$571
FTB29L	9 x 29 x 18	70	55	3	\$591
FTB35L	9 x 35 x 18	70	67	3	\$616

Laminate housing to cover a FreeFit C-leg on the left side. Includes a felt liner at the top. Short side panel is removable to access interior. Specify laminate finish, PVC edge finish and felt finish.

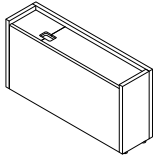

Laminate Leg Shroud, for C-Leg - Right**

FTB23R	9 x 23 x 18	65	47	2	\$571
FTB29R	9 x 29 x 18	70	55	3	\$591
FTB35R	9 x 35 x 18	70	67	3	\$616

Laminate housing to cover a FreeFit C-leg on the right side. Includes a felt liner at the top. Short side panel is removable to access interior. Specify laminate finish, PVC edge finish and felt finish.

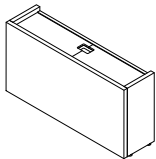

Laminate Leg Shroud for T-Leg**

FTB23	9 x 23 x 18	65	47	2	\$571
FTB29	9 x 29 x 18	70	55	3	\$591
FTB35	9 x 35 x 18	70	67	3	\$616

Laminate housing to cover a FreeFit T-leg. Includes a felt liner at the top. Short side panel is removable to access interior. Specify laminate finish, PVC edge finish and felt finish.

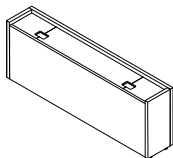

Laminate Leg Shroud for Media Bases

FTB54	9 x 54 x 18	70	110	5	\$1162
FTB64	9 x 64 x 18	70	134	6	\$1352

Laminate shroud for a FreeFit media table base. Includes a felt liner at the top. Side panel is removable to access interior. Specify laminate finish, PVC edge finish and felt finish.

Required specifications

- Laminate finish
- Edge finish
- Felt finish

POWER DELIVERY/CABLE MANAGEMENT	MODEL#	DIMENSIONS D x W x H	FREIGHT CLASS	WT./LBS.	CUBIC FT.	LIST PRICE
---------------------------------	--------	-------------------------	---------------	----------	-----------	------------

4-2-2 Wiring Schematic

8-Wire Shared Neutral

"2 + 2" - 2 Utility Circuits, 2 Dedicated

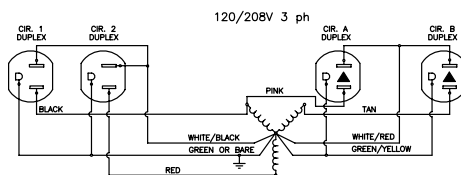
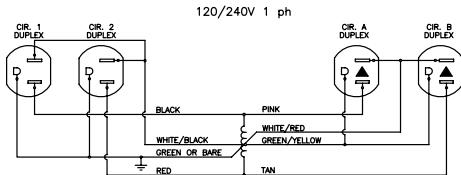

8 Wires	4 Circuits	Receptacles	Specifications
4 Lines (12 ga.)	2 Utility circuits	Duplex - Up to 12 duplex receptacles per circuit	System rated for connection to a grounded 120/240 V single phase, 20A, 60Hz or 120/208 V, 3 phase, 20A, 60Hz branch circuit for U.S. and 15A if product is marked with a C-UL Mark. Outlets rated 15A max.
2 Neutrals (10 ga.)	2 Dedicated Circuits	(Up to 48 per infeed)	
2 Grounds (12 ga.)			

TROUGH KITS	MODEL#	DIMENSIONS	FREIGHT CLASS	WT./LBS.	CUBIC FT.	LIST PRICE
-------------	--------	------------	---------------	----------	-----------	------------

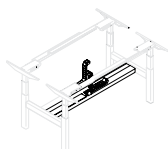

Back-to-Back Trough Kit

FTB2B48KITNB	--	92.5	3.50	.30	\$2422
FTB2B54KITNB	--	92.5	3.50	.30	\$2496
FTB2B60KITNB	--	92.5	3.50	.30	\$2622
FTB2B66KITNB	--	92.5	3.50	.30	\$2672
FTB2B72KITNB	--	92.5	3.50	.30	\$2703

For back-to-back benching applications. Trough kits contain all items needed for a standard back-to-back workstation when combined with the back-to-back height adjustable base and worksurfaces (both sold separately). Kits include two cable chains and one back-to-back power trough with distribution housing included. Specify duplexes separately.

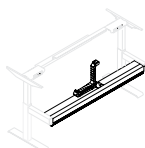

Single Sided Trough Kit

FTSGL48KITNB	--	92.5	3.50	.30	\$1582
FTSGL54KITNB	--	92.5	3.50	.30	\$1658
FTSGL60KITNB	--	92.5	3.50	.30	\$1752
FTSGL66KITNB	--	92.5	3.50	.30	\$1801
FTSGL72KITNB	--	92.5	3.50	.30	\$1852

For single-sided benching applications. Trough kits contain all items needed for a single sided workstation when combined with the single-sided height adjustable base and worksurfaces (both sold separately). Kits include two cable chains and one back-to-back power trough with distribution housing included. Specify duplexes separately.

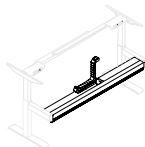

End of Run Trough Kit

FTSGL51T24KITNB	--	92.5	3.50	.30	\$1658
-----------------	----	------	------	-----	---------------

For perpendicular end of run benching applications. Trough kits contain all items needed for a standard back-to-back workstation when combined with the back-to-back height adjustable base and worksurfaces (both sold separately). Kits include two cable chains and one back-to-back power trough with distribution housing included. Specify duplexes separately.

Required specifications
Base finish

ACCESS DOORS

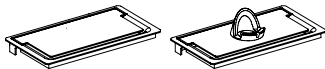

GAADG

GAADGDH

Access Door Module

MODEL# DIMENSIONS FREIGHT CLASS WT/LBS. CUBIC FT. LIST PRICE

D x W x H

GAADG	5.54 x 10.09 x 1.08	--	2	0.04	\$90
GAADGDH	5.54 x 10.09 x 1.08	--	2	0.04	\$97

Soft close door is set back from edge to allow for cable pass thru when closed. Available in all standard base finishes. GAADGDH includes device holder for most mobile phones or tablets. Holder is only available in White. FreeFit can only accommodate one grommet per worksurface.

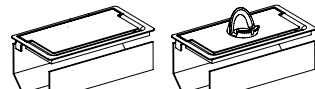

GAADCT

GAADCTDH

Access Door Module w/Cable Tray

GAADCT	5.54 x 10.09 x 5.07	--	4	0.19	\$145
GAADCTDH	5.54 x 10.09 x 5.07	--	4	0.19	\$153

Soft close door is set back from edge to allow for cable pass thru when closed. Cable tray comes standard with one telecom knockout and platform to mount a power bar. Sides are open for easy access. Available in all standard base finishes. GAADCTDH includes device holder for most mobile phones or tablets. Holder is only available in White. FreeFit can only accommodate one grommet per worksurface.

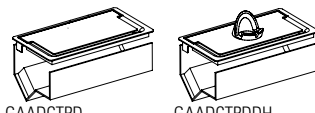

GAADCTPD

GAADCTPDDH

Access Door Module w/Cable Tray and Power Bar

GAADCTPD	5.54 x 10.09 x 6.96	--	4	0.20	\$307
GAADCTPDDH	5.54 x 10.09 x 6.96	--	4	0.20	\$316

Soft close door is set back from edge to allow for cable pass thru when closed. Cable tray comes standard with one telecom knockout and platform to mount a powerbar. Power bar with 3 simplex and 2 USB, CSA Certified. Sides are open for easy access. Available in all standard base finishes. GAADCTPDDH includes device holder for most mobile phones or tablets. Holder is only available in White. FreeFit can only accommodate one grommet per worksurface.

ELECTRICAL COMPONENTS

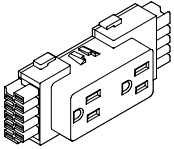

Duplex Receptacles

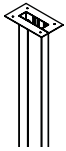

Ceiling Feed Post*



Ceiling Feed Harness

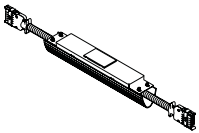

Table to Table Connector*

MODEL#	DIMENSIONS D x W x H	FREIGHT CLASS	WT/LBS.	CUBIC FT.	LIST PRICE
BRTE8D1	1.25 x 4.63 x 2	70	.10	.01	\$42
BRTE8D2	1.25 x 4.63 x 2	70	.10	.01	\$42
BRTE8DA	1.25 x 4.63 x 2	70	.10	.01	\$42
BRTE8DB	1.25 x 4.63 x 2	70	.10	.01	\$42
BRTE8DXW1	1.25 x 4.63 x 2	70	.10	.01	\$59
BRTE8DXW2	1.25 x 4.63 x 2	70	.10	.01	\$59
BRTE8DXWA	1.25 x 4.63 x 2	70	.10	.01	\$59
BRTE8DXWB	1.25 x 4.63 x 2	70	.10	.01	\$59

Snaps into Power Distribution Housing. Up to 13 duplex receptacles per circuit. XW identifies white color plastic, all others standard in black.

- BRTE8D1 / BRTE8DXW1 - Circuit #1 (utility circuit)
- BRTE8D2 / BRTE8DXW2 - Circuit #2 (utility circuit)
- BRTE8DA / BRTE8DXWA - Circuit A (dedicated circuit)
- BRTE8DB / BRTE8DXWB - Circuit B (dedicated circuit)

BWAECF	2.5 x 4.74 x 99.32	92.5	3.50	.30	\$429
--------	--------------------	------	------	-----	--------------

Ceiling pole brings ceiling feed conduit and data cables from the ceiling down to Power troughs height. Accommodates 10' ceiling heights. A two part construction allows power/data conduit lay-in. Includes mounting hardware and ceiling bezel. Ceiling feed harness sold separately.

BWAEECFH120	6 x 6 x 120	250	5	2	\$530
BWAEECFH144	6 x 6 x 144	250	6	3	\$588

Ceiling feed provides a single power entry from ceiling, through Ceiling pole into Power Trough, into Power Distribution Housing. An 8-wire (4-circuit) metal conduit harness with included metal junction box for hard wiring to the building power supply above ceiling tile. Must be hard wired to the building power supply by a licensed electrician. Ceiling feed post sold separately.

FTAETTC12	2.3 x 16 x 3	60	6	.12	\$409
FTAETTC18	2.3 x 22 x 3	60	8	.15	\$442
FTAETTC24	2.3 x 28 x 3	60	9	.18	\$466
FTAETTC30	2.3 x 34 x 3	60	10.60	.22	\$492
FTAETTC36	2.3 x 40 x 3	60	12	.24	\$516
FTAETTC42	2.3 x 46 x 3	60	11.60	.28	\$555
FTAETTC48	2.3 x 52 x 3	60	14	.30	\$591

Connects Freefit legs and trough provide to power data/communication pass thru. Connector kit consists of formed steel housing, mounting brackets, housing to housing harness (jumper) and one charcoal grey extruded data/communication cable manager. Knock out on top cover allows for ceiling post connection. Cover included. Specify paint finish.

- FTAETTC12 is used between two single sided or back to back stations that are 70" w (72" nominal) or less.
- FTAETTC18 is used between two single sided or back to back stations that are 76" w (78" nominal).
- FTAETTC24 is used between two single sided or back to back stations that are 82" w (84" nominal), or when separating two stations (up to 70" w) with a 12" w storage piece.
- FTAETTC30 is used to separate 2 workstations 70" w (72" nominal) or less with an 18" w storage unit in between the surfaces.
- FTAETTC36 is used between two single sided or back to back stations that are 70" w (72" nominal) or less with (2) 12" w storage units or (1) 24" w storage unit.
- FTAETTC42 is used between two single sided or back to back stations that are 70" w (72" nominal) or less with (2) 15" w storage units or (1) 30" w storage unit
- FTAETTC48 is used between two single sided or back to back stations that are 70" w (72" nominal) or less with (2) 18" w storage units or (1) 36" w storage unit.

Required specifications

Base finish*

ELECTRICAL COMPONENTS

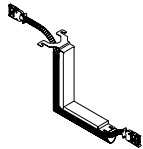
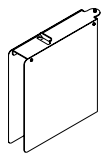

Table to Bridges Connector*



Leg Wire Manager*



Base Feed*

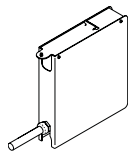

Base Feed* - New York Electrical

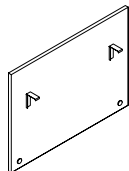

Back-to-Back End Gable*

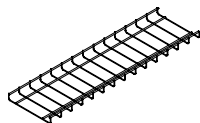

Under Worksurface Cable Basket

MODEL# DIMENSIONS FREIGHT CLASS WT./LBS. CUBIC FT. LIST PRICE

D x W x H

FTTABRC	14 x 2.3 x 15	100	2.40	.28	\$347
---------	---------------	-----	------	-----	--------------

Connects Freefit back-to-back benching to Bridges 29"H table with below worksurface power trough. Please specify paint finish on bracket. Wire manager is always Charcoal.

FTACCL	3.2 x 2 x 16	70	.06	.06	\$531
--------	--------------	----	-----	-----	--------------

Provides wire management from under FreeFit worksurface, down the leg and to the floor. Can only be used on FreeFit regular and media tables. Not for use on back-to-back tables. Kit includes wire manager housing, magnets, screws and cable chain. Magnetically fastens to the FreeFit leg and cable chain is screwed to worksurfaces. Please specify housing paint finish.

FTAEFF	8.75 x 2 x 10.8	92.5	3.50	.30	\$880
--------	-----------------	------	------	-----	--------------

Floor feed housing for FreeFit benching applications only. Includes liquitite whip , 72"L. Must be hard wired to the building power supply by a licensed electrician.

FTAEFF-NYC	14 x 2.55 x 13.41	92.5	3.50	.30	\$743
------------	-------------------	------	------	-----	--------------

Floor feed housing for FreeFit benching applications only. Includes liquitite whip , 72"L. Must be hard wired to the building power supply by a licensed electrician.

FTAEG18H	30.65 x .75 x 18	60	10	.24	\$479
FTAEG22H	30.65 x .75 x 22	60	13	.30	\$516

Optional back-to-back FreeFit Benching end gable is intended to be installed at the end of a FreeFit back-to-back table run. Made of 3/4" thermally fused laminate, it reduces the number of visible elements below the worksurface. Two heights are available. Specify FTAEG18H for extended range bases and FTAEG22H for standard range bases.

FFTCB36	8 x 8 x 1	70	.36	.03	\$121
FFTCB48	8 x 16 x 1	70	.73	.07	\$135
FFTCB54	8 x 22 x 1	70	1.01	.10	\$140
FFTCB60	8 x 28 x 1	70	1.20	.13	\$147
FFTCB66	8 x 34 x 1	70	1.56	.15	\$171
FFTCB72	8 x 40 x 1	70	1.80	.18	\$179
FFTCB78	8 x 46 x 1	92.5	2.16	.21	\$190
FFTCB84	8 x 52 x 1	100	2.39	.24	\$197

Shallow, 8" wide basket manages cable excess. It can be easily unclipped from steel brackets (included). Specify cable basket 30" shorter than worksurface. Steel wire construction, chrome finish baskets; black steel hanging brackets, fasteners.

Required specifications

Base finish*

ELECTRICAL COMPONENTS/ACCESSORIES



Cable Snake

MODEL#	DIMENSIONS D x W x H	FREIGHT CLASS	WT/LBS.	CUBIC FT.	LIST PRICE
BRACS	2 x 8 x 30	70	3	.19	\$153
BRACSH	2 x 8 x 49	70	3	.19	\$290

Flexible cable management trough. Two pathways within the snake, one for data/communication and one for routing power cables. Translucent White finish only.

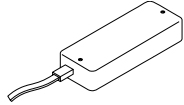

Battery and Charger

FTBATT	8 x 3 x 1.5	70	1.54	.02	\$466
--------	-------------	----	------	-----	--------------

Battery Pak with charging cable mounts to the underside of the worksurface. Features LED bars indicating capacity level and audio alarm when it needs to be charged. On a full charge, the table can cycle from 35 to 45 stroke lengths depending upon the range of column selected and load on the table.

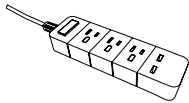

Power Bar with USB

BWAEGC00158GC	1 x 2.3 x 1.3	70	1	.50	\$146
---------------	---------------	----	---	-----	--------------

Power Bar with 3 receptacles + 2 USB and power switch. Standard with 6' cord. Rating 15A, 125V, AC 60Hz, 1875W. USB output 5V, 2.6A (max.) White case, white cord. Available to retrofit CTL/CTR or CTDHL/CTDHR.

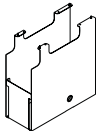

PC Holder

FTACPU	21 x 8 x 21	300	3.57	2.04	\$447
--------	-------------	-----	------	------	--------------

Accepts tower CPU's with a width range from 7.6" to 2.25" - and a maximum height of 18". Durable sheet metal construction. Please specify paint finish.

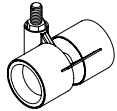

Dual Wheel Casters

BRTLCS	2.7 x 2.5 x 2.6	70	0.06	.01	\$35
--------	-----------------	----	------	-----	-------------

Locking caster. Interchangeable with glides on FreeFit bases. 40mm dia. caster with 8mm thread. White body, light grey tires.

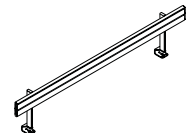

Single Table Accessory Rail*

BRLBST36	2.95 x 33 x 16	65	5.90	.26	\$417
BRLBST42	2.95 x 39 x 16	70	6.44	.30	\$439
BRLBST48	2.95 x 45 x 16	70	6.98	.35	\$455
BRLBST54	2.95 x 51 x 16	70	7.52	.39	\$472
BRLBST60	2.95 x 57 x 16	70	8.07	.43	\$482
BRLBST66	2.95 x 63 x 16	70	8.61	.48	\$499
BRLBST72	2.95 x 69 x 16	70	9.15	.52	\$516
BRLBST78	2.95 x 75 x 16	70	9.69	.56	\$532
BRLBST84	2.95 x 81 x 16	70	10.24	.61	\$548

Table mounted accessory rail. Compatible with standard Bins, Trays and Sorters. Includes end caps and mounting hardware. Please specify paint finish. To ensure proper connection and clearance on tables 46" wide and up, choose accessory rail 13" smaller than the actual table width (70" wide table gets 57" wide rail). Tables 40" wide and smaller use 33" wide accessory rail.

Required specifications

Base finish*

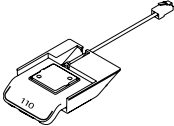
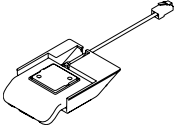
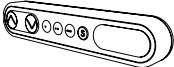
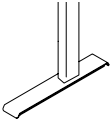
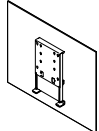
ACCESSORIES	MODEL#	DIMENSIONS	FREIGHT CLASS	WT/LBS.	CUBIC FT.	LIST PRICE
 <p>Anti-Collision Desk Sensor USB Plug</p>		D x W x H				
	FTACDS	8 x 3 x 1.5	60	1.54	.01	\$49
<p>Provides enhanced anti-collision detection. Plugs directly into leg column. Only one USB plug required for table assembly. This is a replacement part. One sensor ships standard with every table.</p>						
 <p>Reminder Controller - LED Display + Bluetooth</p>	FTDPG1C	3 x 4.3 x 1	70	0.4	.01	\$108
	<p>Up/down drive with 4 memory positions. LED light strip reminder, table height display. Bluetooth enabled, connects to Desk Control App. This is a replacement part. Every base comes standard with a controller.</p>					
 <p>Diode Reminder Controller - Memory + Bluetooth</p>	FTDPG1M	3 x 4.3 x 1	70	0.4	.01	\$44
	<p>Up/down drive with 2 memory positions. Bluetooth enabled, connects to Desk Control App. This is a replacement part. Every base comes standard with a controller.</p>					
 <p>Display Handset</p>	FTDHNBT	3 x 4.3 x 1	70	1	.01	\$110
	<p>Up/down drive with 3 memory positions and table height display. Must be specified separately from standard tables and replaced in the field. Use where Bluetooth capabilities are restricted.</p>					
 <p>T-Foot*</p>	FTFOOT24TL	23 x 3 x 1.16	60	4.4	.10	\$121
	FTFOOT30TL	29 x 3 x 1.16	60	4.85	.10	\$131
<p>Replacement single "T" foot or as an optional addition to a 3 leg table.</p>						
 <p>C-Foot*</p>	FTFOOT24CL	23 x 3 x 1.16	60	4.4	.10	\$133
	FTFOOT30CL	29 x 3 x 1.16	60	4.85	.10	\$144
<p>Replacement single "C" foot or as an optional addition to a 3 leg table.</p>						
 <p>Replacement Glides</p>	FTSETGLIDE	- x - x 1.5	70	.06	.10	\$9
	<p>Set of two with 1/2" adjustment.</p>					
 <p>TV Mount</p>	FTMT5145	4 x 51 x 40.5	250	16.82	4.8	\$915
	<p>TV mount for FreeFit media tables. Includes the TV/Display bracket and mounting hardware. Maximum TV size is 50".</p>					

Required specifications

Base finish*

PANTRY STORAGE - 42"H

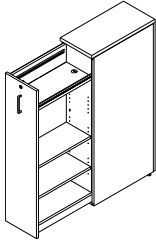

Left (NL) shown

Pantry Storage

MODEL#	DIMENSIONS D x W x H	FREIGHT CLASS	WT/LBS.	CUBIC FT.	LIST PRICE	HP ADD
FFPO1224H42NL	24 x 12 x 42	70	128	7	\$2318	\$29
FFPO1230H42NL	30 x 12 x 42	70	143	9	\$2435	\$35
FFPO1236H42NL	36 x 12 x 42	85	157	11	\$2551	\$40
FFPO1224H42NR	24 x 12 x 42	70	128	7	\$2318	\$29
FFPO1230H42NR	30 x 12 x 42	70	143	9	\$2435	\$35
FFPO1236H42NR	36 x 12 x 42	85	157	11	\$2551	\$40
FFPO1824H42NL	24 x 18 x 42	85	156	11	\$2668	\$40
FFPO1830H42NL	30 x 18 x 42	85	172	13	\$2796	\$51
FFPO1836H42NL	36 x 18 x 42	92.5	187	16	\$2923	\$62
FFPO1824H42NR	24 x 18 x 42	85	156	11	\$2668	\$40
FFPO1830H42NR	30 x 18 x 42	85	172	13	\$2796	\$51
FFPO1836H42NR	36 x 18 x 42	92.5	187	16	\$2923	\$62

The pull out cabinet serves as a multifunctional, customizable storage unit that both defines space and enhances privacy in an open plan environment. Internal organization consists of two fixed shelves on the top and bottom. The two middle shelves are adjustable. Two accessory rails (each 18.25" long) are standard and will accept metal accessories (sold separately - see previous page). Interior cabinet shelves and back are standard in Designer White. Cabinet shell, drawer and top can be specified in any standard laminate. FFPOxxxx will not allow binders.

- For Dry-erase marker board, specify **DE** and **add \$392**. If specified, the dry-erase marker laminate will be applied to the external surface of the pull-out drawer side wall.

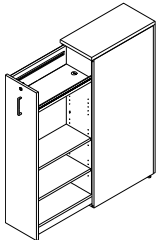

Left (NL) shown

Pantry Storage - w/USB

FFPO1224H42NLUSB	24 x 12 x 42	70	128	7	\$2892	\$29
FFPO1230H42NLUSB	30 x 12 x 42	70	143	9	\$3009	\$35
FFPO1236H42NLUSB	36 x 12 x 42	85	157	11	\$3126	\$40
FFPO1224H42NRUSB	24 x 12 x 42	70	128	7	\$2892	\$29
FFPO1230H42NRUSB	30 x 12 x 42	70	143	9	\$3009	\$35
FFPO1236H42NRUSB	36 x 12 x 42	85	157	11	\$3126	\$40
FFPO1824H42NLUSB	24 x 18 x 42	85	156	11	\$3242	\$40
FFPO1830H42NLUSB	30 x 18 x 42	85	172	13	\$3370	\$51
FFPO1836H42NLUSB	36 x 18 x 42	92.5	187	16	\$3497	\$62
FFPO1824H42NRUSB	24 x 18 x 42	85	156	11	\$3242	\$40
FFPO1830H42NRUSB	30 x 18 x 42	85	172	13	\$3370	\$51
FFPO1836H42NRUSB	36 x 18 x 42	92.5	187	16	\$3497	\$62

The pull out cabinet serves as a multifunctional, customizable storage unit that both defines space and enhances privacy in an open plan environment. Internal organization consists of two fixed shelves on the top and bottom. Top shelf comes with grey felt surface and grommet which allows for cable passage from the USB outlet (located below the top shelf). USB outlet includes one USB-A and one USB-C port. A 2-prong power cord exits the cabinet through the floor at the back. The two middle shelves are adjustable. Two accessory rails (each 18.25" long) are standard and will accept metal accessories (sold separately - see previous page). Interior cabinet shelves and back are standard in Designer White. Cabinet shell, drawer and top can be specified in any standard laminate. FFPOxxxx will not allow binders.

- For Dry-erase marker board, specify **DE** and **add \$392**. If specified, the dry-erase marker laminate will be applied to the external surface of the pull-out drawer side wall.

Required specifications

Laminate finish

Optional specifications

HP laminate
Dry-erase board

PANTRY STORAGE - 49.5"H

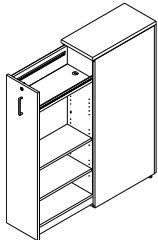

Left (NL) shown

Pantry Storage

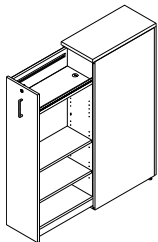

Left (NL) shown

Pantry Storage - w/USB

MODEL#	DIMENSIONS	FREIGHT CLASS	WT/LBS.	CUBIC FT.	LIST PRICE	HP ADD
D x W x H						
FFPO1224NL	24 x 12 x 49.5	70	133	8	\$2472	\$77
FFPO1230NL	30 x 12 x 49.5	85	148	10	\$2591	\$96
FFPO1236NL	36 x 12 x 49.5	92.5	162	15	\$2708	\$109
FFPO1224NR	24 x 12 x 49.5	70	133	8	\$2472	\$77
FFPO1230NR	30 x 12 x 49.5	85	148	10	\$2591	\$96
FFPO1236NR	36 x 12 x 49.5	92.5	162	15	\$2708	\$109
FFPO1824NL	24 x 18 x 49.5	85	161	12	\$2871	\$104
FFPO1830NL	30 x 18 x 49.5	92.5	177	15	\$2997	\$128
FFPO1836NL	36 x 18 x 49.5	92.5	192	18	\$3129	\$147
FFPO1824NR	24 x 18 x 49.5	85	161	12	\$2871	\$104
FFPO1830NR	30 x 18 x 49.5	92.5	177	15	\$2997	\$128
FFPO1836NR	36 x 18 x 49.5	92.5	192	18	\$3129	\$147

The pull out cabinet serves as a multifunctional, customizable storage unit that both defines space and enhances privacy in an open plan environment. Internal organization consists of two fixed shelves on the top and bottom. The two middle shelves are adjustable. Two accessory rails (each 18.25" long) are standard and will accept metal accessories (sold separately - see previous page). Interior cabinet shelves and back are standard in Designer White. Cabinet shell, drawer and top can be specified in any standard laminate. FFPOxxxx will not allow binders.

- For Dry-erase marker board, specify **DE** and **add \$392**. If specified, the dry-erase marker laminate will be applied to the external surface of the pull-out drawer side wall.

FFPO1224NLUSB	24 x 12 x 49.5	70	133	8	\$3046	\$77
FFPO1230NLUSB	30 x 12 x 49.5	85	148	10	\$3165	\$96
FFPO1236NLUSB	36 x 12 x 49.5	92.5	162	15	\$3284	\$109
FFPO1224NRUSB	24 x 12 x 49.5	70	133	8	\$3046	\$77
FFPO1230NRUSB	30 x 12 x 49.5	85	148	10	\$3165	\$96
FFPO1236NRUSB	36 x 12 x 49.5	92.5	162	15	\$3284	\$109
FFPO1824NLUSB	24 x 18 x 49.5	85	161	12	\$3442	\$104
FFPO1830NLUSB	30 x 18 x 49.5	92.5	177	15	\$3573	\$128
FFPO1836NLUSB	36 x 18 x 49.5	92.5	192	18	\$3705	\$147
FFPO1824NRUSB	24 x 18 x 49.5	85	161	12	\$3442	\$104
FFPO1830NRUSB	30 x 18 x 49.5	92.5	177	15	\$3573	\$128
FFPO1836NRUSB	36 x 18 x 49.5	92.5	192	18	\$3705	\$147

The pull out cabinet serves as a multifunctional, customizable storage unit that both defines space and enhances privacy in an open plan environment. Internal organization consists of two fixed shelves on the top and bottom. Top shelf comes with grey felt surface and grommet which allows for cable passage from the USB outlet (located below the top shelf). USB outlet includes one USB-A and one USB-C port. A 2-prong power cord exits the cabinet through the floor at the back. The two middle shelves are adjustable. Two accessory rails (each 18.25" long) are standard and will accept metal accessories (sold separately - see previous page). Interior cabinet shelves and back are standard in Designer White. Cabinet shell, drawer and top can be specified in any standard laminate. FFPOxxxx will not allow binders.

- For Dry-erase marker board, specify **DE** and **add \$392**. If specified, the dry-erase marker laminate will be applied to the external surface of the pull-out drawer side wall.

Required specifications

Laminate finish

Optional specifications

HP laminate
Dry-erase board

PANTRY STORAGE - 54"H

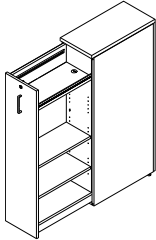

Left (NL) shown

Pantry Storage

MODEL#	DIMENSIONS D x W x H	FREIGHT CLASS	WT/LBS.	CUBIC FT.	LIST PRICE	HP ADD
FFPO1224H54NL	24 x 12 x 54	70	138	9	\$2551	\$29
FFPO1230H54NL	30 x 12 x 54	85	153	11	\$2673	\$29
FFPO1236H54NL	36 x 12 x 54	92.5	167	14	\$2796	\$40
FFPO1224H54NR	24 x 12 x 54	70	138	9	\$2551	\$29
FFPO1230H54NR	30 x 12 x 54	85	153	11	\$2673	\$29
FFPO1236H54NR	36 x 12 x 54	92.5	167	14	\$2796	\$40
FFPO1824H54NL	24 x 18 x 54	92.5	166	14	\$2956	\$40
FFPO1830H54NL	30 x 18 x 54	92.5	182	17	\$3090	\$51
FFPO1836H54NL	36 x 18 x 54	100	197	20	\$3223	\$57
FFPO1824H54NR	24 x 18 x 54	92.5	166	14	\$2956	\$40
FFPO1830H54NR	30 x 18 x 54	92.5	182	17	\$3090	\$51
FFPO1836H54NR	36 x 18 x 54	100	197	20	\$3223	\$57

The pull out cabinet serves as a multifunctional, customizable storage unit that both defines space and enhances privacy in an open plan environment. Internal organization consists of two fixed shelves on the top and bottom. The two middle shelves are adjustable. Two accessory rails (each 18.25" long) are standard and will accept metal accessories (sold separately - see previous page). Interior cabinet shelves and back are standard in Designer White. Cabinet shell, drawer and top can be specified in any standard laminate. FFPOxxxx will not allow binders.

- For Dry-erase marker board, specify **DE** and **add \$392**. If specified, the dry-erase marker laminate will be applied to the external surface of the pull-out drawer side wall.

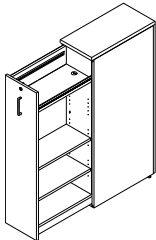

Left (NL) shown

Pantry Storage - w/USB

FFPO1224H54NLUSB	24 x 12 x 54	70	138	9	\$3126	\$29
FFPO1230H54NLUSB	30 x 12 x 54	85	153	11	\$3248	\$29
FFPO1236H54NLUSB	36 x 12 x 54	92.5	167	14	\$3370	\$40
FFPO1224H54NRUSB	24 x 12 x 54	70	138	9	\$3126	\$29
FFPO1230H54NRUSB	30 x 12 x 54	85	153	11	\$3248	\$29
FFPO1236H54NRUSB	36 x 12 x 54	92.5	167	14	\$3370	\$40
FFPO1824H54NLUSB	24 x 18 x 54	92.5	166	14	\$3530	\$40
FFPO1830H54NLUSB	30 x 18 x 54	92.5	182	17	\$3665	\$51
FFPO1836H54NLUSB	36 x 18 x 54	100	197	20	\$3798	\$57
FFPO1824H54NRUSB	24 x 18 x 54	92.5	166	14	\$3530	\$40
FFPO1830H54NRUSB	30 x 18 x 54	92.5	182	17	\$3665	\$51
FFPO1836H54NRUSB	36 x 18 x 54	100	197	20	\$3798	\$57

The pull out cabinet serves as a multifunctional, customizable storage unit that both defines space and enhances privacy in an open plan environment. Internal organization consists of two fixed shelves on the top and bottom. Top shelf comes with grey felt surface and grommet which allows for cable passage from the USB outlet (located below the top shelf). USB outlet includes one USB-A and one USB-C port. A 2-prong power cord exits the cabinet through the floor at the back. The two middle shelves are adjustable. Two accessory rails (each 18.25" long) are standard and will accept metal accessories (sold separately - see previous page). Interior cabinet shelves and back are standard in Designer White. Cabinet shell, drawer and top can be specified in any standard laminate. FFPOxxxx will not allow binders.

- For Dry-erase marker board, specify **DE** and **add \$392**. If specified, the dry-erase marker laminate will be applied to the external surface of the pull-out drawer side wall.

Required specifications

Laminate finish

Optional specifications

HP laminate
Dry-erase board

CUBE PEDESTALS

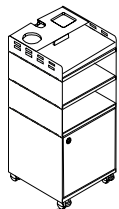

Left (BBFMKL) shown

Mobile Pedestal - BBF

MODEL# DIMENSIONS FREIGHT CLASS WT./LBS. CUBIC FT. LIST PRICE

D x W x H

Without lock:

FTSSP12BBFMKL	12 x 12 x 28	70	35	2.33	\$873
FTSSP12BBFMKR	12 x 12 x 28	70	35	2.33	\$873

With Lock:

FTSSP12BBFMKL	12 x 12 x 28	70	35	2.33	\$951
FTSSP12BBFMKR	12 x 12 x 28	70	35	2.33	\$951

Mobile pedestal with two open boxes in the middle, one file box at the bottom and a top accessory tray. File box interior dimensions: 11-7/8"H x 11-13/16"W x 10-7/16"D. Includes four locking casters, metal wire divider and optional lock (must specify "K" before the left or right option). Metal wire divider is chrome and sits 3-7/16" from either side and is interchangeable. File door lock, if specified, is located on the top right corner for the right pedestal and top left corner for the left pedestal. Bottom, middle and top shelves, front door and back are made of 3/4" LP laminate. Sides are made of powder coated metal. Accessory tray is PET felt. Shipped RTA (ready to assemble).

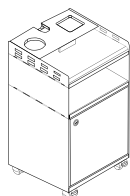

Left (BFMKL) shown

Mobile Pedestal - BF

Without lock:

FTSSP12BFMKL	12 x 12 x 22	70	28	1.83	\$685
FTSSP12BFMR	12 x 12 x 22	70	28	1.83	\$685

With Lock:

FTSSP12BFMKL	12 x 12 x 22	70	28	1.83	\$762
FTSSP12BFMKR	12 x 12 x 22	70	28	1.83	\$762

Mobile pedestal with one open box in the middle, one file box at the bottom and a top accessory tray. File box interior dimensions: 11-7/8"H x 11-13/16"W x 10-7/16"D. Includes four locking casters, metal wire divider and optional lock (must specify "K" before the left or right option). Metal wire divider is chrome and sits 3-7/16" from either side and is interchangeable. File door lock, if specified, is located on the top right corner for the right pedestal and top left corner for the left pedestal. Bottom, middle and top shelves, front door and back are made of 3/4" LP laminate. Sides are made of powder coated metal. Accessory tray is PET felt. Shipped RTA (ready to assemble).

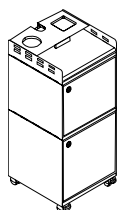

Left (SFMKL) shown

Mobile Pedestal - FF

Without lock:

FTSSP12SFMKL	12 x 12 x 28	70	35	2.33	\$796
FTSSP12SFMR	12 x 12 x 28	70	35	2.33	\$796

With Lock:

FTSSP12SFMKL	12 x 12 x 28	70	35	2.33	\$996
FTSSP12SFMKR	12 x 12 x 28	70	35	2.33	\$996

Mobile pedestal with one closed storage box at the top, one file box at the bottom and a top accessory tray. File box interior dimensions: 11-7/8"H x 11-13/16"W x 10-7/16"D. Closed storage box interior dimensions: 10-1/2"H x 11-13/16"W x 10-7/16"D. Includes four locking casters, metal wire divider and optional lock (must specify "K" before the left or right option). Metal wire divider is chrome and sits 3-7/16" from either side and is interchangeable. Door locks, if specified are located on the top right corner for the right pedestal and top left corner for the left pedestal of each box. Bottom, middle and top shelves, front door and back are made of 3/4" LP laminate. Sides are made of powder coated metal. Accessory tray is PET felt. Shipped RTA (ready to assemble).

Required specifications

- Metal finish
- Laminate finish

HANGING PEDESTALS

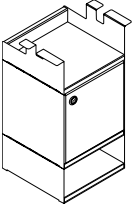

Left (BFBKL) shown

Hanging Pedestal - BFB

MODEL# DIMENSIONS FREIGHT CLASS WT/LBS. CUBIC FT. LIST PRICE

D x W x H

Without lock:

FTSSPH12BFBKL	12 x 12 x 24	92.5	26	2.33	\$679
FTSSPH12BFBKR	12 x 12 x 24	92.5	26	2.33	\$679

With Lock:

FTSSPH12BFBKL	12 x 12 x 24	92.5	26	2.33	\$755
FTSSPH12BFBKR	12 x 12 x 24	92.5	26	2.33	\$755

Hanging pedestal with one file box in the middle and two open boxes, one at the top and one at the bottom. Attaches to the underside of a worksurface with supplied screws. File box interior dimensions: 11-7/8"H x 11-13/16"W x 10-7/16"D. Includes metal wire divider and optional lock (must specify "K" before the left or right option). Metal wire divider is chrome and sits 3-7/16" from either side and is interchangeable. File door lock, if specified, is located on the top right corner for the right pedestal and top left corner for the left pedestal. Bottom, middle and top shelves, front door and back are made of 3/4" LP laminate. Sides are made of powder coated metal. Shipped RTA (ready to assemble).

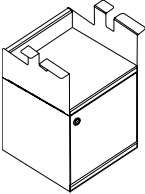

Left (BFBKL) shown

Hanging Pedestal - FB

Without lock:

FTSSPH12BFL	12 x 12 x 18.5	92.5	20	1.83	\$490
FTSSPH12BFR	12 x 12 x 18.5	92.5	20	1.83	\$490

With Lock:

FTSSPH12BFL	12 x 12 x 18.5	92.5	20	1.83	\$568
FTSSPH12BFR	12 x 12 x 18.5	92.5	20	1.83	\$568

Hanging pedestal with one file box at the bottom and one open box at the top. Attaches to the underside of a worksurface with supplied screws. File box interior dimensions: 11-7/8"H x 11-13/16"W x 10-7/16"D. Includes metal wire divider and optional lock (must specify "K" before the left or right option). Metal wire divider is chrome and sits 3-7/16" from either side and is interchangeable. File door lock, if specified, is located on the top right corner for the right pedestal and top left corner for the left pedestal. Bottom, middle and top shelves, front door and back are made of 3/4" LP laminate. Sides are made of powder coated metal. Shipped RTA (ready to assemble).

Required specifications

- Metal finish
- Laminate finish

HANGING PEDESTALS **MODEL#** **DIMENSIONS** **FREIGHT CLASS** **WT./LBS.** **CUBIC FT.** **LIST PRICE**

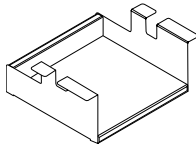

Hanging Pedestal Box*

	D x W x H				
FTSSPH12B	12 x 12 x 6	125	6	0.96	\$190

Hanging pedestal open box. Attaches to the underside of a worksurface with supplied screws to create an open box. Bottom, middle and top shelves, front door and back are made of 3/4" LP laminate. Sides are made of powder coated metal. Shipped RTA (ready to assemble).

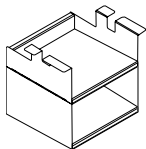

Hanging Pedestal - Two Open Boxes*

FTSSPH12BB	12 x 12 x 6	100	12	1.42	\$379
------------	-------------	-----	----	------	--------------

Hanging pedestal with two open boxes. Attaches to the underside of a worksurface with supplied screws. Bottom, middle and top shelves, front door and back are made of 3/4" LP laminate. Sides are made of powder coated metal. Shipped RTA (ready to assemble).

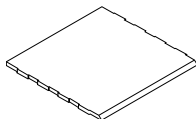

Felt Shelf Liner

FTFELT03BC	12 x 12 x 6	70	0.01	0.03	\$36
------------	-------------	----	------	------	-------------

Felt shelf liner can be added to any closed back shelf. Front edge is cut at 45°.

Required specifications

- Metal finish*
- Laminate finish*

BACK-TO-BACK TABLE - 21"H DIVIDERS

D x W x H

- FreeFit table mounted dividers for single table or single table row; recessed 6.5" at both ends (for example - 72" (70" actual) FreeFit table mounted divider measures 57").
- The center of all dividers is always mounted 2.250" from worksurface's rear edge. Please note the gap between the divider and the worksurface therefore varies, depending on the divider thickness (1.250" framed dividers, 0.750" frameless LP and 0.250" frameless glass).
- 48" (33" actual) - 66" (51" actual) dividers have 2 mounting brackets.
- 72" (57" actual) dividers have 3 mounting brackets.

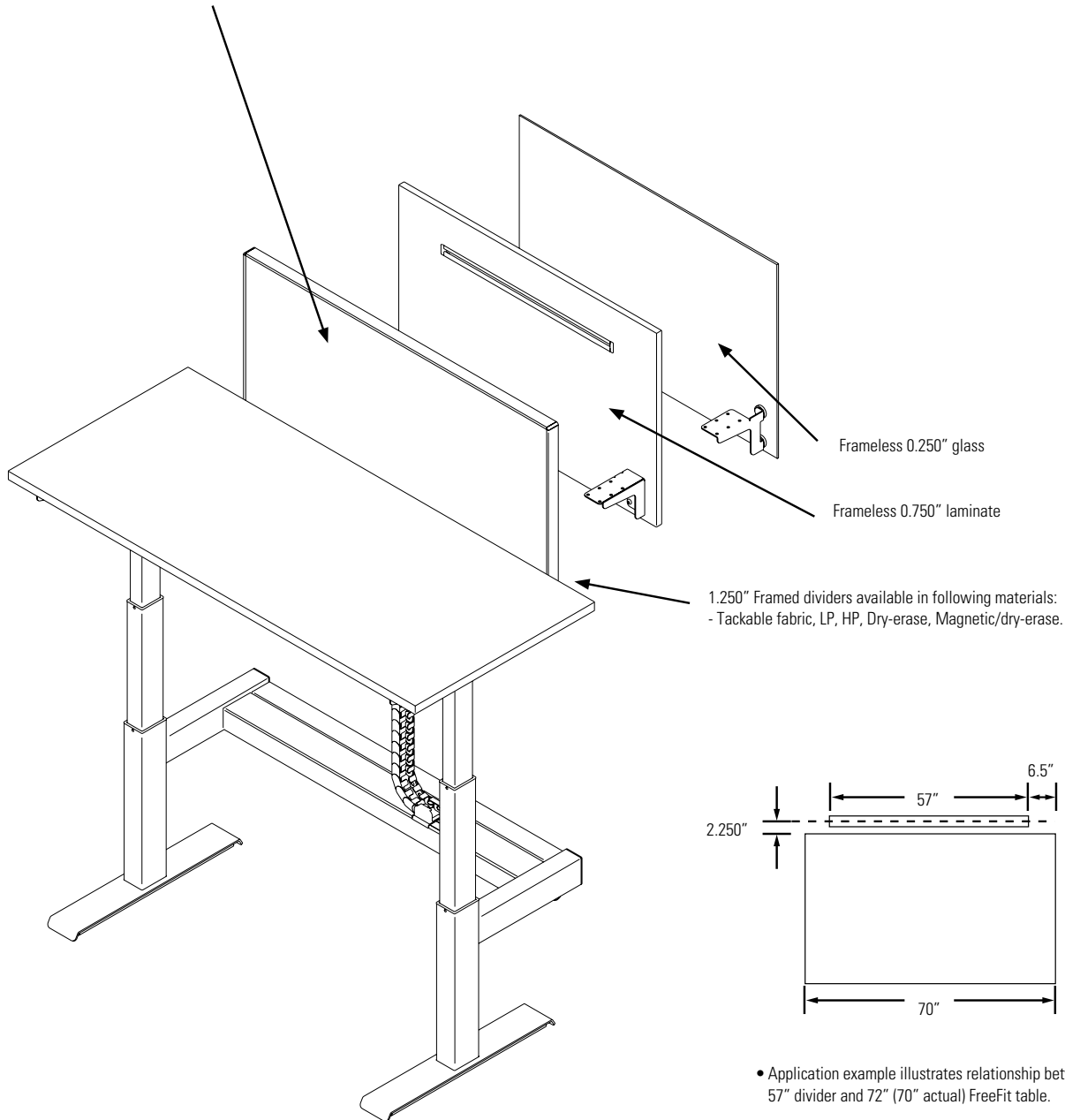

- Application example illustrates relationship between 57" divider and 72" (70" actual) FreeFit table.

- Example Order:
 BWATMFD72
 (actual dimension of 57") for
 BWA2D3072A8
 (actual dimension of 70").

BACK-TO-BACK TABLE - 37"H DIVIDERS

FreeFit Back-to-Back stationary dividers; stationary, shared, secured to table structure; recessed 6.5" at both ends (for example - 72" (70" actual) FreeFit table mounted divider measures 57").

The center of all dividers is always mounted 2.250" from worksurface's rear edge. Please note the gap between the divider and the worksurface therefore varies, depending on the divider thickness (1.250" Framed dividers, 0.750" frameless LP and 0.250" frameless glass).

48" (33" actual) divider for 48" (46" actual) table
 54" (39" actual) divider for 54" (52" actual) table
 60" (45" actual) divider for 60" (58" actual) table
 66" (51" actual) divider for 66" (64" actual) table
 72" (57" actual) divider for 72" (70" actual) table

Framed dividers (Tackable fabric, LP, HP, Dryerase, Magnetic/dry-erase)
 Frameless LP
 Frameless glass

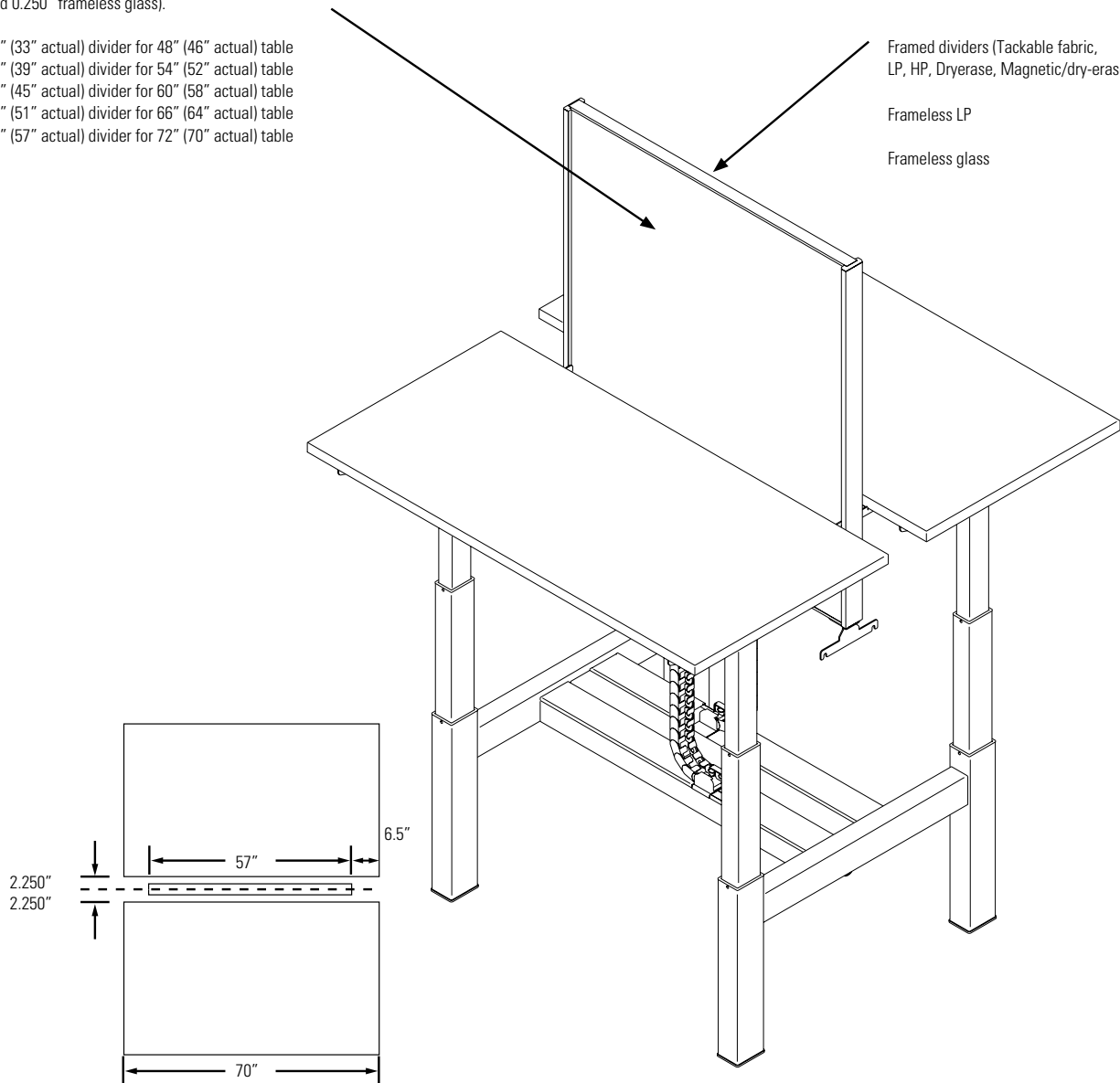

Application example illustrates relationship between 57" shared divider and 72" (70" actual) FreeFit Back-to-Back table.

- Example Order:
 BWASFD72
 (actual dimension of 57") for
 BWA2D6072A8
 (actual dimension of 70").

FELT DIVIDERS

- 9mm thick panels offered in 9 finishes
- Made from 100% PET (polyester) fiber with a high content (50%) of post-recycled material, free of added chemicals, binders and adhesives
- Lightweight panels are tackable, impact and tear resistant, bacteria resistant, moisture resistant, and installation friendly
- Variation in fiber mix and color are inherent to the character of the product

D x W x H

FELT COLORS

BLK	Black	MTS	Mist
BRI	Brick	PWT	Pewter
DEN	Denim	SHR	Shamrock
GPH	Graphite	WHT	White
HVT	Harvest		

BRACKET FINISH

BLK	Black	NEV	Nevada
CHR	Charcoal	SIL	Silver
DWT	Designer White	TPE	Taupe
FOG	Fog	TUN	Tungsten

FELT DIVIDERS

MODEL#

DIMENSIONS

FREIGHT CLASS

WT./LBS.

CUBIC FT.

LIST PRICE

BWAFMPSN36	4.17 x 21 x 13.94	70	1.84	0.71	\$187
BWAFMPSN42	4.17 x 27 x 13.94	250	2.32	0.91	\$204
BWAFMPSN48	4.17 x 33 x 13.94	250	2.44	1.11	\$284
BWAFMPSN54	4.17 x 39 x 13.94	250	2.86	1.31	\$319
BWAFMPSN60	4.17 x 45 x 13.94	250	3.27	1.51	\$360
BWAFMPSN66	4.17 x 51 x 13.94	250	3.68	1.72	\$508
BWAFMPSN72	4.17 x 57 x 13.94	250	4.09	1.92	\$541

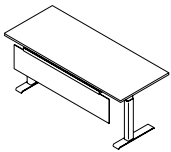

Modesty Felt Divider

9mm thick PET felt divider is tackable. Fastens to the underside of the worksurface. Installed divider measures 15" below top of the worksurface. Kit includes felt modesty, support extrusion and left and right brackets. Available in 9 PET felt colors. Please specify.

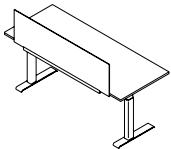

Parallel Felt Divider

BWAFPN36	5.86 x 21 x 18.24	300	2.21	1.3	\$199
BWAFPN42	5.86 x 27 x 18.24	300	2.77	1.67	\$224
BWAFPN48	5.86 x 33 x 18.24	300	2.82	2.04	\$304
BWAFPN54	5.86 x 39 x 18.24	300	3.29	2.41	\$340
BWAFPN60	5.86 x 45 x 18.24	300	3.75	2.78	\$387
BWAFPN66	5.86 x 51 x 18.24	300	4.22	3.15	\$543
BWAFPN72	5.86 x 57 x 18.24	300	4.69	3.53	\$579

Connects parallel on Freefit tables. 9mm thick PET felt divider is tackable. Installed divider measures 15.7" high from the top of the worksurface. Kit includes felt divider, support extrusion and left and right brackets. Available in 9 PET felt colors. Please specify.

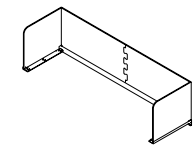

Single

BWAFWR2346	18.46 x 46.84 x 18.24	65	26.58	1.07	\$586
BWAFWR2352	18.46 x 52.84 x 18.24	65	28.4	1.21	\$620
BWAFWR2358	18.46 x 58.84 x 18.24	65	30.22	1.34	\$653
BWAFWR2364	18.46 x 64.84 x 18.24	60	32.02	0.74	\$863
BWAFWR2370	18.46 x 70.84 x 18.24	60	33.84	0.81	\$920
BWAFWR2946	24.46 x 46.84 x 18.24	65	30.74	1.07	\$663
BWAFWR2952	24.46 x 52.84 x 18.24	60	32.55	0.6	\$872
BWAFWR2958	24.46 x 58.84 x 18.24	60	34.37	0.67	\$930
BWAFWR2964	24.46 x 64.84 x 18.24	60	36.19	0.74	\$987
BWAFWR2970	24.46 x 70.84 x 18.24	60	38	0.81	\$1045

End of Run:

BWAFWR2351	18.46 x 51.34 x 18.24	65	27.94	1.05	\$591
BWAFWR2951	24.46 x 51.34 x 18.24	60	32.09	0.62	\$871
BWAFWR2363	18.46 x 63.34 x 18.24	70	31.57	1.5	\$860
BWAFWR2963	24.46 x 63.34 x 18.24	60	35.73	0.87	\$984

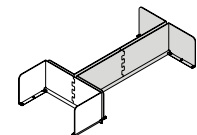

End of Run

Felt Wrap Around Divider*

Wraps around Freefit tables to provide privacy. 9mm thick PET felt divider is tackable. Fastens to the underside of the worksurface. Installed divider measures 15.7" from the top of the worksurface. Divider extends 1.5" past the back of the worksurface. Please choose standard base finish for the extrusion and brackets. PET is available in 9 felt colors. Please specify.

- Anodized Aluminum extrusion - Add **\$156** list upcharge
- **Note:** Cannot use ceiling feed option with this divider.

Required Specifications

Felt color
Bracket finish

Optional Specifications

Anodized extrusion

FELT DIVIDERS

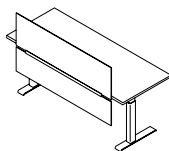

Felt Parallel Divider

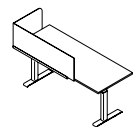

Corner Wrap Felt Divider

MODEL# DIMENSIONS FREIGHT CLASS WT/LBS. CUBIC FT. LIST PRICE

D x W x H

BWAFPDN36	5.86 x 21 x 30.68	300	2.79	2.18	\$294
BWAFPDN42	5.86 x 27 x 30.68	300	3.56	2.81	\$321
BWAFPDN48	5.86 x 33 x 30.68	150	3.82	3.43	\$456
BWAFPDN54	5.86 x 39 x 30.68	150	4.5	4.06	\$505
BWAFPDN60	5.86 x 45 x 30.68	150	5.17	4.68	\$589
BWAFPDN66	5.86 x 51 x 30.68	150	5.85	5.31	\$902
BWAFPDN72	5.86 x 57 x 30.68	150	6.53	5.93	\$957

Felt divider and modesty panel kit secures to the rear bottom of a regular FreeFit table and provides privacy above and below the worksurface. 9mm thick PET felt divider is tackable. Installed divider measures 15.7" from the top of the worksurface and 15" below the top of the worksurface. Kit includes two felt dividers, support extrusion and left and right brackets. Available in 9 PET felt colors. Please specify.

BW AFC2432L	18.52 x 32.46 x 18.24	150	3.82	6.35	\$414
BW AFC2432R	18.52 x 32.46 x 18.24	150	3.82	6.35	\$414
BW AFC2438L	18.52 x 38.46 x 18.24	250	5.46	7.52	\$472
BW AFC2438R	18.52 x 38.46 x 18.24	250	5.46	7.52	\$472
BW AFC2448L	18.52 x 47.46 x 18.24	250	6.16	9.28	\$508
BW AFC2448R	18.52 x 47.46 x 18.24	250	6.16	9.28	\$508

BW AFC3032L	24.52 x 32.46 x 18.24	250	5.72	8.40	\$467
BW AFC3032R	24.52 x 32.46 x 18.24	250	5.72	8.40	\$467
BW AFC3038L	24.52 x 38.46 x 18.24	250	6.19	9.95	\$501
BW AFC3038R	24.52 x 38.46 x 18.24	250	6.19	9.95	\$501
BW AFC3048L	24.52 x 47.46 x 18.24	250	6.89	12.28	\$538
BW AFC3048R	24.52 x 47.46 x 18.24	250	6.89	12.28	\$538

Felt Corner Wrap secures to the side and rear bottom of a FreeFit table, wraps around one side and provides limited privacy. 9mm thick PET felt divider is tackable. Installed divider measures 15.7" from the top of the worksurface. Kit includes felt dividers, support extrusion and large and small brackets. Available in 9 PET felt colors. Please specify.

Required Specifications

- Felt color
- Bracket finish

TABLE MOUNTED DIVIDERS

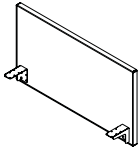

Table Mounted Framed Divider, Fabric*

MODEL#	DIMENSIONS D x W x H	FREIGHT CLASS	WT/LBS.	CUBIC FT.	LIST PRICE
BWATMFD48	1.25 x 33 x 21.5	85	16	1.23	\$431
BWATMFD54	1.25 x 39 x 21.5	85	18	1.46	\$532
BWATMFD60	1.25 x 45 x 21.5	85	20	1.68	\$581
BWATMFD66	1.25 x 51 x 21.5	85	22	1.90	\$652
BWATMFD72	1.25 x 57 x 21.5	85	26	2.13	\$712

Connects parallel on Freefit single and back-to-back tables. Fabric divider is tackable. Fastens to the underside of the worksurface. 1.625" gap between worksurface and divider allows for cable pass-through. Installed divider measures 15.7" from top of worksurface and 5.75" below the worksurface. 48" to 66" dividers include 2 support brackets. 72" divider includes 3 support brackets. Available in the following textiles:

- Global: **Anchorage, Lola, and Merge.**

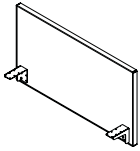

Table Mounted Framed Divider, Laminate**

MODEL#	DIMENSIONS D x W x H	FREIGHT CLASS	WT/LBS.	CUBIC FT.	LIST PRICE	HP ADD	DE ADD	DM ADD
BWATMLD48	1.25 x 33 x 21.5	85	35	1.23	\$283	\$165	\$340	\$519
BWATMLD54	1.25 x 39 x 21.5	85	39	1.46	\$319	\$213	\$424	\$655
BWATMLD60	1.25 x 45 x 21.5	85	44	1.68	\$379	\$225	\$446	\$697
BWATMLD66	1.25 x 51 x 21.5	85	48	1.90	\$436	\$308	\$932	\$1382
BWATMLD72	1.25 x 57 x 21.5	85	52	2.13	\$475	\$311	\$926	\$1373

Connects parallel on Freefit single and back-to-back tables. Divider infill can be specified in low pressure laminate (**LP**), high pressure laminate (**HP**), dry erase whiteboard (**DE**) or dry erase magnetic whiteboard (**DM**) user side only. Fastens to the underside of the worksurface. 1.625" gap between worksurface and divider allows for cable pass-through. Installed divider measures 15.7" from top of worksurface and 5.75" below the worksurface. 48" to 66" dividers include 2 support brackets. 72" divider includes 3 support brackets. When dry erase magnetic whiteboard (DM) is specified it is applied user side ONLY and dry erase whiteboard (DE) is applied on the opposite side.

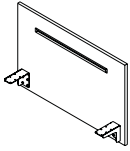

Table Mounted Laminate Divider**

BWATMLLD48	.75 x 33 x 21.5	125	16	1.23	\$339
BWATMLLD54	.75 x 39 x 21.5	125	18	1.46	\$359
BWATMLLD60	.75 x 45 x 21.5	125	20	1.68	\$380
BWATMLLD66	.75 x 51 x 21.5	125	22	1.90	\$561
BWATMLLD72	.75 x 57 x 21.5	125	26	2.13	\$580

Connects parallel on Freefit single and back-to-back tables. Laminate divider with integrated accessory rail, installed on one side only. Integrated anodized aluminum accessory rail, white cut out and rail trims; white power coat brackets. 3/4" LP PVC edged boards. Specify laminate and PVC edge. Fastens to the underside of the worksurface. 1.88" gap between worksurface and divider allows for cable pass-through. Installed divider measures 15.7" from top of worksurface and 5.75" below the worksurface. 48" to 66" dividers include 2 support brackets. 72" divider includes 3 support brackets.

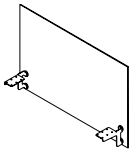

Table Mounted Glass Divider

BWATMGD48	.25 x 33 x 21.5	125	16	1.23	\$724
BWATMGD54	.25 x 39 x 21.5	125	19	1.46	\$779
BWATMGD60	.25 x 45 x 21.5	125	22	1.68	\$834
BWATMGD66	.25 x 51 x 21.5	125	24	1.90	\$884
BWATMGD72	.25 x 57 x 21.5	125	28	2.13	\$942

Frameless glass divider connects parallel on Freefit single and back-to-back tables. Tempered glass, acid etched on one side (similar to frosted), satin chrome disc fasteners and white powder coated steel support brackets. Fastens to the underside of the worksurface. 2.13" gap between worksurface and divider allows for cable pass-through. Installed divider measures 15.7" from top of worksurface and 4.75" below the worksurface. 48" to 66" dividers include 2 support brackets. 72" divider includes 3 support brackets. 1/2" radius on all four corners.

Required specifications

- Fabric*
- Laminate finish**
- Metal frame finish

STATIONARY DIVIDERS

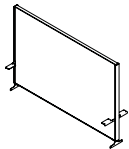

Stationary Framed Divider, Fabric*

MODEL#	DIMENSIONS D x W x H	FREIGHT CLASS	WT/LBS.	CUBIC FT.	LIST PRICE
BWASFD48	1.25 x 33 x 37.2	92.5	25	2.13	\$941
BWASFD54	1.25 x 39 x 37.2	92.5	28	2.52	\$959
BWASFD60	1.25 x 45 x 37.2	92.5	31	2.91	\$990
BWASFD66	1.25 x 51 x 37.2	92.5	34	3.29	\$1052
BWASFD72	1.25 x 57 x 37.2	92.5	37	3.68	\$1344

Provides a stationary framed divider between back-to-back height adjustable tables. Fabric divider is tackable. Divider is anchored to the base and captured between two aluminum upright tracks. The uprights have sliding brackets that connect the worksurfaces to the divider providing continuous support as it travels up and down. 1.625" gap between worksurface and divider allows for cable pass-through. Installed divider measures 54" from floor. Available in the following textiles:

- Global: **Anchorage, Lola, and Merge**

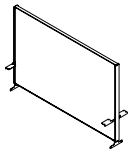

Stationary Framed Divider, Laminate**

MODEL#	DIMENSIONS D x W x H	FREIGHT CLASS	WT/LBS.	CUBIC FT.	LIST PRICE	HP ADD	DE ADD	DM ADD
BWASLD48	2 x 33 x 37.2	65	58	2.13	\$1194	\$405	\$849	\$2224
BWASLD54	2 x 39 x 37.2	65	66	2.52	\$1287	\$434	\$893	\$2338
BWASLD60	2 x 45 x 37.2	65	73	2.91	\$1308	\$435	\$893	\$2339
BWASLD66	2 x 51 x 37.2	65	81	3.29	\$1407	\$486	\$1951	\$4694
BWASLD72	2 x 57 x 37.2	65	88	3.68	\$1923	\$724	\$1875	\$5003

Provides a stationary framed divider between back-to-back height adjustable tables. Divider infill can be specified in low pressure laminate (**LP**), high pressure laminate (**HP**), dry erase whiteboard (**DE**) or dry erase magnetic whiteboard (**DM**) user side only. Divider is anchored to the base and captured between two aluminum upright tracks. The uprights have sliding brackets that connect the worksurfaces to the divider providing continuous support as it travels up and down. 1.625" gap between worksurface and divider allows for cable pass-through. Installed divider measures 54" from floor.

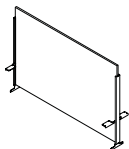

Stationary Laminate Divider**

BWASLLD48	2 x 33 x 37.2	85	28	2.13	\$685
BWASLLD54	2 x 39 x 37.2	85	33	2.52	\$706
BWASLLD60	2 x 45 x 37.2	85	37	2.91	\$725
BWASLLD66	2 x 51 x 37.2	85	41	3.29	\$1098
BWASLLD72	2 x 57 x 37.2	85	46	3.68	\$1120

Provides a stationary laminate divider between back-to-back height adjustable tables. Divider is anchored to the base and captured between two aluminum upright tracks. The uprights have sliding brackets that connect the worksurfaces to the divider providing continuous support as it travels up and down. 1.88" gap between worksurface and divider allows for cable pass-through. Installed divider measures 54" from floor.

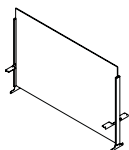

Stationary Glass Divider

BWASGD48	2 x 33 x 37.2	85	30	2.13	\$642
BWASGD54	2 x 39 x 37.2	85	34	2.52	\$730
BWASGD60	2 x 45 x 37.2	85	39	2.91	\$828
BWASGD66	2 x 51 x 37.2	85	43	3.29	\$918
BWASGD72	2 x 57 x 37.2	85	48	3.68	\$1006

Provides a stationary glass divider between back-to-back height adjustable tables. Tempered glass, acid etched on one side (similar to frosted), satin chrome disc fasteners and white powder coated steel support brackets. Divider is anchored to the base and captured between two aluminum upright tracks. The uprights have sliding brackets that connect the worksurfaces to the divider providing continuous support as it travels up and down. 2.13" gap between worksurface and divider allows for cable pass-through. 1/2" radius on top two corners.

Required specifications

- Fabric*
- Laminate finish**
- Metal frame finish

WELLNESS SCREENS- POLYCARBONATE

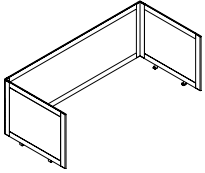

24" H Polycarbonate Divider Screen

MODEL#	DIMENSIONS D x W x H	FREIGHT CLASS	WT./LBS.	CUBIC FT.	LIST PRICE
FFTDP2436H24	31.75 x 34 x 24.6	125	26.55	3.94	\$1126
FFTDP2442H24	31.75 x 40 x 24.6	125	28.10	4.59	\$1162
FFTDP2448H24	31.75 x 46 x 24.6	150	29.65	5.25	\$1194
FFTDP2454H24	31.75 x 52 x 24.6	150	31.20	5.94	\$1229
FFTDP2460H24	31.75 x 58 x 24.6	150	32.75	6.56	\$1263
FFTDP2466H24	31.75 x 64 x 24.6	150	34.30	7.22	\$1295
FFTDP2472H24	31.75 x 70 x 24.6	150	35.85	7.88	\$1331
FFTDP2478H24	31.75 x 76 x 24.6	150	37.40	8.53	\$1366
FFTDP2484H24	31.75 x 82 x 24.6	150	38.95	9.19	\$1399
FFTDP3036H24	37.75 x 34 x 24.6	100	40.50	4.72	\$1205
FFTDP3042H24	37.75 x 40 x 24.6	125	42.05	5.51	\$1241
FFTDP3048H24	37.75 x 46 x 24.6	125	43.60	6.29	\$1275
FFTDP3054H24	37.75 x 52 x 24.6	125	45.15	7.08	\$1312
FFTDP3060H24	37.75 x 58 x 24.6	150	46.70	7.85	\$1344
FFTDP3066H24	37.75 x 64 x 24.6	150	48.25	8.65	\$1377
FFTDP3072H24	37.75 x 70 x 24.6	150	49.80	9.44	\$1412
FFTDP3078H24	37.75 x 76 x 24.6	150	51.35	10.22	\$1446
FFTDP3084H24	37.75 x 82 x 24.6	150	52.90	11.01	\$1481

Powder coated aluminum frame, translucent ribbed polycarbonate. Includes all hardware to connect. Brackets are painted steel. Side dividers extend 7.25" from the front edge of each surface. Back divider extends over the back edge of the worksurface by 1.5", allowing for cable pass-through to trough. Width and depth are nominal sizes representing the sizes of the FreeFit table. Allow for .25" overhang at the sides, 1.5" at the back, and 7.25" at the front. Frame and hardware available in Black (BLK), Charcoal (CHR), Designer White (DWT), Fog (FOG), Nevada (NEV), Silver (SIL), Taupe (TPE), Tungsten (TUN).

- FFTDP24xxH24 are for configurations with 23" deep surfaces.
- FFTDP30xxH24 are for configurations with 29" deep surfaces.

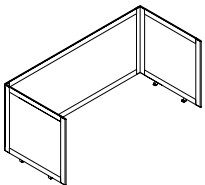

30" H Polycarbonate Divider Screen

FFTDP2436H30	31.75 x 34 x 30.6	125	26.55	3.94	\$1263
FFTDP2442H30	31.75 x 40 x 30.6	125	28.10	4.59	\$1304
FFTDP2448H30	31.75 x 46 x 30.6	150	29.65	5.25	\$1344
FFTDP2454H30	31.75 x 52 x 30.6	150	31.20	5.91	\$1382
FFTDP2460H30	31.75 x 58 x 30.6	150	32.75	6.56	\$1422
FFTDP2466H30	31.75 x 64 x 30.6	150	34.30	7.22	\$1460
FFTDP2472H30	31.75 x 70 x 30.6	150	35.85	7.88	\$1500
FFTDP2478H30	31.75 x 76 x 30.6	150	37.40	8.53	\$1538
FFTDP2484H30	31.75 x 82 x 30.6	150	38.95	9.19	\$1578
FFTDP3036H30	37.75 x 34 x 30.6	100	40.50	4.72	\$1340
FFTDP3042H30	37.75 x 40 x 30.6	125	42.05	5.51	\$1382
FFTDP3048H30	37.75 x 46 x 30.6	125	43.60	6.29	\$1421
FFTDP3054H30	37.75 x 52 x 30.6	125	45.15	7.08	\$1457
FFTDP3060H30	37.75 x 58 x 30.6	150	46.70	7.87	\$1496
FFTDP3066H30	37.75 x 64 x 30.6	150	48.25	8.65	\$1537
FFTDP3072H30	37.75 x 70 x 30.6	150	49.80	9.44	\$1573
FFTDP3078H30	37.75 x 76 x 30.6	150	51.35	10.22	\$1615
FFTDP3084H30	37.75 x 82 x 30.6	150	52.90	11.01	\$1655

Powder coated aluminum frame, translucent ribbed polycarbonate. Includes all hardware to connect. Brackets are painted steel. Side dividers extend 7.25" from the front edge of each surface. Back divider extends over the back edge of the worksurface by 1.5", allowing for cable pass-through to trough. Width and depth are nominal sizes representing the sizes of the FreeFit table. Allow for .25" overhang at the sides, 1.5" at the back, and 7.25" at the front. Frame and hardware available in Black (BLK), Charcoal (CHR), Designer White (DWT), Fog (FOG), Nevada (NEV), Silver (SIL), Taupe (TPE), Tungsten (TUN).

- FFTDP24xxH30 are for configurations with 23" deep surfaces.
- FFTDP30xxH30 are for configurations with 29" deep surfaces.

Required specifications
Frame finish

WELLNESS SCREENS - GLASS

MODEL# DIMENSIONS FREIGHT CLASS WT/LBS. CUBIC FT. LIST PRICE FRST ADD

D x W x H

FFTDG2436H24	31.50 x 36 x 24.60	125	26.55	3.94	\$1569	\$318
FFTDG2442H24	31.50 x 42 x 24.60	125	28.10	4.59	\$1621	\$325
FFTDG2448H24	31.50 x 48 x 24.60	150	29.65	5.25	\$1674	\$338
FFTDG2454H24	31.50 x 54 x 24.60	150	31.20	5.91	\$1724	\$350
FFTDG2460H24	31.50 x 60 x 24.60	150	32.75	6.56	\$1782	\$358
FFTDG2466H24	31.50 x 66 x 24.60	150	34.30	7.22	\$1829	\$371
FFTDG2472H24	31.50 x 72 x 24.60	150	35.85	7.88	\$1894	\$383
FFTDG2478H24	31.50 x 78 x 24.60	150	37.40	8.53	\$1932	\$391
FFTDG2484H24	31.50 x 84 x 24.60	150	38.95	9.19	\$1983	\$403

FFTDG3036H24	37.75 x 36 x 24.60	100	40.50	4.72	\$1674	\$338
FFTDG3042H24	37.75 x 42 x 24.60	125	42.05	5.51	\$1719	\$345
FFTDG3048H24	37.75 x 48 x 24.60	125	43.60	6.29	\$1770	\$358
FFTDG3054H24	37.75 x 54 x 24.60	150	45.15	7.08	\$1822	\$371
FFTDG3060H24	37.75 x 60 x 24.60	150	46.70	7.87	\$1874	\$378
FFTDG3066H24	37.75 x 66 x 24.60	150	48.25	8.65	\$1932	\$391
FFTDG3072H24	37.75 x 72 x 24.60	150	49.80	9.44	\$1977	\$396
FFTDG3078H24	37.75 x 78 x 24.60	150	51.35	10.22	\$2029	\$409
FFTDG3084H24	37.75 x 84 x 24.60	150	52.90	11.01	\$2082	\$423

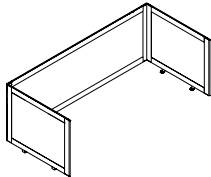

24" H Single Table Glass Divider Screen

Provides privacy in an open plan environment. Easy to clean table mounted partitions. Powder coated aluminum frame with 4mm clear (CLR) glass. Includes all hardware to connect. Brackets are painted steel. Side dividers extend 6.237" from the front edge of each surface. Back divider extends over the back edge of the worksurface by 1.5", allowing for cable pass-through to trough. Width and depth are nominal sizes representing the sizes of the FreeFit table. Allow for .25" overhang at the sides, 1.5" at the back, and 6.237" at the front. Frame and hardware available in Black (BLK), Charcoal (CHR), Designer White (DWT), Fog (FOG), Nevada (NEV), Silver (SIL), Taupe (TPE), Tungsten (TUN). End trim cap is only available in Charcoal (CHR). **Add 20%** upcharge for frosted glass (FRST).

- **FFTDG24xxH24 are for configurations with 24" deep surfaces.**
- **FFTDG30xxH24 are for configurations with 30" deep surfaces.**

FFTDG2436H30	31.50 x 36 x 30.60	125	28.85	3.97	\$1647	\$333
FFTDG2442H30	31.50 x 42 x 30.60	125	30.40	4.59	\$1699	\$345
FFTDG2448H30	31.50 x 48 x 30.60	125	31.95	5.25	\$1749	\$350
FFTDG2454H30	31.50 x 54 x 30.60	150	33.50	5.91	\$1808	\$365
FFTDG2460H30	31.50 x 60 x 30.60	150	35.05	6.56	\$1861	\$378
FFTDG2466H30	31.50 x 66 x 30.60	150	36.60	7.22	\$1907	\$383
FFTDG2472H30	31.50 x 72 x 30.60	150	38.15	7.88	\$1945	\$391
FFTDG2478H30	31.50 x 78 x 30.60	150	39.70	8.53	\$2016	\$409
FFTDG2484H30	31.50 x 84 x 30.60	150	41.25	9.19	\$2074	\$416

FFTDG3036H30	37.75 x 36 x 30.60	100	42.80	4.72	\$1749	\$350
FFTDG3042H30	37.75 x 42 x 30.60	100	44.35	5.51	\$1808	\$365
FFTDG3048H30	37.75 x 48 x 30.60	125	45.90	6.29	\$1854	\$378
FFTDG3054H30	37.75 x 54 x 30.60	125	47.45	7.08	\$1907	\$383
FFTDG3060H30	37.75 x 60 x 30.60	125	49	7.87	\$1965	\$396
FFTDG3066H30	37.75 x 66 x 30.60	150	50.55	8.65	\$2016	\$409
FFTDG3072H30	37.75 x 72 x 30.60	150	52.10	9.44	\$2041	\$409
FFTDG3078H30	37.75 x 78 x 30.60	150	53.65	10.22	\$2120	\$429
FFTDG3084H30	37.75 x 84 x 30.60	150	55.20	11.01	\$2172	\$436

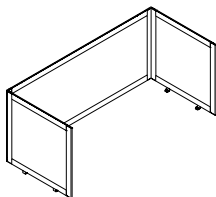

30" H Single Table Glass Divider Screen

Provides privacy in an open plan environment. Easy to clean table mounted partitions. Powder coated aluminum frame with 4mm clear (CLR) glass. Includes all hardware to connect. Brackets are painted steel. Side dividers extend 6.237" from the front edge of each surface. Back divider extends over the back edge of the worksurface by 1.5", allowing for cable pass-through to trough. Width and depth are nominal sizes representing the sizes of the Bridges configuration. Allow for .25" overhang at the sides, 1.5" at the back, and 6.237" at the front. Frame and hardware available in Black (BLK), Charcoal (CHR), Designer White (DWT), Fog (FOG), Nevada (NEV), Silver (SIL), Taupe (TPE), Tungsten (TUN). End trim cap is only available in Charcoal (CHR). **Add 20%** upcharge for frosted glass (FRST).

- **FFTDG24xxH30 are for configurations with 24" deep surfaces.**
- **FFTDG30xxH30 are for configurations with 30" deep surfaces.**

Required specifications
Frame finish

Optional specifications
Frosted glass (FRST)

FELT DIVIDER SCREENS

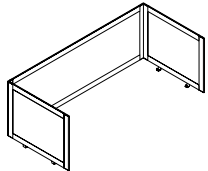

24" H Single Table Felt Divider Screen

MODEL#	DIMENSIONS	FREIGHT CLASS	WT./LBS.	CUBIC FT.	LIST PRICE
D x W x H					
FFTDF2436H24	31.50 x 36 x 24.60	125	22.55	3.94	\$937
FFTDF2442H24	31.50 x 42 x 24.60	125	24.10	4.59	\$961
FFTDF2448H24	31.50 x 48 x 24.60	150	25.65	5.25	\$986
FFTDF2454H24	31.50 x 54 x 24.60	150	27.20	5.91	\$1010
FFTDF2460H24	31.50 x 60 x 24.60	150	28.75	6.56	\$1037
FFTDF2466H24	31.50 x 66 x 24.60	150	30.30	7.22	\$1063
FFTDF2472H24	31.50 x 72 x 24.60	150	31.85	7.88	\$1086
FFTDF2478H24	31.50 x 78 x 24.60	150	33.40	8.53	\$1111
FFTDF2484H24	31.50 x 84 x 24.60	150	34.95	9.19	\$1160
FFTDF3036H24	37.75 x 36 x 24.60	100	36.50	4.72	\$968
FFTDF3042H24	37.75 x 42 x 24.60	125	38.05	5.51	\$1056
FFTDF3048H24	37.75 x 48 x 24.60	125	39.60	6.29	\$1019
FFTDF3054H24	37.75 x 54 x 24.60	150	41.15	7.08	\$1044
FFTDF3060H24	37.75 x 60 x 24.60	150	41.70	7.87	\$1069
FFTDF3066H24	37.75 x 66 x 24.60	150	44.25	8.65	\$1095
FFTDF3072H24	37.75 x 72 x 24.60	150	45.80	9.44	\$1117
FFTDF3078H24	37.75 x 78 x 24.60	150	47.35	10.22	\$1142
FFTDF3084H24	37.75 x 84 x 24.60	150	48.90	11.01	\$1193

Provides privacy in an open plan environment. Powder coated aluminum frame with 9mm felt. Includes all hardware to connect. Brackets are painted steel. Side dividers extend 6.237" from the front edge of each surface. Back divider extends over the back edge of the worksurface by 1.5", allowing for cable pass-through to trough. Width and depth are nominal sizes representing the sizes of the FreeFit table. Allow for .25" overhang at the sides, 1.5" at the back, and 6.237" at the front. Frame and hardware available in Black (BLK), Charcoal (CHR), Designer White (DWT), Fog (FOG), Nevada (NEV), Silver (SIL), Taupe (TPE), Tungsten (TUN). End trim cap is only available in Charcoal (CHR). 9mm PET felt material is tackable and available in 9 colors.

- FFTDF24xxH24 are for configurations with 24" deep surfaces.
- FFTDF30xxH24 are for configurations with 30" deep surfaces.

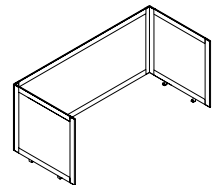

30" H Single Table Felt Divider Screen

FFTDF2436H30	31.50 x 36 x 30.60	125	24.85	3.97	\$930
FFTDF2442H30	31.50 x 42 x 30.60	125	26.40	4.59	\$954
FFTDF2448H30	31.50 x 48 x 30.60	125	27.95	5.25	\$976
FFTDF2454H30	31.50 x 54 x 30.60	150	29.50	5.91	\$999
FFTDF2460H30	31.50 x 60 x 30.60	150	31.05	6.56	\$1022
FFTDF2466H30	31.50 x 66 x 30.60	150	32.60	7.22	\$1045
FFTDF2472H30	31.50 x 72 x 30.60	150	34.14	7.88	\$1069
FFTDF2478H30	31.50 x 78 x 30.60	150	34.70	8.53	\$1092
FFTDF2484H30	31.50 x 84 x 30.60	150	37.25	9.19	\$1147
FFTDF3036H30	37.75 x 36 x 30.60	100	38.80	4.72	\$975
FFTDF3042H30	37.75 x 42 x 30.60	100	40.35	5.51	\$998
FFTDF3048H30	37.75 x 48 x 30.60	125	41.90	6.29	\$1021
FFTDF3054H30	37.75 x 54 x 30.60	125	43.45	7.08	\$1044
FFTDF3060H30	37.75 x 60 x 30.60	125	45	7.87	\$1069
FFTDF3066H30	37.75 x 66 x 30.60	150	46.55	8.65	\$1092
FFTDF3072H30	37.75 x 72 x 30.60	150	48.10	9.44	\$1114
FFTDF3078H30	37.75 x 78 x 30.60	150	49.65	10.22	\$1137
FFTDF3084H30	37.75 x 84 x 30.60	150	51.20	11.01	\$1191

Provides privacy in an open plan environment. Powder coated aluminum frame with 9mm felt. Includes all hardware to connect. Brackets are painted steel. Side dividers extend 6.237" from the front edge of each surface. Back divider extends over the back edge of the worksurface by 1.5", allowing for cable pass-through to trough. Width and depth are nominal sizes representing the sizes of the Bridges configuration. Allow for .25" overhang at the sides, 1.5" at the back, and 6.237" at the front. Frame and hardware available in Black (BLK), Charcoal (CHR), Designer White (DWT), Fog (FOG), Nevada (NEV), Silver (SIL), Taupe (TPE), Tungsten (TUN). End trim cap is only available in Charcoal (CHR). 9mm PET felt material is tackable and available in 9 colors.

- FFTDF24xxH30 are for configurations with 24" deep surfaces.
- FFTDF30xxH30 are for configurations with 30" deep surfaces.

Required Specifications

Frame finish
Felt finish



Designed by Zoey Chu, **JUNCTION™** provides an affordable solution for boardroom, classroom and presentation room applications. Offered in 20", 24" and 30" depths and a variety of table top shapes to create unique configurations.

A freestanding or shared leg configuration with the unique "Y" leg allows you to either create a permanent table or one that can be reconfigured quickly and easily. A straight leg is available for use with half round and keystone tops.

Shared leg configurations allow more legroom and can also decrease cost because they use fewer components. Freestanding configurations provide more flexibility for changing environments.

Features and Benefits

- Tops are 1" thick and constructed of 45 lb. density particleboard.
- Optional Radius Corners (RM) available at no upcharge.
- Optional modesty panel with integrated wire trough available.
- Casters available with or without manual locks provide mobility.
- Black grommets for convenient wire management can be ordered factory installed.
- Optional, easy-to-use thumbscrews allow installation without tools.
- JUNCTION™ tops are available in Global laminate finishes with 2 leg options.



Y Leg Design



Modesty Panel



Shared leg configuration provides more legroom and decreases the overall costs

GENERAL INFORMATION

- Junction is a series of multi-purpose tables for classroom, training room and boardroom applications
- Ability for tables to be set up as freestanding or shared leg configuration
- Unique design by Zooey Chu
- Half round, trapezoid and Keystone tops are available to create a variety of configurations
- Rectangular tops are available in 20", 24" and 30" depths
- Optional modesty panels with integrated wire troughs are available for use with rectangular tops
- Optional large electrical manager provides a safe environment for equipment wires
- Special width tops are available. Use next size up.
- Shipped R.T.A. (Ready to Assemble). Each component is packaged individually; Legs are shipped one per carton.
- For environmental certifications, please visit globalfurnituregroup.com

WORKSURFACES

- Tops are 1" thick, made of 45 lb. density particle board covered on both sides with high performance thermally fused laminate.
- Laminate finishes are available in High Pressure. Contact Customer care for a quote.
- If other than a Global standard laminate finish is preferred, contact Customer Care. Information needed includes the name of the laminate manufacturer, color name, number and model of table. You will then be given a quote for this special order.
- Products specified with the high pressure laminate option are finished on the underside of the surface with a kraft paper backing.

CONSTRUCTION

- Rectangular tops 54" in length and longer include a steel support channel for structural rigidity
- Tops are pre-drilled with threaded steel inserts
- Special width tops are available. Use next size up.
- Adjustable levelers offer up to 1" adjustability.

EDGE DETAIL

- Tops are sealed with Global's preferred edge in matching color.
- Optional Radius corners (**RM**) are available on rectangular tops at no upcharge.

LEGS

- Unique Y design
- Straight leg available for assembly with Half Round tops and Keystone tops
- Heavy duty steel construction
- Coated with environmentally friendly recycled paint that provides a durable finish
- Black plastic leveling glides offer 5/8" adjustability
- Available in Black (**TBL**), Cloud (**TIV**), Designer White (**TDW**), Fog (**TFO**), Frost (**TFR**), Kalua (**TKA**), Latte (**TLA**), Mocha (**TMO**), Nevada (**TNE**), Sand (**TSN**), Shadow (**TSH**), Toast (**TOA**) or Tungsten (**TTU**) finish.
- Y Legs: 17.5" leg span - 20"D top, 21.5" leg span - 24"D top, 24.5" leg span - 30"D top.

CASTERS

- Optional casters are available
- 1½" Dual wheel casters with or without manual lock. Full 360° swivel.
- Can be used in any combination with or without standard glides
- Suggested for carpeted surfaces
- Available in Black only
- Sold in packages of two

GANGING

- Ganging plates are available for ganging workstations together
- Ganging plates are black epoxy coated steel plates with two thumbscrews
- Provides maximum stability and torque reduction

FLUSH PLATE

- Suggested for top clusters (fixed configurations for additional stability)
- Sold individually and shipped with two thumbscrews for mounting
- No tools required
- Flush plate allows for ganging together of two or more tops

WIRE MANAGEMENT

- Available for managing additional larger wires and power connectors
- 3½" high x 4¼" deep Black PVC channel attaches to the underside of top

1. SPECIFY MODEL NUMBER

2. SPECIFY FINISH

Laminate Finishes:

ACJ	Absolute Acajou	NBL	Noce Biondo
ASN	Asian Night	NGL	Noce Grigio
AWC	Avant Cherry	NEL	Noce Leggero
AWH	Avant Honey	NML	Noce Medio
BLK	Black	QTM	Quartered Mahogany
BZD	Blizzard	SBY	Sheer Beauty
BRC	Brushed Cobalt	SDT	Stonedust
CMB	Clear Maple	SOG	Storm Grey
CGY	Custom Grey	WHE	Walnut Heights
DES	Dark Espresso	WHC	White Chocolate
DWT	Designer White	WCR	Winter Cherry
FAS	Fashionista		
FCL	First Class		

Legs:

TBL	Black
TIV	Cloud
TDW	Designer White
TFO	Fog
TFR	Frost
TKA	Kalua
TLA	Latte
TMO	Mocha
TNE	Nevada
TSN	Sand
TSH	Shadow
TOA	Toast
TTU	Tungsten

3. SPECIFY OPTIONS

Modesty Panels

- 11¼" high panel attaches to the underside of rectangular tops
- Standard with integrated wire trough
- Available in black PVC

Grommets

- Grommets are available in **Rectangular and Trapezoid** Tops (left, center or right). See below for available locations. Order as: **AG1, AG2 or AG3. Add \$96.** For **Keystone** worksurface locations, order as **AG2. Add \$96.**
- Grommet hole dimensions are 3¼" wide x 1 7/8" deep.

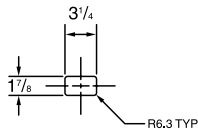

- Grommets may be placed at non-standard locations. Order as: **AGS - Add \$96.** A drawing must be supplied with vertical and horizontal dimensions to the center of the cut-out (as in drawing above). Please refer to CUSTOM GROMMET LOCATION FORM in the back reference section.

Power Block

- A Power Block (model **PMSADM**) may be ordered on all worksurfaces.
- A Power Block is a rectangular worksurface power/data module with one electrical duplex receptacle and two data (RJ45) receptacles. 9' black cord included. Power Block dimensions are 3½" deep x 6½" wide x 2¾" high.
- To purchase a Power Block, you must specify both the Power Block cut-out location and the Power Block model #. Order Power Block as **PMSADM, ADD \$330.** Power Blocks are available in standard worksurface locations (left, center or right). Order as **E1, E2 or E3. Add \$96.**



Power Block **PMSADM, Add \$330**

EXAMPLES OF GROMMET AND POWER BLOCK POSITIONS

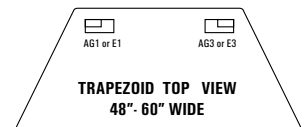
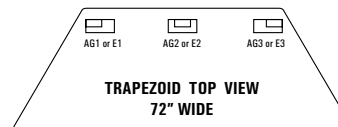
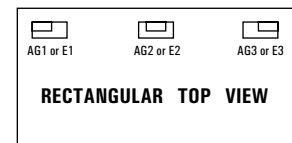
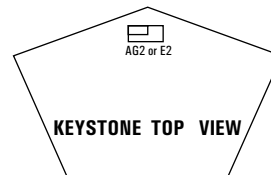

VILLA CUTOUTS

- Optional Villa cutout available in standard worksurface locations (left, center or right) for **Rectangular Tables.** Order as: **V1, V2 or V3. Add \$96 for each cutout.**
- Villa cutouts may be placed at non-standard locations. Please contact customer service.

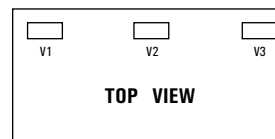

RECTANGULAR TOPS

MODEL#	DIMENSIONS	FREIGHT CLASS	WT/LBS.	CUBIC FT.	LIST PRICE
D x W x H					
JNR2042	20 x 42 x 1	65	26	1.1	\$371
JNR2048	20 x 48 x 1	65	29	1.15	\$414
JNRU2054	20 x 54 x 1	65	33	1.3	\$513
JNRU2060	20 x 60 x 1	65	37	1.4	\$552
JNRU2066	20 x 66 x 1	65	41	1.55	\$596
JNRU2072	20 x 72 x 1	65	45	1.66	\$636
JNR2442	24 x 42 x 1	65	31	1.25	\$371
JNR2448	24 x 48 x 1	65	35	1.4	\$414
JNRU2454	24 x 54 x 1	65	42	1.52	\$513
JNRU2460	24 x 60 x 1	65	47	1.67	\$552
JNRU2466	24 x 66 x 1	65	52	1.82	\$596
JNRU2472	24 x 72 x 1	65	57	2	\$636
JNR3042	30 x 42 x 1	65	38	1.51	\$451
JNR3048	30 x 48 x 1	65	44	1.7	\$475
JNRU3054	30 x 54 x 1	65	52	1.9	\$590
JNRU3060	30 x 60 x 1	65	59	2.1	\$633
JNRU3066	30 x 66 x 1	65	64	2.26	\$677
JNRU3072	30 x 72 x 1	65	70	2.5	\$721

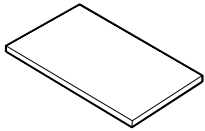

Rectangular Top

Pre-drilled with threaded steel inserts for freestanding and linking installations. **Tops 54" and longer are standard with a 16 gauge steel support channel.**

HALF ROUND TOPS

MODEL #	DIMENSIONS	FREIGHT CLASS	WT/LB.	CUBIC FT.	LIST PRICE
JNHFS2040	20 x 40 x 1	70	23	1.05	\$393
JNHFS2048	20 x 48 x 1	65	27.5	1.15	\$407
JNHFS2448	24 x 48 x 1	65	34	1.4	\$437
JNHFS2454	27 x 54 x 1	65	38.25	1.52	\$516
JNHFS3060	30 x 60 x 1	60	53	1.67	\$566
JNHFS3066	33 x 66 x 1	60	58.3	1.82	\$708

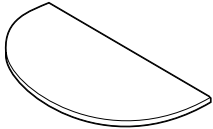

Half Round Top

Pre-drilled with threaded steel inserts for freestanding and linking installations. Four legs are required for freestanding configurations.

- **JNHFS2040/JNHFS2048** for use with 20" deep joining edge
- **JNHFS2448/JNHFS2454** for use with 24" deep joining edge
- **JNHFS3060/JNHFS3066** for use with 30" deep joining edge

TRAPEZOID TOPS

MODEL #	DIMENSIONS	FREIGHT CLASS	WT/LB.	CUBIC FT.	LIST PRICE
JNTT2048	15.25 x 48 x 1	65	27.5	1.15	\$384
JNTT2060	15.25 x 60 x 1	65	34	1.4	\$456
JNTT2448	20.5 x 48 x 1	65	33	1.4	\$434
JNTT2460	20.5 x 60 x 1	65	41.25	1.67	\$522
JNTT3060	25.75 x 60 x 1	65	50.5	2.1	\$570
JNTT3072	25.75 x 72 x 1	65	61	2.5	\$636

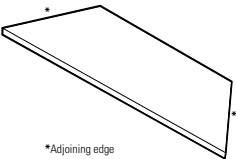

*Adjoining edge

Trapezoid Top

Pre-drilled with threaded steel inserts for linking installations. **Not freestanding.**

- **JNTT2048/JNTT2060** for use with 20" deep joining edge
- **JNTT2448/JNTT2460** for use with 24" deep joining edge
- **JNTT3060/JNTT3072** for use with 30" deep joining edge

Required Specifications
Finish

Optional Specifications
Grommet

Accessories
Power Block

KEYSTONE TOPS

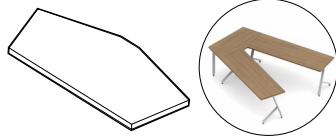

Keystone Top

MODEL#	DIMENSIONS	FREIGHT CLASS	WT/LBS.	CUBIC FT.	LIST PRICE
--------	------------	---------------	---------	-----------	------------

	D x W x H				
JN5S2424	24 x 42 x 1	65	35	1.4	\$443
JN5S3030	30 x 54 x 1	65	53	2.1	\$566

Pre-drilled with threaded steel inserts for linking installations. **Keystone shape is for V configurations/shared applications only; not intended for freestanding applications.**

- **JN5S2424** for use with 20" deep joining edge
- **JN5S3030** for use with 24" deep joining edge

MODESTY PANELS

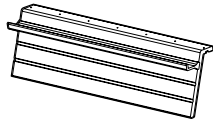

Modesty Panel

MODEL #	DIMENSIONS	FREIGHT CLASS	WT/LB.	CUBIC FT.	LIST PRICE
---------	------------	---------------	--------	-----------	------------

JNMP42	6.92 x 29.19 x 11.25	250	3.7	1.5	\$307
JNMP48	6.92 x 35.19 x 11.25	250	4.5	1.75	\$344
JNMP54	6.92 x 41.19 x 11.25	250	5	2	\$385
JNMP60	6.92 x 47.19 x 11.25	250	5.9	2.25	\$423
JNMP66	6.92 x 53.19 x 11.25	250	6.6	2.5	\$453
JNMP72	6.92 x 59.19 x 11.25	250	7.4	2.75	\$492

For use with **JNR rectangular tops**. 11 ¼" high, Black plastic, attractive ribbed design. Includes integrated wire trough. Connects to predrilled holes in table top.

WIRE MANAGEMENT



Wire Manager

MODEL #	DIMENSIONS	FREIGHT CLASS	WT/LB.	CUBIC FT.	LIST PRICE
---------	------------	---------------	--------	-----------	------------

JNEC5S	4.14 x 12.5 x 3.63	70	1	0.1	\$83
--------	--------------------	----	---	-----	-------------

For use with **JN5S Keystone Tops**. For managing additional wires and power connectors. 3/2"H Black PVC channel connects to predrilled holes in table top.



Wire Manager





JNEC42	4.14 x 41.75 x 3.63	125	2.52	0.33	\$195
JNEC48	4.14 x 47.75 x 3.63	125	2.88	0.38	\$226
JNEC54	4.14 x 53.75 x 3.63	125	3.24	0.43	\$256
JNEC60	4.14 x 59.75 x 3.63	125	3.6	0.48	\$283
JNEC66	4.14 x 65.75 x 3.63	125	3.96	0.53	\$296
JNEC72	4.14 x 71.75 x 3.63	125	4.32	0.58	\$385

For use with **JNR Rectangular Tops**. For managing additional wires and power connectors. 3/2"H Black PVC channel connects to predrilled holes in the table top.

Required Specifications
Finish

Optional Specifications
Grommet

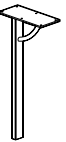
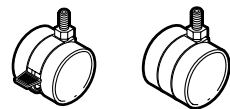
Accessories
Power Block

LEGS	MODEL#	DIMENSIONS D x W x H	FREIGHT CLASS	WT./LBS.	CUBIC FT.	LIST PRICE
 "Y" Leg	GJNLEG20	17.25 x 2 x 27.5	150	8.5	2	\$294
Leg span is 17½". Leveling glides are standard. For assembly with 20" deep tops <ul style="list-style-type: none"> List price is per each leg. See 637 for available finishes. 						
 "Y" Leg	GJNLEG24	21.5 x 2 x 27.5	150	10	2.5	\$294
Leg span is 21½". Leveling glides are standard. For assembly with 24" deep tops <ul style="list-style-type: none"> List Price is per each leg. See 637 for available finishes. 						
 "Y" Leg	GJNLEG30	24.5 x 2 x 27.5	250	11	2.85	\$317
Leg span is 24½". Leveling glides are standard. For assembly with 30" deep tops <ul style="list-style-type: none"> List Price is per each leg. See 637 for available finishes. 						
 Straight Leg	JNLEG	1 x 2 x 27.3	150	6	1.3	\$260
Leveling glides are standard. For assembly with half round and keystone tops. Mounting plate is 11" deep by 5" wide. <ul style="list-style-type: none"> List Price is per each leg. See 637 for available finishes. 						
 Casters	JNCP	--	--	--	--	\$63
Set of (2) 1½" dual wheel casters, one locking. Suggested for carpeted surfaces. Casters are fully interchangeable with glides. Black only. <ul style="list-style-type: none"> For use with Junction units only Casters DO NOT affect table height 						
 Thumbscrews	JNTS	--	--	--	--	\$36
Triangular thumbscrew with ¾" steel thread. Set of 4. Can be used in place of factory supplied screws to allow installation of "Y" legs to tops without tools. Black only.						

Required Specifications
Finish

Optional Specifications
Grommet (Keystone)

Accessories
Power Block (Keystone)

ACCESSORIES

MODEL# DIMENSIONS FREIGHT CLASS WT/LBS. CUBIC FT. LIST PRICE

D x W x H

JNGFP	--	--	--	--	\$66
-------	----	----	----	----	-------------

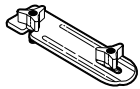

Ganging Flush Plate

Black epoxy coated steel plates with 2 thumbscrews included. Used to connect table tops together for additional stability or for connecting freestanding tops together. Holes with steel inserts are located in the corner of the tops to accommodate this plate. Sold individually.

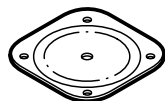

Flush Plate

JNFP1	5.25 d x 5.25 w	--	--	--	\$36
-------	-----------------	----	----	----	-------------

JNFP4	5.25 d x 5.25 w	--	--	--	\$133
-------	-----------------	----	----	----	--------------

Assures alignment on adjoining worksurfaces of the same height. Bolts included. Available in Black only.

JNFP1 - 1 per carton.

JNFP4 - 4 per carton.

Required Specifications

Finish



Kadin adds modern flair to your meeting space. From formal conference rooms to intimate meeting spaces or open forums, Kadin fits wherever people meet. Choose from round, square or rectangular tops in a variety of sizes with multiple edge options. Table depths start at 36", available widths are almost limitless. Surfaces are offered in architectural grade veneer and high-pressure laminate. The beautifully sculpted leg support maximizes leg clearance to keep guests comfortable. Extending from the leg support, the beam structure and connectors create visual interest as people come together. Pre-configured base assemblies make it easy to specify.

Features and Benefits

- Constructed of 45lb. density particleboard with high pressure laminate or grade A veneers
- 3 top shapes
- Solid die-cast aluminum leg with adjustable glide
- 5 edge options
- Metal bases available in 8 finishes
- Beam available in 7 finishes to match leg



90° connector



60° connector (for three leg tables only)



Beam construction

GENERAL INFORMATION

- Laminate or veneer tops with multiple edge options
- Three top shapes - round, square, rectangular
- Pre-configured assemblies make specifying easy
- Kadin pairs perfectly with storage from a number of Global desking series
- For environmental certifications, please visit globalfurnituregroup.com

**TABLES WITH LAMINATE TOPS:
CONSTRUCTION**

- Constructed of 45 lb. density particleboard with high pressure laminate
- Tables are pre-drilled with factory installed inserts for easy metal-to-metal base connection
- Solid die-cast aluminum leg with adjustable glide

WORKSURFACES

- Available in 1-1/16" or 1-7/16" high pressure laminate tops with a 3mm PVC edge trim or 1-3/16" high pressure laminate top with a 3mm PVC edge trim
- Laminate surfaces offer a selection of matching + coordinating edge band, specify separately from the surface finish
- Tables up to and including 96" long are manufactured in one piece, 108" to 180" long are manufactured in two pieces, and over 192" are manufactured in three pieces. If woodgrain laminate is chosen, the woodgrain pattern may not line up.
- Tables in two or three pieces will have the joining edge finished; hardware will be shipped for assembly
- Products specified with the high pressure laminate option are finished on the underside of the surface with a kraft paper backing.

EDGES

- Tables with **B** Edge are 1-1/16" thick and have a 3mm PVC edge
- Tables with a **W** Edge are 1-7/16" thick and have a 3mm PVC edge
- Tables with a **KL** edge are 1-3/16" thick with a 3mm PVC edge and a 2" undercut knife profile
- Square and Rectangular Tables with a **B** or **W** edge have a 1" radius at each corner. For 90° corners, please add **NR** at the end of the product code. No upcharge.
- Square and Rectangular tables with a **KL** edge have 90° corners. There is no radius corner option for the KL edge.

**TABLES WITH VENEER TOPS:
CONSTRUCTION**

- Constructed of 45 lb. density particleboard with grade A veneers
- Tables are pre-drilled with factory installed inserts for easy metal-to-metal base connection
- Solid die-cast aluminum leg with adjustable glide

WORKSURFACES

- 1-3/16" thick veneer tops with choice of edge.
- Tables up to and including 96" long are manufactured in one piece, 108" to 180" long are manufactured in two pieces, and over 192" are manufactured in three pieces.
- Veneer wood grain will run with the **length** of the table and align at the seam up to 180"
- Veneer wood grain will run with the **depth** of the table (i.e. cross grain) on tables 192" and up.
- Tables in two or three pieces will have the joining edge finished; hardware will be shipped for assembly

EDGES

- Tables with a **FV** edge are 1-3/16" thick with a flat 3mm hardwood edge, stained to match to veneer.
- Tables with a **KV** edge are 1-3/16" thick with a flat 3mm hardwood edge and 2" undercut knife edge profile.
- Square and Rectangular Tables with the **FV** and **KV** edge have 90° corners. There is no radius corner option.

GROMMETS

- Grommets available in standard table top locations (left, center or right).
Order as: **AG1, AG2 or AG3. Add \$96**
- Grommet hole dimensions are 3 1/4" wide x 1 7/8" deep.

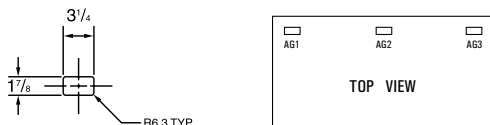

- Actual grommet locations will vary according to base selection.

WIRE MANAGEMENT

- For vertical and horizontal wire management, please refer to wire management section below, or Productivity Solutions on page 474.

CUT-OUTS FOR POWER BLOCKS

- Optional cut-out available in standard worksurface locations (left, center or right) for all table shapes. **Add \$96 for each cut-out.**
- Cut-outs may be placed at non-standard locations. Please contact customer care.
- Match power block desired with cut-out code and location from above grid
- Power module cut-out locations are not available on all models – please see diagrams to the right for restrictions.

*Oasis Mini is not available on 36"D models due to space restrictions caused by beam placement. **Only available on 60" square and 60" round 4-leg tables.**

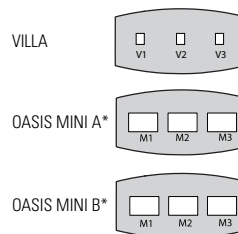
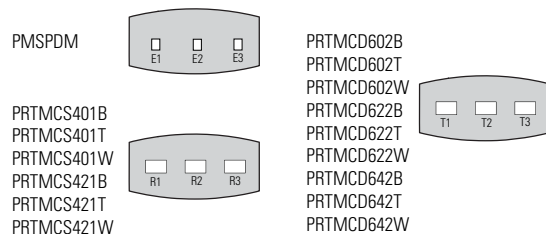

1. SPECIFY MODEL NUMBER

2. SPECIFY FINISH

LAMINATE FINISHES

ACJ	Absolute Acajou	FCL	First Class
ASN	Asian Night	NBL	Noce Biondo
AWC	Avant Cherry	NGL	Noce Grigio
AWH	Avant Honey	NEL	Noce Leggero
BLK	Black	NML	Noce Medio
BRC	Brushed Cobalt	QTM	Quartered Mahogany
BZD	Blizzard	SBY	Sheer Beauty
CMB	Clear Maple	SDT	Stonedust
CGY	Custom Grey	SOG	Storm Grey
DES	Dark Espresso	WHE	Walnut Heights
DWT	Designer White	WHC	White Chocolate
FAS	Fashionista	WCR	Winter Cherry

LEG FINISHES

CHM	Chrome	BLK	Black
CHR	Charcoal	DWT	Designer White
NEV	Nevada	SIL	Silver
TPE	Taupe	TUN	Tungsten

BEAM FINISHES

BLK	Black	CHR	Charcoal
DWT	Designer White	NEV	Nevada
SIL	Silver	TPE	Taupe
TUN	Tungsten		

VENEER FINISHES:

Code	Finish	Veneer Type	Cut
AMW	Almond Cherry	Cherry	Flat Sliced
ACW	Amber Cherry	Cherry	Flat Sliced
BTW	Biscotti	White Oak	Rift
CAW	Cocoa Walnut	Walnut	Flat Sliced
CRW	Coral	White Oak	Rift
DCW	Dark Cherry	Cherry	Flat Sliced
DWW	Dark Walnut	Walnut	Flat Sliced
EWV	Espresso Walnut	Walnut	Flat Sliced
EVW	Evening Oak	White Oak	Rift
GRW	Grey on Oak	White Oak	Rift
HAW	Hazelnut	Maple	Flat Sliced
JAW	Java	White Oak	Rift
LTW	Latte Walnut	Walnut	Flat Sliced
MHW	Mahogany on Walnut	Walnut	Flat Sliced
MTW	Milestone	White Oak	Rift
MPW	Natural Maple	Maple	Flat Sliced
NLW	Natural Walnut	Walnut	Flat Sliced
RCW	Red Cherry	Cherry	Flat Sliced
ULW	Umber Walnut	Walnut	Flat Sliced

EDGE FINISHES (Laminate Surfaces Only)

AAE	Absolute Acajou	NBL	Noce Biondo
ASE	Asian Night	NGL	Noce Grigio
ACE	Avant Cherry	NEL	Noce Leggero
AHE	Avant Honey	NML	Noce Medio
BLK	Black	QTM	Quartered Mahogany
BZD	Blizzard	SBY	Sheer Beauty
BRC	Brushed Cobalt	SIL	Silver
CHR	Charcoal (use w/SOG)	SDT	Stonedust
CME	Clear Maple	SOG	Storm Grey
CGY	Custom Grey	TPE	Taupe
DEE	Dark Espresso	WHE	Walnut Heights
DWE	Designer White	CBE	White Chocolate
FAS	Fashionista	WCE	Winter Cherry
FCL	First Class		

3. SPECIFY OPTIONS

Edge Options:

"B" Edges

Laminate surface with PVC edge

HP (B) 1-1/16" Thickness



"W" Edges

Laminate surface with PVC edge

HP (W) 1-7/16" Thickness



"KL" Edges

Laminate surface with PVC edge

HP (KL) 1-3/16" Thickness

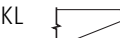

"FV" Edges

Veneer surface with Hardwood edge

(FV) 1-3/16" Thickness

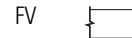

"KV" Edges

Veneer surface with Hardwood edge

(KV) 1-3/16" Thickness

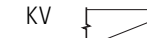

CUT-OUT LOCATIONS:

Square Table - position 2 only

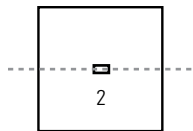

Round Table - position 2 only

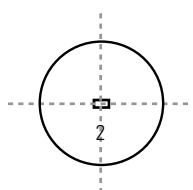

Rectangular Table

- Cut-out only in position 2: LKD3648, LKD3654, LKD4248, LKD4254, LKD4854
- One cut-out choice only (position 1, 2 or 3): LKD3660, LKD3666, LKD3672, LKD4260, LKD4266, LKD4272
- Up to 3 cut-outs in position 1, 2 and/or 3: LKD3678, LKD3684, LKD3696, LKD4278, LKD4284, LKD4296, LKD4878, LKD4884, LKD4896

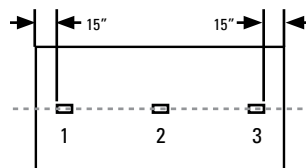

Rectangular Table - 2 piece top

- Up to 2 cut-outs in position 1 and/or 3 - all sizes

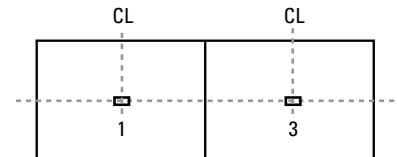

Rectangular Table - 3 piece top

- Up to 3 cut-outs in position 1, 2 and/or 3 - all sizes

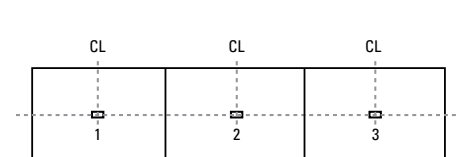

Note: Grommet orientation follows the length of table.

SQUARE TABLES - LAMINATE

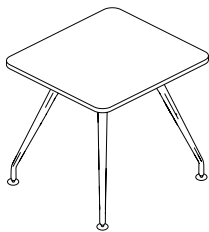

Square Table - Laminate Top*

MODEL#	DIMENSIONS D x W x H	FREIGHT CLASS	WT/LBS.	CUBIC FT.	B-EDGE	W-EDGE	KL-EDGE
LKD3636	36 x 36 x 29-29.5	100	73	4	\$1824	\$2049	\$2124
LKD4242	42 x 42 x 29-29.5	100	86	4	\$2181	\$2395	\$2575
LKD4848	48 x 48 x 29-29.5	92.5	107	5	\$2560	\$2821	\$2996
LKD5454	54 x 54 x 29-29.5	85	120	5	\$2819	\$3136	\$3588
LKD6060	60 x 60 x 29-29.5	92.5	135	6	\$3107	\$3486	\$4106

Tops feature 3mm pvc edge and metal inserts for ease of assembly to base. Also includes four legs, four 90-degree connectors and four leg beams.

SQUARE TABLES - VENEER

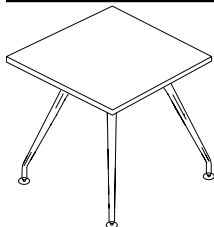

Square Table - Veneer Top

MODEL#	DIMENSIONS D x W x H	FREIGHT CLASS	WT/LBS.	CUBIC FT.	B-EDGE	W-EDGE	KL-EDGE
LKD3636K	36 x 36 x 29-29.5	100	73	4	\$2529	\$2619	
LKD4242K	42 x 42 x 29-29.5	92.5	86	4	\$3012	\$3133	
LKD4848K	48 x 48 x 29-29.5	92.5	107	5	\$3568	\$3726	
LKD5454K	54 x 54 x 29-29.5	85	120	5	\$4321	\$4518	
LKD6060K	60 x 60 x 29-29.5	92.5	135	6	\$5015	\$5257	

Tops feature hardwood edge and metal inserts for ease of assembly to base. Also includes four legs, four 90-degree connectors and four leg beams.

ROUND TABLES - LAMINATE

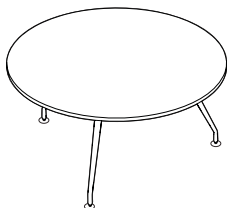

Round Table - 3 Legs*

MODEL#	DIMENSIONS D x W x H	FREIGHT CLASS	WT/LBS.	CUBIC FT.	B-EDGE	W-EDGE	KL-EDGE
LKD36DIA	36 x 36 x 29-29.5	92.5	66	3	\$1470	\$1701	\$1981
LKD42DIA	42 x 42 x 29-29.5	85	78	3	\$1813	\$2029	\$2532
LKD48DIA	48 x 48 x 29-29.5	85	99	4	\$2152	\$2421	\$3074
LKD54DIA	54 x 54 x 29-29.5	85	111	4	\$2412	\$2737	\$3758
LKD60DIA	60 x 60 x 29-29.5	85	126	5	\$2694	\$3083	\$4429

Tops feature 3mm pvc edge and metal inserts for ease of assembly to base. Also includes three legs, three 60-degree connectors and three leg beams.



Round Table - 4 Legs*

LKD436DIA	36 x 36 x 29-29.5	100	66	3	\$1911	\$2136	\$2302
LKD442DIA	42 x 42 x 29-29.5	92.5	78	3	\$2181	\$2395	\$2792
LKD448DIA	48 x 48 x 29-29.5	92.5	99	4	\$2560	\$2821	\$3385
LKD454DIA	54 x 54 x 29-29.5	85	111	4	\$2819	\$3136	\$4003
LKD460DIA	60 x 60 x 29-29.5	92.5	126	5	\$3107	\$3486	\$4700

Tops feature 3mm pvc edge and metal inserts for ease of assembly to base. Also includes four legs, four 90-degree connectors and four leg beams.

Required Specifications

Top Finish
Leg Finish
Edge Finish*
Edge Style

Optional Specifications

Grommet

Accessories

Power Block

ROUND TABLES - VENEER

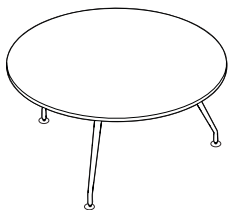

Round Table - 3 Legs



Round Table - 4 Legs

MODEL# DIMENSIONS FREIGHT CLASS WT./LBS. CUBIC FT. FV EDGE KV EDGE

	D x W x H						
LKD36DIAK	36 x 36 x 29-29.5	92.5	66	3	\$2408	\$2522	
LKD42DIAK	42 x 42 x 29-29.5	85	78	3	\$3033	\$3184	
LKD48DIAK	48 x 48 x 29-29.5	85	99	4	\$3735	\$3943	
LKD54DIAK	54 x 54 x 29-29.5	85	111	4	\$4622	\$4877	
LKD60DIAK	60 x 60 x 29-29.5	85	126	5	\$5524	\$5835	

Tops feature hardwood edge and metal inserts for ease of assembly to base. Also includes three legs, three 60-degree connectors and three leg beams.

LKD436DIAK	36 x 36 x 29-29.5	100	66	3	\$2634	\$2748	
LKD442DIAK	42 x 42 x 29-29.5	92.5	78	3	\$3271	\$3422	
LKD448DIAK	48 x 48 x 29-29.5	92.5	99	4	\$4022	\$4230	
LKD454DIAK	54 x 54 x 29-29.5	85	111	4	\$4842	\$5097	
LKD460DIAK	60 x 60 x 29-29.5	92.5	126	5	\$5769	\$6080	

Tops feature hardwood edge and metal inserts for ease of assembly to base. Also includes four legs, four 90-degree connectors and four leg beams.

RECTANGULAR TABLES - LAMINATE

B-EDGE W-EDGE KL-EDGE

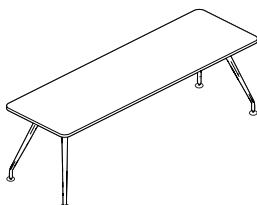

Rectangular Table*

LKD3648	36 x 48 x 29-29.5	100	75	4	\$2258	\$2488	\$2553
LKD3654	36 x 54 x 29-29.5	92.5	81	4	\$2357	\$2614	\$2788
LKD3660	36 x 60 x 29-29.5	100	88	5	\$2458	\$2738	\$2956
LKD3666	36 x 66 x 29-29.5	100	95	5	\$2560	\$2865	\$3123
LKD3672	36 x 72 x 29-29.5	92.5	101	5	\$2658	\$2985	\$3291
LKD3678	36 x 78 x 29-29.5	92.5	105	5	\$2758	\$3110	\$3460
LKD3684	36 x 84 x 29-29.5	92.5	108	5	\$2859	\$3237	\$3627
LKD3696	36 x 96 x 29-29.5	100	115	6	\$3061	\$3487	\$3965
LKD4248	42 x 48 x 29-29.5	92.5	87	4	\$2418	\$2645	\$2774
LKD4254	42 x 54 x 29-29.5	100	90	5	\$2538	\$2789	\$3033
LKD4260	42 x 60 x 29-29.5	100	94	5	\$2657	\$2926	\$3229
LKD4266	42 x 66 x 29-29.5	92.5	101	5	\$2774	\$3069	\$3422
LKD4272	42 x 72 x 29-29.5	92.5	106	5	\$2895	\$3210	\$3620
LKD4278	42 x 78 x 29-29.5	100	110	6	\$3010	\$3350	\$3812
LKD4284	42 x 84 x 29-29.5	100	113	6	\$3130	\$3492	\$4007
LKD4296	42 x 96 x 29-29.5	92.5	129	6	\$3368	\$3774	\$4398
LKD4854	48 x 54 x 29-29.5	100	94	5	\$2753	\$3030	\$3283
LKD4860	48 x 60 x 29-29.5	100	99	5	\$2885	\$3189	\$3504
LKD4866	48 x 66 x 29-29.5	100	107	6	\$3018	\$3343	\$3724
LKD4872	48 x 72 x 29-29.5	100	114	6	\$3151	\$3501	\$3946
LKD4878	48 x 78 x 29-29.5	92.5	120	6	\$3282	\$3662	\$4166
LKD4884	48 x 84 x 29-29.5	92.5	125	6	\$3416	\$3818	\$4387
LKD4896	48 x 96 x 29-29.5	92.5	149	7	\$3678	\$4131	\$4828

Tops feature 3mm pvc edge and metal inserts for ease of assembly to base. Also includes four legs, four 90-degree connectors and four leg beams.

Required Specifications

Top Finish
Leg Finish
Edge Finish*
Edge Style

Optional Specifications

Grommet

Accessories

Power Block

RECTANGULAR TABLES - LAMINATE

MODEL# DIMENSIONS FREIGHT CLASS WT/LBS. CUBIC FT. B-EDGE W-EDGE KL-EDGE

D x W x H

LKD36108	36 x 108 x 29-29.5	92.5	154	7	\$4210	\$4526	\$5009
LKD36120	36 x 120 x 29-29.5	125	164	8	\$4425	\$4777	\$5344
LKD42108	42 x 108 x 29-29.5	150	124	8	\$4491	\$4850	\$5491
LKD42120	42 x 120 x 29-29.5	150	141	9	\$4728	\$5120	\$5880
LKD48108	48 x 108 x 29-29.5	150	127	9	\$4831	\$5220	\$5982
LKD48120	48 x 120 x 29-29.5	150	151	9	\$5101	\$5535	\$6420
LKD48132	48 x 132 x 29-29.5	150	164	10	\$5365	\$5840	\$6864
LKD48144	48 x 144 x 29-29.5	125	181	10	\$5433	\$5915	\$7296
LKD48156	48 x 156 x 29-29.5	150	191	11	\$5893	\$6445	\$7747
LKD48168	48 x 168 x 29-29.5	125	206	11	\$6156	\$6741	\$8188
LKD48180	48 x 180 x 29-29.5	125	220	12	\$6615	\$7270	\$8636
LKD54144	54 x 144 x 29-29.5	150	193	11	\$6069	\$6626	\$8011
LKD54168	54 x 168 x 29-29.5	150	214	12	\$6653	\$7290	\$9000
LKD60144	60 x 144 x 29-29.5	150	206	12	\$6429	\$7033	\$8656
LKD60168	60 x 168 x 29-29.5	150	227	13	\$7064	\$7759	\$9744

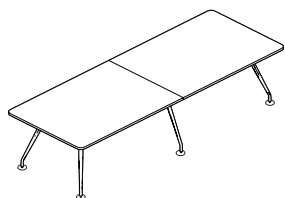

Rectangular Table - 2 piece top

Tops feature 3mm pvc edge and metal inserts for ease of assembly to base. Also includes six legs, four 90-degree connectors, two 3-way connectors and four leg beams.

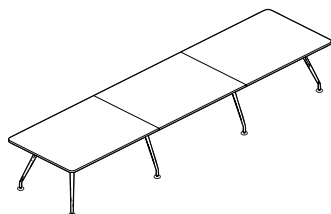

Rectangular Table - 3 piece top

LKD48192	48 x 192 x 29-29.5	150	279	14	\$7442	\$8105	\$9772
LKD54192	54 x 192 x 29-29.5	150	288	15	\$8000	\$8724	\$10697
LKD54216	54 x 216 x 29-29.5	150	270	16	\$8578	\$9387	\$11679
LKD54240	54 x 240 x 29-29.5	150	298	17	\$9161	\$10057	\$12669
LKD60192	60 x 192 x 29-29.5	150	257	16	\$8473	\$9257	\$11551
LKD60216	60 x 216 x 29-29.5	150	283	17	\$9110	\$9987	\$12643
LKD60240	60 x 240 x 29-29.5	150	311	18	\$9744	\$10711	\$13730

Tops feature 3mm pvc edge and metal inserts for ease of assembly to base. Also includes eight legs, four 90-degree connectors, four 3-way connectors and eight leg beams.

Required Specifications

Top Finish
Leg Finish
Edge Finish
Edge Style

Optional Specifications

Grommet

Accessories

Power Block

RECTANGULAR TABLES - VENEER

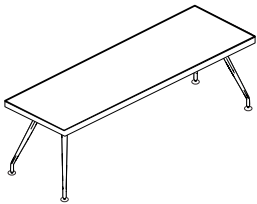

Rectangular Table

MODEL#	DIMENSIONS D x W x H	FREIGHT CLASS	WT/LBS.	CUBIC FT.	FV EDGE	KV EDGE
LKD3648K	36 x 48 x 29-29.5	100	75	4	\$2979	\$3095
LKD3654K	36 x 54 x 29-29.5	92.5	81	4	\$3269	\$3401
LKD3660K	36 x 60 x 29-29.5	100	88	5	\$3492	\$3639
LKD3666K	36 x 66 x 29-29.5	100	95	5	\$3715	\$3877
LKD3672K	36 x 72 x 29-29.5	92.5	101	5	\$3938	\$4111
LKD3678K	36 x 78 x 29-29.5	92.5	105	5	\$4162	\$4353
LKD3684K	36 x 84 x 29-29.5	92.5	108	5	\$4387	\$4592
LKD3696K	36 x 96 x 29-29.5	100	115	6	\$4834	\$5068
LKD4248K	42 x 48 x 29-29.5	92.5	87	4	\$3272	\$3408
LKD4254K	42 x 54 x 29-29.5	100	90	5	\$3596	\$3750
LKD4260K	42 x 60 x 29-29.5	100	94	5	\$3856	\$4026
LKD4266K	42 x 66 x 29-29.5	92.5	101	5	\$4114	\$4301
LKD4272K	42 x 72 x 29-29.5	92.5	106	5	\$4373	\$4578
LKD4278K	42 x 78 x 29-29.5	100	110	6	\$4633	\$4852
LKD4284K	42 x 84 x 29-29.5	100	113	6	\$4890	\$5129
LKD4296K	42 x 96 x 29-29.5	92.5	129	6	\$5409	\$5678
LKD4854K	48 x 54 x 29-29.5	100	94	5	\$3926	\$4104
LKD4860K	48 x 60 x 29-29.5	100	99	5	\$4218	\$4414
LKD4866K	48 x 66 x 29-29.5	100	107	6	\$4513	\$4727
LKD4872K	48 x 72 x 29-29.5	100	114	6	\$4806	\$5040
LKD4878K	48 x 78 x 29-29.5	92.5	120	6	\$5100	\$5355
LKD4884K	48 x 84 x 29-29.5	92.5	125	6	\$5395	\$5665
LKD4896K	48 x 96 x 29-29.5	92.5	149	7	\$5982	\$6293

Tops feature hardwood edge and metal inserts for ease of assembly to base. Also includes four legs, four 90-degree connectors and four leg beams.

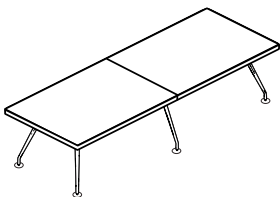

Rectangular Table - 2 piece top

LKD36108K	36 x 108 x 29-29.5	125	154	7	\$5971	\$6233
LKD36120K	36 x 120 x 29-29.5	125	164	8	\$6419	\$6709
LKD42108K	42 x 108 x 29-29.5	150	124	8	\$6625	\$6930
LKD42120K	42 x 120 x 29-29.5	150	141	9	\$7141	\$7480
LKD48108K	48 x 108 x 29-29.5	150	127	9	\$7275	\$7622
LKD48120K	48 x 120 x 29-29.5	150	151	9	\$7863	\$8248
LKD48132K	48 x 132 x 29-29.5	150	164	10	\$8450	\$8876
LKD48144K	48 x 144 x 29-29.5	125	181	10	\$9038	\$9499
LKD48156K	48 x 156 x 29-29.5	150	191	11	\$9627	\$10128
LKD48168K	48 x 168 x 29-29.5	125	206	11	\$10214	\$10752
LKD48180K	48 x 180 x 29-29.5	125	220	12	\$10802	\$11380
LKD54144K	54 x 144 x 29-29.5	150	193	11	\$9965	\$10486
LKD54168K	54 x 168 x 29-29.5	150	214	12	\$11281	\$11890
LKD60144K	60 x 144 x 29-29.5	150	206	12	\$10829	\$11407
LKD60168K	60 x 168 x 29-29.5	150	227	13	\$12284	\$12959

Tops feature hardwood edge and metal inserts for ease of assembly to base. Also includes six legs, four 90-degree connectors, two 3-way connectors and four leg beams.

Required Specifications

Top Finish
Leg Finish
Edge Style

Optional Specifications

Grommet

Accessories

Power Block

RECTANGULAR TABLES - VENEER

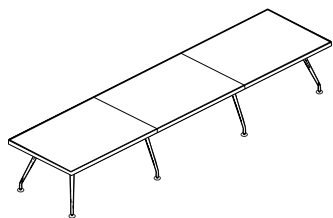

Rectangular Table - 3 piece top

MODEL# DIMENSIONS FREIGHT CLASS WT/LBS. CUBIC FT. FV EDGE KV EDGE

	D x W x H						
LKD48192K	48 x 192 x 29-29.5	150	279	14	\$12092	\$12707	
LKD54192K	54 x 192 x 29-29.5	150	288	15	\$13305	\$13998	
LKD54216K	54 x 216 x 29-29.5	150	270	16	\$14622	\$15401	
LKD54240K	54 x 240 x 29-29.5	150	298	17	\$15937	\$16802	
LKD60192K	60 x 192 x 29-29.5	150	257	16	\$14456	\$15226	
LKD60216K	60 x 216 x 29-29.5	150	283	17	\$15911	\$16776	
LKD60240K	60 x 240 x 29-29.5	150	311	18	\$17367	\$18327	

Tops feature hardwood edge and metal inserts for ease of assembly to base. Also includes eight legs, four 90-degree connectors, four 3-way connectors and eight leg beams.

Required Specifications

Top Finish
Leg Finish
Edge Style

Optional Specifications

Grommet

Accessories

Power Block

WIRE MANAGEMENT



Cable Snake

MODEL #	DIMENSIONS D x W x H	FREIGHT CLASS	WT/LB.	CUBIC FT.	LIST PRICE
PCSN01	-- x -- x --	92.5	2.10	.20	\$135

Flexible cable management. Provides access to power/data from floor to underside of worksurface where it attaches. Two pathways within Cable Snake. Length under desk is 31.25". Silver (**SIL**) plastic only.



Cable Snake

BRTCS	2 x 8 x 30	70	3	.19	\$152
-------	------------	----	---	-----	--------------

Flexible cable management trough. Two pathways within the snake, one for data/communication and one for routing power cables. Translucent White finish only.

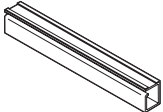

Wire Manager

PEWM5.5	2 x 66 x 2	70	.60	.10	\$198
PEWM5	2 x 60 x 2	70	.60	.10	\$166
PEWM4.5	2 x 54 x 2	70	.50	.10	\$148
PEWM4	2 x 48 x 2	70	.50	.10	\$135
PEWM3.5	2 x 42 x 2	70	.40	.10	\$116
PEWM3	2 x 36 x 2	70	.40	.10	\$104
PEWM2.5	2 x 30 x 2	70	.30	.10	\$85
PEWM2	2 x 24 x 2	70	.30	.10	\$70
PEWM1.5	2 x 18 x 2	70	.20	.10	\$55
PEWM1	2 x 12 x 2	70	.20	.10	\$40

Plastic tray flexes to receive and hold electrical and data wires. Quickly attaches with two strips of double-sided tape. Black (**BLK**) only.

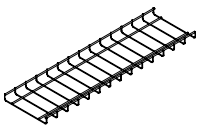

Power/Data Cable Basket

BRTCB76KIT	8 x 34 x 1	70	1.56	.15	\$263
BRTCB70	8 x 70 x 1	100	3.22	.34	\$191
BRTCB64	8 x 64 x 1	92.5	2.94	.29	\$178
BRTCB58	8 x 58 x 1	92.5	2.66	.26	\$172
BRTCB52	8 x 52 x 1	100	2.39	.24	\$162
BRTCB46	8 x 46 x 1	92.5	2.16	.21	\$153
BRTCB40	8 x 40 x 1	70	1.80	.18	\$145
BRTCB34	8 x 34 x 1	70	1.56	.15	\$139
BRTCB28	8 x 28 x 1	70	1.20	.13	\$123
BRTCB22	8 x 22 x 1	70	1.01	.10	\$115
BRTCB16	8 x 16 x 1	70	.73	.07	\$108
BRTCB8	8 x 8 x 1	70	.36	.03	\$97

Shallow, 8" wide basket manages cable excess and serves to manage cords and cables. It can be easily unclipped from spring steel brackets (included) to rearrange cable connections from below worksurface. Spring steel brackets can suspend the Cable Basket below the worksurface where it keeps the cords and cables off the floor and manages them along the horizontal plane - between floor monuments and Storage Vertical Cable Manager, for example. Tall storage cabinet's legs provide easy access to the Cable Basket where it can easily be unclipped from spring steel brackets to rearrange cable connections. Steel wire construction, chrome finish baskets; black spring steel hanging brackets, fasteners.

SWAP TABLES

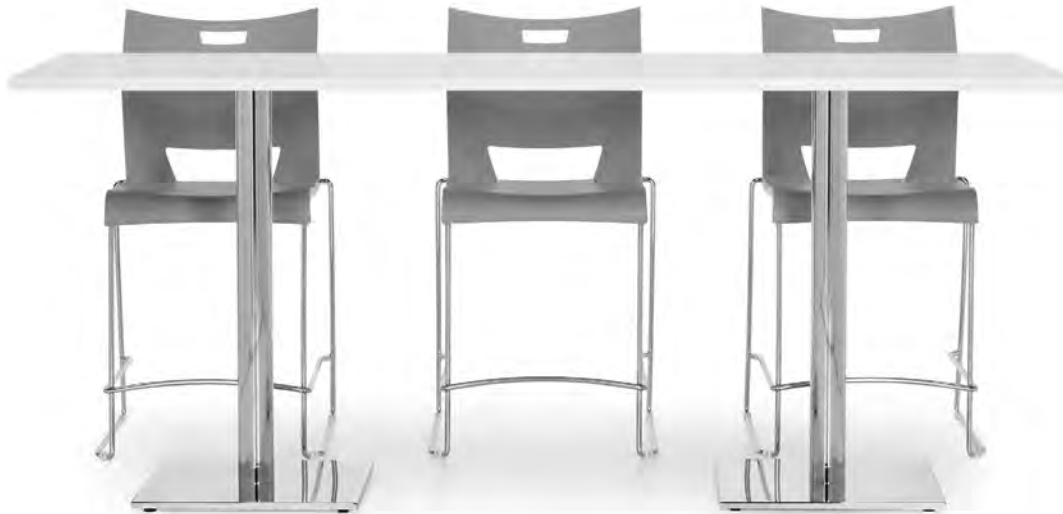

Global's Swap collection is a comprehensive offering including laptop tables, casual meeting tables, café tables, huddle tables and more. Suitable for a variety of applications: break rooms, dedicated/enclosed meeting rooms, casual/open area meeting spaces (lounge, seated, counter and bar height options), and private office (accommodate smaller 3-4 person discussions). Tops and bases are sold separately for ease of specification. Mix and match capabilities to create spaces for multi-purpose use. Choose your top, choose your base. Create the combination you desire for the way you want to work.

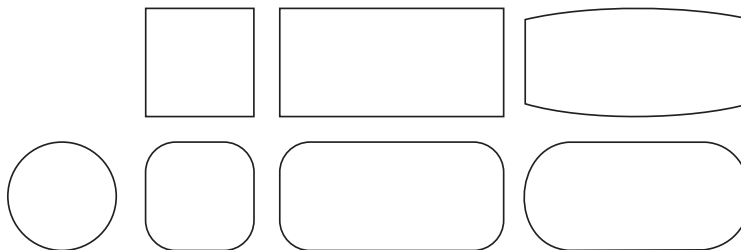

Top shapes



1/2" thick steel square and round metal bases



Optional power & data modules (on select top sizes)



Factory installed metal inserts for easy metal-to-metal base connection

Features and Benefits

- Tops are available in various materials to help perfect your interior design. Material choices include: (1) thermally fused laminate, (2) high pressure laminate (3) veneer and (4) solid surface.
- (1) High performance thermally fused laminate tops are 1" thick, with 45 lb. density particle board and feature 2mm thick edgeband.
- (2) High pressure laminate tops are 1-3/16" thick, with either 2mm flat edge or knife edge profiles. Tops with flat edge have 45 lb. density particle board core, tops with knife edge have MDF core.
- (3) Veneer tops are 1-3/16" thick overall with matching flat edge or knife edge
- (4) Solid surface tops are 1-1/4" thick with a plywood or particleboard melamine subtop depending on size, available with flat edge or knife edge
- Bases are constructed of a solid steel metal plate and cover - round or square.
- Power block cut-outs are available on most tables.
- 6 heights:
Coffee table height at 16"H
End table height at 22"H
Lounge height at 27"H
Seated height at 29"H
Counter height at 36"H
Bar height at 41.5"H

GENERAL INFORMATION

- Swap is a series of tables for use in casual meeting spaces, lounges, café areas and more.
- The right proportions, flawless surfaces and a solid foundation is sure to become your favorite table series to spec.
- Finish palette coordinates with most Global laminate and veneer casegoods series, as well as a variety of solid surface options to choose from – tables can stand-alone or blend with other solutions.
- Each component is packed individually. Bases are shipped assembled, 1 per carton. Easy to assemble.
- Global's counter and bar height stools are a perfect compliment to Swap tables with counter and bar height bases.
- For environmental certifications, please visit globalfurnituregroup.com

WORKSURFACES

- **Four** material choices: high performance thermally fused laminate, high pressure laminate, veneer and solid surface.
- **Thermally fused laminate** tops are 1" thick overall, constructed of 45 lb. density particle board core; 2 mm thick flat edge band to match, contrast with, or complement the top surface or corresponding base finish.
- **High pressure laminate** tops are 1-3/16" thick overall with choice of edge detail. 2mm thick flat edge to match, contrast with or complement the top surface or corresponding base finish on a 45lbs density particle board core. Also available with knife edge detail; edge finish would match top surface; core material is MDF. Recommended for counter applications or other high use areas. Product codes with **suffix LK** indicate high pressure laminate with knife edge.
- **Veneer** tops are 1-3/16" thick overall with choice of edge detail - flat edge or knife edge. Edge finish to correspond to surface finish. When flat edge, core material is 45 lbs density particle board; when knife edge, core material is MDF. Product codes with **suffix V** indicate veneer.
- **Solid surface** tops are 1.25" thick overall with choice of edge detail - flat edge or knife edge. Solid surface material is 0.5" thick with built up edge profile over a particle board or plywood subtop depending on overall top size. Product codes with **suffix SF** indicate solid surface with flat edge; product codes with **suffix SK** indicate solid surface with knife edge. There is no edge finish selection on solid surface tops. For detailed material information, please reference WilsonArt's Solid Surface collection.
- Please see model # for pricing and availability of various material and edge options.
- Refer to 653 or the Global website for available finish options
- While not all sizes are available in all materials:
 - Worksurfaces of 96" or less in length are standard in one piece (1 carton)
 - Worksurfaces 120" to 144" in length are standard in two pieces (2 cartons)
 - Worksurfaces 96", 120" and 144" x 48" include support channels

BASES

- **Caution:** to meet BIFMA standards for performance and stability, appropriate base size must be specified with corresponding top sizes identified. **Top plates and base plates vary by base size and will only work with table shape sizes as referenced on the following pages.**
- Bases are constructed of a round or square solid steel metal plate for counter balance, covered with a finished steel shroud, affixed with four bolts to a 3" diameter cold rolled steel tube.
- GRB14H25 attach to tops with a 6" x 6" steel plate, welded to a 1.5" diameter steel tube, bolted to a 0.5" thick solid steel counter balance. Not to be used on tops greater than 22" x 22" in size.
- GSB13H25 and GSOB13H25 attach to tops with a 6" x 6" steel plate, welded to a 1.5" diameter steel tube, bolted to a 0.5" thick solid steel counter balance. Not to be used on tops greater than 22" x 22" in size.
- GRB22H15, GRB22H21, GRB22H26, GRB22, GRB22H35, GRB22H41, GSB19H15, GSB19H21, GSB19H26, GSB19, GSB19H35 and GSB19H41 attach to tops with a 6" x 6" steel plate, welded to a 3" diameter steel tube, bolted to a 0.5" thick solid steel counter balance.
- GRB28, GRB34, GSB23 and GSB28 attach to tops with an 11" x 11" steel plate, welded to a 4" diameter steel tube, bolted to a 0.375" thick solid steel counter balance.
- Bases are available PAINTED in "Sandtex" finish for extra durability. Also available in plated finishes (see 653) at an upcharge and with an extended lead time. Please see model # for pricing.
- All bases include six height adjustable glides with 0.75" of adjustability.
- Round bases available in 22", 28" and 34" dia.
- Square bases available in 18.5", 22.5" and 28.5".

1. SPECIFY MODEL NUMBER

2. SPECIFY FINISHES

Laminate Finishes (thermally fused and high pressure laminates):

ACJ	Absolute Acajou	FCL	First Class
ASN	Asian Night	NBL	Noce Biondo
AWC	Avant Cherry	NGL	Noce Grigio
AWH	Avant Honey	NEL	Noce Leggero
BLK	Black	NML	Noce Medio
BZD	Blizzard	QTM	Quartered Mahogany
BRC	Brushed Cobalt	SBY	Sheer Beauty
CMB	Clear Maple	SOG	Storm Grey
CGY	Custom Grey	SDT	Stonedust
DES	Dark Espresso	WHE	Walnut Heights
DWT	Designer White	WHC	White Chocolate
FAS	Fashionista	WCR	Winter Cherry

VNW	Vintage Cherry	Cherry	Flat Sliced
WLW	Walnut	Walnut	Flat Sliced
WCW	Warm Cherry	Cherry	Flat Sliced
WMW	White Maple	Maple	Flat Sliced

Solid Surface (applicable for product codes ending in **SF** or **SK** only):

Grade 1

SWH Designer White

Grade 2 (upcharge applies)

SBT	Beige Tempest	SHS	Hot Stone
SBX	Black Onyx Mirage	SFW	Frosty White Mirage
SMG	Milk Glass Spectra	SNM	Northern Melange

Veneer Finishes (applicable for product codes ending in **V** only):

Code	Finish	Veneer Type	Cut
AMW	Almond Cherry	Cherry	Flat Sliced
ACW	Amber Cherry	Cherry	Flat Sliced
BTW	Biscotti	White Oak	Rift
CAW	Cocoa Walnut	Walnut	Flat Sliced
CRW	Coral	White Oak	Rift
DCW	Dark Cherry	Cherry	Flat Sliced
DWW	Dark Walnut	Walnut	Flat Sliced
EWV	Espresso Walnut	Walnut	Flat Sliced
EVW	Evening Oak	White Oak	Rift
GRW	Grey on Oak	White Oak	Rift
HAW	Hazelnut	Maple	Flat Sliced
JAW	Java	White Oak	Rift
LTW	Latte Walnut	Walnut	Flat Sliced
MHW	Mahogany on Walnut	Walnut	Flat Sliced
MTW	Milestone	White Oak	Rift
MPW	Natural Maple	Maple	Flat Sliced
NLW	Natural Walnut	Walnut	Flat Sliced
RCW	Red Cherry	Cherry	Flat Sliced
ULW	Umber Walnut	Walnut	Flat Sliced

Bases (paint):

TBL	Black	TIN	Ink
TBZ	Buzz Blue	TKA	Kalua
TCC	Cactus	TLA	Latte
TCR	Carrot	TMO	Mocha
TIV	Cloud	TNE	Nevada
TDW	Designer White	TSN	Sand
TDJ	Dijon	TSR	Scarlet
TEG	Eggplant	TSH	Shadow
TFO	Fog	TOA	Toast
TFR	Frost	TTU	Tungsten

Bases (plated) (upcharge applies):

CHM	Polished Chrome
BCH	Brushed Chrome
ACO	Antique Copper
SBR	Satin Brass

3. SPECIFY EDGE PROFILE (where applicable)

Thermally fused laminate and HP with flat edge:

- Default profile **FE** - Flat edge
- **R3** optional for 3" radiused corners, excluding round tops, racetrack and boatshaped



FE - Flat edge

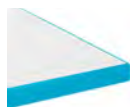

FE -contrasting flat edge

Solid surface tops product codes ending in **SF**:

- Default profile **FE** - Flat edge
- **R3** optional for 3" radiused corners, excluding round tops



FE - flat edge



R3 - radiused corners

High pressure laminate tops product codes ending in **LK**, always knife edge.



FE - flat edge



LK / KS - knife edge

Solid surface tops product codes ending in **SK**:

- Default profile **KS** - Knife Edge
- **KR** optional for knife edge with 3" radiused corners, excluding round tops



KS - knife edge



KR - solid surface knife edge w/3" radiused corners

Veneer tops product codes ending in **V**:

- Default profile **FE** - Flat Edge
- **KS** optional for knife edge



FE - flat edge



KS - knife edge

4. SPECIFY EDGE FINISH

Edge finish only applicable for thermally fused laminate tops and HPL tops with FE flat edge

AAE	Absolute Acajou	FCL	First Class
ASE	Asian Night	FOG	Fog
ACE	Avant Cherry	LAB	Latte
AHE	Avant Honey	NBL	Noce Biondo
BLK	Black	NGL	Noce Grigio
BZD	Blizzard	NEL	Noce Leggero
BRC	Brushed Cobalt	NML	Noce Medio
BZB	Buzz Blue	QTM	Quartered Mahogany
CCT	Cactus	SAR	Scarlet
CRO	Carrot	SBY	Sheer Beauty
CME	Clear Maple	SHW	Shadow
CGY	Custom Grey	SDT	Stonedust
DEE	Dark Espresso	SOG	Storm Grey
DWE	Designer White	WHE	Walnut Heights
DJN	Dijon	CBE	White Chocolate
FAS	Fashionista	WCE	Winter Cherry

5. SPECIFY OPTIONS



POWER BLOCKS AND CUT-OUT LOCATIONS

- A power block delivers power/data to the table surface
- Power block modules are ordered separately
- Not all power block locations are available on all table sizes. Please refer to the top/base chart on the following pages for more information.
- To purchase a power block, you must specify the power block cut-out location when ordering the top and order the power block separately.
- Optional cut-out available in standard worksurface locations (left, center or right) for all table shapes.
- Order as **E1, M1, R1, T1, V1**, etc. **Add \$96** for each cut-out.
- Cut-outs may be placed in non-standard locations.
Order as **ES, MS, RS, TS**, or **VS - Add \$96**.

A drawing must be supplied with vertical and horizontal dimensions to the center of the cut-out. Please refer to the CUSTOM GROMMET LOCATION FORM in the back reference section. Cut-outs may NOT be placed directly over the bases.

- Select power block from Productivity Solutions, beginning on page 491.

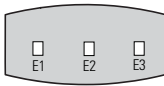
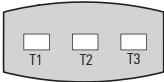
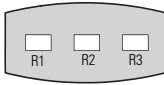
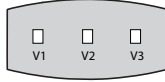
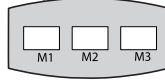
POWER BLOCK OPTIONS AND CUT-OUT LOCATIONS

PMSPPDM		PRTMCD602B PRTMCD602T PRTMCD602W PRTMCD622B PRTMCD622T PRTMCD622W PRTMCD642B PRTMCD642T PRTMCD642W	
PRTMCS401B PRTMCS401T PRTMCS401W PRTMCS421B PRTMCS421T PRTMCS421W			
VILLA			
*OASIS MINI A			
*OASIS MINI B			

*M cut-out not available on Solid Surface tops



TABLE NOTES - ESTIMATED CAPACITY

- Use the following to determine the size of a table and the number of chairs needed for a conference area.
- All estimates are based on an average chair width of 23" with a 4" clearance between chairs. Adjust accordingly for a different chair size.

Top Size	NUMBER OF CHAIRS					
	Round	Square	Rectangular	Boat	Racetrack	
24 x 24	2	2	N/A	N/A	N/A	
24 x 30	N/A	N/A	2-3	N/A	N/A	
24 x 36	N/A	N/A	3-4	N/A	N/A	
30 x 30	3	4	N/A	N/A	N/A	
30 x 36	N/A	N/A	4	N/A	N/A	
30 x 42	N/A	N/A	4	N/A	N/A	
36 x 36	4	4	N/A	N/A	N/A	
36 x 42	N/A	N/A	4	N/A	N/A	
42 x 42	4	4	N/A	N/A	N/A	
48 x 48	4	4	N/A	N/A	N/A	
54 x 54	5	6	N/A	N/A	N/A	
60 x 60	5	6	N/A	N/A	N/A	
24 x 60	N/A	N/A	4-6	N/A	N/A	
24 x 66	N/A	N/A	4-6	N/A	N/A	
24 x 72	N/A	N/A	4-6	N/A	N/A	
24 x 84	N/A	N/A	4-6	N/A	N/A	
24 x 96	N/A	N/A	6-8	N/A	N/A	
30 x 60	N/A	N/A	4-6	4-6	4-6	
30 x 66	N/A	N/A	4-6	4-6	4-6	
30 x 72	N/A	N/A	4-6	4-6	4-6	
30 x 84	N/A	N/A	4-6	4-6	4-6	
30 x 96	N/A	N/A	6-8	6-8	6-8	
36 x 60	N/A	N/A	4-6	4-6	4-6	
36 x 66	N/A	N/A	4-6	4-6	4-6	
36 x 72	N/A	N/A	4-6	4-6	4-6	
36 x 84	N/A	N/A	4-6	4-6	4-6	
36 x 96	N/A	N/A	6-8	6-8	6-8	
48 x 84	N/A	N/A	6-8	6-8	6-8	
48 x 96	N/A	N/A	6-8	6-8	6-8	
48 x 120	N/A	N/A	8-10	8-10	8-10	
48 x 144	N/A	N/A	10-12	10-12	10-12	





S SWAP TABLES - NOTES

APPLICABLE BASE OPTIONS FOR CORRESPONDING TOP											POWER MGMT OPTIONS	
Table Shape/Size	Model # for Top	Lounge Height 27"H		Seated Height 28.5"H		Counter Height 36"H		Bar Height 41.5"h		Base Qty.	# top pieces	Optional cut-outs in tops applicable for power modules ordered separately
		Round base 22"	Square base 19"	Round base 22", 28", 34"	Square base 18.5", 22.5", 28.5"	Round base 22"	Square base 18.5"	Round base 22"	Square base 18.5"			
Round ○												
Nominal base plate dimension indicated by 4th and 5th characters in base model numbers.												
24" diameter	GRBTP24_	GRB22H26	GSB19H26	GRB22	GSB19	GRB22H35	GSB19H35	GRB22H41	GSB19H41	1	1	None
30" diameter	GRBTP30_	GRB22H26	GSB19H26	GRB22	GSB19	GRB22H35	GSB19H35	GRB22H41	GSB19H41	1	1	None
36" diameter	GRBTP36_	GRB22H26	GSB19H26	GRB22	GSB19	GRB22H35	GSB19H35	GRB22H41	GSB19H41	1	1	None
42" diameter	GRBTP42_	N/A	N/A	GRB28	GSB23	N/A	N/A	N/A		1	1	None
48" diameter	GRBTP48_	N/A	N/A	GRB28	GSB23	N/A	N/A	N/A		1	1	None
54" diameter	GRBTP54_	N/A	N/A	GRB34	GSB28	N/A	N/A	N/A		1	1	None
60" diameter	GRBTP60_	N/A	N/A	GRB34	GSB28	N/A	N/A	N/A		1	1	None
Square □												
24" square	GSBTP24_	GRB22H26	GSB19H26	GRB22	GSB19	GRB22H35	GSB19H35	GRB22H41	GSB19H41	1	1	None
30" square	GSBTP30_	GRB22H26	GSB19H26	GRB22	GSB19	GRB22H35	GSB19H35	GRB22H41	GSB19H41	1	1	None
36" square	GSBTP36_	GRB22H26	GSB19H26	GRB22	GSB19	GRB22H35	GSB19H35	GRB22H41	GSB19H41	1	1	None
42" square	GSBTP42_	N/A	N/A	GRB28	GSB23	N/A	N/A	N/A	N/A	1	1	None
54" square	GSBTP54_	N/A	N/A	N/A	N/A	N/A	N/A	N/A	N/A	1	1	None
60" square	GSBTP60_	N/A	N/A	N/A	N/A	N/A	N/A	N/A	N/A	1	1	None
Rectangular ▭												
30x24 Rectangular	GSBTP2430_	GRB22H26	GSB19H26	GRB22	GSB19	GRB22H35	GSB19H35	GRB22H41	GSB19H41	1	1	None
36x24 Rectangular	GSBTP2436_	GRB22H26	GSB19H26	GRB22	GSB19	GRB22H35	GSB19H35	GRB22H41	GSB19H41	1	1	None
36x30 Rectangular	GSBTP3036_	GRB22H26	GSB19H26	GRB22	GSB19	GRB22H35	GSB19H35	GRB22H41	GSB19H41	1	1	None
42x30 Rectangular	GSBTP3042_	N/A	N/A	GRB28	GSB23	N/A	N/A	N/A	N/A	1	1	None
42x36 Rectangular	GSBTP3642_	N/A	N/A	GRB28	GSB23	N/A	N/A	N/A	N/A	1	1	None
60x24 Rectangular	GRT5STP_	GRB22H26	GSB19H26	N/A	N/A	GRB22H35	GSB19H35	GRB22H41	GSB19H41	2	1	Center: A2, E2, J2, K2, M2, R2, T2, U2, V2
66x24 Rectangular	GRT5HSTP_	GRB22H26	GSB19H26	N/A	N/A	GRB22H35	GSB19H35	GRB22H41	GSB19H41	2	1	
72x24 Rectangular	GRT6STP_	GRB22H26	GSB19H26	N/A	N/A	GRB22H35	GSB19H35	GRB22H41	GSB19H41	2	1	
84x24 Rectangular	GRT7STP_	GRB22H26	GSB19H26	N/A	N/A	GRB22H35	GSB19H35	GRB22H41	GSB19H41	2	1	3 positions - Left/ Center/Right
96x24 Rectangular	GRT8STP_	GRB22H26	GSB19H26	N/A	N/A	GRB22H35	GSB19H35	GRB22H41	GSB19H41	2	1	
60x30 Rectangular	GRT5NTP_	GRB22H26	GSB19H26	GRB22	GSB19	GRB22H35	GSB19H35	GRB22H41	GSB19H41	2	1	Center: A2, E2, J2, K2, M2, R2, T2, U2, V2
60x36 Rectangular	GRT5TP_	GRB22H26	GSB19H26	GRB22	GSB19	GRB22H35	GSB19H35	GRB22H41	GSB19H41	2	1	
66x30 Rectangular	GRT5NHTP_	GRB22H26	GSB19H26	GRB22	GSB19	GRB22H35	GSB19H35	GRB22H41	GSB19H41	2	1	
66x36 Rectangular	GRT5HTP_	GRB22H26	GSB19H26	GRB22	GSB19	GRB22H35	GSB19H35	GRB22H41	GSB19H41	2	1	
72x30 Rectangular	GRT6NTP_	GRB22H26	GSB19H26	GRB22	GSB19	GRB22H35	GSB19H35	GRB22H41	GSB19H41	2	1	
72x36 Rectangular	GRT6TP_	GRB22H26	GSB19H26	GRB22	GSB19	GRB22H35	GSB19H35	GRB22H41	GSB19H41	2	1	3 positions - Left/ Center/Right A1/2/3, E1/2/3, J1/2/3, K1/2/3, M1/2/3, R1/2/3, T1/2/3, U1/2/3, V1/2/3
84x30 Rectangular	GRT7NTP_	GRB22H26	GSB19H26	GRB22	GSB19	GRB22H35	GSB19H35	GRB22H41	GSB19H41	2	1	
84x36 Rectangular	GRT7TP_	GRB22H26	GSB19H26	GRB22	GSB19	GRB22H35	GSB19H35	GRB22H41	GSB19H41	2	1	
96x30 Rectangular	GRT8NTP_	GRB22H26	GSB19H26	GRB22	GSB19	GRB22H35	GSB19H35	GRB22H41	GSB19H41	2	1	
96x36 Rectangular	GRT8TP_	GRB22H26	GSB19H26	GRB22	GSB19	GRB22H35	GSB19H35	GRB22H41	GSB19H41	2	1	
96x42 Rectangular	GRT8MTP_	N/A	N/A	GRB28	GSB23	N/A	N/A	N/A	N/A	2	1	Both ends: A1/3, E1/3, J1/3, K1/3, M1/3, R1/3, T1/3, U1/3, V1/3
96x48 Rectangular	GRT8WTP_	N/A	N/A	GRB28	GSB23	N/A	N/A	N/A	N/A	2	1	
120x48 Rectangular	GRT10WTP_	N/A	N/A	GRB28	GSB23	N/A	N/A	N/A	N/A	3	2	Both ends: A1/3, E1/3, J1/3, K1/3, M1/3, R1/3, T1/3, U1/3, V1/3
144x48 Rectangular	GRT12WTP_	N/A	N/A	GRB28	GSB23	N/A	N/A	N/A	N/A	3	2	

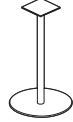
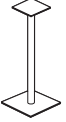
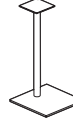
APPLICABLE BASE OPTIONS FOR CORRESPONDING TOP											POWER MGMT OPTIONS	
Table Shape/Size	Model # for Top	Lounge Height 27"H		Seated Height 28.5"H		Counter Height 36"H		Bar Height 41.5"h		Base Qty.	# top pieces	Optional cut-outs in tops applicable for power modules ordered separately
		Round base 22"	Square base 19"	Round base 22", 28", 34"	Square base 18.5", 22.5", 28.5"	Round base 22"	Square base 18.5"	Round base 22"	Square base 18.5"			
Racetrack  Nominal base plate dimension indicated by 4th and 5th characters in base model numbers.												
60X24 Racetrack	GRC5STP_	GRB22H26	GSB19H26	N/A	N/A	GRB22H35	GSB19H35	GRB22H41	GSB19H41	2	1	Center: A2, E2, J2, K2, M2, R2, T2, U2, V2
66X24 Racetrack	GRC5HSTP_	GRB22H26	GSB19H26	N/A	N/A	GRB22H35	GSB19H35	GRB22H41	GSB19H41	2	1	
72X24 Racetrack	GRC6STP_	GRB22H26	GSB19H26	N/A	N/A	GRB22H35	GSB19H35	GRB22H41	GSB19H41	2	1	
84X24 Racetrack	GRC7STP_	GRB22H26	GSB19H26	N/A	N/A	GRB22H35	GSB19H35	GRB22H41	GSB19H41	2	1	3 positions - Left/ Center/Right
96X24 Racetrack	GRC8STP_	GRB22H26	GSB19H26	N/A	N/A	GRB22H35	GSB19H35	GRB22H41	GSB19H41	2	1	
60x30 Racetrack	GRC5NTP_	GRB22H26	GSB19H26	GRB22	GSB19	GRB22H35	GSB19H35	GRB22H41	GSB19H41	2	1	Center: A2, E2, J2, K2, M2, R2, T2, U2, V2
60X36 Racetrack	GRC5TP_	GRB22H26	GSB19H26	GRB22	GSB19	GRB22H35	GSB19H35	GRB22H41	GSB19H41	2	1	
66x30 Racetrack	GRC5NHTP_	GRB22H26	GSB19H26	GRB22	GSB19	GRB22H35	GSB19H35	GRB22H41	GSB19H41	2	1	
66X36 Racetrack	GRC5HTP_	GRB22H26	GSB19H26	GRB22	GSB19	GRB22H35	GSB19H35	GRB22H41	GSB19H41	2	1	
72x30 Racetrack	GRC6NTP_	GRB22H26	GSB19H26	GRB22	GSB19	GRB22H35	GSB19H35	GRB22H41	GSB19H41	2	1	
72x36 Racetrack	GRC6TP_	GRB22H26	GSB19H26	GRB22	GSB19	GRB22H35	GSB19H35	GRB22H41	GSB19H41	2	1	
84x30 Racetrack	GRC7NTP_	GRB22H26	GSB19H26	GRB22	GSB19	GRB22H35	GSB19H35	GRB22H41	GSB19H41	2	1	3 positions - Left/ Center/Right (E1/2/3, V1/2/3; M1/2/3, A1/2/3, J1/2/3, K1/2/3, R1/2/3, T1/2/3, U1/2/3
84x36 Racetrack	GRC7TP_	GRB22H26	GSB19H26	GRB22	GSB19	GRB22H35	GSB19H35	GRB22H41	GSB19H41	2	1	
96x30 Racetrack	GRC8NTP_	GRB22H26	GSB19H26	GRB22	GSB19	GRB22H35	GSB19H35	GRB22H41	GSB19H41	2	1	
96x36 Racetrack	GRC8TP_	GRB22H26	GSB19H26	GRB22	GSB19	GRB22H35	GSB19H35	GRB22H41	GSB19H41	2	1	
96x42 Racetrack	GRC8MTP_	N/A	N/A	GRB28	GSB23	N/A	N/A	N/A	N/A	2	1	
96x48 Racetrack	GRC8WTP_	N/A	N/A	GRB28	GSB23	N/A	N/A	N/A	N/A	2	1	
120x48 Racetrack	GRC10WTP_	N/A	N/A	GRB28	GSB23	N/A	N/A	N/A	N/A	3	2	Both ends: A1/3, E1/3, J1/3, K1/3, M1/3, R1/3, T1/3, U1/3
144x48 Racetrack	GRC12WTP_	N/A	N/A	GRB28	GSB23	N/A	N/A	N/A	N/A	3	2	
Boat Shape 												
60x30 Boat shape	GBT5NTP_	GRB22H26	GSB19H26	GRB22	GSB19	GRB22H35	GSB19H35	GRB22H41	GSB19H41	2	1	Center: A2, E2, J2, K2, M2, R2, T2, U2, V2
60X36 Boat shape	GBT5TP_	GRB22H26	GSB19H26	GRB22	GSB19	GRB22H35	GSB19H35	GRB22H41	GSB19H41	2	1	
66x30 Boat shape	GBT5NHTP_	GRB22H26	GSB19H26	GRB22	GSB19	GRB22H35	GSB19H35	GRB22H41	GSB19H41	2	1	
66X36 Boat shape	GBT5HTP_	GRB22H26	GSB19H26	GRB22	GSB19	GRB22H35	GSB19H35	GRB22H41	GSB19H41	2	1	
72x30 Boat shape	GBT6NTP_	GRB22H26	GSB19H26	GRB22	GSB19	GRB22H35	GSB19H35	GRB22H41	GSB19H41	2	1	
72x36 Boat shape	GBT6TP_	GRB22H26	GSB19H26	GRB22	GSB19	GRB22H35	GSB19H35	GRB22H41	GSB19H41	2	1	
84x30 Boat shape	GBT7NTP_	GRB22H26	GSB19H26	GRB22	GSB19	GRB22H35	GSB19H35	GRB22H41	GSB19H41	2	1	3 positions - Left/ Center/Right A1/2/3, E1/2/3, J1/2/3, K1/2/3, M1/2/3, R1/2/3, T1/2/3, U1/2/3, V1/2/3
84x36 Boat shape	GBT7TP_	GRB22H26	GSB19H26	GRB22	GSB19	GRB22H35	GSB19H35	GRB22H41	GSB19H41	2	1	
96x30 Boat shape	GBT8NTP_	GRB22H26	GSB19H26	GRB22	GSB19	GRB22H35	GSB19H35	GRB22H41	GSB19H41	2	1	
96x36 Boat shape	GBT8TP_	GRB22H26	GSB19H26	GRB22	GSB19	GRB22H35	GSB19H35	GRB22H41	GSB19H41	2	1	
96X42 Boat shape	GBT8MTP_	N/A	N/A	GRB28	GSB23	N/A	N/A	N/A	N/A	2	1	
96x48 Boat shape	GBT8WTP_	N/A	N/A	GRB28	GSB23	N/A	N/A	N/A	N/A	2	1	
120x48 Boat shape	GBT10WTP_	N/A	N/A	GRB28	GSB23	N/A	N/A	N/A	N/A	3	2	Both ends: A1/3, E1/3, J1/3, K1/3, M1/3, R1/3, T1/3, U1/3, V1/3
144x48 Boat shape	GBT12WTP_	N/A	N/A	GRB28	GSB23	N/A	N/A	N/A	N/A	3	2	

S SWAP TABLES - NOTES

APPLICABLE BASE OPTIONS FOR CORRESPONDING TOP						POWER MGMT OPTIONS		
Table Shape/Size	Model # for Top	Laptop height 25.6"H				Base Qty.	# top pieces	Optional cut-outs in tops applicable for power modules ordered separately
		Round base 14" Centered column 	Square base 12.5" Centered column 	Round base N/A	Square base 12.5" Offset column 			
Round Laptop Tables <input checked="" type="checkbox"/> Nominal base plate dimension indicated by 4th and 5th characters in base model numbers.								
16.5" dia centered base	GRBTP16_	GRB14H25	GSB13H25	N/A	N/A	1	1	None
20" dia centered base	GRBTP20_	GRB14H25	GSB13H25	N/A	N/A	1	1	None
22" dia centered base	GRBTP22_	GRB14H25	GSB13H25	N/A	N/A	1	1	None
16.5" dia offset base	GRBOTP16_	N/A	N/A	N/A	GSOB13H25	1	1	None
20" dia offset base	GRBOTP20_	N/A	N/A	N/A	GSOB13H25	1	1	None
22" dia offset base	GRBOTP22_	N/A	N/A	N/A	GSOB13H25	1	1	None
Square Laptop Tables <input type="checkbox"/>								
16.5"x16.5" centered base	GSBTP16_	GRB14H25	GSB13H25	N/A	N/A	1	1	None
20"x20" centered base	GSBTP20_	GRB14H25	GSB13H25	N/A	N/A	1	1	None
22"x22" centered base	GSBTP22_	GRB14H25	GSB13H25	N/A	N/A	1	1	None
16.5"x16.5" offset base	GSBOTP16_	N/A	N/A	N/A	GSOB13H25	1	1	None
20"x20" offset base	GSBOTP20_	N/A	N/A	N/A	GSOB13H25	1	1	None
22"x22" offset base	GSBOTP22_	N/A	N/A	N/A	GSOB13H25	1	1	None
Rectangular Laptop Tables <input type="checkbox"/>								
16"x20" centered base	GSBTP1620_	GRB14H25	GSB13H25	N/A	N/A	1	1	None
16"x22" centered base	GSBTP1622_	GRB14H25	GSB13H25	N/A	N/A	1	1	None
16"x20" offset base	GSBOT1620_	N/A	N/A	N/A	GSOB13H25	1	1	None
16"x22" offset base	GSBOT1622_	N/A	N/A	N/A	GSOB13H25	1	1	None

APPLICABLE BASE OPTIONS FOR CORRESPONDING TOP						POWER MGMT OPTIONS		
Table Shape/Size	Model # for Top	Coffee Table 16"H		End Table 22"H		Base Qty.	# top pieces	Optional cut-outs in tops applicable for power modules ordered separately
		Round base 22" 	Square base 18.5" 	Round base 22" 	Square base 18.5" 			
Round Coffee/End Tables <input checked="" type="checkbox"/> <i>*Nominal base plate dimension indicated by 4th and 5th characters in base model numbers.</i>								
24" dia	GRBTP24_	GRB22H15	GSB19H15	GRB22H21	GSB19H21	1	1	None
30" dia	GRBTP30_	GRB22H15	GSB19H15	GRB22H21	GSB19H21	1	1	None
36" dia	GRBTP36_	GRB22H15	GSB19H15	GRB22H21	GSB19H21	1	1	None
Square Coffee/End Tables <input type="checkbox"/>								
24" square	GSBTP24_	GRB22H15	GSB19H15	GRB22H21	GSB19H21	1	1	None
30" square	GSBTP30_	GRB22H15	GSB19H15	GRB22H21	GSB19H21	1	1	None
36" square	GSBTP36_	GRB22H15	GSB19H15	GRB22H21	GSB19H21	1	1	None

ROUND LAPTOP TABLES FOR CENTER BASE **MODEL#** **DIMENSIONS** **FREIGHT CLASS** **WT/LBS.** **CUBIC FT.** **LIST PRICE** **HP ADD** **GR. 2 ADD** **R3 ADD** **KS ADD**



Round laptop table for center base

D x W x H

TFL, flat edge ⁽¹⁾

GRBTP16	16 x 16.5 x 1	70	6	0.3	\$214	\$100	n/a	n/a	n/a
GRBTP20	20 x 20 x 1	70	9	0.5	\$245	\$115	n/a	n/a	n/a
GRBTP22	22 x 22 x 1	70	9	0.5	\$277	\$126	n/a	n/a	n/a

HPL, knife edge

GRBTP16LK	16 x 16.5 x 1.19	125	7.5	1	\$525	n/a	n/a	n/a	n/a
GRBTP20LK	20 x 20 x 1.19	125	11	1.5	\$596	n/a	n/a	n/a	n/a
GRBTP22LK	22 x 22 x 1.19	150	11	2	\$645	n/a	n/a	n/a	n/a

Veneer ⁽²⁾

GRBTP16V	16 x 16.5 x 1.19	125	7.5	1	\$790	n/a	n/a	n/a	\$75
GRBTP20V	20 x 20 x 1.19	125	11	1.5	\$856	n/a	n/a	n/a	\$75
GRBTP22V	22 x 22 x 1.19	150	11	2	\$921	n/a	n/a	n/a	\$75

Solid Surface, flat edge ⁽³⁾

GRBTP16SF	16 x 16.5 x 1.25	70	11	0.6	\$1652	n/a	\$87	n/a	n/a
GRBTP20SF	20 x 20 x 1.25	70	16	1	\$1939	n/a	\$116	n/a	n/a
GRBTP22SF	22 x 22 x 1.25	70	20	1	\$2031	n/a	\$168	n/a	n/a

Solid Surface, knife edge ⁽³⁾

GRBTP16SK	16 x 16.5 x 1.25	70	11	0.6	\$1749	n/a	\$99	n/a	n/a
GRBTP20SK	20 x 20 x 1.25	70	16	1	\$2043	n/a	\$121	n/a	n/a
GRBTP22SK	22 x 22 x 1.25	70	20	1	\$2140	n/a	\$173	n/a	n/a

Only applicable bases to use with above tops: GRB14H25 or GSB13H25 round or square base with centered column (see 665). Tops feature metal inserts for ease of assembly to base. One base required.

Required Specifications

Top finish
Edge finish⁽¹⁾

Optional Specifications

HP laminate⁽¹⁾
Knife edge⁽²⁾
Grade 2 solid surface⁽³⁾

Applicable Bases

GRB14H25
GSB13H25

S SWAP TABLES

SQUARE LAPTOP TABLES FOR CENTER BASE

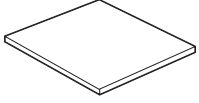

Square Tops, for Center Base

MODEL#	DIMENSIONS	FREIGHT CLASS	WT/LBS.	CUBIC FT.	LIST PRICE	HP ADD	GR. 2 ADD	R3 ADD	KS ADD
D x W x H									
TFL, flat edge ^{(1) (4)}									
GSBTP16	16.5 x 16.5 x 1	65	7	0.3	\$214	\$100	n/a	\$22	n/a
GSBTP20	20 x 20 x 1	70	11	0.5	\$245	\$115	n/a	\$25	n/a
GSBTP22	22 x 22 x 1	65	13	0.5	\$277	\$126	n/a	\$28	n/a
HPL, knife edge									
GSBTP16LK	16.5 x 16.5 x 1.19	100	8.5	1	\$350	n/a	n/a	n/a	n/a
GSBTP20LK	20 x 20 x 1.19	100	13	1.5	\$440	n/a	n/a	n/a	n/a
GSBTP22LK	22 x 22 x 1.19	100	16	2	\$480	n/a	n/a	n/a	n/a
Veneer ⁽²⁾									
GSBTP16V	16.5 x 16.5 x 1.19	100	8.5	1	\$451	n/a	n/a	n/a	\$71
GSBTP20V	20 x 20 x 1.19	100	13	1.5	\$565	n/a	n/a	n/a	\$86
GSBTP22V	22 x 22 x 1.19	100	16	2	\$620	n/a	n/a	n/a	\$96
Solid Surface, flat edge ^{(3) (4)}									
GSBTP16SF	16.5 x 16.5 x 1.25	65	14	0.6	\$1415	n/a	\$81	\$96	n/a
GSBTP20SF	20 x 20 x 1.25	70	21	1	\$1697	n/a	\$121	\$96	n/a
GSBTP22SF	22 x 22 x 1.25	65	26	1	\$1789	n/a	\$145	\$96	n/a
Solid Surface, knife edge ^{(3) (4)}									
GSBTP16SK	16.5 x 16.5 x 1.25	65	14	0.6	\$1749	n/a	\$99	\$202	n/a
GSBTP20SK	20 x 20 x 1.25	70	21	1	\$2043	n/a	\$128	\$202	n/a
GSBTP22SK	22 x 22 x 1.25	65	26	1	\$2140	n/a	\$173	\$202	n/a

Only applicable bases to use with above tops: GRB14H25 or GSB13H25 round or square base with centered column (see 665). Tops feature metal inserts for ease of assembly to base. One base required.

Required Specifications

Top finish
Edge finish⁽¹⁾

Optional Specifications

HP laminate⁽¹⁾
Knife edge⁽²⁾
Grade 2 solid surface⁽³⁾
3" radiused corners⁽⁴⁾

Applicable Bases

GRB14H25
GSB13H25

RECTANGULAR LAPTOP TABLES FOR CENTER BASE MODEL# DIMENSIONS FREIGHT CLASS WT/LBS. CUBIC FT. LIST PRICE HP ADD GR. 2 ADD R3 ADD KS ADD

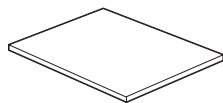

Rectangular Tops, for Center Base

D x W x H

TFL, flat edge ^{(1) (4)}

GSBTP1620	20 x 16 x 1	65	9	0.4	\$223	\$110	n/a	\$21	n/a
GSBTP1622	22 x 16 x 1	70	11	0.5	\$255	\$115	n/a	\$26	n/a

HPL, knife edge

GSBTP1620LK	16 x 20 x 1.19	92.5	11	1	\$451	n/a	n/a	n/a	n/a
GSBTP1622LK	16 x 22 x 1.19	100	13	1.5	\$495	n/a	n/a	n/a	n/a

Veneer ⁽²⁾

GSBTP1620V	16 x 20 x 1.19	92.5	11	1	\$556	n/a	n/a	n/a	\$86
GSBTP1622V	16 x 22 x 1.19	100	13	1.5	\$611	n/a	n/a	n/a	\$90

Solid Surface, flat edge ^{(3) (4)}

GSBTP1620SF	20 x 16 x 1.25	70	17	0.8	\$1571	n/a	\$99	\$96	n/a
GSBTP1622SF	22 x 16 x 1.25	65	19	0.8	\$1593	n/a	\$104	\$96	n/a

Solid Surface, knife edge ^{(3) (4)}

GSBTP1620SK	20 x 16 x 1.25	70	17	0.8	\$1887	n/a	\$121	\$202	n/a
GSBTP1622SK	22 x 16 x 1.25	65	19	0.8	\$1922	n/a	\$139	\$202	n/a

Only applicable bases to use with above tops: GRB14H25 or GSB13H25 round or square base with centered column (see 665). Tops feature metal inserts for ease of assembly to base. One base required.

Required Specifications

Top finish
Edge finish⁽¹⁾

Optional Specifications

HP laminate⁽¹⁾
Knife edge⁽²⁾
Grade 2 solid surface⁽³⁾
3" radiused corners⁽⁴⁾

Applicable Bases

GRB14H25
GSB13H25

S SWAP TABLES

ROUND LAPTOP TABLES FOR OFFSET BASE



Round laptop table for offset base

MODEL#	DIMENSIONS	FREIGHT CLASS	WT/LBS.	CUBIC FT.	LIST PRICE	HP ADD	GR. 2 ADD	R3 ADD	KS ADD
--------	------------	---------------	---------	-----------	------------	--------	-----------	--------	--------

D x W x H

TFL, flat edge ⁽¹⁾

GRBOTP16	16 x 16.5 x 1	70	6	0.3	\$214	\$100	n/a	n/a	n/a
GRBOTP20	20 x 20 x 1	70	9	0.5	\$245	\$115	n/a	n/a	n/a
GRBOTP22	22 x 22 x 1	70	11	0.7	\$277	\$126	n/a	n/a	n/a

HPL, knife edge

GRBOTP16LK	16 x 16.5 x 1.19	100	8	1	\$525	n/a	n/a	n/a	n/a
GRBOTP20LK	20 x 20 x 1.19	100	13	1.5	\$596	n/a	n/a	n/a	n/a
GRBOTP22LK	22 x 22 x 1.19	100	16	2	\$645	n/a	n/a	n/a	n/a

Veneer ⁽²⁾

GRBOTP16V	16 x 16.5 x 1.19	100	8	1	\$790	n/a	n/a	n/a	\$75
GRBOTP20V	20 x 20 x 1.19	100	13	1.5	\$856	n/a	n/a	n/a	\$75
GRBOTP22V	22 x 22 x 1.19	100	16	2	\$921	n/a	n/a	n/a	\$75

Solid Surface, flat edge ⁽³⁾

GRBOTP16SF	16 x 16.5 x 1.25	70	11	0.6	\$1652	n/a	\$87	n/a	n/a
GRBOTP20SF	20 x 20 x 1.25	70	16	1	\$1939	n/a	\$116	n/a	n/a
GRBOTP22SF	22 x 22 x 1.25	70	20	1	\$2031	n/a	\$168	n/a	n/a

Solid Surface, knife edge ⁽³⁾

GRBOTP16SK	16 x 16.5 x 1.25	70	11	0.6	\$1749	n/a	\$99	n/a	n/a
GRBOTP20SK	20 x 20 x 1.25	70	16	1	\$2043	n/a	\$121	n/a	n/a
GRBOTP22SK	22 x 22 x 1.25	70	20	1	\$2140	n/a	\$173	n/a	n/a

Only applicable base to use with above tops: GSOB13H25 square base with offset column (see 665). Tops feature metal inserts for ease of assembly to base. One base required.

Required Specifications

Top finish
Edge finish⁽¹⁾

Optional Specifications

HP laminate⁽¹⁾
Knife edge⁽²⁾
Grade 2 solid surface⁽³⁾

Applicable Bases

GSOB13H25

SQUARE LAPTOP TABLES FOR CENTER BASE

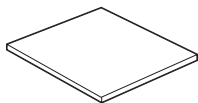

Square Tops, for Offset Base

MODEL# DIMENSIONS FREIGHT CLASS WT/LBS. CUBIC FT. LIST PRICE HP ADD GR. 2 ADD R3 ADD KS ADD

D x W x H

TFL, flat edge ⁽¹⁾⁽⁴⁾

GSBOTP16	16.5 x 16.5 x 1	65	7	0.3	\$214	\$100	n/a	\$22	n/a
GSBOTP20	20 x 20 x 1	70	11	0.5	\$245	\$115	n/a	\$25	n/a
GSBOTP22	22 x 22 x 1	70	13	0.7	\$277	\$126	n/a	\$28	n/a

HPL, knife edge

GSBOTP16LK	16.5 x 16.5 x 1.19	100	8.5	1	\$350	n/a	n/a	n/a	n/a
GSBOTP20LK	20 x 20 x 1.19	100	13	1.5	\$440	n/a	n/a	n/a	n/a
GSBOTP22LK	22 x 22 x 1.19	100	16	2	\$480	n/a	n/a	n/a	n/a

Veneer ⁽²⁾

GSBOTP16V	16.5 x 16.5 x 1.19	100	8.5	1	\$451	n/a	n/a	n/a	\$71
GSBOTP20V	20 x 20 x 1.19	100	13	1.5	\$565	n/a	n/a	n/a	\$86
GSBOTP22V	22 x 22 x 1.19	100	16	2	\$620	n/a	n/a	n/a	\$96

Solid Surface, flat edge ⁽³⁾⁽⁴⁾

GSBOTP16SF	16.5 x 16.5 x 1.25	65	14	0.6	\$1415	n/a	\$81	\$96	n/a
GSBOTP20SF	20 x 20 x 1.25	70	21	1	\$1697	n/a	\$121	\$96	n/a
GSBOTP22SF	22 x 22 x 1.25	65	26	1	\$1789	n/a	\$145	\$96	n/a

Solid Surface, knife edge ⁽³⁾⁽⁴⁾

GSBOTP16SK	16.5 x 16.5 x 1.25	65	14	0.6	\$1749	n/a	\$99	\$202	n/a
GSBOTP20SK	20 x 20 x 1.25	70	21	1	\$2043	n/a	\$128	\$202	n/a
GSBOTP22SK	22 x 22 x 1.25	65	26	1	\$2140	n/a	\$173	\$202	n/a

Only applicable base to use with above tops: GSOB13H25 square base with offset column (see 665). Tops feature metal inserts for ease of assembly to base. One base required.

Required Specifications

Top finish
Edge finish⁽¹⁾

Optional Specifications

HP laminate⁽¹⁾
Knife edge⁽²⁾
Grade 2 solid surface⁽³⁾
3" radiused corners⁽⁴⁾

Applicable Bases

GSOB13H25

S SWAP TABLES

RECTANGULAR LAPTOP TABLES FOR OFFSET BASE

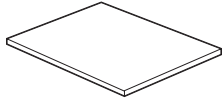

Rectangular Tops, for Offset Base

MODEL#	DIMENSIONS	FREIGHT CLASS	WT/LBS.	CUBIC FT.	LIST PRICE	HP ADD	GR. 2 ADD	R3 ADD	KS ADD
--------	------------	---------------	---------	-----------	------------	--------	-----------	--------	--------

D x W x H

TFL, flat edge ^{(1) (4)}

GSBOT1620	20 x 16 x 1	65	9	0.4	\$223	\$110	n/a	\$23	n/a
GSBOT1622	22 x 16 x 1	70	11	0.5	\$255	\$115	n/a	\$24	n/a

HPL, knife edge

GSBOT1620LK	16 x 20 x 1.19	125	11	1.5	\$451	n/a	n/a	n/a	n/a
GSBOT1622LK	16 x 22 x 1.19	125	13	2	\$495	n/a	n/a	n/a	n/a

Veneer ⁽²⁾

GSBOT1620V	16 x 20 x 1.19	125	11	1.5	\$556	n/a	n/a	n/a	\$86
GSBOT1622V	16 x 22 x 1.19	125	13	2	\$611	n/a	n/a	n/a	\$90

Solid Surface, flat edge ^{(3) (4)}

GSBOT1620SF	20 x 16 x 1.25	70	17	0.8	\$1571	n/a	\$99	\$96	n/a
GSBOT1622SF	22 x 16 x 1.25	65	19	0.8	\$1593	n/a	\$104	\$96	n/a

Solid Surface, knife edge ^{(3) (4)}

GSBOT1620SK	20 x 16 x 1.25	70	17	0.8	\$1887	n/a	\$121	\$202	n/a
GSBOT1622SK	22 x 16 x 1.25	65	19	0.8	\$1922	n/a	\$139	\$202	n/a

Only applicable base to use with above tops: GSOB13H25 square base with offset column (see 665). Tops feature metal inserts for ease of assembly to base. One base required.

Required Specifications

Top finish
Edge finish⁽¹⁾

Optional Specifications

HP laminate⁽¹⁾
Knife edge⁽²⁾
Grade 2 solid surface⁽³⁾
3" radiused corners⁽⁴⁾

Applicable Bases

GSOB13H25

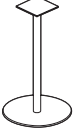
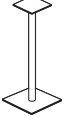
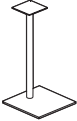
LAPTOP TABLE BASES	MODEL#	DIMENSIONS	FREIGHT CLASS	WT./LBS.	CUBIC FT.	LIST PRICE	CHM/BCH	ACO/SBR
 <p>14" Round Centered Base</p>  <p>12.5" Square Centered Base</p>  <p>12.5" Square Offset Base</p>		D x W x H						
	GRB14H25	14 x 14 x 24.5	150	17.54	3.5	\$749	\$86	\$209
	GSB13H25	12.5 x 12.5 x 24.5	150	17.11	3.5	\$775	\$86	\$226
	GSOB13H25	12.5 x 12.5 x 24.5	150	17.11	3.5	\$775	\$86	\$226
<p>1.5" diameter column. Weighted base for balance includes cover plate, 0.5" adjustable glides to level on uneven surfaces. Screws included with base for attaching to appropriate top(s). Available in paint finishes listed on 653; plated finishes as available on 653 (upcharge applies).</p>								

Required Specifications
Finish

Optional Specifications
Plated finish

S SWAP TABLES

ROUND TOPS, 24-36"



MODEL# DIMENSIONS FREIGHT CLASS WT/LBS. CUBIC FT. LIST PRICE HP ADD GR. 2 ADD R3 ADD KS ADD

D x W x H

TFL, flat edge ⁽¹⁾

GRBTP24	24 x 24 x 1	70	16	1	\$245	\$124	n/a	n/a	n/a
GRBTP30	30 x 30 x 1	70	25	1.5	\$283	\$143	n/a	n/a	n/a
GRBTP36	36 x 36 x 1	70	36	2	\$361	\$183	n/a	n/a	n/a

HPL, knife edge

GRBTP24LK	24 x 24 x 1.19	100	19	2	\$750	n/a	n/a	n/a	n/a
GRBTP30LK	30 x 30 x 1.19	92.5	30	3	\$940	n/a	n/a	n/a	n/a
GRBTP36LK	36 x 36 x 1.19	92.5	43	4	\$1126	n/a	n/a	n/a	n/a

Veneer ⁽²⁾

GRBTP24V	24 x 24 x 1.19	100	19	2	\$911	n/a	n/a	n/a	\$61
GRBTP30V	30 x 30 x 1.19	92.5	30	3	\$1101	n/a	n/a	n/a	\$75
GRBTP36V	36 x 36 x 1.19	92.5	43	4	\$1301	n/a	n/a	n/a	\$75

Solid Surface, flat edge ⁽³⁾

GRBTP24SF	24 x 24 x 1.25	70	24	1.2	\$2083	n/a	\$168	n/a	n/a
GRBTP30SF	29.8 x 29.8 x 1.25	70	37	1.8	\$2273	n/a	\$231	n/a	n/a
GRBTP36SF	36 x 36 x 1.25	70	53	2.5	\$2905	n/a	\$346	n/a	n/a

Solid Surface, knife edge ⁽³⁾

GRBTP24SK	24 x 24 x 1.25	70	24	1.2	\$2140	n/a	\$180	n/a	n/a
GRBTP30SK	29.8 x 29.8 x 1.25	70	37	1.8	\$2358	n/a	\$248	n/a	n/a
GRBTP36SK	36 x 36 x 1.25	70	53	2.5	\$3077	n/a	\$369	n/a	n/a

Round Tops, 24-36"

Only applicable bases to use with above tops: GRB22Hxx or GSB19Hxx round or square base @ 15", 21" 26", 28" 35" or 40.5"H (see 669). Tops feature metal inserts for ease of assembly to base. One base required.

Required Specifications

Top finish
Edge finish⁽¹⁾

Optional Specifications

HP laminate⁽¹⁾
Knife edge⁽²⁾
Grade 2 solid surface⁽³⁾

Applicable Bases

GRB22H15 GRB22H35 GSB19H26
GRB22H21 GRB22H41 GSB19
GRB22H26 GSB19H15 GSB19H35
GRB22 GSB19H21 GSB19H41

SQUARE TOPS, 24-36"

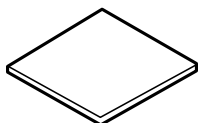

MODEL# DIMENSIONS FREIGHT CLASS WT/LBS. CUBIC FT. LIST PRICE HP ADD GR. 2 ADD R3 ADD KS ADD

D x W x H

TFL, flat edge ⁽¹⁾⁽⁴⁾

GSBTP24	24 x 24 x 1	70	20	1	\$252	\$128	n/a	\$26	n/a
GSBTP30	30 x 30 x 1	70	30	1.5	\$293	\$147	n/a	\$36	n/a
GSBTP36	36 x 36 x 1	70	44	2	\$371	\$186	n/a	\$38	n/a

HPL, knife edge

GSBTP24LK	24 x 24 x 1.19	85	24	2	\$675	n/a	n/a	n/a	n/a
GSBTP30LK	30 x 30 x 1.19	85	36	3	\$740	n/a	n/a	n/a	n/a
GSBTP36LK	36 x 36 x 1.19	85	53	4	\$801	n/a	n/a	n/a	n/a

Veneer ⁽²⁾

GSBTP24V	24 x 24 x 1.19	85	24	2	\$940	n/a	n/a	n/a	\$65
GSBTP30V	30 x 30 x 1.19	85	36	3	\$1001	n/a	n/a	n/a	\$71
GSBTP36V	36 x 36 x 1.19	85	53	4	\$1065	n/a	n/a	n/a	\$65

Solid Surface, flat edge ⁽³⁾⁽⁴⁾

GSBTP24SF	24 x 24 x 1.25	65	30	1.2	\$1841	n/a	\$173	\$96	n/a
GSBTP30SF	29.8 x 29.8 x 1.25	65	47	1.8	\$2273	n/a	\$231	\$96	n/a
GSBTP36SF	36 x 36 x 1.25	65	68	2.5	\$2956	n/a	\$282	\$96	n/a

Solid Surface, knife edge ⁽³⁾⁽⁴⁾

GSBTP24SK	24 x 24 x 1.25	65	30	1.2	\$1898	n/a	\$185	\$202	n/a
GSBTP30SK	29.8 x 29.8 x 1.25	65	47	1.8	\$2847	n/a	\$260	\$202	n/a
GSBTP36SK	36 x 36 x 1.25	65	68	2.5	\$3526	n/a	\$323	\$202	n/a

Square Tops, 24-36"

Only applicable bases to use with above tops: GRB22Hxx or GSB19Hxx round or square base @ 15", 21" 26", 28" 35" or 40.5"H (see 669). Tops feature metal inserts for ease of assembly to base. One base required. .

Required Specifications

Top finish
Edge finish⁽¹⁾

Optional Specifications

HP laminate⁽¹⁾, Knife edge⁽²⁾
Grade 2 solid surface⁽³⁾
3" radiused corners⁽⁴⁾

Applicable Bases

GRB22H15	GRB22H35	GSB19H26
GRB22H21	GRB22H41	GSB19
GRB22H26	GSB19H15	GSB19H35
GRB22	GSB19H21	GSB19H41

S SWAP TABLES

RECTANGULAR TOPS, SMALL

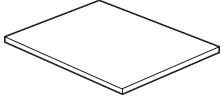

Rectangular Tops, small

MODEL# DIMENSIONS FREIGHT CLASS WT./LBS. CUBIC FT. LIST PRICE HP ADD GR. 2 ADD R3 ADD KS ADD

D x W x H

TFL, flat edge ^{(1) (4)}

GSBTP2430	24 x 30 x 1	70	20	0.91	\$281	\$128	n/a	\$29	n/a
GSBTP2436	24 x 36 x 1	70	24	1.08	\$305	\$139	n/a	\$31	n/a
GSBTP3036	30 x 36 x 1	65	31	1.34	\$353	\$160	n/a	\$36	n/a

HPL, knife edge

GSBTP2430LK	24 x 30 x 1.19	100	24	2.5	\$675	n/a	n/a	n/a	n/a
GSBTP2436LK	24 x 36 x 1.19	100	29	3	\$801	n/a	n/a	n/a	n/a
GSBTP3036LK	30 x 36 x 1.19	92.5	37	3.5	\$845	n/a	n/a	n/a	n/a

Veneer ⁽²⁾

GSBTP2430V	24 x 30 x 1.19	100	24	2.5	\$940	n/a	n/a	n/a	\$65
GSBTP2436V	24 x 36 x 1.19	100	29	3	\$1001	n/a	n/a	n/a	\$71
GSBTP3036V	30 x 36 x 1.19	92.5	37	3.5	\$1065	n/a	n/a	n/a	\$65

Solid Surface, flat edge ^{(3) (4)}

GSBTP2430SF	29.8 x 24 x 1.25	70	38	1.8	\$1991	n/a	\$173	\$96	n/a
GSBTP2436SF	36 x 24 x 1.25	70	45	2.1	\$2244	n/a	\$220	\$96	n/a
GSBTP3036SF	36 x 29.8 x 1.25	65	57	2.1	\$2548	n/a	\$242	\$96	n/a

Solid Surface, knife edge ^{(3) (4)}

GSBTP2430SK	29.8 x 24 x 1.25	70	38	1.8	\$2399	n/a	\$213	\$202	n/a
GSBTP2436SK	36 x 24 x 1.25	70	45	2.1	\$2605	n/a	\$265	\$202	n/a
GSBTP3036SK	36 x 29.8 x 1.25	65	57	2.1	\$2939	n/a	\$294	\$202	n/a

Applicable bases to use with above tops: GRB22Hxx or GSB19Hxx round or square base @ 15", 21" 26", 28" 35" or 40.5"H (see 669). Tops feature metal inserts for ease of assembly to base. One base required.

Required Specifications

Top finish
Edge finish⁽¹⁾

Optional Specifications

HP laminate⁽¹⁾, Knife edge⁽²⁾
Grade 2 solid surface⁽³⁾
3" radius corners⁽⁴⁾

Applicable Bases

GRB22H15 GRB22H35 GSB19H26
GRB22H21 GRB22H41 GSB19
GRB22H26 GSB19H15 GSB19H35
GRB22 GSB19H21 GSB19H41

BASES FOR TOPS 24"-36"

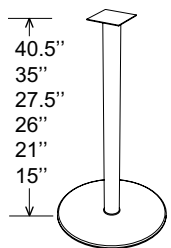

22" Dia Round Bases*

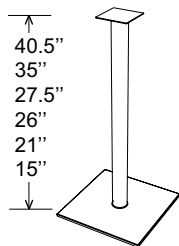

18.5" Square Bases*

MODEL#	DIMENSIONS	FREIGHT CLASS	WT./LBS.	CUBIC FT.	LIST PRICE	CHM/BCH	ACO/SBR
--------	------------	---------------	----------	-----------	------------	---------	---------

D x W x H

GRB22H15	22 x 22 x 15	92.5	47.6	4.69	\$907	\$147	\$270
GRB22H21	22 x 22 x 21	125	48.6	6.45	\$922	\$136	\$250
GRB22H26	22 x 22 x 26	150	50	8.63	\$934	\$147	\$270
GRB22	22 x 22 x 28	150	55	9.33	\$870	\$147	\$270
GRB22H35	22 x 22 x 35	150	57.1	12	\$912	\$145	\$308
GRB22H41	22 x 22 x 40.5	150	58.3	14	\$928	\$160	\$316

GRB22H15 - coffee table height

GRB22H21 - end table height

GRB22H26 - lounge height

GRB22 - seated height

GRB22H35 - counter height

GRB22H41 - bar height

GSB19H15	18.5 x 18.5 x 15	85	43.7	3.52	\$922	\$133	\$249
GSB19H21	18.5 x 18.5 x 21	100	44.8	4.84	\$934	\$133	\$249
GSB19H26	18.5 x 18.5 x 26	125	47	5.94	\$1004	\$133	\$259
GSB19	18.5 x 18.5 x 28	100	50	6.06	\$942	\$145	\$319
GSB19H35	18.5 x 18.5 x 35	125	51.8	7.52	\$999	\$145	\$319
GSB19H41	18.5 x 18.5 x 40.5	125	53.2	8.77	\$1034	\$160	\$319

GSB19H15 - coffee table height

GSB19H21 - end table height

GSB19H26 - lounge height

GSB19 - seated height

GSB19H35 - counter height

GSB19H41 - bar height

Base comes fully assembled and features 0.5" adjustable glides to level on uneven surfaces. Screws included with base for attaching to appropriate top(s). Available in paint finishes listed on 653; plated finishes as available on 653 (upcharge applies).

Required Specifications

Finish

Optional Specifications

Plated finish*

S SWAP TABLES

ROUND TOPS, 42"-48"



Round Tops, 42-48"

MODEL#	DIMENSIONS	FREIGHT CLASS	WT/LBS.	CUBIC FT.	LIST PRICE	HP ADD	GR. 2 ADD	R3 ADD	KS ADD
--------	------------	---------------	---------	-----------	------------	--------	-----------	--------	--------

D x W x H

TFL, flat edge ⁽¹⁾

GRBTP42	42 x 42 x 1	70	44	2.5	\$503	\$254	n/a	n/a	n/a
GRBTP48	48 x 48 x 1	70	56	3	\$537	\$269	n/a	n/a	n/a

HPL, knife edge

GRBTP42LK	42 x 42 x 1.19	92.5	53	5	\$1400	n/a	n/a	n/a	n/a
GRBTP48LK	48 x 48 x 1.19	92.5	67	6.5	\$1600	n/a	n/a	n/a	n/a

Veneer ⁽²⁾

GRBTP42V	42 x 42 x 1.19	92.5	53	5	\$1681	n/a	n/a	n/a	\$71
GRBTP48V	48 x 48 x 1.19	92.5	67	6.5	\$1921	n/a	n/a	n/a	\$80

Solid Surface, flat edge ⁽³⁾

GRBTP42SF	42 x 42 x 1.25	70	73	3.4	\$3939	n/a	\$443	n/a	n/a
GRBTP48SF	48 x 48 x 1.25	70	95	4.3	\$4486	n/a	\$564	n/a	n/a

Solid Surface, knife edge ⁽³⁾

GRBTP42SK	42 x 42 x 1.25	70	73	3.4	\$4147	n/a	\$495	n/a	n/a
GRBTP48SK	48 x 48 x 1.25	70	95	4.3	\$5003	n/a	\$628	n/a	n/a

Applicable bases to use with above tops: GRB28 or GSB23 round or square base @ 28" (see 672). Tops feature metal inserts for ease of assembly to base. One base required.

Required Specifications

Top finish
Edge finish⁽¹⁾

Optional Specifications

HP laminate⁽¹⁾
Knife edge⁽²⁾
Grade 2 solid surface⁽³⁾

Applicable Bases

GRB28
GSB23

SQUARE + RECTANGULAR TOPS, 42"

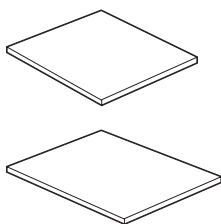

Square and Rectangular Tops

MODEL# DIMENSIONS FREIGHT CLASS WT/LBS. CUBIC FT. LIST PRICE HP ADD GR. 2 ADD R3 ADD KS ADD

D x W x H

TFL, flat edge ^{(1) (4)}

GSBTP3042	30 x 42 x 1	65	36	1.55	\$414	\$187	n/a	\$42	n/a
GSBTP3642	36 x 42 x 1	65	43	1.86	\$519	\$236	n/a	\$56	n/a
GSBTP42	42 x 42 x 1	65	58	2.5	\$512	\$259	n/a	\$52	n/a

HPL, knife edge

GSBTP3042LK	30 x 42 x 1.19	92.5	43	4	\$991	n/a	n/a	n/a	n/a
GSBTP3642LK	36 x 42 x 1.19	92.5	52	4.5	\$1050	n/a	n/a	n/a	n/a
GSBTP42LK	42 x 42 x 1.19	85	70	5	\$1096	n/a	n/a	n/a	n/a

Veneer ⁽²⁾

GSBTP3042V	30 x 42 x 1.19	92.5	43	4	\$1246	n/a	n/a	n/a	\$56
GSBTP3642V	36 x 42 x 1.19	92.5	52	4.5	\$1301	n/a	n/a	n/a	\$65
GSBTP42V	42 x 42 x 1.19	85	70	5	\$1525	n/a	n/a	n/a	\$71

Solid Surface, flat edge ^{(3) (4)}

GSBTP3042SF	42 x 29.8 x 1.25	65	66	2.9	\$2675	n/a	\$294	\$96	n/a
GSBTP3642SF	42 x 36 x 1.25	65	79	2.9	\$3434	n/a	\$393	\$96	n/a
GSBTP42SF	42 x 42 x 1.25	65	92	3.4	\$3577	n/a	\$426	\$96	n/a

Solid Surface, knife edge ^{(3) (4)}

GSBTP3042SK	42 x 29.8 x 1.25	65	66	2.9	\$3135	n/a	\$346	\$202	n/a
GSBTP3642SK	42 x 36 x 1.25	65	79	2.9	\$3963	n/a	\$467	\$202	n/a
GSBTP42SK	42 x 42 x 1.25	65	92	3.4	\$4147	n/a	\$519	\$202	n/a

Applicable bases to use with above tops: GRB28 or GSB23 round or square base @ 28" (see 672). Tops feature metal inserts for ease of assembly to base. One base required.

Required Specifications

Top finish
Edge finish⁽¹⁾

Optional Specifications

HP laminate⁽¹⁾
Knife edge⁽²⁾
Grade 2 solid surface⁽³⁾
3" radiused corners⁽⁴⁾

Applicable Bases

GRB28
GSB23

S SWAP TABLES

BASES FOR TOPS 42" - 48"

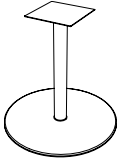

28" Round Base

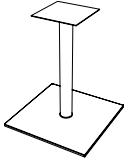

23" Square Base

MODEL# DIMENSIONS FREIGHT CLASS WT/LBS. CUBIC FT. LIST PRICE CHM/BCH ACO/SBR

D x W x H

GRB28	28 x 28 x 28	125	100	15.63	\$1498	\$160	\$452
-------	--------------	-----	-----	-------	---------------	--------------	--------------

seated height

GSB23	22.5 x 22.5 x 28	100	82	9.33	\$1377	\$89	\$287
-------	------------------	-----	----	------	---------------	-------------	--------------

seated height

Base comes fully assembled and features 0.5" adjustable glides to level on uneven surfaces. Screws included with base for attaching to appropriate top(s). Available in paint finishes listed on 653; plated finishes as available on 653 (upcharge applies).

Required Specifications
Finish

Optional Specifications
Plated finish

ROUND TOPS, 54"-60"



MODEL#	DIMENSIONS D x W x H	FREIGHT CLASS	WT/LBS.	CUBIC FT.	LIST PRICE	HP ADD	GR. 2 ADD	R3 ADD	KS ADD
TFL, flat edge ⁽¹⁾									
GRBTP54	54 x 54 x 1	70	73	4.5	\$717	\$360	n/a	n/a	n/a
GRBTP60	60 x 60 x 1	70	92	5	\$741	\$373	n/a	n/a	n/a
HPL, knife edge									
GRBTP54LK	54 x 54 x 1.19	92.5	88	8	\$1805	n/a	n/a	n/a	n/a
GRBTP60LK	60 x 60 x 1.19	92.5	110	10	\$2225	n/a	n/a	n/a	n/a
Veneer ⁽²⁾									
GRBTP54V	54 x 54 x 1.19	92.5	88	8	\$2451	n/a	n/a	n/a	\$96
GRBTP60V	60 x 60 x 1.19	92.5	110	10	\$3026	n/a	n/a	n/a	\$104
Solid Surface, flat edge ⁽³⁾									
GRBTP54SF	54 x 54 x 1.25	70	120	5.4	\$4859	n/a	\$691	n/a	n/a
GRBTP60SF	60 x 60 x 1.25	70	148	6.7	\$6383	n/a	\$863	n/a	n/a
Solid Surface, knife edge ⁽³⁾									
GRBTP54SK	54 x 54 x 1.25	70	120	5.4	\$5745	n/a	\$869	n/a	n/a
GRBTP60SK	60 x 60 x 1.25	70	148	6.7	\$7028	n/a	\$1053	n/a	n/a

Round Tops, 54"-60"

Applicable bases to use with above tops: GRB34 or GSB28 round or square base @ 28" (see 674). Tops feature metal inserts for ease of assembly to base. One base required.

Required Specifications

Top finish
Edge finish⁽¹⁾

Optional Specifications

HP laminate⁽¹⁾
Knife edge⁽²⁾
Grade 2 solid surface⁽³⁾

Applicable Bases

GRB34
GSB28

S SWAP TABLES

BASES FOR TOPS 54" - 60" ROUND

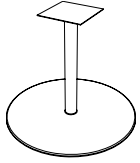

34" Round Base

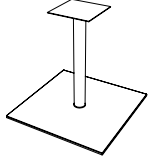

28" Square Base

MODEL#	DIMENSIONS	FREIGHT CLASS	WT./LBS.	CUBIC FT.	LIST PRICE	CHM/BCH	ACO/SBR
--------	------------	---------------	----------	-----------	------------	---------	---------

D x W x H							
GRB34	34 x 34 x 28	125	135	20.56	\$1831	\$160	\$546
seated height							

GSB28	28.5 x 28.5 x 28	125	125	15.63	\$1710	\$75	\$295
seated height							

Base comes fully assembled and features 0.5" adjustable glides to level on uneven surfaces. Screws included with base for attaching to appropriate top(s). Available in paint finishes listed on 653; plated finishes as available on 653 (upcharge applies).

Required Specifications
Finish

Optional Specifications
Plated finish

RECTANGULAR LOUNGE TOPS, 24"D

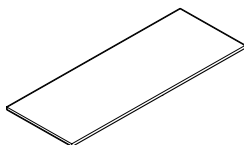

MODEL# DIMENSIONS FREIGHT CLASS WT/LBS. CUBIC FT. LIST PRICE HP ADD GR. 2 ADD R3 ADD KS ADD

D x W x H

TFL, flat edge ⁽¹⁾⁽⁴⁾

GRT5STP	24 x 60 x 1	65	41	1.79	\$472	\$214	n/a	\$48	n/a
GRT5HSTP	24 x 66 x 1	65	46	1.97	\$552	\$252	n/a	\$56	n/a
GRT6STP	24 x 72 x 1	65	49	2.14	\$576	\$260	n/a	\$58	n/a
GRT7STP	24 x 84 x 1	65	57	2.49	\$666	\$302	n/a	\$67	n/a
GRT8STP	24 x 96 x 1	65	66	2.84	\$715	\$322	n/a	\$72	n/a

HPL, knife edge

GRT5STPLK	24 x 60 x 1.19	85	49	4	\$1001	n/a	n/a	n/a	n/a
GRT5HSTPLK	24 x 66 x 1.19	85	55	4.5	\$1065	n/a	n/a	n/a	n/a
GRT6STPLK	24 x 72 x 1.19	92.5	59	5	\$1126	n/a	n/a	n/a	n/a
GRT7STPLK	24 x 84 x 1.19	85	68	5.5	\$1250	n/a	n/a	n/a	n/a
GRT8STPLK	24 x 96 x 1.19	85	79	6.5	\$1425	n/a	n/a	n/a	n/a

Veneer ⁽²⁾

GRT5STPV	24 x 60 x 1.19	85	49	4	\$1250	n/a	n/a	n/a	\$65
GRT5HSTPV	24 x 66 x 1.19	85	55	4.5	\$1316	n/a	n/a	n/a	\$65
GRT6STPV	24 x 72 x 1.19	92.5	59	5	\$1440	n/a	n/a	n/a	\$65
GRT7STPV	24 x 84 x 1.19	85	68	5.5	\$1691	n/a	n/a	n/a	\$65
GRT8STPV	24 x 96 x 1.19	85	79	6.5	\$1940	n/a	n/a	n/a	\$65

Solid Surface, flat edge ⁽³⁾⁽⁴⁾

GRT5STPSF	24 x 60 x 1.25	65	75	2.8	\$3854	n/a	\$432	\$96	n/a
GRT5HSTPSF	24 x 66 x 1.25	65	83	3.1	\$4026	n/a	\$443	\$96	n/a
GRT6STPSF	24 x 71.8 x 1.25	65	90	3.3	\$4245	n/a	\$455	\$96	n/a
GRT7STPSF	24 x 84 x 1.25	65	105	3.9	\$4716	n/a	\$593	\$96	n/a
GRT8STPSF	24 x 96 x 1.25	65	120	4.4	\$5176	n/a	\$605	\$96	n/a

Solid Surface, knife edge ⁽³⁾⁽⁴⁾

GRT5STPSK	24 x 60 x 1.25	65	75	2.8	\$4342	n/a	\$461	\$202	n/a
GRT5HSTPSK	24 x 66 x 1.25	65	83	3.1	\$4515	n/a	\$484	\$202	n/a
GRT6STPSK	24 x 71.8 x 1.25	65	90	3.3	\$4733	n/a	\$507	\$202	n/a
GRT7STPSK	24 x 84 x 1.25	65	105	3.9	\$5394	n/a	\$656	\$202	n/a
GRT8STPSK	24 x 96 x 1.25	65	120	4.4	\$5871	n/a	\$680	\$202	n/a

Applicable bases to use with above tops: GRB22Hxx round or GSB19Hxx square base @ 26"H, 35"H & 40.5"H (see 680). Tops feature metal inserts for ease of assembly to base. Two bases required. 24"D tops not recommended with 28"H bases.

Rectangular Lounge Tops

Required Specifications

Top finish
Edge finish⁽¹⁾

Optional Specifications

HP laminate⁽¹⁾, Knife edge⁽²⁾
Grade 2 solid surface⁽³⁾
3" radiused corners⁽⁴⁾
Cut-out for grommet/power blocks

Applicable Bases

GRB22H26 GSB19H26
GRB22H35 GSB19H35
GRB22H41 GSB19H41

S SWAP TABLES

RACETRACK TOPS, 24"D

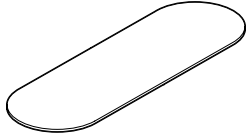

Racetrack Tops, 24"D

MODEL#	DIMENSIONS	FREIGHT CLASS	WT/LBS.	CUBIC FT.	LIST PRICE	HP ADD	GR. 2 ADD	R3 ADD	KS ADD
--------	------------	---------------	---------	-----------	------------	--------	-----------	--------	--------

D x W x H

TFL, flat edge ⁽¹⁾

GRC5STP	24 x 60 x 1	65	41	1.79	\$472	\$214	n/a	n/a	n/a
GRC5HSTP	24 x 66 x 1	65	46	1.97	\$552	\$252	n/a	n/a	n/a
GRC6STP	24 x 72 x 1	65	49	2.14	\$576	\$260	n/a	n/a	n/a
GRC7STP	24 x 84 x 1	65	57	2.49	\$666	\$302	n/a	n/a	n/a
GRC8STP	24 x 96 x 1	65	66	2.84	\$715	\$322	n/a	n/a	n/a

HPL, knife edge

GRC5STPLK	24 x 60 x 1.19	85	49	4	\$1250	n/a	n/a	n/a	n/a
GRC5HSTPLK	24 x 66 x 1.19	85	55	4.5	\$1375	n/a	n/a	n/a	n/a
GRC6STPLK	24 x 72 x 1.19	92.5	59	5	\$1501	n/a	n/a	n/a	n/a
GRC7STPLK	24 x 84 x 1.19	85	68	5.5	\$1626	n/a	n/a	n/a	n/a
GRC8STPLK	24 x 96 x 1.19	85	79	6.5	\$1750	n/a	n/a	n/a	n/a

Veneer ⁽²⁾

GRC5STPV	24 x 60 x 1.19	85	49	4	\$1501	n/a	n/a	n/a	\$225
GRC5HSTPV	24 x 66 x 1.19	85	55	4.5	\$1651	n/a	n/a	n/a	\$250
GRC6STPV	24 x 72 x 1.19	92.5	59	5	\$1801	n/a	n/a	n/a	\$270
GRC7STPV	24 x 84 x 1.19	85	68	5.5	\$2100	n/a	n/a	n/a	\$270
GRC8STPV	24 x 96 x 1.19	85	79	6.5	\$2400	n/a	n/a	n/a	\$270

Applicable bases to use with above tops: GRB22Hxx round or GSB19Hxx square base @ 26"H, 35"H & 40.5"H (see 680). Tops feature metal inserts for ease of assembly to base. **Two bases required.** 24"D tops not recommended with 28"H bases.

Required Specifications

Top finish
Edge finish⁽¹⁾

Optional Specifications

HP laminate⁽¹⁾, Knife edge⁽²⁾
Grade 2 solid surface⁽³⁾
3" radiused corners⁽⁴⁾
Cut-out for grommet/power blocks

Applicable Bases, two required

GRB22H26 GSB19H26
GRB22 GSB19
GRB22H35 GSB19H35
GRB22H41 GSB19H41

RECTANGULAR TOPS, 60"-96"W

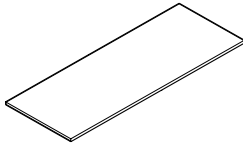

MODEL#	DIMENSIONS	FREIGHT CLASS	WT/LBS.	CUBIC FT.	LIST PRICE	HP ADD	GR. 2 ADD	R3 ADD	KS ADD
--------	------------	---------------	---------	-----------	------------	--------	-----------	--------	--------

D x W x H

TFL, flat edge ^{(1) (4)}

GRT5NTP	30 x 60 x 1	70	46	2.5	\$538	\$272	n/a	\$54	n/a
GRT5NHTP	30 x 66 x 1	65	56	2.44	\$543	\$246	n/a	\$55	n/a
GRT6NTP	30 x 72 x 1	70	62	3	\$584	\$294	n/a	\$59	n/a
GRT7NTP	30 x 84 x 1	100	72	7.5	\$727	\$366	n/a	\$73	n/a
GRT8NTP	30 x 96 x 1	100	80	8.5	\$791	\$397	n/a	\$80	n/a
GRT5TP	36 x 60 x 1	92.5	70	6.6	\$551	\$248	n/a	\$56	n/a
GRT5HTP	36 x 66 x 1	92.5	79	7.21	\$580	\$263	n/a	\$58	n/a
GRT6TP	36 x 72 x 1	100	72	8	\$673	\$337	n/a	\$68	n/a
GRT7TP	36 x 84 x 1	100	85	8.75	\$782	\$394	n/a	\$79	n/a
GRT8TP	36 x 96 x 1	92.5	94	9	\$856	\$431	n/a	\$86	n/a

HPL, knife edge

GRT5NTPLK	30 x 60 x 1.19	92.5	55	5	\$1115	n/a	n/a	n/a	n/a
GRT5NHTPLK	30 x 66 x 1.19	85	67	5.5	\$1225	n/a	n/a	n/a	n/a
GRT6NTPLK	30 x 72 x 1.19	85	74	6	\$1341	n/a	n/a	n/a	n/a
GRT7NTPLK	30 x 84 x 1.19	85	86	7	\$1556	n/a	n/a	n/a	n/a
GRT8NTPLK	30 x 96 x 1.19	85	96	8	\$1780	n/a	n/a	n/a	n/a
GRT5TPLK	36 x 60 x 1.19	85	84	6	\$1341	n/a	n/a	n/a	n/a
GRT5HTPLK	36 x 66 x 1.19	85	95	6.5	\$1470	n/a	n/a	n/a	n/a
GRT6TPLK	36 x 72 x 1.19	85	86	7	\$1605	n/a	n/a	n/a	n/a
GRT7TPLK	36 x 84 x 1.19	85	102	8	\$1870	n/a	n/a	n/a	n/a
GRT8TPLK	36 x 96 x 1.19	85	113	9	\$2140	n/a	n/a	n/a	n/a

Veneer ⁽²⁾

GRT5NTPV	30 x 60 x 1.19	92.5	55	5	\$1550	n/a	n/a	n/a	\$75
GRT5NHTPV	30 x 66 x 1.19	85	67	5.5	\$1655	n/a	n/a	n/a	\$75
GRT6NTPV	30 x 72 x 1.19	85	74	6	\$1780	n/a	n/a	n/a	\$96
GRT7NTPV	30 x 84 x 1.19	85	86	7	\$2081	n/a	n/a	n/a	\$111
GRT8NTPV	30 x 96 x 1.19	85	96	8	\$2375	n/a	n/a	n/a	\$126
GRT5TPV	36 x 60 x 1.19	85	84	6	\$1780	n/a	n/a	n/a	\$96
GRT5HTPV	36 x 66 x 1.19	85	95	6.5	\$1951	n/a	n/a	n/a	\$126
GRT6TPV	36 x 72 x 1.19	85	86	7	\$2126	n/a	n/a	n/a	\$141
GRT7TPV	36 x 84 x 1.19	85	102	8	\$2480	n/a	n/a	n/a	\$175
GRT8TPV	36 x 96 x 1.19	85	113	9	\$2841	n/a	n/a	n/a	\$175

Solid Surface, flat edge ^{(3) (4)}

GRT5NTPSF	29.8 x 60 x 1.25	65	94	3.4	\$4015	n/a	\$426	\$96	n/a
GRT5NHTPSF	29.8 x 66 x 1.25	65	104	3.8	\$4308	n/a	\$495	\$96	n/a
GRT6NTPSF	29.8 x 71.8 x 1.25	65	113	4.1	\$4918	n/a	\$691	\$96	n/a
GRT7NTPSF	29.8 x 84 x 1.25	65	132	4.8	\$5705	n/a	\$680	\$96	n/a
GRT8NTPSF	29.8 x 96 x 1.25	65	150	5.4	\$6280	n/a	\$881	\$96	n/a
GRT5TPSF	36 x 60 x 1.25	65	113	4.1	\$5343	n/a	\$633	\$96	n/a
GRT5HTPSF	36 x 66 x 1.25	65	124	4.5	\$5515	n/a	\$633	\$96	n/a
GRT6TPSF	36 x 71.8 x 1.25	65	135	4.9	\$6091	n/a	\$691	\$96	n/a
GRT7TPSF	36 x 84 x 1.25	65	158	5.7	\$6625	n/a	\$834	\$96	n/a
GRT8TPSF	36 x 96 x 1.25	65	180	6.5	\$7108	n/a	\$875	\$96	n/a

Solid Surface, knife edge ^{(3) (4)}

GRT5NTPSK	29.8 x 60 x 1.25	65	94	3.4	\$4394	n/a	\$484	\$202	n/a
GRT5NHTPSK	29.8 x 66 x 1.25	65	104	3.8	\$4745	n/a	\$564	\$202	n/a
GRT6NTPSK	29.8 x 71.8 x 1.25	65	113	4.1	\$5349	n/a	\$772	\$202	n/a
GRT7NTPSK	29.8 x 84 x 1.25	65	132	4.8	\$6136	n/a	\$772	\$202	n/a
GRT8NTPSK	29.8 x 96 x 1.25	65	150	5.4	\$6815	n/a	\$984	\$202	n/a
GRT5TPSK	36 x 60 x 1.25	65	113	4.1	\$5918	n/a	\$714	\$202	n/a
GRT5HTPSK	36 x 66 x 1.25	65	124	4.5	\$6067	n/a	\$725	\$202	n/a
GRT6TPSK	36 x 71.8 x 1.25	65	135	4.9	\$6722	n/a	\$794	\$202	n/a
GRT7TPSK	36 x 84 x 1.25	65	158	5.7	\$7263	n/a	\$950	\$202	n/a
GRT8TPSK	36 x 96 x 1.25	65	180	6.5	\$7734	n/a	\$1002	\$202	n/a

Applicable bases to use with above tops, TWO bases required: rounds GRB22H26, GRB22, GRB22H35, GRB22H41, or squares GSB19H26, GSB19, GSB19H35, GSB19H41(see 680). Tops feature metal inserts for ease of assembly to base.

Rectangular Tops*

Required Specifications

Top finish
Edge finish⁽¹⁾

Optional Specifications

HP laminate⁽¹⁾, Knife edge⁽²⁾
Grade 2 solid surface⁽³⁾
3" radiused corners⁽⁴⁾
Cut-out for grommet/power blocks

Applicable Bases, two required

GRB22H26 GSB19H26
GRB22 GSB19
GRB22H35 GSB19H35
GRB22H41 GSB19H41

RACETRACK TOPS, 60"-96"W

MODEL# DIMENSIONS FREIGHT CLASS WT/LBS. CUBIC FT. LIST PRICE HP ADD GR. 2 ADD R3 ADD KS ADD

D x W x H

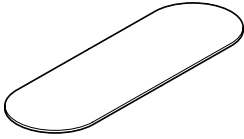
**TFL, flat edge ⁽¹⁾**

GRC5NTP	30 x 60 x 1	70	46	2.5	\$547	\$275	n/a	n/a	n/a
GRC5NHTP	30 x 66 x 1	65	56	2.44	\$553	\$252	n/a	n/a	n/a
GRC6NTP	30 x 72 x 1	70	62	3	\$594	\$299	n/a	n/a	n/a
GRC7NTP	30 x 84 x 1	100	72	7.5	\$740	\$372	n/a	n/a	n/a
GRC8NTP	30 x 96 x 1	100	80	8.5	\$807	\$405	n/a	n/a	n/a
GRC5TP	36 x 60 x 1	92.5	70	6.6	\$562	\$255	n/a	n/a	n/a
GRC5HTP	36 x 66 x 1	92.5	79	7.21	\$591	\$267	n/a	n/a	n/a
GRC6TP	36 x 72 x 1	100	72	7.5	\$684	\$344	n/a	n/a	n/a
GRC7TP	36 x 84 x 1	100	85	8.75	\$799	\$401	n/a	n/a	n/a
GRC8TP	36 x 96 x 1	92.5	94	9	\$873	\$438	n/a	n/a	n/a

HPL, knife edge

GRC5NTPLK	30 x 60 x 1.19	92.5	55	5	\$1560	n/a	n/a	n/a	n/a
GRC5NHTPLK	30 x 66 x 1.19	85	67	5.5	\$1710	n/a	n/a	n/a	n/a
GRC6NTPLK	30 x 72 x 1.19	85	74	6	\$1870	n/a	n/a	n/a	n/a
GRC7NTPLK	30 x 84 x 1.19	85	86	7	\$2010	n/a	n/a	n/a	n/a
GRC8NTPLK	30 x 96 x 1.19	85	96	8	\$2160	n/a	n/a	n/a	n/a
GRC5TPLK	36 x 60 x 1.19	85	84	6	\$1710	n/a	n/a	n/a	n/a
GRC5HTPLK	36 x 66 x 1.19	85	95	6.5	\$1860	n/a	n/a	n/a	n/a
GRC6TPLK	36 x 72 x 1.19	85	86	7	\$2020	n/a	n/a	n/a	n/a
GRC7TPLK	36 x 84 x 1.19	85	102	8	\$2320	n/a	n/a	n/a	n/a
GRC8TPLK	36 x 96 x 1.19	85	113	9	\$2621	n/a	n/a	n/a	n/a

Veneer ⁽²⁾

GRC5NTPV	30 x 60 x 1.19	92.5	55	5	\$1765	n/a	n/a	n/a	\$265
GRC5NHTPV	30 x 66 x 1.19	85	67	5.5	\$1906	n/a	n/a	n/a	\$286
GRC6NTPV	30 x 72 x 1.19	85	74	6	\$2050	n/a	n/a	n/a	\$305
GRC7NTPV	30 x 84 x 1.19	85	86	7	\$2396	n/a	n/a	n/a	\$356
GRC8NTPV	30 x 96 x 1.19	85	96	8	\$2731	n/a	n/a	n/a	\$405
GRC5TPV	36 x 60 x 1.19	85	84	6	\$2050	n/a	n/a	n/a	\$305
GRC5HTPV	36 x 66 x 1.19	85	95	6.5	\$2246	n/a	n/a	n/a	\$335
GRC6TPV	36 x 72 x 1.19	85	86	7	\$2446	n/a	n/a	n/a	\$366
GRC7TPV	36 x 84 x 1.19	85	102	8	\$2856	n/a	n/a	n/a	\$366
GRC8TPV	36 x 96 x 1.19	85	113	9	\$3265	n/a	n/a	n/a	\$485

Racetrack Tops, 60"-96"W

Applicable bases to use with above tops, TWO bases required: rounds GRB22H26, GRB22, GRB22H35, GRB22H41, or squares GSB19H26, GSB19, GSB19H35, GSB19H41 (see 680). Tops feature metal inserts for ease of assembly to base.

Required Specifications

Top finish
Edge finish⁽¹⁾

Optional Specifications

HP laminate⁽¹⁾
Knife edge⁽²⁾
Cut-out for grommet/power blocks

Applicable Bases, two required

GRB22H26 GSB19H26
GRB22 GSB19
GRB22H35 GSB19H35
GRB22H41 GSB19H41

BOAT SHAPED, 60"-96"W

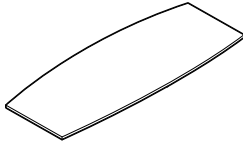

MODEL#	DIMENSIONS	FREIGHT CLASS	WT/LBS.	CUBIC FT.	LIST PRICE	HP ADD	GR. 2 ADD	R3 ADD	KS ADD
--------	------------	---------------	---------	-----------	------------	--------	-----------	--------	--------

D x W x H

TFL, flat edge ⁽¹⁾

GBT5NTP	30 x 60 x 1	70	46	2.5	\$547	\$275	n/a	n/a	n/a
GBT5NHTP	30 x 66 x 1	65	56	2.44	\$553	\$252	n/a	n/a	n/a
GBT6NTP	30 x 72 x 1	70	62	3	\$594	\$299	n/a	n/a	n/a
GBT7NTP	30 x 84 x 1	100	72	7.5	\$740	\$372	n/a	n/a	n/a
GBT8NTP	30 x 96 x 1	100	80	8.5	\$807	\$405	n/a	n/a	n/a
GBT5TP	36 x 60 x 1	92.5	70	6.6	\$562	\$255	n/a	n/a	n/a
GBT5HTP	36 x 66 x 1	92.5	79	7.21	\$591	\$267	n/a	n/a	n/a
GBT6TP	36 x 72 x 1	100	72	7.5	\$684	\$344	n/a	n/a	n/a
GBT7TP	36 x 84 x 1	100	85	8.75	\$799	\$401	n/a	n/a	n/a
GBT8TP	36 x 96 x 1	92.5	94	9	\$873	\$438	n/a	n/a	n/a

HPL, knife edge

GBT5NTPLK	30 x 60 x 1.19	92.5	55	5	\$1560	n/a	n/a	n/a	n/a
GBT5NHTPLK	30 x 66 x 1.19	85	67	5.5	\$1710	n/a	n/a	n/a	n/a
GBT6NTPLK	30 x 72 x 1.19	85	74	6	\$1870	n/a	n/a	n/a	n/a
GBT7NTPLK	30 x 84 x 1.19	85	86	7	\$2010	n/a	n/a	n/a	n/a
GBT8NTPLK	30 x 96 x 1.19	85	96	8	\$2160	n/a	n/a	n/a	n/a
GBT5TPLK	36 x 60 x 1.19	85	84	6	\$1710	n/a	n/a	n/a	n/a
GBT5HTPLK	36 x 66 x 1.19	85	95	6.5	\$1860	n/a	n/a	n/a	n/a
GBT6TPLK	36 x 72 x 1.19	85	86	7	\$2020	n/a	n/a	n/a	n/a
GBT7TPLK	36 x 84 x 1.19	85	102	8	\$2320	n/a	n/a	n/a	n/a
GBT8TPLK	36 x 96 x 1.19	85	113	9	\$2621	n/a	n/a	n/a	n/a

Veneer ⁽²⁾

GBT5NTPV	30 x 60 x 1.19	92.5	55	5	\$1765	n/a	n/a	n/a	\$265
GBT5NHTPV	30 x 66 x 1.19	85	67	5.5	\$1906	n/a	n/a	n/a	\$286
GBT6NTPV	30 x 72 x 1.19	85	74	6	\$2050	n/a	n/a	n/a	\$305
GBT7NTPV	30 x 84 x 1.19	85	86	7	\$2396	n/a	n/a	n/a	\$356
GBT8NTPV	30 x 96 x 1.19	85	96	8	\$2731	n/a	n/a	n/a	\$405
GBT5TPV	36 x 60 x 1.19	85	84	6	\$2050	n/a	n/a	n/a	\$305
GBT5HTPV	36 x 66 x 1.19	85	95	6.5	\$2246	n/a	n/a	n/a	\$335
GBT6TPV	36 x 72 x 1.19	85	86	7	\$2446	n/a	n/a	n/a	\$366
GBT7TPV	36 x 84 x 1.19	85	102	8	\$2856	n/a	n/a	n/a	\$426
GBT8TPV	36 x 96 x 1.19	85	113	9	\$3265	n/a	n/a	n/a	\$485

Boat-Shaped Tops, 60"-96"W

Applicable bases to use with above tops, TWO bases required: rounds GRB22H26, GRB22, GRB22H35, GRB22H41, OR squares GSB19H26, GSB19, GSB19H35, GSB19H41 (see 680). Tops feature metal inserts for ease of assembly to base.

- GBTxNPT - 30"D at center, 24"D at ends; GBTxTP - 36"D at center, 28"D at ends.

Required Specifications

Top finish
Edge finish⁽¹⁾

Optional Specifications

HP laminate⁽¹⁾
Knife edge⁽²⁾
Cut-out for grommet/power blocks

Applicable Bases, two required

GRB22H26	GSB19H26
GRB22	GSB19
GRB22H35	GSB19H35
GRB22H41	GSB19H41

BASES FOR TOPS 60" - 96" WIDE

MODEL#

DIMENSIONS

FREIGHT CLASS

WT./LBS.

CUBIC FT.

LIST PRICE

CHM/BCH

ACO/SBR

D x W x H

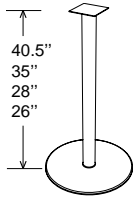

22" Dia Round Bases

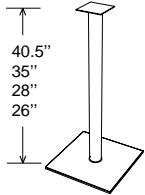

18.5" Square Bases

MODEL#	DIMENSIONS	FREIGHT CLASS	WT./LBS.	CUBIC FT.	LIST PRICE	CHM/BCH	ACO/SBR
GRB22H26	22 x 22 x 26	150	50	8.63	\$934	\$147	\$270
GRB22	22 x 22 x 28	150	55	9.33	\$870	\$147	\$270
GRB22H35	22 x 22 x 35	150	57.1	12	\$912	\$145	\$308
GRB22H41	22 x 22 x 40.5	150	58.3	14	\$928	\$160	\$316

GRB22H26 - lounge height

GRB22 - seated height

GRB22H35 - counter height

GRB22H41 - bar height

MODEL#	DIMENSIONS	FREIGHT CLASS	WT./LBS.	CUBIC FT.	LIST PRICE	CHM/BCH	ACO/SBR
GSB19H26	18.5 x 18.5 x 26	125	47	5.94	\$1004	\$133	\$259
GSB19	18.5 x 18.5 x 28	100	50	6.06	\$942	\$145	\$319
GSB19H35	18.5 x 18.5 x 35	125	51.8	7.52	\$999	\$145	\$319
GSB19H41	18.5 x 18.5 x 40.5	125	53.2	8.77	\$1034	\$160	\$319

GSB19H26 - lounge height

GSB19 - seated height

GSB19H35 - counter height

GSB19H41 - bar height

Base comes fully assembled and features 0.5" adjustable glides to level on uneven surfaces. Screws included with base for attaching to appropriate top(s). Available in paint finishes listed on 653; plated finishes as available on 653 (upcharge applies).

Required Specifications

Finish

Optional Specifications

Plated finish

RECTANGULAR TOPS 96" - 144"

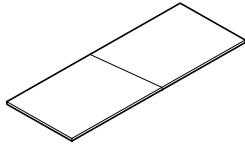

MODEL# DIMENSIONS FREIGHT CLASS WT/LBS. CUBIC FT. LIST PRICE HP ADD GR. 2 ADD R3 ADD KS ADD

D x W x H

TFL, flat edge ⁽¹⁾⁽⁴⁾

1 Piece top - 2 bases required

GRT8MTP	42 x 96 x 1	92.5	128	11.84	\$1442	\$652	n/a	\$145	n/a
GRT8WTP	48 x 96 x 1	85	190	14	\$1460	\$556	n/a	\$147	n/a

2 Piece tops - 3 bases required

GRT10WTP	48 x 120 x 1	85	220	17	\$1836	\$744	n/a	\$184	n/a
GRT12WTP	48 x 144 x 1	65	262	10.5	\$2139	\$842	n/a	\$214	n/a

HPL, knife edge

1 Piece top - 2 bases required

GRT8MTPLK	42 x 96 x 1.19	85	154	11	\$2925	n/a	n/a	n/a	n/a
GRT8WTPLK	48 x 96 x 1.19	70	228	12	\$3280	n/a	n/a	n/a	n/a

2 Piece tops - 3 bases required

GRT10WTPLK	48 x 120 x 1.19	70	264	15	\$4450	n/a	n/a	n/a	n/a
GRT12WTPLK	48 x 144 x 1.19	70	314	18	\$5326	n/a	n/a	n/a	n/a

Veneer ⁽²⁾

1 Piece top - 2 bases required

GRT8MTPV	42 x 96 x 1.19	85	154	11	\$3741	n/a	n/a	n/a	\$371
GRT8WTPV	48 x 96 x 1.19	70	228	12	\$4216	n/a	n/a	n/a	\$421

2 Piece tops - 3 bases required

GRT10WTPV	48 x 120 x 1.19	70	264	15	\$5615	n/a	n/a	n/a	\$561
GRT12WTPV	48 x 144 x 1.19	70	314	18	\$6720	n/a	n/a	n/a	\$670

Applicable bases to use with above tops: round GRB28 or square GSB23. TWO bases required for 96"W tops or THREE bases required for 120" & 144"W tops (see 684). Tops feature metal inserts for ease of assembly to base.

Rectangular Tops, 96-144"

Required Specifications

Top finish
Edge finish⁽¹⁾

Optional Specifications

HP laminate⁽¹⁾
Knife edge⁽²⁾
3" radiused corners⁽⁴⁾
Cut-out for grommet/power blocks

Applicable Bases

GRB28
GSB23

S SWAP TABLES

RACETRACK TOPS 96" - 144"

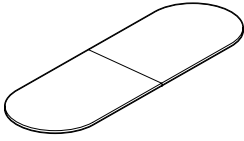

Racetrack Tops, 96-144"

MODEL#	DIMENSIONS	FREIGHT CLASS	WT/LBS.	CUBIC FT.	LIST PRICE	HP ADD	GR. 2 ADD	R3 ADD	KS ADD
D x W x H									
TFL, flat edge ⁽¹⁾									
1 Piece top - 2 bases required									
GRC8MTP	42 x 96 x 1	92.5	128	11.84	\$1442	\$652	n/a	n/a	n/a
GRC8WTP	48 x 96 x 1	85	190	14	\$1460	\$566	n/a	n/a	n/a
2 Piece tops - 3 bases required									
GRC10WTP	48 x 120 x 1	85	220	17	\$1836	\$760	n/a	n/a	n/a
GRC12WTP	48 x 144 x 1	85	262	21	\$2139	\$859	n/a	n/a	n/a
HPL, knife edge									
1 Piece top - 2 bases required									
GRC8MTPLK	42 x 96 x 1.19	85	154	11	\$3501	n/a	n/a	n/a	n/a
GRC8WTPLK	48 x 96 x 1.19	70	228	12	\$4001	n/a	n/a	n/a	n/a
2 Piece tops - 3 bases required									
GRC10WTPLK	48 x 120 x 1.19	70	264	15	\$5001	n/a	n/a	n/a	n/a
GRC12WTPLK	48 x 144 x 1.19	70	314	18	\$6001	n/a	n/a	n/a	n/a
Veneer ⁽²⁾									
1 Piece top - 2 bases required									
GRC8MTPV	42 x 96 x 1.19	85	154	11	\$4450	n/a	n/a	n/a	\$445
GRC8WTPV	48 x 96 x 1.19	70	228	12	\$4950	n/a	n/a	n/a	\$495
2 Piece tops - 3 bases required									
GRC10WTPV	48 x 120 x 1.19	70	264	15	\$6501	n/a	n/a	n/a	\$651
GRC12WTPV	48 x 144 x 1.19	70	314	18	\$7701	n/a	n/a	n/a	\$771

Applicable bases to use with above tops: round GRB28 or square GSB23. TWO bases required for 96"W tops or THREE bases required for 120" & 144"W tops (see 684). Tops feature metal inserts for ease of assembly to base.

Required Specifications

Top finish
Edge finish⁽¹⁾

Optional Specifications

HP laminate⁽¹⁾
Knife edge⁽²⁾
Cut-out for grommet/power blocks

Applicable Bases

GRB28
GSB23

BOAT TOPS 96" - 144"

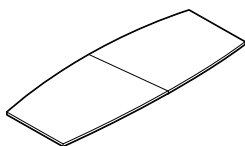

Boat Tops, 96"-144"

MODEL#	DIMENSIONS	FREIGHT CLASS	WT/LBS.	CUBIC FT.	LIST PRICE	HP ADD	GR. 2 ADD	R3 ADD	KS ADD
--------	------------	---------------	---------	-----------	------------	--------	-----------	--------	--------

D x W x H

TFL, flat edge ⁽¹⁾

1 Piece top - 2 bases required

GBT8MTP	42 x 96 x 1	92.5	128	11.84	\$1442	\$652	n/a	n/a	n/a
GBT8WTP	48 x 96 x 1	85	190	14	\$1460	\$566	n/a	n/a	n/a

2 Piece tops - 3 bases required

GBT10WTP	48 x 120 x 1	85	220	17	\$1836	\$760	n/a	n/a	n/a
GBT12WTP	48 x 144 x 1	85	262	21	\$2139	\$859	n/a	n/a	n/a

HPL, knife edge

1 Piece top - 2 bases required

GBT8MTPLK	42 x 96 x 1.19	85	154	11	\$3501	n/a	n/a	n/a	n/a
GBT8WTPLK	48 x 96 x 1.19	70	228	12	\$4001	n/a	n/a	n/a	n/a

2 Piece tops - 3 bases required

GBT10WTPLK	48 x 120 x 1.19	70	264	15	\$5001	n/a	n/a	n/a	n/a
GBT12WTPLK	48 x 144 x 1.19	70	314	18	\$6001	n/a	n/a	n/a	n/a

Veneer ⁽²⁾

1 Piece top - 2 bases required

GBT8MTPV	42 x 96 x 1.19	85	154	11	\$4450	n/a	n/a	n/a	\$445
GBT8WTPV	48 x 96 x 1.19	70	228	12	\$4950	n/a	n/a	n/a	\$495

2 Piece tops - 3 bases required

GBT10WTPV	48 x 120 x 1.19	70	264	15	\$6501	n/a	n/a	n/a	\$651
GBT12WTPV	48 x 144 x 1.19	70	314	18	\$7701	n/a	n/a	n/a	\$771

Applicable bases to use with above tops: round GRB28 or square GSB23. TWO bases required for 96"W tops or THREE bases required for 120" & 144"W tops (see 684). Tops feature metal inserts for ease of assembly to base.

- GBTxM - 42" deep at center and 33" deep at ends; GBTxW - 48" deep at center and 38" deep at ends.

Required Specifications

Top finish
Edge finish⁽¹⁾

Optional Specifications

HP laminate⁽¹⁾
Knife edge⁽²⁾
Cut-out for grommet/power blocks

Applicable Bases

GRB28
GSB23

S SWAP TABLES

BASES FOR TOPS 96"- 144" WIDE

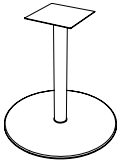

28" Dia Round Base

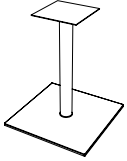

23" Square Base

MODEL#	DIMENSIONS	FREIGHT CLASS	WT./LBS.	CUBIC FT.	LIST PRICE	CHM/BCH	ACO/SBR
--------	------------	---------------	----------	-----------	------------	---------	---------

D x W x H

GRB28	28 x 28 x 28	125	100	15.63	\$1498	\$160	\$452
-------	--------------	-----	-----	-------	---------------	--------------	--------------

seated height

GSB23	22.5 x 22.5 x 28	100	82	9.33	\$1377	\$89	\$287
-------	------------------	-----	----	------	---------------	-------------	--------------

seated height

Base comes fully assembled and features 0.5" adjustable glides to level on uneven surfaces. Screws included with base for attaching to appropriate top(s). Available in paint finishes listed on 653; plated finishes as available on 653 (upcharge applies).

Required Specifications

Finish

Optional Specifications

Plated finish

RECTANGULAR TOPS FOR DUAL COLUMN BASE **MODEL#** **DIMENSIONS** **FREIGHT CLASS** **WT/LBS.** **CUBIC FT.** **LIST PRICE** **HP ADD GR. 2 ADD** **R3 ADD** **KS ADD**

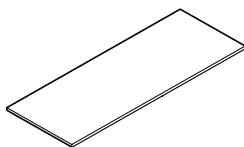

D x W x H

TFL, flat edge ⁽¹⁾⁽⁴⁾

GRTD5TP	36 x 60 x 1	100	60	6.6	\$655	\$305	n/a	\$66	n/a
GRTD5HTP	36 x 66 x 1	100	69	7.21	\$715	\$334	n/a	\$72	n/a
GRTD6TP	36 x 72 x 1	100	75	7.82	\$737	\$343	n/a	\$74	n/a
GRTD5MTP	42 x 60 x 1	100	73	7.62	\$727	\$337	n/a	\$73	n/a
GRTD5HMTP	42 x 66 x 1	100	81	8.32	\$776	\$361	n/a	\$78	n/a
GRTD6MTP	42 x 72 x 1	100	89	9.02	\$799	\$371	n/a	\$80	n/a

HPL, knife edge

GRTD5TPLK	36 x 60 x 1.19	85	72	6	\$1341	n/a	n/a	n/a	n/a
GRTD5HTPLK	36 x 66 x 1.19	85	83	6.5	\$1470	n/a	n/a	n/a	n/a
GRTD6TPLK	36 x 72 x 1.19	85	90	7	\$1605	n/a	n/a	n/a	n/a
GRTD5MTPLK	42 x 60 x 1.19	85	88	7	\$1556	n/a	n/a	n/a	n/a
GRTD5HMTPK	42 x 66 x 1.19	85	97	7.5	\$1716	n/a	n/a	n/a	n/a
GRTD6MTPLK	42 x 72 x 1.19	85	107	8	\$1870	n/a	n/a	n/a	n/a

Veneer ⁽²⁾

GRTD5TPV	36 x 60 x 1.19	85	72	6	\$1780	n/a	n/a	n/a	\$181
GRTD5HTPV	36 x 66 x 1.19	85	83	6.5	\$1951	n/a	n/a	n/a	\$196
GRTD6TPV	36 x 72 x 1.19	85	90	7	\$2126	n/a	n/a	n/a	\$210
GRTD5MTPV	42 x 60 x 1.19	85	88	7	\$2071	n/a	n/a	n/a	\$206
GRTD5HMTPV	42 x 66 x 1.19	85	97	7.5	\$2275	n/a	n/a	n/a	\$225
GRTD6MTPV	42 x 72 x 1.19	85	107	8	\$2480	n/a	n/a	n/a	\$250

Rectangular Top*

Top features metal inserts for ease of assembly to base. One dual column base #GDCB36H28 required (see 688). Limited cut-out options available for power modules include A2, E2, J2, V2 or AG2 only. Power modules corresponding to applicable cut-out codes ordered separately.

Required Specifications

Top finish
Edge finish⁽¹⁾

Optional Specifications

HP laminate⁽¹⁾
Knife edge⁽²⁾
3" radiused corners⁽⁴⁾
Cut-out for grommet/power blocks

Applicable Bases

GDCB36H28

S SWAP TABLES

RACETRACK TOPS FOR DUAL COLUMN BASE

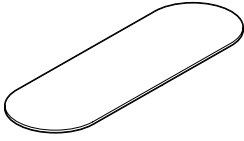

MODEL# DIMENSIONS FREIGHT CLASS WT/LBS. CUBIC FT. LIST PRICE HP ADD GR. 2 ADD R3 ADD KS ADD

D x W x H

TFL, flat edge ⁽¹⁾

GRCD5TP	36 x 60 x 1	100	60	6.6	\$655	\$305	n/a	n/a	n/a
GRCD5HTP	36 x 66 x 1	100	69	7.21	\$715	\$334	n/a	n/a	n/a
GRCD6TP	36 x 72 x 1	100	75	7.82	\$737	\$343	n/a	n/a	n/a
GRCD5MTP	42 x 60 x 1	100	73	7.62	\$727	\$337	n/a	n/a	n/a
GRCD5HMTP	42 x 66 x 1	100	81	8.32	\$776	\$361	n/a	n/a	n/a
GRCD6MTP	42 x 72 x 1	100	89	9.02	\$799	\$371	n/a	n/a	n/a

HPL, knife edge

GRCD5TPLK	36 x 60 x 1.19	85	72	6	\$1875	n/a	n/a	n/a	n/a
GRCD5HTPLK	36 x 66 x 1.19	85	83	6.5	\$2001	n/a	n/a	n/a	n/a
GRCD6TPLK	36 x 72 x 1.19	85	90	7	\$2126	n/a	n/a	n/a	n/a
GRCD5MTPLK	42 x 60 x 1.19	85	88	7	\$2250	n/a	n/a	n/a	n/a
GRCD5HMTPK	42 x 66 x 1.19	85	97	7.5	\$2375	n/a	n/a	n/a	n/a
GRCD6MTPLK	42 x 72 x 1.19	85	107	8	\$2501	n/a	n/a	n/a	n/a

Veneer ⁽²⁾

GRCD5TPV	36 x 60 x 1.19	85	72	6	\$2250	n/a	n/a	n/a	\$225
GRCD5HTPV	36 x 66 x 1.19	85	83	6.5	\$2375	n/a	n/a	n/a	\$236
GRCD6TPV	36 x 72 x 1.19	85	90	7	\$2501	n/a	n/a	n/a	\$250
GRCD5MTPV	42 x 60 x 1.19	85	88	7	\$2626	n/a	n/a	n/a	\$265
GRCD5HMTPV	42 x 66 x 1.19	85	97	7.5	\$2750	n/a	n/a	n/a	\$276
GRCD6MTPV	42 x 72 x 1.19	85	107	8	\$2875	n/a	n/a	n/a	\$286

Racetrack Tops for Dual Column Base

Top features metal inserts for ease of assembly to base. One dual column base #GDCB36H28 required (see 688). Limited cut-out options available for power modules include A2, E2, J2, V2 or AG2 only. Power modules corresponding to applicable cut-out codes ordered separately.

Required Specifications

Top finish
Edge finish⁽¹⁾

Optional Specifications

HP laminate⁽¹⁾
Knife edge⁽²⁾
Cut-out for grommet/power blocks

Applicable Bases

GDCB36H28

BOAT SHAPED TOPS FOR DUAL COLUMN BASE **MODEL#** **DIMENSIONS** **FREIGHT CLASS** **WT/LBS.** **CUBIC FT.** **LIST PRICE** **HP ADD GR. 2 ADD** **R3 ADD** **KS ADD**

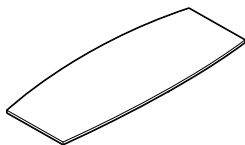

D x W x H

TFL, flat edge ⁽¹⁾

GBTD5TP	36 x 60 x 1	100	60	6.6	\$655	\$305	n/a	n/a	n/a
GBTD5HTP	36 x 66 x 1	100	69	7.21	\$715	\$334	n/a	n/a	n/a
GBTD6TP	36 x 72 x 1	100	75	7.82	\$737	\$343	n/a	n/a	n/a
GBTD5MTP	42 x 60 x 1	100	73	7.62	\$727	\$337	n/a	n/a	n/a
GBTD5HMTP	42 x 66 x 1	100	81	8.32	\$776	\$361	n/a	n/a	n/a
GBTD6MTP	42 x 72 x 1	100	89	9.02	\$799	\$371	n/a	n/a	n/a

HPL, knife edge

GBTD5TPLK	36 x 60 x 1.19	85	72	6	\$1875	n/a	n/a	n/a	n/a
GBTD5HTPLK	36 x 66 x 1.19	85	83	6.5	\$2001	n/a	n/a	n/a	n/a
GBTD6TPLK	36 x 72 x 1.19	85	90	7	\$2126	n/a	n/a	n/a	n/a
GBTD5MTPLK	42 x 60 x 1.19	85	88	7	\$2250	n/a	n/a	n/a	n/a
GBTD5HMTPK	42 x 66 x 1.19	85	97	7.5	\$2375	n/a	n/a	n/a	n/a
GBTD6MTPLK	42 x 72 x 1.19	85	107	8	\$2501	n/a	n/a	n/a	n/a

Veneer ⁽²⁾

GBTD5TPV	36 x 60 x 1.19	85	72	6	\$2250	n/a	n/a	n/a	\$225
GBTD5HTPV	36 x 66 x 1.19	85	83	6.5	\$2375	n/a	n/a	n/a	\$236
GBTD6TPV	36 x 72 x 1.19	85	90	7	\$2501	n/a	n/a	n/a	\$250
GBTD5MTPV	42 x 60 x 1.19	85	88	7	\$2626	n/a	n/a	n/a	\$265
GBTD5HMTPV	42 x 66 x 1.19	85	97	7.5	\$2750	n/a	n/a	n/a	\$276
GBTD6MTPV	42 x 72 x 1.19	85	107	8	\$2875	n/a	n/a	n/a	\$286

Boat Tops for Dual Column Base

Top features metal inserts for ease of assembly to base. One dual column base #GDCB36H28 required (see 688). Limited cut-out options available for power modules include A2, E2, J2, V2 or AG2 only. Power modules corresponding to applicable cut-out codes ordered separately.

Boat tops:

- 36" deep at the center, are 28" deep across ends; 42" deep at the center, are 33" deep at the ends.

Required Specifications

Top finish
Edge finish⁽¹⁾

Optional Specifications

HP laminate⁽¹⁾
Knife edge⁽²⁾
Cut-out for grommet/power blocks

Applicable Bases

GDCB36H28

S SWAP TABLES

DUAL COLUMN BASE FOR GxTDxxx TOPS

MODEL#

DIMENSIONS

FREIGHT CLASS

WT./LBS.

CUBIC FT.

LIST PRICE

CHM/BCH

ACO/SBR

D x W x H

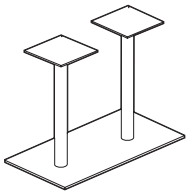

28"H Dual Column Base

Base valid for tops on pages 693-695:

GDCB36H28	36 x 19 x 28	100	116.23	12.16	\$2430	\$567	\$934
seated height							

Order the quantity of bases as indicated by each top size.

Base ships knocked-down; assembly required. Features 0.5" adjustable glides to level on uneven surfaces. Screws included with base for attaching to appropriate top(s). Available in paint finishes listed on 653; plated finishes as available on 653 (upcharge applies).

Required Specifications

Finish

Optional Specifications

Plated finish

HUDDLE TABLES OVERVIEW

- Three heights available: seated desk height - 29", counter height - 36", bar height - 41.5" with D top, wedge, rectangular or soft ellipse shaped tops.
- Bring teams together to huddle, share and collaborate.
- Tops include metal inserts for ease of assembly to metal base. All tops are standard with an edge scoop to help manage cables from wall mounted flat screen monitors and/or edge mounting power module (PS305057/PS305002 as an example). Support channels are included with tops over 60" wide.
- Optional cut-outs available where noted. Add **\$96** per cut-out. Only available in position 1 or position 2.

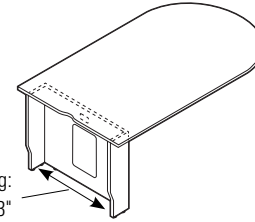
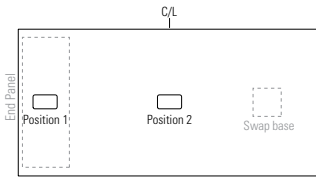

Interior width for base opening:
27.13"/33.3"/39.13"

Please take note when used in conjunction with Zira wall panels.

- Laminate kits are sold separately from metal bases for huddle tables.
- Metal bases ship fully assembled and include 0.5" adjustable glides and metal screws for attaching to the top. Be sure to specify bases specific to huddle tables GRHB22Hxx or GSB19Hxx.

D-TOP HUDDLE TABLES

MODEL#	DIMENSIONS	FREIGHT CLASS	WT./LBS.	CUBIC FT.	LIST PRICE	HP ADD
--------	------------	---------------	----------	-----------	------------	--------

D x W x H

GDH364829	48 x 36 x 29	70	77.05	3.94	\$1068	\$333
GDH366029	60 x 36 x 29	70	86.95	4.46	\$1302	\$472
GDH367229	72 x 36 x 29	70	97	4.98	\$1452	\$563
GDH426029	60 x 42 x 29	70	99.82	5.18	\$1461	\$540
GDH427229	72 x 42 x 29	70	111.5	5.78	\$1637	\$644
GDH428429	84 x 42 x 29	92.5	123.1	11.98	\$1811	\$751
GDH429629	96 x 42 x 29	92.5	134.74	13.3	\$1957	\$836
GDH486029	60 x 48 x 29	70	112.6	5.88	\$1629	\$611
GDH487229	72 x 48 x 29	70	126	6.58	\$1824	\$729
GDH488429	84 x 48 x 29	92.5	139.24	13.5	\$1950	\$805
GDH489629	96 x 48 x 29	92.5	152.56	15	\$2109	\$901

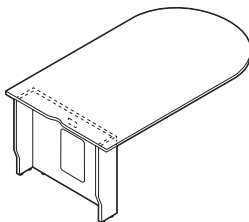

29"H D-Top Huddle

Laminate u-base support is 8"D with 7" inside clearance to wall. Access wall through 14.5"H x 9.5"W hinged door with touch latch in front panel of u-base support. U-base includes 0.5" adjustable glides. U-base side panels are tapered at the bottom to clear most baseboards. Cut-outs available in positions 1 and 2 only; except 36" x 48"D models (cut-out available in position 1 only).

- Metal bases sold separately. Compatible with **GRHB22H28** or **GSHB19H28** only (see 694).

GDH364836	48 x 36 x 36	70	85.95	4.3	\$1102	\$333
GDH366036	60 x 36 x 36	70	95.85	4.84	\$1335	\$472
GDH367236	72 x 36 x 36	70	105.9	5.36	\$1483	\$563
GDH426036	60 x 42 x 36	70	109.82	5.6	\$1497	\$540
GDH427236	72 x 42 x 36	70	121.5	6.22	\$1672	\$644
GDH428436	84 x 42 x 36	92.5	133.1	12.4	\$1847	\$751
GDH429636	96 x 42 x 36	92.5	144.74	13.74	\$1994	\$836
GDH486036	60 x 48 x 36	70	123.6	6.38	\$1669	\$611
GDH487236	72 x 48 x 36	70	137	7.08	\$1865	\$729
GDH488436	84 x 48 x 36	92.5	150.24	14	\$1991	\$805
GDH489636	96 x 48 x 36	92.5	163.56	15.5	\$2149	\$901

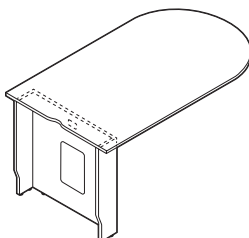

36"H D-Top Huddle

Laminate u-base support is 8"D with 7" inside clearance to wall. Access wall through 14.5"H x 9.5"W hinged door with touch latch in front panel of u-base support. U-base includes 0.5" adjustable glides. U-base side panels are tapered at the bottom to clear most baseboards. Cut-outs available in positions 1 and 2 only; except 36" x 48"D models (cut-out available in position 1 only).

- Metal bases sold separately. Compatible with **GRHB22H35** or **GSHB19H35** only (see 694).

Required Specifications

Top finish
Laminate base finish
Edge

Optional Specifications

HP laminate
Power block cut-out

Accessories

Power block

S SWAP TABLES

D-TOP HUDDLE TABLES

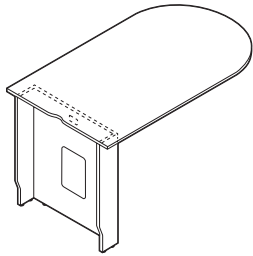

41.5"H D-Top Huddle

MODEL#	DIMENSIONS	FREIGHT CLASS	WT/LBS.	CUBIC FT.	LIST PRICE	HP ADD
--------	------------	---------------	---------	-----------	------------	--------

D x W x H

GDH364841	48 x 36 x 41.5	70	92.65	4.58	\$1158	\$333
GDH366041	60 x 36 x 41.5	70	102.55	5.1	\$1390	\$472
GDH367241	72 x 36 x 41.5	70	112.6	5.62	\$1542	\$563
GDH426041	60 x 42 x 41.5	70	117.32	5.92	\$1561	\$540
GDH427241	72 x 42 x 41.5	70	129	6.52	\$1738	\$644
GDH428441	84 x 42 x 41.5	92.5	140.6	12.72	\$1915	\$751
GDH429641	96 x 42 x 41.5	92.5	152.24	14.06	\$2059	\$836
GDH486041	60 x 48 x 41.5	70	130.1	6.74	\$1741	\$611
GDH487241	72 x 48 x 41.5	70	143.5	7.42	\$1936	\$729
GDH488441	84 x 48 x 41.5	92.5	156.74	14.52	\$2064	\$805
GDH489641	96 x 48 x 41.5	92.5	170.06	15.84	\$2223	\$901

Laminate u-base support is 8"D with 7" inside clearance to wall. Access wall through 14.5"H x 9.5"W hinged door with touch latch in front panel of u-base support. U-base includes 0.5" adjustable glides. U-base side panels are tapered at the bottom to clear most baseboards. Cut-outs available in positions 1 and 2 only; except 36" x 48"D models (cut-out available in position 1 only).

- Metal bases sold separately. Compatible with **GRHB22H41** or **GSHB19H41** only (see 694).

Required Specifications

Top finish
Laminate base finish
Edge

Optional Specifications

HP laminate
Power block cut-out

Accessories

Power block

WEDGE HUDDLE TABLES

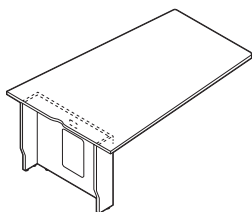

29"H Wedge Huddle

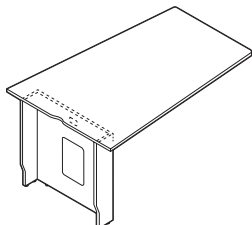

36"H Wedge Huddle

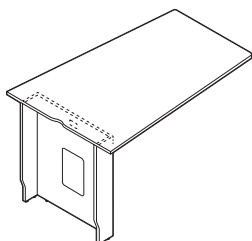

41.5"H Wedge Huddle

MODEL#	DIMENSIONS D x W x H	FREIGHT CLASS	WT./LBS.	CUBIC FT.	LIST PRICE	HP ADD
GWH486029	60 x 48 x 29	70	112.6	5.88	\$1626	\$607
GWH487229	72 x 48 x 29	70	126	6.58	\$1824	\$729
GWH488429	84 x 48 x 29	92.5	139.24	13.5	\$1950	\$805
GWH489629	96 x 48 x 29	92.5	152.56	15	\$2109	\$901

Laminate u-base support is 8"D with 7" inside clearance to wall. Access wall through 14.5"H x 9.5"W hinged door with touch latch in front panel of u-base support. U-base includes 0.5" adjustable glides. U-base side panels are tapered at the bottom to clear most baseboards. Cut-outs available in positions 1 and 2 only.

- Metal bases sold separately. Compatible with **GRHB22H28** or **GSHB19H28** only (see 694).

GWH486036	60 x 48 x 36	70	123.6	6.38	\$1665	\$607
GWH487236	72 x 48 x 36	70	137	7.08	\$1865	\$729
GWH488436	84 x 48 x 36	92.5	150.24	14	\$1991	\$805
GWH489636	96 x 48 x 36	92.5	163.56	15.5	\$2149	\$901

Laminate u-base support is 8"D with 7" inside clearance to wall. Access wall through 14.5"H x 9.5"W hinged door with touch latch in front panel of u-base support. U-base includes 0.5" adjustable glides. U-base side panels are tapered at the bottom to clear most baseboards. Cut-outs available in positions 1 and 2 only.

- Metal bases sold separately. Compatible with **GRHB22H35** or **GSHB19H35** only (see 694).

GWH486041	60 x 48 x 41.5	70	130.1	6.74	\$1736	\$607
GWH487241	72 x 48 x 41.5	70	143.5	7.42	\$1936	\$729
GWH488441	84 x 48 x 41.5	92.5	156.74	14.34	\$2064	\$805
GWH489641	96 x 48 x 41.5	92.5	170.06	15.84	\$2223	\$901

Laminate u-base support is 8"D with 7" inside clearance to wall. Access wall through 14.5"H x 9.5"W hinged door with touch latch in front panel of u-base support. U-base includes 0.5" adjustable glides. U-base side panels are tapered at the bottom to clear most baseboards. Cut-outs available in positions 1 and 2 only.

- Metal bases sold separately. Compatible with **GRHB22H41** or **GSHB19H41** only (see 694).

Required Specifications

Top finish
Laminate base finish
Edge

Optional Specifications

HP laminate
Power block cut-out

Accessories

Power block

S SWAP TABLES

RECTANGULAR HUDDLE TABLES

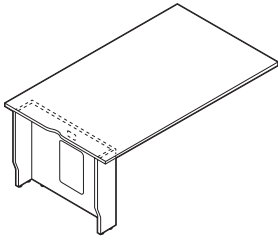

29"H Rectangular Huddle

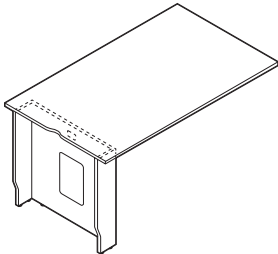

36"H Rectangular Huddle

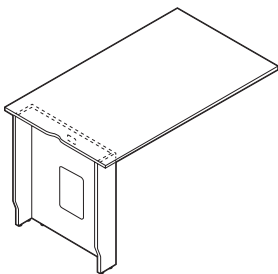

41.5"H Rectangular Huddle*

MODEL#	DIMENSIONS D x W x H	FREIGHT CLASS	WT./LBS.	CUBIC FT.	LIST PRICE	HP ADD
GRH364829	48 x 36 x 29	70	77.05	3.94	\$1068	\$333
GRH366029	60 x 36 x 29	70	86.95	4.46	\$1302	\$472
GRH367229	72 x 36 x 29	70	97	4.98	\$1452	\$563
GRH426029	60 x 42 x 29	70	99.82	5.18	\$1461	\$540
GRH427229	72 x 42 x 29	100	111.5	5.78	\$1637	\$644
GRH428429	84 x 42 x 29	92.5	123.1	11.98	\$1811	\$751
GRH429629	96 x 42 x 29	150	134.74	13.3	\$1957	\$836
GRH486029	60 x 48 x 29	70	112.6	5.88	\$1629	\$611
GRH487229	72 x 48 x 29	70	126	6.58	\$1824	\$729
GRH488429	84 x 48 x 29	92.5	139.24	13.5	\$1950	\$805
GRH489629	96 x 48 x 29	92.5	152.56	15	\$2109	\$901

Laminate u-base support is 8"D with 7" inside clearance to wall. Access wall through 14.5"H x 9.5"W hinged door with touch latch in front panel of u-base support. U-base includes 0.5" adjustable glides. U-base side panels are tapered at the bottom to clear most baseboards. Cut-outs available in positions 1 and 2 only; except 36" x 48"D models (cut-out available in position 1 only).

- Metal bases sold separately. Compatible with **GRHB22H28** or **GSHB19H28** only (see 694)

GRH364836	48 x 36 x 36	70	85.95	4.3	\$1102	\$333
GRH366036	60 x 36 x 36	70	95.85	4.84	\$1335	\$472
GRH367236	72 x 36 x 36	70	105.9	5.36	\$1483	\$563
GRH426036	60 x 42 x 36	70	109.82	5.6	\$1497	\$540
GRH427236	72 x 42 x 36	70	121.5	6.22	\$1672	\$644
GRH428436	84 x 42 x 36	92.5	133.1	12.4	\$1847	\$751
GRH429636	96 x 42 x 36	92.5	144.74	13.74	\$1994	\$836
GRH486036	60 x 48 x 36	70	123.6	6.38	\$1669	\$611
GRH487236	72 x 48 x 36	70	137	7.08	\$1865	\$729
GRH488436	84 x 48 x 36	92.5	150.24	14	\$1991	\$805
GRH489636	96 x 48 x 36	150	163.56	15.5	\$2149	\$901

Laminate u-base support is 8"D with 7" inside clearance to wall. Access wall through 14.5"H x 9.5"W hinged door with touch latch in front panel of u-base support. U-base includes 0.5" adjustable glides. U-base side panels are tapered at the bottom to clear most baseboards. Cut-outs available in positions 1 and 2 only; except 36" x 48"D models (cut-out available in position 1 only).

- Metal bases sold separately. Compatible with **GRHB22H35** or **GSHB19H35** only (see 694).

GRH364841	48 x 36 x 41.5	70	92.65	4.58	\$1158	\$333
GRH366041	60 x 36 x 41.5	70	102.55	5.1	\$1390	\$472
GRH367241	72 x 36 x 41.5	70	112.6	5.62	\$1542	\$563
GRH426041	60 x 42 x 41.5	70	117.32	5.92	\$1561	\$540
GRH427241	72 x 42 x 41.5	70	129	6.52	\$1738	\$644
GRH428441	84 x 42 x 41.5	92.5	140.6	12.72	\$1915	\$751
GRH429641	96 x 42 x 41.5	92.5	152.24	14.06	\$2059	\$836
GRH486041	60 x 48 x 41.5	70	130.1	6.74	\$1741	\$611
GRH487241	72 x 48 x 41.5	70	143.5	7.42	\$1936	\$729
GRH488441	84 x 48 x 41.5	92.5	156.74	14.34	\$2064	\$805
GRH489641	96 x 48 x 41.5	92.5	170.06	15.84	\$2223	\$901

Laminate u-base support is 8"D with 7" inside clearance to wall. Access wall through 14.5"H x 9.5"W hinged door with touch latch in front panel of u-base support. U-base includes 0.5" adjustable glides. U-base side panels are tapered at the bottom to clear most baseboards. Cut-outs available in positions 1 and 2 only; except 36" x 48"D models (cut-out available in position 1 only).

- Metal bases sold separately. Compatible with **GRHB22H41** or **GSHB19H41** only (see 694).

Required Specifications

Top finish
Laminate base finish
Edge

Optional Specifications

HP laminate
Power block cut-out

Accessories

Power block

SOFT ELLIPSE HUDDLE TABLES

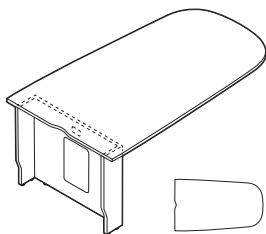

29"H Soft Ellipse Huddle

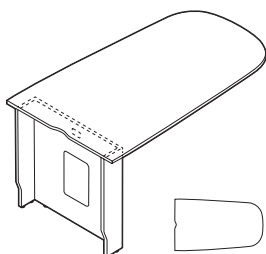

36"H Soft Ellipse Huddle

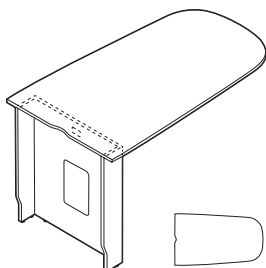

41.5"H Soft Ellipse Huddle*

MODEL#	DIMENSIONS D x W x H	FREIGHT CLASS	WT./LBS.	CUBIC FT.	LIST PRICE	HP ADD
GSEH364829	48 x 36 x 29	70	77.05	3.94	\$1068	\$333
GSEH366029	60 x 36 x 29	70	86.95	4.46	\$1302	\$472
GSEH367229	72 x 36 x 29	70	97	4.98	\$1452	\$563
GSEH426029	60 x 42 x 29	70	99.82	5.18	\$1461	\$540
GSEH427229	72 x 42 x 29	70	111.5	5.78	\$1637	\$644
GSEH428429	84 x 42 x 29	92.5	123.1	11.98	\$1811	\$751
GSEH429629	96 x 42 x 29	92.5	134.7	13.3	\$1957	\$836
GSEH486029	60 x 48 x 29	70	112.6	11.78	\$1629	\$611
GSEH487229	72 x 48 x 29	70	126	6.58	\$1824	\$729
GSEH488429	84 x 48 x 29	92.5	139.2	13.5	\$1950	\$805
GSEH489629	96 x 48 x 29	92.5	152.6	15	\$2109	\$901

Laminate u-base support is 8"D with 7" inside clearance to wall. Access wall through 14.5"H x 9.5"W hinged door with touch latch in front panel of u-base support. U-base includes 0.5" adjustable glides. U-base side panels are tapered at the bottom to clear most baseboards. Cut-outs available in positions 1 and 2 only; except 36" x 48"D models (cut-out available in position 1 only).

- Metal bases sold separately. Compatible with **GRHB22H28** or **GSHB19H28** only (see 694).

GSEH364836	48 x 36 x 36	70	86	4.3	\$1102	\$333
GSEH366036	60 x 36 x 36	70	95.9	4.84	\$1335	\$472
GSEH367236	72 x 36 x 36	70	105.9	5.36	\$1483	\$563
GSEH426036	60 x 42 x 36	70	109.8	5.6	\$1497	\$540
GSEH427236	72 x 42 x 36	70	121.5	6.22	\$1672	\$644
GSEH428436	84 x 42 x 36	92.5	133.1	12.4	\$1847	\$751
GSEH429636	96 x 42 x 36	92.5	144.74	13.74	\$1994	\$836
GSEH486036	60 x 48 x 36	70	123.6	12.76	\$1669	\$611
GSEH487236	72 x 48 x 36	70	137	7.08	\$1865	\$729
GSEH488436	84 x 48 x 36	92.5	150.24	14	\$1991	\$805
GSEH489636	96 x 48 x 36	92.5	163.56	15.5	\$2149	\$901

Laminate u-base support is 8"D with 7" inside clearance to wall. Access wall through 14.5"H x 9.5"W hinged door with touch latch in front panel of u-base support. U-base includes 0.5" adjustable glides. U-base side panels are tapered at the bottom to clear most baseboards. Cut-outs available in positions 1 and 2 only; except 36" x 48"D models (cut-out available in position 1 only).

- Metal bases sold separately. Compatible with **GRHB22H35** or **GSHB19H35** only (see 694).

GSEH364841	48 x 36 x 41.5	92.5	92.65	9.16	\$1158	\$333
GSEH366041	60 x 36 x 41.5	70	102.55	5.1	\$1390	\$472
GSEH367241	72 x 36 x 41.5	70	112.6	5.62	\$1542	\$563
GSEH426041	60 x 42 x 41.5	70	117.32	5.92	\$1561	\$540
GSEH427241	72 x 42 x 41.5	70	129	6.52	\$1738	\$644
GSEH428441	84 x 42 x 41.5	92.5	140.6	12.72	\$1915	\$751
GSEH429641	96 x 42 x 41.5	92.5	152.24	14.06	\$2059	\$836
GSEH486041	60 x 48 x 41.5	70	130.1	6.74	\$1741	\$611
GSEH487241	72 x 48 x 41.5	70	143.5	14.86	\$1936	\$729
GSEH488441	84 x 48 x 41.5	92.5	156.74	14.34	\$2064	\$805
GSEH489641	96 x 48 x 41.5	92.5	170.06	15.84	\$2223	\$901

Laminate u-base support is 8"D with 7" inside clearance to wall. Access wall through 14.5"H x 9.5"W hinged door with touch latch in front panel of u-base support. U-base includes 0.5" adjustable glides. U-base side panels are tapered at the bottom to clear most baseboards. Cut-outs available in positions 1 and 2 only; except 36" x 48"D models (cut-out available in position 1 only).

- Metal bases sold separately. Compatible with **GRHB22H41** or **GSHB19H41** only (see 694).

Required Specifications

Top finish
Laminate base finish
Edge

Optional Specifications

HP laminate
Power block cut-out

Accessories

Power block

S SWAP TABLES

HUDDLE BASES

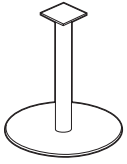

22" Round Huddle Base

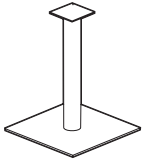

18.5" Square Huddle Base

MODEL#	DIMENSIONS	FREIGHT CLASS	WT/LBS.	CUBIC FT.	LIST PRICE	CHM/BCH	ACO/SBR
--------	------------	---------------	---------	-----------	------------	---------	---------

D x W x H

SELECT BASE COMPATIBLE WITH TOP HEIGHT:

MODEL#	DIMENSIONS	FREIGHT CLASS	WT/LBS.	CUBIC FT.	LIST PRICE	CHM/BCH	ACO/SBR
GRHB22H28	22 x 22 x 28	92.5	10	1	\$1048	\$125	\$303
GRHB22H35	22 x 22 x 35	150	62	12.67	\$1048	\$150	\$327
GRHB22H41	22 x 22 x 40.5	150	63	14.17	\$1093	\$157	\$328

GRHB22H28 - seated height **GRHB22H35** - counter height **GRHB22H41** - bar height

Metal base ships fully assembled. Features 0.5" adjustable glides to level on uneven surfaces. Screws included with base for attaching to appropriate huddle table laminate pieces. Be sure to double check huddle table laminate pieces and metal bases are correct corresponding heights. Available in paint finishes listed on 653; plated finishes as available on 653 (upcharge applies).

MODEL#	DIMENSIONS	FREIGHT CLASS	WT/LBS.	CUBIC FT.	LIST PRICE	CHM/BCH	ACO/SBR
GSHB19H28	18.5 x 18.5 x 28	125	55	6.94	\$1120	\$121	\$304
GSHB19H35	18.5 x 18.5 x 35	125	57	8.8	\$1120	\$137	\$350
GSHB19H41	18.5 x 18.5 x 40.5	150	58	9.84	\$1173	\$150	\$332

GSHB19H28 - seated height **GSHB19H35** - counter height **GSHB19H41** - bar height

Metal base ships fully assembled. Features 0.5" adjustable glides to level on uneven surfaces. Screws included with base for attaching to appropriate huddle table laminate pieces. Be sure to double check huddle table laminate pieces and metal bases are correct corresponding heights. Available in paint finishes listed on 653; plated finishes as available on 653 (upcharge applies).

Required Specifications

Finish

Optional Specifications

Plated finish



Terina is a simple flip top table series that transforms any space into sophisticated areas for training, meetings and collaboration. Terina features unique and elegant aluminum, angled t-leg design paired with high pressure laminate or veneer surface, with optional modesty panels. Surface power modules offer an easy way to charge electronic devices without the need to drop down cords. Wires are managed below the worksurface with snap-in cable clips. Terina can be ganged together with optional flush ganging plates. Single hand release mechanism is active from the center of the user side of the table. Tables can be nested together in an upright position to minimize storage space.

Features and Benefits

- Training, meeting or conferencing. A multi-purpose table that allows you quickly and simply adapt your space to suit your needs.
- Simple flip top mechanism designed for single handed operation.
- Tops offered in high pressure laminate or wood veneer
- 10" modesty panel articulates when tables fold down
- Legs and crossbeam offered in 7 paint finishes
- Optional flush ganging plates
- Tables can be nested together when not in use.

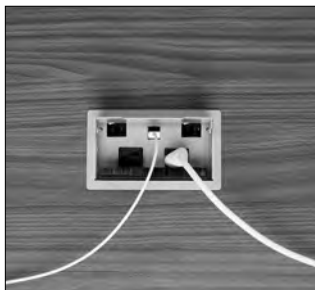

Optional power block includes power and data

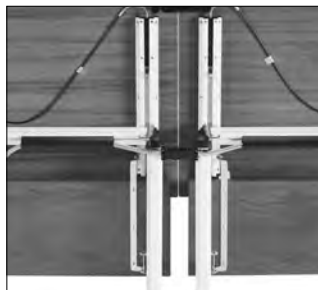

Optional ganging plates and daisy chain power management



Tables can be nested together when not in use.

GENERAL INFORMATION

- Terina flip top tables transform any space into sophisticated areas for training, meetings and collaboration.
- Simple flip top mechanism is designed for one handed operation.
- Unique, angled “T” leg design.
- Shipped R.T.A. (Ready to Assemble).
- For environmental certifications, please visit globalfurnituregroup.com.

WORKSURFACES

- Laminate surfaces are 1-1/16” thick tops constructed of 45 lb. density particle board with high pressure laminate and finished on the underside of the surface with a kraft paper backing.
- Veneer surfaces are 1-3/16” thick tops constructed of 45 lb. density particle board and are balanced on the underside with veneer (unfinished)
- Worksurfaces are pre-drilled for alignment of the Terina base

BASE

- Tables feature an aluminum leg, cross beam and die-cast foot.
- Legs and cross beam are available in (7) different finish options.
- Die-cast foot is always in polished aluminum finish.
- Foot span is 23”

EDGING

- Laminate surfaces offer a selection of matching + coordinated edgeband. Specify separately from the surface finish.
- Veneer tops are finished with a 6mm hardwood edge, stained to match

CASTERS

- Casters are standard on all tables.
- 2-3/8” dual wheel casters with manual lock. Full 360° swivel.
- Suggested for carpeted surfaces.
- Available in grey only

GANGING PLATES

- Ganging plates are available for ganging adjoining tables together.
- Ganging plates are black epoxy coated steel plates with two thumbscrews

WIRE MANAGEMENT

- Wire management option is a snap-in channel that fits on the interior of the leg or on the underside of the flip-top cross beam

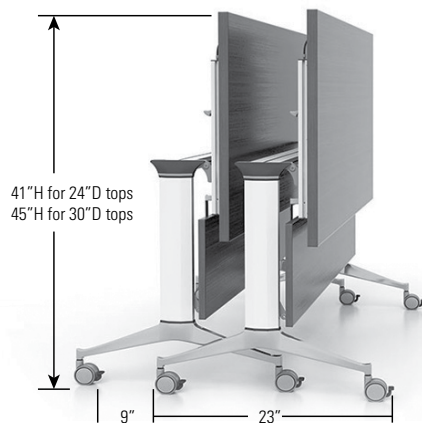

MODESTY PANELS

- 10” modesty panel affixes to the top and base, articulating when it folds down.
- Available in all standard laminates
- Modesty panels up to 60”w have vertical grain. Modesty panels 66” and wider will have horizontal grain.

LAMINATE FINISHES

ACJ	Absolute Acajou	FCL	First Class
ASN	Asian Night	NBL	Noce Biondo
AWC	Avant Cherry	NGL	Noce Grigio
AWH	Avant Honey	NEL	Noce Leggero
BLK	Black	NML	Noce Medio
BZD	Blizzard	QTM	Quartered Mahogany
BRC	Brushed Cobalt	SBY	Sheer Beauty
CMB	Clear Maple	SOG	Storm Grey
CGY	Custom Grey	SDT	Stonedust
DES	Dark Espresso	WHE	Walnut Heights
DWT	Designer White	WHC	White Chocolate
FAS	Fashionista	WCR	Winter Cherry

EDGE FINISHES (Laminate Surfaces Only)

AAE	Absolute Acajou	FCL	First Class
ASE	Asian Night	NBL	Noce Biondo
ACE	Avant Cherry	NGL	Noce Grigio
AHE	Avant Honey	NEL	Noce Leggero
BLK	Black	NML	Noce Medio
BRC	Brushed Cobalt	QTM	Quartered Mahogany
BZD	Blizzard	SBY	Sheer Beauty
CHR	Charcoal (use w/SOG)	SIL	Silver
CME	Clear Maple	SDT	Stonedust
CGY	Custom Grey	TPE	Taupe
DEE	Dark Espresso	WHE	Walnut Heights
DWE	Designer White	CBE	White Chocolate
FAS	Fashionista	WCE	Winter Cherry

LEG FINISHES

BLK	Black	CHR	Charcoal
DWT	Designer White	NEV	Nevada
SIL	Silver	TPE	Taupe
TUN	Tungsten		

VEENER FINISHES:

Code	Finish	Veneer Type	Cut
AMW	Almond Cherry	Cherry	Flat Sliced
ACW	Amber Cherry	Cherry	Flat Sliced
BTW	Biscotti	White Oak	Rift
CAW	Cocoa Walnut	Walnut	Flat Sliced
CRW	Coral	White Oak	Rift
DCW	Dark Cherry	Cherry	Flat Sliced
DWW	Dark Walnut	Walnut	Flat Sliced
EWV	Espresso Walnut	Walnut	Flat Sliced
EVW	Evening Oak	White Oak	Rift
GRW	Grey on Oak	White Oak	Rift
HAW	Hazelnut	Maple	Flat Sliced
JAW	Java	White Oak	Rift
LTW	Latte Walnut	Walnut	Flat Sliced
MHW	Mahogany on Walnut	Walnut	Flat Sliced
MTW	Milestone	White Oak	Rift
MPW	Natural Maple	Maple	Flat Sliced
NLW	Natural Walnut	Walnut	Flat Sliced
RCW	Red Cherry	Cherry	Flat Sliced
ULW	Umber Walnut	Walnut	Flat Sliced
VNW	Vintage Cherry	Cherry	Flat Sliced
WLW	Walnut	Walnut	Flat Sliced
WCW	Warm Cherry	Cherry	Flat Sliced
WMW	White Maple	Maple	Flat Sliced

GROMMETS

- Grommets are available in all tops (left, center or right). Order as: **AG1, AG2 or AG3. Add \$96.**
- Grommet hole dimensions are 3 1/4" wide x 1 7/8" deep.
- Available on all table widths and depths
- Please note limited user space when cut-outs are specified. See dimensions on diagram below.**

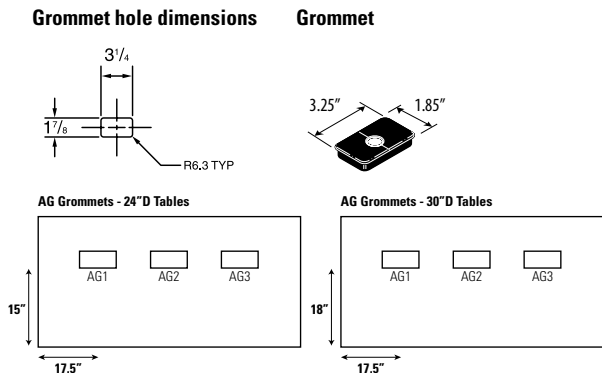

- Grommets may be placed at non-standard locations. Order as: **AGS - Add \$96.** A drawing must be supplied with vertical and horizontal dimensions to the center of the cut-out (as in drawing above). Please refer to CUSTOM GROMMET LOCATION FORM in the back reference section.

POWER BLOCK

- A Power Block (model **PMSPDM**) may be ordered on all worksurfaces.
- A Power Block is a rectangular worksurface power/data module with one electrical duplex receptacle and two data (RJ45) receptacles. 9' black cord included. Power Block dimensions are 3 1/2" deep x 6 1/2" wide x 2 3/4" high.
- A Power Block cut-out (for model **PMSPDM**) may be ordered for **tops 60" and up in any standard location.** Order as **E1, E2 or E3. Add \$96.**
- A Power Block cut-out (for model **PMSPDM**) may be ordered in the **center position only for 48" and 54" tops.** Order as **E2. Add \$96.**

- To purchase a Power Block, you must specify both the Power Block cut-out location and the Power Block model #. Order Power Block as **PMSPDM, Add \$330.**
- Please note limited user space when cut-outs are specified. See dimensions on diagram below.**

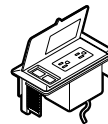

Power Block **PMSPDM, Add \$330**

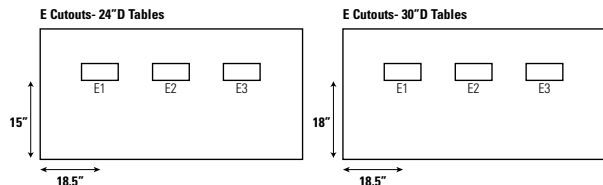

VILLA CUT-OUTS

- A Villa cut-out may be ordered for **tops 60" and up in any standard location.** Order as: **V1, V2 or V3 - Add \$96 for each cut-out.**
- A Villa cut-out may be ordered in the **center position only for 48" and 54" tops.** Order as: **V2 - Add \$96.**
- Villa with USB is not compatible with Terina tables**
- Please note limited user space when cut-outs are specified. See dimensions on diagram below.**

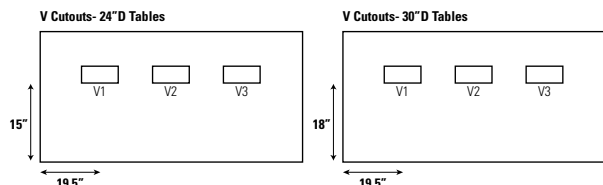

RECTANGULAR TABLES



Rectangular Table - Laminate Top*

MODEL#	DIMENSIONS D x W x H	FREIGHT CLASS	WT/LBS.	CUBIC FT.	LIST PRICE
GFT2472R	24 x 72 x 29	100	66	6.98	\$1900
GFT2466R	24 x 66 x 29	250	61	20.96	\$1863
GFT2460R	24 x 60 x 29	250	55	20.96	\$1832
GFT2454R	24 x 54 x 29	250	53	17.96	\$1790
GFT2448R	24 x 48 x 29	250	48	17.96	\$1638
GFT3072R	30 x 72 x 29	100	68	6.98	\$1958
GFT3066R	30 x 66 x 29	100	66	6.98	\$1938
GFT3060R	30 x 60 x 29	100	61	6.98	\$1907
GFT3054R	30 x 54 x 29	100	55	5.99	\$1863
GFT3048R	30 x 48 x 29	100	53	5.99	\$1749

Tables feature a flip-top **laminated** worksurface for ease of storage. Single hand release mechanism is active from the center of the user side of the table. Leg can be painted in a variety of finishes. Foot is always in polished aluminum. Each table can be ganged together with GFCNGFP ganging plates (see next page). Modesty panels are available (see GFTxxM).

- Casters are available in grey only.



Rectangular Table - Veneer Top

GFT2472RV	24 x 72 x 29	100	66	6.98	\$3154
GFT2466RV	24 x 66 x 29	250	61	20.96	\$2999
GFT2460RV	24 x 60 x 29	250	55	20.96	\$2842
GFT2454RV	24 x 54 x 29	250	53	17.96	\$2753
GFT2448RV	24 x 48 x 29	250	48	17.96	\$2660
GFT3072RV	30 x 72 x 29	100	68	6.98	\$3626
GFT3066RV	30 x 66 x 29	100	66	6.98	\$3428
GFT3060RV	30 x 60 x 29	100	66	6.98	\$3229
GFT3054RV	30 x 54 x 29	100	55	5.99	\$3023
GFT3048RV	30 x 48 x 29	100	53	5.99	\$2822

Tables feature a flip-top **veneer** worksurface for ease of storage. Single hand release mechanism is active from the center of the user side of the table. Leg can be painted in a variety of finishes. Foot is always in polished aluminum. Each table can be ganged together with GFCNGFP ganging plates (see next page). Modesty panels are available (see GFTxxMx).

- Casters are available in grey only.

POWER/DATA



Duo Module

MODEL#	DIMENSIONS	FREIGHT CLASS	WT/LBS.	CUBIC FT.	LIST PRICE
BRED50	3.2 x 5.5 x 1.8	70	2.50	.14	\$386

The duo power module is completely integrated with a mounting clamp to attach to the edge of a worksurface. Provides two outlets and two 2.1 amp USB ports. White face plate, outlets and bracket; 72" long three-prong black cord, silver body.

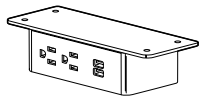

Duo Under Module

BREDU51	2.8 x 5.5 x 1.8	70	2.50	.14	\$335
---------	-----------------	----	------	-----	--------------

The duo under power module comes with a thin flush mounting bracket to attach to the underside of a worksurface or above worksurface shelves. Provides two outlets and two 2.1 amp USB ports. White face plate, outlets and brackets; 72" long three-prong black cord, silver body.

Required Specifications

Top finish
Leg finish
Edge finish*

Optional Specifications

Grommet

Accessories

Power block
Wire management
Ganging plate

MODESTY PANELS

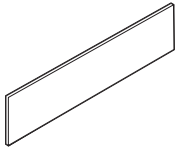

Modesty Panel - Laminate*

MODEL#	DIMENSIONS	FREIGHT CLASS	WT./LBS.	CUBIC FT.	LIST PRICE
D x W x H					
GFT72M	.75 x 70 x 10	92.5	20	2	\$346
GFT66M	.75 x 64 x 10	100	18	2	\$329
GFT60M	.75 x 58 x 10	70	15	1	\$316
GFT54M	.75 x 52 x 10	85	13	1	\$303
GFT48M	.75 x 46 x 10	92.5	11	1	\$288

Laminate modesty panel for use on GFTxxxxR Tables. Articulating modesty panel includes necessary hardware to attach. Can be retrofitted.

- Modesty panels up to 60" w have vertical grain. Modesty panels 66" and wider will have horizontal grain.

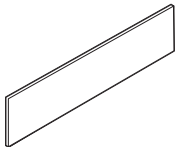

Modesty Panel - Veneer

GFT72MV	.75 x 70 x 10	92.5	20	2	\$964
GFT66MV	.75 x 64 x 10	100	18	2	\$896
GFT60MV	.75 x 58 x 10	70	15	1	\$814
GFT54MV	.75 x 52 x 10	85	13	1	\$732
GFT48MV	.75 x 46 x 10	92.5	11	1	\$664

Veneer modesty panel for use on GFTxxxxR Tables. Articulating modesty panel includes necessary hardware to attach. Can be retrofitted.

- Modesty panels up to 60" w have vertical grain. Modesty panels 66" and wider will have horizontal grain.

WIRE MANAGEMENT



Wire Manager

MODEL#	DIMENSIONS	FREIGHT CLASS	WT./LBS.	CUBIC FT.	LIST PRICE
GFTCM04BLK	2 x 10 x 2	70	1	1	\$54

Set of four, 10" long grey plastic extrusions. Can be snapped into the inside of each leg for wire management from the surface to the floor, or snapped into the cross beam of the table to keep wires tucked neatly below the worksurface.

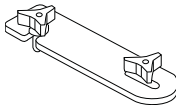

Ganging Flush Plate

GFCNGFP	.1 x 5 x 2.5	70	1	.01	\$54
---------	--------------	----	---	-----	-------------

Black epoxy coated steel plates with 2 thumbscrews included. Used to connect worksurfaces together. Holes with steel inserts are located in the corner of the tops to accommodate this plate. Sold individually.

Required Specifications

- Finish
- Edge finish*



Zook was designed for today's dynamic and diverse learning environments. The tables are lightweight and can be reconfigured easily to create interactive environments and support collaboration.

Choose from a variety of organic and geometric shaped table tops to optimize flexibility. They are available in a wide array of sizes and finishes in both thermally fused laminate and high pressure laminate. Zook's color palette also includes nine new bold finishes available in high pressure laminate only.

Tops are available in 1" thick thermally fused laminate or 1-1/16" high pressure laminate with Global's preferred matching edge or a new optional ergo friendly edge.

Features and Benefits

- Tops are 1" thick thermally fused laminate or 1-1/16" high pressure laminate.
- Tops are constructed of 45 lb. density particle board.
- Global's preferred matching edge or optional ergo friendly edge.
- Tops are available in organic and geometric shapes.
- Surfaces include factory installed metal inserts for solid and secure leg connections.
- Group table's cable tower is constructed from thermally fused laminate with a removable access panel and inside clearance of 9" x 9". Available on group tables ZK44848P, ZK45959P and ZK65990 only.
- Easy to assemble



Variety of organic and geometric shapes



Multiple table configurations. Ideal for group study and encouraging collaboration.



Optional ergo friendly edge

GENERAL INFORMATION

- Zook is a series of tables designed for classrooms and diverse learning environments.
- Organic shapes and rectangular tops are available to create a variety of configurations that naturally bring people together.
- Choose from Zook group tables for groups of 4 to 6 people comfortably, pod tables for individuals, activity tables, or flip top tables.
- Create spaces that encourage discussion and the sharing of ideas
- Supports multi-use, active learning spaces and a variety of teaching styles
- Materials and workmanship stand up to the rigorous demands of today's learning environments
- Shipped easy to assemble. Tops include factory installed metal inserts to accept leg attachment.
- For environmental certifications, please visit globalfurnituregroup.com.

ZOOK GROUP TABLES

- Organic shaped tops available in three sizes: 48" x 48", 59" x 59" or 59" x 90".
- Tops supported by 3" diameter fixed height post legs.
- Select models available with cut-out options for power modules; these select models also include a cable tower for managing cables to floor monuments..

ZOOK POD TABLES

- Available in four geometric shapes; three that when used adjacent to one another, can create various pod configurations as well as rectangular tables in a number of sizes.
- ADA compliant heights available for select models.
- 1.5" diameter fixed height post legs.
- Tables may be specified on levelers or with casters for greater mobility and flexibility

ZOOK ACTIVITY TABLES

- Available in three shapes, all based on a 54" wide footprint.
- Tops are available with two types of mating edges: curved or straight. When planning to mate tables, do not mix mating edge styles.
- 2" diameter tapered legs on levelers or casters.

ZOOK FLIP-TOP TABLES

- Available in three sizes, 30"w x 22"d with concave shaped top; 30"w x 24"d and 60"w x 24"d rectangular top with radius corners.
- Supported by Y legs, equipped with smooth glide casters (two locking). Tungsten (TTU) finish only.
- 60"w tables optional with AG1, AG2, AG3 grommet; ZKFR3024 available with optional AG2 grommet
- Modesty panels are available separately in Tungsten (TUN) finish only.
- Tops and bases sold separately.
- **Caution:** to meet BIFMA standards for performance and stability, appropriate base size must be specified with corresponding top sizes identified.

WORKSURFACES

- Tops are available in 1" thick thermally fused laminate or 1-1/16" thick high pressure laminate
- Available in many finishes in both thermally fused laminate or high pressure laminate
- Worksurface core is made of 45 lb. density particleboard
- Surfaces include factory-installed metal inserts for solid and secure leg connections

WRITEABLE SURFACE OPTION

- Available on group, pod, activity, flip-top and rectangular tables
- High gloss White, non-magnetic dry-erase surface
- Complementary or contrasting edge to be specified, darker edge finish recommended
- Specify (WRW) for top finish. For upcharge, refer to finish option per product.

EDGE DETAIL

- Global's preferred (2mm flat edge) matching edge is standard
- Optional ergo-friendly edge is available at an upcharge (varies by item; see product for details).
- Rectangular tops feature rounded 2.5" radius corners



Ergo friendly edge



2mm flat edge

LEGS

- **Group tables:** 3" diameter steel post legs, 28" high with adjustable 3" diameter plastic glides. Each leg includes a 6" x 6" metal top plate and ships with truss head screws to connect to tops. See 702 for available finishes.
- **Pod tables:** 1.5" diameter tube steel legs, available with adjustable levelers or dual wheel locking casters. Each leg includes top plate and hardware for mounting. See 702 for available finishes. Optional Chrome (CHM) finish is available for pod tables only. **Add \$78** for three-legged models or **add \$102** for four-legged models
- **Activity tables:** 2" diameter tapered legs available with adjustable levelers or optional locking casters. Each leg includes top plate and hardware for mounting. See 702 for available finishes. Optional Chrome (CHM) finish is available. **Add \$164.**

Group tables

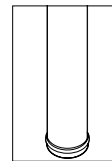

3" dia. leg

Pod tables

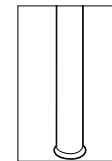

1.5" dia. leg

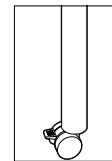

1.5" dia. leg with caster

Activity Tables

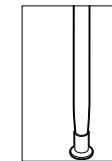

Tapered leg with leveler

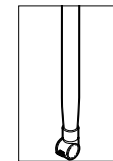

Tapered leg with caster

CASTERS

- Pod table models ending in C indicate legs equipped with 1.5" dia locking casters. Casters are black only.
- Activity table models ending in C indicate legs equipped with 2" dia locking casters. Casters are black only.

GROUP TABLE with CABLE TOWER

- Constructed from thermally fused laminate with a removable access panel
- Inside clearance of 8" x 8.6" will conceal most floor monuments, but still provide easy access.
- Available on group tables ZK44848P, ZK45959P and ZK65990P only.
- Must specify cut-out option when ordering group tables to accommodate select power module. Power modules sold separately.
- Available in Black (BLK), Brushed Cobalt (BRC) or Designer White (DWT) finish

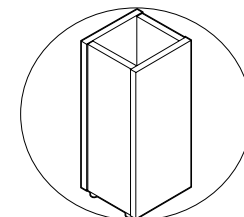

Cable tower

1. SPECIFY MODEL NUMBER

2. SPECIFY TOP FINISH

Thermally Fused and High Pressure Laminate Finishes:

ACJ	Absolute Acajou	CGY	Custom Grey	NML	Noce Medio
ASN	Asian Night	DES	Dark Espresso	QTM	Quartered Mahogany
AWC	Avant Cherry	DWT	Designer White	SBY	Sheer Beauty
AWH	Avant Honey	FAS	Fashionista	SOG	Storm Grey
BLK	Black	FCL	First Class	SDT	Stonedust
BZD	Blizzard	NBL	Noce Biondo	WHE	Walnut Heights
BRC	Brushed Cobalt	NGL	Noce Grigio	WHC	White Chocolate
CMB	Clear Maple	NEL	Noce Leggero	WCR	Winter Cherry

3. SPECIFY EDGE FINISH

2mm Thick Edgebanding:

AAE	Absolute Acajou	FCL	First Class
ASE	Asian Night	FOG	Fog
ACE	Avant Cherry	LAB	Latte
AHE	Avant Honey	NBL	Noce Biondo
BLK	Black	NGL	Noce Grigio
BRC	Brushed Cobalt	NEL	Noce Leggero
BZB	Buzz Blue	NML	Noce Medio
BZD	Blizzard	QTM	Quartered Mahogany
CCT	Cactus	SAR	Scarlet
CRO	Carrot	SBY	Sheer Beauty
CME	Clear Maple	SHW	Shadow
CGY	Custom Grey	SDT	Stonedust
DEE	Dark Espresso	SOG	Storm Grey
DWE	Designer White	WHE	Walnut Heights
DJN	Dijon	CBE	White Chocolate
FAS	Fashionista	WCE	Winter Cherry

Ergo Friendly Edge Finishes (optional - upcharge applies)

EBL	Black
ECP	Latte
ECG	Charcoal Grey
EDW	Designer White
EGR	Grey

4. SPECIFY LEG FINISH

Legs:

TBL	Black
TBZ	Buzz Blue
TCC	Cactus
TCR	Carrot
TIV	Cloud
TDW	Designer White
TDJ	Dijon
TEG	Eggplant
TFO	Fog
TFR	Frost
TIN	Ink
TKA	Kalua
TLA	Latte
TMO	Mocha
TNE	Nevada
TSN	Sand
TSR	Scarlet
TSH	Shadow
TOA	Toast
TTU	Tungsten
CHM	Chrome**

**Upcharges apply for CHM. Refer to model for upcharges.

Note: Leg finish is not optional for flip-top tables. Available in Tungsten (TTU) only.

FINISH	ACTIVITY	FLIP-TOP	GROUP	POD
Black TBL	•	N/A	•	•
Buzz Blue TBZ	•	N/A	•	•
Cactus TCC	•	N/A	•	•
Carrot TCR	•	N/A	•	•
Chrome CHM	•	N/A	N/A	•
Cloud TIV	•	N/A	•	•
Designer White TDW	•	N/A	•	•
Dijon TDJ	•	N/A	•	•
Eggplant TEG	•	N/A	•	•
Fog TFO	•	N/A	•	•
Frost TFR	•	N/A	•	•
Ink TIN	•	N/A	•	•
Kalua TKA	•	N/A	•	•
Latte TLA	•	N/A	•	•
Mocha TMO	•	N/A	•	•
Nevada TNE	•	N/A	•	•
Sand TSN	•	N/A	•	•
Scarlet TSR	•	N/A	•	•
Shadow TSH	•	N/A	•	•
Toast TOA	•	N/A	•	•
Tungsten TTU	•	•	•	•

SPECIFY CABLE TOWER FINISH - ZK44848P, ZK45959P and ZK65990P only

Cable Tower Finishes:

- BLK Black
- BRC Brushed Cobalt
- DWT Designer White

SPECIFY CUT-OUT OPTION - remember to order power module separately

POWER BLOCK AND CUT-OUT OPTIONS

- A power block delivers power/data to the table surface.
- Power block modules must be ordered separately and available for models ZK44848P, ZK45959P and ZK65990P only.
- Must specify the power block cut-out option when ordering the table.
- Optional cut-out available in the **center position** only and corresponds to select power modules. Order as **R2** or **T2** depending on the power module ordered.
- For a custom size cut-out (must be in center position), please contact Customer Care
- Select power block option from Productivity Solutions, beginning on page 462.

- PRTMCS401B
- PRTMCS401T
- PRTMCS401W
- PRTMCS421B
- PRTMCS421T
- PRTMCS421W

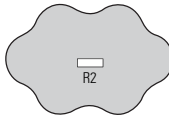

- PRTMCD602B
- PRTMCD602T
- PRTMCD602W
- PRTMCD622B
- PRTMCD622T
- PRTMCD622W
- PRTMCD642B
- PRTMCD642T
- PRTMCD642W

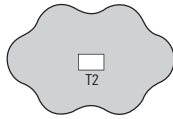

- Match power block desired with cut-out code and location from above grid.
- Example: For power block module # PRTMCS401B, specify cut-out option R2.

MODPOWER DAISY CHAIN SOLUTION

- Add flexible power and USB charging to select Zook tables. Connect up to four units with a single corded infeed with NEMA plug.
- ModPower units are sold separately, refer to Productivity Solutions 465.
- Begin run with a starter unit which includes a corded infeed. Add additional middle or end units as required. Middle and end units are equipped with connecting cables.
- On-surface modules clamp on or screw mount to the table tops.
- In-surface modules require table top cut-outs for mounting. Specify cut-out option:
 - **MPS** for a single cut-out to accommodate one ModPower in-surface unit (cut-out will be centered on the approach side) for **ZKRxxxx(L/C), ZKFR3024* and ZKFR6024*. Add \$96**
 - **MPD** for two cut-outs in the left and right positions, 15" from ends to center of unit on the approach side for **ZKR54xx(L/C), ZKR60xx(L/C), ZKR72xx(L/C) and ZKFR6024*. Add \$192.**

**Note: not for use with Zook flip-top tables if optional modesty panel is specified.*

EXAMPLE ZOOK ORDER CODES:

Group table

ZK65590P	-ACJ	-HPL	-ECG	-TTU	-BRC	-U2
Model #	Top finish	High pressure laminate	Ergo friendly edge and finish	Leg finish	Cable tower finish	Cut out option

Pod table

ZK412529L	-ACJ	-HPL	-WHE	-TTU
Model #	Top finish	High pressure laminate	2mm edge finish	Leg finish

4-6 PERSON GROUP TABLES

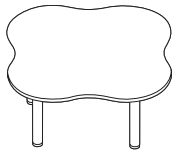

4-Person Table, 20"H



4-Person Table, 29"H

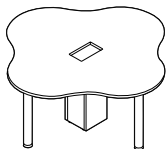

4-Person Table w/Cable Tower, 29"H*

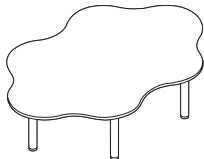

6-Person Table, 20"H

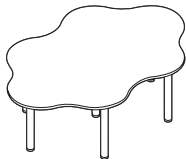

6-Person Table, 29"H

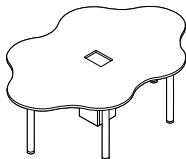

6-Person Table w/Cable Tower, 29"H*

MODEL#	DIMENSIONS D x W x H	FREIGHT CLASS	WT/LBS.	CUBIC FT.	LIST PRICE	HP ADD	ERGO EDGE	WRW
ZK4484820	48 x 48 x 20	60	92	7.10	\$1089	\$317	\$91	\$341
ZK4595920	59 x 59 x 20	65	123	9	\$1119	\$375	\$193	\$510

4-person table includes top and four steel post legs. Top includes factory installed metal inserts for solid and secure leg connections. Legs are 3" in diameter x 19" high each with an adjustable 3" diameter plastic glide and a 6" x 6" metal top plate. Shipped easy to assemble in 5 cartons.

ZK44848	48 x 48 x 29	60	215	7.10	\$1159	\$317	\$91	\$341
ZK45959	59 x 59 x 29	65	220	9.20	\$1192	\$375	\$193	\$510

4-person table includes top and four steel post legs. Top includes factory installed metal inserts for solid and secure leg connections. Legs are 3" in diameter x 28" high each with an adjustable 3" diameter plastic glide and a 6" x 6" metal top plate. Shipped easy to assemble in 5 cartons.

ZK44848P	48 x 48 x 29	65	265	8.86	\$1581	\$317	\$91	\$341
ZK45959P	59 x 59 x 29	65	270	10.96	\$1613	\$375	\$193	\$510

4-person table includes top, four steel post legs and cable tower. Top includes factory installed metal inserts for solid and secure leg connections. Legs are 3" in diameter x 28" high each with an adjustable 3" diameter plastic glide and a 6" x 6" metal top plate. Shipped easy to assemble in 6 cartons. For power block options, see page 462.

ZK6599020	59 x 90 x 20	70	247.50	14	\$1731	\$657	\$285	\$845
-----------	--------------	----	--------	----	---------------	--------------	--------------	--------------

6-person table includes top and seven steel post legs. Top includes factory installed metal inserts for solid and secure leg connections. Legs are 3" in diameter x 19" high each with an adjustable 3" diameter plastic glide and a 6" x 6" metal top plate. Shipped easy to assemble in 8 cartons.

ZK65990	59 x 90 x 29	70	245	13.43	\$1842	\$657	\$285	\$845
---------	--------------	----	-----	-------	---------------	--------------	--------------	--------------

6-person table includes top and seven steel post legs. Top includes factory installed metal inserts for solid and secure leg connections. Legs are 3" in diameter x 28" high each with an adjustable 3" diameter plastic glide and a 6" x 6" metal top plate. Shipped easy to assemble in 8 cartons.

ZK65990P	59 x 90 x 29	70	295	15.28	\$2180	\$657	\$285	\$845
----------	--------------	----	-----	-------	---------------	--------------	--------------	--------------

6-person table includes top, seven steel post legs and cable tower. Top includes factory installed metal inserts for solid and secure leg connections. Legs are 3" in diameter x 28" high with an adjustable 3" diameter plastic glide and a 6" x 6" metal top plate. Shipped easy to assemble in 8 cartons. For power block options, see page 462.

Required specifications





Top finish
Edge finish
Leg finish

Optional specifications

HP laminate
Ergo friendly edge and finish
Power block cut-out*
Writeable surface (WRW)

Accessories

Power block*

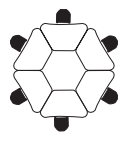
POD TABLES	MODEL#	DIMENSIONS	FREIGHT CLASS	WT/LBS.	CUBIC FT.	LIST PRICE	HP ADD	ERGO EDGE	WRW
Sample pod table configurations	D x W x H								
	ZK412529L shown in left, forward and right facing position	ZK302529L x 4 shown in alternating straight line orientation	ZK412529L x 4	ZK302529L x 6	ZK312129L x 6				
									

POD TABLES - 29" HIGH	MODEL#	DIMENSIONS	FREIGHT CLASS	WT/LBS.	CUBIC FT.	LIST PRICE	HP ADD	ERGO EDGE	WRW
	ZK302529L	24.6 x 30 x 29	70	37	2	\$391	\$69	\$31	\$156

Small Pod Table w/3 Legs

Triangular table with three round tube 18 gauge steel legs. Can be used individually, can alternate front-to-back in a straight row, or can be arranged in groups of six to create a round table effect. Top includes factory installed metal inserts for solid and secure leg connections. Legs are 1.5" in diameter x 28" high with adjustable levelers. Shipped easy to assemble in 4 cartons, top separate from legs; legs individually packed.

- Chrome (CHM) is available on legs. **Add \$78** list.



Medium Pod Table w/4 Legs

ZK352129L	20.9 x 35 x 29	70	41	2.40	\$492	\$83	\$37	\$156
-----------	----------------	----	----	------	--------------	-------------	-------------	--------------

Trapezoid table with four round tube 18 gauge steel legs. Can be used individually or can be arranged in groups of six to create a round table effect. Top includes factory installed metal inserts for solid and secure leg connections. Legs are 1.5" in diameter x 28" high with adjustable levelers. Shipped easy to assemble in 5 cartons, top separate from legs; legs individually packed.

- Chrome (CHM) is available on legs. **Add \$102** list.

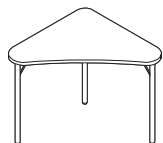

Large Pod Table w/3 Legs

ZK412529L	25.7 x 41 x 29	70	48	2.24	\$505	\$106	\$44	\$182
-----------	----------------	----	----	------	--------------	--------------	-------------	--------------

Triangular table with three round tube 18 gauge steel legs. Can be used individually or can be arranged in groups of four to create a square table effect. Top includes factory installed metal inserts for solid and secure leg connections. Legs are 1.5" in diameter x 28" high with adjustable levelers. Shipped easy to assemble in 4 cartons, top separate from legs; legs individually packed.

- Chrome (CHM) is available on legs. **Add \$78** list.

Required specifications

Top finish
Edge finish
Leg finish

Optional specifications

HP laminate
Ergo friendly edge and finish
Writeable surface (WRW)
Chrome (CHM) legs

POD TABLES - 32" HIGH



Medium Pod Table w/4 Legs



Large Pod Table w/3 Legs

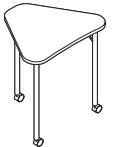

Small Mobile Pod Table w/3 Legs

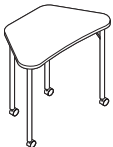

Medium Mobile Pod Table w/4 Legs

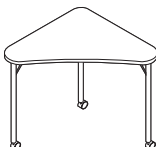

Large Mobile Pod Table w/3 Legs

MODEL#	DIMENSIONS D x W x H	FREIGHT CLASS	WT/LBS.	CUBIC FT.	LIST PRICE	HP ADD	ERGO EDGE	WRW
ZK352132L	20.9 x 35 x 32	70	41	2.55	\$502	\$83	\$37	\$156

ADA compliant table with four round tube 18 gauge steel legs. Can be used individually or can be arranged in groups of six to create a round table effect. Top includes factory installed metal inserts for solid and secure leg connections. Legs are 1.5" in diameter x 31" high with adjustable levelers. Shipped easy to assemble in 5 cartons, top separate from legs; legs individually packed.

- Chrome (CHM) is available on legs. **Add \$102** list.

ZK412532L	25.7 x 41 x 32	70	48	2.36	\$510	\$106	\$44	\$182
-----------	----------------	----	----	------	-------	-------	------	-------

ADA compliant table with three round tube 18 gauge steel legs. Can be used individually or can be arranged in groups of four to create a square table effect. Top includes factory installed metal inserts for solid and secure leg connections. Legs are 1.5" in diameter x 31" high with adjustable levelers. Shipped easy to assemble in 4 cartons, top separate from legs; legs individually packed.

- Chrome (CHM) is available on legs. **Add \$78** list.

ZK302529C	24.6 x 30 x 29	70	37	2	\$418	\$69	\$31	\$156
-----------	----------------	----	----	---	-------	------	------	-------

Triangular table with three round tube 18 gauge steel legs. Can be used individually, can alternate front-to-back in a straight row, or can be arranged in groups of six to create a round table effect. Top includes factory installed metal inserts for solid and secure leg connections. Legs are 1.5" in diameter x 28" high with 1.5" dual wheel locking casters. Shipped easy to assemble in 4 cartons, top separate from legs; legs individually packed.

- Chrome (CHM) is available on legs. **Add \$78** list.

ZK352129C	20.9 x 35 x 29	70	41	2.40	\$531	\$83	\$37	\$156
-----------	----------------	----	----	------	-------	------	------	-------

Trapezoid table with four round tube 18 gauge steel legs. Can be used individually or can be arranged in groups of six to create a round table effect. Top includes factory installed metal inserts for solid and secure leg connections. Legs are 1.5" in diameter x 28" high with 1.5" dual wheel locking casters. Shipped easy to assemble in 5 cartons, top separate from legs; legs individually packed.

- Chrome (CHM) is available on legs. **Add \$102** list.

ZK412529C	25.7 x 41 x 29	70	48	2.24	\$534	\$106	\$44	\$182
-----------	----------------	----	----	------	-------	-------	------	-------

Triangular table with three round tube 18 gauge steel legs. Can be used individually or can be arranged in groups of four to create a square table effect. Top includes factory installed metal inserts for solid and secure leg connections. Legs are 1.5" in diameter x 28" high with 1.5" dual wheel locking casters. Shipped easy to assemble in 4 cartons, top separate from legs; legs individually packed.

- Chrome (CHM) is available on legs. **Add \$78** list.

Required specifications

Top finish
Edge finish
Leg finish

Optional specifications

HP laminate
Ergo friendly edge and finish
Writeable surface (WRW)
Chrome (CHM) legs

RECTANGULAR TABLES - 29" HIGH

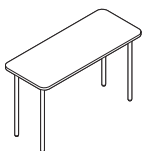

Rectangular Table, 20" Deep

MODEL #	DIMENSIONS D x W x H	FREIGHT CLASS	WT/LB.	CUBIC FT.	LIST PRICE	HP ADD	ERGO EDGE	WRW
ZKR3020L	20 x 30 x 29	70	50	2.55	\$465	\$110	\$35	\$144
ZKR3620L	20 x 36 x 29	70	51	2.65	\$481	\$130	\$37	\$156
ZKR4820L	20 x 48 x 29	70	58	2.95	\$531	\$171	\$44	\$177
ZKR5420L	20 x 54 x 29	70	64	3.15	\$616	\$194	\$48	\$187
ZKR6020L	20 x 60 x 29	70	70	3.25	\$640	\$214	\$52	\$198
ZKR7220L	20 x 72 x 29	65	85	3.55	\$700	\$258	\$58	\$214

Table with four round tube 18 gauge steel legs. Legs are 1.5" in diameter x 28" high with adjustable levelers. Top features 2.5" radius rounded corners and includes factory installed metal inserts for solid and secure leg connections. Tables 54" and wider include support channel. Shipped easy to assemble in 5 cartons, top separate from legs; legs individually packed.

- Chrome (CHM) is available on legs. **Add \$102** list.

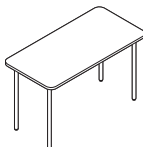

Rectangular Table, 24" Deep

ZKR3024L	24 x 30 x 29	70	51	2.75	\$468	\$130	\$36	\$156
ZKR3624L	24 x 36 x 29	70	53	2.85	\$505	\$158	\$38	\$166
ZKR4824L	24 x 48 x 29	70	59	3.25	\$563	\$206	\$45	\$193
ZKR5424L	24 x 54 x 29	70	65	3.35	\$653	\$232	\$50	\$202
ZKR6024L	24 x 60 x 29	70	71	3.55	\$681	\$256	\$53	\$214
ZKR7224L	24 x 72 x 29	70	86	3.95	\$745	\$307	\$60	\$240

Table with four round tube 18 gauge steel legs. Legs are 1.5" in diameter x 28" high with adjustable levelers. Top features 2.5" radius rounded corners and includes factory installed metal inserts for solid and secure leg connections. Tables 54" and wider include support channel. Shipped easy to assemble in 5 cartons, top separate from legs; legs individually packed.

- Chrome (CHM) is available on legs. **Add \$102** list.

MOBILE RECTANGULAR TABLES - 29" HIGH

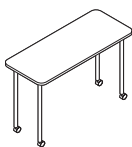

Mobile Rectangular Table, 20" Deep

MODEL #	DIMENSIONS	FREIGHT CLASS	WT/LB.	CUBIC FT.	LIST PRICE	HP ADD	ERGO EDGE	WRW
ZKR3020C	20 x 30 x 29	70	50	2.55	\$504	\$110	\$35	\$144
ZKR3620C	20 x 36 x 29	70	51	2.65	\$516	\$130	\$37	\$156
ZKR4820C	20 x 48 x 29	70	58	2.95	\$566	\$171	\$44	\$177
ZKR5420C	20 x 54 x 29	70	64	3.15	\$654	\$194	\$48	\$187
ZKR6020C	20 x 60 x 29	70	70	3.25	\$678	\$214	\$52	\$198
ZKR7220C	20 x 72 x 29	65	85	3.55	\$737	\$258	\$58	\$214

Table with four round tube 18 gauge steel legs. Legs are 1.5" in diameter x 28" high with 1.5" dual wheel locking casters. Top features 2.5" radius rounded corners and includes factory installed metal inserts for solid and secure leg connections. Tables 54" and wider include support channel. Shipped easy to assemble in 5 cartons, top separate from legs; legs individually packed.

- Chrome (CHM) is available on legs. **Add \$102** list.

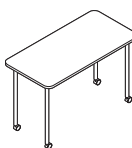

Mobile Rectangular Table, 24" Deep

ZKR3024C	24 x 30 x 29	70	51	2.75	\$507	\$130	\$36	\$156
ZKR3624C	24 x 36 x 29	70	53	2.85	\$543	\$158	\$38	\$166
ZKR4824C	24 x 48 x 29	70	59	3.25	\$602	\$206	\$45	\$193
ZKR5424C	24 x 54 x 29	70	65	3.35	\$691	\$232	\$50	\$202
ZKR6024C	24 x 60 x 29	70	71	3.55	\$719	\$256	\$53	\$214
ZKR7224C	24 x 72 x 29	70	86	3.95	\$785	\$307	\$60	\$240

Table with four round tube 18 gauge steel legs. Legs are 1.5" in diameter x 28" high with 1.5" dual wheel locking casters. Top features 2.5" radius rounded corners and includes factory installed metal inserts for solid and secure leg connections. Tables 54" and wider include support channel. Shipped easy to assemble in 5 cartons, top separate from legs; legs individually packed.

- Chrome (CHM) is available on legs. **Add \$102** list.

Required specifications

Top finish
Edge finish
Leg finish

Optional specifications

HP laminate
Ergo friendly edge and finish
Writeable surface (WRW)
Chrome (CHM) legs

ACTIVITY TABLES

Sample activity table configurations

D x W x H

Straight mating edges

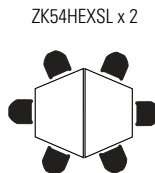
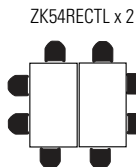

Curved mating edges

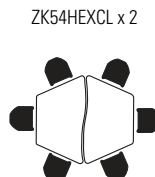
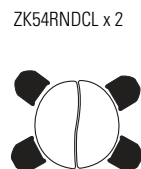
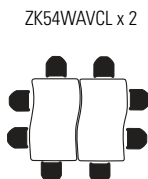

Mixed shapes
Curved mating edges shown.
Can also do the same with
straight mating edge tables.

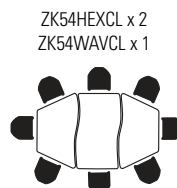
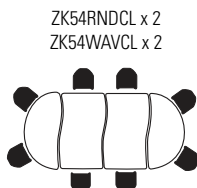

ACTIVITY TABLES - 29" HIGH, CURVED

MODEL# DIMENSIONS FREIGHT CLASS WT/LBS. CUBIC FT. LIST PRICE HP ADD ERGO EDGE WRW

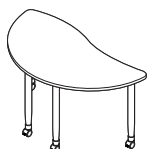

Curved Half Round w/Casters

ZK54RNDCC 28.4 x 54 x 28.75 65 67.4 1.40 \$937 \$214 \$56 \$202

44.3" inside clearance between legs on curved edge, 22.9" on narrow depth side and 24" on other side. Dual leg position on front interferes with users sitting on ends in a racetrack configuration, oriented to seat two - one on either side. Top includes factory installed inserts for metal-to-metal leg connection. Shipped easy to assemble in 2 cartons, top separate from leg.
• Chrome (CHM) is available on legs. **Add \$164** list.

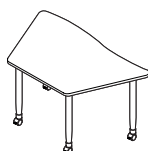

Curved Half Hex w/Casters

ZK54HEXCC 32.4 x 54 x 28.75 65 76.4 1.49 \$1010 \$246 \$66 \$202

42.9" inside clearance between legs on curved edge, 22.3" on narrow depth side and 24" on other side. 22.8" on straight end. Top includes factory installed inserts for metal-to-metal leg connection. Shipped easy to assemble in 2 cartons, top separate from leg.
• Chrome (CHM) is available on legs. **Add \$164** list.

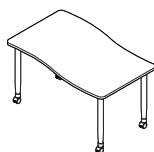

Wave w/Casters

ZK54WAVCC 33.8 x 54 x 28.75 65 77.4 1.52 \$1042 \$262 \$79 \$202

44.9" inside clearance between legs on curved edge, 21.9" on sides. Top includes factory installed inserts for metal-to-metal leg connection. Shipped easy to assemble in 2 cartons, top separate from leg.
• Chrome (CHM) is available on legs. **Add \$164** list.

Required specifications

Top finish
Edge finish
Leg finish

Optional specifications

HP laminate
Ergo friendly edge and finish
Writeable surface (WRW)
Chrome (CHM) legs

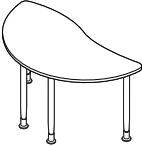
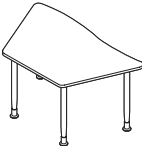
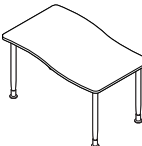
ACTIVITY TABLES - 29" HIGH, CURVED	MODEL #	DIMENSIONS	FREIGHT CLASS	WT/LB.	CUBIC FT.	LIST PRICE	HP ADD	ERGO EDGE	WRW
 <p data-bbox="142 324 412 348">Curved Half Round w/Levelers*</p>	ZK54RNDCL	D x W x H 28.4 x 54 x 28.25	65	67.4	1.40	\$929	\$214	\$56	\$202
<p>44.3" inside clearance between legs on curved edge, 22.9" on narrow depth side and 24" on other side. Dual leg position on front interferes with users sitting on ends in a racetrack configuration, oriented to seat two - one on either side. Top includes factory installed inserts for metal-to-metal leg connection. Levelers offer 1.25" of height adjustability. Shipped easy to assemble in 2 cartons, top separate from leg.</p> <ul style="list-style-type: none"> • Chrome (CHM) is available on legs. Add \$164 list. 									
 <p data-bbox="142 681 391 705">Curved Half Hex w/Levelers*</p>	ZK54HEXCL	32.4 x 54 x 28.25	65	76.4	1.49	\$1003	\$246	\$66	\$202
<p>42.9" inside clearance between legs on curved edge, 22.3" on narrow depth side and 24" on other side. 22.8" on straight end. Top includes factory installed inserts for metal-to-metal leg connection. Levelers offer 1.25" of height adjustability. Shipped easy to assemble in 2 cartons, top separate from leg.</p> <ul style="list-style-type: none"> • Chrome (CHM) is available on legs. Add \$164 list. 									
 <p data-bbox="142 1010 302 1034">Wave w/Levelers*</p>	ZK54WAVCL	33.8 x 54 x 28.25	65	77.4	1.52	\$1034	\$262	\$79	\$202
<p>44.9" inside clearance between legs on curved edge, 21.9" on sides. Top includes factory installed inserts for metal-to-metal leg connection. Levelers offer 1.25" of height adjustability. Shipped easy to assemble in 2 cartons, top separate from leg.</p> <ul style="list-style-type: none"> • Chrome (CHM) is available on legs. Add \$164 list. 									

Required specifications

Top finish
Edge finish
Leg finish

Optional specifications

HP laminate
Ergo friendly edge and finish
Writeable surface (WRW)
Chrome (CHM) legs

ACTIVITY TABLES - 29" HIGH, STRAIGHT

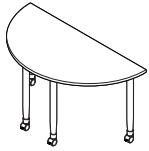

Straight Half Round w/Casters

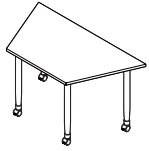

Straight Half Hex w/Casters

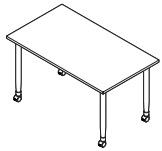

Rectangular w/Casters

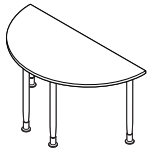

Straight Half Round w/Levelers

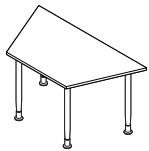

Straight Half Hex w/Levelers

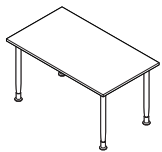

Rectangular w/Levelers

MODEL #	DIMENSIONS D x W x H	FREIGHT CLASS	WT/LB.	CUBIC FT.	LIST PRICE	HP ADD	ERGO EDGE	WRW
ZK54RNDSC	28.4 x 54 x 28.75	65	67.4	1.40	\$885	\$189	N/A	\$202
<p>44.2" inside clearance between legs on long side, 23.7" on the sides. Dual leg position on front interferes with users sitting on ends in a racetrack configuration, oriented to seat two - one on either side. Top includes factory installed inserts for metal-to-metal leg connection. Shipped easy to assemble in 2 cartons, top separate from leg.</p> <ul style="list-style-type: none"> • Chrome (CHM) is available on legs. Add \$164 list. 								
ZK54HEXSC	32.4 x 54 x 28.75	65	73.4	1.49	\$914	\$204	N/A	\$202
<p>40.6" inside clearance between legs on long side, 21.4" on sides and 22.3" on short side. Top includes factory installed inserts for metal-to-metal leg connection. Shipped easy to assemble in 2 cartons, top separate from leg.</p> <ul style="list-style-type: none"> • Chrome (CHM) is available on legs. Add \$164 list. 								
ZK54RECTC	33.8 x 54 x 28.75	65	73.4	1.52	\$965	\$227	N/A	\$202
<p>45.3" inside clearance between legs on long sides and 22.3" on short sides. Top includes factory installed inserts for metal-to-metal leg connection. Shipped easy to assemble in 2 cartons, top separate from leg.</p> <ul style="list-style-type: none"> • Chrome (CHM) is available on legs. Add \$164 list. 								
ZK54RNDSL	28.4 x 54 x 28.25	65	67.4	1.40	\$877	\$189	N/A	\$202
<p>44.2" inside clearance between legs on long side, 23.7" on the sides. Dual leg position on front interferes with users sitting on ends in a racetrack configuration, oriented to seat two - one on either side. Top includes factory installed inserts for metal-to-metal leg connection. Levelers offer 1.25" of height adjustability. Shipped easy to assemble in 2 cartons, top separate from leg.</p> <ul style="list-style-type: none"> • Chrome (CHM) is available on legs. Add \$164 list. 								
ZK54HEXSL	32.4 x 54 x 28.25	65	73.4	1.49	\$907	\$204	N/A	\$202
<p>40.6" inside clearance between legs on long side, 21.4" on sides and 22.3" on short side. Top includes factory installed inserts for metal-to-metal leg connection. Levelers offer 1.25" of height adjustability. Shipped easy to assemble in 2 cartons, top separate from leg.</p> <ul style="list-style-type: none"> • Chrome (CHM) is available on legs. Add \$164 list. 								
ZK54RECTL	33.8 x 54 x 28.25	65	73.4	1.52	\$958	\$227	N/A	\$202
<p>45.3" inside clearance between legs on long sides and 22.3" on short sides. Top includes factory installed inserts for metal-to-metal leg connection. Levelers offer 1.25" of height adjustability. Shipped easy to assemble in 2 cartons, top separate from leg.</p> <ul style="list-style-type: none"> • Chrome (CHM) is available on legs. Add \$164 list. 								

Required specifications

Top finish
Edge finish
Leg finish

Optional specifications

HP laminate
Writeable surface (WRW)
Chrome (CHM) legs

FLIP-TOP TABLES **MODEL#** **DIMENSIONS** **FREIGHT CLASS** **WT/LBS.** **CUBIC FT.** **LIST PRICE** **HP ADD** **ERGO EDGE** **WRW**

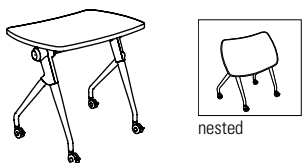

Flip-Top Table, Contoured Top

		D x W x H							
Top:	ZKFC3022T	22 x 30 x 29.5	150	20.6	2.03	\$248	\$127	\$93	\$150
Base:	ZKFTB30		125	26.5	3.6	\$685	n/a	n/a	n/a

Mobile flip-top table with smooth glide locking casters. Easy to operate twist knob with integrated thumb tab. Top includes factory installed inserts for metal-to-metal leg connection. When nested, each additional table adds 5.25" to footprint needed for storage. Optional modesty (ZKFTM30) available separately. Top and base shipped separately. Legs available in Tungsten (TUN) only.

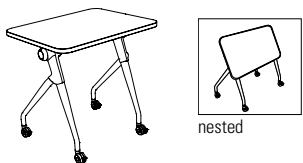

Flip-Top Table, Rectangular Top**

Top:	ZKFR3024T	24 x 30 x 29.5	70	21.5	1.03	\$277	\$139	\$108	\$156
Base:	ZKFTB30		125	26.5	3.6	\$685	n/a	n/a	n/a

Mobile flip-top table with smooth glide locking casters. Easy to operate twist knob with integrated thumb tab. Top includes factory installed inserts for metal-to-metal leg connection. When nested, each additional table adds 5.25" to footprint needed for storage. Optional modesty (ZKFTM30) available separately. Top and base shipped separately. Legs available in Tungsten (TUN) only.

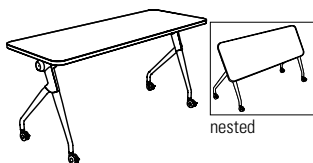

Flip-Top Table, Rectangular Top*

Top:	ZKFR6024T	24 x 60 x 29.5	70	43	1.92	\$405	\$207	\$112	\$214
Base:	ZKFTB60		100	31	3.86	\$778	n/a	n/a	n/a

Mobile flip-top table with smooth glide locking casters. Easy to operate twist knob with integrated thumb tab. Top includes factory installed inserts for metal-to-metal leg connection. When nested, each additional table adds 5.25" to footprint needed for storage. Optional modesty (ZKFTM60) available separately. Top and base shipped separately. Legs available in Tungsten (TUN) only.

MODESTY PANELS FOR FLIP-TOP TABLES **MODEL#** **DIMENSIONS** **FREIGHT CLASS** **WT/LBS.** **CUBIC FT.** **LIST PRICE**



Modesty for ZKFC3022 and ZKFC3024

ZKFTM30	0.5 x 17.8 x 13.8	60	6.6	0.22	\$66
---------	-------------------	----	-----	------	-------------

Hardware included to attach to ZKFC3022 or ZKFR3024. Tungsten finish only. Shipped in 1 carton.

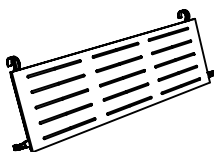

Modesty for ZKFR6024

ZKFTM60	0.5 x 47.3 x 13.8	65	14.3	0.57	\$129
---------	-------------------	----	------	------	--------------

Hardware included to attach **ZKFR6024**. Tungsten finish only. Shipped in 1 carton.

Required Specifications

Top finish
Edge finish

Optional Specifications

HP laminate
Ergo friendly edge and finish
Writeable surface (WRW)

C CITI TABLES

CITI TABLES	MODEL#	DIMENSIONS D x W x H	FREIGHT CLASS	WT/LBS.	CUBIC FT.	LIST PRICE
-------------	--------	-------------------------	---------------	---------	-----------	------------

Notes

- Citi tables complement the contemporary timeless decor of many offices.
- Legs are **standard** in Tungsten (**TTU**) and also available in Black (**TBL**) or Shadow (**TSH**) at no charge. A Chrome (**CHM**) finish is available. **Add \$110.**
- Table tops are available in either tempered glass or laminate
- Citi tables are offered in the following finishes to coordinate with Global casegoods and wood seating:

ACJ	Absolute Acajou	FCL	First Class
ASN	Asian Night	NBL	Noce Biondo
AWC	Avant Cherry	NGL	Noce Grigio
AWH	Avant Honey	NEL	Noce Leggero
BLK	Black	NML	Noce Medio
BZD	Blizzard	QTM	Quartered Mahogany
BRC	Brushed Cobalt	SBY	Sheer Beauty
CMB	Clear Maple	SOG	Storm Grey
CGY	Custom Grey	SDT	Stonedust
DES	Dark Espresso	WHE	Walnut Heights
DWT	Designer White	WHC	White Chocolate
FAS	Fashionista	WCR	Winter Cherry

CITI TABLES	MODEL#	DIMENSIONS	FREIGHT CLASS	WT/LBS.	CUBIC FT.	LIST PRICE
-------------	--------	------------	---------------	---------	-----------	------------

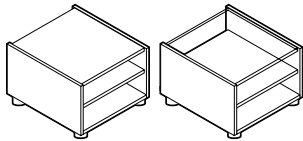

End Table

7885 (laminate top)	20 x 24 x 20	100	53	6	\$827
7886 (glass top)	20 x 24 x 20	92.5	60	6	\$1166

Metal tubular legs. Laminate or tempered glass tops available.

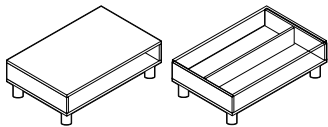

Coffee Table - Rectangular

7887 (laminate top)	20 x 40 x 15	100	60	6.50	\$863
7888 (glass top)	20 x 40 x 15	92.5	75	6.50	\$1343

Metal tubular legs. Laminate or tempered glass tops available.

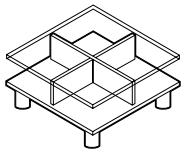

Coffee Table - Square

7889 (glass top)	33 x 33 x 15	92.5	90	8.75	\$1630
---------------------	--------------	------	----	------	---------------

Metal tubular legs. Tempered glass top.

Required Specifications

Finish

COAT TREES



Coat Tree

MODEL#	DIMENSIONS	FREIGHT CLASS	WT/LBS.	CUBIC FT.	LIST PRICE
--------	------------	---------------	---------	-----------	------------

D x W x H					
PCOS2	25 x 25 x 60	300	8	4.67	\$501
PCOS3	25 x 25 x 60	300	8	4.67	\$501

Square tube metal frame, complete with four Chrome double hooks. Adjustable glides. 60" high. Ships UPS.

- 3 per carton
- PCOS2 is finished in **Black**.
- PCOS3 is finished in **Chrome**.



Coat Tree

PCT	25 x 25 x 65	250	6	3	\$642
-----	--------------	-----	---	---	--------------

Square tube wood frame. Complete with four satin brass double hooks. 65" high. Available in the following finishes: Absolute (AAM), Black (BKM), Cherry (ACM), English Oak (EOM), Gray (HGM), Honey (AHM), Maple (AVM), Medium Walnut (MWM), Night (ASM), Sandy Beach (SBM), Mahogany (TMM), Fruitwood (TFM), White (WHM), Winter Cherry (WCM) and Walnut (TWM). Ships assembled via UPS.

- 1 per carton

Required Specifications

Finish

L LAMINATE OCCASIONAL TABLES

LAMINATE OCCASIONAL TABLES	MODEL#	DIMENSIONS	FREIGHT CLASS	WT/LBS.	CUBIC FT.	LIST PRICE
D x W x H						

Notes:

- High pressure laminate exterior with adjustable plastic glides
- Premium cylinder tables have a flexible plywood core construction ideal for institutional and high traffic environments
- Ideal for reception areas - colors coordinate with all Global desks, conference tables and accessories.
- Ships assembled in one carton.
- Available to either match or coordinate with most Global laminate desk series. Available finishes:

ACJ	Absolute Acajou	FCL	First Class
ASN	Asian Night	NBL	Noce Biondo
AWC	Avant Cherry	NGL	Noce Grigio
AWH	Avant Honey	NEL	Noce Leggero
BLK	Black	NML	Noce Medio
BZD	Blizzard	QTM	Quartered Mahogany
BRC	Brushed Cobalt	SBY	Sheer Beauty
CMB	Clear Maple	SOG	Storm Grey
CGY	Custom Grey	SDT	Stonedust
DES	Dark Espresso	WHE	Walnut Heights
DWT	Designer White	WHC	White Chocolate
FAS	Fashionista	WCR	Winter Cherry

LAMINATE OCCASIONAL TABLES	MODEL#	DIMENSIONS	FREIGHT CLASS	WT/LBS.	CUBIC FT.	LIST PRICE
----------------------------	--------	------------	---------------	---------	-----------	------------

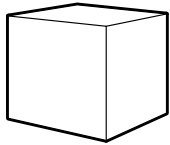

Cube Table

GCU1816	18 x 18 x 16	85	40	3.30	\$615
GCU1821	18 x 18 x 21	92.5	46	4	\$717
GCU2416	24 x 24 x 16	92.5	63	6	\$717
GCU2421	24 x 24 x 21	92.5	83	7	\$717

3/4" plywood covered in high pressure laminate. Plastic glides. **Flush base.**

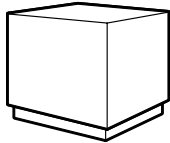

Plinth Cube Table

GCUP1816	18 x 18 x 16	85	40	3	\$680
GCUP1821	18 x 18 x 21	92.5	46	4	\$785
GCUP2416	24 x 24 x 16	92.5	63	6	\$785
GCUP2421	24 x 24 x 21	92.5	83	7	\$785

3/4" plywood covered in high pressure laminate. Plastic glides. **Recessed base.**

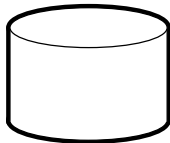

Cylinder Table

GCY1816	18 x 18 x 16	85	43	3.30	\$615
GCY1821	18 x 18 x 21	92.5	49	4.30	\$717
GCY2416	24 x 24 x 16	125	47	6	\$717
GCY2421	24 x 24 x 21	100	66	7	\$717
GCY3016	30 x 30 x 16	125	59	8	\$815
GCY3021	30 x 30 x 21	125	78	11	\$815

3/8" foundation board covered in high pressure laminate. Plastic glides. **Flush base.**

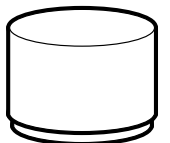

Plinth Cylinder Table

GCYP1816	18 x 18 x 16	85	43	3.30	\$680
GCYP1821	18 x 18 x 21	92.5	49	4.30	\$785
GCYP2416	24 x 24 x 16	125	47	6	\$785
GCYP2421	24 x 24 x 21	100	66	7	\$785
GCYP3016	30 x 30 x 16	125	59	8	\$891
GCYP3021	30 x 30 x 21	125	78	11	\$891

3/8" foundation board covered in high pressure laminate. Plastic glides. **Recessed base.**

Required Specifications

Finish

LAMINATE OCCASIONAL TABLES

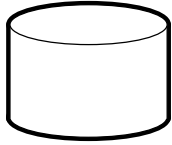

Premium Cylinder Table

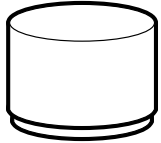

Premium Plinth Cylinder Table

MODEL# DIMENSIONS FREIGHT CLASS WT/LBS. CUBIC FT. LIST PRICE

D x W x H

CPFD1816	18 x 18 x 16	150	30	7	\$1024
CPFD1821	18 x 18 x 21	150	30	7	\$1053
CPFD2416	24 x 24 x 16	250	42	11.50	\$1063
CPFD2421	24 x 24 x 21	250	42	11.50	\$1091
CPFD3016	30 x 30 x 16	250	52	17	\$1203
CPFD3021	30 x 30 x 21	250	52	17	\$1327

1 1/32" plywood covered in high pressure laminate. Plastic glides. **Flush base.**

CPPD1816	18 x 18 x 16	150	30	7	\$1078
CPPD1821	18 x 18 x 21	150	30	7	\$1106
CPPD2416	24 x 24 x 16	250	42	11.50	\$1117
CPPD2421	24 x 24 x 21	250	42	11.50	\$1144
CPPD3016	30 x 30 x 16	250	52	17	\$1277
CPPD3021	30 x 30 x 21	250	52	17	\$1400

1 1/32" plywood covered in high pressure laminate. Plastic glides. **Recessed base.**

Required Specifications

Finish

D DRIFT TABLES

TABLES WITH SLED BASE	MODEL#	DIMENSIONS	FREIGHT CLASS	WT/LBS.	CUBIC FT.	LIST PRICE	HP ADD	GR. 2 ADD
-----------------------	--------	------------	---------------	---------	-----------	------------	--------	-----------

DRIFT TABLES



model 8041R2616C
26"W x 16" H Round Table,
Laminate Surface, Flat Edge,
Chrome Base



model 8042SQ2816I
28"W x 16" H Square Table,
Laminate Surface, Flat Edge,
Sled Base



Model 8042SQ2816W
28"W x 16" H Square Table,
Laminate Surface, Flat Edge
Wood Base



For Drift seating, see page

EXAMPLE OF TABLE ORDER CODE:

8041R2616I	TFL	ACJ	TBL	CG
Model Number	Surface Type	Top HPL Finish	Base Finish (Sled Base)	Glide Type (Sled Base)

STANDARD FEATURES

- Tables are available in three shapes, multiple sizes, two edge styles, three top materials and three base types including: sled, wood and polished Chrome bases.
- Table bases are fixed and do not swivel.
- Wood bases are made from beechwood and are available in all standard wood finishes.
- Sled bases are standard in painted metal.
- Chrome base tables are available in polished Chrome only.
- All table tops are available with flat edge. High pressure laminate (HPL) and solid surface top tables are also available with knife edge.
- Laminate flat edge tops are available in either (TFL) 1" thick thermally fused laminate with 2mm edgeband or (HPL) 1-1/16" thick high pressure laminate with 2mm edgeband, with upcharge.
- Laminate knife edge tops are 1-3/16" thick with 2.5mm edgeband, available in high pressure laminate (HPL) only.
- Solid surface table tops are 1.25" thick, available on models with flat or knife edge. For detailed material information, please reference WilsonArt's Solid Surface collection.
- Wood and Chrome bases are equipped with White non-marking polycarbonate glides suitable for most hard and carpeted floor surfaces.
- Sled bases are available with clear polycarbonate glides, standard.
- Wood and sled bases may be specified with a variety of optional glide types to suit various flooring materials. (See Glide Types for additional glide options and upcharges.)
- Tables are shipped fully assembled.

Add option codes in the following order:

- **Model Number**
Specify model number
- **Surface Type** (Laminate, Flat Edge Tables)
(TFL) Thermally fused laminate
(HPL) High pressure laminate
- **Top Finish** (TFL or HPL laminate, flat edge tables and HPL laminate knife edge tables only)
HPL upcharges apply -see model
(ACJ) Absolute Acajou (ASN) Asian Night
(AWC) Avant Cherry (AWH) Avant Honey
(BLK) Black (BZD) Blizzard
(BRC) Brushed Cobalt (CMB) Clear Maple
(CGY) Custom Grey (DES) Dark Espresso
(DWT) Designer White (FAS) Fashionista
(FCL) First Class (NBL) Noce Biondo
(NGL) Noce Grigio (NEL) Noce Leggero
(NML) Noce Medio (QTM) Quartered Mahogany
(SBY) Sheer Beauty (SOG) Storm Grey
(SDT) Stonedust (WCR) Winter Cherry
(WHC) White Chocolate (WHE) Walnut Heights
- **Top Finish** (solid surface, flat and knife edge tables)
Grade 1
(SWH) Designer White
Grade 2, Upcharge applicable, see models.
(SBT) Beige Tempest
(SBX) Black Onyx Mirage
(SMG) Milk Glass Spectra
(SFW) Frosty White Mirage
(SHS) Hot Stone
(SNM) Northern Melange
- **Base finish** (sled base models only)
Paint finishes:
(TBL) Black (TTU) Tungsten
(TSH) Shadow (TDW) Designer White
(TNE) Nevada (TLA) Latte
(TKA) Kalua (TMO) Mocha
(TOA) Toast (TFO) Fog
(TIV) Cloud (TSN) Sand
(TFR) Frost (TDJ) Dijon
(TCR) Carrot (TSR) Scarlet
(TCC) Cactus (TBZ) Buzz Blue
(TEG) Eggplant (TIN) Ink

Metallic finish:
(CHM) Chrome. Add \$42
- **Base Finish** (Chrome base only)
(CHM) Chrome
- **Glide Type** (sled base)
(CG) Clear, polycarbonate glide for most floor surfaces (standard)
(XG) No glide for carpeted surfaces, no charge
(SG) Steel cushioned glide for carpeted surface. Add \$34
(RG) Rubber, non-slip glide for most hard floor surfaces. Add \$34
(FG) Felt glide for most hard floor surfaces. Add \$34
- **Glide Type** (wood base)
(NM) White non-marking nylon glide for most surfaces (standard)
(SG) Steel cushioned glides for carpeted surfaces. Add \$34.
(RG) Non-slip rubber glides for most hard floor surfaces. Add \$34.
(FG) Felt glides for most hard floor surfaces. Add \$34.

TABLES WITH SLED BASE



Round Table with Sled Base

MODEL#	DIMENSIONS	FREIGHT CLASS	WT./LBS.	CUBIC FT.	LIST PRICE	HP ADD	GR. 2 ADD
Laminate, flat edge (TFL laminate)							
8041R2616I	26 x 26 x 16	250	35	10.25	\$561	\$98	n/a
8041R3016I	30 x 30 x 16	250	44	13	\$591	\$115	n/a
8041R2120I	21 x 21 x 20	250	29	8.75	\$587	\$97	n/a
Laminate, knife edge (HPL laminate)							
8041R2616IK	26 x 26 x 16	250	35	10.25	\$1199	n/a	n/a
8041R3016IK	30 x 30 x 16	250	44	13	\$1284	n/a	n/a
8041R2120IK	21 x 21 x 20	250	29	8.75	\$996	n/a	n/a
Solid surface, flat edge							
8041R2616ISF	26 x 26 x 16	150	48	10.25	\$2343	n/a	\$158
8041R3016ISF	30 x 30 x 16	150	61	13	\$2522	n/a	\$218
8041R2120ISF	21 x 21 x 20	150	37.5	8.75	\$2204	n/a	\$109
Solid surface, knife edge							
8041R2616ISK	26 x 26 x 16	150	48	10.25	\$2397	n/a	\$169
8041R3016ISK	30 x 30 x 16	150	61	13	\$2603	n/a	\$234
8041R2120ISK	21 x 21 x 20	150	37.5	8.75	\$2302	n/a	\$115

Finished height will vary depending on material top. Shipped fully assembled in 1 carton.



Square Table with Sled Base

Laminate, flat edge (TFL laminate)							
8042SQ2216I	22 x 22 x 16	150	34	8	\$561	\$98	n/a
8042SQ2816I	28 x 28 x 16	250	44	11.75	\$591	\$115	n/a
8042SQ1920I	19 x 19 x 20	250	29	7.75	\$568	\$88	n/a
Laminate, knife edge (HPL laminate)							
8042SQ2216IK	22 x 22 x 16	150	34	8	\$996	n/a	n/a
8042SQ2816IK	28 x 28 x 16	250	44	11.75	\$1248	n/a	n/a
8042SQ1920IK	19 x 19 x 20	250	29	7.75	\$955	n/a	n/a
Solid surface, flat edge							
8042SQ2216ISF	22 x 22 x 16	150	39.5	8	\$2065	n/a	\$136
8042SQ2816ISF	28 x 28 x 16	150	62.5	11.75	\$2365	n/a	\$218
8042SQ1920ISF	19 x 19 x 20	150	38	7.75	\$1976	n/a	\$164
Solid surface, knife edge							
8042SQ2216ISK	22 x 22 x 16	150	39.5	8	\$2397	n/a	\$164
8042SQ2816ISK	28 x 28 x 16	150	62.5	11.75	\$2819	n/a	\$245
8042SQ1920ISK	19 x 19 x 20	150	38	7.75	\$2302	n/a	\$120

Finished height will vary depending on material top. Shipped fully assembled in 1 carton.



Oval Table with Sled Base

Laminate, flat edge (TFL laminate)							
8043OV2616I	26 x 22 x 16	150	36.5	8.75	\$561	\$98	n/a
8043OV3116I	31 x 26 x 16	250	46	11.75	\$591	\$115	n/a
8043OV2220I	22 x 18 x 20	250	34	10.75	\$587	\$97	n/a
Laminate, knife edge (HPL laminate)							
8043OV2616IK	26 x 22 x 16	150	36.5	8.75	\$1199	n/a	n/a
8043OV3116IK	31 x 26 x 16	250	46	11.75	\$1365	n/a	n/a
8043OV2220IK	22 x 18 x 20	250	34	10.75	\$1113	n/a	n/a
Solid surface, flat edge							
8043OV2616ISF	26 x 22 x 16	150	42	8.75	\$2343	n/a	\$158
8043OV3116ISF	31 x 26 x 16	150	60	11.75	\$2522	n/a	\$218
8043OV2220ISF	22 x 18 x 20	250	38	10.75	\$2204	n/a	\$109
Solid surface, knife edge							
8043OV2616ISK	26 x 22 x 16	150	42	8.75	\$2397	n/a	\$169
8043OV3116ISK	31 x 26 x 16	150	60	11.75	\$2603	n/a	\$234
8043OV2220ISK	22 x 18 x 20	250	38	10.75	\$2302	n/a	\$115

Finished height will vary depending on material top. Shipped fully assembled in 1 carton.

Required Specifications

Surface type
Top finish
Base finish
Glide type

Optional Specifications

HP laminate
Grade 2 solid surface
Cut-out for grommet/power blocks
Plated base finish

Accessories

Power block

D DRIFT TABLES

TABLES WITH SLED BASE



Round Table with Polished Chrome Base



Round Table with Wood Base



Square Table with Polished Chrome Base

MODEL#	DIMENSIONS	FREIGHT CLASS	WT/LBS.	CUBIC FT.	LIST PRICE	HP ADD	GR. 2 ADD
--------	------------	---------------	---------	-----------	------------	--------	-----------

D x W x H

Laminate, flat edge (TFL laminate)

8041R2616C	26 x 26 x 16	250	38	10.75	\$1058	\$98	n/a
8041R3016C	30 x 30 x 16	250	45	13	\$1088	\$115	n/a

Laminate, knife edge (HPL laminate)

8041R2616CK	26 x 26 x 16	250	38	10.75	\$1696	n/a	n/a
8041R3016CK	30 x 30 x 16	250	45	13	\$1782	n/a	n/a

Solid surface, flat edge

8041R2616CSF	26 x 26 x 16	150	51	10.75	\$2840	n/a	\$158
8041R3016CSF	30 x 30 x 16	150	62.5	13	\$3019	n/a	\$218

Solid surface, knife edge

8041R2616CSK	26 x 26 x 16	150	51	10.75	\$2894	n/a	\$169
8041R3016CSK	30 x 30 x 16	250	31.25	13	\$3101	n/a	\$234

Finished height will vary depending on material top. Shipped fully assembled in 1 carton.

Laminate, flat edge (TFL laminate)

8041R2616W	26 x 26 x 16	250	32	10.75	\$1204	\$98	n/a
8041R3016W	30 x 30 x 16	250	40	13	\$1234	\$115	n/a

Laminate, knife edge (HPL laminate)

8041R2616WK	26 x 26 x 16	250	32	10.75	\$1842	n/a	n/a
8041R3016WK	30 x 30 x 16	250	40	13	\$1927	n/a	n/a

Solid surface, flat edge

8041R2616WSF	26 x 26 x 16	150	45.5	10.75	\$2985	n/a	\$158
8041R3016WSF	30 x 30 x 16	150	57.5	13	\$3165	n/a	\$218

Solid surface, knife edge

8041R2616WSK	26 x 26 x 16	150	45.5	10.75	\$3040	n/a	\$169
8041R3016WSK	30 x 30 x 16	150	57.5	13	\$3246	n/a	\$234

Finished height will vary depending on material top. Shipped fully assembled in 1 carton.

Laminate, flat edge (TFL laminate)

8042SQ2216C	22.75 x 22.75 x 16	150	36	7.75	\$1058	\$98	n/a
8042SQ2816C	28.5 x 28.5 x 16	250	45	11.5	\$1088	\$115	n/a

Laminate, knife edge (HPL laminate)

8042SQ2216CK	22.75 x 22.75 x 16	150	36	7.75	\$1493	n/a	n/a
8042SQ2816CK	28.5 x 28.5 x 16	250	45	11.5	\$1588	n/a	n/a

Solid surface, flat edge

8042SQ2216CSF	22.75 x 22.75 x 16	150	41	7.75	\$2563	n/a	\$136
8042SQ2816CSF	28.5 x 28.5 x 16	150	57.5	11.5	\$2862	n/a	\$218

Solid surface, knife edge

8042SQ2216CSK	22.75 x 22.75 x 16	150	41	7.75	\$2894	n/a	\$164
8042SQ2816CSK	28.5 x 28.5 x 16	150	57.5	11.5	\$3316	n/a	\$245

Finished height will vary depending on material top. Shipped fully assembled in 1 carton.

Required Specifications

Surface type
Top finish
Base finish
Glide type

Optional Specifications

HP laminate
Grade 2 solid surface
Cut-out for grommet/power blocks
Plated base finish

Accessories

Power block

TABLES WITH SLED BASE

MODEL#	DIMENSIONS	FREIGHT CLASS	WT./LBS.	CUBIC FT.	LIST PRICE	HP ADD	GR. 2 ADD
--------	------------	---------------	----------	-----------	------------	--------	-----------

D x W x H

Laminate, flat edge (HPL laminate)

8042SQ2216W	22.75 x 22.75 x 16	250	30	7.75	\$1204	\$98	n/a
8042SQ2816W	28.5 x 28.5 x 16	250	39	11.5	\$1234	\$115	n/a

Laminate, knife edge (HPL laminate)

8042SQ2216WK	22.75 x 22.75 x 16	250	30	7.75	\$1639	n/a	n/a
8042SQ2816WK	28.5 x 28.5 x 16	250	39	11.5	\$1734	n/a	n/a

Solid surface, flat edge

8042SQ2216WSF	22.75 x 22.75 x 16	150	36	7.75	\$2708	n/a	\$136
8042SQ2816WSF	28.5 x 28.5 x 16	150	59	11.5	\$3008	n/a	\$218

Solid surface, knife edge

8042SQ2216WSK	22.75 x 22.75 x 16	150	36	7.75	\$3040	n/a	\$164
8042SQ2816WSK	28.5 x 28.5 x 16	150	59	11.5	\$3462	n/a	\$245

Finished height will vary depending on material top. Shipped fully assembled in 1 carton.



Square Table with Wood Base



Oval Table with Polished Chrome Base

Laminate, flat edge

8043OV2616C	26 x 22 x 16	150	38	9.25	\$1058	\$98	n/a
8043OV3116C	31 x 26 x 16	250	44	11.75	\$1088	\$115	n/a

Laminate, knife edge

8043OV2616CK	26 x 22 x 16	150	38	9.25	\$1696	n/a	n/a
8043OV3116CK	31 x 26 x 16	250	44	11.75	\$1862	n/a	n/a

Solid surface, flat edge

8043OV2616CSF	26 x 22 x 16	150	49.5	9.25	\$2840	n/a	\$158
8043OV3116CSF	31 x 26 x 16	150	61.5	11.75	\$3019	n/a	\$218

Solid surface, knife edge

8043OV2616CSK	26 x 22 x 16	150	49.5	9.25	\$2894	n/a	\$169
8043OV3116CSK	31 x 26 x 16	150	61.5	11.75	\$3101	n/a	\$234

Finished height will vary depending on material top. Shipped fully assembled in 1 carton.



Oval Table with Wood Base

Laminate, flat edge

8043OV2616W	26 x 22 x 16	250	32	9.25	\$1204	\$98	n/a
8043OV3116W	31 x 26 x 16	250	39	11.75	\$1234	\$115	n/a

Laminate, knife edge

8043OV2616WK	26 x 22 x 16	250	32	9.25	\$1842	n/a	n/a
8043OV3116WK	31 x 26 x 16	250	39	11.75	\$2008	n/a	n/a

Solid surface, flat edge

8043OV2616WSF	26 x 22 x 16	150	44.5	9.25	\$2985	n/a	\$158
8043OV3116WSF	31 x 26 x 16	150	56.5	11.75	\$3165	n/a	\$218

Solid surface, knife edge

8043OV2616WSK	26 x 22 x 16	150	44.5	9.25	\$3040	n/a	\$169
8043OV3116WSK	31 x 26 x 16	150	56.5	11.75	\$3246	n/a	\$234

Finished height will vary depending on material top. Shipped fully assembled in 1 carton.

Required Specifications

Surface type
Top finish
Base finish
Glide type

Optional Specifications

HP laminate
Grade 2 solid surface
Cut-out for grommet/power blocks
Plated base finish

Accessories

Power block

L LITE LIFT II

LITE LIFT II	MODEL#	DIMENSIONS D x W x H	FREIGHT CLASS	WT/LBS.	CUBIC FT.	LIST PRICE
--------------	--------	-------------------------	---------------	---------	-----------	------------

Notes:

- Lightweight construction allows tables to easily and safely be lifted and moved by one person.
- Polypropylene top is fully water resistant and easy to clean and maintain.
- Thick, high impact radius corner helps protect individuals from injury.
- Folding legs automatically lock by a gravity activated mechanism when opened.
- Non-marring plastic glides protect floors from scratching when tables are moved.
- Structural side aprons allow tables to easily stack.
- Lite Lift II tables pass all BIFMA standards for strength and stability.
- **Available in Oyster Grey finish only.**

LITE LIFT II TABLES	MODEL#	DIMENSIONS	FREIGHT CLASS	WT/LBS.	CUBIC FT.	LIST PRICE
---------------------	--------	------------	---------------	---------	-----------	------------

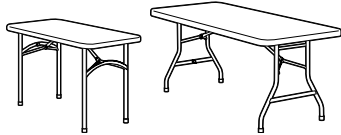

MVLFRT48 MVLFRT60-MVLFRT96

Rectangular Folding Table

MVLFRT48	24 x 48 x 29.25	85	23	1.57	\$310
MVLFRT60	30 x 60 x 29.25	92.5	30	2.54	\$413
MVLFRT72	30 x 72 x 29.25	92.5	36	3.06	\$485
MVLFRT96	30 x 96 x 29.25	92.5	50	4.79	\$712

Lightweight, textured, polypropylene Oyster Grey finish top. High impact radius corners. 19 gauge 11/8" diameter steel tubular legs with welded crossbars automatically lock. Legs finished in scuff resistant textured Charcoal Grey epoxy paint. Shipped fully assembled.

- Available in Oyster Grey finish with Charcoal Grey legs only.
- **Note:** Prices shown are for Global Distribution Center, not delivered pricing. All orders will be charged freight, except orders containing other Global products totaling \$2,000 list or more, before adding folding tables and folding chairs. Any Inside Delivery & Set-up charge for these products must be quoted separately.

RIVER+ TABLES

RIVER+ TABLES



42" Square Coffee Table
model R27858



Outside Curve End Table
model R27864



18" Dia. Round Laptop Table
model 7743

STANDARD FEATURES

- A modular series that is composed of straight and curved sections, as well as freestanding units.
- Linking units can be used together in any combination with River+ seating and bench units to create a wide variety of layouts. Ganging hardware is standard and is factory installed. Ganging hardware swivels out of the way when not in use.
- Front and back faces of end (linking) tables angles slightly inwards. This inward slant matches the inward angles of River seating so all units coordinate in visual appearance.
- The standard 6.5", welded steel legs are straight (vertical) as standard. Linking models are optionally available with an angled back leg to visually align with River+ seating units.
- Legs are standard in Chrome with Black, non-marking, height adjustable glides.
- Tables are made with high pressure laminate. Custom high pressure laminate finishes will be considered upon request.
- Laptop tables have 1" thick laminate tops.
- Laptop table painted metal base finishes are available in Black and Tungsten only.

OPTIONAL FEATURES

- Legs of coffee and end (linking) tables are available in 3" (**S3**) and 8" (**S8**) heights. All leg heights are available with fixed-to-floor (**F3**) and (**F8**) options. Add \$100.
- To match adjacent lounge seating, straight front and angled back 6.5" or 8" legs are available on linking/end tables. Specify (**SA**). No upcharge.
- Power units are available on all tables except laptop tables. Each unit includes one AC outlet and two USB-a, 10 watt charging ports. Add \$661 upcharge per unit.
- Power location options include top, front or end. See electrical placement diagrams. Electrical units must be factory installed.
- Power units are available in either Jet Black (**J**) or White (**W**) with 120", three-prong matching cords.
- Most products can be weighted to reduce the ease of movement. For additional weight options, specify (**CW**). See each model for available additional weight and upcharge.

Please add option codes in the following order:

- **Model number**
R27855 to R27858 Square coffee tables
R27859 Rectangular coffee table
R27860 to R27861 Round coffee tables
R27862 to R27864 Linking/end tables
7443 and 7745 Freestanding tables
- **Laminate finishes**
(ACJ) Absolute Acajou **(ASN)** Asian Night
(AWC) Avant Cherry **(AWH)** Avant Honey
(BLK) Black **(BZD)** Blizzard
(BRC) Brushed Cobalt **(CMB)** Clear Maple
(CGY) Custom Grey **(DES)** Dark Espresso
(DWT) Designer White **(FAS)** Fashionista
(FCL) First Class **(NBL)** Noce Biondo
(NGL) Noce Grigio **(NEL)** Noce Leggero
(NML), Noce Medio **(QTM)** Quartered Mahogany
(SBY) Sheer Beauty **(SOG)** Storm Grey
(SDT) Stonedust **(WCR)** Winter Cherry
(WHC) White Chocolate **(WHE)** Walnut Heights
(colors shown on website)
- **Leg selection**
(S6) Standard height (6.5") w/adjustable glides. No upcharge.
(S3) Low (3") w/adjustable glides. No upcharge.
(S8) High (8") w/adjustable glides. No upcharge.
(F6) Standard height (6.5"), fixed to floor. Add \$100.
(F3) Low (3"), fixed to floor. Add \$100.
(F8) High (8"), fixed to floor. Add \$100.
- **Leg angle** (linking/end tables only)
(AST) Straight legs. No upcharge.
(SA) Straight front legs, angled back legs. No upcharge.
- **Leg finish**
(CHM) Chrome **(TBL)** Black
(TDW) Designer White **(TFO)** Fog
(TFR) Frost **(TIV)** Cloud
(TLA) Latte **(TMO)** Mocha
(TNE) Nevada **(TOA)** Toast
(TSH) Shadow **(TSN)** Sand
(TTU) Tungsten
- **Additional weight**
(CW) Additional weight. Upcharges vary, see model.
- **Power/USB unit position** (coffee and linking/end tables only, as shown below). Add \$661 per unit.
(NP) No power (no upcharge)
(LE1) Left end (coffee table only)
(LE2) Right end (coffee table only)
(F3) Front center (coffee table only)
(T1) Top
- **Power unit finish**
(J) Jet Black
(W) White
- **(TP) Tamperproof fasteners.** Add \$160.

EXAMPLE RIVER+ TABLE ORDER CODE:

R27858	-ACJ	-S6	-AS	-CM	-	-T1	-W	-
Model number	Laminate	Leg selection	Leg angle	Leg finish	Additional weight	Power/USB	Power finish	Fasteners

ELECTRICAL PLACEMENT

Coffee Tables

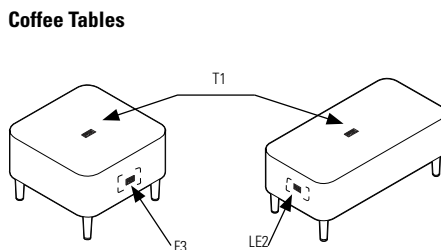

Linking Tables

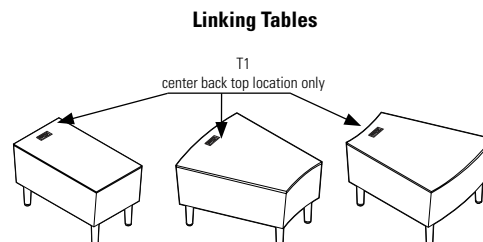

R RIVER+ TABLES

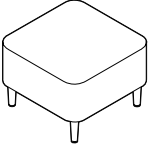
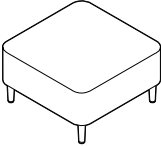
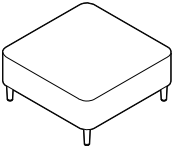
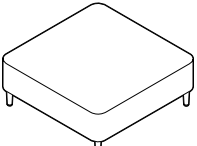
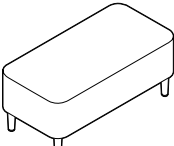
RIVER+ TABLES	MODEL#	DIMENSIONS	FREIGHT CLASS	WT/LBS.	CUBIC FT.	LIST PRICE
 <p>24" Square Coffee Table</p>	R27855	24 x 24 x 17	250	40	10.7	\$1484
	<p>Freestanding unit only. 1 per carton. For power/USB unit, see electrical placement chart. • Add \$733 for 36 lbs. (CW)</p>					
 <p>30" Square Coffee Table</p>	R27856	30 x 30 x 17	250	53	15.3	\$1563
	<p>Freestanding unit only. 1 per carton. For power/USB unit, see electrical placement chart. • Add \$632 for 27 lbs. (CW)</p>					
 <p>36" Square Coffee Table</p>	R27857	36 x 36 x 17	250	75	20.6	\$1791
	<p>Freestanding unit only. 1 per carton. For power/USB unit, see electrical placement chart. No counterweight.</p>					
 <p>42" Square Coffee Table</p>	R27858	42 x 42 x 17	150	115	26.7	\$1991
	<p>Freestanding unit only. 1 per carton. For power/USB unit, see electrical placement chart. No counterweight.</p>					
 <p>Rectangular Coffee Table</p>	R27859	20 x 40 x 17	250	55	14.2	\$1626
	<p>Freestanding unit only. 1 per carton. For power/USB unit, see electrical placement chart. • Add \$317 for 18 lbs. (CW)</p>					

Required Specifications

Top finish
 Leg finish

Optional Specifications

Counterweight

Accessories

Power Block

ROUND COFFEE TABLES

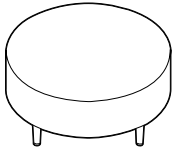

36" Dia. Round Coffee Table

MODEL#	DIMENSIONS	FREIGHT CLASS	WT/LBS.	CUBIC FT.	LIST PRICE
R27860	36 x 36 x 17	150	63	15.3	\$1927

D x W x H

R27860 36 x 36 x 17 150 63 15.3 \$1927

Freestanding unit only. 1 per carton.
 For power/USB unit, see electrical placement chart.
 • Add \$317 for 18 lbs. (CW)

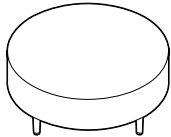

42" Dia. Round Coffee Table

R27861 42 x 42 x 17 150 85 20.6 \$2113

Freestanding unit only. 1 per carton.
 For power/USB unit, see electrical placement chart. No counterweight.

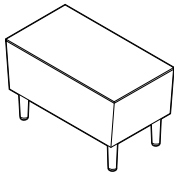

Rectangular End Table

R27862 15 x 28 x 17 300 40 20.6 \$1578

1 per carton. Includes ganging hardware (2 sides).
 For power/USB unit, see electrical placement chart.
 • Add \$632 for 36 lbs. (CW)

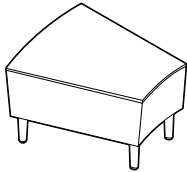

Inside Curve End Table

R27863 17 x 28 x 17 250 47 13.3 \$2073

1 per carton. Includes ganging hardware (2 sides).
 For power/USB unit, see electrical placement chart.
 • Add \$632 for 36 lbs. (CW)

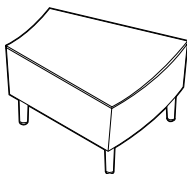

Outside Curve End Table

R27864 17 x 28 x 17 250 47 13.3 \$2073

1 per carton. Includes ganging hardware (2 sides).
 For power/USB unit, see electrical placement chart.
 • Add \$632 for 36 lbs. (CW)

Required Specifications

Top finish
 Leg finish

Optional Specifications

Counterweight

Accessories

Power Block

S SIRENA TABLES

RECTANGULAR TOP	MODEL#	DIMENSIONS D x W x H	FREIGHT CLASS	WT/LBS.	CUBIC FT.	LIST PRICE
-----------------	--------	-------------------------	---------------	---------	-----------	------------

Notes:

- Modern tables for reception areas, meeting rooms, and private office use.
- Sirena tables are offered in the following finishes to coordinate with Global desking and wood seating:

ACJ Absolute Acajou	DES Dark Espresso	NML Noce Medio
ASN Asian Night	DWT Designer White	SBY Sheer Beauty
AWC Avant Cherry	FAS Fashionista	SDT Stonedust
AWH Avant Honey	FCL First Class	WHE Walnut Heights
BZD Blizzard	NBL Noce Biondo	WHC White Chocolate
CMB Clear Maple	NGL Noce Grigio	WCR Winter Cherry
CGY Custom Grey	NEL Noce Leggero	

- Laminate tops are 1.5" thick to coordinate with Global desking and wood seating
- Table legs are available in Black (**TBL**) or Tungsten (**TU**) at no upcharge. Not available in Chrome.
- Legs are 1.5" steel tubing, tapered toward the bottom of the leg to 0.875", equipped with self-leveling pivoting steel glide.

SIRENA TABLES	MODEL#	DIMENSIONS	FREIGHT CLASS	WT/LBS.	CUBIC FT.	LIST PRICE
---------------	--------	------------	---------------	---------	-----------	------------

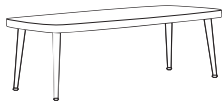

Coffee Table

3400	22 x 48 x 15	250	52	17.25	\$1856
------	--------------	-----	----	-------	---------------

Rectangular coffee table.



Coffee Table

3401	22 x 56 x 15	250	60	19.75	\$2052
------	--------------	-----	----	-------	---------------

Rectangular coffee table.



End Table

3402	22 x 17 x 15	250	26	7.75	\$1489
------	--------------	-----	----	------	---------------

Rectangular end table.

Required Specifications
Finish

Optional Specifications
Grommet

Accessories
Power Block

WIND TABLES	MODEL#	DIMENSIONS	FREIGHT CLASS	WT/LBS.	CUBIC FT.	LIST PRICE
-------------	--------	------------	---------------	---------	-----------	------------

Notes:

D x W x H

- Wind tables complement the modern decor of many offices.
- Legs are standard in Chrome (**CHM**). Also available in Black (**TBL**), Shadow (**TSH**) or Tungsten (**TTU**) finish at no upcharge.
- 1" laminate tops are offered in the following finishes to coordinate with Global casegoods and wood seating:

ACJ	Absolute Acajou	DWT	Designer White	SDT	Stonedust
ASN	Asian Night	FAS	Fashionista	WHE	Walnut Heights
AWC	Avant Cherry	FCL	First Class	WHC	White Chocolate
AWH	Avant Honey	NBL	Noce Biondo	WCR	Winter Cherry
BLK	Black	NGL	Noce Grigio		
BZD	Blizzard	NEL	Noce Leggero		
BRC	Brushed Cobalt	NML	Noce Medio		
CMB	Clear Maple	QTM	Quartered Mahogany		
CGY	Custom Grey	SBY	Sheer Beauty		
DES	Dark Espresso	SOG	Storm Grey		

- Table tops are available in high pressure laminate at a 20% upcharge for the following model numbers: 3366, 3367, 3368, 3870 and 3871; specify (**HPL**) in addition to the finish. HPL is not available on 3878, 3879 or 3880.

WIND TABLES	MODEL#	DIMENSIONS	FREIGHT CLASS	WT/LBS.	CUBIC FT.	LIST PRICE
-------------	--------	------------	---------------	---------	-----------	------------



Square Corner Table

3366	24 x 24 x 17	250	36	11.50	\$933
------	--------------	-----	----	-------	--------------

Steel tubular base. Tops are available with a laminate finish. Shipped assembled in 1 carton.

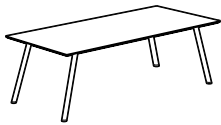

Rectangular Coffee Table

3367	20 x 48 x 15	250	52	16	\$1234
------	--------------	-----	----	----	---------------

Steel tubular base. Tops are available with a laminate finish. Shipped assembled in 1 carton.



Square Coffee Table

3368	36 x 36 x 15	250	66	22	\$1670
------	--------------	-----	----	----	---------------

Steel tubular base. Tops are available with a laminate finish. Shipped assembled in 1 carton.



Round Corner Table

3870	24 x 24 x 17	250	35	11.50	\$1020
------	--------------	-----	----	-------	---------------

Steel tubular base. Tops are available with a laminate finish. Shipped assembled in 1 carton.

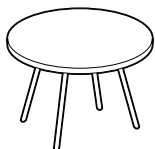

Round Coffee Table

3871	36 x 36 x 15	250	57	22	\$1501
------	--------------	-----	----	----	---------------

Steel tubular base in Chrome finish.

Required Specifications

Top finish
Leg finish

W WIND LINEAR TABLES

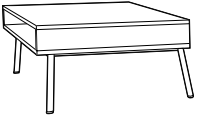
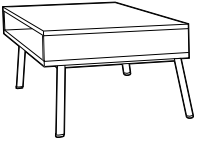
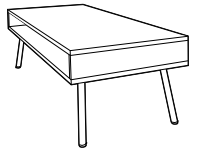
WIND LINEAR TABLES	MODEL#	DIMENSIONS	FREIGHT CLASS	WT/LBS.	CUBIC FT.	LIST PRICE
 Freestanding Rectangular End Table	3878	25 x 20 x 16	250	38	11.50	\$1334
	Steel tubular base. Laminate top is 5" thick with opening on front for storage and visual recess at rear. Shipped assembled in 1 carton.					
	3879	25 x 25 x 16	250	40	11.50	\$1455
 Freestanding Corner Table	Steel tubular base. Laminate top is 5" thick with opening on front for storage and visual recess at rear. Shipped assembled in 1 carton.					
	3880	54 x 20 x 15	250	52	16	\$1623
 Freestanding Coffee Table	Steel tubular base. Laminate top is 5" thick with opening on front for storage and visual recess at rear. Shipped assembled in 1 carton.					

WORK TABLES	MODEL#	DIMENSIONS	FREIGHT CLASS	WT/LBS.	CUBIC FT.	LIST PRICE
-------------	--------	------------	---------------	---------	-----------	------------

Notes:

• Work tables are offered in the following top finishes to coordinate with Global casegoods and wood seating:

ACJ	Absolute Acajou	FCL	First Class
ASN	Asian Night	NBL	Noce Biondo
AWC	Avant Cherry	NGL	Noce Grigio
AWH	Avant Honey	NEL	Noce Leggero
BLK	Black	NML	Noce Medio
BZD	Blizzard	QTM	Quartered Mahogany
BRC	Brushed Cobalt	SBY	Sheer Beauty
CMB	Clear Maple	SOG	Storm Grey
CGY	Custom Grey	SDT	Stonedust
DES	Dark Espresso	WHE	Walnut Heights
DWT	Designer White	WHC	White Chocolate
FAS	Fashionista	WCR	Winter Cherry

• Legs available in Chrome (**CHM**) or Black (**TBL**)

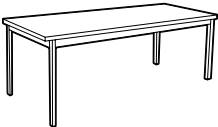
WORK TABLES	MODEL#	DIMENSIONS	FREIGHT CLASS	WT/LBS.	CUBIC FT.	LIST PRICE
 Work Tables	GATMS6030	30 x 60 x 29	70	132	8	\$690
	GATMS7230	30 x 72 x 29	92.5	87	8	\$786
	GATMS7236	36 x 72 x 29	70	132	8	\$968
	1" high performance thermally fused laminate with self edge top. Black metal skirt. Rectangular top with metal legs and leveling glides. Self edge is standard. Shipped easy to assemble in 1 carton.					

Required Specifications
Top finish

Optional Specifications
Leg finish

textiles and finishes

Care and Cleaning

Textiles

Fabrics: To extend the life of your seating upholstered in fabric, regularly dust the chair to prevent airborne particles from penetrating the fabric surface.

For light soiling, use a damp cloth and blot the spot with very slight pressure, taking care never to soak the fabric. Dry with a clean cloth by blotting - never rub fabric. More intense stains can be treated the same way, but with a mild detergent. Always test fabric first in an unseen area before using any cleaning method.

Leather: For regular cleaning, simply use a soft damp cloth, taking care not to soak the leather. For more thorough treatment, soak a soft cloth in mild soap solution and wipe surface in a light circular motion. Repeat with clean water. Allow to dry and polish with a soft dry cloth. Do not use detergents, aerosol sprays or other polishes.

Hard Surfaces

Wood Veneer Finishes: Waxing or polishing catalyzed finishes is not recommended because this will give a greasy, cloudy or uneven appearance to the product and could void your warranty. Global's conversion varnish is best cleaned by wiping the surface with a damp cloth, followed by a soft dry cloth in the direction of the grain. If the surfaces are heavily soiled, a gentle product like "Windex" can be used, following the same instructions as above.

Laminate, painted & plated metal finishes, and solid surfaces: Wipe the surface with a clean soft damp cloth; if needed, a mild soap solution (i.e. Ivory dishwashing liquid) can be used. To prevent streaks, dry the surface with a clean, dry soft cloth moving in a circular motion.

Textiles

- **Water-Based Cleaner:** Spot clean, using the foam only from a water-based cleaning agent, such as a mild detergent or non-solvent upholstery shampoo product. Apply foam with a soft brush in a circular motion. Vacuum when dry. Pretest small area before proceeding.
- **Solvent Cleaner:** Spot clean, using a mild water-free solvent or dry cleaning product. Clean only in a well-ventilated room and avoid any product containing carbon tetrachloride or other toxic materials. Pretest a small area before proceeding.
- **Water/Solvent Cleaner:** Spot clean with a mild solvent, an upholstery shampoo, or the foam from a mild detergent. When using a solvent or dry cleaning product, follow instructions carefully and clean only in a well-ventilated room. Avoid any product that contains carbon tetrachloride or other toxic materials. With either method, pretest a small area before proceeding.
- **Vacuum Only:** Clean this fabric only by vacuuming or light brushing to prevent accumulation of dust and grime. Water-based foam cleaning agents of any kind may cause excessive shrinking, staining, or distortion of the surface pile and therefore, should not be used.
- **Crypton Cleaning:** Generally stains are removed with plain water and powdered enzyme detergent. Upholstery foam shampoo, waterbased cleaning products and germicidal detergents can be used. Be sure to remove all residue from cleaning products with clean water. Do not use solvent-based cleaners or dry cleaning products.
- These recommendations and codes were developed by fabric specialists. However, because of the various ways fabric can be stained or damaged, there is no guarantee that the results will be completely successful. Use suggested methods on your own responsibility. To help prevent overall soil, frequent vacuuming or light brushing to remove dust and grime is recommended. Use professional furniture cleaning services when overall soiled condition has been reached.

TEXTILES + FINISHES

Textile Price Grades - Global Textiles

Grade 1	Carrera, Dobby, Fusion, Illusion, Jenny, Quilt, Terrace, Trak, Urban, Waterfall, Wavelength
Grade 2	Allante FRee, Elevate, Etch, GC Linen, Imprint, Luxhide, Release
Grade 3	Non standard GLOBAL textiles
Grade 4	Non standard GLOBAL textiles
Grade 5	Non standard GLOBAL textiles
Grade 6	Novaro Genuine Leather, non standard GLOBAL textiles
Grade 7	Non standard GLOBAL textiles
Grade 8	Non standard GLOBAL textiles
Grade 9	Non standard GLOBAL textiles
Grade 11	Non standard GLOBAL textiles
Grade 10	Non standard GLOBAL textiles
Grade 12	Non standard GLOBAL textiles

Please refer to individual seating series for availability of a particular textile.

The charts above do not include Textiles offered by Alliance Partners: Arc-Com Fabrics, Architex, CF Stinson, Designtex, Knoll Textiles, Green Hides, LDI Interiors, Luum Textiles, Maharam, Mayer Fabrics, Momentum, and Ultrafabrics.

Blend Seating Textiles

The grid below outlines the grade structure for using multiple textiles on select seating series. Blended textiles occur when one textile is chosen for one part of the chair and a different textile is selected for another part of the chair, resulting in a revised blended grade. For opportunities regarding more than two different textiles, please contact Global CustomerCare for approval process and grading.

FIRST TEXTILE SELECTED

		FIRST TEXTILE SELECTED																	
		1	2	3	4	5	6	7	8	9	10	11	12	13	14	15	16	17	18
SECOND TEXTILE SELECTED	1	1																	
	2	2	2																
	3	3	3	3															
	4	3	4	4	4														
	5	4	4	5	5	5													
	6	5	5	5	6	6	6												
	7	5	6	6	6	7	7	7											
	8	6	6	7	7	7	8	8	8										
	9	7	7	7	8	8	8	9	9	9									
	10	8	8	8	8	9	9	9	10	10	10								
	11	9	9	9	9	9	10	10	10	11	11	11							
	12	10	10	10	10	10	10	11	11	11	12	12	12						
	13	11	11	11	11	11	11	12	12	12	12	13	13	13					
	14	11	12	12	12	12	12	12	13	13	13	13	14	14	14				
	15	12	12	13	13	13	13	13	13	14	14	14	14	15	15	15			
	16	13	13	13	14	14	14	14	14	14	15	15	15	15	16	16	16		
	17	14	14	14	14	15	15	15	15	15	15	16	16	16	16	17	17	17	
	18	15	15	15	15	15	16	16	16	16	16	16	17	17	17	17	18	18	18

TEXTILE AND COLOR LISTINGS

Grade 1

Carrera 100% Polyester

CE84 Zest	CE85 Savannah	CE86 Slate	CE87 Rainforest	CE88 Aspen	CE89 Dune	CE90 Flannel
CE91 Azure	CE92 Chili	CE93 Jute	CE95 Ink	CE96 Sangria	CE97 Java	CE98 Charcoal

Dobby 96% Recycled Polyester / 4% Virgin Polyester

DB30 Snowcap	DB31 Bonsai	DB32 Cloud	DB33 Sand	DB34 Pewter	DB35 Santa Fe	DB36 Corfu
DB37 Medium Taupe	DB38 Charcoal	DB39 Berry	DB40 Royal	DB41 Titanium	DB42 Black	

Fusion 90% Virgin Polyester / 10% Post-Consumer Recycled Polyester

FU71 Tangerine	FU72 Fresh	FU73 Moss	FU74 Tomato	FU75 Aqua	FU76 Sandstone	FU77 Granite
FU78 Poppy	FU79 Cadet	FU80 Oasis	FU81 Graphite	FU82 Viola	FU83 Cobalt	FU84 Flax
FU85 Carbon						

Illusion 100% Virgin Polyester

II01 Cappuccino	II02 Paprika	II03 Tropic	II04 Wicker	II05 Hemp	II06 Cayenne	II07 Maui
II08 Dusk	II09 Smoke	II10 Currant	II11 Fiji	II12 Ozone	II13 Ebony	

Jenny 100% Polyester

JN01 Midnite	JN02 Ebony	JN03 Slate	JN07 Vermilion	JN08 Admiral	JN11 Charcoal	JN25 Silver Lining
JN26 Oatmeal	JN27 Sunflower	JN28 Cascade	JN29 Harvest	JN30 Melon	JN31 Berry	JN32 Green Grass
JN33 Roast						

Quilt 100% Polyester

QL10 Black	QL11 Charcoal Grey	QL14 Navy	QL16 Wine	QL19 Silver	QL20 Feather	QL21 Dune
QL22 Meadow	QL23 Cadet	QL24 Geranium	QL25 Daisy	QL26 Quest	QL27 Punch	QL28 Tangerine
QL29 Cocoa						

Terrace 70% Virgin Polyester / 30% Post-Consumer Recycled Polyester

TC61 Tigerlily	TC62 Shadow	TC63 Cobble	TC64 Cherry Blossom	TC65 Bluebell	TC66 Apple	TC67 Haze
TC68 Cerise	TC69 Twilight	TC70 Wintergreen	TC71 Ironwork	TC72 Pine Cone	TC73 Flirt	TC74 Echo
TC75 Glacier						

Trak 100% Recycled Polyester

TK40 Taupe	TK41 Mustard	TK42 Latte	TK43 Cement	TK44 Silver	TK45 Copper	TK46 Teal
TK47 Apple	TK48 Steel	TK49 Merlot	TK50 Midnight Sky	TK51 Mocha	TK52 Carbon	

Urban 62% Recycled Polyester / 32% Polyester

UR10 Red Rose	UR11 Ocean Blue	UR12 Blue Bayou	UR13 Green Grass	UR17 Earth	UR18 Brown Ridge	UR19 White Sand
UR20 Granite Rock	UR21 Gravel Road	UR22 Black Coal				

Waterfall 60% Virgin Polyester / 40% Post-Consumer Recycled Polyester

WA40 Trance	WA41 Tryst	WA42 Splash	WA43 Victoria	WA44 Imagine	WA45 Sky	WA46 Rainforest
WA47 Rumble	WA48 Prism	WA49 Tranquility	WA50 Grand	WA51 Rushing	WA52 Magestic	WA53 Pacific
WA54 Dance						

Wavelength 100% Virgin Polyester

WV01 Lime	WV02 Mint	WV03 Stone	WV04 Flame	WV05 Mykonos	WV06 Savannah	WV07 Mesa
WV08 Plasma	WV09 Cancun	WV10 Quartz	WV11 Moonrock	WV12 Rubine	WV13 Corfu	WV14 Bluejay
WV14 Panther						

Grade 2

Elevate 80% Post-Consumer Recycled Polyester / 20% Rayon

EL51 Halo	EL52 Dove	EL53 Safari	EL54 Sunglow	EL55 Margarita	EL56 Fiji	EL57 Mist
EL58 Blaze	EL59 Wasabi	EL60 Mystic	EL61 Mica	EL62 Cherry	EL63 Scuba	EL64 Lapis
EL65 Onyx						

Etch 80% Post-Consumer Recycled Polyester / 20% Rayon

ET81 Drift	ET82 Citron	ET83 Calypso	ET84 Mandarin	ET85 Crisp	ET86 Iris	ET87 Nickel
ET88 Paprika	ET89 Nutmeg	ET90 Marine	ET91 Magnet	ET92 Infrared	ET93 Espresso	ET94 Indigo
ET95 Anthracite						

Imprint 100% Post-Consumer Polyester

IM70 Almond	IM71 Cork	IM72 Sand	IM73 Currie	IM74 Candy Apple	IM75 Ocean	IM76 Navy
IM77 Green Tea	IM78 Celery	IM79 Oregon	IM80 Walnut	IM81 Paprika	IM82 Graphite	IM83 Slate
IM84 Licorice						

TEXTILES + FINISHES

Grade 2 (Vinyl) For availability of chair series in Vinyl, please contact a Global Sales Representative.

Allante Free 100% Vinyl Face / 100% Polyester Backing

A01F Illusion	A02F Bright White	A03F White Crush	A04F Ivory	A05F Ice	A06F Bleached Sand	A07F Taupe Fawn
A08F Warm Smoke	A09F Autumn Rain	A10F Cookie	A11F Sierra Brick	A12F Gibraltar	A13F Chateau Grey	A14F Garden Green
A15F Oasis Green	A16F Ink Black	A17F Purple Impulse	A18F Italian Rose	A19F Mountain Sky	A20F Old Navy	A21F Galaxy
A22F Red Truffle	A23F Chocolate Sundae	A24F Province Blue	A25F Eclipse			

GC Linen 100% Vinyl Face

LE50 Potters Clay	LE51 Pearl	LE52 Tan	LE53 Storm	LE54 Butter	LE55 Haystack	LE56 Ganache
LE57 Sunset	LE58 Burnt Orange	LE59 Cayenne	LE60 Navy	LE61 Bamboo	LE62 Gray	LE63 Charcoal
LE64 Moss						

Luxhide 100% Vinyl Face / Bonded Leather Backing

BL20 Black	BL22 Parchment	BL23 Saddle	BL24 Dark Brown	BL26 Burgundy	BL27 Charcoal	BL28 White
BL34 Light Grey						

Release 100% Vinyl Face

RL11 White	RL12 Chalk	RL13 Stone	RL14 Taupe	RL15 Orange	RL16 Country	RL17 Tuscan
RL18 Cottage	RL19 Yellow	RL21 Red Barn	RL22 Brave Red	RL23 Gypsy Red	RL24 Cajun	RL25 Vineyard
RL26 Olive	RL27 Bonsai	RL28 Summer's Dream	RL29 Calico	RL31 Green	RL32 Blue	RL33 Black
RL34 Cool Grey	RL35 Thunder Grey	RL36 Navy	RL37 Dark Chocolate	RL38 Espresso		

Grade 6

Novaro Genuine Leather 100% Leather

N050 Ash	N051 Asphalt	N052 Bison	N053 Blueberry	N054 Cloud	N055 Clove	N056 Cordovan
N057 Doe	N058 Linen	N059 Marina	N060 Phantom	N061 Pigeon	N062 Scarlet	N063 Turtle
N064 Wheat						

PANEL/TACKBOARD FABRICS

GRADE 2

Lola 100% Polyester.

LL11 Medium Taupe LL12 Caramel Cream LL14 Blue Mist LL35 Spray LL36 Granite LL37 Cinder LL38 Sandstone

GRADE 3

Anchorage 65% Pre-consumer Polyester / 35% Post-consumer Polyester

AN40 Birch AN41 Green Apple AN42 Lapis AN43 Straw AN44 Wolf AN45 Goose AN46 Angora
 AN47 Cumin AN48 Asteroid AN49 Geranium AN50 Thistle AN51 Graphite AN52 Slate AN53 Quarry Blue
 AN54 Onyx AN55 Pumpkin AN56 Red Delicious AN57 Sunshine AN59 Waterfall AN61 Vanilla AN62 Cobalt
 AN64 Cloud

Merge 100% Polyester / 75% Post-consumer Recycled Polyester

MG20 Fawn MG21 Marshmallow MG22 Driftwood MG23 Dove MG24 Graphite MG25 Slate MG26 Eucalyptus
 MG27 Fire Engine MG28 Mediterranean MG29 Midnight

FINISHES

Seating Finishes - Metal & Polymer: *Please consult each Seating Series for finish availability.*

Black (BK) Charcoal Grey (CHR) Chrome (CHM) Fog (FG) Polished Aluminum (ALU) Tungsten (TUN)

Seating Finishes - Plastic (Duet, Popcorn, Sonic and Stream)

Buzz Blue (BZB) Cactus (CCT) Carrot (CRO) Cloud (IVC) Dijon (DJN) Eggplant (EGP) Fog (FOG)
 Frost (FRO) Ink (INK) Latte (LAB) Night (BLK) Sand (SND) Scarlet (SAR) Shadow (SHW)

Seating Finishes - Wood Seating finishes will not necessarily match Casegoods finishes. This is due to the fact that Seating and Casegoods finishes use different wood species and are manufactured at multiple locations.

Absolute (AAM) Black (BKM) Cherry (ACM) Espresso Cafe (ECM) English Oak (EOM) Fruitwood (TFM) Gray (HGM)
 Honey (AHM) Mahogany (TMM) Maple (AVM) Medium Walnut (MWM) Natural Walnut (NLW) Night (ASM) Noce Biondo (NBM)
 Noce Grigio (NGM) Noce Leggero (NEM) Noce Medio (NMM) Shaker Cherry (SKM) Walnut (TWM) WC Cream (WTM) White (WHM)
 Winter Cherry (WCM)

Desks, Workstations, Tables and Accessories - Laminate

Absolute Acajou (ACJ) Asian Night (ASN) Avant Cherry (AWC) Avant Honey (AWH) Black (BLK) Blizzard (BZD) Brushed Cobalt (BRC)
 Clear Maple (CMB) Custom Grey (CGY) Dark Espresso (DES) Designer White (DWT) Fashionista (FAS) First Class (FCL) Noce Biondo (NBL)
 Noce Grigio (NGL) Noce Leggero (NEL) Noce Medio (NML) Quartered Mahogany (QTM) Sheer Beauty (SBL) Stonedust (SDT) Storm Grey (SOG)
 Walnut Heights (WHE) White Chocolate (WHC) Winter Cherry (WCR)

Desks, Workstations, Tables and Accessories - Wood Veneer

Almond Cherry (AMW) Amber Cherry (ACW) Biscotti (BTW) Cocoa Walnut (CAW) Coral (CRW) Dark Cherry (DCW) Dark Walnut (DWW)
 Espresso Walnut (EWW) Evening Oak (EVW) Grey on Oak (GRW) Hazelnut (HAW) Java (JAW) Latte Walnut (LTW) Mahogany on Walnut (MHW)
 Milestone (MTW) Natural Maple (MPW) Natural Walnut (NLW) Red Cherry (RCW) Vintage Cherry (VNW) Umber Walnut (ULW) Walnut (WLW)
 Warm Cherry (WCW) White Maple (WMW)

Metal Leg Finishes (*check series for applicable finishes*)

Antique Copper (ACO) Black (TBL) Brushed Chrome (BCH) Buzz Blue (TBZ) Cactus (TCC) Carrot (TCR) Cloud (TIV)
 Chrome (CHM) Designer White (TDW) Dijon (TDJ) Eggplant (TEG) Fog (TFO) Frost (TFR) Ink (TIN)
 Kalua (TKA) Latte (TLA) Mocha (TMO) Nevada (TNE) Sand (TSN) Satin Brass (SBR) Scarlet (TSR)
 Shadow (TSH) Toast (TOA) Tungsten (TTU)

Metal File + Storage Finishes

Business Grey (BGR) Black Coffee Textured (BKC) Black (BLK) Bone (BNE) Blizzard Textured (BZD) Charcoal (CHR)
 Claret (CLT) Dark Chocolate Textured (DCH) Desert Putty (DPT) Designer White (DWT) Fog (FOG) Grey (GRY)
 Light Grey (LGR) Ice (ICE) Ivory (IVR) Mocha Textured (MCH) Metro (MET) Moss (MOS)
 Nevada (NEV) Navy (NVY) Oyster (OYS) Stonedust Textured (SDT) Storm Grey (SGR) Silver (SIL)
 Sky (SKY) Stone (STN) Taupe (TPE) Tahiti Sand (TSA) Tungsten (TUN)* Willow (WIL)

*10% upcharge applies

TEXTILES + FINISHES - LAMINATE FINISH CHART

FINISH CODE:	ACJ	ASN	AWC	AWH	BLK	BRC	BZD	CMB	CGY	DES	DWT	FAS	FCL	NBL	NGL	NEL	NML	OTM	SBY	SOG	SDT	STG	WHC	WHE	WCR	
LAMINATE DESKING																										
Adaptabilities	•	•	•	•	•	•	•	•	•	•	•	•	•	•	•	•	•	•	•	•	•			•	•	•
Genoa	•	•	•	•	•	•		•		•	•	•	•	•	•	•	•	•	•					•	•	•
Princeton	•	•	•	•	•	•	•	•	•	•	•	•	•	•	•	•	•	•	•	•		•		•	•	•
Zira	•	•	•	•	•	•	•	•	•	•	•	•	•	•	•	•	•	•	•	•	•	•		•	•	•
METAL DESKING																										
StreamLINE II	•	•	•	•	•	•		•		•	•	•	•	•	•	•	•	•	•	•				•	•	•
BENCHING																										
Bridges II	•	•	•	•	•*	•*	•	•	•	•	•	•	•	•	•	•	•		•	•*	•	•	•	•	•	•
FreeFit	•	•	•	•	•	•	•	•	•	•	•	•	•	•	•	•	•	•	•	•	•	•	•	•	•	•
PANELS + COMPONENTS																										
Divide	•	•	•	•	•	•	•	•	•	•	•	•	•	•	•	•	•	•	•	•	•	•		•	•	•
TABLES - MEETING + CONFERENCE																										
Boardroom	•	•	•	•	•	•	•	•	•	•	•	•	•	•	•	•	•	•	•	•	•	•		•	•	•
Bungee / Bungee SL	•	•	•	•	•	•	•	•	•	•	•	•	•	•	•	•	•	•	•	•	•	•		•	•	•
Connectables	•	•	•	•	•	•	•	•	•	•	•	•	•	•	•	•	•	•	•	•	•	•		•	•	•
Junction	•	•	•	•	•	•	•	•	•	•	•	•	•	•	•	•	•	•	•	•	•	•		•	•	•
Kadin	•	•	•	•	•	•	•		•	•	•	•	•	•	•	•	•		•	•	•		•	•	•	
Swap	•	•	•	•	•	•	•	•	•	•	•	•	•	•	•	•	•	•	•	•	•	•		•	•	•
Terina	•	•	•	•	•	•	•	•	•	•	•	•	•	•	•	•	•	•	•	•	•	•		•	•	•
Zira Boardroom	•	•	•	•	•	•	•	•	•	•	•	•	•	•	•	•	•	•	•	•	•	•		•	•	•
TABLES - RECEPTION + OCCASIONAL																										
Citi	•	•	•	•	•	•	•	•	•	•	•	•	•	•	•	•	•	•	•	•	•	•		•	•	•
Occasional Tables	•	•	•	•	•	•	•	•	•	•	•	•	•	•	•	•	•	•	•	•	•	•		•	•	•
Reception Tables	•	•	•	•	•	•	•	•	•	•	•	•	•	•	•	•	•	•	•	•	•	•		•	•	•
Work Tables	•	•	•	•	•	•	•	•	•	•	•	•	•	•	•	•	•	•	•	•	•	•		•	•	•
Sirena Tables	•	•	•	•			•	•	•	•	•	•	•	•	•	•	•		•		•		•	•	•	•
Wind Tables	•	•	•	•	•	•	•	•	•	•	•	•	•	•	•	•	•	•	•	•	•	•		•	•	•
TABLES - TRAINING																										
2gether	•	•	•	•	•	•	•	•	•	•	•	•	•	•	•	•	•	•	•	•	•	•		•	•	•
TABLES - HEIGHT ADJUSTABLE																										
Foli Tables	•	•	•	•	•	•	•	•	•	•	•	•	•	•	•	•	•	•	•	•	•	•		•	•	•
FILING + STORAGE																										
Lateral File Tops	•	•	•	•	•	•	•	•	•	•	•	•	•	•	•	•	•	•	•	•	•	•		•	•	•
WOOD VENEER DESKING																										
Corby - Laminate chassis	•	•			•			•	•	•	•	•	•	•	•	•	•		•	•				•	•	•
Dufferin - Laminate chassis					•			•		•										•		•				•

* Bridges II finishes coordinate with metal paint finishes as follows: Black (BLK) - Black Paint (BLK); Brushed Cobalt (BRC) - Tungsten Paint (TUN); Storm Grey (SOG) - Charcoal Paint (CHR); Designer White (DWT) - Designer White Paint (DWT); Custom Grey (CGY) - Silver Paint (SIL); String (STG) - Nevada Paint (NEV).

LAMINATE FINISHES COORDINATION CHART			
LAMINATE FINISH		COORDINATING WOOD FINISH	
ACJ	Absolute Acajou	AAM	Absolute
ASN	Asian Night	ASM	Night
AWC	Avant Cherry	ACM	Cherry
AWH	Avant Honey	AHM	Honey
BLK	Black	BKM	Black
CMB	Clear Maple	AVM	Maple
DES	Dark Espresso	ECM	Espresso Cafe
DWT	Designer White	WHM	White
NBL	Noce Biondo	NBM	Noce Biondo
NEL	Noce Leggero	NEM	Noce Leggero
NGL	Noce Grigio	NGM	Noce Grigio
NML	Noce Medio	NMM	Noce Medio
QTM	Quartered Mahogany	TMM	Mahogany
WCR	Winter Cherry	WCM	Winter Cherry
WHC	White Chocolate	WTM	WC Cream
WHE	Walnut Heights	MWM	Medium Walnut
LAMINATE FINISHES WITH NO COORDINATING WOOD FINISHES		WOOD FINISHES WITH NO COORDINATING LAMINATE FINISHES	
BRC	Brushed Cobalt	EOM	English Oak
BZD	Blizzard	HGM	Grey
CGY	Custom Grey	NLW	Natural Walnut
FAS	Fashionista	SKM	Shaker Cherry
FCL	First Class	TFM	Fruitwood
SBY	Sheer Beauty	TWM	Walnut
SOG	Storm Grey		
SDT	Stonedust		
STG	String		

THINK GLOBAL/THINK GREEN



LEVEL 3 CERTIFIED
Many programs in various categories



LEED PARTNERSHIP PROGRAM
Products can help you earn credits



GREENGUARD CERTIFIED
Children & Schools Certified

THE ENVIRONMENT We believe now more than ever, that it is our responsibility to protect the environment and our precious natural resources for future generations. The growing importance of energy and environmental concerns continues to challenge us in this ever changing marketplace.

As an industry leader, Global continues to take proactive steps towards reducing the negative impacts on the environment. We are building "healthier" offices; investing in Research & Development and new technologies; reducing waste and the consumption of energy; and improving the quality of the air we breathe, all which can have a significant impact on our quality of life.



Epoxy Powder coating process is solvent free. No harmful VOC's or lead. No toxins are released into the atmosphere.

Global's recycled fabrics offer affordable, environmentally responsible alternatives to commercial textiles. We recycle 35,000 lbs of fabric offcuts weekly.



Global has the products and resources to help your projects achieve LEED certification.

New technology allows us to reduce glue usage by 50%. In addition, our polyurethane glue reduces emissions and requires less energy to apply.



powder paint process:
98% paint recovery and reuse

more recycled fabric
less to the landfill

talk to us about our
leed partnership program

we've diverted
90% of our wood waste from landfill in four years

For further information on Global's environmental initiatives, please visit <https://www.globalfurnituregroup.com/us/company/environmental-commitment>

CUSTOM GROMMET LOCATION FORM

This form is for use with rectangular and square units only. Application drawings must be provided for any other shape units.

Model # _____ (Please use one page for each model #)

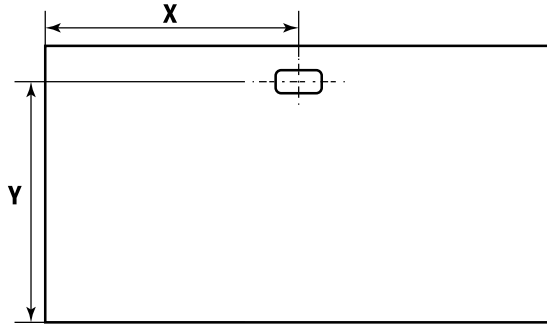

Operator Side

Template for Tops

X = _____

Y = _____

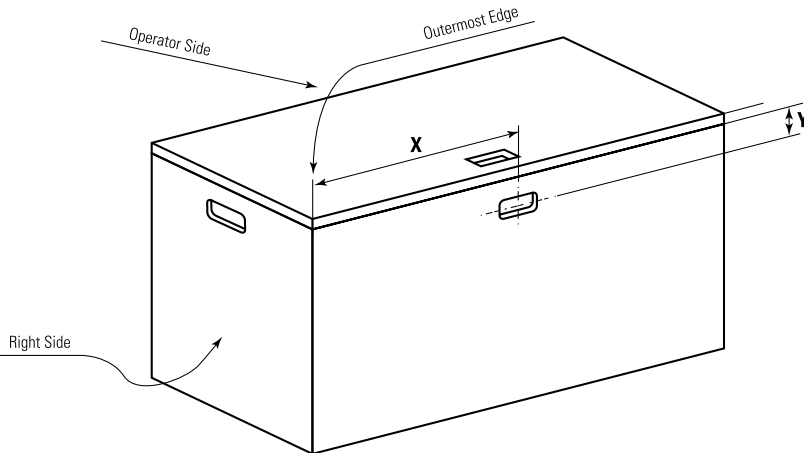
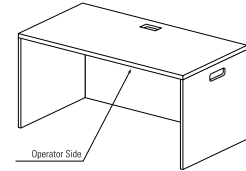

Template for Modesty Panels

X = _____

Y = _____

Note: X = Taken from outermost edge

Note: Y = Taken from underside of top

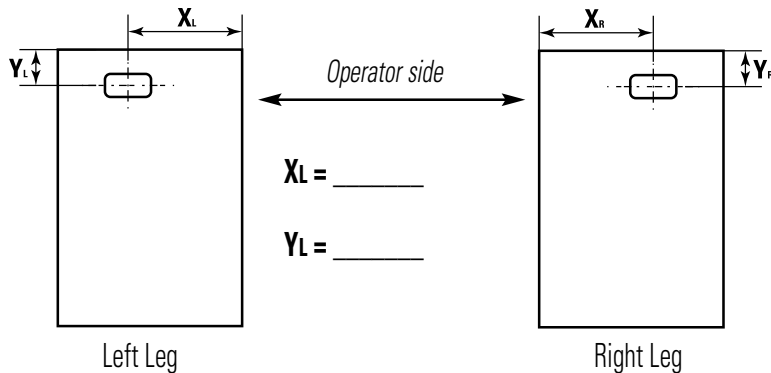

Left Leg

Right Leg

X_L = _____

Y_L = _____

Template for Legs

X_R = _____

Y_R = _____

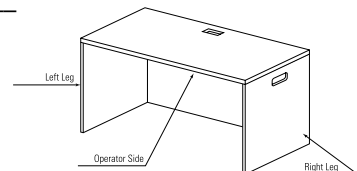

THIS FORM IS TO BE USED FOR NON-STANDARD CUT-OUT SIZES

Zira boardroom tables only (96" table)

Model # _____ (please use one page for each model #)

Please check all that apply. Note: Shaded grey areas represent position of bases.

CUT-OUT POSITION(S)

- Position 1 - over left base - always 24.6" to center point of cut-out from left edge - use option code **CCU1**
- Position 2 - center of table - use option code **CCU2**
- Position 3 - over right base - always 24.6" to center point of cut-out from right edge - use option code **CCU3**
- Custom position(s) - indicate on diagram below w/dimensions to **center point** of cut-outs - use option code **CCUS**

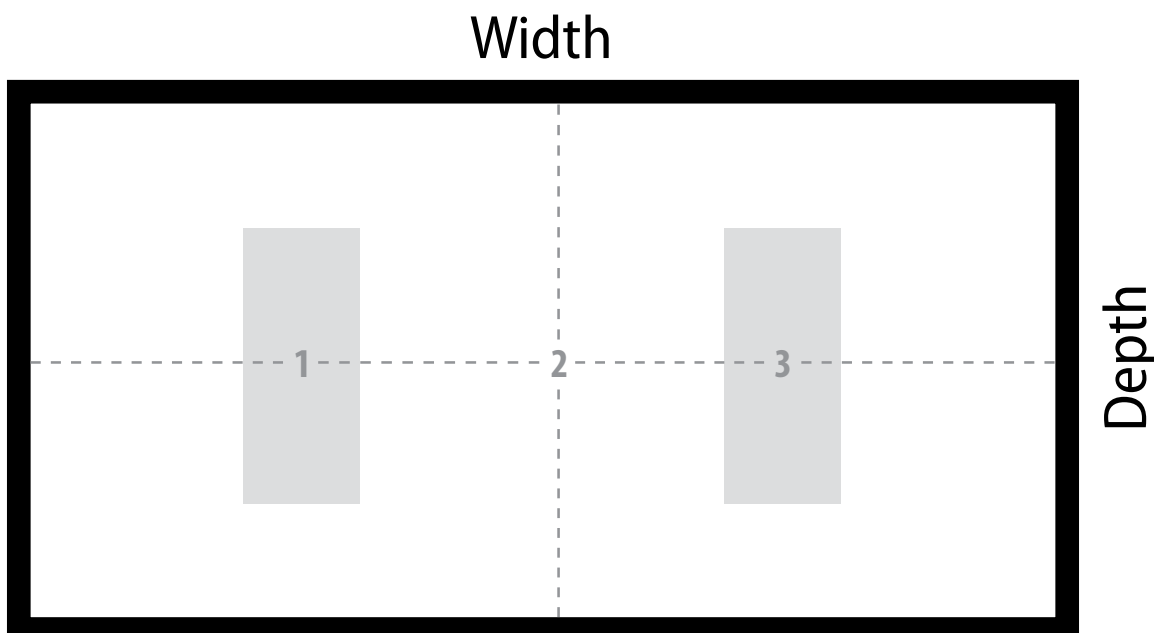

CUT-OUT CRITERIA

All cut-outs require a minimum 8mm radius at each corner.

Cut-outs **must be centered** on the depth of each table due to wire management runners below the worksurface.

Power and data modules that extend more than 3.75" below the worksurface **CANNOT** be positioned over bases.

Indicate cut-out size:

_____ " X dimension of cut-out runs the width of the table.

_____ " Y dimension of cut-out runs the depth of the table.
Y dimension not to exceed 14"

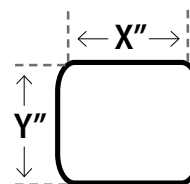

Dealer PO# _____

Internal use only

Global order# _____

Global trailer/load #: L _____ ID #: _____

THIS FORM IS TO BE USED FOR NON-STANDARD CUT-OUT SIZES

Zira boardroom tables only (120" - 168" table)

Model # _____ (please use one page for each model #)

Please check all that apply. Note: Shaded grey areas represent position of bases.

CUT-OUT POSITION(S)

- Position 1 - over left base - always 25.2" to center point of cut-out from left edge - use option code **CCU1**
- Position 2 - center of table - use option code **CCU2**
- Position 3 - over right base - always 25.2" to center point of cut-out from right edge - use option code **CCU3**
- Custom position(s) - indicate on diagram below w/dimensions to **center point** of cut-outs - use option code **CCUS**

Width

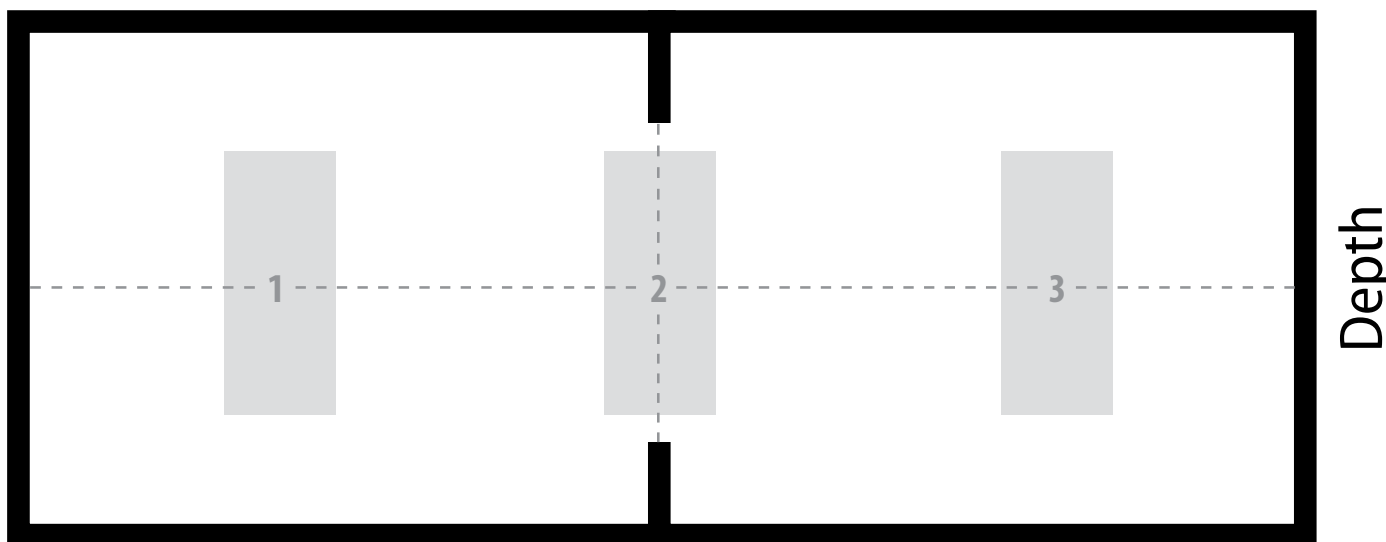

CUT-OUT CRITERIA

All cut-outs require a minimum 8mm radius at each corner.

Cut-outs **must be centered** on the depth of each table due to wire management runners below the worksurface.

Power and data modules that extend more than 3.75" below the worksurface **CANNOT** be positioned over bases.

Indicate cut-out size:

_____ " X dimension of cut-out runs the width of the table.

_____ " Y dimension of cut-out runs the depth of the table.

Y dimension not to exceed 14"

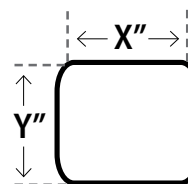

Dealer PO# _____

Internal use only

Global order# _____

Global trailer/load #: L _____ ID #: _____

THIS FORM IS TO BE USED FOR NON-STANDARD CUT-OUT SIZES

Zira boardroom tables only (192" - 288" table)

Model # _____ (please use one page for each model #)

Please check all that apply. Note: Shaded grey areas represent position of bases.

CUT-OUT POSITION(S)

- Position 1 - over left base - always 25.2" to center point of cut-out from left edge - use option code **CCU1**
- Position 2 - center of table - use option code **CCU2**
- Position 3 - over right base - always 25.2" to center point of cut-out from right edge - use option code **CCU3**
- Custom position(s) - indicate on diagram below w/dimensions to **center point** of cut-outs - use option code **CCUS**

Width

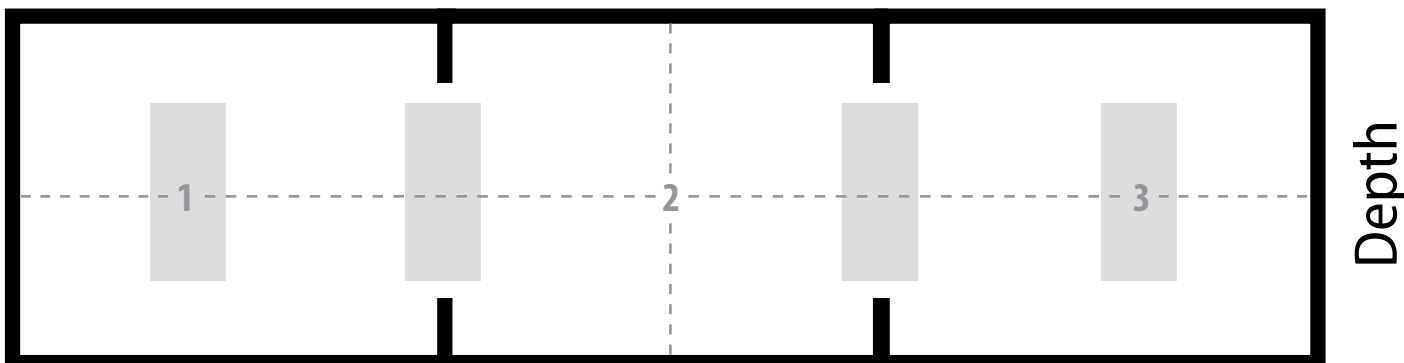

CUT-OUT CRITERIA

All cut-outs require a minimum 8mm radius at each corner.

Cut-outs **must be centered** on the depth of each table due to wire management runners below the worksurface.

Power and data modules that extend more than 3.75" below the worksurface **CANNOT** be positioned over bases.

Indicate cut-out size:

_____ " X dimension of cut-out runs the width of the table.

_____ " Y dimension of cut-out runs the depth of the table.

Y dimension not to exceed 14"

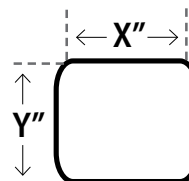

Dealer PO# _____

Internal Use Only

Global Order# _____

Global Trailer/Load #: L _____ ID #: _____

THIS FORM IS TO BE USED FOR NON-STANDARD CUT-OUT SIZES

Zira boardroom tables only (square tables)

Model # _____ (please use one page for each model #)

Please check all that apply. Note: Shaded grey area represents position of base.

CUT-OUT POSITION(S)

Position 2 - center of table - use option code **CCU2**

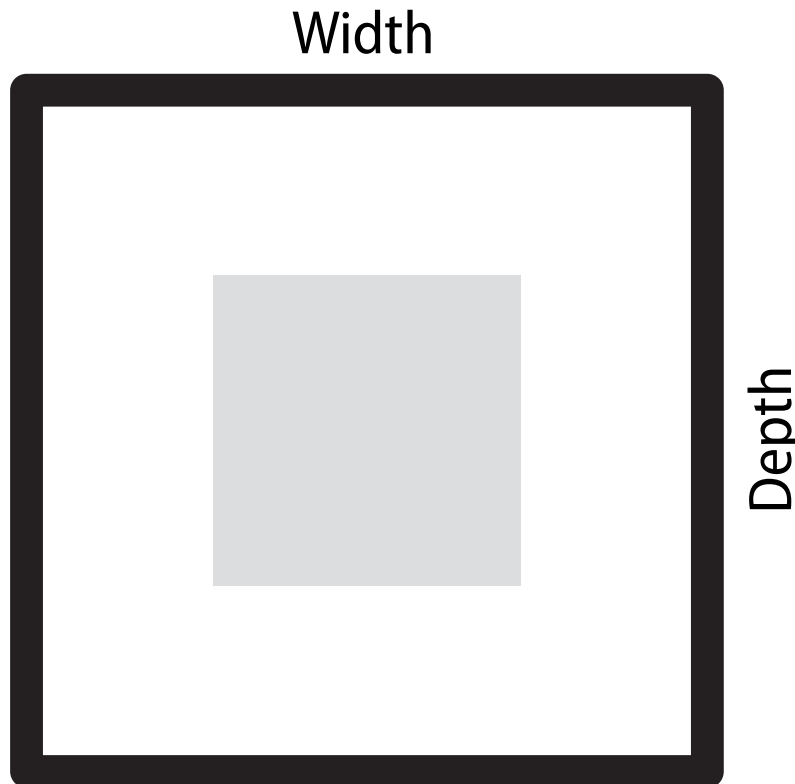

CUT-OUT CRITERIA

All cut-outs require a minimum 8mm radius at each corner.

Cut-outs **must be centered** on the depth of each table.

Power and data modules that extend more than 3.75" below the worksurface **CANNOT** be positioned over bases.

_____ " X dimension of cut-out runs the width of the table.

_____ " Y dimension of cut-out runs the depth of the table.
Y dimension not to exceed 11"

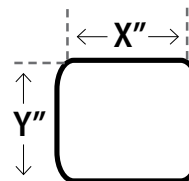

Dealer PO# _____

Internal use only

Global order# _____

Global trailer/load #: L _____ ID #: _____

THIS FORM IS TO BE USED FOR NON-STANDARD CUT-OUT SIZES

Zira media tables only

Model # _____ (please use one page for each model #)

Please check all that apply. Note: Shaded grey area represents position of base.

CUT-OUT POSITION(S)

- Position 1 - over left base - always 24.6" to center point of cut-out from left edge - use option code **CCU1**
- Custom position(s) - indicate on diagram below w/ dimensions to **center point** of cut-outs - use option code **CCUS**

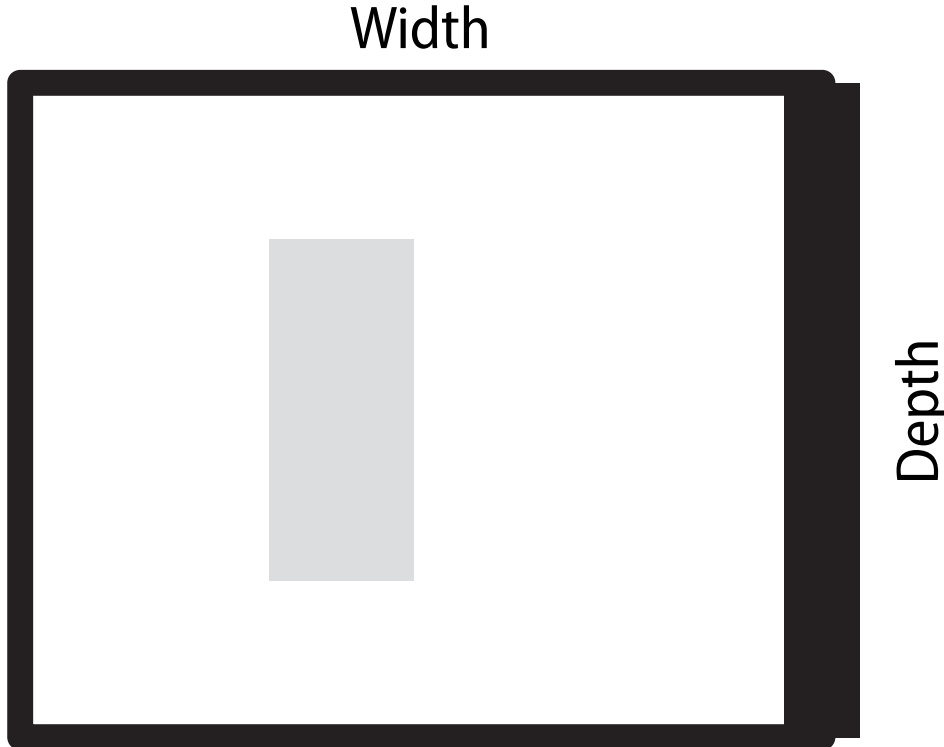

CUT-OUT CRITERIA

All cut-outs require a minimum 8mm radius at each corner.

Cut-outs **must be centered** on the depth of each table due to wire management runners below the worksurface.

Power and data modules that extend more than 3.75" below the worksurface **CANNOT** be positioned over bases.

_____ " X dimension of cut-out runs the width of the table.

_____ " Y dimension of cut-out runs the depth of the table.
Y dimension not to exceed 14"

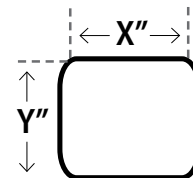

Dealer PO# _____

Internal use only

Global order# _____

Global trailer/load #: L _____ ID #: _____

THIS FORM IS TO BE USED FOR NON-STANDARD CUT-OUT SIZES

Zira collaborative tables only

Model # _____ (please use one page for each model #)

Please check all that apply.

CUT-OUT POSITION(S)

- Position 1 - always 24.6" to center point of cut-out from left edge - use option code **CCU1**
- Position 2 - center of table - use option code **CCU2**
- Position 3 - always 24.6" to center point of cut-out from right edge - use option code **CCU3**
- Custom position(s) - Please indicate on diagram below with dimensions to **center point** of cut-outs - use option code **CCUS**

Width

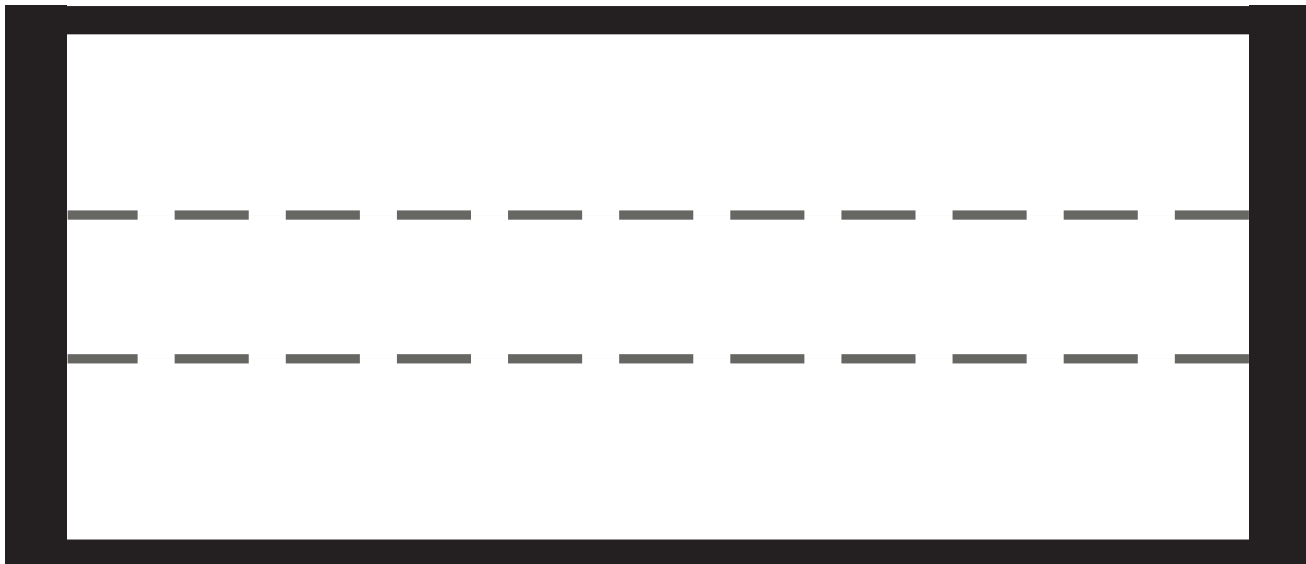

Depth

CUT-OUT CRITERIA

All cut-outs require a minimum 8mm radius at each corner.

Cut-outs **must be centered** on the depth of each table due to wire management runners below the worksurface.

_____ " X dimension of cut-out runs the width of the table.

_____ " Y dimension of cut-out runs the depth of the table.
Y dimension not to exceed 10"

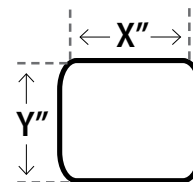

Dealer PO# _____

Internal use only

Global order# _____

Global trailer/load #: L _____ ID #: _____

This illustrated price list has been designed to facilitate fast reference and easy use. Products are categorized into "seating", "desks", "files", "panels", or "tables", and are listed numerically within their categories. The line drawings match actual photographs (where possible) to aid in instant recognition of the total range within a series.

Sales of Global Furniture Group ("Global") products are made only on Global's standard Terms and Conditions of sale which are contained in this list price book. These standard terms and conditions may be modified or supplemented only by a separately written document signed by Global's authorized personnel at its head office in Marlton, NJ. Any term or condition contained in any purchase order or other form used by dealer/purchaser to order goods (including standard, printed language) which is different from, in addition to, or in any way inconsistent with Global's standard terms and conditions shall be of no force or effect whatsoever.

All illustrations, specifications and prices in this list price book are based on the latest product information available at time of publication. Global reserves the right to make changes at any time and without prior notice to prices, colors, materials, specifications and models offered.

Description

Each product shown or described in this list price book is standard Global product. Available options are noted at the beginning of each series. Available options may require additional delivery time and cost, and may affect the warranty given. Sizes and weights shown are approximate and are subject to slight changes from time to time.

Prices and Payment

The prices shown in this book, as well as those quoted by Global, are in United States dollars for orders shipped to destinations in the U.S. and Mexico.

If shipping date requested is more than 90 days from date of order, Global shall reserve right to use published list prices effective at the time of shipment.

Orders are invoiced at the time of shipment. Terms of payment are net 30 days from date of invoice (1% 15 days) unless otherwise stated. The Purchaser agrees that Global reserve the right to enforce a charge amounting to 1.5% per month (18% per year) on invoices outstanding more than 30 days.

If the Purchaser's most recent annual net volume is less than \$5,000.00, payment must be made in advance.

Any products sold by Global shall remain the personal property of Global until fully paid.

Prices are suggested list prices only and are subject to change without notice. Global will, however, attempt to keep dealer/purchasers up-to-date on all developments including price changes.

Taxes

All prices shown in this book are exclusive of sales, use, excise and other applicable taxes and are the dealer/purchaser's responsibility as per the invoice issued by Global. If dealer/purchaser claims an exemption from such taxes, it shall be the dealer/purchaser's responsibility to furnish Global with an appropriate exemption certificate at time of order.

Ordering Information

Global requires that all orders be submitted in writing and will be acknowledged on Global's acknowledgment forms governing the transaction. The details appearing on this acknowledgment will describe the items to be shipped and the approximate shipping date. It is the Purchaser's responsibility to determine that the information in the acknowledgment is correct. In the event of an error, the Purchaser must notify their Global Customer Service representative immediately by telephone followed by written confirmation. Shipping dates are assigned to orders based on the items having the longest manufacturing lead time (unless instructed to partial ship).

At time of order, please provide the following information:

1. Account number (if possible)
2. PO number
3. "Bill to" and "Ship to" name and address
4. Complete model number and selected options including textiles/finishes
5. Special instructions and tag information
6. Shipping instructions, please indicate:
 - a. pick up
 - b. Global trailer program
 - c. common carrier, provide name of carrier, your account number
7. Special quote (SQ) # or MTM # (if applicable)
8. Customer's Own Material (COM), Global Purchased Material (GPM), Customer's Own Leather (COL), see below.
9. For specials and custom quoted product, please indicate the custom quote # on your PO. If changes are made to the quote a new quote must be issued prior to submitting the order. It is the Purchaser's responsibility to determine that the information on the quote is correct. Global will not be responsible for wrong product due to errors in the quote

The above points will be checked by Global for accuracy. Global will process orders using the codes provided by the Purchaser. Price discrepancy is the responsibility of the Purchaser. The Purchaser must notify Global prior to invoicing.

The Purchaser is responsible for providing correct information at time of order. If no option(s) are selected the system will default to standard feature(s). Orders with missing/incorrect information (finish, etc.) will be put on hold until all information is complete. Orders will be scheduled for manufacturing upon receipt of complete information.

Changes and Cancellations

After the date of Global's acknowledgment of the Purchaser's order, the order may not be changed or canceled by the Purchaser without the written consent of Global. Special order items, C.O.M. and fabric-covered items already in production are not subject to change or cancellation under any circumstances. Textile-covered items are considered to be in production once the textile is scheduled for cutting. Other standard items already in production are subject to a minimum 35% cancellation charge.

Errors and Omissions

All quotations, acknowledgements and invoices are subject to corrections for any errors and omissions.

FINISHES

Wood Finishes

For custom stain requests, submit a special request for quotation. Non-standard wood finish orders will incur a one time charge of \$250 net to dealer per matching custom wood stain. This one time fee will be valid for 5 years from the time of matching. After 5 years, a new \$250 net to dealer charge will apply. All custom wood stain products will receive a 10% list per unit upcharge, included on the special quote. Requests with unit quantities of 30 or more, may be considered for reduced or eliminated upcharge. At time of order, a 3" x 3" color sample is required to be submitted with order. Extended order lead time is required for custom matching and approval process.

File Finishes

All non-standard finishes must be approved by Global prior to acceptance of order and may be subject to an upcharge.

Laminate Tops - Pricing for all non-standard finishes and sizes must be provided by Global Customer Service and may be subject to an upcharge.

Desk Finishes

Because the distinctive characteristics and the nature of wood products cause variations, exact matches are not always possible.

Global has launched a finishes program between marketing companies within the Global Group to match products as best as possible when same finishes are specified.

Customers Own Material (COM)

Use of COM must be approved by Global prior to acceptance of order. Please refer to back of the Seating List Price Book and fill out the Authorization Request Form. Photocopy and use this form as often as necessary. The customer must provide a 12" x 12" fabric sample and advise how the fabric is to be applied. **Textile yardage requirement will be advised by the factory, and additional yardage may be required if pattern requires matching.** Yardage shown in the List Price Book does not allow for pattern repeat/matching. Send to the address provided on shipping document upon approval from Global. If C.O.M. is difficult to apply or if product shall be modified, extra charges shall be made. Global reserves the right to cancel an order at any time if C.O.M. is inadequate for any reason. Customer's Own Material must be shipped freight and duties paid to our factory. Such shipment must be fully identified with purchaser's order number, RGA # provided by Global, and the item for which material is intended. Performance of C.O.M. when applied to product is the sole responsibility of the purchaser. Global's standard product warranty shall not apply to C.O.M. Use of C.O.M. will not reduce the published list price.

Textile Grading

All products are priced according to their standard textile grade. Lower grade textiles may be available but at the same price as standard textile grade. See Textiles and Finishes section for graded textiles.

Combining two grades of textiles may result in a revised grade. Please refer to "Two Grades Combination Chart" in the Textiles and Finishes section. For more than two textiles a special quotation is required.

Global Purchased Material, Customer Specified (GPM)

Global may purchase material specified by the customer. Use of GPM must be approved by Global prior to acceptance of order. If it is difficult to apply or if product is required to be modified, extra charges will apply. Global reserves the right to cancel an order at any time if GPM is inadequate for any reason. Performance of GPM when applied to product is the sole responsibility of the textile vendor. Global's standard warranty will not apply to GPM materials.

Customer's Own Leather (COL)

Not all seating can be upholstered in leather. Please consult series notes for availability. COL price is the lowest published grade for the series (leather or fabric).

Upholstery Coverings

Slight variations in color may occur between dye lots. Although Global attempts to minimize these variances, they do occur and must be accepted as normal and will not be considered defects.

Leather is a Natural Product

Natural variations occur in the color, grain and texture of leather. As a result, a degree of variation should be expected. As leather is used it develops a patina. Its color changes slightly, it will get marked and it will stretch and pull, these are the hallmarks of genuine leather and are not considered defects.

Yardage

Required yardage (ydg) is based on unmatched materials with widths of 54" for seating, 63" for panels. Yardage calculations are based on imperial measurements.

Arms

A wide selection of arms are available for some series. See Arm Chart in the Seating price list for details.

Delays

Global's order acknowledgement will state a shipping date which is Global's best estimate at the time the order is acknowledged. However, Global shall not incur any obligation or liability to Purchaser for failure to ship by specified date unless Global has agreed to an unequivocal shipping date in a separately signed written document executed by its authorized personnel at its head office. In addition, Global shall not be liable for any loss or damage resulting from any delay or failure in shipment or other failure to perform all or any part of the agreement between the parties with respect to the goods shown on the face of the order acknowledgement where such delay, failure, loss or damage is the proximate result of any act of any governmental authority or political subdivision thereof, revolution, riot, civil disorder or disturbance, delay or default in transportation, strike disputes among or between labor unions or other labor disputes, delay or inability in obtaining materials and facilities, fire, flood, act of God or any cause not within the reasonable control of the company, whether of the class of causes enumerated or otherwise.

F.O.B.

F.O.B. point is Global's Factory, Downsview, Ontario, Canada, or any Global Regional Distribution Center.

UPS Shipments

Seating products marked with a UPS symbol are packaged for UPS-able shipments.

Handling

A \$25. net handling charge per shipment will be applied for non UPS-able orders of less than \$2000 list.

Special Delivery Requirements

Global's delivered pricing provides for dock delivery during normal business hours (considered to be 8 am to 4 pm Monday through Friday) to customer/end user only. Additional delivery requirements such as inside delivery, lift gate, limited access sites, installations and weekend deliveries will incur an additional expense and will be the responsibility of the dealer.

Service

Service requests are normally the responsibility of Global's authorized dealers. Where this cannot be accomplished on a local level, service problems should be referred to Global's Customer Service Department in the nearest distribution center.

Returns

No returns of goods will be accepted without written consent and shipping instruction of Global. A minimum re-stocking charge of 35% is made on all authorized returns for credit or refund, provided goods are received by Global in the condition in which they left the factory. This may increase depending on the type of product. Global's Return Goods Authorization (R.G.A.) numbers must appear prominently on all authorized returns. Global will not be responsible for freight costs. No credit will be given if goods cannot be reused as new. Special order items, non-stock items and C.O.M. products are in no event subject to return. All returns must be approved and authorized in writing by Global Customer Service. Global reserves the right to refuse delivery of any unauthorized returns.

Claims

All goods are sold FOB plant or Global Distribution Center. Global is not responsible for damage which occurs in transit (or in storage). The carrier signs for all goods received in apparently good order. It is the Purchaser's responsibility to examine goods upon receipt and to file any claims with the carrier for losses or damage to the product occurring during transit, including concealed damage.

Any claims made against Global for apparent defects, errors or shortages must be made by the Purchaser, in writing, within 15 working days after any delivery. Failure by the dealer/purchaser to make any claim against Global within 15 days shall constitute acceptance of the goods and a waiver of any apparent defects, errors or shortages.

Suspension

In the event that the dealer/purchaser defaults in the payment of any sum due to Global, or in the event the dealer/purchaser's financial condition becomes unsatisfactory to Global, Global shall have the right to defer or discontinue shipment of any goods until such time as the default is cured or the dealer/purchaser provides assurance of payment to Global.

Copyright

All catalogs, photographs, drawings, price lists and other printed material are protected by copyright. All rights reserved.

Trademarks

All trademarks are owned by Global Furniture Group other than OBUSFORME™ which is owned by OBUSFORME LTD. and are used under license. OBUSFORME® and the distinctive backrest design are registered trademarks of OBUSFORME LTD.

Designs and Patents

Many of the products produced by Global are protected by design registrations, design patents and/or patents. Design and specifications are subject to change, discontinuance or additions without notice.

For a full listing of issued trademarks, please visit globalfurnituregroup.com.

Cubic Measure

The stated volume is an approximate cubic foot measure that may be used to calculate freight costs. The figure shown is the total shipping volume of a unit (e.g. if a part is sent in 2 cartons the volume indicated reflects both cartons together) and is subject to change without notice. It is most economical to purchase the specified number per carton.

Combined Shipments

Global will make every effort to combine shipments and orders on written request. However, Global cannot be held responsible where such request is not complied with.

Offer of Sale

Possession of this price list or any other literature shall not imply the company's willingness to sell to the holder and shall not be construed as a direct offer of sale.

If a conflict arises between: (i) prices found in software support packages furnished to the customer by Global or by any other source on behalf of Global; and (ii) Global's current pricing found on Global's website, then the most current shall prevail.

Disclaimer

All dimensions are in inches. Prices shown are current manufacturer's suggested list prices at the time of printing. Updated pricing is available on Global's website. All applicable taxes are extra. Descriptions, specifications and prices are subject to change without notice. Errors and omissions are subject to correction.

Testing Qualifications

Many Global products pass or exceed the most stringent industry testing standards.

Flammability

The foam used in Global chairs meets the requirements of California TB117:2013. In addition to the foam, upholstery materials must also meet the California TB117 smolder resistant requirements. Please contact Customer Care to determine if a selected textile meets the California TB117 requirement.

This list price book is effective as of January 1, 2023.

For periodic updates, please check the PDF at globalfurnituregroup.com. Select Resources then Price Lists. From here you will have the option to select either the Seating, Desking + Tables or Metal Filing + Storage price list books. Global warrants that all commercial products are free from defects in material and workmanship, for the life of the product, to the original Purchaser.

Global will repair or replace, at Global's option, as the sole remedy for any defect covered by the warranty. The warranty applies to products manufactured after March 22, 2016.

Global makes no warranty that any of its products are suitable for any particular purpose and makes no other warranties, express or implied, other than those set out here. As codes and standards vary from one jurisdiction to another, references to compliance are solely for convenience and without any representation as to accuracy or suitability. Users must verify the suitability of such information or product for their specific application. In no event shall Global be liable in either tort or contract for any loss or direct, special, incidental, consequential, or exemplary damages. The warranty applies to single shift, standard commercial usage, defined as a standard eight (8) hour day, forty (40) hour week for users weighing up to 300 pounds.

General Commercial Seating

Global's warranty for general commercial seating covers all chair components including pneumatic cylinders, bases, casters, glides, frames, arms, plastic seats, backs and other structural components.

Exceptions to the warranty for general commercial seating are as follows:

- Foam, textiles (as sampled on Global branded and textile program cards), mesh material and electrical devices, are warranted for five (5) Years
- Control mechanisms are warranted for twelve (12) Years
- Heavy duty seating and Indoor/Outdoor Furniture are not defined as General commercial seating (see below for warranty exceptions)

Heavy Duty Seating

Global offers products designed for multiple shift applications (24 hours a day / 7 days a week) and larger individuals weighing up to 400, 500 and/or 600 pounds (depending on series and/or model). Global warrants these products for twelve (12) years to the original purchaser. All components (including control mechanisms, pneumatic cylinders, bases, casters, glides, frames, arms, plastic seats/backs, etc.) are covered for 24/7 applications under the warranty. The exceptions are foam, upholstery and textiles, which are covered for five (5) years. Fabric or upholstery material on these products must exceed 100,000 double rubs for the textile portion of the warranty to apply. Heavy Duty product series that apply under this warranty can be found in the Heavy Duty section of this list price book.

Outdoor Furniture

Global offers products designed for use indoors or outdoors. Global warrants these products for three (3) years to the original purchaser. This warranty applies to single shift (eight (8) hour day, forty (40) hour week) for users weighing up to 275 pounds, unless noted otherwise. Outdoor furniture must be stored indoors during inclement or extreme weather such as extreme cold, extreme heat, or excessive wind.

Exceptions to the warranty for indoor/outdoor furniture is as follows:

- Only Global branded textiles and Alliance Partner carded textile program materials expressly identified for outdoor application are covered for three (3) years when used outdoors.

Global's Warranty does not apply (for any product category) to the following:

- Products not purchased directly from authorized Global resellers
- Nominal or normal amount of wear and tear that can occur over time
- Failures which result from negligence, abuse, accident or misuse
- Failure to apply, install or maintain products according to Global's written instructions and warnings
- Modifications, attachments or repair methods not approved by Global
- Damage caused by a carrier in transit, or delivery/installation contractors
- The matching of colors, grains or textures (wood, leather, etc.) of natural materials
- Products exposed to extreme hot or cold temperatures or excessively dry or humid environments
- Colorfastness or the matching of color of textiles, dye lots of textile can vary
- Damage by markings or staining; damage by sharp objects or imprinting from instruments
- Damage to textiles or laminate and wood surfaces/edges from exposure to sunlight (including UV rays)
- Products used for rental purposes
- Purchased parts are warranted for one (1) year
- Failure to follow specific cleaning and disinfecting instructions posted on globalfurnituregroup.com

Seating Warranty Summary

Seating Type	Components Warranty For Original Purchaser	Use Time For Warranty Coverage	Exceptions
General Commercial Seating	Lifetime	8 Hours/5 Days Per Week	Foam/Upholstery/Textiles/Mesh/Electrical Devices - 5 Years Control Mechanisms - 12 Years
Heavy Duty Seating	12 Years	24 Hours/7 Days Per Week	Foam/Upholstery/Textiles - 5 Years
Indoor/Outdoor Furniture	3 Years	8 Hours/5 Days Per Week	Outdoor Use Textiles – 3 Years

Textiles

Global warrants Global branded textiles and Alliance Partner carded textile programs inclusive of fabrics, vinyls and leather products for five (5) years. Global does not warrant COM (Customer Own Materials) or graded-in materials (non-carded) and purchased by Global for a customer. For graded-in or COM products, please contact the textile supplier for performance information and warranty details. Please refer to our website at globalfurnituregroup.com for detailed information on cleaning and disinfecting procedures. Improper usage of disinfecting/cleaning products may void the warranty.

Global textiles and finishes are updated periodically to meet the demand and trends of the market. As a result, some textiles and finishes may be discontinued by Global or the manufacturer. In the event that a textile or finish is discontinued, Global will make every reasonable effort to provide an alternative product(s) of comparable function.

Global warrants that all commercial products are free from defects in material and workmanship, for the life of the product, to the original Purchaser.

Global will repair or replace, at Global's option, as the sole remedy for any defect covered by the warranty. The warranty applies to products manufactured after March 22, 2016.

Global makes no warranty that any of its products are suitable for any particular purpose and makes no other warranties, express or implied, other than those set out here. As codes and standards vary from one jurisdiction to another, references to compliance are solely for convenience and without any representation as to accuracy or suitability. Users must verify the suitability of such information or product for their specific application. In no event shall Global be liable in either tort or contract for any loss or direct, special, incidental, consequential, or exemplary damages.

Files, Desks, Modular Furniture, Tables, Panels & Accessories

Global warrants all components of metal storage and filing, laminate and wood veneer desks, laminate and wood veneer tables, metal leg components and panels for the lifetime of the product to the original purchaser.

The warranty applies to single shift, standard commercial usage, defined as a standard eight (8) hour day, forty (40) hour week. Load restrictions apply, refer to individual product descriptions.

Exceptions to the warranty for files/desks/tables and panels are as follows:

- Electrical devices, panel and tackboard textiles, adjustable keyboard mechanisms, non-electrical table mechanisms, monitor arms, lecterns, coat trees and task lights - five (5) years
- Laminate folding tables - one (1) year
- Motorized electrical components - two (2) years
- Keyless lock options - two (2) years

Files, Desks, Modular Furniture, Tables, Panels & Accessories Warranty Summary

Product Type	Components Warranty For Original Purchaser	Exceptions
Metal storage and filing	Lifetime	keyless lock options - 2 years
Laminate/wood veneer desks and modular furniture	Lifetime	tackboard textiles, electrical devices, task lights - 5 years
Boardroom, conference and training tables	Lifetime	electrical devices - 5 years moving parts - 5 years
Panels	Lifetime	panel textiles, electrical devices, task lights - 5 years
Coat racks and lecterns	5 years	none
Folding tables (laminate & molded)	1 year	none
Height adjustable tables	5 years	motorized parts (on electrical tables) - 2 years

Global's Warranty does not apply (for any product category) to the following:

- Nominal or normal amount of wear and tear that can occur over time
- Failures which result from negligence, abuse, accident or misuse
- Failure to apply, install or maintain products according to Global's written instructions and warnings
- Modifications, attachments or repair methods not approved by Global
- Damage caused by a carrier in transit, or delivery/installation contractors
- The matching of colors, grains or textures (wood, leather, etc.) of natural materials
- Products exposed to extreme hot or cold temperatures or excessively dry or humid environments
- Colorfastness or the matching of color of textiles, dye lots of textile can vary
- Damage by markings or staining; damage by sharp objects or imprinting from instruments
- Damage to textiles or laminate and wood surfaces/edges from exposure to sunlight (including UV rays)
- Products used for rental purposes
- Purchased parts are warranted for one (1) year
- Failure to follow specific cleaning and disinfecting instructions posted on globalfurnituregroup.com

Global's warranty does not cover the costs of transportation or labor. Repair or replacement will be at Global's option.

Global makes no warranty that any of its products are suitable for any particular purpose and makes no other warranties, express or implied, other than those set out here. As codes and standards vary from one jurisdiction to another, references to compliance are solely for convenience and without any representation as to accuracy or suitability. Users must verify the suitability of such information or product for their specific application. In no event shall Global be liable in either tort or contract for any loss or direct, special, incidental, consequential, or exemplary damages.

Global's warranty applies to products sold within the United States of America, Mexico, the Commonwealth of Puerto Rico and Canada.

Textiles and Finishes

Global textiles and finishes are updated periodically to meet the demand and trends of the market. As a result, some textiles and finishes may be discontinued by Global or the manufacturer. In the event that a textile or finish is discontinued, Global will make every reasonable effort to provide an alternative product(s) of comparable function.

Global US Headquarters/Distribution Center

17 West Stow Road, P.O. Box 562
Marlton, New Jersey U.S.A. 08053
T (856) 596-3390
T (800) 220-1900

Showrooms

Atlanta

10 10th Street
Suite 150
Atlanta, GA 30309
T (404) 879-0998

Boston

One Harbor Street
Suite 104
Boston, MA 02210
T (617) 406-5435

Chicago

222 Merchandise
Mart Plaza
10th Floor, Suite 1035
Chicago, IL 60654
T (312) 755-0843

Irvine

18400 Von Karman Ave.
Suite 100
Irvine, CA 92618

Miami

112 NE 41st Street
6th floor
Miami, FL 33137

New York City

386 Park Avenue South
7th floor
New York, NY 10016
T (212) 545-9900

Philadelphia

1735 Market Street
38th Floor
Philadelphia PA, 19103
T (215) 861-0963

New Jersey (Southern)

119 West Greentree Road
Marlton, NJ 08053
T (856) 596-3390

Phoenix

4675 E Cotton Center Blvd.
Suite 165
Phoenix, AZ 85040
T (602) 426-0666
T (602) 426-0777

Washington, DC

1130 Connecticut Avenue
10th Floor, Suite 1000
Washington, DC 20036
T (202) 659-0230
T (202) 659-0236

Distribution Centers

Atlanta Area

6715 Maple Ave.
Suite 100
Buford, GA 30518
T (678) 602-4130

Baltimore Area

Troy Hill
Corporate Center
7030 Troy Hill Drive
Elkridge, MD 21075
T (410) 379-8021

Chicago Area

27W501 North Ave.
Suite 300
West Chicago, IL 60185
T (630) 681-2818

Cincinnati Area

8712 LeSaint Drive
Fairfield, OH 45014
T (513) 777-0009

Dallas Area

2025 West Beltline Road
#100
Carrollton, TX 75006
T (972) 236-1366

Denver Area

16401 East 33rd Drive
Suite 50
Aurora, CO 80011
T (303) 340-1617

Ft. Lauderdale Area

560 Sawgrass
Corporate Pkwy
Sunrise, FL 33325
T (954) 846-8888

Houston Area

7865 Northcourt Road
Suite 200
Houston, TX 77040
T (713) 695-5777

Los Angeles Area

3629 Workman Mill Road
Whittier, CA 90601
T (562) 484-9686

Seattle Area

Oakesdale Commerce Ctr.
820 Southwest 34th Street
Building W7, Suite A
Renton, WA 98057
T (425) 291-9282

Kansas City Area

11617 West 81st Street
Lenexa, KS 66214
T (913) 310-9963

Tampa Area

10351 Windhorst Road
Tampa, FL 33619
T (813) 621-6272



globalfurnituregroup.com

