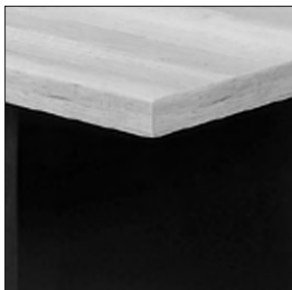




With over 370 components available in 400 color combinations, Adaptabilities provides the ultimate in flexibility and modularity. Rich laminate colors coordinate easily with any office or home decor. All surfaces are constructed from Global's exclusive premium grade, high performance laminate and preferred matching edges.

Adaptabilities features an extensive range of versatile components which can be configured into multi-user workstations suitable for intensive task functions, or for private executive suites requiring stately elegance and work-force functions. All laminate filing cabinets have a safety mechanism that prevents two drawers from being opened at the same time. File drawers have fully progressive ball bearing suspensions and accommodate letter and legal filing. For heavy duty usage, two, three and four drawer laminate files are available with steel drawer interiors.



Tops are 1" thick and a top over side, edge panel design.



3/4 modesty panel available at no extra charge.



For heavy duty usage, two, three and four drawer laminate files are available with steel drawer interiors.

Features and Benefits

- 45lb. density particle board substructure with high performance thermally fused laminate
- 1" thick worksurfaces in thermally fused or high pressure laminate
- Worksurfaces feature 2mm edging in matching color.
- Full to floor or 3/4 pedestals available on most components
- All desks are size (incrementally) accurate
- 11/16" thick full modesty panel is standard
- 11/16" thick 3/4 modesty panel is available on most components
- Pencil tray included in box drawer
- File drawers can accommodate legal or letter documents
- Full progressive ball bearing suspension on file drawers
- All drawer fronts edge banded with side pull opening pedestals and standard with pedestal locks
- Compatible with **Divide** panel system for increased privacy and storage requirements

GENERAL INFORMATION

- Constructed of 45 lb. density particleboard with high performance thermally fused laminate
- Adaptabilities components are compatible with Divide transaction tops and partitioning panels. See page 376 for Divide specifications and prices.
- See pages 40-41 for keyboard drawers and additional accessory options.
- Adaptabilities desk and storage products have been tested and comply with all BIFMA mechanical tests.
- For environmental certifications, please visit globalfurnituregroup.com.

WORKSURFACES

- 1" thick high performance thermally fused laminate tops sealed with Global's Preferred edging in matching color
- Woodgrain surfaces feature edging with matching printed woodgrain
- High Pressure Tops are available in all Adaptabilities laminate finishes at an extended lead time. Please see model # for pricing and availability.
- Products specified with the high pressure laminate option are finished on the underside of the surface with a kraft paper backing.

CONSTRUCTION

- Constructed of 45 lb. density particleboard with high performance thermally fused laminate.
- Cabinets and Wardrobes are 65" high to match overall height of a worksurface with hutch (worksurface 29" + hutch 36" = 65").
- End Shelves are available as 65" high also to match overall height.
- Models with monoposts are available with a Black (**TBL**) or Tungsten (**TTU**) monoposts. Please specify.
- Models with handles are available with Black (**HX**) or Silver (**HS**) handles; please specify.
- All drawer fronts edge banded with side pull opening pedestals and standard pedestal locks
- Double wall pedestal housing with fully closed bottom

MODESTY PANELS

- 11/16" thick full modesty panel is standard
- 11/16" thick ¾ modesty panel available on most components
- ¾ height modesty panels available on most models at no additional charge. Please specify "**3MP**". (Corners must have both modesty panels as ¾ or full).
- **Note:** Woodgrain modesty panels 60" wide and up will have the grain pattern in the horizontal direction. All end panels and modesty panels 59" or less will have the grain pattern in the vertical direction.

STORAGE

- All lateral file drawer fronts feature the woodgrain running in a horizontal direction.
- Pencil tray included in box drawer
- File drawers can accommodate legal or letter documents
- Triple progressive ball bearing suspension on file drawers

LOCKS

- Optional locks available for all straight hutch unit doors. Add **\$126** each lock
- Front-to-back filing bars for all steel drawer files available separately. Order FBB file bars. See "FBB" on page 41.
- Key alike or specific key number optional for all products with locks
- Reserved for new orders greater than \$20,000 list, all Adaptabilities units with locks may be ordered with **CA** cap option and specific lock cores/keys can be ordered separately for field installation rather than specifying duplicate product lines with different key numbers.
- When **CA** option is specified, product will ship with a cap over the empty lock housing.
- Separately order the appropriate number of cores with keys; use product code **SIL-CORE-H-SHOE** for Silver core/key sets or product code **BLK-CORE-H-SHOE** for Black core/key sets. Specify quantity and lock number required. One order line per key number required. Key number range: 401-440. **Must be ordered at the same time product is ordered with CA lock cap option specified.**
- One core removal key is required. Recommend one core removal for every 25 cores ordered. Order as **REMOVE-K-H-SHOE**.
- No charge applies for separate lock cores or core removal keys only when ordered with product. If replacement lock core and key required, contact Customer Care for applicable product code and pricing.

SPECIAL SIZES

- Additional custom sized components available upon request.
- Secretarial height returns (26 ½") available at a 15% upcharge.
- Full to the floor pedestal configurations can be switched for a 15% upcharge.

1. SPECIFY MODEL NUMBER

2. SPECIFY FINISH

Top Finishes:

ACJ	Absolute Acajou	FCL	First Class
ASN	Asian Night	NBL	Noce Biondo
AWC	Avant Cherry	NGL	Noce Grigio
AWH	Avant Honey	NEL	Noce Leggero
BLK	Black	NML	Noce Medio
BZD	Blizzard	QTM	Quartered Mahogany
BRC	Brushed Cobalt	SBY	Sheer Beauty
CMB	Clear Maple	SOG	Storm Grey
CGY	Custom Grey	SDT	Stonedust
DES	Dark Espresso	WHE	Walnut Heights
DWT	Designer White	WHC	White Chocolate
FAS	Fashionista	WCR	Winter Cherry

Body Finishes (including pedestals):

ACJ	Absolute Acajou	FCL	First Class
ASN	Asian Night	NBL	Noce Biondo
AWC	Avant Cherry	NGL	Noce Grigio
AWH	Avant Honey	NEL	Noce Leggero
BLK	Black	NML	Noce Medio
BZD	Blizzard	QTM	Quartered Mahogany
BRC	Brushed Cobalt	SBY	Sheer Beauty
CMB	Clear Maple	SOG	Storm Grey
CGY	Custom Grey	SDT	Stonedust
DES	Dark Espresso	WHE	Walnut Heights
DWT	Designer White	WHC	White Chocolate
FAS	Fashionista	WCR	Winter Cherry

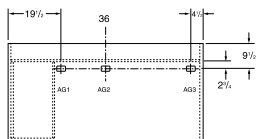
3. SPECIFY OPTIONS

Grommets

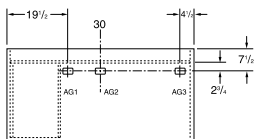
- Additional grommets available in standard worksurface locations (left, center or right).
- Order as: **AG1, AG2 or AG3. Add \$96.**



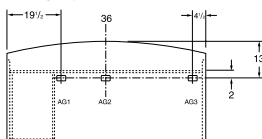
- Grommet hole dimensions are 3 1/4" wide x 1 7/8" deep.
- Actual grommet locations on the worksurface are depicted in the example drawings shown below. Dimensions shown are actual measurements (in inches).



36 x 72 single pedestal left desks (A3672SPL)

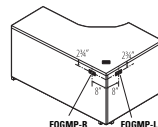


30 x 60 single pedestal left desks (A3060SPL)

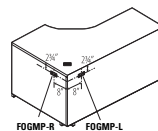


36 x 72 single pedestal left bow top desks (A3672SLB)

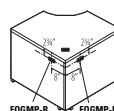
- Grommets may be placed at non-standard locations. Order as: **AGS - Add \$96.** A drawing must be supplied with vertical and horizontal dimensions to the center of the cut-out (as in drawing above). Please refer to CUSTOM GROMMET LOCATION FORM in the back reference section.
- Components that come standard with grommet may be ordered without a grommet. **Add \$53.**
- Grommets are available on modesty panels of extended corners and 5-sided corners 6 1/2" in where the two modesty panels meet at a 90° angle. Please specify FOGMPR for right grommet placement and FOGMPL for left grommet (placement is as shown on diagrams below). Cost is **\$96.**
- **Modesty panels are 1" off of ground**



Left Extended Corner Unit



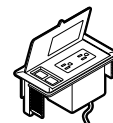
Right Extended Corner Unit



5-Sided Corner Unit

Power Block

- A Power Block (model PMSPDM) may be ordered on all worksurfaces.
- A Power Block is a rectangular worksurface power/data module with one electrical duplex receptacle and includes two data (CAT5) receptacles. 9 foot black cord included. Power Block dimensions are 3 1/2" deep x 6 1/2" wide x 2 3/4" high.
- To purchase a Power Block, you must specify both the Power Block cut-out location and the Power Block model #. Order Power Block as **PMSPDM, Add \$330.** Power Blocks are available in standard worksurface locations (left, center or right). Order as **E1, E2 or E3. Add \$96.**



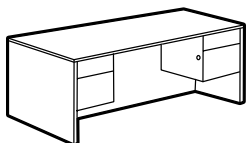
Power Block **PMSPDM Add \$330**



Specify location **E1, E2 or E3 Add \$96**

A ADAPTABILITIES®

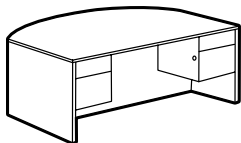
DOUBLE PEDESTAL DESKS



Double Pedestal Desk*

MODEL#	DIMENSIONS D x W x H	FREIGHT CLASS	WT./LBS.	CUBIC FT.	LIST PRICE	HP ADD
A3672DP	36 x 72 x 29.6	150	296	52.5	\$1806	\$532
A3072DP	29.69 x 72 x 29.6	125	263	43	\$1774	\$498
A3066DP	29.69 x 66 x 29.6	125	254	39.75	\$1759	\$498
A3060DP	29.69 x 60 x 29.6	125	247	36.25	\$1606	\$464

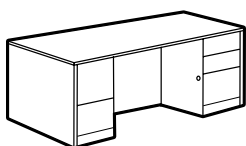
Standard with box/file pedestals on both sides. Pedestals lock. One pencil tray.



Double Pedestal Bow Top Desk*

A3672DPB	30-36 x 72 x 29.6	150	280	52.5	\$2151	\$532
----------	-------------------	-----	-----	------	---------------	--------------

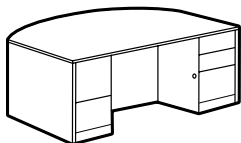
Standard with box/file pedestals on both sides and bow top. Pedestals lock. One pencil tray.



Full to Floor Double Pedestal Desk

A3672D4	36 x 72 x 29.6	125	330	52.5	\$2301	\$532
A3072D4	30 x 72 x 29.6	125	295	41.15	\$2261	\$532
A3066D4	29.69 x 66 x 29.6	125	285	39.75	\$2251	\$498
A3060D4	29.69 x 60 x 29.6	125	276	36.25	\$2097	\$464

Standard with full to floor box/box/file in right pedestal and file/file on left pedestal. Pedestals lock. On box/box/file pedestals, lower box drawer and file drawer lock. One pencil tray. Full to the floor pedestal configurations can be switched for a **15% upcharge**.

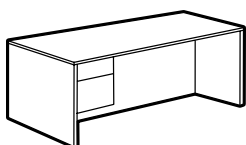


Full to Floor Double Pedestal Bow Top Desk

A3672DB4	32-36 x 72 x 29.6	150	311	52.5	\$2643	\$532
----------	-------------------	-----	-----	------	---------------	--------------

Standard with full to floor box/box/file in right pedestal and file/file on left pedestal. Bow top. Pedestals lock. On box/box/file pedestals, lower box drawer and file drawer lock. One pencil tray. Full to the floor pedestal configurations can be switched for a **15% upcharge**.

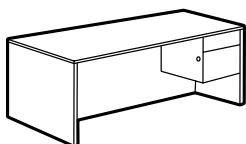
SINGLE PEDESTAL DESKS



Single Pedestal Desk - LEFT*

MODEL#	DIMENSIONS	FREIGHT CLASS	WT./LBS.	CUBIC FT.	LIST PRICE	HP ADD
A3672SPL	36 x 72 x 29.6	150	245	52.5	\$1507	\$532
A3072SPL	29.69 x 72 x 29.6	150	216	43	\$1323	\$498
A3066SPL	29.69 x 66 x 29.6	150	207	39.75	\$1307	\$498
A3060SPL	29.69 x 60 x 29.6	150	197	36.25	\$1302	\$464
A3048SPL	29.69 x 48 x 29.6	125	177	29.25	\$1169	\$394
A2448SPL	24 x 48 x 29.6	125	150	24.25	\$1169	\$256

Standard with box/file pedestal. Pedestal locks. One pencil tray. Pedestal is on the **left**.



Single Pedestal Desk - RIGHT*

A3672SPR	36 x 72 x 29.6	150	245	52.5	\$1507	\$532
A3072SPR	29.69 x 72 x 29.6	150	216	43	\$1323	\$498
A3066SPR	29.69 x 66 x 29.6	150	207	39.75	\$1307	\$498
A3060SPR	29.69 x 60 x 29.6	150	197	36.25	\$1302	\$464
A3048SPR	29.69 x 48 x 29.6	125	177	29.25	\$1169	\$394
A2448SPR	24 x 48 x 29.6	125	150	24.25	\$1169	\$256

Standard with box/file pedestal. Pedestal locks. One pencil tray. Pedestal is on the **right**.

Required Specifications

Top finish
Base finish

Optional Specifications

Key #
Grommet/power block cut-out
HP laminate
Modesty panel, 3/4*

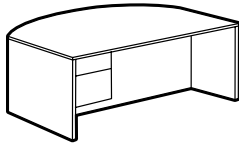
Accessories

Power block
Keyboard tray
Pencil tray

SINGLE PEDESTAL DESKS

MODEL# DIMENSIONS FREIGHT CLASS WT/LBS. CUBIC FT. LIST PRICE HP ADD

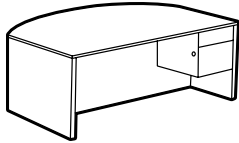
D x W x H



Single Pedestal Bow Top Desk - LEFT*

A3672SLB 30-36 x 72 x 29.6 150 233 52.5 \$1845 \$532

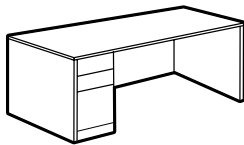
Standard with box/file pedestal on **left** and bow top. Pedestal locks. One pencil tray.



Single Pedestal Bow Top Desk - RIGHT*

A3672SRB 30-36 x 72 x 29.6 150 233 52.5 \$1845 \$532

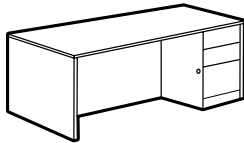
Standard with box/file pedestal on **right** and bow top. Pedestal locks. One pencil tray.



Full to Floor Single Pedestal Desk - LEFT

A3672S4L	36 x 72 x 29.6	150	261	52.5	\$1754	\$532
A3072S4L	29.69 x 72 x 29.6	150	232	43.75	\$1712	\$532
A3066S4L	29.69 x 66 x 29.6	150	221	39.5	\$1701	\$498
A3060S4L	29.69 x 60 x 29.6	150	211	36.25	\$1543	\$464
A3048S4L	29.69 x 48 x 29.6	125	191	29.5	\$1360	\$394
A2448S4L	24 x 48 x 29.6	125	164	24.25	\$1360	\$256

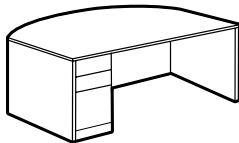
Standard with full to floor box/box/file pedestal on the **left**. One pencil tray. Lower box drawer and file drawer lock. Full to the floor pedestal configurations can be switched for a **15% upcharge**.



Full to Floor Single Pedestal Desk - RIGHT

A3672S4R	36 x 72 x 29.6	150	261	52.5	\$1754	\$532
A3072S4R	29.69 x 72 x 29.6	150	232	43.75	\$1712	\$532
A3066S4R	29.69 x 66 x 29.6	150	221	39.75	\$1701	\$498
A3060S4R	29.69 x 60 x 29.6	150	211	36.25	\$1543	\$464
A3048S4R	29.69 x 48 x 29.6	125	191	29.5	\$1360	\$394
A2448S4R	24 x 48 x 29.6	125	164	24.25	\$1360	\$256

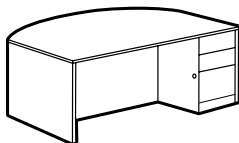
Standard with full to floor box/box/file pedestal on the **right**. One pencil tray. Lower box drawer and file drawer lock. Full to the floor pedestal configurations can be switched for a **15% upcharge**.



Full to Floor Single Pedestal Bow Top Desk - LEFT

A3672S4LB 32-36 x 72 x 29.6 150 247 52.5 \$2091 \$532

Standard with box/box/file pedestal on **left** and bow top. One pencil tray. Lower box drawer and file drawer lock. One pencil tray. Full to the floor pedestal configurations can be switched for a **15% upcharge**.



Full to Floor Single Pedestal Bow Top Desk - RIGHT

A3672S4RB 32-36 x 72 x 29.6 150 247 52.5 \$2091 \$532

Standard with box/box/file pedestal on **right** and bow top. One pencil tray. Lower box drawer and file drawer lock. One pencil tray. Full to the floor pedestal configurations can be switched for a **15% upcharge**.

Required Specifications

Top finish
Base finish

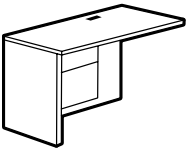
Optional Specifications

Key #
Grommet/power block cut-out
HP laminate
Modesty panel, 3/4*

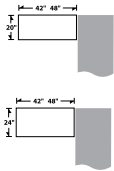
Accessories

Power block
Keyboard tray
Pencil tray

RETURNS

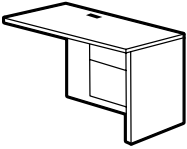


Flush Return - LEFT

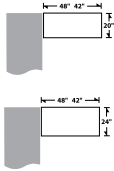


MODEL#	DIMENSIONS D x W x H	FREIGHT CLASS	WT/LBS.	CUBIC FT.	LIST PRICE	HP ADD
A2448FL	24 x 48 x 29.6	150	141	24	\$1102	\$273
A2442FL	24 x 42 x 29.6	125	131	21.25	\$1079	\$227
A2048FL	20 x 48 x 29.6	125	128	20.25	\$1036	\$227
A2042FL	20 x 42 x 29.6	125	119	18	\$1016	\$227

Standard with box/file drawer pedestal. One pencil tray. Pedestal locks. Grommet in worksurface. Pedestal is on the **left**.

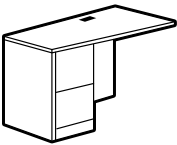


Flush Return - RIGHT

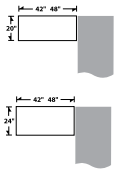


A2448FR	24 x 48 x 29.6	150	141	24	\$1102	\$273
A2442FR	24 x 42 x 29.6	125	131	21.25	\$1079	\$227
A2048FR	20 x 48 x 29.6	125	128	20.25	\$1036	\$227
A2042FR	20 x 42 x 29.6	125	119	18	\$1016	\$227

Standard with box/file drawer pedestal. One pencil tray. Pedestal locks. Grommet in worksurface. Pedestal is on the **right**.

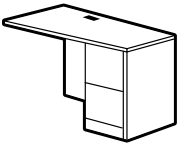


Full to Floor Flush Return - LEFT

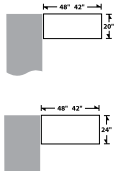


A2448L4	24 x 48 x 29.6	125	156	24.25	\$1347	\$273
A2442L4	24 x 42 x 29.6	125	146	21.5	\$1328	\$227
A2048L4	20 x 48 x 29.6	125	142	20.5	\$1284	\$227
A2042L4	20 x 42 x 29.6	125	133	18	\$1264	\$227

Standard with file/file drawer pedestal. One pencil tray. Pedestal locks. Grommet in worksurface. Pedestal is on the **left**. Full to the floor pedestal configurations can be switched for a **15% upcharge**.

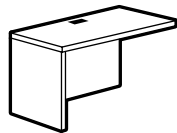


Full to Floor Flush Return - RIGHT

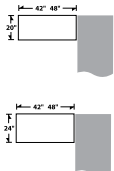


A2448R4	24 x 48 x 29.6	125	156	24.25	\$1347	\$273
A2442R4	24 x 42 x 29.6	125	146	21.5	\$1328	\$227
A2048R4	20 x 48 x 29.6	125	142	20.5	\$1284	\$227
A2042R4	20 x 42 x 29.6	125	133	18	\$1264	\$227

Standard with file/file drawer pedestal. One pencil tray. Pedestal locks. Grommet in worksurface. Pedestal is on the **right**. Full to the floor pedestal configurations can be switched for a **15% upcharge**.



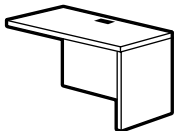
Flush Return - LEFT



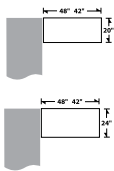
A2448EL	24 x 48 x 29.6	70	92	4.3	\$799	\$273
A2442EL	24 x 42 x 29.6	70	82	3.8	\$773	\$227
A2048EL	20 x 48 x 29.6	70	84	4.3	\$729	\$227
A2042EL	20 x 42 x 29.6	70	75	3.8	\$711	\$227

Return has no pedestal. Grommet in worksurface. Shipped RTA (ready to assemble).

- Cannot accept same depth storage shells due to 1" thick modesty



Flush Return - RIGHT



A2448ER	24 x 48 x 29.6	70	92	4.3	\$799	\$273
A2442ER	24 x 42 x 29.6	70	82	3.8	\$773	\$227
A2048ER	20 x 48 x 29.6	70	84	4.3	\$729	\$227
A2042ER	20 x 42 x 29.6	70	75	3.8	\$711	\$227

Return has no pedestal. Grommet in worksurface. Shipped RTA (ready to assemble).

- Cannot accept same depth storage shells due to 1" thick modesty

Required Specifications

Top finish
Base finish

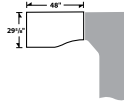
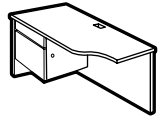
Optional Specifications

Key #*
Grommet/power block cut-out
HP laminate

Accessories

Power block
Keyboard tray
Pencil tray

RETURNS

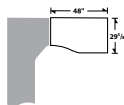
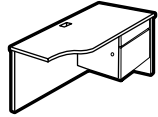


Space Saver Return - LEFT

MODEL#	DIMENSIONS	FREIGHT CLASS	WT/LBS.	CUBIC FT.	LIST PRICE	HP ADD
A3048FSL	29.69 x 48 x 29.6	150	148	29	\$1169	\$394

D x W x H

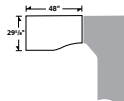
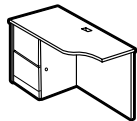
Standard with box/file pedestal on the **left**, grommet in worksurface. One pencil tray. Pedestal locks. Connects to 24"D 5-sided corner unit and 2466/2472 NFL or NNL extended corner unit.



Space Saver Return - RIGHT

A3048FSR	29.69 x 48 x 29.6	150	148	29	\$1169	\$394
----------	-------------------	-----	-----	----	---------------	--------------

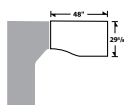
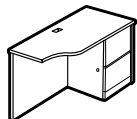
Standard with box/file pedestal on the **right**, grommet in worksurface. One pencil tray. Pedestal locks. Connects to 24"D 5-sided corner unit and 2466/2472 FNR or NNR extended corner unit.



Space Saver Return - LEFT

A3048PAL	29.69 x 48 x 29.6	150	170	29	\$1414	\$394
----------	-------------------	-----	-----	----	---------------	--------------

Standard with file/file pedestal on the **left**, grommet in worksurface. One pencil tray. Pedestal locks. Connects to 24"D 5-sided corner unit and 2466/2472 NFL or NNL extended corner unit. Full to the floor pedestal configurations can be switched for a **15% upcharge**.

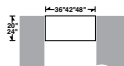
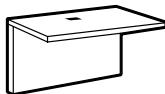


Space Saver Return - RIGHT

A3048P4R	29.69 x 48 x 29.6	150	170	29	\$1414	\$394
----------	-------------------	-----	-----	----	---------------	--------------

Standard with file/file pedestal on the **right**, grommet in worksurface. One pencil tray. Pedestal locks. Connects to 24"D 5-sided corner unit and 2466/2472 FNR or NNR extended corner unit. Full to the floor pedestal configurations can be switched for a **15% upcharge**.

FLUSH BRIDGE

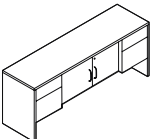


Flush Bridge*

MODEL#	DIMENSIONS	FREIGHT CLASS	WT/LBS.	CUBIC FT.	LIST PRICE	HP ADD
A2448FB	24 x 48 x 29.6	70	75	4.3	\$601	\$273
A2442FB	24 x 42 x 29.6	70	65	3.8	\$577	\$227
A2436FB	24 x 36 x 29.6	70	58	3.3	\$577	\$172
A2048FB	20 x 48 x 29.6	70	71	4.3	\$577	\$227
A2042FB	20 x 42 x 29.6	70	54	3.3	\$553	\$227
A2036FB	20 x 36 x 29.6	70	54	3.3	\$553	\$117

Top surface, back panel and hardware to connect two units. Grommet in worksurface. Shipped RTA (ready to assemble).

CRENZAS



Center Storage Credenza

MODEL#	DIMENSIONS	FREIGHT CLASS	WT/LBS.	CUBIC FT.	LIST PRICE	HP ADD
A2072C	20 x 72 x 29.6	100	243	30	\$2171	\$356

Standard with box/file pedestals on both sides and self-closing hinged center doors covering one adjustable shelf. Pedestals and doors lock. One pencil tray.

Required Specifications

Top finish
Base finish
Handles**

Optional Specifications

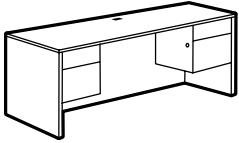
Key #
Additional grommet position (not A2072C)
HP laminate
Power block cut-out (not A2072C)

Accessories

Power block
Keyboard tray*
Pencil tray*

A ADAPTABILITIES®

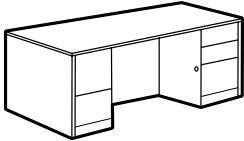
CREDENZAS



Kneespace Credenza

MODEL#	DIMENSIONS D x W x H	FREIGHT CLASS	WT./LBS.	CUBIC FT.	LIST PRICE	HP ADD
A2472CK	24 x 72 x 29.6	125	234	35.75	\$1817	\$372
A2466CK	24 x 66 x 29.6	125	225	32.75	\$1763	\$372
A2072CK	20 x 72 x 29.6	125	212	30.25	\$1659	\$356
A2066CK	20 x 66 x 29.6	125	204	27.75	\$1635	\$343
A2060CK	20 x 60 x 29.6	125	199	25.25	\$1593	\$314

Standard with box/file pedestals on both sides. Center is open. Pedestals lock. One pencil tray. Grommet in worksurface.

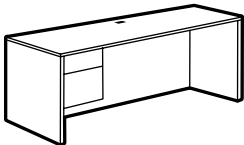


Full to Floor Kneespace Credenza

A2472D4	24 x 72 x 29.6	125	261	35.5	\$2302	\$372
A2466D4	24 x 66 x 29.6	125	252	33	\$2253	\$372
A2072D4	20 x 72 x 29.6	125	236	30	\$2151	\$356
A2066D4	20 x 66 x 29.6	100	228	27.75	\$2129	\$343
A2060D4	20 x 60 x 29.6	100	220	25.25	\$2118	\$314

Standard with full to floor box/box/file in right pedestal and file/file on left pedestal. Pedestals lock on box/box/file pedestals, lower box drawer and file drawer lock. One pencil tray. Grommet in worksurface.

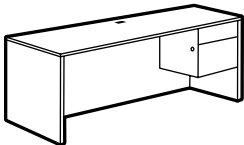
- Full to the floor pedestal configurations can be switched for a **15% upcharge**.



Single Pedestal Credenza - LEFT

A2472CSL	24 x 72 x 29.6	150	190	35.75	\$1539	\$372
A2466CSL	24 x 66 x 29.6	150	181	32.75	\$1487	\$372
A2072CSL	20 x 72 x 29.6	150	172	30.25	\$1388	\$356
A2066CSL	20 x 66 x 29.6	150	163	27.75	\$1366	\$343
A2060CSL	20 x 60 x 29.6	125	155	25.25	\$1320	\$314

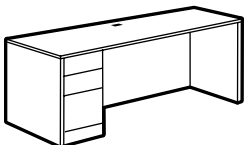
Standard with box/file pedestal. Pedestal locks. One pencil tray. Pedestal is on the **left**. Grommet in worksurface.



Single Pedestal Credenza - RIGHT

A2472CSR	24 x 72 x 29.6	150	190	35.75	\$1539	\$372
A2466CSR	24 x 66 x 29.6	150	181	32.75	\$1487	\$372
A2072CSR	20 x 72 x 29.6	150	171	30	\$1388	\$356
A2066CSR	20 x 66 x 29.6	150	163	27.75	\$1366	\$343
A2060CSR	20 x 60 x 29.6	125	155	25.25	\$1320	\$314

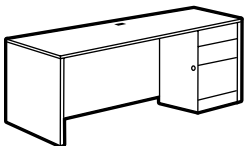
Standard with box/file pedestal. Pedestal locks. One pencil tray. Pedestal is on the **right**. Grommet in worksurface.



Full to Floor Single Pedestal Credenza - LEFT

A2472S4L	24 x 72 x 29.6	150	205	35.5	\$1754	\$372
A2466S4L	24 x 66 x 29.6	150	196	33	\$1701	\$372
A2072S4L	20 x 72 x 29.6	125	187	30	\$1543	\$356
A2066S4L	20 x 66 x 29.6	125	177	27.75	\$1516	\$356
A2060S4L	20 x 60 x 29.6	125	168	25.25	\$1478	\$314

Standard with full to floor box/box/file pedestal on the **left**. Lower box drawer and file drawer lock. Grommet in worksurface. One pencil tray.



Full to Floor Single Pedestal Credenza - RIGHT

A2472S4R	24 x 72 x 29.6	150	205	35.5	\$1754	\$372
A2466S4R	24 x 66 x 29.6	150	196	33	\$1701	\$372
A2072S4R	20 x 72 x 29.6	125	187	30	\$1543	\$356
A2066S4R	20 x 66 x 29.6	125	177	27.75	\$1516	\$356
A2060S4R	20 x 60 x 29.6	125	168	25.25	\$1478	\$314

Standard with full to floor box/box/file pedestal on the **right**. Lower box drawer and file drawer lock. Grommet in worksurface. One pencil tray.

Required Specifications

Top finish
Base finish

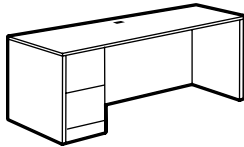
Optional Specifications

Key #
Grommet/power block cut-out
HP laminate

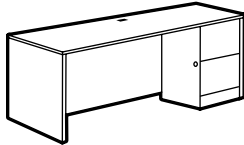
Accessories

Power block
Keyboard tray
Pencil tray

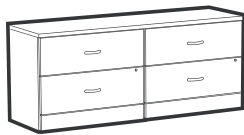
CREDENZAS



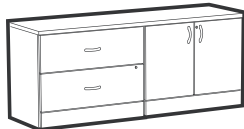
Full to Floor Single Pedestal Credenza- LEFT*



Full to Floor Single Pedestal Credenza- RIGHT*



Lateral File Credenza



Lateral File/Storage Cabinet Credenza



Kneespace Lateral File Credenza - LEFT*



Kneespace Lateral File Credenza - RIGHT*

MODEL#	DIMENSIONS	FREIGHT CLASS	WT./LBS.	CUBIC FT.	LIST PRICE	HP ADD
--------	------------	---------------	----------	-----------	------------	--------

D x W x H

A2472S2L	24 x 72 x 29.6	150	205	35.5	\$1754	\$372
A2466S2L	24 x 66 x 29.6	150	196	33	\$1701	\$372
A2072S2L	20 x 72 x 29.6	125	187	30	\$1543	\$356
A2066S2L	20 x 66 x 29.6	125	177	27.75	\$1516	\$356
A2060S2L	20 x 60 x 29.6	125	168	25.25	\$1478	\$314

Standard with full to floor file/file pedestal on the **left**. Pedestal Locks. Grommet in worksurface.

A2472S2R	24 x 72 x 29.6	150	205	35.5	\$1754	\$372
A2466S2R	24 x 66 x 29.6	150	196	33	\$1701	\$372
A2072S2R	20 x 72 x 29.6	125	187	30	\$1543	\$356
A2066S2R	20 x 66 x 29.6	125	177	27.75	\$1516	\$356
A2060S2R	20 x 60 x 29.6	125	168	25.25	\$1478	\$314

Standard with full to floor file/file pedestal on the **right**. Pedestal locks. Grommet in worksurface.

A2472LF2	24 x 72 x 29.6	100	322	35.75	\$2652	\$372
A2072LF2	20 x 72 x 29.6	100	296	30.25	\$2599	\$356

Two 2-drawer lateral files side-by-side. Locking drawers, keyed alike. File bars included for side-to-side and front-to-back letter/legal filing capability. Anti-lock tilt suspension.

- Black handles are standard. Silver is available at no charge, please specify as **SI**.
- *File drawer construction is for accommodating hanging files NOT for stacking materials on the drawer bottom.*

A2472LS	24 x 72 x 29.6	100	297	35.75	\$2374	\$372
A2072LS	20 x 72 x 29.6	100	267	30.25	\$2318	\$356

One 2-drawer lateral file and one storage cabinet. Locking doors/drawers, keyed alike. Storage cabinet includes one adjustable shelf. File bars included for side-to-side and front-to-back letter/legal filing capability. Anti-lock tilt suspension.

- Black handles are standard. Silver is available at no charge, please specify as **SI**.
- *File drawer construction is for accommodating hanging files NOT for stacking materials on the drawer bottom.*

A2472LKL	24 x 72 x 29.6	125	239	35.75	\$2086	\$372
A2072LKL	20 x 72 x 29.6	125	216	30.25	\$2033	\$356

One 2-drawer lateral file on the **left**. Locking drawers. File bars included for side-to-side and front-to-back letter/legal filing capability. Anti-lock tilt suspension. Grommet in worksurface.

- Black handles are standard. Silver is available at no charge, please specify as **SI**.
- *File drawer construction is for accommodating hanging files NOT for stacking materials on the drawer bottom.*

A2472LKR	24 x 72 x 29.6	125	239	35.75	\$2086	\$372
A2072LKR	20 x 72 x 29.6	125	216	30.25	\$2033	\$356

One 2-drawer lateral file on the **right**. Locking drawers. File bars included for side-to-side and front-to-back letter/legal filing capability. Anti-lock tilt suspension. Grommet in worksurface.

- Black handles are standard. Silver is available at no charge, please specify as **SI**.
- *File drawer construction is for accommodating hanging files NOT for stacking materials on the drawer bottom.*

Required Specifications

Top finish
Base finish
Handles (not A2xxxS2L/A2xxxS2R)

Optional Specifications

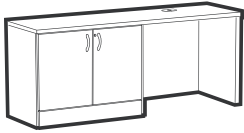
Key #
Additional grommet
HP laminate
Power block cut-out*

Accessories

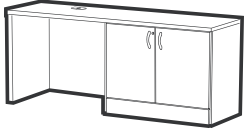
Power block*
Keyboard tray*
Pencil tray*

A ADAPTABILITIES®

CREDENZAS



Kneespace Storage Cabinet Credenza - LEFT*



Kneespace Storage Cabinet Credenza - RIGHT*

MODEL#	DIMENSIONS	FREIGHT CLASS	WT/LBS.	CUBIC FT.	LIST PRICE	HP ADD
--------	------------	---------------	---------	-----------	------------	--------

D x W x H

A2472SKL	24 x 72 x 29.6	125	218	35.75	\$1647	\$372
A2072SKL	20 x 72 x 29.6	125	188	30.25	\$1592	\$356

One storage cabinet on the **left**. Locking doors. Storage cabinet has one adjustable shelf. Grommet in worksurface.

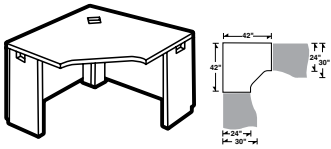
- Black handles are standard. Silver is available at no charge, please specify as **SI**.

A2472SKR	24 x 72 x 29.6	125	218	35.75	\$1647	\$372
A2072SKR	20 x 72 x 29.6	125	188	30.25	\$1592	\$356

One storage cabinet on the **right**. Locking doors. Storage cabinet has one adjustable shelf. Grommet in worksurface.

- Black handles are standard. Silver is available at no charge, please specify as **SI**.

5-SIDED CORNERS



5-Sided Corner

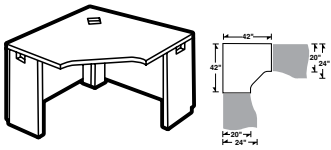
MODEL#	DIMENSIONS	FREIGHT CLASS	WT/LBS.	CUBIC FT.	LIST PRICE	HP ADD
--------	------------	---------------	---------	-----------	------------	--------

A42245C	42 x 42 x 29.6	70	113	5.75	\$1031	\$498
---------	----------------	----	-----	------	---------------	--------------

Connects to **30" D** space saver connectable surfaces, **24" D** connectables, returns and bridge. Grommet in worksurface.

Narrow end panels on left and right. Predrilled to accept 22" keyboard trays. **Will not accept keyboard trays wider than 22"**. Shipped RTA (ready to assemble). *Not Freestanding*.

- **Modesty Panel is 1" off of ground.**
- Full End Panel(s) are available - add **15% upcharge**

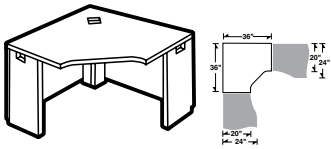


5-Sided Corner

A42205C	42 x 42 x 29.6	70	110	5.75	\$1001	\$498
---------	----------------	----	-----	------	---------------	--------------

Connects to **24" D** space saver connectable surfaces, **20" D** returns, lateral files, storage/lateral file credenzas, credenzas, bridges and end shelves. Grommet in worksurface. Narrow end panels on left and right. Predrilled to accept 22-28" keyboard trays. **Will not accept keyboard trays wider than 28"**. Shipped RTA (ready to assemble). *Not freestanding*.

- **Modesty Panel is 1" off of ground.**
- Full End Panel(s) are available - add **15% upcharge**



5-Sided Corner

A36205C	36 x 36 x 29.6	70	94	4.8	\$886	\$321
---------	----------------	----	----	-----	--------------	--------------

Connects to **24" D** space saver connectable surfaces, **20" D** returns, lateral files, storage/lateral file credenzas, credenzas, bridges and end shelves. Grommet in worksurface. Narrow end panels on left and right. Predrilled to accept 22" keyboard trays. **Will not accept keyboard trays wider than 22"**. Shipped RTA (ready to assemble). *Not freestanding*.

- **Modesty Panel is 1" off of ground.**
- Full End Panel(s) are available - add **15% upcharge**

Required Specifications

Top finish
Base finish
Handles*

Optional Specifications

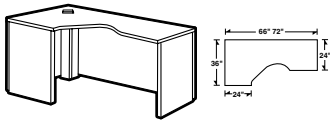
Key #
Additional grommet position
HP laminate
Power block cut-out

Accessories

Power block
Keyboard tray
Pencil tray

LEFT EXTENDED CORNERS

MODEL# DIMENSIONS FREIGHT CLASS WT/LBS. CUBIC FT. LIST PRICE HP ADD

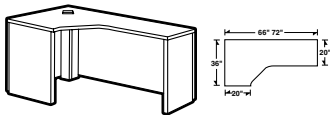


Left Extended Corner - Freestanding

	D x W x H						
A2472FFL	24-36 x 72 x 29.6	70	157	7	\$1323	\$532	
A2466FFL	24-36 x 66 x 29.6	70	151	7	\$1323	\$532	

Extended worksurface on right. **Full end panels on left and right. Cannot be connected on left or right, due to full end panel.** Corner has one grommet. Predrilled to accept 22" keyboard trays. **Will not accept keyboard trays wider than 22".** Shipped RTA (ready to assemble).

- **Modesty Panel is 1" off of ground.**
- **A2466FFL cannot accept pedestals.**

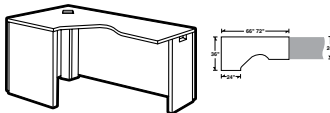


Left Extended Corner

A2072FFL	20-36 x 72 x 29.6	70	147	7	\$1266	\$511	
A2066FFL	20-36 x 66 x 29.6	70	141	7	\$1266	\$511	

Extended worksurface on right. **Full end panels on left and right. Cannot be connected on left or right, due to full end panel.** Corner has one grommet. Predrilled to accept 22" keyboard trays. **Will not accept keyboard trays wider than 22".** Shipped RTA (ready to assemble).

- **Modesty Panel is 1" off of ground.**

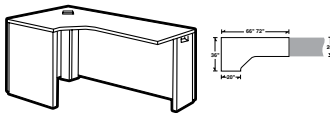


Left Extended Corner

A2472FNL	24-36 x 72 x 29.6	70	149	7	\$1281	\$532	
A2466FNL	24-36 x 66 x 29.6	70	142	7	\$1281	\$532	

Extended worksurface on right. **Narrow end panel on right. Full end panel on left.** Connects to 30"D space saver connectables, 24"D returns or 24"D connectable tables. **Full end panel cannot be connected.** Corner has one grommet. Predrilled to accept 22" keyboard trays. **Will not accept keyboard trays wider than 22".** Shipped RTA (ready to assemble).

- **Modesty Panel is 1" off of ground.**
- **A2466FNL cannot accept pedestals.**

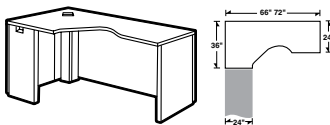


Left Extended Corner

A2072FNL	20-36 x 72 x 29.6	70	141	7	\$1220	\$511	
A2066FNL	20-36 x 66 x 29.6	70	135	7	\$1220	\$511	

Extended worksurface on right. **Narrow end panel on right. Full end panel on left.** Connects to 24"D space saver connectables, 20"D returns or 20"D connectable tables. **Full end panel cannot be connected.** Corner has one grommet. Predrilled to accept 22" keyboard trays. **Will not accept keyboard trays wider than 22".** Shipped RTA (ready to assemble).

- **Modesty Panel is 1" off of ground.**



Left Extended Corner

A2472NFL	24-36 x 72 x 29.6	70	149	7	\$1281	\$532	
A2466NFL	24-36 x 66 x 29.6	70	142	7	\$1281	\$532	

Extended worksurface on right. **Narrow end panel on left. Full end panel on right.** Connects to 30"D space saver connectables, 24"D returns or 24"D connectable tables. **Full end panel cannot be connected.** Corner has one grommet. Predrilled to accept 22" keyboard trays. **Will not accept keyboard trays wider than 22".** Shipped RTA (ready to assemble).

- **Modesty Panel is 1" off of ground.**
- **A2466NFL cannot accept pedestals.**

Required Specifications

Top finish
Base finish

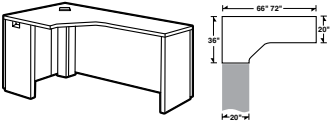
Optional Specifications

Additional grommet position
HP laminate
Power block cut-out

Accessories

Power block
Keyboard tray
Pencil tray

LEFT EXTENDED CORNERS

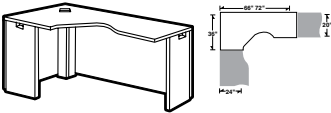


Left Extended Corner

MODEL#	DIMENSIONS D x W x H	FREIGHT CLASS	WT/LBS.	CUBIC FT.	LIST PRICE	HP ADD
A2072NFL	20-36 x 72 x 29.6	70	141	7	\$1220	\$532
A2066NFL	20-36 x 66 x 29.6	70	135	7	\$1220	\$511

Extended worksurface on right. **Narrow end panel on left. Full end panel on right.** Connects to 24"D space saver connectables and 20"D returns. **Full end panel cannot be connected.** Corner has one grommet. Predrilled to accept 22" keyboard trays. **Will not accept keyboard trays wider than 22"**. Shipped RTA (ready to assemble).

- Modesty Panel is 1" off of ground.

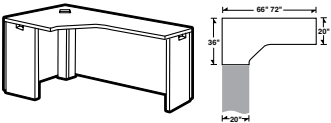


Left Extended Corner

A2472NNL	24-36 x 72 x 29.6	70	140	7	\$1239	\$532
A2466NNL	24-36 x 66 x 29.6	70	134	7	\$1239	\$532

Extended worksurface on right. **Narrow end panels on left and right.** Connects to 30"D space saver connectables, 24"D returns and 24"D connectable tables on either end. Corner has one grommet. Predrilled to accept 22" keyboard trays. **Will not accept keyboard trays wider than 22"**. Shipped RTA (ready to assemble).

- Modesty Panel is 1" off of ground.
- **A2466NNL** cannot accept pedestals.



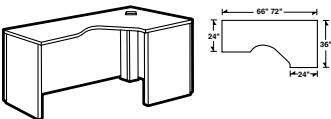
Left Extended Corner

A2072NNL	20-36 x 72 x 29.6	70	136	7	\$1205	\$532
A2066NNL	20-36 x 66 x 29.6	70	130	7	\$1205	\$511

Extended worksurface on right. **Narrow end panels on left and right.** Connects to 24"D space saver connectables and 20"D returns or bridge on either end. Corner has one grommet. Predrilled to accept 22" keyboard trays. **Will not accept keyboard trays wider than 22"**. Shipped RTA (ready to assemble).

- Modesty Panel is 1" off of ground.

RIGHT EXTENDED CORNERS

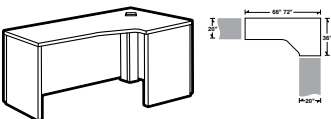


Right Extended Corner - Freestanding

MODEL#	DIMENSIONS	FREIGHT CLASS	WT/LBS.	CUBIC FT.	LIST PRICE	HP ADD
A2472FFR	24-36 x 72 x 29.6	70	157	7	\$1323	\$532
A2466FFR	24-36 x 66 x 29.6	70	151	7	\$1323	\$532

Extended worksurface on left. **Full end panels on left and right. Cannot be connected on left or right, due to full end panel.** Corner has one grommet. Predrilled to accept 22" keyboard trays. **Will not accept keyboard trays wider than 22"**. Shipped RTA (ready to assemble).

- Modesty Panel is 1" off of ground.
- **A2466FFR** cannot accept pedestals.



Right Extended Corner

A2072FFR	20-36 x 72 x 29.6	70	147	7	\$1266	\$511
A2066FFR	20-36 x 66 x 29.6	70	141	7	\$1266	\$511

Extended worksurface on left. **Full end panels on left and right. Cannot be connected on left or right, due to full end panel.** Corner has one grommet. Predrilled to accept 22" keyboard trays. **Will not accept keyboard trays wider than 22"**. Shipped RTA (ready to assemble).

- Modesty Panel is 1" off of ground.

Required Specifications

Top finish
Base finish

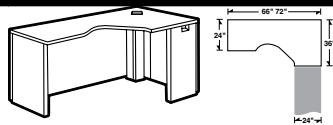
Optional Specifications

Additional grommet position
HP laminate
Power block cut-out

Accessories

Power block
Keyboard tray
Pencil tray

RIGHT EXTENDED CORNERS

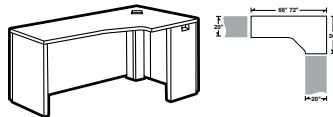


Right Extended Corner

MODEL#	DIMENSIONS	FREIGHT CLASS	WT/LBS.	CUBIC FT.	LIST PRICE	HP ADD
D x W x H						
A2472FNR	24-36 x 72 x 29.6	70	149	7	\$1281	\$548
A2466FNR	24-36 x 66 x 29.6	70	142	7	\$1281	\$532

Extended worksurface on left. **Narrow end panel on right. Full end panel on left.** Connects to 30"D space saver connectables, 24"D returns or 24"D connectable tables. **Full end panel cannot be connected.** Corner has one grommet. Predrilled to accept 22" keyboard trays. **Will not accept keyboard trays wider than 22"**. Shipped RTA (ready to assemble).

- **Modesty Panel is 1" off of ground.**
- **A2466FNR cannot accept pedestals.**

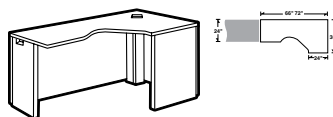


Right Extended Corner

A2072FNR	20-36 x 72 x 29.6	70	141	7	\$1220	\$511
A2066FNR	20-36 x 66 x 29.6	70	135	7	\$1220	\$511

Extended worksurface on left. **Narrow end panel on right. Full end panel on left.** Connects to 24"D space saver connectables, 20"D returns or 20"D connectable tables. **Full end panel cannot be connected.** Corner has one grommet. Predrilled to accept 22" keyboard trays. **Will not accept keyboard trays wider than 22"**. Shipped RTA (ready to assemble).

- **Modesty Panel is 1" off of ground.**

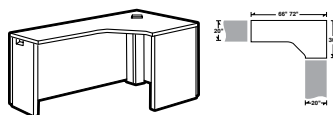


Right Extended Corner

A2472NFR	24-36 x 72 x 29.6	70	149	7	\$1281	\$532
A2466NFR	24-36 x 66 x 29.6	70	142	7	\$1281	\$532

Extended worksurface on left. **Narrow end panel on left. Full end panel on right.** Connects to 30"D space saver connectables, 24"D returns or 24"D connectable tables. **Full end panel cannot be connected.** Corner has one grommet. Predrilled to accept 22" keyboard trays. **Will not accept keyboard trays wider than 22"**. Shipped RTA (ready to assemble).

- **Modesty Panel is 1" off of ground.**
- **A2466NFR cannot accept pedestals.**

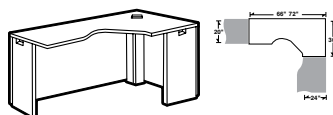


Right Extended Corner

A2072NFR	20-36 x 72 x 29.6	70	141	7	\$1220	\$532
A2066NFR	20-36 x 66 x 29.6	70	135	7	\$1220	\$511

Extended worksurface on left. **Narrow end panel on left. Full end panel on right.** Connects to 24"D space saver connectables and 20"D returns. **Full end panel cannot be connected.** Corner has one grommet. Predrilled to accept 22" keyboard trays. **Will not accept keyboard trays wider than 22"**. Shipped RTA (ready to assemble).

- **Modesty Panel is 1" off of ground.**



Right Extended Corner

A2472NNR	24-36 x 72 x 29.6	70	140	7	\$1239	\$532
A2466NNR	24-36 x 66 x 29.6	70	133	7	\$1239	\$532

Extended worksurface on left. **Narrow end panels on left and right.** Connects to 30"D space saver connectables, 24"D returns and 24"D connectable tables on either end. Corner has one grommet. Predrilled to accept 22" keyboard trays. **Will not accept keyboard trays wider than 22"**. Shipped RTA (ready to assemble).

- **Modesty Panel is 1" off of ground.**
- **A2466NNR cannot accept pedestals.**

Required Specifications

Top finish
Base finish

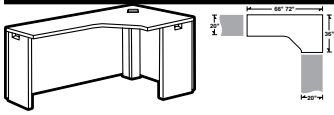
Optional Specifications

Additional grommet position
HP laminate
Power block cut-out

Accessories

Power block
Keyboard tray
Pencil tray

RIGHT EXTENDED CORNERS



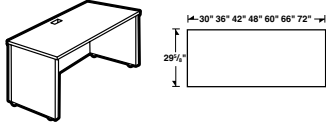
Right Extended Corner

MODEL#	DIMENSIONS	FREIGHT CLASS	WT/LBS.	CUBIC FT.	LIST PRICE	HP ADD
	D x W x H					
A2072NNR	20-36 x 72 x 29.6	70	136	7	\$1205	\$532
A2066NNR	20-36 x 66 x 29.6	70	130	7	\$1205	\$511

Extended worksurface on left. **Narrow end panels on left and right.** Connects to 24"D space saver connectables and 20"D returns or bridge on either end. Corner has one grommet. Predrilled to accept 22" keyboard trays. **Will not accept keyboard trays wider than 22"**. Shipped RTA (ready to assemble).

- Modesty Panel is 1" off of ground.

FREESTANDING TABLES

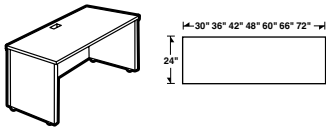


30" Deep Freestanding Table

MODEL#	DIMENSIONS	FREIGHT CLASS	WT/LBS.	CUBIC FT.	LIST PRICE	HP ADD
A3072T	29.69 x 72 x 29.6	65	148	6	\$1016	\$498
A3066T	29.69 x 66 x 29.6	65	140	6	\$1016	\$498
A3060T	29.69 x 60 x 29.6	65	131	5.25	\$928	\$464
A3048T	29.69 x 48 x 29.6	70	116	5.25	\$840	\$394
A3042T	29.69 x 42 x 29.6	70	108	5.25	\$840	\$356
A3036T	29.69 x 36 x 29.6	65	97	4.3	\$754	\$321
A3030T	29.69 x 30 x 29.6	65	88	3.6	\$711	\$286

Two full end panels. Cannot be connected on left or right side. Grommet in worksurface. Shipped RTA (ready to assemble).

- Modesty Panel is 1" off of ground



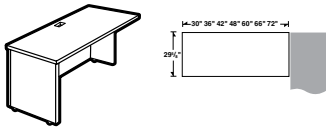
24" Deep Freestanding Table

A2472T	24 x 72 x 29.6	70	130	6	\$928	\$372
A2466T	24 x 66 x 29.6	70	123	6	\$928	\$372
A2460T	24 x 60 x 29.6	70	114	5.25	\$840	\$343
A2448T	24 x 48 x 29.6	65	99	4.3	\$754	\$273
A2442T	24 x 42 x 29.6	70	92	4.3	\$754	\$227
A2436T	24 x 36 x 29.6	70	84	4.2	\$667	\$172
A2430T	24 x 30 x 29.6	70	76	3.6	\$623	\$172

Two full end panels. Cannot be connected on left or right side. Grommet in worksurface. Shipped RTA (ready to assemble).

- Modesty Panel is 1" off of ground

CONNECTABLE TABLES - LEFT

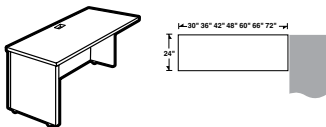


30" Deep Connectable Table - LEFT

MODEL#	DIMENSIONS	FREIGHT CLASS	WT/LBS.	CUBIC FT.	LIST PRICE	HP ADD
A3072L	29.69 x 72 x 29.6	65	140	6	\$980	\$498
A3066L	29.69 x 66 x 29.6	70	132	6	\$980	\$498
A3060L	29.69 x 60 x 29.6	65	123	5.25	\$897	\$464
A3048L	29.69 x 48 x 29.6	65	105	4.3	\$807	\$394
A3042L	29.69 x 42 x 29.6	65	98	4.3	\$807	\$356
A3036L	29.69 x 36 x 29.6	70	88	4.2	\$719	\$321
A3030L	29.69 x 30 x 29.6	70	80	3.6	\$677	\$286

Full end panel on left. Right narrow end panel connects to 30"D center/right connectable table, or at 90° angle to a freestanding table; and "D" islands or "P" islands with "T" and "H" bases. Grommet in worksurface. Shipped RTA (ready to assemble).

- Modesty Panel is 1" off of ground.



24" Deep Connectable Table - LEFT

A2472L	24 x 72 x 29.6	70	121	6	\$897	\$372
A2466L	24 x 66 x 29.6	70	115	6	\$897	\$372
A2460L	24 x 60 x 29.6	70	106	5.25	\$807	\$343
A2448L	24 x 48 x 29.6	70	90	4.3	\$719	\$273
A2442L	24 x 42 x 29.6	70	82	3.8	\$719	\$227
A2436L	24 x 36 x 29.6	70	74	3.3	\$634	\$172
A2430L	24 x 30 x 29.6	70	68	3.6	\$589	\$172

Full end panel on left. Right narrow end panel connects to 24"D center/right connectable table, or at 90° angle to a freestanding table; 24"D extended corners, 42" 5-sided corners or at the end of a straight run; "D" islands or "P" islands with "T" and "H" bases. Grommet in worksurface. Shipped RTA (ready to assemble).

- Modesty Panel is 1" off of ground.

Required Specifications

Top finish
Base finish

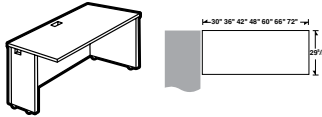
Optional Specifications

Additional grommet position
HP laminate
Power block cut-out

Accessories

Power block
Keyboard tray
Pencil tray

CONNECTABLE TABLES - RIGHT

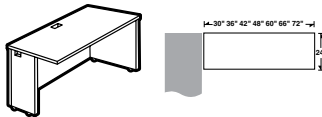


30" Deep Connectable Table - RIGHT

MODEL#	DIMENSIONS	FREIGHT CLASS	WT./LBS.	CUBIC FT.	LIST PRICE	HP ADD
D x W x H						
A3072R	29.69 x 72 x 29.6	65	140	6	\$980	\$498
A3066R	29.69 x 66 x 29.6	70	132	6	\$980	\$498
A3060R	29.69 x 60 x 29.6	65	123	5.25	\$897	\$464
A3048R	29.69 x 48 x 29.6	65	105	4.3	\$807	\$394
A3042R	29.69 x 42 x 29.6	65	98	4.3	\$807	\$356
A3036R	29.69 x 36 x 29.6	70	88	4.3	\$719	\$321
A3030R	29.69 x 30 x 29.6	70	80	3.6	\$677	\$286

Full end panel on **right**. Left narrow end panel connects to 30"D center/left connectable table, or at 90° angle to a freestanding table; "D" islands or "P" islands with "T" and "H" bases. Grommet in worksurface. Shipped RTA (ready to assemble).

• **Modesty Panel is 1" off of ground**



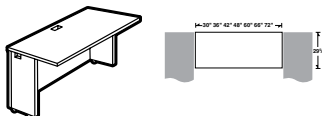
24" Deep Connectable Table - RIGHT

A2472R	24 x 72 x 29.6	70	121	6	\$897	\$384
A2466R	24 x 66 x 29.6	70	115	6	\$897	\$372
A2460R	24 x 60 x 29.6	70	105	5.25	\$807	\$343
A2448R	24 x 48 x 29.6	70	90	4.3	\$719	\$273
A2442R	24 x 42 x 29.6	70	82	3.8	\$719	\$227
A2436R	24 x 36 x 29.6	70	74	3.3	\$634	\$172
A2430R	24 x 30 x 29.6	70	67	3.6	\$589	\$172

Full end panel on **right**. Left narrow end panel connects to 24"D center/left connectable table, or at 90° angle to a freestanding table; 24"D extended corners, 42" 5-sided corners or at the end of a straight run; "D" islands or "P" islands with "T" and "H" bases. Grommet in worksurface. Shipped RTA (ready to assemble).

• **Modesty Panel is 1" off of ground**

CONNECTABLE TABLES

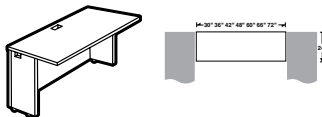


30" Deep Connectable Table

MODEL#	DIMENSIONS	FREIGHT CLASS	WT./LBS.	CUBIC FT.	LIST PRICE	HP ADD
A3072N	29.69 x 72 x 29.6	70	131	6	\$950	\$498
A3066N	29.69 x 66 x 29.6	70	124	6	\$950	\$498
A3060N	29.69 x 60 x 29.6	70	114	5.25	\$859	\$464
A3048N	29.69 x 48 x 29.6	65	97	4.3	\$773	\$394
A3042N	29.69 x 42 x 29.6	65	89	3.8	\$773	\$356
A3036N	29.69 x 36 x 29.6	65	80	3.3	\$686	\$321
A3030N	29.69 x 30 x 29.6	70	71	3.6	\$642	\$286

Narrow end panels on both sides connects to 30"D worksurfaces; "D" islands or "P" islands with "T" and "H" bases; or at 90° angle to freestanding table(s). Grommet in worksurface. Shipped RTA (ready to assemble).

• **Modesty Panel is 1" off of ground**



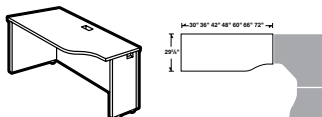
24" Deep Connectable Table

A2472N	24 x 72 x 29.6	70	113	6	\$859	\$372
A2466N	24 x 66 x 29.6	70	105	6	\$859	\$372
A2460N	24 x 60 x 29.6	70	100	4.5	\$773	\$343
A2448N	24 x 48 x 29.6	70	82	4.3	\$686	\$273
A2442N	24 x 42 x 29.6	70	73	3.8	\$686	\$227
A2436N	24 x 36 x 29.6	70	66	3.3	\$601	\$172
A2430N	24 x 30 x 29.6	70	59	3.6	\$553	\$172

Narrow end panels on both sides connects to 24"D worksurfaces; "D" islands or "P" islands with "T" and "H" bases; or at 90° angle to freestanding table(s). Grommet in worksurface. Shipped RTA (ready to assemble).

• **Modesty Panel is 1" off of ground**

SPACE SAVER CONNECTABLE TABLES - LEFT



30" Deep Space Saver Connectable Table - LEFT

MODEL#	DIMENSIONS	FREIGHT CLASS	WT./LBS.	CUBIC FT.	LIST PRICE	HP ADD
A3072LK	29.69 x 72 x 29.6	70	133	6	\$991	\$498
A3066LK	29.69 x 66 x 29.6	70	126	6	\$991	\$498
A3060LK	29.69 x 60 x 29.6	70	117	5.25	\$906	\$464
A3048LK	29.69 x 48 x 29.6	65	100	4.3	\$817	\$394
A3042LK	29.69 x 42 x 29.6	65	92	3.8	\$817	\$356
A3036LK	29.69 x 36 x 29.6	70	83	4.3	\$729	\$321
A3030LK	29.69 x 30 x 29.6	70	74	3.6	\$686	\$286

Full end panel on left. Narrow right end panel connects to 24"D 5-sided corner unit. Grommet in worksurface. Shipped RTA (ready to assemble).

• **Modesty Panel is 1" off of ground**

• *Keyboard and pencil trays for use on units 42" and above*

Required Specifications

Top finish
Base finish

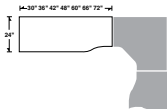
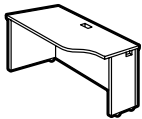
Optional Specifications

Additional grommet position
HP laminate
Power block cut-out

Accessories

Power block
Keyboard tray
Pencil tray

SPACE SAVER CONNECTABLE TABLES - LEFT



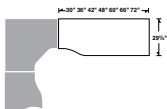
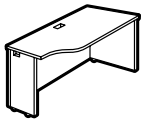
24" Deep Space Saver Connectable Table - LEFT

MODEL#	DIMENSIONS D x W x H	FREIGHT CLASS	WT./LBS.	CUBIC FT.	LIST PRICE	HP ADD
A2472LK	24 x 72 x 29.6	70	120	6	\$906	\$372
A2466LK	24 x 66 x 29.6	70	114	6	\$906	\$372
A2460LK	24 x 60 x 29.6	70	105	5.25	\$817	\$343
A2448LK	24 x 48 x 29.6	70	89	4.3	\$729	\$273
A2442LK	24 x 42 x 29.6	70	81	3.8	\$729	\$227
A2436LK	24 x 36 x 29.6	70	73	3.3	\$642	\$172
A2430LK	24 x 30 x 29.6	70	66	3.6	\$601	\$172

Full end panel on left. Narrow right end panel connects to 20"D 5-sided corner unit. Grommet in worksurface. Shipped RTA (ready to assemble).

- **Modesty Panel is 1" off of ground.**
- Keyboard and pencil trays for use on units 42" and above

SPACE SAVER CONNECTABLE TABLES - RIGHT

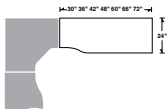
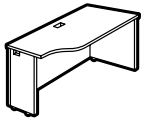


30" Deep Space Saver Connectable Table - RIGHT

MODEL#	DIMENSIONS	FREIGHT CLASS	WT./LBS.	CUBIC FT.	LIST PRICE	HP ADD
A3072RK	29.69 x 72 x 29.6	70	133	6	\$991	\$498
A3066RK	29.69 x 66 x 29.6	70	126	6	\$991	\$498
A3060RK	29.69 x 60 x 29.6	70	117	5.25	\$906	\$464
A3048RK	29.69 x 48 x 29.6	65	100	4.3	\$817	\$394
A3042RK	29.69 x 42 x 29.6	65	91	3.8	\$817	\$356
A3036RK	29.69 x 36 x 29.6	70	83	4.3	\$729	\$321
A3030RK	29.69 x 30 x 29.6	70	74	3.6	\$686	\$286

Full end panel on right. Narrow right end panel connects to 24"D 5-sided corner unit. Grommet in worksurface. Shipped RTA (ready to assemble).

- **Modesty Panel is 1" off of ground**
- Keyboard and pencil trays for use on units 42" and above



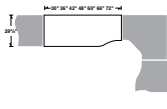
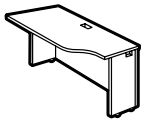
24" Deep Space Saver Connectable Table - RIGHT

A2472RK	24 x 72 x 29.6	70	120	6	\$906	\$372
A2466RK	24 x 66 x 29.6	70	114	6	\$906	\$372
A2460RK	24 x 60 x 29.6	70	105	5.25	\$817	\$343
A2448RK	30 x 48 x 29.6	70	89	4.3	\$729	\$273
A2442RK	24 x 42 x 29.6	70	81	3.8	\$729	\$227
A2436RK	24 x 36 x 29.6	70	73	3.3	\$642	\$172
A2430RK	24 x 30 x 29.6	70	66	3.6	\$601	\$172

Full end panel on right. Narrow right end panel connects to 20"D 5-sided corner unit. Grommet in worksurface. Shipped RTA (ready to assemble).

- **Modesty Panel is 1" off of ground.**
- Keyboard and pencil trays for use on units 42" and above

SPACE SAVER CONNECTABLE TABLES



30" Deep Space Saver Connectable Table

MODEL#	DIMENSIONS	FREIGHT CLASS	WT./LBS.	CUBIC FT.	LIST PRICE	HP ADD
A3072LN	29.69 x 72 x 29.6	70	125	6	\$961	\$498
A3066LN	29.69 x 66 x 29.6	70	117	6	\$961	\$498
A3060LN	29.69 x 60 x 29.6	70	108	5.25	\$875	\$464
A3048LN	29.69 x 48 x 29.6	70	91	4.3	\$788	\$394
A3042LN	29.69 x 42 x 29.6	70	83	3.8	\$788	\$356
A3036LN	29.69 x 36 x 29.6	70	74	3.3	\$700	\$321
A3030LN	29.69 x 30 x 29.6	70	66	3.6	\$655	\$286

Narrow end panels on both sides. Connects the **right end only to 24"D 5-sided corner unit.** Left end allows the continuation of additional connectable center or left connectable worksurface. Grommet in worksurface. Shipped RTA (ready to assemble).

- **Modesty Panel is 1" off of ground.**
- Keyboard and pencil trays for use on units 42" and above

Required Specifications

Top finish
Base finish

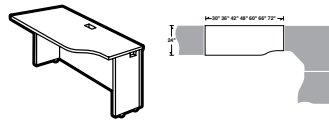
Optional Specifications

Additional grommet position
HP laminate
Power block cut-out

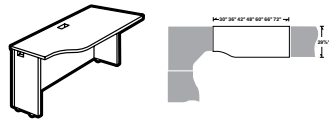
Accessories

Power block
Keyboard tray
Pencil tray

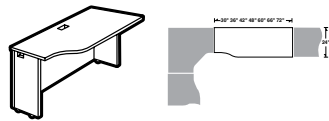
SPACE SAVER CONNECTABLE TABLES



24" Deep Space Saver Connectable Table



30" Deep Space Saver Connectable Table



24" Deep Space Saver Connectable Table

MODEL#	DIMENSIONS	FREIGHT CLASS	WT/LBS.	CUBIC FT.	LIST PRICE	HP ADD
--------	------------	---------------	---------	-----------	------------	--------

D x W x H

A2472LN	24 x 72 x 29.6	70	112	6	\$875	\$372
A2466LN	24 x 66 x 29.6	70	105	6	\$875	\$372
A2460LN	24 x 60 x 29.6	70	96	5.25	\$788	\$343
A2448LN	24 x 48 x 29.6	70	81	4.3	\$700	\$273
A2442LN	24 x 42 x 29.6	70	73	3.8	\$700	\$227
A2436LN	24 x 36 x 29.6	70	65	3.3	\$614	\$172
A2430LN	24 x 30 x 29.6	70	58	3.6	\$570	\$172

Narrow end panels on both sides. Connects the **right end only to 20"D 5-sided corner unit.** Left end allows the continuation of additional connectable center or left connectable worksurface. Grommet in worksurface. Shipped RTA (ready to assemble).

- **Modesty Panel is 1" off of ground.**
- *Keyboard and pencil trays for use on units 42" and above*

A3072RN	29.69 x 72 x 29.6	70	125	6	\$961	\$498
A3066RN	29.69 x 66 x 29.6	70	117	6	\$961	\$498
A3060RN	29.69 x 60 x 29.6	70	108	5.25	\$875	\$464
A3048RN	29.69 x 48 x 29.6	70	91	4.3	\$788	\$394
A3042RN	29.69 x 42 x 29.6	70	83	3.8	\$788	\$356
A3036RN	29.69 x 36 x 29.6	70	74	3.3	\$700	\$321
A3030RN	29.69 x 30 x 29.6	70	66	3.6	\$655	\$286

Narrow end panels on both sides. Connects the **left end only to 24"D 5-sided corner unit.** Right end allows the continuation of additional connectable center or right connectable worksurface. Grommet in worksurface. Shipped RTA (ready to assemble).

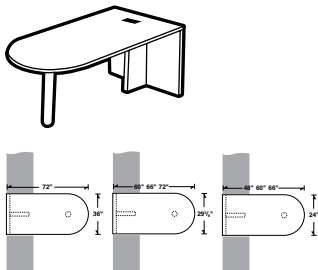
- **Modesty Panel is 1" off of ground.**
- *Keyboard and pencil trays for use on units 42" and above*

A2472RN	24 x 72 x 29.6	70	112	6	\$875	\$372
A2466RN	24 x 66 x 29.6	70	105	6	\$875	\$372
A2460RN	24 x 60 x 29.6	70	96	5.25	\$788	\$343
A2448RN	24 x 48 x 29.6	70	81	4.3	\$700	\$273
A2442RN	24 x 42 x 29.6	70	72	3.8	\$700	\$227
A2436RN	24 x 36 x 29.6	70	59	3.3	\$614	\$172
A2430RN	24 x 30 x 29.6	85	53	3.6	\$570	\$172

Narrow end panels on both sides. Connects the **left end only to 20"D 5-sided corner unit.** Right end allows the continuation of additional connectable center or right connectable worksurface. Grommet in worksurface. Shipped RTA (ready to assemble).

- **Modesty Panel is 1" off of ground.**
- *Keyboard and pencil trays for use on units 42" and above*

"D" ISLANDS



"D" Island - Full End Panel & Post (T-Base)

MODEL#	DIMENSIONS	FREIGHT CLASS	WT/LBS.	CUBIC FT.	LIST PRICE	HP ADD
--------	------------	---------------	---------	-----------	------------	--------

A3672FI	36 x 72 x 29.6	85	124	8.5	\$1079	\$532
A3072FI	29.69 x 72 x 29.6	85	107	7.5	\$1048	\$499
A3066FI	29.69 x 66 x 29.6	85	102	7.5	\$991	\$498
A3060FI	29.69 x 60 x 29.6	85	96	6.76	\$939	\$464
A2466FI	24 x 66 x 29.6	85	90	7.5	\$883	\$372
A2460FI	24 x 60 x 29.6	85	84	6.76	\$831	\$343
A2448FI	24 x 48 x 29.6	85	74	5.76	\$773	\$273

Connects to narrow end panel. Attaching hardware included. Not freestanding. Grommet in worksurface. Shipped RTA (ready to assemble).

- Post is shipped in separate carton. Standard in Black (**TBL**); Tungsten is available at no charge, please specify (**TTU**).

Required Specifications

Top finish
Base finish

Optional Specifications

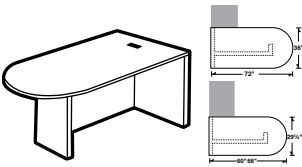
Additional grommet position
HP laminate
Power block cut-out

Accessories

Power block
Keyboard tray
Pencil tray

A ADAPTABILITIES®

"D" ISLANDS

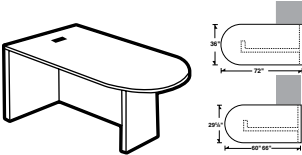


"D" Island LEFT - Full Modesty Panel (H-Base)

MODEL#	DIMENSIONS	FREIGHT CLASS	WT/LBS.	CUBIC FT.	LIST PRICE	HP ADD
A3672FIL	36 x 72 x 29.6	70	139	7	\$991	\$532
A3066FIL	29.69 x 66 x 29.6	70	116	6	\$883	\$498
A3060FIL	29.69 x 60 x 29.6	70	106	5.25	\$831	\$464

Connects to the left side of a worksurface. Accommodates all 19" pedestals (freestanding, mobile and hanging pedestals). Grommet in worksurface. Shipped RTA (ready to assemble).

- Modesty Panel is 1" off of ground.

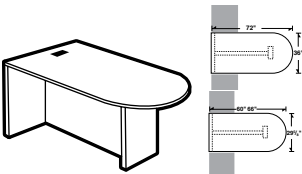


"D" Island RIGHT - Full Modesty Panel (H-Base)

A3672FIR	36 x 72 x 29.6	70	139	7	\$991	\$532
A3066FIR	29.69 x 66 x 29.6	70	116	6	\$883	\$498
A3060FIR	29.69 x 60 x 29.6	70	106	5.25	\$831	\$464

Connects to the right side of a worksurface. Accommodates all 19" pedestals (freestanding, mobile and hanging pedestals). Grommet in worksurface. Shipped RTA (ready to assemble).

- Modesty Panel is 1" off of ground.

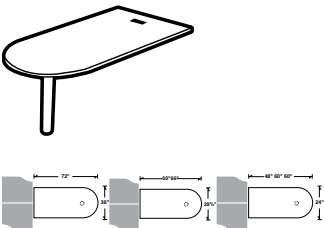


"D" Island Center - Full Modesty Panel (H-Base)

A3672FIC	36 x 72 x 29.6	70	139	7	\$991	\$532
A3066FIC	29.69 x 66 x 29.6	70	116	6	\$883	\$498
A3060FIC	29.69 x 60 x 29.6	70	106	5.25	\$831	\$464

Connects in between two worksurfaces. Will not accommodate pedestals. Grommet in worksurface. Shipped RTA (ready to assemble).

- Modesty Panel is 1" off of ground.



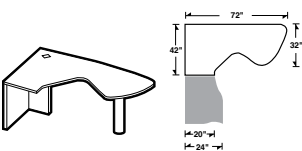
Attachable "D" Island with Post*

A3672I	36 x 72 x 29.6	92.5	88	8.5	\$939	\$532
A3066I	29.69 x 66 x 29.6	100	71	7.5	\$831	\$498
A3060I	29.69 x 60 x 29.6	100	65	6.76	\$773	\$464
A2466I	24 x 66 x 29.6	100	63	7.5	\$719	\$372
A2460I	24 x 60 x 29.6	100	57	6.76	\$667	\$343
A2448I	24 x 48 x 29.6	100	47	5.76	\$614	\$273

Attaches to edge of worksurfaces. Attaching hardware included. Grommet in worksurface. Shipped RTA (ready to assemble).

- Post is shipped in separate carton. Standard in Black (**TBL**); Tungsten is available at no charge, please specify (**TTU**).

EXTENDED CORNER ISLANDS



Extended Corner Island - RIGHT*

MODEL#	DIMENSIONS	FREIGHT CLASS	WT/LBS.	CUBIC FT.	LIST PRICE	HP ADD
A4272EIR	42-32 x 72 x 29.6	100	104	11.5	\$1294	\$710

Extended island worksurface on right. Connects to 20"D returns or 24"D space saver connectables on the left. **Not freestanding.** Predrilled to accept 22"-28" keyboard trays. Grommet in worksurface. Shipped RTA (ready to assemble).

- Post is shipped in separate carton. Standard in Black (**TBL**); Tungsten is available at no charge, please specify (**TTU**).

Required Specifications

Top finish
Base finish
Post finish*

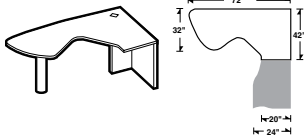
Optional Specifications

Additional grommet position
HP laminate
Power block cut-out

Accessories

Power block
Keyboard tray
Pencil tray

EXTENDED CORNER ISLANDS

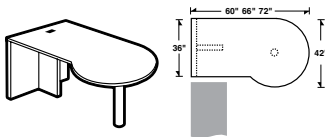


Extended Corner Island - LEFT*

MODEL#	DIMENSIONS	FREIGHT CLASS	WT/LBS.	CUBIC FT.	LIST PRICE	HP ADD
D x W x H						
A4272EIL	42-32 x 72 x 29.6	100	104	11.5	\$1294	\$710

Extended island worksurface on left. Connects to 20"D returns or 24"D space saver connectables on the right. **Not freestanding.** Predrilled to accept 22"-28" keyboard trays. Grommet in worksurface. Shipped RTA (ready to assemble).
 • Post is shipped in separate carton. Standard in Black (**TBL**); Tungsten is available at no charge, please specify (**TTU**).

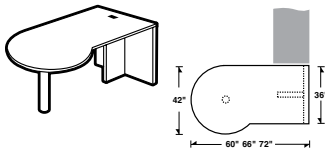
"P" ISLANDS



"P" Island LEFT - Full End Panel & Post (T-Base)*

MODEL#	DIMENSIONS	FREIGHT CLASS	WT/LBS.	CUBIC FT.	LIST PRICE	HP ADD
A3672FPL	36-42 x 72 x 29.6	85	128	9.26	\$1267	\$710
A3666FPL	36-42 x 66 x 29.6	85	122	8.76	\$1157	\$710
A3660FPL	36-42 x 60 x 29.6	85	116	8	\$1102	\$603

Connects to left side of worksurface. Attaching hardware included. **Not freestanding.** Grommet in worksurface. Shipped RTA (ready to assemble).
 • Post is shipped in separate carton. Standard in Black (**TBL**); Tungsten is available at no charge, please specify (**TTU**).

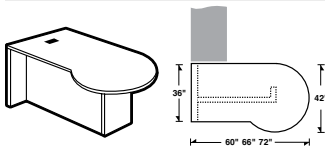


"P" Island RIGHT - Full End Panel & Post (T-Base)*

A3672FPR	36-42 x 72 x 29.6	85	128	9.26	\$1267	\$710
A3666FPR	36-42 x 66 x 29.6	85	122	8.76	\$1157	\$710
A3660FPR	36-42 x 60 x 29.6	85	116	8	\$1102	\$603

Connects to right side of worksurface. Attaching hardware included. **Not freestanding.** Grommet in worksurface. Shipped RTA (ready to assemble).
 • Post is shipped in separate carton. Standard in Black (**TBL**); Tungsten is available at no charge, please specify (**TTU**).

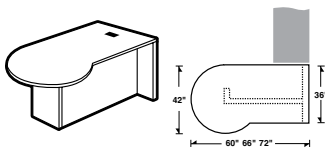
"P" ISLANDS WITH FULL MODESTY PANEL



"P" Island LEFT - Full Modesty Panel (H-Base)

MODEL#	DIMENSIONS	FREIGHT CLASS	WT/LBS.	CUBIC FT.	LIST PRICE	HP ADD
A3672PL	36-42 x 72 x 29.6	70	143	7.75	\$1157	\$710
A3666PL	36-42 x 66 x 29.6	70	136	7.25	\$1048	\$710
A3660PL	36-42 x 60 x 29.6	70	126	6.5	\$991	\$603

Connects to the left side of a worksurface. Accommodates all 19" pedestals (freestanding, mobile and hanging pedestals). Grommet in worksurface. Shipped RTA (ready to assemble).
 • Modesty Panel is 1" off of ground.



"P" Island RIGHT - Full Modesty Panel (H-Base)

A3672PR	36-42 x 72 x 29.6	70	143	7.75	\$1157	\$710
A3666PR	36-42 x 66 x 29.6	70	136	7.25	\$1048	\$710
A3660PR	36-42 x 60 x 29.6	70	126	6.5	\$991	\$603

Connects to the right side of a worksurface. Accommodates all 19" pedestals (freestanding, mobile and hanging pedestals). Grommet in worksurface. Shipped RTA (ready to assemble).
 • Modesty Panel is 1" off of ground.

Required Specifications

Top finish
 Base finish
 Post finish*

Optional Specifications

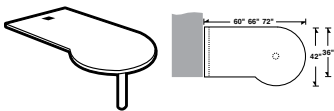
Additional grommet position
 HP laminate
 Power block cut-out

Accessories

Power block
 Keyboard tray
 Pencil tray

A ADAPTABILITIES®

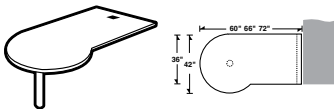
"P" ISLANDS (ATTACHABLE)



"P" Island LEFT with Post*

MODEL#	DIMENSIONS D x W x H	FREIGHT CLASS	WT/LBS.	CUBIC FT.	LIST PRICE	HP ADD
A3672IPL	36-42 x 72 x 29.6	100	92	9.26	\$1102	\$710
A3666IPL	36-42 x 66 x 29.6	100	86	8.76	\$991	\$710
A3660IPL	36-42 x 60 x 29.6	92.5	80	8	\$939	\$603

Attaches to edge of worksurfaces. Attaching hardware included. Grommet in worksurface. Shipped RTA (ready to assemble).
 • Post is shipped in separate carton. Standard in Black (TBL); Tungsten is available at no charge, please specify (TTU).

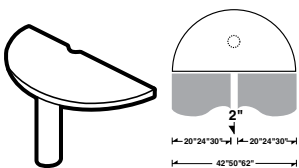


"P" Island RIGHT with Post*

A3672IPR	36-42 x 72 x 29.6	100	92	9.26	\$1102	\$710
A3666IPR	36-42 x 66 x 29.6	100	86	8.76	\$991	\$710
A3660IPR	36-42 x 60 x 29.6	92.5	80	8	\$939	\$603

Attaches to edge of worksurfaces. Attaching hardware included. Grommet in worksurface. Shipped RTA (ready to assemble).
 • Post is shipped in separate carton. Standard in Black (TBL); Tungsten is available at no charge, please specify (TTU).

RADIUS SPANNER ISLANDS

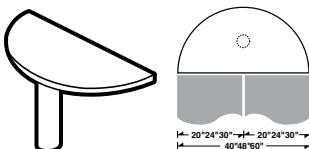


Radius Spanner Island with Panel Cut-Out*

MODEL#	DIMENSIONS	FREIGHT CLASS	WT/LBS.	CUBIC FT.	LIST PRICE	HP ADD
A62RS	31 x 62 x 29.6	100	59	6.76	\$1016	\$427
A50RS	25 x 50 x 29.6	125	46	5.76	\$883	\$356
A42RS	21 x 42 x 29.6	125	41	5.26	\$799	\$286

Used to connect two back-to-back units of same depth with a panel. Includes monopost. Requires "L" bracket (model **MLB90**) for connection to full end panels. Shipped RTA (ready to assemble).

- MLB90 must be ordered separately - see page 470.
- Post is shipped in separate carton. Standard in Black (TBL); Tungsten is available at no charge, please specify (TTU).
- **Cannot accept keyboard trays or pencil tray**



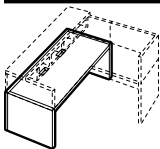
Radius Spanner Island*

A60RS	29.69 x 60 x 29.6	100	56	5.76	\$1016	\$356
A48RS	24 x 48 x 29.6	125	43	5.76	\$883	\$286
A40RS	20 x 40 x 29.6	125	40	5.26	\$799	\$286

Used to connect two back-to-back units of same depth. Includes monopost. Requires "L" bracket (model **MLB90**) for connection to full end panels. Shipped RTA (ready to assemble).

- MLB90 must be ordered separately - see page 470.
- Post is shipped in separate carton. Standard in Black (TBL); Tungsten is available at no charge, please specify (TTU).
- **Cannot accept keyboard trays or pencil tray**

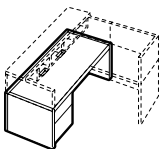
RECEPTION DESKS



Lower Desk Unit**

MODEL#	DIMENSIONS	FREIGHT CLASS	WT/LBS.	CUBIC FT.	LIST PRICE	HP ADD
A3072RD	29.69 x 72 x 29.6	70	149	7	\$1102	\$498

No pedestals. Two grommets in worksurface. Shipped RTA (ready to assemble).
 • Cannot be used with Divide.



Single Pedestal Lower Desk Unit - LEFT**

A3072RDL	29.69 x 72 x 29.6	150	222	43.75	\$1593	\$498
A3060RDL	29.63 x 60 x 29	150	201	36	\$1376	\$464

Box/file pedestal on **left** with lock. Two grommets in worksurface.
 • Cannot be used with Divide.

Required Specifications

Top finish
 Base finish (not radius spanner islands)
 Post finish*

Optional Specifications

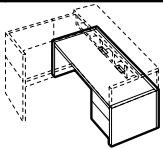
Additional grommet position*
 HP laminate*
 Power block cut-out*

Accessories

Power block*
 Keyboard tray**
 Pencil tray**

RECEPTION DESKS

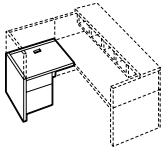
MODEL# DIMENSIONS FREIGHT CLASS WT/LBS. CUBIC FT. LIST PRICE HP ADD



Single Pedestal Lower Desk Unit - RIGHT

D x W x H							
A3072RDR	29.69 x 72 x 29.6	150	222	43.75	\$1593	\$498	
A3060RDR	29.63 x 60 x 29	150	201	36	\$1376	\$464	

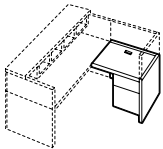
Box/file pedestal on **right** with lock. Two grommets in worksurface.
 • Cannot be used with Divide.



Reception Return - LEFT

A2442RRL	24 x 42 x 29.6	125	131	21.25	\$1048	\$227	
----------	----------------	-----	-----	-------	--------	-------	--

Box/file pedestal on **left** with lock. Grommet in worksurface.
 • Cannot be used with Divide.
 • **Cannot accept keyboard trays or pencil tray**



Reception Return - RIGHT

A2442RRR	24 x 42 x 29.6	125	131	21.25	\$1048	\$227	
----------	----------------	-----	-----	-------	--------	-------	--

Box/file pedestal on **right** with lock. Grommet in worksurface.
 • Cannot be used with Divide.
 • **Cannot accept keyboard trays or pencil tray**



Reception Return - LEFT

A2442KRL	24 x 42 x 29.6	70	83	3.8	\$773	\$227	
----------	----------------	----	----	-----	-------	-------	--

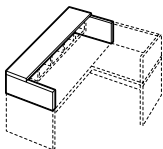
No pedestal. Grommet in worksurface.
 • Cannot be used with Divide.



Reception Return - RIGHT

A2442KRR	24 x 42 x 29.6	70	83	3.8	\$773	\$227	
----------	----------------	----	----	-----	-------	-------	--

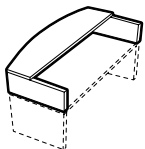
No pedestal. Grommet in worksurface.
 • Cannot be used with Divide.



Transaction Counter

A3072URD	29.69 x 72 x 13.75	70	67	4.3	\$667	\$286	
A3060URD	29.63 x 60 x 13.75	65	59	2.6	\$626	\$286	

For main reception desk. Shipped RTA (ready to assemble). Depth of reception top is 12".
 • Reception top units are to be used only with lower reception units. Tops have mini-fix fasteners to attach the reception top units.



Bow Front Transaction Counter

A3072URB	29.69-36 x 72 x 13.75	70	72	4.3	\$904	\$356	
----------	-----------------------	----	----	-----	-------	-------	--

For main reception desk. To be used on A3072RD, A3072RDL or A3072RDR. Shipped RTA (ready to assemble). Depth of reception bow top is 12-15".
 • Reception top units are to be used only with desks listed. Tops have mini-fix fasteners to attach the reception top units.

Required Specifications

Top finish
 Base finish

Optional Specifications

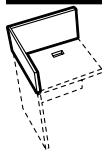
Additional grommet position*
 HP laminate*
 Power block cut-out*

Accessories

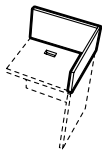
Power block*
 Keyboard tray*
 Pencil tray*

A ADAPTABILITIES®

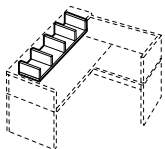
RECEPTION DESKS



Return Screen Unit - LEFT



Return Screen Unit - RIGHT



Desk Top Organizer

MODEL#	DIMENSIONS	FREIGHT CLASS	WT/LBS.	CUBIC FT.	LIST PRICE	HP ADD
--------	------------	---------------	---------	-----------	------------	--------

D x W x H

A2442URL	24 x 42 x 12.75	85	27	2	\$337	N/A
----------	-----------------	----	----	---	--------------	-----

To be used on top of left reception return (A2442RRL/KRL). Shipped RTA (ready to assemble).

- Reception top units are to be used only with returns listed. Tops have mini-fix fasteners to attach the reception top units.

A2442URR	24 x 42 x 12.75	85	27	2	\$337	N/A
----------	-----------------	----	----	---	--------------	-----

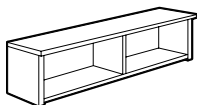
To be used on top of right reception return (A2442RRR/KRR). Shipped RTA (ready to assemble).

- Reception top units are to be used only with returns listed. Tops have mini-fix fasteners to attach the reception top units.

A1172ORD	11 x 52 x 6	100	22	2.6	\$226	N/A
----------	-------------	-----	----	-----	--------------	-----

To be used under transaction counter. Black (BK) finish only. Shipped RTA (ready to assemble).

WALL/PANEL MOUNT OVERSTORAGE UNITS



Overstorage Unit*

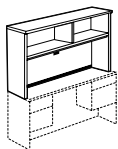
MODEL#	DIMENSIONS	FREIGHT CLASS	WT/LBS.	CUBIC FT.	LIST PRICE	HP ADD
--------	------------	---------------	---------	-----------	------------	--------

A00S60	15 x 60 x 16	70	86	5.25	\$829	N/A
A00S48	15 x 48 x 16	70	70	4.3	\$677	N/A
A00S42	15 x 42 x 16	70	62	3.8	\$667	N/A
A00S36	15 x 36 x 16	70	56	3.3	\$589	N/A
A00S30	15 x 30 x 16	70	48	3	\$551	N/A

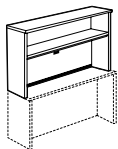
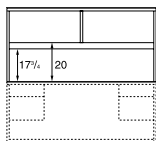
Standard with pre-mounted "J" bracket for wall mount applications. One fixed shelf, closed back. Uses standard Adaptabilities hutch doors. Shipped RTA (ready to assemble).

- **NOTE:** Care should be taken to mount the units. Units should be mounted to wall studs using correct fasteners. Failure to do so may result in collapse of the unit and subsequent personal injury. **Mounting hardware not included.** Mounting hardware used should be based on wall material. Consult an installation professional for proper wall mounting.

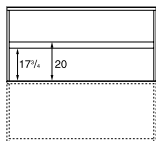
OPEN HUTCHES



Open Hutch with Closed Back*



Open Hutch with Closed Back



MODEL#	DIMENSIONS	FREIGHT CLASS	WT/LBS.	CUBIC FT.	LIST PRICE	HP ADD
--------	------------	---------------	---------	-----------	------------	--------

A72HOCB	15 x 72 x 36	125	175	28.25	\$1187	N/A
A71HOCB	15 x 71.69 x 36	125	175	28.25	\$1187	N/A
A66HOCB	15 x 66 x 36	125	164	26	\$1133	N/A
A60HOCB	15 x 60 x 36	125	151	23.75	\$1048	N/A

One fixed shelf and fixed shelf divider. Closed back features a grommet and flexible sweep for wire management. All hutches shipped pre-assembled. ***A71HOCB** for use when spanning 30" x 60/66" SPL/R and 20/24" x 42" FL/FR/L4/R4.

- Clearance from worksurface to valance is 17 3/4"; clearance from worksurface to hutch doors is 20".
- Woodgrain runs horizontal on both the upper and lower back panels.

A48HOCB	15 x 48 x 36	125	124	19	\$831	N/A
A42HOCB	15 x 42 x 36	125	111	16.75	\$831	N/A
A36HOCB	15 x 36 x 36	125	99	14.5	\$719	N/A
A30HOCB	15 x 30 x 36	125	88	12.25	\$667	N/A

One fixed shelf. Closed back features a grommet and flexible sweep for wire management. All hutches shipped pre-assembled.

- Clearance from worksurface to valance is 17 3/4"; clearance from worksurface to hutch doors is 20".
- Woodgrain runs horizontal on both the upper and lower back panels.

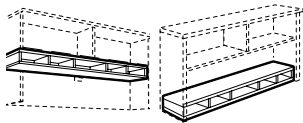
Required Specifications

Top finish
Base finish

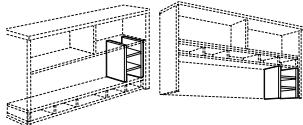
Optional Specifications

Doors*

PIGEON-HOLE STORAGE



Horizontal Pigeon-Hole Storage



Vertical Pigeon-Hole Storage

MODEL#	DIMENSIONS D x W x H	FREIGHT CLASS	WT./LBS.	CUBIC FT.	LIST PRICE	HP ADD
AHS72	11.25 x 70 x 5.62	85	41	3	\$698	N/A
AHS71	11.25 x 69 x 5.62	70	43.5	2.3	\$698	N/A
AHS66	11.25 x 64 x 5.62	85	38	2.8	\$698	N/A
AHS60	11.25 x 58 x 5.62	85	35	2.5	\$572	N/A
AHS48	11.25 x 46 x 5.62	85	28	2	\$423	N/A
AHS42	11.25 x 40 x 5.62	85	24	2	\$423	N/A
AHS36	11.25 x 34 x 5.62	92.5	22	2	\$346	N/A

For additional storage. Can be **top** or **bottom** mounted. For use inside hutch. Shipped RTA (ready to assemble).

• **Cannot be used on AOS and COOS Overstorage Units.**

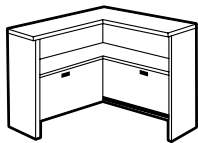
• Black finish is standard. Brushed Cobalt is available at no charge, please specify as **BRC**.

AVS14	11.25 x 13.37 x 14.37	85	13	0.9	\$436	N/A
-------	-----------------------	----	----	-----	--------------	-----

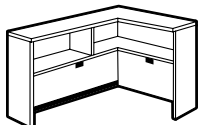
For use in conjunction with the Horizontal Pigeon-Hole Storage. Can be used under or over horizontal unit. Shipped RTA (ready to assemble).

• Black finish is standard. Brushed Cobalt is available at no charge, please specify as **BRC**.

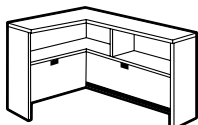
CORNER HUTCHES



Corner Hutch with Closed Back



RIGHT Corner Hutch with Closed Back



LEFT Corner Hutch with Closed Back

MODEL#	DIMENSIONS	FREIGHT CLASS	WT./LBS.	CUBIC FT.	LIST PRICE	HP ADD
A42CH	15 x 42 x 36	65	144	6.25	\$1398	N/A
A36CH	15 x 36 x 36	65	125	4.8	\$1178	N/A

One fixed shelf. Closed back features a grommet in both back panels and flexible sweep for wire management. Shipped RTA (ready to assemble).

• Woodgrain runs horizontal on both the upper and lower back panels.

A3672CHR	15 x 36-72 x 36	65	186	7	\$1539	N/A
A3666CHR	15 x 36-66 x 36	65	177	7	\$1483	N/A

One fixed shelf and shelf divider on left side. Closed back features a grommet in both back panels and flexible sweep for wire management on the left side. Shipped RTA (ready to assemble).

• Woodgrain runs horizontal on both the upper and lower back panels.

A3672CHL	15 x 36-72 x 36	65	186	7.25	\$1539	N/A
A3666CHL	15 x 36-66 x 36	65	177	7.25	\$1483	N/A

One fixed shelf and shelf divider on right side. Closed back features a grommet in both back panels and flexible sweep for wire management on the right side. Shipped RTA (ready to assemble).

• Woodgrain runs horizontal on both the upper and lower back panels.

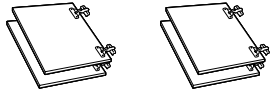
Required Specifications

Top finish
Base finish

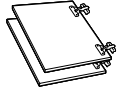
Optional Specifications

Doors

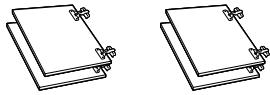
HUTCH DOORS



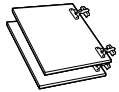
Four-Door Kit



Two-Door Kit



Corner Hutch Four-Door Kit



Corner Hutch Two-Door Kit

MODEL#	DIMENSIONS	FREIGHT CLASS	WT/LBS.	CUBIC FT.	LIST PRICE	HP ADD
--------	------------	---------------	---------	-----------	------------	--------

D x W x H

ADOOR72	.69 x 17.75 x 15	85	25	1.8	\$436	N/A
ADOOR71	.69 x 17.12 x 15	85	25	1.8	\$436	N/A
ADOOR66	.69 x 16.75 x 15	85	24	1.8	\$436	N/A
ADOOR60	.69 x 14.75 x 15	85	22	1.8	\$436	N/A

For use on 72", 71", 66" and 60"W straight hutches. Hinges included. Locks available. Add **\$137** each lock. Doors for units 60" wide or more require two locks.

ADOOR48	.69 x 23.5 x 15	92.5	18	1.8	\$283	N/A
ADOOR42	.69 x 20.5 x 15	100	17	1.8	\$283	N/A
ADOOR36	.69 x 17.5 x 15	100	15	1.8	\$283	N/A
ADOOR30	.69 x 14.5 x 15	125	13	1.8	\$283	N/A

For use on 48", 42" 36" and 30"W straight hutches. Hinges included. Locks available, Add **\$137** each lock. Doors for units 48" wide or less require one lock.

ADOOR72C	.69 x 56.5 x 15	70	27	1.8	\$553	N/A
ADOOR66C	.69 x 50.5 x 15	85	25	1.8	\$505	N/A

For use on 72" and 66"W corner hutches. Hinges included. Locks not available on corner hutch doors.

ADOOR42C	.69 x 26.5 x 15	92.5	20	1.8	\$480	N/A
ADOOR36C	.69 x 21.5 x 15	100	17	1.8	\$314	N/A

For use on 42" and 36"W corner hutches. Hinges included. Locks not available on corner hutch doors.

Required Specifications

Finish

TACKBOARDS FOR HUTCHES

MODEL# DIMENSIONS FREIGHT CLASS WT/LBS. CUBIC FT. FABRIC GRADE LIST PRICE

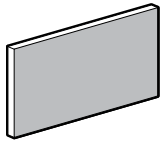
D x W x H

TACKBOARD Notes: Tackboards can be upholstered in all of the following fabrics:

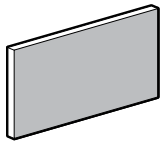
Grade 1: Jenny, Quilt, Terrace, Urban, Waterfall

Grade 2: Imprint, Lola

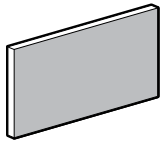
Grade 3: Anchorage, Merge



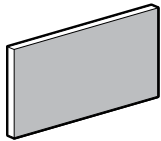
Tackboard



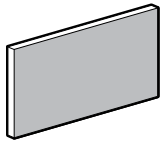
Tackboard



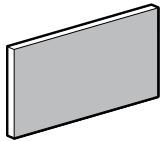
Tackboard



Tackboard



Tackboard



Tackboard

ATB7016	1 x 70 x 15	92.5	7	0.65	1	\$442
					2	\$528
					3	\$588
					4	\$688
					5	\$790

For use on **A72HOCB** straight hutch. Includes mounting screws and covers.

ATB6916	1 x 69.5 x 15	92.5	7	0.65	1	\$442
					2	\$528
					3	\$589
					4	\$688
					5	\$790

For use on **A71HOCB** straight hutch. Includes mounting screws and covers.

ATB6416	1 x 64 x 15	100	6.4	0.65	1	\$435
					2	\$510
					3	\$568
					4	\$651
					5	\$749

For use on **A66HOCB** straight hutch. Includes mounting screws and covers.

ATB5816	1 x 58 x 15	92.5	5.8	0.54	1	\$424
					2	\$499
					3	\$554
					4	\$643
					5	\$740

For use on **A60HOCB** straight hutch. Includes mounting screws and covers.

ATB4616	1 x 46 x 15	92.5	4.6	0.43	1	\$295
					2	\$356
					3	\$398
					4	\$462
					5	\$531

For use on **A48HOCB** straight hutch. Includes mounting screws and covers.

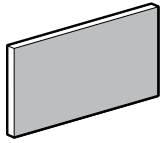
ATB4016	1 x 40 x 15	100	4	0.43	1	\$287
					2	\$337
					3	\$374
					4	\$432
					5	\$495

For use on **A42HOCB** straight hutch. Includes mounting screws and covers.

Required Specifications

Fabric

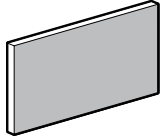
TACKBOARDS FOR HUTCHES



Tackboard

MODEL#	DIMENSIONS D x W x H	FREIGHT CLASS	WT/LBS.	CUBIC FT.	FABRIC GRADE	LIST PRICE
ATB3416	1 x 34 x 15	125	3.40	.43	1	\$278
					2	\$326
					3	\$364
					4	\$416
					5	\$480

For use on **A36HOCB** straight hutch. Includes mounting screws and covers.

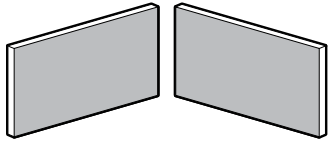


Tackboard

ATB2816	1 x 28 x 15	125	2.8	0.43	1	\$267
					2	\$307
					3	\$336
					4	\$377
					5	\$434

For use on **A30HOCB** straight hutch. Includes mounting screws and covers.

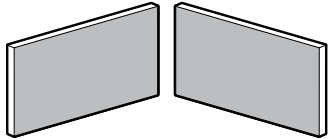
TACKBOARDS FOR CORNER HUTCHES



Tackboard

MODEL#	DIMENSIONS	FREIGHT CLASS	WT/LBS.	CUBIC FT.	LIST PRICE	HP ADD
ATB72CH	1 x 33-72 x 15 70 w x 15¾ h	125	9.94	1.3	1	\$682
					2	\$769
					3	\$830
					4	\$929
					5	\$1068

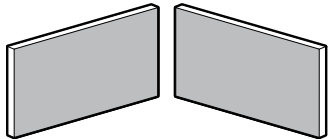
For use on **A3672CHR/L corner** hutch. Includes mounting screws and covers.



Tackboard

ATB66CH	1 x 33-64 x 15 64 w x 15¾ h	125	9.4	1.3	1	\$671
					2	\$746
					3	\$808
					4	\$890
					5	\$1024

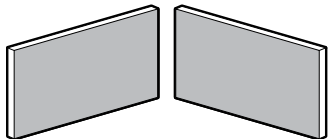
For use on **A3666CHR/L corner** hutch. Includes mounting screws and covers.



Tackboard

ATB42CH	1 x 39-40 x 15	100	7.7	0.85	1	\$536
					2	\$590
					3	\$639
					4	\$703
					5	\$809

For use on **A42CH corner** hutch. Includes mounting screws and covers.



Tackboard

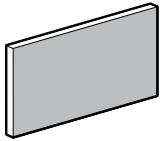
ATB36CH	1 x 33-34 x 15	125	6.6	0.85	1	\$513
					2	\$566
					3	\$602
					4	\$675
					5	\$777

For use on **A36CH corner** hutch. Includes mounting screws and covers.

Required Specifications

Fabric - Tackboards
Finish - Transaction Top

WALL MOUNTED TACKBOARDS



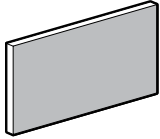
Wall Mounted Tackboard

MODEL# DIMENSIONS FREIGHT CLASS WT./LBS. CUBIC FT. FABRIC GRADE LIST PRICE

	D x W x H					
AWHT3019	1.25 x 30 x 19	125	6.3	1	1	\$343
					2	\$397
					3	\$457
					4	\$523
					5	\$601

For use under **A00S30** overstorage unit. Standard with pre-mounted "J" bracket for wall mount applications. There will be a 1.75" clearance between the top of the tackboard and bottom of the overhead, and a .25" clearance between the bottom of the tackboard and the worksurface.

- **NOTE:** Care should be taken to mount the units. Units should be mounted to wall studs using correct fasteners. Failure to do so may result in collapse of the unit and subsequent personal injury. **Mounting hardware not included.** Mounting hardware used should be based on wall material. Consult an installation professional for proper wall mounting.

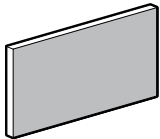


Wall Mounted Tackboard

AWHT3619	1.25 x 36 x 19	125	7.6	1	1	\$382
					2	\$443
					3	\$507
					4	\$581
					5	\$668

For use under **A00S36** overstorage unit. Standard with pre-mounted "J" bracket for wall mount applications. There will be a 1.75" clearance between the top of the tackboard and bottom of the overhead, and a .25" clearance between the bottom of the tackboard and the worksurface.

- **NOTE:** Care should be taken to mount the units. Units should be mounted to wall studs using correct fasteners. Failure to do so may result in collapse of the unit and subsequent personal injury. **Mounting hardware not included.** Mounting hardware used should be based on wall material. Consult an installation professional for proper wall mounting.

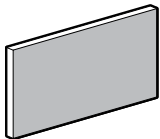


Wall Mounted Tackboard

AWHT4219	1.25 x 42 x 19	100	8.9	1	1	\$443
					2	\$512
					3	\$588
					4	\$675
					5	\$774

For use under **A00S42** overstorage unit. Standard with pre-mounted "J" bracket for wall mount applications. There will be a 1.75" clearance between the top of the tackboard and bottom of the overhead, and a .25" clearance between the bottom of the tackboard and the worksurface.

- **NOTE:** Care should be taken to mount the units. Units should be mounted to wall studs using correct fasteners. Failure to do so may result in collapse of the unit and subsequent personal injury. **Mounting hardware not included.** Mounting hardware used should be based on wall material. Consult an installation professional for proper wall mounting.



Wall Mounted Tackboard

AWHT4819	1.25 x 48 x 19	92.5	10.1	1	1	\$482
					2	\$556
					3	\$639
					4	\$735
					5	\$842

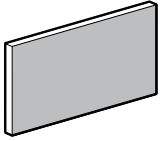
For use under **A00S48** overstorage unit. Standard with pre-mounted "J" bracket for wall mount applications. There will be a 1.75" clearance between the top of the tackboard and bottom of the overhead, and a .25" clearance between the bottom of the tackboard and the worksurface.

- **NOTE:** Care should be taken to mount the units. Units should be mounted to wall studs using correct fasteners. Failure to do so may result in collapse of the unit and subsequent personal injury. **Mounting hardware not included.** Mounting hardware used should be based on wall material. Consult an installation professional for proper wall mounting.

Required Specifications

Fabric

WALL MOUNTED TACKBOARDS

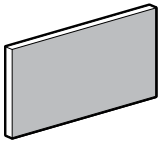


Wall Mounted Tackboard

MODEL#	DIMENSIONS D x W x H	FREIGHT CLASS	WT/LBS.	CUBIC FT.	FABRIC GRADE	LIST PRICE
AWHT6019	1.25 x 60 x 19	125	12.7	1.8	1	\$594
					2	\$686
					3	\$789
					4	\$907
					5	\$1039

For use under **A00S60** overstorage unit. Standard with pre-mounted "J" bracket for wall mount applications. There will be a 1.75" clearance between the top of the tackboard and bottom of the overhead, and a .25" clearance between the bottom of the tackboard and the worksurface.

- **NOTE:** Care should be taken to mount the units. Units should be mounted to wall studs using correct fasteners. Failure to do so may result in collapse of the unit and subsequent personal injury. **Mounting hardware not included.** Mounting hardware used should be based on wall material. Consult an installation professional for proper wall mounting.

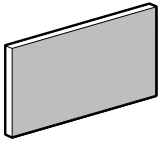


Wall Mounted Tackboard

AWHT6619	1.25 x 66 x 19	125	13.9	1.8	1	\$632
					2	\$731
					3	\$838
					4	\$963
					5	\$1107

For use under **multiple** Adaptabilities wall mounted overstorage units. Standard with pre-mounted "J" bracket for wall mount applications. There will be a 1.75" clearance between the top of the tackboard and bottom of the overhead, and a .25" clearance between the bottom of the tackboard and the worksurface.

- **NOTE:** Care should be taken to mount the units. Units should be mounted to wall studs using correct fasteners. Failure to do so may result in collapse of the unit and subsequent personal injury. **Mounting hardware not included.** Mounting hardware used should be based on wall material. Consult an installation professional for proper wall mounting.

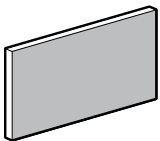


Wall Mounted Tackboard

AWHT7219	1.25 x 72 x 19	100	15.2	1.8	1	\$693
					2	\$799
					3	\$917
					4	\$1055
					5	\$1212

For use under **multiple** Adaptabilities wall mounted overstorage units. Standard with pre-mounted "J" bracket for wall mount applications. There will be a 1.75" clearance between the top of the tackboard and bottom of the overhead, and a .25" clearance between the bottom of the tackboard and the worksurface.

- **NOTE:** Care should be taken to mount the units. Units should be mounted to wall studs using correct fasteners. Failure to do so may result in collapse of the unit and subsequent personal injury. **Mounting hardware not included.** Mounting hardware used should be based on wall material. Consult an installation professional for proper wall mounting.



Wall Mounted Tackboard

AWHT7819	1.25 x 78 x 19	100	16.5	1.8	1	\$732
					2	\$844
					3	\$968
					4	\$1114
					5	\$1278

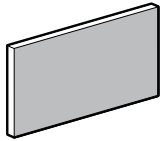
For use under **multiple** Adaptabilities wall mounted overstorage units. Standard with pre-mounted "J" bracket for wall mount applications. There will be a 1.75" clearance between the top of the tackboard and bottom of the overhead, and a .25" clearance between the bottom of the tackboard and the worksurface.

- **NOTE:** Care should be taken to mount the units. Units should be mounted to wall studs using correct fasteners. Failure to do so may result in collapse of the unit and subsequent personal injury. **Mounting hardware not included.** Mounting hardware used should be based on wall material. Consult an installation professional for proper wall mounting.

Required Specifications

Fabric

ACCESSORY PIECES



Wall Mounted Tackboard**

MODEL#	DIMENSIONS	FREIGHT CLASS	WT/LBS.	CUBIC FT.	LIST PRICE	HP ADD
	D x W x H					
AWHT8419	1.25 x 84 x 19	100	17.7	1.8	1	\$791
					2	\$914
					3	\$1049
					4	\$1205
					5	\$1385

For use under **multiple** Adaptabilities wall mounted overstorage units. Standard with pre-mounted "J" bracket for wall mount applications. There will be a 1.75" clearance between the top of the tackboard and bottom of the overhead, and a .25" clearance between the bottom of the tackboard and the worksurface.

- **NOTE:** Care should be taken to mount the units. Units should be mounted to wall studs using correct fasteners. Failure to do so may result in collapse of the unit and subsequent personal injury. **Mounting hardware not included.** Mounting hardware used should be based on wall material. Consult an installation professional for proper wall mounting.

ACCESSORY PIECES



Mixed Drawer Cabinet - LEFT*

MODEL#	DIMENSIONS	FREIGHT CLASS	WT/LBS.	CUBIC FT.	LIST PRICE	HP ADD
A2036MDL	20 x 36 x 29.6	92.5	162	15.5	\$2094	\$172
A2436MDL	24 x 36 x 29.6	100	176	18.25	\$2126	\$172

Two box drawers on **right**, one file drawer on **left** and one lateral file drawer on bottom. File on lateral file drawers locking. 1 pencil tray. Front-to-back filing bars.

- Black handles are standard. Silver is available at no charge, please specify as **SI**.
- To comply with ANSI/BIFMA stability tests, the Lateral File Counter Weight Kit, model "LFCWKIT36" on page 41 MUST be used.
- *File drawer construction is for accommodating hanging files NOT for stacking materials on the drawer bottom.*
- Top file drawer supports hanging folders only. Does not accept hanging folders with plastic tabs.



Mixed Drawer Cabinet - RIGHT*

A2036MDR	20 x 36 x 29.6	92.5	162	15.5	\$2094	\$172
A2436MDR	24 x 36 x 29.6	100	176	18.25	\$2126	\$172

Two box drawers on **left**, one file drawer on **right** and one lateral file drawer on bottom. File on lateral file drawers locking. 1 pencil tray. Front-to-back filing bars.

- Black handles are standard. Silver is available at no charge, please specify as **SI**.
- To comply with ANSI/BIFMA stability tests, the Lateral File Counter Weight Kit, model "LFCWKIT36" on page 41 MUST be used.
- *File drawer construction is for accommodating hanging files NOT for stacking materials on the drawer bottom.*
- Top file drawer supports hanging folders only. Does not accept hanging folders with plastic tabs.



Mixed Drawer Cabinet Shell - LEFT*

A2036MDLS	19.25 x 36 x 28.6	100	137	15	\$2041	N/A
A2436MDLS	23.25 x 36 x 28.6	100	150	18	\$2075	N/A

For use **under 29"H limited single pedestal desks, workstations or limited single pedestal credenzas. Unfinished top, no back.** Two box drawers on **right**, one file drawer on **left** and one lateral file drawer on bottom. File and lateral file drawers locking. 1 pencil tray. Front-to-back filing bars.

- Black handles are standard. Silver is available at no charge, please specify as **SI**.
- *File drawer construction is for accommodating hanging files NOT for stacking materials on the drawer bottom.*
- *For 24" deep worksurfaces, order **A2436MDLS**. For 20" deep worksurfaces, order **A2036MDLS**.*
- Top file drawer supports hanging folders only. Does not accept hanging folders with plastic tabs.

Required Specifications

Fabric**
Top finish*
Handle finish*
Base finish*

Optional Specifications

Key #*

ACCESSORY PIECES

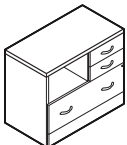


Mixed Drawer Cabinet Shell - RIGHT

MODEL#	DIMENSIONS D x W x H	FREIGHT CLASS	WT/LBS.	CUBIC FT.	LIST PRICE	HP ADD
A2036MDRS	19.25 x 36 x 28.6	100	137	15	\$2041	N/A
A2436MDRS	23.25 x 36 x 28.6	100	150	18	\$2075	N/A

For use **under 29"H limited single pedestal desks, workstations or limited single pedestal credenzas. Unfinished top, no back.** Two box drawers on **left**, one file drawer on **right** and one lateral file drawer on bottom. File and lateral file drawers locking. 1 pencil tray. Front-to-back filing bars.

- Black handles are standard. Silver is available at no charge, please specify as **SI**.
- File drawer construction is for accommodating hanging files **NOT** for stacking materials on the drawer bottom.
- For 24" deep worksurfaces, order **A2436MDRS**. For 20" deep worksurfaces, order **A2036MDRS**.
- Top file drawer supports hanging folders only. Does not accept hanging folders with plastic tabs.

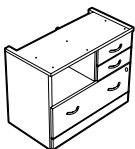


Mixed Storage Cabinet*

A2436MSC	24 x 36 x 29.6	100	163	18.25	\$1566	\$172
A2036MSC	20 x 36 x 29.6	100	147	15.5	\$1447	\$172

Features open storage compartment with access grommet on back. 2 box drawers and 1 lateral file drawer, all locking. 1 pencil tray. Front-to-back filing bars.

- To comply with ANSI/BIFMA stability tests, the Lateral File Counter Weight Kit, model "LFCWKIT36" on page 41 **MUST** be used.
- Black handles are standard. Silver is available at no charge, please specify as **SI**.
- File drawer construction is for accommodating hanging files **NOT** for stacking materials on the drawer bottom.



Mixed Storage Cabinet Shell

A2436MSCS	23.25 x 36 x 28	100	121	14.9	\$1527	N/A
A2036MSCS	19.25 x 36 x 28	125	136	17.45	\$1407	N/A

For use **under 29"H limited single pedestal desks, workstations or limited single pedestal credenzas. Unfinished top, no back.** Features open storage compartment with access grommet on back. 2 box drawers and 1 lateral file drawer, all locking. 1 pencil tray. Front-to-back filing bars.

- Black handles are standard. Silver is available at no charge, please specify as **SI**.
- File drawer construction is for accommodating hanging files **NOT** for stacking materials on the drawer bottom.
- For 24" deep worksurfaces, order **A2436MSCS**. For 20" deep worksurfaces, order **A2036MSCS**.

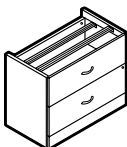


2 Drawer Lateral File*

A2036LF	20 x 36 x 29.6	100	145	15.5	\$1294	\$172
---------	----------------	-----	-----	------	---------------	--------------

Two full suspension drawers. Front-to-back and side-to-side letter/legal filing capability with lock. Anti-lock tilt suspension.

- To comply with ANSI/BIFMA stability tests, the Lateral File Counter Weight Kit, model "LFCWKIT36" on page 41 **MUST** be used.
- Black handles are standard. Silver is available at no charge, please specify as **SI**.
- File drawer construction is for accommodating hanging files **NOT** for stacking materials on the drawer bottom.



2 Drawer Lateral File Shell

A2436S2	24 x 36 x 28.6	125	114	18	\$1717	N/A
A2036S2	20 x 36 x 28.5	125	104	14.75	\$1717	N/A

For use **under 29"H limited single pedestal desks, workstations or limited single pedestal credenzas. No top or back.** Two full suspension locking drawers with **steel drawer interior**. Steel drawer construction includes metal sides and masonite bottoms. Side-to-side file bars included. Anti-lock tilt suspension.

- Black handles are standard. Silver is available at no charge, please specify as **SI**.
- To prevent overloading, steel drawers do not include a back panel
- For 24" deep worksurfaces, order **A2436S2**. For 20" deep worksurfaces, order **A2036S2**.
- For front-to-back file bars order **FBB**, "FBB" on page 41.

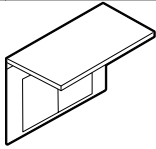
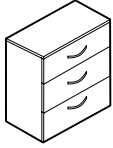
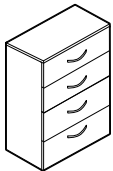
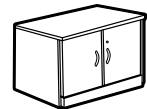
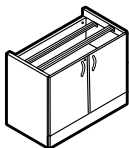
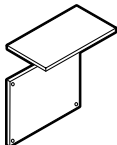
Required Specifications

Top finish*
Base finish
Handles

Optional Specifications

Key #
HP laminate*

ACCESSORY PIECES

**2 Drawer Lateral File Top and Back*****3 Drawer Lateral File*****4 Drawer Lateral File*****Storage Cabinet*****Storage Cabinet Shell****Storage Cabinet Top and Back***

MODEL#	DIMENSIONS	FREIGHT CLASS	WT./LBS.	CUBIC FT.	LIST PRICE	HP ADD
--------	------------	---------------	----------	-----------	------------	--------

D x W x H

ALF24TB	24 x 36 x 29.6	65	82	3.3	\$537	\$215
ALF20TB	20 x 36 x 29.6	65	78	3.3	\$537	\$215

For use with Lateral File Shell. Counterweights included. Shipped RTA (ready to assemble).

- Use **ALF24TB** for model A2436S2. Use **ALF20TB** for model A2036S2.

A2036S3	20 x 36 x 37.75	92.5	219	20	\$2479	\$172
---------	-----------------	------	-----	----	--------	-------

Three full suspension locking drawers with **steel drawer interior**. Steel drawer construction includes metal sides and masonite bottoms. Side-to-side file bars included. Anti-lock tilt suspension.

- Black handles are standard. Silver is available at no charge, please specify as **SI**.
- For front-to-back file bars order **FBB**; See "FBB" on page 41.
- To prevent overloading, steel drawers do not include a back panel

A2036S4	20 x 36 x 49.5	92.5	267	25.75	\$3142	\$172
---------	----------------	------	-----	-------	--------	-------

Four full suspension locking drawers with **steel drawer interior**. Steel drawer construction includes metal sides and masonite bottoms. Side-to-side file bars included. Anti-lock tilt suspension.

- Black handles are standard. Silver is available at no charge, please specify as **SI**.
- For front-to-back file bars order **FBB**; See "FBB" on page 41.
- To prevent overloading, steel drawers do not include a back panel

A2036SC	20 x 36 x 29.6	125	121	15.5	\$991	\$172
---------	----------------	-----	-----	------	-------	-------

Self-closing hinged doors cover one adjustable shelf. Standard with lock.

- Black handles are standard. Silver is available at no charge, please specify as **SI**.

A2436SCS	23.25 x 36 x 28.6	150	106	18	\$856	N/A
A2036SCS	19.25 x 36 x 28.6	125	91	14.75	\$856	N/A

For use **under 29" H limited single pedestal desks, workstations or limited single pedestal credenzas. No top or back**. Self-closing hinged doors cover one adjustable shelf. Standard with lock.

- Black handles are standard. Silver is available at no charge, please specify as **SI**.
- For 24" deep worksurfaces, order **A2436SCS**. For 20" deep worksurfaces, order **A2036SCS**.

ASC24TB	24 x 36 x 29.6	85	49	3.3	\$362	\$215
ASC20TB	20 x 36 x 29.6	85	45	3.3	\$362	\$215

For use with **Storage Cabinet Shell**. Shipped RTA (ready to assemble).

- Use **ASC24TB** for model A2436SCS/MSCS; use **ASC20TB** for model A2036SCS/MSCS.

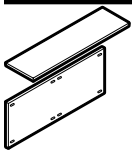
Required Specifications

Top finish*
Base finish
Handles

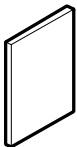
Optional Specifications

Key #
HP laminate*

ACCESSORY PIECES



Credenza Top and Back*



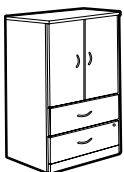
Full Leg



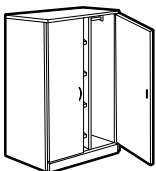
Personal Tower**



Personal Tower**



Vertical Storage/Lateral File Cabinet**



Storage Wardrobe Cabinet**

MODEL#	DIMENSIONS D x W x H	FREIGHT CLASS	WT./LBS.	CUBIC FT.	LIST PRICE	HP ADD
A2472TB	24 x 72 x 29.6	70	95	6	\$741	\$372
A2072TB	20 x 72 x 29.6	85	87	6	\$741	\$356

For use with the following: **two Lateral File Shells**, or **two Storage Cabinet Shells**, or **two Mixed Storage Cabinet Shells**, or any combination. May also be used with **one Lateral File Shell plus one Full Leg**, or **one Storage Cabinet/Mixed Storage Cabinet Shell plus one Full Leg**. Shipped RTA (ready to assemble).

- For 24" deep worksurfaces, order **A2472TB**. For 20" deep worksurfaces, order **A2072TB**.
- **Does not include hardware to attach to storage shells.**

A24FL	23.4 x 1 x 28.6	92.5	20	1.7	\$261	N/A
A20FL	19.3 x 1 x 28.6	65	16	0.6	\$261	N/A

For use at **either end of A24/2072TB Credenza Top and Back** to create a knee-space. Non-handed; can be used left or right. Shipped RTA (ready to assemble).

- For 24" deep worksurfaces, order **A24FL**. For 20" deep worksurfaces, order **A20FL**.
- **Does not include hardware for installation.**

A24PTFF	24 x 24 x 65.5	100	219	27	\$2580	N/A
A20PTFF	20 x 24 x 65.5	100	198	22.75	\$2580	N/A

Includes 7" wardrobe section with a hanging rod; storage section with one adjustable shelf; and file section with **two file drawers**. Locks are keyed alike. Upper lock secures wardrobe and storage section. Lower lock secures both file drawers.

- Black handles are standard. Silver is available at no charge, please specify as **SI**.

A24PTBBF	24 x 24 x 65.5	125	213	27	\$2580	N/A
A20PTBBF	20 x 24 x 65.5	100	193	22.75	\$2580	N/A

Includes 7" wardrobe section with a hanging rod; storage section with one adjustable shelf; and file section with **box-box-file drawers**. Locks are keyed alike. Upper lock secures wardrobe and storage section. Lower lock secures all drawers.

- Black handles are standard. Silver is available at no charge, please specify as **SI**.

A3665VSL	20 x 36 x 65.5	100	273	33	\$2412	N/A
----------	----------------	-----	-----	----	---------------	-----

Contains storage area with one adjustable shelf behind a self-closing hinged door, plus two full suspension file drawers. Lateral file drawers lock.

- File drawer construction is for accommodating hanging files NOT for stacking materials on the drawer bottom.
- Black handles are standard. Silver is available at no charge, please specify as **SI**.

A2436DI	24 x 36 x 65.5	70	254	11.5	\$2982	N/A
A3665DI	20 x 36 x 65.5	70	237	11.5	\$2631	N/A

Includes 16" hanging rod on one side and four adjustable shelves on the other. Lock. Shipped RTA (ready to assemble).

- Black handles are standard. Silver is available at no charge, please specify as **SI**.

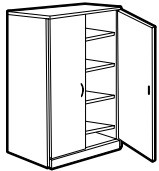
Required Specifications

Top finish
Base finish
Handles (only personal towers)

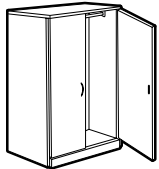
Optional Specifications

Key #**
HP laminate*

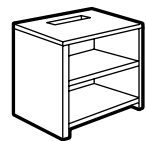
ACCESSORY PIECES



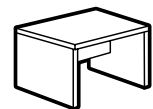
Storage Cabinet**



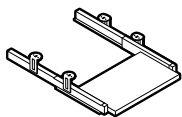
Wardrobe Cabinet**



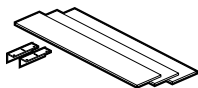
Printer Table*



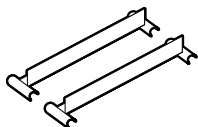
Magazine Table*



Pull-Out Keyboard



Counter Weight Kit



Front-to-Back Hanging File Bars

MODEL#	DIMENSIONS D x W x H	FREIGHT CLASS	WT/LBS.	CUBIC FT.	LIST PRICE	HP ADD
A2436SH	24 x 36 x 65.5	65	280	11.5	\$2626	N/A
A3665SH	20 x 36 x 65.5	65	261	11.5	\$2302	N/A
Includes four adjustable shelves. Lock. Shipped RTA (ready to assemble). • Black handles are standard. Silver is available at no charge, please specify as SI .						
A2436ROD	24 x 36 x 65.5	70	205	11.5	\$2842	N/A
A3665ROD	20 x 36 x 65.5	70	198	11.5	\$2412	N/A
Includes full width hanging rod. Lock. Shipped RTA (ready to assemble). • Black handles are standard. Silver is available at no charge, please specify as SI .						
A2430PT	24 x 30 x 29.6	65	108	4.3	\$991	\$172
Includes two fixed shelves, cut-back top shelf allows paper to fall onto lower shelf. Shipped RTA (ready to assemble).						
A2248MT	22 x 48 x 18.5	85	61	4.3	\$553	\$245
A2222MT	22 x 22 x 18.5	85	40	3	\$447	\$130
Shipped RTA (ready to assemble).						
APOKL28	17 x 28 x 3.5	85	13	0.9	\$337	N/A
APOKL22	17 x 22 x 3.5	85	12	0.9	\$305	N/A
Constructed of thermofused laminate. APOKL28 will accommodate keyboard and mousepad. APOKL28 will only fit on a single pedestal desk, freestanding table, or A42205C . Please specify color from available finishes listed on pg. 11. • APOKL28 will not fit extended corners or A42245C, A36205C 5-sided corners.						
LFCWKIT36	6 x 33 x 1	60	40	0.25	\$754	N/A
3 metal plates. Plates mount to the underside of any 36" wide Lateral File or Mixed Storage/Drawer cabinet. Includes mounting hardware. Must be ordered separately. Field installed. • To comply with ANSI/BIFMA stability tests, the Lateral File Counter Weight Kit MUST be used with the appropriate Lateral Files and Mixed Storage Cabinets.						
FBB	-- x 15.2 x --	70	1	0.01	\$30	N/A
FBB-50	-- x 15.2 x --	60	50	0.5	\$910	N/A
FBB-100	-- x 15.2 x --	60	100	2.71	\$1666	N/A
Includes two bars. Grey. FBB is one pair; FBB-50 is fifty pairs; FBB-100 is 100 pairs. • Not recommended for "L" opening with receding door and roll-out shelves.						

Required Specifications

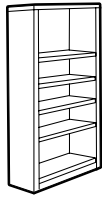
Top finish
Base finish
Handles**

Optional Specifications

Key #**
HP laminate*

A ADAPTABILITIES®

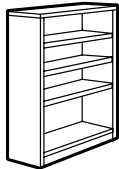
BOOKCASES



Bookcase - 72" High*

MODEL#	DIMENSIONS D x W x H	FREIGHT CLASS	WT/LBS.	CUBIC FT.	LIST PRICE	HP ADD
ABC72	12 x 36 x 72.5	125	170	23	\$1187	N/A

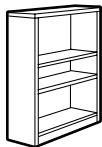
One fixed heavy duty shelf and **three adjustable shelves**. Shipped fully assembled.



Bookcase - 65" High*

ABC65	12 x 36 x 65.5	125	150	21	\$1157	N/A
-------	----------------	-----	-----	----	---------------	-----

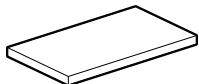
One fixed heavy duty shelf and **two adjustable shelves**. Shipped fully assembled.



Bookcase - 48" High*

ABC48	12 x 36 x 48.5	125	116	15.75	\$883	N/A
-------	----------------	-----	-----	-------	--------------	-----

Two adjustable shelves. Shipped fully assembled.



Bookcase Shelf

ABCSELF	11 x 34 x 1	100	13	1.5	\$276	N/A
---------	-------------	-----	----	-----	--------------	-----

Extra shelf for bookcases. 1" thick.

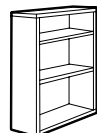
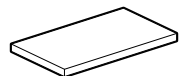


Table Top Bookcase

A3636TBC	15 x 36 x 36	125	111	17	\$759	N/A
ADOOR3636	.69 x 36 x 36	125	35	4.5	\$384	N/A

To be placed on top of 36" w lateral file or storage cabinet. Two adjustable shelves.

- For a set of doors, order **ADOOR3636**
- Locks available on ADOOR3636. Add \$101 each lock.



Bookcase Shelf

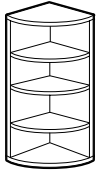
ATBC36SH	13.25 x 34 x 1	100	16	1.7	\$212	N/A
----------	----------------	-----	----	-----	--------------	-----

Extra shelf for TABLE TOP bookcases. 1" thick.

Required Specifications

Top finish*
Base finish*

END SHELVES

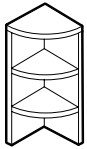


End Shelf - 65" High

MODEL#	DIMENSIONS D x W x H	FREIGHT CLASS	WT/LBS.	CUBIC FT.	LIST PRICE	HP ADD
A2465ESHL	24 x 24 x 65.5	65	136	5	\$1246	N/A
A2065ESHL	20 x 20 x 65.5	65	113	5	\$1048	N/A
A2465ESHR	24 x 24 x 65.5	65	136	5	\$1246	N/A
A2065ESHR	20 x 20 x 65.5	65	113	5	\$1048	N/A

For use at end of **wardrobe/storage, vertical storage cabinets, and personal towers**. Four fixed shelves. Shipped RTA (ready to assemble). **Specify left or right.**

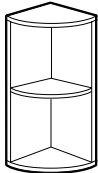
- For 24" deep cabinet, order **A2465ESH**. For 20" deep cabinet, order **A2065ESH**.



End Shelf - 36" High

A1536ESHL	15 x 15 x 36	85	44	3.3	\$505	N/A
A1536ESHR	15 x 15 x 36	85	44	3.3	\$505	N/A

For use at end of **hutches**. Two fixed shelves. To be used on top of **A3029ESHL/R, A2429ESHL/R or A2029ESHL/R**. Shipped RTA (ready to assemble). **Specify left or right.**

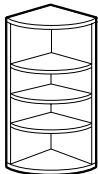


End Shelf - 29" High

A3029ESHL	30 x 30 x 29.6	70	104	5.25	\$883	\$286
A2429ESHL	24 x 24 x 29.6	70	77	4.3	\$719	\$145
A2029ESHL	20 x 20 x 29.6	70	60	3.8	\$614	\$117
A3029ESHR	30 x 30 x 29.6	70	104	5.25	\$883	\$286
A2429ESHR	24 x 24 x 29.6	70	77	4.3	\$719	\$145
A2029ESHR	20 x 20 x 29.6	70	60	3.8	\$614	\$117

For use at end of **worksurfaces**. Two fixed shelves. Shipped RTA (ready to assemble). **Specify left or right.**

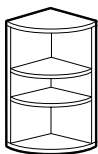
- For 30" deep worksurface, order **A3029ESH**. For 24" deep worksurface, order **A2429ESH**.
For 20" deep worksurface, order **A2029ESH**.



End Shelf - 49 1/2" High

A2049ESHL	20 x 20 x 49.5	65	94	3.8	\$924	N/A
A2049ESHR	20 x 20 x 49.5	65	94	3.8	\$924	N/A

For use at end of **A2036S4 4-high lateral file**. Four fixed shelves. Shipped RTA (ready to assemble). **Specify left or right.**



End Shelf - 37 1/4" High

A2037ESHL	20 x 20 x 38.2	70	77	5	\$672	N/A
A2037ESHR	20 x 20 x 38.2	70	77	5	\$672	N/A

For use at end of **A2036S3 3-high lateral file**. Three fixed shelves. Shipped RTA (ready to assemble). **Specify left or right.**

Required Specifications

Top finish
Base finish

Optional Specifications

HP Laminate (End Shelf, 29"h)

PEDESTALS

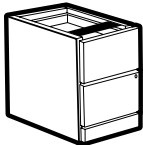


Freestanding Pedestal

MODEL#	DIMENSIONS D x W x H	FREIGHT CLASS	WT/LBS.	CUBIC FT.	LIST PRICE	HP ADD
AFPBBF19	19 x 16 x 28.6	100	68	7.25	\$1079	N/A
AFPBBF22	22 x 16 x 28.6	100	72	8.25	\$1105	N/A
AFPBBF28	28 x 16 x 28.6	100	88	10.25	\$1151	N/A

For use under a freestanding worksurface (20", 24" or 30"); attaches to worksurface top. No top and unfinished back. Two box and one file drawer. One pencil tray. File drawer and lower box drawer are locking.

- Cannot be used with **A2466** extended corners.
- When used with Connectable Tables (e.g. A2472T) bottom rear of pedestal will show because of the modesty on table units

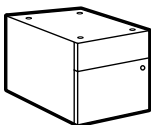


Freestanding Pedestal

AFPFF19	19 x 16 x 28.6	100	67	7.25	\$1169	N/A
AFPFF22	22 x 16 x 28.6	100	75	8.25	\$1183	N/A
AFPFF28	28 x 16 x 28.6	100	89	10.25	\$1250	N/A

For use under a freestanding worksurface (20", 24" or 30"); attaches to worksurface top. No top and unfinished back. Two file drawers. Locking.

- Cannot be used with **A2466** extended corners.
- When used with Connectable Tables (e.g. A2472T) bottom rear of pedestal will show because of the modesty on table units

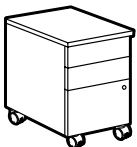


Hanging Pedestal

AHPBF18	18 x 16 x 18	92.5	48	4.5	\$754	N/A
---------	--------------	------	----	-----	--------------	-----

For use under a freestanding worksurface (20", 24" or 30"); attaches to worksurface top. No top and unfinished back. One box and one file drawer. One pencil tray. Locking. 18" high.

- Cannot be used with **A2466** extended corners.
- When used with Connectable Tables (e.g. A2472T) bottom rear of pedestal will show because of the modesty on table units

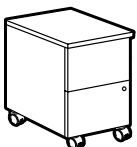


Mobile Pedestal*

AMPBBF19	19 x 16 x 28	85	96	6.5	\$1128	\$215
AMPBBF22	23 x 16 x 28	92.5	92	7.75	\$1140	\$221
AMPBBF28	29 x 16 x 28	92.5	105	9.5	\$1183	\$223

Pedestal on casters. Front casters lock. Fits under worksurfaces and is easily moved. Two box and one file drawer. One pencil tray. File drawer and lower box drawer are locking. Includes counterweight to prevent tipping.

- Cannot be used with **A2466** extended corners.

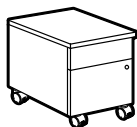


Mobile Pedestal*

AMPFF19	19 x 16 x 28	85	97	6.5	\$1214	\$215
AMPFF22	23 x 16 x 28	85	95	7.75	\$1231	\$223
AMPFF28	29 x 16 x 28	92.5	106	9.5	\$1294	\$223

Pedestal on casters. Front casters lock. Fits under worksurfaces and is easily moved. Two file drawers. Locking. Includes counterweight to prevent tipping.

- Cannot be used with **A2466** extended corners.



Mobile Pedestal*

AMPBF19	19 x 16 x 22	85	77	5.25	\$991	\$215
AMPBF22	23 x 16 x 22	85	73	6	\$1016	\$223
AMPBF28	29 x 16 x 22	92.5	83	7.5	\$1043	\$223

Pedestal on casters. Front casters lock. Fits under worksurfaces and is easily moved. One box and one file drawer. One pencil tray. Locking. 22" high. Includes counterweight to prevent tipping.

Required Specifications

Top finish
Base finish*

Optional Specifications

Key #
HP laminate (mobile pedestal)
Handle

BOARDROOM TABLES



Boardroom Table - Round Top*

MODEL#	DIMENSIONS D x W x H	FREIGHT CLASS	WT/LBS.	CUBIC FT.	LIST PRICE	HP ADD
A48R	48 x 48 x 1.5	85	95	7.5	\$642	\$498
A42R	42 x 42 x 1.5	85	73	5.75	\$614	\$498
A36R	36 x 36 x 1.5	92.5	54	4.9	\$447	\$286

- Available with the **Bicut edge** at no upcharge. Please specify "**CR**".
- **A48R** to be used with four monopost legs only, model **A5L**.
- **A42R** to be used with cross base **A2727XB** only
- **A36R** to be used with drum base **A18Z** or cross base **A2727XB**



Boardroom Table - Rectangular Top*

A48120RE	48 x 120 x 1.5	70	274	13	\$1376	\$1132
A4896RE	48 x 96 x 1.5	65	314	11.5	\$1048	\$923
A3672RE	36 x 72 x 1.5	65	175	7	\$773	\$532

For use with two drum bases, two "V" bases, one panel base OR four monoposts. Predrilled for "V" base and panel base.

Top comes in one piece, except for A48120RE (two pieces)

- Available with the **Bicut Edge** at no upcharge. Please Specify "**CR**".
- **A48120RE** uses three drum bases, three "V" bases, one double panel base OR six monoposts.



Boardroom Table - Boat Shape Top*

A48144B	48 x 144 x 1.5	60	237	7.5	\$1593	\$1344
A48120B	48 x 120 x 1.5	60	198	6.3	\$1376	\$1132
A4896B	48 x 96 x 1.5	70	193	9.8	\$1079	\$923

For use with three drum bases, three "V" bases, one double panel base OR six monoposts. Predrilled for "V" base and panel base. **Top comes in two pieces, except for A4896B.**

- Available with the **Bicut Edge** at no upcharge. Please Specify "**CR**".
- **A4896B** uses two drum bases, two "V" bases, one panel base OR four monoposts.

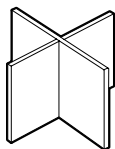


Boardroom Table - Racetrack Top*

A48144RT	48 x 144 x 1.5	60	251	7.5	\$1593	\$1344
A48120RT	48 x 120 x 1.5	60	204	6.3	\$1376	\$1132
A4896RT	48 x 96 x 1.5	70	200	9.8	\$1079	\$923
A3672RT	36 x 72 x 1.5	70	112	5.8	\$831	\$532

For use with three drum bases, three "V" bases, one double panel base OR six monoposts. Predrilled for "V" base and panel base. **Top comes in two pieces except for A4896RT and A3672RT.**

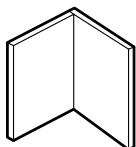
- Available with the **Bicut Edge** at no upcharge. Please Specify "**CR**".
- **NOTE:** 48" x 120" and 48" x 144" woodgrain finish Adaptabilities tables will not have a perfect match of grain at the center where the two halves meet.
- **A4896RT** and **A3672RT** use two drum bases, two "V" bases, one panel base OR four monoposts.



Cross Base

A2727XB	27 x 27 x 29.6	70	63	3.6	\$412	N/A
---------	----------------	----	----	-----	-------	-----

Use as the base for **36" or 42" round tops (model A36R or A42R)**. Shipped RTA (ready to assemble).



"V" Base

A1616V	16 x 16 x 28.6	60	39	1.1	\$351	N/A
A1616V2	16 x 16 x 28.6	60	74	2.2	\$693	N/A

Use as the base for **rectangular, boat shaped or racetrack tops**. Shipped RTA (ready to assemble).

- **A1616V2** is shipped 2 bases per carton.

Required Specifications

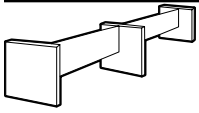
Finish
Edge detail*

Optional Specifications

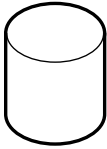
HP laminate*

A ADAPTABILITIES®

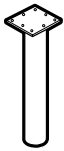
BOARDROOM TABLES



Panel Base



Drum Base



Mono Post

MODEL#	DIMENSIONS	FREIGHT CLASS	WT./LBS.	CUBIC FT.	LIST PRICE	HP ADD
--------	------------	---------------	----------	-----------	------------	--------

D x W x H

A2488PB	24 x 88 x 29.6	70	119	6	\$1102	N/A
A2445PB	24 x 45 x 28.6	70	76	4.3	\$719	N/A

Use as the base for **rectangular, boat shaped or racetrack tops**. Shipped RTA (ready to assemble).

- Use **A2488PB** for 120 - 144" wide tops.
- Use **A2445PB** for 72 - 96" wide tops.

A18Z	18 x 18 x 28.6	250	29	7.5	\$773	N/A
------	----------------	-----	----	-----	--------------	-----

Use as the base for **36" round top (model A36R) and 72", 96", 120" or 144" wide tops**.

Available in Black finish only.

- All Drum Bases require approx. 125 lb. of sand in each base for adequate stability. Sand not included.

A5L	4 x 4 x 28.6	100	13	1.5	\$337	N/A
-----	--------------	-----	----	-----	--------------	-----

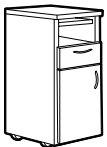
Use as the base for **48" (model A48R) round tops and 72", 96", 120" or 144" wide tops**.

- Post is shipped in separate carton. Standard in Black (**TBL**); Tungsten is available at no charge, please specify (**TTU**).

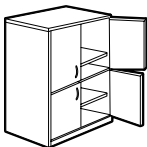
BOARDROOM ACCESSORIES



Serving Cart*



Serving Cart*



Audio/Visual Cabinet*

MODEL#	DIMENSIONS	FREIGHT CLASS	WT./LBS.	CUBIC FT.	LIST PRICE	HP ADD
--------	------------	---------------	----------	-----------	------------	--------

A2036SK	20 x 36 x 36.5	100	179	19	\$2302	\$172
---------	----------------	-----	-----	----	---------------	--------------

Includes **two** side opening, self-closing hinged doors, **two box drawers**, one slide-out tray and storage shelf. On casters.

- Available with the **Bicut Edge** at no upcharge. Please Specify "**AR**".
- Black handles are standard. Silver is available at no charge, please specify as **SI**.

A2020SK	20 x 20 x 36	92.5	114	11	\$1444	\$117
---------	--------------	------	-----	----	---------------	--------------

Includes **one** side opening, self-closing hinged door, **one box drawer**, one slide-out tray and storage shelf. On casters.

- Available with the **Bicut Edge** at no upcharge. Please Specify "**CR**".
- Black handles are standard. Silver is available at no charge, please specify as **SI**.

A2436AV	24 x 36 x 65.5	65	272	11.25	\$2631	N/A
---------	----------------	----	-----	-------	---------------	-----

Includes **four** side opening doors covering two adjustable and two fixed shelves. Wire access through one grommet on back panel. Holds up to 27"H TV monitor. Shipped RTA (ready to assemble).

- Black handles are standard. Silver is available at no charge, please specify as **SI**.

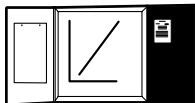
Required Specifications

Top finish *
Base finish
Handles*

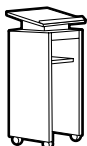
Optional Specifications

Key #*
HP laminate*

BOARDROOM ACCESSORIES



Visual Board



Lectern*

MODEL#	DIMENSIONS	FREIGHT CLASS	WT./LBS.	CUBIC FT.	LIST PRICE	HP ADD
--------	------------	---------------	----------	-----------	------------	--------

D x W x H						
AVB4848	4 x 48 x 48	70	135	9	\$1650	N/A

Includes white board and two side opening doors containing cork board on right door and 50-sheet paper writing pad on left door. Marker board can be used for projection.

- **NOTE:** Care should be taken to mount the units. Units should be mounted to wall studs using correct fasteners. Failure to do so may result in collapse of the unit and subsequent personal injury. Mounting hardware not included. Mounting hardware used should be based on wall material. Consult an installation professional for proper wall mounting.

A1844LC	18 x 24 x 44	70	92	4.8	\$883	\$117
---------	--------------	----	----	-----	--------------	--------------

Features angled stand, storage shelf and casters. Shipped RTA (ready to assemble).

Required Specifications

Top finish
Base finish

Optional Specifications

HP laminate*



The **Genoa**® series combines the value of laminate furniture with the contemporary styling of top over end panel design. This versatile offering of components and wide selection of laminate finish options is the perfect complement to any office environment.

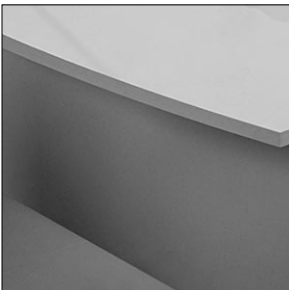
For added security of confidential material, all desks and credenzas are equipped with one locking pedestal. Genoa's kneespace credenza easily accommodates a computer, books, binders and files to maximize space.

Genoa features quality construction with the added strength of dovetailed box and file drawers. Fully progressive ball bearing suspensions ensure years of smooth, trouble-free drawer service.

Genoa's classic styling and simplicity integrate easily with existing furnishings and any interior decor. For new offices or current office expansions, Genoa is clearly the affordable and practical choice.

Features and Benefits

- 45lb. density particle board substructure with high performance thermally fused laminate
- Available bow front desk provides extra legroom and work area for visitors
- ¾ modesty panel is standard
- Most components shipped fully assembled, 1 per carton
- Pencil tray included in box drawer
- Box drawers mounted on ¾ extension steel ball bearings
- All drawers feature French dovetail joint in front and lapjoint in back
- Drawers open with side pull
- Compatible with **Divide** panel system for increased privacy and storage requirements



Bow front available on 36" x 72" desks



Contemporary top-over-end panel design



Drawer fronts are edge banded on all sides

GENERAL INFORMATION

- Constructed of 45 lb. density particle board with high performance thermally fused laminate
- Genoa components are compatible with **Divide** partitioning panels.
- Large offering of extended corners, full to floor pedestals, islands and storage options
- Double wall pedestal housing
- Genoa desk and storage products have been tested and comply with all BIFMA mechanical tests.
- For environmental certifications, please visit globalfurnituregroup.com

CONSTRUCTION

- 1" worksurfaces constructed of 45 lb. density particleboard with high performance thermally fused laminate
- Double wall pedestal housing
- Panel end style with top over side panel design
- 1" adjustable leveling glides standard on all units
- Standard with locks

MODESTY PANELS

- Recessed ¾ height modesty panel is standard. Full modesty panel available. **Add \$75.**
- All full to floor units, bridges and returns are standard with a full modesty panel

STORAGE

- All lateral file drawer fronts feature the woodgrain running in a horizontal direction
- Pencil tray included in box drawer
- All drawers feature French dovetail joint in front and lapjoint in back

FINISHES

LAMINATE FINISHES

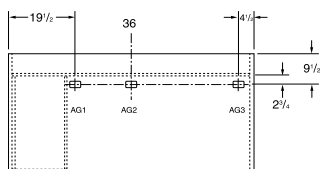
ACJ Absolute Acajou	NBL Noce Biondo
ASN Asian Night	NGL Noce Grigio
AWC Avant Cherry	NEL Noce Leggero
AWH Avant Honey	NML Noce Medio
BLK Black	QTM Quartered Mahogany
BRC Brushed Cobalt	SOG Storm Grey
CMB Clear Maple	WHE Walnut Heights
DES Dark Espresso	WHC White Chocolate
DWT Designer White	WCR Winter Cherry

GROMMETS

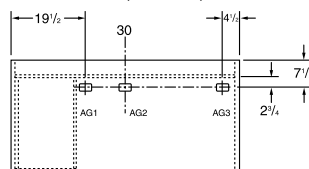
- Grommets may be ordered on Genoa hutch back panel
- Additional grommets available in standard worksurface locations (left, center or right). Order as: **AG1, AG2 or AG3. Add \$96.**
- Grommet hole dimensions are 3 ¼" wide x 1 7/8" deep



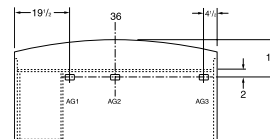
- Actual grommet locations on the worksurface are depicted in the example drawings shown below. Dimensions shown are actual measurements (in inches).



36 x 72 single pedestal left desks (3672SPL)

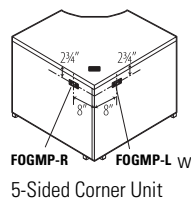


30 x 60 single pedestal left desks (3060SPL)



36 x 72 single pedestal left bow top desks (3672SLB)

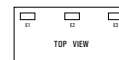
- Grommets may be placed at non-standard locations. Order as: **AGS - Add \$96.** A drawing must be supplied with vertical and horizontal dimensions to the center of the cut-out (as in drawing above). Please refer to CUSTOM GROMMET LOCATION FORM in the back reference section.
 - Components that come standard with grommet may be ordered without a grommet. **Add \$53.**
 - Grommets are available on modesty panels of **5-sided corners** 6 ½" in where the two modesty panels meet at a 90° angle. Please specify **FOGMPL** for right grommet placement and **FOGMPR** for left grommet (placement is as shown on diagrams below). Cost is **\$96.**
- *Modesty Panels are 1" off of ground



5-Sided Corner Unit

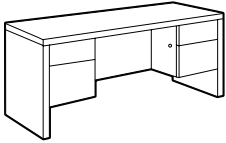
POWER BLOCK

- A Power Block (model **PMSPPDM**) may be ordered on all worksurfaces
- A Power Block is a rectangular worksurface power/data module with one electrical duplex receptacle and two data (RJ45) receptacles. 9 foot black cord included. Power Block dimensions are 3 ½" deep x 6 ½" wide x 2 ¾" high.
- To purchase a Power Block, you must specify both the Power Block cut-out location and the Power Block model #. Order Power Block as **PMSPPDM, Add \$330.** Power Blocks are available in standard worksurface locations (left, center or right). Order as **E1, E2 or E3. Add \$96.**



Power Block **PMSPPDM. Add \$330** Specify location **E1, E2 or E3. Add \$96.**

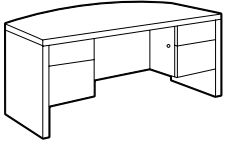
DOUBLE PEDESTAL DESKS



Double Pedestal Desk

MODEL#	DIMENSIONS D x W x H	FREIGHT CLASS	WT/LBS.	CUBIC FT.	LIST PRICE
G3672DP	36 x 72 x 29.4	150	286	50.5	\$1376
G3072DP	29.63 x 72 x 29	150	245	43.75	\$1341
G3066DP	29.69 x 66 x 29.4	150	235	39.25	\$1302
G3060DP	29.69 x 60 x 29.4	125	226	35.5	\$1092

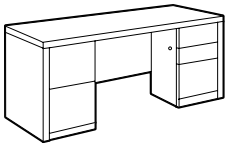
Standard with box/file pedestals on both sides. Pedestals lock. One pencil tray.



Double Pedestal Bow Top Desk

G3672DPB	32-36 x 72 x 29.4	150	256	50.5	\$1687
----------	-------------------	-----	-----	------	---------------

Standard with box/file pedestals on both sides and bow top. Pedestals lock. One pencil tray.

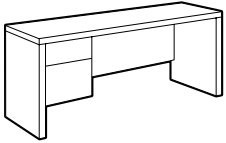


Full to Floor Double Pedestal Desk

G3072D4	29.69 x 72 x 29	125	277	43.75	\$1755
---------	-----------------	-----	-----	-------	---------------

Standard with full to floor box/box/file on right pedestal and file/file on left pedestal. Pedestals lock. One pencil tray.

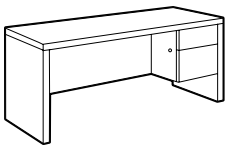
SINGLE PEDESTAL DESKS



Single Pedestal Desk - LEFT

G3672SPL	36 x 72 x 29.4	150	235	50.5	\$1251
G3072SPL	30 x 72 x 29	150	192	43.75	\$1187
G3066SPL	29.69 x 66 x 29.4	150	192	39.25	\$1167
G3060SPL	29.69 x 60 x 29.4	150	183	35.5	\$965
G3048SPL	29.69 x 48 x 29.4	150	166	28.75	\$965
G2445SPL	24 x 45 x 29.4	150	137	23.5	\$754

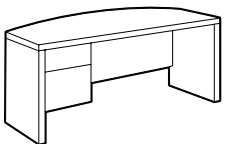
Standard with box/file pedestal. Pedestal locks. One pencil tray. Pedestal is on the **left**.



Single Pedestal Desk - RIGHT

G3672SPR	36 x 72 x 29.4	150	235	50.5	\$1251
G3072SPR	30 x 72 x 29	150	192	43.75	\$1187
G3066SPR	29.69 x 66 x 29.4	150	192	39.25	\$1167
G3060SPR	29.69 x 60 x 29.4	150	183	35.5	\$965
G3048SPR	29.69 x 48 x 29.4	150	166	28.75	\$965
G2445SPR	24 x 45 x 29.4	150	137	23.5	\$754

Standard with box/file pedestal. Pedestal locks. One pencil tray. Pedestal is on the **right**.



Single Pedestal Bow Top Desk - LEFT

G3672SLB	36-36 x 72 x 29	150	270	50	\$1544
----------	-----------------	-----	-----	----	---------------

Standard with box/file pedestal on **left** and bow top. Pedestal locks. One pencil tray.

Required Specifications

Finish

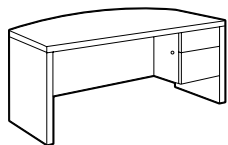
Optional Specifications

Full modesty
Grommet
Key #

Accessories

Power block
Keyboard tray
Pencil tray

SINGLE PEDESTAL DESKS

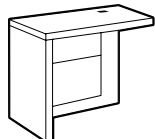


Single Pedestal Bow Top Desk - RIGHT

MODEL#	DIMENSIONS	FREIGHT CLASS	WT/LBS.	CUBIC FT.	LIST PRICE
D x W x H					
G3672SRB	36 x 72 x 29	150	270	50	\$1544

Standard with box/file pedestal on **right** and bow top. Pedestal locks. One pencil tray.

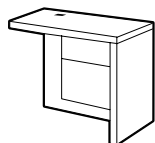
RETURNS



Typing Return - LEFT

G2448SDL	24 x 48 x 26	150	137	23.5	\$777
G2040SDL	20 x 40 x 26	125	111	17.5	\$754

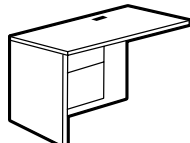
Standard with box/file pedestal and lower **26" height**. Pedestal locks. Grommet in worksurface. Pedestal is on the **left**.



Typing Return - RIGHT

G2448SDR	24 x 48 x 26	150	137	23.5	\$777
G2040SDR	20 x 40 x 26	125	111	17.5	\$754

Standard with box/file pedestal and lower **26" height**. Pedestal locks. Grommet in worksurface. Pedestal is on the **right**.

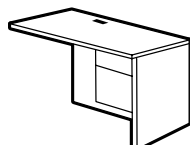


Flush Return - LEFT

G2454FL	24 x 54 x 29	150	127	27	\$943
G2448FL	24 x 48 x 29.4	125	142	23.5	\$837
G2442FL	24 x 42 x 29	150	111	21.5	\$807
G2054FL	20 x 54 x 29	150	114	23	\$943
G2048FL	20 x 48 x 29	150	107	20.5	\$837
G2042FL	20 x 42 x 29	150	100	18	\$807
G2040FL	20 x 40 x 29.4	125	115	17.5	\$796
G2036FL	20 x 36 x 29	125	93	15.5	\$796

Standard with box/file drawer pedestal. Pedestal locks. Grommet in worksurface. Pedestal is on the **left**.

- For 24" deep worksurfaces, order **G24__FL**. For 20" deep worksurfaces, order **G20__FL**.
- Keyboard and pencil trays for use on units 42" and above



Flush Return - RIGHT

G2454FR	24 x 54 x 29	150	127	27	\$943
G2448FR	24 x 48 x 29.4	125	142	23.5	\$837
G2442FR	24 x 42 x 29	150	111	21.5	\$807
G2054FR	20 x 54 x 29	150	114	23	\$943
G2048FR	20 x 48 x 29	150	107	20.5	\$837
G2042FR	20 x 42 x 29	150	100	18	\$807
G2040FR	20 x 40 x 29.4	125	115	17.5	\$796
G2036FR	20 x 36 x 29	125	93	15.5	\$796

Standard with box/file drawer pedestal. Pedestal locks. Grommet in worksurface. Pedestal is on the **right**.

- For 24" deep worksurfaces, order **G24__FR**. For 20" deep worksurfaces, order **G20__FR**.
- Keyboard and pencil trays for use on units 42" and above

Required Specifications

Finish

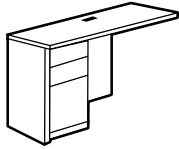
Optional Specifications

Key #

Accessories

- Power block
- Keyboard tray
- Pencil tray

RETURNS

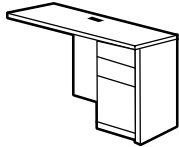


Full to Floor Flush Return - LEFT

MODEL#	DIMENSIONS D x W x H	FREIGHT CLASS	WT./LBS.	CUBIC FT.	LIST PRICE
G2448BL4	24 x 48 x 29.4	150	136	25	\$1215
G2442BL4	24 x 42 x 29.4	150	128	21.5	\$1199
G2436BL4	24 x 36 x 29.4	125	120	18	\$1174
G2048BL4	20 x 48 x 29	150	121	20.5	\$1183
G2042BL4	20 x 42 x 29	125	114	18	\$1154
G2036BL4	20 x 36 x 29	125	108	15.5	\$1133

Standard with box/box/file drawer pedestal. Lower box drawer and file drawer lock. Grommet in worksurface. Pedestal is on the **left**.

- For 24" deep worksurfaces, order **G24__BL4**. For 20" deep worksurfaces, order **G20__BL4**.
- Keyboard and pencil trays for use on units 42" and above

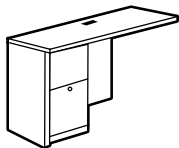


Full to Floor Flush Return - RIGHT

G2448BR4	24 x 48 x 29.4	150	136	25	\$1215
G2442BR4	24 x 42 x 29.4	150	128	21.5	\$1199
G2436BR4	24 x 36 x 29.4	125	120	18	\$1174
G2048BR4	20 x 48 x 29	150	121	20.5	\$1183
G2042BR4	20 x 42 x 29	125	114	18	\$1154
G2036BR4	20 x 36 x 29	125	108	15.5	\$1133

Standard with box/box/file drawer pedestal. Lower box drawer and file drawer lock. Grommet in worksurface. Pedestal is on the **right**.

- For 24" deep worksurfaces, order **G24__BR4**. For 20" deep worksurfaces, order **G20__BR4**.
- Keyboard and pencil trays for use on units 42" and above

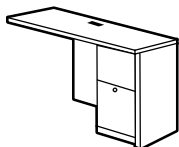


Full to Floor Flush Return - LEFT

G2448L4	24 x 48 x 29.4	150	132	25	\$1251
G2442L4	24 x 42 x 29.4	150	124	21.5	\$1227
G2436L4	24 x 36 x 29.4	125	116	18	\$1207
G2048L4	20 x 48 x 29	150	118	20.5	\$1215
G2042L4	20 x 42 x 29	125	111	18	\$1183
G2036L4	20 x 36 x 29	125	104	15.5	\$1167

Standard with file/file drawer pedestal. Pedestal locks. Grommet in worksurface. Pedestal is on the **left**.

- For 24" deep worksurfaces, order **G24__L4**. For 20" deep worksurfaces, order **G20__L4**.
- Keyboard and pencil trays for use on units 42" and above

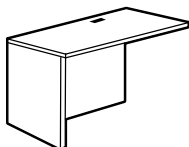


Full to Floor Flush Return - RIGHT

G2448R4	24 x 48 x 29.4	150	132	25	\$1251
G2442R4	24 x 42 x 29.4	150	124	21.5	\$1227
G2436R4	24 x 36 x 29.4	125	116	18	\$1207
G2048R4	20 x 48 x 29	150	118	20.5	\$1215
G2042R4	20 x 42 x 29	125	111	18	\$1183
G2036R4	20 x 36 x 29	125	104	15.5	\$1167

Standard with file/file drawer pedestal. Pedestal locks. Grommet in worksurface. Pedestal is on the **right**.

- For 24" deep worksurfaces, order **G24__R4**. For 20" deep worksurfaces, order **G20__R4**.
- Keyboard and pencil trays for use on units 42" and above



Flush Return - LEFT

G2454EL	24 x 54 x 29	70	87	5.25	\$777
G2448EL	24 x 48 x 29	70	96	4.5	\$672
G2442EL	24 x 42 x 29	70	71	3.8	\$672
G2054EL	20 x 54 x 29	85	78	5.25	\$737
G2048EL	20 x 48 x 29	70	70	4.2	\$693
G2042EL	20 x 42 x 29	70	56	3.3	\$672
G2040EL	20 x 40 x 29	70	78	4.5	\$648
G2036EL	20 x 36 x 29	70	56	3.3	\$648

Return has no pedestal. Grommet in worksurface. Shipped RTA (ready to assemble).

- For 24" deep worksurfaces, order **G24__EL**. For 20" deep worksurfaces, order **G20__EL**.

Required Specifications

Finish

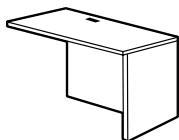
Optional Specifications

Additional grommet
Key #

Accessories

Power block
Keyboard tray
Pencil tray

RETURNS



Flush Return - RIGHT

MODEL# DIMENSIONS FREIGHT CLASS WT/LBS. CUBIC FT. LIST PRICE

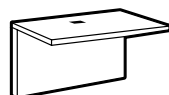
D x W x H

G2454ER	24 x 54 x 29	70	87	5.25	\$777
G2448ER	24 x 48 x 29	70	96	4.5	\$672
G2442ER	24 x 42 x 29	70	71	3.8	\$672
G2054ER	20 x 54 x 29	85	78	5.25	\$737
G2048ER	20 x 48 x 29	70	70	4.2	\$693
G2042ER	20 x 42 x 29	70	63	3.8	\$672
G2040ER	20 x 40 x 29	70	78	4.5	\$648
G2036ER	20 x 36 x 29	70	56	3.3	\$648

Return has no pedestal. Grommet in worksurface. Shipped RTA (ready to assemble).

- For 24" deep worksurfaces, order **G24__ER**. For 20" deep worksurfaces, order **G20__ER**.

FLUSH BRIDGE



Flush Bridge

G2448FB	24 x 48 x 29.4	70	78	3.5	\$511
G2442FB	24 x 42 x 29	70	65	3.06	\$494
G2436FB	24 x 36 x 29.4	70	58	3.5	\$492
G2048FB	20 x 48 x 29	70	71	3.3	\$511
G2042FB	20 x 42 x 29	70	61	4	\$494

Top surface, back panel and hardware to connect two units. Grommet in worksurface. Shipped RTA (ready to assemble).

- **G2448/G2442** models will connect 66" and 72" units plus all D islands.
- **G2048/G2042** models will connect 60", 66" and 72" units plus all D islands and 5 sided corners.

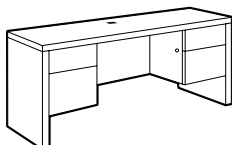
CREDENZAS



Center Storage Credenza*

G2066C	20 x 66 x 29	100	225	27	\$1492
--------	--------------	-----	-----	----	---------------

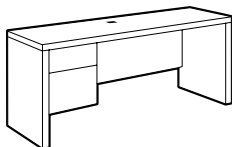
Standard with box/file pedestals on both sides and self-closing hinged center doors covering one adjustable shelf. Right pedestal and doors lock. One pencil tray.



Kneespace Credenza*

G2072CK	20 x 72 x 29.4	125	209	29.5	\$1376
G2066CK	20 x 66 x 29.4	125	201	27	\$1302
G2060CK	20 x 60 x 29	125	193	24.5	\$1207

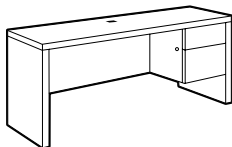
Standard with box/file pedestals on both sides. Center is open. Pedestals lock. One pencil tray. Grommet in worksurface.



Single Pedestal Credenza - LEFT*

G2072CSL	20 x 72 x 29.4	150	171	29.5	\$1167
G2066CSL	20 x 66 x 29	150	163	27.75	\$1144
G2060CSL	20 x 60 x 29	125	155	24.5	\$1007

Standard with box/file pedestal. Pedestal locks. One pencil tray. Pedestal is on the **left**. Grommet in worksurface.



Single Pedestal Credenza - RIGHT*

G2072CSR	20 x 72 x 29.4	150	150	29.5	\$1167
G2066CSR	20 x 66 x 29	150	150	29.4	\$1144
G2060CSR	20 x 60 x 29	150	136	24.5	\$1007

Standard with box/file pedestal. Pedestal locks. One pencil tray. Pedestal is on the **right**. Grommet in worksurface.

Required Specifications

Finish

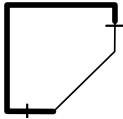
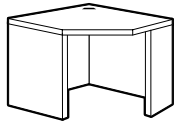
Optional Specifications

Full modesty*
Grommet
Key #

Accessories

Power block
Keyboard tray
Pencil tray

5-SIDE CORNERS

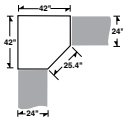
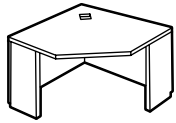


5-Sided Corner

MODEL#	DIMENSIONS D x W x H	FREIGHT CLASS	WT/LBS.	CUBIC FT.	LIST PRICE
G42205C9	20 x 42 x 29	70	123	5.75	\$1048
G36205C9	20 x 36 x 29	65	105	4.3	\$889

Connects to lateral file, storage cabinet, single pedestal credenza with half end panel, and flush bridge. Grommet in worksurface. Full and narrow end panels supplied. Can be assembled left or right. Shipped RTA (ready to assemble)

- ¾ Modesty Panel is not available

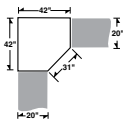
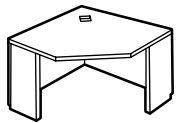


5-Sided Corner

G42245C	42 x 42 x 29.4	65	114	5	\$1063
---------	----------------	----	-----	---	---------------

Connects to **24"** returns, bridges and other **24"** units. Grommet in worksurface. Narrow end panels on left and right. Shipped RTA (ready to assemble).

- ¾ Modesty Panel is not available



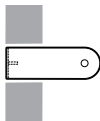
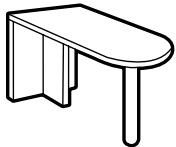
5-Sided Corner

G42205C	42 x 42 x 29.4	70	108	5	\$1030
G36205C	36 x 36 x 29.4	70	92	4.75	\$912

Connects to **20"** returns, bridges and other **20"** units. Grommet in worksurface. Narrow end panels on left and right. Shipped RTA (ready to assemble).

- ¾ Modesty Panel is not available

"D" ISLANDS



"D" Island - Full End Panel & Post

G3072FI	29.69 x 72 x 29.4	70	101	5	\$1016
G3066FI	29.69 x 66 x 29.4	70	96	4.6	\$996
G3060FI	29.69 x 60 x 29.4	70	91	4.2	\$925

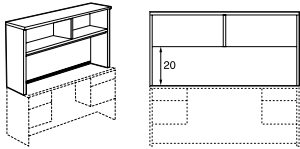
Connects to single pedestal credenza with half end panel or bridge to create a "T" grouping. **Not freestanding.** Connecting hardware for flush installation included. Shipped RTA (ready to assemble). Post is Black only.

Required Specifications
Finish

Optional Specifications
Grommet

Accessories
Power Block
Keyboard Tray
Pencil Tray
Doors*

HUTCHES



Open Hutch with Closed Back*

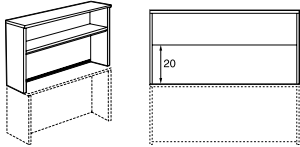
MODEL# DIMENSIONS FREIGHT CLASS WT./LBS. CUBIC FT. LIST PRICE

D x W x H

G72HOCB	15 x 72 x 36	70	138	7	\$1167
G71HOCB	15 x 71.5 x 36	70	137	7	\$1167
G69HOCB	15 x 69 x 36	70	135	7	\$1167
G66HOCB	15 x 66 x 36	70	133	7	\$1120
G60HOCB	15 x 60 x 36	65	123	5.25	\$1007

One 1" thick fixed shelf **and fixed shelf divider**. Closed back features a flexible sweep for wire management. Available in single color only. Rectangular grommet available on back panel - **Add \$96**. Shipped RTA (ready to assemble).

- **G71HOCB** for use when spanning 30" x 60/66" SPL/R and 20/24" x 42" FL/FR/L4/R4.
- **G69HOCB** for use when spanning 30" x 60/66" SPL/R and 20" x 40" FL/FR/EL/ER.
- Clearance from worksurface to hutch doors is 20".
- Woodgrain runs horizontal on both the upper and lower back panels.

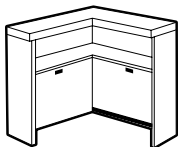


Open Hutch with Closed Back*

G48HOCB	15 x 48 x 36	65	100	4.2	\$807
G42HOCB	15 x 42 x 36	65	91	3.8	\$807
G40HOCB	15 x 40 x 36	65	88	3.8	\$807
G36HOCB	15 x 36 x 36	65	82	3.3	\$712

One 1" thick fixed shelf. Closed back features a flexible sweep for wire management. Available in single color only. Rectangular grommet available on back panel - **Add \$96**. Shipped RTA (ready to assemble).

- Clearance from worksurface to hutch doors is 20".
- Woodgrain runs horizontal on both the upper and lower back panels.



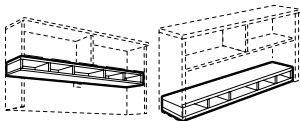
Corner Hutch with Closed Back*

G4242CH	15 x 42 x 36	70	137	6.25	\$1284
G3636CH	15 x 36 x 36	65	119	4.8	\$1167

One 1" thick fixed shelf. Closed back features a flexible sweep for wire management on lower right panel. Available in single color only. Rectangular grommet available on back panel - **Add \$96**. Shipped RTA (ready to assemble).

- Woodgrain runs horizontal on both the upper and lower back panels.

PIGEON HOLE STORAGE

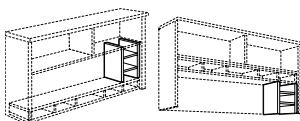


Horizontal Pigeon-Hole Storage

AHS72	11.25 x 70 x 5.62	85	41	3	\$698
AHS71	11.25 x 69 x 5.62	70	43.5	2.3	\$698
AHS66	11.25 x 64 x 5.62	85	38	2.8	\$698
AHS60	11.25 x 58 x 5.62	85	35	2.5	\$572
AHS48	11.25 x 46 x 5.62	85	28	2	\$423
AHS42	11.25 x 40 x 5.62	85	24	2	\$423
AHS36	11.25 x 34 x 5.62	92.5	22	2	\$346

For additional storage. Can be **top** or **bottom** mounted. For use inside **straight hutch** (end panels not finished). Shipped RTA (ready to assemble). **Black finish only**.

- Cannot be used on A00S and C00S Overstorage Units.



Vertical Pigeon-Hole Storage

AVS14	11.25 x 13.37 x 14.37	85	13	.90	\$436
-------	-----------------------	----	----	-----	--------------

For use in conjunction with the Horizontal Pigeon-Hole Storage. Can be used **under** or **over** horizontal unit. Shipped RTA (ready to assemble). **Black finish only**.

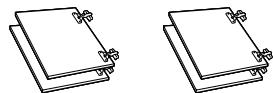
Required Specifications

Finish

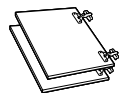
Accessories

Doors*

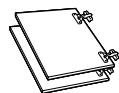
HUTCH DOORS



Four-Door Kit



Two-Door Kit



Corner Hutch Two-Door Kit

MODEL#	DIMENSIONS D x W x H	FREIGHT CLASS	WT/LBS.	CUBIC FT.	LIST PRICE
GDOOR72	.69 x 72 x 15	85	24	1.75	\$429
GDOOR71	0 x 17.5 x 15	85	24	1.75	\$429
GDOOR69	0 x 17 x 15	85	23	1.75	\$429
GDOOR66	.69 x 66 x 15	85	22	1.75	\$429
GDOOR60	.69 x 60 x 15	92.5	20	1.75	\$429

For use on 72", 71", 69", 66" and 60"W straight hutches. Hinges included. Locks available. Add **\$126** for each lock. Doors for units 60" wide or more require two locks.

GDOOR48	.69 x 48 x 15	100	17	1.75	\$270
GDOOR42	.69 x 42 x 15	100	16	1.75	\$270
GDOOR40	.69 x 40 x 15	100	15	1.75	\$270
GDOOR36	.69 x 36 x 15	100	14	1.75	\$270

For use on 48", 42" 40" and 36"W straight hutches. Hinges included. Locks available. Add **\$126** for each lock. Doors for units 48" wide or less require one lock.

GDOOR42C	0 x 26.5 x 15	92.5	19	1.75	\$461
GDOOR36C	0 x 21.5 x 15	100	16	1.75	\$300

For use on 42" and 36"W corner hutches. Hinges included. **Locks not available on corner hutch doors.**

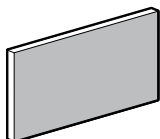
TACKBOARDS FOR HUTCHES

TACKBOARD Notes: Tackboards can be upholstered in all of the following fabrics:

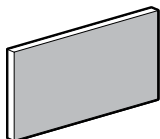
Grade 1: Jenny, Quilt, Terrace, Urban, Waterfall

Grade 2: Imprint, Lola

Grade 3: Anchorage, Merge



Tackboard



Tackboard

FABRIC GRADE LIST PRICE

TB7018	1 x 70 x 18	92.5	12	1.1	1	\$536
					2	\$621
					3	\$683
					4	\$782
					5	\$898

For use on **G72HOCB** straight hutch. Includes mounting screws and covers.

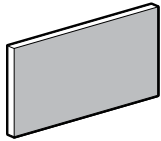
TB6918	1 x 69.5 x 18	92.5	12	1.05	1	\$536
					2	\$621
					3	\$683
					4	\$782
					5	\$898

For use on **G71HOCB** straight hutch. Includes mounting screws and covers.

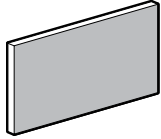
Required Specifications

Fabric (Tackboards)

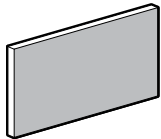
TACKBOARDS



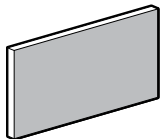
Tackboard



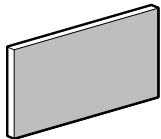
Tackboard



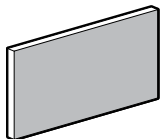
Tackboard



Tackboard



Tackboard



Tackboard

MODEL#	DIMENSIONS	FREIGHT CLASS	WT./LBS.	CUBIC FT.	FABRIC GRADE	LIST PRICE
--------	------------	---------------	----------	-----------	--------------	------------

D x W x H

TB6718	1 x 67.5 x 18	92.5	12	1.05	1	\$536
					2	\$621
					3	\$683
					4	\$782
					5	\$898

For use on **G69HOCB** straight hutch. Includes mounting screws and covers.

TB6418	1 x 64 x 18	92.5	11	1	1	\$482
					2	\$556
					3	\$617
					4	\$704
					5	\$811

For use on **G66HOCB** straight hutch. Includes mounting screws and covers.

TB5818	1 x 58 x 18	92.5	10	0.9	1	\$445
					2	\$512
					3	\$568
					4	\$643
					5	\$740

For use on **G60HOCB** straight hutch. Includes mounting screws and covers.

TB4618	1 x 46 x 18	92.5	9	0.8	1	\$307
					2	\$367
					3	\$412
					4	\$474
					5	\$545

For use on **G48HOCB** straight hutch. Includes mounting screws and covers.

TB4018	1 x 40 x 18	92.5	8	0.7	1	\$297
					2	\$345
					3	\$384
					4	\$439
					5	\$506

For use on **G42HOCB** straight hutch. Includes mounting screws and covers.

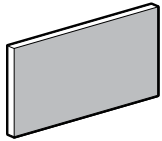
TB3818	1 x 38 x 18	92.5	7	0.7	1	\$297
					2	\$344
					3	\$382
					4	\$436
					5	\$503

For use on **G40HOCB** straight hutch. Includes mounting screws and covers.

Required Specifications

Fabric

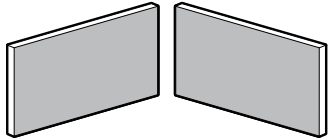
TACKBOARDS



Tackboard

MODEL#	DIMENSIONS D x W x H	FREIGHT CLASS	WT/LBS.	CUBIC FT.	FABRIC GRADE	LIST PRICE
TB3418	1 x 34 x 18	92.5	6	0.6	1	\$287
					2	\$333
					3	\$372
					4	\$425
					5	\$486

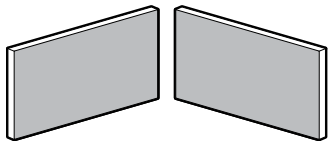
For use on **G36HOCB** straight hutch. Includes mounting screws and covers.



Tackboard

TB42CH	1 x 40 x 15.75	70	16	0.85	1	\$536
					2	\$590
					3	\$639
					4	\$703
					5	\$809

For use on **G4242CH corner** hutch. Includes mounting screws and covers.



Tackboard

TB36CH	1 x 34 x 15.25	85	12	0.85	1	\$513
					2	\$566
					3	\$602
					4	\$675
					5	\$777

For use on **G3636CH** corner hutch. Includes mounting screws and covers.

ACCESSORY PIECES

LIST PRICE

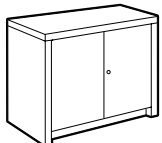


2 Drawer Lateral File*

G2036LF	20 x 36 x 29.4	100	145	15	\$1167
---------	----------------	-----	-----	----	---------------

Two full suspension drawers. Front-to-back and side-to-side letter/legal filing capability with lock. Anti-lock tilt suspension.

- To comply with ANSI/BIFMA stability tests, the Lateral File Counter Weight Kit (model "LFCWKIT36") MUST be used.
- *Back of file is always Black.*
- *File drawer construction is for accommodating hanging files NOT for stacking materials on the drawer bottom.*

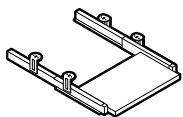


Storage Cabinet*

G2036SC	20 x 36 x 29.4	100	121	15	\$830
---------	----------------	-----	-----	----	--------------

Hinged doors cover one adjustable shelf. Standard with lock.

- *Back of storage cabinet is always Black.*



Pull-Out Keyboard

GPOKL28	17 x 28 x 3.5	85	13	0.9	\$300
GPOKL22	17 x 22 x 3.5	85	11	0.9	\$283

Constructed of thermally fused laminate.

Required Specifications

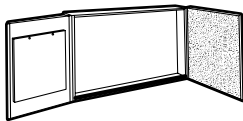
Fabric (tackboards)
Finish (accessories)

Optional Specifications

Key #*
Grommet (only G2036LF)

ACCESSORIES

MODEL# DIMENSIONS FREIGHT CLASS WT/LBS. CUBIC FT. LIST PRICE

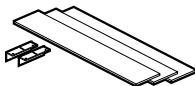


Visual Board

MODEL#	DIMENSIONS	FREIGHT CLASS	WT/LBS.	CUBIC FT.	LIST PRICE
GVB4848	D x W x H 4 x 48 x 48	85	122	9.25	\$1695

Includes white board and two side opening doors containing cork board on right door and 50-sheet paper writing pad on left door. Marker board can be used for projection.

• **NOTE:** Care should be taken to mount the units. Units should be mounted to wall studs using correct fasteners. Failure to do so may result in collapse of the unit and subsequent personal injury. **Mounting hardware not included.** Mounting hardware used should be based on wall material. Consult an installation professional for proper wall mounting.

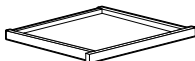


Counter Weight Kit

LFCWKIT36	6 x 33 x 1	60	40	0.25	\$754
-----------	------------	----	----	------	--------------

3 metal plates. Plates mount to the underside of any 36" wide Lateral File or Mixed Storage/Drawer cabinet. Includes mounting hardware. Must be ordered separately. Field installed.

• To comply with ANSI/BIFMA stability tests, the Lateral File Counter Weight Kit MUST be used with the appropriate Lateral Files and Mixed Storage Cabinets.



Center Drawer

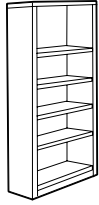
CD20	18 x 20 x 3	100	8	1	\$214
------	-------------	-----	---	---	--------------

Laminate drawer front is attached to a 4-sided frame. Recommended for use on small L-shaped units, and on 30" x 60" and 66" desks.

Required Specifications

Finish (bookcases)

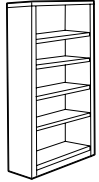
BOOKCASES



Bookcase - 84" High

MODEL#	DIMENSIONS D x W x H	FREIGHT CLASS	WT/LBS.	CUBIC FT.	LIST PRICE
GHBC84	12 x 36 x 84	125	198	26	\$1466

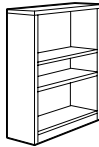
One fixed heavy duty shelf and **four adjustable shelves**. Shipped fully assembled.



Bookcase - 72" High

GHBC72	12 x 36 x 72	100	173	20	\$1223
--------	--------------	-----	-----	----	---------------

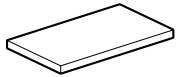
One fixed heavy duty shelf and **four adjustable shelves**. Shipped fully assembled.



Bookcase - 48½" High

GHBC48	12 x 36 x 48	100	118	13.7	\$899
--------	--------------	-----	-----	------	--------------

Two adjustable heavy duty shelves. Shipped fully assembled.



Bookcase Shelf

GHBCSHELF	11 x 34 x 1	100	13	1.60	\$276
-----------	-------------	-----	----	------	--------------

Extra shelf for bookcases. 1" thick.

Required Specifications

Finish



The design of Princeton reflects the personality of today's young, dynamic workforce. The freestanding, modular components build out from you and where you work. With over 500 available components, Princeton offers a flexible footprint that's simple to reconfigure. A variety of storage options allows you to do more with less space.

Princeton delivers contemporary design to the workplace; whether it be in Commercial and Corporate offices, Government offices, Small Businesses, Banking, Legal, Accounting, Hospitality or the professional home office. Every element, from the mix of materials and finishes to open storage pieces, floating modesties and overlapping surfaces, has been designed to provide visual appeal and intelligent function. Princeton is a freestanding and fully modular collection offering maximum flexibility; ease of installation and facilitates simple reconfigurations. The overlapping worksurface design also allows the footprint to adapt to smaller spaces by just a few inches.

Features and Benefits

- 1" thick worksurfaces in thermally fused or high pressure laminate
- Worksurfaces feature Global's preferred edging in matching color
- Counterweights standard on all mobile pedestals, lateral files and credenzas
- Handles & pulls in satin anodized finish standard on all credenza, pedestal drawers and cabinet doors
- Monoposts and hutch supports standard in tungsten finish
- Benches double as lateral filing
- Pull-out equipment shelves on select credenzas
- Energy efficient LED lighting for overhead storage cabinets
- Grommets and power blocks to accommodate power/data needs
- Choose glass or fabric equipment screens



Bench doubles as lateral filing



Pull out equipment shelf
(printer not included)



Bookshelf with accessory hook

GENERAL INFORMATION

- Over 500 components are available
- No cubicles or panels needed for configurations
- Product can be added and reconfigured as needed
- Princeton desk and storage products have been tested and comply with all BIFMA mechanical tests.
- For environmental certifications, please visit globalfurnituregroup.com.

WORKSURFACES

- 1" thick high performance thermally fused laminate tops sealed with Global's preferred edge detail in matching color
- High Pressure Tops are available in all Princeton laminate finishes at an extended lead time. Please see model # for pricing and availability
- Products specified with the high pressure laminate option are finished on the underside of the surface with a kraft paper backing.
- Worksurfaces with metal legs which have a span of 54" and over are standard with metal support channel. Support channels come in Black (BLK) only. 24"D and 30"D - 1 - 2"H support channel
36"D - 2 - 2"H support channels

CONSTRUCTION

- Laminate end panel and metal leg products are **not intended** to be combined for the most visually compatible design. They are, however, interchangeable if required.
- All components have Global's preferred matching edge
- Leveling glides are standard on all floor units.
- End panels are 1.5" thick on laminate end panel desks and credenzas. Cabinet end panels are 11/16" thick.
- 1" x 2" metal frame legs finished in Tungsten (**TTU**), Black (**TBL**) or Designer White (**TDW**) for desks and returns (closed 'O' style leg)
- 1" x 2.5" metal frame legs finished in Tungsten (**TTU**), Black (**TBL**) or Designer White (**TDW**) for freestanding tables (open 'U' style leg)
- Constructed of 45 lb. density particleboard with high performance thermally fused laminate.
- Mobile pedestals and mobile lateral files come standard with front locking casters
- Counterweights are standard on all pedestals, lateral files, credenzas and cabinets
- Rolling table come standard with non-locking casters
- Laminate shelves are 11/16" thick and edged on all 4 sides.
- Tempered glass is 6mm thick with satin-etched finish on one side.
- Credenzas come standard with file bars for side-to-side and front-to-back letter and legal filing capability.
- Handles and pulls in satin anodized finish are standard on all credenza, pedestal drawers and cabinet doors.
- Pull-out equipment shelves are available on select credenzas.
- Grommets and power blocks are available to accommodate power/data needs.

EDGE DETAILS

- All worksurfaces and components have Global's preferred matching edge detail on all sides
- Edging cannot be specified separately. No substitutions.

STORAGE

- Mobile storage greater than 25.5"H may only be used with 29"H Princeton products with laminate end panels or gables. Princeton products with **metal legs** will not accommodate anything higher than 25.5".
- Roll-out shelf on credenza holds up to 80 lbs
- All cabinets with side open shelf area that aligns with 29"H or 27"H credenzas - fixed shelf is 1" thick
- Recycling/waste drawer accommodates 1 recycling basket and 1 waste basket

LAMINATE MODESTY PANELS

- Standard on all desks with laminate end panels, returns with laminate end panels and bridges for laminate end panel desks.
- Flush on Freestanding Returns with laminate end panels
- Recessed 4"D on 24"D desks with laminate end panels, 5"D on 30"D desks with laminate end panels and 6"D on 36"D desks with laminate end panels.
- Recessed 4"D on 24"D, 5"D on 30"D, and 6"D on 36"D flush and overlapping returns with laminate end panels.
- Recessed 4" on 24"D and 5"D on 30"D flush and overlapping bridges with laminate end panels.
- Desks and returns feature modesty panel that is flush with end panel
- Bottom of laminate modesty panel is 17 3/4" from floor.

GLASS DESKTOP PANELS

- Glass desktop panel is sold separately. See selection on page 77.
- Available for installation onto desks, returns, bridges and conference tops
- Made of 6mm tempered glass with satin-etched finish on one side
- On-site installation is required. Installation instructions will be provided.

FABRIC DESKTOP/MODESTY PANELS

- Fabric desktop/fabric modesty panels are sold separately. See selection on page 77.
- Available in:
 - Grade 2:** Lola
 - Grade 3:** Anchorage, Merge
- On-site installation is required. Installation instructions included with product.
- Non-tackable
- Bottom of fabric modesty panel is 15.5" from floor

CREDENZAS

- Available in 29", 27" and 23" heights
- 29"H connect to flush returns, flush conference tops and flush bridges
- 27"H connect to overlapping returns, overlapping conference tops and overlapping bridges
- Fixed drawer widths - see individual models for details
- Upper adjustable shelf must be removed when products with laminate modesty panels are installed (i.e. PN2448RFR flush return with laminate end panel or PN2436BF flush bridge for laminate end panel desk)
- Connection of flush or overlapping surfaces to credenzas is only possible over full height opening
- All credenza tops are 1" thick
- Grommet location is 2.5" from the back edge to the cut out edge

LOCKS

- Standard on all credenzas, storage cabinets, lateral files, pedestals & benches
- Lock on all credenzas, cabinets and pedestals is always on the bottom drawer
- All components within a workstation or private office can be keyed alike. For up to 40 key numbers, the lead times are standard. For projects larger than 40 offices, additional lock numbers are available. Delivery will be extended an additional week at no upcharge.
- To order specified keying, tag each component of each workstation or office with a lock number between 401 and 440.
- Storage cabinets and pedestal with box/box/file drawer - only five drawer and lower box drawer are locking. Credenza file drawer lock secures both drawers.
- Key alike or specific key number optional for all products with locks
- Reserved for new orders greater than \$20,000 list, all Princeton units with locks may be ordered with **CA** cap option and specific lock cores/keys can be ordered separately for field installation rather than specifying duplicate product lines with different key numbers.
- When **CA** option is specified, product will ship with a cap over the empty lock housing.
- Separately order the appropriate number of cores with keys; use product code **SIL-CORE-H-SHOE** for Silver core/key sets. Specify quantity and lock number required. One order line per key number required. Key number range: 401-440. **Must be ordered at the same time product is ordered with CA lock cap option specified.**
- One core removal key is required. Recommend one core removal for every 25 cores ordered. Order as **REMOVE-K-H-SHOE**.
- No charge applies for separate lock cores or core removal keys only when ordered with product. If replacement lock core and key required, contact Customer Care for applicable product code and pricing.

HUTCHES & OVERHEAD STORAGE

- Available in 60", 72" and 84" widths
- Hutches with full back feature one small hole in each corner for wire pass through
- 15.75" height clearance between worksurface and underside of hutch
- Overhead Storage Cabinets have full width lower storage with center divider
- Hutches feature 1" x 2" steel support frame in Black (**TBL**), Designer White (**TDW**) or Tungsten (**TTU**).
- Laminate and tempered glass sliding doors available
- Hutches cannot be placed on desks with laminate end panels
- Wall hung mounting rails are provided; wall fastener hardware is not included.
- Locks are not available
- Energy efficient LED lighting available (page 106)

TABLES

- 1" x 2.5" open metal frame leg. Available finish options: Black (**TBL**), Designer White (**TDW**) or Tungsten (**TTU**).
- Standard with 1" thick top and Global's preferred edging in matching color
- 120" and 144" wide table tops with center leg are shipped in two pieces
- Tables which have a span of 54" or wider are standard with 2"H metal support channel(s)
- Grommets and power block cutouts are available for most tables. Due to support channel location(s) for all 29" high tables, quote request required. Contact our Specials Department.
- Available standard with levelers or locking casters.
- Locking casters available in grey finish only.
- Casters prevent tables from sitting flush against each other, vertically or horizontally

KEYBOARDS

- Keyboard tray adapter kits are required to accommodate worksurface support channels on the following: freestanding desks with metal legs, returns with metal legs, bridges for desks and returns with metal legs, and returns with bookshelf.

TACKBOARDS

- Tackboards available for hutches and overhead units.
- Available to fit 60", 72" and 84" widths
- Available in:
 - Grade 1:** Jenny, Quilt, Terrace, Urban, Waterfall
 - Grade 2:** Imprint, Lola
 - Grade 3:** Anchorage, Merge
- Contact customer care for COM selection.

CUSHIONS

- Sold separately.
- Cushions available in all Global seating fabrics. Contact customer care for COM selection and procedure.

CONNECTION

- Metal flat plates and wood screws are provided for connection between two units.

SPECIAL SIZES

- Custom widths, depths and heights are available, but require a custom quote. Please contact Customer Care for more information.
- Custom orders must indicate the "custom quote number" and list price as provided by Customer Care.
- Changes to a custom quote are not permissible. Any revisions will necessitate a new quotation.

TASK LIGHTS

- Optional, energy efficient LED task lights (ultra slim design) are available for mounting under hutches and overheads
- Hutches and overhead storage cabinets are pre-drilled for easy installation
- Available in 12", 20" and 40" widths

WIRE MANAGEMENT

- 2"W x 2"H
- Plastic tray flexes to receive and hold electrical and data wires
- Quickly attaches with double-sided tape (included)

MONOPOST

- Standard support for conference tops; support for select desks and returns
- 4" square post with 10" square base

PLANTERS

- Plastic planter pots provided
- 8½" diameter x 8"H
- Available in Black (**BK**) or White (**WT**). Must specify at time of order.

SHIPPING

- Items are shipped R.T.A. (Ready To Assemble) unless otherwise noted
- Shipped in 1 carton unless otherwise noted
- Connecting hardware included

1. SPECIFY MODEL NUMBER

2. SPECIFY FINISHES

Laminate Finishes

Top/base/door, drawer and cabinet fronts:

ACJ	Absolute Acajou
ASN	Asian Night
AWC	Avant Cherry
AWH	Avant Honey
BLK	Black
BZD	Blizzard
BRC	Brushed Cobalt
CMB	Clear Maple
CGY	Custom Grey
DES	Dark Espresso
DWT	Designer White
FAS	Fashionista
FCL	First Class
NBL	Noce Biondo
NGL	Noce Grigio
NEL	Noce Leggero
NML	Noce Medio
QTM	Quartered Mahogany
SBY	Sheer Beauty
SDT	Stonedust
WHE	Walnut Heights
WCR	Winter Cherry
WHC	White Chocolate

Monopost Finishes

4" square monopost is available in Tungsten (TTU), Black (TBL) or Designer White (TDW)

Planters

Planter pots are standard in white. Available in Black (BK) at no upcharge. Must specify at time of order.

Metal Frame Desk Legs

1" x 2" metal frame legs are available in Tungsten (TTU), Black (TBL) or Designer White (TDW)

Metal Frame Table Legs

1" x 2.5" metal frame legs are available in Tungsten (TTU), Black (TBL) or Designer White (TDW)

Metal Hutch Supports

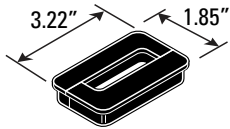
1" x 2" metal supports are available in Tungsten (TTU), Black (TBL) or Designer White (TDW)

For detailed finish specification guidelines, please download the **Princeton Design Guide** at www.globalfurnituregroup.com

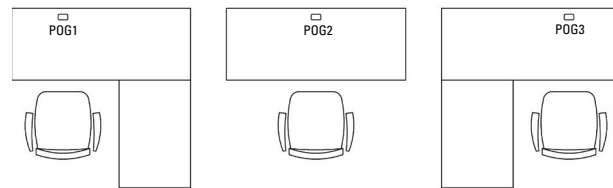
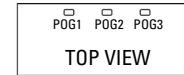
3. SPECIFY OPTIONS

GROMMETS

- One grommet in satin anodized finish is standard on many components, as specified
- Additional grommets may be available in other standard worksurface locations (left, center or right)
- Order as: **Left POG1, Center POG2 or Right POG3: Add \$96**



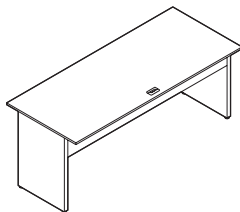
- Worksurface Grommet hole dimensions are 3.22" W x 1.85"D
- Standard grommet position is POG2 in desks, returns, bridges and conference tops
- Modesty panel pass through hole dimensions are 3.43"W x 2"H
- Grommets may be placed at non-standard locations. Order as **PCSG - Add \$96**. A drawing must be supplied with vertical and horizontal dimensions to the center of the cut-out (as in drawing above)
- Components that come standard with grommet may be ordered without a grommet. Order as **RSG - Add \$53**.
- Grommet only available at POG2 on the following 48"W worksurfaces:
 - Desks: PN2448DK, PN3048DK, PN3648DK
 - Returns, flush: PN2448RFR, PN2448RFL



POWER BLOCK

- Power Block (model **PGDPS20**) with 1 power outlet, 12 foot long power cord, for mounting under worksurfaces or inside of laminate end panels
- Power Block (model **PGDPS21**) with 2 power outlets and 1 data opening, 12 foot long power cord, for mounting under worksurfaces or inside of laminate end panels
- Power Bar (model **PGDPS41**) with 4 power outlets and 1 data opening, 12 foot long power cord, for mounting behind credenza pull-out shelf or at back of credenza opening
- Rectangular shape. Finished in Tungsten (TUN)
- Power Block dimensions:
 - PGDPS20: 2.5"D x 3.5"W x 2.25"H
 - PGDPS21: 2.5"D x 6.75"W x 2.25"H
- Power Bar dimensions:
 - PGDPS41: 2.5"D x 10.25"W x 2.22"H

FREESTANDING DESKS - LAMINATE END PANELS **MODEL#** **DIMENSIONS** **FREIGHT CLASS** **WT./LBS.** **CUBIC FT.** **LIST PRICE** **HP ADD**

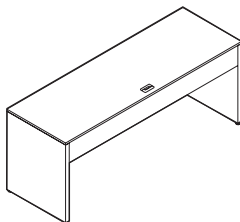


Freestanding Desk

	D x W x H						
PN2484DK	24 x 84 x 29	65	117	5	\$1033	\$120	
PN2478DK	24 x 78 x 29	70	111	5	\$1003	\$119	
PN2472DK	24 x 72 x 29	70	105	5	\$963	\$118	
PN2466DK	24 x 66 x 29	65	101	4	\$951	\$118	
PN2460DK	24 x 60 x 29	65	95	4	\$906	\$118	
PN2454DK	24 x 54 x 29	60	95	3	\$906	\$119	
PN2448DK	24 x 48 x 29	70	84	4	\$868	\$114	
PN3084DK	30 x 84 x 29	70	133	6.50	\$1049	\$123	
PN3078DK	30 x 78 x 29	70	127	6	\$1021	\$121	
PN3072DK	30 x 72 x 29	70	120	5.50	\$988	\$121	
PN3066DK	30 x 66 x 29	65	114	5	\$958	\$120	
PN3060DK	30 x 60 x 29	70	109	5	\$925	\$118	
PN3054DK	30 x 54 x 29	60	108	3.25	\$925	\$119	
PN3048DK	30 x 48 x 29	65	98	4	\$882	\$118	
PN3684DK	36 x 84 x 29	70	152	8	\$1104	\$137	
PN3678DK	36 x 78 x 29	70	145	7	\$1074	\$132	
PN3672DK	36 x 72 x 29	70	138	7	\$1055	\$129	
PN3666DK	36 x 66 x 29	70	130	6	\$1007	\$121	
PN3660DK	36 x 60 x 29	70	117	6	\$974	\$119	
PN3654DK	36 x 54 x 29	60	120	4	\$974	\$120	
PN3648DK	36 x 48 x 29	70	111.50	6.50	\$891	\$118	

Standard with inset end panel on both ends and 10" h modesty panel with pass through grommet. Connects to flush return with laminate end panel, bridges for laminate end panel desks, flush return with bookshelf, flush conference tops. Can be placed over 27" H freestanding returns or 23" H/27" H credenzas. Grommet in worksurface. Shipped in 2 cartons.

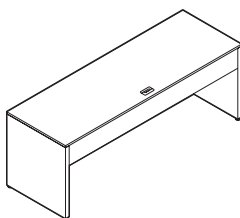
RETURNS - LAMINATE END PANELS **MODEL#** **DIMENSIONS** **FREIGHT CLASS** **WT./LBS.** **CUBIC FT.** **LIST PRICE** **HP ADD**



Freestanding Return- 29" H

PN248429R	24 x 84 x 29	65	131	5	\$1008	\$135	
PN247829R	24 x 78 x 29	65	127	5	\$980	\$130	
PN247229R	24 x 72 x 29	65	123	5	\$953	\$123	
PN246629R	24 x 66 x 29	65	118	4	\$907	\$120	
PN246029R	24 x 60 x 29	65	112	4	\$901	\$118	

Standard with flush laminate 1.5" thick end panels. 10" h thick modesty panel without pass through grommet. Connects to flush return with laminate end panel, bridges for laminate end panel desks, flush return with bookshelf, flush conference tops. Can be placed over 27" H freestanding returns or 23" H/27" H credenzas. Grommet in worksurface.



Freestanding Return- 27" H

PN248427R	24 x 84 x 27	65	129	5	\$996	\$131	
PN247827R	24 x 78 x 27	65	125	5	\$965	\$127	
PN247227R	24 x 72 x 27	65	120	5	\$939	\$121	
PN246627R	24 x 66 x 27	65	116	4	\$911	\$119	
PN246027R	24 x 60 x 27	65	109	4	\$852	\$117	

Standard with flush laminate 1.5" thick end panels. 10" h thick modesty panel without pass through grommet. Supports overlapping return with laminate end panel, overlapping bridge for laminate end panel desks, overlapping return with bookshelf, overlapping conference top. Can be placed under desk. Grommet in worksurface.

Required Specifications

Top finish
Base finish

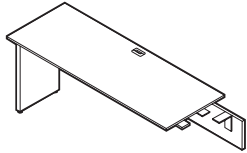
Optional Specifications

HP laminate
POG1, POG3 - additional grommet
PCSG - custom grommet
RSG - remove grommet

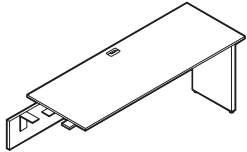
Accessories

Power block Wire manager
Keyboard tray Desktop screen
Keyboard mechanism (not available on 27" H return)

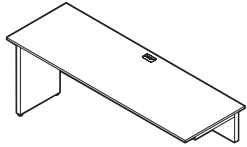
RETURNS - LAMINATE END PANELS



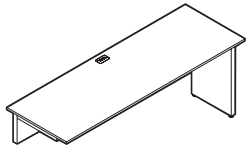
Flush Return - 29" H - LEFT



Flush Return - 29" H - RIGHT



Overlapping Return - 29" H - LEFT



Overlapping Return - 29" H - RIGHT

MODEL#	DIMENSIONS D x W x H	FREIGHT CLASS	WT/LBS.	CUBIC FT.	LIST PRICE	HP ADD
PN2472RFL	24 x 72 x 29	70	95	5.50	\$834	\$129
PN2466RFL	24 x 66 x 29	70	90	5	\$805	\$123
PN2460RFL	24 x 60 x 29	70	84	4.50	\$759	\$119
PN2454RFL	24 x 54 x 29	70	78	4	\$739	\$120
PN2448RFL	24 x 48 x 29	70	72	4	\$706	\$117

Return has no pedestal. Standard with inset end panel on **left**. 10" h modesty panel with pass-through grommet. Connects to Freestanding Desk with laminate end panels, **29" H** Freestanding Returns and **29" H** Credenzas. Grommet in worksurface.

PN2472RFR	24 x 72 x 29	70	95	5.50	\$834	\$129
PN2466RFR	24 x 66 x 29	70	90	5	\$805	\$123
PN2460RFR	24 x 60 x 29	70	84	4.50	\$759	\$119
PN2454RFR	24 x 54 x 29	70	88	4	\$739	\$120
PN2448RFR	24 x 48 x 29	70	72	4	\$706	\$117

Return has no pedestal. Standard with inset end panel on **right**. 10" h modesty panel with pass-through grommet. Connects to Freestanding Desk with laminate end panels, **29" H** Freestanding Returns and **29" H** Credenzas. Grommet in worksurface.

PN2484ROL	24 x 84 x 29	70	118	6	\$925	\$107
PN2478ROL	24 x 78 x 29	65	126	5	\$861	\$106
PN2472ROL	24 x 72 x 29	70	104	5	\$832	\$100

Standard with inset laminate end panel on **left** and 10" h modesty panel with pass-through grommet. Overlaps **27" H** Credenza and **27" H** Freestanding Returns. Grommet in worksurface. 1" spacer included.

PN2484ROR	24 x 84 x 29	70	118	6	\$925	\$107
PN2478ROR	24 x 78 x 29	65	126	5	\$861	\$106
PN2472ROR	24 x 72 x 29	70	104	5	\$832	\$100

Standard with inset laminate end panel on **right** and 10" h modesty panel with pass-through grommet. Overlaps **27" H** Credenza and **27" H** Freestanding Returns. Grommet in worksurface. 1" spacer included.

Required Specifications

Top finish
Base finish

Optional Specifications

HP laminate
POG1, POG3 - additional grommet
PCSG - custom grommet
RSG - remove grommet

Accessories

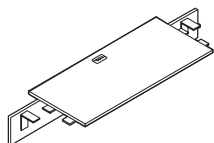
Power block
Keyboard tray
Desktop screen
Wire manager
Keyboard mechanism

BRIDGES FOR LAMINATE END PANEL DESKS

MODEL# DIMENSIONS FREIGHT CLASS WT/LBS. CUBIC FT. LIST PRICE HP ADD

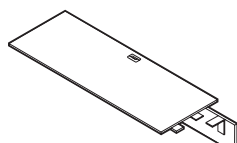
D x W x H

PN2454BF	24 x 54 x 12	65	97	3.50	\$659	\$106
PN2448BF	24 x 48 x 12	70	77	4.50	\$600	\$87
PN2442BF	24 x 42 x 12	70	70	4	\$572	\$88
PN2436BF	24 x 36 x 12	70	63	4	\$538	\$86



Flush Bridge

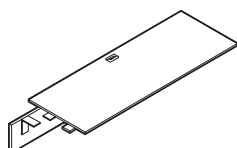
Standard with 10" h modesty panel with pass-through grommet. Connects between any two: Freestanding Desk with laminate end panels, **29" H** Freestanding Returns, Conference top for U configurations or **29" H** Credenzas opening. Subtop finish is Granite with black edge. Grommet in worksurface.



Overlapping Bridge - LEFT*

PN2478BOL	24 x 78 x 12	65	119	4	\$788	\$118
PN2472BOL	24 x 72 x 12	70	96	5	\$748	\$108
PN2466BOL	24 x 66 x 12	70	90	4.50	\$722	\$100
PN2460BOL	24 x 60 x 12	70	83	4.50	\$712	\$96

Standard with 10" h modesty panel with pass-through grommet. Connects Freestanding Desk with laminate end panels, **29" H** Freestanding Returns, Conference top for U configurations on one end, and overlaps **27" H** Credenza or **27" H** Freestanding Return on other end. Subtop finish is Granite with black edge. Grommet in worksurface. Includes 1" spacer, one side only.



Overlapping Bridge - RIGHT*

PN2478BOR	24 x 78 x 12	65	119	4	\$788	\$118
PN2472BOR	24 x 72 x 12	70	96	5	\$748	\$108
PN2466BOR	24 x 66 x 12	70	90	4.50	\$722	\$100
PN2460BOR	24 x 60 x 12	70	83	4.50	\$712	\$96

Standard with 10" h modesty panel with pass-through grommet. Connects Freestanding Desk with laminate end panels, **29" H** Freestanding Returns, Conference top for U configurations on one end, and overlaps **27" H** Credenza or **27" H** Freestanding Return on other end. Subtop finish is Granite with black edge. Grommet in worksurface. Includes 1" spacer, one side only.

Required Specifications

Top finish
Base finish

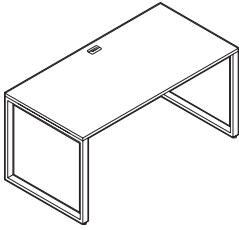
Optional Specifications

HP laminate
POG1, POG3 - additional grommet*
PCSG - custom grommet
RSG - remove grommet

Accessories

Power block
Keyboard tray
Desktop screen
Wire manager
Keyboard mechanism

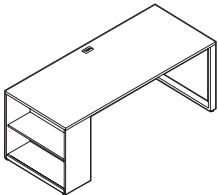
FREESTANDING DESKS WITH METAL LEGS



Freestanding Desk with Metal Legs

MODEL#	DIMENSIONS D x W x H	FREIGHT CLASS	WT/LBS.	CUBIC FT.	LIST PRICE	HP ADD
PN2484DM	24 x 84 x 29	250	111	43.41	\$1595	\$253
PN2478DM	24 x 78 x 29	250	109	41.92	\$1475	\$236
PN2472DM	24 x 72 x 29	250	106	38.92	\$1293	\$208
PN2466DM	24 x 66 x 29	250	102	31.44	\$1281	\$206
PN2460DM	24 x 60 x 29	250	91	29.94	\$1253	\$202
PN2454DM	24 x 54 x 29	250	88	29.94	\$1217	\$197
PN2448DM	24 x 48 x 29	250	76	28.44	\$1077	\$175
PN3084DM	30 x 84 x 29	250	137	53.89	\$1659	\$262
PN3078DM	30 x 78 x 29	250	124	52.40	\$1542	\$247
PN3072DM	30 x 72 x 29	250	117	47.90	\$1382	\$221
PN3066DM	30 x 66 x 29	250	110	38.92	\$1335	\$213
PN3060DM	30 x 60 x 29	250	104	38.17	\$1293	\$208
PN3054DM	30 x 54 x 29	250	99	37.43	\$1267	\$205
PN3048DM	30 x 48 x 29	250	82	35.93	\$1119	\$182
PN3684DM	36 x 84 x 29	250	154	65.87	\$1883	\$297
PN3678DM	36 x 78 x 29	250	139	62.87	\$1725	\$273
PN3672DM	36 x 72 x 29	250	132	59.88	\$1679	\$264
PN3666DM	36 x 66 x 29	250	123	47.16	\$1471	\$235
PN3660DM	36 x 60 x 29	250	117	46.41	\$1422	\$226
PN3654DM	36 x 54 x 29	250	106	44.91	\$1343	\$214
PN3648DM	36 x 48 x 29	250	92	44.91	\$1215	\$197

Standard with two 1" x 2" metal open frame legs with support channel(s). Connects to flush returns with metal leg, bridges for desks and returns with metal leg, flush return with bookshelf and flush conference tops. Grommet in worksurface. Shipped in 3 cartons.

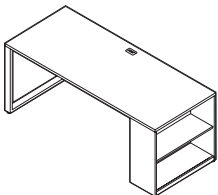


LEFT

Freestanding Desk with Bookshelf*

PN3060DBL	30 x 60 x 29	250	123	51.65	\$1402	\$236
PN3066DBL	30 x 66 x 29	250	129	52.40	\$1549	\$258
PN3072DBL	30 x 72 x 29	250	136	61.38	\$1595	\$261
PN3078DBL	30 x 78 x 29	250	150	65.87	\$1724	\$283
PN3084DBL	30 x 84 x 29	250	156	67.37	\$1817	\$319
PN3672DBL	36 x 72 x 29	250	154	73.35	\$1657	\$261
PN3678DBL	36 x 78 x 29	250	161	76.35	\$1799	\$283
PN3684DBL	36 x 84 x 29	250	176	79.34	\$2027	\$319

12"D Bookcase with adjustable shelf on **left**. One 1" x 2" metal open frame leg with support channel(s). Right side connects to flush returns with metal leg, bridges for desks and returns with metal leg, flush return with bookshelf, flush conference tops. Grommet in worksurface. Shipped in 3 cartons.



RIGHT

Freestanding Desk with Bookshelf*

PN3060DBR	30 x 60 x 29	250	123	51.65	\$1402	\$218
PN3066DBR	30 x 66 x 29	250	129	52.40	\$1549	\$239
PN3072DBR	30 x 72 x 29	250	136	61.38	\$1595	\$247
PN3078DBR	30 x 78 x 29	250	150	65.87	\$1724	\$260
PN3084DBR	30 x 84 x 29	250	156	67.37	\$1817	\$278
PN3672DBR	36 x 72 x 29	250	154	73.35	\$1657	\$253
PN3678DBR	36 x 78 x 29	250	161	76.35	\$1799	\$273
PN3684DBR	36 x 84 x 29	250	176	79.34	\$2027	\$286

12"D Bookcase with adjustable shelf on **right**. One 1" x 2" metal open frame leg with support channel(s). Left side connects to flush returns with metal leg, bridges for desks and returns with metal leg, flush return with bookshelf, flush conference tops. Grommet in worksurface. Shipped in 3 cartons.

Required Specifications

Top finish
Base finish*
Leg finish*

Optional Specifications

HP laminate
POG1, POG3 - additional grommet
PCSG - custom grommet
RSG - remove grommet

Accessories

Power block Wire manager
Keyboard tray Keyboard mechanism
Desktop screen
Keyboard tray mounting kit*

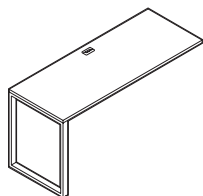
RETURNS WITH METAL LEGS

MODEL# DIMENSIONS FREIGHT CLASS WT./LBS. CUBIC FT. LIST PRICE HP ADD

D x W x H

PN2448FML	24 x 48 x 29	150	56	12	\$744	\$114
PN2454FML	24 x 54 x 29	150	68	13	\$893	\$137
PN2460FML	24 x 60 x 29	150	71	13	\$937	\$144
PN2466FML	24 x 66 x 29	150	82	14	\$974	\$151
PN2472FML	24 x 72 x 29	150	86	20	\$1004	\$156
PN2478FML	24 x 78 x 29	150	89	21	\$1118	\$170

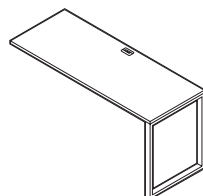
PN3048FML	30 x 48 x 29	150	61	15	\$790	\$121
PN3054FML	30 x 54 x 29	150	78	16	\$931	\$142
PN3060FML	30 x 60 x 29	150	82	16.50	\$976	\$151
PN3066FML	30 x 66 x 29	150	89	17	\$1008	\$156
PN3072FML	30 x 72 x 29	150	96	23	\$1072	\$164
PN3078FML	30 x 78 x 29	250	103	26	\$1172	\$180



LEFT

Flush Return with Metal Leg

1" x 2" metal frame leg on **left**. Support channel(s) included for units 72"W and above. Connects to freestanding desk with metal legs, freestanding desk with bookshelf and metal leg, 29"H credenza opening. Grommet in worksurface. Shipped in 2 cartons.



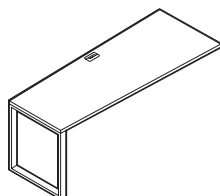
RIGHT

Flush Return with Metal Leg

PN2448FMR	24 x 48 x 29	150	56	12	\$744	\$114
PN2454FMR	24 x 54 x 29	150	68	13	\$893	\$137
PN2460FMR	24 x 60 x 29	150	71	13	\$937	\$144
PN2466FMR	24 x 66 x 29	150	82	14	\$974	\$151
PN2472FMR	24 x 72 x 29	150	86	20	\$1004	\$156
PN2478FMR	24 x 78 x 29	150	89	21	\$1118	\$170

PN3048FMR	30 x 48 x 29	150	61	7.50	\$790	\$121
PN3054FMR	30 x 54 x 29	150	78	16	\$931	\$142
PN3060FMR	30 x 60 x 29	150	83	16.50	\$976	\$151
PN3066FMR	30 x 66 x 29	150	89	17	\$1008	\$156
PN3072FMR	30 x 72 x 29	150	96	23	\$1072	\$164
PN3078FMR	30 x 78 x 29	250	103	26	\$1172	\$180

1" x 2" metal frame leg on **right**. Support channel(s) included for units 72"W and above. Connects to freestanding desk with metal legs, freestanding desk with bookshelf and metal leg, 29"H credenza opening. Grommet in worksurface. Shipped in 2 cartons.

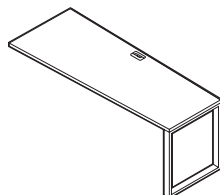


LEFT

Flush Wedge Return w/Metal Leg

PN3048FTL	30 x 48 x 29	150	61	15	\$780	\$120
PN3054FTL	30 x 54 x 29	150	78	16	\$921	\$142
PN3060FTL	30 x 60 x 29	150	83	16.50	\$976	\$151
PN3066FTL	30 x 66 x 29	150	89	17	\$1029	\$158
PN3072FTL	30 x 72 x 29	150	96	23	\$1072	\$164

1" x 2" metal frame leg on **left**. Support channel(s) included for units 72"W and above. 30"D has 24"D leg. 36"D has 30"D leg. Connects to freestanding desk with metal legs, freestanding desk with bookshelf and metal leg, 29"H credenza opening. Grommet in worksurface. Shipped in 2 cartons.



RIGHT

Flush Wedge Return w/Metal Leg

PN3048FTR	30 x 48 x 29	150	61	15	\$780	\$120
PN3054FTR	30 x 54 x 29	150	78	16	\$921	\$142
PN3060FTR	30 x 60 x 29	150	83	16.50	\$976	\$151
PN3066FTR	30 x 66 x 29	150	89	17	\$1029	\$158
PN3072FTR	30 x 72 x 29	150	96	23	\$1072	\$164

1" x 2" metal frame leg on **right**. Support channel(s) included for units 72"W and above. 30"D has 24"D leg. 36"D has 30"D leg. Connects to freestanding desk with metal legs, freestanding desk with bookshelf and metal leg, 29"H credenza opening. Grommet in worksurface. Shipped in 2 cartons.

Required Specifications

Top finish
Leg finish

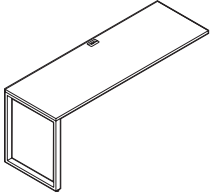
Optional Specifications

HP laminate
POG1, POG3 - additional grommet
PCSG - custom grommet
RSG - remove grommet

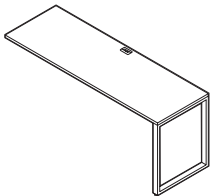
Accessories

Power block
Keyboard tray
Desktop screen
Keyboard tray mounting kit
Wire manager
Keyboard mechanism

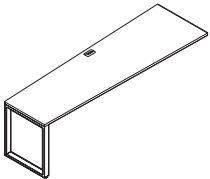
OVERLAPPING RETURNS WITH METAL LEGS



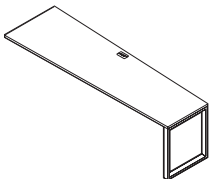
LEFT
Overlapping Return w/Metal Leg



RIGHT
Overlapping Return w/Metal Leg



LEFT
Overlapping Wedge Return w/Metal Leg



RIGHT
Overlapping Wedge Return w/Metal Leg

MODEL#	DIMENSIONS D x W x H	FREIGHT CLASS	WT./LBS.	CUBIC FT.	LIST PRICE	HP ADD
PN24600ML	24 x 60 x 29	150	71	13	\$835	\$129
PN24660ML	24 x 66 x 29	150	82	14	\$859	\$132
PN24720ML	24 x 72 x 29	150	86	20	\$889	\$137
PN24780ML	24 x 78 x 29	150	89	21	\$1059	\$162
PN24840ML	24 x 84 x 29	150	91	22	\$1225	\$187
PN30600ML	30 x 60 x 29	150	83	16.50	\$873	\$133
PN30660ML	30 x 66 x 29	150	89	17	\$904	\$139
PN30720ML	30 x 72 x 29	150	96	23	\$956	\$146
PN30780ML	30 x 78 x 29	250	103	26	\$1134	\$175
PN30840ML	30 x 84 x 29	150	116	27	\$1269	\$194

1" x 2" metal frame leg on **left**. Support channel(s) included for 84"W unit only. Overlaps 27"H credenza opening. Grommet in worksurface. Shipped in 2 cartons.

PN24600MR	24 x 60 x 29	150	71	13	\$835	\$129
PN24660MR	24 x 66 x 29	150	82	14	\$859	\$132
PN24720MR	24 x 72 x 29	150	86	20	\$889	\$137
PN24780MR	24 x 78 x 29	150	89	21	\$1059	\$162
PN24840MR	24 x 84 x 29	150	91	22	\$1225	\$187
PN30600MR	30 x 60 x 29	150	83	16.50	\$873	\$133
PN30660MR	30 x 66 x 29	150	89	17	\$904	\$139
PN30720MR	30 x 72 x 29	150	96	23	\$956	\$146
PN30780MR	30 x 78 x 29	250	103	26	\$1134	\$175
PN30840MR	30 x 84 x 29	150	137	27	\$1269	\$194

1" x 2" metal frame leg on **right**. Support channel(s) included for 84"W unit only. Overlaps 27"H credenza opening. Grommet in worksurface. Shipped in 2 cartons.

PN30600TL	30 x 60 x 29	150	83	16.50	\$890	\$137
PN30660TL	30 x 66 x 29	150	89	17	\$923	\$142
PN30720TL	30 x 72 x 29	150	96	23	\$965	\$148
PN30780TL	30 x 78 x 29	250	103	26	\$1154	\$177
PN30840TL	30 x 84 x 29	150	116	27	\$1289	\$197

1" x 2" metal frame leg on **left**. Support channel(s) included for 84"W unit only. 30"D has 24"D leg. 36"D has 30"D leg. Overlaps 27"H credenza opening. Grommet in worksurface. Includes 1" spacer. Shipped in 2 cartons.

PN30600TR	30 x 60 x 29	150	83	16.50	\$890	\$137
PN30660TR	30 x 66 x 29	150	89	17	\$923	\$142
PN30720TR	30 x 72 x 29	150	96	23	\$965	\$148
PN30780TR	30 x 78 x 29	250	103	26	\$1154	\$177
PN30840TR	30 x 84 x 29	150	116	27	\$1289	\$197

1" x 2" metal frame leg on **right**. Support channel(s) included for 84"W unit only. 30"D has 24"D leg. 36"D has 30"D leg. Overlaps 27"H credenza opening. Grommet in worksurface. Includes 1" spacer. Shipped in 2 cartons.

Required Specifications

Top finish
Leg finish

Optional Specifications

HP laminate
POG1, POG3 - additional grommet
PCSG - custom grommet
RSG - remove grommet

Accessories

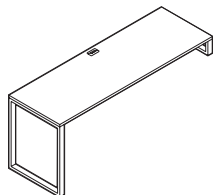
Power block
Keyboard tray
Desktop screen
Keyboard tray mounting kit
Wire manager
Keyboard mechanism

OVERLAPPING RETURNS WITH METAL LEGS

MODEL# DIMENSIONS FREIGHT CLASS WT/LBS. CUBIC FT. LIST PRICE HP ADD

D x W x H

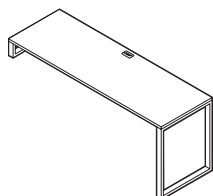
PN2460SOL	24 x 60 x 29	250	83	23.95	\$1226	\$187
PN2466SOL	24 x 66 x 29	250	94	25.45	\$1264	\$194
PN2472SOL	24 x 72 x 29	250	98	34.43	\$1296	\$199
PN2478SOL	24 x 78 x 29	250	101	35.93	\$1409	\$214
PN2484SOL	24 x 84 x 29	250	103	37.43	\$1484	\$226
PN3060SOL	30 x 60 x 29	250	95	26.20	\$1304	\$200
PN3066SOL	30 x 66 x 29	250	101	26.95	\$1343	\$206
PN3072SOL	30 x 72 x 29	250	108	35.93	\$1376	\$209
PN3078SOL	30 x 78 x 29	250	115	40.42	\$1473	\$224
PN3084SOL	30 x 84 x 29	250	128	41.92	\$1571	\$239



LEFT

Overlapping Return w/Metal Leg and Spacer for 23"H Credenza

1" x 2" metal frame leg on **left** and 5"H metal frame spacer on right. Support channel(s) included for units 78"W and above. Overlaps 23"H credenza. Grommet in worksurface. Shipped in 3 cartons.

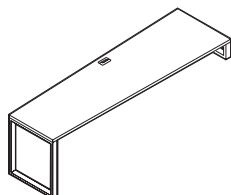


RIGHT

Overlapping Return w/Metal Leg and Spacer for 23"H Credenza

PN2460SOR	24 x 60 x 29	250	83	23.95	\$1226	\$187
PN2466SOR	24 x 66 x 29	250	94	25.45	\$1264	\$194
PN2472SOR	24 x 72 x 29	250	98	34.43	\$1296	\$199
PN2478SOR	24 x 78 x 29	250	101	35.93	\$1409	\$214
PN2484SOR	24 x 84 x 29	250	103	37.43	\$1484	\$226
PN3060SOR	30 x 60 x 29	250	95	26.20	\$1304	\$200
PN3066SOR	30 x 66 x 29	250	101	26.95	\$1343	\$206
PN3072SOR	30 x 72 x 29	250	108	35.93	\$1376	\$209
PN3078SOR	30 x 78 x 29	250	115	40.42	\$1473	\$224
PN3084SOR	30 x 84 x 29	250	128	41.92	\$1571	\$239

1" x 2" metal frame leg on **right** and 5"H metal frame spacer on left. Support channel(s) included for units 78"W and above. Overlaps 23"H credenza. Grommet in worksurface. Shipped in 3 cartons.

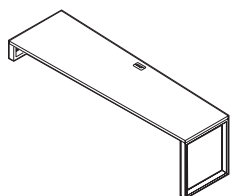


LEFT

Overlapping Wedge Return w/Metal Leg and Spacer for 23"H Credenza

PN3060TSL	30 x 60 x 29	250	95	26.20	\$1281	\$197
PN3066TSL	30 x 66 x 29	250	101	26.95	\$1329	\$205
PN3072TSL	30 x 72 x 29	250	108	35.93	\$1363	\$208
PN3078TSL	30 x 78 x 29	250	115	40.42	\$1460	\$223
PN3084TSL	30 x 84 x 29	250	128	41.92	\$1544	\$236

1" x 2" metal frame leg on **left** and 5"H metal frame spacer on right. Support channel(s) included for units 78"W and above. 24"D leg and 30"D spacer. Overlaps 23"H credenza. Grommet in worksurface. Shipped in 3 cartons.



RIGHT

Overlapping Wedge Return w/Metal Leg and Spacer for 23"H Credenza

PN3060TSR	30 x 60 x 29	250	95	26.20	\$1281	\$197
PN3066TSR	30 x 66 x 29	250	101	26.95	\$1329	\$205
PN3072TSR	30 x 72 x 29	250	108	35.93	\$1363	\$208
PN3078TSR	30 x 78 x 29	250	115	40.42	\$1460	\$223
PN3084TSR	30 x 84 x 29	250	128	41.92	\$1544	\$236

1" x 2" metal frame leg on **right** and 5"H metal frame spacer on left. Support channel(s) included for units 78"W and above. 24"D leg and 30"D spacer. Overlaps 23"H credenza. Grommet in worksurface. Shipped in 3 cartons.

Required Specifications

Top finish
Leg finish

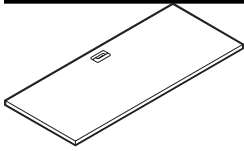
Optional Specifications

HP laminate
POG1, POG3 - additional grommet
PCSG - custom grommet
RSG - remove grommet

Accessories

Power block
Keyboard tray
Desktop screen
Keyboard tray mounting kit
Wire manager
Keyboard mechanism

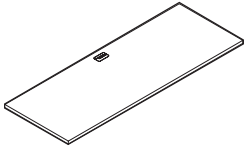
BRIDGES FOR DESKS + RETURNS W/ METAL LEGS



Flush Bridge for Metal Leg Configurations

MODEL#	DIMENSIONS D x W x H	FREIGHT CLASS	WT/LBS.	CUBIC FT.	LIST PRICE	HP ADD
PN2436BFM	24 x 36 x 1	70	31	2	\$351	\$80
PN2442BFM	24 x 42 x 1	70	40	2.50	\$358	\$83
PN2448BFM	24 x 48 x 1	85	44	3	\$376	\$85
PN2454BFM	24 x 54 x 1	70	51	3	\$511	\$113

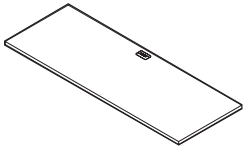
Connects between any two: freestanding desk with metal legs, freestanding desk with bookshelf and metal leg, conference top for U configurations, 29"H credenza opening. Grommet in worksurface.



**LEFT
Overlapping Bridge for Metal Leg Configurations**

PN2460OBL	24 x 60 x 2	70	51	3	\$489	\$102
PN2466OBL	24 x 66 x 2	70	62	3.25	\$505	\$106
PN2472OBL	24 x 72 x 2	92.5	66	6.50	\$515	\$107
PN2478OBL	24 x 78 x 2	92.5	76	6.50	\$697	\$142

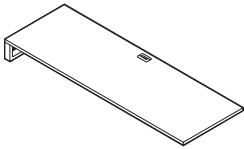
Connects freestanding desk with metal legs, freestanding desk with bookshelf and metal leg, conference top for U configurations flush on one end, and overlaps 27"H credenza opening on the other end. Includes 1" spacer. Grommet in worksurface.



**RIGHT
Overlapping Bridge for Metal Leg Configurations**

PN2460OBR	24 x 60 x 2	70	51	3	\$489	\$102
PN2466OBR	24 x 66 x 2	70	62	3.25	\$505	\$106
PN2472OBR	24 x 72 x 2	92.5	66	6.50	\$515	\$107
PN2478OBR	24 x 78 x 2	92.5	76	6.50	\$697	\$142

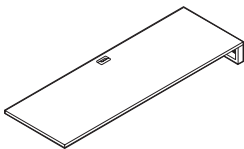
Connects freestanding desk with metal legs, freestanding desk with bookshelf and metal leg, conference top for U configurations flush on one end, and overlaps 27"H credenza opening on the other end. Includes 1" spacer. Grommet in worksurface.



**LEFT
Overlapping Bridge with Metal Spacer for 23"H Credenza***

PN2460OSL	24 x 60 x 6	125	63	9	\$806	\$178
PN2466OSL	24 x 66 x 6	125	74	9.50	\$845	\$186
PN2472OSL	24 x 72 x 6	150	78	16	\$874	\$193
PN2478OSL	24 x 78 x 6	150	88	16	\$988	\$215

One 5"H metal frame spacer with support channel(s). Connects flush on **right** side to freestanding desk with metal legs, freestanding desk with bookshelf and metal leg, or conference top for U configurations. Overlaps 23"H credenza opening on the **left**. Grommet in worksurface. Shipped in 2 cartons.



**RIGHT
Overlapping Bridge with Metal Spacer for 23"H Credenza***

PN2460OSR	24 x 60 x 6	125	63	9	\$806	\$178
PN2466OSR	24 x 66 x 6	125	74	9.50	\$845	\$186
PN2472OSR	24 x 72 x 6	150	78	16	\$874	\$193
PN2478OSR	24 x 78 x 6	150	88	16	\$988	\$215

One 5"H metal frame spacer with support channel(s). Connects flush on **left** side to freestanding desk with metal legs, freestanding desk with bookshelf and metal leg, or conference top for U configurations. Overlaps 23"H credenza opening on the **right**. Grommet in worksurface. Shipped in 2 cartons.

Required Specifications

Top finish
Leg finish*

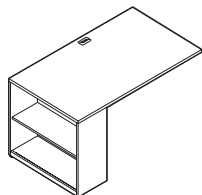
Optional Specifications

HP laminate
POG1, POG3 - additional grommet
PCSG - custom grommet
RSG - remove grommet

Accessories

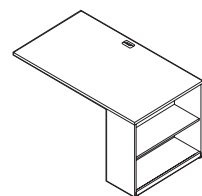
Power block Wire manager
Keyboard tray Keyboard mechanism
Desktop screen
Keyboard tray mounting kit

RETURNS WITH BOOKSHELF



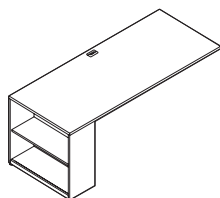
LEFT

Flush Return with Bookshelf



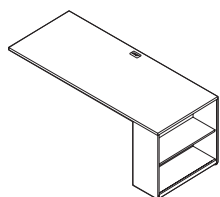
RIGHT

Flush Return with Bookshelf



LEFT

Overlapping Return with Bookshelf



RIGHT

Overlapping Return with Bookshelf

MODEL#	DIMENSIONS D x W x H	FREIGHT CLASS	WT/LBS.	CUBIC FT.	LIST PRICE	HP ADD
PN2460FBL	24 x 60 x 29	150	86	20	\$951	\$145
PN2466FBL	24 x 66 x 29	150	97	20.50	\$1082	\$165
PN2472FBL	24 x 72 x 29	250	101	27	\$1117	\$169
PN2478FBL	24 x 78 x 29	150	111	27	\$1182	\$182
PN2484FBL	24 x 84 x 29	250	106	29	\$1250	\$189
PN3060FBL	30 x 60 x 29	150	102	25.50	\$1007	\$156
PN3066FBL	30 x 66 x 29	150	108	26	\$1144	\$175
PN3072FBL	30 x 72 x 29	250	115	32	\$1180	\$181
PN3078FBL	30 x 78 x 29	250	129	35	\$1265	\$194
PN3084FBL	30 x 84 x 29	250	135	36	\$1385	\$210

12"D Bookcase with adjustable shelf on **left**. With support channel(s). Connects on **right** side to freestanding desk with metal legs or laminate end panels, 29"H freestanding returns, 29"H credenza opening. Laminate shelf is standard. Grommet in worksurface. Shipped in 2 cartons.

PN2460FBR	24 x 60 x 29	150	86	20	\$951	\$145
PN2466FBR	24 x 66 x 29	150	97	20.50	\$1082	\$165
PN2472FBR	24 x 72 x 29	250	101	27	\$1117	\$169
PN2478FBR	24 x 78 x 29	150	111	27	\$1182	\$182
PN2484FBR	24 x 84 x 29	250	106	29	\$1250	\$189
PN3060FBR	30 x 60 x 29	150	102	25.50	\$1007	\$156
PN3066FBR	30 x 66 x 29	150	108	26	\$1144	\$175
PN3072FBR	30 x 72 x 29	250	115	32	\$1180	\$181
PN3078FBR	30 x 78 x 29	250	129	35	\$1265	\$194
PN3084FBR	30 x 84 x 29	250	135	36	\$1385	\$210

12"D Bookcase with adjustable shelf on **right**. With support channel(s). Connects on **left** side to freestanding desk with metal legs or laminate end panels, 29"H freestanding returns, 29"H credenza opening. Laminate shelf is standard. Grommet in worksurface. Shipped in 2 cartons.

PN2484RBL	24 x 84 x 29	250	106	29	\$1231	\$187
PN2490RBL	24 x 90 x 29	250	110	30	\$1369	\$209
PN2496RBL	24 x 96 x 29	250	123	31	\$1440	\$219
PN3084RBL	30 x 84 x 29	250	135	36	\$1281	\$197
PN3090RBL	30 x 90 x 29	250	142	42	\$1402	\$213
PN3096RBL	30 x 96 x 29	250	146	38.50	\$1478	\$225

12"D Bookcase with adjustable shelf on **left**. With support channel(s). **Right** side overlaps 27"H credenza opening, 27"H freestanding return. Laminate shelf is standard. Grommet in worksurface. Shipped in 2 cartons.

PN2484RBR	24 x 84 x 29	250	106	29	\$1231	\$187
PN2490RBR	24 x 90 x 29	250	110	30	\$1369	\$209
PN2496RBR	24 x 96 x 29	250	123	31	\$1440	\$219
PN3084RBR	30 x 84 x 29	250	135	36	\$1281	\$197
PN3090RBR	30 x 90 x 29	250	142	42	\$1402	\$213
PN3096RBR	30 x 96 x 29	250	146	38.50	\$1478	\$225

12"D Bookcase with adjustable shelf on **right**. With support channel(s). **Left** side overlaps 27"H credenza opening, 27"H freestanding return. Laminate shelf is standard. Grommet in worksurface. Shipped in 2 cartons.

Required Specifications

Top finish
Base finish

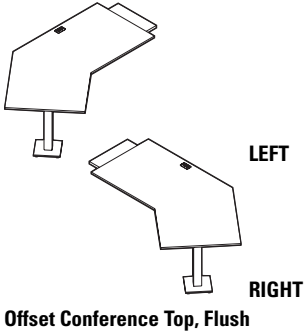
Optional Specifications

HP laminate
POG1, POG3 - additional grommet
PCSG - custom grommet
RSG - remove grommet

Accessories

Power block
Keyboard tray
Desktop screen
Keyboard tray mounting kit
Wire manager
Keyboard mechanism

CONFERENCE TOPS - FLUSH



MODEL#	DIMENSIONS D x W x H	FREIGHT CLASS	WT/LBS.	CUBIC FT.	LIST PRICE	HP ADD
PN3066CFL	47 x 66 x 29	150	142	25	\$1223	\$159
PN3072CFL	47 x 72 x 29	92.5	52	5	\$1276	\$151

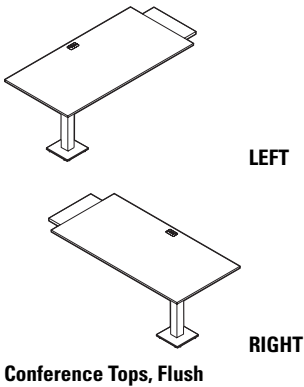
PN3066CFR	47 x 66 x 29	150	142	25	\$1223	\$159
PN3072CFR	47 x 72 x 29	92.5	52	5	\$1276	\$151

Specify PNxxxxCFL for **LEFT** or PNxxxxCFR for **RIGHT**.

Standard with square monopost and base. Connects to freestanding desks with metal legs or laminate end panels, 29"H freestanding returns, 29"H credenza opening. Subtop finish is Granite with black edge. Grommet in worksurface. Shipped in 2 cartons.

Recommended Maximum Modesty Panel Size:

PN3066CFR/CFL: 36"W (PN3613DMF)
 PN3072CFR/CFL: 42"W (PN4213DMF)



PN2448DFL	24 x 48 x 29	125	55	8.50	\$781	\$113
PN3048DFL	30 x 48 x 29	150	59	5.50	\$834	\$121
PN3060DFL	30 x 60 x 29	125	76	6	\$866	\$127

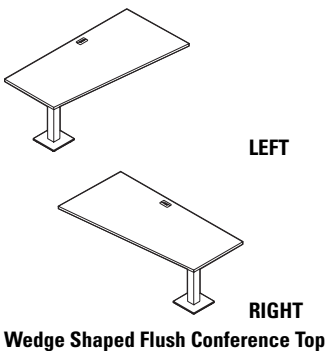
PN2448DFR	24 x 48 x 29	125	55	8.50	\$781	\$113
PN3048DFR	30 x 48 x 29	150	59	5.50	\$834	\$121
PN3060DFR	30 x 60 x 29	125	76	6	\$866	\$127

Specify PNxxxxDFL for **LEFT** or PNxxxxDFR for **RIGHT**.

Standard with square monopost with base. Connects to Freestanding Desks with metal legs or laminate end panels, 29"H Freestanding Returns or 29"H credenza opening. Subtop finish is Granite with black edge. Grommet in worksurface. Shipped in 2 cartons.

Recommended Maximum Modesty Panel Size:

PN2448DFR/DFL: 30"W (PN3013DMF)
 PN3048DFR/DFL: 30"W (PN3013DMF)
 PN3060DFR/DFL: 36"W (PN3613DMF)



PN3048TFL	30 x 48 x 29	150	59	11	\$834	\$121
PN3060TFL	30 x 60 x 29	125	81	12.50	\$866	\$127

PN3048TFR	30 x 48 x 29	150	59	11	\$834	\$121
PN3060TFR	30 x 60 x 29	125	81	12.50	\$866	\$127

Specify PNxxxxTFL for **LEFT** or PNxxxxTFR for **RIGHT**.

Standard with square monopost with base. 30"D at connecting end, 24"D at monopost end. Connects to Freestanding Desks with metal legs or laminate end panels, 29"H Freestanding Returns or 29"H credenza opening. Subtop finish is Granite with black edge. Grommet in worksurface. Shipped in 2 cartons.

Recommended Maximum Modesty Panel Size:

PN3048TFR/TFL: 30"W (PN3013DMF)
 PN3060TFR/TFL: 36"W (PN3013DMF)

Required Specifications

Top finish
 Monopost finish

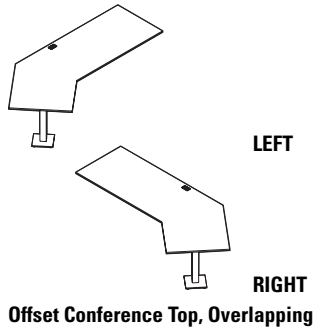
Optional Specifications

HP laminate
 PCSG - custom grommet
 RSG - remove grommet

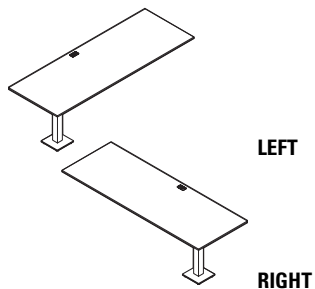
Accessories

Power block
 Keyboard tray
 Desktop screen
 Keyboard tray mounting kit
 Wire manager
 Keyboard mechanism

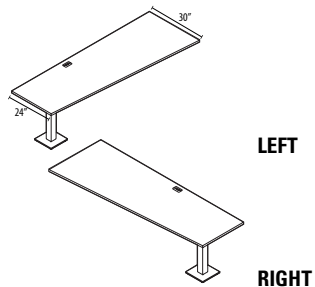
CONFERENCE TOPS - OVERLAPPING



Offset Conference Top, Overlapping



Conference Top, Overlapping



Wedge Shaped Overlapping Conference Top

MODEL#	DIMENSIONS D x W x H	FREIGHT CLASS	WT/LBS.	CUBIC FT.	LIST PRICE	HP ADD
PN3090COL	47 x 90 x 29	150	174	32	\$1379	\$148
PN3096COL	47 x 96 x 29	100	58.50	6.50	\$1393	\$157

PN3090COR	47 x 90 x 29	150	174	32	\$1379	\$148
PN3096COR	47 x 96 x 29	100	58.50	6.50	\$1393	\$157

Specify PNxxxxCOL for **LEFT** or PNxxxxCOR for **RIGHT**.

Standard with square monopost and base. Overlaps **27"H** credenza opening or **27"H** Freestanding Return. Subtop finish is Granite with black edge. Grommet in worksurface. 1" spacer included. Shipped in 2 cartons.

Recommended Maximum Modesty Panel Size:

PN3090COR/COL: 36"W (PN3613DMF)

PN3096COR/COL: 42"W (PN4213DMF)

PN3072DOL	30 x 72 x 29	150	94	19	\$1056	\$132
PN3078DOL	30 x 78 x 29	150	101	23	\$1076	\$133
PN3084DOL	30 x 84 x 29	92.5	44.50	4	\$1155	\$142

PN3072DOR	30 x 72 x 29	150	94	9.50	\$1056	\$132
PN3078DOR	30 x 78 x 29	150	101	23	\$1076	\$133
PN3084DOR	30 x 84 x 29	92.5	44.50	4	\$1155	\$142

Specify PNxxxxDOL for **LEFT** or PNxxxxDOR for **RIGHT**.

Standard with square monopost and base. Overlaps **27"H** credenza opening or **27"H** Freestanding Return. Subtop finish is Granite with black edge. Grommet in worksurface. 1" spacer included. Shipped in 2 cartons.

Recommended Maximum Modesty Panel Size:

PN3072DOR/DOL: 30"W (PN3013DMF)

PN3078DOR/DOL: 30"W (PN3013DMF)

PN3084DOR/DOL: 36"W (PN3613DMF)

PN3072TOL	30 x 72 x 29	150	94	19	\$1056	\$145
PN3084TOL	30 x 84 x 29	150	114	23	\$1155	\$160

PN3072TOR	30 x 72 x 29	150	94	19	\$1056	\$145
PN3084TOR	30 x 84 x 29	150	114	23	\$1155	\$160

Specify PNxxxxDOL for **LEFT** or PNxxxxDOR for **RIGHT**.

Standard with square monopost and base. 30"d at overlapping end, 24"d at monopost end. Overlaps **27"H** Credenza opening or **27"H** Freestanding Return. Grommet in worksurface. 1" spacer included. Shipped in 2 cartons.

Recommended Maximum Modesty Panel Size:

PN3072TOR/TOL: 30"W (PN3013DMF)

PN3084TOR/TOL: 36"W (PN3613DMF)

Required Specifications

Top finish
Monopost finish

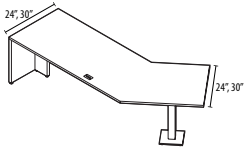
Optional Specifications

HP laminate
PCSG - custom grommet
RSG - remove grommet

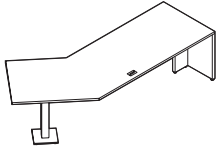
Accessories

Power block
Keyboard tray
Desktop screen
Keyboard tray mounting kit
Wire manager
Keyboard mechanism

CONFERENCE TOPS FOR U CONFIGURATIONS

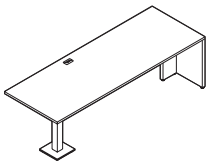


LEFT

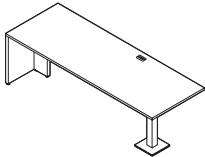


RIGHT

Offset Conference Top, for U Configurations*



LEFT



RIGHT

Conference Top for U Configurations*

MODEL#	DIMENSIONS	FREIGHT CLASS	WT/LBS.	CUBIC FT.	LIST PRICE	HP ADD
--------	------------	---------------	---------	-----------	------------	--------

D x W x H						
PN3090CUL	47 x 90 x 29	125	194	32	\$1458	\$201
PN3096CUL	47 x 96 x 29	125	195	32	\$1475	\$202

PN3090CUR	47 x 90 x 29	125	194	32	\$1458	\$201
PN3096CUR	47 x 96 x 29	125	195	32	\$1475	\$202

Specify PNxxxxCUL for **LEFT** or PNxxxxCUR for **RIGHT**.

Standard with T base with square monopost and base. End panel is 1" thick. 1.5" thick support gable extends 12" for end panel. Not freestanding, must be connected. Connects to bridges. Grommet in worksurface. Shipped in 2 cartons.

Recommended Maximum Modesty Panel Size:

PN3090CUR/CUL: 60"W (PN6013DMF)

PN3096CUR/CUL: 66"W (PN6613DMF)

PN3072DUL	30 x 72 x 29	125	114	19	\$1240	\$169
PN3084DUL	30 x 84 x 29	150	134	23	\$1457	\$201

PN3072DUR	30 x 72 x 29	125	114	19	\$1240	\$169
PN3084DUR	30 x 84 x 29	150	134	23	\$1457	\$201

Specify PNxxxxDUL for **LEFT** or PNxxxxDUR for **RIGHT**.

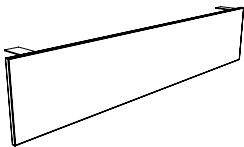
Standard with T base with square monopost and base. End panel is 1" thick. 1.5" thick support gable extends 12" for end panel. Not freestanding, must be connected. Connects to bridges. Grommet in worksurface. Shipped in 2 cartons.

Recommended Maximum Modesty Panel Size:

PN3072DUR/DUL: 48"W (PN4813DMF)

PN3084DUR/DUL: 60"W (PN6013DMF)

DESKTOP/MODESTY PANELS



Laminate Modesty Panel

MODEL#	DIMENSIONS	FREIGHT CLASS	WT/LBS.	CUBIC FT.	LIST PRICE
--------	------------	---------------	---------	-----------	------------

PN3013DML	.69 x 30 x 13	85	10	.75	\$407
PN3613DML	.69 x 36 x 13	70	12	.75	\$441
PN4213DML	.69 x 42 x 13	70	14	.75	\$475
PN4813DML	.69 x 48 x 13	70	16	1	\$494
PN5413DML	.69 x 54 x 13	70	18	1	\$553
PN6013DML	.69 x 60 x 13	70	20	1.50	\$648
PN6613DML	.69 x 66 x 13	70	22	1.50	\$668
PN7213DML	.69 x 72 x 13	70	24	1.50	\$691
PN7813DML	.69 x 78 x 13	70	26	1.70	\$810
PN8413DML	.69 x 84 x 13	70	28	1.70	\$1004

Attaches to worksurface with black "L" brackets. Laminate modesty panels up to 54"w include two brackets. Panels 60" and wider have three brackets. Specify a nominal size 6" shorter than worksurface size. If using modesty with overlapping worksurface or lower storage, contact Customer Care.

Required Specifications

- Top finish*
- Base finish
- Monopost finish*

Optional Specifications

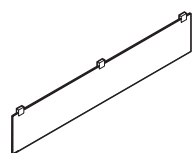
- HP laminate*
- POG1, POG3 - additional grommet*
- PCSG - custom grommet*
- RSG - remove grommet*

Accessories

- Power block*
- Keyboard tray*
- Desktop screen*
- Keyboard tray mounting kit*
- Wire manager*
- Keyboard mechanism*

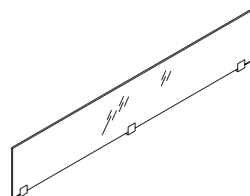
DESKTOP AND MODESTY PANELS

Fabric Desktop/Modesty Panel*



MODEL#	DIMENSIONS D x W x H	FREIGHT CLASS	WT/LBS.	CUBIC FT.	GRADE	LIST PRICE
PN3013DMF	.37 x 30 x 13	250	3	1	1	\$493
					2	\$531
					3	\$560
					4	\$603
PN3613DMF	.37 x 36 x 13	250	3.60	1	1	\$521
					2	\$568
					3	\$605
					4	\$656
PN4213DMF	.37 x 42 x 13	150	4.20	1	1	\$547
					2	\$594
					3	\$631
					4	\$682
PN4813DMF	.37 x 48 x 13	250	4.80	1.50	1	\$561
					2	\$619
					3	\$660
					4	\$723
PN5413DMF	.37 x 54 x 13	250	5.40	1.50	1	\$586
					2	\$651
					3	\$700
					4	\$772
PN6013DMF	.37 x 60 x 13	150	6	1.50	1	\$621
					2	\$686
					3	\$735
					4	\$807
PN6613DMF	.37 x 66 x 13	150	6.60	1.50	1	\$729
					2	\$802
					3	\$859
					4	\$943
PN7213DMF	.37 x 72 x 13	150	7.20	1.75	1	\$776
					2	\$860
					3	\$921
					4	\$1015
PN7813DMF	.37 x 78 x 13	150	7.80	1.75	1	\$782
					2	\$872
					3	\$944
					4	\$1047

Panels up to 54" w have two clamps. Panels 60" and wider have three clamps. **When used as a modesty panel, specify a nominal size 6" shorter than worksurface size.**



Frosted Glass Desktop Panel

PN3013DG	.25 x 30 x 13	85	10	.75		\$384
PN3613DG	.25 x 36 x 13	70	14	.75		\$401
PN4213DG	.25 x 42 x 13	70	16	.75		\$436
PN4813DG	.25 x 48 x 13	70	20	1		\$453
PN5413DG	.25 x 54 x 13	70	22	1		\$510
PN6013DG	.25 x 60 x 13	70	24	1.50		\$598
PN6613DG	.25 x 66 x 13	70	26	1.50		\$616
PN7213DG	.25 x 72 x 13	70	28	1.50		\$634

Panels up to 54" w have two clamps. Panels 60" and wider have three clamps.

Required Specifications

Fabric*

FELT PANELS **MODEL#** **DIMENSIONS** **FREIGHT CLASS** **WT./LBS.** **CUBIC FT.** **LIST PRICE** **HP ADD**

D x W x H

- 9mm thick panels offered in 9 finishes
- Made from 100% PET (polyester) fiber with a high content (50%) of post-recycled material, free of added chemicals, binders and adhesives
- Lightweight panels are tackable, impact and tear resistant, bacteria resistant, moisture resistant, and installation friendly
- Variation in fiber mix and color are inherent to the character of the product
- Clamps are included. Available in satin anodized finish only.

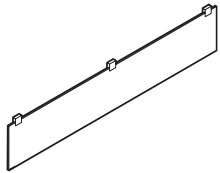
FELT COLORS

BLK	Black	MTS	Mist
BRI	Brick	PWT	Pewter
DEN	Denim	SHR	Shamrock
GPH	Graphite	WHT	White
HVT	Harvest		

FELT DESKTOP/MODESTY PANELS

MODEL# **DIMENSIONS** **FREIGHT CLASS** **WT./LBS.** **CUBIC FT.** **LIST PRICE**

D x W x H

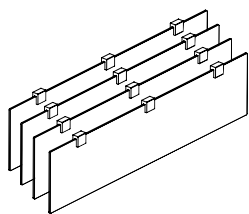


PET Felt Desktop/Modesty Panel, 1 pk.

PN3013PT9-1	.36 x 30 x 12.5	150	2.48	.57	\$198
PN3613PT9-1	.36 x 36 x 12.5	250	2.74	.69	\$208
PN4213PT9-1	.36 x 42 x 12.5	250	2.99	.80	\$282
PN4813PT9-1	.36 x 48 x 12.5	150	3.85	.91	\$294
PN5413PT9-1	.36 x 54 x 12.5	250	4.11	1.03	\$357
PN6013PT9-1	.36 x 60 x 12.5	250	4.36	1.14	\$367
PN6613PT9-1	.36 x 66 x 12.5	150	5.22	1.25	\$441
PN7213PT9-1	.36 x 72 x 12.5	150	5.48	1.36	\$450
PN7813PT9-1	.36 x 78 x 12.5	250	5.73	1.48	\$458

PET Felt Desktop/Modesty Panel available in 9 finishes, please specify. 2, 3 or 4 clamps are included depending on screen size. Clamps available in satin anodized finish only. **When used as a modesty panel, specify a nominal size 6" shorter than worksurface size.**

- Up to 42" w - 2 clamps per panel
- 48"-60" w - 3 clamps per panel
- 66"-78" w - 4 clamps per panel



PET Felt Desktop/Modesty Panel, 4 pk.

PN3013PT9-4	0.36 x 30 x 12.5	85	8.93	.60	\$754
PN3613PT9-4	0.36 x 36 x 12.5	85	9.86	.71	\$791
PN4213PT9-4	0.36 x 42 x 12.5	85	10.80	.83	\$1082
PN4813PT9-4	0.36 x 48 x 12.5	85	13.90	.98	\$1119
PN5413PT9-4	0.36 x 54 x 12.5	85	14.80	1.09	\$1369
PN6013PT9-4	0.36 x 60 x 12.5	85	15.70	1.20	\$1402
PN6613PT9-4	0.36 x 66 x 12.5	85	18.80	1.32	\$1692
PN7213PT9-4	0.36 x 72 x 12.5	85	19.70	1.43	\$1725
PN7813PT9-4	0.36 x 78 x 12.5	85	20.60	1.54	\$1759

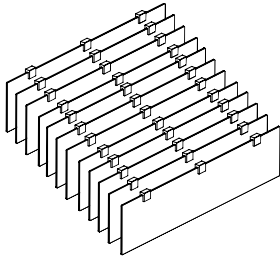
PET Felt Desktop/Modesty Panel available in 9 finishes, please specify. 2, 3 or 4 clamps are included depending on screen size. Clamps available in satin anodized finish only. **When used as a modesty panel, specify a nominal size 6" shorter than worksurface size.**

- Up to 42" w - 2 clamps per panel
- 48"-60" w - 3 clamps per panel
- 66"-78" w - 4 clamps per panel

Required Specifications

Felt color

FELT DESKTOP/MODESTY PANELS



PET Felt Desktop/Modesty Panel, 12 pk.

MODEL# DIMENSIONS FREIGHT CLASS WT/LBS. CUBIC FT. LIST PRICE

	D x W x H				
PN3013PT9-12	0.36 x 30 x 12.5	85	25.30	1.92	\$2213
PN3613PT9-12	0.36 x 36 x 12.5	85	27.90	2.26	\$2320
PN4213PT9-12	0.36 x 42 x 12.5	92.5	30.50	2.60	\$3181
PN4813PT9-12	0.36 x 48 x 12.5	85	39.30	3.05	\$3284
PN5413PT9-12	0.36 x 54 x 12.5	85	41.90	3.39	\$4029
PN6013PT9-12	0.36 x 60 x 12.5	92.5	44.50	3.72	\$4119
PN6613PT9-12	0.36 x 66 x 12.5	85	53.20	4.18	\$4983
PN7213PT9-12	0.36 x 72 x 12.5	85	55.90	4.51	\$5071
PN7813PT9-12	0.36 x 78 x 12.5	85	58.50	4.85	\$5163

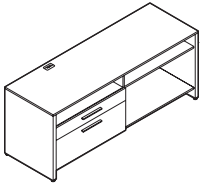
PET Felt Desktop/Modesty Panel available in 9 finishes, please specify. 2, 3 or 4 clamps are included depending on screen size. Clamps available in satin anodized finish only. **When used as a modesty panel, specify a nominal size 6" shorter than worksurface size.**

- Up to 42" w - 2 clamps per panel
- 48"-60" w - 3 clamps per panel
- 66"-78" w - 4 clamps per panel

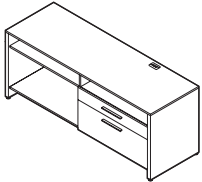
Required Specifications

Felt color

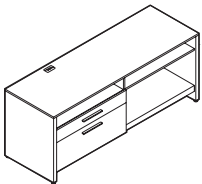
29" H CREDENZAS



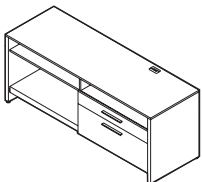
29" H Credenza - LEFT



29" H Credenza - RIGHT



29" H Credenza w/Pull-Out Equipment Tray - LEFT



29" H Credenza w/Pull-Out Equipment Tray - RIGHT

MODEL#	DIMENSIONS	FREIGHT CLASS	WT/LBS.	CUBIC FT.	LIST PRICE	HP ADD
--------	------------	---------------	---------	-----------	------------	--------

D x W x H

PN2984CRL	24 x 84 x 29	100	320	33.83	\$2064	\$240
PN2972CRL	24 x 72 x 29	92.5	290	29	\$1956	\$236
PN2966CRL	24 x 66 x 29	100	265	31	\$1936	\$238
PN2960CRL	24 x 60 x 29	92.5	242	24.17	\$1906	\$223

Standard with locking 34"W box and lateral file drawer on **left**. File bars included for front-to-back letter and legal filing capability. Lock on file drawer secures both drawers. Adjustable 5 position shelf. Wire management grommet on surface and internal pass-through behind equipment shelf. Connects to flush returns, flush bridges and flush conference tops. Shipped Fully Assembled.

PN2984CRR	24 x 84 x 29	100	320	33.83	\$2064	\$240
PN2972CRR	24 x 72 x 29	92.5	290	29	\$1956	\$236
PN2966CRR	24 x 66 x 29	100	265	31	\$1936	\$238
PN2960CRR	24 x 60 x 29	92.5	242	24.17	\$1906	\$223

Standard with locking 34"W box and lateral file drawer on **right**. File bars included for front-to-back letter and legal filing capability. Lock on file drawer secures both drawers. Adjustable 5 position shelf. Wire management grommet on surface and internal pass-through behind equipment shelf. Connects to flush returns, flush bridges and flush conference tops. Shipped Fully Assembled.

PN2984CPL	24 x 84 x 29	100	320	33.83	\$2331	\$253
PN2978CPL	24 x 78 x 29	100	310	36	\$2266	\$258
PN2972CPL	24 x 72 x 29	92.5	290	29	\$2211	\$250
PN2966CPL	24 x 66 x 29	100	270	31	\$2127	\$252
PN2960CPL	24 x 60 x 29	92.5	242	24.17	\$2073	\$229

Standard with locking 34"W box and lateral file drawer on **left**. File bars included for front-to-back letter and legal filing capability. Lock on file drawer secures both drawers. Adjustable 5 position shelf. Pull-out equipment shelf can support up to 80lbs. Wire management grommet on surface and internal pass-through behind equipment shelf. Connects to flush returns, flush bridges and flush conference tops. Shipped Fully Assembled.

PN2984CPR	24 x 84 x 29	100	320	33.83	\$2331	\$253
PN2978CPR	24 x 78 x 29	100	310	36	\$2266	\$258
PN2972CPR	24 x 72 x 29	92.5	290	29	\$2211	\$250
PN2966CPR	24 x 66 x 29	100	270	31	\$2127	\$252
PN2960CPR	24 x 60 x 29	92.5	242	24.17	\$2073	\$229

Standard with locking 34"W box and lateral file drawer on **right**. File bars included for front-to-back letter and legal filing capability. Lock on file drawer secures both drawers. Adjustable 5 position shelf. Pull-out equipment shelf can support up to 80lbs. Wire management grommet on surface and internal pass-through behind equipment shelf. Connects to flush returns, flush bridges and flush conference tops. Shipped Fully Assembled.

Required Specifications

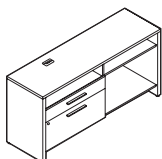
Top finish
Base finish
Drawer front finish

Optional Specifications

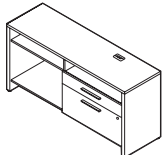
HP laminate
RSG - remove grommet

29" H CREDENZAS

MODEL#	DIMENSIONS	FREIGHT CLASS	WT/LBS.	CUBIC FT.	LIST PRICE	HP ADD
--------	------------	---------------	---------	-----------	------------	--------



LEFT



RIGHT

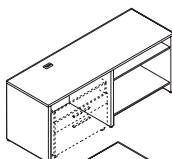
29" H Narrow Credenza*

	D x W x H					
PN2954NCL	20 x 54 x 29	92.5	250	22	\$1885	\$259
PN2960NCL	20 x 60 x 29	92.5	260	24	\$1910	\$261

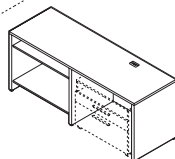
PN2954NCR	20 x 54 x 29	92.5	250	22	\$1885	\$259
PN2960NCR	20 x 60 x 29	92.5	260	24	\$1910	\$261

Specify PNxxxxNCL for **LEFT** or PNxxxxNCR for **RIGHT**.

20"D. Standard with 30"W box and lateral file drawer. Front-to-back letter and legal filing capability. Lock on file drawer secures both drawers. Adjustable 5 position shelf. Wire management grommet on surface and internal pass-through behind lower shelf. Connects to flush returns, flush bridges and flush conference tops. File bars included. Shipped Fully Assembled.



LEFT



RIGHT

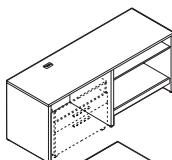
29" H Credenza for Mobile Lateral File

PN2972MCL	24 x 72 x 29	125	252	34	\$1542	\$212
PN2984MCL	24 x 84 x 29	125	268	39.50	\$1664	\$227

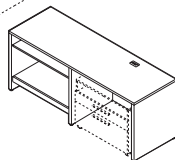
PN2972MCR	24 x 72 x 29	125	252	34	\$1542	\$212
PN2984MCR	24 x 84 x 29	125	268	39	\$1664	\$227

Specify PNxxxxMCL for **LEFT** or PNxxxxMCR for **RIGHT**.

Standard with 42" w space for lateral file. Adjustable 5 position shelf. Wire management grommet on surface and internal pass-through behind lower shelf. Connects to flush returns, flush bridges and flush conference tops. Accepts all mobile lateral file units. Shipped Fully Assembled.



LEFT



RIGHT

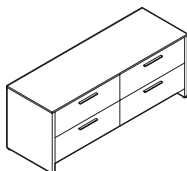
29" H Credenza for Mobile Lateral File w/Pull-Out Equipment Tray*

PN2972MPL	24 x 72 x 29	125	258	34	\$1764	\$240
PN2984MPL	24 x 84 x 29	125	274	39.50	\$1880	\$258

PN2972MPR	24 x 72 x 29	125	258	34	\$1764	\$240
PN2984MPR	24 x 84 x 29	125	274	39.50	\$1880	\$258

Specify PNxxxxMPL for **LEFT** or PNxxxxMPR for **RIGHT**.

Standard with 42" w space for lateral file, adjustable 5 position shelf, and pull-out equipment shelf that can support up to 80lbs. Grommet in worksurface and internal pass-through behind equipment shelf. Connects to flush returns, flush bridges and flush conference tops. Accepts all mobile lateral file units. Shipped Fully Assembled.



29" H Lateral File Credenza*

PN2972LF	24 x 72 x 29	92.5	290	29	\$2327	\$300
----------	--------------	------	-----	----	---------------	--------------

Standard with four lateral file drawers. File bars included for front-to-back letter and legal filing capability. Lock on lower drawer secures both drawers. Anti-tip mechanism. Shipped Fully Assembled.

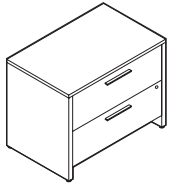
Required Specifications

Top finish
Base finish
Drawer front finish*

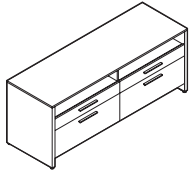
Optional Specifications

HP laminate
RSG - remove grommet
Grommet (PN2972LF)

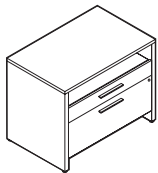
29" H CREDENZAS



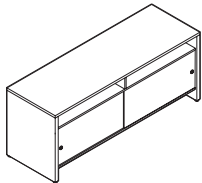
29" H Single Lateral File Credenza*



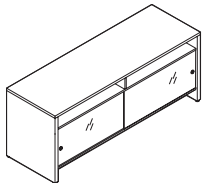
29" H Double Credenza*



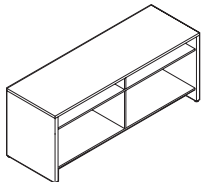
29" H Single Credenza*



29" H Credenza w/Sliding Laminate Doors*



29" H Credenza w/Sliding Glass Doors



29" H Open Credenza

MODEL#	DIMENSIONS	FREIGHT CLASS	WT/LBS.	CUBIC FT.	LIST PRICE	HP ADD
--------	------------	---------------	---------	-----------	------------	--------

D x W x H

PN2937LFS	24 x 37 x 29	100	155	18	\$1578	\$215
-----------	--------------	-----	-----	----	---------------	--------------

Standard with two lateral file drawers. File bars included for front-to-back letter and legal filing capability. Lock on lower drawer secures both drawers. Anti-tip mechanism. Shipped Fully Assembled.

PN2972CRD	24 x 72 x 29	92.5	290	29	\$2239	\$280
-----------	--------------	------	-----	----	---------------	--------------

Standard with 34" w box and lateral file drawer on each side. File bars included for front-to-back letter and legal filing capability. Lock on file drawer secures both drawers. Shipped Fully Assembled.

PN2937CRS	24 x 37 x 29	100	145	18	\$1578	\$215
-----------	--------------	-----	-----	----	---------------	--------------

Standard with 34" w box and lateral file drawer. File bars included for front-to-back letter and legal filing capability. Lock on file drawer secures both drawers. Shipped Fully Assembled.

PN2960CLS	24 x 60 x 29	100	265	28.25	\$1826	\$250
PN2972CLS	24 x 72 x 29	100	289	34	\$1914	\$261
PN2984CLS	24 x 84 x 29	100	337	39.50	\$2089	\$285

Standard with sliding laminate doors in upper plastic track. Recessed brushed aluminum finger pulls. No lock. Shipped Fully Assembled.

PN2960CGS	24 x 60 x 29	100	265	28.25	\$2304	\$314
PN2972CGS	24 x 72 x 29	100	289	34	\$2549	\$348
PN2984CGS	24 x 84 x 29	100	337	39.50	\$2817	\$384

Standard with sliding glass doors in upper aluminum track. Satin etched 6mm glass. Brushed aluminum finger pulls. No lock. Shipped assembled in 2 cartons. Glass doors shipped separately.

PN2960CO	24 x 60 x 29	92.5	296	28.25	\$1536	\$210
PN2972CO	24 x 72 x 29	100	316	34	\$1628	\$224
PN2984CO	24 x 84 x 29	100	336	39.50	\$1805	\$248

Open storage with adjustable 5 position upper shelves with pass-throughs at back of lower shelves. Connects to flush returns, flush bridges and flush conference tops. Shipped Fully Assembled.

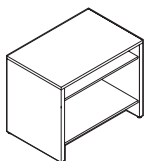
Required Specifications

- Top finish
- Base finish
- Drawer front finish*

Optional Specifications

- HP laminate
- Grommet

29"H CREDENZAS

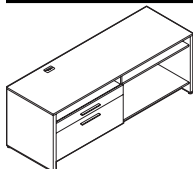


29"H Single Open Credenza**

MODEL#	DIMENSIONS	FREIGHT CLASS	WT./LBS.	CUBIC FT.	LIST PRICE	HP ADD
	D x W x H					
PN2930CO	24 x 30 x 29	92.5	153	15	\$988	\$137
PN2936CO	24 x 36 x 29	100	158	18	\$1033	\$142

Open storage with adjustable 5 position upper shelf with pass-through at back of lower shelf. Connects to flush returns, flush bridges and flush conference tops. Shipped Fully Assembled.

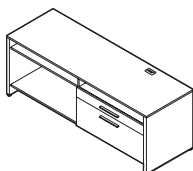
27"H CREDENZAS



27"H Credenza - LEFT *

MODEL#	DIMENSIONS	FREIGHT CLASS	WT./LBS.	CUBIC FT.	LIST PRICE	HP ADD
PN2760CRL	24 x 60 x 27	92.5	241	22.50	\$1887	\$214
PN2766CRL	24 x 66 x 27	100	262	29	\$1917	\$226
PN2772CRL	24 x 72 x 27	92.5	290	27	\$1936	\$226
PN2778CRL	24 x 78 x 27	100	290	34	\$1995	\$237
PN2784CRL	24 x 84 x 27	92.5	335	31.50	\$2045	\$235

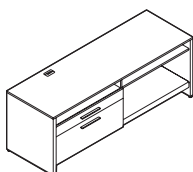
Standard with locking 34"W box and lateral file drawer on **left**. File bars included for front-to-back letter and legal filing capability. Lock on file drawer secures both drawers. Adjustable 5 position shelf. Wire management grommet on surface and internal pass-through behind equipment shelf. Supports overlapping returns, bridges, and conference tops that have a 1" spacer (example: PN24600MR). Cannot nest under 29"H products with metal legs. Shipped Fully Assembled.



27"H Credenza - RIGHT *

PN2760CRR	24 x 60 x 27	92.5	241	22.50	\$1887	\$214
PN2766CRR	24 x 66 x 27	100	262	29	\$1917	\$226
PN2772CRR	24 x 72 x 27	92.5	290	27	\$1936	\$226
PN2778CRR	24 x 78 x 27	100	290	34	\$1995	\$237
PN2784CRR	24 x 84 x 27	92.5	335	31.50	\$2045	\$235

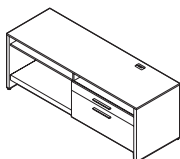
Standard with locking 34"W box and lateral file drawer on **right**. File bars included for front-to-back letter and legal filing capability. Lock on file drawer secures both drawers. Adjustable 5 position shelf. Wire management grommet on surface and internal pass-through behind equipment shelf. Supports overlapping returns, bridges, and conference tops that have a 1" spacer (example: PN24600MR). Cannot nest under 29"H products with metal legs. Shipped Fully Assembled.



27"H Credenza w/Pull-Out Equipment Tray - LEFT*

PN2760CPL	24 x 60 x 27	92.5	241	22.50	\$2052	\$224
PN2766CPL	24 x 66 x 27	100	267	29	\$2111	\$239
PN2772CPL	24 x 72 x 27	92.5	290	27	\$2194	\$242
PN2778CPL	24 x 78 x 27	100	300	34	\$2249	\$253
PN2784CPL	24 x 84 x 27	92.5	335	31.50	\$2312	\$255

Standard with locking 34"W box and lateral file drawer on **left**. File bars included for front-to-back letter and legal filing capability. Lock on file drawer secures both drawers. Adjustable 5 position shelf. Pull-out equipment tray can support up to 80 lbs. Wire management grommet on surface and internal pass-through behind equipment shelf. Supports overlapping returns, bridges, and conference tops that have a 1" spacer (example: PN24600MR). Cannot nest under 29"H products with metal legs. Shipped Fully Assembled.



27"H Credenza w/Pull-Out Equipment Tray - RIGHT*

PN2760CPR	24 x 60 x 27	92.5	241	22.50	\$2052	\$224
PN2766CPR	24 x 66 x 27	100	267	29	\$2111	\$239
PN2772CPR	24 x 72 x 27	92.5	290	27	\$2194	\$242
PN2778CPR	24 x 78 x 27	100	300	34	\$2249	\$253
PN2784CPR	24 x 84 x 27	92.5	335	31.50	\$2312	\$255

Standard with locking 34"W box and lateral file drawer on **right**. File bars included for front-to-back letter and legal filing capability. Lock on file drawer secures both drawers. Adjustable 5 position shelf. Pull-out equipment tray can support up to 80 lbs. Wire management grommet on surface and internal pass-through behind equipment shelf. Supports overlapping returns, bridges, and conference tops that have a 1" spacer (example: PN24600MR). Cannot nest under 29"H products with metal legs. Shipped Fully Assembled.

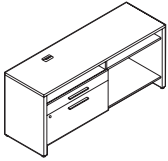
Required Specifications

Top finish
Base finish
Drawer/door front finish*

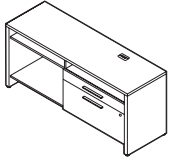
Optional Specifications

HP laminate
Grommet**
RSG - remove grommet*

27" H CREDENZAS



LEFT



RIGHT

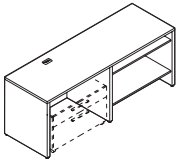
27" H Narrow Credenza*

MODEL#	DIMENSIONS D x W x H	FREIGHT CLASS	WT/LBS.	CUBIC FT.	LIST PRICE	HP ADD
PN2754NCL	20 x 54 x 27	92.5	250	22	\$1835	\$252
PN2760NCL	20 x 60 x 27	92.5	260	24	\$1859	\$255

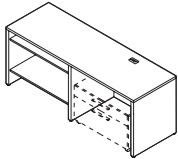
PN2754NCR	20 x 54 x 27	92.5	250	22	\$1835	\$252
PN2760NCR	20 x 60 x 27	92.5	260	24	\$1859	\$255

Specify PNxxxxNCL for **LEFT** or PNxxxxNCR for **RIGHT**.

20"D. Standard with 30"W box and lateral file drawer. Front-to-back letter and legal filing capability. Lock on file drawer secures both drawers. Adjustable 5 position shelf. Wire management grommet on surface and internal pass-through at back of lower shelf. Supports overlapping returns, bridges, and conference tops that have a 1" spacer (example: PN24600MR). Cannot nest under 29"H products with metal legs. File bars included. Shipped Fully Assembled.



LEFT



RIGHT

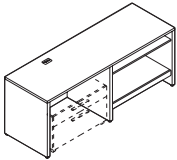
27" H Credenza for Mobile Lateral File

PN2772MCL	24 x 72 x 27	125	252	31.75	\$1522	\$209
PN2784MCL	24 x 84 x 27	125	268	37	\$1644	\$225

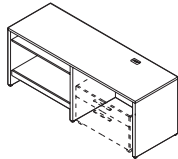
PN2772MCR	24 x 72 x 27	125	252	31.75	\$1522	\$209
PN2784MCR	24 x 84 x 27	125	268	37	\$1644	\$225

Specify PNxxxxMCL for **LEFT** or PNxxxxMCR for **RIGHT**.

Standard with 42"W space for lateral file. Adjustable 5 position shelf. Wire management grommet on surface and internal pass-through at back of lower shelf. Supports overlapping returns, bridges, and conference tops that have a 1" spacer (example: PN24600MR). Cannot nest under 29"H products with metal legs. Accepts mobile lateral file units: PN21MLSF and PN22MLBF with and without cushions, and PN25MLSBF without cushions. Shipped Fully Assembled.



LEFT



RIGHT

27" H Credenza for Mobile Lateral File w/Pull-Out Equipment Tray

PN2772MPL	24 x 72 x 27	100	258	31.75	\$1748	\$239
PN2784MPL	24 x 84 x 27	125	274	37	\$1859	\$255

PN2772MPR	24 x 72 x 27	100	258	31.75	\$1748	\$239
PN2784MPR	24 x 84 x 27	125	274	37	\$1859	\$255

Specify PNxxxxMPL for **LEFT** or PNxxxxMPR for **RIGHT**.

Standard with 42"W space for lateral file, adjustable 5 position shelf, and pull-out equipment shelf that can support up to 80lbs. Wire management grommet in surface and internal pass-through at back of pull-out equipment shelf. Supports overlapping returns, bridges, and conference tops that have a 1" spacer (example: PN24600MR). Cannot nest under 29"H products with metal legs. Accepts mobile lateral file units: PN21MLSF and PN22MLBF with and without cushions, and PN25MLSBF without cushions. Shipped Fully Assembled.

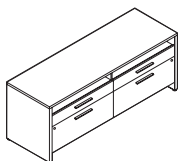
Required Specifications

Top finish
Base finish
Drawer/door front finish*

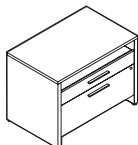
Optional Specifications

HP laminate
RSG - remove grommet

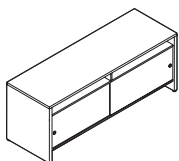
27"H CREDENZAS



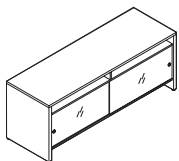
27"H Double Credenza*



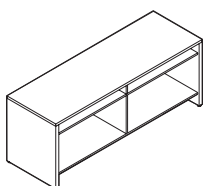
27"H Single Credenza*



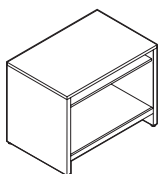
27"H Credenza w/Sliding Laminate Doors*



27"H Credenza w/Sliding Glass Doors



27"H Open Credenza



27"H Single Open Credenza

MODEL#	DIMENSIONS	FREIGHT CLASS	WT/LBS.	CUBIC FT.	LIST PRICE	HP ADD
--------	------------	---------------	---------	-----------	------------	--------

D x W x H

PN2772CRD	24 x 72 x 27	100	290	31.75	\$2197	\$280
-----------	--------------	-----	-----	-------	--------	-------

Standard with locking 34"W box and lateral file drawer on each side. File bars included for front-to-back letter and legal filing capability. Lock on file drawer secures both drawers. Shipped Fully Assembled.

PN2737CRS	24 x 37 x 27	100	145	18	\$1534	\$210
-----------	--------------	-----	-----	----	--------	-------

Standard with 34"W box and lateral file drawer. Lock on file drawer secures both drawers. File bars included for front-to-back letter and legal filing capability. Shipped Fully Assembled.

PN2760CLS	24 x 60 x 27	92.5	265	26.50	\$1807	\$248
PN2772CLS	24 x 72 x 27	100	289	31.75	\$1896	\$260
PN2784CLS	24 x 84 x 27	100	337	37	\$2071	\$283

Standard with sliding laminate doors in upper plastic track. Recessed brushed aluminum finger pulls. No lock. Shipped Fully Assembled.

PN2760CGS	24 x 60 x 27	92.5	265	26.50	\$2285	\$312
PN2772CGS	24 x 72 x 27	100	289	31.75	\$2542	\$348
PN2784CGS	24 x 84 x 27	100	337	37	\$2797	\$381

Standard with sliding glass doors in upper aluminum track. Satin etched 6mm glass. Brushed aluminum finger pulls. No lock. Shipped assembled in 2 cartons. Glass doors shipped separately.

PN2760CO	24 x 60 x 27	92.5	296	26.50	\$1536	\$210
PN2772CO	24 x 72 x 27	100	316	31.75	\$1628	\$224
PN2784CO	24 x 84 x 27	100	336	37	\$1805	\$248

Open storage with adjustable 5 position upper shelves with pass-throughs at back of lower shelves. Supports overlapping returns, bridges, and conference tops that have a 1" spacer (example: PN24600MR). Cannot nest under 29"H products with metal legs. Shipped Fully Assembled.

PN2730CO	24 x 30 x 27	92.5	153	14	\$969	\$133
PN2736CO	24 x 36 x 27	100	158	16	\$1015	\$142

Open storage with adjustable 5 position upper shelf with pass-through at back of lower shelf. Supports overlapping returns, bridges, and conference tops that have a 1" spacer (example: PN24600MR). Cannot nest under 29"H products with metal legs. Shipped Fully Assembled.

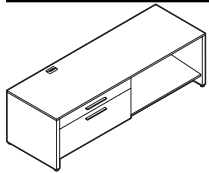
Required Specifications

Top finish
Base finish
Drawer/door front finish*

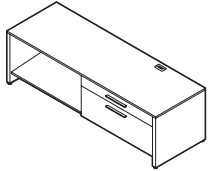
Optional Specifications

HP laminate
Grommet

23"H CREDENZAS



LEFT



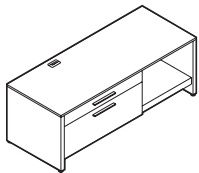
RIGHT

23"H Credenza*

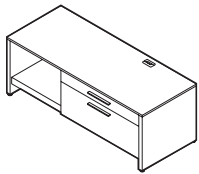
MODEL#	DIMENSIONS D x W x H	FREIGHT CLASS	WT/LBS.	CUBIC FT.	LIST PRICE	HP ADD
PN2360CRL	24 x 60 x 23	100	190	19.17	\$1574	\$199
PN2366CRL	24 x 66 x 23	100	227	25	\$1610	\$208
PN2372CRL	24 x 72 x 23	100	228	23	\$1635	\$206
PN2378CRL	24 x 78 x 23	100	248	30	\$1671	\$213
PN2384CRL	24 x 84 x 23	100	266	26.83	\$1705	\$213

PN2360CRR	24 x 60 x 23	100	190	19.17	\$1574	\$199
PN2366CRR	24 x 66 x 23	100	227	25	\$1610	\$208
PN2372CRR	24 x 72 x 23	100	228	23	\$1635	\$206
PN2378CRR	24 x 78 x 23	100	248	30	\$1671	\$213
PN2384CRR	24 x 84 x 23	100	266	26.83	\$1705	\$213

Standard with 34"W box and lateral file drawer. File bars included for front-to-back letter and legal filing capability. Lock on file drawer secures both drawers. Wire management grommet on surface and internal pass-through at back of lower shelf. Supports Overlapping Return with metal leg and spacer for 23"H credenza, Overlapping Wedge Shaped Return with metal leg and spacer for 23"H credenza, and Overlapping Bridges with metal spacer for 23"H credenza. Shipped Fully Assembled.



LEFT



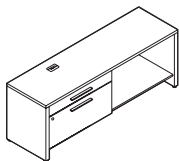
RIGHT

23"H Credenza w/Pull-Out Equipment Tray - RIGHT*

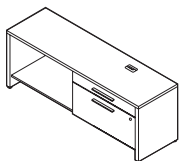
PN2360CPL	24 x 60 x 23	100	190	19.17	\$1785	\$209
PN2366CPL	24 x 66 x 23	100	233	25	\$1844	\$221
PN2372CPL	24 x 72 x 23	100	228	23	\$1902	\$218
PN2378CPL	24 x 78 x 23	100	254	30	\$1947	\$226
PN2384CPL	24 x 84 x 23	100	266	26.83	\$1983	\$226

PN2360CPR	24 x 60 x 23	100	190	19.17	\$1785	\$209
PN2366CPR	24 x 66 x 23	100	233	25	\$1844	\$221
PN2372CPR	24 x 72 x 23	100	228	23	\$1902	\$218
PN2378CPR	24 x 78 x 23	100	254	30	\$1947	\$226
PN2384CPR	24 x 84 x 23	100	266	26.83	\$1983	\$226

Standard with 34"W box and lateral file drawer. Pull-out equipment shelf can support up to 80lbs. Adjustable 5 position shelf. File bars included for front-to-back letter and legal filing capability. Lock on file drawer secures both drawers. Wire management grommet on surface and internal pass-through at back of lower shelf. Supports Overlapping Return with metal leg and spacer for 23"H credenza, Overlapping Wedge Shaped Return with metal leg and spacer for 23"H credenza, and Overlapping Bridges with metal spacer for 23"H credenza. Shipped Fully Assembled.



LEFT



RIGHT

23"H Narrow Credenza

PN2354NCL	20 x 54 x 23	92.5	230	21	\$1539	\$210
PN2360NCL	20 x 60 x 23	92.5	240	23	\$1546	\$212

PN2354NCR	20 x 54 x 23	92.5	230	21	\$1539	\$210
PN2360NCR	20 x 60 x 23	92.5	240	23	\$1546	\$212

Specify PNxxxxNCL for **LEFT** or PNxxxxNCR for **RIGHT**.

20"D. Standard with 30"W box and lateral file drawer. File bars included for front-to-back letter and legal filing capability. Lock on file drawer secures both drawers. Wire management grommet on surface and internal pass-through at back of lower shelf. Supports Overlapping Return with metal leg and spacer for 23"H credenza, Overlapping Wedge Shaped Return with metal leg and spacer for 23"H credenza, and Overlapping Bridges with metal spacer for 23"H credenza. Shipped Fully Assembled.

Required Specifications

Top finish
Base finish
Drawer front finish

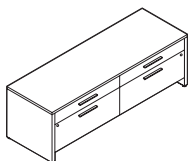
Optional Specifications

HP laminate
RSG - remove grommet

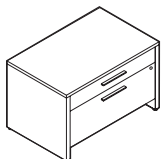
Accessories

Cushion

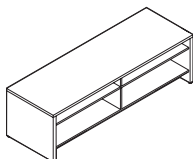
23"H CREDENZAS



23"H Double Credenza*



23"H Single Credenza*



23"H Open Credenza

MODEL#	DIMENSIONS	FREIGHT CLASS	WT/LBS.	CUBIC FT.	LIST PRICE	HP ADD
--------	------------	---------------	---------	-----------	------------	--------

D x W x H

PN2372CRD	24 x 72 x 23	92.5	275	27	\$2027	\$278
-----------	--------------	------	-----	----	--------	-------

Standard with locking 34"W box and lateral file drawer on each side. File bars included for front-to-back letter and legal filing capability. Lock on file drawer secures both drawers. Shipped Fully Assembled.

PN2337CRS	24 x 37 x 23	100	125	15	\$1379	\$188
-----------	--------------	-----	-----	----	--------	-------

Standard with 34" w box and lateral file drawer. File bars included for front-to-back letter and legal filing capability. Lock on file drawer secures both drawers. Shipped Fully Assembled.

PN2360CO	24 x 60 x 23	85	276	23	\$1357	\$186
PN2372CO	24 x 72 x 23	92.5	296	27.50	\$1471	\$202
PN2384CO	24 x 84 x 23	100	316	32	\$1637	\$225

Open storage with adjustable 5 position upper shelves with pass-throughs at back of lower shelves. Supports Overlapping Return with metal leg and spacer for 23"H credenza, Overlapping Wedge Shaped Return with metal leg and spacer for 23"H credenza, and Overlapping Bridges with metal spacer for 23"H credenza. Shipped Fully Assembled.

Required Specifications

Top finish
Base finish
Drawer front finish*

Optional Specifications

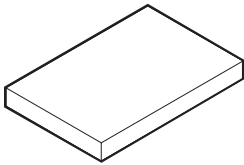
HP laminate
Grommet

Accessories

Cushion

CUSHIONS FOR 23"H CREDENZAS

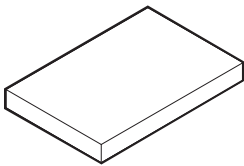
MODEL#	DIMENSIONS	FREIGHT CLASS	WT/LBS.	CUBIC FT.	GRADE	LIST	GRADE	LIST
	D x W x H							
PN2430CU	24 x 30 x 2.5	150	13	2.40	1	\$309	7	\$667
					2	\$367	8	\$814
					3	\$408	9	\$886
					4	\$469	10	\$1023
					5	\$557	11	\$1210
					6	\$590	12	\$1441
PN2433CU	24 x 33 x 2.5	150	13	2.40	1	\$337	7	\$813
					2	\$410	8	\$1010
					3	\$466	9	\$1104
					4	\$550	10	\$1287
					5	\$669	11	\$1536
					6	\$709	12	\$1846
PN2436CU	24 x 36 x 2.5	250	7	2	1	\$358	7	\$892
					2	\$441	8	\$1113
					3	\$503	9	\$1220
					4	\$596	10	\$1427
					5	\$729	11	\$1705
					6	\$775	12	\$2054
PN2439CU	24 x 39 x 2.5	150	14	2.40	1	\$382	7	\$916
					2	\$465	8	\$1137
					3	\$527	9	\$1244
					4	\$620	10	\$1451
					5	\$753	11	\$1729
					6	\$799	12	\$2078
PN2442CU	24 x 42 x 2.5	150	14	2.40	1	\$400	7	\$934
					2	\$483	8	\$1155
					3	\$545	9	\$1262
					4	\$638	10	\$1469
					5	\$771	11	\$1747
					6	\$817	12	\$2096



Cushion for 23"H Credenzas

Cushion attaches with Velcro strips. Fits **24"d** credenzas.

PN2027CU	20 x 27 x 2.5	150	12	2.40	1	\$273	7	\$570
					2	\$320	8	\$695
					3	\$356	9	\$755
					4	\$406	10	\$867
					5	\$481	11	\$1025
					6	\$508	12	\$1217
PN2030CU	20 x 30 x 2.5	150	12	2.40	1	\$295	7	\$592
					2	\$342	8	\$717
					3	\$378	9	\$777
					4	\$428	10	\$889
					5	\$503	11	\$1047
					6	\$530	12	\$1239

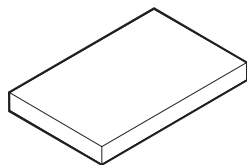


Cushion for 23"H Narrow Credenzas

Cushion attaches with Velcro strips. Fits **20"d** credenzas.

Required Specifications
Fabric

CUSHIONS FOR 23"H CREDENZAS

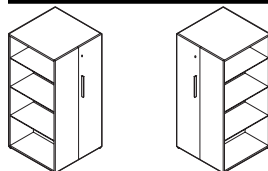


Cushion for 23"H Single Credenza**

MODEL#	DIMENSIONS	FREIGHT CLASS	WT./LBS.	CUBIC FT.	GRADE	LIST	GRADE	LIST
D x W x H								
PN2437CU	24 x 37 x 2.5	150	14	2.40	1	\$377	7	\$911
					2	\$460	8	\$1133
					3	\$522	9	\$1239
					4	\$615	10	\$1446
					5	\$748	11	\$1724
					6	\$794	12	\$2073

Cushion attaches with Velcro strips. Fits **PN2337CRS** credenza.

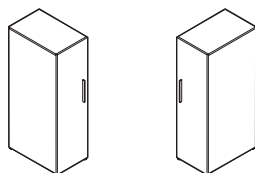
52"H STORAGE CABINETS



LEFT

RIGHT

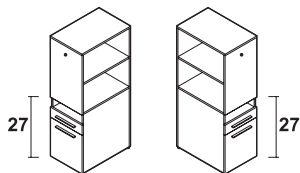
52"H Tower Wardrobe w/Full Height Bookcase*



LEFT

RIGHT

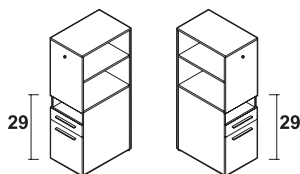
52"H Wardrobe*



LEFT

RIGHT

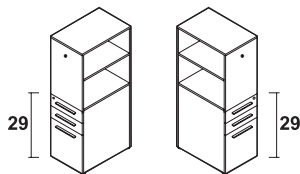
52"H Storage Cabinet w/Bookshelf at 27"H*



LEFT

RIGHT

52"H Storage Cabinet w/Bookshelf at 29"H



LEFT

RIGHT

52"H Storage Cabinet w/Bookshelf at 29"H

MODEL#	DIMENSIONS	FREIGHT CLASS	WT./LBS.	CUBIC FT.	LIST PRICE
PN52TWBL	24 x 24 x 52	125	129	17.33	\$1805
PN52TWBR	24 x 24 x 52	125	129	17.33	\$1805

Specify PN52TWBL for **LEFT** or PN52TWBR for **RIGHT**.

Locking wardrobe with full height bookcase. Three adjustable laminate shelves with fixed bottom laminate shelf. Coat rail. Shipped Fully Assembled.

PN1652WDL	24 x 16 x 52	125	84	11.56	\$1075
PN1652WDR	24 x 16 x 52	125	84	11.56	\$1075

Specify PN1652WDL for **LEFT** or PN1652WDR for **RIGHT**.

Locking wardrobe with coat rail. Shipped Fully Assembled.

PN57CSBFL	24 x 16 x 52	100	102	11.56	\$1543
PN57CSBFR	24 x 16 x 52	100	102	11.56	\$1543

Specify PN57CSBFL for **LEFT** or PN57CSBFR for **RIGHT**.

Open Shelf/Box/File Drawer. Lock on file drawer secures both drawers. One adjustable laminate shelf. Fixed bottom shelf aligns with **27"H** surfaces. Outside accessory hook. Shipped Fully Assembled.

PN59CSBFL	24 x 16 x 52	100	102	11.56	\$1566
PN59CSBFR	24 x 16 x 52	100	102	11.56	\$1566

Specify PN59CSBFL for **LEFT** or PN59CSBFR for **RIGHT**.

Open Shelf/Box/File Drawer. Lock on file drawer secures both drawers. One adjustable laminate shelf. Fixed bottom shelf aligns with **29"H** surfaces. Outside accessory hook. Shipped fully assembled.

PN59CBBFL	24 x 16 x 52	100	102	11.56	\$1656
PN59CBBFR	24 x 16 x 52	100	102	11.56	\$1656

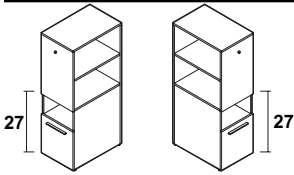
Specify PN59CBBFL for **LEFT** or PN59CBBFR for **RIGHT**.

Box/Box/File Drawer. Lock on upper box drawer secures both drawers. One adjustable laminate shelf. Fixed bottom shelf aligns with **29"H** surfaces. Outside accessory hook. Shipped fully assembled.

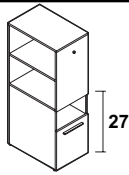
Required Specifications

- Top finish*
- Base finish*
- Drawer/door front finish*
- Fabric**

52" H STORAGE CABINETS



LEFT
52" H Recycling Cabinet
w/Bookshelf at 27" H

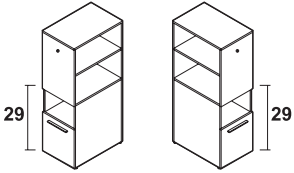


RIGHT

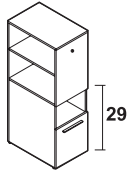
MODEL#	DIMENSIONS D x W x H	FREIGHT CLASS	WT/LBS.	CUBIC FT.	LIST PRICE
PN57RCSL	24 x 16 x 52	100	102	11.56	\$1447
PN57RCSR	24 x 16 x 52	100	102	11.56	\$1447

Specify PN57RCSL for **LEFT** or PN57RCSR for **RIGHT**.

Drawer with one waste bin, one recycling bin and an open shelf above. One adjustable laminate shelf. Fixed bottom shelf aligns with **27" H** surfaces. Outside accessory hook. Shipped Fully Assembled.



LEFT
52" H Recycling Cabinet
w/Bookshelf at 29" H

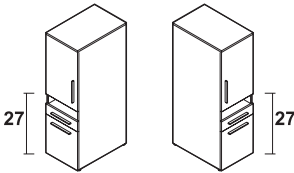


RIGHT

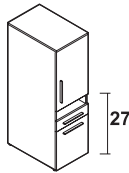
PN59RCSL	24 x 16 x 52	100	102	11.56	\$1464
PN59RCSR	24 x 16 x 52	100	102	11.56	\$1464

Specify PN59RCSL for **LEFT** or PN59RCSR for **RIGHT**.

Drawer with one waste bin, one recycling bin and an open shelf above. One adjustable laminate shelf. Fixed bottom shelf aligns with **29" H** surfaces. Outside accessory hook. Shipped Fully Assembled.



LEFT
52" H Storage Cabinet w/Door at 27" H

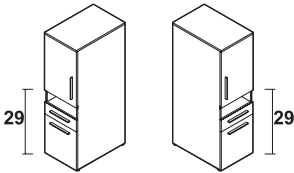


RIGHT

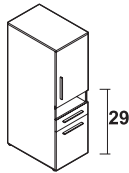
PN57DSBFL	24 x 16 x 52	100	102	11.56	\$1698
PN57DSBFR	24 x 16 x 52	100	102	11.56	\$1698

Specify PN57DSBFL for **LEFT** or PN57DSBFR for **RIGHT**.

Open Shelf/Box/File Drawer. Lock on file drawer secures both drawers. Upper storage cabinet with locking door and one adjustable laminate shelf inside. Door aligns with **27" H** surfaces. Shipped Fully Assembled.



LEFT
52" H Storage Cabinet w/Door at 29" H

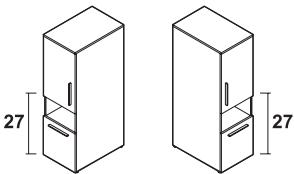


RIGHT

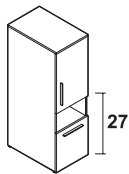
PN59DSBFL	24 x 16 x 52	100	102	11.56	\$1731
PN59DSBFR	24 x 16 x 52	100	102	11.56	\$1731

Specify PN59DSBFL for **LEFT** or PN59DSBFR for **RIGHT**.

Open Shelf/Box/File Drawer. Lock on file drawer secures both drawers. Upper storage cabinet with locking door and one adjustable laminate shelf inside. Door aligns with **29" H** surfaces. Shipped Fully Assembled.



LEFT
52" H Recycling Cabinet w/Door at 27" H

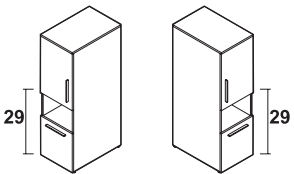


RIGHT

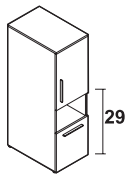
PN57DRCSL	24 x 16 x 52	100	102	11.56	\$1504
PN57DRCSR	24 x 16 x 52	100	102	11.56	\$1504

Specify PN57DRCSL for **LEFT** or PN57DRCSR for **RIGHT**.

Upper storage cabinet with locking door. Drawer with one waste bin, one recycling bin, and an open shelf above. One adjustable laminate shelf inside locking cabinet door. Door aligns with **27" H** surfaces. Shipped Fully Assembled.



LEFT
52" H Recycling Cabinet w/Door at 29" H



RIGHT

PN59DRCSL	24 x 16 x 52	100	102	11.56	\$1536
PN59DRCSR	24 x 16 x 52	100	102	11.56	\$1536

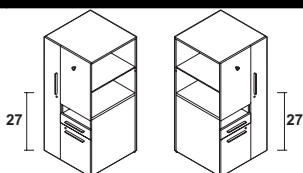
Specify PN59DRCSL for **LEFT** or PN59DRCSR for **RIGHT**.

Upper storage cabinet with locking door. Drawer with one waste bin, one recycling bin, and an open shelf above. One adjustable laminate shelf inside locking cabinet door. Door aligns with **29" H** surfaces. Shipped Fully Assembled.

Required Specifications

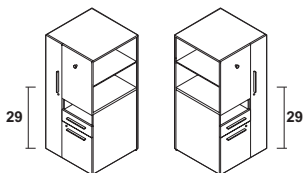
- Top finish
- Base finish
- Drawer/door front finish

52" H STORAGE CABINETS



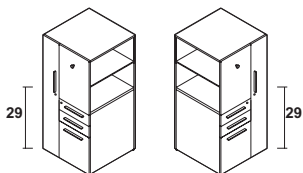
LEFT RIGHT

52" H Storage Tower w/Wardrobe, Shelf and Bookshelf at 27" H



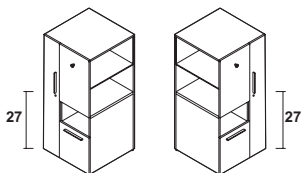
LEFT RIGHT

52" H Storage Tower w/Wardrobe, Shelf and Bookshelf at 29" H



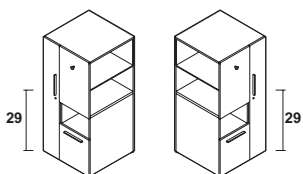
LEFT RIGHT

52" H Storage Tower w/Wardrobe, and Bookshelf at 29" H



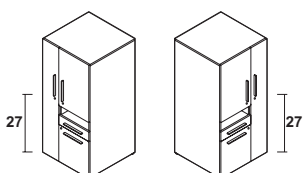
LEFT RIGHT

52" H Storage Tower w/Wardrobe, Shelf, Recycling and Bookshelf at 27" H



LEFT RIGHT

52" H Storage Tower w/Wardrobe, Shelf, Recycling and Bookshelf at 29" H



LEFT RIGHT

52" H Storage Tower w/Wardrobe, Shelf/Box/File and Door at 27" H

MODEL# DIMENSIONS FREIGHT CLASS WT/LBS. CUBIC FT. LIST PRICE

D x W x H

PN57TSBFL	24 x 24 x 52	92.5	225	21	\$1855
PN57TSBFR	24 x 24 x 52	92.5	225	21	\$1855

Specify PN57TSBFL for **LEFT** or PN57TSBFR for **RIGHT**.

Open Shelf/Box/File drawer. Lock on file drawer secures both drawers. One adjustable laminate shelf. Fixed bottom shelf aligns with **27" H** surfaces. Outside accessory hook and locking wardrobe with coat rail. Shipped Fully Assembled.

PN59TSBFL	24 x 24 x 52	92.5	225	21	\$1570
PN59TSBFR	24 x 24 x 52	92.5	225	21	\$1570

Specify PN59TSBFL for **LEFT** or PN59TSBFR for **RIGHT**.

Open Shelf/Box/File drawer. Lock on file drawer secures both drawers. One adjustable laminate shelf. Fixed bottom shelf aligns with **29" H** surfaces. Outside accessory hook and locking wardrobe with coat rail. Shipped Fully Assembled.

PN59TBBFL	24 x 24 x 52	92.5	250	21	\$2142
PN59TBBFR	24 x 24 x 52	92.5	250	21	\$2142

Specify PN59TBBFL for **LEFT** or PN59TBBFR for **RIGHT**.

Box/Box/File drawer. Lock on upper box drawer secures file and lower box drawer. One adjustable laminate shelf. Fixed bottom shelf aligns with **29" H** surfaces. Outside accessory hook and locking wardrobe with coat rail. Shipped fully assembled.

PN57RTSL	24 x 24 x 52	92.5	238	21	\$1991
PN57RTSR	24 x 24 x 52	92.5	238	21	\$1991

Specify PN57RTSL for **LEFT** or PN57RTSR for **RIGHT**.

Drawer with one waste and one recycling bin. Open shelf above. One adjustable laminate shelf. Fixed bottom shelf aligns with **27" H** surfaces. Outside accessory hook. Locking wardrobe with coat rail. Shipped Fully Assembled.

PN59RTSL	24 x 24 x 52	92.5	238	21	\$1991
PN59RTSR	24 x 24 x 52	92.5	238	21	\$1991

Specify PN59RTSL for **LEFT** or PN59RTSR for **RIGHT**.

Drawer with one waste and one recycling bin. Open shelf above. One adjustable laminate shelf. Fixed bottom shelf aligns with **29" H** surfaces. Outside accessory hook. Locking wardrobe with coat rail. Shipped Fully Assembled.

PN57SBFTL	24 x 24 x 52	92.5	234	21	\$2085
PN57SBFTR	24 x 24 x 52	92.5	234	21	\$2085

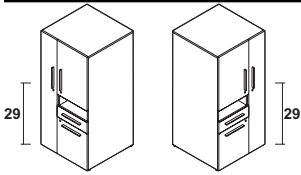
Specify PN57SBFTL for **LEFT** or PN57SBFTR for **RIGHT**.

Open Shelf/Box/File drawer. Lock on file drawer secures both drawers. Upper storage cabinet with locking door and one adjustable laminate shelf inside. Door aligns with **27" H** surfaces. Locking wardrobe with coat rail. Shipped Fully Assembled.

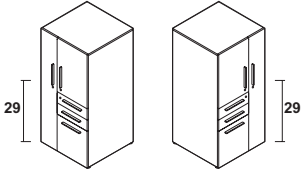
Required Specifications

- Top finish
- Base finish
- Drawer/door front finish

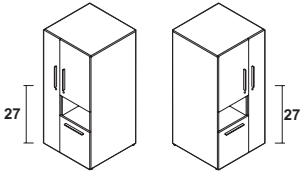
52" H STORAGE CABINETS



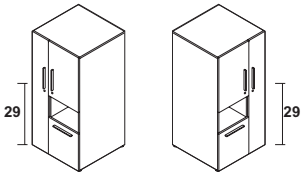
LEFT RIGHT
52" H Storage Tower w/Wardrobe, Shelf/Box/File and Door at 29" H



LEFT RIGHT
52" H Storage Tower w/Wardrobe, Shelf, Box/Box/File and Door at 29" H



LEFT RIGHT
52" H Storage Tower w/Wardrobe, Shelf, Recycling and Door at 27" H



LEFT RIGHT
52" H Storage Tower w/Wardrobe, Shelf, Recycling and Door at 29" H

MODEL#	DIMENSIONS D x W x H	FREIGHT CLASS	WT/LBS.	CUBIC FT.	LIST PRICE
PN59SBFTL	24 x 24 x 52	92.5	234	21	\$2085
PN59SBFTR	24 x 24 x 52	92.5	234	21	\$2085

Specify PN59SBFTL for **LEFT** or PN59SBFTR for **RIGHT**.

Open Shelf/Box/File drawer. Lock on file drawer secures both drawers. Upper storage cabinet with locking door and one adjustable laminate shelf inside. Door aligns with **29" H** surfaces. Locking wardrobe with coat rail. Shipped Fully Assembled.

PN59BBFTL	24 x 24 x 52	92.5	234	21	\$2198
PN59BBFTR	24 x 24 x 52	92.5	234	21	\$2198

Specify PN59BBFTL for **LEFT** or PN59BBFTR for **RIGHT**.

Box/Box/File drawer. Lock on upper box drawer secures file and lower box drawers. Upper storage cabinet with locking door and one adjustable laminate shelf inside. Door aligns with **29" H** surfaces. Locking wardrobe with coat rail. Shipped fully assembled.

PN57DRTSL	24 x 24 x 52	92.5	234	21	\$2122
PN57DRTSR	24 x 24 x 52	92.5	234	21	\$2122

Specify PN57DRTSL for **LEFT** or PN57DRTSR for **RIGHT**.

Drawer with one waste and one recycling bin Open shelf above. Upper storage cabinet with locking door and one adjustable laminate shelf inside. Door aligns with **27" H** surfaces. Locking wardrobe with coat rail. Shipped Fully Assembled.

PN59DRTSL	24 x 24 x 52	92.5	234	21	\$2122
PN59DRTSR	24 x 24 x 52	92.5	234	21	\$2122

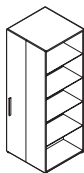
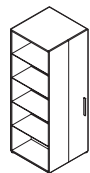
Specify PN59DRTSL for **LEFT** or PN59DRTSR for **RIGHT**.

Drawer with one waste and one recycling bin Open shelf above. Upper storage cabinet with locking door and one adjustable laminate shelf inside. Door aligns with **29" H** surfaces. Locking wardrobe with coat rail. Shipped Fully Assembled.

Required Specifications

- Top finish
- Base finish
- Drawer/door front finish

66" H STORAGE CABINETS



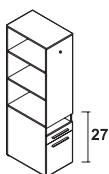
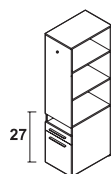
LEFT
66" H Tower Wardrobe w/Full Height Bookcase

RIGHT



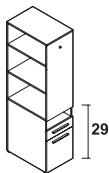
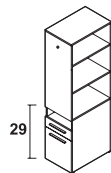
LEFT
66" H Wardrobe

RIGHT



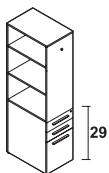
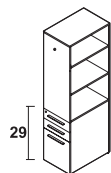
LEFT
66" H Storage Cabinet w/Bookshelf at 27" H

RIGHT



LEFT
66" H Storage Cabinet w/Bookshelf at 29" H

RIGHT



LEFT
66" H Storage Cabinet w/Bookshelf at 29" H

RIGHT

MODEL#	DIMENSIONS	FREIGHT CLASS	WT/LBS.	CUBIC FT.	LIST PRICE
--------	------------	---------------	---------	-----------	------------

D x W x H

PN66TWBL	24 x 24 x 66	125	165	22	\$2094
PN66TWBR	24 x 24 x 66	125	165	22	\$2094

Specify PN66TWBL for **LEFT** or PN66TWBR for **RIGHT**.

Locking wardrobe and full height bookcase. Four adjustable laminate shelves with fixed bottom laminate shelf. Coat rail. Shipped Fully Assembled.

PN1666WDL	24 x 16 x 66	125	106	14.67	\$1215
PN1666WDR	24 x 16 x 66	125	106	14.67	\$1215

Specify PN1666WDL for **LEFT** or PN1666WDR for **RIGHT**.

Locking wardrobe with coat rail and fixed shelf above. Shipped Fully Assembled.

PN67CSBFL	24 x 16 x 66	100	130	14.67	\$1659
PN67CSBFR	24 x 16 x 66	100	130	14.67	\$1659

Specify PN67CSBFL for **LEFT** or PN67CSBFR for **RIGHT**.

Open Shelf/Box/File Drawer. Lock on file drawer secures both drawers. Two adjustable laminate shelves. Fixed bottom shelf aligns with **27" H** surfaces. Outside accessory hook. Shipped Fully Assembled.

PN69CSBFL	24 x 16 x 66	100	130	14.67	\$1659
PN69CSBFR	24 x 16 x 66	100	130	14.67	\$1659

Specify PN69CSBFL for **LEFT** or PN69CSBFR for **RIGHT**.

Open Shelf/Box/File Drawer. Lock on file drawer secures both drawers. Two adjustable laminate shelves. Fixed bottom shelf aligns with **29" H** surfaces. Outside accessory hook. Shipped Fully Assembled.

PN69CBBFL	24 x 16 x 66	100	130	14.67	\$1774
PN69CBBFR	24 x 16 x 66	100	130	14.67	\$1774

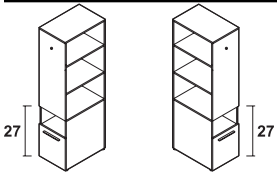
Specify PN69CBBFL for **LEFT** or PN69CBBFR for **RIGHT**.

Box/Box/File Drawer. Lock on upper box drawer secures file and lower box drawer. Two adjustable laminate shelves. Fixed bottom shelf aligns with **29" H** surfaces. Outside accessory hook. Shipped fully assembled.

Required Specifications

- Top finish
- Base finish
- Drawer/door front finish

66" H STORAGE CABINETS

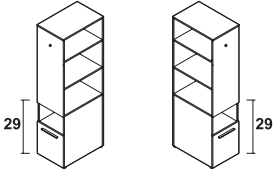


LEFT RIGHT
66" H Recycling Cabinet
w/Bookshelf at 27" H

MODEL#	DIMENSIONS D x W x H	FREIGHT CLASS	WT/LBS.	CUBIC FT.	LIST PRICE
PN67RCSL	24 x 16 x 66	100	130	14.67	\$1592
PN67RCSR	24 x 16 x 66	100	130	14.67	\$1592

Specify PN67RCSL for **LEFT** or PN67RCSR for **RIGHT**.

Drawer with one waste bin and one recycling bin. Open shelf above. Two adjustable laminate shelves. Fixed bottom shelf aligns with **27" H** surfaces. Outside accessory hook. Shipped Fully Assembled.

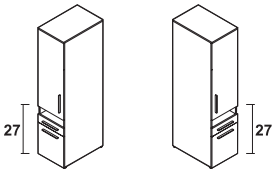


LEFT RIGHT
66" H Recycling Cabinet
w/Bookshelf at 29" H

PN69RCSL	24 x 16 x 66	100	130	14.67	\$1592
PN69RCSR	24 x 16 x 66	100	130	14.67	\$1592

Specify PN69RCSL for **LEFT** or PN69RCSR for **RIGHT**.

Drawer with one waste bin and one recycling bin. Open shelf above. Two adjustable laminate shelves. Fixed bottom shelf aligns with **29" H** surfaces. Outside accessory hook. Shipped Fully Assembled.

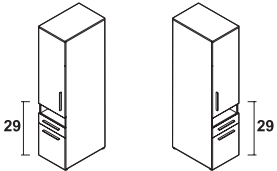


LEFT RIGHT
66" H Storage Cabinet w/Door at 27" H

PN67DSBFL	24 x 16 x 66	100	130	14.67	\$1759
PN67DSBFR	24 x 16 x 66	100	130	14.67	\$1759

Specify PN67DSBFL for **LEFT** or PN67DSBFR for **RIGHT**.

Open Shelf/Box/File Drawer. Lock on file drawer secures both drawers. Upper storage cabinet with locking door and two adjustable laminate shelves inside. Door aligns with **27" H** surfaces. Shipped Fully Assembled.

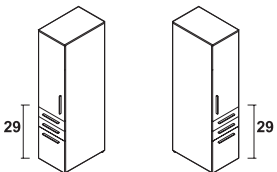


LEFT RIGHT
66" H Storage Cabinet w/Door at 29" H

PN69DSBFL	24 x 16 x 66	100	130	14.67	\$1820
PN69DSBFR	24 x 16 x 66	100	130	14.67	\$1820

Specify PN69DSBFL for **LEFT** or PN69DSBFR for **RIGHT**.

Open Shelf/Box/File Drawer. Lock on file drawer secures both drawers. Upper storage cabinet with locking door and two adjustable laminate shelves inside. Door aligns with **29" H** surfaces. Shipped Fully Assembled.



LEFT RIGHT
66" H Storage Cabinet w/Door at 29" H

PN69DBBFL	24 x 16 x 66	100	130	14.67	\$1932
PN69DBBFR	24 x 16 x 66	100	130	14.67	\$1932

Specify PN69DBBFL for **LEFT** or PN69DBBFR for **RIGHT**.

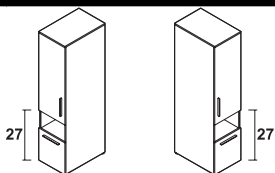
Box/Box/File Drawer. Lock on upper box drawer secures file and lower box drawer. Upper storage cabinet with locking door and two adjustable laminate shelves inside. Door aligns with **29" H** surfaces. Shipped Fully Assembled.

Required Specifications

- Top finish
- Base finish
- Drawer/door front finish

66" H STORAGE CABINETS

MODEL# DIMENSIONS FREIGHT CLASS WT./LBS. CUBIC FT. LIST PRICE



LEFT

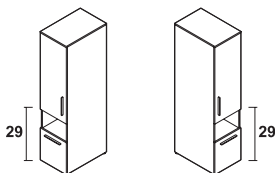
RIGHT

66" H Recycling Cabinet w/Door at 27" H

	D x W x H				
PN67DRCSL	24 x 16 x 66	100	130	14.67	\$1653
PN67DRCSR	24 x 16 x 66	100	130	14.67	\$1653

Specify PN67DRCSL for **LEFT** or PN67DRCSR for **RIGHT**.

Upper storage cabinet with locking door and two adjustable laminate shelves inside. Drawer with one waste bin, one recycling bin, and an open shelf above. Door aligns with **27" H** surfaces. Shipped Fully Assembled.



LEFT

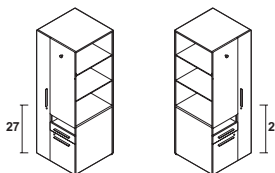
RIGHT

66" H Recycling Cabinet w/Door at 29" H

PN69DRCSL	24 x 16 x 66	100	130	14.67	\$1739
PN69DRCSR	24 x 16 x 66	100	130	14.67	\$1739

Specify PN69DRCSL for **LEFT** or PN69DRCSR for **RIGHT**.

Upper storage cabinet with locking door and two adjustable laminate shelves inside. Drawer with one waste bin, one recycling bin, and an open shelf above. Door aligns with **29" H** surfaces. Shipped fully assembled.



LEFT

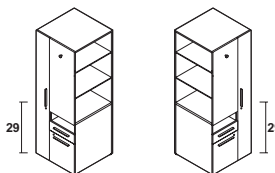
RIGHT

66" H Storage Tower w/Wardrobe, Shelf, Box/File and Bookshelf at 27" H

PN67TSBFL	24 x 24 x 66	92.5	260	26	\$2605
PN67TSBFR	24 x 24 x 66	92.5	260	26	\$2605

Specify PN67TSBFL for **LEFT** or PN67TSBFR for **RIGHT**.

Open Shelf/Box/File drawer. Lock on file drawer secures both drawers. Two adjustable laminate shelves. Fixed bottom shelf aligns with **27" H** surfaces. Outside accessory hook and locking wardrobe with coat rail. Shipped fully assembled.



LEFT

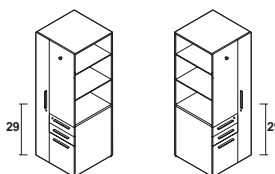
RIGHT

66" H Storage Tower w/Wardrobe, Shelf, Box/File and Bookshelf at 29" H

PN69TSBFL	24 x 24 x 66	92.5	260	26	\$2605
PN69TSBFR	24 x 24 x 66	92.5	260	26	\$2605

Specify PN69TSBFL for **LEFT** or PN69TSBFR for **RIGHT**.

Open Shelf/Box/File drawer. Lock on file drawer secures both drawers. Two adjustable laminate shelves. Fixed bottom shelf aligns with **29" H** surfaces. Outside accessory hook and locking wardrobe with coat rail. Shipped Fully Assembled.



LEFT

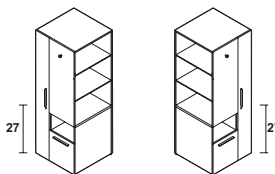
RIGHT

66" H Storage Tower w/Wardrobe, Shelf, Box/Box/File and Bookshelf at 29" H

PN69TBBFL	24 x 24 x 66	92.5	262	26	\$2744
PN69TBBFR	24 x 24 x 66	92.5	262	26	\$2744

Specify PN69TBBFL for **LEFT** or PN69TBBFR for **RIGHT**.

Box/Box/File drawer. Lock on upper box drawer secures file and lower box drawer. Two adjustable laminate shelves. Fixed bottom shelf aligns with **29" H** surfaces. Outside accessory hook and locking wardrobe with coat rail. Shipped fully assembled.



LEFT

RIGHT

66" H Storage Tower w/Wardrobe, Shelf, Recycling and Bookshelf at 27" H

PN67RTSL	24 x 24 x 66	92.5	260	26	\$2617
PN67RTSR	24 x 24 x 66	92.5	260	26	\$2617

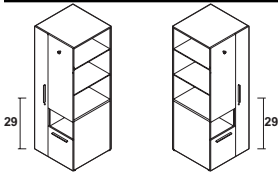
Specify PN67RTSL for **LEFT** or PN67RTSR for **RIGHT**.

Drawer with one waste and one recycling bin. Open shelf above. Two adjustable laminate shelves. Fixed bottom shelf aligns with **27" H** surfaces. Outside accessory hook. Locking wardrobe with coat rail. Shipped fully assembled.

Required Specifications

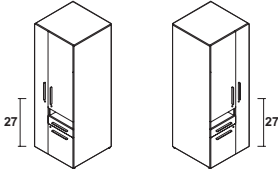
- Top finish
- Base finish
- Drawer/door front finish

66" H STORAGE CABINETS



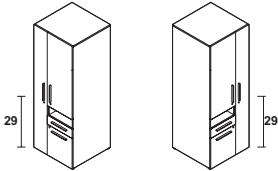
LEFT RIGHT

66" H Storage Tower w/Wardrobe, Shelf, Recycling and Bookshelf at 29" H



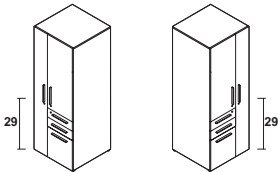
LEFT RIGHT

66" H Storage Tower w/Wardrobe, Shelf, Box/File and Door at 27" H



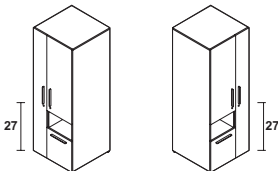
LEFT RIGHT

66" H Storage Tower w/Wardrobe, Shelf, Box/File and Door at 29" H



LEFT RIGHT

66" H Storage Tower w/Wardrobe, Box/Box/File and Door at 29" H



LEFT RIGHT

66" H Storage Tower w/Wardrobe, Large Shelf, Recycling and Door at 27" H

MODEL#	DIMENSIONS D x W x H	FREIGHT CLASS	WT./LBS.	CUBIC FT.	LIST PRICE
PN69RTSL	24 x 24 x 66	92.5	260	26	\$2617
PN69RTSR	24 x 24 x 66	92.5	260	26	\$2617

Specify PN69RTSL for **LEFT** or PN69RTSR for **RIGHT**.

Drawer with one waste and one recycling bin. Open shelf above. Two adjustable laminate shelves. Fixed bottom shelf aligns with **29" H** surfaces. Outside accessory hook. Locking wardrobe with coat rail. Shipped Fully Assembled.

PN67SBFTL	24 x 24 x 66	100	257	26	\$2702
PN67SBFTR	24 x 24 x 66	100	257	26	\$2702

Specify PN67SBFTL for **LEFT** or PN67SBFTR for **RIGHT**.

Open Shelf/Box/File Drawer. Lock on file drawer secures both drawers. Upper storage cabinet with locking door and two adjustable laminate shelves inside. Door aligns with **27" H** surfaces. Outside accessory hook. Locking wardrobe with coat rail. Shipped Fully Assembled.

PN69SBFTL	24 x 24 x 66	100	257	26	\$2702
PN69SBFTR	24 x 24 x 66	100	257	26	\$2702

Specify PN69SBFTL for **LEFT** or PN69SBFTR for **RIGHT**.

Open Shelf/Box/File Drawer. Lock on file drawer secures both drawers. Upper storage cabinet with locking door and two adjustable laminate shelves inside. Door aligns with **29" H** surfaces. Locking wardrobe with coat rail. Shipped Fully Assembled.

PN69BBFTL	24 x 24 x 66	100	257	26	\$2840
PN69BBFTR	24 x 24 x 66	100	257	26	\$2840

Specify PN69BBFTL for **LEFT** or PN69BBFTR for **RIGHT**.

Box/Box/File Drawer. Lock on upper box drawer secures file and lower box drawer. Upper storage cabinet with locking door and two adjustable laminate shelves inside. Door aligns with **29" H** surfaces. Locking wardrobe with coat rail. Shipped fully assembled.

PN67DRTSL	24 x 24 x 66	100	230	26	\$2769
PN67DRTSR	24 x 24 x 66	100	230	26	\$2769

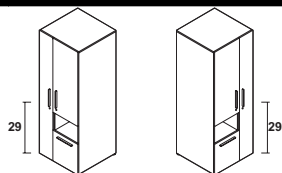
Specify PN67DRTSL for **LEFT** or PN67DRTSR for **RIGHT**.

Drawer with one waste and one recycling bin. Open shelf above. Upper storage cabinet with locking door and two adjustable laminate shelves inside. Door aligns with **27" H** surfaces. Locking wardrobe with coat rail. Shipped Fully Assembled.

Required Specifications

- Top finish
- Base finish
- Drawer/door front finish

66" H STORAGE CABINETS



LEFT

RIGHT

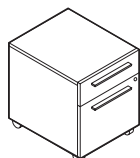
66" H Storage Tower w/Wardrobe, Large Shelf, Recycling and Door at 29" H

MODEL#	DIMENSIONS D x W x H	FREIGHT CLASS	WT/LBS.	CUBIC FT.	LIST PRICE
PN69DRTSL	24 x 24 x 66	100	230	26	\$2769
PN69DRTSR	24 x 24 x 66	100	230	26	\$2769

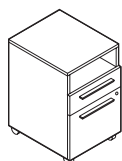
Specify PN69DRTSL for **LEFT** or PN69DRTSR for **RIGHT**.

Drawer with one waste and one recycling bin. Open shelf above. Upper storage cabinet with locking door and two adjustable laminate shelves inside. Door aligns with 29" H surfaces. Locking wardrobe with coat rail. Shipped Fully Assembled.

MOBILE PEDESTALS



20.9" H Mobile Pedestal



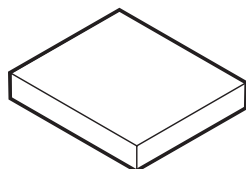
25.4" H Mobile Pedestal



25.4" H Mobile Pedestal



26.8" H Mobile Pedestal



Pedestal Cushion*

MODEL#	DIMENSIONS	FREIGHT CLASS	WT/LBS.	CUBIC FT.	LIST PRICE	HP ADD
PN22MBF	22 x 16 x 20.9	85	79	5.75	\$967	\$102

Box/File drawer. Lock on box drawer secures both drawers. Front casters are locking. Shipped Fully Assembled.

PN25MSBF	22 x 16 x 25.4	92.5	80	7	\$1025	\$110
----------	----------------	------	----	---	--------	-------

Open Shelf/Box/File drawer. Lock on file drawer secures both drawers. Front casters are locking. Shipped Fully Assembled.

PN25MBBF	22 x 16 x 25.4	92.5	95	8	\$1080	\$131
----------	----------------	------	----	---	--------	-------

Box/Box/File drawer. Lock on file drawer secures file and lower box drawer. Front casters are locking. Shipped Fully Assembled.

PN27MFF	22 x 16 x 26.8	85	101	8	\$1058	\$121
---------	----------------	----	-----	---	--------	-------

File/File. Lock on lower file drawer secures both drawers. Front casters are locking. Shipped assembled in 1 carton.

- 26.8" H mobile storage can only be used with 29" H Princeton products that have laminate end panels/gables. 29" H units with HAT channels have underside clearance of only 25.9" H.

PN1622CU	21 x 16 x 2.5	125	6	.90	1	\$193	7	\$432
					2	\$231	8	\$532
					3	\$260	9	\$580
					4	\$301	10	\$670
					5	\$360	11	\$795
					6	\$380	12	\$948

For **PN22MBF** mobile pedestals.

Required Specifications

Top finish
Base finish
Drawer/door front finish
Fabric*

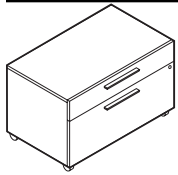
Optional Specifications

HP laminate

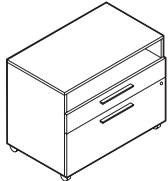
Accessories

Pedestal cushion

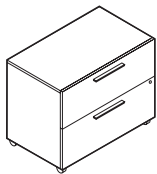
MOBILE LATERAL FILES



20.5”h Mobile Lateral File*



25.5”h Mobile Lateral File



27”H Mobile Lateral File

MODEL#	DIMENSIONS	FREIGHT CLASS	WT/LBS.	CUBIC FT.	LIST PRICE	HP ADD
--------	------------	---------------	---------	-----------	------------	--------

	D x W x H					
PN22MLBF	22 x 35.5 x 20.5	100	132	14	\$1524	\$209

Box/File drawer. Lock on file drawer secures both drawers. File bars included for front-to-back letter and legal filing capability. Front casters are locking. Shipped Fully Assembled. Can fit under 29”H and 27”H credenzas for mobile lateral file with or without a cushion. Can fit under 23”H credenzas without cushion only.

PN25MLSBF	22 x 35.5 x 25.5	100	138	16	\$1595	\$219
-----------	------------------	-----	-----	----	---------------	--------------

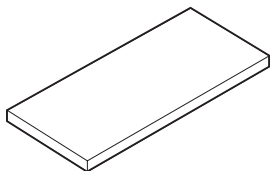
Open Shelf/Box/File drawer. Lock on file drawer secures both drawers. File bars included for front-to-back letter and legal filing capability. Front casters are locking. Shipped Fully Assembled. Can fit under 29”H credenzas for mobile lateral file without cushion only.

PN27MLFF	22 x 35.5 x 27	92.5	170	16	\$1664	\$227
----------	----------------	------	-----	----	---------------	--------------

File/File drawer. Lock on bottom file drawer secures both drawers. File bars included for front-to-back letter and legal filing capability. Front casters are locking. Shipped Fully Assembled. Can fit under 29”H credenzas for mobile lateral file without cushion only.

- 27”H mobile pedestals can only be used with 29”H Princeton products that have laminate end panels/gables. Princeton products with metal legs will not accommodate 27”H mobile units.

CUSHIONS FOR MOBILE LATERAL FILE



Mobile Lateral File Cushion**

MODEL#	DIMENSIONS	FREIGHT CLASS	WT/LBS.	CUBIC FT.	GRADE	LIST	GRADE	LIST
--------	------------	---------------	---------	-----------	-------	------	-------	------

PN3622CU	21 x 35.5 x 2.5	150	14	2.40	1	\$387	7	\$863
					2	\$460	8	\$1060
					3	\$516	9	\$1154
					4	\$600	10	\$1337
					5	\$719	11	\$1586
					6	\$759	12	\$1896

For **PN21MLSF** and **PN22MLBF** mobile lateral files.

Required Specifications

Fabric**
 Top finish (Mobile Laterals)
 Base finish (Mobile Laterals)
 Door/drawer front finish (Mobile Laterals)

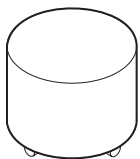
Optional Specifications

HP laminate (Mobile Laterals)

Accessories

Cushion*

STOOLS



Round Mobile Stool

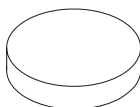
MODEL#	DIMENSIONS	FREIGHT CLASS	WT/LBS.	CUBIC FT.	LIST PRICE
	D x W x H				
PN1920ST	19 x 19 x 19.5	250	20	5.50	\$744

Laminate base for use with cushion. **CANNOT BE USED WITHOUT CUSHION. Cushion sold separately.** Six casters.

• **NOTE: Maximum weight capacity is 200 lbs.**

• Recommended for carpet applications.

CUSHION FOR MOBILE STOOL

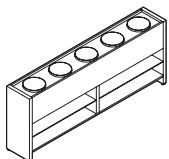


Cushion for Round Mobile Stool*

MODEL#	DIMENSIONS	FREIGHT CLASS	WT/LBS.	CUBIC FT.	GRADE	LIST	GRADE	LIST
SEAT-PN1920ST	--	150	8	1.60	1	\$266	7	\$471
					2	\$299	8	\$540
					3	\$322	9	\$594
					4	\$355	10	\$653
					5	\$404	11	\$777
					6	\$425	12	\$908

To be used with PN1920ST.

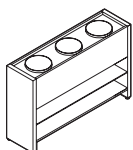
PLANTERS



Five Pot Planter**

MODEL#	DIMENSIONS	FREIGHT CLASS	WT/LBS.	CUBIC FT.	LIST PRICE
PN7229PL	12 x 72 x 29	100	124	14.50	\$1410

Five plastic pots - specify Black (**BK**) or White (**WT**). Adjustable 3 position laminate shelves/open pass through. Shipped fully assembled.

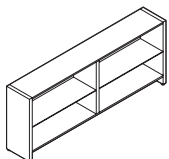


Three Pot Planter**

PN4229PL	12 x 42 x 29	92.5	86	8.46	\$1074
----------	--------------	------	----	------	---------------

Three plastic pots - specify Black (**BK**) or White (**WT**). Adjustable 3 position laminate shelf/open pass through. Shipped fully assembled.

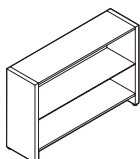
DIVIDER SHELVES



72" w Divider Shelf

MODEL#	DIMENSIONS	FREIGHT CLASS	WT/LBS.	CUBIC FT.	LIST PRICE
PN7229BGS	12 x 72 x 29	125	124	18	\$1167

Fixed laminate shelves/open pass through. Shipped fully assembled.



42" w Divider Shelf

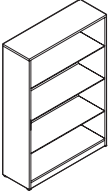
PN4229BGS	12 x 42 x 29	125	86	11	\$940
-----------	--------------	-----	----	----	--------------

Fixed laminate shelf/open pass through. Shipped fully assembled.

Required Specifications

- Fabric*
- Planter pot finish**
- Top finish
- Base finish

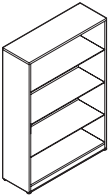
BOOKSHELVES



Bookshelf w/Laminate Shelves

MODEL#	DIMENSIONS D x W x H	FREIGHT CLASS	WT/LBS.	CUBIC FT.	LIST PRICE	HP ADD
PN2429BLS	12 x 24 x 29	70	37	2	\$717	\$114
PN2452BLS	12 x 24 x 52	70	60	3	\$908	N/A
PN2466BLS	12 x 24 x 66	70	74	4	\$998	N/A
PN3029BLS	12 x 30 x 29	70	44	2	\$806	\$132
PN3052BLS	12 x 30 x 52	65	68	3	\$941	N/A
PN3066BLS	12 x 30 x 66	70	79	4	\$1038	N/A
PN3629BLS	12 x 36 x 29	70	66	3	\$866	\$142
PN3652BLS	12 x 36 x 52	70	80	4	\$991	N/A
PN3666BLS	12 x 36 x 66	70	106	5	\$1091	N/A

66"H models have four adjustable shelves. 52"H models have 3 adjustable shelves. 29"H models have 1 adjustable shelf. Shipped Fully Assembled.

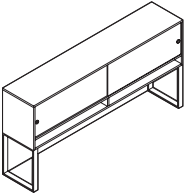


Bookshelf w/Glass Shelves

PN2429BGS	12 x 24 x 29	70	37	2	\$747	\$114
PN2452BGS	12 x 24 x 52	70	60	3	\$1105	N/A
PN2466BGS	12 x 24 x 66	70	74	4	\$1316	N/A
PN3029BGS	12 x 30 x 29	70	44	2	\$863	\$132
PN3052BGS	12 x 30 x 52	65	68	3	\$1192	N/A
PN3066BGS	12 x 30 x 66	70	79	4	\$1373	N/A
PN3629BGS	12 x 36 x 29	70	66	3	\$862	\$142
PN3652BGS	12 x 36 x 52	70	80	4	\$1295	N/A
PN3666BGS	12 x 36 x 66	70	106	5	\$1520	N/A

66"H models have four adjustable shelves. 52"H models have 3 adjustable shelves. 29"H models have 1 adjustable shelf. Shipped Fully Assembled.

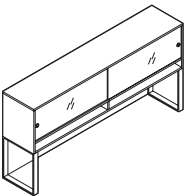
DESKTOP AND OVERHEAD STORAGE



Hutch w/Laminate Doors*

MODEL#	DIMENSIONS	FREIGHT CLASS	WT/LBS.	CUBIC FT.	LIST PRICE
PN3560LCH	16 x 60 x 35	125	131	18	\$1831
PN3572LCH	16 x 72 x 35	125	135	21	\$1895
PN3584LCH	16 x 84 x 35	150	145	25	\$2033

Sliding laminate doors in upper plastic track. Recessed brushed aluminum finger pulls. No lock. Metal hutch supports. Laminate back board. 15.75" clearance between worksurface and underside. Shipped Partially Assembled.



Hutch w/Glass Doors*

PN3560CH	16 x 60 x 35	125	120	19.44	\$2657
PN3572CH	16 x 72 x 35	125	144	23.33	\$2857
PN3584CH	16 x 84 x 35	150	145	25	\$3136

Sliding glass doors in upper aluminum track. Satin etched 6mm glass. Brushed aluminum finger pulls. No lock. Metal hutch supports. Laminate back board. 15.75" clearance between worksurface and underside. Shipped partially assembled in 2 cartons. Glass doors shipped separately.

Required Specifications

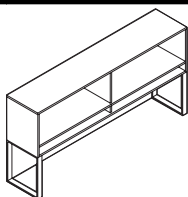
- Top finish
- Base finish
- Door finish (laminated doors)
- Hutch support finish*

Optional Specifications

- HP laminate (29"H bookshelves)

DESKTOP AND OVERHEAD STORAGE

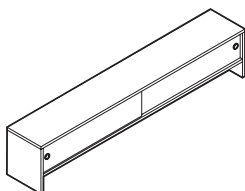
MODEL# DIMENSIONS FREIGHT CLASS WT/LBS. CUBIC FT. LIST PRICE



Open Hutch*

	D x W x H				
PN3560CHO	16 x 60 x 35	125	124	18	\$1598
PN3572CHO	16 x 72 x 35	125	128	21	\$1644
PN3584CHO	16 x 84 x 35	150	138	25	\$1775

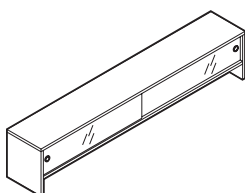
Metal hutch supports. Laminate back board. 15.75" clearance between worksurface and underside. Shipped Partially Assembled.



Desktop Storage w/Laminate Doors

PN1160LDS	11 x 60 x 12	100	54	6.50	\$961
PN1172LDS	11 x 72 x 12	100	62	7.75	\$1034

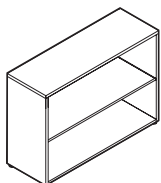
Sliding laminate doors in upper plastic track. Recessed brushed aluminum finger pulls. No lock. Shipped Fully Assembled.



Desktop Storage w/Glass Doors

PN1160DS	11 x 60 x 12	100	43	4.58	\$1543
PN1172DS	11 x 72 x 12	100	51	5.50	\$1739

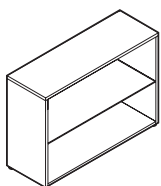
Sliding glass doors in upper aluminum track. Satin etched 6mm glass. Recessed aluminum finger pulls. No lock. Shipped assembled in 2 cartons. Glass doors shipped separately.



Desktop Shelf - Two High w/Laminate Shelf

PN2423LDB	12 x 24 x 23	60	45	1.50	\$454
PN3023LDB	12 x 30 x 23	60	49	1.50	\$496
PN3623LDB	12 x 36 x 23	65	53	2	\$502
PN2425LDB	12 x 24 x 25	60	47	1.50	\$454
PN3025LDB	12 x 30 x 25	65	51	2	\$496
PN3625LDB	12 x 36 x 25	65	55	2	\$502

One multiple-position adjustable laminate shelf. Shipped Fully Assembled.



Desktop Shelf - Two High w/Glass Shelf

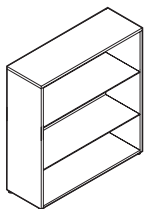
PN2423GDB	12 x 24 x 23	60	45	1.50	\$523
PN3023GDB	12 x 30 x 23	60	49	1.50	\$572
PN3623GDB	12 x 36 x 23	65	53	2	\$610
PN2425GDB	12 x 24 x 25	60	47	1.50	\$523
PN3025GDB	12 x 30 x 25	65	51	2	\$572
PN3625GDB	12 x 36 x 25	65	55	2	\$610

One multiple-position adjustable glass shelf. Shipped Fully Assembled.

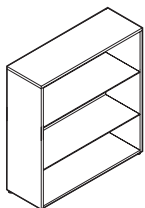
Required Specifications

- Top finish
- Base finish
- Door finish (laminate doors)
- Hutch support finish*

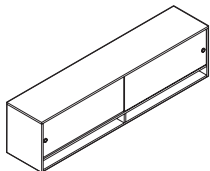
DESKTOP AND OVERHEAD STORAGE



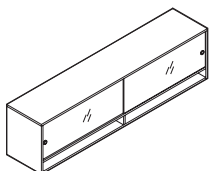
Desktop Shelf - Three High w/Laminate Shelves



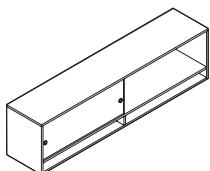
Desktop Shelf - Three High w/Glass Shelves



Large Overhead Storage w/Laminate Doors, Wall-Mounted



Large Overhead Storage w/Glass Doors Wall-Mounted



Large Overhead Storage w/Single Laminate Door, Wall-Mounted

MODEL#	DIMENSIONS D x W x H	FREIGHT CLASS	WT/LBS.	CUBIC FT.	LIST PRICE
PN2437LDB	12 x 24 x 37	65	58	2	\$567
PN3037LDB	12 x 30 x 37	70	64	3	\$603
PN3637LDB	12 x 36 x 37	65	71	3	\$627
PN2439LDB	12 x 24 x 39	65	58	2	\$567
PN3039LDB	12 x 30 x 39	70	64	3	\$603
PN3639LDB	12 x 36 x 39	65	71	3	\$627

Two multiple-position adjustable laminate shelves. Shipped Fully Assembled.

PN2437GDB	12 x 24 x 37	65	58	2	\$732
PN3037GDB	12 x 30 x 37	70	64	3	\$810
PN3637GDB	12 x 36 x 37	65	71	3	\$843
PN2439GDB	12 x 24 x 39	65	58	2	\$732
PN3039GDB	12 x 30 x 39	70	64	3	\$810
PN3639GDB	12 x 36 x 39	65	71	3	\$843

Two multiple-position adjustable glass shelves. Shipped Fully Assembled.

PN1960LWH	16 x 60 x 19	100	119	13.25	\$1350
PN1972LWH	16 x 72 x 19	100	138	16	\$1411
PN1984LWH	16 x 84 x 19	100	158	19	\$1554

Sliding laminate doors in upper plastic track. Recessed brushed aluminum finger pulls. No lock. Shipped Fully Assembled.

• **NOTE:** Care should be taken to mount the units. Units should be mounted to wall studs using correct fasteners. Failure to do so may result in collapse of the unit and subsequent personal injury. **Mounting hardware not included.** Mounting hardware used should be based on wall material. Consult an installation professional for proper wall mounting.

PN1960WH	16 x 60 x 19	100	101	10.56	\$2108
PN1972WH	16 x 72 x 19	100	121	12.67	\$2361
PN1984WH	16 x 84 x 19	100	158	19	\$2588

Sliding glass doors in upper aluminum track. Satin etched 6mm glass. Brushed aluminum finger pulls. No lock. Shipped assembled in two cartons. Glass doors shipped separately.

• **NOTE:** Care should be taken to mount the units. Units should be mounted to wall studs using correct fasteners. Failure to do so may result in collapse of the unit and subsequent personal injury. **Mounting hardware not included.** Mounting hardware used should be based on wall material. Consult an installation professional for proper wall mounting.

PN1960LS	16 x 60 x 19	100	117	13.25	\$1255
PN1972LS	16 x 72 x 19	100	136	16	\$1320
PN1984LS	16 x 84 x 19	100	156	19	\$1449

Sliding laminate door in upper plastic track. Recessed brushed aluminum finger pulls. No lock. Shipped Fully Assembled.

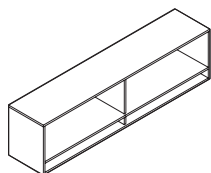
• **NOTE:** Care should be taken to mount the units. Units should be mounted to wall studs using correct fasteners. Failure to do so may result in collapse of the unit and subsequent personal injury. **Mounting hardware not included.** Mounting hardware used should be based on wall material. Consult an installation professional for proper wall mounting.

Required Specifications

- Top finish
- Base finish
- Door finish (laminate doors)

DESKTOP AND OVERHEAD STORAGE

MODEL# DIMENSIONS FREIGHT CLASS WT/LBS. CUBIC FT. LIST PRICE

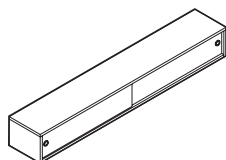


Large Overhead Storage, Wall-Mounted

	D x W x H				
PN1960WHO	16 x 60 x 19	100	112	13.25	\$1137
PN1972WHO	16 x 72 x 19	100	131	16	\$1182
PN1984WHO	16 x 84 x 19	125	151	19	\$1315

Open storage with center divider. Shipped Fully Assembled.

• **NOTE:** Care should be taken to mount the units. Units should be mounted to wall studs using correct fasteners. Failure to do so may result in collapse of the unit and subsequent personal injury. **Mounting hardware not included.** Mounting hardware used should be based on wall material. Consult an installation professional for proper wall mounting.

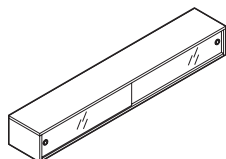


Small Overhead Storage w/Laminate Doors, Wall-Mounted

PN1260LWH	12 x 60 x 8	100	49	5.25	\$990
PN1272LWH	12 x 72 x 8	100	56	6.25	\$1074
PN1284LWH	12 x 84 x 8	100	64	8	\$1128

Sliding laminate doors in upper plastic track. Recessed brushed aluminum finger pulls. No lock. Shipped Fully Assembled.

• **NOTE:** Care should be taken to mount the units. Units should be mounted to wall studs using correct fasteners. Failure to do so may result in collapse of the unit and subsequent personal injury. **Mounting hardware not included.** Mounting hardware used should be based on wall material. Consult an installation professional for proper wall mounting.

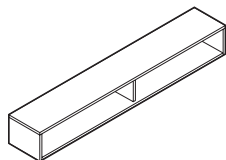


Small Overhead Storage w/Glass Doors, Wall-Mounted

PN1260WH	12 x 60 x 8	100	31	3.33	\$1937
PN1272WH	12 x 72 x 8	100	38	4	\$2183
PN1284WH	12 x 84 x 8	100	64	8	\$2307

Sliding glass doors in upper aluminum track. Satin etched 6mm glass. Brushed aluminum finger pulls. No lock. Shipped assembled in 2 cartons. Glass doors shipped separately.

• **NOTE:** Care should be taken to mount the units. Units should be mounted to wall studs using correct fasteners. Failure to do so may result in collapse of the unit and subsequent personal injury. **Mounting hardware not included.** Mounting hardware used should be based on wall material. Consult an installation professional for proper wall mounting.

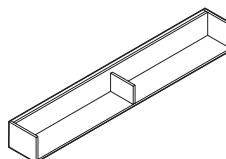


Small Overhead Storage, Wall-Mounted

PN1260WHO	12 x 60 x 8	100	45	5.25	\$760
PN1272WHO	12 x 72 x 8	100	52	6.25	\$854
PN1284WHO	12 x 84 x 8	125	60	8	\$928

Open storage shelf with center divider. Shipped Fully Assembled.

• **NOTE:** Care should be taken to mount the units. Units should be mounted to wall studs using correct fasteners. Failure to do so may result in collapse of the unit and subsequent personal injury. **Mounting hardware not included.** Mounting hardware used should be based on wall material. Consult an installation professional for proper wall mounting.



Wall-Mounted Shelf

PN1260WHS	12 x 60 x 8	150	31	5.50	\$564
PN1272WHS	12 x 72 x 8	125	37	6	\$611
PN1284WHS	12 x 84 x 8	125	44	7	\$659

Open storage shelf with center divider. Shipped Fully Assembled.

• **NOTE:** Care should be taken to mount the units. Units should be mounted to wall studs using correct fasteners. Failure to do so may result in collapse of the unit and subsequent personal injury. **Mounting hardware not included.** Mounting hardware used should be based on wall material. Consult an installation professional for proper wall mounting.

Required Specifications

- Top finish
- Base finish
- Door finish (laminated doors)

TACKBOARD NOTES

D x W x H

TACKBOARD Notes: Tackboards can be upholstered in all of the following fabrics:

Grade 1: Jenny, Quilt, Terrace, Urban, Waterfall

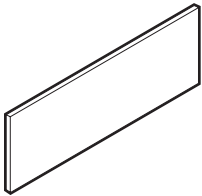
Grade 2: Imprint, Lola

Grade 3: Anchorage, Merge

TACKBOARDS

MODEL# DIMENSIONS FREIGHT CLASS WT/LBS. CUBIC FT. FABRIC GRD. LIST PRICE

PN1556TBH	1 x 56 x 14.5	100	9.50	1	1	\$583
					2	\$702
					3	\$842
					4	\$1006
					5	\$1157
PN1568TBH	1 x 68 x 14.5	92.5	11	1	1	\$606
					2	\$730
					3	\$873
					4	\$1048
					5	\$1203
PN1580TBH	1 x 80 x 14.5	125	10	1.50	1	\$964
					2	\$1160
					3	\$1388
					4	\$1666
					5	\$1917



Tackboard for Hutches

Attaches with Velcro to Hutch backboard.

Required Specifications

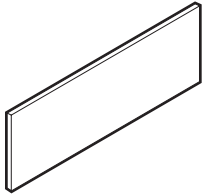
Fabric

TACKBOARDS

MODEL# DIMENSIONS FREIGHT CLASS WT/LBS. CUBIC FT. FABRIC GRD. LIST PRICE

D x W x H

PN1560TBW	1 x 60 x 14.5	85	14	1	1	\$596
					2	\$716
					3	\$859
					4	\$1031
					5	\$1185
PN1566TBW	.62 x 66 x 14.4	85	12	1	1	\$794
					2	\$956
					3	\$1148
					4	\$1376
					5	\$1580
PN1572TBW	1 x 72 x 14.5	70	16.50	1	1	\$695
					2	\$837
					3	\$1003
					4	\$1202
					5	\$1381
PN1578TBW	.62 x 78 x 14.4	100	14	1.50	1	\$1002
					2	\$1207
					3	\$1444
					4	\$1733
					5	\$1991
PN1584TBW	.62 x 84 x 14.4	92.5	15	1.50	1	\$1090
					2	\$1310
					3	\$1572
					4	\$1882
					5	\$2165



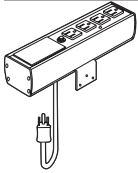
Tackboard for Overhead Storage

Attaches with adhesive-backed Velcro.

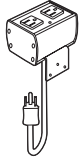
Required Specifications

Fabric

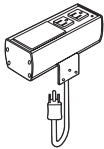
ELECTRICAL / DATA



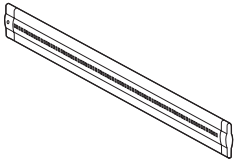
4 Outlet, 1 Telecom Blank Plate



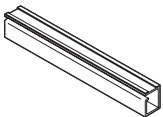
2 Outlet Power Block



2 Outlet, 1 Telecom Blank Plate



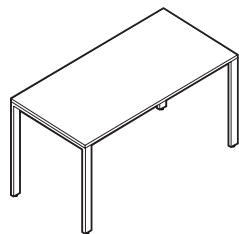
LED Task Light



Wire Manager

MODEL#	DIMENSIONS D x W x H	FREIGHT CLASS	WT/LBS.	CUBIC FT.	LIST PRICE
PGDPS41	2.5 x 10.25 x 2.22	70	1.50	.02	\$234
4 power receptacles and 1 telecom blank plate. For mounting behind pull-out shelf or open space credenza. Tungsten (TUN) finish. 12 foot black cord. UL listed: UL153.					
PGDPS20	2.5 x 3.58 x 2.22	70	1	.01	\$168
2 power receptacles. For side mounted installation. Tungsten (TUN) finish. 12 foot black cord. UL listed: UL153.					
PGDPS21	2.5 x 6.75 x 2.22	70	1.25	.01	\$217
2 power receptacles and 1 telecom blank plate. For side mounted installation. Tungsten (TUN) finish. 12 foot black cord. UL listed: UL153.					
PLED30	1.5 x 15.5 x .5	150	2	.50	\$494
PLED50	1.5 x 23.5 x .5	150	2	.50	\$569
PLED100	1.5 x 43.5 x .5	125	3	.50	\$660
Energy efficient LED. Ultra slim design. Suitable for hanging under Hutch or Wallhung units. 6' power cord. UL listed: UL153.					
PEWM5.5	2 x 66 x 2	70	.60	.10	\$198
PEWM5	2 x 60 x 2	70	.60	.10	\$166
PEWM4.5	2 x 54 x 2	70	.50	.10	\$148
PEWM4	2 x 48 x 2	70	.50	.10	\$135
PEWM3.5	2 x 42 x 2	70	.40	.10	\$116
PEWM3	2 x 36 x 2	70	.40	.10	\$104
PEWM2.5	2 x 30 x 2	70	.30	.10	\$85
PEWM2	2 x 24 x 2	70	.30	.10	\$70
PEWM1.5	2 x 18 x 2	70	.20	.10	\$55
PEWM1	2 x 12 x 2	70	.20	.10	\$40
Plastic tray flexes to receive and hold electrical and data wires. Quickly attaches with two strips of double-sided tape. Black (BLK) only.					

TABLES



29" H Table

MODEL#	DIMENSIONS	FREIGHT CLASS	WT/LBS.	CUBIC FT.	LIST PRICE	HP ADD
D x W x H						
PN242429	24 x 24 x 29	150	53	10	\$1028	\$144
PN482429	24 x 48 x 29	125	71	10.50	\$1097	\$156
PN542429	24 x 54 x 29	125	83	13	\$1302	\$183
PN602429	24 x 60 x 29	125	86	13	\$1323	\$186
PN662429	24 x 66 x 29	125	90	14	\$1352	\$188
PN722429	24 x 72 x 29	150	97	21	\$1361	\$189
PN782429	24 x 78 x 29	150	101	21	\$1492	\$209
PN842429	24 x 84 x 29	150	106	22	\$1612	\$225
PN902429	24 x 90 x 29	150	110	23	\$1694	\$237
PN962429	24 x 96 x 29	150	123	24	\$1754	\$245
PN303029	30 x 30 x 29	150	66	12	\$1131	\$159
PN483029	30 x 48 x 29	150	77	13	\$1205	\$168
PN543029	30 x 54 x 29	150	94	16	\$1419	\$199
PN603029	30 x 60 x 29	125	99	16.50	\$1428	\$200
PN663029	30 x 66 x 29	125	105	17	\$1468	\$206
PN723029	30 x 72 x 29	150	112	23	\$1492	\$209
PN783029	30 x 78 x 29	150	119	26	\$1630	\$227
PN843029	30 x 84 x 29	150	132	27	\$1749	\$245
PN903029	30 x 90 x 29	150	139	33	\$1830	\$256
PN963029	30 x 96 x 29	150	143	29.50	\$1874	\$261
PN363629	36 x 36 x 29	150	80	15	\$1203	\$168
PN603629	36 x 60 x 29	150	113	20	\$1638	\$227
PN663629	36 x 66 x 29	150	119	21	\$1692	\$236
PN723629	36 x 72 x 29	150	128	29	\$1718	\$239
PN783629	36 x 78 x 29	150	135	31	\$1694	\$237
PN843629	36 x 84 x 29	150	150	32	\$1812	\$253
PN903629	36 x 90 x 29	150	161	33.50	\$1947	\$273
PN963629	36 x 96 x 29	150	164	35	\$1968	\$274
PN424229	42 x 42 x 29	150	96	17	\$1388	\$195
PN604229	42 x 60 x 29	150	125	22	\$1712	\$239
PN664229	42 x 66 x 29	150	134	23	\$1767	\$248
PN724229	42 x 72 x 29	150	142	32	\$1802	\$252
PN784229	42 x 78 x 29	150	150	35	\$2002	\$280
PN844229	42 x 84 x 29	150	167	36	\$2184	\$303
PN904229	42 x 90 x 29	150	176	38	\$2340	\$327
PN964229	42 x 96 x 29	150	182	40	\$2387	\$332
PN484829	48 x 48 x 29	150	114	21	\$1434	\$201
PN604829	48 x 60 x 29	150	138	26	\$1775	\$248
PN664829	48 x 66 x 29	150	147	27	\$1836	\$256
PN724829	48 x 72 x 29	150	158	38	\$1861	\$260
PN784829	48 x 78 x 29	150	166	40	\$2106	\$294
PN844829	48 x 84 x 29	150	184	42	\$2285	\$319
PN904829	48 x 90 x 29	150	193	43	\$2439	\$337
PN964829	48 x 96 x 29	150	202	45	\$2478	\$346

Freestanding. 1" x 2.5" open metal frame legs with levelers, finished in Tungsten (TTU), Designer White (TDW) or Black (TBL). Metal support hat channel(s) provided on tables exceeding 54" in width. Shipped in 2 cartons.

Required Specifications

Top finish
Leg finish

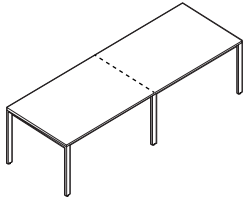
Optional Specifications

HP laminate

Accessories

Wire manager
Desktop screen

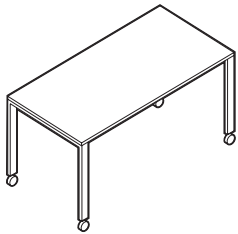
TABLES **MODEL#** **DIMENSIONS** **FREIGHT CLASS** **WT/LBS.** **CUBIC FT.** **LIST PRICE** **HP ADD**



29" H Table with Center Leg

	D x W x H						
PN1203629	36 x 120 x 29	250	221	86.83	\$2995	\$416	
PN1443629	36 x 144 x 29	250	246	97.31	\$3174	\$441	
PN1204229	42 x 120 x 29	250	246	101.8	\$3116	\$431	
PN1444229	42 x 144 x 29	250	287	110.7	\$3286	\$454	
PN1204829	48 x 120 x 29	250	271	113.7	\$3300	\$456	
PN1444829	48 x 144 x 29	250	291	116.7	\$3472	\$480	

Freestanding. 1" x 2.5" open metal frame legs with levelers, finished in Tungsten (TTU), Designer White (TDW) or Black (TBL). 120" and 144"W with 2 piece top. Metal support hat channel(s) provided on tables exceeding 54" in width. Shipped in 4 cartons.



29" H Table with Casters

PN242429C	24 x 24 x 29	92.5	53	4.50	\$1061	\$151	
PN482429C	24 x 48 x 29	85	71	5.26	\$1126	\$159	
PN542429C	24 x 54 x 29	85	83	6.50	\$1348	\$188	
PN602429C	24 x 60 x 29	85	86	6.50	\$1373	\$193	
PN662429C	24 x 66 x 29	85	90	7	\$1398	\$197	
PN722429C	24 x 72 x 29	85	97	7	\$1421	\$200	
PN303029C	30 x 30 x 29	92.5	66	6	\$1168	\$164	
PN483029C	30 x 48 x 29	100	77	9.50	\$1232	\$174	
PN543029C	30 x 54 x 29	92.5	94	8	\$1466	\$206	
PN603029C	30 x 60 x 29	92.5	99	8.26	\$1478	\$207	
PN663029C	30 x 66 x 29	85	105	8.50	\$1510	\$210	
PN723029C	30 x 72 x 29	85	112	9	\$1561	\$218	
PN363629C	36 x 36 x 29	92.5	80	7.50	\$1226	\$170	
PN603629C	36 x 60 x 29	92.5	113	10	\$1546	\$215	
PN663629C	36 x 66 x 29	92.5	119	10.50	\$1586	\$221	
PN723629C	36 x 72 x 29	100	124	14.50	\$1812	\$253	
PN424229C	42 x 42 x 29	92.5	96	8.50	\$1420	\$200	
PN484829C	48 x 48 x 29	150	114	21	\$1469	\$206	

Freestanding. 1" x 2.5" open metal frame legs with casters, finished in Tungsten (TTU), Designer White (TDW) or Black (TBL). All casters are locking. Metal support hat channel(s) provided on tables exceeding 54" in width. Shipped in 2 cartons.

Required Specifications

Top finish
Leg finish

Optional Specifications

HP laminate

Accessories

Wire manager
Desktop screen



Zira™ is a contemporary desking solution with extensive options to personalize your workspace. Components can be freestanding for single workstation configurations, or joined together to form multiple work groups. Create a work environment that meets your worksurface needs and storage requirements - then go ahead and personalize it!

Select from the following: hundreds of components for any size or shape office, storage components that can tower to 84" high, 20 laminate finishes, 5 edge options, 9 handle options in silver, black, nickel or brass finishes, 2 glazing options with 2 frame finishes on doors and modesty panels, and lastly, work surface grommets and power blocks for your electrical needs.

Zira is your most functional solution to work environment efficiency and organization.



Tops are available in a choice of 1" or 1 1/2" thick with a variety of edge details and a top over side, edge panel design
* Shown with 1.5" thick top and Bicut Edge (CR).



Optional Frosted or Ribbed glazing on doors and modesty panels. Available with Tungsten or Black frames.



Collator option is available for the convenient storage of day-to-day documents. Available in Black or Brushed Cobalt finish.

Features and Benefits

- 45 lb. density particle board substructure with high performance thermally fused laminate
- Top over side panel design
- Worksurfaces feature preferred edging in matching color
- Available in 1" or 1.5" thick top with a variety of edge details
- 11/16" thick full modesty panel is standard
- 11/16" thick 3/4 modesty panel available on most components
- Pencil tray included in box drawer
- Lateral file drawers can accommodate legal or letter documents
- Premium full extension progressive ball bearing slides on file drawers & box drawers
- All drawer fronts edge banded with side pull opening pedestals and standard pedestal locks
- Compatible with Divide partitioning system for increased privacy and storage requirements

GENERAL INFORMATION

- Over 5300 different standard components are available
- Zira components are compatible with **Divide** partitioning panels.
- Handles, lock finish and trim color (if applicable) **MUST MATCH**
- Dimensionally compatible with the Adaptabilities series.
- For environmental certification, please visit globalfurnituregroup.com

WORKSURFACES

- Available in 1" or 1.5" thick thermally fused laminate tops with a variety of edge details
- Tops are sealed with Global's preferred edge in matching color. Woodgrain surfaces feature edging with matching printed woodgrain.
- High pressure tops are available in all Zira laminate finishes at an extended lead time. Please see model # for pricing and availability.
- Products specified with the high pressure laminate option are finished on the underside of the surface with a kraft paper backing.

CONSTRUCTION

- Constructed of 45 lb. density particleboard with high performance thermally fused laminate
- All desks are size (incrementally) accurate
- Desk drawers/storage open with side pulls and feature a French dovetail joint in front, lap joint in back. Pulls are available for these units at an upcharge, see below. All other drawers/storage feature built-in pulls available in 9 different styles
- Virtually no loose hardware
- Models with Monopost are standard with 4" Square Monopost. Optional 5" Round and 4" Round Monopost are available at no upcharge. Available in Black (**TBL**) or Tungsten (**TTU**) finish. Please Specify
- Leveling glides are standard on all floor units
- Premium full extension progressive ball bearing slides on file drawers & box drawers
- All drawer fronts edge banded with side pull opening pedestals and standard pedestal locks

HEIGHT ADJUSTABLE DESKS

- Zira height adjustable desks include a laminate chassis. **Height adjustable base mechanism sold separately.**
- Use **FTZ52SFNL** with all **ZHxx60Fxx**, **ZHxx66Fxx**, **ZHxx72Fxx** and **ZHxx60NP** models.
- Use **FTZ52LFNL** with all **ZHxx84Fxx** and **ZHxx66NP**, **ZHxx72NP** and **ZH3684NP** models.
- Use **FTZ539FSLNL** with all **ZH60xx24L/R** models.
- Steel constructed leg tubing and cross bar.
- Table frame designed with 3.15" x 1.97" rectangular outer leg with the larger tube attaching to a bracket within the pedestal.
- Powder coat finishes for bases is standard in Black (**BLK**) or Tungsten (**TUN**).
- Wire management channels available in Black (**BLK**) or Silver (**SIL**). Silver (**SIL**) complements Tungsten.
- Zira Height Adjustable desks have 2-stages and feature an adjustment range of 29.5"/30" – 49"/49.5".
- Lifts 350 pounds.
- Operates at 1.5" per second.
- All bases feature a dual actuator system with a motor driving each leg.

STANDARD RANGE COLUMNS

The 2-part lifting column is a perfect choice for a wide range of different desk applications in the office.

- Compact design where guide and actuator functions are an integrated unit
- Reinforced column and optimized motor housing design for extra strength and stability
- Max. load 800 N per column
- Max. speed 1.5"/second unloaded
- Standard installation dimension 25.4"
- Standard stroke length 19.7"
- Weight: Approximately 14.3 lbs. per column
- Column dimensions: 1.97" x 3.15" (outer profile) and 1.71" x 2.89" (inner profile)
- Motor housing dimensions: 6.97" x 3.82" x 1.81"
- Low noise level
- No visible gliding pads
- Standard Range Tables have 2-stages and feature an adjustment range of 27.5" – 45.5" (18" travel).

DESK MOUNT FRAME

- All metal parts are Black
- Cantilever length: 21.7"
- Includes all connecting hardware

CONTROL BOX

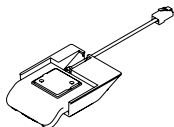
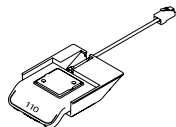
- Two leg tables come standard with a 200 W Control Box
 - Mains voltage 230 VAC, 50 Hz, or 120 VAC, 60 Hz
 - Ultra-compact; 8.25" long
 - Lightweight control box; weight is approximately 1 lb.
- Common features for the (200 W and 300 W):
- Ultra-low; only 1.5" high
- Environment: Operation Storage
 - Ambient temperature: 5 to 40 °C -10 to +50 °C
 - Relative humidity: 20 to 80 % at 30 °C 20 to 80 % at 30 °C
 - Atmospheric pressure: 700 to 1060 hPa 700 to 1060 hPa
- Compact high-power SMPS (Switch Mode Power Supply)
- Color: Black
- Protection against overload (EOP), by individual current limitation
- The control box is designed with a soft start/stop function
- Autodetection of the number and type of columns connected
- Cable grooves at the bottom to optimise cable management
- White plugs for easy recognition when mounting/dismounting
- PVC-Free™
- Low standby power consumption – only 0.1 W.
- Exchangeable standard mains cable

STANDARD HANDSET (S)

- Features Bluetooth® connection, two favorite positions and an LED reminder to prompt users to change position.
- Controller is activated by tilting the desk panel in the same direction as the desk is intended to drive.
- Pulsating orange and green LED lights remind users to change positions.
- Using the integrated Bluetooth® and downloading the Desk Control App, users can also be reminded via notifications on their computer or smart devices.
- Black only. Black cable with RJ45 modular plug. 63" long.
- PVC-Free™, featuring ZERO™. Very low power consumption in standby mode.
- Approved according to EN 60335-1 and UL962

DISPLAY HANDSET (D)

- Features Bluetooth® connection, four favorite positions, a display to guide users, and a light strip to prompt users to change position.
- Controller is activated by tilting the desk panel in the same direction as the desk is intended to drive.
- Display controller features a modern, discreet design with a glossy surface and integrated display to ensure a clean and minimalist design.
- The display provides guidance to users when operating the desk.
- Via pulsating orange and green lights, the light strip reminds users to change positions.
- Using the integrated Bluetooth® and downloading the Desk Control App, users can also be reminded via notifications on their computer or smart devices.
- Black only. Black cable with RJ45 modular plug. 63" long.
- PVC-Free™, featuring ZERO™. Very low power consumption in standby mode.
- Approved according to EN 60335-1 and UL962
- A basic handset without Bluetooth® capabilities is available and must be purchased separately, replacing the **S** or **D** handset in the field. See page 619 for details and pricing.

Standard handset (**S**)Display handset (**D**)**ANTI-COLLISION SENSOR**

- Features enhanced Anti-Collision protection which can limit material damage to a desk or an object if a collision occurs during driving of the desk.
- The sensor is a compact plug-in adapter based on gyroscope-technology, and it detects even slight tilting of the desk when the desk is driving up or down.
- Upon detected tilting, the system stops and drives in the opposite direction to avoid collision and damage to the desk or the object.
- The sensor can detect both hard and soft obstacles.
- The Anti-Collision Sensor is standard on all desks.
- Reacts to angle changes bigger than 0.7° per second
- Just plug it in – no mounting required
- ZERO™ power capable
- PVC-Free™

USAGE

- Ambient temperature: 41 to 104 °C
- Storage temperature: 32 to 113 °C

Approved according to:

- EN 62133 (Battery safety testing)
- UL 1642 (Lithium cells, standard test)
- UN 38.3 (transportation of Lithium batteries)
- UL 2054 (Household and commercial batteries)
- EN 60335-1 with CBH Advanced

MODESTY PANELS

- Laminate full modesty panel is standard. Laminate ¾ modesty panel is available on select models at no additional charge. Please specify (**3MP**).
- Glazing options are available on the full modesty panel, ¾ modesty panel and the 12" modesty panel (where available). Please specify. See next page for options and codes.
- 11/16" thick full modesty panel is standard on most components
- 11/16" thick ¾ modesty panel available on most components
- **Note:** Woodgrain modesty panels 60" wide and up will have the grain pattern in the horizontal direction. All end panels and modesty panels 59" or less will have the grain pattern in the vertical direction

CUSTOM WIDTHS

- Custom widths are available for products that feature a worksurface as follows: desks, credenzas (applies to kneespace and single pedestal credenzas only), islands (excludes spanner islands), returns, bridges, extended corners and corners.
- Desks and credenzas that incorporate drawers and/or doors will be modified by changing the width of the worksurface and modesty panel, drawer and/or door dimensions are not affected.
- No upcharge for next size up
- Custom width does not apply to cabinets, hutches, pedestals or any other units.

STORAGE

- All lateral files feature a foolproof interlock device
- Pencil tray included in box drawer
- Lateral file drawers can accommodate legal or letter documents
- All drawers are locking unless otherwise noted
- Front-to-back filing bars for all steel drawer files available separately. Order FBB bars. See "FBB" on page 41.
- All desks, returns and credenzas with fixed storage are shipped standard with box/box/file, file/file or box/file 16" wide pedestals.
- Storage modules, wardrobe cabinets, personal towers, hutches and table top bookcases have 11/16" thick shelves
- End shelves, bookcases and table top end shelves have 1" thick shelves
- **All shelves are 3 position fixed/height adjustable.**
- Storage cabinets **less than 30" wide are not intended to be freestanding** and should be ganged or otherwise anchored. Ganging hardware and instructions are provided. Interior of all cabinets are pre-drilled for ganging connections; does require drill through on site.
- Adjustable shelves can be positioned to accept **binder** storage as follows:
 - For units **29" to 53" H** where applicable:
 - with one shelf - cannot accommodate binder row
 - with two shelves - can accommodate one row of binders
 - with three shelves - can accommodate two rows of binders
 - with four shelves - can accommodate three rows of binders
 - For units **65.5" to 84.5" H** where applicable:
 - with one shelf - can accommodate one row of binders
 - with two shelves - 65.5" and 72" H can accommodate one row of binders
 - 84" H can accommodate two rows of binders
 - with three shelves - can accommodate two rows of binders
 - with four shelves - can accommodate three rows of binders
 - with five shelves - can accommodate four rows of binders
 - with six shelves - can accommodate five rows of binders

LOCKS

- Locks are standard on all storage modules. Finish will coordinate with handles and/or aluminum doors. For desk, return or table components, etc. please specify finish: Black (**BK**) or Silver (**SI**).
- Please note that Flared Brass (**HW**) handle defaults to Black locks, so trim options must be Black to match.
- Key alike or specific key number optional for all products with locks
- Reserved for new orders greater than \$20,000 list, all Zira units with locks may be ordered with **CA** cap option and specific lock cores/keys can be ordered separately for field installation rather than specifying duplicate product lines with different key numbers.
- When **CA** option is specified, product will ship with a cap over the empty lock housing.
- Separately order the appropriate number of cores with keys; use product code **SIL-CORE-H-SHOE** for Silver core/key sets or product code **BLK-CORE-H-SHOE** for Black core/key sets. Specify quantity and lock number required. One order line per key number required. Key number range: 401-440. **Must be ordered at the same time product is ordered with CA lock cap option specified.**
- One core removal key is required. Recommend one core removal for every 25 cores ordered. Order as **REMOVE-K-H-SHOE**.
- No charge applies for separate lock cores or core removal keys only when ordered with product. If replacement lock core and key required, contact Customer Care for applicable product code and pricing.

SHIPPING

- Shipped assembled, 1 per carton, unless otherwise noted. Other components are easy to assemble.

HUTCHES

- 71" hutches (actual width 71.69") are for use when a hutch is placed across the back of a 42" wide return and across the depth of a 30" deep surface top (actual depth 29.69").
 - ZxxxxDK, ZxxxxDM and ZxxxxDML/DMR are exactly 30" deep. Therefore 72" hutches may be used.
- Hutches should not be placed on the approach side of any single pedestal and double pedestal desks with an overhang.

SPECIFICATIONS

- Specifications marked with an * are applicable to only those products which have the * symbol beside the product name.

GLAZING (Doors and Modesty Panels)



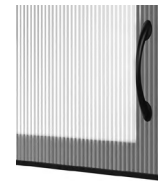
Z1 frosted glazing, Tungsten (TUN) frame



Z2 frosted glazing, Black (BLK) frame



Z3 ribbed glazing, Tungsten (TUN) frame



Z4 ribbed glazing, Black (BLK) frame



Full modesty panel - **Z1** frosted glazing, Tungsten (TUN) frame
 $\frac{3}{4}$ modesty (shown) - **Z1 + 3MP**
ZA - 12"H modesty (select models)



Full modesty panel - **Z2** frosted glazing, Black (BLK) frame
 $\frac{3}{4}$ modesty (shown) - **Z2 + 3MP**
ZB - 12"H modesty (select models)



Full modesty panel - **Z3** ribbed glazing, Tungsten (TUN) frame
 $\frac{3}{4}$ modesty (shown) - **Z3 + 3MP**
ZC - 12"H modesty (select models)



Full modesty panel - **Z4** ribbed glazing, Black (BLK) frame
 $\frac{3}{4}$ modesty (shown) - **Z4 + 3MP**
ZD - 12"H modesty (select models)

1. SPECIFY MODEL NUMBER

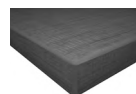
2. SPECIFY FINISH AND TOP THICKNESS/EDGE DETAIL

- All units available in solid color (Top and Chassis matching) or Two-Tone combination except for the following units:
 - Shells: One Tone in all standard finishes
 - Collators: One Tone in Black (**K**) or Brushed Cobalt (**T**)
 - Horizontal Pigeon Holes: One Tone in all standard finishes
 - Vertical and Transitional Pigeon Holes: Two-Tone - Chassis/Shell in all standard finishes, Collator Shelves in Black (**K**) or Brushed Cobalt (**T**).

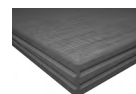
Finishes:

ACJ Absolute Acajou	FCL First Class
ASN Asian Night	NBL Noce Biondo
AWC Avant Cherry	NGL Noce Grigio
AWH Avant Honey	NEL Noce Leggero
BLK Black	NML Noce Medio
BZD Blizzard	QTM Quartered Mahogany
BRC Brushed Cobalt	SBY Sheer Beauty
CMB Clear Maple	SOG Storm Grey
CGY Custom Grey	SDT Stonedust
DES Dark Espresso	WHE Walnut Heights
DWT Designer White	WHC White Chocolate
FAS Fashionista	WCR Winter Cherry

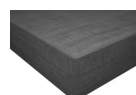
Top Thickness/Edge Detail



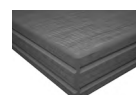
A3 1" top, standard flat edge



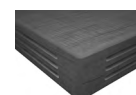
AR 1" top, bicut edge



C3 1.5" top, standard flat edge



CR 1.5" top, bicut edge

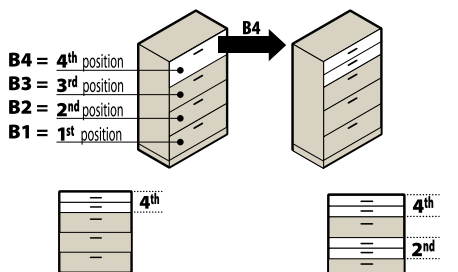


CF 1.5" top, fluted edge

3. SPECIFY OPTIONS

BOX DRAWERS for lateral file drawers (no upcharge)

- Specify **B_** (Drawer Position **1-4** must be specified)



- Not available on drawers with steel interiors

HANDLES

- Handles are applied to all lateral drawers and doors, and are included in the published list price. When ordering, please indicate handle choice from the list of options below. Integrated vertical finger pulls are the standard default for mobile pedestals, hanging pedestals, or where BBF or FF pedestals are part of a desk, return credenza or corner desk. Handles are optional on these units with a list upcharge of **\$54**. If a handle is not desired, select lock finish **BK** for Black or **SI** for Silver.
- General guideline: when handles are shown in individual product line art within the price list, handles are included; and where not shown in line art, **\$54** list upcharge applies when handle option is selected.
- To order handles, please specify corresponding code to image as below (**HS, HO, HW, HX, HV, HU, HQ, HZ**, or **HR**):



HS Flared Silver



HV Square Edge Silver



HO Crescent Black



HW Flared Brass



HU Square Edge Black



HZ Dimpled Nickel



HX Flared Black



HQ Bar Silver



HR Bar Black

MONOPOST



P1 square 4" Tungsten



P2 square 4" Black



P3 round 4" Tungsten



P4 round 4" Black



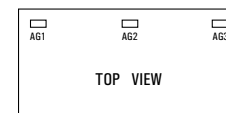
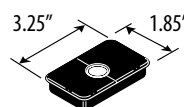
P5 round 5" Tungsten



P6 round 5" Black

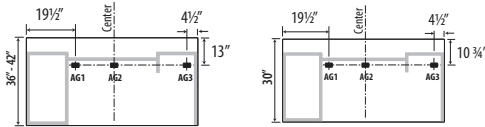
GROMMETS

- Additional grommets available in standard worksurface locations (left, center or right).
- Order as: **AG1, AG2 or AG3. Add \$96**
- Grommets may be placed at non-standard locations. Order as: **AGS - Add \$96**. A drawing must be supplied with vertical and horizontal dimensions to the center of the cut-out (as in drawing above). Please refer to **CUSTOM GROMMET LOCATION FORM** in the back reference section.
- Components that come standard with grommet as stated within the product descriptions or shown in the corresponding price list line art, may be ordered without a grommet. **Add \$53**.
- Option to remove standard grommet when required - specify **RSG - Add \$53**.
- Option to remove standard grommet position and add another position - specify **RSG** and **AG_** or **AGS**, upcharge applies. For **RSG + AG_** combination, **Add \$149**. For **RSG + AGS** combination, **Add \$149**.



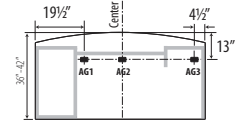
- Grommet hole dimensions are 3 1/4" wide x 1 7/8" deep.

- Actual grommet locations on the worksurface are depicted in the example drawings shown below. Dimensions shown are actual measurements (in inches).

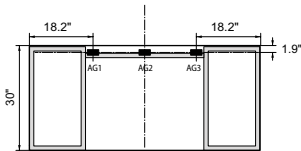


Straight Front, 36" - 42"D

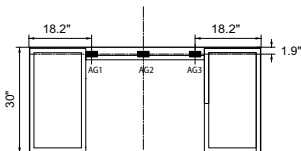
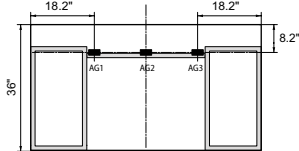
Straight Front, 30"D



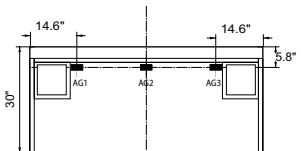
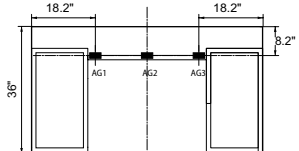
Bow Front



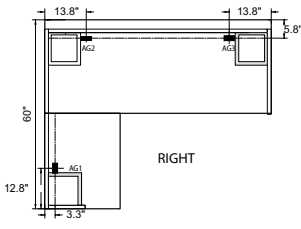
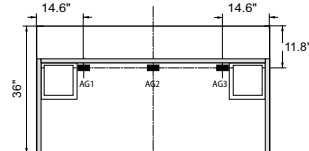
HA Double Ped



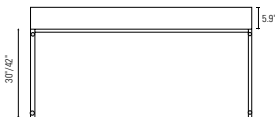
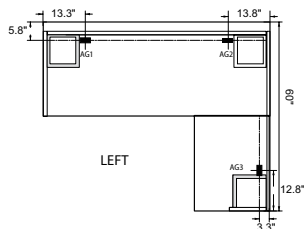
HA Single Ped



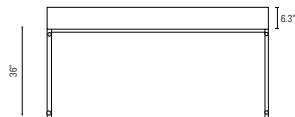
Freestanding HA



L HA desk

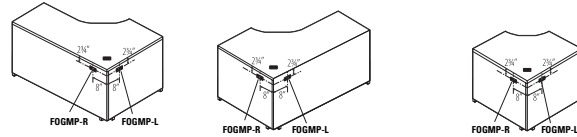


NHD desk



- Grommets are available on modesty panels of **extended corners** and **5-sided corners** 8" in where the two modesty panels meet at a 90° angle. Please specify **FOGMP-R** for right grommet placement and **FOGMP-L** for left grommet (placement is as shown on diagrams below). Cost is **\$96**.

***Modesty Panels are 1" off of ground*



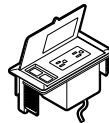
Left Extended Corner Unit

Right Extended Corner Unit

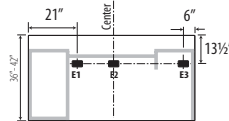
5-Sided Corner Unit

POWER BLOCK

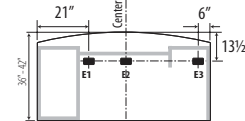
- A Power Block (model **PMSPDM**) may be ordered on all worksurfaces.
- A Power Block is a rectangular worksurface power/data module with one electrical duplex receptacle and two data (RJ45) receptacles. 9 foot black cord included. Power Block dimensions are 3 1/2" deep x 6 1/2" wide x 2 3/4" high.
- To purchase a Power Block, you must specify both the Power Block cut-out location and the Power Block model #. Order Power Block as **PMSPDM**, **Add \$330**. Power Blocks are available in standard worksurface locations (left, center or right). Order as **E1**, **E2** or **E3**. **Add \$96**.



Power Block **PMSPDM** Add **\$330**



Straight Front

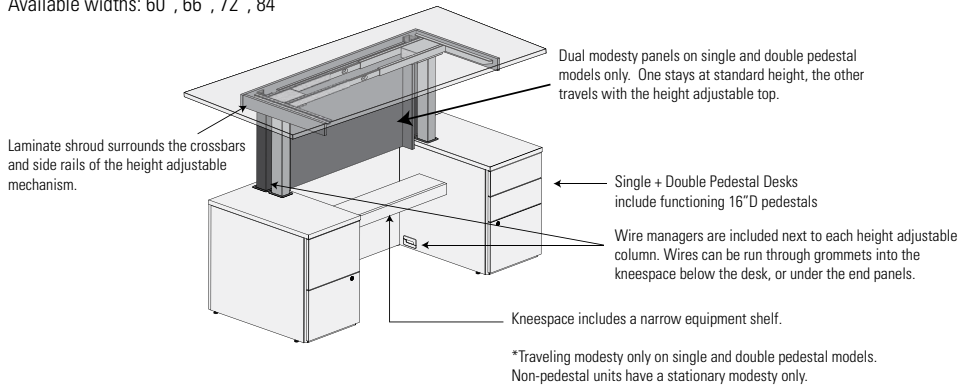


Bow Front

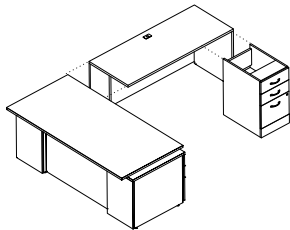
Specify location **E1**, **E2** or **E3**. **Add \$96**

Executive Height Adjustable Desks

Available widths: 60", 66", 72", 84"



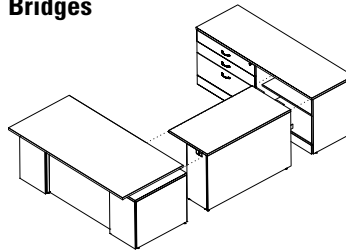
Returns



For "L" Shape Layouts

- Pre-configured
- With custom shell storage

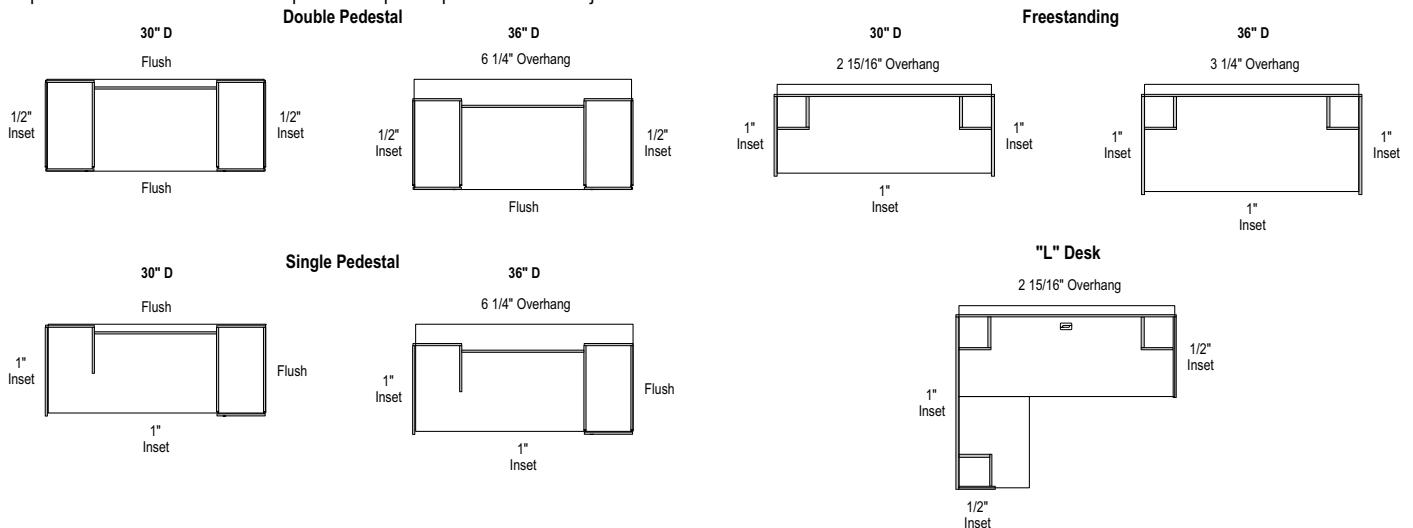
Bridges



For "U" shape Layouts

Top conditions for Height Adjustable Desks

Top recesses are to minimize potential pinch points when adjacent to fixed surfaces.



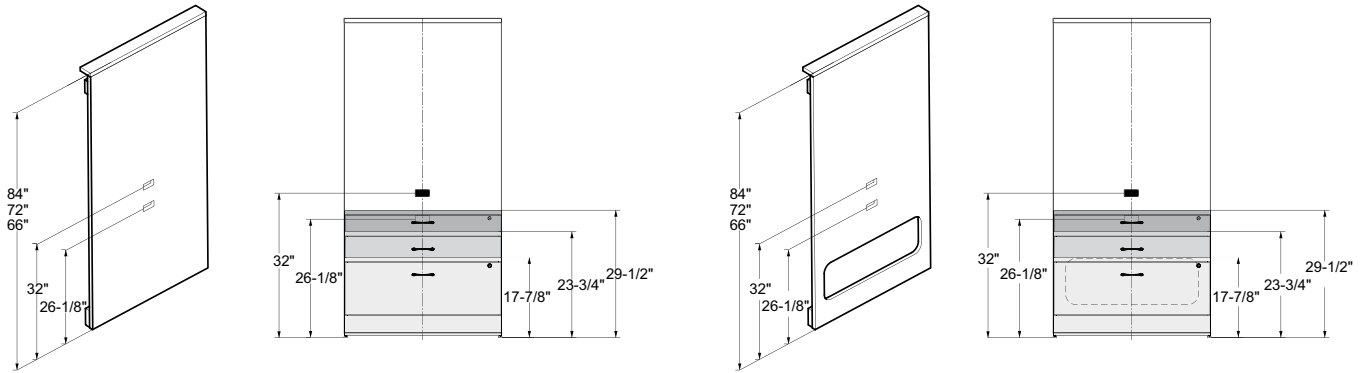
Wall Panels

Weight capacities for wall panels

- When mounting customer supplied flat screen or other to a wall panel, total weight including mounting hardware **should not exceed 140 lbs.** in total. Not approved for use with articulating or extendable mounting arms.
- Wall panels with floating shelves:
 - 1 mm space between shelves when units side by side.
 - **24"W** up to 50 lbs.; **30"W** up to 65 lbs.; **36"W** up to 75 lbs.; **42"W** up to 90 lbs. per floating shelf
 - Note: weight should be evenly distributed over surface
- Wall panels with overhead cabinet storage:
 - Note: weight should be evenly distributed over surface
 - **66"H - 24"W**: 30 lbs. top/55 lbs. inside bottom; **30"W**: 40 lbs. top/70 lbs. inside bottom; **36"W**: 45 lbs. top/85 lbs. inside bottom; **42"W**: 55 lbs. top/95 lbs. inside bottom.
 - **72"H - 24"W**: 30 lbs. top/65 lbs. inside bottom; **30"W**: 40 lbs. top/80 lbs. inside bottom; **36"W**: 50 lbs. top/95 lbs. inside bottom; **42"W**: 60 lbs. top/100 lbs. inside bottom.
 - **84"H - 24"W**: 30 lbs. top/65 lbs. shelf & inside bottom; **30"W**: 40 lbs. top/80 lbs. shelf & inside bottom; **36"W**: 50 lbs. top/95 lbs. shelf & inside bottom; **42"W**: 60 lbs. top/100 lbs. shelf & inside bottom.

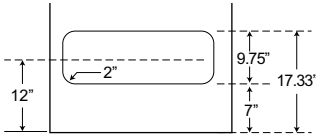
Wall Panels

*Grommet locations for wall panels



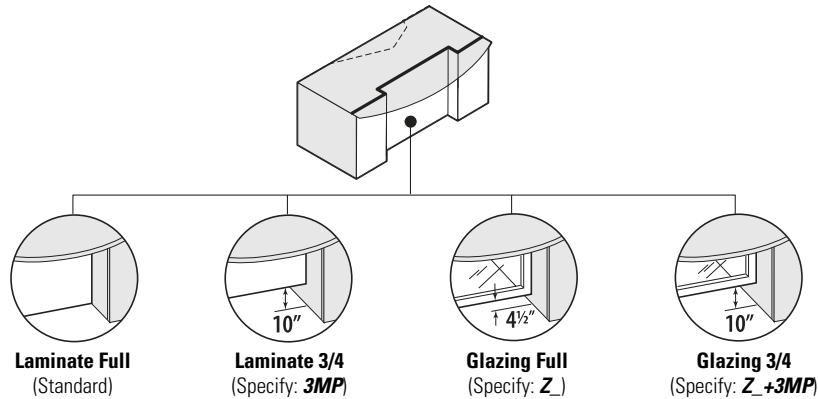
- AG1 grommet sits at 26-1/8" above the floor, just about 1-1/2" high storage, but below standard 29-1/2" storage
- AG2 grommet sits at 32" above the floor, above 29-1/2" storage
- *Cove Mini power units are not for use in this application due to depth.
- When the wall with wire management access is specified, the wire management access opening will sit below all storage heights (see chart below).

Wall Width	Opening Width
42"	35.75"
36"	29.75"
30"	23.75"
24"	17.75"

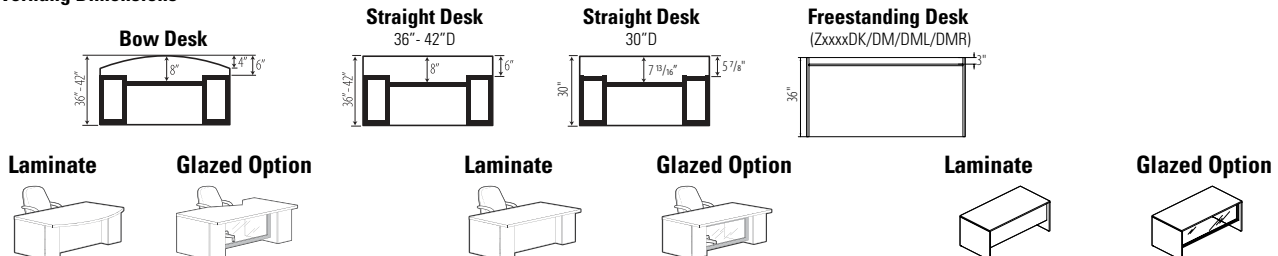


Desks / Extended Corner Desks - available width: 60", 66", 72", 84"

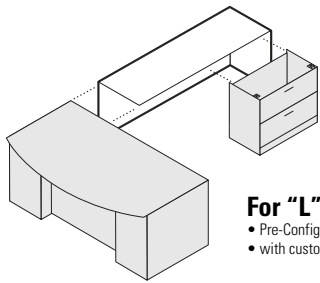
Modesty Treatments



Overhang Dimensions



Returns - available width: 36", 42", 48", 54", 60", 66", 72"



For "L" shape Layouts

- Pre-Configured
- with custom shell storage

Transitional Pigeon-Hole

Accepts all (same width) Transitional Pigeon-Holes.

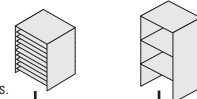
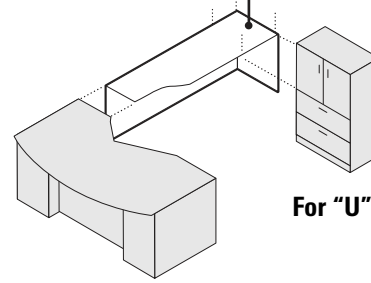


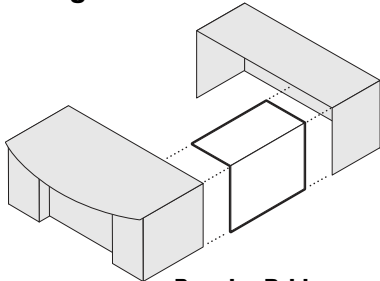
Table Top Bookcase

Accepts all (same width) Table Top Bookcases.



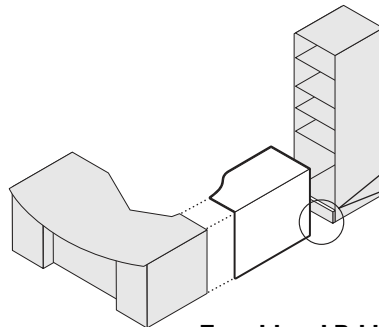
For "U" shape Layouts

Bridges - available width: 42", 48"



Regular Bridge

- join worksurface to worksurface



Transitional Bridge

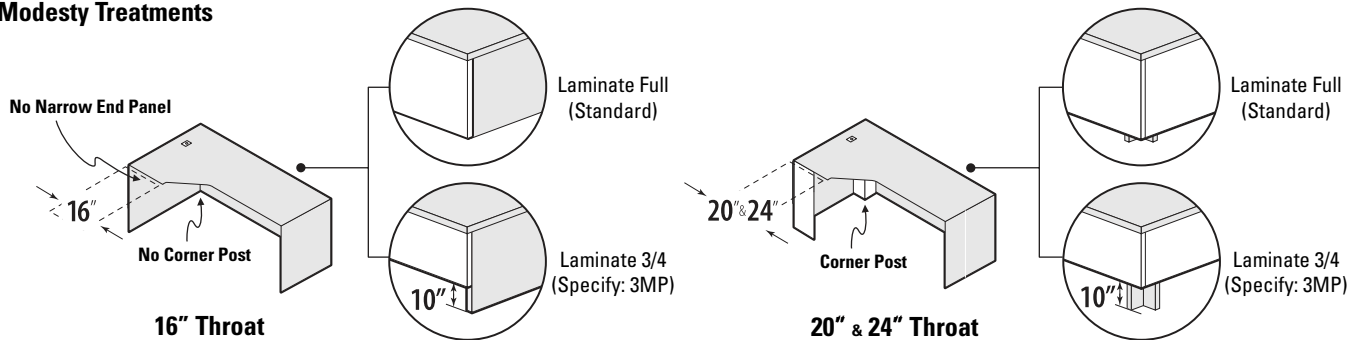
- join worksurface to storage modules

Remove Existing Kickbase

Replace with supplied Kickbase (shorter)

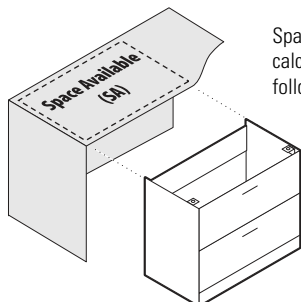
Extended Corners - available widths: 60", 66", 72", 84"

Modesty Treatments



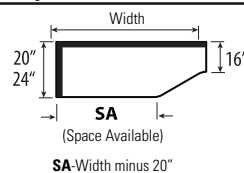
Shells - available width: 12", 15", 16", 18", 21", 30", 36"

For Extended Corners, Space Saver Returns and Connectables

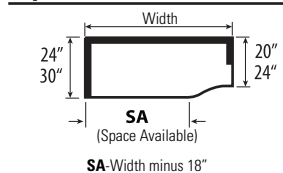


Space Available can be calculated with the following formulas:

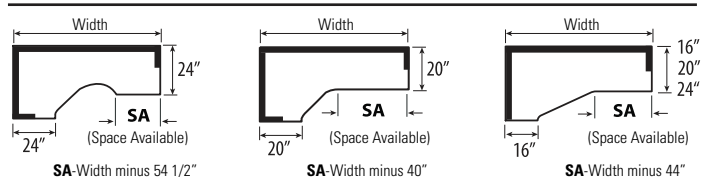
Space Saver Returns



Space Saver Connectables

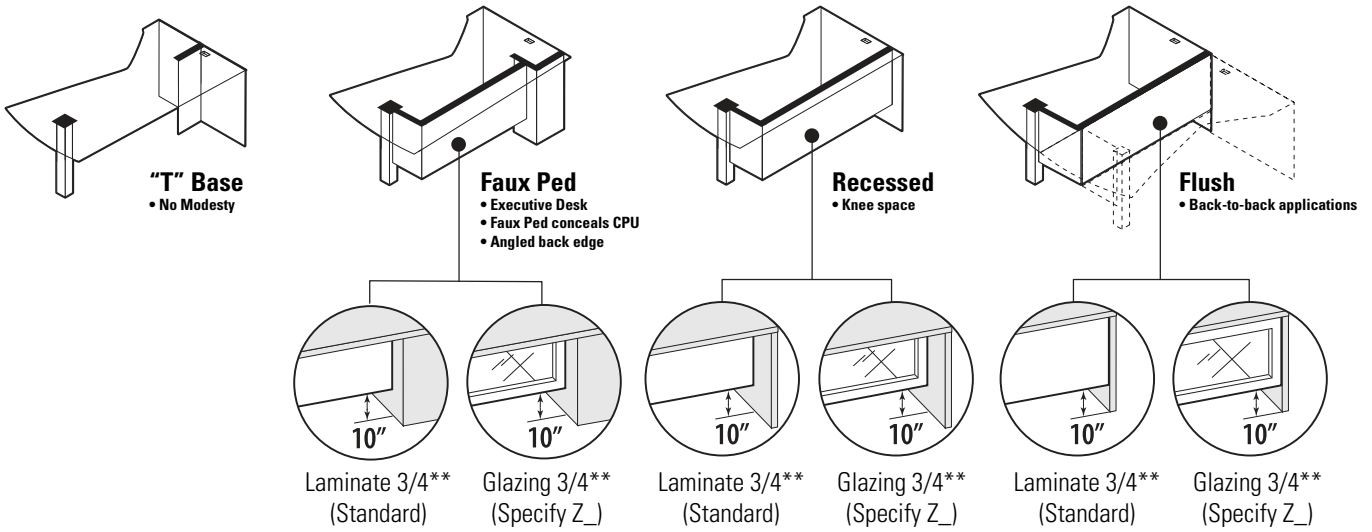


Extended Corners



Extended Corner Islands - available width: 60", 66", 72" 84"

Modesty Treatments

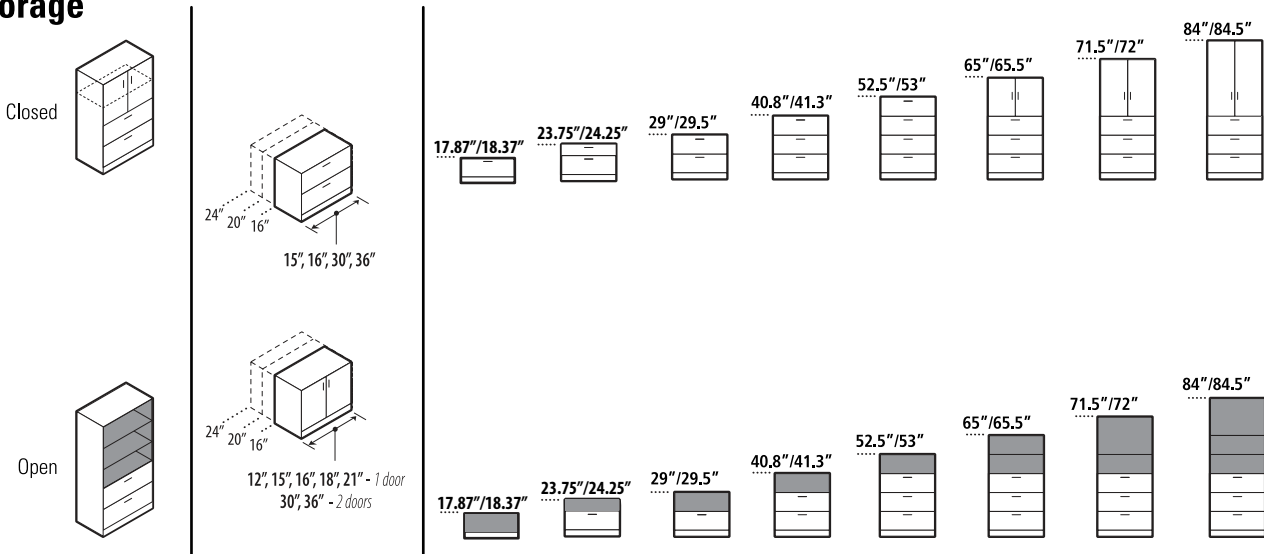


** Full modesty not available

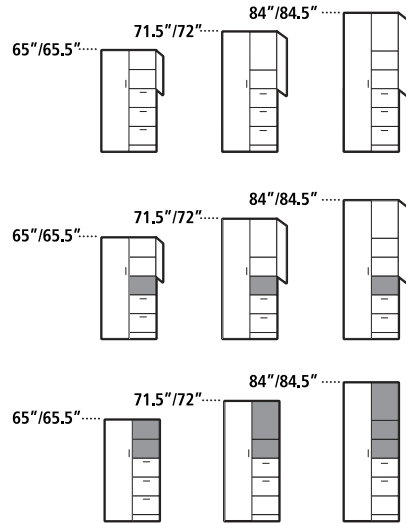
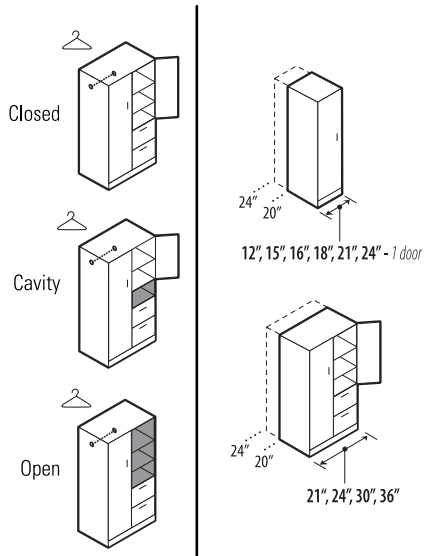
Overhang Dimensions



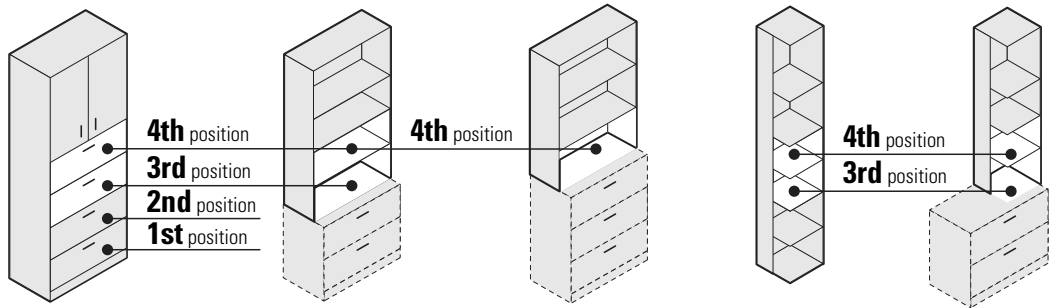
Storage



Wardrobe & Personal Towers



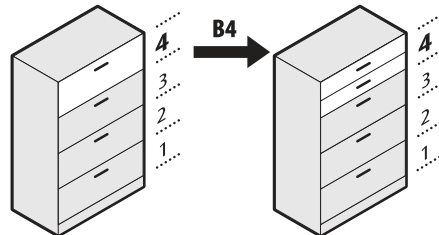
Drawer & Cavity Positions



Box Drawer Option

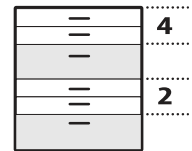
Lateral file drawers can be converted to box/box drawers in any of the four standard positions

- B1** = 2 box drawers on 1st position
- B2** = 2 box drawers on 2nd position
- B3** = 2 box drawers on 3rd position
- B4** = 2 box drawers on 4th position



Example
File drawer converted to 2 box drawers on **4th** position

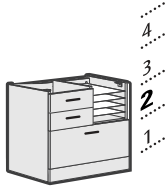
Please specify: Z36L54F - **B4**



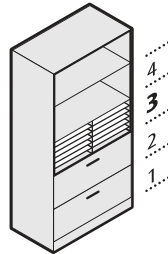
Converting 2 or more drawers please contact customer service.

Collator Positions

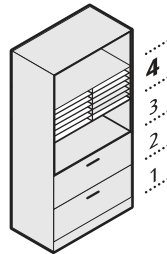
All storage units can be specified with an optional collator on 2nd, 3rd and/or 4th position.



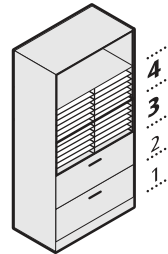
Collator on 2nd position
Specify: **2K - Black** or
2T - Brushed Cobalt



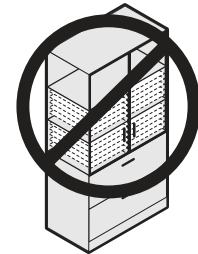
Collator on 3rd position
Specify: **3K - Black** or
3T - Brushed Cobalt



Collator on 4th position
Specify: **4K - Black** or
4T - Brushed Cobalt



Collator on 3rd & 4th positions
Specify: **7K - Black** or
7T - Brushed Cobalt



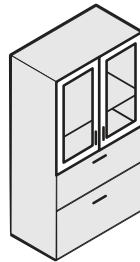
Collators do not fit behind doors

For 2K / 2T, 3K / 3T OR 4K / 4T - Add \$305

For 7K / 7T - Add \$538

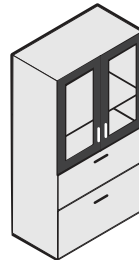
Glazing

Glazing is available in the following options:



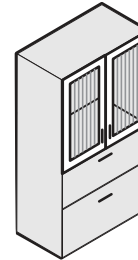
Tungsten Frame
Frosted Glazing
Z1

Please specify:
Z36L6E - **Z1**



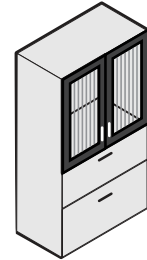
Black Frame
Frosted Glazing
Z2

Please specify:
Z36L6E - **Z2**



Tungsten Frame
Ribbed Glazing
Z3

Please specify:
Z36L6E - **Z3**



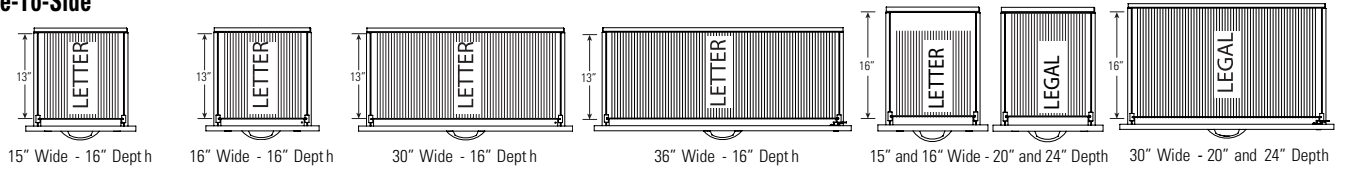
Black Frame
Ribbed Glazing
Z4

Please specify:
Z36L6E - **Z4**

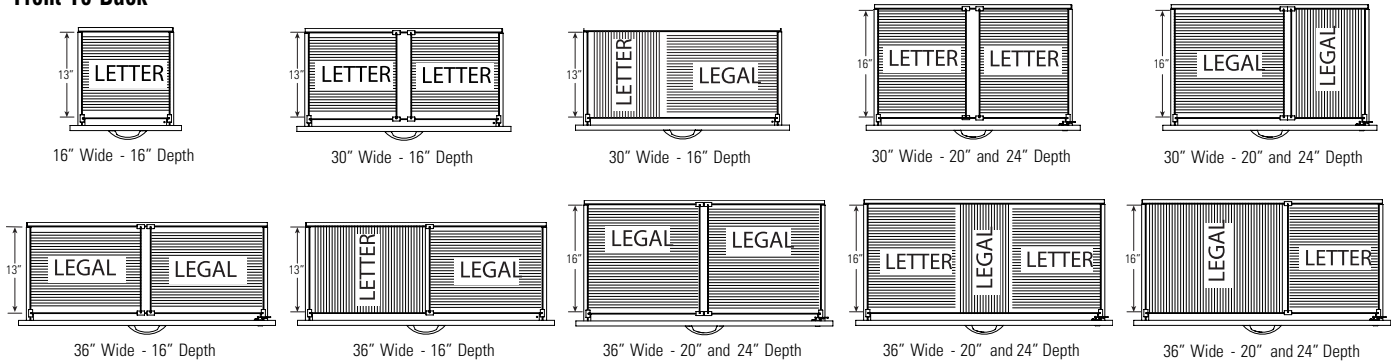
Filing Options - For Filing Components

On 16" deep files, drawer interiors are only 13" deep. On 20" and 24" deep files, drawer interiors are 16" deep.
 Full to floor BBF, FF and BF pedestals are 16" wide with all pedestal desks, returns with pedestals and credenzas with pedestals.
 Full to floor BBF and FF storage shells 15" wide x 28.5" high are required under 36" wide Space Saver Return with 16" deep connection top. re: Zxx3616R.
 Filing hardware included with all laminate drawer models. Steel drawer models do NOT include FBB bars.

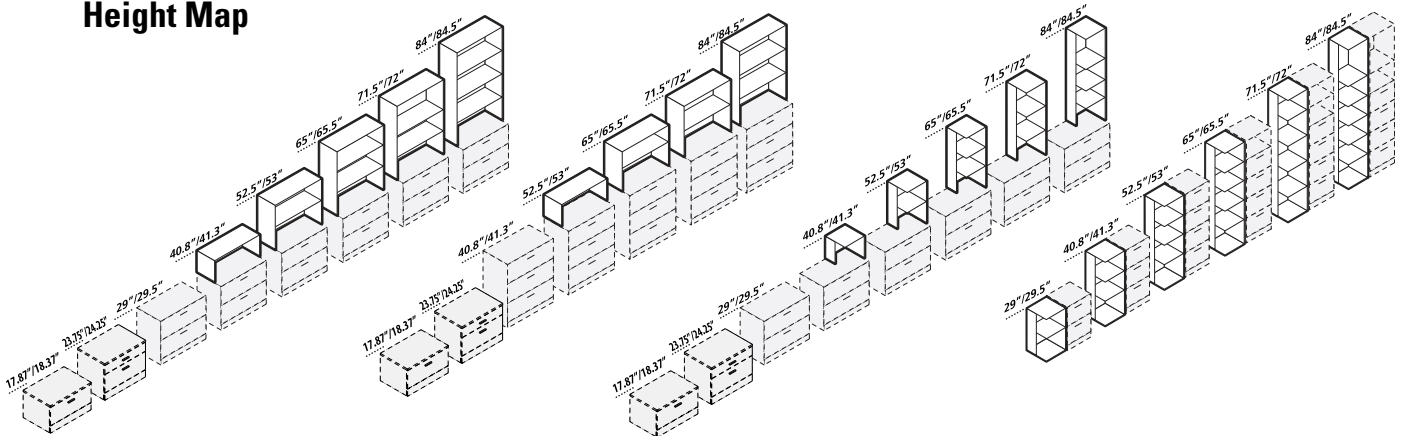
Side-To-Side



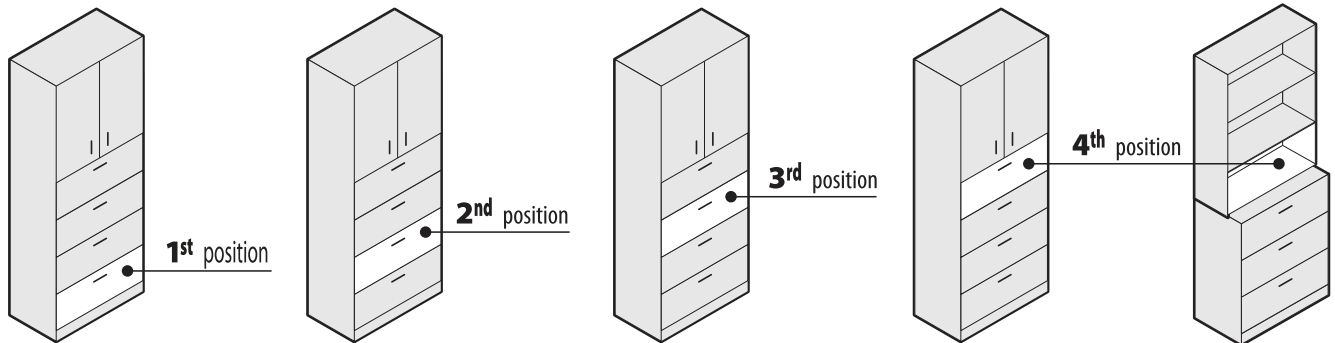
Front-To-Back



Height Map



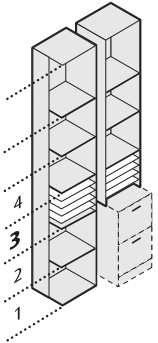
Drawer & Cavity Positions



Collator Positions

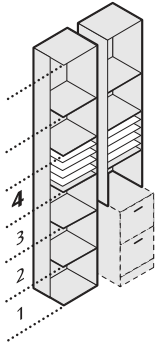
For 12" to 21" wide units

****If no collator is desired, must specify when placing order.**

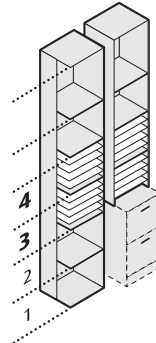


Collator on 3rd position
Specify: **3K - Black** or
3T - Brushed Cobalt

For 3K / 3T or 4K / 4T.....Add \$305

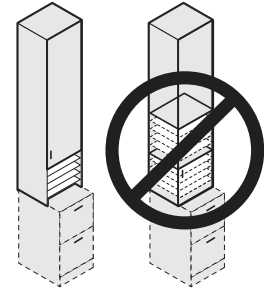


Collator on 4th position
Specify: **4K - Black** or
4T - Brushed Cobalt



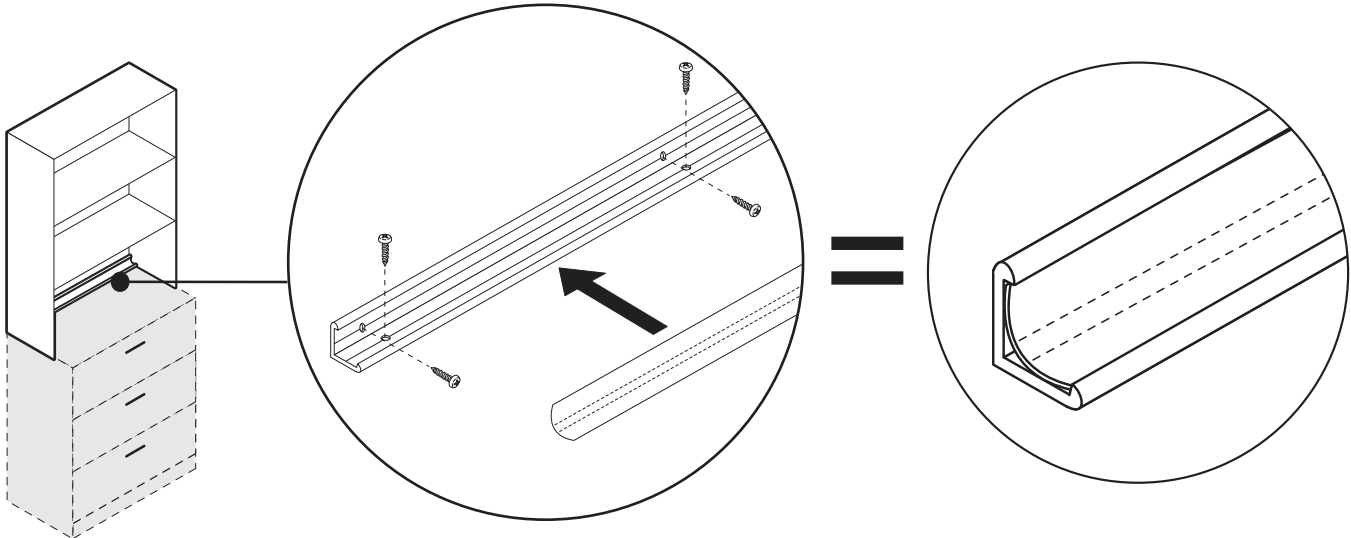
Collator on 3rd & 4th position
Specify: **7K - Black** or
7T - Brushed Cobalt

For 7K / 7T.....Add \$538



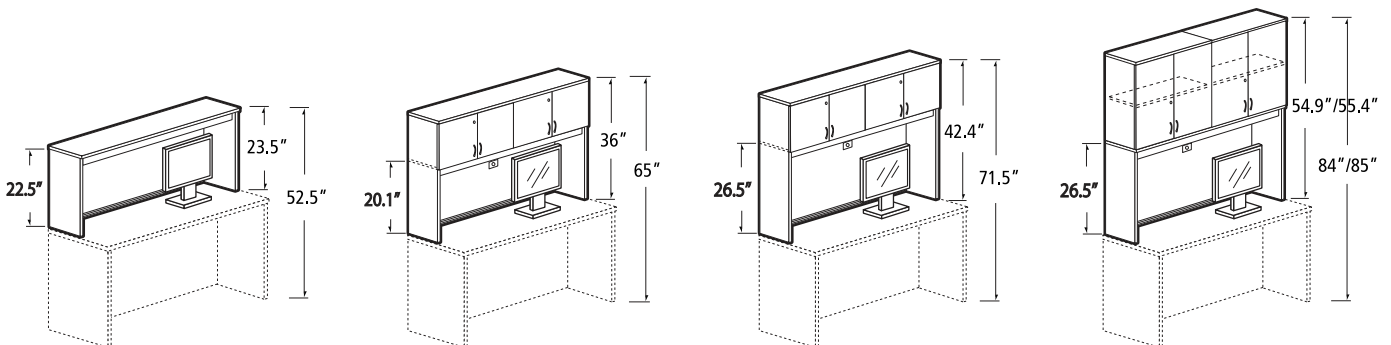
Collators do not fit behind door

Table Top Bookcase



Hutches

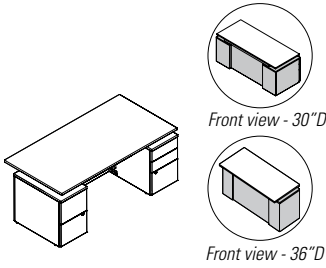
Monitor clearance dimensions



HEIGHT ADJUSTABLE DESKS

MODEL#	DIMENSIONS	FREIGHT CLASS	WT/LBS.	CUBIC FT.	1"TOP	1.5" TOP	GLAZE ADD	HP ADD
--------	------------	---------------	---------	-----------	-------	----------	-----------	--------

D x W x H

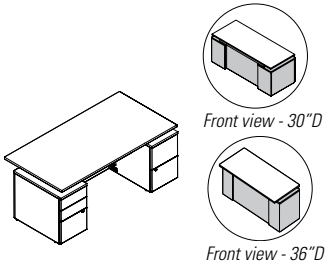


Double Pedestal Desk for Height Adj. Base

ZH3684F23	36 x 84 x 29.5-49.5	85	362	26.68	\$3908	\$4140	\$642	\$685
ZH3672F23	36 x 72 x 29.5-49.5	85	335	26.68	\$3878	\$4084	\$550	\$587
ZH3666F23	36 x 66 x 29.5-49.5	85	321	25.18	\$3773	\$3959	\$495	\$538
ZH3660F23	36 x 60 x 29.5-49.5	85	307	24.70	\$3643	\$3829	\$532	\$489
ZH3084F23	30 x 84 x 29.5-49.5	85	347	25.69	\$4001	\$4201	\$642	\$567
ZH3072F23	30 x 72 x 29.5-49.5	85	321	24.70	\$3810	\$3985	\$550	\$489
ZH3066F23	30 x 66 x 29.5-49.5	85	309	24.19	\$3707	\$3869	\$495	\$451
ZH3060F23	30 x 60 x 29.5-49.5	85	296	23.68	\$3600	\$3744	\$538	\$409

- Specify FTZ52SFNL for 60" - 72" wide desks and FTZ52LFNL for 84" wide desks.

Height adjustable frame sold separately. Standard with file/file (FF) pedestal on **left** and box/box/file (BBF) pedestal on **right**. **30"D**: Top is recessed 1/2" on either side over chassis, flush on user and guest side. **36"D**: Top is recessed 1/2" on either side over chassis, flush on user side, 6.25" overhang on guest side. BBF - file drawer and lower box drawer lock. FF - drawers lock. Unit has dual modesty panels - one stationary/one traveling. See notes on page 115 for illustration. Shipped RTA (ready to assemble).

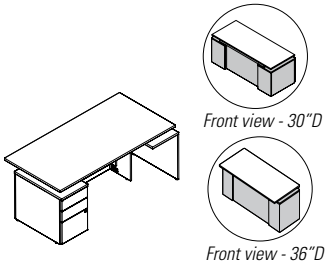


Double Pedestal Desk for Height Adj. Base

ZH3684F32	36 x 84 x 29.5-49.5	85	362	26.68	\$3908	\$4140	\$642	\$685
ZH3672F32	36 x 72 x 29.5-49.5	85	335	26.68	\$3878	\$4084	\$550	\$587
ZH3666F32	36 x 66 x 29.5-49.5	85	321	25.18	\$3773	\$3959	\$495	\$538
ZH3660F32	36 x 60 x 29.5-49.5	85	307	24.70	\$3643	\$3829	\$532	\$489
ZH3084F32	30 x 84 x 29.5-49.5	85	347	25.69	\$4001	\$4201	\$642	\$567
ZH3072F32	30 x 72 x 29.5-49.5	85	321	24.70	\$3810	\$3985	\$550	\$489
ZH3066F32	30 x 66 x 29.5-49.5	85	309	24.19	\$3707	\$3869	\$495	\$451
ZH3060F32	30 x 60 x 29.5-49.5	85	296	23.68	\$3600	\$3744	\$538	\$409

- Specify FTZ52SFNL for 60" - 72" wide desks and FTZ52LFNL for 84" wide desks.

Height adjustable frame sold separately. Standard with box/box/file (BBF) pedestal on **left** and file/file (FF) pedestal on **right**. **30"D**: Top is recessed 1/2" on either side over chassis, flush on user and guest side. **36"D**: Top is recessed 1/2" on either side over chassis, flush on user side, 6.25" overhang on guest side. BBF - file drawer and lower box drawer lock. FF - drawers lock. Unit has dual modesty panels - one stationary/one traveling. See notes on page 115 for illustration. Shipped RTA (ready to assemble).

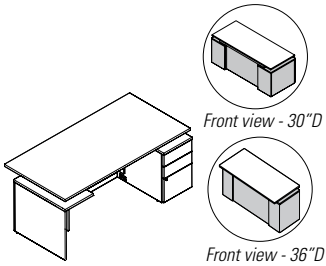


Single Pedestal Desk for Height Adj. Base

ZH3684F3S	36 x 84 x 29.5-49.5	85	325	26.68	\$3558	\$3782	\$642	\$685
ZH3672F3S	36 x 72 x 29.5-49.5	92.5	298	25.69	\$3508	\$3714	\$550	\$587
ZH3666F3S	36 x 66 x 29.5-49.5	92.5	284	25.18	\$3405	\$3591	\$495	\$538
ZH3660F3S	36 x 60 x 29.5-49.5	92.5	271	24.70	\$3274	\$3449	\$434	\$489
ZH3084F3S	30 x 84 x 29.5-49.5	85	310	25.69	\$3633	\$3833	\$642	\$567
ZH3072F3S	30 x 72 x 29.5-49.5	92.5	285	24.70	\$3441	\$3616	\$550	\$489
ZH3066F3S	30 x 66 x 29.5-49.5	92.5	272	24.19	\$3337	\$3499	\$495	\$451
ZH3060F3S	30 x 60 x 29.5-49.5	92.5	260	23.68	\$3232	\$3376	\$439	\$409

- Specify FTZ52SFNL for 60" - 72" wide desks and FTZ52LFNL for 84" wide desks.

Height adjustable frame sold separately. Standard with box/box/file pedestal on **left**. **30"D**: Top is recessed 1" on non-ped side and user side over chassis; flush on ped side and guest side. **36"D**: Top is recessed 1" on non-ped side and user side over chassis; flush on ped side and 6.25" overhang on guest side. File drawer and lower box drawer lock. Unit has dual modesty panels - one stationary/one traveling. See notes on page 115 for illustration. Shipped RTA (ready to assemble).



Single Pedestal Desk for Height Adj. Base

ZH3684FS3	36 x 84 x 29.5-49.5	85	325	26.68	\$3558	\$3782	\$642	\$685
ZH3672FS3	36 x 72 x 29.5-49.5	92.5	298	25.69	\$3508	\$3714	\$550	\$587
ZH3666FS3	36 x 66 x 29.5-49.5	92.5	284	25.18	\$3405	\$3591	\$495	\$538
ZH3660FS3	36 x 60 x 29.5-49.5	92.5	271	24.70	\$3274	\$3449	\$434	\$489
ZH3084FS3	30 x 84 x 29.5-49.5	85	310	25.69	\$3633	\$3833	\$642	\$567
ZH3072FS3	30 x 72 x 29.5-49.5	92.5	285	24.70	\$3441	\$3616	\$550	\$489
ZH3066FS3	30 x 66 x 29.5-49.5	92.5	272	24.19	\$3337	\$3499	\$495	\$451
ZH3060FS3	30 x 60 x 29.5-49.5	92.5	260	23.68	\$3232	\$3376	\$439	\$409

- Specify FTZ52SFNL for 60" - 72" wide desks and FTZ52LFNL for 84" wide desks.

Height adjustable frame sold separately. Standard with box/box/file pedestal on **right**. **30"D**: Top is recessed 1" on non-ped side and user side over chassis; flush on ped side and guest side. **36"D**: Top is recessed 1" on non-ped side and user side over chassis; flush on ped side and 6.25" overhang on guest side. File drawer and lower box drawer lock. Unit has dual modesty panels - one stationary/one traveling. See notes on page 115 for illustration. Shipped RTA (ready to assemble).

Required Specifications

Top finish / Base finish
 Top/edge detail
 Wire management finish
 Default no handle, specify lock finish

Must use with FTZ52SFNL or FTZ52LFNL (sold separately)

Optional Specifications

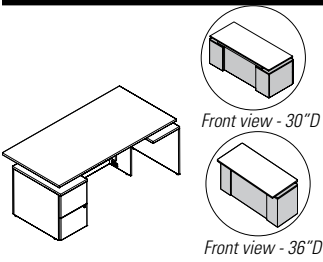
HP laminate, Handles, Key #
 Glazed modesty / modesty type

Grommet position or power block cut-out

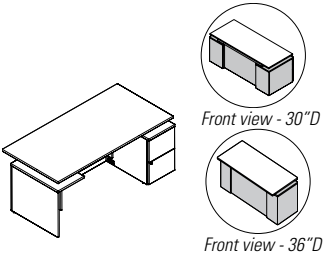
Accessories

Power block / Pencil drawer

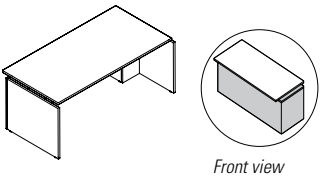
HEIGHT ADJUSTABLE DESKS



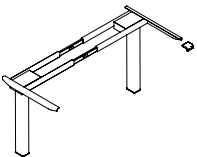
Single Pedestal Desk for Height Adj. Base**



Single Pedestal Desk for Height Adj. Base**



Height Adj. Desk - Freestanding



Height Adjustable Frame*

MODEL#	DIMENSIONS D x W x H	FREIGHT CLASS	WT/LBS.	CUBIC FT.	1" TOP	1.5" TOP	GLAZE ADD	HP ADD
ZH3684F2S	36 x 84 x 29.5-49.5	85	323	26.68	\$3508	\$3732	\$642	\$685
ZH3672F2S	36 x 72 x 29.5-49.5	92.5	296	26.68	\$3460	\$3660	\$550	\$587
ZH3666F2S	36 x 66 x 29.5-49.5	92.5	282	25.18	\$3348	\$3534	\$495	\$538
ZH3660F2S	36 x 60 x 29.5-49.5	92.5	268	24.70	\$3224	\$3392	\$434	\$489
ZH3084F2S	30 x 84 x 29.5-49.5	92.5	308	25.69	\$3583	\$3783	\$642	\$567
ZH3072F2S	30 x 72 x 29.5-49.5	92.5	283	24.70	\$3392	\$3560	\$550	\$489
ZH3066F2S	30 x 66 x 29.5-49.5	92.5	270	24.19	\$3288	\$3445	\$495	\$451
ZH3060F2S	30 x 60 x 29.5-49.5	92.5	258	23.68	\$3182	\$3326	\$434	\$409

• Specify FTZ52SFNL for 60" - 72" wide desks and FTZ52LFNL for 84" wide desks.

Height adjustable frame sold separately. Standard with file/file pedestal on **left. 30"D**: Top is recessed 1" on non-ped side and user side over chassis; flush on ped side and guest side. **36"D**: Top is recessed 1" on non-ped side and user side over chassis; flush on ped side and 6.25" overhang on guest side. Pedestal locks. Unit has dual modesty panels - one stationary/one traveling. See notes on page 115 for illustration. *30"D desks are not compatible with monitor arm models MONxxxx/M775xxx.* Shipped RTA (ready to assemble).

ZH3684FS2	36 x 84 x 29.5-49.5	85	323	26.68	\$3508	\$3732	\$642	\$685
ZH3672FS2	36 x 72 x 29.5-49.5	92.5	296	26.68	\$3460	\$3660	\$550	\$587
ZH3666FS2	36 x 66 x 29.5-49.5	92.5	282	25.18	\$3348	\$3534	\$495	\$538
ZH3660FS2	36 x 60 x 29.5-49.5	92.5	268	24.70	\$3224	\$3392	\$434	\$489
ZH3084FS2	30 x 84 x 29.5-49.5	92.5	308	25.69	\$3583	\$3783	\$642	\$567
ZH3072FS2	30 x 72 x 29.5-49.5	92.5	283	24.70	\$3392	\$3560	\$550	\$489
ZH3066FS2	30 x 66 x 29.5-49.5	92.5	270	24.19	\$3288	\$3445	\$495	\$451
ZH3060FS2	30 x 60 x 29.5-49.5	92.5	258	23.68	\$3182	\$3326	\$434	\$409

• Specify FTZ52SFNL for 60" - 72" wide desks and FTZ52LFNL for 84" wide desks.

Height adjustable frame sold separately. Standard with file/file pedestal on **right. 30"D**: Top is recessed 1" on non-ped side and user side over chassis; flush on ped side and guest side. **36"D**: Top is recessed 1" on non-ped side and user side over chassis; flush on ped side and 6.25" overhang on guest side. Pedestal locks. Unit has dual modesty panels - one stationary/one traveling. See notes on page 115 for illustration. *30"D desks are not compatible with monitor arm models MONxxxx/M775xxx.* Shipped RTA (ready to assemble).

ZH3684NP	36 x 84 x 29.5-49.5	70	231	10.48	\$2427	\$2659	N/A	\$685
ZH3672NP	36 x 72 x 29.5-49.5	125	206	27.69	\$2389	\$2589	N/A	\$587
ZH3666NP	36 x 66 x 29.5-49.5	65	198	8.47	\$2315	\$2501	N/A	\$538
ZH3660NP	36 x 60 x 29.5-49.5	65	198	8.47	\$2261	\$2429	N/A	\$489
ZH3072NP	30 x 72 x 29.5-49.5	70	188	8.71	\$2273	\$2448	N/A	\$489
ZH3066NP	30 x 66 x 29.5-49.5	70	178	7.96	\$2198	\$2360	N/A	\$451
ZH3060NP	30 x 60 x 29.5-49.5	70	168	7.49	\$2162	\$2306	N/A	\$409

• Specify FTZ52SFNL for 60" wide desks and FTZ52LFNL for 66" - 84" wide desks.

Height adjustable frame sold separately. **30"D** - Top is recessed 1" on user and both sides over chassis; 2.9375" overhang on guest side. **36"D** - Top is recessed 1" on user and both sides over chassis; 3.25" overhang on guest side. Shipped RTA (ready to assemble). Unit has a stationary modesty only. *30"D desks are not compatible with monitor arm models MONxxxx/M775xxx.*

FTZ52SFNL	22 x -- x 26	60	67	1.47	\$1138
FTZ52LFNL	22 x -- x 26	60	67	1.47	\$1138

- For models ending in F23/F32/F3S/FS3/F2S/FS2, specify FTZ52SFNL for 60" - 72" and FTZ52LFNL for 84" wide desks.
- For models ending in NP, specify FTZ52SFNL for 60" wide, and FTZ52LFNL for 66" - 84" wide desks

For use with Zira height adjustable desks. Lifts 350 lbs. Available in Black or Tungsten. Shipped RTA (ready to assemble).

• **Recommended torque range for installing all fasteners is 3-5 foot pounds and should not be exceeded. In addition, no impact drivers or high-torque equipment are to be used for any fasteners included in the table assembly kits, as this creates a high risk for damage that is not covered under warranty. The use of hand tools is highly recommended.**

Required Specifications

Top finish Top/edge detail
Base finish*
Wire management finish
Must use with base (sold separately)

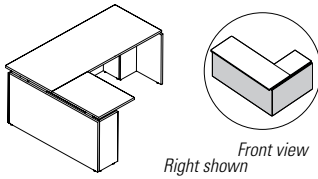
Optional Specifications

HP laminate Handles**
Key #*** Modesty finish glazed**
Modesty Type
Grommet position or power block cut-out

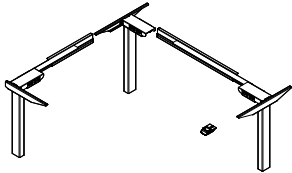
Accessories

Power block
Pencil drawer

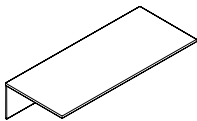
HEIGHT ADJUSTABLE DESKS



L Desk Shell for Height Adj. Base



Height Adjustable Frame*



Top and Modesty Panel Kit

MODEL#	DIMENSIONS	FREIGHT CLASS	WT/LBS.	CUBIC FT.	1" TOP	1.5" TOP	GLAZE ADD	HP ADD
--------	------------	---------------	---------	-----------	--------	----------	-----------	--------

D x W x H								
ZH608424L	60 x 84 x 29.5-49.5	70	294	14.48	\$3202	\$3457	N/A	\$876
ZH607224L	60 x 72 x 29.5-49.5	70	273	13.24	\$3059	\$3291	N/A	\$778
ZH608424R	60 x 84 x 29.5-49.5	70	294	14.48	\$3202	\$3457	N/A	\$876
ZH607224R	60 x 72 x 29.5-49.5	70	273	13.24	\$3059	\$3291	N/A	\$778

- Specify FTZ539FSLNL separately.

Height adjustable frame sold separately. Specify ZH60xx24L for **LEFT** with return on the right side or ZH60xx24R for **RIGHT** with return on left side. Top on long return side is recessed 1" over chassis, 1/2" recessed on primary top (non-return side) and 2.9375" overhang on guest side. Return top is 24"D x 30"W. Shipped RTA (ready to assemble). *Not compatible with monitor arm models MONxxxx/M775xxx.*

FTZ539FSLNL	10 x -- x 26.8	60	101	1.47	\$1847	N/A	N/A	N/A
-------------	----------------	----	-----	------	---------------	-----	-----	-----

For use with Zira height adjustable L desks. Lifts 350 lbs. Available in Black, Designer White or Tungsten. Shipped RTA (ready to assemble).

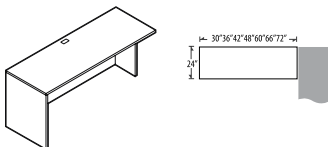
- **Recommended torque range for installing all fasteners is 3-5 foot pounds and should not be exceeded. In addition, no impact drivers or high-torque equipment are to be used for any fasteners included in the table assembly kits, as this creates a high risk for damage that is not covered under warranty. The use of hand tools is highly recommended.**

ZH3084TB	29 x 82 x 16-16.5	85	99	6.75	\$1084	\$1375	\$680	\$567
ZH3072TB	29 x 70 x 16-16.5	85	85	6	\$956	\$1206	\$600	\$489
ZH3066TB	29 x 64 x 16-16.5	85	79	5.50	\$894	\$1126	\$556	\$451
ZH3060TB	29 x 58 x 16-16.5	85	71	5	\$796	\$1008	\$545	\$409
ZH3054TB	29 x 52 x 16-16.5	85	64	4.50	\$735	\$929	\$476	\$372
ZH3048TB	29 x 46 x 16-16.5	85	57	4	\$673	\$841	\$439	\$329
ZH3042TB	29 x 40 x 16-16.5	85	50	3.75	\$604	\$755	\$397	\$285
ZH2484TB	23 x 82 x 16-16.5	85	74	5	\$967	\$1203	\$580	\$457
ZH2472TB	23 x 70 x 16-16.5	70	86	5.50	\$857	\$1063	\$600	\$390
ZH2466TB	23 x 64 x 16-16.5	70	68	4.50	\$796	\$990	\$556	\$359
ZH2460TB	23 x 58 x 16-16.5	85	61	4.25	\$711	\$886	\$545	\$329
ZH2454TB	23 x 52 x 16-16.5	85	55	3.75	\$655	\$812	\$476	\$312
ZH2448TB	23 x 46 x 16-16.5	85	49	3.50	\$600	\$744	\$439	\$261
ZH2442TB	23 x 40 x 16-16.5	85	43	3	\$532	\$670	\$409	\$232

For use with height adjustable mechanisms. Height adjustable frame not included. Shipped RTA (ready to assemble).

- Compatible with FreeFit + FOLI Height Adjustable bases (FOLI compatible with 48" w – 72" w tops)
- Cannot be used with FTZ52SFNL or FTZ52LFNL

CONNECTABLE TABLES



24" Deep Connectable Table - Left

MODEL#	DIMENSIONS	FREIGHT CLASS	WT/LBS.	CUBIC FT.	1" TOP	1.5" TOP	GLAZE ADD	HP ADD
--------	------------	---------------	---------	-----------	--------	----------	-----------	--------

Z2472L	24 x 72 x 29.5-30	65	144	6	\$880	\$1036	N/A	\$384
Z2466L	24 x 66 x 29.5-30	65	135	6	\$880	\$1015	N/A	\$384
Z2460L	24 x 60 x 29.5-30	65	125	5.25	\$796	\$914	N/A	\$353
Z2448L	24 x 48 x 29.5-30	65	106	4.30	\$725	\$827	N/A	\$281
Z2442L	24 x 42 x 29.5-30	65	95	3.80	\$725	\$814	N/A	\$236
Z2436L	24 x 36 x 29.5-30	65	86	3.30	\$637	\$710	N/A	\$178
Z2430L	24 x 30 x 29.5-30	70	77	3.60	\$600	\$658	N/A	\$178

Full end panel on left. Right narrow end panel connects to **24"D** center/right connectable table, or at 90° angle to a freestanding table, height adjustable desk, 24"D extended corners or at the end of a straight run; "D" islands or "P" islands with "T" and "H" bases. Grommet in worksurface. Shipped RTA (ready to assemble).

- Units 48" and under require storage for stability
- **Modesty Panel is 1" off of ground.**

Required Specifications

Top finish
Top/edge detail
Base finish
Wire management finish

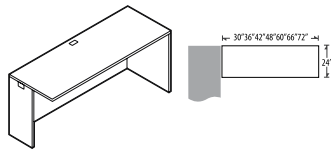
Optional Specifications

HP laminate
Grommet position or power block cut-out

Accessories

Power block

BRIDGES COMPATIBLE W/ ZXXXXBBOL/R AND ZXXXXBLF/R CREDENZAS DIMENSIONS FREIGHT CLASS WT/LBS. CUBIC FT. 1"TOP 1.5" TOP GLAZE ADD HP ADD

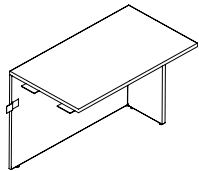


24" Deep Connectable Table - Right

	D x W x H								
Z2472R	24 x 72 x 29.5-30	65	144	6	\$880	\$1036	N/A	\$384	
Z2466R	24 x 66 x 29.5-30	65	135	6	\$880	\$1015	N/A	\$384	
Z2460R	24 x 60 x 29.5-30	65	125	5.25	\$796	\$914	N/A	\$353	
Z2448R	24 x 48 x 29.5-30	65	106	4.30	\$725	\$827	N/A	\$281	
Z2442R	24 x 42 x 29.5-30	65	95	3.80	\$725	\$814	N/A	\$236	
Z2436R	24 x 36 x 29.5-30	65	86	3.30	\$637	\$710	N/A	\$178	
Z2430R	24 x 30 x 29.5-30	70	77	3.60	\$600	\$658	N/A	\$178	

Full end panel on right. Left narrow end panel connects to **24"D** center/right connectable table, or at 90° angle to a freestanding table, height adjustable desk, 24"D extended corners or at the end of a straight run; "D" islands or "P" islands with "T" and "H" bases. Grommet in worksurface. Shipped RTA (ready to assemble).

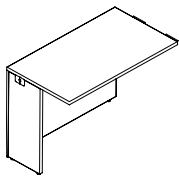
- Units 48" and under require storage for stability
- **Modesty Panel is 1" off of ground.**



Bridge w/Full Laminate Modesty, Left

ZA2448RL	24 x 48 x 29.5-30	70	78	4.30	\$831	\$973	N/A	\$261
ZA2442RL	24 x 42 x 29.5-30	70	66	3.80	\$723	\$848	N/A	\$229
ZA2436RL	24 x 36 x 29.5-30	70	59	3.30	\$673	\$781	N/A	\$197
ZA2048RL	20 x 48 x 29.5-30	70	72	4.30	\$792	\$913	N/A	\$219
ZA2042RL	20 x 42 x 29.5-30	70	62	3.80	\$691	\$797	N/A	\$189
ZA2036RL	20 x 36 x 29.5-30	70	56	3.30	\$643	\$735	N/A	\$164

For use with height adjustable desks - single pedestal. Connects to credenza on **left**. Shipped RTA (ready to assemble).

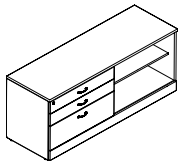


Bridge w/Full Laminate Modesty, Right

ZA2448RR	24 x 48 x 29.5-30	70	78	4.30	\$831	\$973	N/A	\$261
ZA2442RR	24 x 42 x 29.5-30	70	66	3.80	\$723	\$848	N/A	\$229
ZA2436RR	24 x 36 x 29.5-30	70	59	3.30	\$673	\$781	N/A	\$197
ZA2048RR	20 x 48 x 29.5-30	70	72	4.30	\$792	\$913	N/A	\$219
ZA2042RR	20 x 42 x 29.5-30	70	62	3.80	\$691	\$797	N/A	\$189
ZA2036RR	20 x 36 x 29.5-30	70	56	3.30	\$643	\$735	N/A	\$164

For use with height adjustable desks - single pedestal. Connects to credenza on **right**. Shipped RTA (ready to assemble).

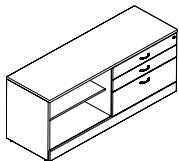
CREDENZAS COMPATIBLE W/HT ADJ. BRIDGES



Credenza

MODEL#	DIMENSIONS	FREIGHT CLASS	WT/LBS.	CUBIC FT.	1"TOP	1.5" TOP	GLAZE ADD	HP ADD
Z2472BBOL	24 x 72 x 29.5-30	125	261	35.75	\$2468	\$2601	N/A	\$390
Z2460BBOL	24 x 60 x 29.5-30	125	231	30	\$2216	\$2327	N/A	\$327
Z2072BBOL	20 x 72 x 29.5-30	125	234	30.25	\$2358	\$2469	N/A	\$327
Z2060BBOL	20 x 60 x 29.5-30	100	207	25.25	\$2141	\$2234	N/A	\$273

Compatible with height adjustable bridges. Box/box/lateral file on **left** with open storage on the **right**. Connects to bridge on **right**. Adjustable shelf. Shipped assembled in 1 carton.



Credenza

Z2472BBOR	24 x 72 x 29.5-30	125	261	35.75	\$2468	\$2601	N/A	\$390
Z2460BBOR	24 x 60 x 29.5-30	125	231	30	\$2216	\$2327	N/A	\$327
Z2072BBOR	20 x 72 x 29.5-30	125	234	30.25	\$2358	\$2469	N/A	\$327
Z2060BBOR	20 x 60 x 29.5-30	100	207	25.25	\$2141	\$2234	N/A	\$273

Compatible with height adjustable bridges. Box/box/lateral file on **right** with open storage on the **left**. Connects to bridge on **left**. Adjustable shelf. Shipped assembled in 1 carton.

Required Specifications

Top finish
Top/edge detail
Base finish

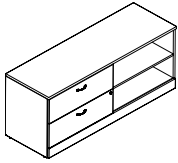
Optional Specifications

HP laminate
Modesty panel type
Grommet position or power block cut-out

Accessories

Power block
Keyboard
Pencil drawer

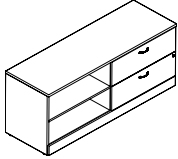
CREDENZAS COMPATIBLE W/HT ADJ. BRIDGES



Credenza

	DIMENSIONS	FREIGHT CLASS	WT/LBS.	CUBIC FT.	1"TOP	1.5" TOP	GLAZE ADD	HP ADD	
D x W x H									
Z2472BLFL	24 x 72 x 29.5-30	125	265	35.75	\$2430	\$2563	N/A	\$390	
Z2460BLFL	24 x 60 x 29.5-30	125	235	30	\$2191	\$2302	N/A	\$327	
Z2072BLFL	20 x 72 x 29.5-30	125	239	30.25	\$2320	\$2431	N/A	\$327	
Z2060BLFL	20 x 60 x 29.5-30	100	212	25.25	\$2112	\$2205	N/A	\$273	

Compatible with height adjustable bridges. Two drawer lateral file on **left** with open storage on the **right**. Connects to bridge on **right**. Adjustable shelf. Shipped assembled in 1 carton.

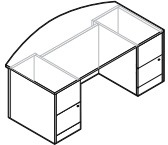


Credenza

Z2472BLFR	24 x 72 x 29.5-30	125	265	35.75	\$2430	\$2563	N/A	\$390
Z2460BLFR	24 x 60 x 29.5-30	125	235	30	\$2191	\$2302	N/A	\$327
Z2072BLFR	20 x 72 x 29.5-30	125	239	30.25	\$2320	\$2431	N/A	\$327
Z2060BLFR	20 x 60 x 29.5-30	100	212	25.25	\$2112	\$2205	N/A	\$273

Compatible with height adjustable bridges. Two drawer lateral file on **right** with open storage on the **left**. Connects to bridge on **left**. Adjustable shelf. Shipped assembled in 1 carton.

DOUBLE PEDESTAL DESKS

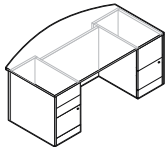


Double Pedestal Bow Top Desk

MODEL#	DIMENSIONS	FREIGHT CLASS	WT/LBS.	CUBIC FT.	1"TOP	1.5" TOP	GLAZE ADD	HP ADD
Z4284FB22	42 x 84 x 29.5-30	250	381.15	102.5	\$2843	\$3163	\$916	\$1015
Z4272FB22	42 x 72 x 29.5-30	125	377	59	\$2734	\$3014	\$760	\$762
Z3672FB22	36 x 72 x 29.5-30	125	317.10	50.75	\$2553	\$2801	\$760	\$573
Z3666FB22	36 x 66 x 29.5-30	125	305.55	46.75	\$2502	\$2731	\$678	\$573
Z3660FB22	36 x 60 x 29.5-30	125	295.05	42.50	\$2427	\$2637	\$600	\$477

Standard with **freestanding** file/file pedestals on **left** and **right**. Pedestals lock. Bow top overhangs 2 ¼" at ends and 8" on center.

- 84" wide desks are shipped RTA (ready to assemble) in 3 cartons.

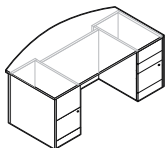


Double Pedestal Bow Top Desk

Z4284FB32	42 x 84 x 29.5-30	250	379.05	102.5	\$2881	\$3201	\$916	\$1015
Z4272FB32	42 x 72 x 29.5-30	125	375	59	\$2770	\$3050	\$760	\$762
Z3672FB32	36 x 72 x 29.5-30	125	315	50.75	\$2586	\$2836	\$760	\$573
Z3666FB32	36 x 66 x 29.5-30	125	303.45	46.75	\$2535	\$2762	\$678	\$573
Z3660FB32	36 x 60 x 29.5-30	125	292.95	42.50	\$2465	\$2675	\$600	\$477

Standard with **Freestanding** file/file pedestal on **right** and box/box/file pedestal on **left**. File drawer and lower box drawer lock. File pedestal locks. Bow top overhangs 2 ¼" at ends and 8" on center.

- 84" wide desks are shipped RTA (ready to assemble) in 3 cartons.

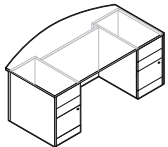


Double Pedestal Bow Top Desk

Z4284FB23	42 x 84 x 29.5-30	250	379.05	102.5	\$2881	\$3201	\$916	\$1015
Z4272FB23	42 x 72 x 29.5-30	125	375	59	\$2770	\$3050	\$760	\$762
Z3672FB23	36 x 72 x 29.5-30	125	315	50.75	\$2586	\$2836	\$760	\$573
Z3666FB23	36 x 66 x 29.5-30	125	303.45	46.75	\$2535	\$2762	\$678	\$573
Z3660FB23	36 x 60 x 29.5-30	125	292.95	42.50	\$2465	\$2675	\$600	\$477

Standard with **Freestanding** file/file pedestal on **left** and box/box/file pedestal on **right**. File drawer and lower box drawer lock. File pedestal locks. Bow top overhangs 2 ¼" at ends and 8" on center.

- 84" wide desks are shipped RTA (ready to assemble) in 3 cartons.



Double Pedestal Bow Top Desk

Z4284FB33	42 x 84 x 29.5-30	250	381.15	102.5	\$2916	\$3236	\$916	\$1015
Z4272FB33	42 x 72 x 29.5-30	125	378	59	\$2805	\$3086	\$760	\$762
Z3672FB33	36 x 72 x 29.5-30	125	317.10	50.75	\$2624	\$2874	\$760	\$573
Z3666FB33	36 x 66 x 29.5-30	125	305.55	46.75	\$2573	\$2800	\$678	\$573
Z3660FB33	36 x 60 x 29.5-30	125	295.05	42.50	\$2507	\$2731	\$600	\$477

Standard with **Freestanding** box/box/file pedestals on **left** and **right**. File drawer and lower box drawer lock. Bow top overhangs 2 ¼" at ends and 8" on center.

- 84" wide desks are shipped RTA (ready to assemble) in 3 cartons.

Required Specifications

Top finish
Top/edge detail
Base finish
Lock finish

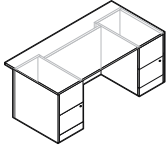
Optional Specifications

HP laminate Handles
Key # Modesty finish glazed
Modesty panel type
Grommet position or power block cut-out

Accessories

Power block
Keyboard
Pencil drawer

DOUBLE PEDESTAL DESKS

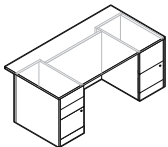


Double Pedestal Desk

MODEL#	DIMENSIONS D x W x H	FREIGHT CLASS	WT./LBS.	CUBIC FT.	1" TOP	1.5" TOP	GLAZE ADD	HP ADD
Z4284F22	42 x 84 x 29.5-30	250	385.35	102.5	\$2744	\$3017	\$916	\$1015
Z4272F22	42 x 72 x 29.5-30	125	373	59	\$2643	\$2878	\$760	\$762
Z3684F22	36 x 84 x 29.5-30	250	366.12	176.6	\$2583	\$2819	\$916	\$762
Z3672F22	36 x 72 x 29.5-30	125	326.01	50.75	\$2465	\$2671	\$760	\$573
Z3666F22	36 x 66 x 29.5-30	125	314.77	46.75	\$2419	\$2607	\$678	\$573
Z3660F22	36 x 60 x 29.5-30	125	294.93	42.50	\$2374	\$2546	\$600	\$477
Z3072F22	29.7 x 72 x 29.5-30	125	326.01	50.75	\$2465	\$2670	\$760	\$573
Z3066F22	29.7 x 66 x 29.5-30	125	314.77	46.75	\$2419	\$2606	\$678	\$573
Z3060F22	29.7 x 60 x 29.5-30	125	294.93	42.50	\$2374	\$2544	\$600	\$477

Standard with **Freestanding** file/file pedestals on **left** and **right**. Pedestals lock.

- 84" wide desks are shipped RTA (ready to assemble) in 3 cartons.
- Hutches may not be placed on this desk

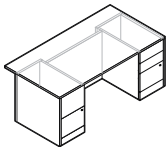


Double Pedestal Desk

Z4284F32	42 x 84 x 29.5-30	250	383.25	102.5	\$2780	\$3050	\$916	\$1015
Z4272F32	42 x 72 x 29.5-30	125	371	59	\$2679	\$2914	\$760	\$762
Z3684F32	36 x 84 x 29.5-30	250	364.54	176.6	\$2619	\$2855	\$916	\$762
Z3672F32	36 x 72 x 29.5-30	125	324.43	50.75	\$2503	\$2709	\$760	\$573
Z3666F32	36 x 66 x 29.5-30	125	313.18	46.75	\$2455	\$2643	\$678	\$573
Z3660F32	36 x 60 x 29.5-30	125	267.10	42.50	\$2410	\$2584	\$600	\$477
Z3072F32	29.69 x 72 x 29.5-30	125	324.43	50.75	\$2503	\$2709	\$760	\$573
Z3066F32	29.7 x 66 x 29.5-30	125	313.18	46.75	\$2455	\$2643	\$678	\$573
Z3060F32	29.7 x 60 x 29.5-30	125	267.10	42.50	\$2410	\$2582	\$600	\$477

Standard with **Freestanding** box/box/file pedestal on **left** and file/file pedestal on **right**. File drawer and lower box drawer lock. File pedestal locks.

- 84" wide desks are shipped RTA (ready to assemble) in 3 cartons.
- Hutches may not be placed on this desk

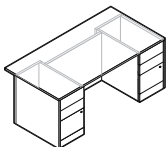


Double Pedestal Desk

Z4284F23	42 x 84 x 29.5-30	250	383.25	102.5	\$2780	\$3050	\$916	\$1015
Z4272F23	42 x 72 x 29.5-30	125	371	59	\$2679	\$2914	\$760	\$762
Z3684F23	36 x 84 x 29.5-30	250	364.54	176.6	\$2619	\$2855	\$916	\$762
Z3672F23	36 x 72 x 29.5-30	125	324.43	50.75	\$2503	\$2709	\$760	\$573
Z3666F23	36 x 66 x 29.5-30	125	313.18	46.75	\$2455	\$2643	\$678	\$573
Z3660F23	36 x 60 x 29.5-30	125	267.10	42.50	\$2410	\$2584	\$600	\$477
Z3072F23	29.7 x 72 x 29.5-30	125	324.43	50.75	\$2503	\$2709	\$760	\$573
Z3066F23	29.7 x 66 x 29.5-30	125	313.18	46.75	\$2455	\$2643	\$678	\$573
Z3060F23	29.7 x 60 x 29.5-30	125	267.10	42.50	\$2410	\$2582	\$600	\$477

Standard with **Freestanding** file/file pedestal on **left** and box/box/file pedestal on **right**. File drawer and lower box drawer lock. File pedestal locks.

- 84" wide desks are shipped RTA (ready to assemble) in 3 cartons.
- Hutches may not be placed on this desk



Double Pedestal Desk

Z4284F33	42 x 84 x 29.5-30	250	381.15	102.5	\$2817	\$3087	\$916	\$1015
Z4272F33	42 x 72 x 29.5-30	125	370	59	\$2717	\$2951	\$760	\$762
Z3684F33	36 x 84 x 29.5-30	300	341.25	176.6	\$2656	\$2892	\$916	\$762
Z3672F33	36 x 72 x 29.5-30	125	316.05	50.75	\$2536	\$2742	\$760	\$573
Z3666F33	36 x 66 x 29.5-30	125	304.50	46.75	\$2492	\$2680	\$678	\$573
Z3660F33	36 x 60 x 29.5-30	125	261.45	42.50	\$2447	\$2621	\$600	\$477
Z3072F33	29.7 x 72 x 29.5-30	125	316.05	50.75	\$2536	\$2742	\$760	\$573
Z3066F33	29.7 x 66 x 29.5-30	125	304.50	46.75	\$2492	\$2675	\$678	\$573
Z3060F33	29.69 x 60 x 29.5-30	125	261.45	42.50	\$2447	\$2621	\$600	\$477

Standard with **Freestanding** box/box/file pedestals on **left** and **right**. File drawer and lower box drawer lock.

- 84" wide desks are shipped RTA (ready to assemble) in 3 cartons.
- Hutches may not be placed on this desk

Required Specifications

Top finish
Top/edge detail
Base finish
Lock finish

Optional Specifications

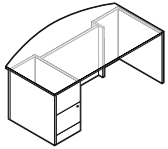
HP laminate
Key #
Modesty Type
Grommet position or power block cut-out

Handles
Modesty finish glazed

Accessories

Power block
Keyboard
Pencil drawer

SINGLE PEDESTAL DESKS

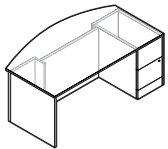


Single Pedestal Bow Top Desk - LEFT

MODEL#	DIMENSIONS D x W x H	FREIGHT CLASS	WT./LBS.	CUBIC FT.	1" TOP	1.5" TOP	GLAZE ADD	HP ADD
Z4284FB2L	42 x 84 x 29.5-30	125	322.35	43.50	\$2175	\$2495	\$916	\$1015
Z4272FB2L	42 x 72 x 29.5-30	150	315	59	\$2064	\$2345	\$760	\$762
Z3672FB2L	36 x 72 x 29.5-30	150	281.35	50.75	\$1914	\$2162	\$760	\$573
Z3666FB2L	36 x 66 x 29.5-30	150	274.68	46.75	\$1861	\$2090	\$678	\$573
Z3660FB2L	36 x 60 x 29.5-30	125	259.86	42.50	\$1792	\$2002	\$600	\$477

Standard with **Freestanding** file/file pedestal on **left** and faux pedestal **right**. Pedestal locks. Bow top overhangs 2 ¼" at ends and 8" on center.

- 84" wide desks are shipped RTA (ready to assemble) in 2 cartons.

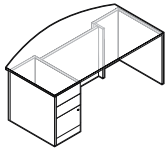


Single Pedestal Bow Top Desk - RIGHT

Z4284FB2R	42 x 84 x 29.5-30	125	322.35	43.50	\$2175	\$2495	\$916	\$1015
Z4272FB2R	42 x 72 x 29.5-30	150	315	59	\$2064	\$2345	\$760	\$762
Z3672FB2R	36 x 72 x 29.5-30	150	281.35	50.75	\$1914	\$2162	\$760	\$573
Z3666FB2R	36 x 66 x 29.5-30	150	274.68	46.75	\$1861	\$2090	\$678	\$573
Z3660FB2R	36 x 60 x 29.5-30	125	259.86	42.50	\$1792	\$2002	\$600	\$477

Standard with **Freestanding** faux pedestal **left** and file/file pedestal on **right**. Pedestal locks. Bow top overhangs 2 ¼" at ends and 8" on center.

- 84" wide desks are shipped RTA (ready to assemble) in 2 cartons.

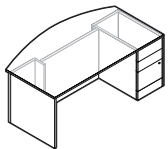


Single Pedestal Bow Top Desk - LEFT

Z4284FB3L	42 x 84 x 29.5-30	125	320.25	43.50	\$2212	\$2531	\$916	\$1015
Z4272FB3L	42 x 72 x 29.5-30	150	313	59	\$2099	\$2379	\$760	\$762
Z3672FB3L	36 x 72 x 29.5-30	150	279.77	50.75	\$1950	\$2200	\$760	\$573
Z3666FB3L	36 x 66 x 29.5-30	150	273.10	46.75	\$1900	\$2127	\$678	\$573
Z3660FB3L	36 x 60 x 29.5-30	125	258.27	42.50	\$1848	\$2061	\$600	\$477

Standard with **Freestanding** box/box/file pedestal on **left** and faux pedestal **right**. File drawer and lower box drawer lock. Bow top overhangs 2 ¼" at ends and 8" on center.

- 84" wide desks are shipped RTA (ready to assemble) in 2 cartons.

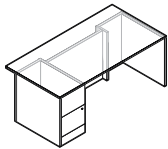


Single Pedestal Bow Top Desk - RIGHT

Z4284FB3R	42 x 84 x 29.5-30	125	320.25	43.50	\$2212	\$2531	\$916	\$1015
Z4272FB3R	42 x 72 x 29.5-30	150	313	59	\$2099	\$2379	\$760	\$762
Z3672FB3R	36 x 72 x 29.5-30	150	279.77	50.75	\$1950	\$2200	\$760	\$573
Z3666FB3R	36 x 66 x 29.5-30	150	273.10	46.75	\$1900	\$2127	\$678	\$573
Z3660FB3R	36 x 60 x 29.5-30	125	258.27	42.50	\$1848	\$2061	\$600	\$477

Standard with **Freestanding** faux pedestal **left** and box/box/file pedestal on **right**. File drawer and lower box drawer lock. Bow top overhangs 2 ¼" at ends and 8" on center.

- 84" wide desks are shipped RTA (ready to assemble) in 2 cartons.



Single Pedestal Desk - LEFT

Z4284F2L	42 x 84 x 29.5-30	125	326.55	43.50	\$2074	\$2347	\$916	\$1015
Z4272F2L	42 x 72 x 29.5-30	150	327	59	\$1974	\$2209	\$760	\$762
Z3684F2L	36 x 84 x 29.5-30	250	290.85	118	\$1947	\$2183	\$916	\$762
Z3672F2L	36 x 72 x 29.5-30	150	265.65	50.75	\$1826	\$2032	\$760	\$573
Z3666F2L	36 x 66 x 29.5-30	150	254.10	46.75	\$1781	\$1969	\$678	\$573
Z3660F2L	36 x 60 x 29.5-30	150	243.60	42.50	\$1736	\$1911	\$600	\$477
Z3072F2L	29.69 x 72 x 29.5-30	150	265.65	50.75	\$1826	\$2032	\$760	\$573
Z3066F2L	29.7 x 66 x 29.5-30	150	254.10	46.75	\$1781	\$1968	\$678	\$573
Z3060F2L	29.7 x 60 x 29.5-30	150	243.60	42.50	\$1736	\$1911	\$600	\$477

Standard with **Freestanding** file/file pedestal on **left** and faux pedestal **right**. Pedestal locks.

- 84" wide desks are shipped RTA (ready to assemble) in 2 cartons.
- Hutches may not be placed on this desk

Required Specifications

Top finish
Top/edge detail
Base finish
Lock finish

Optional Specifications

HP laminate
Key #
Modesty Type
Grommet position or power block cut-out

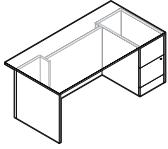
Handles

Modesty finish glazed

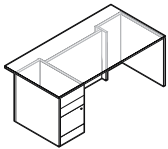
Accessories

Power block
Keyboard
Pencil drawer

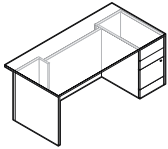
SINGLE PEDESTAL DESKS



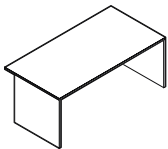
Single Pedestal Desk - RIGHT*



Single Pedestal Desk - LEFT*



Single Pedestal Desk - RIGHT*



Non-Handed Desk

MODEL#	DIMENSIONS D x W x H	FREIGHT CLASS	WT/LBS.	CUBIC FT.	1" TOP	1.5" TOP	GLAZE ADD	HP ADD
Z4284F2R	42 x 84 x 29.5-30	125	326.55	43.50	\$2074	\$2347	\$916	\$1015
Z4272F2R	42 x 72 x 29.5-30	150	327	59	\$1974	\$2209	\$760	\$762
Z3684F2R	36 x 84 x 29.5-30	250	290.85	118	\$1947	\$2183	\$916	\$762
Z3672F2R	36 x 72 x 29.5-30	150	265.65	50.75	\$1826	\$2032	\$760	\$573
Z3666F2R	36 x 66 x 29.5-30	150	254.10	46.75	\$1781	\$1969	\$678	\$573
Z3660F2R	36 x 60 x 29.5-30	150	243.60	42.50	\$1736	\$1911	\$600	\$477
Z3072F2R	29.7 x 72 x 29.5-30	150	265.65	50.75	\$1826	\$2032	\$760	\$573
Z3066F2R	29.7 x 66 x 29.5-30	150	254.10	46.75	\$1781	\$1968	\$678	\$573
Z3060F2R	29.7 x 60 x 29.5-30	150	243.60	42.50	\$1736	\$1911	\$600	\$477

Standard with **Freestanding** faux pedestal on **left** and file/file pedestal **right**. Pedestal locks.

- 84" wide desks are shipped RTA (ready to assemble) in 2 cartons.
- Hutches may not be placed on this desk

Z4284F3L	42 x 84 x 29.5-30	125	324.45	43.50	\$2112	\$2382	\$916	\$1015
Z4272F3L	42 x 72 x 29.5-30	150	324	59	\$2011	\$2246	\$760	\$762
Z3684F3L	36 x 84 x 29.5-30	250	288.75	118	\$1947	\$2183	\$916	\$762
Z3672F3L	36 x 72 x 29.5-30	150	263.55	50.75	\$1863	\$2069	\$760	\$573
Z3666F3L	36 x 66 x 29.5-30	150	252	46.75	\$1819	\$2007	\$678	\$573
Z3660F3L	36 x 60 x 29.5-30	150	241.50	42.50	\$1750	\$1922	\$600	\$477
Z3072F3L	29.7 x 72 x 29.5-30	150	253.55	50.75	\$1863	\$2069	\$760	\$573
Z3066F3L	29.7 x 66 x 29.5-30	150	252	46.75	\$1819	\$2006	\$678	\$573
Z3060F3L	29.7 x 60 x 29.5-30	150	241.50	42.50	\$1750	\$1922	\$600	\$477

Standard with **Freestanding** box/box/file pedestal on **left** and faux pedestal **right**. File drawer and lower box drawer lock.

- 84" wide desks are shipped RTA (ready to assemble) in 2 cartons.
- Hutches may not be placed on this desk

Z4284F3R	42 x 84 x 29.5-30	125	324.45	43.50	\$2112	\$2382	\$916	\$1015
Z4272F3R	42 x 72 x 29.5-30	150	324	59	\$2011	\$2246	\$760	\$762
Z3684F3R	36 x 84 x 29.5-30	250	288.75	118	\$1947	\$2183	\$916	\$762
Z3672F3R	36 x 72 x 29.5-30	150	263.55	50.75	\$1863	\$2069	\$760	\$573
Z3666F3R	36 x 66 x 29.5-30	150	252	46.75	\$1819	\$2007	\$678	\$573
Z3660F3R	36 x 60 x 29.5-30	150	241.50	42.50	\$1750	\$1922	\$600	\$477
Z3072F3R	29.7 x 72 x 29.5-30	150	253.55	50.75	\$1863	\$2069	\$760	\$573
Z3066F3R	29.7 x 66 x 29.5-30	150	252	46.75	\$1819	\$2006	\$678	\$573
Z3060F3R	29.7 x 60 x 29.5-30	150	241.50	42.50	\$1750	\$1922	\$600	\$477

Standard with **Freestanding** faux pedestal on **left** and box/box/file pedestal **right**. File drawer and lower box drawer lock.

- 84" wide desks are shipped RTA (ready to assemble) in 2 cartons.
- Hutches may not be placed on this desk

Z4284NHD	42 x 84 x 29.5-30	65	267	9.5	\$1583	\$1893	n/a	\$796
Z3684NHD	36 x 84 x 29.5-30	70	182	8.3	\$1436	\$1697	n/a	\$685
Z3672NHD	36 x 72 x 29.5-30	70	159	7.2	\$1294	\$1517	n/a	\$587
Z3666NHD	36 x 66 x 29.5-30	65	152	6.7	\$1220	\$1432	n/a	\$538
Z3660NHD	36 x 60 x 29.5-30	65	143	6.1	\$1153	\$1347	n/a	\$489
Z3072NHD	29.7 x 72 x 29.5-30	65	140	6.2	\$1178	\$1364	n/a	\$489
Z3066NHD	29.7 x 66 x 29.5-30	65	133	5.7	\$1092	\$1273	n/a	\$451
Z3060NHD	29.7 x 60 x 29.5-30	65	124	5.2	\$1030	\$1186	n/a	\$409

Two laminate end panels + recessed full modesty panel (laminate only). Accepts all standard Zira storage shells. Shipped RTA (ready to assemble).

- Hutches may not be placed on this desk

Required Specifications

Top finish
Top/edge detail
Base finish
Lock finish

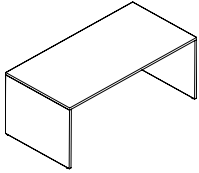
Optional Specifications

HP laminate Handles
Key # Modesty finish glazed
Modesty Type
Grommet position or power block cut-out

Accessories

Power block
Keyboard
Pencil drawer

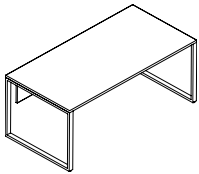
FREESTANDING DESKS



Freestanding Desk

MODEL#	DIMENSIONS D x W x H	FREIGHT CLASS	WT/LBS.	CUBIC FT.	1" TOP	1.5" TOP	GLAZE ADD	HP ADD
Z3684DK	36 x 84 x 29.5-30	70	168	8.25	\$1239	\$1494	\$957	\$681
Z3672DK	36 x 72 x 29.5-30	70	152	7.25	\$1133	\$1357	\$854	\$585
Z3666DK	36 x 66 x 29.5-30	70	144	6.75	\$1084	\$1290	\$780	\$537
Z3660DK	36 x 60 x 29.5-30	65	137	6	\$1036	\$1222	\$729	\$488
Z3072DK	30 x 72 x 29.5-30	70	130	6.25	\$1011	\$1197	\$854	\$488
Z3066DK	30 x 66 x 29.5-30	70	123	5.75	\$963	\$1149	\$780	\$448
Z3060DK	30 x 60 x 29.5-30	70	117	5.25	\$913	\$1099	\$729	\$407

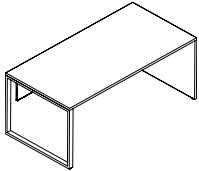
Two full laminate end panels. 12"H laminate modesty panel. Shipped RTA (ready to assemble).



Freestanding Desk - Metal Legs*

Z3684DM	36 x 84 x 29.5-30	100	167	18.44	\$2648	\$2909	\$734	\$681
Z3672DM	36 x 72 x 29.5-30	100	151	17.46	\$2549	\$2773	\$630	\$585
Z3666DM	36 x 66 x 29.5-30	100	143	16.95	\$2500	\$2706	\$556	\$488
Z3660DM	36 x 60 x 29.5-30	100	143	16.95	\$2500	\$2706	\$504	\$488
Z3072DM	30 x 72 x 29.5-30	100	133	14.70	\$2427	\$2613	\$630	\$488
Z3066DM	30 x 66 x 29.5-30	100	126	14.22	\$2378	\$2564	\$556	\$448
Z3060DM	30 x 60 x 29.5-30	100	120	13.95	\$2327	\$2513	\$504	\$407

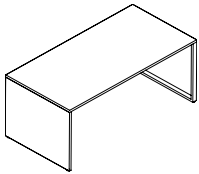
Double metal legs. 12"H laminate modesty panel. Metal leg available in Black (BLK) or Tungsten (TUN). Shipped RTA (ready to assemble).



Freestanding Desk - Metal Legs*

Z3684DML	36 x 84 x 29.5-30	85	167	13.50	\$1946	\$2201	\$840	\$681
Z3672DML	36 x 72 x 29.5-30	85	151	12.04	\$1847	\$2066	\$738	\$585
Z3666DML	36 x 66 x 29.5-30	85	144	11.74	\$1799	\$2005	\$664	\$537
Z3660DML	36 x 60 x 29.5-30	85	135	11.24	\$1749	\$1935	\$614	\$488
Z3072DML	30 x 72 x 29.5-30	85	131	10.50	\$1725	\$1911	\$738	\$488
Z3066DML	30 x 66 x 29.5-30	85	125	10	\$1676	\$1862	\$664	\$448
Z3060DML	30 x 60 x 29.5-30	85	118	9.50	\$1628	\$1814	\$614	\$407

Single metal leg on **left** and laminate end panel on **right**. 12"H laminate modesty panel. Metal leg available in Black (BLK) or Tungsten (TUN). Shipped RTA (ready to assemble).



Freestanding Desk - Metal Legs*

Z3684DMR	36 x 84 x 29.5-30	85	167	13.50	\$1946	\$2201	\$840	\$681
Z3672DMR	36 x 72 x 29.5-30	85	151	12.04	\$1847	\$2066	\$738	\$585
Z3666DMR	36 x 66 x 29.5-30	85	144	11.74	\$1799	\$2005	\$664	\$537
Z3660DMR	36 x 60 x 29.5-30	85	135	11.24	\$1749	\$1935	\$614	\$488
Z3072DMR	30 x 72 x 29.5-30	85	131	10.50	\$1725	\$1911	\$738	\$488
Z3066DMR	30 x 66 x 29.5-30	85	125	10	\$1676	\$1862	\$664	\$448
Z3060DMR	30 x 60 x 29.5-30	85	118	9.50	\$1628	\$1814	\$614	\$407

Single metal leg on **right** and laminate end panel on **left**. 12"H laminate modesty panel. Metal leg available in Black (BLK) or Tungsten (TUN). Shipped RTA (ready to assemble).

Required Specifications

Top finish
Top/edge detail
Base finish
Lock finish

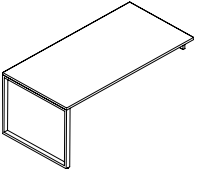
Optional Specifications

HP laminate Handles
Key # Modesty finish glazed*
Modesty Type*
Grommet position or power block cut-out

Accessories

Power block
Keyboard
Pencil drawer

TRANSITIONAL TABLES

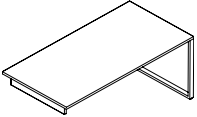


LEFT

Overlapping Table

MODEL#	DIMENSIONS D x W x H	FREIGHT CLASS	WT./LBS.	CUBIC FT.	1" TOP	1.5" TOP	GLAZE ADD	HP ADD
Z3684OML	36 x 84 x 29.5-30	100	132	13.50	\$1780	\$2035	N/A	\$681
Z3672OML	36 x 72 x 29.5-30	100	120	12.24	\$1700	\$1955	N/A	\$585
Z3666OML	36 x 66 x 29.5-30	100	112	11.74	\$1663	\$1918	N/A	\$537
Z3660OML	36 x 60 x 29.5-30	100	105	11.24	\$1632	\$1882	N/A	\$488
Z3072OML	30 x 72 x 29.5-30	100	104	10.50	\$1609	\$1851	N/A	\$488
Z3066OML	30 x 66 x 29.5-30	100	97	10	\$1571	\$1821	N/A	\$448
Z3060OML	30 x 60 x 29.5-30	100	90	9.50	\$1541	\$1791	N/A	\$407

Metal open frame leg with support channels on **left**. To be placed on top of 23.75"/24.25" high units.
Not freestanding. Metal leg available in Black (**BLK**) or Tungsten (**TUN**). Shipped RTA (ready to assemble).

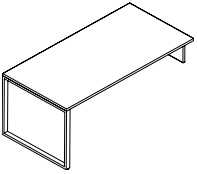


RIGHT

Overlapping Table

Z3684OMR	36 x 84 x 29.5-30	100	132	13.50	\$1780	\$2035	N/A	\$681
Z3672OMR	36 x 72 x 29.5-30	100	120	12.24	\$1700	\$1955	N/A	\$585
Z3666OMR	36 x 66 x 29.5-30	100	112	11.74	\$1663	\$1918	N/A	\$537
Z3660OMR	36 x 60 x 29.5-30	100	105	11.24	\$1632	\$1882	N/A	\$488
Z3072OMR	30 x 72 x 29.5-30	100	104	10.50	\$1609	\$1851	N/A	\$488
Z3066OMR	30 x 66 x 29.5-30	100	97	10	\$1571	\$1821	N/A	\$448
Z3060OMR	30 x 60 x 29.5-30	100	90	9.50	\$1541	\$1791	N/A	\$407

Metal open frame leg with support channels on **right**. To be placed on top of 23.75"/24.25" high units.
Not freestanding. Metal leg available in Black (**BLK**) or Tungsten (**TUN**). Shipped RTA (ready to assemble).

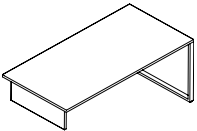


LEFT

Overlapping Table

Z3684SOL	36 x 84 x 29.5-30	92.5	139	13.50	\$1799	\$2054	N/A	\$681
Z3672SOL	36 x 72 x 29.5-30	92.5	126	12.24	\$1720	\$1975	N/A	\$585
Z3666SOL	36 x 66 x 29.5-30	92.5	118	11.74	\$1682	\$1937	N/A	\$537
Z3660SOL	36 x 60 x 29.5-30	100	110	11.24	\$1651	\$1901	N/A	\$488
Z3072SOL	30 x 72 x 29.5-30	92.5	108	10.50	\$1628	\$1870	N/A	\$488
Z3066SOL	30 x 66 x 29.5-30	92.5	100	10	\$1590	\$1840	N/A	\$448
Z3060SOL	30 x 60 x 29.5-30	92.5	96	9.50	\$1559	\$1809	N/A	\$407

Metal open frame leg with support channels on **left**. To be placed on top of 17.87"/18.37" high units.
Not freestanding. Metal leg available in Black (**BLK**) or Tungsten (**TUN**). Shipped RTA (ready to assemble).



RIGHT

Overlapping Table

Z3684SOR	36 x 84 x 29.5-30	92.5	139	13.50	\$1799	\$2054	N/A	\$681
Z3672SOR	36 x 72 x 29.5-30	92.5	126	12.24	\$1720	\$1975	N/A	\$585
Z3666SOR	36 x 66 x 29.5-30	92.5	118	11.74	\$1682	\$1937	N/A	\$537
Z3660SOR	36 x 60 x 29.5-30	100	110	11.24	\$1651	\$1901	N/A	\$488
Z3072SOR	30 x 72 x 29.5-30	92.5	108	10.50	\$1628	\$1870	N/A	\$488
Z3066SOR	30 x 66 x 29.5-30	92.5	100	10	\$1590	\$1840	N/A	\$448
Z3060SOR	30 x 60 x 29.5-30	92.5	96	9.50	\$1559	\$1809	N/A	\$407

Metal open frame leg with support channels on **right**. To be placed on top of 17.87"/18.37" high units.
Not freestanding. Metal leg available in Black (**BLK**) or Tungsten (**TUN**). Shipped RTA (ready to assemble).

Required Specifications

- Top finish
- Top/edge detail
- Base finish
- Leg finish (BLK or TUN)

Optional Specifications

- HP laminate
- Grommet position or power block cut-out

Accessories

- Power block
- Keyboard
- Pencil drawer

FLUSH RETURNS		MODEL#	DIMENSIONS	FREIGHT CLASS	WT./LBS.	CUBIC FT.	1" TOP	1.5" TOP	GLAZE ADD	HP ADD
		Z2448FL	24 x 48 x 29.5-30	125	155	24	\$1015	\$1117	N/A	\$281
		Z2442FL	24 x 42 x 29.5-30	125	144	21.25	\$1015	\$1104	N/A	\$236
		Z2048FL	20 x 48 x 29.5-30	125	140	20.25	\$941	\$1030	N/A	\$236
		Z2042FL	20 x 42 x 29.5-30	125	130	18	\$941	\$1030	N/A	\$236
		<p>Standard with box/file drawer pedestal. One pencil tray. Pedestal locks. Grommet in worksurface. Pedestal is on the left. For use with right handed single pedestal desks, 20"/24" deep extended corners with narrow end panel or 20"/24" deep five-sided corners with narrow end panel.</p>								
		Z2448FR	24 x 48 x 29.5-30	125	155	24	\$1015	\$1117	N/A	\$281
		Z2442FR	24 x 42 x 29.5-30	125	144	21.25	\$1015	\$1104	N/A	\$236
		Z2048FR	20 x 48 x 29.5-30	125	140	20.25	\$941	\$1030	N/A	\$236
		Z2042FR	20 x 42 x 29.5-30	125	130	18	\$941	\$1030	N/A	\$236
		<p>Standard with box/file drawer pedestal. One pencil tray. Pedestal locks. Grommet in worksurface. Pedestal is on the right. For use with left handed single pedestal desks, 20"/24" deep extended corners with narrow end panel or 20"/24" deep five-sided corners with narrow end panel.</p>								
		Z2448EL	24 x 48 x 29.5-30	65	107	4.30	\$718	\$820	N/A	\$281
		Z2442EL	24 x 42 x 29.5-30	65	96	3.80	\$718	\$807	N/A	\$236
		Z2048EL	20 x 48 x 29.5-30	65	97	4.30	\$663	\$754	N/A	\$236
		Z2042EL	20 x 42 x 29.5-30	65	86	3.80	\$663	\$754	N/A	\$236
		<p>Return has no pedestal. Grommet in worksurface. Shipped RTA (ready to assemble). For use with right handed single pedestal desks, 20"/24" deep extended corners with narrow end panel or 20"/24" deep five-sided corners with narrow end panel.</p>								
		Z2448ER	24 x 48 x 29.5-30	65	107	4.30	\$718	\$820	N/A	\$281
		Z2442ER	24 x 42 x 29.5-30	65	96	3.80	\$718	\$807	N/A	\$236
		Z2048ER	20 x 48 x 29.5-30	65	97	4.30	\$663	\$754	N/A	\$236
		Z2042ER	20 x 42 x 29.5-30	65	86	3.80	\$663	\$754	N/A	\$236
		<p>Return has no pedestal. Grommet in worksurface. Shipped RTA (ready to assemble). For use with left handed single pedestal desks, 20"/24" deep extended corners with narrow end panel or 20"/24" deep five-sided corners with narrow end panel.</p>								
		Z1672RL	15.8 x 72 x 29.5-30	70	109.20	6	\$714	\$839	N/A	\$289
		Z1666RL	15.8 x 66 x 29.5-30	70	101.85	5.75	\$684	\$801	N/A	\$289
		Z1660RL	1w5.8 x 60 x 29.5-30	70	94.50	5.25	\$645	\$752	N/A	\$240
		Z1654RL	15.8 x 54 x 29.5-30	70	87.15	5.25	\$611	\$711	N/A	\$240
		Z1648RL	15.8 x 48 x 29.5-30	70	79.80	4.25	\$562	\$650	N/A	\$195
		Z1642RL	15.8 x 42 x 29.5-30	70	70.35	4	\$503	\$584	N/A	\$195
		Z1636RL	15.8 x 36 x 29.5-30	70	61.95	3.50	\$450	\$522	N/A	\$146
		<p>16" Throat. Return has no pedestal. Grommet in worksurface. Shipped RTA (ready to assemble). For use with extended corners, desks and islands with 16" throat.</p>								
		Z1672RR	15.8 x 72 x 29.5-30	70	109.20	6	\$714	\$839	N/A	\$289
		Z1666RR	15.8 x 66 x 29.5-30	70	101.85	5.75	\$684	\$801	N/A	\$289
		Z1660RR	15.8 x 60 x 29.5-30	70	94.50	5.25	\$645	\$752	N/A	\$240
		Z1654RR	15.8 x 54 x 29.5-30	70	87.15	5.25	\$611	\$711	N/A	\$240
		Z1648RR	15.8 x 48 x 29.5-30	70	79.80	4.25	\$562	\$650	N/A	\$195
		Z1642RR	15.8 x 42 x 29.5-30	70	70.35	4	\$503	\$584	N/A	\$195
		Z1636RR	15.8 x 36 x 29.5-30	70	61.95	3.50	\$450	\$522	N/A	\$146
		<p>16" Throat. Return has no pedestal. Grommet in worksurface. Shipped RTA (ready to assemble). For use with extended corners, desks and islands with 16" throat.</p>								

Required Specifications

- Top finish
- Top/edge detail
- Base finish
- Lock finish*

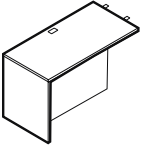
Optional Specifications

- HP laminate
- Handles*
- Key #
- Modesty Type
- Grommet position or power block cut-out

Accessories

- Power block
- Keyboard
- Pencil drawer

NON-HANDED RETURN

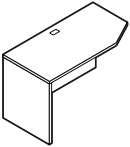


Non-Handed Return

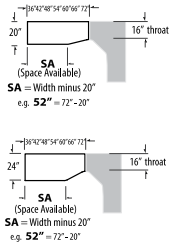
MODEL#	DIMENSIONS D x W x H	FREIGHT CLASS	WT/LBS.	CUBIC FT.	1" TOP	1.5" TOP	GLAZE ADD	HP ADD
Z2448NHR	24 x 48 x 29.5-30	70	83	4.3	\$740	\$852	N/A	\$261
Z2442NHR	24 x 42 x 29.5-30	70	75	3.8	\$642	\$761	N/A	\$232
Z2048NHR	20 x 48 x 29.5-30	70	75	4.3	\$673	\$780	N/A	\$219
Z2042NHR	20 x 42 x 29.5-30	70	67	3.8	\$617	\$693	N/A	\$194

Non-handed (reversible) return. 24" d returns accept all standard 23.4" storage shells. 20" d returns accept all standard 19.3" storage shells. Full modesty panel (laminate only). Shipped RTA (ready to assemble).

SPACE SAVER RETURNS

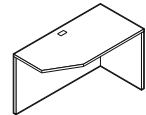


Space Saver Return - LEFT

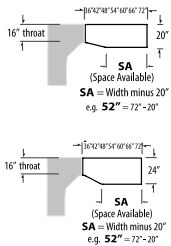


MODEL#	DIMENSIONS	FREIGHT CLASS	WT/LBS.	CUBIC FT.	1" TOP	1.5" TOP	GLAZE ADD	HP ADD
Z247216RL	24 x 72 x 29.5-30	65	135.45	6	\$849	\$1033	N/A	\$384
Z246616RL	24 x 66 x 29.5-30	70	127.05	5.75	\$812	\$981	N/A	\$384
Z246016RL	24 x 60 x 29.5-30	70	117.60	5.25	\$761	\$919	N/A	\$319
Z245416RL	24 x 54 x 29.5-30	70	108.15	5.25	\$718	\$862	N/A	\$319
Z244816RL	24 x 48 x 29.5-30	65	99.75	4.25	\$659	\$789	N/A	\$258
Z244216RL	24 x 42 x 29.5-30	70	88.20	4	\$590	\$707	N/A	\$258
Z243616RL	24 x 36 x 29.5-30	70	77.70	3.50	\$536	\$641	N/A	\$195
Z207216RL	20 x 72 x 29.5-30	70	122.85	6	\$777	\$933	N/A	\$384
Z206616RL	20 x 66 x 29.5-30	70	114.45	5.75	\$740	\$882	N/A	\$384
Z206016RL	20 x 60 x 29.5-30	70	106.05	5.25	\$696	\$827	N/A	\$319
Z205416RL	20 x 54 x 29.5-30	70	97.65	5.25	\$655	\$774	N/A	\$319
Z204816RL	20 x 48 x 29.5-30	70	90.30	4.25	\$602	\$710	N/A	\$258
Z204216RL	20 x 42 x 29.5-30	70	79.80	4	\$540	\$640	N/A	\$258
Z203616RL	20 x 36 x 29.5-30	70	70.35	3.50	\$488	\$573	N/A	\$195

16" Throat. Return has **no pedestal**. Grommet in worksurface. Shipped RTA (ready to assemble). For use with extended corners, desks and islands with 16" throat. Accepts same depth storage shells under worksurface.

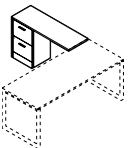


Space Saver Return - RIGHT



Z247216RR	24 x 72 x 29.5-30	65	135.45	6	\$849	\$1033	N/A	\$384
Z246616RR	24 x 66 x 29.5-30	70	127.05	5.75	\$812	\$981	N/A	\$384
Z246016RR	24 x 60 x 29.5-30	70	117.60	5.25	\$761	\$919	N/A	\$319
Z245416RR	24 x 54 x 29.5-30	70	108.15	5.25	\$718	\$862	N/A	\$319
Z244816RR	24 x 48 x 29.5-30	65	99.75	4.25	\$659	\$789	N/A	\$258
Z244216RR	24 x 42 x 29.5-30	70	88.20	4	\$590	\$707	N/A	\$258
Z243616RR	24 x 36 x 29.5-30	70	77.70	3.50	\$536	\$641	N/A	\$195
Z207216RR	20 x 72 x 29.5-30	70	122.85	6	\$777	\$933	N/A	\$384
Z206616RR	20 x 66 x 29.5-30	70	114.45	5.75	\$740	\$882	N/A	\$384
Z206016RR	20 x 60 x 29.5-30	70	106.05	5.25	\$696	\$827	N/A	\$319
Z205416RR	20 x 54 x 29.5-30	70	97.65	5.25	\$655	\$774	N/A	\$319
Z204816RR	20 x 48 x 29.5-30	70	90.30	4.25	\$602	\$710	N/A	\$258
Z204216RR	20 x 42 x 29.5-30	70	79.80	4	\$540	\$640	N/A	\$258
Z203616RR	20 x 36 x 29.5-30	70	70.35	3.50	\$488	\$573	N/A	\$195

16" Throat. Return has **no pedestal**. Grommet in worksurface. Shipped RTA (ready to assemble). For use with extended corners, desks and islands with 16" throat. Accepts same depth storage shells under worksurface.



Full to Floor Return, No Modesty - LEFT

Z2448NRL	24 x 48 x 29.5-30	150	127	24.25	\$1170	\$1276	N/A	\$261
Z2442NRL	24 x 42 x 29.5-30	150	123	21.25	\$1158	\$1250	N/A	\$229
Z2048NRL	20 x 48 x 29.5-30	150	114	20.50	\$1102	\$1191	N/A	\$219
Z2042NRL	20 x 42 x 29.5-30	125	111	18	\$1076	\$1156	N/A	\$189

Return has no modesty. File/file pedestal on **left**. Pedestal locks.

Required Specifications

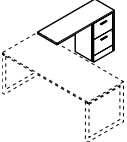
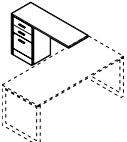
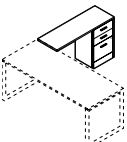
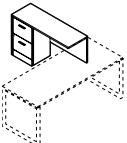
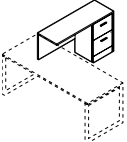
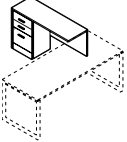
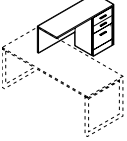
- Top finish
- Top/edge detail
- Base finish
- Lock finish

Optional Specifications

- HP laminate
- Handles*
- Key #
- Modesty Type*
- Grommet position or power block cut-out

Accessories

- Power block
- Keyboard
- Pencil drawer

RETURNS	MODEL#	DIMENSIONS	FREIGHT CLASS	WT/LBS.	CUBIC FT.	1" TOP	1.5" TOP	GLAZE ADD	HP ADD	
 <p>Full to Floor Return, No Modesty - RIGHT</p>	D x W x H									
	Z2448NRR	24 x 48 x 29.5-30	150	127	24.25	\$1170	\$1276	N/A	\$261	
	Z2442NRR	24 x 42 x 29.5-30	150	123	21.25	\$1158	\$1250	N/A	\$229	
	Z2048NRR	20 x 48 x 29.5-30	150	114	20.50	\$1102	\$1191	N/A	\$219	
	Z2042NRR	20 x 42 x 29.5-30	125	111	18	\$1076	\$1156	N/A	\$189	
Return has no modesty. File/file pedestal on right . Pedestal locks.										
 <p>Full to Floor Return, No Modesty - LEFT</p>	Z2448BNRL	24 x 48 x 29.5-30	150	130	24.25	\$1170	\$1276	N/A	\$261	
	Z2442BNRL	24 x 42 x 29.5-30	150	126	21.5	\$1158	\$1250	N/A	\$229	
	Z2048BNRL	20 x 48 x 29.5-30	150	117	20.5	\$1102	\$1191	N/A	\$219	
	Z2042BNRL	20 x 42 x 29.5-30	125	113	18	\$1076	\$1156	N/A	\$189	
Return has no modesty. Box/box/file pedestal on left . Pedestal locks.										
 <p>Full to Floor Return, No Modesty - RIGHT</p>	Z2448BNRR	24 x 48 x 29.5-30	150	130	24.25	\$1170	\$1276	N/A	\$261	
	Z2442BNRR	24 x 42 x 29.5-30	150	126	21.5	\$1158	\$1250	N/A	\$229	
	Z2048BNRR	20 x 48 x 29.5-30	150	117	20.5	\$1102	\$1191	N/A	\$219	
	Z2042BNRR	20 x 42 x 29.5-30	125	113	18	\$1076	\$1156	N/A	\$189	
Return has no modesty. Box/box/file pedestal on right . Pedestal locks.										
 <p>Full to Floor Return - LEFT</p>	Z2448SRL	24 x 48 x 29.5-30	150	135	24.25	\$1272	\$1378	N/A	\$261	
	Z2442SRL	24 x 42 x 29.5-30	125	130	21.25	\$1251	\$1343	N/A	\$229	
	Z2048SRL	20 x 48 x 29.5-30	125	123	20.5	\$1205	\$1294	N/A	\$219	
	Z2042SRL	20 x 42 x 29.5-30	125	119	18	\$1169	\$1249	N/A	\$189	
File/file pedestal on left . 12"H modesty panel. Pedestal locks.										
 <p>Full to Floor Return - RIGHT</p>	Z2448SRR	24 x 48 x 29.5-30	150	135	24.25	\$1272	\$1378	N/A	\$261	
	Z2442SRR	24 x 42 x 29.5-30	125	130	21.25	\$1251	\$1343	N/A	\$229	
	Z2048SRR	20 x 48 x 29.5-30	125	123	20.5	\$1205	\$1294	N/A	\$219	
	Z2042SRR	20 x 42 x 29.5-30	125	119	18	\$1169	\$1249	N/A	\$189	
File/file pedestal on right . 12"H modesty panel. Pedestal locks.										
 <p>Full to Floor Return - LEFT</p>	Z2448BSRL	24 x 48 x 29.5-30	150	138	24.25	\$1272	\$1378	N/A	\$261	
	Z2442BSRL	24 x 42 x 29.5-30	125	132	21.5	\$1251	\$1343	N/A	\$229	
	Z2048BSRL	20 x 48 x 29.5-30	125	125	20.5	\$1205	\$1294	N/A	\$219	
	Z2042BSRL	20 x 42 x 29.5-30	125	121	18	\$1169	\$1249	N/A	\$189	
Box/box/file pedestal on left . 12"H modesty panel. Pedestal locks.										
 <p>Full to Floor Return - RIGHT</p>	Z2448BSRR	24 x 48 x 29.5-30	150	138	24.25	\$1272	\$1378	N/A	\$261	
	Z2442BSRR	24 x 42 x 29.5-30	125	132	21.5	\$1251	\$1343	N/A	\$229	
	Z2048BSRR	20 x 48 x 29.5-30	125	125	20.5	\$1205	\$1294	N/A	\$219	
	Z2042BSRR	20 x 42 x 29.5-30	125	121	18	\$1169	\$1249	N/A	\$189	
Box/box/file pedestal on right . 12"H modesty panel. Pedestal locks.										

Required Specifications

Top finish
 Top/edge detail
 Base finish
 Handles

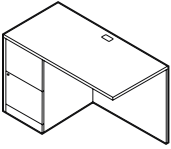
Optional Specifications

HP laminate
 Key #
 Grommet position or power block cut-out

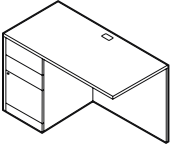
Accessories

Power block
 Keyboard
 Pencil drawer

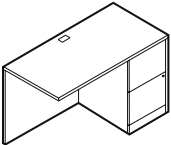
RETURNS



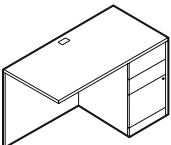
Full to Floor Flush Return - LEFT



Full to Floor Flush Return - LEFT



Full to Floor Flush Return - RIGHT



Full to Floor Flush Return - RIGHT

MODEL#	DIMENSIONS D x W x H	FREIGHT CLASS	WT./LBS.	CUBIC FT.	1" TOP	1.5" TOP	GLAZE ADD	HP ADD
Z24722L	24 x 72 x 29.5-30	150	206	35.75	\$1528	\$1621	N/A	\$384
Z24662L	24 x 66 x 29.5-30	150	195	32.75	\$1459	\$1551	N/A	\$384
Z24602L	24 x 60 x 29.5-30	125	184	30	\$1389	\$1482	N/A	\$353
Z24542L	24 x 54 x 29.5-30	150	165	29.75	\$1320	\$1413	N/A	\$353
Z24482L	24 x 48 x 29.5-30	125	156	24.25	\$1250	\$1343	N/A	\$281
Z20722L	20 x 72 x 29.5-30	150	169	30.25	\$1343	\$1436	N/A	\$384
Z20662L	20 x 66 x 29.5-30	150	162	27.75	\$1320	\$1413	N/A	\$384
Z20602L	20 x 60 x 29.5-30	125	153	25.25	\$1297	\$1389	N/A	\$319
Z20542L	20 x 54 x 29.5-30	150	136	23	\$1274	\$1366	N/A	\$319
Z20482L	20 x 48 x 29.5-30	125	129	20.5	\$1213	\$1297	N/A	\$236

Standard with file/file pedestal on **left**. Grommet in worksurface. One pencil tray. Pedestal locks.

- Does not accommodate storage shells.

Z24723L	24 x 72 x 29.5-30	125	171	24.5	\$1686	\$1841	N/A	\$384
Z24663L	24 x 66 x 29.5-30	125	171	24.5	\$1656	\$1795	N/A	\$384
Z24603L	24 x 60 x 29.5-30	125	171	24.5	\$1549	\$1682	N/A	\$353
Z24543L	24 x 54 x 29.5-30	125	171	24.5	\$1496	\$1617	N/A	\$353
Z24483L	24 x 48 x 29.5-30	125	171	24.5	\$1411	\$1519	N/A	\$281
Z20723L	20 x 72 x 29.5-30	65	97	4.3	\$1543	\$1675	N/A	\$384
Z20663L	20 x 66 x 29.5-30	65	97	4.3	\$1492	\$1619	N/A	\$384
Z20603L	20 x 60 x 29.5-30	65	97	4.3	\$1466	\$1580	N/A	\$319
Z20543L	20 x 54 x 29.5-30	65	97	4.3	\$1406	\$1514	N/A	\$319
Z20483L	20 x 48 x 29.5-30	125	154	20.75	\$1373	\$1467	N/A	\$236

Standard with box/box/file pedestal on **left**. Grommet in worksurface. One pencil tray. File drawer and lower box drawer lock.

- Does not accommodate storage shells.

Z24722R	24 x 72 x 29.5-30	150	206	35.75	\$1528	\$1621	N/A	\$384
Z24662R	24 x 66 x 29.5-30	150	195	32.75	\$1459	\$1551	N/A	\$384
Z24602R	24 x 60 x 29.5-30	125	184	30	\$1389	\$1482	N/A	\$353
Z24542R	24 x 54 x 29.5-30	150	165	29.75	\$1320	\$1413	N/A	\$353
Z24482R	24 x 48 x 29.5-30	125	156	24.25	\$1250	\$1343	N/A	\$281
Z20722R	20 x 72 x 29.5-30	150	169	30.25	\$1343	\$1436	N/A	\$384
Z20662R	20 x 66 x 29.5-30	150	162	27.75	\$1320	\$1413	N/A	\$384
Z20602R	20 x 60 x 29.5-30	125	153	25.25	\$1297	\$1389	N/A	\$319
Z20542R	20 x 54 x 29.5-30	150	136	23	\$1274	\$1366	N/A	\$319
Z20482R	20 x 48 x 29.5-30	125	129	20.5	\$1213	\$1297	N/A	\$236

Standard with file/file pedestal on **right**. Grommet in worksurface. One pencil tray. Pedestal locks.

- Does not accommodate storage shells.

Z24723R	24 x 72 x 29.5-30	125	171	24.5	\$1686	\$1841	N/A	\$384
Z24663R	24 x 66 x 29.5-30	125	171	24.5	\$1656	\$1795	N/A	\$384
Z24603R	24 x 60 x 29.5-30	125	171	24.5	\$1549	\$1682	N/A	\$353
Z24543R	24 x 54 x 29.5-30	125	171	24.5	\$1496	\$1617	N/A	\$353
Z24483R	24 x 48 x 29.5-30	125	171	24.5	\$1411	\$1519	N/A	\$281
Z20723R	20 x 72 x 29.5-30	65	97	4.3	\$1543	\$1675	N/A	\$384
Z20663R	20 x 66 x 29.5-30	65	97	4.3	\$1492	\$1619	N/A	\$384
Z20603R	20 x 60 x 29.5-30	65	97	4.3	\$1466	\$1580	N/A	\$319
Z20543R	20 x 54 x 29.5-30	65	97	4.3	\$1406	\$1514	N/A	\$319
Z20483R	20 x 48 x 29.5-30	125	154	20.75	\$1373	\$1467	N/A	\$236

Standard with box/box/file pedestal on **right**. Grommet in worksurface. One pencil tray. File drawer and lower box drawer lock.

- Does not accommodate storage shells.

Required Specifications

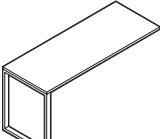
Top finish
Top/edge detail
Base finish
Handles

Optional Specifications

HP laminate
Key #
Grommet position or power block cut-out

Accessories

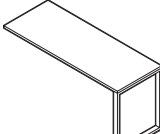
Power block
Keyboard
Pencil drawer

METAL LEG RETURNS	MODEL#	DIMENSIONS	FREIGHT CLASS	WT./LBS.	CUBIC FT.	1" TOP	1.5" TOP	GLAZE ADD	HP ADD
		D x W x H							
	Z3672MRL	36 x 72 x 29	100	116	11.25	\$1101	\$1301	N/A	\$624
	Z3072MRL	30 x 72 x 29	92.5	100	10	\$1008	\$1182	N/A	\$513
	Z3066MRL	30 x 66 x 29	70	94	9.75	\$970	\$1125	N/A	\$513
	Z3060MRL	30 x 60 x 29	70	88	9.25	\$925	\$1073	N/A	\$477
	Z2472MRL	24 x 72 x 29	70	85	8.25	\$925	\$1064	N/A	\$384
	Z2466MRL	24 x 66 x 29	70	80	8	\$890	\$1017	N/A	\$384
	Z2460MRL	24 x 60 x 29	70	75	7.75	\$853	\$974	N/A	\$353
	Z2448MRL	24 x 48 x 29	70	56	5.75	\$736	\$830	N/A	\$281

Return w/Metal Legs - LEFT*

Flush return attached to the edge of work surface. Attaching hardware included. Leg shipped in separate carton. Shipped RTA (ready to assemble). **Not freestanding.** Metal leg available in Black (BLK) or Tungsten (TUN).


- Please note, glides need to be extended a small amount to accommodate the 29.5" height of standard Zira pieces.

	Z3672MRR	36 x 72 x 29	100	116	11.25	\$1101	\$1301	N/A	\$624
	Z3072MRR	30 x 72 x 29	92.5	100	10	\$1008	\$1182	N/A	\$513
	Z3066MRR	30 x 66 x 29	70	94	9.75	\$970	\$1125	N/A	\$513
	Z3060MRR	30 x 60 x 29	70	88	9.25	\$925	\$1073	N/A	\$477
	Z2472MRR	24 x 72 x 29	70	85	8.25	\$925	\$1064	N/A	\$384
	Z2466MRR	24 x 66 x 29	70	80	8	\$890	\$1017	N/A	\$384
	Z2460MRR	24 x 60 x 29	70	75	7.75	\$853	\$974	N/A	\$353
	Z2448MRR	24 x 48 x 29	70	56	5.75	\$736	\$830	N/A	\$281

Return w/Metal Legs - RIGHT*

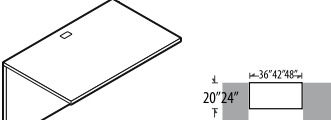
Flush return attached to the edge of work surface. Attaching hardware included. Leg shipped in separate carton. Shipped RTA (ready to assemble). **Not freestanding.** Metal leg available in Black (BLK) or Tungsten (TUN).

- Please note, glides need to be extended a small amount to accommodate the 29.5" height of standard Zira pieces.

	Z72LMP	.69 x 66 x 18.1	70	28	1.25	\$291	N/A	N/A	N/A
	Z66LMP	.69 x 60 x 18.1	65	26	1	\$278	N/A	N/A	N/A
	Z60LMP	.69 x 54 x 18.1	65	23	1	\$259	N/A	N/A	N/A
	Z48LMP	.69 x 42 x 18.1	65	19	.75	\$219	N/A	N/A	N/A

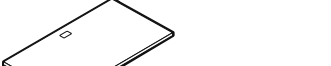
Melamine Modesty Panel

For returns with metal legs. Modular laminate modesty panel. Specify model # corresponding to work surface length.

BRIDGES	MODEL#	DIMENSIONS	FREIGHT CLASS	WT./LBS.	CUBIC FT.	1" TOP	1.5" TOP	GLAZE ADD	HP ADD
	Z2448FB	24 x 48 x 29.5-30	70	91	4.30	\$627	\$729	N/A	\$258
	Z2442FB	24 x 42 x 29.5-30	70	79	3.80	\$580	\$669	N/A	\$258
	Z2436FB	24 x 36 x 29.5-30	70	69	3.30	\$580	\$669	N/A	\$195
	Z2048FB	20 x 48 x 29.5-30	70	83	4.30	\$609	\$698	N/A	\$258
	Z2042FB	20 x 42 x 29.5-30	70	72	3.80	\$564	\$653	N/A	\$258
	Z2036FB	20 x 36 x 29.5-30	70	63	3.30	\$564	\$653	N/A	\$195

Flush Bridge*

Top surface, back panel and hardware to create a "U" shape by connecting two units with full end panels. Grommet in work surface. Shipped RTA (ready to assemble).

	Z1648B	15.8 x 48 x 29.5-30	70	66.15	4.25	\$476	\$564	N/A	\$195
	Z1642B	15.8 x 42 x 29.5-30	70	59.85	3.75	\$416	\$497	N/A	\$195

Flush Bridge

16" Throat. Top surface, back panel and hardware to create a "U" shape by connecting two units with a 16" throat and full end panels. Grommet in work surface. Shipped RTA (ready to assemble).

Required Specifications

- Top finish
- Top/edge detail
- Base finish
- Leg finish* (BLK or TUN)
- Lock finish

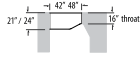
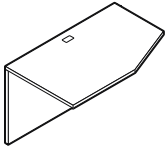
Optional Specifications

- HP laminate
- Handles
- Key #
- Modesty type
- Grommet position or power block cut-out

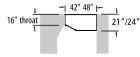
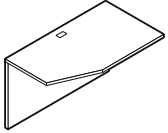
Accessories

- Power block
- Pencil drawer

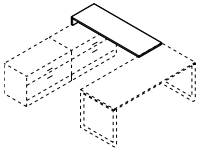
SPACE SAVER BRIDGES



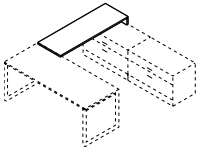
Space Saver Bridge - LEFT



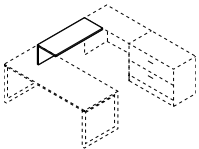
Space Saver Bridge - RIGHT



Overlapping Bridge - LEFT*



Overlapping Bridge - RIGHT*



Flush Bridge

MODEL# DIMENSIONS FREIGHT CLASS WT/LBS. CUBIC FT. 1" TOP 1.5" TOP GLAZE ADD HP ADD

D x W x H

Z244816BL	24 x 48 x 29.5-30	70	82	4.25	\$556	\$686	N/A	\$258
Z244216BL	24 x 42 x 29.5-30	70	71	3.75	\$489	\$606	N/A	\$258
Z214816BL	21 x 48 x 29.5-30	70	76	4.25	\$516	\$624	N/A	\$258
Z214216BL	21 x 42 x 29.5-30	70	65	3.75	\$447	\$547	N/A	\$258

16" Throat. Top surface, back panel and hardware to connect extended corners, desks and islands with a 16" throat. Grommet in worksurface. Shipped RTA (ready to assemble).

Z244816BR	24 x 48 x 29.5-30	70	82	4.25	\$556	\$686	N/A	\$258
Z244216BR	24 x 42 x 29.5-30	70	71	3.75	\$489	\$606	N/A	\$258
Z214816BR	21 x 48 x 29.5-30	70	76	4.25	\$516	\$624	N/A	\$258
Z214216BR	21 x 42 x 29.5-30	70	65	3.75	\$447	\$547	N/A	\$258

16" Throat. Top surface, back panel and hardware to connect extended corners, desks and islands with a 16" throat. Grommet in worksurface. Shipped RTA (ready to assemble).

Z2468TRL	24 x 68 x 5.9	85	64	5.25	\$590	\$745	N/A	\$370
Z2462TRL	24 x 62 x 5.9	85	59	4.70	\$550	\$690	N/A	\$336
Z2472TRL	24 x 72 x 5.9	85	64	5.25	\$600	\$755	N/A	\$390
Z2466TRL	24 x 66 x 5.9	85	62	4.70	\$564	\$706	N/A	\$358

For 20"/24"D, 23.75"/24.25"H Storage with No Modesty. Overlaps storage on **left**.

- Use Z2462TRR and Z2468TRR for 20"D storage.
- Use Z2466TRR and Z2472TRR for 24"D storage.

Z2468TRR	24 x 68 x 5.9	85	64	5.25	\$590	\$745	N/A	\$370
Z2462TRR	24 x 62 x 5.9	85	59	4.70	\$550	\$690	N/A	\$336
Z2472TRR	24 x 72 x 5.9	85	64	5.25	\$600	\$755	N/A	\$390
Z2466TRR	24 x 66 x 5.9	85	62	4.70	\$564	\$706	N/A	\$358

For 20"/24"D, 23.75"/24.25"H Storage with No Modesty. Overlaps storage on **right**.

- Use Z2462TRR and Z2468TRR for 20"D storage.
- Use Z2466TRR and Z2472TRR for 24"D storage.

Z24483BR	24 x 48 x 13-13.5	70	55	3.50	\$627	\$729	N/A	\$258
Z24423BR	24 x 42 x 13-13.5	70	48	3.10	\$580	\$705	N/A	\$229
Z24363BR	24 x 36 x 13-13.5	70	43	2.70	\$580	\$688	N/A	\$197
Z20483BR	20 x 48 x 13-13.5	70	48	3	\$609	\$728	N/A	\$219
Z20423BR	20 x 42 x 13-13.5	70	43	2.70	\$564	\$670	N/A	\$189
Z20363BR	20 x 36 x 13-13.5	70	38	2.40	\$564	\$656	N/A	\$164

12"H modesty panel.

Required Specifications

Top finish
Top/edge detail
Base finish

Optional Specifications

HP laminate
Grommet position or power block cut-out

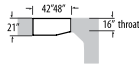
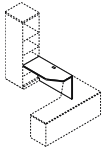
Accessories

Power block
Pencil drawer*

TRANSITIONAL BRIDGES

MODEL#	DIMENSIONS	FREIGHT CLASS	WT/LBS.	CUBIC FT.	1" TOP	1.5" TOP	GLAZE ADD	HP ADD
--------	------------	---------------	---------	-----------	--------	----------	-----------	--------

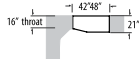
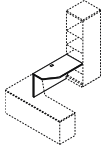
D x W x H



Transitional Bridge - LEFT

For 21" Wide Storage Module. Top surface, back panel, shorter kickplate and hardware to connect 21" wide storage module with 16" throat. Grommet in worksurface. Shipped RTA (ready to assemble).

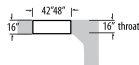
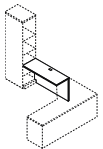
Z2148TRBL	21 x 48 x 29.5-30	70	75.83	4.25	\$537	\$645	N/A	\$258
Z2142TRBL	21 x 42 x 29.5-30	70	64.78	3.75	\$469	\$569	N/A	\$258



Transitional Bridge - RIGHT

For 21" Wide Storage Module. Top surface, back panel, shorter kickplate and hardware to connect 21" wide storage module with 16" throat. Grommet in worksurface. Shipped RTA (ready to assemble).

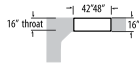
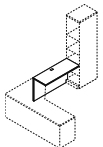
Z2148TRBR	21 x 48 x 29.5-30	70	75.83	4.25	\$537	\$645	N/A	\$258
Z2142TRBR	21 x 42 x 29.5-30	70	64.78	3.75	\$469	\$569	N/A	\$258



Transitional Bridge - LEFT

For 16" Wide Storage Module. Top surface, back panel and hardware to connect 16" wide storage module with 16" throat. Grommet in worksurface. Shipped RTA (ready to assemble).

Z1648TRBL	16 x 48 x 29.5-30	70	68.58	4.25	\$496	\$584	N/A	\$195
Z1642TRBL	16 x 42 x 29.5-30	70	58.96	3.75	\$438	\$521	N/A	\$195



Transitional Bridge - RIGHT

For 16" Wide Storage Module. Top surface, back panel and hardware to connect 16" wide storage module with 16" throat. Grommet in worksurface. Shipped RTA (ready to assemble).

Z1648TRBR	16 x 48 x 29.5-30	70	68.58	4.25	\$496	\$584	N/A	\$195
Z1642TRBR	16 x 42 x 29.5-30	70	58.96	3.75	\$438	\$521	N/A	\$195

Required Specifications

Top finish
Top/edge detail
Base finish

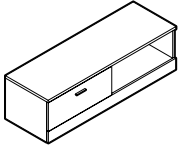
Optional Specifications

HP laminate
Grommet position or power block cut-out

Accessories

Power block
Pencil drawer*

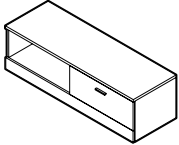
18"H CREDENZAS



Lateral File Credenza - LEFT

MODEL#	DIMENSIONS D x W x H	FREIGHT CLASS	WT/LBS.	CUBIC FT.	1"TOP	1.5" TOP	GLAZE ADD	HP ADD
Z2472LOFL	24 x 72 x 17.87-18.37	125	181	22.75	\$1626	\$1759	N/A	\$390
Z2460LOFL	24 x 60 x 17.87-18.37	100	160	19.25	\$1444	\$1555	N/A	\$327
Z2072LOFL	20 x 72 x 17.87-18.37	100	164	19.25	\$1515	\$1626	N/A	\$327
Z2060LOFL	20 x 60 x 17.87-18.37	100	143	16.25	\$1335	\$1427	N/A	\$273

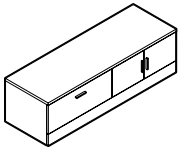
1 high lateral file on the **left**, open storage on the **right**.



Lateral File Credenza - RIGHT

Z2472LOFR	24 x 72 x 17.87-18.37	125	181	22.75	\$1626	\$1759	N/A	\$390
Z2460LOFR	24 x 60 x 17.87-18.37	100	160	19.25	\$1444	\$1555	N/A	\$327
Z2072LOFR	20 x 72 x 17.87-18.37	100	164	19.25	\$1515	\$1626	N/A	\$327
Z2060LOFR	20 x 60 x 17.87-18.37	100	143	16.25	\$1335	\$1427	N/A	\$273

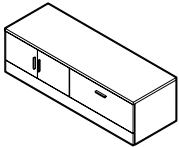
1 high lateral file on the **right**, open storage on the **left**.



Lateral File Credenza - LEFT*

Z2472LSFL	24 x 72 x 17.87-18.37	100	197	22.75	\$1895	\$2028	\$403	\$390
Z2460LSFL	24 x 60 x 17.87-18.37	100	174	19.25	\$1708	\$1819	\$359	\$327
Z2072LSFL	20 x 72 x 17.87-18.37	100	178	19.25	\$1774	\$1885	\$403	\$327
Z2060LSFL	20 x 60 x 17.87-18.37	100	155	16.25	\$1592	\$1684	\$359	\$273

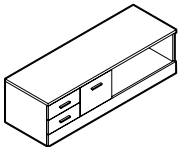
1 high lateral file on the **left**, closed storage on the **right**.



Lateral File Credenza - RIGHT*

Z2472LSFR	24 x 72 x 17.87-18.37	100	197	22.75	\$1895	\$2028	\$403	\$390
Z2460LSFR	24 x 60 x 17.87-18.37	100	174	19.25	\$1708	\$1819	\$359	\$327
Z2072LSFR	20 x 72 x 17.87-18.37	100	178	19.25	\$1774	\$1885	\$403	\$327
Z2060LSFR	20 x 60 x 17.87-18.37	100	155	16.25	\$1592	\$1684	\$359	\$273

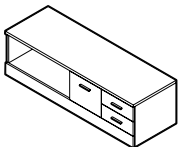
1 high lateral file on the **right**, closed storage on the **left**.



Mixed Storage Credenza - LEFT

Z2472LMOL	24 x 72 x 17.87-18.37	100	197	22.75	\$1873	\$2006	N/A	\$390
Z2460LMOL	24 x 60 x 17.87-18.37	100	176	19.25	\$1709	\$1820	N/A	\$327
Z2072LMOL	20 x 72 x 17.87-18.37	100	178	19.25	\$1754	\$1865	N/A	\$327
Z2060LMOL	20 x 60 x 17.87-18.37	100	157	16.25	\$1595	\$1688	N/A	\$273

1 high mixed drawers on the **left**, open storage on the **right**.



Mixed Storage Credenza - RIGHT

Z2472LMOR	24 x 72 x 17.87-18.37	100	197	22.75	\$1873	\$2006	N/A	\$390
Z2460LMOR	24 x 60 x 17.87-18.37	100	176	19.25	\$1709	\$1819	N/A	\$327
Z2072LMOR	20 x 72 x 17.87-18.37	100	178	19.25	\$1754	\$1865	N/A	\$327
Z2060LMOR	20 x 60 x 17.87-18.37	100	157	16.25	\$1595	\$1688	N/A	\$273

1 high mixed drawers on the **right**, open storage on the **left**.

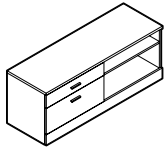
Required Specifications

Top finish
Top/edge detail
Base finish
Handles

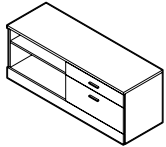
Optional Specifications

HP laminate
Key #
Glazed doors*
Box drawer - no upcharge

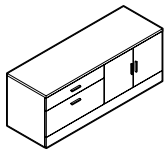
24"H CRENZAS



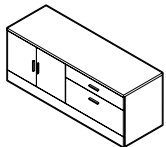
Lateral File Credenza - LEFT



Lateral File Credenza - RIGHT



Lateral File Credenza - LEFT



Lateral File Credenza - RIGHT

MODEL#	DIMENSIONS D x W x H	FREIGHT CLASS	WT/LBS.	CUBIC FT.	1" TOP	1.5" TOP	GLAZE ADD	HP ADD
Z2472HBFL	24 x 72 x 23.75-24.25	125	229	29.25	\$2037	\$2170	N/A	\$390
Z2460HBFL	24 x 60 x 23.75-24.25	100	201	24.50	\$1805	\$1916	N/A	\$327
Z2072HBFL	20 x 72 x 23.75-24.25	100	207	24.75	\$1919	\$2030	N/A	\$327
Z2060HBFL	20 x 60 x 23.75-24.25	100	180	20.75	\$1691	\$1784	N/A	\$273

1.5 high box/lateral file on the **left**, open storage on the **right**.

Z2472HBFR	24 x 72 x 23.75-24.25	125	229	29.25	\$2037	\$2170	N/A	\$390
Z2460HBFR	24 x 60 x 23.75-24.25	100	201	24.50	\$1805	\$1916	N/A	\$327
Z2072HBFR	20 x 72 x 23.75-24.25	100	207	24.75	\$1919	\$2030	N/A	\$327
Z2060HBFR	20 x 60 x 23.75-24.25	100	180	20.75	\$1691	\$1784	N/A	\$273

1.5 high box/lateral file on the **right**, open storage on the **left**.

Z2472HFSL	24 x 72 x 23.75-24.25	100	251	29.25	\$2384	\$2517	\$553	\$390
Z2460HFSL	24 x 60 x 23.75-24.25	100	221	24.50	\$2126	\$2237	\$479	\$327
Z2072HFSL	20 x 72 x 23.75-24.25	100	227	24.75	\$2239	\$2350	\$553	\$327
Z2060HFSL	20 x 60 x 23.75-24.25	100	198	20.75	\$2001	\$2094	\$479	\$273

1.5 high box/lateral file on the **left**, closed storage on the **right**.

Z2472HFSS	24 x 72 x 23.75-24.25	100	251	29.25	\$2384	\$2517	\$553	\$390
Z2460HFSS	24 x 60 x 23.75-24.25	100	221	24.50	\$2126	\$2237	\$479	\$327
Z2072HFSS	20 x 72 x 23.75-24.25	100	227	24.75	\$2239	\$2350	\$553	\$327
Z2060HFSS	20 x 60 x 23.75-24.25	100	198	20.75	\$2001	\$2094	\$479	\$273

1.5 high box/lateral file on the **right**, closed storage on the **left**.

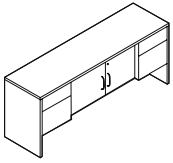
Required Specifications

Top finish
Top/edge detail
Base finish
Handles

Optional Specifications

HP laminate
Key #
Glazed doors*
Box drawer - no upcharge

CREDENZAS

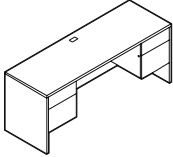


Glazed door option

Center Storage Credenza**

MODEL#	DIMENSIONS D x W x H	FREIGHT CLASS	WT/LBS.	CUBIC FT.	1" TOP	1.5" TOP	GLAZE ADD	HP ADD
Z2072C	20 x 72 x 29.5-30	100	286	30	\$2059	\$2564	\$677	\$384

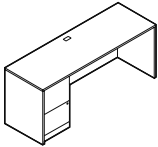
Standard with box/file pedestals on both sides and self-closing hinged center doors covering one adjustable shelf. Pedestals and doors lock, keyed alike. Two pencil trays.



Kneespace Credenza*

Z2472CK	24 x 72 x 29.5-30	125	262	35.50	\$1671	\$1954	N/A	\$384
Z2466CK	24 x 66 x 29.5-30	125	250	33	\$1671	\$1893	N/A	\$384
Z2072CK	20 x 72 x 29.5-30	125	235	30	\$1596	\$1758	N/A	\$384
Z2066CK	20 x 66 x 29.5-30	100	225	27.75	\$1596	\$1723	N/A	\$384
Z2060CK	20 x 60 x 29.5-30	100	219	25.25	\$1535	\$1637	N/A	\$319

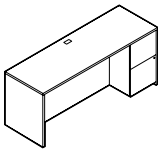
Standard with box/file pedestals on both sides. Center is open. Pedestals lock, keyed alike. Two pencil trays. Grommet in worksurface.



Full to Floor Single Pedestal Credenza- LEFT*

Z2472CS2L	24 x 72 x 29.5-30	100	228	25.75	\$1571	\$1731	N/A	\$384
Z2466CS2L	24 x 66 x 29.5-30	125	217	32.75	\$1542	\$1690	N/A	\$384
Z2072CS2L	20 x 72 x 29-29.5	125	203	30.25	\$1440	\$1573	N/A	\$384
Z2066CS2L	20 x 66 x 29-29.5	125	193	27.75	\$1386	\$1506	N/A	\$384

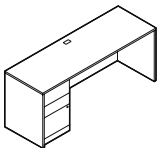
Standard with full to floor file/file pedestal on the **left**. Pedestal locks. Grommet in worksurface.



Full to Floor Single Pedestal Credenza- RIGHT*

Z2472CS2R	24 x 72 x 29.5-30	100	228	25.75	\$1571	\$1731	N/A	\$384
Z2466CS2R	24 x 66 x 29.5-30	125	217	32.75	\$1542	\$1690	N/A	\$384
Z2072CS2R	20 x 72 x 29.5-30	125	203	30.25	\$1440	\$1573	N/A	\$384
Z2066CS2R	20 x 66 x 29.5-30	125	193	27.75	\$1386	\$1506	N/A	\$384

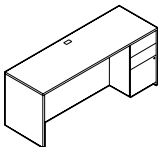
Standard with full to floor file/file pedestal on the **right**. Pedestal locks. Grommet in worksurface.



Full to Floor Single Pedestal Credenza- LEFT*

Z2472CS4L	24 x 72 x 29-29.5	125	228	35.75	\$1635	\$1795	N/A	\$384
Z2466CS4L	24 x 66 x 29-29.5	125	217	32.75	\$1609	\$1757	N/A	\$384
Z2072CS4L	20 x 72 x 29-29.5	125	203	30.25	\$1492	\$1622	N/A	\$384
Z2066CS4L	20 x 66 x 29-29.5	125	193	25.75	\$1440	\$1567	N/A	\$384

Standard with full to floor box/box/file pedestal on the **left**. File drawer and lower box drawer lock. One pencil tray. Grommet in worksurface.



Full to Floor Single Pedestal Credenza- RIGHT*

Z2472CS4R	24 x 72 x 29-29.5	125	228	35.75	\$1635	\$1795	N/A	\$384
Z2466CS4R	24 x 66 x 29-29.5	125	217	32.75	\$1609	\$1757	N/A	\$384
Z2072CS4R	20 x 72 x 29-29.5	125	203	30.25	\$1492	\$1624	N/A	\$384
Z2066CS4R	20 x 66 x 29-29.5	125	193	25.75	\$1440	\$1567	N/A	\$384

Standard with full to floor box/box/file pedestal on the **right**. File drawer and lower box drawer lock. One pencil tray. Grommet in worksurface.

Required Specifications

- Top finish
- Top/edge detail
- Base finish
- Lock finish*

Optional Specifications

- HP laminate
- Key #*
- Modesty type (only Z2xxxxCK)
- Grommet position or power block cut-out
- Handles*
- Glazed door**

Accessories

- Keyboard**
- Power block (not Z2072C)
- Pencil drawer (Z2472S2L/R only)

CREDENZAS	MODEL#	DIMENSIONS	FREIGHT CLASS	WT/LBS.	CUBIC FT.	1" TOP	1.5" TOP	GLAZE ADD	HP ADD	
  <p>Glazed door option</p> <p>Storage Cabinet Credenza**</p>		D x W x H								
	Z2472SCSC	24 x 72 x 29.5-30	100	345	35.75	\$2254	\$2410	\$1516	\$384	
	Z2072SCSC	20 x 72 x 29.5-30	92.5	315	30.25	\$1981	\$2148	\$1516	\$384	
Two storage cabinets side-by-side. Hinged doors cover one adjustable shelf. Locking doors keyed alike.										
 <p>Lateral File Credenza**</p>										
	Z2472LF2	24 x 72 x 29.5-30	100	345	35.75	\$2600	\$2966	N/A	\$384	
	Z2072LF2	20 x 72 x 29.5-30	92.5	315	30.25	\$2547	\$2963	N/A	\$384	
Two 2-drawer lateral files side-by-side. Locking drawers, keyed alike. File bars included for side-to-side and front-to-back letter and legal filing capability. Anti-lock tilt suspension										
  <p>Glazed door option</p> <p>Lateral File/Storage Cabinet Credenza**</p>										
	Z2472LS	24 x 72 x 29.5-30	100	321	35.75	\$2326	\$2679	\$760	\$384	
	Z2072LS	20 x 72 x 29.5-30	100	286	30.25	\$2273	\$2677	\$760	\$384	
One 2-drawer lateral file and one storage cabinet. Locking door/drawers, keyed alike. Storage cabinet includes one adjustable shelf. File bars included for side-to-side and front-to-back letter and legal filing capability. Anti-lock tilt suspension. <ul style="list-style-type: none"> File drawer construction is for accommodating hanging files NOT for stacking materials on the drawer bottom. 										
  <p>Glazed door option</p> <p>Buffet Credenza**</p>										
	Z482036BD	20 x 48 x 36	125	163	22.50	\$2209	\$2338	\$953	\$415	
Buffet credenza with one locking storage compartment with two doors. Hinged doors cover one three-position height adjustable shelf. Two 6" drawers above storage compartment are non-locking.										
   <p>Glazed door option</p> <p>Buffet Credenza*</p>										
	Z722036BD	20 x 72 x 36	125	242	33.50	\$3203	\$3360	\$1902	\$668	
	Z602036BD	20 x 60 x 36	125	188	28	\$2777	\$2919	\$1747	\$542	
Buffet credenza with two locking storage compartments side by side. Hinged doors cover 1 three-position height adjustable shelf. Two 6" drawers above storage compartment are non-locking.										
 <p>Kneespace Lateral File Credenza - LEFT</p>										
	Z2472LKL	24 x 72 x 29.5-30	125	262	35.75	\$2045	\$2359	N/A	\$384	
	Z2072LKL	20 x 72 x 29.5-30	125	235	30.25	\$1993	\$2360	N/A	\$384	
One 2-drawer lateral file on the left . Locking drawers. File bars included for side-to-side and front-to-back letter/legal filing capability. Anti-lock tilt suspension. Grommet in worksurface. <ul style="list-style-type: none"> File drawer construction is for accommodating hanging files NOT for stacking materials on the drawer bottom. 										

Required Specifications

Top finish
 Top/edge detail
 Base finish
 Lock finish*

Optional Specifications

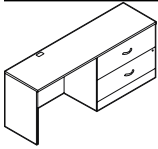
HP laminate
 Key #*
 Modesty type (only Z2xxxxCK)
 Grommet position or power block cut-out

Handles*
 Glazed door**

Accessories

Keyboard**
 Power block (not Z2072C)
 Pencil drawer (Z2472S2L/R only)

CREDENZAS

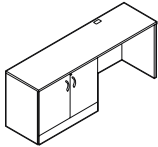


Kneespace Lateral File Credenza - RIGHT

MODEL#	DIMENSIONS D x W x H	FREIGHT CLASS	WT./LBS.	CUBIC FT.	1" TOP	1.5" TOP	GLAZE ADD	HP ADD
Z2472LKR	24 x 72 x 29.5-30	125	262	35.75	\$2045	\$2359	N/A	\$384
Z2072LKR	20 x 72 x 29.5-30	125	235	30.25	\$1993	\$2360	N/A	\$384

One 2-drawer lateral file on the **right**. Locking drawers. File bars included for side-to-side and front-to-back letter/legal filing capability. Anti-lock tilt suspension. Grommet in worksurface.

- File drawer construction is for accommodating hanging files *NOT* for stacking materials on the drawer bottom.



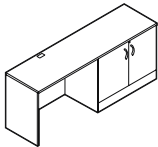
Kneespace Storage Cabinet Credenza- LEFT**



Glazed door option

Z2472SKL	24 x 72 x 29.5-30	125	241	35.75	\$1612	\$1939	\$760	\$384
Z2072SKL	20 x 72 x 29.5-30	125	207	30.25	\$1559	\$1936	\$760	\$384

One storage cabinet on the **left**. Locking doors. Storage cabinet has one adjustable shelf. Grommet in worksurface.



Kneespace Storage Cabinet Credenza- RIGHT**



Glazed door option

Z2472SKR	24 x 72 x 29.5-30	125	241	35.75	\$1612	\$1939	\$760	\$384
Z2072SKR	20 x 72 x 29.5-30	125	207	30.25	\$1559	\$1936	\$760	\$384

One storage cabinet on the **right**. Locking doors. Storage cabinet has one adjustable shelf. Grommet in worksurface.

Required Specifications

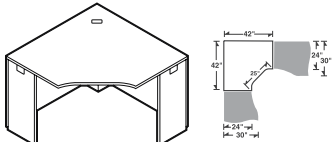
Top finish Base finish
Top/edge detail
Handles*
Lock finish*

Optional Specifications

HP laminate Handles
Key # Glazed door*
Grommet position or power block cut-out

Accessories

Power block

5-SIDED CORNERS	MODEL#	DIMENSIONS D x W x H	FREIGHT CLASS	WT/LBS.	CUBIC FT.	1" TOP	1.5" TOP	GLAZE ADD	HP ADD
 <p>5-Sided Corner, 24" Throat</p>	Z42245C	42 x 42 x 29.5-30	65	133	5.75	\$978	\$1187	N/A	\$513
<p>Connects to 30" D space saver connectable surfaces, 24" D connectables, returns and bridge. Grommet in worksurface. Narrow end panels on left and right. Shipped RTA (ready to assemble). <i>Not freestanding.</i></p> <ul style="list-style-type: none"> • Modesty Panel is 1" off of ground. • Full End Panel(s) are available - add 15% upcharge 									
 <p>5-Sided Corner, 20" Throat</p>	Z42205C	42 x 42 x 29.5-30	70	129	5.75	\$978	\$1187	N/A	\$513
<p>Connects to 24" D space saver connectable surfaces, 20" D returns, lateral files, storage/lateral file credenzas, credenzas, and bridges. Grommet in worksurface. Narrow end panels on left and right. Shipped RTA (ready to assemble). <i>Not freestanding.</i></p> <ul style="list-style-type: none"> • Modesty Panel is 1" off of ground. • Full End Panel(s) are available - add 15% upcharge 									
 <p>5-Sided Corner, 16" Throat</p>	Z42165C	42 x 42 x 29.5-30	70	124	5.75	\$1007	\$1159	N/A	\$510
<p>Connects to 20" D space saver connectable surfaces, 16" D returns, lateral files, storage/lateral file credenzas, credenzas, and bridges. Grommet in worksurface. Narrow end panels on left and right. Shipped RTA (ready to assemble). <i>Not freestanding.</i></p> <ul style="list-style-type: none"> • Modesty Panel is 1" off of ground. • Full End Panel(s) are available - add 15% upcharge 									
 <p>5-Sided Corner, 20" Throat</p>	Z36205C	36 x 36 x 29.5-30	65	109	4.80	\$827	\$947	N/A	\$332
<p>Connects to 24" D space saver connectable surfaces, 20" D returns, lateral files, storage/lateral file credenzas, credenzas, and bridges. Grommet in worksurface. Narrow end panels on left and right. Shipped RTA (ready to assemble). <i>Not freestanding.</i></p> <ul style="list-style-type: none"> • Modesty Panel is 1" off of ground. • Full End Panel(s) are available - add 15% upcharge 									
 <p>5-Sided Corner, 16" Throat</p>	Z36165C	36 x 36 x 29.5-30	70	105	4.80	\$881	\$999	N/A	\$289
<p>Connects to 20" D space saver connectable surfaces, 16" D returns, lateral files, storage/lateral file credenzas, credenzas, and bridges. Grommet in worksurface. Narrow end panels on left and right. Shipped RTA (ready to assemble). <i>Not freestanding.</i></p> <ul style="list-style-type: none"> • Modesty Panel is 1" off of ground. • Full End Panel(s) are available - add 15% upcharge 									

Required Specifications

Top finish
Top/edge detail
Base finish

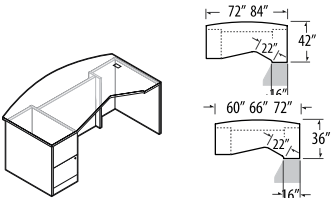
Optional Specifications

HP laminate
Grommet position or power block cut-out

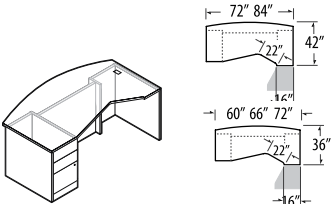
Accessories

Power block
Keyboard (*Not available on Z36165C*)

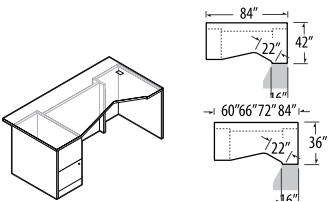
LEFT EXTENDED CORNER DESKS



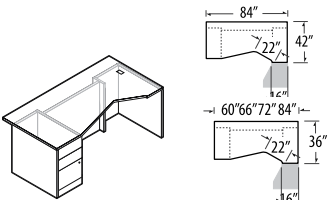
Single Pedestal Bow Top
Extended Corner Desk - LEFT*



Single Pedestal Bow Top
Extended Corner Desk - LEFT*



Single Pedestal Extended
Corner Desk - LEFT*



Single Pedestal Extended
Corner Desk - LEFT

MODEL# DIMENSIONS FREIGHT CLASS WT/LBS. CUBIC FT. 1" TOP 1.5" TOP GLAZE ADD HP ADD

	D x W x H								
Z4284EB2L	42 x 84 x 29.5-30	70	316.05	20.50	\$2086	\$2376	\$916	\$1015	
Z4272EB2L	42 x 72 x 29.5-30	150	331	59	\$2059	\$2309	\$760	\$762	
Z3672EB2L	36 x 72 x 29.5-30	150	273	50.75	\$1874	\$2093	\$760	\$573	
Z3666EB2L	36 x 66 x 29.5-30	150	260.40	46.75	\$1844	\$2045	\$678	\$573	
Z3660EB2L	36 x 60 x 29.5-30	125	257.25	42.50	\$1792	\$1975	\$600	\$477	

Extended worksurface on right. Standard with **Freestanding** full to floor file/file pedestal on **left** and faux pedestal on **right**. Pedestal locks. Connects to returns or bridges with a 16" throat. Corner has one grommet. Bow top overhangs 2¼" at ends and 6" on center.

- 84" wide desks are shipped RTA (ready to assemble) in 2 cartons.
- Hutches may not be placed on this desk.

Z4284EB3L	42 x 84 x 29.5-30	70	315	20.50	\$2106	\$2395	\$916	\$1015	
Z4272EB3L	42 x 72 x 29.5-30	150	329	59	\$2083	\$2333	\$760	\$762	
Z3672EB3L	36 x 72 x 29.5-30	150	270.90	50.75	\$1910	\$2129	\$760	\$573	
Z3666EB3L	36 x 66 x 29.5-30	150	259.35	46.75	\$1856	\$2057	\$678	\$573	
Z3660EB3L	36 x 60 x 29.5-30	125	255.15	42.50	\$1825	\$2008	\$600	\$477	

Extended worksurface on right. Standard with **Freestanding** full to floor box/box/file pedestal on **left** and faux pedestal on **right**. File drawer and lower box drawer lock. Connects to returns or bridges with a 16" throat. Corner has one grommet. Bow top overhangs 2¼" at ends and 6" on center.

- 84" wide desks are shipped RTA (ready to assemble) in 2 cartons.
- Hutches may not be placed on this desk.

Z4284E2L	42 x 84 x 29.5-30	70	321.30	20.50	\$2171	\$2447	\$916	\$1015	
Z3684E2L	36 x 84 x 29.5-30	250	311.85	118	\$2082	\$2358	\$916	\$762	
Z3672E2L	36 x 72 x 29.5-30	150	278.25	50.75	\$1867	\$2074	\$760	\$573	
Z3666E2L	36 x 66 x 29.5-30	150	265.65	46.75	\$1817	\$2006	\$678	\$573	
Z3660E2L	36 x 60 x 29.5-30	125	259.35	42.50	\$1786	\$1958	\$600	\$477	

Extended worksurface on right. Standard with **Freestanding** full to floor file/file pedestal on **left** and faux pedestal on **right**. Pedestal locks. Connects to returns or bridges with a 16" throat. Corner has one grommet. Top overhangs 2¼"

- 84" wide desks are shipped RTA (ready to assemble) in 2 cartons.
- Hutches may not be placed on this desk.

Z4284E3L	42 x 84 x 29.5-30	70	318.15	20.50	\$2098	\$2374	\$916	\$1015	
Z3684E3L	36 x 84 x 29.5-30	250	309.75	118	\$2115	\$2390	\$916	\$762	
Z3672E3L	36 x 72 x 29.5-30	150	275.10	50.75	\$1905	\$2112	\$760	\$573	
Z3666E3L	36 x 66 x 29.5-30	150	263.55	46.75	\$1853	\$2042	\$678	\$573	
Z3660E3L	36 x 60 x 29.5-30	125	257.25	42.50	\$1821	\$1991	\$600	\$477	

Extended worksurface on right. Standard with **Freestanding** full to floor box/box/file pedestal on **left** and faux pedestal on **right**. File drawer and lower box drawer lock. Connects to returns or bridges with a 16" throat. Corner has one grommet. Top overhangs 2¼".

- 84" wide desks are shipped RTA (ready to assemble) in 2 cartons.
- Hutches may not be placed on this desk.

Required Specifications

Top finish
Top/edge detail
Lock finish
Base finish

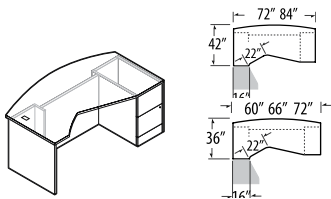
Optional Specifications

HP laminate Handles
Key # Modesty panel type
Grommet position or power block cut-out

Accessories

Power block
Keyboard
Pencil drawer

RIGHT EXTENDED CORNER DESKS

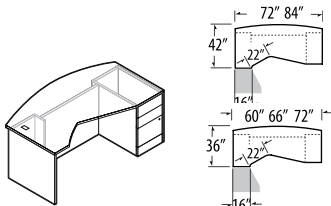


**Single Pedestal Bow Top
Extended Corner Desk - RIGHT**

MODEL#	DIMENSIONS	FREIGHT CLASS	WT/LBS.	CUBIC FT.	1" TOP	1.5" TOP	GLAZE ADD	HP ADD	
D x W x H									
Z4284EB2R	42 x 84 x 29.5-30	70	316.05	20.50	\$2086	\$2376	\$916	\$1015	
Z4272EB2R	42 x 72 x 29.5-30	150	331	59	\$2059	\$2309	\$760	\$762	
Z3672EB2R	36 x 72 x 29.5-30	150	273	50.75	\$1874	\$2093	\$760	\$573	
Z3666EB2R	36 x 66 x 29.5-30	150	260.40	46.75	\$1844	\$2045	\$678	\$573	
Z3660EB2R	36 x 60 x 29.5-30	125	257.25	42.50	\$1792	\$1975	\$600	\$477	

Extended worksurface on right. Standard with faux pedestal on **left** and **Freestanding** full to floor file/file pedestal on **right**. Pedestal locks. Connects to returns or bridges with a 16" throat. Corner has one grommet. Bow top overhangs 2¼" at ends and 6" on center.

- 84" wide desks are shipped RTA (ready to assemble) in 2 cartons.
- Hutches may not be placed on this desk.

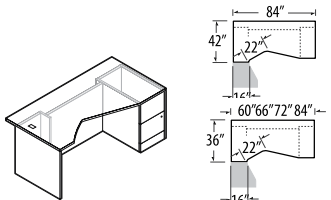


**Single Pedestal Bow Top
Extended Corner Desk - RIGHT**

Z4284EB3R	42 x 84 x 29.5-30	70	315	20.50	\$2106	\$2395	\$916	\$1015
Z4272EB3R	42 x 72 x 29.5-30	150	329	59	\$2083	\$2333	\$760	\$762
Z3672EB3R	36 x 72 x 29.5-30	150	270.90	50.75	\$1910	\$2129	\$760	\$573
Z3666EB3R	36 x 66 x 29.5-30	150	259.35	46.75	\$1856	\$2057	\$678	\$573
Z3660EB3R	36 x 60 x 29.5-30	125	255.15	42.50	\$1825	\$2008	\$600	\$477

Extended worksurface on right. Standard with faux pedestal on **left** and **Freestanding** full to floor box/box/file pedestal on **right**. File drawer and lower box drawer lock. Connects to returns or bridges with a 16" throat. Corner has one grommet. Bow top overhangs 2¼" at ends and 6" on center.

- 84" wide desks are shipped RTA (ready to assemble) in 2 cartons.
- Hutches may not be placed on this desk.

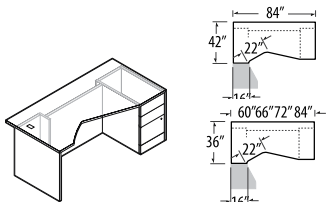


**Single Pedestal Extended
Corner Desk - RIGHT**

Z4284E2R	42 x 84 x 29.5-30	70	321.30	20.50	\$2171	\$2447	\$916	\$1015
Z3684E2R	36 x 84 x 29.5-30	250	311.85	118	\$2082	\$2358	\$916	\$762
Z3672E2R	36 x 72 x 29.5-30	150	278.25	50.75	\$1867	\$2074	\$760	\$573
Z3666E2R	36 x 66 x 29.5-30	150	265.65	46.75	\$1817	\$2006	\$678	\$573
Z3660E2R	36 x 60 x 29.5-30	125	259.35	42.50	\$1786	\$1958	\$600	\$477

Extended worksurface on right. Standard with **Freestanding** full to floor file/file pedestal on **right** and faux pedestal on **left**. Pedestal locks. Connects to returns or bridges with a 16" throat. Corner has one grommet. Top overhangs 2¼"

- 84" wide desks are shipped RTA (ready to assemble) in 2 cartons.
- Hutches may not be placed on this desk.



**Single Pedestal Extended
Corner Desk - RIGHT**

Z4284E3R	42 x 84 x 29.5-30	70	318.15	20.50	\$2098	\$2374	\$916	\$1015
Z3684E3R	36 x 84 x 29.5-30	250	309.75	118	\$2115	\$2390	\$916	\$762
Z3672E3R	36 x 72 x 29.5-30	150	275.10	50.75	\$1905	\$2112	\$760	\$573
Z3666E3R	36 x 66 x 29.5-30	150	263.55	46.75	\$1853	\$2042	\$678	\$573
Z3660E3R	36 x 60 x 29.5-30	125	257.25	42.50	\$1821	\$1991	\$600	\$477

Extended worksurface on right. Standard with **Freestanding** full to floor box/box/file pedestal on **right** and faux pedestal on **left**. File drawer and lower box drawer lock. Connects to returns or bridges with a 16" throat. Corner has one grommet. Top overhangs 2¼".

- 84" wide desks are shipped RTA (ready to assemble) in 2 cartons.
- Hutches may not be placed on this desk.

Required Specifications

Top finish
Top/edge detail
Lock finish
Base finish

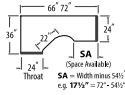
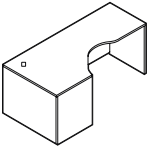
Optional Specifications

HP laminate
Key #
Grommet position or power block cut-out
Handles
Modesty panel type

Accessories

Power block
Keyboard
Pencil drawer

LEFT EXTENDED CORNERS (DOES NOT CONNECT)

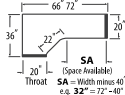
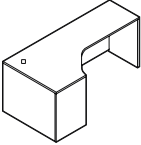


Left Extended Corner, 24" Throat Freestanding

MODEL#	DIMENSIONS D x W x H	FREIGHT CLASS	WT./LBS.	CUBIC FT.	1" TOP	1.5" TOP	GLAZE ADD	HP ADD
Z2472FFL	36 x 72 x 29.5-30	65	184	7	\$1247	\$1412	N/A	\$548
Z2466FFL	36 x 66 x 29.5-30	65	175	7	\$1247	\$1406	N/A	\$548

Extended worksurface on right. **Full end panels on left and right. Cannot be connected on left or right, due to full end panel.** Corner has one grommet. Shipped RTA (ready to assemble).

- Modesty Panel is 1" off of ground.
- Z2466FFL cannot accept pedestals



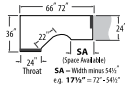
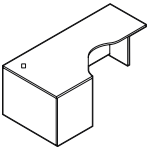
Left Extended Corner, 20" Throat

Z2072FFL	36 x 72 x 29.5-30	65	171	7	\$1212	\$1406	N/A	\$526
Z2066FFL	36 x 66 x 29.5-30	65	164	7	\$1212	\$1370	N/A	\$526

Extended worksurface on right. **Full end panels on left and right. Can be placed next to** lateral files, storage cabinets, wardrobe units, credenzas and end-shelves. Corner has one grommet. Shipped RTA (ready to assemble).

- Modesty Panel is 1" off of ground.

LEFT EXTENDED CORNERS (CONNECTS ON EXTENDED SIDE)

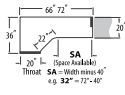
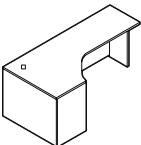


Left Extended Corner, 24" Throat

MODEL#	DIMENSIONS D x W x H	FREIGHT CLASS	WT./LBS.	CUBIC FT.	1" TOP	1.5" TOP	GLAZE ADD	HP ADD
Z2472FNL	36 x 72 x 29.5-30	65	175	7	\$1212	\$1377	N/A	\$548
Z2466FNL	36 x 66 x 29.5-30	65	167	7	\$1212	\$1370	N/A	\$548

Extended worksurface on right. **Narrow end panel on right. Full end panel on left.** Connects to 30"D space saver connectables, 24"D returns, 24"D connectable tables or "D" and "P" islands with "T" or "H" bases. **Full end panel can be placed next to** lateral files, storage cabinets, wardrobe units, credenzas and end-shelves. Corner has one grommet. Shipped RTA (ready to assemble).

- Modesty Panel is 1" off of ground.
- Z2466FNL cannot accept pedestals.



Left Extended Corner, 20" Throat

Z2072FNL	36 x 72 x 29.5-30	65	165	7	\$1176	\$1370	N/A	\$526
Z2066FNL	36 x 66 x 29.5-30	65	158	7	\$1176	\$1334	N/A	\$526

Extended worksurface on right. **Narrow end panel on right. Full end panel on left.** Connects to 24"D space saver connectables, 20"D returns, 20"D connectable tables or "D" and "P" islands with "T" or "H" bases. **Full end panel can be placed next to** lateral files, storage cabinets, wardrobe units, credenzas and end-shelves. Corner has one grommet. Shipped RTA (ready to assemble).

- Modesty Panel is 1" off of ground.
- FNL end panels can be switched to make NFL.

Required Specifications

Top finish
Top/edge detail
Lock finish
Base finish

Optional Specifications

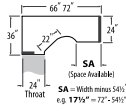
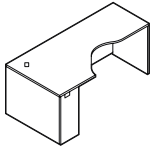
HP laminate
Key #
Grommet position or power block cut-out

Handles
Modesty panel type

Accessories

Power block
Keyboard
Pencil drawer

LEFT EXTENDED CORNERS (CONNECTS ON THROAT SIDE)

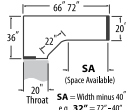
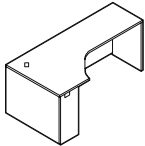


Left Extended Corner, 24" Throat

MODEL#	DIMENSIONS	FREIGHT CLASS	WT/LBS.	CUBIC FT.	1" TOP	1.5" TOP	GLAZE ADD	HP ADD
D x W x H								
Z2472NFL	36 x 72 x 29.5-30	65	175	7	\$1212	\$1377	N/A	\$548
Z2466NFL	36 x 66 x 29.5-30	65	167	7	\$1212	\$1370	N/A	\$548

Extended worksurface on right. **Narrow end panel on left. Full end panel on right.** Connects to 30"D space saver connectables, 30"D space saver returns, 24"D returns or 24"D connectable tables. **Full end panel can be placed next to** lateral files, storage cabinets, wardrobe units, credenzas and end-shelves. Corner has one grommet. Shipped RTA (ready to assemble).

- **Modesty Panel is 1" off of ground.**
- **Z2466NFL cannot accept pedestals.**

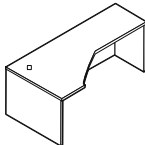
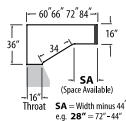
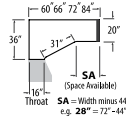
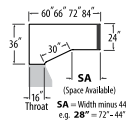


Left Extended Corner, 20" Throat

Z2072NFL	36 x 72 x 29.5-30	65	165	7	\$1176	\$1370	N/A	\$548
Z2066NFL	36 x 66 x 29.5-30	65	158	7	\$1176	\$1334	N/A	\$526

Extended worksurface on right. **Narrow end panel on left. Full end panel on right.** Connects to 24"D space saver connectables and 20"D returns. **Full end panel can be placed next to** lateral files, storage cabinets, wardrobe units, credenzas and end-shelves. Corner has one grommet. Shipped RTA (ready to assemble).

- **Modesty Panel is 1" off of ground.**
- *NFL end panels can be switched to make FNL.*



Left Extended Corner, 16" Throat

Z2484ECFL	36 x 84 x 29.5-30	65	196.35	8	\$1215	\$1502	N/A	\$762
Z2472ECFL	36 x 72 x 29.5-30	65	176.40	7.50	\$1087	\$1339	N/A	\$573
Z2466ECFL	36 x 66 x 29.5-30	70	168	7.50	\$1034	\$1268	N/A	\$573
Z2460ECFL	36 x 60 x 29.5-30	65	158.55	6	\$983	\$1198	N/A	\$477
Z2084ECFL	36 x 84 x 29.5-30	65	184.80	8	\$1212	\$1501	N/A	\$762
Z2072ECFL	36 x 72 x 29.5-30	70	168	7.50	\$1082	\$1335	N/A	\$573
Z2066ECFL	36 x 66 x 29.5-30	70	159.60	7.50	\$1030	\$1265	N/A	\$573
Z2060ECFL	36 x 60 x 29.5-30	65	151.20	6	\$965	\$1175	N/A	\$477

Extended worksurface on right. **No narrow end panel on left. Full end panel on right.** Connects to returns and bridges with 16" throat on the left. **Full end panel can be placed next to** lateral files, storage cabinets, wardrobe units, credenzas and end-shelves. Corner has one grommet. **Does not accept pencil drawers.** Shipped RTA (ready to assemble).

Required Specifications

- Top finish
- Top/edge detail
- Lock finish
- Base finish

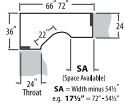
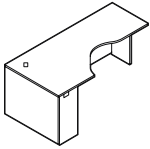
Optional Specifications

- HP laminate
- Key #
- Grommet position or power block cut-out
- Handles
- Modesty panel type

Accessories

- Power block
- Keyboard
- Pencil drawer

LEFT EXTENDED CORNERS (CONNECTS ON BOTH SIDES)



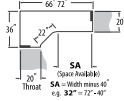
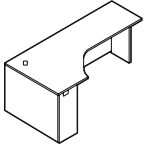
Left Extended Corner, 24" Throat

MODEL# DIMENSIONS FREIGHT CLASS WT/LBS. CUBIC FT. 1" TOP 1.5" TOP GLAZE ADD HP ADD

D x W x H									
Z2472NNL	36 x 72 x 29.5-30	65	166	7	\$1176	\$1341	N/A	\$548	
Z2466NNL	36 x 66 x 29.5-30	65	158	7	\$1176	\$1334	N/A	\$548	

Extended worksurface on right. **Narrow end panels on left and right.** Connects to 30"D space saver connectables, 30"D space saver returns, 24"D returns or 24"D connectable tables or "D" and "P" islands with "T" or "H" bases on either end. **Full end panel can be placed next to** lateral files, storage cabinets, wardrobe units, credenzas and end-shelves. Corner has one grommet. Shipped RTA (ready to assemble).

- **Modesty Panel is 1" off of ground.**
- **Z2466NNL cannot accept pedestals.**

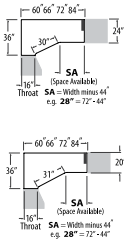
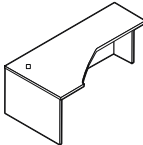


Left Extended Corner, 20" Throat

Z2072NNL	36 x 72 x 29.5-30	65	160	7	\$1140	\$1334	N/A	\$548	
Z2066NNL	36 x 66 x 29.5-30	70	152	7	\$1140	\$1299	N/A	\$526	

Extended worksurface on right. **Narrow end panels on left and right.** Connects to 24"D space saver connectables and 20"D returns, bridges or "D" and "P" islands with "T" or "H" bases one either end. **Full end panel can be placed next to** lateral files, storage cabinets, wardrobe units, credenzas and end-shelves. Corner has one grommet. Shipped RTA (ready to assemble).

- **Modesty Panel is 1" off of ground.**

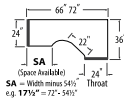
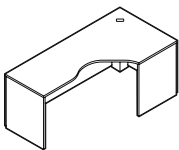


Left Extended Corner, 16" Throat

Z2484ECNL	36 x 84 x 29.5-30	65	186.90	8	\$1180	\$1469	N/A	\$762	
Z2472ECNL	36 x 72 x 29.5-30	70	168	7.50	\$1051	\$1306	N/A	\$573	
Z2466ECNL	36 x 66 x 29.5-30	70	158.55	7.50	\$999	\$1233	N/A	\$573	
Z2460ECNL	36 x 60 x 29.5-30	65	150.15	6	\$935	\$1144	N/A	\$477	
Z2084ECNL	36 x 84 x 29.5-30	70	178.50	8	\$1176	\$1465	N/A	\$762	
Z2072ECNL	36 x 72 x 29.5-30	70	161.70	7.50	\$1048	\$1300	N/A	\$573	
Z2066ECNL	36 x 66 x 29.5-30	70	153.30	7.50	\$996	\$1230	N/A	\$573	
Z2060ECNL	36 x 60 x 29.5-30	65	145.95	6	\$930	\$1140	N/A	\$477	

Extended worksurface on right. **No narrow end panel on left. Narrow end panel on right.** Connects to returns and bridges with 16" throat on the left. **Full end panel can be placed next to** lateral files, storage cabinets, wardrobe units, credenzas and end-shelves. Corner has one grommet. **Does not accept pencil drawers.** Shipped RTA (ready to assemble).

RIGHT EXTENDED CORNERS (DOES NOT CONNECT)



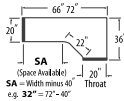
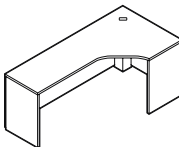
Right Extended Corner, 24" Throat Freestanding

MODEL# DIMENSIONS FREIGHT CLASS WT/LBS. CUBIC FT. 1" TOP 1.5" TOP GLAZE ADD HP ADD

Z2472FFR	36 x 72 x 29.5-30	65	184	7	\$1247	\$1412	N/A	\$548	
Z2466FFR	36 x 66 x 29.5-30	65	175	7	\$1247	\$1406	N/A	\$548	

Extended worksurface on left. **Full end panels on left and right. Cannot be connected on left or right, due to full end panel.** Corner has one grommet. Shipped RTA (ready to assemble).

- **Modesty Panel is 1" off of ground.**
- **Z2466FFR cannot accept pedestals**



Right Extended Corner, 20" Throat

Z2072FFR	36 x 72 x 29.5-30	65	171	7	\$1212	\$1406	N/A	\$526	
Z2066FFR	36 x 66 x 29.5-30	65	164	7	\$1212	\$1370	N/A	\$526	

Extended worksurface on left. **Full end panels on left and right. Can be placed next to** lateral files, storage cabinets, wardrobe units, credenzas and end-shelves. Corner has one grommet. Shipped RTA (ready to assemble).

- **Modesty Panel is 1" off of ground.**

Required Specifications

Top finish
Top/edge detail
Base finish

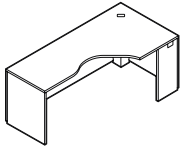
Optional Specifications

HP laminate
Modesty panel type
Grommet position or power block cut-out

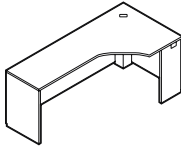
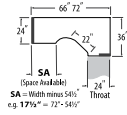
Accessories

Power block
Keyboard (*Not available on 16" throat*)
Pencil drawer (*Not available on 16" throat*)

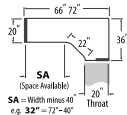
RIGHT EXTENDED CORNERS (CONNECTS ON THROAT SIDE)



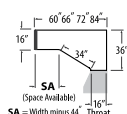
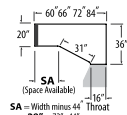
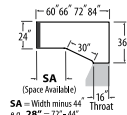
Right Extended Corner, 24" Throat



Right Extended Corner, 20" Throat



Right Extended Corner, 16" Throat



MODEL#	DIMENSIONS	FREIGHT CLASS	WT/LBS.	CUBIC FT.	1" TOP	1.5" TOP	GLAZE ADD	HP ADD
D x W x H								
Z2472FNR	36 x 72 x 29.5-30	65	175	7	\$1212	\$1377	N/A	\$548
Z2466FNR	36 x 66 x 29.5-30	65	167	7	\$1212	\$1370	N/A	\$548

Extended worksurface on left. **Narrow end panel on right. Full end panel on left.** Connects to 30"D space saver connectables, 24"D returns, 24"D connectable tables or "D" and "P" islands with "T" or "H" bases. **Full end panel can be placed next to** lateral files, storage cabinets, wardrobe units, credenzas and end-shelves. Corner has one grommet. Shipped RTA (ready to assemble).

- Modesty Panel is 1" off of ground.
- Z2466FNR cannot accept pedestals.

Z2072FNR	36 x 72 x 29.5-30	65	165	7	\$1176	\$1370	N/A	\$526
Z2066FNR	36 x 66 x 29.5-30	65	158	7	\$1176	\$1334	N/A	\$526

Extended worksurface on left. **Narrow end panel on right. Full end panel on left.** Connects to 24"D space saver connectables, 20"D returns, 20"D connectable tables or "D" and "P" islands with "T" or "H" bases. **Full end panel can be placed next to** lateral files, storage cabinets, wardrobe units, credenzas and end-shelves. Corner has one grommet. Shipped RTA (ready to assemble).

- Modesty Panel is 1" off of ground.
- FNR end panels can be switched to make NFR.

Z2484ECFR	36 x 84 x 29.5-30	65	196.35	8	\$1215	\$1502	N/A	\$762
Z2472ECFR	36 x 72 x 29.5-30	65	176.40	7.50	\$1087	\$1339	N/A	\$573
Z2466ECFR	36 x 66 x 29.5-30	70	168	7.50	\$1034	\$1268	N/A	\$573
Z2460ECFR	36 x 60 x 29.5-30	65	158.55	6	\$983	\$1198	N/A	\$477

Z2084ECFR	36 x 84 x 29.5-30	65	184.80	8	\$1212	\$1501	N/A	\$762
Z2072ECFR	36 x 72 x 29.5-30	70	168	7.50	\$1082	\$1335	N/A	\$573
Z2066ECFR	36 x 66 x 29.5-30	70	159.60	7.50	\$1030	\$1265	N/A	\$573
Z2060ECFR	36 x 60 x 29.5-30	65	151.20	6	\$965	\$1175	N/A	\$477

Z1684ECFR	36 x 84 x 29.5-30	70	175.35	8	\$1207	\$1496	N/A	\$762
Z1672ECFR	36 x 72 x 29.5-30	70	159.60	7.50	\$1078	\$1331	N/A	\$573
Z1666ECFR	36 x 66 x 29.5-30	70	153.30	7.50	\$1026	\$1261	N/A	\$573
Z1660ECFR	36 x 60 x 29.5-30	65	147	6	\$957	\$1166	N/A	\$477

Extended worksurface on left. **No narrow end panel on right. Full end panel on left.** Connects to returns and bridges with 16" throat on the right. **Full end panel can be placed next to** lateral files, storage cabinets, wardrobe units, credenzas and end-shelves. Corner has one grommet. **Does not accept pencil drawers.** Shipped RTA (ready to assemble).

Required Specifications

Top finish
Top/edge detail
Base finish

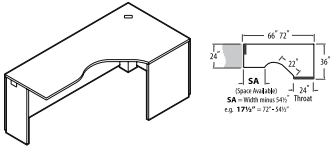
Optional Specifications

HP laminate
Modesty panel type
Grommet position or power block cut-out

Accessories

Power block
Keyboard (Not available on 16" throat)
Pencil drawer (Not available on 16" throat)

RIGHT EXTENDED CORNERS (CONNECTS ON EXTENDED SIDE)

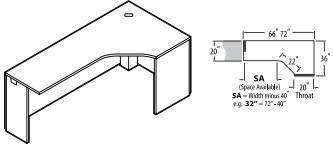


Right Extended Corner, 24" Throat

MODEL#	DIMENSIONS	FREIGHT CLASS	WT/LBS.	CUBIC FT.	1" TOP	1.5" TOP	GLAZE ADD	HP ADD
Z2472NFR	36 x 72 x 29.5-30	65	175	7	\$1212	\$1377	N/A	\$548
Z2466NFR	36 x 66 x 29.5-30	65	167	7	\$1212	\$1370	N/A	\$548

Extended worksurface on left. **Narrow end panel on left. Full end panel on right.** Connects to 30"D space saver connectables, 24"D returns, 24"D connectable tables, or "D" and "P" islands with "T" or "H" bases. **Full end panel can be placed next to** lateral files, storage cabinets, wardrobe units, credenzas and end-shelves. Corner has one grommet. Shipped RTA (ready to assemble).

- Modesty Panel is 1" off of ground.
- Z2466NFR cannot accept pedestals.



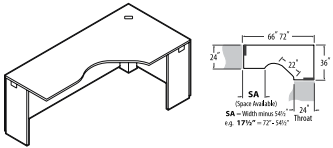
Right Extended Corner, 20" Throat

Z2072NFR	36 x 72 x 29.5-30	65	165	7	\$1176	\$1370	N/A	\$548
Z2066NFR	36 x 66 x 29.5-30	65	158	7	\$1176	\$1334	N/A	\$526

Extended worksurface on left. **Narrow end panel on left. Full end panel on right.** Connects to 24"D space saver connectables, 20"D returns or "D" and "P" islands with "T" or "H" bases. **Full end panel can be placed next to** lateral files, storage cabinets, wardrobe units, credenzas and end-shelves. Corner has one grommet. Shipped RTA (ready to assemble).

- Modesty Panel is 1" off of ground.
- NFR end panels can be switched to make FNR.

RIGHT EXTENDED CORNERS (CONNECTS ON BOTH SIDES)

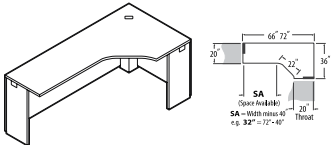


Left Extended Corner, 24" Throat

MODEL#	DIMENSIONS	FREIGHT CLASS	WT/LBS.	CUBIC FT.	1" TOP	1.5" TOP	GLAZE ADD	HP ADD
Z2472NNR	36 x 72 x 29.5-30	65	166	7	\$1176	\$1341	N/A	\$548
Z2466NNR	36 x 66 x 29.5-30	65	158	7	\$1176	\$1334	N/A	\$548

Extended worksurface on left. **Narrow end panels on left and right.** Connects to 30"D space saver connectables, 30"D space saver returns, 24"D returns, 24"D connectable tables or "D" and "P" islands with "T" or "H" bases on either end. Corner has one grommet. Shipped RTA (ready to assemble).

- Modesty Panel is 1" off of ground.
- Z2466NNR cannot accept pedestals.



Right Extended Corner, 20" Throat

Z2072NNR	36 x 72 x 29.5-30	65	160	7	\$1140	\$1334	N/A	\$548
Z2066NNR	36 x 66 x 29.5-30	70	152	7	\$1140	\$1284	N/A	\$526

Extended worksurface on left. **Narrow end panels on left and right.** Connects to 24"D space saver connectables and 20"D returns, bridges or "D" and "P" islands with "T" or "H" bases on either end. **Full end panel can be placed next to** lateral files, storage cabinets, wardrobe units, credenzas and end-shelves. Corner has one grommet. Shipped RTA (ready to assemble).

- Modesty Panel is 1" off of ground.

Required Specifications

Top finish
Top/edge detail
Base finish

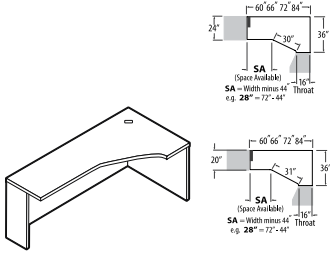
Optional Specifications

HP laminate
Modesty panel type
Grommet position or power block cut-out

Accessories

Power block
Keyboard
Pencil drawer

RIGHT EXTENDED CORNERS (CONNECTS ON BOTH SIDES)

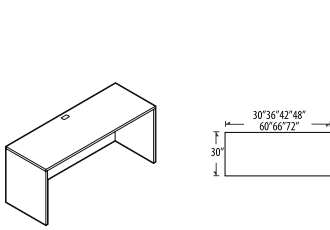


Right Extended Corner, 16" Throat

MODEL#	DIMENSIONS	FREIGHT CLASS	WT/LBS.	CUBIC FT.	1" TOP	1.5" TOP	GLAZE ADD	HP ADD
D x W x H								
Z2484ECNR	36 x 84 x 29.5-30	65	186.90	8	\$1180	\$1469	N/A	\$762
Z2472ECNR	36 x 72 x 29.5-30	70	168	7.50	\$1051	\$1306	N/A	\$573
Z2466ECNR	36 x 66 x 29.5-30	70	158.55	7.50	\$999	\$1233	N/A	\$573
Z2460ECNR	36 x 60 x 29.5-30	65	150.15	6	\$935	\$1144	N/A	\$477
Z2084ECNR	36 x 84 x 29.5-30	70	178.50	8	\$1176	\$1465	N/A	\$762
Z2072ECNR	36 x 72 x 29.5-30	70	161.70	7.50	\$1048	\$1300	N/A	\$573
Z2066ECNR	36 x 66 x 29.5-30	70	153.30	7.50	\$996	\$1230	N/A	\$573
Z2060ECNR	36 x 60 x 29.5-30	65	145.95	6	\$930	\$1140	N/A	\$477

Extended worksurface on left. **No narrow end panel on right. Narrow end panel on left.** Connects to returns and bridges with 16" throat on the right. **Full end panel can be placed next to** lateral files, storage cabinets, wardrobe units, credenzas and end-shelves. Corner has one grommet. **Does not accept pencil drawers.** Shipped RTA (ready to assemble).

FREESTANDING TABLES

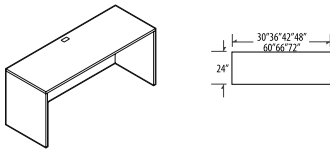


30" Deep Freestanding Table

MODEL#	DIMENSIONS	FREIGHT CLASS	WT/LBS.	CUBIC FT.	1" TOP	1.5" TOP	GLAZE ADD	HP ADD
Z3072T	29.7 x 72 x 29.5-30	65	176	6	\$1031	\$1192	N/A	\$513
Z3066T	29.7 x 66 x 29.5-30	65	166	6	\$1031	\$1183	N/A	\$513
Z3060T	29.7 x 60 x 29.5-30	60	159	5.25	\$941	\$1083	N/A	\$477
Z3048T	29.7 x 48 x 29.5-30	65	135	5.25	\$852	\$979	N/A	\$404
Z3042T	29.7 x 42 x 29.5-30	65	125	5.25	\$852	\$970	N/A	\$367
Z3036T	29.7 x 36 x 29.5-30	65	111	4.30	\$753	\$861	N/A	\$332
Z3030T	29.7 x 30 x 29.5-30	65	100	3.60	\$706	\$795	N/A	\$296

Two full end panels. Cannot be connected on left or right side. Grommet in worksurface. Shipped RTA (ready to assemble).

- Modesty Panel is 1" off of ground.



24" Deep Freestanding Table

Z2472T	24 x 72 x 29.5-30	65	152	6	\$926	\$1078	N/A	\$384
Z2466T	24 x 66 x 29.5-30	65	144	6	\$926	\$1078	N/A	\$384
Z2460T	24 x 60 x 29.5-30	65	133	5.25	\$843	\$960	N/A	\$353
Z2448T	24 x 48 x 29.5-30	65	114	4.30	\$761	\$863	N/A	\$281
Z2442T	24 x 42 x 29.5-30	65	105	4.30	\$761	\$850	N/A	\$236
Z2436T	24 x 36 x 29.5-30	65	95	4.20	\$680	\$755	N/A	\$178
Z2430T	24 x 30 x 29.5-30	65	85	3.60	\$645	\$702	N/A	\$178

Two full end panels. Cannot be connected on left or right side. Grommet in worksurface. Shipped RTA (ready to assemble).

- Modesty Panel is 1" off of ground.

Required Specifications

Top finish
Top/edge detail
Base finish

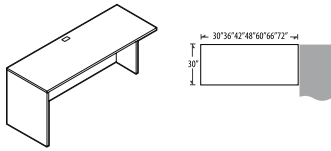
Optional Specifications

HP laminate
Modesty panel type
Grommet position or power block cut-out

Accessories

Power block
Keyboard (Not available on 16" throat)
Pencil drawer (Not available on 16" throat)

CONNECTABLE TABLES - LEFT

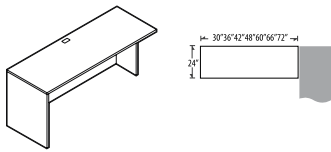


30" Deep Connectable Table - Left

MODEL#	DIMENSIONS D x W x H	FREIGHT CLASS	WT/LBS.	CUBIC FT.	1" TOP	1.5" TOP	GLAZE ADD	HP ADD
Z3072L	29.7 x 72 x 29.5-30	65	168	6	\$996	\$1157	N/A	\$513
Z3066L	29.7 x 66 x 29.5-30	65	158	6	\$996	\$1148	N/A	\$513
Z3060L	29.7 x 60 x 29.5-30	65	150	5.25	\$906	\$1048	N/A	\$477
Z3048L	29.7 x 48 x 29.5-30	65	124	4.30	\$815	\$942	N/A	\$404
Z3042L	29.7 x 42 x 29.5-30	65	115	4.30	\$815	\$933	N/A	\$367
Z3036L	29.7 x 36 x 29.5-30	65	103	4.20	\$718	\$828	N/A	\$332
Z3030L	29.7 x 30 x 29.5-30	65	92	3.60	\$672	\$761	N/A	\$296

Full end panel on left. Right narrow end panel connects to **30"D** center/right connectable table, or at 90° angle to a freestanding table; and "D" islands or "P" islands with "T" and "H" bases. Grommet in worksurface. Shipped RTA (ready to assemble).

- Modesty Panel is 1" off of ground.



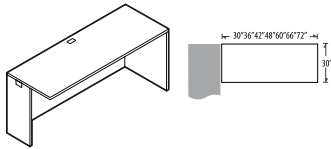
24" Deep Connectable Table - Left

Z2472L	24 x 72 x 29.5-30	65	144	6	\$880	\$1036	N/A	\$384
Z2466L	24 x 66 x 29.5-30	65	135	6	\$880	\$1015	N/A	\$384
Z2460L	24 x 60 x 29.5-30	65	125	5.25	\$796	\$914	N/A	\$353
Z2448L	24 x 48 x 29.5-30	65	106	4.30	\$725	\$827	N/A	\$281
Z2442L	24 x 42 x 29.5-30	65	95	3.80	\$725	\$814	N/A	\$236
Z2436L	24 x 36 x 29.5-30	65	86	3.30	\$637	\$710	N/A	\$178
Z2430L	24 x 30 x 29.5-30	70	77	3.60	\$600	\$658	N/A	\$178

Full end panel on left. Right narrow end panel connects to **24"D** center/right connectable table, or at 90° angle to a freestanding table; 24"D extended corners or at the end of a straight run; "D" islands or "P" islands with "T" and "H" bases. Grommet in worksurface. Shipped RTA (ready to assemble).

- Modesty Panel is 1" off of ground.

CONNECTABLE TABLES - RIGHT

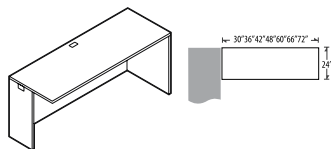


30" Deep Connectable Table - Right

MODEL#	DIMENSIONS D x W x H	FREIGHT CLASS	WT/LBS.	CUBIC FT.	1" TOP	1.5" TOP	GLAZE ADD	HP ADD
Z3072R	29.7 x 72 x 29.5-30	65	168	6	\$996	\$1157	N/A	\$513
Z3066R	29.7 x 66 x 29.5-30	65	158	6	\$996	\$1148	N/A	\$513
Z3060R	29.7 x 60 x 29.5-30	65	150	5.25	\$906	\$1048	N/A	\$477
Z3048R	29.7 x 48 x 29.5-30	65	124	4.30	\$815	\$942	N/A	\$404
Z3042R	29.7 x 42 x 29.5-30	65	115	4.30	\$815	\$933	N/A	\$367
Z3036R	29.7 x 36 x 29.5-30	65	103	4.20	\$718	\$828	N/A	\$332
Z3030R	29.7 x 30 x 29.5-30	65	92	3.60	\$672	\$761	N/A	\$296

Full end panel on right. Left narrow end panel connects to **30"D** center/right connectable table, or at 90° angle to a freestanding table; and "D" islands or "P" islands with "T" and "H" bases. Grommet in worksurface. Shipped RTA (ready to assemble).

- Modesty Panel is 1" off of ground.



24" Deep Connectable Table - Right

Z2472R	24 x 72 x 29.5-30	65	144	6	\$880	\$1036	N/A	\$384
Z2466R	24 x 66 x 29.5-30	65	135	6	\$880	\$1015	N/A	\$384
Z2460R	24 x 60 x 29.5-30	65	125	5.25	\$796	\$914	N/A	\$353
Z2448R	24 x 48 x 29.5-30	65	106	4.30	\$725	\$827	N/A	\$281
Z2442R	24 x 42 x 29.5-30	65	95	3.80	\$725	\$814	N/A	\$236
Z2436R	24 x 36 x 29.5-30	65	86	3.30	\$637	\$710	N/A	\$178
Z2430R	24 x 30 x 29.5-30	70	77	3.60	\$600	\$658	N/A	\$178

Full end panel on right. Left narrow end panel connects to **24"D** center/right connectable table, or at 90° angle to a freestanding table; 24"D extended corners or at the end of a straight run; "D" islands or "P" islands with "T" and "H" bases. Grommet in worksurface. Shipped RTA (ready to assemble).

- Modesty Panel is 1" off of ground.

Required Specifications

Top finish
Top/edge detail
Base finish

Optional Specifications

HP laminate
Modesty panel type
Grommet position or power block cut-out

Accessories

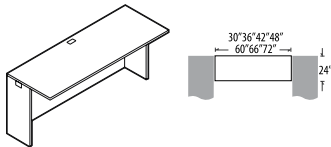
Power block
Keyboard
Pencil drawer

CONNECTABLE TABLES	MODEL#	DIMENSIONS	FREIGHT CLASS	WT/LBS.	CUBIC FT.	1"TOP	1.5" TOP	GLAZE ADD	HP ADD	
	D x W x H									
	Z3072N	29.7 x 72 x 29.5-30	65	159	6	\$958	\$1120	N/A	\$513	
	Z3066N	29.7 x 66 x 29.5-30	65	149	6	\$958	\$1114	N/A	\$513	
	Z3060N	29.7 x 60 x 29.5-30	65	142	5.25	\$859	\$1003	N/A	\$477	
	Z3048N	29.7 x 48 x 29.5-30	65	116	4.30	\$753	\$879	N/A	\$404	
	Z3042N	29.7 x 42 x 29.5-30	65	106	3.80	\$753	\$870	N/A	\$367	
	Z3036N	29.7 x 36 x 29.5-30	65	94	3.30	\$672	\$782	N/A	\$332	
Z3030N	29.7 x 30 x 29.5-30	65	83	3.60	\$637	\$726	N/A	\$296		

30" Deep Connectable Table

Narrow end panels on both sides connect to **30"D** worksurfaces, "D" islands or "P" islands with "T" and "H" bases; or at 90° angle to freestanding table(s). Grommet in worksurface. Shipped RTA (ready to assemble).

- Modesty Panel is 1" off of ground.



24" Deep Connectable Table

Z2472N	24 x 72 x 29.5-30	65	135	6	\$835	\$987	N/A	\$384
Z2466N	24 x 66 x 29.5-30	70	127	6	\$835	\$968	N/A	\$384
Z2460N	24 x 60 x 29.5-30	65	116	4.50	\$753	\$870	N/A	\$353
Z2448N	24 x 48 x 29.5-30	65	97	4.30	\$680	\$782	N/A	\$281
Z2442N	24 x 42 x 29.5-30	65	87	3.80	\$680	\$764	N/A	\$236
Z2436N	24 x 36 x 29.5-30	65	77	3.30	\$589	\$662	N/A	\$178
Z2430N	24 x 30 x 29.5-30	70	68	3.60	\$553	\$610	N/A	\$178

Narrow end panels on both sides connect to **24"D** worksurfaces, "D" islands or "P" islands with "T" and "H" bases; or at 90° angle to freestanding table(s). Grommet in worksurface. Shipped RTA (ready to assemble).

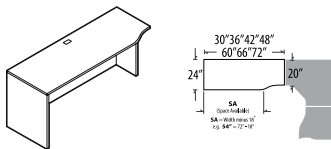
- Modesty Panel is 1" off of ground.

SPACE SAVER CONNECTABLE TABLES - LEFT	MODEL#	DIMENSIONS	FREIGHT CLASS	WT/LBS.	CUBIC FT.	1"TOP	1.5" TOP	GLAZE ADD	HP ADD
	Z3072LK	29.7 x 72 x 29.5-30	65	161	6	\$1015	\$1189	N/A	\$513
	Z3066LK	29.7 x 66 x 29.5-30	65	151	6	\$1015	\$1180	N/A	\$513
	Z3060LK	29.7 x 60 x 29.5-30	65	144	5.25	\$926	\$1084	N/A	\$477
	Z3048LK	29.7 x 48 x 29.5-30	65	118	4.30	\$835	\$973	N/A	\$404
	Z3042LK	29.7 x 42 x 29.5-30	65	107	3.80	\$835	\$965	N/A	\$367
	Z3036LK	29.7 x 36 x 29.5-30	70	96	4.30	\$736	\$856	N/A	\$332
	Z3030LK	29.7 x 30 x 29.5-30	65	85	3.60	\$691	\$797	N/A	\$296

30" Deep Space Saver Connectable Table - Left

Full end panel on left. Narrow right end panel connects to any corner unit with a 24" throat. Grommet in worksurface. Shipped RTA (ready to assemble).

- Modesty Panel is 1" off of ground.



24" Deep Space Saver Connectable Table - Left

Z2472LK	24 x 72 x 29.5-30	65	140	6	\$906	\$1071	N/A	\$384
Z2466LK	24 x 66 x 29.5-30	70	134	6	\$906	\$1054	N/A	\$384
Z2460LK	24 x 60 x 29.5-30	65	123	5.25	\$827	\$957	N/A	\$353
Z2448LK	24 x 48 x 29.5-30	65	104	4.30	\$753	\$865	N/A	\$281
Z2442LK	24 x 42 x 29.5-30	65	94	3.80	\$753	\$858	N/A	\$236
Z2436LK	24 x 36 x 29.5-30	65	85	3.30	\$663	\$750	N/A	\$178
Z2430LK	24 x 30 x 29.5-30	70	75	3.60	\$627	\$697	N/A	\$178

Full end panel on left. Narrow right end panel connects to any corner unit with a 20" throat. Grommet in worksurface. Shipped RTA (ready to assemble).

- Modesty Panel is 1" off of ground.

Required Specifications

Top finish
Top/edge detail
Base finish

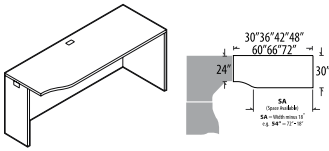
Optional Specifications

HP laminate
Modesty panel type
Grommet position or power block cut-out

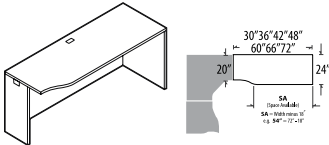
Accessories

Power block
Keyboard
Pencil drawer

SPACE SAVER CONNECTABLE TABLES - RIGHT



30" Deep Space Saver Connectable Table - Right



24" Deep Space Saver Connectable Table - Right

MODEL#	DIMENSIONS	FREIGHT CLASS	WT./LBS.	CUBIC FT.	1" TOP	1.5" TOP	GLAZE ADD	HP ADD
	D x W x H							
Z3072RK	29.7 x 72 x 29.5-30	65	161	6	\$1015	\$1189	N/A	\$513
Z3066RK	29.7 x 66 x 29.5-30	65	151	6	\$1015	\$1180	N/A	\$513
Z3060RK	29.7 x 60 x 29.5-30	65	144	5.25	\$926	\$1084	N/A	\$477
Z3048RK	29.7 x 48 x 29.5-30	65	119	4.30	\$835	\$973	N/A	\$404
Z3042RK	29.7 x 42 x 29.5-30	65	107	3.80	\$835	\$965	N/A	\$367
Z3036RK	29.7 x 36 x 29.5-30	70	96	4.30	\$736	\$856	N/A	\$332
Z3030RK	29.7 x 30 x 29.5-30	65	85	3.60	\$691	\$797	N/A	\$296

Full end panel on right. Narrow left end panel connects to any corner unit with a 24" throat. Grommet in worksurface. Shipped RTA (ready to assemble).

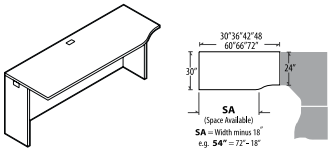
- Modesty Panel is 1" off of ground.

Z2472RK	24 x 72 x 29.5-30	65	142	6	\$906	\$1071	N/A	\$384
Z2466RK	24 x 66 x 29.5-30	70	134	6	\$906	\$1054	N/A	\$384
Z2460RK	24 x 60 x 29.5-30	65	123	5.25	\$827	\$957	N/A	\$353
Z2448RK	24 x 48 x 29.5-30	65	104	4.30	\$753	\$865	N/A	\$281
Z2442RK	24 x 42 x 29.5-30	65	94	3.80	\$753	\$858	N/A	\$236
Z2436RK	24 x 36 x 29.5-30	65	85	3.30	\$663	\$750	N/A	\$178
Z2430RK	24 x 30 x 29.5-30	70	75	3.60	\$627	\$697	N/A	\$178

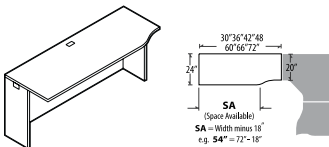
Full end panel on right. Narrow left end panel connects to any corner unit with a 20" throat. Grommet in worksurface. Shipped RTA (ready to assemble).

- Modesty Panel is 1" off of ground.

SPACE SAVER CONNECTABLE TABLES



30" Deep Space Saver Connectable Table



24" Deep Space Saver Connectable Table

MODEL#	DIMENSIONS	FREIGHT CLASS	WT./LBS.	CUBIC FT.	1" TOP	1.5" TOP	GLAZE ADD	HP ADD
Z3072LN	29.7 x 72 x 29.5-30	65	153	6	\$978	\$1152	N/A	\$513
Z3066LN	29.7 x 66 x 29.5-30	65	143	6	\$978	\$1143	N/A	\$513
Z3060LN	29.7 x 60 x 29.5-30	65	136	5.25	\$880	\$1039	N/A	\$477
Z3048LN	29.7 x 48 x 29.5-30	65	110	4.30	\$769	\$908	N/A	\$404
Z3042LN	29.7 x 42 x 29.5-30	65	100	3.80	\$769	\$900	N/A	\$367
Z3036LN	29.7 x 36 x 29.5-30	65	88	3.30	\$691	\$812	N/A	\$332
Z3030LN	29.7 x 30 x 29.5-30	70	77	3.60	\$653	\$759	N/A	\$296

Narrow end panels on both sides. Connects the **right end only** to any corner unit with a 24" throat. Left end allows the continuation of additional 30" connectable center or left connectable worksurface. Grommet in worksurface. Shipped RTA (ready to assemble).

- Modesty Panel is 1" off of ground.

Z2472LN	24 x 72 x 29.5-30	70	134	6	\$859	\$1026	N/A	\$384
Z2466LN	24 x 66 x 29.5-30	70	125	6	\$859	\$1009	N/A	\$384
Z2460LN	24 x 60 x 29.5-30	70	115	5.25	\$780	\$919	N/A	\$353
Z2448LN	24 x 48 x 29.5-30	70	96	4.30	\$706	\$819	N/A	\$281
Z2442LN	24 x 42 x 29.5-30	70	85	3.80	\$706	\$812	N/A	\$236
Z2436LN	24 x 36 x 29.5-30	65	76	3.30	\$618	\$704	N/A	\$178
Z2430LN	24 x 30 x 29.5-30	70	67	3.60	\$580	\$651	N/A	\$178

Narrow end panels on both sides. Connects the **right end only** to any corner unit with a 24" throat. Left end allows the continuation of additional 24" connectable center or left connectable worksurface. Grommet in worksurface. Shipped RTA (ready to assemble).

- Modesty Panel is 1" off of ground.

Required Specifications

Top finish
Top/edge detail
Base finish

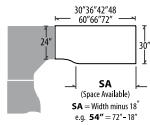
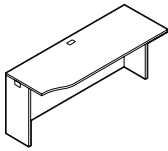
Optional Specifications

HP laminate
Modesty panel type
Grommet position or power block cut-out

Accessories

Power block
Keyboard
Pencil drawer

SPACE SAVER CONNECTABLE TABLES

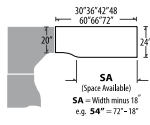
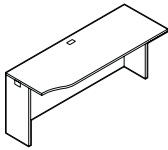


30" Deep Space Saver Connectable Table

MODEL#	DIMENSIONS	FREIGHT CLASS	WT/LBS.	CUBIC FT.	1" TOP	1.5" TOP	GLAZE ADD	HP ADD
Z3072RN	29.7 x 72 x 29.5-30	65	153	6	\$978	\$1152	N/A	\$513
Z3066RN	29.7 x 66 x 29.5-30	65	143	6	\$978	\$1143	N/A	\$513
Z3060RN	29.7 x 60 x 29.5-30	65	136	5.25	\$880	\$1039	N/A	\$477
Z3048RN	29.7 x 48 x 29.5-30	65	110	4.30	\$769	\$908	N/A	\$404
Z3042RN	29.7 x 42 x 29.5-30	65	99	3.80	\$769	\$900	N/A	\$367
Z3036RN	29.7 x 36 x 29.5-30	65	88	3.30	\$691	\$812	N/A	\$332
Z3030RN	29.7 x 30 x 29.5-30	70	77	3.60	\$653	\$759	N/A	\$296

Narrow end panels on both sides. Connects the **left end only** to any corner unit with a 24" throat. Right end allows the continuation of additional 30" connectable center or right connectable worksurface. Grommet in worksurface. Shipped RTA (ready to assemble).

- Modesty Panel is 1" off of ground.



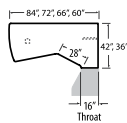
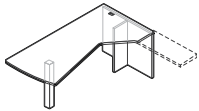
24" Deep Space Saver Connectable Table

Z2472RN	24 x 72 x 29.5-30	70	134	6	\$859	\$1026	N/A	\$384
Z2466RN	24 x 66 x 29.5-30	70	125	6	\$859	\$1009	N/A	\$384
Z2460RN	24 x 60 x 29.5-30	70	115	5.25	\$780	\$919	N/A	\$353
Z2448RN	24 x 48 x 29.5-30	70	95	4.30	\$706	\$819	N/A	\$281
Z2442RN	24 x 42 x 29.5-30	70	85	3.80	\$706	\$812	N/A	\$236
Z2436RN	24 x 36 x 29.5-30	65	76	3.30	\$618	\$704	N/A	\$178
Z2430RN	24 x 30 x 29.5-30	70	67	3.60	\$580	\$651	N/A	\$178

Narrow end panels on both sides. Connects the **left end only** to any corner unit with a 20" throat. Right end allows the continuation of additional 30" connectable center or right connectable worksurface. Grommet in worksurface. Shipped RTA (ready to assemble).

- Modesty Panel is 1" off of ground.

EXTENDED CORNER ISLANDS

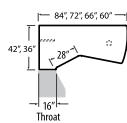
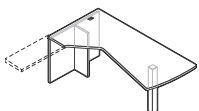


Extended Corner Island - LEFT Full End Panel & Post (T-Base)*

MODEL#	DIMENSIONS	FREIGHT CLASS	WT/LBS.	CUBIC FT.	1" TOP	1.5" TOP	GLAZE ADD	HP ADD
Z4284EDTL	42 x 84 x 29.5-30	70	180.60	10.76	\$1227	\$1546	N/A	\$1015
Z4272EDTL	42 x 72 x 29.5-30	70	164.85	9.50	\$1154	\$1437	N/A	\$762
Z3672EDTL	36 x 72 x 29.5-30	70	139.65	8.76	\$1053	\$1252	N/A	\$573
Z3666EDTL	36 x 66 x 29.5-30	70	133.35	8.76	\$1008	\$1205	N/A	\$573
Z3660EDTL	36 x 60 x 29.5-30	70	127.05	6.50	\$961	\$1160	N/A	\$477

Extended island worksurface on **left**. Connects to returns or bridges with a 16" throat on the right. **Not freestanding.** Grommet in worksurface. Shipped RTA (ready to assemble).

- Post is shipped in separate carton.



Extended Corner Island - RIGHT Full End Panel & Post (T-Base)*

Z4284EDTR	42 x 84 x 29.5-30	70	180.60	10.76	\$1227	\$1546	N/A	\$1015
Z4272EDTR	42 x 72 x 29.5-30	70	164.85	9.50	\$1154	\$1437	N/A	\$762
Z3672EDTR	36 x 72 x 29.5-30	70	139.65	8.76	\$1053	\$1252	N/A	\$573
Z3666EDTR	36 x 66 x 29.5-30	70	133.35	8.76	\$1008	\$1205	N/A	\$573
Z3660EDTR	36 x 60 x 29.5-30	70	127.05	6.50	\$961	\$1160	N/A	\$477

Extended island worksurface on **right**. Connects to returns or bridges with a 16" throat on the left. **Not freestanding.** Grommet in worksurface. Shipped RTA (ready to assemble).

- Post is shipped in separate carton.

Required Specifications

- Top finish
- Top/edge detail
- Base finish

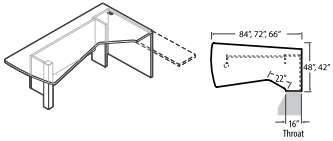
Optional Specifications

- HP laminate
- Modesty panel type
- Grommet position or power block cut-out

Accessories

- Power block
- Keyboard
- Pencil drawer

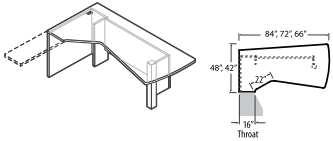
EXTENDED CORNER ISLANDS (WITH FAUX PEDESTAL)



**Extended Corner Island - LEFT
Faux Pedestal and Post**

MODEL#	DIMENSIONS	FREIGHT CLASS	WT/LBS.	CUBIC FT.	1" TOP	1.5" TOP	GLAZE ADD	HP ADD
Z4884EDFL	48 x 84 x 29.5-30	70	214.20	12	\$1535	\$1891	\$690	\$1015
Z4872EDFL	48 x 72 x 29.5-30	70	192.15	10.76	\$1423	\$1733	\$570	\$762
Z4284EDFL	42 x 84 x 29.5-30	70	186.90	10.76	\$1441	\$1760	\$690	\$1015
Z4272EDFL	42 x 72 x 29.5-30	70	168	8.76	\$1341	\$1619	\$570	\$762
Z4266EDFL	42 x 66 x 29.5-30	70	158.55	8.76	\$1288	\$1547	\$510	\$762

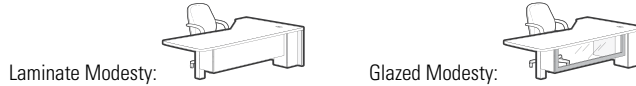
Extended island worksurface on **left**. Connects to returns or bridges with a 16" throat on the right. **Not freestanding**. Faux pedestal on the **right** is ideal for concealing a CPU. ¾ modesty panel is standard. Grommet in worksurface. Shipped RTA (ready to assemble) in 2 cartons.



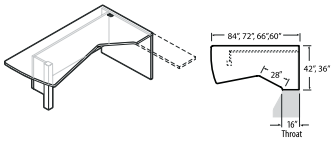
**Extended Corner Island - RIGHT
Faux Pedestal and Post**

Z4884EDFR	48 x 84 x 29.5-30	70	214.20	12	\$1535	\$1891	\$690	\$1015
Z4872EDFR	48 x 72 x 29.5-30	70	192.15	10.76	\$1423	\$1733	\$570	\$762
Z4284EDFR	42 x 84 x 29.5-30	70	186.90	10.76	\$1441	\$1760	\$690	\$1015
Z4272EDFR	42 x 72 x 29.5-30	70	168	8.76	\$1341	\$1619	\$570	\$762
Z4266EDFR	42 x 66 x 29.5-30	70	158.55	8.76	\$1288	\$1547	\$510	\$762

Extended island worksurface on **right**. Connects to returns or bridges with a 16" throat on the right. **Not freestanding**. Faux pedestal on the **left** is ideal for concealing a CPU. ¾ modesty panel is standard. Grommet in worksurface. Shipped RTA (ready to assemble) in 2 cartons.



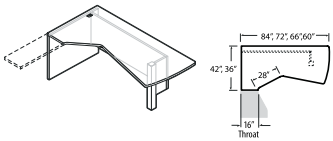
EXTENDED CORNER ISLANDS (WITH RECESSED MODESTY)



**Extended Corner Island - LEFT
Recessed Modesty and Post**

MODEL#	DIMENSIONS	FREIGHT CLASS	WT/LBS.	CUBIC FT.	1" TOP	1.5" TOP	GLAZE ADD	HP ADD
Z4284EDRL	42 x 84 x 29.5-30	70	199	10.76	\$1361	\$1681	\$810	\$1015
Z4272EDRL	42 x 72 x 29.5-30	70	180	9.50	\$1278	\$1560	\$738	\$762
Z3672EDRL	36 x 72 x 29.5-30	70	154	8.76	\$1132	\$1372	\$738	\$573
Z3666EDRL	36 x 66 x 29.5-30	70	144	8.76	\$1091	\$1314	\$678	\$573
Z3660EDRL	36 x 60 x 29.5-30	70	136	6.50	\$1048	\$1255	\$620	\$477

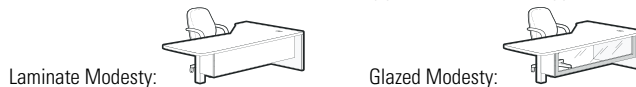
Extended island worksurface on **left**. Connects to returns or bridges with a 16" throat on the right. **Not freestanding**. Grommet in worksurface. ¾ **recessed** modesty panel is standard. Shipped RTA (ready to assemble) in 2 cartons.



**Extended Corner Island - RIGHT
Recessed Modesty and Post**

Z4284EDRR	42 x 84 x 29.5-30	70	199	10.76	\$1361	\$1681	\$810	\$1015
Z4272EDRR	42 x 72 x 29.5-30	70	180	9.50	\$1278	\$1560	\$738	\$762
Z3672EDRR	36 x 72 x 29.5-30	70	154	8.76	\$1132	\$1372	\$738	\$573
Z3666EDRR	36 x 66 x 29.5-30	70	144	8.76	\$1091	\$1314	\$678	\$573
Z3660EDRR	36 x 60 x 29.5-30	70	136	6.50	\$1048	\$1255	\$620	\$477

Extended island worksurface on **right**. Connects to returns or bridges with a 16" throat on the left. **Not freestanding**. Grommet in worksurface. ¾ **recessed** modesty panel is standard. Shipped RTA (ready to assemble) in 2 cartons.



Required Specifications

- Top finish
- Top/edge detail
- Base finish
- Monopost finish*

Optional Specifications

- HP laminate
- Modesty panel type
- Grommet position or power block cut-out

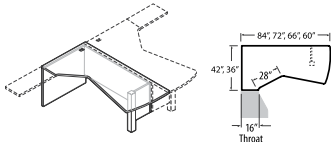
Accessories

- Power block
- Keyboard
- Pencil drawer

EXTENDED CORNER ISLANDS (WITH FLUSH MODESTY)	MODEL#	DIMENSIONS	FREIGHT CLASS	WT/LBS.	CUBIC FT.	1" TOP	1.5" TOP	GLAZE ADD	HP ADD	
D x W x H										
	Z4284EDML	42 x 84 x 29.5-30	70	208.95	10.76	\$1381	\$1701	\$810	\$1015	
	Z4272EDML	42 x 72 x 29.5-30	70	183.75	9.50	\$1293	\$1575	\$738	\$762	
	Z3672EDML	36 x 72 x 29.5-30	70	158.55	8.76	\$1144	\$1380	\$738	\$573	
	Z3666EDML	36 x 66 x 29.5-30	70	150.15	8.76	\$1097	\$1347	\$678	\$573	
	Z3660EDML	36 x 60 x 29.5-30	70	141.75	6.50	\$1069	\$1264	\$620	\$477	

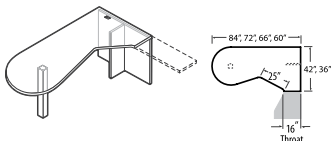
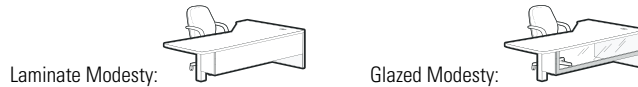
Extended Corner Island - LEFT
Flush Modesty and Post

Extended island worksurface on **left**. Connects to returns or bridges with a 16" throat on the right. **Not freestanding.** Grommet in worksurface. **¾ flush** modesty panel is standard. Shipped RTA (ready to assemble) in 2 cartons.



Extended Corner Island - RIGHT
Flush Modesty and Post

Extended island worksurface on **right**. Connects to returns or bridges with a 16" throat on the left. **Not freestanding.** Grommet in worksurface. **¾ flush** modesty panel is standard. Shipped RTA (ready to assemble) in 2 cartons.

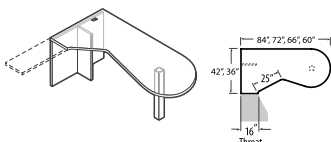


Extended Corner "P" Island - LEFT
Full End Panel & Post (T-Base)

Z4284EPTL	42 x 84 x 29.5-30	70	178.50	10.76	\$1219	\$1538	N/A	\$1015
Z3684EPTL	36 x 84 x 29.5-30	100	153.30	19	\$1124	\$1407	N/A	\$762
Z3672EPTL	36 x 72 x 29.5-30	70	144.90	8.76	\$1036	\$1246	N/A	\$573
Z3666EPTL	36 x 66 x 29.5-30	70	138.60	8.76	\$994	\$1220	N/A	\$573
Z3660EPTL	36 x 60 x 29.5-30	70	129.15	6.50	\$957	\$1167	N/A	\$477

Extended island worksurface on **left**. Connects to returns or bridges with a 16" throat on the right. **Not freestanding.** Grommet in worksurface. Shipped RTA (ready to assemble).

- Post is shipped in separate carton.



Extended Corner "P" Island - RIGHT
Full End Panel & Post (T-Base)

Z4284EPTR	42 x 84 x 29.5-30	70	178.50	10.76	\$1219	\$1538	N/A	\$1015
Z3684EPTR	36 x 84 x 29.5-30	100	153.30	19	\$1124	\$1407	N/A	\$762
Z3672EPTR	36 x 72 x 29.5-30	70	144.90	8.76	\$1036	\$1246	N/A	\$573
Z3666EPTR	36 x 66 x 29.5-30	70	138.60	8.76	\$994	\$1220	N/A	\$573
Z3660EPTR	36 x 60 x 29.5-30	70	129.15	6.50	\$957	\$1167	N/A	\$477

Extended island worksurface on **right**. Connects to returns or bridges with a 16" throat on the left. **Not freestanding.** Grommet in worksurface. Shipped RTA (ready to assemble).

- Post is shipped in separate carton.

EXTENDED CORNER ISLANDS (WITH FAUX MODESTY)	MODEL#	DIMENSIONS	FREIGHT CLASS	WT/LBS.	CUBIC FT.	1" TOP	1.5" TOP	GLAZE ADD	HP ADD
	Z4884EPFL	48 x 84 x 29.5-30	70	217	12	\$1535	\$1888	\$690	\$1015
	Z4872EPFL	48 x 72 x 29.5-30	70	194	10.50	\$1422	\$1731	\$570	\$762
	Z4284EPFL	42 x 84 x 29.5-30	70	191	10.76	\$1441	\$1759	\$690	\$1015
	Z4272EPFL	42 x 72 x 29.5-30	70	172	8.76	\$1340	\$1618	\$570	\$762
	Z4266EPFL	42 x 66 x 29.5-30	70	160	8.76	\$1286	\$1544	\$510	\$762

Extended Corner "P" Island - LEFT
Faux Pedestal and Post

Extended island worksurface on **left**. Connects to returns or bridges with a 16" throat on the right. **Not freestanding.** Faux pedestal on the **right** is ideal for concealing a CPU. **¾** modesty panel is standard. Grommet in worksurface. Shipped RTA (ready to assemble) in 2 cartons.



Required Specifications

- Top finish
- Top/edge detail
- Base finish
- Monopost finish

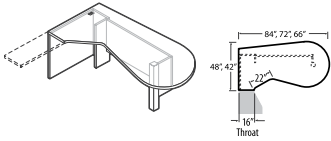
Optional Specifications

- HP laminate
- Glazing - modesty panel
- Grommet position or power block cut-out

Accessories

- Power block
- Keyboard
- Pencil drawer

EXTENDED CORNER ISLANDS (WITH FAUX MODESTY)



Extended Corner "P" Island - RIGHT Faux Pedestal and Post

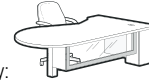
MODEL#	DIMENSIONS	FREIGHT CLASS	WT./LBS.	CUBIC FT.	1"TOP	1.5" TOP	GLAZE ADD	HP ADD
D x W x H								
Z4884EPFR	48 x 84 x 29.5-30	70	217	12	\$1535	\$1888	\$690	\$1015
Z4872EPFR	48 x 72 x 29.5-30	70	194	10.50	\$1422	\$1731	\$570	\$762
Z4284EPFR	42 x 84 x 29.5-30	70	191	10.76	\$1441	\$1759	\$690	\$1015
Z4272EPFR	42 x 72 x 29.5-30	70	172	8.76	\$1340	\$1618	\$570	\$762
Z4266EPFR	42 x 66 x 29.5-30	70	160	8.76	\$1286	\$1544	\$510	\$762

Extended island worksurface on **left**. Connects to returns or bridges with a 16" throat on the right. **Not freestanding.** Faux pedestal on the **right** is ideal for concealing a CPU. ¾ modesty panel is standard. Grommet in worksurface. Shipped RTA (ready to assemble) in 2 cartons.

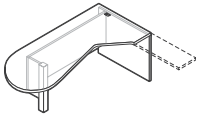
Laminate Modesty:



Glazed Modesty:



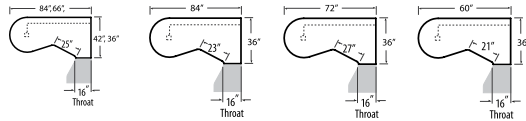
EXTENDED CORNER ISLANDS (WITH RECESSED MODESTY)



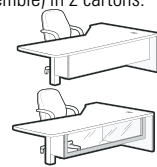
Extended Corner "P" Island - LEFT Recessed Modesty and Post

MODEL#	DIMENSIONS	FREIGHT CLASS	WT./LBS.	CUBIC FT.	1"TOP	1.5" TOP	GLAZE ADD	HP ADD
Z4284EPRL	42 x 84 x 29.5-30	70	199.50	10.76	\$1358	\$1677	\$810	\$1015
Z3684EPRL	36 x 84 x 29.5-30	70	173.25	9.50	\$1231	\$1543	\$810	\$762
Z3672EPRL	36 x 72 x 29.5-30	70	156.45	8.76	\$1132	\$1372	\$738	\$573
Z3666EPRL	36 x 66 x 29.5-30	70	149.10	8.76	\$1103	\$1330	\$678	\$573
Z3660EPRL	36 x 60 x 29.5-30	70	140.70	6.50	\$1056	\$1266	\$620	\$477

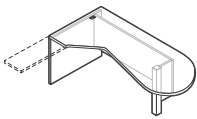
Extended island worksurface on **left**. Connects to returns or bridges with a 16" throat on the right. **Not freestanding.** Grommet in worksurface. ¾ **recessed** modesty panel is standard. Shipped RTA (ready to assemble) in 2 cartons.



Laminate Modesty:



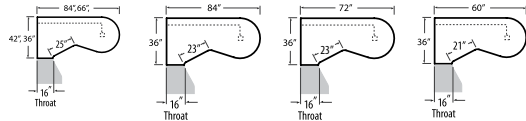
Glazed Modesty:



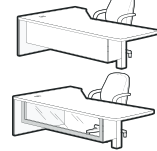
Extended Corner "P" Island - RIGHT Recessed Modesty and Post

Z4284EPRR	42 x 84 x 29.5-30	70	199.50	10.76	\$1358	\$1677	\$810	\$1015
Z3684EPRR	36 x 84 x 29.5-30	70	173.25	9.50	\$1231	\$1543	\$810	\$762
Z3672EPRR	36 x 72 x 29.5-30	70	156.45	8.76	\$1132	\$1372	\$738	\$573
Z3666EPRR	36 x 66 x 29.5-30	70	149.10	8.76	\$1103	\$1330	\$678	\$573
Z3660EPRR	36 x 60 x 29.5-30	70	140.70	6.50	\$1056	\$1266	\$620	\$477

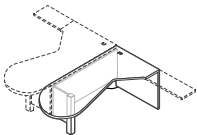
Extended island worksurface on **right**. Connects to returns or bridges with a 16" throat on the right. **Not freestanding.** Grommet in worksurface. ¾ **recessed** modesty panel is standard. Shipped RTA (ready to assemble) in 2 cartons.



Laminate Modesty:



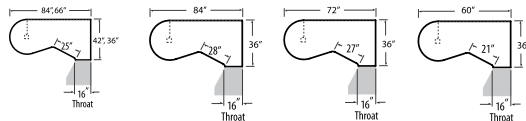
Glazed Modesty:



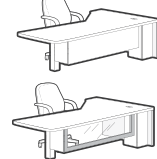
Extended Corner "P" Island - LEFT Flush Modesty and Post

Z4284EPML	42 x 84 x 29.5-30	70	200	10.76	\$1373	\$1692	\$810	\$1015
Z3684EPML	36 x 84 x 29.5-30	70	172	9.50	\$1244	\$1527	\$810	\$762
Z3672EPML	36 x 72 x 29.5-30	70	156	8.76	\$1141	\$1380	\$738	\$573
Z3666EPML	36 x 66 x 29.5-30	70	150	8.76	\$1096	\$1296	\$678	\$573
Z3660EPML	36 x 60 x 29.5-30	70	141	6.50	\$1063	\$1272	\$620	\$477

Extended island worksurface on **left**. Connects to returns or bridges with a 16" throat on the right. **Not freestanding.** Grommet in worksurface. ¾ **flush** modesty panel is standard. Shipped RTA (ready to assemble) in 2 cartons.



Laminate Modesty:



Glazed Modesty:

Required Specifications

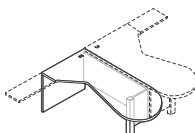
- Top finish
- Top/edge detail
- Base finish
- Monopost finish

Optional Specifications

- HP laminate
- Glazing - modesty panel
- Grommet position or power block cut-out

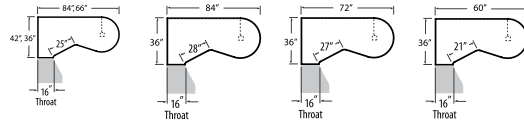
Accessories

- Power block
- Keyboard
- Pencil drawer

EXTENDED CORNER ISLANDS (WITH RECESSED MODESTY)	MODEL#	DIMENSIONS	FREIGHT CLASS	WT/LBS.	CUBIC FT.	1"TOP	1.5" TOP	GLAZE ADD	HP ADD
		D x W x H							
	Z4284EPMR	42 x 84 x 29.5-30	70	200	10.76	\$1373	\$1692	\$810	\$1015
	Z3684EPMR	36 x 84 x 29.5-30	70	172	9.50	\$1244	\$1527	\$810	\$762
	Z3672EPMR	36 x 72 x 29.5-30	70	156	8.76	\$1141	\$1380	\$738	\$573
	Z3666EPMR	36 x 66 x 29.5-30	70	150	8.76	\$1096	\$1296	\$678	\$573
Z3660EPMR	36 x 60 x 29.5-30	70	141	6.50	\$1063	\$1272	\$620	\$477	

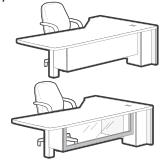
Extended Corner "P" Island - RIGHT Flush Modesty and Post

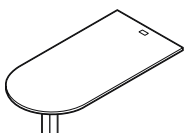
Extended island worksurface on **left**. Connects to returns or bridges with a 16" throat on the right. **Not freestanding.** Grommet in worksurface. $\frac{3}{4}$ " flush modesty panel is standard. Shipped RTA (ready to assemble) in 2 cartons.



Laminate Modesty:

Glazed Modesty:

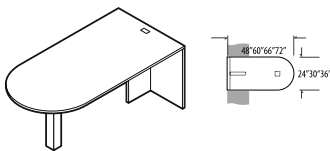


"D" ISLANDS	MODEL#	DIMENSIONS	FREIGHT CLASS	WT/LBS.	CUBIC FT.	1"TOP	1.5" TOP	GLAZE ADD	HP ADD
	Z3672I	36 x 72 x 29.5-30	70	144	8.50	\$789	\$1003	N/A	\$548
	Z3066I	29.7 x 66 x 29.5-30	70	115	7.50	\$736	\$905	N/A	\$513
	Z3060I	29.7 x 60 x 29.5-30	70	104	6.76	\$736	\$897	N/A	\$477
	Z2466I	24 x 66 x 29.5-30	85	101	7.50	\$672	\$822	N/A	\$384
	Z2460I	24 x 60 x 29.5-30	85	92	6.76	\$637	\$770	N/A	\$353
	Z2448I	24 x 48 x 29.5-30	85	74	5.76	\$589	\$707	N/A	\$281

"D" Island with Monopost

Attaches to edge of worksurfaces. Attaching hardware included. Includes grommet as shown. Shipped RTA (ready to assemble).

- Post is shipped in separate carton.

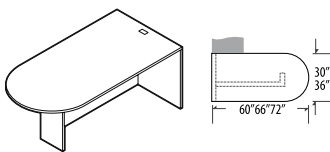


"D" Island - Full End Panel and Monopost (T-Base)

Z3672FI	36 x 72 x 29.5-30	85	123	8.50	\$967	\$1181	N/A	\$548
Z3072FI	29.7 x 72 x 29.5-30	85	106	7.50	\$967	\$1145	N/A	\$515
Z3066FI	29.7 x 66 x 29.5-30	85	101	7.50	\$880	\$1049	N/A	\$513
Z3060FI	29.7 x 60 x 29.5-30	85	94	6.76	\$827	\$988	N/A	\$477
Z2466FI	24 x 66 x 29.5-30	85	90	7.50	\$815	\$967	N/A	\$384
Z2460FI	24 x 60 x 29.5-30	85	84	6.76	\$780	\$915	N/A	\$353
Z2448FI	24 x 48 x 29.5-30	85	74	5.76	\$736	\$853	N/A	\$281

Attaches to edge of worksurfaces. Attaching hardware included. Includes grommet as shown. **Not freestanding.** Shipped RTA (ready to assemble).

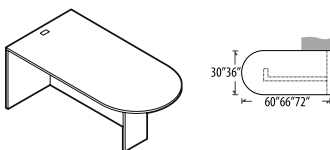
- Post is shipped in separate carton.



"D" Island LEFT - Full Modesty Panel (H-Base)

Z3672FIL	36 x 72 x 29.5-30	65	171	7	\$913	\$1127	N/A	\$548
Z3066FIL	29.7 x 66 x 29.5-30	65	140	6	\$815	\$1044	N/A	\$513
Z3060FIL	29.7 x 60 x 29.5-30	65	128	5.25	\$742	\$903	N/A	\$477

Connects to the left side of a worksurface. Attaching hardware included. Accommodates all 19" pedestals (mobile and hanging pedestals and 19.3" deep storage shells). Includes grommet as shown. Shipped RTA (ready to assemble).



"D" Island RIGHT - Full Modesty Panel (H-Base)

Z3672FIR	36 x 72 x 29.5-30	65	171	7	\$913	\$1127	N/A	\$548
Z3066FIR	29.7 x 66 x 29.5-30	65	140	6	\$815	\$1044	N/A	\$513
Z3060FIR	29.7 x 60 x 29.5-30	65	128	5.25	\$742	\$903	N/A	\$477

Connects to the right side of a worksurface. Attaching hardware included. Accommodates all 19" pedestals (mobile and hanging pedestals and 19.3" deep storage shells). Includes grommet as shown. Shipped RTA (ready to assemble).

Required Specifications

- Top finish
- Top/edge detail
- Base finish
- Monopost finish

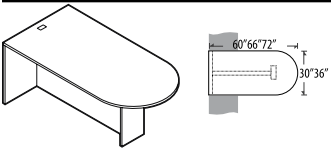
Optional Specifications

- HP laminate
- Glazing - modesty panel
- Remove standard grommet (RSG)

Accessories

- Power block
- Keyboard
- Pencil drawer

"D" ISLANDS

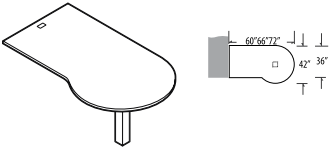


"D" Island CENTER - Full Modesty Panel (H-Base)

MODEL#	DIMENSIONS D x W x H	FREIGHT CLASS	WT./LBS.	CUBIC FT.	1" TOP	1.5" TOP	GLAZE ADD	HP ADD
Z3672FIC	36 x 72 x 29.5-30	65	171	7	\$913	\$1127	N/A	\$548
Z3066FIC	29.7 x 66 x 29.5-30	65	140	6	\$815	\$1044	N/A	\$513
Z3060FIC	29.7 x 60 x 29.5-30	65	123	5.25	\$742	\$903	N/A	\$477

Connects in between two worksurfaces. Attaching hardware included. **Will not accommodate pedestals.** Includes grommet as shown. Shipped RTA (ready to assemble).

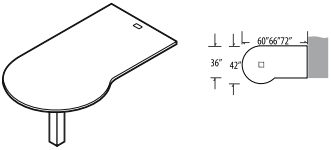
"P" ISLANDS



"P" Island LEFT with Post

MODEL#	DIMENSIONS	FREIGHT CLASS	WT./LBS.	CUBIC FT.	1" TOP	1.5" TOP	GLAZE ADD	HP ADD
Z3672IPL	42 x 72 x 29.5-30	85	128	9.26	\$899	\$1118	N/A	\$731
Z3666IPL	42 x 66 x 29.5-30	85	119	8.76	\$899	\$1068	N/A	\$731
Z3660IPL	42 x 60 x 29.5-30	85	110	8	\$815	\$984	N/A	\$623

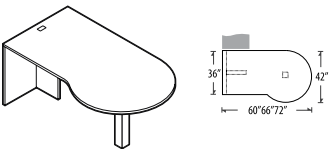
Attaches to edge of worksurfaces. Attaching hardware included. Includes grommet as shown. Shipped RTA (ready to assemble).
 • Post is shipped in separate carton.



"P" Island RIGHT with Post

Z3672IPR	42 x 72 x 29.5-30	85	128	9.26	\$899	\$1118	N/A	\$731
Z3666IPR	42 x 66 x 29.5-30	85	119	8.76	\$899	\$1068	N/A	\$731
Z3660IPR	42 x 60 x 29.5-30	85	110	8	\$815	\$984	N/A	\$623

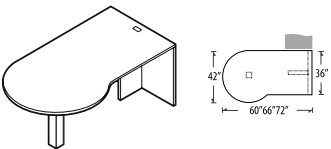
Attaches to edge of worksurfaces. Attaching hardware included. Includes grommet as shown. Shipped RTA (ready to assemble).
 • Post is shipped in separate carton.



"P" Island LEFT - Full End Panel and Post (T-Base)

Z3672FPL	42 x 72 x 29.5-30	70	163	9.26	\$1077	\$1296	N/A	\$731
Z3666FPL	42 x 66 x 29.5-30	70	155	8.76	\$1077	\$1255	N/A	\$731
Z3660FPL	42 x 60 x 29.5-30	70	145	8	\$996	\$1165	N/A	\$623

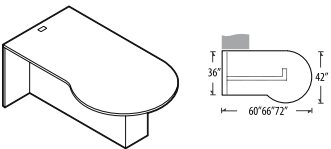
Connects to left side of worksurface. Attaching hardware included. **Not freestanding.** Includes grommet as shown. Shipped RTA (ready to assemble).
 • Post is shipped in separate carton.



"P" Island RIGHT - Full End Panel and Post (T-Base)

Z3672FPR	42 x 72 x 29.5-30	70	163	9.26	\$1077	\$1296	N/A	\$731
Z3666FPR	42 x 66 x 29.5-30	70	155	8.76	\$1077	\$1255	N/A	\$731
Z3660FPR	42 x 60 x 29.5-30	70	145	8	\$996	\$1165	N/A	\$623

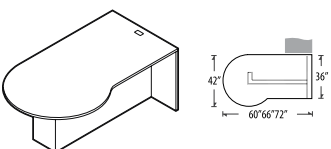
Connects to right side of worksurface. Attaching hardware included. **Not freestanding.** Includes grommet as shown. Shipped RTA (ready to assemble).
 • Post is shipped in separate carton.



"P" Island LEFT - Full Modesty Panel (H-Base)

Z3672PL	42 x 72 x 29.5-30	65	178	7.75	\$1015	\$1233	N/A	\$731
Z3666PL	42 x 66 x 29.5-30	65	167	7.25	\$926	\$1095	N/A	\$731
Z3660PL	42 x 60 x 29.5-30	65	155	6.50	\$852	\$1022	N/A	\$623

Connects to the left side of a worksurface. Attaching hardware included. Accommodates all 19" pedestals (freestanding, mobile and hanging pedestals). Includes grommet as shown. Shipped RTA (ready to assemble).



"P" Island RIGHT - Full Modesty Panel (H-Base)

Z3672PR	42 x 72 x 29.5-30	65	178	7.75	\$1015	\$1233	N/A	\$731
Z3666PR	42 x 66 x 29.5-30	65	167	7.25	\$926	\$1095	N/A	\$731
Z3660PR	42 x 60 x 29.5-30	65	155	6.50	\$852	\$1022	N/A	\$623

Connects to the left side of a worksurface. Attaching hardware included. Accommodates all 19" pedestals (freestanding, mobile and hanging pedestals). Includes grommet as shown. Shipped RTA (ready to assemble).

Required Specifications

- Top finish
- Top/edge detail
- Base finish
- Monopost finish

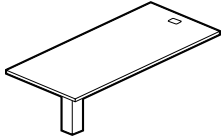
Optional Specifications

- HP laminate
- Remove standard grommet (RSG)

Accessories

- Power block
- Keyboard
- Pencil drawer

RECTANGULAR ISLANDS

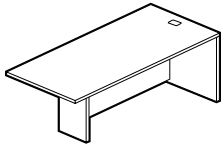


Rectangular Island w/Monopost

MODEL#	DIMENSIONS D x W x H	FREIGHT CLASS	WT/LBS.	CUBIC FT.	1" TOP	1.5" TOP	GLAZE ADD	HP ADD
Z3672RI	36 x 72 x 29.5-30	125	90	14.50	\$780	\$993	N/A	\$624
Z3066RI	30 x 66 x 29.5-30	150	72	12.50	\$728	\$895	N/A	\$513
Z3060RI	30 x 60 x 29.5-30	125	66	10.50	\$728	\$888	N/A	\$480
Z2466RI	24 x 66 x 29.5-30	150	63	15	\$664	\$820	N/A	\$384
Z2460RI	24 x 60 x 29.5-30	150	57	13	\$630	\$763	N/A	\$356
Z2448RI	24 x 48 x 29.5-30	150	47	11.50	\$586	\$706	N/A	\$285

Attaches to edge of worksurfaces. Attaching hardware included. Includes grommet as shown. Shipped RTA (ready to assemble). **Not freestanding.**

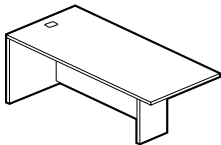
- Post is shipped in separate carton.



Rectangular Island LEFT - Full Modesty Panel (H-Base)

Z3672RFIL	36 x 72 x 29.5-30	70	145	7.25	\$904	\$1117	N/A	\$624
Z3084RFIL	29.69 x 84 x 29.5-30	70	146	7.25	\$900	\$1112	N/A	\$618
Z3066RFIL	29.69 x 66 x 29.5-30	70	121	6.25	\$807	\$1040	N/A	\$513
Z3060RFIL	29.69 x 60 x 29.5-30	70	110	5.25	\$736	\$896	N/A	\$480
Z2472RFIL	24 x 72 x 29.5-30	70	116	6.25	\$691	\$856	N/A	\$390
Z2466RFIL	24 x 66 x 29.5-30	70	109	5.75	\$656	\$823	N/A	\$384
Z2460RFIL	24 x 60 x 29.5-30	70	99	5.25	\$624	\$757	N/A	\$356
Z2448RFIL	24 x 48 x 29.5-30	70	85	4.20	\$590	\$694	N/A	\$285

Connects to the **left** side of a worksurface. Attaching hardware included. 36" and 30"D accommodates all 19" pedestals (freestanding, mobile and hanging pedestals). Includes grommet as shown. Shipped RTA (ready to assemble). **Not freestanding.**



Rectangular Island RIGHT - Full Modesty Panel (H-Base)

Z3672RFIR	36 x 72 x 29.5-30	70	145	7.25	\$904	\$1117	N/A	\$624
Z3084RFIR	29.69 x 84 x 29.5-30	70	146	7.25	\$900	\$1112	N/A	\$618
Z3066RFIR	29.69 x 66 x 29.5-30	70	121	6.25	\$807	\$1040	N/A	\$513
Z3060RFIR	29.69 x 60 x 29.5-30	70	110	5.25	\$736	\$896	N/A	\$480
Z2472RFIR	24 x 72 x 29.5-30	70	116	6.25	\$691	\$856	N/A	\$390
Z2466RFIR	24 x 66 x 29.5-30	70	109	5.75	\$656	\$823	N/A	\$384
Z2460RFIR	24 x 60 x 29.5-30	70	99	5.25	\$624	\$757	N/A	\$356
Z2448RFIR	24 x 48 x 29.5-30	70	85	4.20	\$590	\$694	N/A	\$285

Connects to the **right** side of a worksurface. Attaching hardware included. 36" and 30"D accommodates all 19" pedestals (freestanding, mobile and hanging pedestals). Includes grommet as shown. Shipped RTA (ready to assemble). **Not freestanding.**

Required Specifications

Top finish
Top/edge detail
Base finish
Monopost finish

Optional Specifications

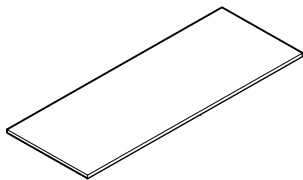
HP laminate
Remove standard grommet (RSG)

Accessories

Power block
Keyboard
Pencil drawer

UNIVERSAL TOPS

MODEL#	DIMENSIONS D x W x H	FREIGHT CLASS	WT/LBS.	CUBIC FT.	1" TOP	1.5" TOP	GLAZE ADD	HP ADD
ZUT1696	16 x 96 x 1	100	42	5	\$556	\$742	N/A	\$334
ZUT1690	16 x 90 x 1	100	39	4.75	\$525	\$700	N/A	\$310
ZUT1684	16 x 84 x 1	100	37	4.50	\$476	\$637	N/A	\$291
ZUT1678	16 x 78 x 1	100	34	4.25	\$457	\$607	N/A	\$274
ZUT1672	16 x 72 x 1	85	31	2.25	\$427	\$565	N/A	\$250
ZUT1666	16 x 66 x 1	85	29	2	\$397	\$522	N/A	\$232
ZUT1660	16 x 60 x 1	85	26	1.75	\$367	\$479	N/A	\$212
ZUT1654	16 x 54 x 1	85	24	1.75	\$329	\$436	N/A	\$186
ZUT1648	16 x 48 x 1	85	21	1.50	\$299	\$392	N/A	\$168
ZUT1642	16 x 42 x 1	85	18	1.25	\$267	\$350	N/A	\$151
ZUT1636	16 x 36 x 1	85	16	1.25	\$232	\$302	N/A	\$126
ZUT1630	16 x 30 x 1	85	13	1	\$200	\$257	N/A	\$107
ZUT1896	18 x 96 x 1	100	47	5.50	\$567	\$749	N/A	\$372
ZUT1890	18 x 90 x 1	100	44	5.25	\$538	\$706	N/A	\$353
ZUT1884	18 x 84 x 1	100	41	4.75	\$501	\$663	N/A	\$329
ZUT1878	18 x 78 x 1	100	38	4.50	\$470	\$614	N/A	\$303
ZUT1872	18 x 72 x 1	70	35	2.25	\$439	\$577	N/A	\$280
ZUT1866	18 x 66 x 1	85	32	2.25	\$401	\$527	N/A	\$261
ZUT1860	18 x 60 x 1	85	29	2	\$372	\$485	N/A	\$236
ZUT1854	18 x 54 x 1	85	26	1.75	\$334	\$441	N/A	\$212
ZUT1848	18 x 48 x 1	85	23	1.75	\$310	\$403	N/A	\$186
ZUT1842	18 x 42 x 1	85	20	1.50	\$280	\$363	N/A	\$168
ZUT1836	18 x 36 x 1	85	18	1.25	\$236	\$306	N/A	\$144
ZUT1830	18 x 30 x 1	85	15	1.25	\$206	\$264	N/A	\$119
ZUT2096	20 x 96 x 1	100	52	6	\$575	\$761	N/A	\$415
ZUT2090	20 x 90 x 1	100	49	5.50	\$545	\$720	N/A	\$390
ZUT2084	20 x 84 x 1	100	45	5.25	\$507	\$668	N/A	\$367
ZUT2078	20 x 78 x 1	100	42	4.75	\$447	\$597	N/A	\$341
ZUT2072	20 x 72 x 1	70	39	2.50	\$447	\$585	N/A	\$310
ZUT2066	20 x 66 x 1	70	36	2.25	\$409	\$540	N/A	\$285
ZUT2060	20 x 60 x 1	85	32	2.25	\$377	\$489	N/A	\$261
ZUT2054	20 x 54 x 1	85	29	2	\$348	\$449	N/A	\$236
ZUT2048	20 x 48 x 1	85	26	1.75	\$318	\$405	N/A	\$212
ZUT2042	20 x 42 x 1	70	23	1.50	\$285	\$361	N/A	\$186
ZUT2036	20 x 36 x 1	85	20	1.50	\$242	\$312	N/A	\$157
ZUT2030	20 x 30 x 1	85	16	1.25	\$212	\$270	N/A	\$132
ZUT2496	24 x 96 x 1	100	62	6.75	\$661	\$879	N/A	\$495
ZUT2490	24 x 90 x 1	100	58	6.25	\$624	\$830	N/A	\$465
ZUT2484	24 x 84 x 1	100	55	6	\$580	\$773	N/A	\$434
ZUT2478	24 x 78 x 1	100	51	5.50	\$545	\$726	N/A	\$401
ZUT2472	24 x 72 x 1	100	47	5.25	\$507	\$664	N/A	\$372
ZUT2466	24 x 66 x 1	100	43	4.75	\$470	\$627	N/A	\$341
ZUT2460	24 x 60 x 1	100	39	4.50	\$434	\$571	N/A	\$310
ZUT2454	24 x 54 x 1	100	35	4	\$397	\$522	N/A	\$280
ZUT2448	24 x 48 x 1	70	31	2	\$359	\$471	N/A	\$250
ZUT2442	24 x 42 x 1	70	27	1.75	\$318	\$419	N/A	\$219
ZUT2436	24 x 36 x 1	70	23	1.50	\$280	\$368	N/A	\$186
ZUT2430	24 x 30 x 1	85	20	1.50	\$242	\$312	N/A	\$157



Laminate Tops

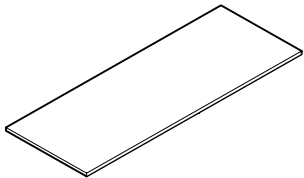
Laminate tops for placement over Zira storage.

- Contact Global for pricing on special size tops.
- No drilling or hardware included.

Required Specifications

- Top finish
- Top/edge detail
- Leg finish

UNIVERSAL TOPS	MODEL#	DIMENSIONS	FREIGHT CLASS	WT/LBS.	CUBIC FT.	1" TOP	1.5" TOP	GLAZE ADD	HP ADD
		D x W x H							
ZUT3096		29.7 x 96 x 1	100	77	8	\$778	\$1056	N/A	\$617
ZUT3090		29.7 x 90 x 1	100	72	7.50	\$735	\$996	N/A	\$580
ZUT3084		29.7 x 84 x 1	100	67	7.25	\$692	\$934	N/A	\$545
ZUT3078		29.7 x 78 x 1	100	62	6.75	\$642	\$866	N/A	\$507
ZUT3072		29.7 x 72 x 1	100	58	6.25	\$624	\$834	N/A	\$465
ZUT3066		29.7 x 66 x 1	100	53	5.75	\$556	\$742	N/A	\$427
ZUT3060		29.7 x 60 x 1	100	48	5.25	\$513	\$681	N/A	\$390
ZUT3054		29.7 x 54 x 1	100	43	4.75	\$470	\$620	N/A	\$353
ZUT3048		29.7 x 48 x 1	70	38	2.50	\$422	\$566	N/A	\$310
ZUT3042		29.7 x 42 x 1	70	34	2.25	\$377	\$496	N/A	\$274
ZUT3036		29.7 x 36 x 1	85	29	2	\$329	\$436	N/A	\$236
ZUT3030		29.7 x 30 x 1	85	24	1.75	\$285	\$373	N/A	\$200
ZUT3696		36 x 96 x 1	92.5	93	9.25	\$907	\$1235	N/A	\$740
ZUT3690		36 x 90 x 1	100	87	8.75	\$852	\$1162	N/A	\$698
ZUT3684		36 x 84 x 1	100	81	8.25	\$785	\$1076	N/A	\$648
ZUT3678		36 x 78 x 1	100	76	7.75	\$748	\$1013	N/A	\$604
ZUT3672		36 x 72 x 1	100	70	7.25	\$698	\$946	N/A	\$556
ZUT3666		36 x 66 x 1	100	64	6.75	\$630	\$853	N/A	\$513
ZUT3660		36 x 60 x 1	100	58	6.25	\$587	\$793	N/A	\$465
ZUT3654		36 x 54 x 1	100	52	5.50	\$545	\$726	N/A	\$422
ZUT3648		36 x 48 x 1	100	47	5	\$489	\$657	N/A	\$372
ZUT3642		36 x 42 x 1	100	41	4.50	\$439	\$583	N/A	\$329
ZUT3636		36 x 36 x 1	100	35	4	\$385	\$510	N/A	\$280
ZUT3630		36 x 30 x 1	100	29	3.50	\$329	\$436	N/A	\$236
ZUT4296		42 x 96 x 1	92.5	108	10	\$1024	\$1408	N/A	\$864
ZUT4290		42 x 90 x 1	92.5	102	10	\$967	\$1326	N/A	\$815
ZUT4284		42 x 84 x 1	92.5	95	9.50	\$888	\$1222	N/A	\$760
ZUT4278		42 x 78 x 1	92.5	88	8.75	\$852	\$1162	N/A	\$704
ZUT4272		42 x 72 x 1	100	81	8.25	\$790	\$1081	N/A	\$648
ZUT4266		42 x 66 x 1	92.5	75	7.50	\$735	\$996	N/A	\$600
ZUT4260		42 x 60 x 1	100	68	7	\$673	\$915	N/A	\$545
ZUT4254		42 x 54 x 1	100	61	6.25	\$613	\$831	N/A	\$489
ZUT4248		42 x 48 x 1	100	54	5.75	\$556	\$750	N/A	\$434
ZUT4242		42 x 42 x 1	100	48	5.25	\$495	\$663	N/A	\$385
ZUT4236		42 x 36 x 1	100	41	4.50	\$422	\$608	N/A	\$329
ZUT4230		42 x 30 x 1	100	34	4	\$341	\$467	N/A	\$274
ZUT4896		48 x 96 x 1	92.5	124	11.25	\$1153	\$1592	N/A	\$987
ZUT4890		48 x 90 x 1	92.5	116	10.50	\$1092	\$1500	N/A	\$926
ZUT4884		48 x 84 x 1	92.5	108	10.50	\$1018	\$1402	N/A	\$864
ZUT4878		48 x 78 x 1	92.5	101	10	\$950	\$1303	N/A	\$802
ZUT4872		48 x 72 x 1	92.5	93	9.25	\$888	\$1217	N/A	\$740
ZUT4866		48 x 66 x 1	92.5	85	8.50	\$819	\$1122	N/A	\$680
ZUT4860		48 x 60 x 1	92.5	77	7.25	\$760	\$1034	N/A	\$617
ZUT4854		48 x 54 x 1	100	70	7.25	\$692	\$940	N/A	\$556
ZUT4848		48 x 48 x 1	100	62	6.50	\$617	\$841	N/A	\$495
ZUT4842		48 x 42 x 1	100	54	5.75	\$556	\$750	N/A	\$434
ZUT4836		48 x 36 x 1	100	47	5	\$489	\$651	N/A	\$372
ZUT4830		48 x 30 x 1	100	36	4.25	\$415	\$553	N/A	\$310



Laminate Tops

Laminate tops for placement over Zira storage.

- Contact Global for pricing on special size tops.
- **No drilling or hardware included.**

Required Specifications

Top finish
Top/edge detail

Optional Specifications

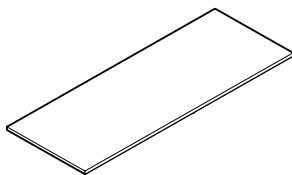
HP laminate
Grommet position or power block cut-out

Accessories

Power block

UNIVERSAL TOPS

MODEL#	DIMENSIONS D x W x H	FREIGHT CLASS	WT/LBS.	CUBIC FT.	1" TOP	1.5" TOP	GLAZE ADD	HP ADD
ZUT5496	54 x 96 x 1	92.5	139	12.50	\$1281	\$1770	N/A	\$1110
ZUT5490	54 x 90 x 1	92.5	131	11.75	\$1208	\$1672	N/A	\$1043
ZUT5484	54 x 84 x 1	92.5	122	11	\$1141	\$1573	N/A	\$976
ZUT5478	54 x 78 x 1	92.5	113	10.25	\$1074	\$1470	N/A	\$907
ZUT5472	54 x 72 x 1	92.5	105	9.50	\$999	\$1371	N/A	\$832
ZUT5466	54 x 66 x 1	92.5	96	9.50	\$931	\$1265	N/A	\$766
ZUT5460	54 x 60 x 1	100	87	8.75	\$857	\$1166	N/A	\$698
ZUT5454	54 x 54 x 1	100	78	8	\$766	\$1044	N/A	\$630
ZUT5448	54 x 48 x 1	100	70	7.25	\$692	\$940	N/A	\$556
ZUT5442	54 x 42 x 1	100	61	6.25	\$613	\$831	N/A	\$489
ZUT5436	54 x 36 x 1	100	52	5.50	\$470	\$651	N/A	\$422
ZUT5430	54 x 30 x 1	100	44	4.75	\$470	\$627	N/A	\$353
ZUT6096	60 x 96 x 1	92.5	155	14	\$1411	\$1954	N/A	\$1232
ZUT6090	60 x 90 x 1	92.5	145	13	\$1330	\$1843	N/A	\$1158
ZUT6084	60 x 84 x 1	92.5	135	12.25	\$1251	\$1733	N/A	\$1079
ZUT6078	60 x 78 x 1	92.5	126	11.50	\$1178	\$1623	N/A	\$1005
ZUT6072	60 x 72 x 1	92.5	116	10.50	\$1079	\$1487	N/A	\$926
ZUT6066	60 x 66 x 1	92.5	106	9.75	\$999	\$1376	N/A	\$852
ZUT6060	60 x 60 x 1	92.5	97	8.75	\$926	\$1267	N/A	\$772
ZUT6054	60 x 54 x 1	100	87	8.75	\$857	\$1166	N/A	\$698
ZUT6048	60 x 48 x 1	100	77	7.75	\$760	\$1034	N/A	\$617
ZUT6042	60 x 42 x 1	100	68	7	\$673	\$915	N/A	\$545
ZUT6036	60 x 36 x 1	100	58	6.25	\$617	\$823	N/A	\$465
ZUT6030	60 x 30 x 1	100	49	5.25	\$513	\$681	N/A	\$390

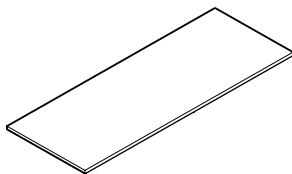


Laminate Tops

Laminate tops for placement over Zira storage.

- Contact Global for pricing on special size tops.
- No drilling or hardware included.

ZPHAT2370	23 x 70 x 1	100	39	4.5	\$501	\$663	N/A	\$348
ZPHAT2364	23 x 64 x 1	100	39	4.5	\$457	\$614	N/A	\$322
ZPHAT2358	23 x 58 x 1	70	35	2.25	\$422	\$560	N/A	\$291
ZPHAT2352	23 x 52 x 1	70	32	2	\$385	\$510	N/A	\$261
ZPHAT2346	23 x 46 x 1	85	29	2	\$348	\$460	N/A	\$232
ZPHAT2340	23 x 40 x 1	85	25	1.75	\$310	\$403	N/A	\$200
ZPHAT2334	23 x 34 x 1	85	21	1.5	\$274	\$357	N/A	\$175
ZPHAT2970	29 x 70 x 1	100	43	5	\$593	\$799	N/A	\$439
ZPHAT2964	29 x 64 x 1	100	49	5.5	\$550	\$735	N/A	\$801
ZPHAT2958	29 x 58 x 1	100	45	5	\$501	\$676	N/A	\$367
ZPHAT2952	29 x 52 x 1	70	40	2.5	\$457	\$614	N/A	\$329
ZPHAT2946	29 x 46 x 1	70	35	2.25	\$415	\$553	N/A	\$291
ZPHAT2940	29 x 40 x 1	70	31	2	\$367	\$492	N/A	\$255
ZPHAT2934	29 x 34 x 1	85	26	1.75	\$322	\$429	N/A	\$219



Laminate Tops

Laminate tops for placement over height adjustable tables.

- Contact Global for pricing on special size tops.
- No drilling or hardware included.

Required Specifications

Top finish
Top/edge detail

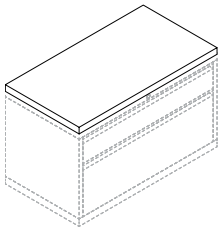
Optional Specifications

HP laminate
Grommet position or power block cut-out

Accessories

Power block

UNIVERSAL TOPS	MODEL#	DIMENSIONS	FREIGHT CLASS	WT/LBS.	CUBIC FT.	1" TOP	1.5" TOP	GLAZE ADD	HP ADD
		D x W x H							
	ZUFT1896	18.11 x 96.10 x 1	100	47	5.50	\$567	\$749	N/A	\$377
	ZUFT1890	18.11 x 90.12 x 1	100	44	5.25	\$538	\$706	N/A	\$353
	ZUFT1884	18.11 x 84.09 x 1	100	41	4.75	\$501	\$663	N/A	\$329
	ZUFT1878	18.11 x 78.11 x 1	100	38	4.50	\$470	\$614	N/A	\$310
	ZUFT1872	18.11 x 72.13 x 1	70	35	2.25	\$439	\$577	N/A	\$285
	ZUFT1866	18.11 x 66.10 x 1	85	32	2.25	\$401	\$527	N/A	\$261
	ZUFT1860	18.11 x 60.12 x 1	85	29	2	\$372	\$485	N/A	\$236
	ZUFT1854	18.11 x 54.09 x 1	70	27	1.75	\$334	\$441	N/A	\$219
	ZUFT1848	18.11 x 48.11 x 1	85	24	1.75	\$299	\$400	N/A	\$194
	ZUFT1842	18.11 x 42.13 x 1	85	21	1.50	\$267	\$354	N/A	\$168
	ZUFT1836	18.11 x 36.10 x 1	85	18	1.25	\$236	\$294	N/A	\$144
	ZUFT1830	18.11 x 30.12 x 1	85	15	1.25	\$206	\$264	N/A	\$119
	ZUFT1996	19.25 x 96.10 x 1	100	50	5.75	\$575	\$761	N/A	\$401
	ZUFT1990	19.25 x 90.12 x 1	100	47	5.50	\$545	\$720	N/A	\$377
	ZUFT1984	19.25 x 84.09 x 1	100	44	5	\$507	\$668	N/A	\$353
	ZUFT1978	19.25 x 78.11 x 1	100	41	4.75	\$476	\$626	N/A	\$329
	ZUFT1972	19.25 x 72.13 x 1	70	38	2.50	\$447	\$585	N/A	\$303
	ZUFT1966	19.25 x 66.10 x 1	70	34	2.25	\$409	\$535	N/A	\$280
	ZUFT1960	19.25 x 60.12 x 1	70	31	2	\$377	\$489	N/A	\$255
	ZUFT1954	19.25 x 54.09 x 1	85	27	2	\$348	\$449	N/A	\$232
	ZUFT1948	19.25 x 48.11 x 1	85	25	1.75	\$310	\$403	N/A	\$206
	ZUFT1942	19.25 x 42.13 x 1	85	22	1.50	\$280	\$363	N/A	\$182
	ZUFT1936	19.25 x 36.10 x 1	70	19	1.25	\$242	\$312	N/A	\$157
	ZUFT1930	19.25 x 30.12 x 1	85	16	1.25	\$212	\$270	N/A	\$132

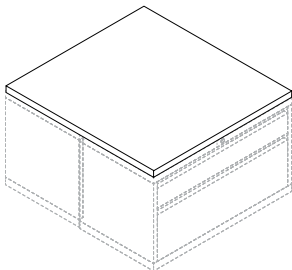


Lateral File Tops

Laminate tops for placement over 1900 Series Lateral Files + Storage. **No drilling or hardware included.**

- Contact Global for pricing on special size tops.

ZUFT3696	36.14 x 96.10 x 1	100	93	9.50	\$907	\$1235	N/A	\$748
ZUFT3690	36.14 x 90.12 x 1	92.5	88	8.75	\$852	\$1162	N/A	\$704
ZUFT3684	36.14 x 84.09 x 1	92.5	82	7.75	\$785	\$1076	N/A	\$654
ZUFT3678	36.14 x 78.11 x 1	100	76	7.75	\$748	\$1013	N/A	\$613
ZUFT3672	36.14 x 72.13 x 1	100	70	7.25	\$698	\$920	N/A	\$563
ZUFT3666	36.14 x 66.10 x 1	100	64	6.75	\$630	\$853	N/A	\$513
ZUFT3660	36.14 x 60.12 x 1	100	59	6.25	\$587	\$793	N/A	\$470
ZUFT3654	36.14 x 54.09 x 1	100	53	5.50	\$545	\$726	N/A	\$422
ZUFT3648	36.14 x 48.11 x 1	100	47	5	\$489	\$657	N/A	\$377
ZUFT3642	36.14 x 42.13 x 1	100	41	4.50	\$439	\$583	N/A	\$329
ZUFT3636	36.14 x 36.10 x 1	70	35	2.25	\$385	\$510	N/A	\$285
ZUFT3630	36.14 x 30.12 x 1	85	29	2	\$334	\$436	N/A	\$236
ZUFT3896	38.62 x 96.10 x 1	92.5	100	10	\$1011	\$1395	N/A	\$796
ZUFT3890	38.62 x 90.12 x 1	100	94	9.50	\$950	\$1309	N/A	\$748
ZUFT3884	38.62 x 84.09 x 1	100	87	8.75	\$894	\$1228	N/A	\$698
ZUFT3878	38.62 x 78.11 x 1	100	81	8.25	\$832	\$1150	N/A	\$648
ZUFT3872	38.62 x 72.13 x 1	100	75	7.75	\$778	\$1063	N/A	\$600
ZUFT3866	38.62 x 66.10 x 1	100	69	7	\$717	\$982	N/A	\$550
ZUFT3860	38.62 x 60.12 x 1	100	62	6.50	\$661	\$901	N/A	\$501
ZUFT3854	38.62 x 54.09 x 1	100	56	6	\$604	\$816	N/A	\$451
ZUFT3848	38.62 x 48.11 x 1	100	50	5.25	\$545	\$738	N/A	\$401
ZUFT3842	38.62 x 42.13 x 1	100	44	4.75	\$483	\$657	N/A	\$353
ZUFT3836	38.62 x 36.10 x 1	100	38	4.25	\$427	\$569	N/A	\$303
ZUFT3830	38.62 x 30.12 x 1	100	31	3.75	\$367	\$492	N/A	\$255



Lateral File Tops - Back to Back

Laminate tops for placement over back-to-back metal filing + storage. **No drilling or hardware included.**

- Use ZUFT36xx models for 18" D laterals back-to-back
- Use ZUFT38xx models for 19.25" D laterals back-to-back
- Contact Global for pricing on special size tops.

Required Specifications

Top finish
Top/edge detail

Optional Specifications

HP laminate
Grommet position or power block cut-out

Accessories

Power block

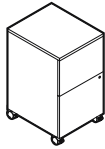
FILE TOPS



Mobile Pedestal with Overhang*

MODEL#	DIMENSIONS D x W x H	FREIGHT CLASS	WT/LBS.	CUBIC FT.	1" TOP	1.5" TOP	GLAZE ADD	HP ADD
ZMPFF28	29 x 16 x 28	92.5	106	10.25	\$1286	N/A	N/A	\$223
ZMPFF22	23 x 16 x 28	92.5	95	8.25	\$1221	N/A	N/A	\$223

File/File drawers on fully progressive ball bearing slides, accommodate letter and legal size hanging files. Pedestal top features 1" overhang with built-in grip for ease of mobility. Includes counterweight to prevent tipping. Drawers are locking. Only front casters are locking.



Mobile Pedestal*

ZMPFF19	19 x 16 x 28	85	97	7.25	\$1155	N/A	N/A	\$223
---------	--------------	----	----	------	--------	-----	-----	-------

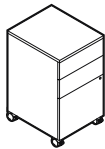
File/File drawers on fully progressive ball bearing slides, accommodate letter and legal size hanging files. Drawers are locking. Only front casters are locking.



Mobile Pedestal with Overhang*

ZMPBBF28	29 x 16 x 28	92.5	105	10.25	\$1179	N/A	N/A	\$223
ZMPBBF22	23 x 16 x 28	92.5	92	8.25	\$1134	N/A	N/A	\$221

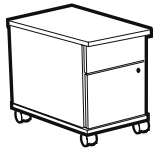
Box/Box/File drawers on fully progressive ball bearing slides, accommodate letter and legal size hanging files. Pedestal top features 1" overhang with built-in grip for ease of mobility. Includes counterweight to prevent tipping. File drawer and lower box drawer are locking. Only front casters are locking.



Mobile Pedestal*

ZMPBBF19	19 x 16 x 28	85	96	7.25	\$1076	N/A	N/A	\$223
----------	--------------	----	----	------	--------	-----	-----	-------

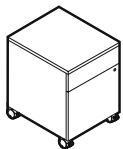
Box/Box/File drawers on fully progressive ball bearing slides, accommodate letter and legal size hanging files. File drawer and lower box drawer are locking. Only front casters are locking.



Mobile Pedestal with Overhang*

ZMPBF28	29 x 16 x 22	92.5	83	8.25	\$1036	N/A	N/A	\$223
ZMPBF22	23 x 16 x 22	92.5	73	6.75	\$1010	N/A	N/A	\$223

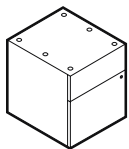
Box/File drawers on fully progressive ball bearing slides, accommodate letter and legal size hanging files. Pedestal top features 1" overhang with built-in grip for ease of mobility. Includes counterweight to prevent tipping. Drawers are locking. Only front casters are locking.



Mobile Pedestal*

ZMPBF19	19 x 16 x 22	85	77	6.25	\$949	N/A	N/A	\$223
---------	--------------	----	----	------	-------	-----	-----	-------

Box/File drawers on fully progressive ball bearing slides, accommodate letter and legal size hanging files. Drawers are locking. Only front casters are locking.



Hanging Pedestal

ZHPBF18	19 x 16 x 18	92.5	48	4.50	\$706	N/A	N/A	N/A
---------	--------------	------	----	------	-------	-----	-----	-----

Box/File drawers on fully progressive ball bearing slides, accommodate letter and legal size hanging files. Drawers are locking.

Required Specifications

Top finish
Top/edge detail

Optional Specifications

HP laminate
Grommet position or power block cut-out

Accessories

Power block

PEDESTALS	MODEL#	DIMENSIONS	FREIGHT CLASS	WT/LBS.	CUBIC FT.	1" TOP	1.5" TOP	GLAZE ADD	HP ADD
-----------	--------	------------	---------------	---------	-----------	--------	----------	-----------	--------

D x W x H

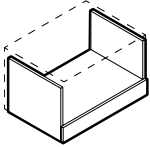
Required Specifications

Top finish
Base finish
Lock finish

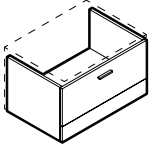
Optional Specifications

HP laminate*
Handles

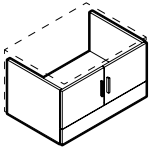
STORAGE SHELLS - 16.87" HIGH



Open Storage Shell

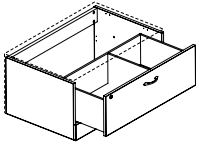


Lateral File Shell

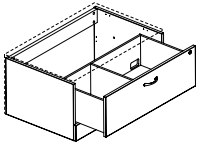


Glazed door option

Closed Storage Shell**



Split Drawer Storage Shell* - LEFT



Split Drawer Storage Shell* - RIGHT

MODEL#	DIMENSIONS D x W x H	FREIGHT CLASS	WT/LBS.	CUBIC FT.	1" TOP	1.5" TOP	GLAZE ADD	HP ADD
Z36L21SNS	24 x 36 x 16.87	150	62	11.25	\$639	N/A	N/A	N/A
Z30L21SNS	24 x 30 x 16.87	150	55	9.50	\$573	N/A	N/A	N/A
Z36M21SNS	20 x 36 x 16.87	150	56	9.50	\$589	N/A	N/A	N/A
Z30M21SNS	20 x 30 x 16.87	125	49	8	\$526	N/A	N/A	N/A

For use under Zxxxx1TB 17.37" H top and back kit. **No top or back.**

Z36L21ES	24 x 36 x 16.87	125	82	11.25	\$935	N/A	N/A	N/A
Z30L21ES	24 x 30 x 16.87	100	77	9.50	\$816	N/A	N/A	N/A
Z36M21ES	20 x 36 x 16.87	100	78	9.50	\$901	N/A	N/A	N/A
Z30M21ES	20 x 30 x 16.87	100	73	8	\$780	N/A	N/A	N/A

For use under Zxxxx1TB 17.37" H top and back kit. **No top or back.** For filing capabilities, see page 121.

- Lateral file drawer construction is for accommodating hanging files NOT for stacking materials on the drawer bottom.

Z36L21SHS	24 x 36 x 16.87	125	71	11.25	\$850	N/A	\$407	N/A
Z30L21SHS	24 x 30 x 16.87	125	62	9.50	\$767	N/A	\$362	N/A
Z36M21SHS	20 x 36 x 16.87	125	65	9.50	\$801	N/A	\$407	N/A
Z30M21SHS	20 x 30 x 16.87	125	57	8	\$722	N/A	\$361	N/A

For use under Zxxxx1TB 17.37" H top and back kit. **No top or back.** Laminate doors are standard. Standard with lock.

Z36L21XSL	24 x 36 x 16.87	125	81	11.25	\$866	N/A	N/A	N/A
Z30L21XSL	24 x 30 x 16.87	125	72	9.50	\$790	N/A	N/A	N/A
Z36M21XSL	20 x 36 x 16.87	100	78	9.50	\$831	N/A	N/A	N/A
Z30M21XSL	20 x 30 x 16.87	100	69	8	\$756	N/A	N/A	N/A

For use under Zxxxx1TB 17.37" H top and back kit. **No top or back.** Pull out drawer includes filing space on **left** and storage on **right**. Front-to-back letter capability.

- Lateral file drawer construction is for accommodating hanging files NOT for stacking materials on the drawer bottom.

Z36L21XSR	24 x 36 x 16.87	125	81	11.25	\$866	N/A	N/A	N/A
Z30L21XSR	24 x 30 x 16.87	125	72	9.50	\$790	N/A	N/A	N/A
Z36M21XSR	20 x 36 x 16.87	100	78	9.50	\$831	N/A	N/A	N/A
Z30M21XSR	20 x 30 x 16.87	100	69	8	\$756	N/A	N/A	N/A

For use under Zxxxx1TB 17.37" H top and back kit. **No top or back.** Pull out drawer includes filing space on **right** and storage on **left**. Front-to-back letter capability.

- Lateral file drawer construction is for accommodating hanging files NOT for stacking materials on the drawer bottom.

Required Specifications

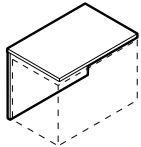
Base finish
Handles*

Optional Specifications

Key #*
Glazed doors**

TOP AND BACK KITS FOR 16.87" H SHELLS

MODEL#	DIMENSIONS D x W x H	FREIGHT CLASS	WT/LBS.	CUBIC FT.	1" TOP	1.5" TOP	GLAZE ADD	HP ADD
Z24961TB	24 x 96 x 17.37-17.87	70	104	6.75	\$802	\$979	N/A	\$520
Z24901TB	24 x 90 x 17.37-17.87	70	97	6.25	\$762	\$927	N/A	\$488
Z24841TB	24 x 84 x 17.37-17.87	70	91	6	\$717	\$873	N/A	\$454
Z24781TB	24 x 78 x 17.37-17.87	70	86	5.50	\$672	\$814	N/A	\$423
Z24721TB	24 x 72 x 17.37-17.87	85	78	5.25	\$624	\$757	N/A	\$390
Z24661TB	24 x 66 x 17.37-17.87	70	72	4.75	\$577	\$700	N/A	\$358
Z24601TB	24 x 60 x 17.37-17.87	85	66	4.50	\$529	\$640	N/A	\$327
Z24541TB	24 x 54 x 17.37-17.87	85	59	4	\$479	\$580	N/A	\$294
Z24481TB	24 x 48 x 17.37-17.87	85	55	3.75	\$441	\$530	N/A	\$261
Z24421TB	24 x 42 x 17.37-17.87	85	47	3.25	\$390	\$470	N/A	\$229
Z24361TB	24 x 36 x 17.37-17.87	85	40	3	\$337	\$406	N/A	\$197
Z24301TB	24 x 30 x 17.37-17.87	85	34	2.50	\$291	\$348	N/A	\$164
Z20961TB	20 x 96 x 17.37-17.87	70	93	6	\$739	\$885	N/A	\$434
Z20901TB	20 x 90 x 17.37-17.87	70	86	5.50	\$693	\$831	N/A	\$407
Z20841TB	20 x 84 x 17.37-17.87	70	76	4.75	\$652	\$782	N/A	\$378
Z20781TB	20 x 78 x 17.37-17.87	70	80	5.25	\$616	\$736	N/A	\$353
Z20721TB	20 x 72 x 17.37-17.87	70	69	4.50	\$570	\$681	N/A	\$327
Z20661TB	20 x 66 x 17.37-17.87	70	64	4.25	\$526	\$628	N/A	\$299
Z20601TB	20 x 60 x 17.37-17.87	70	58	3.75	\$484	\$577	N/A	\$273
Z20541TB	20 x 54 x 17.37-17.87	70	53	3.50	\$442	\$527	N/A	\$246
Z20481TB	20 x 48 x 17.37-17.87	70	50	3.25	\$407	\$482	N/A	\$219
Z20421TB	20 x 42 x 17.37-17.87	70	42	2.75	\$358	\$424	N/A	\$189
Z20361TB	20 x 36 x 17.37-17.87	85	35	2.50	\$309	\$366	N/A	\$164
Z20301TB	20 x 30 x 17.37-17.87	85	28	2.25	\$265	\$312	N/A	\$138



Credenza Top and Back Kit

For use with 16.87" high storage shells. Shipped RTA (ready to assemble).

- Does not include hardware to attach to storage shells.

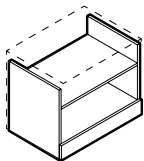
Required Specifications

Top finish
Top/edge detail
Base finish

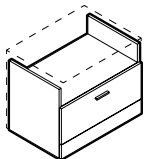
Optional Specifications

HP laminate

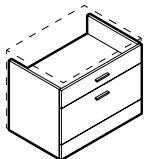
STORAGE SHELLS - 22.75" HIGH



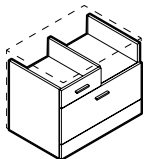
1.5H Open Storage Shell



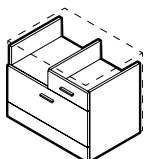
1.5H Open/Lateral File Shell*



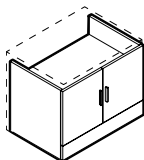
1.5H Box/Lateral File Shell*



1.5H Mixed Storage Shell - LEFT*



1.5H Mixed Storage Shell - RIGHT*



Glazed door option

1.5H Closed Storage Shell**

MODEL#	DIMENSIONS D x W x H	FREIGHT CLASS	WT./LBS.	CUBIC FT.	1" TOP	1.5" TOP	GLAZE ADD	HP ADD
Z36L2HSHNS	24 x 36 x 22.75	150	83	14.50	\$791	N/A	N/A	N/A
Z30L2HSHNS	24 x 30 x 22.75	125	75	12.25	\$715	N/A	N/A	N/A
Z24L2HSHNS	24 x 24 x 22.75	125	66	10	\$636	N/A	N/A	N/A
Z36M2HSHNS	20 x 36 x 22.75	150	73	12.25	\$722	N/A	N/A	N/A
Z30M2HSHNS	20 x 30 x 22.75	125	64	10.50	\$645	N/A	N/A	N/A
Z24M2HSHNS	20 x 24 x 22.75	125	55	8.50	\$576	N/A	N/A	N/A

For use under ZxxxxHTB 23.25" H top and back kit. **No top or back.**

Z36L2HFS	24 x 36 x 22.75	125	102	14.50	\$1087	N/A	N/A	N/A
Z30L2HFS	24 x 30 x 22.75	125	97	12.25	\$957	N/A	N/A	N/A
Z36M2HFS	20 x 36 x 22.75	125	95	12.25	\$1034	N/A	N/A	N/A
Z30M2HFS	20 x 30 x 22.75	100	88	10.50	\$900	N/A	N/A	N/A

For use under ZxxxxHTB 23.25" H top and back kit. **No top or back.** Open shelf and lateral file storage. For filing capabilities, see page 121.

- Lateral file drawer construction is for accommodating hanging files NOT for stacking materials on the drawer bottom

Z36L2HES	24 x 36 x 22.75	125	103	14.50	\$1143	N/A	N/A	N/A
Z30L2HES	24 x 30 x 22.75	100	99	12.25	\$1015	N/A	N/A	N/A
Z36M2HES	20 x 36 x 22.75	100	98	12.25	\$1105	N/A	N/A	N/A
Z30M2HES	20 x 30 x 22.75	100	92	10.50	\$969	N/A	N/A	N/A

For use under ZxxxxHTB 23.25" H top and back kit. **No top or back.** Box drawer and lateral file storage. For filing capabilities, see page 121.

- Lateral file drawer construction is for accommodating hanging files NOT for stacking materials on the drawer bottom

Z36L2HXSL	24 x 36 x 22.75	125	110	14.50	\$1232	N/A	N/A	N/A
Z30L2HXSL	24 x 30 x 22.75	100	105	12.25	\$1104	N/A	N/A	N/A
Z36M2HXSL	20 x 36 x 22.75	100	104	12.25	\$1164	N/A	N/A	N/A
Z30M2HXSL	20 x 30 x 22.75	100	97	10.50	\$1030	N/A	N/A	N/A

For use under ZxxxxHTB 23.25" H top and back kit. **No top or back.** Open shelf on **right**, box drawer on **left** and lateral file storage below. For filing capabilities, see page 121.

- Lateral file drawer construction is for accommodating hanging files NOT for stacking materials on the drawer bottom

Z36L2HXSR	24 x 36 x 22.75	125	110	14.50	\$1232	N/A	N/A	N/A
Z30L2HXSR	24 x 30 x 22.75	100	105	12.25	\$1104	N/A	N/A	N/A
Z36M2HXSR	20 x 36 x 22.75	100	104	12.25	\$1164	N/A	N/A	N/A
Z30M2HXSR	20 x 30 x 22.75	100	97	10.50	\$1030	N/A	N/A	N/A

For use under ZxxxxHTB 23.25" H top and back kit. **No top or back.** Open shelf on **left**, box drawer on **right** and lateral file storage below. For filing capabilities, see page 121.

- Lateral file drawer construction is for accommodating hanging files NOT for stacking materials on the drawer bottom

Z36L2HSHS	24 x 36 x 22.75	125	96	14.50	\$1044	N/A	\$505	N/A
Z30L2HSHS	24 x 30 x 22.75	125	86	12.25	\$943	N/A	\$449	N/A
Z36M2HSHS	20 x 36 x 22.75	125	86	12.25	\$976	N/A	\$505	N/A
Z30M2HSHS	20 x 30 x 22.75	125	75	10.50	\$873	N/A	\$449	N/A

For use under ZxxxxHTB 23.25" H top and back kit. **No top or back.** Laminate doors are standard. Standard with lock.

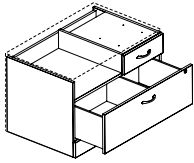
Required Specifications

Base finish
Handles*

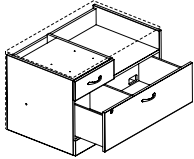
Optional Specifications

Key #*
Glazed doors**

STORAGE SHELLS - 22.75" HIGH



1.5H Split Drawer Storage Shell* - LEFT



1.5H Split Drawer Storage Shell* - RIGHT

MODEL#	DIMENSIONS D x W x H	FREIGHT CLASS	WT/LBS.	CUBIC FT.	1" TOP	1.5" TOP	GLAZE ADD	HP ADD
Z36L2HCSL	24 x 36 x 22.75	125	110	14.50	\$1174	N/A	N/A	N/A
Z30L2HCSL	24 x 30 x 22.75	100	101	12.25	\$1095	N/A	N/A	N/A
Z36M2HCSL	20 x 36 x 22.75	100	104	12.25	\$1104	N/A	N/A	N/A
Z30M2HCSL	20 x 30 x 22.75	100	92	10.50	\$1019	N/A	N/A	N/A

For use **under ZxxxxHTB 23.25" H** top and back kit. **No top or back.** Open shelf on **right**, box drawer on **left**. Pull out drawer includes filing space on **left** and storage on **right**. Front-to-back letter capability.

- Lateral file drawer construction is for accommodating hanging files **NOT** for stacking materials on the drawer bottom.

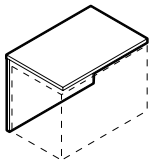
Z36L2HCSR	24 x 36 x 22.75	125	110	14.50	\$1174	N/A	N/A	N/A
Z30L2HCSR	24 x 30 x 22.75	100	101	12.25	\$1095	N/A	N/A	N/A
Z36M2HCSR	20 x 36 x 22.75	100	104	12.25	\$1104	N/A	N/A	N/A
Z30M2HCSR	20 x 30 x 22.75	100	92	10.50	\$1019	N/A	N/A	N/A

For use **under ZxxxxHTB 23.25" H** top and back kit. **No top or back.** Open shelf on **left**, box drawer on **right**. Pull out drawer includes filing space on **right** and storage on **left**. Front-to-back letter capability.

- Lateral file drawer construction is for accommodating hanging files **NOT** for stacking materials on the drawer bottom.

TOP AND BACK KITS FOR 22.75" H SHELLS

MODEL#	DIMENSIONS	FREIGHT CLASS	WT/LBS.	CUBIC FT.	1" TOP	1.5" TOP	GLAZE ADD	HP ADD
Z2496HTB	24 x 96 x 23.25-23.75	70	114	6.75	\$849	\$1026	N/A	\$520
Z2490HTB	24 x 90 x 23.25-23.75	70	107	6.25	\$806	\$971	N/A	\$488
Z2484HTB	24 x 84 x 23.25-23.75	70	100	6	\$756	\$912	N/A	\$454
Z2478HTB	24 x 78 x 23.25-23.75	70	94	5.50	\$710	\$854	N/A	\$423
Z2472HTB	24 x 72 x 23.25-23.75	70	87	5.25	\$659	\$792	N/A	\$390
Z2466HTB	24 x 66 x 23.25-23.75	70	80	4.75	\$610	\$733	N/A	\$358
Z2460HTB	24 x 66 x 23.25-23.75	70	72	4.50	\$561	\$672	N/A	\$327
Z2454HTB	24 x 54 x 23.25-23.75	70	65	4	\$507	\$608	N/A	\$294
Z2448HTB	24 x 48 x 23.25-23.75	85	55	3.75	\$463	\$552	N/A	\$261
Z2442HTB	24 x 42 x 23.25-23.75	70	51	3.25	\$411	\$491	N/A	\$229
Z2436HTB	24 x 36 x 23.25-23.75	85	44	3	\$357	\$426	N/A	\$197
Z2430HTB	24 x 30 x 23.25-23.75	85	37	2.50	\$309	\$366	N/A	\$164
Z2096HTB	20 x 96 x 23.25-23.75	70	103	6.25	\$793	\$939	N/A	\$434
Z2090HTB	20 x 90 x 23.25-23.75	70	97	6	\$750	\$888	N/A	\$407
Z2084HTB	20 x 84 x 23.25-23.75	70	91	5.75	\$705	\$835	N/A	\$378
Z2078HTB	20 x 78 x 23.25-23.75	70	86	5.25	\$660	\$780	N/A	\$353
Z2072HTB	20 x 72 x 23.25-23.75	70	78	5	\$616	\$727	N/A	\$327
Z2066HTB	20 x 66 x 23.25-23.75	70	71	4.50	\$564	\$666	N/A	\$299
Z2060HTB	20 x 66 x 23.25-23.75	70	65	4.25	\$520	\$612	N/A	\$273
Z2054HTB	20 x 54 x 23.25-23.75	70	59	3.75	\$474	\$559	N/A	\$246
Z2048HTB	20 x 48 x 23.25-23.75	70	55	3.50	\$434	\$509	N/A	\$219
Z2042HTB	20 x 42 x 23.25-23.75	70	47	3	\$384	\$450	N/A	\$189
Z2036HTB	20 x 36 x 23.25-23.75	85	40	2.75	\$331	\$388	N/A	\$164
Z2030HTB	20 x 30 x 23.25-23.75	85	33	2.25	\$286	\$333	N/A	\$138



Credenza Top and Back Kit**

For use with 22.75" high storage shells. Shipped RTA (ready to assemble).

- **Does not include hardware to attach to storage shells.**

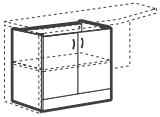
Required Specifications

- Top finish**
- Top/edge detail**
- Base finish
- Handles*

Optional Specifications

- HP laminate**

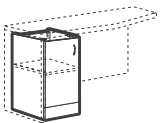
STORAGE SHELLS - 28" HIGH



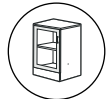
Storage Shell*



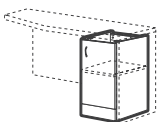
Glazed door option



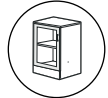
Storage Shell - LEFT*



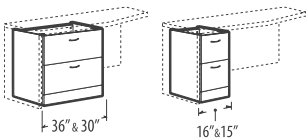
Glazed door option



Storage Shell - RIGHT*



Glazed door option



File/File Shell

MODEL#	DIMENSIONS D x W x H	FREIGHT CLASS	WT/LBS.	CUBIC FT.	1" TOP	1.5" TOP	GLAZE ADD	HP ADD
Z36L2SHS	23.4 x 36 x 28-28.5	150	100	18.50	\$978	N/A	\$762	N/A
Z30L2SHS	23.4 x 30 x 28-28.5	150	88	15.50	\$873	N/A	\$699	N/A
Z36M2SHS	19.3 x 36 x 28-28.5	150	89	15.50	\$856	N/A	\$762	N/A
Z30M2SHS	19.3 x 30 x 28-28.5	150	78	13.25	\$777	N/A	\$699	N/A

For use under 29" H returns, extended corners, freestanding and connectable tables of the same depth. **No top or back. One adjustable shelf.** Standard with lock.

Z21L2SHSL	23.4 x 21 x 28-28.5	125	70	11	\$674	N/A	\$432	N/A
Z18L2SHSL	23.4 x 18 x 28-28.5	125	64	9.75	\$646	N/A	\$395	N/A
Z16L2SHSL	23.4 x 16 x 28-28.5	125	60	9	\$607	N/A	\$386	N/A
Z15L2SHSL	23.4 x 15 x 28-28.5	125	59	8.25	\$587	N/A	\$348	N/A
Z12L2SHSL	23.4 x 12 x 28-28.5	125	53	6.75	\$548	N/A	\$314	N/A
Z21M2SHSL	19.3 x 21 x 28-28.5	125	61	9.50	\$577	N/A	\$432	N/A
Z18M2SHSL	19.3 x 18 x 28-28.5	125	56	8.25	\$551	N/A	\$395	N/A
Z16M2SHSL	19.3 x 16 x 28-28.5	125	52	7	\$523	N/A	\$386	N/A
Z15M2SHSL	19.3 x 15 x 28-28.5	125	52	6.75	\$495	N/A	\$348	N/A
Z12M2SHSL	19.3 x 12 x 28-28.5	100	47	5.75	\$465	N/A	\$314	N/A

For use under 29" H returns, extended corners, freestanding and connectable tables of the same depth. **No top or back. One adjustable shelf.** Standard with lock.

Z21L2SHSR	23.4 x 21 x 28-28.5	125	70	11	\$674	N/A	\$432	N/A
Z18L2SHSR	23.4 x 18 x 28-28.5	125	64	9.75	\$646	N/A	\$395	N/A
Z16L2SHSR	23.4 x 16 x 28-28.5	125	60	9	\$607	N/A	\$386	N/A
Z15L2SHSR	23.4 x 15 x 28-28.5	125	59	8.25	\$587	N/A	\$348	N/A
Z12L2SHSR	23.4 x 12 x 28-28.5	125	53	6.75	\$548	N/A	\$314	N/A
Z21M2SHSR	19.3 x 21 x 28-28.5	125	61	9.50	\$577	N/A	\$432	N/A
Z18M2SHSR	19.3 x 18 x 28-28.5	125	56	8.25	\$551	N/A	\$395	N/A
Z16M2SHSR	19.3 x 16 x 28-28.5	125	52	7	\$523	N/A	\$386	N/A
Z15M2SHSR	19.3 x 15 x 28-28.5	125	52	6.75	\$495	N/A	\$348	N/A
Z12M2SHSR	19.3 x 12 x 28-28.5	100	47	5.75	\$465	N/A	\$314	N/A

For use under 29" H returns, extended corners, freestanding and connectable tables of the same depth. **No top or back. One adjustable shelf.** Standard with lock.

Z36L2ES	23.4 x 36 x 28-28.5	125	121	18.50	\$1469	N/A	N/A	N/A
Z30L2ES	23.4 x 30 x 28-28.5	125	110	15.50	\$1347	N/A	N/A	N/A
Z16L2ES	23.4 x 16 x 28-28.5	100	75	9	\$812	N/A	N/A	N/A
Z15L2ES	23.4 x 15 x 28-28.5	100	75	8.25	\$791	N/A	N/A	N/A
Z36M2ES	19.3 x 36 x 28-28.5	125	114	15.50	\$1353	N/A	N/A	N/A
Z30M2ES	19.3 x 30 x 28-28.5	125	102	13.25	\$1265	N/A	N/A	N/A
Z16M2ES	19.3 x 16 x 28-28.5	100	69	7	\$741	N/A	N/A	N/A
Z15M2ES	19.3 x 15 x 28-28.5	92.5	68	6.75	\$723	N/A	N/A	N/A

For use under 29" H returns, extended corners, freestanding and connectable tables of the same depth. **No top or back. Two file drawers.** Lock secures all drawers. For filing capabilities, see page 121.

- 15" wide models have only side-to-side filing capability
- Lateral file drawer construction is for accommodating hanging files NOT for stacking materials on the drawer bottom.

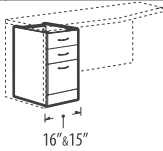
Required Specifications

Base finish
Handles

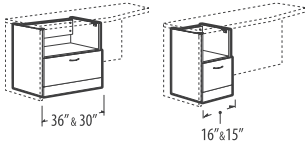
Optional Specifications

Glazed doors - storage shell doors*
Key #

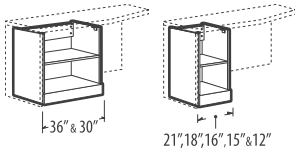
STORAGE SHELLS - 28" HIGH



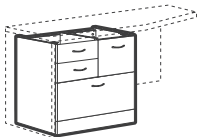
Box/Box/File Shell*



File Shell with Open Shelf*



Open Shelving Shell



Mixed Storage Shell - LEFT*

MODEL#	DIMENSIONS D x W x H	FREIGHT CLASS	WT/LBS.	CUBIC FT.	1" TOP	1.5" TOP	GLAZE ADD	HP ADD
Z16L2BFS	23.4 x 16 x 28-28.5	100	77	9	\$935	N/A	N/A	N/A
Z15L2BFS	23.4 x 15 x 28-28.5	100	77	8.25	\$915	N/A	N/A	N/A
Z16M2BFS	19.3 x 16 x 28-28.5	92.5	71	7	\$847	N/A	N/A	N/A
Z15M2BFS	19.3 x 15 x 28-28.5	92.5	71	6.75	\$831	N/A	N/A	N/A

For use **under 29" H** returns, extended corners, freestanding and connectable tables of the same depth. **No top or back. Two box and one file drawer.** One pencil tray. Lock secures all drawers.

- 15" wide models have only side-to-side filing capability

Z36L2FS	23.4 x 36 x 28-28.5	150	109	18.50	\$1144	N/A	N/A	N/A
Z30L2FS	23.4 x 30 x 28-28.5	125	98	15.50	\$1028	N/A	N/A	N/A
Z16L2FS	23.4 x 16 x 28-28.5	125	68	9	\$684	N/A	N/A	N/A
Z15L2FS	23.4 x 15 x 28-28.5	100	67	8.25	\$675	N/A	N/A	N/A
Z36M2FS	19.3 x 36 x 28-28.5	125	99	15.50	\$1018	N/A	N/A	N/A
Z30M2FS	19.3 x 30 x 28-28.5	125	89	13.25	\$937	N/A	N/A	N/A
Z16M2FS	19.3 x 16 x 28-28.5	100	59	7	\$576	N/A	N/A	N/A
Z15M2FS	19.3 x 15 x 28-28.5	100	57	6.75	\$564	N/A	N/A	N/A

For use **under 29" H** returns, extended corners, freestanding and connectable tables of the same depth. **No top or back. One file drawer.** Lock secures file drawer. For filing capabilities, see page 121.

- 15" wide models have only side-to-side filing capability
- Lateral file drawer construction is for accommodating hanging files NOT for stacking materials on the drawer bottom.

Z36L2SHSN	23.4 x 36 x 28-28.5	150	84.03	18.50	\$699	N/A	N/A	N/A
Z30L2SHSN	23.4 x 30 x 28-28.5	150	74.69	15.50	\$620	N/A	N/A	N/A
Z21L2SHSN	23.4 x 21 x 28-28.5	150	60.69	11	\$522	N/A	N/A	N/A
Z18L2SHSN	23.4 x 18 x 28-28.5	150	56.02	9.75	\$503	N/A	N/A	N/A
Z16L2SHSN	23.4 x 16 x 28-28.5	150	52.90	9	\$467	N/A	N/A	N/A
Z15L2SHSN	23.4 x 15 x 28-28.5	125	52.35	8.25	\$456	N/A	N/A	N/A
Z12L2SHSN	23.4 x 12 x 28-28.5	125	47.68	6.75	\$428	N/A	N/A	N/A
Z36M2SHSN	19.3 x 36 x 28-28.5	150	73.03	15.50	\$579	N/A	N/A	N/A
Z30M2SHSN	19.3 x 30 x 28-28.5	150	64.69	13.25	\$526	N/A	N/A	N/A
Z21M2SHSN	19.3 x 21 x 28-28.5	150	51.69	9.50	\$424	N/A	N/A	N/A
Z18M2SHSN	19.3 x 18 x 28-28.5	150	48.02	8.25	\$408	N/A	N/A	N/A
Z16M2SHSN	19.3 x 16 x 28-28.5	125	44.90	7	\$382	N/A	N/A	N/A
Z15M2SHSN	19.3 x 15 x 28-28.5	125	45.35	6.75	\$367	N/A	N/A	N/A
Z12M2SHSN	19.3 x 12 x 28-28.5	125	41.68	5.75	\$344	N/A	N/A	N/A

For use **under 29" H** returns, extended corners, freestanding and connectable tables of the same depth. **No top or back. One adjustable shelf.**

Z36L2XSL	23.4 x 36 x 28-28.5	100	152	18.50	\$1770	N/A	N/A	N/A
Z30L2XSL	23.4 x 30 x 28-28.5	100	136	15.50	\$1619	N/A	N/A	N/A
Z36M2XSL	19.3 x 36 x 28-28.5	100	139	15.50	\$1668	N/A	N/A	N/A
Z30M2XSL	19.3 x 30 x 28-28.5	100	124	13.25	\$1550	N/A	N/A	N/A

For use **under 29" H** returns, extended corners, freestanding and connectable tables of the same depth. **No top or back.** Two box drawers on **left**, one file drawer on **right** accommodates letter filing side to side, and one lateral file drawer on bottom (see filing orientations on page 120). Right lock secures one file drawer, the left lock secures two box and the lateral file. One pencil tray. For filing capabilities, see page 121.

- Lateral file drawer construction is for accommodating hanging files NOT for stacking materials on the drawer bottom.
- Top file drawer supports hanging folders only. Does not accept hanging folders with plastic tabs.

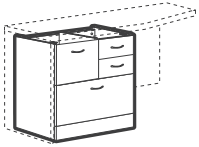
Required Specifications

Base finish
Handles*

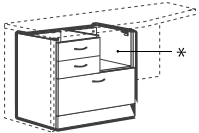
Optional Specifications

Box Drawer Option (no upcharge - not available on Open Shelving Shell)
Key #

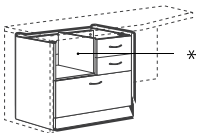
STORAGE SHELLS - 28" HIGH



Mixed Storage Shell - RIGHT**



Mixed Storage Shell with Open Shelf - LEFT*



Mixed Storage Shell with Open Shelf - RIGHT*



* Accepts collator



* Accepts collator

MODEL#	DIMENSIONS D x W x H	FREIGHT CLASS	WT/LBS.	CUBIC FT.	1" TOP	1.5" TOP	GLAZE ADD	HP ADD
Z36L2XSR	23.4 x 36 x 28.5	100	152	18.50	\$1770	N/A	N/A	N/A
Z30L2XSR	23.4 x 30 x 28.5	100	136	15.50	\$1619	N/A	N/A	N/A
Z36M2XSR	19.3 x 36 x 28.5	100	139	15.50	\$1668	N/A	N/A	N/A
Z30M2XSR	19.3 x 30 x 28.5	100	124	13.25	\$1550	N/A	N/A	N/A

For use **under 29" H** returns, extended corners, freestanding and connectable tables of the same depth. **No top or back.** Two box drawers on **right**, one file drawer on **left** accommodates letter filing side to side, and one lateral file drawer on bottom (see filing orientations on page 120). Right lock secures two box and lateral file, the left lock secures one file drawer. One pencil tray. For filing capabilities, see page 121.

- Lateral file drawer construction is for accommodating hanging files NOT for stacking materials on the drawer bottom.
- Top file drawer supports hanging folders only. Does not accept hanging folders with plastic tabs.

Z36L2XNSL	23.4 x 36 x 28.5	125	133	18.50	\$1495	N/A	N/A	N/A
Z30L2XNSL	23.4 x 30 x 28.5	125	121	15.50	\$1361	N/A	N/A	N/A
Z36M2XNSL	19.3 x 36 x 28.5	125	121	15.50	\$1393	N/A	N/A	N/A
Z30M2XNSL	19.3 x 30 x 28.5	100	109	13.25	\$1296	N/A	N/A	N/A

For use **under 29" H** returns, extended corners, freestanding and connectable tables of the same depth. **No top or back.** Two box drawers on **left**, one open shelf on **right** and one lateral file drawer on bottom. Lock secures all drawers. One pencil tray. For filing capabilities, see page 121.

- Lateral file drawer construction is for accommodating hanging files NOT for stacking materials on the drawer bottom.

Z36L2XNSR	23.4 x 36 x 28-28.5	125	133	18.50	\$1495	N/A	N/A	N/A
Z30L2XNSR	23.4 x 30 x 28-28.5	125	121	15.50	\$1361	N/A	N/A	N/A
Z36M2XNSR	19.3 x 36 x 28-28.5	125	121	15.50	\$1393	N/A	N/A	N/A
Z30M2XNSR	19.3 x 30 x 28-28.5	100	109	13.25	\$1296	N/A	N/A	N/A

For use **under 29" H** returns, extended corners, freestanding and connectable tables of the same depth. **No top or back.** Two box drawers on **right**, one open shelf on **left** and one lateral file drawer on bottom. Lock secures all drawers. One pencil tray. For filing capabilities, see page 121.

- Lateral file drawer construction is for accommodating hanging files NOT for stacking materials on the drawer bottom.

Required Specifications

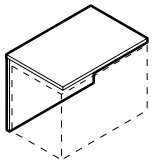
Base finish
Handles

Optional Specifications

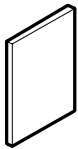
Box drawer - no upcharge
Collator (open shelves)

TOP AND BACK KITS FOR 28" H STORAGE SHELLS

MODEL#	DIMENSIONS	FREIGHT CLASS	WT/LBS.	CUBIC FT.	1" TOP	1.5" TOP	GLAZE ADD	HP ADD
D x W x H								
Z2496TB	24 x 96 x 29-29.5	70	126	7.75	\$930	\$1107	N/A	\$520
Z2490TB	24 x 90 x 29-29.5	70	118	7.25	\$877	\$1042	N/A	\$488
Z2484TB	24 x 84 x 29-29.5	70	111	6.75	\$827	\$983	N/A	\$454
Z2478TB	24 x 78 x 29-29.5	70	104	6.25	\$769	\$913	N/A	\$423
Z2472TB	24 x 72 x 29-29.5	70	117	5.90	\$681	\$842	N/A	\$384
Z2466TB	24 x 66 x 29-29.5	70	117	5.90	\$656	\$804	N/A	\$384
Z2460TB	24 x 60 x 29-29.5	70	117	5.90	\$598	\$731	N/A	\$319
Z2454TB	24 x 54 x 29-29.5	70	72	4.50	\$550	\$651	N/A	\$294
Z2448TB	24 x 48 x 29-29.5	70	66	4	\$503	\$592	N/A	\$261
Z2442TB	24 x 42 x 29-29.5	70	57	3.75	\$449	\$529	N/A	\$229
Z2436TB	24 x 36 x 29-29.5	70	49	3.25	\$378	\$447	N/A	\$197
Z2430TB	24 x 30 x 29-29.5	85	41	2.75	\$336	\$393	N/A	\$164
Z2096TB	20 x 96 x 29-29.5	85	116	7.75	\$877	\$1023	N/A	\$434
Z2090TB	20 x 90 x 29-29.5	70	102	6.75	\$828	\$966	N/A	\$407
Z2084TB	20 x 84 x 29-29.5	70	102	6.75	\$778	\$908	N/A	\$378
Z2078TB	20 x 78 x 29-29.5	70	95	6.25	\$725	\$845	N/A	\$353
Z2072TB	20 x 72 x 29-29.5	70	106	6	\$656	\$789	N/A	\$384
Z2066TB	20 x 66 x 29-29.5	70	106	6	\$643	\$756	N/A	\$384
Z2060TB	20 x 60 x 29-29.5	70	106	6	\$564	\$684	N/A	\$319
Z2054TB	20 x 54 x 29-29.5	85	66	4.50	\$521	\$606	N/A	\$246
Z2048TB	20 x 48 x 29-29.5	70	61	4	\$475	\$550	N/A	\$219
Z2042TB	20 x 42 x 29-29.5	85	52	3.75	\$424	\$490	N/A	\$189
Z2036TB	20 x 36 x 29-29.5	85	45	3.25	\$358	\$415	N/A	\$164
Z2030TB	20 x 30 x 29-29.5	85	38	2.75	\$319	\$366	N/A	\$138



Top and Back Kits - 29" H



Full Leg

For use with 28" high storage shells. Shipped RTA (ready to assemble).

- Does not include hardware to attach to storage shells.

Z24FL	23.4 x 1 x 28.5	92.5	20	1.70	\$261	N/A	N/A	N/A
Z20FL	19.3 x 1 x 28.5	65	16	.60	\$261	N/A	N/A	N/A

For use at either end of 29" H top and back kits. Non-handed; can be used left or right. Shipped RTA (ready to assemble).

- For 24" deep worksurfaces, order **Z24FL**.
- For 20" deep worksurfaces, order **Z20FL**.
- Does not include hardware for installation.

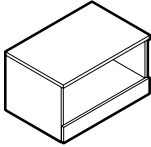
Required Specifications

Top finish
Top/edge detail
Base finish

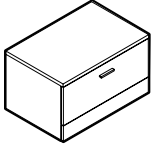
Optional Specifications

HP laminate

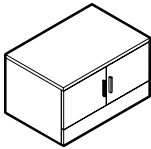
STORAGE MODULES - 17.87"/18.37" HIGH



Open Storage



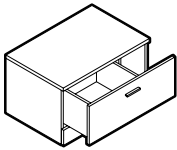
Lateral File*



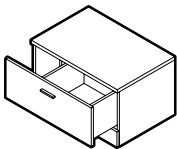
Storage Cabinet*



Glazed door option



Split Drawer Storage* - LEFT



Split Drawer Storage* - RIGHT

MODEL#	DIMENSIONS D x W x H	FREIGHT CLASS	WT./LBS.	CUBIC FT.	1" TOP	1.5" TOP	GLAZE ADD	HP ADD
Z36L21SHN	24 x 36 x 17.87-18.37	125	82	11.75	\$753	\$822	N/A	\$197
Z30L21SHN	24 x 30 x 17.87-18.37	125	74	10	\$691	\$748	N/A	\$164
Z36M21SHN	20 x 36 x 17.87-18.37	125	71	10	\$683	\$740	N/A	\$164
Z30M21SHN	20 x 30 x 17.87-18.37	125	62	8.50	\$615	\$662	N/A	\$138

Open Shelf.

Z36L21E	24 x 36 x 17.87-18.37	100	103	11.75	\$1112	\$1181	N/A	\$197
Z30L21E	24 x 30 x 17.87-18.37	100	97	10	\$950	\$1007	N/A	\$164
Z36M21E	20 x 36 x 17.87-18.37	100	95	10	\$1056	\$1113	N/A	\$164
Z30M21E	20 x 30 x 17.87-18.37	92.5	88	8.50	\$887	\$934	N/A	\$138

One file drawer. Lock secures drawer. For filing capabilities, see page 121.

- Lateral file drawer construction is for accommodating hanging files NOT for stacking materials on the drawer bottom

Z36L21SH	24 x 36 x 17.87-18.37	125	90	11.75	\$964	\$1033	\$407	\$197
Z30L21SH	24 x 30 x 17.87-18.37	100	81	10	\$886	\$943	\$361	\$164
Z36M21SH	20 x 36 x 17.87-18.37	100	80	10	\$893	\$950	\$407	\$164
Z30M21SH	20 x 30 x 17.87-18.37	100	69	8.50	\$810	\$857	\$361	\$138

Laminate doors are standard. Standard with lock.

Z36L21XHL	24 x 36 x 17.87-18.37	100	102	11.75	\$1045	\$1114	N/A	\$197
Z30L21XHL	24 x 30 x 17.87-18.37	100	92	10	\$928	\$985	N/A	\$164
Z36M21XHL	20 x 36 x 17.87-18.37	100	95	10	\$989	\$1046	N/A	\$164
Z30M21XHL	20 x 30 x 17.87-18.37	100	83	8.50	\$866	\$913	N/A	\$138

Pull out drawer includes filing space on **left** and storage on **right**. Lock secures drawer. For filing capabilities, see page 121.

- Lateral file drawer construction is for accommodating hanging files NOT for stacking materials on the drawer bottom

Z36L21XHR	24 x 36 x 17.87-18.37	100	102	11.75	\$1045	\$1114	N/A	\$197
Z30L21XHR	24 x 30 x 17.87-18.37	100	92	10	\$928	\$985	N/A	\$164
Z36M21XHR	20 x 36 x 17.87-18.37	100	95	10	\$989	\$1046	N/A	\$164
Z30M21XHR	20 x 30 x 17.87-18.37	100	83	8.50	\$866	\$913	N/A	\$138

Pull out drawer includes filing space on **right** and storage on **left**. Lock secures drawer. For filing capabilities, see page 121.

- Lateral file drawer construction is for accommodating hanging files NOT for stacking materials on the drawer bottom

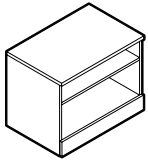
Required Specifications

Top finish
Top/edge detail
Base finish
Handles*

Optional Specifications

HP laminate
Key #

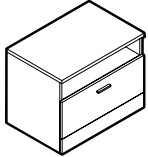
STORAGE MODULES - 23.75" / 24.25" HIGH



1.5H Open Storage

MODEL#	DIMENSIONS D x W x H	FREIGHT CLASS	WT/LBS.	CUBIC FT.	1" TOP	1.5" TOP	GLAZE ADD	HP ADD
Z36L2HSHN	24 x 36 x 23.75-24.25	125	106	15	\$926	\$995	N/A	\$197
Z30L2HSHN	24 x 30 x 23.75-24.25	125	94	12.75	\$839	\$896	N/A	\$164
Z36M2HSHN	20 x 36 x 23.75-24.25	125	92	12.75	\$834	\$891	N/A	\$164
Z30M2HSHN	20 x 30 x 23.75-24.25	125	80	10.75	\$749	\$796	N/A	\$138

One adjustable shelf.

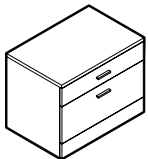


1.5H Open/Lateral File Storage*

Z36L2HFN	24 x 36 x 23.75-24.25	100	127	15	\$1284	\$1353	N/A	\$197
Z30L2HFN	24 x 30 x 23.75-24.25	100	118	12.75	\$1097	\$1154	N/A	\$164
Z36M2HFN	20 x 36 x 23.75-24.25	100	116	12.75	\$1207	\$1264	N/A	\$164
Z30M2HFN	20 x 30 x 23.75-24.25	100	106	10.75	\$1020	\$1067	N/A	\$138

Open shelf on top. Lateral file below. Lock secures drawer. For filing capabilities, see page 121.

- Lateral file drawer construction is for accommodating hanging files NOT for stacking materials on the drawer bottom

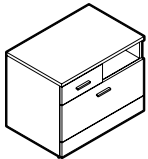


1.5H Box/Lateral File Storage**

Z36L2HE	24 x 36 x 23.75-24.25	100	126	15	\$1357	\$1426	N/A	\$197
Z30L2HE	24 x 30 x 23.75-24.25	100	118	12.75	\$1357	\$1414	N/A	\$164
Z36M2HE	20 x 36 x 23.75-24.25	100	118	12.75	\$1295	\$1352	N/A	\$164
Z30M2HE	20 x 30 x 23.75-24.25	92.5	108	10.75	\$1102	\$1149	N/A	\$138

Box drawer on top. Lateral file below. Lock secures both drawers. For filing capabilities, see page 121.

- Lateral file drawer construction is for accommodating hanging files NOT for stacking materials on the drawer bottom

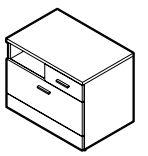


1.5H Mixed Storage - LEFT*

Z36L2HXNL	24 x 36 x 23.75-24.25	100	132	15	\$1401	\$1470	N/A	\$197
Z30L2HXNL	24 x 30 x 23.75-24.25	100	123	12.75	\$1217	\$1274	N/A	\$164
Z36M2HXNL	20 x 36 x 23.75-24.25	100	121	12.75	\$1328	\$1385	N/A	\$164
Z30M2HXNL	20 x 30 x 23.75-24.25	92.5	111	10.75	\$1142	\$1189	N/A	\$138

Open shelf on **right**, box drawer on **left** and lateral file storage below. Lock secures both drawers. For filing capabilities, see page 121.

- Lateral file drawer construction is for accommodating hanging files NOT for stacking materials on the drawer bottom

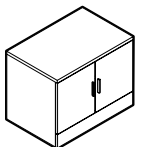


1.5H Mixed Storage - RIGHT*

Z36L2HXNR	24 x 36 x 23.75-24.25	100	132	15	\$1401	\$1470	N/A	\$197
Z30L2HXNR	24 x 30 x 23.75-24.25	100	123	12.75	\$1217	\$1274	N/A	\$164
Z36M2HXNR	20 x 36 x 23.75-24.25	100	121	12.75	\$1328	\$1385	N/A	\$164
Z30M2HXNR	20 x 30 x 23.75-24.25	92.5	111	10.75	\$1142	\$1189	N/A	\$138

Open shelf on **left**, box drawer on **right** and lateral file storage below. Lock secures both drawers. For filing capabilities, see page 121.

- Lateral file drawer construction is for accommodating hanging files NOT for stacking materials on the drawer bottom



Closed Storage**



Glazed door option

Z36L2HSH	24 x 36 x 23.75-24.25	125	119	15	\$1177	\$1246	\$505	\$197
Z30L2HSH	24 x 30 x 23.75-24.25	100	105	12.75	\$1066	\$1123	\$449	\$164
Z36M2HSH	20 x 36 x 23.75-24.25	100	105	12.75	\$1086	\$1143	\$505	\$164
Z30M2HSH	20 x 30 x 23.75-24.25	100	91	10.75	\$977	\$1024	\$449	\$138

Laminate doors are standard. Includes one adjustable shelf. Standard with lock.

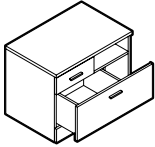
Required Specifications

Top finish
Top/edge detail
Base finish
Handles*

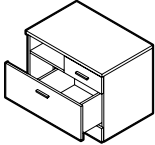
Optional Specifications

HP laminate
Key #
Glazed doors**
Box drawer† - no upcharge

STORAGE MODULES - 23.75" / 24.25" HIGH



1.5H Split Drawer Storage - LEFT



1.5H Split Drawer Storage - RIGHT

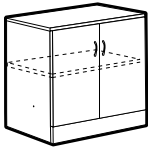
MODEL#	DIMENSIONS D x W x H	FREIGHT CLASS	WT/LBS.	CUBIC FT.	1" TOP	1.5" TOP	GLAZE ADD	HP ADD
Z36L2HXHL	24 x 36 x 23.75-24.25	100	132	15	\$1345	\$1414	N/A	\$197
Z30L2HXHL	24 x 30 x 23.75-24.25	100	118	12.75	\$1207	\$1264	N/A	\$164
Z36M2HXHL	20 x 36 x 23.75-24.25	100	121	12.75	\$1272	\$1329	N/A	\$164
Z30M2HXHL	20 x 30 x 23.75-24.25	100	107	10.75	\$1132	\$1179	N/A	\$138

Open shelf on **right**, box drawer on **left**. Pull out drawer includes filing space on **left** and storage on **right**.

Z36L2HXHR	24 x 36 x 23.75-24.25	100	132	15	\$1345	\$1414	N/A	\$197
Z30L2HXHR	24 x 30 x 23.75-24.25	100	118	12.75	\$1207	\$1264	N/A	\$164
Z36M2HXHR	20 x 36 x 23.75-24.25	100	121	12.75	\$1272	\$1329	N/A	\$164
Z30M2HXHR	20 x 30 x 23.75-24.25	100	107	10.75	\$1132	\$1179	N/A	\$138

Open shelf on **left**, box drawer on **right**. Pull out drawer includes filing space on **right** and storage on **left**.

STORAGE MODULES - 29.5" / 30" HIGH



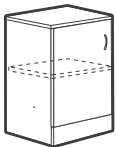
Storage Cabinet with Doors*



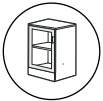
Glazed door option

MODEL#	DIMENSIONS	FREIGHT CLASS	WT/LBS.	CUBIC FT.	1" TOP	1.5" TOP	GLAZE ADD	HP ADD
Z36L2SH	24 x 36 x 29.5-30	125	142.80	18.50	\$1305	\$1385	\$762	\$195
Z30L2SH	24 x 30 x 29.5-30	125	123.90	15.50	\$1174	\$1241	\$699	\$162
Z36M2SH	20 x 36 x 29.5-30	100	126	15.50	\$1197	\$1267	\$762	\$195
Z30M2SH	20 x 30 x 29.5-30	100	109.20	13.25	\$1086	\$1144	\$699	\$162
Z36S2SH	16 x 36 x 29.5-30	100	110.25	12.50	\$1105	\$1172	\$762	\$146
Z30S2SH	16 x 30 x 29.5-30	100	93.45	10.50	\$976	\$1022	\$699	\$131

Laminate doors are standard. **Includes one adjustable shelf.** Standard with lock.



Storage Cabinet with Door - LEFT*



Glazed door option

Z21L2SHL	24 x 21 x 29.5-30	100	94.50	11	\$957	\$1013	\$432	\$131
Z18L2SHL	24 x 18 x 29.5-30	100	85.05	9.75	\$903	\$950	\$395	\$101
Z16L2SHL	24 x 16 x 29.5-30	100	79.80	9	\$866	\$912	\$386	\$76
Z15L2SHL	24 x 15 x 29.5-30	100	76.65	8.25	\$801	\$839	\$348	\$76
Z12L2SHL	24 x 12 x 29.5-30	92.5	68.25	6.75	\$759	\$792	\$314	\$69
Z21M2SHL	20 x 21 x 29.5-30	100	84	9.50	\$849	\$896	\$432	\$101
Z18M2SHL	20 x 18 x 29.5-30	100	75.60	8.25	\$804	\$847	\$395	\$101
Z16M2SHL	20 x 16 x 29.5-30	100	69.30	7	\$762	\$804	\$386	\$76
Z15M2SHL	20 x 15 x 29.5-30	100	66.15	6.75	\$725	\$760	\$348	\$69
Z12M2SHL	20 x 12 x 29.5-30	92.5	60	5.75	\$675	\$705	\$314	\$69
Z21S2SHL	16 x 21 x 29.5-30	100	71.40	7.50	\$777	\$814	\$432	\$69
Z18S2SHL	16 x 18 x 29.5-30	100	64.05	6.75	\$742	\$780	\$395	\$69
Z16S2SHL	16 x 16 x 29.5-30	100	58.80	6	\$711	\$749	\$386	\$69
Z15S2SHL	16 x 15 x 29.5-30	100	56.70	5.75	\$671	\$704	\$348	\$69
Z12S2SHL	16 x 12 x 29.5-30	92.5	50.40	4.75	\$624	\$654	\$314	\$69

Laminate doors are standard. **Includes one adjustable shelf.** Standard with lock.

Required Specifications

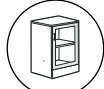
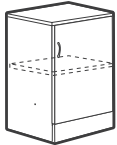
- Top finish
- Handles
- Top/edge detail
- Base finish

Optional Specifications

- Glazed doors*
- HP laminate
- Key #

STORAGE MODULES - 29.5" / 30" HIGH

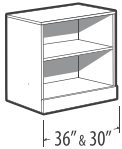
MODEL#	DIMENSIONS	FREIGHT CLASS	WT/LBS.	CUBIC FT.	1" TOP	1.5" TOP	GLAZE ADD	HP ADD
D x W x H								
Z21L2SHR	24 x 21 x 29.5-30	100	94.50	11	\$957	\$1013	\$432	\$131
Z18L2SHR	24 x 18 x 29.5-30	100	85.05	9.75	\$903	\$950	\$395	\$101
Z16L2SHR	24 x 16 x 29.5-30	100	79.80	9	\$866	\$912	\$386	\$76
Z15L2SHR	24 x 15 x 29.5-30	100	76.65	8.25	\$801	\$839	\$348	\$76
Z12L2SHR	24 x 12 x 29.5-30	92.5	68.25	6.75	\$759	\$792	\$314	\$69
Z21M2SHR	20 x 21 x 29.5-30	100	84	9.50	\$849	\$896	\$432	\$101
Z18M2SHR	20 x 18 x 29.5-30	100	75.60	8.25	\$804	\$847	\$395	\$101
Z16M2SHR	20 x 16 x 29.5-30	100	69.30	7	\$762	\$804	\$386	\$76
Z15M2SHR	20 x 15 x 29.5-30	100	66.15	6.75	\$725	\$760	\$348	\$69
Z12M2SHR	20 x 12 x 29.5-30	92.5	60	5.75	\$675	\$705	\$314	\$69
Z21S2SHR	16 x 21 x 29.5-30	100	71.40	7.50	\$777	\$814	\$432	\$69
Z18S2SHR	16 x 18 x 29.5-30	100	64.05	6.75	\$742	\$780	\$395	\$69
Z16S2SHR	16 x 16 x 29.5-30	100	58.80	6	\$711	\$749	\$386	\$69
Z15S2SHR	16 x 15 x 29.5-30	100	56.70	5.75	\$671	\$704	\$348	\$69
Z12S2SHR	16 x 12 x 29.5-30	92.5	50.40	4.75	\$624	\$654	\$314	\$69



Glazed door option

Storage Cabinet with Door - RIGHT**

Laminate doors are standard. **Includes one adjustable shelf.** Standard with lock



36" & 30"



21", 18", 16", 15" & 12"

Open Storage Cabinet

Z36L2SHN	24 x 36 x 29.5-30	125	127	18.50	\$1029	\$1109	N/A	\$195
Z30L2SHN	24 x 30 x 29.5-30	125	111	15.50	\$925	\$994	N/A	\$162
Z21L2SHN	24 x 21 x 29.5-30	125	86	11	\$804	\$860	N/A	\$131
Z18L2SHN	24 x 18 x 29.5-30	100	78	9.75	\$760	\$807	N/A	\$101
Z16L2SHN	24 x 16 x 29.5-30	100	73	9	\$725	\$771	N/A	\$76
Z15L2SHN	24 x 15 x 29.5-30	100	71	8.25	\$673	\$711	N/A	\$69
Z12L2SHN	24 x 12 x 29.5-30	100	63	6.75	\$638	\$671	N/A	\$69
Z36M2SHN	20 x 36 x 29.5-30	125	111.95	15.50	\$918	\$987	N/A	\$146
Z30M2SHN	20 x 30 x 29.5-30	125	97.14	13.25	\$835	\$895	N/A	\$131
Z21M2SHN	20 x 21 x 29.5-30	125	74.40	9.50	\$696	\$743	N/A	\$101
Z18M2SHN	20 x 18 x 29.5-30	100	67.53	8.25	\$660	\$703	N/A	\$84
Z16M2SHN	20 x 16 x 29.5-30	100	62.59	7	\$623	\$665	N/A	\$69
Z15M2SHN	20 x 15 x 29.5-30	100	60.65	6.75	\$596	\$631	N/A	\$69
Z12M2SHN	20 x 12 x 29.5-30	100	55	5.75	\$552	\$583	N/A	\$69
Z36S2SHN	16 x 36 x 29.5-30	125	96.24	12.50	\$829	\$896	N/A	\$146
Z30S2SHN	16 x 30 x 29.5-30	125	82.82	10.50	\$723	\$769	N/A	\$131
Z21S2SHN	16 x 21 x 29.5-30	100	62.70	7.50	\$623	\$660	N/A	\$101
Z18S2SHN	16 x 18 x 29.5-30	100	55.99	6.75	\$601	\$643	N/A	\$84
Z16S2SHN	16 x 16 x 29.5-30	100	52.22	6	\$572	\$610	N/A	\$69
Z15S2SHN	16 x 15 x 29.5-30	100	50.34	5.75	\$540	\$572	N/A	\$69
Z12S2SHN	16 x 12 x 29.5-30	100	44.68	4.75	\$502	\$532	N/A	\$69

One adjustable shelf.



36" & 30"



16" & 15"

File Module with Open Shelf**

Z36L2FN	24 x 36 x 29.5-30	100	153.30	18.50	\$1473	\$1552	N/A	\$195
Z30L2FN	24 x 30 x 29.5-30	100	134.40	15.50	\$1330	\$1399	N/A	\$162
Z16L2FN	24 x 16 x 29.5-30	100	87.15	9	\$930	\$976	N/A	\$101
Z15L2FN	24 x 15 x 29.5-30	92.5	82.95	8.25	\$876	\$914	N/A	\$84
Z36M2FN	20 x 36 x 29.5-30	100	135.45	15.50	\$1361	\$1430	N/A	\$195
Z30M2FN	20 x 30 x 29.5-30	100	118.65	13.25	\$1252	\$1310	N/A	\$162
Z16M2FN	20 x 16 x 29.5-30	92.5	75.60	7	\$830	\$872	N/A	\$101
Z15M2FN	20 x 15 x 29.5-30	92.5	72.45	6.75	\$793	\$828	N/A	\$84
Z36S2FN	16 x 36 x 29.5-30	100	114.45	12.50	\$1231	\$1298	N/A	\$146
Z30S2FN	16 x 30 x 29.5-30	100	97.65	10.50	\$1091	\$1137	N/A	\$131
Z16S2FN	16 x 16 x 29.5-30	92.5	63	6	\$769	\$807	N/A	\$76
Z15S2FN	16 x 15 x 29.5-30	92.5	60.90	5.75	\$736	\$768	N/A	\$69

Open shelf and one file drawer on bottom. Lock secures file drawer. For filing capabilities, see page 121.

- 15" wide models have only side-to-side filing capability
- Lateral file drawer construction is for accommodating hanging files NOT for stacking materials on the drawer bottom

Required Specifications

Top finish
Handles*
Top/edge detail
Base finish

Optional Specifications

Glazed doors**
HP laminate
Key #

Box drawer† - no upcharge (30" - 36" wide models only)

STORAGE MODULES - 29.5" / 30" HIGH



36" & 30"



16" & 15"

Two File Module†

MODEL#	DIMENSIONS D x W x H	FREIGHT CLASS	WT./LBS.	CUBIC FT.	1" TOP	1.5" TOP	GLAZE ADD	HP ADD
Z36L2E	24 x 36 x 29.5-30	100	164.85	18.50	\$1805	\$1884	N/A	\$195
Z30L2E	24 x 30 x 29.5-30	100	145.95	15.50	\$1651	\$1720	N/A	\$162
Z16L2E	24 x 16 x 29.5-30	92.5	95.55	9	\$1063	\$1109	N/A	\$101
Z15L2E	24 x 15 x 29.5-30	92.5	91.35	8.25	\$1003	\$1041	N/A	\$84
Z36M2E	20 x 36 x 29.5-30	100	149.10	15.50	\$1706	\$1776	N/A	\$195
Z30M2E	20 x 30 x 29.5-30	92.5	133.35	13.25	\$1582	\$1642	N/A	\$162
Z16M2E	20 x 16 x 29.5-30	85	85.05	7	\$965	\$1007	N/A	\$101
Z15M2E	20 x 15 x 29.5-30	85	81.90	6.75	\$931	\$966	N/A	\$84
Z36S2E	16 x 36 x 29.5-30	92.5	128.10	12.50	\$1600	\$1667	N/A	\$146
Z30S2E	16 x 30 x 29.5-30	92.5	110.25	10.50	\$1454	\$1500	N/A	\$131
Z16S2E	16 x 16 x 29.5-30	85	73.50	6	\$957	\$995	N/A	\$76
Z15S2E	16 x 15 x 29.5-30	85	71.40	5.75	\$925	\$958	N/A	\$69

Two file drawers. Lock secures all drawers. For filing capabilities, see page 121.

- 15" wide models have only side-to-side filing capability
- *Lateral file drawer construction is for accommodating hanging files NOT for stacking materials on the drawer bottom*



Two File Module†

Z36L2SE	24 x 36 x 29.5-30	100	180	18.50	\$2183	\$2262	N/A	\$195
Z36M2SE	20 x 36 x 29.5-30	92.5	164	15.50	\$2038	\$2108	N/A	\$195

Two lateral file drawers with steel drawer interior. Steel drawer construction includes metal sides and masonite bottoms. Lock secures all drawers. Front-to-back and side-to-side letter/legal filing capability. For filing capabilities, see page 121.

- Front-to-back filing bars sold separately. Order **FBB** bars. See "FBB" on page 41.
- *Lateral file drawer construction is for accommodating hanging files NOT for stacking materials on the drawer bottom*
- To prevent overloading, steel drawers do not include a back panel



16" & 15"

Box/Box/File Module†

Z16L2BF	24 x 16 x 29.5-30	92.5	97.65	9	\$1197	\$1243	N/A	\$101
Z15L2BF	24 x 15 x 29.5-30	92.5	93.45	8.25	\$1142	\$1180	N/A	\$101
Z16M2BF	20 x 16 x 29.5-30	85	87.15	7	\$1097	\$1139	N/A	\$101
Z15M2BF	20 x 15 x 29.5-30	85	84	6.75	\$1069	\$1104	N/A	\$101
Z16S2BF	16 x 16 x 29.5-30	85	73.50	6	\$1023	\$1061	N/A	\$76
Z15S2BF	16 x 15 x 29.5-30	85	71.40	5.75	\$977	\$1010	N/A	\$76

Two box and one file drawer. One pencil tray. Lock secures all drawers.



Mixed Storage Cabinet - LEFT†

Z36L2XL	24 x 36 x 29.5-30	92.5	187	18.50	\$2058	\$2130	N/A	\$195
Z30L2XL	24 x 30 x 29.5-30	92.5	166	15.50	\$1876	\$1945	N/A	\$162
Z36M2XL	20 x 36 x 29.5-30	92.5	177	15.50	\$1933	\$2002	N/A	\$195
Z30M2XL	20 x 30 x 29.5-30	92.5	152	13.25	\$1779	\$1839	N/A	\$162
Z36S2XL	16 x 36 x 29.5-30	92.5	145	12.50	\$1658	\$1720	N/A	\$146
Z30S2XL	16 x 30 x 29.5-30	92.5	124	10.50	\$1485	\$1539	N/A	\$131

Two box drawers on **left**, one file drawer on **right** which accommodates letter filing side to side, and one lateral file drawer on bottom. Right lock secures one file drawer, the left lock secures two box and lateral file. One pencil tray. For filing capabilities, see page 121.

- *Lateral file drawer construction is for accommodating hanging files NOT for stacking materials on the drawer bottom*
- Top file drawer supports hanging folders only. Does not accept hanging folders with plastic tabs.

Required Specifications

Top finish
Top/edge detail
Handles
Base finish

Optional Specifications

HP laminate
Key #
Box drawer† - no upcharge (30"-36" wide models only)

STORAGE MODULES - 29.5" / 30" HIGH

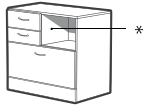


Mixed Storage Cabinet - RIGHT

MODEL#	DIMENSIONS D x W x H	FREIGHT CLASS	WT/LBS.	CUBIC FT.	1" TOP	1.5" TOP	GLAZE ADD	HP ADD
Z36L2XR	24 x 36 x 29.5-30	92.5	187	18.50	\$2058	\$2130	N/A	\$195
Z30L2XR	24 x 30 x 29.5-30	92.5	166	15.50	\$1876	\$1945	N/A	\$162
Z36M2XR	20 x 36 x 29.5-30	92.5	177	15.50	\$1933	\$2002	N/A	\$195
Z30M2XR	20 x 30 x 29.5-30	92.5	152	13.25	\$1779	\$1839	N/A	\$162
Z36S2XR	16 x 36 x 29.5-30	92.5	145	12.50	\$1658	\$1720	N/A	\$146
Z30S2XR	16 x 30 x 29.5-30	92.5	124	10.50	\$1485	\$1539	N/A	\$131

Two box drawers on **right**, one file drawer on **left** which accommodates letter filing side to side, and one lateral file drawer on bottom. Right lock secures two box and lateral file, the left lock secures one file drawer. One pencil tray. For filing capabilities, see page 121.

- Lateral file drawer construction is for accommodating hanging files NOT for stacking materials on the drawer bottom
- Top file drawer supports hanging folders only. Does not accept hanging folders with plastic tabs.



Mixed Drawer Cabinet with Open Shelf - LEFT*

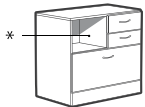


* Accepts collator

Z36L2XNL	24 x 36 x 29.5-30	100	176.40	18.50	\$1781	\$1861	N/A	\$195
Z30L2XNL	24 x 30 x 29.5-30	92.5	155.40	15.50	\$1636	\$1705	N/A	\$162
Z36M2XNL	20 x 36 x 29.5-30	92.5	157.50	15.50	\$1667	\$1736	N/A	\$195
Z30M2XNL	20 x 30 x 29.5-30	92.5	138.60	13.25	\$1542	\$1602	N/A	\$162
Z36S2XNL	16 x 36 x 29.5-30	92.5	128.10	12.50	\$1494	\$1552	N/A	\$146
Z30S2XNL	16 x 30 x 29.5-30	92.5	114.45	10.50	\$1354	\$1396	N/A	\$131

Two box drawers on **left**, open shelf on **right** and one lateral file drawer on bottom. Right lock secures two box and one file drawer, the left lock secures the lateral file. One pencil tray. For filing capabilities, see page 121.

- Lateral file drawer construction is for accommodating hanging files NOT for stacking materials on the drawer bottom



Mixed Drawer Cabinet with Open Shelf - RIGHT*



* Accepts collator

Z36L2XNR	24 x 36 x 29.5-30	100	176.40	18.50	\$1781	\$1861	N/A	\$195
Z30L2XNR	24 x 30 x 29.5-30	92.5	155.40	15.50	\$1636	\$1705	N/A	\$162
Z36M2XNR	20 x 36 x 29.5-30	92.5	157.50	15.50	\$1667	\$1736	N/A	\$195
Z30M2XNR	20 x 30 x 29.5-30	92.5	138.60	13.25	\$1542	\$1602	N/A	\$162
Z36S2XNR	16 x 36 x 29.5-30	92.5	128.10	12.50	\$1494	\$1552	N/A	\$146
Z30S2XNR	16 x 30 x 29.5-30	92.5	114.45	10.50	\$1354	\$1396	N/A	\$131

Two box drawers on **right**, open shelf on **left** and one lateral file drawer on bottom. Right lock secures two box and one file drawer, the left lock secures the lateral file. One pencil tray. For filing capabilities, see page 121.

- Lateral file drawer construction is for accommodating hanging files NOT for stacking materials on the drawer bottom

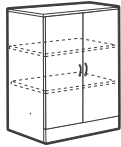
Required Specifications

Top finish
Top/edge detail
Base finish
Handles

Optional Specifications

HP laminate
Key #
Collator*

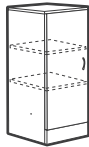
STORAGE MODULES - 41.3"/41.8" HIGH



Storage Cabinet with Doors**

MODEL#	DIMENSIONS D x W x H	FREIGHT CLASS	WT./LBS.	CUBIC FT.	1" TOP	1.5" TOP	GLAZE ADD	HP ADD
Z36L4SH	24 x 36 x 41.3-41.8	125	185.85	25	\$1591	\$1671	\$1016	\$195
Z30L4SH	24 x 30 x 41.3-41.8	125	161.70	21.25	\$1457	\$1524	\$887	\$162
Z36M4SH	20 x 36 x 41.3-41.8	125	165.90	21.25	\$1485	\$1555	\$1016	\$195
Z30M4SH	20 x 30 x 41.3-41.8	125	143.85	18	\$1344	\$1404	\$887	\$162
Z36S4SH	16 x 36 x 41.3-41.8	100	142.80	17.50	\$1345	\$1412	\$1016	\$146
Z30S4SH	16 x 30 x 41.3-41.8	100	121.80	14.50	\$1207	\$1253	\$887	\$84

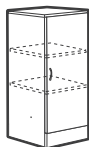
Laminate doors are standard. **Includes two 3-position fixed/height adjustable shelves.** Standard with lock.



Storage Cabinet with Door - LEFT*

Z21L4SHL	24 x 21 x 41.3-41.8	100	123.90	15.25	\$1180	\$1237	\$560	\$131
Z18L4SHL	24 x 18 x 41.3-41.8	100	112.35	13.25	\$1112	\$1158	\$503	\$101
Z16L4SHL	24 x 16 x 41.3-41.8	100	105	12	\$1045	\$1092	\$496	\$101
Z15L4SHL	24 x 15 x 41.3-41.8	100	100.80	11.25	\$1002	\$1039	\$441	\$101
Z12L4SHL	24 x 12 x 41.3-41.8	100	89.25	9.25	\$928	\$961	\$398	\$69
Z21M4SHL	20 x 21 x 41.3-41.8	100	116.55	13	\$1064	\$1111	\$560	\$131
Z18M4SHL	20 x 18 x 41.3-41.8	100	98.70	11.25	\$1007	\$1049	\$503	\$101
Z16M4SHL	20 x 16 x 41.3-41.8	100	91.35	10.25	\$945	\$987	\$496	\$84
Z15M4SHL	20 x 15 x 41.3-41.8	100	88.20	9.50	\$906	\$939	\$441	\$84
Z12M4SHL	20 x 12 x 41.3-41.8	100	78.75	8	\$842	\$872	\$398	\$69
Z21S4SHL	16 x 21 x 41.3-41.8	100	94.50	10.50	\$951	\$989	\$560	\$101
Z18S4SHL	16 x 18 x 41.3-41.8	100	84	9.50	\$912	\$950	\$503	\$84
Z16S4SHL	16 x 16 x 41.3-41.8	100	76.65	8.50	\$855	\$893	\$496	\$84
Z15S4SHL	16 x 15 x 41.3-41.8	100	73.50	8	\$809	\$842	\$441	\$84
Z12S4SHL	16 x 12 x 41.3-41.8	92.5	65.10	6.50	\$749	\$778	\$398	\$69

Laminate doors are standard. **Includes two 3-position fixed/height adjustable shelves.** Standard with lock.



Storage Cabinet with Door - RIGHT*

Z21L4SHR	24 x 21 x 41.3-41.8	100	123.90	15.25	\$1180	\$1237	\$560	\$131
Z18L4SHR	24 x 18 x 41.3-41.8	100	112.35	13.25	\$1112	\$1158	\$503	\$101
Z16L4SHR	24 x 16 x 41.3-41.8	100	105	12	\$1045	\$1092	\$496	\$101
Z15L4SHR	24 x 15 x 41.3-41.8	100	100.80	11.25	\$1002	\$1039	\$441	\$101
Z12L4SHR	24 x 12 x 41.3-41.8	100	89.25	9.25	\$928	\$961	\$398	\$69
Z21M4SHR	20 x 21 x 41.3-41.8	100	116.55	13	\$1064	\$1111	\$560	\$131
Z18M4SHR	20 x 18 x 41.3-41.8	100	98.70	11.25	\$1007	\$1049	\$503	\$101
Z16M4SHR	20 x 16 x 41.3-41.8	100	91.35	10.25	\$945	\$987	\$496	\$84
Z15M4SHR	20 x 15 x 41.3-41.8	100	88.20	9.50	\$906	\$939	\$441	\$84
Z12M4SHR	20 x 12 x 41.3-41.8	100	78.75	8	\$842	\$872	\$398	\$69
Z21S4SHR	16 x 21 x 41.3-41.8	100	94.50	10.50	\$951	\$989	\$560	\$101
Z18S4SHR	16 x 18 x 41.3-41.8	100	84	9.50	\$912	\$950	\$503	\$84
Z16S4SHR	16 x 16 x 41.3-41.8	100	76.65	8.50	\$855	\$893	\$496	\$84
Z15S4SHR	16 x 15 x 41.3-41.8	100	73.50	8	\$809	\$842	\$441	\$84
Z12S4SHR	16 x 12 x 41.3-41.8	92.5	65.10	6.50	\$749	\$778	\$398	\$69

Laminate doors are standard. **Includes two 3-position fixed/height adjustable shelves.** Standard with lock.

Required Specifications

- Top finish
- Top/edge detail
- Handles*
- Base finish

Optional Specifications

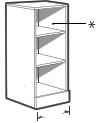
- HP laminate
- Glazed doors**
- Key #

STORAGE MODULES - 41.3"/41.8" HIGH

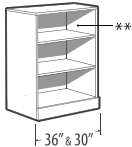
MODEL#	DIMENSIONS	FREIGHT CLASS	WT/LBS.	CUBIC FT.	1" TOP	1.5" TOP	GLAZE ADD	HP ADD
--------	------------	---------------	---------	-----------	--------	----------	-----------	--------

D x W x H

Z36L4SHN	24 x 36 x 41.3-41.8	125	162.55	25	\$1253	\$1332	N/A	\$195
Z30L4SHN	24 x 30 x 41.3-41.8	125	142.46	21.25	\$1155	\$1224	N/A	\$162
Z21L4SHN	24 x 21 x 41.3-41.8	125	111.80	15.25	\$991	\$1047	N/A	\$131
Z18L4SHN	24 x 18 x 41.3-41.8	125	101.23	13.25	\$937	\$984	N/A	\$101
Z16L4SHN	24 x 16 x 41.3-41.8	125	94.53	12	\$874	\$920	N/A	\$101
Z15L4SHN	24 x 15 x 41.3-41.8	100	91.70	11.25	\$845	\$883	N/A	\$101
Z12L4SHN	24 x 12 x 41.3-41.8	100	81.13	9.25	\$786	\$819	N/A	\$69
Z36M4SHN	20 x 36 x 41.3-41.8	125	141.59	21.25	\$1147	\$1216	N/A	\$195
Z30M4SHN	20 x 30 x 41.3-41.8	125	123.94	18	\$1043	\$1103	N/A	\$162
Z21M4SHN	20 x 21 x 41.3-41.8	125	102.19	13	\$876	\$923	N/A	\$131
Z18M4SHN	20 x 18 x 41.3-41.8	125	86.54	11.25	\$835	\$877	N/A	\$101
Z16M4SHN	20 x 16 x 41.3-41.8	125	81.01	10.25	\$773	\$815	N/A	\$101
Z15M4SHN	20 x 15 x 41.3-41.8	100	78.24	9.50	\$750	\$783	N/A	\$101
Z12M4SHN	20 x 12 x 41.3-41.8	100	69.95	8	\$698	\$728	N/A	\$69
Z36S4SHN	16 x 36 x 41.3-41.8	125	119.57	17.50	\$1004	\$1073	N/A	\$146
Z30S4SHN	16 x 30 x 41.3-41.8	125	111.72	14.50	\$906	\$953	N/A	\$131
Z21S4SHN	16 x 21 x 41.3-41.8	125	81.04	10.50	\$762	\$799	N/A	\$101
Z18S4SHN	16 x 18 x 41.3-41.8	125	72.91	9.50	\$738	\$780	N/A	\$84
Z16S4SHN	16 x 16 x 41.3-41.8	125	67.49	8.50	\$683	\$721	N/A	\$84
Z15S4SHN	16 x 15 x 41.3-41.8	100	64.78	8	\$653	\$685	N/A	\$84
Z12S4SHN	16 x 12 x 41.3-41.8	100	57.71	6.50	\$604	\$634	N/A	\$69



21", 18", 16", 15" & 12"

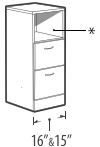
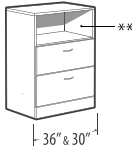


Open Storage Cabinet**



* Accepts collator 11" high
** Accepts collator 11.3" high

Includes two 3-position fixed/height adjustable shelves.



Two File Module with Open Shelf**†

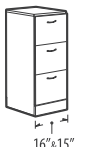


* Accepts collator 11" high
** Accepts collator 11.3" high

Z36L4EN	24 x 36 x 41.3-41.8	125	199.50	25	\$2025	\$2104	N/A	\$195
Z30L4EN	24 x 30 x 41.3-41.8	100	178.50	21.25	\$1934	\$2001	N/A	\$162
Z16L4EN	24 x 16 x 41.3-41.8	100	116.55	12	\$1215	\$1262	N/A	\$101
Z15L4EN	24 x 15 x 41.3-41.8	100	112.35	11.25	\$1181	\$1219	N/A	\$101
Z36M4EN	20 x 36 x 41.3-41.8	100	182	21.25	\$1932	\$2001	N/A	\$195
Z30M4EN	20 x 30 x 41.3-41.8	100	163	18	\$1831	\$1889	N/A	\$162
Z16M4EN	20 x 16 x 41.3-41.8	92.5	105	10.25	\$1118	\$1160	N/A	\$101
Z15M4EN	20 x 15 x 41.3-41.8	92.5	101	9.50	\$1087	\$1120	N/A	\$101
Z36S4EN	16 x 36 x 41.3-41.8	100	153.30	17.50	\$1771	\$1838	N/A	\$146
Z30S4EN	16 x 30 x 41.3-41.8	100	131.25	14.50	\$1612	\$1658	N/A	\$131
Z16S4EN	16 x 16 x 41.3-41.8	92.5	85.05	8.50	\$1026	\$1064	N/A	\$84
Z15S4EN	16 x 15 x 41.3-41.8	92.5	82.95	8	\$1001	\$1033	N/A	\$84

Open fixed shelf and two file drawers on bottom. Lock secures all drawers. For filing capabilities, see page 121.

- Lateral file drawer construction is for accommodating hanging files NOT for stacking materials on the drawer bottom.



Three File Module†

Z36L43F	24 x 36 x 41.3-41.8	100	210	25	\$2380	\$2459	N/A	\$195
Z30L43F	24 x 30 x 41.3-41.8	100	190.05	21.25	\$2261	\$2330	N/A	\$162
Z16L43F	24 x 16 x 41.3-41.8	92.5	126	12	\$1398	\$1444	N/A	\$84
Z15L43F	24 x 15 x 41.3-41.8	92.5	120.75	11.25	\$1360	\$1398	N/A	\$84
Z36M43F	20 x 36 x 41.3-41.8	100	198.45	21.25	\$2316	\$2385	N/A	\$195
Z30M43F	20 x 30 x 41.3-41.8	100	177.45	18	\$2163	\$2223	N/A	\$162
Z16M43F	20 x 16 x 41.3-41.8	92.5	114.45	10.25	\$1304	\$1346	N/A	\$84
Z15M43F	20 x 15 x 41.3-41.8	92.5	110.25	9.50	\$1271	\$1304	N/A	\$84
Z36S43F	16 x 36 x 41.3-41.8	100	165.90	17.50	\$2090	\$2157	N/A	\$146
Z30S43F	16 x 30 x 41.3-41.8	92.5	148.05	14.50	\$1925	\$1972	N/A	\$131
Z16S43F	16 x 16 x 41.3-41.8	92.5	94.50	8.50	\$1233	\$1271	N/A	\$84
Z15S43F	16 x 15 x 41.3-41.8	92.5	91.35	8	\$1193	\$1226	N/A	\$84

Three file drawers. Lock secures all drawers. For filing capabilities, see page 121.

- Lateral file drawer construction is for accommodating hanging files NOT for stacking materials on the drawer bottom.

Required Specifications

Top finish
Top/edge detail
Handles*
Base finish

Optional Specifications

Glazed door*
HP laminate
Collator**

STORAGE MODULES - 41.3"/41.8" HIGH



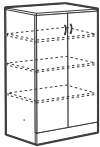
Three File Module

MODEL#	DIMENSIONS D x W x H	FREIGHT CLASS	WT/LBS.	CUBIC FT.	1" TOP	1.5" TOP	GLAZE ADD	HP ADD
Z36L4S3F	24 x 36 x 41.3-41.8	100	233	25	\$2931	\$3010	N/A	\$195
Z36M4S3F	20 x 36 x 41.3-41.8	92.5	221	21.25	\$2843	\$2913	N/A	\$162

Three lateral file drawers with steel drawer interior. Steel drawer construction includes metal sides and masonite bottoms. Lock secures all drawers front-to-back and side-to-side letter/legal filing capability. For filing capabilities, see page 121.

- Front-to-back filing bars sold separately. Order **FBB** bars. See "FBB" on page 41
- Lateral file drawer construction is for accommodating hanging files **NOT** for stacking materials on the drawer bottom.
- To prevent overloading, steel drawers do not include a back panel

STORAGE MODULES - 53" / 53.5" HIGH

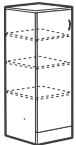


Glazed door option

Storage Cabinet with Doors**

MODEL#	DIMENSIONS	FREIGHT CLASS	WT/LBS.	CUBIC FT.	1" TOP	1.5" TOP	GLAZE ADD	HP ADD
Z36L5SH	24 x 36 x 53-53.5	125	229.95	31.25	\$1919	\$1998	\$1246	\$195
Z30L5SH	24 x 30 x 53-53.5	125	199.50	27	\$1748	\$1817	\$1082	\$162
Z36M5SH	20 x 36 x 53-53.5	125	203.70	27	\$1787	\$1856	\$1246	\$195
Z30M5SH	20 x 30 x 53-53.5	100	184.80	22.75	\$1569	\$1627	\$1082	\$162
Z36S5SH	16 x 36 x 53-53.5	100	175.35	21.75	\$1674	\$1741	\$1246	\$146
Z30S5SH	16 x 30 x 53-53.5	100	152.25	18.50	\$1467	\$1513	\$1082	\$131

Laminate doors are standard. **Includes three 3-position fixed/height adjustable shelves.** Standard with lock.

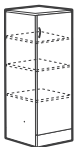


Glazed door option

Storage Cabinet with Door - LEFT**

Z21L5SHL	24 x 21 x 53-53.5	125	154.35	19.50	\$1382	\$1439	\$691	\$131
Z18L5SHL	24 x 18 x 53-53.5	100	139.65	17	\$1316	\$1363	\$620	\$101
Z16L5SHL	24 x 16 x 53-53.5	100	130.20	15.50	\$1246	\$1293	\$614	\$101
Z15L5SHL	24 x 15 x 53-53.5	100	124.95	14.25	\$1188	\$1226	\$539	\$101
Z12L5SHL	24 x 12 x 53-53.5	100	110.25	11.75	\$1106	\$1139	\$486	\$69
Z21M5SHL	20 x 21 x 53-53.5	100	142.80	16.50	\$1264	\$1311	\$691	\$131
Z18M5SHL	20 x 18 x 53-53.5	100	122.85	14.25	\$1197	\$1240	\$620	\$101
Z16M5SHL	20 x 16 x 53-53.5	100	113.40	13	\$1134	\$1176	\$614	\$101
Z15M5SHL	20 x 15 x 53-53.5	100	109.20	12.25	\$1077	\$1112	\$539	\$101
Z12M5SHL	20 x 12 x 53-53.5	100	96.60	10	\$999	\$1030	\$486	\$69
Z21S5SHL	16 x 21 x 53-53.5	100	116.55	13.25	\$1176	\$1213	\$691	\$101
Z18S5SHL	16 x 18 x 53-53.5	100	103.95	11.50	\$1118	\$1156	\$620	\$84
Z16S5SHL	16 x 16 x 53-53.5	100	96.60	10.50	\$1059	\$1097	\$614	\$84
Z15S5SHL	16 x 15 x 53-53.5	100	91.35	9.75	\$1019	\$1051	\$539	\$84
Z12S5SHL	16 x 12 x 53-53.5	100	79.80	8.25	\$937	\$967	\$486	\$69

Laminate doors are standard. **Includes three 3-position fixed/height adjustable shelves.** Standard with lock.



Glazed door option

Storage Cabinet with Door - RIGHT**

Z21L5SHR	24 x 21 x 53-53.5	125	154.35	19.50	\$1382	\$1439	\$691	\$131
Z18L5SHR	24 x 18 x 53-53.5	100	139.65	17	\$1316	\$1363	\$620	\$101
Z16L5SHR	24 x 16 x 53-53.5	100	130.20	15.50	\$1246	\$1293	\$614	\$101
Z15L5SHR	24 x 15 x 53-53.5	100	124.95	14.25	\$1188	\$1226	\$539	\$101
Z12L5SHR	24 x 12 x 53-53.5	100	110.25	11.75	\$1106	\$1139	\$486	\$69
Z21M5SHR	20 x 21 x 53-53.5	100	142.80	16.50	\$1264	\$1311	\$691	\$131
Z18M5SHR	20 x 18 x 53-53.5	100	122.85	14.25	\$1197	\$1240	\$620	\$101
Z16M5SHR	20 x 16 x 53-53.5	100	113.40	13	\$1134	\$1176	\$614	\$101
Z15M5SHR	20 x 15 x 53-53.5	100	109.20	12.25	\$1077	\$1112	\$539	\$101
Z12M5SHR	20 x 12 x 53-53.5	100	96.60	10	\$999	\$1030	\$486	\$69
Z21S5SHR	16 x 21 x 53-53.5	100	116.55	13.25	\$1176	\$1213	\$691	\$101
Z18S5SHR	16 x 18 x 53-53.5	100	103.95	11.50	\$1118	\$1156	\$620	\$84
Z16S5SHR	16 x 16 x 53-53.5	100	96.60	10.50	\$1059	\$1097	\$614	\$84
Z15S5SHR	16 x 15 x 53-53.5	100	91.35	9.75	\$1019	\$1051	\$539	\$84
Z12S5SHR	16 x 12 x 53-53.5	100	79.80	8.25	\$937	\$967	\$486	\$69

Laminate doors are standard. **Includes three 3-position fixed/height adjustable shelves.** Standard with lock.

Required Specifications

- Top finish
- Top/edge detail
- Handles
- Base finish

Optional Specifications

- Glazed doors*
- HP laminate
- Collator**

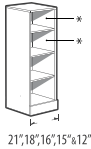
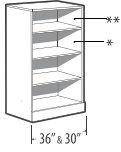
Box drawer† - no upcharge (30" - 36" wide models only)

STORAGE MODULES - 53" / 53.5" HIGH

MODEL# DIMENSIONS FREIGHT CLASS WT/LBS. CUBIC FT. 1" TOP 1.5" TOP GLAZE ADD HP ADD

D x W x H

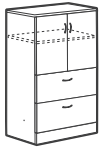
Z36L5SHN	24 x 36 x 53-53.5	125	198.49	31.25	\$1493	\$1573	N/A	\$195
Z30L5SHN	24 x 30 x 53-53.5	125	173.45	27	\$1395	\$1464	N/A	\$162
Z21L5SHN	24 x 21 x 53-53.5	125	136.43	19.50	\$1147	\$1204	N/A	\$131
Z18L5SHN	24 x 18 x 53-53.5	125	124.44	17	\$1102	\$1149	N/A	\$101
Z16L5SHN	24 x 16 x 53-53.5	125	116.10	15.50	\$1030	\$1076	N/A	\$101
Z15L5SHN	24 x 15 x 53-53.5	125	112.45	14.25	\$996	\$1034	N/A	\$101
Z12L5SHN	24 x 12 x 53-53.5	100	100.46	11.75	\$930	\$963	N/A	\$69
Z36M5SHN	20 x 36 x 53-53.5	125	172.27	27	\$1359	\$1429	N/A	\$195
Z30M5SHN	20 x 30 x 53-53.5	125	158.08	22.75	\$1215	\$1275	N/A	\$162
Z21M5SHN	20 x 21 x 53-53.5	125	123.68	16.50	\$1026	\$1073	N/A	\$131
Z18M5SHN	20 x 18 x 53-53.5	125	106.61	14.25	\$980	\$1023	N/A	\$101
Z16M5SHN	20 x 16 x 53-53.5	125	99.43	13	\$916	\$958	N/A	\$101
Z15M5SHN	20 x 15 x 53-53.5	125	95.84	12.25	\$885	\$920	N/A	\$101
Z12M5SHN	20 x 12 x 53-53.5	100	85.07	10	\$822	\$853	N/A	\$69
Z36S5SHN	16 x 36 x 53-53.5	125	145.01	21.75	\$1187	\$1254	N/A	\$146
Z30S5SHN	16 x 30 x 53-53.5	125	126.96	18.50	\$1069	\$1115	N/A	\$131
Z21S5SHN	16 x 21 x 53-53.5	125	98.33	13.25	\$902	\$940	N/A	\$101
Z18S5SHN	16 x 18 x 53-53.5	125	88.78	11.50	\$864	\$906	N/A	\$84
Z16S5SHN	16 x 16 x 53-53.5	125	82.76	10.50	\$807	\$845	N/A	\$84
Z15S5SHN	16 x 15 x 53-53.5	100	78.18	9.75	\$794	\$826	N/A	\$84
Z12S5SHN	16 x 12 x 53-53.5	100	69.69	8.25	\$736	\$766	N/A	\$69



* Accepts collator 11" high
** Accepts collator 11.3" high

Open Storage Cabinet*

Includes three 3-position fixed/height adjustable shelves



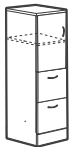
Glazed door option

Two File Module with Doors**

Z36L5E	24 x 36 x 53-53.5	100	250.95	31.25	\$2602	\$2682	\$762	\$195
Z30L5E	24 x 30 x 53-53.5	100	222.60	27	\$2427	\$2496	\$668	\$162
Z36M5E	20 x 36 x 53-53.5	100	229.95	27	\$2482	\$2552	\$792	\$195
Z30M5E	20 x 30 x 53-53.5	100	201.60	22.75	\$2261	\$2321	\$699	\$162
Z36S5E	16 x 36 x 53-53.5	100	193.20	21.75	\$2190	\$2257	\$792	\$146
Z30S5E	16 x 30 x 53-53.5	100	170.10	18.50	\$2015	\$2061	\$699	\$131

Two lateral file drawers on bottom. Laminate doors are standard. Includes one 3-position fixed/height adjustable shelf. Upper lock secures storage compartment. Lower lock secures two file drawers. For filing capabilities, see page 121.

- Lateral file drawer construction is for accommodating hanging files NOT for stacking materials on the drawer bottom.

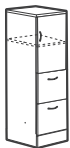


Glazed door option

Two File Module with Door - LEFT

Z16L5EL	24 x 16 x 53-53.5	100	144.90	15.50	\$1512	\$1558	\$387	\$101
Z15L5EL	24 x 15 x 53-53.5	100	139.65	14.25	\$1456	\$1494	\$348	\$101
Z16M5EL	20 x 16 x 53-53.5	92.5	130.20	13	\$1406	\$1448	\$386	\$101
Z15M5EL	20 x 15 x 53-53.5	92.5	126	12.25	\$1350	\$1385	\$348	\$101
Z16S5EL	16 x 16 x 53-53.5	92.5	109.20	10.50	\$1290	\$1328	\$386	\$84
Z15S5EL	16 x 15 x 53-53.5	92.5	105	9.75	\$1266	\$1299	\$348	\$84

Two file drawers on bottom. Laminate door is standard. Includes one 3-position fixed/height adjustable shelf. Upper lock secures storage compartment. Lower lock secures two file drawers.



Glazed door option

Two File Module with Door - RIGHT

Z16L5ER	24 x 16 x 53-53.5	100	144.90	15.50	\$1512	\$1558	\$387	\$101
Z15L5ER	24 x 15 x 53-53.5	100	139.65	14.25	\$1456	\$1494	\$348	\$101
Z16M5ER	20 x 16 x 53-53.5	92.5	130.20	13	\$1406	\$1448	\$386	\$101
Z15M5ER	20 x 15 x 53-53.5	92.5	126	12.25	\$1350	\$1385	\$348	\$101
Z16S5ER	16 x 16 x 53-53.5	92.5	109.20	10.50	\$1290	\$1328	\$386	\$84
Z15S5ER	16 x 15 x 53-53.5	92.5	105	9.75	\$1266	\$1299	\$348	\$84

Two file drawers on bottom. Laminate door is standard. Includes one 3-position fixed/height adjustable shelf. Upper lock secures storage compartment. Lower lock secures two file drawers.

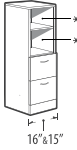
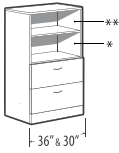
Required Specifications

- Top finish
- Top/edge detail
- Handles
- Base finish

Optional Specifications

- HP laminate
- Box drawer³ - no upcharge (30" - 36" wide models only)
- Collator*

STORAGE MODULES - 53" / 53.5" HIGH



Two File Module with Open Shelves**



MODEL#	DIMENSIONS D x W x H	FREIGHT CLASS	WT./LBS.	CUBIC FT.	1" TOP	1.5" TOP	GLAZE ADD	HP ADD
Z36L5EN	24 x 36 x 53-53.5	125	235.45	31.25	\$2324	\$2404	N/A	\$195
Z30L5EN	24 x 30 x 53-53.5	125	209.86	27	\$2175	\$2242	N/A	\$162
Z16L5EN	24 x 16 x 53-53.5	100	137.89	15.50	\$1370	\$1416	N/A	\$101
Z15L5EN	24 x 15 x 53-53.5	100	133.80	14.25	\$1328	\$1366	N/A	\$101
Z36M5EN	20 x 36 x 53-53.5	125	213.43	27	\$2207	\$2276	N/A	\$195
Z30M5EN	20 x 30 x 53-53.5	100	188.19	22.75	\$2007	\$2067	N/A	\$162
Z16M5EN	20 x 16 x 53-53.5	100	123.33	13	\$1264	\$1306	N/A	\$101
Z15M5EN	20 x 15 x 53-53.5	100	119.29	12.25	\$1220	\$1253	N/A	\$101
Z36S5EN	16 x 36 x 53-53.5	100	178.82	21.75	\$1912	\$1979	N/A	\$146
Z30S5EN	16 x 30 x 53-53.5	100	158.12	18.50	\$1762	\$1808	N/A	\$131
Z16S5EN	16 x 16 x 53-53.5	100	102.46	10.50	\$1147	\$1185	N/A	\$84
Z15S5EN	16 x 15 x 53-53.5	92.5	98.48	9.75	\$1139	\$1171	N/A	\$84

Two open shelves and two file drawers on bottom. **Includes one 3-position fixed/height adjustable shelf.** Lock secures all drawers. For filing capabilities, see page 121.

- Lateral file drawer construction is for accommodating hanging files NOT for stacking materials on the drawer bottom.



Four File Module†

Z36L54F	24 x 36 x 53-53.5	100	256.20	31.25	\$2934	\$3013	N/A	\$195
Z30L54F	24 x 30 x 53-53.5	100	234.15	27	\$2814	\$2883	N/A	\$162
Z16L54F	24 x 16 x 53-53.5	92.5	155.40	15.50	\$1684	\$1730	N/A	\$101
Z15L54F	24 x 15 x 53-53.5	92.5	148.05	14.25	\$1628	\$1666	N/A	\$101
Z36M54F	20 x 36 x 53-53.5	100	239.40	27	\$2843	\$2912	N/A	\$195
Z30M54F	20 x 30 x 53-53.5	100	218.40	22.75	\$2670	\$2730	N/A	\$162
Z16M54F	20 x 16 x 53-53.5	92.5	141.75	13	\$1590	\$1632	N/A	\$101
Z15M54F	20 x 15 x 53-53.5	92.5	136.50	12.25	\$1535	\$1568	N/A	\$101
Z36S54F	16 x 36 x 53-53.5	100	205	21.75	\$2544	\$2611	N/A	\$146
Z30S54F	16 x 30 x 53-53.5	100	180	18.50	\$2318	\$2364	N/A	\$131
Z16S54F	16 x 16 x 53-53.5	92.5	122	10.50	\$1562	\$1600	N/A	\$84
Z15S54F	16 x 15 x 53-53.5	92.5	116	9.75	\$1505	\$1538	N/A	\$84

Four file drawers. Lock secures all drawers. For filing capabilities, see page 121.

- Lateral file drawer construction is for accommodating hanging files NOT for stacking materials on the drawer bottom.

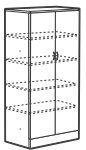


Four File Module

Z36L5S4F	24 x 36 x 53-53.5	100	286	31.25	\$3508	\$3587	N/A	\$195
Z36M5S4F	20 x 36 x 53-53.5	100	269	27	\$3582	\$3652	N/A	\$195

Four file drawers with steel drawer interior. Steel drawer construction includes metal sides and masonite bottoms. Lock secures all drawers. Front-to-back and side-to-side letter/legal filing capability. For filing capabilities, see page 121.

- Front-to-back filing bars sold separately. Order **FBB** bars. See "FBB" on page 41.
- Lateral file drawer construction is for accommodating hanging files NOT for stacking materials on the drawer bottom.
- To prevent overloading, steel drawers do not include a back panel



Storage Cabinet with Doors**



Z36L6SH	24 x 36 x 65.5-66	125	273	39	\$2273	\$2353	\$1475	N/A
Z30L6SH	24 x 30 x 65.5-66	125	238.35	32.75	\$1987	\$2056	\$1276	N/A
Z36M6SH	20 x 36 x 65.5-66	125	246.75	33.25	\$2109	\$2179	\$1475	N/A
Z30M6SH	20 x 30 x 65.5-66	125	212.10	27.75	\$1840	\$1898	\$1276	N/A
Z36S6SH	16 x 36 x 65.5-66	125	210	26.50	\$1908	\$1975	\$1475	N/A
Z30S6SH	16 x 30 x 65.5-66	100	183.75	22.50	\$1640	\$1687	\$1276	N/A

Laminate doors are standard. **Includes four 3-position fixed/height adjustable shelves.** Standard with lock.

Required Specifications

Top finish
Top/edge detail
Handles
Base finish

Optional Specifications

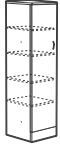
HP laminate
Collator*
Glazed doors**

STORAGE MODULES - 53" / 53.5" HIGH

MODEL# DIMENSIONS FREIGHT CLASS WT/LBS. CUBIC FT. 1" TOP 1.5" TOP GLAZE ADD HP ADD

D x W x H

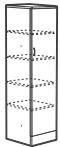
Z21L6SHL	24 x 21 x 65.5-66	125	185.85	23.50	\$1629	\$1686	\$817	N/A
Z18L6SHL	24 x 18 x 65.5-66	100	168	20.50	\$1521	\$1568	\$736	N/A
Z16L6SHL	24 x 16 x 65.5-66	100	156.45	18.75	\$1434	\$1480	\$728	N/A
Z15L6SHL	24 x 15 x 65.5-66	100	149.10	17.50	\$1390	\$1428	\$637	N/A
Z12L6SHL	24 x 12 x 65.5-66	100	133.35	14.50	\$1263	\$1298	\$572	N/A
Z21M6SHL	20 x 21 x 65.5-66	100	170.10	20	\$1457	\$1504	\$817	N/A
Z18M6SHL	20 x 18 x 65.5-66	100	148.05	17.25	\$1390	\$1432	\$736	N/A
Z16M6SHL	20 x 16 x 65.5-66	100	137.55	15.75	\$1308	\$1350	\$728	N/A
Z15M6SHL	20 x 15 x 65.5-66	100	133.35	14.75	\$1247	\$1282	\$637	N/A
Z12M6SHL	20 x 12 x 65.5-66	100	116.55	12.25	\$1155	\$1186	\$572	N/A
Z21S6SHL	16 x 21 x 65.5-66	100	140.70	16	\$1344	\$1381	\$817	N/A
Z18S6SHL	16 x 18 x 65.5-66	100	126	14	\$1245	\$1283	\$736	N/A
Z16S6SHL	16 x 16 x 65.5-66	100	116.55	13	\$1170	\$1208	\$728	N/A
Z15S6SHL	16 x 15 x 65.5-66	100	111.30	12	\$1112	\$1145	\$637	N/A
Z12S6SHL	16 x 12 x 65.5-66	100	96.60	10	\$1020	\$1050	\$572	N/A



Glazed door option

Storage Cabinet with Door - LEFT**

Laminate doors are standard. Includes four 3-position fixed/height adjustable shelves. Standard with lock.

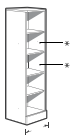
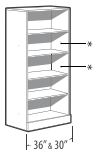


Glazed door option

Storage Cabinet with Door - RIGHT**

Z21L6SHR	24 x 21 x 65.5-66	125	185.85	23.50	\$1629	\$1686	\$817	N/A
Z18L6SHR	24 x 18 x 65.5-66	100	168	20.50	\$1521	\$1568	\$736	N/A
Z16L6SHR	24 x 16 x 65.5-66	100	156.45	18.75	\$1434	\$1480	\$728	N/A
Z15L6SHR	24 x 15 x 65.5-66	100	149.10	17.50	\$1390	\$1428	\$637	N/A
Z12L6SHR	24 x 12 x 65.5-66	100	133.35	14.50	\$1263	\$1298	\$572	N/A
Z21M6SHR	20 x 21 x 65.5-66	100	170.10	20	\$1457	\$1504	\$817	N/A
Z18M6SHR	20 x 18 x 65.5-66	100	148.05	17.25	\$1390	\$1432	\$736	N/A
Z16M6SHR	20 x 16 x 65.5-66	100	137.55	15.75	\$1308	\$1350	\$728	N/A
Z15M6SHR	20 x 15 x 65.5-66	100	133.35	14.75	\$1247	\$1282	\$637	N/A
Z12M6SHR	20 x 12 x 65.5-66	100	116.55	12.25	\$1155	\$1186	\$572	N/A
Z21S6SHR	16 x 21 x 65.5-66	100	140.70	16	\$1344	\$1381	\$817	N/A
Z18S6SHR	16 x 18 x 65.5-66	100	126	14	\$1245	\$1283	\$736	N/A
Z16S6SHR	16 x 16 x 65.5-66	100	116.55	13	\$1170	\$1208	\$728	N/A
Z15S6SHR	16 x 15 x 65.5-66	100	111.30	12	\$1112	\$1145	\$637	N/A
Z12S6SHR	16 x 12 x 65.5-66	100	96.60	10	\$1020	\$1050	\$572	N/A

Laminate doors are standard. Includes four 3-position fixed/height adjustable shelves. Standard with lock.



21"18"16"15"12"



* Accepts collator 11" high

Open Storage Cabinet

Z36L6SHN	24 x 36 x 65.5-66	125	234.42	39	\$1761	\$1841	N/A	N/A
Z30L6SHN	24 x 30 x 65.5-66	125	205.50	32.75	\$1560	\$1629	N/A	N/A
Z21L6SHN	24 x 21 x 65.5-66	125	163.17	23.50	\$1354	\$1411	N/A	N/A
Z18L6SHN	24 x 18 x 65.5-66	125	148.71	20.50	\$1271	\$1318	N/A	N/A
Z16L6SHN	24 x 16 x 65.5-66	125	139.77	18.75	\$1183	\$1229	N/A	N/A
Z15L6SHN	24 x 15 x 65.5-66	125	134.25	17.50	\$1171	\$1209	N/A	N/A
Z12L6SHN	24 x 12 x 65.5-66	100	119.79	14.50	\$1063	\$1096	N/A	N/A
Z36M6SHN	20 x 36 x 65.5-66	125	206.11	33.25	\$1593	\$1662	N/A	N/A
Z30M6SHN	20 x 30 x 65.5-66	125	178.58	27.75	\$1410	\$1468	N/A	N/A
Z21M6SHN	20 x 21 x 65.5-66	125	146.22	20	\$1183	\$1230	N/A	N/A
Z18M6SHN	20 x 18 x 65.5-66	125	127.73	17.25	\$1142	\$1185	N/A	N/A
Z16M6SHN	20 x 16 x 65.5-66	125	119.95	15.75	\$1061	\$1103	N/A	N/A
Z15M6SHN	20 x 15 x 65.5-66	125	116.59	14.75	\$1029	\$1064	N/A	N/A
Z12M6SHN	20 x 12 x 65.5-66	100	102.30	12.25	\$957	\$987	N/A	N/A
Z36S6SHN	16 x 36 x 65.5-66	125	172.54	26.50	\$1397	\$1464	N/A	N/A
Z30S6SHN	16 x 30 x 65.5-66	125	151.66	22.50	\$1213	\$1260	N/A	N/A
Z21S6SHN	16 x 21 x 65.5-66	125	117.71	16	\$1068	\$1106	N/A	N/A
Z18S6SHN	16 x 18 x 65.5-66	125	105.70	14	\$996	\$1034	N/A	N/A
Z16S6SHN	16 x 16 x 65.5-66	125	99.09	13	\$926	\$964	N/A	N/A
Z15S6SHN	16 x 15 x 65.5-66	125	94.73	12	\$893	\$926	N/A	N/A
Z12S6SHN	16 x 12 x 65.5-66	100	83.76	10	\$822	\$852	N/A	N/A

Includes four 3-position fixed/height adjustable shelves.

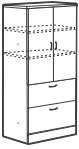
Required Specifications

- Top finish
- Top/edge detail
- Handles
- Base finish

Optional Specifications

- HP laminate
- Collator*
- Glazed doors**

STORAGE MODULES - 65.5" / 66" HIGH



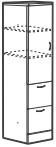
Glazed door option

Two File Module with Doors**

MODEL#	DIMENSIONS D x W x H	FREIGHT CLASS	WT./LBS.	CUBIC FT.	1" TOP	1.5" TOP	GLAZE ADD	HP ADD
Z36L6E	24 x 36 x 65.5-66	125	294	39	\$2867	\$2947	\$1021	N/A
Z30L6E	24 x 30 x 65.5-66	125	260.40	32.75	\$2621	\$2690	\$893	N/A
Z36M6E	20 x 36 x 65.5-66	100	269.85	33.25	\$2745	\$2814	\$1021	N/A
Z30M6E	20 x 30 x 65.5-66	100	236.25	27.75	\$2482	\$2542	\$893	N/A
Z36S6E	16 x 36 x 65.5-66	100	225	26.50	\$2349	\$2418	\$1021	N/A
Z30S6E	16 x 30 x 65.5-66	100	197	22.50	\$2247	\$2293	\$893	N/A

Two lateral file drawers on bottom. Laminate doors are standard. **Includes two 3-position fixed/height adjustable shelves.** Upper lock secures storage compartment. Lower lock secures two file drawers. For filing capabilities, see page 121.

- Lateral file drawer construction is for accommodating hanging files NOT for stacking materials on the drawer bottom.

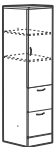


Glazed door option

Two File Module with Door - LEFT

Z16L6EL	24 x 16 x 65.5-66	100	171.15	18.75	\$1698	\$1745	\$499	N/A
Z15L6EL	24 x 15 x 65.5-66	100	163.80	17.50	\$1658	\$1696	\$444	N/A
Z16M6EL	20 x 16 x 65.5-66	100	153.30	15.75	\$1579	\$1621	\$499	N/A
Z15M6EL	20 x 15 x 65.5-66	92.5	148.05	14.75	\$1521	\$1556	\$444	N/A
Z16S6EL	16 x 16 x 65.5-66	100	129.15	13	\$1442	\$1480	\$499	N/A
Z15S6EL	16 x 15 x 65.5-66	92.5	123.90	12	\$1397	\$1430	\$444	N/A

Two file drawers on bottom. Laminate door is standard. **Includes two 3-position fixed/height adjustable shelves.** Upper lock secures storage compartment. Lower lock secures two file drawers.

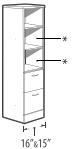
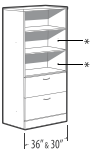


Glazed door option

Two File Module with Door - RIGHT

Z16L6ER	24 x 16 x 65.5-66	100	171.15	18.75	\$1698	\$1745	\$499	N/A
Z15L6ER	24 x 15 x 65.5-66	100	163.80	17.50	\$1658	\$1696	\$444	N/A
Z16M6ER	20 x 16 x 65.5-66	100	153.30	15.75	\$1579	\$1621	\$499	N/A
Z15M6ER	20 x 15 x 65.5-66	92.5	148.05	14.75	\$1521	\$1556	\$444	N/A
Z16S6ER	16 x 16 x 65.5-66	100	129.15	13	\$1442	\$1480	\$499	N/A
Z15S6ER	16 x 15 x 65.5-66	92.5	123.90	12	\$1397	\$1430	\$444	N/A

Two file drawers on bottom. Laminate door is standard. **Includes three 3-position fixed/height adjustable shelves.** Upper lock secures storage compartment. Lower lock secures two file drawers.



* Accepts collator 11" high

Two File Module with Open Shelves†

Z36L6EN	24 x 36 x 65.5-66	125	271.38	39	\$2504	\$2584	N/A	N/A
Z30L6EN	24 x 30 x 65.5-66	125	240.85	32.75	\$2295	\$2364	N/A	N/A
Z16L6EN	24 x 16 x 65.5-66	100	161.56	18.75	\$1524	\$1570	N/A	N/A
Z15L6EN	24 x 15 x 65.5-66	100	155.60	17.50	\$1503	\$1541	N/A	N/A
Z36M6EN	20 x 36 x 65.5-66	125	243.07	33.25	\$2381	\$2450	N/A	N/A
Z30M6EN	20 x 30 x 65.5-66	125	213.93	27.75	\$2158	\$2218	N/A	N/A
Z16M6EN	20 x 16 x 65.5-66	100	142.80	15.75	\$1407	\$1449	N/A	N/A
Z15M6EN	20 x 15 x 65.5-66	100	137.94	14.75	\$1365	\$1400	N/A	N/A
Z36S6EN	16 x 36 x 65.5-66	125	202.15	26.50	\$1983	\$2052	N/A	N/A
Z30S6EN	16 x 30 x 65.5-66	125	177.56	22.50	\$1921	\$1967	N/A	N/A
Z16S6EN	16 x 16 x 65.5-66	100	118.78	13	\$1267	\$1305	N/A	N/A
Z15S6EN	16 x 15 x 65.5-66	100	113.98	12	\$1242	\$1275	N/A	N/A

Three open shelves and two file drawers on bottom. **Includes two 3-position fixed/height adjustable shelves.** Lock secures all drawers. For filing capabilities, see page 121.

- Lateral file drawer construction is for accommodating hanging files NOT for stacking materials on the drawer bottom.

Required Specifications

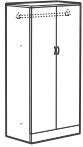
Top finish
Top/edge detail
Handles
Base finish

Optional Specifications

HP laminate
Collator*
Glazed doors**

Box drawer† - no upcharge (30" - 36" wide models only)

WARDROBE MODULES - 65.5" / 66" HIGH



Wardrobe Cabinet

MODEL#	DIMENSIONS	FREIGHT CLASS	WT/LBS.	CUBIC FT.	1" TOP	1.5" TOP	GLAZE ADD	HP ADD
Z36L6WA	24 x 36 x 65.5-66	150	216.30	39	\$1947	\$2026	N/A	N/A
Z30L6WA	24 x 30 x 65.5-66	150	192.15	32.75	\$1753	\$1822	N/A	N/A
Z36M6WA	20 x 36 x 65.5-66	125	200.55	33.25	\$1865	\$1934	N/A	N/A
Z30M6WA	20 x 30 x 65.5-66	125	173.25	27.75	\$1651	\$1711	N/A	N/A

Laminate doors are standard. Full length hanging rod included. Standard with lock.



Wardrobe Cabinet - LEFT

MODEL#	DIMENSIONS	FREIGHT CLASS	WT/LBS.	CUBIC FT.	1" TOP	1.5" TOP	GLAZE ADD	HP ADD
Z24L6WAL	24 x 24 x 65.5-66	125	165.90	26.75	\$1608	\$1665	N/A	N/A
Z21L6WAL	24 x 21 x 65.5-66	125	152.25	23.50	\$1480	\$1536	N/A	N/A
Z18L6WAL	24 x 18 x 65.5-66	125	139.65	20.50	\$1314	\$1361	N/A	N/A
Z16L6WAL	24 x 16 x 65.5-66	125	132.30	18.75	\$1286	\$1333	N/A	N/A
Z15L6WAL	24 x 15 x 65.5-66	125	128.10	17.50	\$1233	\$1271	N/A	N/A
Z12L6WAL	24 x 12 x 65.5-66	125	115.50	14.50	\$1140	\$1173	N/A	N/A
Z24M6WAL	20 x 24 x 65.5-66	125	149.10	22.50	\$1383	\$1430	N/A	N/A
Z21M6WAL	20 x 21 x 65.5-66	125	143.85	20	\$1341	\$1387	N/A	N/A
Z18M6WAL	20 x 18 x 65.5-66	125	124.95	17.25	\$1214	\$1256	N/A	N/A
Z16M6WAL	20 x 16 x 65.5-66	125	116.55	15.75	\$1183	\$1225	N/A	N/A
Z15M6WAL	20 x 15 x 65.5-66	125	113.40	14.75	\$1113	\$1148	N/A	N/A
Z12M6WAL	20 x 12 x 65.5-66	100	102.90	12.25	\$1061	\$1091	N/A	N/A

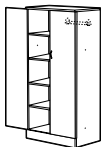
Laminate doors are standard. Full length hanging rod included. Standard with lock.



Wardrobe Cabinet - RIGHT

MODEL#	DIMENSIONS	FREIGHT CLASS	WT/LBS.	CUBIC FT.	1" TOP	1.5" TOP	GLAZE ADD	HP ADD
Z24L6WAR	24 x 24 x 65.5-66	125	165.90	26.75	\$1608	\$1665	N/A	N/A
Z21L6WAR	24 x 21 x 65.5-66	125	152.25	23.50	\$1480	\$1536	N/A	N/A
Z18L6WAR	24 x 18 x 65.5-66	125	139.65	20.50	\$1314	\$1361	N/A	N/A
Z16L6WAR	24 x 16 x 65.5-66	125	132.30	18.75	\$1286	\$1333	N/A	N/A
Z15L6WAR	24 x 15 x 65.5-66	125	128.10	17.50	\$1233	\$1271	N/A	N/A
Z12L6WAR	24 x 12 x 65.5-66	125	115.50	14.50	\$1140	\$1173	N/A	N/A
Z24M6WAR	20 x 24 x 65.5-66	125	149.10	22.50	\$1383	\$1430	N/A	N/A
Z21M6WAR	20 x 21 x 65.5-66	125	143.85	20	\$1341	\$1387	N/A	N/A
Z18M6WAR	20 x 18 x 65.5-66	125	124.95	17.25	\$1214	\$1256	N/A	N/A
Z16M6WAR	20 x 16 x 65.5-66	125	116.55	15.75	\$1183	\$1225	N/A	N/A
Z15M6WAR	20 x 15 x 65.5-66	125	113.40	14.75	\$1113	\$1148	N/A	N/A
Z12M6WAR	20 x 12 x 65.5-66	100	102.90	12.25	\$1061	\$1091	N/A	N/A

Laminate doors are standard. Full length hanging rod included. Standard with lock.



Glazed door option

Wardrobe Cabinet/Shelving Combo with Doors - LEFT*

MODEL#	DIMENSIONS	FREIGHT CLASS	WT/LBS.	CUBIC FT.	1" TOP	1.5" TOP	GLAZE ADD	HP ADD
Z36L6DIL	24 x 36 x 65.5-66	125	269.85	39	\$2325	\$2405	\$1475	N/A
Z30L6DIL	24 x 30 x 65.5-66	125	240.45	32.75	\$2060	\$2127	\$1276	N/A
Z24L6DIL	24 x 24 x 65.5-66	125	208.95	26.75	\$1922	\$1980	\$1153	N/A
Z21L6DIL	24 x 21 x 65.5-66	100	193.20	23.50	\$1805	\$1862	\$1142	N/A
Z36M6DIL	20 x 36 x 65.5-66	125	243.60	33.25	\$2187	\$2256	\$1475	N/A
Z30M6DIL	20 x 30 x 65.5-66	100	226.80	27.75	\$1910	\$1970	\$1276	N/A
Z24M6DIL	20 x 24 x 65.5-66	100	184.80	22.50	\$1713	\$1760	\$1153	N/A
Z21M6DIL	20 x 21 x 65.5-66	100	171.15	20	\$1664	\$1711	\$1142	N/A

Laminate doors are standard. Storage compartment on **left includes four 3-position fixed/height adjustable shelves**. Wardrobe compartment on **right** includes hanging rod. Two locks secure storage and wardrobe compartments.

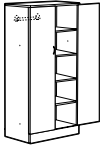
Required Specifications

- Top finish
- Top/edge detail
- Handles
- Base finish

Optional Specifications

- Collator*
- Glazed doors**

WARDROBE MODULES - 65.5" / 66" HIGH

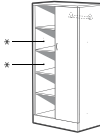


Glazed door option

Wardrobe Cabinet/Shelving Combo with Doors - RIGHT*

MODEL#	DIMENSIONS D x W x H	FREIGHT CLASS	WT./LBS.	CUBIC FT.	1" TOP	1.5" TOP	GLAZE ADD	HP ADD
Z36L6DIR	24 x 36 x 65.5-66	125	269.85	39	\$2325	\$2405	\$1475	N/A
Z30L6DIR	24 x 30 x 65.5-66	125	240.45	32.75	\$2060	\$2127	\$1276	N/A
Z24L6DIR	24 x 24 x 65.5-66	125	208.95	26.75	\$1922	\$1980	\$1153	N/A
Z21L6DIR	24 x 21 x 65.5-66	100	193.20	23.50	\$1805	\$1862	\$1142	N/A
Z36M6DIR	20 x 36 x 65.5-66	125	243.60	33.25	\$2187	\$2256	\$1475	N/A
Z30M6DIR	20 x 30 x 65.5-66	100	226.80	27.75	\$1910	\$1970	\$1276	N/A
Z24M6DIR	20 x 24 x 65.5-66	100	184.80	22.50	\$1713	\$1760	\$1153	N/A
Z21M6DIR	20 x 21 x 65.5-66	100	171.15	20	\$1664	\$1711	\$1142	N/A

Laminate doors are standard. Storage compartment on **right includes four 3-position fixed/height adjustable shelves**. Wardrobe compartment on **left** includes hanging rod. Two locks secure storage and wardrobe compartments.



Glazed door option



* Accepts collator 11" high

Wardrobe Cabinet/Open Shelving Combo - LEFT*

Z36L6DINL	24 x 36 x 65.5-66	125	251.50	39	\$2077	\$2157	\$737	N/A
Z30L6DINL	24 x 30 x 65.5-66	125	224.46	32.75	\$1856	\$1925	\$638	N/A
Z24L6DINL	24 x 24 x 65.5-66	125	196.37	26.75	\$1750	\$1807	\$573	N/A
Z21L6DINL	24 x 21 x 65.5-66	125	183.37	23.50	\$1633	\$1690	\$570	N/A
Z36M6DINL	20 x 36 x 65.5-66	125	223.19	33.25	\$1943	\$2013	\$737	N/A
Z30M6DINL	20 x 30 x 65.5-66	125	197.54	27.75	\$1707	\$1767	\$638	N/A
Z24M6DINL	20 x 24 x 65.5-66	125	174.14	22.50	\$1542	\$1589	\$573	N/A
Z21M6DINL	20 x 21 x 65.5-66	125	159.07	20	\$1492	\$1539	\$570	N/A

Laminate door is standard. Storage compartment on **left includes four 3-position fixed/height adjustable shelves**. Wardrobe compartment on **right** includes hanging rod. Single lock secures storage and wardrobe compartments.



Glazed door option



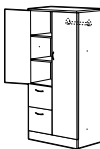
* Accepts collator 11" high

Wardrobe Cabinet/Open Shelving Combo - RIGHT*

Z36L6DINR	24 x 36 x 65.5-66	125	251.50	39	\$2077	\$2157	\$737	N/A
Z30L6DINR	24 x 30 x 65.5-66	125	224.46	32.75	\$1856	\$1925	\$638	N/A
Z24L6DINR	24 x 24 x 65.5-66	125	196.37	26.75	\$1750	\$1807	\$573	N/A
Z21L6DINR	24 x 21 x 65.5-66	125	183.37	23.50	\$1633	\$1690	\$570	N/A
Z36M6DINR	20 x 36 x 65.5-66	125	223.19	33.25	\$1943	\$2013	\$737	N/A
Z30M6DINR	20 x 30 x 65.5-66	125	197.54	27.75	\$1707	\$1767	\$638	N/A
Z24M6DINR	20 x 24 x 65.5-66	125	174.14	22.50	\$1542	\$1589	\$573	N/A
Z21M6DINR	20 x 21 x 65.5-66	125	159.07	20	\$1492	\$1539	\$570	N/A

Laminate door is standard. Storage compartment on **right includes four 3-position fixed/height adjustable shelves**. Wardrobe compartment on **left** includes hanging rod. Single lock secures storage and wardrobe compartments.

PERSONAL TOWERS - 65.5" / 66" HIGH



Glazed door option

Personal Tower with Doors - LEFT

MODEL#	DIMENSIONS D x W x H	FREIGHT CLASS	WT./LBS.	CUBIC FT.	1" TOP	1.5" TOP	GLAZE ADD	HP ADD
Z36L6EL	24 x 36 x 65.5-66	125	290.85	39	\$2551	\$2630	\$1239	N/A
Z30L6EL	24 x 30 x 65.5-66	100	266.70	32.75	\$2360	\$2429	\$1128	N/A
Z24L6EL	24 x 24 x 65.5-66	100	243.24	26.75	\$2263	\$2320	\$988	N/A
Z36M6EL	20 x 36 x 65.5-66	125	256.20	33.25	\$2414	\$2483	\$1239	N/A
Z30M6EL	20 x 30 x 65.5-66	100	229.95	27.75	\$2205	\$2265	\$1128	N/A
Z24M6EL	20 x 24 x 65.5-66	100	217	22.50	\$2114	\$2161	\$988	N/A

Two file drawers on bottom. Laminate doors are standard. Storage compartment on **left includes two 3-position fixed/height adjustable shelves**. Wardrobe compartment on **right** includes hanging rod. Two upper locks, one per each hinged door, and one lower lock secures drawers, all keyed alike.



Glazed door option

Personal Tower with Doors - RIGHT

Z36L6ER	24 x 36 x 65.5-66	125	290.85	39	\$2551	\$2630	\$1239	N/A
Z30L6ER	24 x 30 x 65.5-66	100	266.70	32.75	\$2360	\$2429	\$1128	N/A
Z24L6ER	24 x 24 x 65.5-66	100	243.24	26.75	\$2263	\$2320	\$988	N/A
Z36M6ER	20 x 36 x 65.5-66	125	256.20	33.25	\$2414	\$2483	\$1239	N/A
Z30M6ER	20 x 30 x 65.5-66	100	229.95	27.75	\$2205	\$2265	\$1128	N/A
Z24M6ER	20 x 24 x 65.5-66	100	217	22.50	\$2114	\$2161	\$988	N/A

Two file drawers on bottom. Laminate doors are standard. Storage compartment on **right includes four 3-position fixed/height adjustable shelves**. Wardrobe compartment on **left** includes hanging rod. Two upper locks, one per each hinged door, and one lower lock secures drawers, all keyed alike.

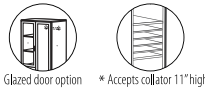
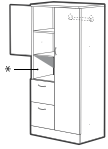
Required Specifications

- Top finish
- Top/edge detail
- Handles
- Base finish

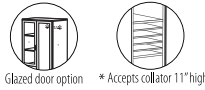
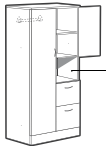
Optional Specifications

- Collator
- Glazed doors*

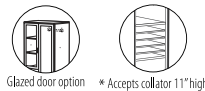
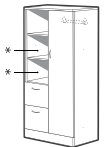
PERSONAL TOWERS - 65.5" / 66" HIGH



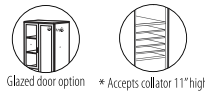
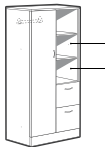
Personal Tower with Doors and cavity - LEFT*



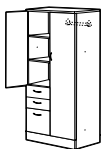
Personal Tower with Doors and cavity - RIGHT*



Personal Tower with Open Shelves - LEFT*



Personal Tower with Open*



Personal Tower with Doors - LEFT

MODEL#	DIMENSIONS	FREIGHT CLASS	WT/LBS.	CUBIC FT.	1" TOP	1.5" TOP	GLAZE ADD	HP ADD	
D x W x H									
Z36L6ECL	24 x 36 x 65.5-66	125	288.74	39	\$2518	\$2598	\$1181	N/A	
Z30L6ECL	24 x 30 x 65.5-66	100	264.24	32.75	\$2328	\$2397	\$1074	N/A	
Z24L6ECL	24 x 24 x 65.5-66	100	239.24	26.75	\$2232	\$2289	\$931	N/A	
Z36M6ECL	20 x 36 x 65.5-66	125	252.03	33.25	\$2371	\$2440	\$1181	N/A	
Z30M6ECL	20 x 30 x 65.5-66	100	226.82	27.75	\$2160	\$2218	\$1074	N/A	
Z24M6ECL	20 x 24 x 65.5-66	100	213	22.50	\$2085	\$2132	\$931	N/A	

Two file drawers on bottom. Laminate doors are standard. Storage compartment on left includes one 3-position fixed/height adjustable shelf. Wardrobe compartment on right includes hanging rod. Two upper locks, one per each hinged door, and one lower lock secures drawers, all keyed alike.

Z36L6ECR	24 x 36 x 65.5-66	125	288.74	39	\$2518	\$2598	\$1181	N/A
Z30L6ECR	24 x 30 x 65.5-66	100	264.24	32.75	\$2328	\$2397	\$1074	N/A
Z24L6ECR	24 x 24 x 65.5-66	100	239.24	26.75	\$2232	\$2289	\$931	N/A
Z36M6ECR	20 x 36 x 65.5-66	125	252.03	33.25	\$2371	\$2440	\$1181	N/A
Z30M6ECR	20 x 30 x 65.5-66	100	226.82	27.75	\$2160	\$2218	\$1074	N/A
Z24M6ECR	20 x 24 x 65.5-66	100	213	22.50	\$2085	\$2132	\$931	N/A

Two file drawers on bottom. Laminate doors are standard. Storage compartment on right includes one 3-position fixed/height adjustable shelf. Wardrobe compartment on left includes hanging rod. Two upper locks, one per each hinged door, and one lower lock secures drawers, all keyed alike.

Z36L6ENL	24 x 36 x 65.5-66	125	280.48	39	\$2380	\$2459	\$741	N/A
Z30L6ENL	24 x 30 x 65.5-66	125	257.36	32.75	\$2187	\$2256	\$634	N/A
Z24L6ENL	24 x 24 x 65.5-66	100	230.24	26.75	\$2094	\$2151	\$492	N/A
Z36M6ENL	20 x 36 x 65.5-66	125	243.77	33.25	\$2230	\$2299	\$741	N/A
Z30M6ENL	20 x 30 x 65.5-66	125	219.94	27.75	\$2020	\$2080	\$634	N/A
Z24M6ENL	20 x 24 x 65.5-66	100	204	22.50	\$1915	\$1978	\$492	N/A

Two file drawers on bottom. Laminate doors are standard on wardrobe section. Storage compartment on left includes two 3-position fixed/height adjustable shelves. Wardrobe compartment on right includes hanging rod. Upper lock secures storage and wardrobe compartments. Lower lock secures all drawers.

Z36L6ENR	24 x 36 x 65.5-66	125	280.48	39	\$2380	\$2459	\$741	N/A
Z30L6ENR	24 x 30 x 65.5-66	125	257.36	32.75	\$2187	\$2256	\$634	N/A
Z24L6ENR	24 x 24 x 65.5-66	100	230.24	26.75	\$2094	\$2151	\$492	N/A
Z36M6ENR	20 x 36 x 65.5-66	125	243.77	33.25	\$2230	\$2299	\$741	N/A
Z30M6ENR	20 x 30 x 65.5-66	125	219.94	27.75	\$2020	\$2080	\$634	N/A
Z24M6ENR	20 x 24 x 65.5-66	100	204	22.50	\$1915	\$1978	\$492	N/A

Two file drawers on bottom. Laminate doors is standard on wardrobe section. Storage compartment on right includes two 3-position fixed/height adjustable shelves. Wardrobe compartment on left includes hanging rod. Upper lock secures storage and wardrobe compartments. Lower lock secures all drawers.

Z36L6BFL	24 x 36 x 65.5-66	125	294	39	\$2682	\$2761	\$1239	N/A
Z30L6BFL	24 x 30 x 65.5-66	100	268.80	32.75	\$2492	\$2561	\$1128	N/A
Z24L6BFL	24 x 24 x 65.5-66	100	244.24	26.75	\$2368	\$2426	\$988	N/A
Z36M6BFL	20 x 36 x 65.5-66	125	258.30	33.25	\$2554	\$2623	\$1239	N/A
Z30M6BFL	20 x 30 x 65.5-66	100	232.05	27.75	\$2343	\$2403	\$1128	N/A
Z24M6BFL	20 x 24 x 65.5-66	100	218	22.50	\$2222	\$2269	\$988	N/A

Two box and one file drawer on bottom. Laminate doors are standard. Storage compartment on left includes two 3-position fixed/height adjustable shelves. Wardrobe compartment on right includes hanging rod. Two upper locks, one per each hinged door, and one lower lock secures drawers, all keyed alike.

Required Specifications

- Top finish
- Top/edge detail
- Handles
- Base finish

Optional Specifications

- Collator**
- Glazed doors*
- Box drawer† - no upcharge (30"-36" wide models only)

PERSONAL TOWERS - 65.5" / 66" HIGH

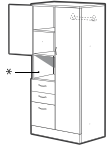


Glazed door option

Personal Tower with Doors - RIGHT

MODEL#	DIMENSIONS D x W x H	FREIGHT CLASS	WT./LBS.	CUBIC FT.	1" TOP	1.5" TOP	GLAZE ADD	HP ADD
Z36L6BFR	24 x 36 x 65.5-66	125	294	39	\$2682	\$2761	\$1239	N/A
Z30L6BFR	24 x 30 x 65.5-66	100	268.80	32.75	\$2492	\$2561	\$1128	N/A
Z24L6BFR	24 x 24 x 65.5-66	100	244.24	26.75	\$2368	\$2426	\$988	N/A
Z36M6BFR	20 x 36 x 65.5-66	125	258.30	33.25	\$2554	\$2623	\$1239	N/A
Z30M6BFR	20 x 30 x 65.5-66	100	232.05	27.75	\$2343	\$2403	\$1128	N/A
Z24M6BFR	20 x 24 x 65.5-66	100	218	22.50	\$2222	\$2269	\$988	N/A

Two box and one file drawer on bottom. Laminate doors are standard. Storage compartment on **right** includes **two 3-position fixed/height adjustable shelves**. Wardrobe compartment on **left** includes hanging rod. Two upper locks, one per each hinged door, and one lower lock secures drawers, all keyed alike.



Glazed door option

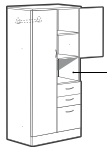


* Accepts collator 11" high

Personal Tower with Doors*

Z36L6BFCL	24 x 36 x 65.5-66	125	291.89	39	\$2652	\$2732	\$1181	N/A
Z30L6BFCL	24 x 30 x 65.5-66	100	266.34	32.75	\$2462	\$2531	\$1074	N/A
Z24L6BFCL	24 x 24 x 65.5-66	100	240.24	26.75	\$2338	\$2396	\$931	N/A
Z36M6BFCL	20 x 36 x 65.5-66	125	254.13	33.25	\$2503	\$2572	\$1181	N/A
Z30M6BFCL	20 x 30 x 65.5-66	100	228.92	27.75	\$2290	\$2350	\$1074	N/A
Z24M6BFCL	20 x 24 x 65.5-66	100	214	22.50	\$2191	\$2238	\$931	N/A

Two box and one file drawer on bottom. Laminate doors are standard. Storage compartment on **left** includes **one 3-position fixed/height adjustable shelf**. Wardrobe compartment on **right** includes hanging rod. Two upper locks, one per each hinged door, and one lower lock secures drawers, all keyed alike.



Glazed door option

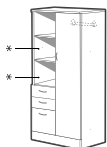


* Accepts collator 11" high

Personal Tower with Doors and Cavity - RIGHT*

Z36L6BFCL	24 x 36 x 65.5-66	125	291.89	39	\$2652	\$2732	\$1181	N/A
Z30L6BFCL	24 x 30 x 65.5-66	100	266.34	32.75	\$2462	\$2531	\$1074	N/A
Z24L6BFCL	24 x 24 x 65.5-66	100	240.24	26.75	\$2338	\$2396	\$931	N/A
Z36M6BFCL	20 x 36 x 65.5-66	125	254.13	33.25	\$2503	\$2572	\$1181	N/A
Z30M6BFCL	20 x 30 x 65.5-66	100	228.92	27.75	\$2290	\$2350	\$1074	N/A
Z24M6BFCL	20 x 24 x 65.5-66	100	214	22.50	\$2191	\$2238	\$931	N/A

Two box and one file drawer on bottom. Laminate doors are standard. Storage compartment on **left** includes **one 3-position fixed/height adjustable shelf**. Wardrobe compartment on **right** includes hanging rod. Two upper locks, one per each hinged door, and one lower lock secures drawers, all keyed alike.



Glazed door option

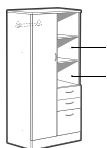


* Accepts collator 11" high

Personal Tower with Open Shelves - LEFT*

Z36L6BFNL	24 x 36 x 65.5-66	125	280	39	\$2513	\$2592	\$741	N/A
Z30L6BFNL	24 x 30 x 65.5-66	125	257	32.75	\$2322	\$2391	\$634	N/A
Z24L6BFNL	24 x 24 x 65.5-66	100	232	26.75	\$2202	\$2259	\$492	N/A
Z36M6BFNL	20 x 36 x 65.5-66	125	242	33.25	\$2383	\$2452	\$741	N/A
Z30M6BFNL	20 x 30 x 65.5-66	125	219	27.75	\$2172	\$2232	\$634	N/A
Z24M6BFNL	20 x 24 x 65.5-66	100	206	22.50	\$2072	\$2119	\$492	N/A

Two box and one file drawer on bottom. Laminate doors are standard. Storage compartment on **left** includes **two 3-position fixed/height adjustable shelves**. Wardrobe compartment on **right** includes hanging rod. Upper lock secures storage and wardrobe compartments. Lower lock secures all drawers.



Glazed door option



* Accepts collator 11" high

Personal Tower with Open Shelves - RIGHT*

Z36L6BFNR	24 x 36 x 65.5-66	125	280	39	\$2513	\$2592	\$741	N/A
Z30L6BFNR	24 x 30 x 65.5-66	125	257	32.75	\$2322	\$2391	\$634	N/A
Z24L6BFNR	24 x 24 x 65.5-66	100	232	26.75	\$2202	\$2259	\$492	N/A
Z36M6BFNR	20 x 36 x 65.5-66	125	242	33.25	\$2383	\$2452	\$741	N/A
Z30M6BFNR	20 x 30 x 65.5-66	125	219	27.75	\$2172	\$2232	\$634	N/A
Z24M6BFNR	20 x 24 x 65.5-66	100	206	22.50	\$2072	\$2119	\$492	N/A

Two box and one file drawer on bottom. Laminate doors are standard. Storage compartment on **right** includes **two 3-position fixed/height adjustable shelves**. Wardrobe compartment on **left** includes hanging rod. Upper lock secures storage and wardrobe compartments. Lower lock secures all drawers.

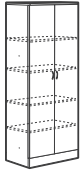
Required Specifications

- Top finish
- Top/edge detail
- Handles
- Base finish

Optional Specifications

- Collator*
- Glazed doors
- Box drawer - no upcharge† (30"-36" wide models only)

STORAGE MODULES - 65.5" / 66" HIGH



Glazed door option

Storage Cabinet with Doors



Glazed door option

Storage Cabinet with Door - LEFT



Glazed door option

Storage Cabinet with Door - RIGHT

MODEL#	DIMENSIONS	FREIGHT CLASS	WT./LBS.	CUBIC FT.	1" TOP	1.5" TOP	GLAZE ADD	HP ADD	
D x W x H									
Z36L7SH	24 x 36 x 71.9-72.4	125	295.05	43.25	\$2374	\$2453	\$1590	N/A	
Z30L7SH	24 x 30 x 71.9-72.4	125	253.05	36.25	\$2072	\$2141	\$1376	N/A	
Z36M7SH	20 x 36 x 71.9-72.4	125	261.45	36.75	\$2204	\$2273	\$1590	N/A	
Z30M7SH	20 x 30 x 71.9-72.4	125	225.75	30.50	\$1910	\$1968	\$1376	N/A	
Z36S7SH	16 x 36 x 71.9-72.4	125	225.75	29.50	\$1976	\$2043	\$1590	N/A	
Z30S7SH	16 x 30 x 71.9-72.4	125	195.30	25	\$1736	\$1782	\$1376	N/A	

Laminate doors are standard. **Includes four 3-position fixed/height adjustable shelves.** Standard with lock.

Z21L7SHL	24 x 21 x 71.9-72.4	125	196.35	26	\$1716	\$1773	\$883	N/A
Z18L7SHL	24 x 18 x 71.9-72.4	125	178.50	22.75	\$1600	\$1647	\$792	N/A
Z16L7SHL	24 x 16 x 71.9-72.4	100	166.95	20.75	\$1504	\$1551	\$787	N/A
Z15L7SHL	24 x 15 x 71.9-72.4	100	160.65	19.25	\$1439	\$1477	\$683	N/A
Z12L7SHL	24 x 12 x 71.9-72.4	100	136.50	16	\$1321	\$1356	\$614	N/A
Z21M7SHL	20 x 21 x 71.9-72.4	100	174.30	21.25	\$1535	\$1581	\$883	N/A
Z18M7SHL	20 x 18 x 71.9-72.4	100	156.45	19.25	\$1465	\$1508	\$792	N/A
Z16M7SHL	20 x 16 x 71.9-72.4	100	147	17.50	\$1376	\$1418	\$787	N/A
Z15M7SHL	20 x 15 x 71.9-72.4	100	139.65	16.25	\$1313	\$1346	\$683	N/A
Z12M7SHL	20 x 12 x 71.9-72.4	100	123.90	13.25	\$1205	\$1235	\$614	N/A
Z21S7SHL	16 x 21 x 71.9-72.4	100	150.15	18	\$1416	\$1454	\$883	N/A
Z18S7SHL	16 x 18 x 71.9-72.4	100	134.40	15.50	\$1316	\$1358	\$792	N/A
Z16S7SHL	16 x 16 x 71.9-72.4	100	124.95	14	\$1263	\$1301	\$787	N/A
Z15S7SHL	16 x 15 x 71.9-72.4	100	118.65	12.50	\$1214	\$1246	\$683	N/A
Z12S7SHL	16 x 12 x 71.9-72.4	100	103.95	11	\$1066	\$1096	\$614	N/A

Laminate doors are standard. **Includes four 3-position fixed/height adjustable shelves.** Standard with lock.

Z21L7SHR	24 x 21 x 71.9-72.4	125	196.35	26	\$1716	\$1773	\$883	N/A
Z18L7SHR	24 x 18 x 71.9-72.4	125	178.50	22.75	\$1600	\$1647	\$792	N/A
Z16L7SHR	24 x 16 x 71.9-72.4	100	166.95	20.75	\$1504	\$1551	\$787	N/A
Z15L7SHR	24 x 15 x 71.9-72.4	100	160.65	19.25	\$1439	\$1477	\$683	N/A
Z12L7SHR	24 x 12 x 71.9-72.4	100	136.50	16	\$1321	\$1356	\$614	N/A
Z21M7SHR	20 x 21 x 71.9-72.4	100	174.30	21.25	\$1535	\$1581	\$883	N/A
Z18M7SHR	20 x 18 x 71.9-72.4	100	156.45	19.25	\$1465	\$1508	\$792	N/A
Z16M7SHR	20 x 16 x 71.9-72.4	100	147	17.50	\$1376	\$1418	\$787	N/A
Z15M7SHR	20 x 15 x 71.9-72.4	100	139.65	16.25	\$1313	\$1346	\$683	N/A
Z12M7SHR	20 x 12 x 71.9-72.4	100	123.90	13.25	\$1205	\$1235	\$614	N/A
Z21S7SHR	16 x 21 x 71.9-72.4	100	150.15	18	\$1416	\$1454	\$883	N/A
Z18S7SHR	16 x 18 x 71.9-72.4	100	134.40	15.50	\$1316	\$1358	\$792	N/A
Z16S7SHR	16 x 16 x 71.9-72.4	100	124.95	14	\$1263	\$1301	\$787	N/A
Z15S7SHR	16 x 15 x 71.9-72.4	100	118.65	12.50	\$1214	\$1246	\$683	N/A
Z12S7SHR	16 x 12 x 71.9-72.4	100	103.95	11	\$1066	\$1096	\$614	N/A

Laminate doors are standard. **Includes four 3-position fixed/height adjustable shelves.** Standard with lock.

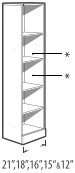
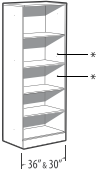
Required Specifications

- Top finish
- Top/edge detail
- Handles
- Base finish

Optional Specifications

- Collator*
- Glazed doors**
- Box drawer† - no upcharge (30"-36" wide models only)

STORAGE MODULES - 72" / 72.5" HIGH

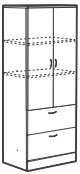


Open Storage Cabinet



MODEL#	DIMENSIONS D x W x H	FREIGHT CLASS	WT/LBS.	CUBIC FT.	1" TOP	1.5" TOP	GLAZE ADD	HP ADD
Z36L7SHN	24 x 36 x 71.9-72.4	150	249.61	43.25	\$1855	\$1935	N/A	N/A
Z30L7SHN	24 x 30 x 71.9-72.4	150	216.23	36.25	\$1644	\$1713	N/A	N/A
Z21L7SHN	24 x 21 x 71.9-72.4	125	171.94	26	\$1424	\$1481	N/A	N/A
Z18L7SHN	24 x 18 x 71.9-72.4	125	156.83	22.75	\$1340	\$1387	N/A	N/A
Z16L7SHN	24 x 16 x 71.9-72.4	125	147.10	20.75	\$1244	\$1290	N/A	N/A
Z15L7SHN	24 x 15 x 71.9-72.4	125	141.72	19.25	\$1207	\$1245	N/A	N/A
Z12L7SHN	24 x 12 x 71.9-72.4	125	121.35	16	\$1117	\$1235	N/A	N/A
Z36M7SHN	20 x 36 x 71.9-72.4	150	217.09	36.75	\$1684	\$1753	N/A	N/A
Z30M7SHN	20 x 30 x 71.9-72.4	125	188.26	30.50	\$1482	\$1542	N/A	N/A
Z21M7SHN	20 x 21 x 71.9-72.4	125	148.69	21.25	\$1128	\$1174	N/A	N/A
Z18M7SHN	20 x 18 x 71.9-72.4	125	134.80	19.25	\$1200	\$1243	N/A	N/A
Z16M7SHN	20 x 16 x 71.9-72.4	125	127.29	17.50	\$1113	\$1155	N/A	N/A
Z15M7SHN	20 x 15 x 71.9-72.4	125	121.96	16.25	\$1080	\$1115	N/A	N/A
Z12M7SHN	20 x 12 x 71.9-72.4	100	109.11	13.25	\$999	\$1029	N/A	N/A
Z36S7SHN	16 x 36 x 71.9-72.4	125	181.43	29.50	\$1457	\$1526	N/A	N/A
Z30S7SHN	16 x 30 x 71.9-72.4	125	158.19	25	\$1309	\$1355	N/A	N/A
Z21S7SHN	16 x 21 x 71.9-72.4	125	124.38	18	\$1125	\$1162	N/A	N/A
Z18S7SHN	16 x 18 x 71.9-72.4	125	112.77	15.50	\$1055	\$1097	N/A	N/A
Z16S7SHN	16 x 16 x 71.9-72.4	125	105.37	14	\$999	\$1037	N/A	N/A
Z15S7SHN	16 x 15 x 71.9-72.4	100	100.10	12.50	\$985	\$1017	N/A	N/A
Z12S7SHN	16 x 12 x 71.9-72.4	100	89.53	11	\$861	\$891	N/A	N/A

Four adjustable shelves.

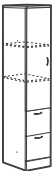


Two File Module with Doors*

Z36L7E	24 x 36 x 71.9-72.4	125	316.05	43.25	\$3028	\$3107	\$1252	N/A
Z30L7E	24 x 30 x 71.9-72.4	125	276.15	36.25	\$2765	\$2834	\$1091	N/A
Z36M7E	20 x 36 x 71.9-72.4	125	285.60	36.75	\$2866	\$2935	\$1252	N/A
Z30M7E	20 x 30 x 71.9-72.4	100	249.90	30.50	\$2613	\$2673	\$1091	N/A
Z36S7E	16 x 36 x 71.9-72.4	100	244.65	29.50	\$2619	\$2688	\$1252	N/A
Z30S7E	16 x 30 x 71.9-72.4	100	213.15	25	\$2361	\$2407	\$1091	N/A

Two lateral file drawers. Laminate doors are standard. **Includes two adjustable shelves.** Upper lock secures storage compartment. Lower lock secures two file drawers. For filing capabilities, see page 121.

- Lateral file drawer construction is for accommodating hanging files NOT for stacking materials on the drawer bottom.



Two File Module with Door - LEFT

Z16L7EL	24 x 16 x 71.9-72.4	100	181.65	20.75	\$1786	\$1833	\$617	N/A
Z15L7EL	24 x 15 x 71.9-72.4	100	176.40	19.25	\$1716	\$1754	\$542	N/A
Z16M7EL	20 x 16 x 71.9-72.4	100	162.75	17.50	\$1659	\$1701	\$617	N/A
Z15M7EL	20 x 15 x 71.9-72.4	100	155.40	16.25	\$1593	\$1628	\$542	N/A
Z16S7EL	16 x 16 x 71.9-72.4	100	137.55	14	\$1544	\$1582	\$617	N/A
Z15S7EL	16 x 15 x 71.9-72.4	92.5	132.30	12.50	\$1510	\$1542	\$542	N/A

Two file drawers on bottom. Laminate door is standard. **Includes two 3-position fixed/height adjustable shelves.** Upper lock secures storage compartment. Lower lock secures two file drawers.



Two File Module with Door - RIGHT

Z16L7ER	24 x 16 x 71.9-72.4	100	181.65	20.75	\$1786	\$1833	\$617	N/A
Z15L7ER	24 x 15 x 71.9-72.4	100	176.40	19.25	\$1716	\$1754	\$542	N/A
Z16M7ER	20 x 16 x 71.9-72.4	100	162.75	17.50	\$1659	\$1701	\$617	N/A
Z15M7ER	20 x 15 x 71.9-72.4	100	155.40	16.25	\$1593	\$1628	\$542	N/A
Z16S7ER	16 x 16 x 71.9-72.4	100	137.55	14	\$1544	\$1582	\$617	N/A
Z15S7ER	16 x 15 x 71.9-72.4	92.5	132.30	12.50	\$1510	\$1542	\$542	N/A

Two file drawers on bottom. Laminate door is standard. **Includes two 3-position fixed/height adjustable shelves.** Upper lock secures storage compartment. Lower lock secures two file drawers.

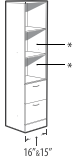
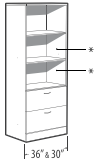
Required Specifications

- Top finish
- Top/edge detail
- Handles
- Base finish

Optional Specifications

- Collator*
- Glazed doors**
- Box drawer† - no upcharge (30" - 36" wide models only)

STORAGE MODULES - 72"/72.5" HIGH



* Accepts collator 11" high

Two File Module with Open Shelves*

MODEL#	DIMENSIONS	FREIGHT CLASS	WT/LBS.	CUBIC FT.	1" TOP	1.5" TOP	GLAZE ADD	HP ADD
D x W x H								
Z36L7EN	24 x 36 x 71.9-72.4	125	286.57	43.25	\$2628	\$2708	N/A	N/A
Z30L7EN	24 x 30 x 71.9-72.4	125	252.63	36.25	\$2419	\$2488	N/A	N/A
Z16L7EN	24 x 16 x 71.9-72.4	100	168.90	20.75	\$1586	\$1632	N/A	N/A
Z15L7EN	24 x 15 x 71.9-72.4	100	164.12	19.25	\$1539	\$1577	N/A	N/A
Z36M7EN	20 x 36 x 71.9-72.4	125	257.21	36.75	\$2472	\$2542	N/A	N/A
Z30M7EN	20 x 30 x 71.9-72.4	125	225.71	30.50	\$2265	\$2325	N/A	N/A
Z16M7EN	20 x 16 x 71.9-72.4	100	150.13	17.50	\$1458	\$1500	N/A	N/A
Z15M7EN	20 x 15 x 71.9-72.4	100	144.36	16.25	\$1419	\$1452	N/A	N/A
Z36S7EN	16 x 36 x 71.9-72.4	125	216.29	29.50	\$2223	\$2290	N/A	N/A
Z30S7EN	16 x 30 x 71.9-72.4	125	189.34	25	\$2015	\$2061	N/A	N/A
Z16S7EN	16 x 16 x 71.9-72.4	100	125.06	14	\$1345	\$1383	N/A	N/A
Z15S7EN	16 x 15 x 71.9-72.4	100	120.40	12.50	\$1332	\$1365	N/A	N/A

Three open shelves and two file drawers on bottom. **Includes two 3-position fixed/height adjustable shelves.** Lock secures all drawers. For filing capabilities, see page 121.

- Lateral file drawer construction is for accommodating hanging files NOT for stacking materials on the drawer bottom.

WARDROBE CABINETS - 72"/72.5" HIGH



Wardrobe Cabinet

MODEL#	DIMENSIONS	FREIGHT CLASS	WT/LBS.	CUBIC FT.	1" TOP	1.5" TOP	GLAZE ADD	HP ADD
Z36L7WA	24 x 36 x 71.9-72.4	150	252	43.25	\$2158	\$2237	N/A	N/A
Z30L7WA	24 x 30 x 71.9-72.4	125	218.40	36.25	\$2015	\$2084	N/A	N/A
Z36M7WA	20 x 36 x 71.9-72.4	125	226.80	36.75	\$2029	\$2098	N/A	N/A
Z30M7WA	20 x 30 x 71.9-72.4	125	196.35	30.50	\$1801	\$1861	N/A	N/A

Laminate doors are standard. Full length hanging rod included. **Includes one 3-position fixed/height adjustable shelf** above hanging rod. Standard with lock.



Wardrobe Cabinet - LEFT

Z24L7WAL	24 x 24 x 71.9-72.4	125	191.10	29.75	\$1635	\$1692	N/A	N/A
Z21L7WAL	24 x 21 x 71.9-72.4	125	178.50	26	\$1577	\$1634	N/A	N/A
Z18L7WAL	24 x 18 x 71.9-72.4	125	158.55	22.75	\$1448	\$1495	N/A	N/A
Z16L7WAL	24 x 16 x 71.9-72.4	125	149.10	20.75	\$1390	\$1436	N/A	N/A
Z15L7WAL	24 x 15 x 71.9-72.4	125	144.90	19.25	\$1322	\$1360	N/A	N/A
Z12L7WAL	24 x 12 x 71.9-72.4	100	130.20	16	\$1232	\$1265	N/A	N/A
Z24M7WAL	20 x 24 x 71.9-72.4	125	171.15	25.25	\$1512	\$1561	N/A	N/A
Z21M7WAL	20 x 21 x 71.9-72.4	125	154.35	21.25	\$1449	\$1496	N/A	N/A
Z18M7WAL	20 x 18 x 71.9-72.4	125	139.65	19.25	\$1340	\$1382	N/A	N/A
Z16M7WAL	20 x 16 x 71.9-72.4	125	131.25	17.50	\$1278	\$1320	N/A	N/A
Z15M7WAL	20 x 15 x 71.9-72.4	125	126	16.25	\$1214	\$1249	N/A	N/A
Z12M7WAL	20 x 12 x 71.9-72.4	100	113.40	13.25	\$1139	\$1169	N/A	N/A

Laminate doors are standard. Full length hanging rod included. **Includes one 3-position fixed/height adjustable shelf** above hanging rod. Standard with lock.



Wardrobe Cabinet - RIGHT

Z24L7WAR	24 x 24 x 71.9-72.4	125	191.10	29.75	\$1635	\$1692	N/A	N/A
Z21L7WAR	24 x 21 x 71.9-72.4	125	178.50	26	\$1577	\$1634	N/A	N/A
Z18L7WAR	24 x 18 x 71.9-72.4	125	158.55	22.75	\$1448	\$1495	N/A	N/A
Z16L7WAR	24 x 16 x 71.9-72.4	125	149.10	20.75	\$1390	\$1436	N/A	N/A
Z15L7WAR	24 x 15 x 71.9-72.4	125	144.90	19.25	\$1322	\$1360	N/A	N/A
Z12L7WAR	24 x 12 x 71.9-72.4	100	130.20	16	\$1232	\$1265	N/A	N/A
Z24M7WAR	20 x 24 x 71.9-72.4	125	171.15	25.25	\$1512	\$1561	N/A	N/A
Z21M7WAR	20 x 21 x 71.9-72.4	125	154.35	21.25	\$1449	\$1496	N/A	N/A
Z18M7WAR	20 x 18 x 71.9-72.4	125	139.65	19.25	\$1340	\$1382	N/A	N/A
Z16M7WAR	20 x 16 x 71.9-72.4	125	131.25	17.50	\$1278	\$1320	N/A	N/A
Z15M7WAR	20 x 15 x 71.9-72.4	125	126	16.25	\$1214	\$1249	N/A	N/A
Z12M7WAR	20 x 12 x 71.9-72.4	100	113.40	13.25	\$1139	\$1169	N/A	N/A

Laminate doors are standard. Full length hanging rod included. **Includes one 3-position fixed/height adjustable shelf** above hanging rod. Standard with lock.

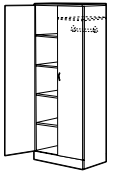
Required Specifications

- Top finish
- Top/edge detail
- Handles
- Base finish

Optional Specifications

- Glazed doors*

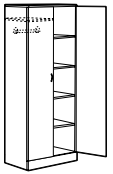
WARDROBE CABINETS - 72"/72.5" HIGH



Wardrobe Cabinet/Shelving Combo with Doors - LEFT

MODEL#	DIMENSIONS D x W x H	FREIGHT CLASS	WT./LBS.	CUBIC FT.	1" TOP	1.5" TOP	GLAZE ADD	HP ADD
Z36L7DIL	24 x 36 x 71.9-72.4	125	300.30	43.25	\$2544	\$2624	\$1590	N/A
Z30L7DIL	24 x 30 x 71.9-72.4	125	262.50	36.25	\$2223	\$2292	\$1376	N/A
Z24L7DIL	24 x 24 x 71.9-72.4	125	232.05	29.75	\$2022	\$2079	\$1239	N/A
Z21L7DIL	24 x 21 x 71.9-72.4	125	200.55	26	\$1963	\$2019	\$1228	N/A
Z36M7DIL	20 x 36 x 71.9-72.4	125	276.15	36.75	\$2388	\$2457	\$1590	N/A
Z30M7DIL	20 x 30 x 71.9-72.4	125	241.50	30.50	\$2073	\$2133	\$1376	N/A
Z24M7DIL	20 x 24 x 71.9-72.4	100	214.20	25.25	\$1901	\$1948	\$1239	N/A
Z21M7DIL	20 x 21 x 71.9-72.4	100	196.35	21.25	\$1825	\$1872	\$1228	N/A

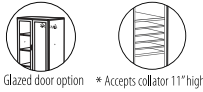
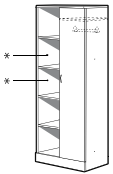
Laminate doors are standard. Storage compartment on **left includes four 3-position fixed/height adjustable shelves**. Wardrobe compartment on **right** includes hanging rod and one adjustable shelf above rod. Storage and wardrobe compartments lock independently. Each door lock keyed alike.



Wardrobe Cabinet/Shelving Combo with Doors - RIGHT

Z36L7DIR	24 x 36 x 71.9-72.4	125	300.30	43.25	\$2544	\$2624	\$1590	N/A
Z30L7DIR	24 x 30 x 71.9-72.4	125	262.50	36.25	\$2223	\$2292	\$1376	N/A
Z24L7DIR	24 x 24 x 71.9-72.4	125	232.05	29.75	\$2022	\$2079	\$1239	N/A
Z21L7DIR	24 x 21 x 71.9-72.4	125	200.55	26	\$1963	\$2019	\$1228	N/A
Z36M7DIR	20 x 36 x 71.9-72.4	125	276.15	36.75	\$2388	\$2457	\$1590	N/A
Z30M7DIR	20 x 30 x 71.9-72.4	125	241.50	30.50	\$2073	\$2133	\$1376	N/A
Z24M7DIR	20 x 24 x 71.9-72.4	100	214.20	25.25	\$1901	\$1948	\$1239	N/A
Z21M7DIR	20 x 21 x 71.9-72.4	100	196.35	21.25	\$1825	\$1872	\$1228	N/A

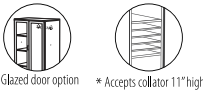
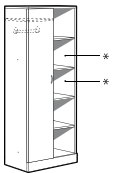
Laminate doors are standard. Storage compartment on **right includes four 3-position fixed/height adjustable shelves**. Wardrobe compartment on **left** includes hanging rod and one adjustable shelf above rod. Storage and wardrobe compartments lock independently. Each door lock keyed alike.



Wardrobe Cabinet/Open Shelving Combo - LEFT

Z36L7DINL	24 x 36 x 71.9-72.4	125	277.47	43.25	\$2295	\$2375	\$793	N/A
Z30L7DINL	24 x 30 x 71.9-72.4	125	244.53	36.25	\$2020	\$2089	\$686	N/A
Z24L7DINL	24 x 24 x 71.9-72.4	125	217.88	29.75	\$1840	\$1897	\$617	N/A
Z21L7DINL	24 x 21 x 71.9-72.4	125	189.33	26	\$1777	\$1834	\$611	N/A
Z36M7DINL	20 x 36 x 71.9-72.4	125	254.41	36.75	\$2139	\$2208	\$793	N/A
Z30M7DINL	20 x 30 x 71.9-72.4	125	222.86	30.50	\$1868	\$1928	\$686	N/A
Z24M7DINL	20 x 24 x 71.9-72.4	100	202.22	25.25	\$1716	\$1763	\$617	N/A
Z21M7DINL	20 x 21 x 71.9-72.4	100	183.93	21.25	\$1641	\$1688	\$611	N/A

Laminate door is standard on wardrobe section. Storage compartment on **left includes four 3-position fixed/height adjustable shelves**. Wardrobe compartment on **right** includes hanging rod and one adjustable shelf above rod. Single lock secures wardrobe compartment.



Wardrobe Cabinet/Open Shelving Combo - RIGHT

Z36L7DINR	24 x 36 x 71.9-72.4	125	277.47	43.25	\$2295	\$2375	\$793	N/A
Z30L7DINR	24 x 30 x 71.9-72.4	125	244.53	36.25	\$2020	\$2089	\$686	N/A
Z24L7DINR	24 x 24 x 71.9-72.4	125	217.88	29.75	\$1840	\$1897	\$617	N/A
Z21L7DINR	24 x 21 x 71.9-72.4	125	189.33	26	\$1777	\$1834	\$611	N/A
Z36M7DINR	20 x 36 x 71.9-72.4	125	254.41	36.75	\$2139	\$2208	\$793	N/A
Z30M7DINR	20 x 30 x 71.9-72.4	125	222.86	30.50	\$1868	\$1928	\$686	N/A
Z24M7DINR	20 x 24 x 71.9-72.4	100	202.22	25.25	\$1716	\$1763	\$617	N/A
Z21M7DINR	20 x 21 x 71.9-72.4	100	183.93	21.25	\$1641	\$1688	\$611	N/A

Laminate door is standard on wardrobe section. Storage compartment on **right includes four 3-position fixed/height adjustable shelves**. Wardrobe compartment on **left** includes hanging rod and one adjustable shelf above rod. Single lock secures wardrobe compartment.

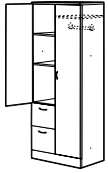
Required Specifications

Top finish
Top/edge detail
Handles
Base finish

Optional Specifications

Collator*
Glazed doors

PERSONAL TOWERS - 72"/72.5" HIGH

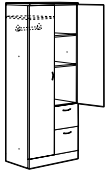


Glazed door option

Personal Tower with Doors - LEFT

MODEL#	DIMENSIONS D x W x H	FREIGHT CLASS	WT/LBS.	CUBIC FT.	1" TOP	1.5" TOP	GLAZE ADD	HP ADD
Z36L7EL	24 x 36 x 71.9-72.4	125	324.45	43.25	\$2788	\$2867	\$1410	N/A
Z30L7EL	24 x 30 x 71.9-72.4	125	289.80	36.25	\$2557	\$2626	\$1294	N/A
Z24L7EL	24 x 24 x 71.9-72.4	100	260.76	29.75	\$2436	\$2494	\$1145	N/A
Z36M7EL	20 x 36 x 71.9-72.4	125	288.75	36.75	\$2607	\$2677	\$1410	N/A
Z30M7EL	20 x 30 x 71.9-72.4	100	259.35	30.50	\$2391	\$2451	\$1294	N/A
Z24M7EL	20 x 24 x 71.9-72.4	100	231.65	25.25	\$2276	\$2323	\$1145	N/A

Two file drawers on bottom. Laminate doors are standard. Storage compartment on **left includes two 3-position fixed/height adjustable shelves**. Wardrobe compartment on **right** includes hanging rod and one adjustable shelf above rod. Two upper locks, one per each hinged door, and one lower lock secures drawers, all keyed alike.

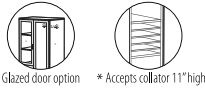
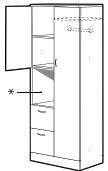


Glazed door option

Personal Tower with Doors - RIGHT

Z36L7ER	24 x 36 x 71.9-72.4	125	324.45	43.25	\$2788	\$2867	\$1410	N/A
Z30L7ER	24 x 30 x 71.9-72.4	125	289.80	36.25	\$2557	\$2626	\$1294	N/A
Z24L7ER	24 x 24 x 71.9-72.4	100	260.76	29.75	\$2436	\$2494	\$1145	N/A
Z36M7ER	20 x 36 x 71.9-72.4	125	288.75	36.75	\$2607	\$2677	\$1410	N/A
Z30M7ER	20 x 30 x 71.9-72.4	100	259.35	30.50	\$2391	\$2451	\$1294	N/A
Z24M7ER	20 x 24 x 71.9-72.4	100	231.65	25.25	\$2276	\$2323	\$1145	N/A

Two file drawers on bottom. Laminate doors are standard. Storage compartment on **right includes two 3-position fixed/height adjustable shelves**. Wardrobe compartment on **left** includes hanging rod and one adjustable shelf above rod. Two upper locks, one per each hinged door, and one lower lock secures drawers, all keyed alike.

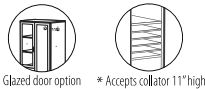
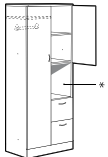


Glazed door option * Accepts collator 11" high

Personal Tower with Doors and cavity - LEFT

Z36L7ECL	24 x 36 x 71.9-72.4	125	320.24	43.25	\$2770	\$2850	\$1284	N/A
Z30L7ECL	24 x 30 x 71.9-72.4	125	287.34	36.25	\$2541	\$2610	\$1166	N/A
Z24L7ECL	24 x 24 x 71.9-72.4	100	257.23	29.75	\$2410	\$2467	\$1016	N/A
Z36M7ECL	20 x 36 x 71.9-72.4	125	285.63	36.75	\$2565	\$2634	\$1284	N/A
Z30M7ECL	20 x 30 x 71.9-72.4	100	256.22	30.50	\$2351	\$2409	\$1166	N/A
Z24M7ECL	20 x 24 x 71.9-72.4	100	228.11	25.25	\$2233	\$2280	\$1016	N/A

Two file drawers on bottom. Laminate doors are standard. Storage compartment on **left includes one 3-position fixed/height adjustable shelf**. Wardrobe compartment on **right** includes hanging rod and one adjustable shelf above rod. Two upper locks, one per each hinged door, and one lower lock secures drawers, all keyed alike.

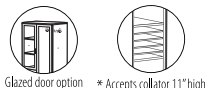
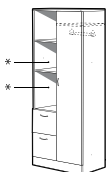


Glazed door option * Accepts collator 11" high

Personal Tower with Doors and cavity - RIGHT

Z36L7ECR	24 x 36 x 71.9-72.4	125	320.24	43.25	\$2770	\$2850	\$1284	N/A
Z30L7ECR	24 x 30 x 71.9-72.4	125	287.34	36.25	\$2541	\$2610	\$1166	N/A
Z24L7ECR	24 x 24 x 71.9-72.4	100	257.23	29.75	\$2410	\$2467	\$1016	N/A
Z36M7ECR	20 x 36 x 71.9-72.4	125	285.63	36.75	\$2565	\$2634	\$1284	N/A
Z30M7ECR	20 x 30 x 71.9-72.4	100	256.22	30.50	\$2351	\$2409	\$1166	N/A
Z24M7ECR	20 x 24 x 71.9-72.4	100	228.11	25.25	\$2233	\$2280	\$1016	N/A

Two file drawers on bottom. Laminate doors are standard. Storage compartment on **left includes one 3-position fixed/height adjustable shelf**. Wardrobe compartment on **right** includes hanging rod and one adjustable shelf above rod. Two upper locks, one per each hinged door, and one lower lock secures drawers, all keyed alike.



Glazed door option * Accepts collator 11" high

Personal Tower with Open Shelves - LEFT

Z36L7ENL	24 x 36 x 71.9-72.4	125	309.60	43.25	\$2630	\$2710	\$799	N/A
Z30L7ENL	24 x 30 x 71.9-72.4	125	278.48	36.25	\$2405	\$2474	\$681	N/A
Z24L7ENL	24 x 24 x 71.9-72.4	100	247.90	29.75	\$2286	\$2343	\$533	N/A
Z36M7ENL	20 x 36 x 71.9-72.4	125	274.99	36.75	\$2439	\$2508	\$799	N/A
Z30M7ENL	20 x 30 x 71.9-72.4	100	247.36	30.50	\$2226	\$2286	\$681	N/A
Z24M7ENL	20 x 24 x 71.9-72.4	100	218.79	25.25	\$2124	\$2173	\$533	N/A

Two file drawers on bottom. Laminate door is standard on wardrobe section. Storage compartment on **left includes two 3-position fixed/height adjustable shelves**. Wardrobe compartment on **right** includes hanging rod and one adjustable shelf above rod. Single lock secures wardrobe compartment. Lower lock secures all drawers.

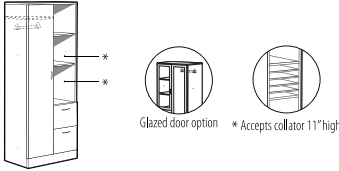
Required Specifications

Top finish
Top/edge detail
Handles
Base finish

Optional Specifications

Collator*
Glazed doors

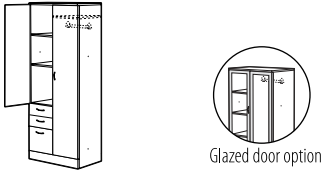
PERSONAL TOWERS - 72"/72.5" HIGH



Personal Tower with Open Shelves - RIGHT

MODEL#	DIMENSIONS D x W x H	FREIGHT CLASS	WT./LBS.	CUBIC FT.	1" TOP	1.5" TOP	GLAZE ADD	HP ADD
Z36L7ENR	24 x 36 x 71.9-72.4	125	309.60	43.25	\$2630	\$2710	\$799	N/A
Z30L7ENR	24 x 30 x 71.9-72.4	125	278.48	36.25	\$2405	\$2474	\$681	N/A
Z24L7ENR	24 x 24 x 71.9-72.4	100	247.90	29.75	\$2286	\$2343	\$533	N/A
Z36M7ENR	20 x 36 x 71.9-72.4	125	274.99	36.75	\$2439	\$2508	\$799	N/A
Z30M7ENR	20 x 30 x 71.9-72.4	100	247.36	30.50	\$2226	\$2286	\$681	N/A
Z24M7ENR	20 x 24 x 71.9-72.4	100	218.79	25.25	\$2124	\$2173	\$533	N/A

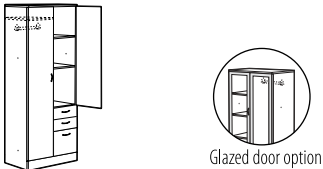
Two file drawers on bottom. Laminate door is standard on wardrobe section. Storage compartment on **right** includes **two 3-position fixed/height adjustable shelves**. Wardrobe compartment on **left** includes hanging rod and one adjustable shelf above rod. Single lock secures wardrobe compartment. Lower lock secures all drawers.



Personal Tower with Doors - LEFT

Z36L7BFL	24 x 36 x 71.9-72.4	125	326.55	43.25	\$2928	\$3007	\$1410	N/A
Z30L7BFL	24 x 30 x 71.9-72.4	100	292.95	36.25	\$2704	\$2773	\$1294	N/A
Z24L7BFL	24 x 24 x 71.9-72.4	100	262.10	29.75	\$2544	\$2601	\$1145	N/A
Z36M7BFL	20 x 36 x 71.9-72.4	125	291.90	36.75	\$2745	\$2814	\$1410	N/A
Z30M7BFL	20 x 30 x 71.9-72.4	100	262.50	30.50	\$2562	\$2620	\$1219	N/A
Z24M7BFL	20 x 24 x 71.9-72.4	100	232.98	25.25	\$2383	\$2430	\$1145	N/A

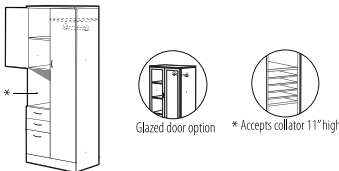
Two box and one file drawer on bottom. Laminate doors are standard. Storage compartment on **left** includes **two 3-position fixed/height adjustable shelves**. Wardrobe compartment on **right** includes hanging rod and one adjustable shelf above rod. Two upper locks, one per each hinged door, and one lower lock secures drawers, all keyed alike.



Personal Tower with Doors - RIGHT

Z36L7BFR	24 x 36 x 71.9-72.4	125	326.55	43.25	\$2928	\$3007	\$1410	N/A
Z30L7BFR	24 x 30 x 71.9-72.4	100	292.95	36.25	\$2704	\$2773	\$1294	N/A
Z24L7BFR	24 x 24 x 71.9-72.4	100	262.10	29.75	\$2544	\$2601	\$1145	N/A
Z36M7BFR	20 x 36 x 71.9-72.4	125	291.90	36.75	\$2745	\$2814	\$1410	N/A
Z30M7BFR	20 x 30 x 71.9-72.4	100	262.50	30.50	\$2562	\$2620	\$1219	N/A
Z24M7BFR	20 x 24 x 71.9-72.4	100	232.98	25.25	\$2383	\$2430	\$1145	N/A

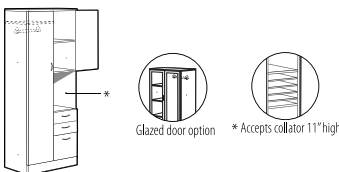
Two box and one file drawer on bottom. Laminate doors are standard. Storage compartment on **right** includes **two 3-position fixed/height adjustable shelves**. Wardrobe compartment on **left** includes hanging rod and one adjustable shelf above rod. Two upper locks, one per each hinged door, and one lower lock secures drawers, all keyed alike.



Personal Tower with Doors and Cavity - LEFT

Z36L7BFCL	24 x 36 x 71.9-72.4	125	317.68	43.25	\$2895	\$2942	\$1284	N/A
Z30L7BFCL	24 x 30 x 71.9-72.4	125	287	36.25	\$2675	\$2713	\$1166	N/A
Z24L7BFCL	24 x 24 x 71.9-72.4	100	258.59	29.75	\$2503	\$2560	\$1016	N/A
Z36M7BFCL	20 x 36 x 71.9-72.4	125	288.78	36.75	\$2695	\$2764	\$1284	N/A
Z30M7BFCL	20 x 30 x 71.9-72.4	100	259.37	30.50	\$2509	\$2569	\$1166	N/A
Z24M7BFCL	20 x 24 x 71.9-72.4	100	229.45	25.25	\$2339	\$2386	\$1016	N/A

Two box and one file drawer on bottom. Laminate doors are standard. Storage compartment on **left** includes **one 3-position fixed/height adjustable shelves**. Wardrobe compartment on **right** includes hanging rod and one adjustable shelf above rod. Two upper locks, one per each hinged door, and one lower lock secures drawers, all keyed alike.



Personal Tower with Doors and Cavity - RIGHT

Z36L7BFCD	24 x 36 x 71.9-72.4	125	317.68	43.25	\$2895	\$2942	\$1284	N/A
Z30L7BFCD	24 x 30 x 71.9-72.4	125	287	36.25	\$2675	\$2713	\$1166	N/A
Z24L7BFCD	24 x 24 x 71.9-72.4	100	258.59	29.75	\$2503	\$2560	\$1016	N/A
Z36M7BFCD	20 x 36 x 71.9-72.4	125	288.78	36.75	\$2695	\$2764	\$1284	N/A
Z30M7BFCD	20 x 30 x 71.9-72.4	100	259.37	30.50	\$2509	\$2569	\$1166	N/A
Z24M7BFCD	20 x 24 x 71.9-72.4	100	229.45	25.25	\$2339	\$2386	\$1016	N/A

Two box and one file drawer on bottom. Laminate doors are standard. Storage compartment on **left** includes **one 3-position fixed/height adjustable shelves**. Wardrobe compartment on **right** includes hanging rod and one adjustable shelf above rod. Two upper locks, one per each hinged door, and one lower lock secures drawers, all keyed alike.

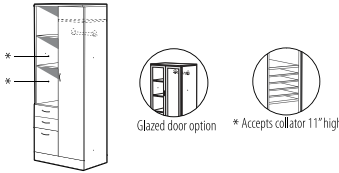
Required Specifications

Top finish
Top/edge detail
Handles
Base finish

Optional Specifications

Collator*
Glazed doors

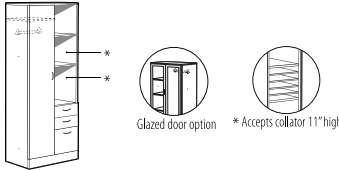
PERSONAL TOWERS - 72"/72.5" HIGH



Personal Tower with Open Shelves - LEFT

MODEL#	DIMENSIONS D x W x H	FREIGHT CLASS	WT/LBS.	CUBIC FT.	1" TOP	1.5" TOP	GLAZE ADD	HP ADD
Z36L7BFNL	24 x 36 x 71.9-72.4	125	309	43.25	\$2762	\$2816	\$799	N/A
Z30L7BFNL	24 x 30 x 71.9-72.4	125	277	36.25	\$2535	\$2577	\$681	N/A
Z24L7BFNL	24 x 24 x 71.9-72.4	100	249.24	29.75	\$2335	\$2392	\$533	N/A
Z36M7BFNL	20 x 36 x 71.9-72.4	125	274	36.75	\$2553	\$2623	\$799	N/A
Z30M7BFNL	20 x 30 x 71.9-72.4	100	246	30.50	\$2366	\$2426	\$681	N/A
Z24M7BFNL	20 x 24 x 71.9-72.4	100	220.12	25.25	\$2173	\$2220	\$533	N/A

Two box and one file drawer on bottom. Laminate doors are standard. Storage compartment on **left** includes **two 3-position fixed/height adjustable shelves**. Wardrobe compartment on **right** includes hanging rod and **one adjustable shelf** above rod. Upper lock secures wardrobe compartment. Lower lock secures all drawers.

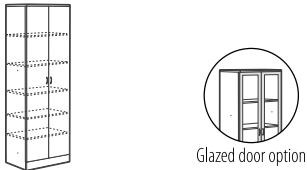


Personal Tower with Open Shelves - RIGHT

Z36L7BFNR	24 x 36 x 71.9-72.4	125	309	43.25	\$2762	\$2816	\$799	N/A
Z30L7BFNR	24 x 30 x 71.9-72.4	125	277	36.25	\$2535	\$2577	\$681	N/A
Z24L7BFNR	24 x 24 x 71.9-72.4	100	249.24	29.75	\$2335	\$2392	\$533	N/A
Z36M7BFNR	20 x 36 x 71.9-72.4	125	274	36.75	\$2553	\$2623	\$799	N/A
Z30M7BFNR	20 x 30 x 71.9-72.4	100	246	30.50	\$2366	\$2426	\$681	N/A
Z24M7BFNR	20 x 24 x 71.9-72.4	100	220.12	25.25	\$2173	\$2220	\$533	N/A

Two box and one file drawer on bottom. Laminate doors are standard. Storage compartment on **right** includes **two 3-position fixed/height adjustable shelves**. Wardrobe compartment on **left** includes hanging rod and **one adjustable shelf** above rod. Upper lock secures wardrobe compartment. Lower lock secures all drawers.

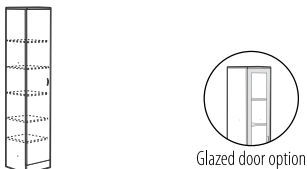
STORAGE MODULES - 84.5"/85" HIGH



Storage Cabinet with Doors

MODEL#	DIMENSIONS	FREIGHT CLASS	WT/LBS.	CUBIC FT.	1" TOP	1.5" TOP	GLAZE ADD	HP ADD
Z36L8SH	24 x 36 x 84.4-84.9	125	332.85	50	\$2716	\$2796	\$1934	N/A
Z30L8SH	24 x 30 x 84.4-84.9	125	290.85	42	\$2409	\$2478	\$1655	N/A
Z36M8SH	20 x 36 x 84.4-84.9	125	299.25	42.25	\$2504	\$2573	\$1934	N/A
Z30M8SH	20 x 30 x 84.4-84.9	125	259.35	35.50	\$2239	\$2299	\$1655	N/A
Z36S8SH	16 x 36 x 84.4-84.9	125	259.35	34	\$2256	\$2323	\$1934	N/A
Z30S8SH	16 x 30 x 84.4-84.9	125	224.70	29	\$2011	\$2058	\$1655	N/A

Laminate doors are standard. **Includes five 3-position fixed/height adjustable shelves**. Standard with lock.



Storage Cabinet with Door - LEFT

Z21L8SHL	24 x 21 x 84.4-84.9	125	226.80	30.25	\$1965	\$2022	\$1079	N/A
Z18L8SHL	24 x 18 x 84.4-84.9	125	205.80	26.25	\$1848	\$1895	\$964	N/A
Z16L8SHL	24 x 16 x 84.4-84.9	125	186.90	24	\$1734	\$1780	\$957	N/A
Z15L8SHL	24 x 15 x 84.4-84.9	100	181.65	22.50	\$1711	\$1749	\$823	N/A
Z12L8SHL	24 x 12 x 84.4-84.9	100	163.80	18.50	\$1593	\$1626	\$736	N/A
Z21M8SHL	20 x 21 x 84.4-84.9	125	201.60	25.50	\$1774	\$1820	\$1079	N/A
Z18M8SHL	20 x 18 x 84.4-84.9	100	180.60	22.25	\$1700	\$1742	\$964	N/A
Z16M8SHL	20 x 16 x 84.4-84.9	100	169.05	20.25	\$1593	\$1635	\$957	N/A
Z15M8SHL	20 x 15 x 84.4-84.9	100	162.75	19	\$1527	\$1560	\$823	N/A
Z12M8SHL	20 x 12 x 84.4-84.9	100	144.90	15.75	\$1415	\$1445	\$736	N/A
Z21S8SHL	16 x 21 x 84.4-84.9	100	172.20	21	\$1622	\$1659	\$1079	N/A
Z18S8SHL	16 x 18 x 84.4-84.9	100	154.35	18	\$1518	\$1556	\$964	N/A
Z16S8SHL	16 x 16 x 84.4-84.9	100	142.80	16.50	\$1423	\$1461	\$957	N/A
Z15S8SHL	16 x 15 x 84.4-84.9	100	137.55	15.50	\$1357	\$1389	\$823	N/A
Z12S8SHL	16 x 12 x 84.4-84.9	100	120.75	13	\$1252	\$1281	\$736	N/A

Laminate doors are standard. **Includes five 3-position fixed/height adjustable shelves**. Standard with lock.

Required Specifications

- Top finish
- Top/edge detail
- Handles
- Base finish

Optional Specifications

- Collator*
- Glazed doors

STORAGE MODULES - 84.5"/85" HIGH

MODEL#	DIMENSIONS D x W x H	FREIGHT CLASS	WT./LBS.	CUBIC FT.	1" TOP	1.5" TOP	GLAZE ADD	HP ADD
Z21L8SHR	24 x 21 x 84.4-84.9	125	226.80	30.25	\$1965	\$2022	\$1079	N/A
Z18L8SHR	24 x 18 x 84.4-84.9	125	205.80	26.25	\$1848	\$1895	\$964	N/A
Z16L8SHR	24 x 16 x 84.4-84.9	125	186.90	24	\$1734	\$1780	\$957	N/A
Z15L8SHR	24 x 15 x 84.4-84.9	100	181.65	22.50	\$1711	\$1749	\$823	N/A
Z12L8SHR	24 x 12 x 84.4-84.9	100	163.80	18.50	\$1593	\$1626	\$736	N/A
Z21M8SHR	20 x 21 x 84.4-84.9	125	201.60	25.50	\$1774	\$1820	\$1079	N/A
Z18M8SHR	20 x 18 x 84.4-84.9	100	180.60	22.25	\$1700	\$1742	\$964	N/A
Z16M8SHR	20 x 16 x 84.4-84.9	100	169.05	20.25	\$1593	\$1635	\$957	N/A
Z15M8SHR	20 x 15 x 84.4-84.9	100	162.75	19	\$1527	\$1560	\$823	N/A
Z12M8SHR	20 x 12 x 84.4-84.9	100	144.90	15.75	\$1415	\$1445	\$736	N/A
Z21S8SHR	16 x 21 x 84.4-84.9	100	172.20	21	\$1622	\$1659	\$1079	N/A
Z18S8SHR	16 x 18 x 84.4-84.9	100	154.35	18	\$1518	\$1556	\$964	N/A
Z16S8SHR	16 x 16 x 84.4-84.9	100	142.80	16.50	\$1423	\$1461	\$957	N/A
Z15S8SHR	16 x 15 x 84.4-84.9	100	137.55	15.50	\$1357	\$1389	\$823	N/A
Z12S8SHR	16 x 12 x 84.4-84.9	100	120.75	13	\$1252	\$1281	\$736	N/A

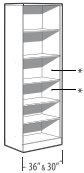


Glazed door option

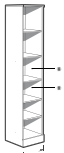
Storage Cabinet with Door - RIGHT

Laminate doors are standard. **Includes five 3-position fixed/height adjustable shelves.** Standard with lock.

Z36L8SHN	24 x 36 x 84.4-84.9	150	281.34	50	\$2111	\$2190	N/A	N/A
Z30L8SHN	24 x 30 x 84.4-84.9	150	247.23	42	\$1880	\$1949	N/A	N/A
Z21L8SHN	24 x 21 x 84.4-84.9	125	227.72	30.25	\$1626	\$1682	N/A	N/A
Z18L8SHN	24 x 18 x 84.4-84.9	125	206.74	26.25	\$1541	\$1588	N/A	N/A
Z16L8SHN	24 x 16 x 84.4-84.9	125	189.25	24	\$1430	\$1477	N/A	N/A
Z15L8SHN	24 x 15 x 84.4-84.9	100	182.61	22.50	\$1407	\$1445	N/A	N/A
Z12L8SHN	24 x 12 x 84.4-84.9	100	164.78	18.50	\$1350	\$1385	N/A	N/A
Z36M8SHN	20 x 36 x 84.4-84.9	150	245.68	42.25	\$1898	\$1967	N/A	N/A
Z30M8SHN	20 x 30 x 84.4-84.9	125	215.06	35.50	\$1711	\$1771	N/A	N/A
Z21M8SHN	20 x 21 x 84.4-84.9	125	170.18	25.50	\$1437	\$1484	N/A	N/A
Z18M8SHN	20 x 18 x 84.4-84.9	125	154.86	22.25	\$1390	\$1433	N/A	N/A
Z16M8SHN	20 x 16 x 84.4-84.9	125	145.71	20.25	\$1291	\$1333	N/A	N/A
Z15M8SHN	20 x 15 x 84.4-84.9	125	140.60	19	\$1257	\$1290	N/A	N/A
Z12M8SHN	20 x 12 x 84.4-84.9	100	126.34	15.75	\$1171	\$1201	N/A	N/A
Z36S8SHN	16 x 36 x 84.4-84.9	125	206.87	34	\$1651	\$1718	N/A	N/A
Z30S8SHN	16 x 30 x 84.4-84.9	125	180.79	29	\$1483	\$1529	N/A	N/A
Z21S8SHN	16 x 21 x 84.4-84.9	125	141.67	21	\$1285	\$1322	N/A	N/A
Z18S8SHN	16 x 18 x 84.4-84.9	125	127.58	18	\$1152	\$1190	N/A	N/A
Z16S8SHN	16 x 16 x 84.4-84.9	125	119.59	16.50	\$1118	\$1156	N/A	N/A
Z15S8SHN	16 x 15 x 84.4-84.9	125	115.59	15.50	\$1088	\$1120	N/A	N/A
Z12S8SHN	16 x 12 x 84.4-84.9	125	102.56	13	\$1007	\$1037	N/A	N/A



36" x 30"



21"18"16"15"12"



* Accepts collator 11" high

Open Storage Cabinet

Five adjustable shelves.

Z36L8E	24 x 36 x 84.4-84.9	125	365.40	50	\$3369	\$3448	\$1443	N/A
Z30L8E	24 x 30 x 84.4-84.9	125	306.60	42	\$3068	\$3135	\$1246	N/A
Z36M8E	20 x 36 x 84.4-84.9	125	323.40	42.25	\$3167	\$3236	\$1443	N/A
Z30M8E	20 x 30 x 84.4-84.9	100	284.55	35.50	\$2916	\$2976	\$1246	N/A
Z36S8E	16 x 36 x 84.4-84.9	100	285	34	\$2892	\$2961	\$1443	N/A
Z30S8E	16 x 30 x 84.4-84.9	100	244.65	29	\$2614	\$2660	\$1246	N/A



Glazed door option

Two File Module with Doors*

Two lateral file drawers. Laminate doors are standard. **Includes three adjustable shelves.** Upper lock secures storage compartment. Lower lock secures two file drawers. For filing capabilities, see page 121.

- Lateral file drawer construction is for accommodating hanging files NOT for stacking materials on the drawer bottom.

Required Specifications

Finishes
Top/Edge Detail
Handles

Optional Specifications

Glazing - Doors
Collator (Open Shelves)

STORAGE MODULES - 84.5"/85" HIGH



Glazed door option

Two File Module with Door - LEFT

MODEL#	DIMENSIONS	FREIGHT CLASS	WT/LBS.	CUBIC FT.	1" TOP	1.5" TOP	GLAZE ADD	HP ADD	
D x W x H									
Z16L8EL	24 x 16 x 84.4-84.9	100	205.80	24	\$2006	\$2053	\$712	N/A	
Z15L8EL	24 x 15 x 84.4-84.9	100	192.15	22.50	\$1950	\$1988	\$620	N/A	
Z16M8EL	20 x 16 x 84.4-84.9	100	185.85	20.25	\$1880	\$1922	\$712	N/A	
Z15M8EL	20 x 15 x 84.4-84.9	100	179.55	19	\$1807	\$1842	\$620	N/A	
Z16S8EL	16 x 16 x 84.4-84.9	100	156.45	16.50	\$1708	\$1746	\$712	N/A	
Z15S8EL	16 x 15 x 84.4-84.9	100	149.10	15.50	\$1653	\$1685	\$620	N/A	

Two file drawers on bottom. Laminate door is standard. **Includes three 3-position fixed/height adjustable shelves.** Upper lock secures storage compartment. Lower lock secures two file drawers.

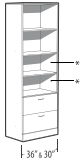


Glazed door option

Two File Module with Door - RIGHT

Z16L8ER	24 x 16 x 84.4-84.9	100	205.80	24	\$2006	\$2053	\$712	N/A
Z15L8ER	24 x 15 x 84.4-84.9	100	192.15	22.50	\$1950	\$1988	\$620	N/A
Z16M8ER	20 x 16 x 84.4-84.9	100	185.85	20.25	\$1880	\$1922	\$712	N/A
Z15M8ER	20 x 15 x 84.4-84.9	100	179.55	19	\$1807	\$1842	\$620	N/A
Z16S8ER	16 x 16 x 84.4-84.9	100	156.45	16.50	\$1708	\$1746	\$712	N/A
Z15S8ER	16 x 15 x 84.4-84.9	100	149.10	15.50	\$1653	\$1685	\$620	N/A

Two file drawers on bottom. Laminate door is standard. **Includes three 3-position fixed/height adjustable shelves.** Upper lock secures storage compartment. Lower lock secures two file drawers.



* Accepts collator 11" high

Two File Module with Open Shelves*

Z36L8EN	24 x 36 x 84.4-84.9	125	329.85	50	\$2888	\$2967	N/A	N/A
Z30L8EN	24 x 30 x 84.4-84.9	125	276.28	42	\$2644	\$2713	N/A	N/A
Z16L8EN	24 x 16 x 84.4-84.9	125	191.52	24	\$1762	\$1809	N/A	N/A
Z15L8EN	24 x 15 x 84.4-84.9	125	177.51	22.50	\$1736	\$1774	N/A	N/A
Z36M8EN	20 x 36 x 84.4-84.9	125	285.79	42.25	\$2685	\$2754	N/A	N/A
Z30M8EN	20 x 30 x 84.4-84.9	125	253.56	35.50	\$2497	\$2557	N/A	N/A
Z16M8EN	20 x 16 x 84.4-84.9	100	169.60	20.25	\$1636	\$1678	N/A	N/A
Z15M8EN	20 x 15 x 84.4-84.9	100	164.05	19	\$1592	\$1627	N/A	N/A
Z36S8EN	16 x 36 x 84.4-84.9	125	247	34	\$2232	\$2299	N/A	N/A
Z30S8EN	16 x 30 x 84.4-84.9	125	213	29	\$2014	\$2060	N/A	N/A
Z16S8EN	16 x 16 x 84.4-84.9	100	139.28	16.50	\$1465	\$1503	N/A	N/A
Z15S8EN	16 x 15 x 84.4-84.9	100	133.79	15.50	\$1437	\$1469	N/A	N/A

Four open shelves and two file drawers on bottom. **Includes two 3-position fixed/height adjustable shelves.** Lock secures all drawers. For filing capabilities, see page 121.

- Lateral file drawer construction is for accommodating hanging files NOT for stacking materials on the drawer bottom.

Required Specifications

Top finish
Base finish
Top/edge detail
Handles

Optional Specifications

Glazing - Doors
Collator (Open Shelves)

WARDROBE CABINETS - 84.5"/85" HIGH



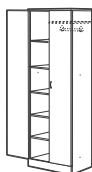
Wardrobe Cabinet



Wardrobe Cabinet - LEFT



Wardrobe Cabinet - RIGHT



Glazed door option

Wardrobe Cabinet/Shelving Combo with Doors - LEFT



Glazed door option

Wardrobe Cabinet/Shelving Combo with Doors - RIGHT

MODEL#	DIMENSIONS D x W x H	FREIGHT CLASS	WT/LBS.	CUBIC FT.	1" TOP	1.5" TOP	GLAZE ADD	HP ADD
Z36L8WA	24 x 36 x 84.4-84.9	150	290.85	50	\$2519	\$2598	N/A	N/A
Z30L8WA	24 x 30 x 84.4-84.9	125	256.20	42	\$2262	\$2331	N/A	N/A
Z36M8WA	20 x 36 x 84.4-84.9	125	264.60	42.25	\$2354	\$2423	N/A	N/A
Z30M8WA	20 x 30 x 84.4-84.9	125	231	35.50	\$2127	\$2187	N/A	N/A

Laminate doors are standard. Full length hanging rod included. **One adjustable shelf** above hanging rod. Standard with lock.

Z24L8WAL	24 x 24 x 84.4-84.9	125	220.50	34.25	\$1888	\$1945	N/A	N/A
Z21L8WAL	24 x 21 x 84.4-84.9	125	192.15	30.25	\$1819	\$1875	N/A	N/A
Z18L8WAL	24 x 18 x 84.4-84.9	125	184.80	26.25	\$1695	\$1742	N/A	N/A
Z16L8WAL	24 x 16 x 84.4-84.9	125	172.20	24	\$1617	\$1663	N/A	N/A
Z15L8WAL	24 x 15 x 84.4-84.9	125	161.70	22.50	\$1571	\$1609	N/A	N/A
Z12L8WAL	24 x 12 x 84.4-84.9	100	150.15	18.50	\$1444	\$1479	N/A	N/A
Z24M8WAL	20 x 24 x 84.4-84.9	125	197.40	28.50	\$1759	\$1806	N/A	N/A
Z21M8WAL	20 x 21 x 84.4-84.9	125	182.70	25.50	\$1694	\$1741	N/A	N/A
Z18M8WAL	20 x 18 x 84.4-84.9	125	164.85	22.25	\$1570	\$1612	N/A	N/A
Z16M8WAL	20 x 16 x 84.4-84.9	125	154.35	20.25	\$1496	\$1538	N/A	N/A
Z15M8WAL	20 x 15 x 84.4-84.9	125	149.10	19	\$1436	\$1471	N/A	N/A
Z12M8WAL	20 x 12 x 84.4-84.9	100	133.35	15.75	\$1341	\$1371	N/A	N/A

Laminate doors are standard. Full length hanging rod included. **One adjustable shelf** above hanging rod. Standard with lock.

Z24L8WAR	24 x 24 x 84.4-84.9	125	220.50	34.25	\$1888	\$1945	N/A	N/A
Z21L8WAR	24 x 21 x 84.4-84.9	125	192.15	30.25	\$1819	\$1875	N/A	N/A
Z18L8WAR	24 x 18 x 84.4-84.9	125	184.80	26.25	\$1695	\$1742	N/A	N/A
Z16L8WAR	24 x 16 x 84.4-84.9	125	172.20	24	\$1617	\$1663	N/A	N/A
Z15L8WAR	24 x 15 x 84.4-84.9	125	161.70	22.50	\$1571	\$1609	N/A	N/A
Z12L8WAR	24 x 12 x 84.4-84.9	100	150.15	18.50	\$1444	\$1479	N/A	N/A
Z24M8WAR	20 x 24 x 84.4-84.9	125	197.40	28.50	\$1759	\$1806	N/A	N/A
Z21M8WAR	20 x 21 x 84.4-84.9	125	182.70	25.50	\$1694	\$1741	N/A	N/A
Z18M8WAR	20 x 18 x 84.4-84.9	125	164.85	22.25	\$1570	\$1612	N/A	N/A
Z16M8WAR	20 x 16 x 84.4-84.9	125	154.35	20.25	\$1496	\$1538	N/A	N/A
Z15M8WAR	20 x 15 x 84.4-84.9	125	149.10	19	\$1436	\$1471	N/A	N/A
Z12M8WAR	20 x 12 x 84.4-84.9	100	133.35	15.75	\$1341	\$1371	N/A	N/A

Laminate doors are standard. Full length hanging rod included. **One adjustable shelf** above hanging rod. Standard with lock.

Z36L8DIL	24 x 36 x 84.4-84.9	125	339	50	\$2913	\$2992	\$1934	N/A
Z30L8DIL	24 x 30 x 84.4-84.9	125	301	42	\$2557	\$2626	\$1655	N/A
Z24L8DIL	24 x 24 x 84.4-84.9	125	269	34.25	\$2313	\$2370	\$1518	N/A
Z21L8DIL	24 x 21 x 84.4-84.9	100	252	30.25	\$2239	\$2272	\$1505	N/A
Z36M8DIL	20 x 36 x 84.4-84.9	125	306	42.25	\$2742	\$2811	\$1934	N/A
Z30M8DIL	20 x 30 x 84.4-84.9	125	266	35.50	\$2416	\$2476	\$1655	N/A
Z24M8DIL	20 x 24 x 84.4-84.9	100	233	28.50	\$2180	\$2229	\$1518	N/A
Z21M8DIL	20 x 21 x 84.4-84.9	100	215	25.50	\$2072	\$2130	\$1505	N/A

Laminate doors are standard. Storage compartment on **left includes five adjustable shelves**. Wardrobe compartment on **right** includes hanging rod and **one adjustable shelf** above rod. Two locks secure storage and wardrobe.

Z36L8DIR	24 x 36 x 84.4-84.9	125	339	50	\$2913	\$2992	\$1934	N/A
Z30L8DIR	24 x 30 x 84.4-84.9	125	301	42	\$2557	\$2626	\$1655	N/A
Z24L8DIR	24 x 24 x 84.4-84.9	125	269	34.25	\$2313	\$2370	\$1518	N/A
Z21L8DIR	24 x 21 x 84.4-84.9	100	252	30.25	\$2239	\$2272	\$1505	N/A
Z36M8DIR	20 x 36 x 84.4-84.9	125	306	42.25	\$2742	\$2811	\$1934	N/A
Z30M8DIR	20 x 30 x 84.4-84.9	125	266	35.50	\$2416	\$2476	\$1655	N/A
Z24M8DIR	20 x 24 x 84.4-84.9	100	233	28.50	\$2180	\$2229	\$1518	N/A
Z21M8DIR	20 x 21 x 84.4-84.9	100	215	25.50	\$2072	\$2130	\$1505	N/A

Laminate doors are standard. Storage compartment on **right includes five adjustable shelves**. Wardrobe compartment on **left** includes hanging rod and **one adjustable shelf** above rod. Two locks secure storage and wardrobe.

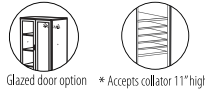
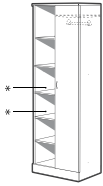
Required Specifications

- Top finish
- Base finish
- Top/Edge Detail
- Handles

Optional Specifications

- Glazing - Doors
- Collator (Open Shelves)
- Box drawer* - no upcharge (30"-36" wide models only)

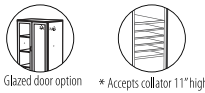
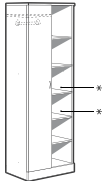
WARDROBE CABINETS - 84.5"/85" HIGH



Wardrobe Cabinet/Open Shelving Combo - LEFT

MODEL#	DIMENSIONS D x W x H	FREIGHT CLASS	WT./LBS.	CUBIC FT.	1" TOP	1.5" TOP	GLAZE ADD	HP ADD
Z36L8DINL	24 x 36 x 84.4-84.9	125	312	50	\$2608	\$2687	\$964	N/A
Z30L8DINL	24 x 30 x 84.4-84.9	125	278	42	\$2289	\$2358	\$823	N/A
Z24L8DINL	24 x 24 x 84.4-84.9	125	245	34.25	\$2095	\$2152	\$736	N/A
Z21L8DINL	24 x 21 x 84.4-84.9	125	236	30.25	\$2041	\$2066	\$731	N/A
Z36M8DINL	20 x 36 x 84.4-84.9	125	275	42.25	\$2436	\$2505	\$964	N/A
Z30M8DINL	20 x 30 x 84.4-84.9	125	243	35.50	\$2153	\$2213	\$823	N/A
Z24M8DINL	20 x 24 x 84.4-84.9	125	215	28.50	\$1962	\$2009	\$736	N/A
Z21M8DINL	20 x 21 x 84.4-84.9	125	199	25.50	\$1875	\$1922	\$731	N/A

Laminate door is standard on wardrobe section. Storage compartment on **left includes five adjustable shelves**. Wardrobe compartment on **right** includes hanging rod and **one adjustable shelf** above rod. Single lock secures wardrobe compartment.

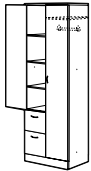


Wardrobe Cabinet/Open Shelving Combo - RIGHT

Z36L8DINR	24 x 36 x 84.4-84.9	125	312	50	\$2608	\$2687	\$964	N/A
Z30L8DINR	24 x 30 x 84.4-84.9	125	278	42	\$2289	\$2358	\$823	N/A
Z24L8DINR	24 x 24 x 84.4-84.9	125	245	34.25	\$2095	\$2152	\$736	N/A
Z21L8DINR	24 x 21 x 84.4-84.9	125	236	30.25	\$2041	\$2066	\$731	N/A
Z36M8DINR	20 x 36 x 84.4-84.9	125	275	42.25	\$2436	\$2505	\$964	N/A
Z30M8DINR	20 x 30 x 84.4-84.9	125	243	35.50	\$2153	\$2213	\$823	N/A
Z24M8DINR	20 x 24 x 84.4-84.9	125	215	28.50	\$1962	\$2009	\$736	N/A
Z21M8DINR	20 x 21 x 84.4-84.9	125	199	25.50	\$1875	\$1922	\$731	N/A

Laminate door is standard on wardrobe section. Storage compartment on **right includes five adjustable shelves**. Wardrobe compartment on **left** includes hanging rod and **one adjustable shelf** above rod. Single lock secures wardrobe compartment.

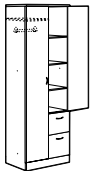
PERSONAL TOWERS - 84.5"/85" HIGH



Personal Tower with Doors - LEFT

MODEL#	DIMENSIONS	FREIGHT CLASS	WT./LBS.	CUBIC FT.	1" TOP	1.5" TOP	GLAZE ADD	HP ADD
Z36L8EL	24 x 36 x 84.4-84.9	125	368.55	50	\$3112	\$3192	\$1676	N/A
Z30L8EL	24 x 30 x 84.4-84.9	125	334.95	42	\$2841	\$2910	\$1530	N/A
Z24L8EL	24 x 24 x 84.4-84.9	100	299.24	34.25	\$2746	\$2804	\$1320	N/A
Z36M8EL	20 x 36 x 84.4-84.9	125	332.85	42.25	\$2941	\$3010	\$1676	N/A
Z30M8EL	20 x 30 x 84.4-84.9	100	298.20	35.50	\$2712	\$2772	\$1530	N/A
Z24M8EL	20 x 24 x 84.4-84.9	100	266	29	\$2586	\$2633	\$1320	N/A

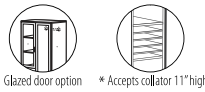
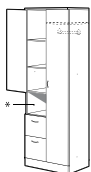
Two file drawers on bottom. Laminate doors are standard. Storage compartment on **left includes three adjustable shelves**. Wardrobe compartment on **right** includes hanging rod and **one adjustable shelf** above rod. Two upper locks secure storage and wardrobe compartments. Lower lock secures all drawers.



Personal Tower with Doors - RIGHT

Z36L8ER	24 x 36 x 84.4-84.9	125	368.55	50	\$3112	\$3192	\$1676	N/A
Z30L8ER	24 x 30 x 84.4-84.9	125	334.95	42	\$2841	\$2910	\$1530	N/A
Z24L8ER	24 x 24 x 84.4-84.9	100	299.24	34.25	\$2746	\$2804	\$1320	N/A
Z36M8ER	20 x 36 x 84.4-84.9	125	332.85	42.25	\$2941	\$3010	\$1676	N/A
Z30M8ER	20 x 30 x 84.4-84.9	100	298.20	35.50	\$2712	\$2772	\$1530	N/A
Z24M8ER	20 x 24 x 84.4-84.9	100	266	29	\$2586	\$2633	\$1320	N/A

Two file drawers on bottom. Laminate doors are standard. Storage compartment on **right includes three adjustable shelves**. Wardrobe compartment on **left** includes hanging rod and **one adjustable shelf** above rod. Two upper locks secure storage and wardrobe compartments. Lower lock secures all drawers.



Personal Tower with Doors and cavity - LEFT

Z36L8ECL	24 x 36 x 84.4-84.9	125	366.44	50	\$3082	\$3161	\$1583	N/A
Z30L8ECL	24 x 30 x 84.4-84.9	125	332.49	42	\$2812	\$2881	\$1436	N/A
Z24L8ECL	24 x 24 x 84.4-84.9	100	295.24	34.25	\$2705	\$2762	\$1227	N/A
Z36M8ECL	20 x 36 x 84.4-84.9	125	328.68	42.25	\$2895	\$2964	\$1583	N/A
Z30M8ECL	20 x 30 x 84.4-84.9	100	295.07	35.50	\$2667	\$2725	\$1436	N/A
Z24M8ECL	20 x 24 x 84.4-84.9	100	263	29	\$2544	\$2591	\$1227	N/A

Two file drawers on bottom. Laminate doors are standard. Storage compartment on **left includes two 3-position fixed/height adjustable shelves**. Wardrobe compartment on **right** includes hanging rod and **one adjustable shelf** above rod. Two upper locks secure storage and wardrobe compartments. Lower lock secures all drawers.

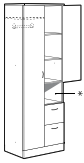
Required Specifications

- Top finish
- Base finish
- Top/Edge Detail
- Handles

Optional Specifications

- Glazing - Doors
- Collator (Open Shelves)
- Box drawer - no upcharge* (30"-36" wide models only)

PERSONAL TOWERS - 84.5"/85" HIGH

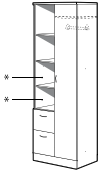


Glazed door option * Accepts collator 11" high

Personal Tower with Doors and cavity - RIGHT

MODEL#	DIMENSIONS D x W x H	FREIGHT CLASS	WT/LBS.	CUBIC FT.	1" TOP	1.5" TOP	GLAZE ADD	HP ADD
Z36L8ECR	24 x 36 x 84.4-84.9	125	366.44	50	\$3082	\$3161	\$1583	N/A
Z30L8ECR	24 x 30 x 84.4-84.9	125	332.49	42	\$2812	\$2881	\$1436	N/A
Z24L8ECR	24 x 24 x 84.4-84.9	100	295.24	34.25	\$2705	\$2762	\$1227	N/A
Z36M8ECR	20 x 36 x 84.4-84.9	125	328.68	42.25	\$2895	\$2964	\$1583	N/A
Z30M8ECR	20 x 30 x 84.4-84.9	100	295.07	35.50	\$2667	\$2725	\$1436	N/A
Z24M8ECR	20 x 24 x 84.4-84.9	100	263	29	\$2544	\$2591	\$1227	N/A

Two file drawers on bottom. Laminate doors are standard. Storage compartment on **right** includes **two 3-position fixed/height adjustable shelves**. Wardrobe compartment on **left** includes hanging rod and **one adjustable shelf** above rod. Two upper locks secure storage and wardrobe compartments. Lower lock secures all drawers.

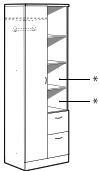


Glazed door option * Accepts collator 11" high

Personal Tower with Open Shelves - LEFT

Z36L8ENL	24 x 36 x 84.4-84.9	125	351.72	50	\$2914	\$2993	\$969	N/A
Z30L8ENL	24 x 30 x 84.4-84.9	125	320.22	42	\$2643	\$2712	\$819	N/A
Z24L8ENL	24 x 24 x 84.4-84.9	100	283.24	34.25	\$2507	\$2564	\$613	N/A
Z36M8ENL	20 x 36 x 84.4-84.9	125	313.96	42.25	\$2729	\$2798	\$964	N/A
Z30M8ENL	20 x 30 x 84.4-84.9	125	282.80	35.50	\$2502	\$2560	\$823	N/A
Z24M8ENL	20 x 24 x 84.4-84.9	100	249	29	\$2349	\$2396	\$613	N/A

Two file drawers on bottom. Laminate door is standard on wardrobe section. Storage compartment on **left** includes **three 3-position fixed/height adjustable shelves**. Wardrobe compartment on **right** includes hanging rod and **one adjustable shelf** above rod. Upper lock secures wardrobe compartment. Lower lock secures all drawers.

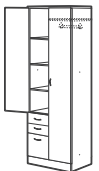


Glazed door option * Accepts collator 11" high

Personal Tower with Open Shelves - RIGHT

Z36L8ENR	24 x 36 x 84.4-84.9	125	351.72	50	\$2914	\$2993	\$969	N/A
Z30L8ENR	24 x 30 x 84.4-84.9	125	320.22	42	\$2643	\$2712	\$819	N/A
Z24L8ENR	24 x 24 x 84.4-84.9	100	283.24	34.25	\$2507	\$2564	\$613	N/A
Z36M8ENR	20 x 36 x 84.4-84.9	125	313.96	42.25	\$2729	\$2798	\$964	N/A
Z30M8ENR	20 x 30 x 84.4-84.9	125	282.80	35.50	\$2502	\$2560	\$823	N/A
Z24M8ENR	20 x 24 x 84.4-84.9	100	249	29	\$2349	\$2396	\$613	N/A

Two file drawers on bottom. Laminate door is standard on wardrobe section. Storage compartment on **right** includes **three 3-position fixed/height adjustable shelves**. Wardrobe compartment on **right** includes hanging rod and **one adjustable shelf** above rod. Upper lock secures wardrobe compartment. Lower lock secures all drawers.

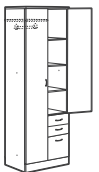


Glazed door option

Personal Tower with Doors - LEFT

Z36L8BFL	24 x 36 x 84.4-84.9	125	371.70	50	\$3258	\$3337	\$1676	N/A
Z30L8BFL	24 x 30 x 84.4-84.9	100	337.05	42	\$3001	\$3070	\$1530	N/A
Z24L8BFL	24 x 24 x 84.4-84.9	100	301.24	34.25	\$2856	\$2913	\$1320	N/A
Z36M8BFL	20 x 36 x 84.4-84.9	125	334.95	42.25	\$3074	\$3143	\$1676	N/A
Z30M8BFL	20 x 30 x 84.4-84.9	100	300.30	35.50	\$2856	\$2916	\$1530	N/A
Z24M8BFL	20 x 24 x 84.4-84.9	100	268	29	\$2695	\$2742	\$1320	N/A

Two box and one file drawer on bottom. Laminate doors are standard. Storage compartment on **left** includes **three 3-position fixed/height adjustable shelves**. Wardrobe compartment on **right** includes hanging rod and **one adjustable shelf** above rod. Two upper locks secure storage and wardrobe compartments. Lower lock secures all drawers.



Glazed door option

Personal Tower with Doors - RIGHT

Z36L8BFR	24 x 36 x 84.4-84.9	125	371.70	50	\$3258	\$3337	\$1676	N/A
Z30L8BFR	24 x 30 x 84.4-84.9	100	337.05	42	\$3001	\$3070	\$1530	N/A
Z24L8BFR	24 x 24 x 84.4-84.9	100	301.24	34.25	\$2856	\$2913	\$1320	N/A
Z36M8BFR	20 x 36 x 84.4-84.9	125	334.95	42.25	\$3074	\$3143	\$1676	N/A
Z30M8BFR	20 x 30 x 84.4-84.9	100	300.30	35.50	\$2856	\$2916	\$1530	N/A
Z24M8BFR	20 x 24 x 84.4-84.9	100	268	29	\$2695	\$2742	\$1320	N/A

Two box and one file drawer on bottom. Laminate doors are standard. Storage compartment on **right** includes **three 3-position fixed/height adjustable shelves**. Wardrobe compartment on **left** includes hanging rod and **one adjustable shelf** above rod. Two upper locks secure storage and wardrobe compartments. Lower lock secures all drawers.

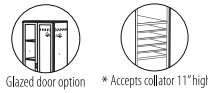
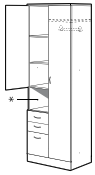
Required Specifications

- Top finish
- Base finish
- Top/Edge Detail
- Handles

Optional Specifications

- Glazing - Doors
- Collator (Open Shelves)
- Box drawer* - no upcharge (30" - 36" wide models only)

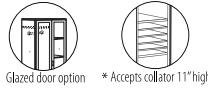
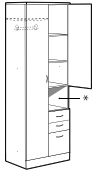
PERSONAL TOWERS - 84.5"/85" HIGH



Personal Tower with Doors and Cavity - LEFT

MODEL#	DIMENSIONS D x W x H	FREIGHT CLASS	WT./LBS.	CUBIC FT.	1"TOP	1.5" TOP	GLAZE ADD	HP ADD
Z36L8BFCL	24 x 36 x 84.4-84.9	125	369.59	50	\$3215	\$3295	\$1583	N/A
Z30L8BFCL	24 x 30 x 84.4-84.9	125	334.59	42	\$2955	\$3024	\$1436	N/A
Z24L8BFCL	24 x 24 x 84.4-84.9	100	297.24	34.25	\$2812	\$2870	\$1227	N/A
Z36M8BFCL	20 x 36 x 84.4-84.9	125	330.78	42.25	\$3030	\$3099	\$1583	N/A
Z30M8BFCL	20 x 30 x 84.4-84.9	100	299.27	35.50	\$2812	\$2872	\$1436	N/A
Z24M8BFCL	20 x 24 x 84.4-84.9	100	265	29	\$2652	\$2699	\$1227	N/A

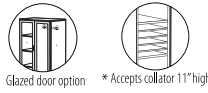
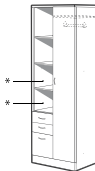
Two box and one file drawer on bottom. Laminate doors are standard. Storage compartment on **left** includes **two 3-position fixed/height adjustable shelves**. Wardrobe compartment on **left** includes hanging rod and **one adjustable shelf** above rod. Two upper locks secure storage and wardrobe compartments. Lower lock secures all drawers.



Personal Tower with Doors and Cavity - RIGHT

Z36L8BFCL	24 x 36 x 84.4-84.9	125	369.59	50	\$3215	\$3295	\$1583	N/A
Z30L8BFCL	24 x 30 x 84.4-84.9	125	334.59	42	\$2955	\$3024	\$1436	N/A
Z24L8BFCL	24 x 24 x 84.4-84.9	100	297.24	34.25	\$2812	\$2870	\$1227	N/A
Z36M8BFCL	20 x 36 x 84.4-84.9	125	330.78	42.25	\$3030	\$3099	\$1583	N/A
Z30M8BFCL	20 x 30 x 84.4-84.9	100	299.27	35.50	\$2812	\$2872	\$1436	N/A
Z24M8BFCL	20 x 24 x 84.4-84.9	100	265	29	\$2652	\$2699	\$1227	N/A

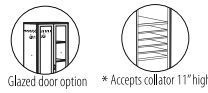
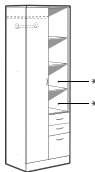
Two box and one file drawer on bottom. Laminate doors are standard. Storage compartment on **right** includes **two 3-position fixed/height adjustable shelves**. Wardrobe compartment on **left** includes hanging rod and **one adjustable shelf** above rod. Two upper locks secure storage and wardrobe compartments. Lower lock secures all drawers.



Personal Tower with Open Shelves - LEFT

Z36L8BFNL	24 x 36 x 84.4-84.9	125	354.87	50	\$3044	\$3124	\$969	N/A
Z30L8BFNL	24 x 30 x 84.4-84.9	125	322.32	42	\$2790	\$2859	\$819	N/A
Z24L8BFNL	24 x 24 x 84.4-84.9	100	285.24	34.25	\$2616	\$2673	\$613	N/A
Z36M8BFNL	20 x 36 x 84.4-84.9	125	316.06	42.25	\$2861	\$2944	\$964	N/A
Z30M8BFNL	20 x 30 x 84.4-84.9	100	287	35.50	\$2643	\$2703	\$823	N/A
Z24M8BFNL	20 x 24 x 84.4-84.9	100	251	29	\$2454	\$2501	\$613	N/A

Two box and one file drawer on bottom. Laminate door is standard on wardrobe section. Storage compartment on **left** includes **three 3-position fixed/height adjustable shelves**. Wardrobe compartment on **right** includes hanging rod and **one adjustable shelf** above rod. Upper lock secures wardrobe compartment. Lower lock secures all drawers.

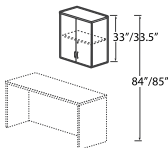


Personal Tower with Open Shelves - RIGHT

Z36L8BFNR	24 x 36 x 84.4-84.9	125	354.87	50	\$3044	\$3124	\$969	N/A
Z30L8BFNR	24 x 30 x 84.4-84.9	125	322.32	42	\$2790	\$2859	\$819	N/A
Z24L8BFNR	24 x 24 x 84.4-84.9	100	285.24	34.25	\$2616	\$2673	\$613	N/A
Z36M8BFNR	20 x 36 x 84.4-84.9	125	316.06	42.25	\$2861	\$2944	\$964	N/A
Z30M8BFNR	20 x 30 x 84.4-84.9	100	287	35.50	\$2643	\$2703	\$823	N/A
Z24M8BFNR	20 x 24 x 84.4-84.9	100	251	29	\$2454	\$2501	\$613	N/A

Two box and one file drawer on bottom. Laminate door is standard on wardrobe section. Storage compartment on **right** includes **three 3-position fixed/height adjustable shelves**. Wardrobe compartment on **left** includes hanging rod and **one adjustable shelf** above rod. Upper lock secures wardrobe compartment. Lower lock secures all drawers.

CLOSED FRONT OVERHEAD STORAGE - 33"H



Closed Front Overhead Storage with Doors - 32.5"/33"H

MODEL#	DIMENSIONS	FREIGHT CLASS	WT./LBS.	CUBIC FT.	1"TOP	1.5" TOP	GLAZE ADD	HP ADD
Z42S33OS	16 x 42 x 32.5-33	100	135.98	16.25	\$1140	\$1216	\$1105	N/A
Z36S33OS	16 x 36 x 32.5-33	100	119.70	14	\$1034	\$1101	\$998	N/A
Z30S33OS	16 x 30 x 32.5-33	100	104.42	11.75	\$926	\$969	\$870	N/A
Z24S33OS	16 x 24 x 32.5-33	100	81.13	9.75	\$830	\$876	\$761	N/A

Includes steel hanging rail for wall mount applications. Includes one fixed shelf. Doors lock.

• **NOTE:** Care should be taken to mount the units. Units should be mounted to wall studs using correct fasteners. Failure to do so may result in collapse of the unit and subsequent personal injury. **Fastening hardware not included.** Mounting hardware used should be based on wall material. Consult an installation professional for proper wall mounting.

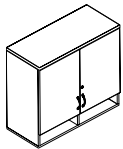
Required Specifications

Top finish
Base finish
Top/Edge Detail
Handles

Optional Specifications

Glazing - Doors
Collator (Open Shelves)

OVERHEAD STORAGE - 33"H



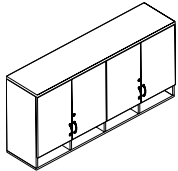
Glazed door option

Closed Front Overhead Storage with Pigeon Hole - 32.5"/33"H

MODEL#	DIMENSIONS D x W x H	FREIGHT CLASS	WT/LBS.	CUBIC FT.	1" TOP	1.5" TOP	GLAZE ADD	HP ADD
Z42S33OP	16 x 42 x 32.5-33	100	140	16.25	\$1455	\$1534	\$729	N/A
Z36S33OP	16 x 36 x 32.5-33	100	122	14	\$1257	\$1328	\$664	N/A
Z30S33OP	16 x 30 x 32.5-33	100	105	12	\$1126	\$1184	\$590	N/A
Z24S33OP	16 x 24 x 32.5-33	100	88	9.75	\$1011	\$1065	\$537	N/A

Includes steel hanging rail for wall mount applications. Includes one fixed shelf. Doors lock.

- **NOTE:** Care should be taken to mount the units. Units should be mounted to wall studs using correct fasteners. Failure to do so may result in collapse of the unit and subsequent personal injury. **Fastening hardware not included.** Mounting hardware used should be based on wall material. Consult an installation professional for proper wall mounting.



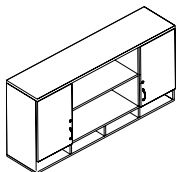
Glazed door option

Closed Front Overhead Storage with Pigeon Hole - 32.5"/33"H

Z72S33OS	16 x 72 x 32.5-33	100	230	26	\$2356	\$2460	\$1329	N/A
Z66S33OS	16 x 66 x 32.5-33	100	215	24	\$2264	\$2358	\$1305	N/A
Z60S33OS	16 x 60 x 32.5-33	100	199	22	\$2088	\$2175	\$1182	N/A
Z54S33OS	16 x 54 x 32.5-33	100	184	21	\$1984	\$2067	\$1158	N/A

Includes steel hanging rail for wall mount applications. Includes one fixed shelf. Doors lock.

- **NOTE:** Care should be taken to mount the units. Units should be mounted to wall studs using correct fasteners. Failure to do so may result in collapse of the unit and subsequent personal injury. **Fastening hardware not included.** Mounting hardware used should be based on wall material. Consult an installation professional for proper wall mounting.



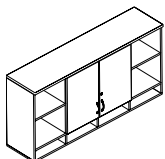
Glazed door option

Overhead Storage, 2 Outer Doors with Pigeon Hole - 32.5"/33"H

Z72S33SOS	16 x 72 x 32.5-33	100	215	26	\$2131	\$2235	\$666	N/A
Z66S33SOS	16 x 66 x 32.5-33	100	201	24	\$2035	\$2129	\$654	N/A
Z60S33SOS	16 x 60 x 32.5-33	100	187	22	\$1912	\$1999	\$642	N/A
Z54S33SOS	16 x 54 x 32.5-33	100	173	21	\$1779	\$1862	\$580	N/A

6 compartments. **Doors on outer compartments only.** Includes steel hanging rail for wall mount applications. Includes one fixed shelf. Doors lock.

- **NOTE:** Care should be taken to mount the units. Units should be mounted to wall studs using correct fasteners. Failure to do so may result in collapse of the unit and subsequent personal injury. **Fastening hardware not included.** Mounting hardware used should be based on wall material. Consult an installation professional for proper wall mounting.



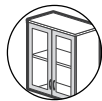
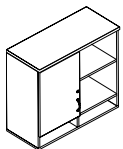
Glazed door option

Overhead Storage, 2 Center Doors with Pigeon Hole - 32.5"/33"H

Z72S33OSO	16 x 72 x 32.5-33	100	214	26	\$2090	\$2194	\$666	N/A
Z66S33OSO	16 x 66 x 32.5-33	100	200	24	\$2000	\$2094	\$654	N/A
Z60S33OSO	16 x 60 x 32.5-33	100	186	22	\$1876	\$1963	\$593	N/A
Z54S33OSO	16 x 54 x 32.5-33	100	172	21	\$1774	\$1857	\$580	N/A

6 compartments. **Doors on inner compartments only.** Includes steel hanging rail for wall mount applications. Includes one fixed shelf. Doors lock.

- **NOTE:** Care should be taken to mount the units. Units should be mounted to wall studs using correct fasteners. Failure to do so may result in collapse of the unit and subsequent personal injury. **Fastening hardware not included.** Mounting hardware used should be based on wall material. Consult an installation professional for proper wall mounting.



Glazed door option

Overhead Storage, 1 Door - LEFT with Pigeon Hole - 32.5"/33"H

Z36S33OSL	16 x 36 x 32.5-33	100	119	14	\$1177	\$1248	\$333	N/A
Z30S33OSL	16 x 30 x 32.5-33	100	104	11.75	\$1074	\$1132	\$297	N/A
Z24S33OSL	16 x 24 x 32.5-33	100	88	9.75	\$964	\$1018	\$260	N/A

Includes steel hanging rail for wall mount applications. Includes one fixed shelf. Door locks. Open storage on **right.**

- **NOTE:** Care should be taken to mount the units. Units should be mounted to wall studs using correct fasteners. Failure to do so may result in collapse of the unit and subsequent personal injury. **Fastening hardware not included.** Mounting hardware used should be based on wall material. Consult an installation professional for proper wall mounting.

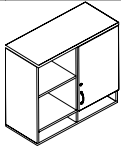
Required Specifications

- Top finish
- Base finish
- Top/Edge Detail
- Handles

Optional Specifications

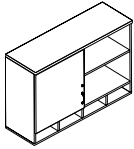
- Glazing - Doors

OVERHEAD STORAGE - 33"H



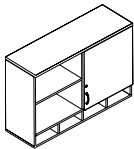
Glazed door option

Overhead Storage, 1 Door - RIGHT with Pigeon Hole - 32.5"/33"H



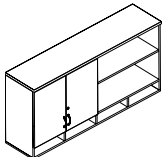
Glazed door option

Overhead Storage, 1 Door - LEFT with Pigeon Hole - 32.5"/33"H



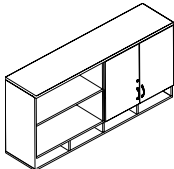
Glazed door option

Overhead Storage, 1 Door - RIGHT with Pigeon Hole - 32.5"/33"H*



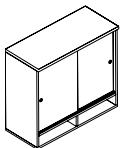
Glazed door option

Overhead Storage, 1 Door - LEFT with Pigeon Hole - 32.5"/33"H*



Glazed door option

Overhead Storage, 1 Door - RIGHT with Pigeon Hole - 32.5"/33"H*



Overhead Storage, Glass Doors with Pigeon Hole - 32.5"/33"H

MODEL#	DIMENSIONS D x W x H	FREIGHT CLASS	WT/LBS.	CUBIC FT.	1" TOP	1.5" TOP	GLAZE ADD	HP ADD
Z36S33OSR	16 x 36 x 32.5-33	100	119	14	\$1177	\$1248	\$333	N/A
Z30S33OSR	16 x 30 x 32.5-33	100	104	11.75	\$1074	\$1132	\$297	N/A
Z24S33OSR	16 x 24 x 32.5-33	100	88	9.75	\$964	\$1018	\$260	N/A

Includes steel hanging rail for wall mount applications. Includes one fixed shelf. Door locks. Open storage on **left**.

• **NOTE:** Care should be taken to mount the units. Units should be mounted to wall studs using correct fasteners. Failure to do so may result in collapse of the unit and subsequent personal injury. **Fastening hardware not included.** Mounting hardware used should be based on wall material. Consult an installation professional for proper wall mounting.

Z48S33OSL	16 x 48 x 32.5-33	100	135	16.25	\$1522	\$1605	\$375	N/A
Z42S33OSL	16 x 42 x 32.5-33	100	135	16.25	\$1354	\$1433	\$367	N/A

Includes steel hanging rail for wall mount applications. Includes one fixed shelf. Door locks. Open storage on **right**.

• **NOTE:** Care should be taken to mount the units. Units should be mounted to wall studs using correct fasteners. Failure to do so may result in collapse of the unit and subsequent personal injury. **Fastening hardware not included.** Mounting hardware used should be based on wall material. Consult an installation professional for proper wall mounting.

Z48S33OSR	16 x 48 x 32.5-33	100	135	16.25	\$1522	\$1605	\$375	N/A
Z42S33OSR	16 x 42 x 32.5-33	100	135	16.25	\$1354	\$1433	\$367	N/A

Includes steel hanging rail for wall mount applications. Includes one fixed shelf. Door locks. Open storage on **left**.

• **NOTE:** Care should be taken to mount the units. Units should be mounted to wall studs using correct fasteners. Failure to do so may result in collapse of the unit and subsequent personal injury. **Fastening hardware not included.** Mounting hardware used should be based on wall material. Consult an installation professional for proper wall mounting.

Z72S33OSL	16 x 72 x 32.5-33	125	207	26	\$2047	\$2151	\$665	N/A
Z66S33OSL	16 x 66 x 32.5-33	100	193	24	\$1953	\$2047	\$656	N/A
Z60S33OSL	16 x 60 x 32.5-33	100	179	22	\$1809	\$1896	\$596	N/A
Z54S33OSL	16 x 54 x 32.5-33	125	166	21	\$1711	\$1794	\$578	N/A

Includes steel hanging rail for wall mount applications. Includes one fixed shelf. Doors lock. Open storage on **right**.

• **NOTE:** Care should be taken to mount the units. Units should be mounted to wall studs using correct fasteners. Failure to do so may result in collapse of the unit and subsequent personal injury. **Fastening hardware not included.** Mounting hardware used should be based on wall material. Consult an installation professional for proper wall mounting.

Z72S33OSR	16 x 72 x 32.5-33	125	207	26	\$2047	\$2151	\$665	N/A
Z66S33OSR	16 x 66 x 32.5-33	100	193	24	\$1953	\$2047	\$656	N/A
Z60S33OSR	16 x 60 x 32.5-33	100	179	22	\$1809	\$1896	\$596	N/A
Z54S33OSR	16 x 54 x 32.5-33	125	166	21	\$1711	\$1794	\$578	N/A

Includes steel hanging rail for wall mount applications. Includes one fixed shelf. Doors lock. Open storage on **left**.

• **NOTE:** Care should be taken to mount the units. Units should be mounted to wall studs using correct fasteners. Failure to do so may result in collapse of the unit and subsequent personal injury. **Fastening hardware not included.** Mounting hardware used should be based on wall material. Consult an installation professional for proper wall mounting.

Z36S33OSD	16 x 36 x 32.5-33	100	127	14	\$2497	\$2568	N/A	N/A
Z30S33OSD	16 x 30 x 32.5-33	100	110	12	\$2197	\$2255	N/A	N/A
Z24S33OSD	16 x 24 x 32.5-33	100	91	9.75	\$1947	\$2001	N/A	N/A

Includes steel hanging rail for wall mount applications. Includes one fixed shelf. Sliding glass doors do not lock. Shipped easy to assemble in 2 cartons. Glass doors shipped separately. Finger pull is silver.

• **NOTE:** Care should be taken to mount the units. Units should be mounted to wall studs using correct fasteners. Failure to do so may result in collapse of the unit and subsequent personal injury. **Fastening hardware not included.** Mounting hardware used should be based on wall material. Consult an installation professional for proper wall mounting.

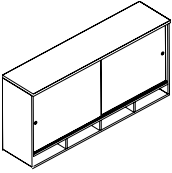
Required Specifications

Top finish
Base finish
Top/Edge Detail
Handles

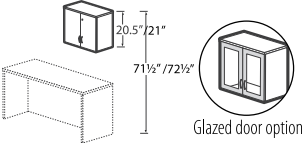
Optional Specifications

Glazing - Doors
Key #*

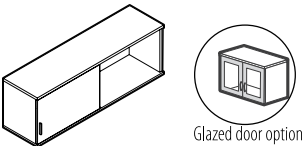
OVERHEAD STORAGE



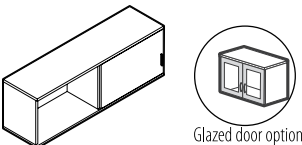
Overhead Storage, Glass Doors with Pigeon Hole - 32.5"/33"H



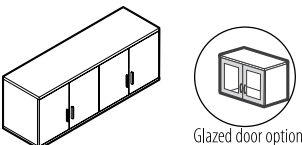
Closed Front Overhead Storage with Doors - 20"/20.5"H*



Overhead Storage w/1 door - LEFT* 20"/20.5"H



Overhead Storage w/1 door - RIGHT 20"/20.5"H*



Closed Front Overhead Storage w/Center Divider- 20/20.5"H*

MODEL#	DIMENSIONS D x W x H	FREIGHT CLASS	WT/LBS.	CUBIC FT.	1"TOP	1.5" TOP	GLAZE ADD	HP ADD
Z72S330SD	16 x 72 x 32.5-33	100	224	26	\$4401	\$4505	N/A	N/A
Z66S330SD	16 x 66 x 32.5-33	100	208	24	\$4115	\$4209	N/A	N/A
Z60S330SD	16 x 60 x 32.5-33	100	193	22	\$3807	\$3894	N/A	N/A
Z54S330SD	16 x 54 x 32.5-33	100	178	21	\$3546	\$3629	N/A	N/A
Z48S330SD	16 x 48 x 32.5-33	100	162	17.70	\$3240	\$3323	N/A	N/A
Z42S330SD	16 x 42 x 32.5-33	100	145	16.25	\$2895	\$2974	N/A	N/A

Includes steel hanging rail for wall mount applications. Includes one fixed shelf. Sliding glass doors do not lock.

Shipped easy to assemble in 2 cartons. Glass doors shipped separately. Finger pull is silver.

- **NOTE:** Care should be taken to mount the units. Units should be mounted to wall studs using correct fasteners. Failure to do so may result in collapse of the unit and subsequent personal injury. **Fastening hardware not included.** Mounting hardware used should be based on wall material. Consult an installation professional for proper wall mounting.

Z42S200S	16 x 42 x 20-20.5	100	93.99	10.50	\$815	\$890	\$789	N/A
Z36S200S	16 x 36 x 20-20.5	100	82.70	9	\$747	\$814	\$721	N/A
Z30S200S	16 x 30 x 20-20.5	100	72.42	7.50	\$674	\$717	\$640	N/A
Z24S200S	16 x 24 x 20-20.5	100	56.13	6.25	\$633	\$680	\$572	N/A

Includes steel hanging rail for wall mount applications. Doors lock.

- **NOTE:** Care should be taken to mount the units. Units should be mounted to wall studs using correct fasteners. Failure to do so may result in collapse of the unit and subsequent personal injury. **Fastening hardware not included.** Mounting hardware used should be based on wall material. Consult an installation professional for proper wall mounting.

Z48S200SL	16 x 48 x 20-20.5	125	95	12.50	\$926	\$1009	\$321	N/A
Z42S200SL	16 x 42 x 20-20.5	100	85	10.50	\$818	\$897	\$297	N/A
Z36S200SL	16 x 36 x 20-20.5	100	76	9	\$750	\$821	\$273	N/A
Z30S200SL	16 x 30 x 20-20.5	100	67	7.60	\$687	\$745	\$234	N/A
Z24S200SL	16 x 24 x 20-20.5	100	58	6.50	\$637	\$691	\$214	N/A

Door on **left**. Includes steel hanging rail for wall mount applications. Includes one fixed shelf. Door locks.

- **NOTE:** Care should be taken to mount the units. Units should be mounted to wall studs using correct fasteners. Failure to do so may result in collapse of the unit and subsequent personal injury. **Fastening hardware not included.** Mounting hardware used should be based on wall material. Consult an installation professional for proper wall mounting.

Z48S200SR	16 x 48 x 20-20.5	125	95	12.50	\$926	\$1009	\$321	N/A
Z42S200SR	16 x 42 x 20-20.5	100	85	10.50	\$818	\$897	\$297	N/A
Z36S200SR	16 x 36 x 20-20.5	100	76	9	\$750	\$821	\$273	N/A
Z30S200SR	16 x 30 x 20-20.5	100	67	7.60	\$687	\$745	\$234	N/A
Z24S200SR	16 x 24 x 20-20.5	100	58	6.50	\$637	\$691	\$214	N/A

Door on **right**. Includes steel hanging rail for wall mount applications. Includes one fixed shelf. Door locks.

- **NOTE:** Care should be taken to mount the units. Units should be mounted to wall studs using correct fasteners. Failure to do so may result in collapse of the unit and subsequent personal injury. **Fastening hardware not included.** Mounting hardware used should be based on wall material. Consult an installation professional for proper wall mounting.

Z72S200S	16 x 72 x 20-20.5	100	149	18	\$1560	\$1664	\$1076	N/A
Z66S200S	16 x 66 x 20-20.5	100	139	16.50	\$1487	\$1581	\$1052	N/A
Z60S200S	16 x 60 x 20-20.5	100	129	15	\$1372	\$1459	\$963	N/A
Z54S200S	16 x 54 x 20-20.5	100	119	13.75	\$1307	\$1390	\$938	N/A

Includes steel hanging rail for wall mount applications. Includes one fixed shelf. Doors lock.

- **NOTE:** Care should be taken to mount the units. Units should be mounted to wall studs using correct fasteners. Failure to do so may result in collapse of the unit and subsequent personal injury. **Fastening hardware not included.** Mounting hardware used should be based on wall material. Consult an installation professional for proper wall mounting.

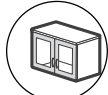
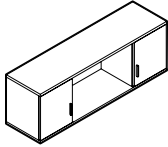
Required Specifications

Top finish
Base finish
Top/Edge Detail
Handles

Optional Specifications

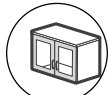
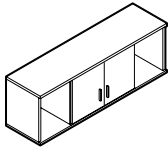
Glazed doors*
Key #*

OVERHEAD STORAGE



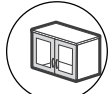
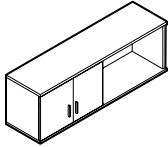
Glazed door option

Overhead Storage w/2 Outer Doors
20/20.5"H*



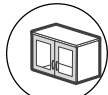
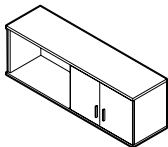
Glazed door option

Overhead Storage w/2 Inner Doors
20/20.5"H*



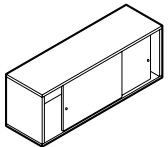
Glazed door option

Overhead Storage w/2 Doors - LEFT
20/20.5"H*



Glazed door option

Overhead Storage w/2 Doors - RIGHT
20/20.5"H*



Overhead Storage, w/Glass Doors
20/20.5"H

MODEL#	DIMENSIONS D x W x H	FREIGHT CLASS	WT/LBS.	CUBIC FT.	1" TOP	1.5" TOP	GLAZE ADD	HP ADD
Z72S20SOS	16 x 72 x 20-20.5	125	137	18	\$1341	\$1445	\$543	N/A
Z66S20SOS	16 x 66 x 20-20.5	125	128	16.50	\$1269	\$1363	\$530	N/A
Z60S20SOS	16 x 60 x 20-20.5	100	120	15	\$1194	\$1281	\$520	N/A
Z54S20SOS	16 x 54 x 20-20.5	100	110	13.75	\$1113	\$1196	\$474	N/A

4 compartments. **Doors on outer compartments only.** Includes steel hanging rail for wall mount applications. Doors lock.
 • **NOTE:** Care should be taken to mount the units. Units should be mounted to wall studs using correct fasteners. Failure to do so may result in collapse of the unit and subsequent personal injury. **Fastening hardware not included.** Mounting hardware used should be based on wall material. Consult an installation professional for proper wall mounting.

Z72S20OSO	16 x 72 x 20-20.5	125	137	18	\$1357	\$1461	\$539	N/A
Z66S20OSO	16 x 66 x 20-20.5	125	128	16.50	\$1286	\$1380	\$526	N/A
Z60S20OSO	16 x 60 x 20-20.5	100	120	15	\$1209	\$1296	\$483	N/A
Z54S20OSO	16 x 54 x 20-20.5	100	110	13.75	\$1129	\$1212	\$470	N/A

4 compartments. **Doors on inner compartments only.** Includes steel hanging rail for wall mount applications. Doors lock.
 • **NOTE:** Care should be taken to mount the units. Units should be mounted to wall studs using correct fasteners. Failure to do so may result in collapse of the unit and subsequent personal injury. **Fastening hardware not included.** Mounting hardware used should be based on wall material. Consult an installation professional for proper wall mounting.

Z72S20OSL	16 x 72 x 20-20.5	125	132	18	\$1301	\$1405	\$540	N/A
Z66S20OSL	16 x 66 x 20-20.5	125	123	16.50	\$1230	\$1324	\$528	N/A
Z60S20OSL	16 x 60 x 20-20.5	125	114	15	\$1137	\$1224	\$484	N/A
Z54S20OSL	16 x 54 x 20-20.5	125	105	13.75	\$1074	\$1157	\$471	N/A

2 doors on **left** cavity. Includes steel hanging rail for wall mount applications. Includes one fixed shelf. Doors lock.
 • **NOTE:** Care should be taken to mount the units. Units should be mounted to wall studs using correct fasteners. Failure to do so may result in collapse of the unit and subsequent personal injury. **Fastening hardware not included.** Mounting hardware used should be based on wall material. Consult an installation professional for proper wall mounting.

Z72S20OSR	16 x 72 x 20-20.5	125	132	18	\$1301	\$1405	\$540	N/A
Z66S20OSR	16 x 66 x 20-20.5	125	123	16.50	\$1230	\$1324	\$528	N/A
Z60S20OSR	16 x 60 x 20-20.5	125	114	15	\$1137	\$1224	\$484	N/A
Z54S20OSR	16 x 54 x 20-20.5	125	105	13.75	\$1074	\$1157	\$471	N/A

2 doors on **right** cavity. Includes steel hanging rail for wall mount applications. Includes one fixed shelf. Doors lock.
 • **NOTE:** Care should be taken to mount the units. Units should be mounted to wall studs using correct fasteners. Failure to do so may result in collapse of the unit and subsequent personal injury. **Fastening hardware not included.** Mounting hardware used should be based on wall material. Consult an installation professional for proper wall mounting.

Z72S20OSD	16 x 72 x 20-20.5	100	145	18	\$3291	\$3395	N/A	N/A
Z66S20OSD	16 x 66 x 20-20.5	100	135	16	\$3064	\$3158	N/A	N/A
Z60S20OSD	16 x 60 x 20-20.5	100	125	15	\$2826	\$2913	N/A	N/A
Z54S20OSD	16 x 54 x 20-20.5	100	115	13.75	\$2704	\$2787	N/A	N/A
Z48S20OSD	16 x 48 x 20-20.5	100	104	12.50	\$2391	\$2474	N/A	N/A
Z42S20OSD	16 x 42 x 20-20.5	100	93	10.50	\$2136	\$2215	N/A	N/A
Z36S20OSD	16 x 36 x 20-20.5	100	83	9	\$1888	\$1959	N/A	N/A
Z30S20OSD	16 x 30 x 20-20.5	100	75	7.60	\$1691	\$1749	N/A	N/A
Z24S20OSD	16 x 24 x 20-20.5	100	63	6.40	\$1566	\$1620	N/A	N/A

Includes steel hanging rail for wall mount applications. Sliding glass doors do not lock. Shipped easy to assemble in 2 cartons. Glass doors shipped separately. Finger pull is silver.
 • **NOTE:** Care should be taken to mount the units. Units should be mounted to wall studs using correct fasteners. Failure to do so may result in collapse of the unit and subsequent personal injury. **Fastening hardware not included.** Mounting hardware used should be based on wall material. Consult an installation professional for proper wall mounting.

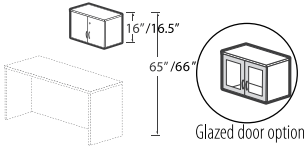
Required Specifications

Top finish
 Base finish
 Top/Edge Detail
 Handles

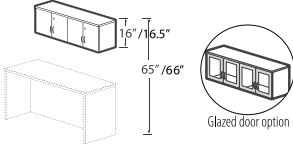
Optional Specifications

Glazed doors*
 Key #*

CLOSED FRONT OVERHEAD STORAGE - 16" H



Closed Front Overhead Storage* with Doors - 16"/16.5"H*



Closed Front Overhead Storage* with Doors - 16"/16.5" High, 60" Wide

MODEL#	DIMENSIONS D x W x H	FREIGHT CLASS	WT/LBS.	CUBIC FT.	1" TOP	1.5" TOP	GLAZE ADD	HP ADD
Z48S160S	15 x 48 x 16-16.5	92.5	98.63	9.25	\$813	\$884	\$761	N/A
Z42S160S	15 x 42 x 16-16.5	92.5	87.42	7.75	\$705	\$767	\$737	N/A
Z36S160S	15 x 36 x 16-16.5	92.5	77.22	6.75	\$643	\$699	\$665	N/A
Z30S160S	15 x 30 x 16-16.5	92.5	64.02	5.75	\$587	\$634	\$584	N/A

Standard with pre-mounted "J" bracket for wall mount applications. Doors lock.

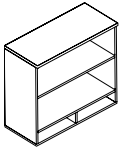
• **NOTE:** Care should be taken to mount the units. Units should be mounted to wall studs using correct fasteners. Failure to do so may result in collapse of the unit and subsequent personal injury. **Fastening hardware not included.** Mounting hardware used should be based on wall material. Consult an installation professional for proper wall mounting.

Z60S160S	15 x 60 x 16-16.5	92.5	118.03	11	\$1068	\$1153	\$1159	N/A
----------	-------------------	------	--------	----	--------	--------	--------	-----

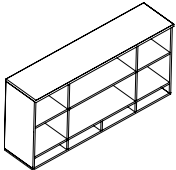
Standard with pre-mounted "J" bracket for wall mount applications. Doors lock.

• **NOTE:** Care should be taken to mount the units. Units should be mounted to wall studs using correct fasteners. Failure to do so may result in collapse of the unit and subsequent personal injury. **Fastening hardware not included.** Mounting hardware used should be based on wall material. Consult an installation professional for proper wall mounting.

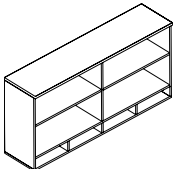
OVERHEAD STORAGE W/OPEN FRONTS - 33"



Open Front Overhead Storage w/Pigeon Hole - 32.5"/33"H



Open Front Overhead Storage w/Pigeon Hole - 32.5"/33"H



Open Front Overhead Storage w/Pigeon Hole - 32.5"/33"H

MODEL#	DIMENSIONS	FREIGHT CLASS	WT/LBS.	CUBIC FT.	1" TOP	1.5" TOP	GLAZE ADD	HP ADD
Z42S330PN	16 x 42 x 32.5-33	125	116	16.25	\$1117	\$1196	N/A	N/A
Z36S330PN	16 x 36 x 32.5-33	125	101	14	\$951	\$1022	N/A	N/A
Z30S330PN	16 x 30 x 32.5-33	125	88	12	\$854	\$912	N/A	N/A
Z24S330PN	16 x 24 x 32.5-33	125	74	9.75	\$762	\$816	N/A	N/A

Includes steel hanging rail for wall mount applications. Includes one fixed shelf.

• **NOTE:** Care should be taken to mount the units. Units should be mounted to wall studs using correct fasteners. Failure to do so may result in collapse of the unit and subsequent personal injury. **Fastening hardware not included.** Mounting hardware used should be based on wall material. Consult an installation professional for proper wall mounting.

Z72S330N	16 x 72 x 32.5-33	125	194	26	\$1846	\$1940	N/A	N/A
Z66S330N	16 x 66 x 32.5-33	125	181	24	\$1734	\$1821	N/A	N/A
Z60S330N	16 x 60 x 32.5-33	125	169	22	\$1608	\$1691	N/A	N/A
Z54S330N	16 x 54 x 32.5-33	125	157	21	\$1507	\$1590	N/A	N/A

6 compartments. Includes steel hanging rail for wall mount applications. Includes one fixed shelf.

• **NOTE:** Care should be taken to mount the units. Units should be mounted to wall studs using correct fasteners. Failure to do so may result in collapse of the unit and subsequent personal injury. **Fastening hardware not included.** Mounting hardware used should be based on wall material. Consult an installation professional for proper wall mounting.

Z72S330SN	16 x 72 x 32.5-33	125	187	26	\$1739	\$1833	N/A	N/A
Z66S330SN	16 x 66 x 32.5-33	125	174	24	\$1651	\$1738	N/A	N/A
Z60S330SN	16 x 60 x 32.5-33	125	162	22	\$1542	\$1625	N/A	N/A
Z54S330SN	16 x 54 x 32.5-33	125	149	21	\$1441	\$1524	N/A	N/A

4 compartments. Includes steel hanging rail for wall mount applications. Includes one fixed shelf.

• **NOTE:** Care should be taken to mount the units. Units should be mounted to wall studs using correct fasteners. Failure to do so may result in collapse of the unit and subsequent personal injury. **Fastening hardware not included.** Mounting hardware used should be based on wall material. Consult an installation professional for proper wall mounting.

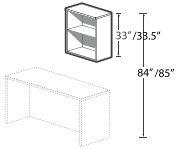
Required Specifications

- Top finish
- Base finish
- Top/Edge Detail
- Handles

Optional Specifications

- Glazed doors*
- Key #*

OVERHEAD STORAGE W/OPEN FRONTS - 33"



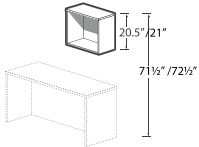
Open Front Overhead Storage
33"/33.5"H

MODEL#	DIMENSIONS	FREIGHT CLASS	WT/LBS.	CUBIC FT.	1"TOP	1.5" TOP	GLAZE ADD	HP ADD
D x W x H								
Z42S33OSN	16 x 42 x 32.5-33	125	108.98	16.25	\$772	\$848	N/A	N/A
Z36S33OSN	16 x 36 x 32.5-33	125	96.70	14	\$700	\$767	N/A	N/A
Z30S33OSN	16 x 30 x 32.5-33	125	84.42	11.75	\$627	\$670	N/A	N/A
Z24S33OSN	16 x 24 x 32.5-33	125	67.20	9.75	\$578	\$625	N/A	N/A

Includes steel hanging rail for wall mount applications. Includes one fixed shelf.

- **NOTE:** Care should be taken to mount the units. Units should be mounted to wall studs using correct fasteners. Failure to do so may result in collapse of the unit and subsequent personal injury. **Fastening hardware not included.** Mounting hardware used should be based on wall material. Consult an installation professional for proper wall mounting.

OVERHEAD STORAGE W/OPEN FRONTS - 33"

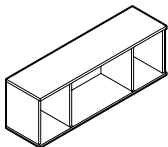


Open Front Overhead Storage
20"/20.5" High

MODEL#	DIMENSIONS	FREIGHT CLASS	WT/LBS.	CUBIC FT.	1"TOP	1.5" TOP	GLAZE ADD	HP ADD
Z42S20OSN	16 x 42 x 20-20.5	125	77.98	10.50	\$539	\$615	N/A	N/A
Z36S20OSN	16 x 36 x 20-20.5	125	69.70	9	\$489	\$556	N/A	N/A
Z30S20OSN	16 x 30 x 20-20.5	100	60.42	7.50	\$439	\$482	N/A	N/A
Z24S20OSN	16 x 24 x 20-20.5	125	48.13	6.25	\$397	\$444	N/A	N/A

Includes steel hanging rail for wall mount applications.

- **NOTE:** Care should be taken to mount the units. Units should be mounted to wall studs using correct fasteners. Failure to do so may result in collapse of the unit and subsequent personal injury. **Fastening hardware not included.** Mounting hardware used should be based on wall material. Consult an installation professional for proper wall mounting.

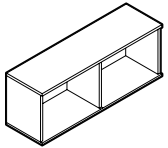


Open Front Overhead Storage
20/20.5"H

Z72S200N	16 x 72 x 20-20.5	125	122	18	\$1083	\$1187	N/A	N/A
Z66S200N	16 x 66 x 20-20.5	125	114	16.50	\$1015	\$1109	N/A	N/A
Z60S200N	16 x 60 x 20-20.5	125	106	15	\$945	\$1032	N/A	N/A
Z54S200N	16 x 54 x 20-20.5	125	99	13.75	\$883	\$966	N/A	N/A

4 compartments. Includes steel hanging rail for wall mount applications.

- **NOTE:** Care should be taken to mount the units. Units should be mounted to wall studs using correct fasteners. Failure to do so may result in collapse of the unit and subsequent personal injury. **Fastening hardware not included.** Mounting hardware used should be based on wall material. Consult an installation professional for proper wall mounting.



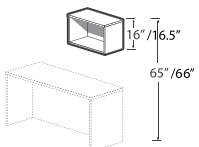
Open Front Overhead Storage
w/Center Divider - 20"/20.5"H

Z72S20OSN	16 x 72 x 20-20.5	125	117	18	\$1046	\$1150	N/A	N/A
Z66S20OSN	16 x 66 x 20-20.5	125	109	16.50	\$976	\$1070	N/A	N/A
Z60S20OSN	16 x 60 x 20-20.5	125	101	15	\$906	\$993	N/A	N/A
Z54S20OSN	16 x 54 x 20-20.5	125	94	13.75	\$843	\$926	N/A	N/A

Standard with pre-mounted "J" bracket for wall mount applications.

- **NOTE:** Care should be taken to mount the units. Units should be mounted to wall studs using correct fasteners. Failure to do so may result in collapse of the unit and subsequent personal injury. **Fastening hardware not included.** Mounting hardware used should be based on wall material. Consult an installation professional for proper wall mounting.

OVERHEAD STORAGE W/OPEN FRONTS - 16"



Open Front Overhead Storage
16"/16.5"H

MODEL#	DIMENSIONS	FREIGHT CLASS	WT/LBS.	CUBIC FT.	1"TOP	1.5" TOP	GLAZE ADD	HP ADD
Z48S16OSN	15 x 48 x 16-16.5	100	79.63	9.25	\$539	\$610	N/A	N/A
Z42S16OSN	15 x 42 x 16-16.5	100	70.42	7.75	\$470	\$533	N/A	N/A
Z36S16OSN	15 x 36 x 16-16.5	100	63.22	6.75	\$432	\$488	N/A	N/A
Z30S16OSN	15 x 30 x 16-16.5	100	54.02	5.75	\$395	\$441	N/A	N/A

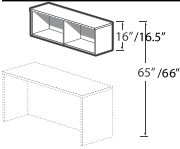
Standard with pre-mounted "J" bracket for wall mount applications.

- **NOTE:** Care should be taken to mount the units. Units should be mounted to wall studs using correct fasteners. Failure to do so may result in collapse of the unit and subsequent personal injury. **Fastening hardware not included.** Mounting hardware used should be based on wall material. Consult an installation professional for proper wall mounting.

Required Specifications

- Top finish
- Base finish
- Top/Edge Detail

OVERHEAD STORAGE W/OPEN FRONTS - 16"H



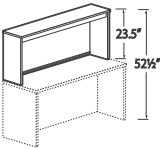
Open Front Overhead Storage
16"/16.5" High, 60" Wide

MODEL#	DIMENSIONS D x W x H	FREIGHT CLASS	WT/LBS.	CUBIC FT.	1"TOP	1.5" TOP	GLAZE ADD	HP ADD
Z60S160SN	15 x 60 x 16-16.5	100	98.03	11	\$665	\$750	N/A	N/A

Standard with pre-mounted "J" bracket for wall mount applications.

- **NOTE:** Care should be taken to mount the units. Units should be mounted to wall studs using correct fasteners. Failure to do so may result in collapse of the unit and subsequent personal injury. **Fastening hardware not included.** Mounting hardware used should be based on wall material. Consult an installation professional for proper wall mounting.

OPEN HUTCHES

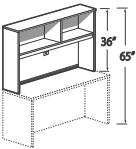


Open Hutch w/Closed Back - 23.5"H

MODEL#	DIMENSIONS	FREIGHT CLASS	WT/LBS.	CUBIC FT.	1"TOP	1.5" TOP	GLAZE ADD	HP ADD
Z84S23HN	15 x 84 x 23-23.5	150	129	23	\$974	\$1091	N/A	N/A
Z72S23HN	15 x 72 x 23-23.5	150	114	19.75	\$854	\$968	N/A	N/A
Z71S23HN	15 x 71.7 x 23-23.5	150	113	19.75	\$854	\$956	N/A	N/A
Z66S23HN	15 x 66 x 23-23.5	150	106	18.25	\$785	\$876	N/A	N/A
Z60S23HN	15 x 60 x 23-23.5	125	99	16.50	\$693	\$779	N/A	N/A
Z48S23HN	15 x 48 x 23-23.5	125	84	13.50	\$600	\$671	N/A	N/A
Z42S23HN	15 x 42 x 23-23.5	125	76	11.75	\$558	\$620	N/A	N/A
Z36S23HN	15 x 36 x 23-23.5	125	68	10.25	\$515	\$572	N/A	N/A
Z30S23HN	15 x 30 x 23-23.5	125	61	8.50	\$477	\$531	N/A	N/A

Closed back features one grommet and flexible sweep for wire management. All hutches shipped pre-assembled.

- Clearance from worksurface to valance is 20.25".
- Woodgrain runs horizontal on both the upper and lower back panels.

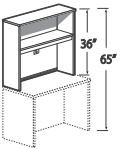


Open Hutch w/Closed Back - 36"H

Z84S36HN	15 x 84 x 35.5-36	125	206	33	\$1263	\$1380	N/A	N/A
Z72S36HN	15 x 72 x 35.5-36	125	181	28.25	\$1156	\$1258	N/A	N/A
Z71S36HN	15 x 71.7 x 35.5-36	125	173	28.25	\$1145	\$1249	N/A	N/A
Z66S36HN	15 x 66 x 35.5-36	125	161	26	\$1082	\$1176	N/A	N/A
Z60S36HN	15 x 60 x 35.5-36	125	150	23.75	\$1014	\$1099	N/A	N/A
Z54S36HN	15 x 54 x 35.5-36	125	128	21	\$1014	\$1099	N/A	N/A

One fixed shelf **and fixed shelf divider**. Closed back features one grommet and flexible sweep for wire management. All hutches shipped pre-assembled.

- Clearance from worksurface to valance is 17.75".
- Woodgrain runs horizontal on both the upper and lower back panels.

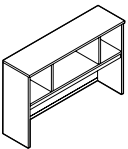


Open Hutch w/Closed Back - 36"H

Z48S36HN	15 x 48 x 35.5-36	125	123	19	\$836	\$907	N/A	N/A
Z42S36HN	15 x 42 x 35.5-36	125	112	16.75	\$773	\$835	N/A	N/A
Z36S36HN	15 x 36 x 35.5-36	125	100	14.50	\$709	\$765	N/A	N/A
Z30S36HN	15 x 30 x 35.5-36	125	89	12.25	\$646	\$692	N/A	N/A

One fixed shelf. Closed back features one grommet and flexible sweep for wire management. All hutches shipped pre-assembled.

- Clearance from worksurface to valance is 17.75".
- Woodgrain runs horizontal on both the upper and lower back panels.



Open Hutch w/Closed Back - 36"H

Z72S360HN	15 x 72 x 35.5-36	150	162	27.75	\$1332	\$1439	N/A	N/A
Z66S360HN	15 x 66 x 35.5-36	150	152	25.50	\$1264	\$1364	N/A	N/A
Z60S360HN	15 x 60 x 35.5-36	125	142	23.25	\$1188	\$1277	N/A	N/A
Z54S360HN	15 x 54 x 35.5-36	125	133	21	\$1113	\$1196	N/A	N/A

Four compartments. Closed back features one grommet and flexible sweep for wire management. All hutches shipped pre-assembled.

- Clearance from worksurface to valance is 17.75".
- Woodgrain runs horizontal on both the upper and lower back panels.

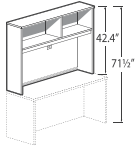
Required Specifications

- Top finish
- Base finish
- Top/Edge Detail

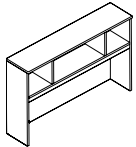
Accessories

- Tackboard
- Pigeon-hole storage

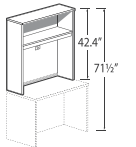
OPEN HUTCHES



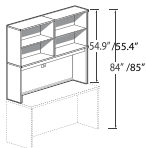
Open Hutch w/Closed Back - 42.4"H



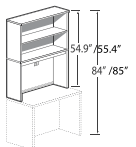
Open Hutch w/Closed Back - 42.4"H



Open Hutch w/Closed Back - 42.4"H



Open Hutch w/Closed Back
54.9"/55.4"H



Open Hutch w/Closed Back
54.9"/55.4"H

MODEL#	DIMENSIONS D x W x H	FREIGHT CLASS	WT/LBS.	CUBIC FT.	1" TOP	1.5" TOP	GLAZE ADD	HP ADD
Z84S42HN	15 x 84 x 41.9-42.4	150	223	38.50	\$1346	\$1463	N/A	N/A
Z72S42HN	15 x 72 x 41.9-42.4	150	196	33	\$1246	\$1348	N/A	N/A
Z71S42HN	15 x 71.7 x 41.9-42.4	150	188	33	\$1239	\$1341	N/A	N/A
Z66S42HN	15 x 66 x 41.9-42.4	150	175	30.75	\$1166	\$1257	N/A	N/A
Z60S42HN	15 x 60 x 41.9-42.4	150	164	27.75	\$1091	\$1176	N/A	N/A
Z54S42HN	15 x 54 x 41.9-42.4	150	140	24.50	\$1091	\$1176	N/A	N/A

One fixed shelf **and fixed shelf divider**. Closed back features one grommet and flexible sweep for wire management. All hutches shipped pre-assembled.

- Clearance from worksurface to valance is 24.25".
- Woodgrain runs horizontal on both the upper and lower back panels.

Z72S42OHN	15 x 72 x 41.9-42.4	150	177	32.50	\$1487	\$1585	N/A	N/A
Z66S42OHN	15 x 66 x 41.9-42.4	150	166	29.75	\$1363	\$1452	N/A	N/A
Z60S42OHN	15 x 60 x 41.9-42.4	150	155	27.25	\$1281	\$1364	N/A	N/A
Z54S42OHN	15 x 54 x 41.9-42.4	150	145	24.50	\$1201	\$1273	N/A	N/A

Four compartments. Closed back features one grommet and flexible sweep for wire management. All hutches shipped pre-assembled.

- Clearance from worksurface to valance is 24.25".
- Woodgrain runs horizontal on both the upper and lower back panels.

Z48S42HN	15 x 48 x 41.9-42.4	125	134	22.25	\$906	\$977	N/A	N/A
Z42S42HN	15 x 42 x 41.9-42.4	125	123	19.50	\$836	\$899	N/A	N/A
Z36S42HN	15 x 36 x 41.9-42.4	125	110	17	\$766	\$822	N/A	N/A
Z30S42HN	15 x 30 x 41.9-42.4	125	105	14.25	\$694	\$741	N/A	N/A

One fixed shelf. Closed back features one grommet and flexible sweep for wire management. All hutches shipped pre-assembled.

- Clearance from worksurface to valance is 24.25".
- Woodgrain runs horizontal on both the upper and lower back panels.

Z84S55HN	15 x 84 x 54.4-54.9	150	306	62.37	\$2208	\$2328	N/A	N/A
Z72S55HN	15 x 72 x 54.4-54.9	150	272	53.65	\$2060	\$2166	N/A	N/A
Z71S55HN	15 x 71.7 x 54.4-54.9	150	271	53.65	\$2049	\$2156	N/A	N/A
Z66S55HN	15 x 66 x 54.4-54.9	150	254	49.40	\$1980	\$2085	N/A	N/A
Z60S55HN	15 x 60 x 54.4-54.9	150	238	45.15	\$1772	\$1860	N/A	N/A
Z54S55HN	15 x 54 x 54.4-54.9	100	190	19.75	\$2278	\$2366	N/A	N/A

One fixed shelf and one adjustable shelf (per compartment). Closed back features one grommet and flexible sweep for wire management. Top portion ships pre-assembled. Lower portion ships RTA.

- Clearance from worksurface to valance is 24.25".
- Woodgrain runs horizontal on both the upper and lower back panels.

Z48S55HN	15 x 48 x 54.4-54.9	150	183	36	\$1334	\$1405	N/A	N/A
Z42S55HN	15 x 42 x 54.4-54.9	150	168	31.50	\$1233	\$1296	N/A	N/A
Z36S55HN	15 x 36 x 54.4-54.9	150	149	27.26	\$1124	\$1180	N/A	N/A
Z30S55HN	15 x 30 x 54.4-54.9	150	132	23	\$1020	\$1069	N/A	N/A

One fixed shelf and one adjustable shelf. Closed back features one grommet and flexible sweep for wire management. Shipped RTA (ready to assemble).

- Clearance from worksurface to valance is 24.25".
- Woodgrain runs horizontal on both the upper and lower back panels.

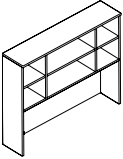
Required Specifications

Top finish
Base finish
Top/Edge Detail

Accessories

Tackboard
Pigeon-hole storage

OPEN HUTCHES



Open Hutch w/Closed Back
54.9"/55.4"H

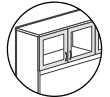
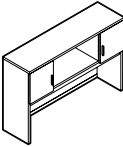
MODEL#	DIMENSIONS D x W x H	FREIGHT CLASS	WT/LBS.	CUBIC FT.	1"TOP	1.5" TOP	GLAZE ADD	HP ADD
Z72S550HN	15 x 72 x 54.4-54.9	100	242	26	\$2191	\$2295	N/A	N/A
Z66S550HN	15 x 66 x 54.4-54.9	100	228	24	\$2064	\$2158	N/A	N/A
Z60S550HN	15 x 60 x 54.4-54.9	100	214	22	\$1943	\$2029	N/A	N/A
Z54S550HN	15 x 54 x 54.4-54.9	92.5	199	19.76	\$1824	\$1903	N/A	N/A

Four compartments. Closed back features one grommet and flexible sweep for wire management.

Top portion ships pre-assembled. Lower portion ships RTA.

- Clearance from worksurface to valance is 24.25".
- Woodgrain runs horizontal on both the upper and lower back panels.

CLOSED HUTCHES



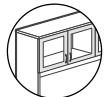
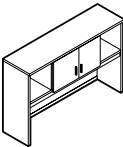
Glazed door option

Hutch w/2 Outer Doors - 36"H*

MODEL#	DIMENSIONS	FREIGHT CLASS	WT/LBS.	CUBIC FT.	1"TOP	1.5" TOP	GLAZE ADD	HP ADD
Z72S36HOH	15 x 72 x 35.5-36	125	172	27.75	\$1561	\$1668	\$471	N/A
Z66S36HOH	15 x 66 x 35.5-36	125	161	25.50	\$1492	\$1592	\$458	N/A
Z60S36HOH	15 x 60 x 35.5-36	125	151	23.25	\$1397	\$1488	\$423	N/A
Z54S36HOH	15 x 54 x 35.5-36	125	140	21	\$1320	\$1403	\$410	N/A

4 compartments. **Doors on outer compartments only.** Closed back features one grommet and flexible sweep for wire management. Doors lock. All hutches shipped pre-assembled.

- Clearance from worksurface to valance is 17.75".
- Woodgrain runs horizontal on both the upper and lower back panels.



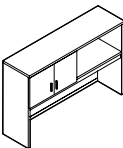
Glazed door option

Hutch w/2 Inner Doors - 36"H*

Z72S36OHO	15 x 72 x 35.5-36	125	173	27.75	\$1559	\$1672	\$476	N/A
Z66S36OHO	15 x 66 x 35.5-36	125	162	25.50	\$1494	\$1594	\$464	N/A
Z60S36OHO	15 x 60 x 35.5-36	125	151	23.25	\$1416	\$1505	\$447	N/A
Z54S36OHO	15 x 54 x 35.5-36	125	141	21	\$1323	\$1406	\$415	N/A

4 compartments. **Doors on inner compartments only.** Closed back features one grommet and flexible sweep for wire management. Doors lock. All hutches shipped pre-assembled.

- Clearance from worksurface to valance is 17.75".
- Woodgrain runs horizontal on both the upper and lower back panels.



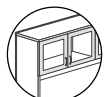
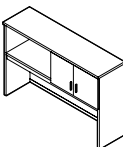
Glazed door option

Hutch w/2 Doors - LEFT, 36"H*

Z72S36HSL	15 x 72 x 35.5-36	125	169	27.75	\$1529	\$1635	\$470	N/A
Z66S36HSL	15 x 66 x 35.5-36	125	157	25.50	\$1456	\$1556	\$454	N/A
Z60S36HSL	15 x 60 x 35.5-36	125	146	23.25	\$1363	\$1454	\$424	N/A
Z54S36HSL	15 x 54 x 35.5-36	125	135	21	\$1286	\$1370	\$411	N/A

4 compartments. Doors on **left** side, open storage on **right**. Closed back features one grommet and flexible sweep for wire management. Doors lock. All hutches shipped pre-assembled.

- Clearance from worksurface to valance is 17.75".
- Woodgrain runs horizontal on both the upper and lower back panels.



Glazed door option

Hutch w/2 Doors - RIGHT, 36"H*

Z72S36HSR	15 x 72 x 35.5-36	125	169	27.75	\$1529	\$1635	\$470	N/A
Z66S36HSR	15 x 66 x 35.5-36	125	157	25.50	\$1456	\$1556	\$454	N/A
Z60S36HSR	15 x 60 x 35.5-36	125	146	23.25	\$1363	\$1454	\$424	N/A
Z54S36HSR	15 x 54 x 35.5-36	125	135	21	\$1286	\$1370	\$411	N/A

4 compartments. Doors on **right** side, open storage on **left**. Closed back features one grommet and flexible sweep for wire management. Doors lock. All hutches shipped pre-assembled.

- Clearance from worksurface to valance is 17.75".
- Woodgrain runs horizontal on both the upper and lower back panels.

Required Specifications

Top finish
Base finish
Top/Edge Detail

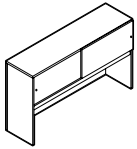
Optional Specifications

Glazing - Doors*

Accessories

Tackboard
Pigeon-hole storage

CLOSED HUTCHES

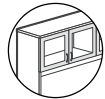
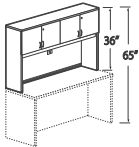


Hutch w/Sliding Glass Doors - 36" H

MODEL#	DIMENSIONS D x W x H	FREIGHT CLASS	WT/LBS.	CUBIC FT.	1" TOP	1.5" TOP	GLAZE ADD	HP ADD
Z72S36HSD	15 x 72 x 35.5-36	125	178	27.75	\$3332	\$3439	N/A	N/A
Z66S36HSD	15 x 66 x 35.5-36	125	166	25.50	\$3110	\$3210	N/A	N/A
Z60S36HSD	15 x 60 x 35.5-36	125	154	23.25	\$2887	\$2978	N/A	N/A
Z54S36HSD	15 x 54 x 35.5-36	125	143	21	\$2669	\$2760	N/A	N/A

Sliding glass doors do not lock. Closed back features one grommet and flexible sweep for wire management. Shipped easy to assemble in 2 cartons. Glass doors shipped separately. Finger pull is silver.

- Clearance from worksurface to valance is 17.75".
- Woodgrain runs horizontal on both the upper and lower back panels.



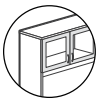
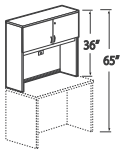
Glazed door option

Closed Hutch with Doors - 36" H*

Z84S36H	15 x 84 x 35.5-36	125	231	33	\$1731	\$1849	\$1386	N/A
Z72S36H	15 x 72 x 35.5-36	125	201	28.25	\$1612	\$1716	\$1266	N/A
Z71S36H	15 x 71.7 x 35.5-36	125	193	28.25	\$1598	\$1702	\$1264	N/A
Z66S36H	15 x 66 x 35.5-36	125	179	26	\$1519	\$1613	\$1205	N/A
Z60S36H	15 x 60 x 35.5-36	125	167	23.75	\$1416	\$1501	\$1132	N/A

One fixed shelf **and fixed shelf divider**. Closed back features one grommet and flexible sweep for wire management. Doors lock. All hutches shipped pre-assembled.

- Clearance from worksurface to valance is 17.75".
- Woodgrain runs horizontal on both the upper and lower back panels.



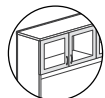
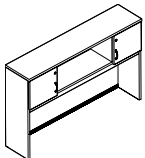
Glazed door option

Closed Hutch with Doors - 36" H*

Z48S36H	15 x 48 x 35.5-36	125	136	19	\$1110	\$1181	\$719	N/A
Z42S36H	15 x 42 x 35.5-36	125	124	16.75	\$1007	\$1070	\$696	N/A
Z36S36H	15 x 36 x 35.5-36	125	110	14.50	\$923	\$979	\$637	N/A
Z30S36H	15 x 30 x 35.5-36	100	98	12.25	\$840	\$887	\$570	N/A

One fixed shelf. Closed back features one grommet and flexible sweep for wire management. Doors lock. All hutches shipped pre-assembled.

- Clearance from worksurface to valance is 17.75".
- Woodgrain runs horizontal on both the upper and lower back panels.



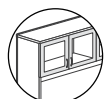
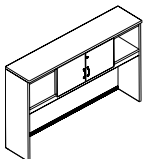
Glazed door option

Hutch w/2 Outer Doors - 42.4" H*

Z72S42HOH	15 x 72 x 41.9-42.4	150	187	32.50	\$1718	\$1816	\$471	N/A
Z66S42HOH	15 x 66 x 41.9-42.4	150	176	29.75	\$1590	\$1679	\$458	N/A
Z60S42HOH	15 x 60 x 41.9-42.4	125	164	27.25	\$1493	\$1576	\$423	N/A
Z54S42HOH	15 x 54 x 41.9-42.4	125	153	24.50	\$1410	\$1483	\$410	N/A

4 compartments. **Doors on outer compartments only**. Closed back features one grommet and flexible sweep for wire management. Doors lock. All hutches shipped pre-assembled.

- Clearance from worksurface to valance is 24.25".
- Woodgrain runs horizontal on both the upper and lower back panels.



Glazed door option

Hutch w/2 Inner Doors - 42.4" H*

Z72S42OHO	15 x 72 x 41.9-42.4	150	188	32.50	\$1721	\$1819	\$476	N/A
Z66S42OHO	15 x 66 x 41.9-42.4	150	176	29.75	\$1592	\$1681	\$464	N/A
Z60S42OHO	15 x 60 x 41.9-42.4	125	165	27.25	\$1510	\$1591	\$447	N/A
Z54S42OHO	15 x 54 x 41.9-42.4	125	153	24.50	\$1414	\$1487	\$415	N/A

4 compartments. **Doors on inner compartments only**. Closed back features one grommet and flexible sweep for wire management. Doors lock. All hutches shipped pre-assembled.

- Clearance from worksurface to valance is 24.25".
- Woodgrain runs horizontal on both the upper and lower back panels.

Required Specifications

Top finish
Base finish
Top/Edge Detail

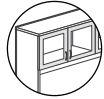
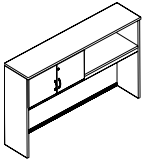
Optional Specifications

Glazing - Doors*

Accessories

Tackboard
Pigeon-hole storage

CLOSED HUTCHES



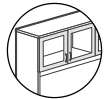
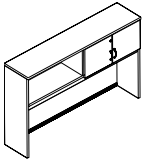
Glazed door option

Hutch w/2 Doors - LEFT, 42.4" H*

MODEL#	DIMENSIONS D x W x H	FREIGHT CLASS	WT/LBS.	CUBIC FT.	1" TOP	1.5" TOP	GLAZE ADD	HP ADD
Z72S42HSL	15 x 72 x 41.9-42.4	150	184	32.50	\$1683	\$1781	\$470	N/A
Z66S42HSL	15 x 66 x 41.9-42.4	150	171	29.75	\$1554	\$1645	\$454	N/A
Z60S42HSL	15 x 60 x 41.9-42.4	150	159	27.25	\$1457	\$1538	\$424	N/A
Z54S42HSL	15 x 54 x 41.9-42.4	125	148	24.50	\$1373	\$1446	\$411	N/A

4 compartments. Doors on **left** side, open storage on **right**. Closed back features one grommet and flexible sweep for wire management. Doors lock. All hutches shipped pre-assembled.

- Clearance from worksurface to valance is 24.25".
- Woodgrain runs horizontal on both the upper and lower back panels.



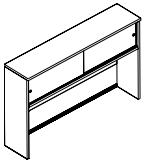
Glazed door option

Hutch w/2 Doors - RIGHT, 42.4" H*

Z72S42HSR	15 x 72 x 41.9-42.4	150	184	32.50	\$1683	\$1781	\$470	N/A
Z66S42HSR	15 x 66 x 41.9-42.4	150	171	29.75	\$1554	\$1645	\$454	N/A
Z60S42HSR	15 x 60 x 41.9-42.4	150	159	27.25	\$1457	\$1538	\$424	N/A
Z54S42HSR	15 x 54 x 41.9-42.4	125	148	24.50	\$1373	\$1446	\$411	N/A

4 compartments. Doors on **right** side, open storage on **left**. Closed back features one grommet and flexible sweep for wire management. Doors lock. All hutches shipped pre-assembled.

- Clearance from worksurface to valance is 24.25".
- Woodgrain runs horizontal on both the upper and lower back panels.

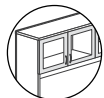
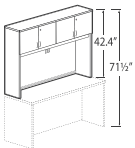


Hutch w/Sliding Glass Doors - 42.4" H

Z72S42HSD	15 x 72 x 41.9-42.4	150	193	32.50	\$3480	\$3578	N/A	N/A
Z66S42HSD	15 x 66 x 41.9-42.4	125	180	29.75	\$3208	\$3297	N/A	N/A
Z60S42HSD	15 x 60 x 41.9-42.4	125	168	27.25	\$2979	\$3062	N/A	N/A
Z54S42HSD	15 x 54 x 41.9-42.4	125	156	24.50	\$2759	\$2831	N/A	N/A

Sliding glass doors do not lock. Closed back features one grommet and flexible sweep for wire management. Shipped easy to assemble in 2 cartons. Glass doors shipped separately. Finger pull is silver.

- Clearance from worksurface to valance is 24.25".
- Woodgrain runs horizontal on both the upper and lower back panels.



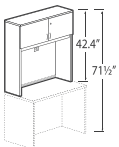
Glazed door option

Closed Hutch with Doors - 42.4" High

Z84S42H	15 x 84 x 41.9-42.4	125	247	38.50	\$1923	\$2041	\$1386	N/A
Z72S42H	15 x 72 x 41.9-42.4	125	217	33	\$1706	\$1808	\$1266	N/A
Z71S42H	15 x 71.7 x 41.9-42.4	125	207	33	\$1694	\$1796	\$1264	N/A
Z66S42H	15 x 66 x 41.9-42.4	125	194	30.75	\$1600	\$1694	\$1205	N/A
Z60S42H	15 x 60 x 41.9-42.4	125	180	27.75	\$1494	\$1579	\$1132	N/A

One fixed shelf **and fixed shelf divider**. Closed back features one grommet and flexible sweep for wire management. Doors lock. All hutches shipped pre-assembled.

- Clearance from worksurface to valance is 24.25".
- Woodgrain runs horizontal on both the upper and lower back panels.



Glazed door option

Closed Hutch with Doors - 42.4" High

Z48S42H	15 x 48 x 41.9-42.4	125	148	22.25	\$1180	\$1251	\$719	N/A
Z42S42H	15 x 42 x 41.9-42.4	125	134	19.50	\$1069	\$1132	\$696	N/A
Z36S42H	15 x 36 x 41.9-42.4	125	120	17	\$978	\$1035	\$637	N/A
Z30S42H	15 x 30 x 41.9-42.4	125	106	14.25	\$899	\$945	\$570	N/A

One fixed shelf. Closed back features one grommet and flexible sweep for wire management. Doors lock. All hutches shipped pre-assembled.

- Clearance from worksurface to valance is 24.25".
- Woodgrain runs horizontal on both the upper and lower back panels.

Required Specifications

Top finish
Base finish
Top/Edge Detail

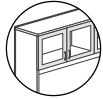
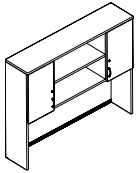
Optional Specifications

Glazing - Doors*

Accessories

Tackboard
Pigeon-hole storage

CLOSED HUTCHES



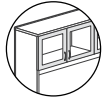
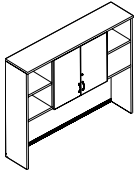
Glazed door option

Hutch w/2 Outer Doors - 55"H*

MODEL#	DIMENSIONS	FREIGHT CLASS	WT/LBS.	CUBIC FT.	1"TOP	1.5" TOP	GLAZE ADD	HP ADD
D x W x H								
Z72S55HOH	15 x 72 x 54.4-54.9	92.5	262	26	\$2502	\$2604	\$674	N/A
Z66S55HOH	15 x 66 x 54.4-54.9	92.5	246	24	\$2372	\$2466	\$661	N/A
Z60S55HOH	15 x 60 x 54.4-54.9	92.5	229	22	\$2217	\$2373	\$600	N/A
Z54S55HOH	15 x 54 x 54.4-54.9	92.5	213	19.76	\$2095	\$2240	\$588	N/A

4 compartments. **Doors on outer compartments only.** Closed back features one grommet and flexible sweep for wire management. Doors lock. Top portion ships pre-assembled. Lower portion ships RTA.

- Clearance from worksurface to valance is 24.25".
- Woodgrain runs horizontal on both the upper and lower back panels.



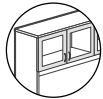
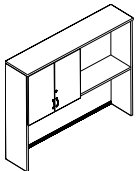
Glazed door option

Hutch w/2 Inner Doors - 55"H*

Z72S55OHO	15 x 72 x 54.4-54.9	92.5	263	26	\$2504	\$2608	\$677	N/A
Z66S55OHO	15 x 66 x 54.4-54.9	92.5	247	24	\$2375	\$2469	\$665	N/A
Z60S55OHO	15 x 60 x 54.4-54.9	92.5	230	22	\$2251	\$2337	\$603	N/A
Z54S55OHO	15 x 54 x 54.4-54.9	92.5	214	19.76	\$2097	\$2176	\$590	N/A

4 compartments. **Doors on inner compartments only.** Closed back features one grommet and flexible sweep for wire management. Doors lock. Top portion ships pre-assembled. Lower portion ships RTA.

- Clearance from worksurface to valance is 24.25".
- Woodgrain runs horizontal on both the upper and lower back panels.



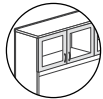
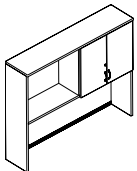
Glazed door option

Hutch w/2 Doors - LEFT, 55"H*

Z72S55HSL	15 x 72 x 54.4-54.9	100	258	26	\$2416	\$2520	\$651	N/A
Z66S55HSL	15 x 66 x 54.4-54.9	100	237	24	\$2307	\$2401	\$639	N/A
Z60S55HSL	15 x 60 x 54.4-54.9	92.5	221	22	\$2141	\$2228	\$600	N/A
Z54S55HSL	15 x 54 x 54.4-54.9	92.5	204	19.76	\$2031	\$2111	\$588	N/A

4 compartments. Doors on **left** side, open storage on **right**. Closed back features one grommet and flexible sweep for wire management. Doors lock. Top portion ships pre-assembled. Lower portion ships RTA.

- Clearance from worksurface to valance is 24.25".
- Woodgrain runs horizontal on both the upper and lower back panels.



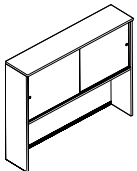
Glazed door option

Hutch w/2 Doors - RIGHT, 55"H*

Z72S55HSR	15 x 72 x 54.4-54.9	100	258	26	\$2416	\$2520	\$651	N/A
Z66S55HSR	15 x 66 x 54.4-54.9	100	237	24	\$2307	\$2401	\$639	N/A
Z60S55HSR	15 x 60 x 54.4-54.9	92.5	221	22	\$2141	\$2228	\$600	N/A
Z54S55HSR	15 x 54 x 54.4-54.9	92.5	204	19.76	\$2031	\$2111	\$588	N/A

4 compartments. Doors on **right** side, open storage on **left**. Closed back features one grommet and flexible sweep for wire management. Doors lock. Top portion ships pre-assembled. Lower portion ships RTA.

- Clearance from worksurface to valance is 24.25".
- Woodgrain runs horizontal on both the upper and lower back panels.



Hutch w/Sliding Glass Doors - 55"H

Z72S55HSD	15 x 72 x 54.4-54.9	92.5	271	26	\$4729	\$4831	N/A	N/A
Z66S55HSD	15 x 66 x 54.4-54.9	92.5	253	24	\$4421	\$4514	N/A	N/A
Z60S55HSD	15 x 60 x 54.4-54.9	92.5	235	22	\$4092	\$4178	N/A	N/A
Z54S55HSD	15 x 54 x 54.4-54.9	92.5	217	19.75	\$3789	\$3868	N/A	N/A

Sliding glass doors do not lock. Closed back features one grommet and flexible sweep for wire management. Shipped easy to assemble in 3 cartons. Glass doors shipped separately. Finger pull is silver.

- Clearance from worksurface to valance is 24.25".
- Woodgrain runs horizontal on both the upper and lower back panels.

Required Specifications

Top finish
Base finish
Top/Edge Detail

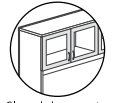
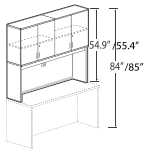
Optional Specifications

Glazing - Doors*

Accessories

Tackboard
Pigeon-hole storage

CLOSED HUTCHES



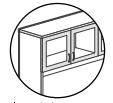
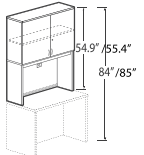
Glazed door option

Closed Hutch w/Doors - 55\"/>

MODEL#	DIMENSIONS	FREIGHT CLASS	WT/LBS.	CUBIC FT.	1\"/>			
Z84S55H	15 x 84 x 54.4-54.9	150	349	62.37	\$2916	\$3036	\$2014	N/A
Z72S55H	15 x 72 x 54.4-54.9	150	308	53.65	\$2628	\$2747	\$1820	N/A
Z71S55H	15 x 71.7 x 54.4-54.9	150	307	53.65	\$2619	\$2726	\$1799	N/A
Z66S55H	15 x 66 x 54.4-54.9	150	287	49.40	\$2478	\$2584	\$1713	N/A
Z60S55H	15 x 60 x 54.4-54.9	150	269	45.15	\$2278	\$2366	\$1593	N/A

One fixed shelf and one adjustable shelf (per compartment). Closed back features one grommet and flexible sweep for wire management. Doors lock. Shipped RTA (ready to assemble).

- Clearance from worksurface to valance is 24.25\"/>



Glazed door option

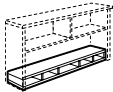
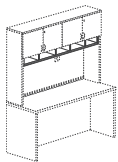
Closed Hutch w/Doors - 55\"/>

Z48S55H	15 x 48 x 54.4-54.9	150	207	36	\$1695	\$1752	\$1112	N/A
Z42S55H	15 x 42 x 54.4-54.9	150	188	31.50	\$1545	\$1608	\$1008	N/A
Z36S55H	15 x 36 x 54.4-54.9	125	167	27.26	\$1408	\$1464	\$912	N/A
Z30S55H	15 x 30 x 54.4-54.9	125	148	23	\$1273	\$1319	\$799	N/A

One fixed shelf and one adjustable shelf. Closed back features one grommet and flexible sweep for wire management. Doors lock. Shipped RTA (ready to assemble).

- Clearance from worksurface to valance is 24.25\"/>

PIGEON-HOLE STORAGE

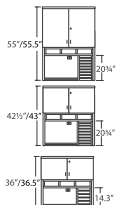
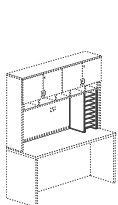


Horizontal Pigeon-Hole Storage

MODEL#	DIMENSIONS	FREIGHT CLASS	WT/LBS.	CUBIC FT.	1\"/>			
ZHS84	12 x 82 x 5.66	70	49	3	\$840	N/A	N/A	N/A
ZHS72	12 x 70 x 5.66	70	49	3	\$756	N/A	N/A	N/A
ZHS71	12 x 69.6 x 5.66	70	49	3	\$756	N/A	N/A	N/A
ZHS66	12 x 63.9 x 5.66	70	46	2.80	\$715	N/A	N/A	N/A
ZHS60	12 x 58 x 5.66	70	42	2.50	\$683	N/A	N/A	N/A
ZHS48	12 x 45.9 x 5.66	70	33	2	\$511	N/A	N/A	N/A
ZHS42	12 x 40 x 5.66	85	29	2	\$479	N/A	N/A	N/A
ZHS36	12 x 33.9 x 5.66	85	26	2	\$450	N/A	N/A	N/A

For additional storage. Can be **top** or **bottom** mounted. For use inside hutch. Shipped RTA (ready to assemble).

- *Cannot be used on overstorage units.*
- Available in all standard laminate finishes (see page 113).



Vertical Pigeon-Hole Storage

ZVS21	11.8 x 13.42 x 20.75	70	30	1.80	\$377	N/A	N/A	N/A
ZVS14	11.8 x 13.42 x 14.3	85	24	1.80	\$307	N/A	N/A	N/A

For use in conjunction with the horizontal pigeon-hole storage. Can be used **under** or **over** horizontal unit. Not freestanding. Shipped RTA (ready to assemble).

Vertical pigeon-hole shell - available in all standard laminate finishes (see page 113).

- Collator shelves - available in Black (**K**) or Brushed Cobalt (**T**) finish. Please specify.
Use Brushed Cobalt to match Silver finish handles.
- When used together with tackboard and hutch, reduce tackboard width by 12.5\"/>

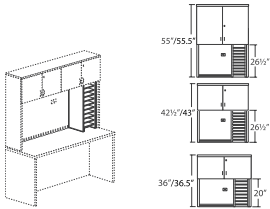
Required Specifications

Top finish Base/door finish*
Wall finish
Top/Edge Detail
Handles*

Optional Specifications

Glazing - Doors*
Grommet position
Key #
End filler cap

PIGEON-HOLE STORAGE

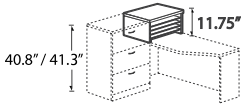


Vertical Pigeon-Hole Storage

MODEL#	DIMENSIONS	FREIGHT CLASS	WT/LBS.	CUBIC FT.	1" TOP	1.5" TOP	GLAZE ADD	HP ADD
D x W x H								
ZVS26	11.8 x 13.42 x 25.4-25.9	70	36	1.80	\$452	N/A	N/A	N/A
ZVS20	11.8 x 13.42 x 19-19.5	70	29	1.80	\$362	N/A	N/A	N/A

- Used alone with a hutch. **Not freestanding.** Shipped easy to assemble in 1 carton.
- Vertical pigeon-hole shell - available in all standard laminate finishes (see page 113).
 - Collator shelves - available in Black (**K**) or Brushed Cobalt (**T**) finish. Please specify.
Use Brushed Cobalt to match Silver finish handles.
 - When used together with tackboard and hutch, reduce tackboard width by 12.5"
 - Removal of valance required.

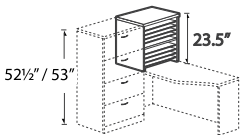
TRANSITIONAL PIGEON-HOLE STORAGE



Transitional Pigeon-Hole Storage
11.75" H

MODEL#	DIMENSIONS	FREIGHT CLASS	WT/LBS.	CUBIC FT.	1" TOP	1.5" TOP	GLAZE ADD	HP ADD
Z24L12PH	24 x 24 x 11.25-11.75	65	63	2.70	\$747	\$823	N/A	N/A
Z20L12PH	24 x 20 x 11.25-11.75	70	56	2.70	\$659	\$725	N/A	N/A
Z16L12PH	24 x 16 x 11.25-11.75	65	46	1.60	\$603	\$660	N/A	N/A
Z24M12PH	20 x 24 x 11.25-11.75	70	55	2.70	\$659	\$725	N/A	N/A
Z20M12PH	20 x 20 x 11.25-11.75	70	48	2.70	\$585	\$639	N/A	N/A
Z16M12PH	20 x 16 x 11.25-11.75	65	40	1.60	\$530	\$576	N/A	N/A
Z24S12PH	16 x 24 x 11.25-11.75	65	43	1.60	\$607	\$663	N/A	N/A
Z20S12PH	16 x 20 x 11.25-11.75	65	38	1.60	\$533	\$578	N/A	N/A
Z16S12PH	16 x 16 x 11.25-11.75	70	33	1.60	\$499	\$537	N/A	N/A

- Designed to fit on top of returns and transition worksurface to match 40.8"/41.3" high storage modules. Pigeon-hole shell and four collator shelves. Shipped RTA (ready to assemble).
- Pigeon-Hole Shell - Available in all standard laminate finishes (page 113).
 - Collator Shelves - Available in Black (**K**) or Brushed Cobalt (**T**) finish. Please Specify.
Use Brushed Cobalt to match silver finish handles.



Transitional Pigeon-Hole Storage
23.5" H

Z24L23PH	24 x 24 x 23-23.5	60	101	2.70	\$1344	\$1420	N/A	N/A
Z20L23PH	24 x 20 x 23-23.5	60	88	2.70	\$1176	\$1239	N/A	N/A
Z16L23PH	24 x 16 x 23-23.5	65	76	2.70	\$1103	\$1160	N/A	N/A
Z24M23PH	20 x 24 x 23-23.5	60	87	2.70	\$1179	\$1242	N/A	N/A
Z20M23PH	20 x 20 x 23-23.5	65	76	2.70	\$1031	\$1085	N/A	N/A
Z16M23PH	20 x 16 x 23-23.5	60	64	1.60	\$948	\$994	N/A	N/A
Z24S23PH	16 x 24 x 23-23.5	65	74	2.70	\$1115	\$1171	N/A	N/A
Z20S23PH	16 x 20 x 23-23.5	65	65	2.70	\$974	\$1020	N/A	N/A
Z16S23PH	16 x 16 x 23-23.5	60	54	1.60	\$890	\$932	N/A	N/A

- Designed to fit on top of returns and transition worksurface to match 52.5"/53" high storage modules. Pigeon-hole shell and eight collator shelves. Shipped RTA (ready to assemble).
- Pigeon-Hole Shell - Available in all standard laminate finishes (page 113).
 - Collator Shelves - Available in Black (**K**) or Brushed Cobalt (**T**) finish. Please Specify.
Use Brushed Cobalt to match silver finish handles.

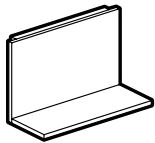
Required Specifications

- Top finish
- Wall finish
- Top/Edge Detail
- Shelf finish

Optional Specifications

- End filler cap
- Grommet

FLOATING SHELVES

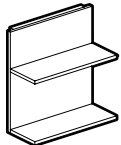


Floating Shelf - 20" H

MODEL#	DIMENSIONS D x W x H	FREIGHT CLASS	WT/LBS.	CUBIC FT.	1" TOP	1.5" TOP	GLAZE ADD	HP ADD
ZFS4220	14.25 x 42 x 20	70	55	2.75	\$610	\$648	N/A	N/A
ZFS3620	14.25 x 36 x 20	70	47	2.40	\$548	\$582	N/A	N/A
ZFS3020	14.25 x 30 x 20	70	39	2	\$466	\$496	N/A	N/A
ZFS2420	14.25 x 24 x 20	70	33	1.90	\$411	\$441	N/A	N/A

To match 71.9/72.4"H units. Standard with pre-mounted "J" bracket for wall mount applications. End cap required at the end of a run of floating shelves. End cap sold separately, see page 227.

• **NOTE:** Care should be taken to mount the units. Units should be mounted to wall studs using correct fasteners. Failure to do so may result in collapse of the unit and subsequent personal injury. **Fastening hardware not included.** Mounting hardware used should be based on wall material. Consult an installation professional for proper wall mounting.



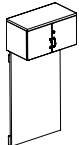
Double Floating Shelf - 32.5" H

ZF2S4232	14.25 x 42 x 32.5	65	85	3.30	\$870	\$908	N/A	N/A
ZF2S3632	14.25 x 36 x 32.5	65	73	2.90	\$779	\$813	N/A	N/A
ZF2S3032	14.25 x 30 x 32.5	65	60	2.50	\$664	\$694	N/A	N/A
ZF2S2432	14.25 x 24 x 32.5	70	50	2.40	\$588	\$618	N/A	N/A

To match 84.4/84.9"H units. Standard with pre-mounted "J" bracket for wall mount applications. End cap required at the end of a run of floating shelves. End cap sold separately, see page 227.

• **NOTE:** Care should be taken to mount the units. Units should be mounted to wall studs using correct fasteners. Failure to do so may result in collapse of the unit and subsequent personal injury. **Fastening hardware not included.** Mounting hardware used should be based on wall material. Consult an installation professional for proper wall mounting.

WALLS W/OVERHEAD STORAGE

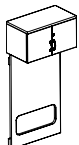


Wall w/Closed Storage - 66" H*

MODEL#	DIMENSIONS	FREIGHT CLASS	WT/LBS.	CUBIC FT.	1" TOP	1.5" TOP	GLAZE ADD	HP ADD
Z4266WS	16 x 42 x 65.5-66	85	122	8.26	\$1465	\$1528	\$515	N/A
Z3666WS	16 x 36 x 65.5-66	85	113	8.80	\$1233	\$1289	\$474	N/A
Z3066WS	16 x 30 x 65.5-66	85	97	7.50	\$1233	\$1269	\$424	N/A
Z2466WS	16 x 24 x 65.5-66	92.5	79	6.60	\$1088	\$1126	\$382	N/A

Standard with pre-mounted "J" bracket for wall mount applications. Doors lock. End cap required at the end of a run of wall units. End cap sold separately, see page 227.

• **NOTE:** Care should be taken to mount the units. Units should be mounted to wall studs using correct fasteners. Failure to do so may result in collapse of the unit and subsequent personal injury. **Mounting hardware not included.** Mounting hardware used should be based on wall material. Consult an installation professional for proper wall mounting.

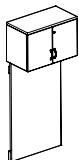


Wall w/Closed Storage - 66" H*

Z4266WSO	16 x 42 x 65.5-66	125	112	18.60	\$1562	\$1625	\$515	N/A
Z3666WSO	16 x 36 x 65.5-66	125	100	16.20	\$1421	\$1477	\$474	N/A
Z3066WSO	16 x 30 x 65.5-66	125	85	13.50	\$1239	\$1290	\$424	N/A
Z2466WSO	16 x 24 x 65.5-66	92.5	70	6.20	\$1099	\$1137	\$382	N/A

Standard with pre-mounted "J" bracket for wall mount applications. Doors lock. Large cutout provides direct access to wall for access to electrical. End cap required at the end of a run of wall units. End cap sold separately, see page 227.

• **NOTE:** Care should be taken to mount the units. Units should be mounted to wall studs using correct fasteners. Failure to do so may result in collapse of the unit and subsequent personal injury. **Mounting hardware not included.** Mounting hardware used should be based on wall material. Consult an installation professional for proper wall mounting.



Wall w/Closed Storage - 72" H*

Z4272WS	16 x 42 x 71.9-72.4	85	134	10.20	\$1562	\$1641	\$590	N/A
Z3672WS	16 x 36 x 71.9-72.4	85	119	9.46	\$1505	\$1575	\$539	N/A
Z3072WS	16 x 30 x 71.9-72.4	85	102	8.10	\$1322	\$1380	\$483	N/A
Z2472WS	16 x 24 x 71.9-72.4	85	84	6.60	\$1159	\$1207	\$439	N/A

Standard with pre-mounted "J" bracket for wall mount applications. Doors lock. End cap required at the end of a run of wall units. End cap sold separately, see page 227.

• **NOTE:** Care should be taken to mount the units. Units should be mounted to wall studs using correct fasteners. Failure to do so may result in collapse of the unit and subsequent personal injury. **Mounting hardware not included.** Mounting hardware used should be based on wall material. Consult an installation professional for proper wall mounting.

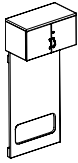
Required Specifications

Top finish Base/door finish*
 Wall finish Handles*
 Top/Edge Detail
 Shelf finish

Optional Specifications

End filler cap
 Key #*
 Grommet position
 Glazed doors*

WALLS W/OVERHEAD STORAGE

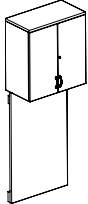


Wall w/Closed Storage - 72"H*

MODEL#	DIMENSIONS	FREIGHT CLASS	WT/LBS.	CUBIC FT.	1" TOP	1.5" TOP	GLAZE ADD	HP ADD	
D x W x H									
Z4272WSO	16 x 42 x 71.9-72.4	85	120	9.30	\$1578	\$1657	\$590	N/A	
Z3672WSO	16 x 36 x 71.9-72.4	85	105	8.66	\$1518	\$1588	\$539	N/A	
Z3072WSO	16 x 30 x 71.9-72.4	85	91	7.50	\$1333	\$1413	\$483	N/A	
Z2472WSO	16 x 24 x 71.9-72.4	92.5	74	6.20	\$1170	\$1218	\$439	N/A	

Standard with pre-mounted "J" bracket for wall mount applications. Doors lock. Large cutout provides direct access to wall for access to electrical. End cap required at the end of a run of wall units. End cap sold separately, see page 227.

• **NOTE:** Care should be taken to mount the units. Units should be mounted to wall studs using correct fasteners. Failure to do so may result in collapse of the unit and subsequent personal injury. **Mounting hardware not included.** Mounting hardware used should be based on wall material. Consult an installation professional for proper wall mounting.

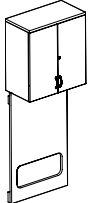


Wall w/Closed Storage - 84"H*

Z4284WS	16 x 42 x 84.4-84.9	85	134	10.20	\$1932	\$2011	\$819	N/A
Z3684WS	16 x 36 x 84.4-84.9	85	119	9.46	\$1835	\$1918	\$748	N/A
Z3084WS	16 x 30 x 84.4-84.9	85	102	8.10	\$1613	\$1671	\$664	N/A
Z2484WS	16 x 24 x 84.4-84.9	85	84	6.60	\$1421	\$1469	\$603	N/A

Standard with pre-mounted "J" bracket for wall mount applications. Doors lock. End cap required at the end of a run of wall units. End cap sold separately, see page 227.

• **NOTE:** Care should be taken to mount the units. Units should be mounted to wall studs using correct fasteners. Failure to do so may result in collapse of the unit and subsequent personal injury. **Mounting hardware not included.** Mounting hardware used should be based on wall material. Consult an installation professional for proper wall mounting.



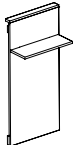
Wall w/Closed Storage - 84"H*

Z4284WSO	16 x 42 x 84.4-84.9	85	120	9.30	\$1946	\$2025	\$819	N/A
Z3684WSO	16 x 36 x 84.4-84.9	85	105	8.66	\$1848	\$1931	\$748	N/A
Z3084WSO	16 x 30 x 84.4-84.9	85	91	7.50	\$1625	\$1683	\$664	N/A
Z2484WSO	16 x 24 x 84.4-84.9	92.5	74	6.20	\$1430	\$1478	\$603	N/A

Standard with pre-mounted "J" bracket for wall mount applications. Doors lock. Large cutout provides direct access to wall for access to electrical. End cap required at the end of a run of wall units. End cap sold separately, see page 227.

• **NOTE:** Care should be taken to mount the units. Units should be mounted to wall studs using correct fasteners. Failure to do so may result in collapse of the unit and subsequent personal injury. **Mounting hardware not included.** Mounting hardware used should be based on wall material. Consult an installation professional for proper wall mounting.

WALLS W/FLOATING SHELVES

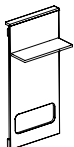


Wall w/Floating Shelf* - 66"H

MODEL#	DIMENSIONS	FREIGHT CLASS	WT/LBS.	CUBIC FT.	1" TOP	1.5" TOP	GLAZE ADD	HP ADD
ZF1S4266	14.25 x 42 x 65.5-66	70	117	7.50	\$1141	\$1179	N/A	N/A
ZF1S3666	14.25 x 36 x 65.5-66	70	103	6.60	\$994	\$1028	N/A	N/A
ZF1S3066	14.25 x 30 x 65.5-66	70	86	5.70	\$857	\$891	N/A	N/A
ZF1S2466	14.25 x 24 x 65.5-66	85	69	4.70	\$735	\$764	N/A	N/A

Standard with pre-mounted "J" bracket for wall mount applications. End cap required at the end of a run of floating shelves. End cap sold separately, see page 227.

• **NOTE:** Care should be taken to mount the units. Units should be mounted to wall studs using correct fasteners. Failure to do so may result in collapse of the unit and subsequent personal injury. **Fastening hardware not included.** Mounting hardware used should be based on wall material. Consult an installation professional for proper wall mounting.



Wall w/Floating Shelf* - 66"H

ZF1S42660	14.25 x 42 x 65.5-66	85	110	7.50	\$1153	\$1191	N/A	N/A
ZF1S36660	14.25 x 36 x 65.5-66	85	97	6.60	\$1005	\$1039	N/A	N/A
ZF1S30660	14.25 x 30 x 65.5-66	85	81	5.70	\$864	\$898	N/A	N/A
ZF1S24660	14.25 x 24 x 65.5-66	85	66	4.70	\$740	\$769	N/A	N/A

Standard with pre-mounted "J" bracket for wall mount applications. Large cutout provides direct access to wall for access to electrical. End cap required at the end of a run of floating shelves. End cap sold separately, see page 227.

• **NOTE:** Care should be taken to mount the units. Units should be mounted to wall studs using correct fasteners. Failure to do so may result in collapse of the unit and subsequent personal injury. **Fastening hardware not included.** Mounting hardware used should be based on wall material. Consult an installation professional for proper wall mounting.

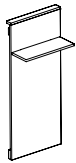
Required Specifications

Top finish Base/door finish*
Wall finish Handles*
Top/Edge Detail
Shelf finish

Optional Specifications

End filler cap
Grommet*

WALLS W/FLOATING SHELVES

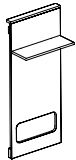


Wall w/Floating Shelf* - 72"H

MODEL#	DIMENSIONS D x W x H	FREIGHT CLASS	WT/LBS.	CUBIC FT.	1" TOP	1.5" TOP	GLAZE ADD	HP ADD
ZF1S4272	14.25 x 42 x 71.9-72.4	70	127	8	\$1201	\$1239	N/A	N/A
ZF1S3672	14.25 x 36 x 71.9-72.4	70	110	7.10	\$1049	\$1083	N/A	N/A
ZF1S3072	14.25 x 30 x 71.9-72.4	70	92	6.10	\$926	\$960	N/A	N/A
ZF1S2472	14.25 x 24 x 71.9-72.4	85	74	5	\$785	\$814	N/A	N/A

Standard with pre-mounted "J" bracket for wall mount applications. End cap required at the end of a run of floating shelves. End cap sold separately, see page 227.

• **NOTE:** Care should be taken to mount the units. Units should be mounted to wall studs using correct fasteners. Failure to do so may result in collapse of the unit and subsequent personal injury. **Fastening hardware not included.** Mounting hardware used should be based on wall material. Consult an installation professional for proper wall mounting.

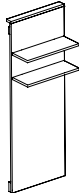


Wall w/Floating Shelf* - 72"H

ZF1S42720	14.25 x 42 x 71.9-72.4	70	120	8	\$1215	\$1253	N/A	N/A
ZF1S36720	14.25 x 36 x 71.9-72.4	85	104	7.10	\$1061	\$1095	N/A	N/A
ZF1S30720	14.25 x 30 x 71.9-72.4	85	87	6.10	\$938	\$972	N/A	N/A
ZF1S24720	14.25 x 24 x 71.9-72.4	85	71	5	\$790	\$819	N/A	N/A

Standard with pre-mounted "J" bracket for wall mount applications. Large cutout provides direct access to wall for access to electrical. End cap required at the end of a run of floating shelves. End cap sold separately, see page 227.

• **NOTE:** Care should be taken to mount the units. Units should be mounted to wall studs using correct fasteners. Failure to do so may result in collapse of the unit and subsequent personal injury. **Fastening hardware not included.** Mounting hardware used should be based on wall material. Consult an installation professional for proper wall mounting.

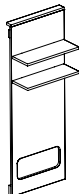


Wall w/Floating Shelves - 84"H

ZF2S4284	14.25 x 42 x 84.4-84.9	70	158	9.50	\$1411	\$1449	N/A	N/A
ZF2S3684	14.25 x 36 x 84.4-84.9	70	136	8.40	\$1215	\$1261	N/A	N/A
ZF2S3084	14.25 x 30 x 84.4-84.9	70	113	7.10	\$1074	\$1103	N/A	N/A
ZF2S2484	14.25 x 24 x 84.4-84.9	85	91	6.25	\$931	\$960	N/A	N/A

Standard with pre-mounted "J" bracket for wall mount applications. End cap required at the end of a run of floating shelves. End cap sold separately, see page 227.

• **NOTE:** Care should be taken to mount the units. Units should be mounted to wall studs using correct fasteners. Failure to do so may result in collapse of the unit and subsequent personal injury. **Fastening hardware not included.** Mounting hardware used should be based on wall material. Consult an installation professional for proper wall mounting.

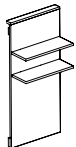


Wall w/Floating Shelves - 84"H

ZF2S42840	14.25 x 42 x 84.4-84.9	70	148	9.50	\$1423	\$1461	N/A	N/A
ZF2S36840	14.25 x 36 x 84.4-84.9	70	128	8.40	\$1232	\$1270	N/A	N/A
ZF2S30840	14.25 x 30 x 84.4-84.9	85	106	7.10	\$1166	\$1195	N/A	N/A
ZF2S24840	14.25 x 24 x 84.4-84.9	85	86	6.25	\$938	\$967	N/A	N/A

Standard with pre-mounted "J" bracket for wall mount applications. Large cutout provides direct access to wall for access to electrical. End cap required at the end of a run of floating shelves. End cap sold separately, see page 227.

• **NOTE:** Care should be taken to mount the units. Units should be mounted to wall studs using correct fasteners. Failure to do so may result in collapse of the unit and subsequent personal injury. **Fastening hardware not included.** Mounting hardware used should be based on wall material. Consult an installation professional for proper wall mounting.



Wall w/Floating Shelves - 66"H

ZF2S4266	14.25 x 42 x 65.5-66	70	132	7.50	\$1177	\$1215	N/A	N/A
ZF2S3666	14.25 x 36 x 65.5-66	70	115	6.60	\$1021	\$1055	N/A	N/A
ZF2S3066	14.25 x 30 x 65.5-66	70	96	5.70	\$887	\$917	N/A	N/A
ZF2S2466	14.25 x 24 x 65.5-66	70	77	4.70	\$759	\$789	N/A	N/A

Standard with pre-mounted "J" bracket for wall mount applications. End cap required at the end of a run of floating shelves. End cap sold separately, see page 227.

• **NOTE:** Care should be taken to mount the units. Units should be mounted to wall studs using correct fasteners. Failure to do so may result in collapse of the unit and subsequent personal injury. **Fastening hardware not included.** Mounting hardware used should be based on wall material. Consult an installation professional for proper wall mounting.

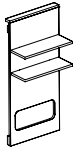
Required Specifications

Top finish
Wall finish
Top/Edge Detail
Shelf finish

Optional Specifications

End filler cap
Grommet

WALLS W/FLOATING SHELVES

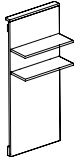


Wall w/Floating Shelves - 66"H

MODEL#	DIMENSIONS	FREIGHT CLASS	WT/LBS.	CUBIC FT.	1"TOP	1.5" TOP	GLAZE ADD	HP ADD
D x W x H								
ZF2S42660	14.25 x 42 x 65.5-66	70	125	7.50	\$1192	\$1230	N/A	N/A
ZF2S36660	14.25 x 36 x 65.5-66	70	109	6.60	\$1033	\$1067	N/A	N/A
ZF2S30660	14.25 x 30 x 65.5-66	70	91	5.70	\$899	\$929	N/A	N/A
ZF2S24660	14.25 x 24 x 65.5-66	70	74	4.70	\$766	\$796	N/A	N/A

Standard with pre-mounted "J" bracket for wall mount applications. Large cutout provides direct access to wall for access to electrical. End cap required at the end of a run of floating shelves. End cap sold separately, see page 227.

- **NOTE:** Care should be taken to mount the units. Units should be mounted to wall studs using correct fasteners. Failure to do so may result in collapse of the unit and subsequent personal injury. **Fastening hardware not included.** Mounting hardware used should be based on wall material. Consult an installation professional for proper wall mounting.

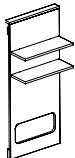


Wall w/Floating Shelves - 72"H

ZF2S4272	14.25 x 42 x 71.9-72.4	70	142	8	\$1239	\$1277	N/A	N/A
ZF2S3672	14.25 x 36 x 71.9-72.4	70	122	7.10	\$1077	\$1111	N/A	N/A
ZF2S3072	14.25 x 30 x 71.9-72.4	70	102	6.10	\$954	\$984	N/A	N/A
ZF2S2472	14.25 x 24 x 71.9-72.4	70	82	5	\$807	\$837	N/A	N/A

Standard with pre-mounted "J" bracket for wall mount applications. End cap required at the end of a run of floating shelves. End cap sold separately, see page 227.

- **NOTE:** Care should be taken to mount the units. Units should be mounted to wall studs using correct fasteners. Failure to do so may result in collapse of the unit and subsequent personal injury. **Fastening hardware not included.** Mounting hardware used should be based on wall material. Consult an installation professional for proper wall mounting.

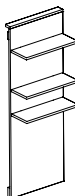


Wall w/Floating Shelves - 72"H

ZF2S42720	14.25 x 42 x 71.9-72.4	70	135	8	\$1253	\$1291	N/A	N/A
ZF2S36720	14.25 x 36 x 71.9-72.4	70	116	7.10	\$1091	\$1125	N/A	N/A
ZF2S30720	14.25 x 30 x 71.9-72.4	70	97	6.10	\$965	\$995	N/A	N/A
ZF2S24720	14.25 x 24 x 71.9-72.4	70	79	5	\$815	\$845	N/A	N/A

Standard with pre-mounted "J" bracket for wall mount applications. Large cutout provides direct access to wall for access to electrical. End cap required at the end of a run of floating shelves. End cap sold separately, see page 227.

- **NOTE:** Care should be taken to mount the units. Units should be mounted to wall studs using correct fasteners. Failure to do so may result in collapse of the unit and subsequent personal injury. **Fastening hardware not included.** Mounting hardware used should be based on wall material. Consult an installation professional for proper wall mounting.

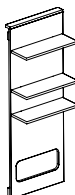


Wall w/Floating Shelves - 84"H

ZF3S4284	14.25 x 42 x 84.4-84.9	70	173	9.50	\$1447	\$1477	N/A	N/A
ZF3S3684	14.25 x 36 x 84.4-84.9	70	148	8.40	\$1253	\$1287	N/A	N/A
ZF3S3084	14.25 x 30 x 84.4-84.9	70	116	7.10	\$1102	\$1132	N/A	N/A
ZF3S2484	14.25 x 24 x 84.4-84.9	70	99	6.25	\$956	\$986	N/A	N/A

Standard with pre-mounted "J" bracket for wall mount applications. End cap required at the end of a run of floating shelves. End cap sold separately, see page 227.

- **NOTE:** Care should be taken to mount the units. Units should be mounted to wall studs using correct fasteners. Failure to do so may result in collapse of the unit and subsequent personal injury. **Fastening hardware not included.** Mounting hardware used should be based on wall material. Consult an installation professional for proper wall mounting.



Wall w/Floating Shelves - 84"H

ZF3S42840	14.25 x 42 x 84.4-84.9	70	163	9.50	\$1462	\$1500	N/A	N/A
ZF3S36840	14.25 x 36 x 84.4-84.9	70	140	8.40	\$1267	\$1301	N/A	N/A
ZF3S30840	14.25 x 30 x 84.4-84.9	70	116	7.10	\$1196	\$1226	N/A	N/A
ZF3S24840	14.25 x 24 x 84.4-84.9	70	94	6.25	\$962	\$992	N/A	N/A

Standard with pre-mounted "J" bracket for wall mount applications. Large cutout provides direct access to wall for access to electrical. End cap required at the end of a run of floating shelves. End cap sold separately, see page 227.

- **NOTE:** Care should be taken to mount the units. Units should be mounted to wall studs using correct fasteners. Failure to do so may result in collapse of the unit and subsequent personal injury. **Fastening hardware not included.** Mounting hardware used should be based on wall material. Consult an installation professional for proper wall mounting.

Required Specifications

- Top finish
- Wall finish
- Top/Edge Detail
- Shelf finish

Optional Specifications

- End filler cap
- Grommet

WALL PANELS

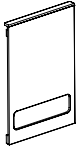


Wall Panel - 66"H

MODEL#	DIMENSIONS D x W x H	FREIGHT CLASS	WT/LBS.	CUBIC FT.	1" TOP	1.5" TOP	GLAZE ADD	HP ADD
ZWHP4266	3.5 x 42 x 65.5-66	85	99	7.50	\$1011	\$1049	N/A	N/A
ZWHP3666	3.5 x 36 x 65.5-66	85	90	6.60	\$804	\$838	N/A	N/A
ZWHP3066	3.5 x 30 x 65.5-66	85	75	5.70	\$697	\$727	N/A	N/A
ZWHP2466	3.5 x 24 x 65.5-66	85	61	4.70	\$597	\$627	N/A	N/A

Standard with pre-mounted "J" bracket for wall mount applications. End cap required at the end of a run of floating shelves. End cap sold separately, see page 227.

- **NOTE:** Care should be taken to mount the units. Units should be mounted to wall studs using correct fasteners. Failure to do so may result in collapse of the unit and subsequent personal injury. **Fastening hardware not included.** Mounting hardware used should be based on wall material. Consult an installation professional for proper wall mounting.



Wall Panel - 66"H

ZWHP42660	3.5 x 42 x 65.5-66	85	90	7.50	\$1026	\$1064	N/A	N/A
ZWHP36660	3.5 x 36 x 65.5-66	85	82	6.60	\$816	\$850	N/A	N/A
ZWHP30660	3.5 x 30 x 65.5-66	85	69	5.70	\$709	\$739	N/A	N/A
ZWHP24660	3.5 x 24 x 65.5-66	92.5	56	4.70	\$603	\$633	N/A	N/A

Standard with pre-mounted "J" bracket for wall mount applications. Large cutout provides direct access to wall for access to electrical. End cap required at the end of a run of floating shelves. End cap sold separately, see page 227.

- **NOTE:** Care should be taken to mount the units. Units should be mounted to wall studs using correct fasteners. Failure to do so may result in collapse of the unit and subsequent personal injury. **Fastening hardware not included.** Mounting hardware used should be based on wall material. Consult an installation professional for proper wall mounting.

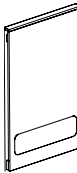


Wall Panel - 72"H

ZWHP4272	3.5 x 42 x 71.9-72.4	85	113	8	\$988	\$1026	N/A	N/A
ZWHP3672	3.5 x 36 x 71.9-72.4	85	97	7.10	\$861	\$895	N/A	N/A
ZWHP3072	3.5 x 30 x 71.9-72.4	85	81	6.10	\$765	\$795	N/A	N/A
ZWHP2472	3.5 x 24 x 71.9-72.4	85	67	5	\$645	\$675	N/A	N/A

Standard with pre-mounted "J" bracket for wall mount applications. End cap required at the end of a run of floating shelves. End cap sold separately, see page 227.

- **NOTE:** Care should be taken to mount the units. Units should be mounted to wall studs using correct fasteners. Failure to do so may result in collapse of the unit and subsequent personal injury. **Fastening hardware not included.** Mounting hardware used should be based on wall material. Consult an installation professional for proper wall mounting.



Wall Panel - 72"H

ZWHP42720	3.5 x 42 x 71.9-72.4	85	104	8	\$1003	\$1041	N/A	N/A
ZWHP36720	3.5 x 36 x 71.9-72.4	85	89	7.10	\$873	\$907	N/A	N/A
ZWHP30720	3.5 x 30 x 71.9-72.4	85	75	6.10	\$776	\$806	N/A	N/A
ZWHP24720	3.5 x 24 x 71.9-72.4	85	62	5	\$653	\$683	N/A	N/A

Standard with pre-mounted "J" bracket for wall mount applications. Large cutout provides direct access to wall for access to electrical. End cap required at the end of a run of floating shelves. End cap sold separately, see page 227.

- **NOTE:** Care should be taken to mount the units. Units should be mounted to wall studs using correct fasteners. Failure to do so may result in collapse of the unit and subsequent personal injury. **Fastening hardware not included.** Mounting hardware used should be based on wall material. Consult an installation professional for proper wall mounting.



Wall Panel - 84"H

ZWHP4284	3.5 x 42 x 84.4-84.9	85	128	9.50	\$1053	\$1091	N/A	N/A
ZWHP3684	3.5 x 36 x 84.4-84.9	85	111	8.40	\$928	\$962	N/A	N/A
ZWHP3084	3.5 x 30 x 84.4-84.9	85	92	7.10	\$827	\$857	N/A	N/A
ZWHP2484	3.5 x 24 x 84.4-84.9	85	75	6.25	\$713	\$743	N/A	N/A

Standard with pre-mounted "J" bracket for wall mount applications. End cap required at the end of a run of floating shelves. End cap sold separately, see page 227.

- **NOTE:** Care should be taken to mount the units. Units should be mounted to wall studs using correct fasteners. Failure to do so may result in collapse of the unit and subsequent personal injury. **Fastening hardware not included.** Mounting hardware used should be based on wall material. Consult an installation professional for proper wall mounting.

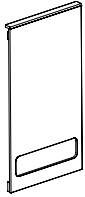
Required Specifications

Top finish
Wall finish
Top/Edge Detail

Optional Specifications

End filler cap
Grommet

WALL PANELS



Wall Panel - 84"H

MODEL#	DIMENSIONS D x W x H	FREIGHT CLASS	WT/LBS.	CUBIC FT.	1" TOP	1.5" TOP	GLAZE ADD	HP ADD
ZWHP42840	3.5 x 42 x 84.4-84.9	85	119	9.50	\$1068	\$1106	N/A	N/A
ZWHP36840	3.5 x 36 x 84.4-84.9	85	103	8.40	\$940	\$974	N/A	N/A
ZWHP30840	3.5 x 30 x 84.4-84.9	85	92	7.10	\$836	\$866	N/A	N/A
ZWHP24840	3.5 x 24 x 84.4-84.9	92.5	70	6.25	\$721	\$751	N/A	N/A

Standard with pre-mounted "J" bracket for wall mount applications. Large cutout provides direct access to wall for access to electrical. End cap required at the end of a run of floating shelves. End cap sold separately, see page 227.

• **NOTE:** Care should be taken to mount the units. Units should be mounted to wall studs using correct fasteners. Failure to do so may result in collapse of the unit and subsequent personal injury. **Fastening hardware not included.** Mounting hardware used should be based on wall material. Consult an installation professional for proper wall mounting.

END FILLER CAPS



End Cap

MODEL#	DIMENSIONS	FREIGHT CLASS	WT/LBS.	CUBIC FT.	1" TOP	1.5" TOP	GLAZE ADD	HP ADD
ZEFC19	.75 x 2.5 x 17	70	1.50	.25	\$168	N/A	N/A	N/A

For ZFSxxxx 20"H floating shelf.



End Cap

ZEFC32	.75 x 2.5 x 30	300	2	2	\$274	N/A	N/A	N/A
--------	----------------	-----	---	---	--------------	-----	-----	-----

For ZF2Sxxxx 32.5"H floating shelf.



End Cap

ZEFC49	.75 x 2.5 x 47	250	3	1.20	\$359	N/A	N/A	N/A
--------	----------------	-----	---	------	--------------	-----	-----	-----

For Zxx66WS/Zxx66WSO 65.5/66"H walls with overhead.



End Cap

ZEFC52	.75 x 2.5 x 50	250	4	1.30	\$385	N/A	N/A	N/A
--------	----------------	-----	---	------	--------------	-----	-----	-----

For Zxx72WS/Zxx72WSO/Zxx84WS/Zxx84WSO 71.9/72.4"H or 84.4/84.9"H walls with overhead.



End Cap

ZEFC66	.75 x 2.5 x 64	300	4	4	\$470	N/A	N/A	N/A
--------	----------------	-----	---	---	--------------	-----	-----	-----

For ZF1Sxx66/ZF1Sxx66O/ZF2Sxx66/ZF2Sxx66O/ZWHPxx66/ZWHPxx66O 65.5/66"H wall panels, with or without shelves.

Required Specifications

Top finish
Wall finish
Top/Edge Detail

Optional Specifications

End filler cap
Grommet

END FILLER CAPS

MODEL# DIMENSIONS FREIGHT CLASS WT/LBS. CUBIC FT. 1" TOP 1.5" TOP GLAZE ADD HP ADD

D x W x H

ZEFC72	.75 x 2.5 x 70.5	300	4	4	\$507	N/A	N/A	N/A
--------	------------------	-----	---	---	--------------	-----	-----	-----



End Cap

For ZF1Sxx72/ZF1Sxx720/ZF2Sxx72/ZF2Sxx720/ZWHPxx72/ZWHPxx720 71.9/72.4"H wall panels, with or without shelves.

ZEFC84	.75 x 2.5 x 83	300	5	4.50	\$593	N/A	N/A	N/A
--------	----------------	-----	---	------	--------------	-----	-----	-----



End Cap

For ZF1Sxx84/ZF1Sxx840/ZF2Sxx84/ZF2Sxx840/ZWHPxx84/ZWHPxx840 84.4/84.9"H wall panels, with or without shelves.

Required Specifications

Finish

TACKBOARDS FOR HUTCHES

MODEL# DIMENSIONS FREIGHT CLASS WT/LBS. CUBIC FT. FABRIC GRADE LIST PRICE

D x W x H

TACKBOARD Notes: Tackboards can be upholstered in all of the following fabrics:

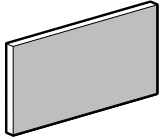
Grade 1: Jenny, Quilt, Terrace, Urban, Waterfall

Grade 2: Imprint, Lola

Grade 3: Anchorage, Merge

TACKBOARDS FOR HUTCHES - 23.5" / 24" HIGH

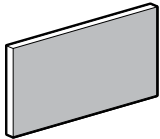
MODEL# DIMENSIONS FREIGHT CLASS WT/LBS. CUBIC FT. FABRIC GRADE LIST PRICE



Tackboard

ZTB8217	.62 x 82 x 16.5-17	150	8.20	2	1	\$773
					2	\$930
					3	\$1112
					4	\$1329
					5	\$1527

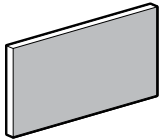
For use on **Z84S23HN** hutch. Includes mounting screws.



Tackboard

ZTB7017	.62 x 70 x 16.5-17	150	7	1.30	1	\$513
					2	\$619
					3	\$741
					4	\$882
					5	\$1016

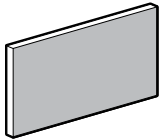
For use on **Z72S23HN** hutch. Includes mounting screws.



Tackboard

ZTB6917	.62 x 69 x 16.5-17	150	7	1.30	1	\$510
					2	\$616
					3	\$738
					4	\$877
					5	\$1006

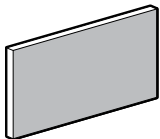
For use on **Z71S23HN** hutch. Includes mounting screws.



Tackboard

ZTB6417	.62 x 64 x 16.5-17	150	6.40	1.30	1	\$506
					2	\$609
					3	\$725
					4	\$864
					5	\$994

For use on **Z66S23HN** hutch. Includes mounting screws.



Tackboard

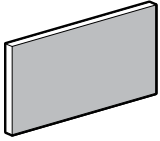
ZTB5817	.62 x 58 x 16.5-17	150	5.80	1.08	1	\$493
					2	\$593
					3	\$712
					4	\$848
					5	\$975

For use on **Z60S23HN** hutch. Includes mounting screws.

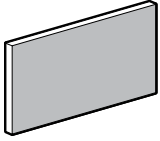
Required Specifications

Fabric

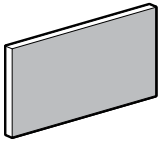
TACKBOARDS - 23.5" / 24" HIGH



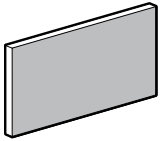
Tackboard



Tackboard



Tackboard



Tackboard

MODEL# DIMENSIONS FREIGHT CLASS WT/LBS. CUBIC FT. FABRIC GRADE LIST PRICE

	D x W x H					
ZTB4617	.62 x 46 x 16.5-17	150	4.60	.85	1	\$331
					2	\$400
					3	\$477
					4	\$566
					5	\$649

For use on **Z48S23HN** hutch. Includes mounting screws.

ZTB4017	.62 x 40 x 16.5-17	150	4	.85	1	\$318
					2	\$383
					3	\$458
					4	\$541
					5	\$623

For use on **Z42S23HN** hutch. Includes mounting screws.

ZTB3417	.62 x 34 x 16.5-17	150	3.40	.85	1	\$308
					2	\$373
					3	\$445
					4	\$523
					5	\$601

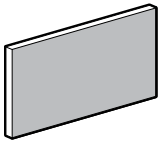
For use on **Z36S23HN** hutch. Includes mounting screws.

ZTB2817	.62 x 28 x 16.5-17	250	2.80	.85	1	\$295
					2	\$359
					3	\$428
					4	\$507
					5	\$582

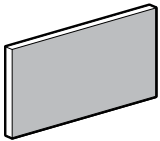
For use on **Z30S23HN** hutch. Includes mounting screws.

TACKBOARDS FOR HUTCHES - 36" / 36.5" HIGH

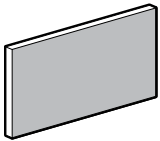
FABRIC GRADE LIST PRICE



Tackboard



Tackboard



Tackboard

ZTB8216	.62 x 82 x 15-15.5	150	8.20	2	1	\$773
					2	\$930
					3	\$1112
					4	\$1329
					5	\$1527

For use on **Z84S36H and Z84S36HN** hutches. Includes mounting screws.

ZTB7016	.62 x 70 x 15-15.5	150	7	1.30	1	\$513
					2	\$619
					3	\$741
					4	\$882
					5	\$1016

For use on **Z72S36xxx** hutches. Includes mounting screws.

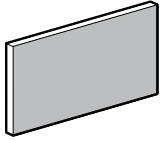
ZTB6916	.62 x 69.5 x 15-15.5	150	7	1.30	1	\$510
					2	\$616
					3	\$738
					4	\$877
					5	\$1006

For use on **Z71S36H and Z71S36HN** hutches. Includes mounting screws.

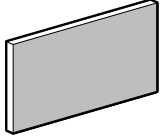
Required Specifications

Fabric

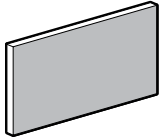
TACKBOARDS - 36" / 36.5" HIGH



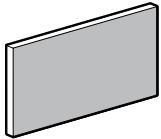
Tackboard



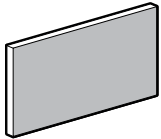
Tackboard



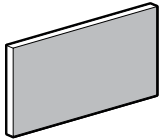
Tackboard



Tackboard



Tackboard



Tackboard

MODEL# DIMENSIONS FREIGHT CLASS WT/LBS. CUBIC FT. FABRIC GRADE LIST PRICE

D x W x H

ZTB6416	.62 x 64 x 15-15.5	150	6.40	1.30	1	\$506
					2	\$609
					3	\$725
					4	\$864
					5	\$994

For use on **Z66S36xxx** hutches. Includes mounting screws.

ZTB5816	.62 x 58 x 15-15.5	150	5.80	1.08	1	\$493
					2	\$593
					3	\$712
					4	\$848
					5	\$975

For use on **Z60S36xxx** hutches. Includes mounting screws.

ZTB4616	.62 x 46 x 15-15.5	150	4.60	.85	1	\$331
					2	\$400
					3	\$477
					4	\$566
					5	\$649

For use on **Z48S36H and Z48S36HN** hutches. Includes mounting screws.

ZTB4016	.62 x 40 x 15-15.5	150	4	.85	1	\$318
					2	\$383
					3	\$458
					4	\$541
					5	\$623

For use on **Z42S36H and Z42S36HN** hutch. Includes mounting screws.

ZTB3416	.62 x 34 x 15-15.5	150	3.40	.85	1	\$308
					2	\$373
					3	\$445
					4	\$523
					5	\$601

For use on **Z36S36H and Z36S36HN** hutch. Includes mounting screws.

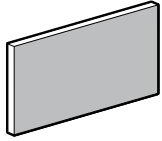
ZTB2816	.62 x 28 x 15-15.5	250	2.80	.85	1	\$295
					2	\$359
					3	\$428
					4	\$507
					5	\$582

For use on **Z30S36H and Z30S36HN** hutch. Includes mounting screws.

Required Specifications

Fabric

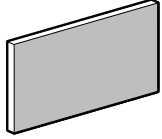
TACKBOARDS - 42.4", 42.9" & 54.9", 55.4" HIGH



Tackboard

MODEL#	DIMENSIONS D x W x H	FREIGHT CLASS	WT/LBS.	CUBIC FT.	FABRIC GRADE	LIST PRICE
ZTB8221	.62 x 82 x 20.5-21	150	12.80	2.30	1	\$941
					2	\$1127
					3	\$1353
					4	\$1615
					5	\$1855

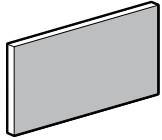
For use on **Z84S42H, Z84S42HN, Z84S55H and Z84S55HN** hutches. Includes mounting screws.



Tackboard

ZTB7021	.62 x 70 x 20.5-21	125	11	1.50	1	\$633
					2	\$757
					3	\$908
					4	\$1081
					5	\$1244

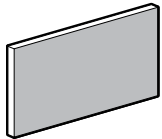
For use on **Z72S42xxx and Z72S55xxx** hutches. Includes mounting screws.



Tackboard

ZTB6921	.62 x 69 x 20.5-21	125	10.70	1.50	1	\$620
					2	\$749
					3	\$895
					4	\$1067
					5	\$1226

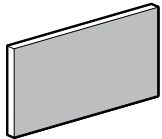
For use on **Z71S42H, Z71S42HN, Z71S55H and Z71S55HN** hutches. Includes mounting screws.



Tackboard

ZTB6421	.62 x 64 x 20.5-21	125	10	1.50	1	\$586
					2	\$706
					3	\$848
					4	\$1008
					5	\$1158

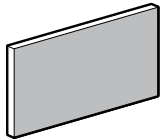
For use on **Z66S42xxx and Z66S55xxx** hutches. Includes mounting screws.



Tackboard

ZTB5821	.62 x 58 x 20.5-21	125	9	1.50	1	\$582
					2	\$705
					3	\$842
					4	\$998
					5	\$1148

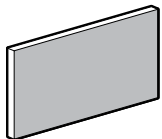
For use on **Z60S42xxx and Z60S55xxx** hutches. Includes mounting screws.



Tackboard

ZTB4621	.62 x 46 x 20.5-21	125	7.20	1	1	\$360
					2	\$435
					3	\$519
					4	\$616
					5	\$707

For use on **Z48S42H, Z48S42HN, Z48S55H and Z48S55HN** hutches. Includes mounting screws.



Tackboard

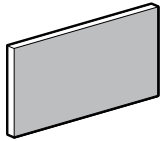
ZTB4021	.62 x 40 x 20.5-21	125	6.20	1	1	\$347
					2	\$419
					3	\$505
					4	\$595
					5	\$686

For use on **Z42S42H, Z42S42HN, Z42S55H and Z42S55HN** hutches. Includes mounting screws.

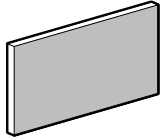
Required Specifications

Fabric

TACKBOARDS - 42.4", 42.9" & 54.9", 55.4" HIGH



Tackboard



Tackboard

MODEL# DIMENSIONS FREIGHT CLASS WT/LBS. CUBIC FT. FABRIC GRADE LIST PRICE

MODEL#	DIMENSIONS	FREIGHT CLASS	WT/LBS.	CUBIC FT.	FABRIC GRADE	LIST PRICE	
ZTB3421	.62 x 34 x 20.5-21	150	5.30	1			
					D x W x H	1	\$343
					2	\$413	
					3	\$496	
					4	\$585	
5	\$674						

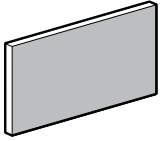
For use on **Z36S42H, Z36S42HN, Z36S55H and Z36S55HN** hutches. Includes mounting screws.

ZTB2821	.62 x 28 x 20.5-21	150	4.50	1		
					1	\$339
					2	\$408
					3	\$486
					4	\$578
5	\$662					

For use on **Z30S42H, Z30S42HN, Z30S55H and Z30S55HN** hutches. Includes mounting screws.

Required Specifications
Fabric

14" WALL-MOUNTED TACKBOARDS

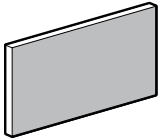


Wall Mounted Tackboard

MODEL#	DIMENSIONS D x W x H	FREIGHT CLASS	WT/LBS.	CUBIC FT.	FABRIC GRADE	LIST PRICE
ZWHT3014	1.25 x 30 x 13.5-14	150	4.70	1	1	\$333
					2	\$386
					3	\$443
					4	\$507
					5	\$581

For use under **Z30S200S/OSN/OSD/OSR/OSL/OSO/SOS** for a finished height of **65"/65.5"**. Standard with pre-mounted "J" bracket for wall mount applications.

• **NOTE:** Care should be taken to mount the units. Units should be mounted to wall studs using correct fasteners. Failure to do so may result in collapse of the unit and subsequent personal injury. **Mounting hardware not included.** Mounting hardware used should be based on wall material. Consult an installation professional for proper wall mounting.

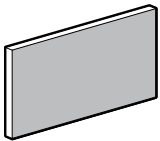


Wall Mounted Tackboard

ZWHT3614	1.25 x 36 x 13.5-14	150	5.60	1	1	\$367
					2	\$427
					3	\$487
					4	\$561
					5	\$642

For use under **Z36S200S/OSN/OSD/OSR/OSL/OSO/SOS** for a finished height of **65"/65.5"**. Standard with pre-mounted "J" bracket for wall mount applications.

• **NOTE:** Care should be taken to mount the units. Units should be mounted to wall studs using correct fasteners. Failure to do so may result in collapse of the unit and subsequent personal injury. **Mounting hardware not included.** Mounting hardware used should be based on wall material. Consult an installation professional for proper wall mounting.

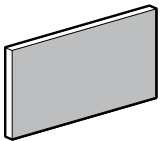


Wall Mounted Tackboard

ZWHT4214	1.25 x 42 x 13.5-14	125	6.50	1	1	\$430
					2	\$496
					3	\$569
					4	\$652
					5	\$748

For use under **Z42S200S/OSN/OSD/OSR/OSL/OSO/SOS** for a finished height of **65"/65.5"**. Standard with pre-mounted "J" bracket for wall mount applications.

• **NOTE:** Care should be taken to mount the units. Units should be mounted to wall studs using correct fasteners. Failure to do so may result in collapse of the unit and subsequent personal injury. **Mounting hardware not included.** Mounting hardware used should be based on wall material. Consult an installation professional for proper wall mounting.

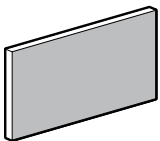


Wall Mounted Tackboard

ZWHT4814	1.25 x 48 x 13.5-14	125	7.50	1	1	\$464
					2	\$536
					3	\$614
					4	\$706
					5	\$810

For use under **Z48S200S/OSN/OSD/OSR/OSL/OSO/SOS** for a finished height of **65"/65.5"**. Standard with pre-mounted "J" bracket for wall mount applications.

• **NOTE:** Care should be taken to mount the units. Units should be mounted to wall studs using correct fasteners. Failure to do so may result in collapse of the unit and subsequent personal injury. **Mounting hardware not included.** Mounting hardware used should be based on wall material. Consult an installation professional for proper wall mounting.



Wall Mounted Tackboard

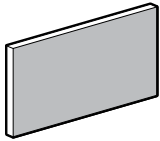
ZWHT6014	1.25 x 60 x 13.5-14	150	9.30	1.80	1	\$578
					2	\$666
					3	\$765
					4	\$880
					5	\$1010

For use under **Z60S200S/OSN/OSD/OSR/OSL/OSO/SOS** for a finished height of **65"/65.5"**. Standard with pre-mounted "J" bracket for wall mount applications.

• **NOTE:** Care should be taken to mount the units. Units should be mounted to wall studs using correct fasteners. Failure to do so may result in collapse of the unit and subsequent personal injury. **Mounting hardware not included.** Mounting hardware used should be based on wall material. Consult an installation professional for proper wall mounting.

Required Specifications
Fabric

14" WALL-MOUNTED TACKBOARDS



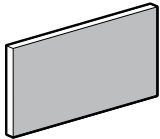
Wall Mounted Tackboard

MODEL#	DIMENSIONS	FREIGHT CLASS	WT/LBS.	CUBIC FT.	FABRIC GRADE	LIST PRICE
--------	------------	---------------	---------	-----------	--------------	------------

D x W x H						
ZWHT6614	1.25 x 66 x 13.5-14	150	10.30	1.80	1	\$614
					2	\$707
					3	\$812
					4	\$932
					5	\$1071

For use under **ZxxS200S/OSN/OSD/OSR/OSL/OSO/SOS** for a finished height of **65"/65.5"**. Standard with pre-mounted "J" bracket for wall mount applications.

• **NOTE:** Care should be taken to mount the units. Units should be mounted to wall studs using correct fasteners. Failure to do so may result in collapse of the unit and subsequent personal injury. **Mounting hardware not included.** Mounting hardware used should be based on wall material. Consult an installation professional for proper wall mounting.

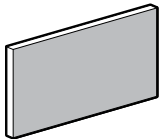


Wall Mounted Tackboard

ZWHT7214	1.25 x 72 x 13.5-14	125	11.20	1.80	1	\$673
					2	\$778
					3	\$892
					4	\$1027
					5	\$1178

For use under **ZxxS200S/OSN/OSD/OSR/OSL/OSO/SOS** for a finished height of **65"/65.5"**. Standard with pre-mounted "J" bracket for wall mount applications.

• **NOTE:** Care should be taken to mount the units. Units should be mounted to wall studs using correct fasteners. Failure to do so may result in collapse of the unit and subsequent personal injury. **Mounting hardware not included.** Mounting hardware used should be based on wall material. Consult an installation professional for proper wall mounting.

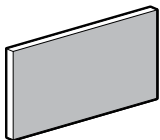


Wall Mounted Tackboard

ZWHT7814	1.25 x 78 x 13.5-14	125	12.10	1.80	1	\$710
					2	\$820
					3	\$943
					4	\$1079
					5	\$1242

For use under **ZxxS200S/OSN/OSD/OSR/OSL/OSO/SOS** for a finished height of **65"/65.5"**. Standard with pre-mounted "J" bracket for wall mount applications.

• **NOTE:** Care should be taken to mount the units. Units should be mounted to wall studs using correct fasteners. Failure to do so may result in collapse of the unit and subsequent personal injury. **Mounting hardware not included.** Mounting hardware used should be based on wall material. Consult an installation professional for proper wall mounting.



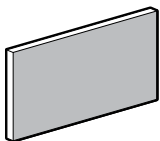
Wall Mounted Tackboard

ZWHT8414	1.25 x 84 x 13.5-14	125	13.10	1.80	1	\$767
					2	\$886
					3	\$1019
					4	\$1171
					5	\$1344

For use under **ZxxS200S/OSN/OSD/OSR/OSL/OSO/SOS** for a finished height of **65"/65.5"**. Standard with pre-mounted "J" bracket for wall mount applications.

• **NOTE:** Care should be taken to mount the units. Units should be mounted to wall studs using correct fasteners. Failure to do so may result in collapse of the unit and subsequent personal injury. **Mounting hardware not included.** Mounting hardware used should be based on wall material. Consult an installation professional for proper wall mounting.

18" WALL MOUNTED TACKBOARDS



Wall Mounted Tackboard

MODEL#	DIMENSIONS	FREIGHT CLASS	WT/LBS.	CUBIC FT.	FABRIC GRADE	LIST PRICE
--------	------------	---------------	---------	-----------	--------------	------------

ZWHT3018	1.25 x 30 x 17.5-18	125	6	1	1	\$343
					2	\$399
					3	\$457
					4	\$525
					5	\$602

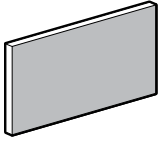
For use under **Z30S160S/OSN** for a finished height of **65"/65.5"**. Standard with pre-mounted "J" bracket for wall mount applications.

• **NOTE:** Care should be taken to mount the units. Units should be mounted to wall studs using correct fasteners. Failure to do so may result in collapse of the unit and subsequent personal injury. **Mounting hardware not included.** Mounting hardware used should be based on wall material. Consult an installation professional for proper wall mounting.

Required Specifications

Fabric

18" WALL MOUNTED TACKBOARDS

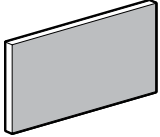


Wall Mounted Tackboard

MODEL#	DIMENSIONS D x W x H	FREIGHT CLASS	WT/LBS.	CUBIC FT.	FABRIC GRADE	LIST PRICE
ZWHT3618	1.25 x 36 x 17.5-18	125	7.20	1	1	\$381
					2	\$442
					3	\$506
					4	\$580
					5	\$667

For use under **Z36S160S/OSN** for a finished height of **65"/65.5"**. Standard with pre-mounted "J" bracket for wall mount applications.

• **NOTE:** Care should be taken to mount the units. Units should be mounted to wall studs using correct fasteners. Failure to do so may result in collapse of the unit and subsequent personal injury. **Mounting hardware not included.** Mounting hardware used should be based on wall material. Consult an installation professional for proper wall mounting.

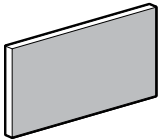


Wall Mounted Tackboard

ZWHT4218	1.25 x 42 x 17.5-18	100	8.40	1	1	\$442
					2	\$511
					3	\$585
					4	\$674
					5	\$773

For use under **Z42S160S/OSN** for a finished height of **65"/65.5"**. Standard with pre-mounted "J" bracket for wall mount applications.

• **NOTE:** Care should be taken to mount the units. Units should be mounted to wall studs using correct fasteners. Failure to do so may result in collapse of the unit and subsequent personal injury. **Mounting hardware not included.** Mounting hardware used should be based on wall material. Consult an installation professional for proper wall mounting.

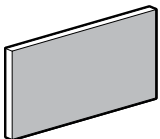


Wall Mounted Tackboard

ZWHT4818	1.25 x 48 x 17.5-18	100	9.60	1	1	\$481
					2	\$555
					3	\$639
					4	\$733
					5	\$841

For use under **Z48S160S/OSN** for a finished height of **65"/65.5"**. Standard with pre-mounted "J" bracket for wall mount applications.

• **NOTE:** Care should be taken to mount the units. Units should be mounted to wall studs using correct fasteners. Failure to do so may result in collapse of the unit and subsequent personal injury. **Mounting hardware not included.** Mounting hardware used should be based on wall material. Consult an installation professional for proper wall mounting.

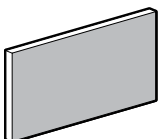


Wall Mounted Tackboard

ZWHT6018	1.25 x 60 x 17.5-18	125	12	1.80	1	\$591
					2	\$681
					3	\$785
					4	\$900
					5	\$1034

For use under **Z60S160S/OSN** for a finished height of **65"/65.5"**. Standard with pre-mounted "J" bracket for wall mount applications.

• **NOTE:** Care should be taken to mount the units. Units should be mounted to wall studs using correct fasteners. Failure to do so may result in collapse of the unit and subsequent personal injury. **Mounting hardware not included.** Mounting hardware used should be based on wall material. Consult an installation professional for proper wall mounting.



Wall Mounted Tackboard

ZWHT6618	1.25 x 66 x 17.5-18	125	13.20	1.80	1	\$630
					2	\$728
					3	\$837
					4	\$961
					5	\$1102

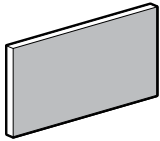
For use under **ZxxS160S/OSN** for a finished height of **65"/65.5"**. Standard with pre-mounted "J" bracket for wall mount applications.

• **NOTE:** Care should be taken to mount the units. Units should be mounted to wall studs using correct fasteners. Failure to do so may result in collapse of the unit and subsequent personal injury. **Mounting hardware not included.** Mounting hardware used should be based on wall material. Consult an installation professional for proper wall mounting.

Required Specifications

Fabric

18" WALL MOUNTED TACKBOARDS

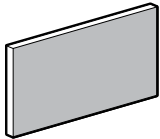


Wall Mounted Tackboard

MODEL#	DIMENSIONS	FREIGHT CLASS	WT./LBS.	CUBIC FT.	FABRIC GRADE	LIST PRICE
ZWHT7218	1.25 x 72 x 17.5-18	100	14.40	1.80	D x W x H	
					1	\$692
					2	\$799
					3	\$915
					4	\$1053
5	\$1208					

For use under **ZxxS160S/OSN** for a finished height of **65"/65.5"**. Standard with pre-mounted "J" bracket for wall mount applications.

• **NOTE:** Care should be taken to mount the units. Units should be mounted to wall studs using correct fasteners. Failure to do so may result in collapse of the unit and subsequent personal injury. **Mounting hardware not included.** Mounting hardware used should be based on wall material. Consult an installation professional for proper wall mounting.

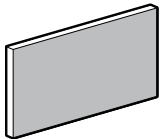


Wall Mounted Tackboard

ZWHT7818	1.25 x 78 x 17.5-18	100	15.60	1.80	1	\$729
					2	\$842
					3	\$965
					4	\$1111
					5	\$1273

For use under **ZxxS160S/OSN** for a finished height of **65"/65.5"**. Standard with pre-mounted "J" bracket for wall mount applications.

• **NOTE:** Care should be taken to mount the units. Units should be mounted to wall studs using correct fasteners. Failure to do so may result in collapse of the unit and subsequent personal injury. **Mounting hardware not included.** Mounting hardware used should be based on wall material. Consult an installation professional for proper wall mounting.



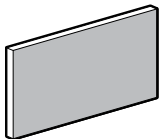
Wall Mounted Tackboard

ZWHT8418	1.25 x 84 x 17.5-18	100	16.80	1.80	1	\$789
					2	\$909
					3	\$1047
					4	\$1202
					5	\$1380

For use under **ZxxS160S/OSN** for a finished height of **65"/65.5"**. Standard with pre-mounted "J" bracket for wall mount applications.

• **NOTE:** Care should be taken to mount the units. Units should be mounted to wall studs using correct fasteners. Failure to do so may result in collapse of the unit and subsequent personal injury. **Mounting hardware not included.** Mounting hardware used should be based on wall material. Consult an installation professional for proper wall mounting.

21" WALL MOUNTED TACKBOARDS

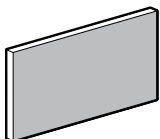


Wall Mounted Tackboard

MODEL#	DIMENSIONS	FREIGHT CLASS	WT./LBS.	CUBIC FT.	FABRIC GRADE	LIST PRICE
ZWHT3021	1.25 x 30 x 20.5-21	125	7	1	1	\$351
					2	\$408
					3	\$466
					4	\$535
					5	\$614

For use under **Z30S210S/OSN/OSD/OSR/OSL/OSO/SOS** for a finished height of **71.5"/72"**. Standard with pre-mounted "J" bracket for wall mount applications. For use under **Z30S330S/OSN** for a finished height of **84"/84.5"**

• **NOTE:** Care should be taken to mount the units. Units should be mounted to wall studs using correct fasteners. Failure to do so may result in collapse of the unit and subsequent personal injury. **Mounting hardware not included.** Mounting hardware used should be based on wall material. Consult an installation professional for proper wall mounting.



Wall Mounted Tackboard

ZWHT3621	1.25 x 36 x 20.5-21	100	8.40	1	1	\$388
					2	\$451
					3	\$514
					4	\$593
					5	\$680

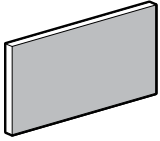
For use under **Z36S210S/OSN/OSD/OSR/OSL/OSO/SOS** for a finished height of **71.5"/72"**. Standard with pre-mounted "J" bracket for wall mount applications. For use under **Z36S330S/OSN** for a finished height of **84"/84.5"**

• **NOTE:** Care should be taken to mount the units. Units should be mounted to wall studs using correct fasteners. Failure to do so may result in collapse of the unit and subsequent personal injury. **Mounting hardware not included.** Mounting hardware used should be based on wall material. Consult an installation professional for proper wall mounting.

Required Specifications

Fabric

21" WALL MOUNTED TACKBOARDS

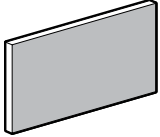


Wall Mounted Tackboard

MODEL#	DIMENSIONS D x W x H	FREIGHT CLASS	WT/LBS.	CUBIC FT.	FABRIC GRADE	LIST PRICE
ZWHT4221	1.25 x 42 x 20.5-21	100	9.80	1	1	\$448
					2	\$518
					3	\$595
					4	\$684
					5	\$785

For use under **Z42S210S/OSN/OSD/OSR/OSL/OSO/SOS** for a finished height of **71.5"/72"**. Standard with pre-mounted "J" bracket for wall mount applications. For use under **Z42S330S/OSN** for a finished height of **84"/84.5"**

• **NOTE:** Care should be taken to mount the units. Units should be mounted to wall studs using correct fasteners. Failure to do so may result in collapse of the unit and subsequent personal injury. **Mounting hardware not included.** Mounting hardware used should be based on wall material. Consult an installation professional for proper wall mounting.

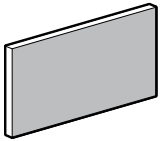


Wall Mounted Tackboard

ZWHT4821	1.25 x 48 x 20.5-21	92.5	11.20	1	1	\$488
					2	\$563
					3	\$647
					4	\$744
					5	\$854

For use under **Z48S210S/OSN/OSD/OSR/OSL/OSO/SOS** for a finished height of **71.5"/72"**. Standard with pre-mounted "J" bracket for wall mount applications. For use under **Z48S330S/OSN** for a finished height of **84"/84.5"**

• **NOTE:** Care should be taken to mount the units. Units should be mounted to wall studs using correct fasteners. Failure to do so may result in collapse of the unit and subsequent personal injury. **Mounting hardware not included.** Mounting hardware used should be based on wall material. Consult an installation professional for proper wall mounting.

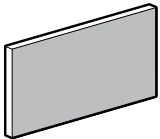


Wall Mounted Tackboard

ZWHT6021	1.25 x 60 x 20.5-21	125	14	1.80	1	\$604
					2	\$696
					3	\$801
					4	\$920
					5	\$1057

For use under **Z60S210S/OSN/OSD/OSR/OSL/OSO/SOS** for a finished height of **71.5"/72"**. Standard with pre-mounted "J" bracket for wall mount applications. For use under **Z60S330S/OSN** for a finished height of **84"/84.5"**

• **NOTE:** Care should be taken to mount the units. Units should be mounted to wall studs using correct fasteners. Failure to do so may result in collapse of the unit and subsequent personal injury. **Mounting hardware not included.** Mounting hardware used should be based on wall material. Consult an installation professional for proper wall mounting.

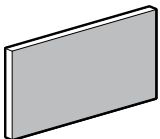


Wall Mounted Tackboard

ZWHT6621	1.25 x 66 x 20.5-21	100	15.40	1.80	1	\$641
					2	\$741
					3	\$850
					4	\$977
					5	\$1124

For use under **Z66S210S/OSN/OSD/OSR/OSL/OSO/SOS** for a finished height of **71.5"/72"**. Standard with pre-mounted "J" bracket for wall mount applications. For use under **Z66S330S/OSN** for a finished height of **84"/84.5"**

• **NOTE:** Care should be taken to mount the units. Units should be mounted to wall studs using correct fasteners. Failure to do so may result in collapse of the unit and subsequent personal injury. **Mounting hardware not included.** Mounting hardware used should be based on wall material. Consult an installation professional for proper wall mounting.



Wall Mounted Tackboard

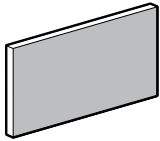
ZWHT7221	1.25 x 72 x 20.5-21	100	16.80	1.80	1	\$704
					2	\$812
					3	\$932
					4	\$1071
					5	\$1232

For use under **Z72S210S/OSN/OSD/OSR/OSL/OSO/SOS** for a finished height of **71.5"/72"**. Standard with pre-mounted "J" bracket for wall mount applications. For use under **Z72S330S/OSN** for a finished height of **84"/84.5"**

• **NOTE:** Care should be taken to mount the units. Units should be mounted to wall studs using correct fasteners. Failure to do so may result in collapse of the unit and subsequent personal injury. **Mounting hardware not included.** Mounting hardware used should be based on wall material. Consult an installation professional for proper wall mounting.

Required Specifications
Fabric

21" WALL MOUNTED TACKBOARDS

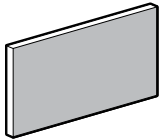


Wall Mounted Tackboard

MODEL#	DIMENSIONS D x W x H	FREIGHT CLASS	WT./LBS.	CUBIC FT.	FABRIC GRADE	LIST PRICE
ZWHT7821	1.25 x 78 x 20.5-21	92.5	18.20	1.80	1	\$740
					2	\$854
					3	\$982
					4	\$1128
					5	\$1296

For use under **Z78S210S/OSN/OSD/OSR/OSL/OSO/SOS** for a finished height of **71.5"/72"**. Standard with pre-mounted "J" bracket for wall mount applications. For use under **Z78S330S/OSN** for a finished height of **84"/84.5"**

• **NOTE:** Care should be taken to mount the units. Units should be mounted to wall studs using correct fasteners. Failure to do so may result in collapse of the unit and subsequent personal injury. **Mounting hardware not included.** Mounting hardware used should be based on wall material. Consult an installation professional for proper wall mounting.



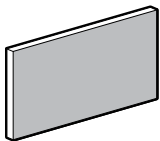
Wall Mounted Tackboard

ZWHT8421	1.25 x 84 x 20.5-21	92.5	19.60	1.80	1	\$806
					2	\$929
					3	\$1068
					4	\$1223
					5	\$1409

For use under **Z84S210S/OSN/OSD/OSR/OSL/OSO/SOS** for a finished height of **71.5"/72"**. Standard with pre-mounted "J" bracket for wall mount applications. For use under **Z84S330S/OSN** for a finished height of **84"/84.5"**

• **NOTE:** Care should be taken to mount the units. Units should be mounted to wall studs using correct fasteners. Failure to do so may result in collapse of the unit and subsequent personal injury. **Mounting hardware not included.** Mounting hardware used should be based on wall material. Consult an installation professional for proper wall mounting.

25" WALL MOUNTED TACKBOARDS

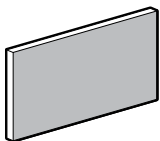


Wall Mounted Tackboard

MODEL#	DIMENSIONS	FREIGHT CLASS	WT./LBS.	CUBIC FT.	FABRIC GRADE	LIST PRICE
ZWHT3025	1.25 x 30 x 24.5-25	100	8.30	1	1	\$361
					2	\$419
					3	\$479
					4	\$548
					5	\$630

For use under **Z30S160S/OSN** for a finished height of **71.5"/72"**. Standard with pre-mounted "J" bracket for wall mount applications.

• **NOTE:** Care should be taken to mount the units. Units should be mounted to wall studs using correct fasteners. Failure to do so may result in collapse of the unit and subsequent personal injury. **Mounting hardware not included.** Mounting hardware used should be based on wall material. Consult an installation professional for proper wall mounting.

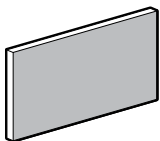


Wall Mounted Tackboard

ZWHT3625	1.25 x 36 x 24.5-25	92.5	10	1	1	\$400
					2	\$464
					3	\$532
					4	\$612
					5	\$699

For use under **Z36S160S/OSN** for a finished height of **71.5"/72"**. Standard with pre-mounted "J" bracket for wall mount applications.

• **NOTE:** Care should be taken to mount the units. Units should be mounted to wall studs using correct fasteners. Failure to do so may result in collapse of the unit and subsequent personal injury. **Mounting hardware not included.** Mounting hardware used should be based on wall material. Consult an installation professional for proper wall mounting.



Wall Mounted Tackboard

ZWHT4225	1.25 x 42 x 24.5-25	92.5	11.70	1	1	\$464
					2	\$536
					3	\$614
					4	\$706
					5	\$810

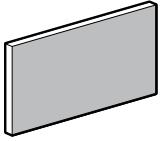
For use under **Z42S160S/OSN** for a finished height of **71.5"/72"**. Standard with pre-mounted "J" bracket for wall mount applications.

• **NOTE:** Care should be taken to mount the units. Units should be mounted to wall studs using correct fasteners. Failure to do so may result in collapse of the unit and subsequent personal injury. **Mounting hardware not included.** Mounting hardware used should be based on wall material. Consult an installation professional for proper wall mounting.

Required Specifications

Fabric

25" WALL MOUNTED TACKBOARDS

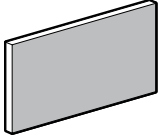


Wall Mounted Tackboard

MODEL#	DIMENSIONS D x W x H	FREIGHT CLASS	WT/LBS.	CUBIC FT.	FABRIC GRADE	LIST PRICE
ZWHT4825	1.25 x 48 x 24.5-25	85	13.30	1	1	\$504
					2	\$582
					3	\$669
					4	\$767
					5	\$882

For use under **Z48S160S/OSN** for a finished height of **71.5"/72"**. Standard with pre-mounted "J" bracket for wall mount applications.

- **NOTE:** Care should be taken to mount the units. Units should be mounted to wall studs using correct fasteners. Failure to do so may result in collapse of the unit and subsequent personal injury. **Mounting hardware not included.** Mounting hardware used should be based on wall material. Consult an installation professional for proper wall mounting.

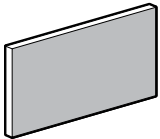


Wall Mounted Tackboard

ZWHT6025	1.25 x 60 x 24.5-25	100	16.70	1.80	1	\$621
					2	\$715
					3	\$823
					4	\$943
					5	\$1086

For use under **Z60S160S/OSN** for a finished height of **71.5"/72"**. Standard with pre-mounted "J" bracket for wall mount applications.

- **NOTE:** Care should be taken to mount the units. Units should be mounted to wall studs using correct fasteners. Failure to do so may result in collapse of the unit and subsequent personal injury. **Mounting hardware not included.** Mounting hardware used should be based on wall material. Consult an installation professional for proper wall mounting.

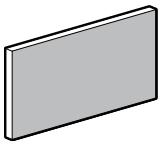


Wall Mounted Tackboard

ZWHT6625	1.25 x 66 x 24.5-25	92.5	18.30	1.80	1	\$661
					2	\$764
					3	\$876
					4	\$1005
					5	\$1155

For use under **ZxxS160S/OSN** for a finished height of **71.5"/72"**. Standard with pre-mounted "J" bracket for wall mount applications.

- **NOTE:** Care should be taken to mount the units. Units should be mounted to wall studs using correct fasteners. Failure to do so may result in collapse of the unit and subsequent personal injury. **Mounting hardware not included.** Mounting hardware used should be based on wall material. Consult an installation professional for proper wall mounting.

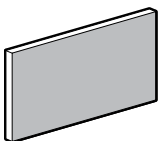


Wall Mounted Tackboard

ZWHT7225	1.25 x 72 x 24.5-25	92.5	20	1.80	1	\$725
					2	\$837
					3	\$960
					4	\$1103
					5	\$1267

For use under **ZxxS160S/OSN** for a finished height of **71.5"/72"**. Standard with pre-mounted "J" bracket for wall mount applications.

- **NOTE:** Care should be taken to mount the units. Units should be mounted to wall studs using correct fasteners. Failure to do so may result in collapse of the unit and subsequent personal injury. **Mounting hardware not included.** Mounting hardware used should be based on wall material. Consult an installation professional for proper wall mounting.



Wall Mounted Tackboard

ZWHT7825	1.25 x 78 x 24.5-25	85	21.70	1.80	1	\$763
					2	\$881
					3	\$1010
					4	\$1160
					5	\$1334

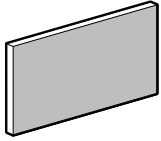
For use under **ZxxS160S/OSN** for a finished height of **71.5"/72"**. Standard with pre-mounted "J" bracket for wall mount applications.

- **NOTE:** Care should be taken to mount the units. Units should be mounted to wall studs using correct fasteners. Failure to do so may result in collapse of the unit and subsequent personal injury. **Mounting hardware not included.** Mounting hardware used should be based on wall material. Consult an installation professional for proper wall mounting.

Required Specifications

Fabric

25" WALL MOUNTED TACKBOARDS



Wall Mounted Tackboard

MODEL# DIMENSIONS FREIGHT CLASS WT/LBS. CUBIC FT. FABRIC GRADE LIST PRICE

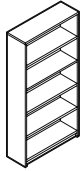
	D x W x H					
ZWHT8425	1.25 x 84 x 24.5-25	85	23.30	1.80	1	\$829
					2	\$955
					3	\$1096
					4	\$1261
					5	\$1448

For use under **ZxxS160S/OSN** for a finished height of **71.5"/72"**. Standard with pre-mounted "J" bracket for wall mount applications.

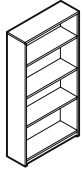
- **NOTE:** Care should be taken to mount the units. Units should be mounted to wall studs using correct fasteners. Failure to do so may result in collapse of the unit and subsequent personal injury. **Mounting hardware not included.** Mounting hardware used should be based on wall material. Consult an installation professional for proper wall mounting.

Required Specifications
Fabric

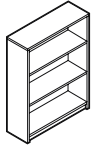
BOOKCASES



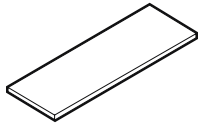
Bookcase - 72" High



Bookcase - 65.5" High



Bookcase - 48.5" High



Bookcase Shelf

MODEL#	DIMENSIONS	FREIGHT CLASS	WT./LBS.	CUBIC FT.	1"TOP	1.5" TOP	GLAZE ADD	HP ADD
--------	------------	---------------	----------	-----------	-------	----------	-----------	--------

	D x W x H							
ZHBC72	12 x 36 x 71.9-72.4	125	176	23	\$1150	\$1217	N/A	N/A

One fixed shelf.

ZHBC65	12 x 36 x 65.5-66	125	156	21	\$1113	\$1179	N/A	N/A
--------	-------------------	-----	-----	----	---------------	---------------	-----	-----

One fixed shelf and two adjustable shelves.

ZHBC48	12 x 36 x 48.5-49	125	122	15.75	\$843	\$909	N/A	N/A
--------	-------------------	-----	-----	-------	--------------	--------------	-----	-----

Two adjustable shelves.

ZHSHELF	11 x 34 x .5-1	100	13	1.50	\$295	N/A	N/A	N/A
---------	----------------	-----	----	------	--------------	-----	-----	-----

Extra shelf for bookcases. 1" thick.

TABLE TOP BOOKCASES

NOTE: UNITS UNDER 30"W MUST BE SECURELY FASTENED TO THE WALL OR GANGED TO AN ADJACENT UNIT 30"W OR WIDER

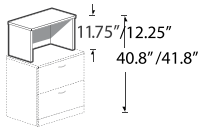


Table Top Bookcase 11.75"/12.25" High

Z36S12TN	16 x 36 x 11.25-11.75	100	44.91	5.25	\$336	\$403	N/A	N/A
Z30S12TN	16 x 30 x 11.25-11.75	100	39.33	4.30	\$308	\$366	N/A	N/A

To be placed **on top of 29"/29.5" high units to achieve 40.8"/41.8" final height** or placed on top of **40.8"/41.3" high units to achieve 52.5"/53.5" final height.**

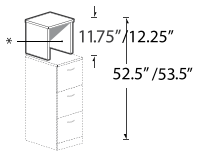


Table Top Bookcase 11.75"/12.25" High

Z21S12TN	16 x 21 x 11.25-11.75	100	28.87	3.10	\$258	\$304	N/A	N/A
Z18S12TN	16 x 18 x 11.25-11.75	92.5	27.13	2.70	\$247	\$289	N/A	N/A
Z16S12TN	16 x 16 x 11.25-11.75	92.5	24.57	2.40	\$235	\$273	N/A	N/A
Z15S12TN	16 x 15 x 11.25-11.75	92.5	24.34	2.30	\$225	\$258	N/A	N/A
Z12S12TN	16 x 12 x 11.25-11.75	92.5	21.55	1.90	\$213	\$242	N/A	N/A

To be placed **on top of 29"/29.5" high units to achieve 40.8"/41.8" final height** or placed on top of **40.8"/41.3" high units to achieve 52.5"/53.5" final height.**

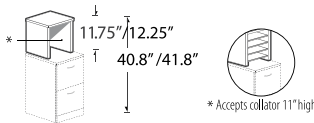


Table Top Bookcase 11.75"/12.25" High

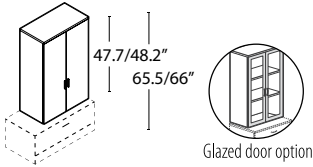
Required Specifications

- Top finish
- Base finish
- Top/Edge Detail

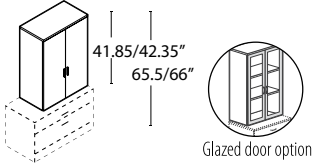
Optional Specifications

- Collator (open shelf)

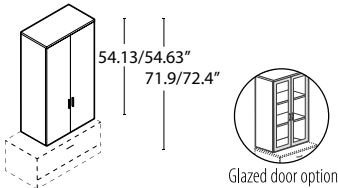
TABLE TOP BOOKCASES



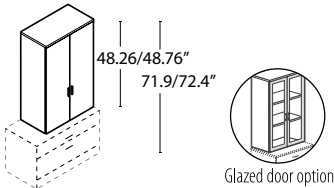
**Closed Table Top Bookcase
47.7" High**



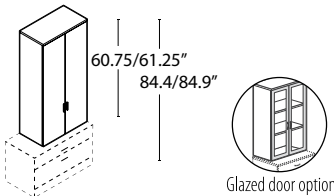
**Closed Table Top Bookcase
41" High**



**Closed Table Top Bookcase
54" High**



**Closed Table Top Bookcase
48" High**



**Closed Table Top Bookcase
61" High**

MODEL#	DIMENSIONS D x W x H	FREIGHT CLASS	WT/LBS.	CUBIC FT.	1" TOP	1.5" TOP	GLAZE ADD	HP ADD
Z36S48T	36 x 16 x 47.7	125	149	20.25	\$1370	\$1437	\$1443	N/A
Z30S48T	30 x 16 x 47.7	125	130	17	\$1251	\$1309	\$1246	N/A

Designed to be placed **on top of 17.87"/18.37" high units to achieve 65.5"/66" final height.**
Laminate doors are standard. **Includes one adjustable shelf.** Standard with lock.

Z36S41T	36 x 16 x 41.85	125	128	17.75	\$1126	\$1193	\$1252	N/A
Z30S41T	30 x 16 x 41.85	125	111	15	\$1179	\$1237	\$1091	N/A

Designed to be placed **on top of 23.75"/24.25" high units to achieve 65.5"/66" final height.**
Laminate doors are standard. **Includes one adjustable shelf.** Standard with lock.

Z36S54T	36 x 16 x 54.13	125	163	22.75	\$1617	\$1684	\$1443	N/A
Z30S54T	30 x 16 x 54.13	125	142	19	\$1251	\$1309	\$1246	N/A

Designed to be placed **on top of 17.87"/18.37" high units to achieve 71.9"/72.4" final height.**
Laminate doors are standard. **Includes one adjustable shelf.** Standard with lock.

Z36S49T	36 x 16 x 48.26	125	141	20.25	\$1437	\$1504	\$952	N/A
Z30S49T	30 x 16 x 48.26	125	123	17.25	\$1289	\$1346	\$850	N/A

Designed to be placed **on top of 23.75"/24.25" high units to achieve 71.9"/72.4" final height.**
Laminate doors are standard. **Includes one adjustable shelf.** Standard with lock.

Z36S61T	36 x 16 x 60.75	125	176	25.25	\$1697	\$1764	\$1132	N/A
Z30S61T	30 x 16 x 60.75	125	153	21.25	\$1517	\$1574	\$1010	N/A

Designed to be placed **on top of 23.75"/24.25" high units to achieve 84.4"/84.9" final height.**
Laminate doors are standard. **Includes one adjustable shelf.** Standard with lock.

Required Specifications

Top finish
Base finish
Top/Edge Detail

Optional Specifications

Glazed doors

TABLE TOP BOOKCASES

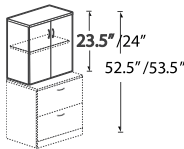


Table Top Bookcase 23.5"/24" High

MODEL#	DIMENSIONS D x W x H	FREIGHT CLASS	WT/LBS.	CUBIC FT.	1" TOP	1.5" TOP	GLAZE ADD	HP ADD
Z36S23T	16 x 36 x 23-23.5	100	87.45	9.50	\$804	\$871	\$792	N/A
Z30S23T	16 x 30 x 23-23.5	100	75.78	8	\$732	\$790	\$699	N/A

Designed to be placed **on top of 29"/29.5" high units to achieve 52.5"/53.5" final height.** DO NOT USE ON TOP OF 40.8"/41.3" HIGH UNITS. Laminate doors are standard. **Includes one adjustable shelf.** Standard with lock.

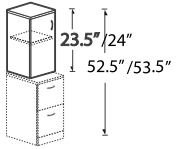


Table Top Bookcase with Door - LEFT 23.5"/24" High

Z21S23TL	16 x 21 x 23-23.5	92.5	58.83	5.75	\$573	\$618	\$432	N/A
Z18S23TL	16 x 18 x 23-23.5	92.5	54.65	5	\$552	\$590	\$395	N/A
Z16S23TL	16 x 16 x 23-23.5	92.5	46.71	4.50	\$490	\$528	\$386	N/A
Z15S23TL	16 x 15 x 23-23.5	92.5	46.06	4.20	\$465	\$498	\$348	N/A
Z12S23TL	16 x 12 x 23-23.5	92.5	40.77	3.50	\$434	\$463	\$314	N/A

Designed to be placed **on top of 29"/29.5" high units to achieve 52.5"/53.5" final height.** DO NOT USE ON TOP OF 40.8"/41.3" HIGH UNITS. Laminate door is standard. **Includes one adjustable shelf.** Standard with lock.

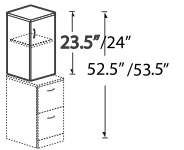


Table Top Bookcase with Door - RIGHT 23.5"/24" High

Z21S23TR	16 x 21 x 23-23.5	92.5	58.83	5.75	\$573	\$618	\$432	N/A
Z18S23TR	16 x 18 x 23-23.5	92.5	54.65	5	\$552	\$590	\$395	N/A
Z16S23TR	16 x 16 x 23-23.5	92.5	46.71	4.50	\$490	\$528	\$386	N/A
Z15S23TR	16 x 15 x 23-23.5	92.5	46.06	4.20	\$465	\$498	\$348	N/A
Z12S23TR	16 x 12 x 23-23.5	92.5	40.77	3.50	\$434	\$463	\$314	N/A

Designed to be placed **on top of 29"/29.5" high units to achieve 52.5"/53.5" final height.** DO NOT USE ON TOP OF 40.8"/41.3" HIGH UNITS. Laminate door is standard. **Includes one adjustable shelf.** Standard with lock.

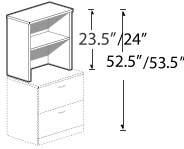


Table Top Bookcase 23.5"/24" High

Z36S23TN	16 x 36 x 23-23.5	125	69.06	9.50	\$526	\$593	N/A	N/A
Z30S23TN	16 x 30 x 23-23.5	125	60.33	8	\$483	\$540	N/A	N/A

Designed to be placed **on top of 29"/29.5" high units to achieve 52.5"/53.5" final height.** DO NOT USE ON TOP OF 40.8"/41.3" HIGH UNITS. **Includes one adjustable shelf.**

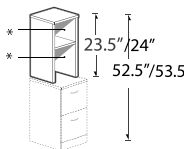


Table Top Bookcase 23.5"/24" High*

Z21S23TN	16 x 21 x 23-23.5	100	47.77	5.75	\$411	\$456	N/A	N/A
Z18S23TN	16 x 18 x 23-23.5	100	44.98	5	\$404	\$442	N/A	N/A
Z16S23TN	16 x 16 x 23-23.5	100	38.22	4.50	\$343	\$381	N/A	N/A
Z15S23TN	16 x 15 x 23-23.5	100	37	4.20	\$329	\$361	N/A	N/A
Z12S23TN	16 x 12 x 23-23.5	100	34.15	3.50	\$307	\$337	N/A	N/A

Designed to be placed **on top of 29"/29.5" high units to achieve 52.5"/53.5" final height.** DO NOT USE ON TOP OF 40.8"/41.3" HIGH UNITS. **Includes one adjustable shelf.**

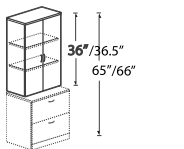


Table Top Bookcase with Doors 36"/36.5" High

Z36S36T	16 x 36 x 35.5-36	100	124.30	14.25	\$1033	\$1100	\$1021	N/A
Z30S36T	16 x 30 x 35.5-36	100	106.67	12	\$894	\$951	\$893	N/A

Designed to be placed **on top of 29"/29.5" high units to achieve 65"/66" final height.** Laminate doors are standard. **Includes two adjustable shelves.** Standard with lock.

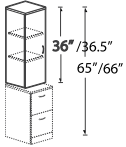
Required Specifications

Top finish
Base finish
Top/Edge Detail

Optional Specifications

Collator*
Glazed doors

TABLE TOP BOOKCASES

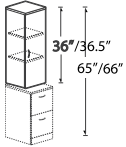


**Table Top Bookcase with Doors
36"/36.5" High - LEFT**



MODEL#	DIMENSIONS	FREIGHT CLASS	WT./LBS.	CUBIC FT.	1" TOP	1.5" TOP	GLAZE ADD	HP ADD
D x W x H								
Z21S36TL	16 x 21 x 35.5-36	100	82.99	8.75	\$732	\$778	\$561	N/A
Z18S36TL	16 x 18 x 35.5-36	100	74.72	7.50	\$700	\$738	\$507	N/A
Z16S36TL	16 x 16 x 35.5-36	92.5	67.82	6.75	\$640	\$678	\$499	N/A
Z15S36TL	16 x 15 x 35.5-36	92.5	66.46	6.50	\$609	\$642	\$444	N/A
Z12S36TL	16 x 12 x 35.5-36	92.5	59.30	5.25	\$565	\$594	\$400	N/A

Designed to be placed **on top of 29"/29.5" high units to achieve 65"/66" final height.** Laminate door is standard.
Includes two adjustable shelves. Standard with lock.

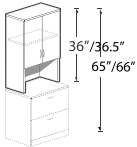


**Table Top Bookcase with Doors
36"/36.5" High - RIGHT**



Z21S36TR	16 x 21 x 35.5-36	100	82.99	8.75	\$732	\$778	\$561	N/A
Z18S36TR	16 x 18 x 35.5-36	100	74.72	7.50	\$700	\$738	\$507	N/A
Z16S36TR	16 x 16 x 35.5-36	92.5	67.82	6.75	\$640	\$678	\$499	N/A
Z15S36TR	16 x 15 x 35.5-36	92.5	66.46	6.50	\$609	\$642	\$444	N/A
Z12S36TR	16 x 12 x 35.5-36	92.5	59.30	5.25	\$565	\$594	\$400	N/A

Designed to be placed **on top of 29"/29.5" high units to achieve 65"/66" final height.** Laminate door is standard.
Includes two adjustable shelves. Standard with lock.

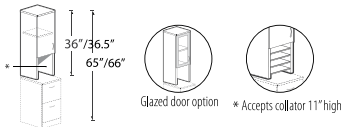


**Table Top Bookcase with Doors and
Cavity - 36"/36.5" High**

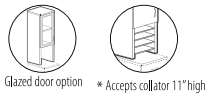


Z36S36TC	16 x 36 x 35.5-36	100	116.98	14.25	\$976	\$1043	\$902	N/A
Z30S36TC	16 x 30 x 35.5-36	100	100.58	12	\$845	\$903	\$786	N/A

Designed to be placed **on top of 29"/29.5" high units to achieve 65"/66" final height.** Laminate doors are standard.
Includes one adjustable shelf. Standard with lock.

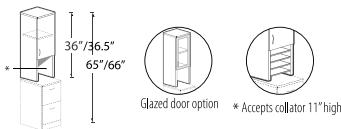


**Table Top Bookcase with Doors and*
Cavity - 36"/36.5" High - LEFT**

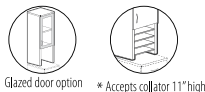


Z21S36TCL	16 x 21 x 35.5-36	100	78.72	8.75	\$697	\$743	\$501	N/A
Z18S36TCL	16 x 18 x 35.5-36	100	71.07	7.50	\$672	\$714	\$451	N/A
Z16S36TCL	16 x 16 x 35.5-36	100	64.57	6.75	\$610	\$648	\$444	N/A
Z15S36TCL	16 x 15 x 35.5-36	100	63.42	6.50	\$586	\$618	\$394	N/A
Z12S36TCL	16 x 12 x 35.5-36	92.5	56.87	5.25	\$545	\$575	\$353	N/A

Designed to be placed **on top of 29"/29.5" high units to achieve 65"/66" final height.** Laminate door is standard.
Includes one adjustable shelf. Standard with lock.



**Table Top Bookcase with Doors and*
Cavity - 36"/36.5" High - RIGHT**



Z21S36TCR	16 x 21 x 35.5-36	100	78.72	8.75	\$697	\$743	\$501	N/A
Z18S36TCR	16 x 18 x 35.5-36	100	71.07	7.50	\$672	\$714	\$451	N/A
Z16S36TCR	16 x 16 x 35.5-36	100	64.57	6.75	\$610	\$648	\$444	N/A
Z15S36TCR	16 x 15 x 35.5-36	100	63.42	6.50	\$586	\$618	\$394	N/A
Z12S36TCR	16 x 12 x 35.5-36	92.5	56.87	5.25	\$545	\$575	\$353	N/A

Designed to be placed **on top of 29"/29.5" high units to achieve 65"/66" final height.** Laminate door is standard.
Includes one adjustable shelf. Standard with lock.

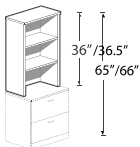


Table Top Bookcase 36"/36.5" High

Z36S36TN	16 x 36 x 35.5-36	125	95.31	14.25	\$694	\$763	N/A	N/A
Z30S36TN	16 x 30 x 35.5-36	125	82.38	12	\$591	\$649	N/A	N/A

Designed to be placed **on top of 29"/29.5" high units to achieve 65"/66" final height.** **Includes two adjustable shelves.**

Required Specifications

Top finish
Base finish
Top/Edge Detail

Optional Specifications

Collator*
Glazed doors

TABLE TOP BOOKCASES

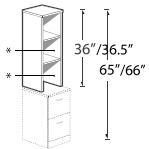


Table Top Bookcase 36"/36.5" High*

MODEL#	DIMENSIONS D x W x H	FREIGHT CLASS	WT/LBS.	CUBIC FT.	1" TOP	1.5" TOP	GLAZE ADD	HP ADD
Z21S36TN	16 x 21 x 35.5-36	125	65.62	8.75	\$537	\$583	N/A	N/A
Z18S36TN	16 x 18 x 35.5-36	125	59.68	7.50	\$523	\$565	N/A	N/A
Z16S36TN	16 x 16 x 35.5-36	100	56	6.75	\$463	\$501	N/A	N/A
Z15S36TN	16 x 15 x 35.5-36	100	53.74	6.50	\$448	\$481	N/A	N/A
Z12S36TN	16 x 12 x 35.5-36	125	48.85	6.25	\$418	\$447	N/A	N/A

Designed to be placed on top of 29"/29.5" high units to achieve 65"/66" final height. Includes two adjustable shelves.

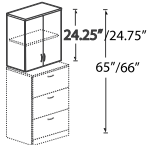


Table Top Bookcase with Doors 24.25"/24.75" High

Z36S24T	16 x 36 x 23.75-24.25	100	89.26	10	\$806	\$873	\$902	N/A
Z30S24T	16 x 30 x 23.75-24.25	100	77.47	8.25	\$736	\$793	\$786	N/A

Designed to be placed on top of 40.8"/41.3" high units to achieve 65"/66" final height. DO NOT USE ON TOP OF 29"/29.5 HIGH UNITS. Laminate doors are standard. Includes one adjustable shelf. Standard with lock.

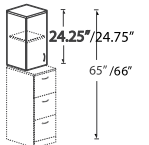


Table Top Bookcase with Door - LEFT 24.25"/24.75" High

Z21S24TL	16 x 21 x 23.75-24.25	100	59.24	6	\$573	\$619	\$501	N/A
Z18S24TL	16 x 18 x 23.75-24.25	92.5	56.11	5.25	\$553	\$591	\$451	N/A
Z16S24TL	16 x 16 x 23.75-24.25	92.5	48.13	4.60	\$491	\$529	\$444	N/A
Z15S24TL	16 x 15 x 23.75-24.25	92.5	46.35	4.30	\$466	\$499	\$394	N/A
Z12S24TL	16 x 12 x 23.75-24.25	85	44.32	3.60	\$435	\$464	\$353	N/A

Designed to be placed on top of 40.8"/41.3" high units to achieve 65"/66" final height. DO NOT USE ON TOP OF 29"/29.5 HIGH UNITS. Laminate door is standard. Includes one adjustable shelf. Standard with lock.

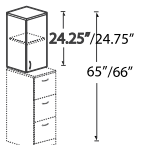


Table Top Bookcase with Door - RIGHT 24.25"/24.75" High

Z21S24TR	16 x 21 x 23.75-24.25	100	59.24	6	\$573	\$619	\$501	N/A
Z18S24TR	16 x 18 x 23.75-24.25	92.5	56.11	5.25	\$553	\$591	\$451	N/A
Z16S24TR	16 x 16 x 23.75-24.25	92.5	48.13	4.60	\$491	\$529	\$444	N/A
Z15S24TR	16 x 15 x 23.75-24.25	92.5	46.35	4.30	\$466	\$499	\$394	N/A
Z12S24TR	16 x 12 x 23.75-24.25	85	44.32	3.60	\$435	\$464	\$353	N/A

Designed to be placed on top of 40.8"/41.3" high units to achieve 65"/66" final height. DO NOT USE ON TOP OF 29"/29.5 HIGH UNITS. Laminate door is standard. Includes one adjustable shelf. Standard with lock.

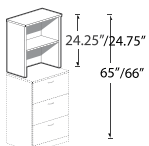


Table Top Bookcase 24.25"/24.75" High

Z36S24TN	16 x 36 x 23.75-24.25	125	70.11	10	\$526	\$595	N/A	N/A
Z30S24TN	16 x 30 x 23.75-24.25	125	61.38	8.25	\$483	\$541	N/A	N/A

Designed to be placed on top of 40.8"/41.3" high units to achieve 65"/66" final height. DO NOT USE ON TOP OF 29"/29.5 HIGH UNITS. Includes one adjustable shelf.

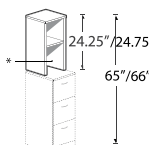


Table Top Bookcase* 24.25"/24.75" High

Z21S24TN	16 x 21 x 23.75-24.25	125	47.77	6	\$411	\$457	N/A	N/A
Z18S24TN	16 x 18 x 23.75-24.25	100	46.03	5.25	\$404	\$446	N/A	N/A
Z16S24TN	16 x 16 x 23.75-24.25	100	39.27	4.60	\$344	\$382	N/A	N/A
Z15S24TN	16 x 15 x 23.75-24.25	100	37.99	4.30	\$329	\$362	N/A	N/A
Z12S24TN	16 x 12 x 23.75-24.25	92.5	37.30	3.60	\$308	\$337	N/A	N/A

Designed to be placed on top of 40.8"/41.3" high units to achieve 65"/66" final height. DO NOT USE ON TOP OF 29"/29.5 HIGH UNITS. Includes one adjustable shelf.

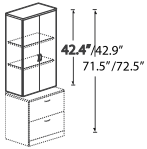
Required Specifications

- Top finish
- Base finish
- Top/Edge Detail

Optional Specifications

- Collator*
- Glazed doors

TABLE TOP BOOKCASES

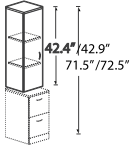


Glazed door option

Table Top Bookcase with Doors
42.4\"/>

MODEL#	DIMENSIONS	FREIGHT CLASS	WT/LBS.	CUBIC FT.	1\"/>			
Z36S42T	16 x 36 x 41.9-42.4	100	137.40	16.75	\$1126	\$1193	\$1252	N/A
Z30S42T	16 x 30 x 41.9-42.4	100	119.06	14	\$983	\$1041	\$1091	N/A

Designed to be placed **on top of 29\"/>**

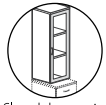
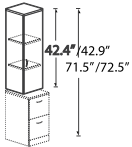


Glazed door option

Table Top Bookcase with Door - LEFT
42.4\"/>

Z21S42TL	16 x 21 x 41.9-42.4	300	119	70	\$798	\$844	\$693	N/A
Z18S42TL	16 x 18 x 41.9-42.4	85	117	8.75	\$766	\$804	\$623	N/A
Z16S42TL	16 x 16 x 41.9-42.4	300	112	62	\$691	\$729	\$617	N/A
Z15S42TL	16 x 15 x 41.9-42.4	250	109	54	\$655	\$687	\$542	N/A
Z12S42TL	16 x 12 x 41.9-42.4	250	105	49	\$609	\$639	\$489	N/A

Designed to be placed **on top of 29\"/>**

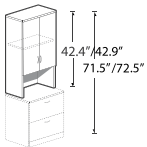


Glazed door option

Table Top Bookcase with Door - RIGHT
42.4\"/>

Z21S42TR	16 x 21 x 41.9-42.4	300	119	70	\$798	\$844	\$693	N/A
Z18S42TR	16 x 18 x 41.9-42.4	85	117	8.75	\$766	\$804	\$623	N/A
Z16S42TR	16 x 16 x 41.9-42.4	300	112	62	\$691	\$729	\$617	N/A
Z15S42TR	16 x 15 x 41.9-42.4	250	109	54	\$655	\$687	\$542	N/A
Z12S42TR	16 x 12 x 41.9-42.4	250	105	49	\$609	\$639	\$489	N/A

Designed to be placed **on top of 29\"/>**

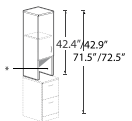


Glazed door option

Table Top Bookcase with Doors and Cavity
42.4\"/>

Z36S42TC	16 x 36 x 41.9-42.4	125	130.09	16.75	\$1091	\$1158	\$985	N/A
Z30S42TC	16 x 30 x 41.9-42.4	100	112.97	14	\$953	\$1011	\$857	N/A

Designed to be placed **on top of 29\"/>**

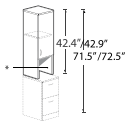


* Accepts collator 11\"/>

Table Top Bookcase with Door and* Cavity
42.4\"/>

Z21S42TCL	16 x 21 x 41.9-42.4	100	87.84	10	\$780	\$825	\$547	N/A
Z18S42TCL	16 x 18 x 41.9-42.4	100	79.83	8.75	\$749	\$787	\$492	N/A
Z16S42TCL	16 x 16 x 41.9-42.4	100	73.75	8	\$672	\$710	\$488	N/A
Z15S42TCL	16 x 15 x 41.9-42.4	100	70.71	7.50	\$640	\$672	\$429	N/A
Z12S42TCL	16 x 12 x 41.9-42.4	92.5	62.70	6	\$593	\$623	\$386	N/A

Designed to be placed **on top of 29\"/>**



* Accepts collator 11\"/>

Table Top Bookcase with Door and* Cavity
42.4\"/>

Z21S42TCR	16 x 21 x 41.9-42.4	100	87.84	10	\$780	\$825	\$547	N/A
Z18S42TCR	16 x 18 x 41.9-42.4	100	79.83	8.75	\$749	\$787	\$492	N/A
Z16S42TCR	16 x 16 x 41.9-42.4	100	73.75	8	\$672	\$710	\$488	N/A
Z15S42TCR	16 x 15 x 41.9-42.4	100	70.71	7.50	\$640	\$672	\$429	N/A
Z12S42TCR	16 x 12 x 41.9-42.4	92.5	62.70	6	\$593	\$623	\$386	N/A

Designed to be placed **on top of 29\"/>**

Required Specifications

Top finish
Base finish
Top/Edge Detail

Optional Specifications

Collator*
Glazed doors

TABLE TOP BOOKCASES

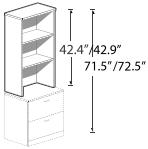
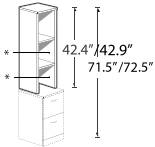
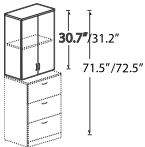


Table Top Bookcase
42.4\"/>



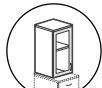
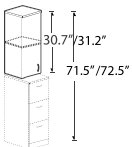
* Accepts collator 11\"/>

Table Top Bookcase*
42.4\"/>



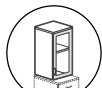
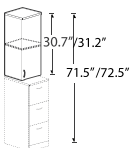
Glazed door option

Table Top Bookcase with Doors
30.7\"/>



Glazed door option

Table Top Bookcase with Door
30.7\"/>



Glazed door option

Table Top Bookcase with Door
30.7\"/>

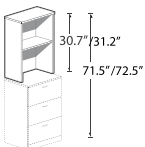


Table Top Bookcase
30.7\"/>

MODEL#	DIMENSIONS D x W x H	FREIGHT CLASS	WT/LBS.	CUBIC FT.	1" TOP	1.5" TOP	GLAZE ADD	HP ADD
Z36S42TN	16 x 36 x 41.9-42.4	125	103.71	16.75	\$756	\$823	N/A	N/A
Z30S42TN	16 x 30 x 41.9-42.4	125	90.78	14	\$658	\$716	N/A	N/A

Designed to be placed **on top of 29\"/>**

Z21S42TN	16 x 21 x 41.9-42.4	125	71.92	10	\$586	\$632	N/A	N/A
Z18S42TN	16 x 18 x 41.9-42.4	125	65.98	8.75	\$573	\$611	N/A	N/A
Z16S42TN	16 x 16 x 41.9-42.4	125	61.32	8	\$495	\$533	N/A	N/A
Z15S42TN	16 x 15 x 41.9-42.4	125	58.99	7.50	\$483	\$516	N/A	N/A
Z12S42TN	16 x 12 x 41.9-42.4	100	53.05	6	\$450	\$479	N/A	N/A

Designed to be placed **on top of 29\"/>**

Z36S31T	16 x 36 x 30.2-30.7	100	104.19	12.25	\$886	\$953	\$985	N/A
Z30S31T	16 x 30 x 30.2-30.7	100	89.36	10.50	\$793	\$851	\$857	N/A

Designed to be placed **on top of 40.8\"/>**

Z21S31TL	16 x 21 x 30.2-30.7	100	69.88	7.50	\$634	\$680	\$547	N/A
Z18S31TL	16 x 18 x 30.2-30.7	92.5	65.22	6.50	\$580	\$618	\$492	N/A
Z16S31TL	16 x 16 x 30.2-30.7	92.5	59.18	5.75	\$553	\$591	\$488	N/A
Z15S31TL	16 x 15 x 30.2-30.7	92.5	56.15	5.50	\$528	\$560	\$429	N/A
Z12S31TL	16 x 12 x 30.2-30.7	92.5	50.39	4.40	\$492	\$522	\$386	N/A

Designed to be placed **on top of 40.8\"/>**

Z21S31TR	16 x 21 x 30.2-30.7	100	69.88	7.50	\$634	\$680	\$547	N/A
Z18S31TR	16 x 18 x 30.2-30.7	92.5	65.22	6.50	\$580	\$618	\$492	N/A
Z16S31TR	16 x 16 x 30.2-30.7	92.5	59.18	5.75	\$553	\$591	\$488	N/A
Z15S31TR	16 x 15 x 30.2-30.7	92.5	56.15	5.50	\$528	\$560	\$429	N/A
Z12S31TR	16 x 12 x 30.2-30.7	92.5	50.39	4.40	\$492	\$522	\$386	N/A

Designed to be placed **on top of 40.8\"/>**

Z36S31TN	16 x 36 x 30.2-30.7	125	79.56	12.25	\$577	\$644	N/A	N/A
Z30S31TN	16 x 30 x 30.2-30.7	125	68.73	10.50	\$520	\$577	N/A	N/A

Designed to be placed **on top of 40.8\"/>**

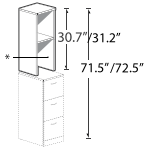
Required Specifications

Top finish
Base finish
Top/Edge Detail

Optional Specifications

Collator*
Glazed doors

TABLE TOP BOOKCASES

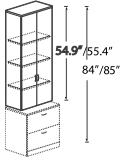


* Accepts collator 11\"/>

Table Top Bookcase*
30.7\"/>

MODEL#	DIMENSIONS D x W x H	FREIGHT CLASS	WT./LBS.	CUBIC FT.	1\"/>			
Z21S31TN	16 x 21 x 30.2-30.7	125	55.12	7.50	\$454	\$499	N/A	N/A
Z18S31TN	16 x 18 x 30.2-30.7	100	52.33	6.50	\$416	\$454	N/A	N/A
Z16S31TN	16 x 16 x 30.2-30.7	100	47.67	5.75	\$394	\$432	N/A	N/A
Z15S31TN	16 x 15 x 30.2-30.7	100	45.34	5.50	\$381	\$413	N/A	N/A
Z12S31TN	16 x 12 x 30.2-30.7	100	41.50	4.40	\$354	\$383	N/A	N/A

Designed to be placed **on top of 40.8\"/>**

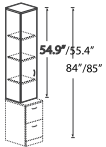


Glazed door option

Table Top Bookcase with Doors
54.9\"/>

Z36S55T	16 x 36 x 54.4-54.9	100	174.25	21.50	\$1370	\$1437	\$1443	N/A
Z30S55T	16 x 30 x 54.4-54.9	100	152.16	18	\$1251	\$1309	\$1246	N/A

Designed to be placed **on top of 29\"/>**

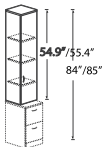


Glazed door option

Table Top Bookcase with Door - LEFT
54.9\"/>

Z21S55TL	16 x 21 x 54.4-54.9	100	116.26	13	\$972	\$1018	\$804	N/A
Z18S55TL	16 x 18 x 54.4-54.9	100	104.66	11.25	\$913	\$955	\$719	N/A
Z16S55TL	16 x 16 x 54.4-54.9	100	97.67	10	\$870	\$908	\$712	N/A
Z15S55TL	16 x 15 x 54.4-54.9	100	94.17	9.50	\$830	\$862	\$620	N/A
Z12S55TL	16 x 12 x 54.4-54.9	92.5	83.67	7.75	\$769	\$798	\$553	N/A

Designed to be placed **on top of 29\"/>**

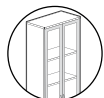
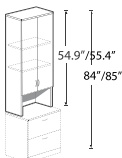


Glazed door option

Table Top Bookcase with Door - RIGHT
54.9\"/>

Z21S55TR	16 x 21 x 54.4-54.9	100	116.26	13	\$972	\$1018	\$804	N/A
Z18S55TR	16 x 18 x 54.4-54.9	100	104.66	11.25	\$913	\$955	\$719	N/A
Z16S55TR	16 x 16 x 54.4-54.9	100	97.67	10	\$870	\$908	\$712	N/A
Z15S55TR	16 x 15 x 54.4-54.9	100	94.17	9.50	\$830	\$862	\$620	N/A
Z12S55TR	16 x 12 x 54.4-54.9	92.5	83.67	7.75	\$769	\$798	\$553	N/A

Designed to be placed **on top of 29\"/>**

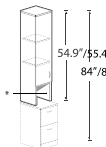


Glazed door option

Table Top Bookcase with Doors and Cavity
54.9\"/>

Z36S55TC	16 x 36 x 54.4-54.9	125	166.94	21.50	\$1334	\$1401	\$1257	N/A
Z30S55TC	16 x 30 x 54.4-54.9	100	146.06	18	\$1219	\$1277	\$1095	N/A

Designed to be placed **on top of 29\"/>**



* Accepts collator 11\"/>

Table Top Bookcase with Door - LEFT and Cavity
54.9\"/>

Z21S55TCL	16 x 21 x 54.4-54.9	100	112	13	\$939	\$984	\$696	N/A
Z18S55TCL	16 x 18 x 54.4-54.9	100	101.01	11.25	\$885	\$923	\$625	N/A
Z16S55TCL	16 x 16 x 54.4-54.9	100	94.42	10	\$837	\$879	\$618	N/A
Z15S55TCL	16 x 15 x 54.4-54.9	100	91.12	9.50	\$799	\$832	\$545	N/A
Z12S55TCL	16 x 12 x 54.4-54.9	92.5	81.24	7.75	\$742	\$771	\$491	N/A

Designed to be placed **on top of 29\"/>**

Required Specifications

Top finish
Base finish
Top/Edge Detail

Optional Specifications

Collator*
Glazed doors

TABLE TOP BOOKCASES

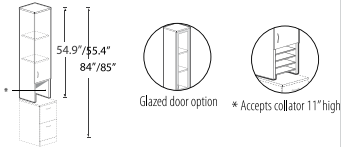


Table Top Bookcase with Door - RIGHT and Cavity - 54.9\"/>

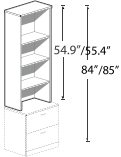


Table Top Bookcase 54.9\"/>

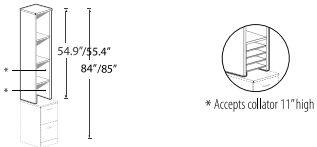


Table Top Bookcase* 54.9\"/>

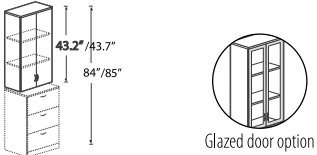


Table Top Bookcase with Doors 43.2\"/>



Table Top Bookcase with Door 43.2\"/>



Table Top Bookcase with Door 43.2\"/>

MODEL#	DIMENSIONS D x W x H	FREIGHT CLASS	WT/LBS.	CUBIC FT.	1" TOP	1.5" TOP	GLAZE ADD	HP ADD
Z21S55TCR	16 x 21 x 54.4-54.9	100	112	13	\$939	\$984	\$696	N/A
Z18S55TCR	16 x 18 x 54.4-54.9	100	101.01	11.25	\$885	\$923	\$625	N/A
Z16S55TCR	16 x 16 x 54.4-54.9	100	94.42	10	\$837	\$879	\$618	N/A
Z15S55TCR	16 x 15 x 54.4-54.9	100	91.12	9.50	\$799	\$832	\$545	N/A
Z12S55TCR	16 x 12 x 54.4-54.9	92.5	81.24	7.75	\$742	\$771	\$491	N/A

Designed to be placed **on top of 29\"/>**

Z36S55TN	16 x 36 x 54.4-54.9	125	129.96	21.50	\$912	\$979	N/A	N/A
Z30S55TN	16 x 30 x 54.4-54.9	125	114.93	18	\$849	\$906	N/A	N/A

Designed to be placed **on top of 29\"/>**

Z21S55TN	16 x 21 x 54.4-54.9	125	89.77	13	\$711	\$756	N/A	N/A
Z18S55TN	16 x 18 x 54.4-54.9	125	81.73	11.25	\$677	\$715	N/A	N/A
Z16S55TN	16 x 16 x 54.4-54.9	125	77.07	10	\$633	\$671	N/A	N/A
Z15S55TN	16 x 15 x 54.4-54.9	125	74.74	9.50	\$618	\$651	N/A	N/A
Z12S55TN	16 x 12 x 54.4-54.9	100	67.75	7.75	\$577	\$606	N/A	N/A

Designed to be placed **on top of 29\"/>**

Z36S43T	16 x 36 x 42.7-43.2	100	139.22	17	\$1151	\$1218	\$1257	N/A
Z30S43T	16 x 30 x 42.7-43.2	100	120.76	14.50	\$983	\$1041	\$1095	N/A

Designed to be placed **on top of 40.8\"/>**

Z21S43TL	16 x 21 x 42.7-43.2	100	93.62	10.25	\$815	\$860	\$696	N/A
Z18S43TL	16 x 18 x 42.7-43.2	100	84.94	9	\$780	\$818	\$625	N/A
Z16S43TL	16 x 16 x 42.7-43.2	100	78.42	8	\$699	\$737	\$618	N/A
Z15S43TL	16 x 15 x 42.7-43.2	92.5	75.16	7.50	\$658	\$690	\$545	N/A
Z12S43TL	16 x 12 x 42.7-43.2	92.5	66.48	6.25	\$610	\$640	\$491	N/A

Designed to be placed **on top of 40.8\"/>**

Z21S43TR	16 x 21 x 42.7-43.2	100	93.62	10.25	\$815	\$860	\$696	N/A
Z18S43TR	16 x 18 x 42.7-43.2	100	84.94	9	\$780	\$818	\$625	N/A
Z16S43TR	16 x 16 x 42.7-43.2	100	78.42	8	\$699	\$737	\$618	N/A
Z15S43TR	16 x 15 x 42.7-43.2	92.5	75.16	7.50	\$658	\$690	\$545	N/A
Z12S43TR	16 x 12 x 42.7-43.2	92.5	66.48	6.25	\$610	\$640	\$491	N/A

Designed to be placed **on top of 40.8\"/>**

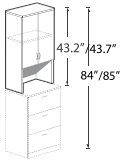
Required Specifications

- Top finish
- Base finish
- Top/Edge Detail

Optional Specifications

- Collator*
- Glazed doors

TABLE TOP BOOKCASES

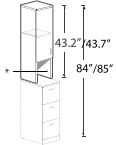


Glazed door option

Table Top Bookcase with Doors and Cavity - 43.2\"/>

MODEL#	DIMENSIONS	FREIGHT CLASS	WT/LBS.	CUBIC FT.	1\"/>			
Z36S43TC	16 x 36 x 42.7-43.2	125	131.91	17	\$1113	\$1180	\$989	N/A
Z30S43TC	16 x 30 x 42.7-43.2	125	114.67	14.50	\$974	\$1031	\$843	N/A

Designed to be placed **on top of 40.8\"/>**

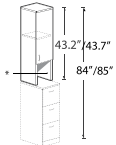


Glazed door option * Accepts collator 11\"/>

Table Top Bookcase with Door and Cavity - 43.2\"/>

Z21S43TCL	16 x 21 x 42.7-43.2	100	89.36	10.25	\$793	\$839	\$546	N/A
Z18S43TCL	16 x 18 x 42.7-43.2	100	81.29	9	\$761	\$799	\$491	N/A
Z16S43TCL	16 x 16 x 42.7-43.2	100	75.17	8	\$681	\$719	\$486	N/A
Z15S43TCL	16 x 15 x 42.7-43.2	100	72.11	7.50	\$642	\$674	\$428	N/A
Z12S43TCL	16 x 12 x 42.7-43.2	92.5	64.05	6.25	\$596	\$626	\$386	N/A

Designed to be placed **on top of 40.8\"/>**



Glazed door option * Accepts collator 11\"/>

Table Top Bookcase with Door and Cavity - 43.2\"/>

Z21S43TCR	16 x 21 x 42.7-43.2	100	89.36	10.25	\$793	\$839	\$546	N/A
Z18S43TCR	16 x 18 x 42.7-43.2	100	81.29	9	\$761	\$799	\$491	N/A
Z16S43TCR	16 x 16 x 42.7-43.2	100	75.17	8	\$681	\$719	\$486	N/A
Z15S43TCR	16 x 15 x 42.7-43.2	100	72.11	7.50	\$642	\$674	\$428	N/A
Z12S43TCR	16 x 12 x 42.7-43.2	92.5	64.05	6.25	\$596	\$626	\$386	N/A

Designed to be placed **on top of 40.8\"/>**

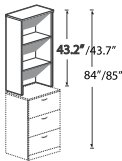
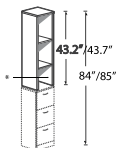


Table Top Bookcase 43.2\"/>

Z36S43TN	16 x 36 x 42.7-43.2	125	104.76	17	\$779	\$846	N/A	N/A
Z30S43TN	16 x 30 x 42.7-43.2	125	91.83	14.50	\$675	\$733	N/A	N/A

Designed to be placed **on top of 40.8\"/>**



* Accepts collator 11\"/>

Table Top Bookcase* 43.2\"/>

Z21S43TN	16 x 21 x 42.7-43.2	125	72.97	10.25	\$601	\$647	N/A	N/A
Z18S43TN	16 x 18 x 42.7-43.2	125	67.03	9	\$585	\$623	N/A	N/A
Z16S43TN	16 x 16 x 42.7-43.2	125	62.37	8	\$503	\$541	N/A	N/A
Z15S43TN	16 x 15 x 42.7-43.2	100	60.04	7.50	\$484	\$517	N/A	N/A
Z12S43TN	16 x 12 x 42.7-43.2	100	54.10	6.25	\$451	\$480	N/A	N/A

Designed to be placed **on top of 40.8\"/>**

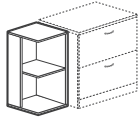
Required Specifications

Top finish
Base finish
Top/Edge Detail

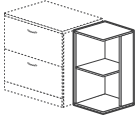
Optional Specifications

Collator**
Glazed doors*

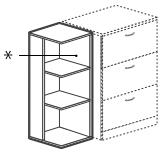
END SHELVES



End Shelf - LEFT 29"/29.5" High*

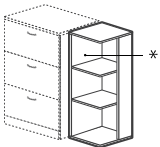


End Shelf - RIGHT 29"/29.5" High*



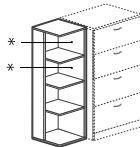
* Accepts collator 11" high

End Shelf - LEFT 40.8"/41.3" High**



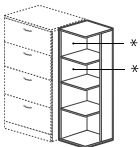
* Accepts collator 11" high

End Shelf - RIGHT 40.8"/41.3" High**



* Accepts collator 11" high

End Shelf - LEFT 52.5"/53" High**



* Accepts collator 11" high

End Shelf - RIGHT 52.5"/53" High**

MODEL#	DIMENSIONS D x W x H	FREIGHT CLASS	WT./LBS.	CUBIC FT.	1" TOP	1.5" TOP	GLAZE ADD	HP ADD
Z24L2ESHL	24 x 24 x 29.5-30	70	99.75	4.75	\$667	\$724	N/A	\$131
Z20M2ESHL	20 x 20 x 29.5-30	70	76.65	3.75	\$553	\$596	N/A	\$84
Z16S2ESHL	16 x 16 x 29.5-30	65	53.55	2.25	\$470	\$508	N/A	\$84

For use at **LEFT end of 29"/29.5" H units. One adjustable shelf.** Shipped RTA (ready to assemble).

Z24L2ESHR	24 x 24 x 29.5-30	70	99.75	4.75	\$667	\$724	N/A	\$131
Z20M2ESHR	20 x 20 x 29.5-30	70	76.65	3.75	\$553	\$596	N/A	\$84
Z16S2ESHR	16 x 16 x 29.5-30	65	53.55	2.25	\$470	\$508	N/A	\$84

For use at **RIGHT end of 29"/29.5" H units. One adjustable shelf.** Shipped RTA (ready to assemble).

Z24L4ESHL	24 x 24 x 41.3-41.8	65	130.20	4.75	\$856	\$914	N/A	N/A
Z20M4ESHL	20 x 20 x 41.3-41.8	60	101	3.25	\$719	\$762	N/A	N/A
Z16S4ESHL	16 x 16 x 41.3-41.8	65	73.87	2.50	\$611	\$649	N/A	N/A

For use at **LEFT end of 40.8"/41.3" H units. Two adjustable shelves.** Shipped RTA (ready to assemble).

- Collator only available on **Z16S4ESHL**

Z24L4ESHR	24 x 24 x 41.3-41.8	65	130.20	4.75	\$856	\$914	N/A	N/A
Z20M4ESHR	20 x 20 x 41.3-41.8	60	101	3.25	\$719	\$762	N/A	N/A
Z16S4ESHR	16 x 16 x 41.3-41.8	65	73.87	2.50	\$611	\$649	N/A	N/A

For use at **RIGHT end of 40.8"/41.3" H units. Two adjustable shelves.** Shipped RTA (ready to assemble).

- Collator only available on **Z16S4ESHR**

Z24L5ESHL	24 x 24 x 53-53.5	60	162.75	4.75	\$1061	\$1118	N/A	N/A
Z20M5ESHL	20 x 20 x 53-53.5	60	125.69	4	\$875	\$918	N/A	N/A
Z16S5ESHL	16 x 16 x 53-53.5	65	91.35	3.25	\$738	\$780	N/A	N/A

For use at **LEFT end of 52.5"/53" H units. Three adjustable shelves.** Shipped RTA (ready to assemble).

- Collator only available on **Z16S5ESHL**

Z24L5ESHR	24 x 24 x 53-53.5	60	162.75	4.75	\$1061	\$1118	N/A	N/A
Z20M5ESHR	20 x 20 x 53-53.5	60	125.69	4	\$875	\$918	N/A	N/A
Z16S5ESHR	16 x 16 x 53-53.5	65	91.35	3.25	\$738	\$780	N/A	N/A

For use at **RIGHT end of 52.5"/53" H units. Three adjustable shelves.** Shipped RTA (ready to assemble).

- Collator only available on **Z16S5ESHR**

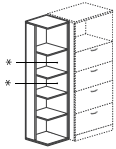
Required Specifications

Top finish
Base finish
Top/Edge Detail

Optional Specifications

Collator**
Glazed doors*

END SHELVES

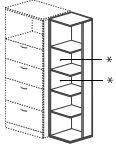


* Accepts collator 11" high

End Shelf - LEFT 65"/65.5" High

MODEL#	DIMENSIONS D x W x H	FREIGHT CLASS	WT/LBS.	CUBIC FT.	1" TOP	1.5" TOP	GLAZE ADD	HP ADD
Z24L6ESHL	24 x 24 x 65.5-66	60	196	6	\$1240	\$1298	N/A	N/A
Z20M6ESHL	20 x 20 x 65.5-66	60	152	5	\$1031	\$1074	N/A	N/A
Z16S6ESHL	16 x 16 x 65.5-66	65	111.30	4.25	\$880	\$918	N/A	N/A

For use at **LEFT end of 65"/65.5"H units. Four adjustable shelves.** Shipped RTA (ready to assemble).
 • Collator only available on **Z16S6ESHL**

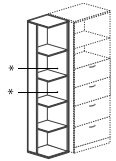


* Accepts collator 11" high

End Shelf - RIGHT 65"/65.5" High

Z24L6ESHR	24 x 24 x 65.5-66	60	196	6	\$1240	\$1298	N/A	N/A
Z20M6ESHR	20 x 20 x 65.5-66	60	152	5	\$1031	\$1074	N/A	N/A
Z16S6ESHR	16 x 16 x 65.5-66	65	111.30	4.25	\$880	\$918	N/A	N/A

For use at **RIGHT end of 65"/65.5"H units. Four adjustable shelves.** Shipped RTA (ready to assemble).
 • Collator only available on **Z16S6ESHR**

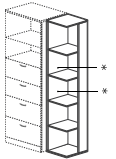


* Accepts collator 11" high

End Shelf - LEFT 71.5"/72" High

Z24L7ESHL	24 x 24 x 71.9-72.4	60	206.85	6.50	\$1302	\$1359	N/A	N/A
Z20M7ESHL	20 x 20 x 71.9-72.4	65	160.65	5.75	\$1087	\$1130	N/A	N/A
Z16S7ESHL	16 x 16 x 71.9-72.4	65	117.60	4.75	\$925	\$963	N/A	N/A

For use at **LEFT end of 71.5"/72"H units. Four adjustable shelves.** Shipped RTA (ready to assemble).
 • Collator only available on **Z16S7ESHL**

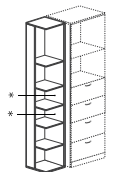


* Accepts collator 11" high

End Shelf - RIGHT 71.5"/72" High

Z24L7ESHR	24 x 24 x 71.9-72.4	60	206.85	6.50	\$1302	\$1359	N/A	N/A
Z20M7ESHR	20 x 20 x 71.9-72.4	65	160.65	5.75	\$1087	\$1130	N/A	N/A
Z16S7ESHR	16 x 16 x 71.9-72.4	65	117.60	4.75	\$925	\$963	N/A	N/A

For use at **RIGHT end of 71.5"/72"H units. Four adjustable shelves.** Shipped RTA (ready to assemble).
 • Collator only available on **Z16S7ESHR**

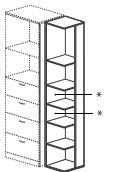


* Accepts collator 11" high

End Shelf - LEFT 84"/84.5" High

Z24L8ESHL	24 x 24 x 84.4-84.9	60	241.50	7.75	\$1494	\$1551	N/A	N/A
Z20M8ESHL	20 x 20 x 84.4-84.9	65	185.85	6.50	\$1246	\$1289	N/A	N/A
Z16S8ESHL	16 x 16 x 84.4-84.9	65	136.50	5.50	\$1058	\$1096	N/A	N/A

For use at **LEFT end of 84"/84.5"H units. Five adjustable shelves.** Shipped RTA (ready to assemble).
 • Collator only available on **Z16S8ESHL**



* Accepts collator 11" high

End Shelf - RIGHT 84"/84.5" High

Z24L8ESHR	24 x 24 x 84.4-84.9	60	241.50	7.75	\$1494	\$1551	N/A	N/A
Z20M8ESHR	20 x 20 x 84.4-84.9	65	185.85	6.50	\$1246	\$1289	N/A	N/A
Z16S8ESHR	16 x 16 x 84.4-84.9	65	136.50	5.50	\$1058	\$1096	N/A	N/A

For use at **RIGHT end of 84"/84.5"H units. Five adjustable shelves.** Shipped RTA (ready to assemble).
 • Collator only available on **Z16S8ESHR**

Required Specifications

Top finish
 Base finish
 Top/Edge Detail

Optional Specifications

Collator

TABLE TOP END SHELVES

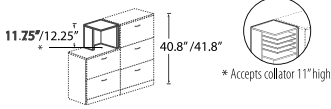


Table Top End Shelf - LEFT
11.75\"/>

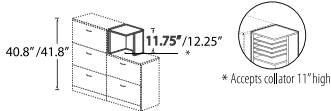


Table Top End Shelf - RIGHT
11.75\"/>

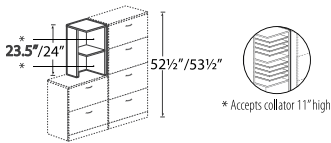


Table Top End Shelf - LEFT
23.5\"/>

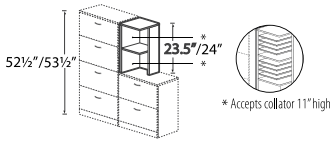


Table Top End Shelf - RIGHT
23.5\"/>

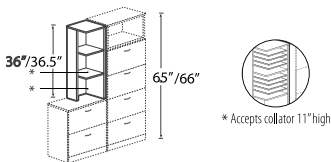


Table Top End Shelf - LEFT
36\"/>

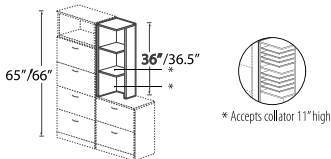


Table Top End Shelf - RIGHT
36\"/>

MODEL#	DIMENSIONS D x W x H	FREIGHT CLASS	WT./LBS.	CUBIC FT.	1" TOP	1.5" TOP	GLAZE ADD	HP ADD
Z16S12DL	16 x 16 x 11.25-11.75	70	26	1.60	\$239	\$277	N/A	N/A

To be placed **on top of 29\"/>**

Z16S12DR	16 x 16 x 11.25-11.75	70	26	1.60	\$239	\$277	N/A	N/A
----------	-----------------------	----	----	------	-------	-------	-----	-----

To be placed **on top of 29\"/>**

Z16S23DL	16 x 16 x 23-23.5	65	42	1.60	\$367	\$409	N/A	N/A
----------	-------------------	----	----	------	-------	-------	-----	-----

To be placed **on top of 29\"/>**

Z16S23DR	16 x 16 x 23-23.5	65	42	1.60	\$367	\$409	N/A	N/A
----------	-------------------	----	----	------	-------	-------	-----	-----

To be placed **on top of 29\"/>**

Z16S36DL	16 x 16 x 35.5-36	70	62.84	2.80	\$511	\$549	N/A	N/A
----------	-------------------	----	-------	------	-------	-------	-----	-----

To be placed **on top of 29\"/>**

Z16S36DR	16 x 16 x 35.5-36	70	62.84	2.80	\$511	\$549	N/A	N/A
----------	-------------------	----	-------	------	-------	-------	-----	-----

To be placed **on top of 29\"/>**

Required Specifications

- Top finish
- Base finish
- Top/Edge Detail

Optional Specifications

- Collator

TABLE TOP END SHELVES

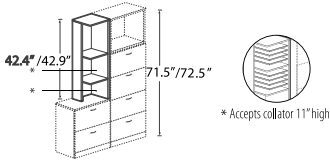


Table Top End Shelf - LEFT*
42.4\"/>

MODEL#	DIMENSIONS	FREIGHT CLASS	WT/LBS.	CUBIC FT.	1\"/>			
Z16S42DL	16-36 x 16 x 41.9-42.4	65	70	2.80	\$552	\$590	N/A	N/A

To be placed **on top of 29\"/>**

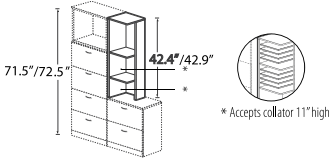


Table Top End Shelf - RIGHT*
42.4\"/>

Z16S42DR	16-36 x 16 x 41.9-42.4	65	70	2.80	\$552	\$590	N/A	N/A
----------	------------------------	----	----	------	-------	-------	-----	-----

To be placed **on top of 29\"/>**

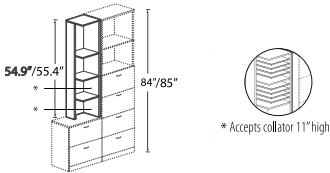


Table Top End Shelf - LEFT*
54.9\"/>

Z16S55DL	16-36 x 16 x 54.4-54.9	60	89	2.80	\$681	\$723	N/A	N/A
----------	------------------------	----	----	------	-------	-------	-----	-----

To be placed **on top of 29\"/>**

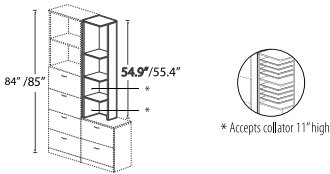


Table Top End Shelf - RIGHT*
54.9\"/>

Z16S55DR	16-36 x 16 x 54.4-54.9	60	89	2.80	\$681	\$723	N/A	N/A
----------	------------------------	----	----	------	-------	-------	-----	-----

To be placed **on top of 29\"/>**

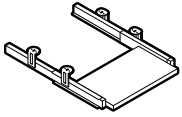
Required Specifications

- Top finish
- Base finish
- Top/Edge Detail

Optional Specifications

- Collator

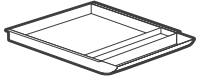
ACCESSORIES



Pull-Out Keyboard

MODEL#	DIMENSIONS D x W x H	FREIGHT CLASS	WT/LBS.	CUBIC FT.	LIST PRICE
APOKL28	17 x 28 x 3.5	85	13	.90	\$337
APOKL22	17 x 22 x 3.5	85	12	.90	\$305

APOKL28 will accommodate keyboard and mousepad. **APOKL28** will only fit on a single pedestal desk, freestanding table, or **Z42205C**.



Pencil Drawer

W1518PDR	18 x 15 x 2.25	92.5	4	0.4	\$274
----------	----------------	------	---	-----	--------------

Black ABS plastic. Provides space for writing instruments and small items at the workspace. Attaches to underside of any 24"D and 30"D worksurface with included roller slides. Shipped RTA (ready to assemble).



L Bracket

MLB90	--	70	1	.01	\$60
-------	----	----	---	-----	-------------

Used to attach worksurfaces to end panels.

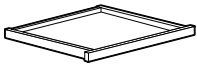


LEFT
RIGHT
Skateboard

Z1425SKL (left)	13.9-36 x 25 x 3.2-3.7	100	13	1.50	\$137
---------------------------	------------------------	-----	----	------	--------------

Z1425SKR (right)	13.9-36 x 25 x 3.2-3.7	100	13	1.50	\$137
----------------------------	------------------------	-----	----	------	--------------

Mobile CPU holder designed to fit inside 'faux' pedestals of a single pedestal desk.



Center Drawer

CD20	18 x 20 x 3	100	8	1	\$214
------	-------------	-----	---	---	--------------

Laminate drawer front is attached to a 4-sided frame. Recommended for use on small L-shaped units, and on 30" x 60" and 66" desks.

Required Specifications

Finish

zira boardroom + reception



Zira Boardroom + Reception

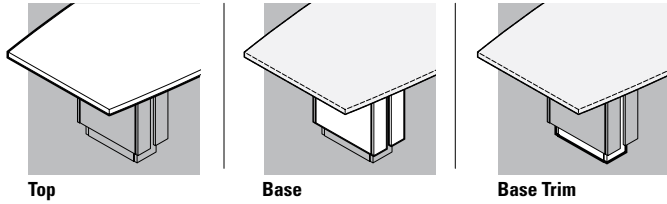
258

TOP AND BASE FINISHES

ACJ	Absolute Acajou	FCL	First Class
ASN	Asian Night	NBL	Noce Biondo
AWC	Avant Cherry	NGL	Noce Grigio
AWH	Avant Honey	NEL	Noce Leggero
BLK	Black	NML	Noce Medio
BZD	Blizzard	QTM	Quartered Mahogany
BRC	Brushed Cobalt	SBY	Sheer Beauty
CMB	Clear Maple	SOG	Storm Grey
CGY	Custom Grey	SDT	Stonedust
DES	Dark Espresso	WHE	Walnut Heights
DWT	Designer White	WHC	White Chocolate
FAS	Fashionista	WCR	Winter Cherry

BASE TRIM FINISHES

BRC	Brushed Cobalt
BLK	Black



TOP THICKNESS/EDGE DETAIL



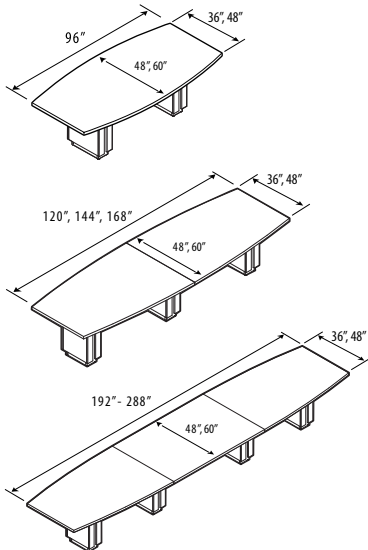
C3 1.5" top, standard **CR** 1.5" top, bicut edge **CF** 1.5" top, fluted edge

BASES

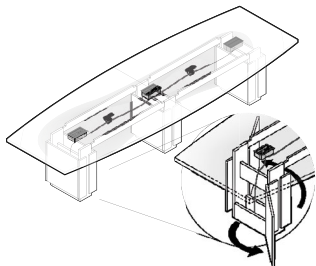
- 2 doors on base for wire management access from both sides

TOPS

- 96" tops are standard in one piece. All tops 120", 144" and 168" tops are standard in two equal size pieces. Woodgrain laminate finishes may NOT align where the two tops join. Tops 192" and larger are standard in 3 equal pieces.
- 96" tops are standard with **two bases**
- Tops 120", 144" and 168" are standard with **three bases**
- Tops 192" and larger are standard with **four bases**
- **Four** top shapes: **boat shaped, bow end, rectangular** and **racetrack**



POWER BLOCK OPTIONS AND CUT-OUT LOCATIONS

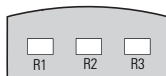


PRODUCT CODE DIAGRAM

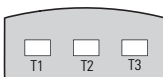
PMSPPDM



PRTMCS401B
PRTMCS401T
PRTMCS401W
PRTMCS421B
PRTMCS421T
PRTMCS421W



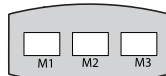
PRTMCD602B
PRTMCD602T
PRTMCD602W
PRTMCD622B
PRTMCD622T
PRTMCD622W
PRTMCD642B
PRTMCD642T
PRTMCD642W



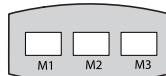
VILLA



OASIS MINI A



OASIS MINI B

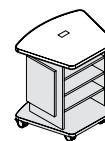
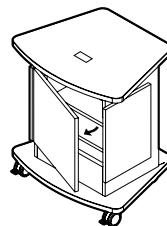


CUT-OUTS

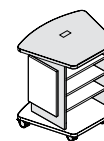
- **Boardroom** and **collaborative** tables offer optional cut-outs for in-surface mounted power modules in three standard locations (left, center or right) as shown above for all table shapes excluding square boardroom tables. Order as **E1, M1, R1, T1, V1**, etc. **Add \$96** for each cut-out.
- Cut-out options for **square boardroom tables** in centered position only. Order as **E2, M2, R2, T2**, or **V2**. **Add \$96** for each cut-out.
- Cut-out options for **media tables** in position 1 only. Order as **E1, M1, R1, T1**, or **V1**. **Add \$96** for each cut-out.
- Select power block from **Productivity Solutions**, beginning on page 491.
- Match power block desired with cut-out code and location from above grid.
- Optional custom sized cut-out available in standard locations (left, center or right) for all table shapes. Submit appropriate form beginning on page 735 with order. **Add \$294** for each cut-out.

AUDIOVISUAL

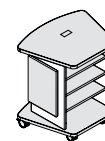
Three components:
Multimedia Cart



Top

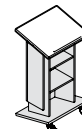
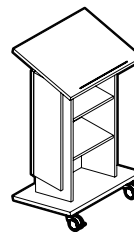


Base



Base trim

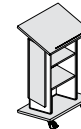
Lectern



Top

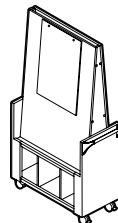


Base

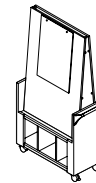


Base Trim

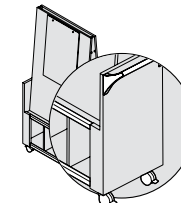
Visual Board



Lower Portion



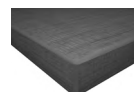
Push Bar & Casters



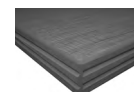
Visual Board

Multimedia Cart and Lectern:

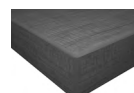
- Available in all standard laminates
- Color of casters will match base trim
- Offered in the following **top thickness and edge details**:



A3 1" top, standard



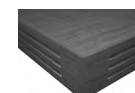
AR 1" top, bicut edge



C3 1.5" top, standard



CR 1.5" top, bicut edge



CF 1.5" top, fluted edge

Visual Board:

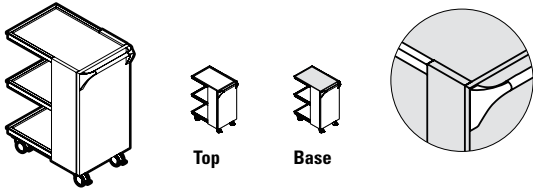
- Available in all laminates listed above
- Push Bar available in Black (**BLK**) or Tungsten (**TUN**)
- Color of casters and aluminum trim will match push bar
- Visual Board comes standard in white color

BUFFET

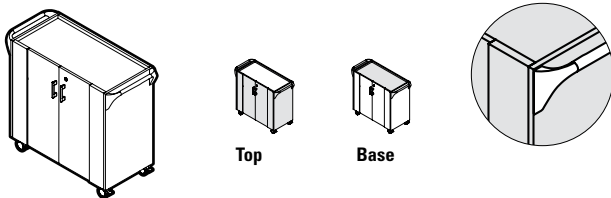
Three components: **Buffet Carts, Buffets** and **Serving Carts**

- Top and/or base available in all laminates
- Push Bar on Buffet Carts and Serving Carts and Aluminum Trim on Open and Mixed Buffets available in Black (BLK) or Tungsten (TUN)
- Optional glazing available on Serving Carts with doors and Buffets with doors

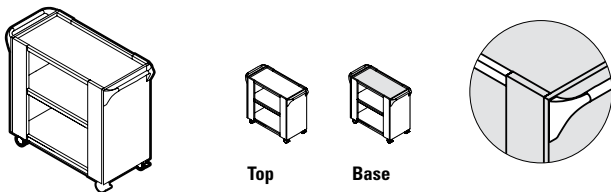
Buffet Carts



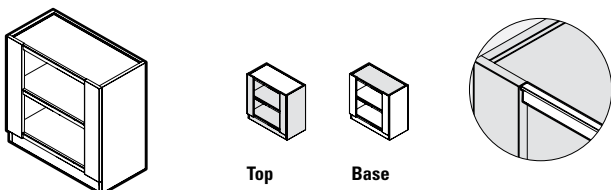
Serving Cart with Doors



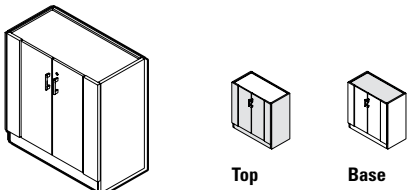
Serving Cart - Open



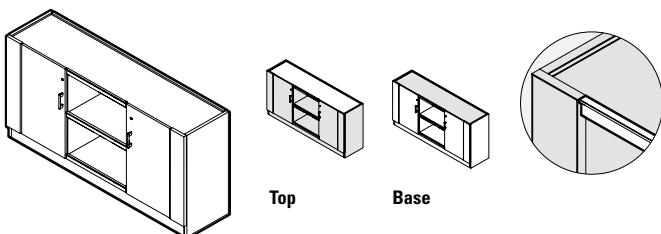
Buffet - Open



Buffet with Doors



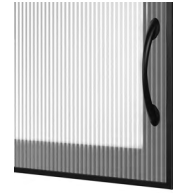
Buffet - Mixed



Glazing (Doors - Serving Cart and Buffets)



Z1 frosted glazing, Tungsten (TUN) frame Z2 frosted glazing, Black (BLK) frame



Z3 ribbed glazing, Tungsten (TUN) frame Z4 ribbed glazing, Black (BLK) frame

Handles

- Handles are standard on models with doors. Each handle is identified by the letters "HU", "HV", "HW", "HX", "HS", "HZ", "HO", "HQ", and "HR". To specify a handle, please specify the code after the model number.



HS Flared Silver



HV Square Edge Silver



HO Crescent Black



HW Flared Brass



HU Square Edge Black



HZ Dimpled Nickel



HX Flared Black



HQ Bar Silver



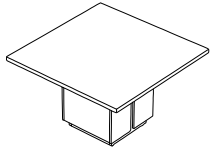
HR Bar Black

- Use the following for determining the size of a table and the number of chairs needed for a conference area. All estimates are based on an average chair width of 23" with a 4" clearance between chairs. Adjust accordingly for a different chair size.

Top Size	Rectangular	Bow End	Boat	Racetrack
48x96	6-8	6-8	6-8	6-8
48x120	8-10	8-10	8-10	8-10
48x144	10-12	10-12	10-12	10-12
48x168	12-14	12-14	12-14	12-14
48x192	14-16	14-16	14-16	14-16
48x216	16-18	16-18	16-18	16-18
48x240	18-20	18-20	18-20	18-20
48x264	20-22	20-22	20-22	20-22
48x288	22-24	22-24	22-24	22-24

BOARDROOM TABLES

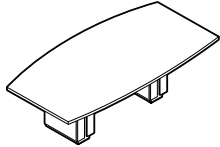
MODEL#	DIMENSIONS D x W x H (1.5" TOP)	FREIGHT CLASS	WT/LBS.	CUBIC FT.	1" TOP	1.5" TOP	GLAZE ADD	HP ADD
--------	------------------------------------	---------------	---------	-----------	--------	----------	-----------	--------



Boardroom Table - Square

Z3636SQ	36 x 36 x 30	85	129	10	N/A	\$2405	N/A	\$356
Z4242SQ	42 x 42 x 30	85	165.50	13.50	N/A	\$2738	N/A	\$488
Z4848SQ	48 x 48 x 30	85	190	14.24	N/A	\$2966	N/A	\$630
Z5454SQ	54 x 54 x 30	85	262	21.24	N/A	\$3318	N/A	\$799
Z6060SQ	60 x 60 x 30	85	300	22.74	N/A	\$3546	N/A	\$982

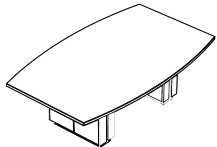
Square Table includes ONE BASE with wire access doors on each side of base. Shipped in 2 cartons.



Boardroom Table - Boat Shaped

Z4896BE	48 x 96 x 30	70	342	21.95	N/A	\$3920	N/A	\$967
---------	--------------	----	-----	-------	-----	---------------	-----	--------------

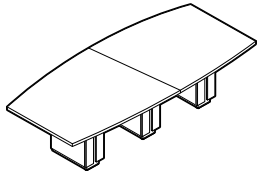
Boat Shaped Table includes TWO BASES with wire access doors on each side of base and wire concealment runners between bases. Shipped in 3 cartons.



Boardroom Table - Boat Shaped

Z6096BE	60 x 96 x 30	85	432	35.39	N/A	\$6361	N/A	\$1571
---------	--------------	----	-----	-------	-----	---------------	-----	---------------

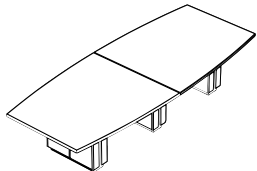
Boat Shaped Table includes TWO BASES with wire access doors on each side of base and wire concealment runners between bases. Shipped in 3 cartons.



Boardroom Table - Boat Shaped

Z48120BE	48 x 120 x 30	70	452	23.48	N/A	\$5635	N/A	\$1208
Z48144BE	48 x 144 x 30	70	502	25.72	N/A	\$5690	N/A	\$1448
Z48168BE	48 x 168 x 30	85	557	37.25	N/A	\$7593	N/A	\$1831

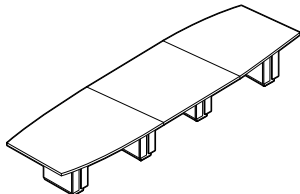
Boat Shaped Table includes THREE BASES with wire access doors on each side of base and wire concealment runners between bases. Z48144BE and Z48120BE shipped in 4 cartons. Z48168BE shipped in 5 cartons.



Boardroom Table - Boat Shaped

Z60120BE	60 x 120 x 30	85	599	48.50	N/A	\$9643	N/A	\$1961
Z60144BE	60 x 144 x 30	85	664.65	53.25	N/A	\$10321	N/A	\$2354
Z60168BE	60 x 168 x 30	85	741.30	58	N/A	\$11129	N/A	\$2745

Boat Shaped Table includes THREE BASES with wire access doors on each side of base and wire concealment runners between bases. Shipped in 5 cartons.



Boardroom Table - Boat Shaped

Z48192BE	48 x 192 x 30	70	688	45.66	N/A	\$9483	N/A	\$2091
Z48216BE	48 x 216 x 30	70	746	48.67	N/A	\$9929	N/A	\$2354
Z48240BE	48 x 240 x 30	70	803	51.68	N/A	\$10556	N/A	\$2614
Z48264BE	48 x 264 x 30	70	855	54.69	N/A	\$11181	N/A	\$2875
Z48288BE	48 x 288 x 30	70	906	57.69	N/A	\$11181	N/A	\$3136

Boat Shaped Table includes FOUR BASES with wire access doors on each side of base and wire concealment runners between bases. Shipped in 7 cartons.

Required Specifications

Top finish
Top/edge detail
Base finish
Base trim finish

Optional Specifications

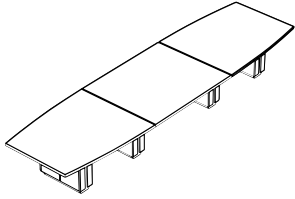
HP laminate
Additional grommet

Accessories

Power block

BOARDROOM TABLES

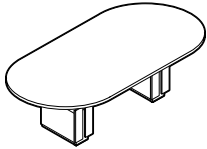
MODEL# DIMENSIONS FREIGHT CLASS WT/LBS. CUBIC FT. 1"TOP 1.5" TOP GLAZE ADD HP ADD



Boardroom Table - Boat Shaped

	D x W x H (1.5" TOP)								
Z60192BE	60 x 192 x 30	85	912.45	71.19	N/A	\$13999	N/A	\$3136	
Z60216BE	60 x 216 x 30	85	980.70	75.94	N/A	\$14784	N/A	\$3526	
Z60240BE	60 x 240 x 30	85	1062.60	80.98	N/A	\$15419	N/A	\$3920	
Z60264BE	60 x 264 x 30	85	1129.80	85.73	N/A	\$16031	N/A	\$4311	
Z60288BE	60 x 288 x 30	85	1198.05	90.49	N/A	\$17007	N/A	\$4704	

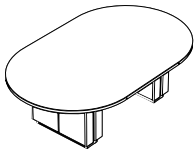
Boat Shaped Table includes FOUR BASES with wire access doors on each side of base and wire concealment runners between bases. Shipped in 7 cartons.



Boardroom Table - Racetrack

Z4896RTE	48 x 96 x 30	70	336	21.95	N/A	\$3811	N/A	\$967	
----------	--------------	----	-----	-------	-----	--------	-----	-------	--

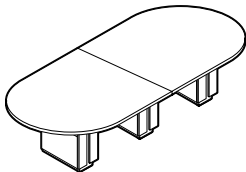
Racetrack Shaped Table includes TWO BASES with wire access doors on each side of base and wire concealment runners between bases. Shipped in 3 cartons.



Boardroom Table - Racetrack

Z6096RTE	60 x 96 x 30	92.5	417	35.39	N/A	\$6361	N/A	\$1571	
----------	--------------	------	-----	-------	-----	--------	-----	--------	--

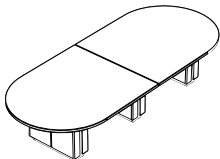
Racetrack Shaped Table includes TWO BASES with wire access doors on each side of base and wire concealment runners between bases. Shipped in 3 cartons.



Boardroom Table - Racetrack

Z48120RTE	48 x 120 x 30	70	453	28.28	N/A	\$5299	N/A	\$1208	
Z48144RTE	48 x 144 x 30	70	506	25.72	N/A	\$5648	N/A	\$1448	
Z48168RTE	48 x 168 x 30	70	563	37.25	N/A	\$7639	N/A	\$1297	

Racetrack Shaped Table includes THREE BASES with wire access doors on each side of base and wire concealment runners between bases. Z48144RTE and Z48120RTE shipped in 4 cartons. Z48168RTE shipped in 5 cartons.



Boardroom Table - Racetrack

Z60120RTE	60 x 120 x 30	85	585.90	48.50	N/A	\$9643	N/A	\$1961	
Z60144RTE	60 x 144 x 30	85	656.25	53.25	N/A	\$10321	N/A	\$2354	
Z60168RTE	60 x 168 x 30	85	737.10	58	N/A	\$11129	N/A	\$2745	

Racetrack Shaped Table includes THREE BASES with wire access doors on each side of base and wire concealment runners between bases. Shipped in 5 cartons.

Required Specifications

Top finish
Top/edge detail
Base finish
Base trim finish

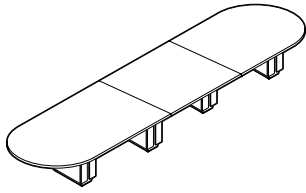
Optional Specifications

HP laminate
Additional grommet

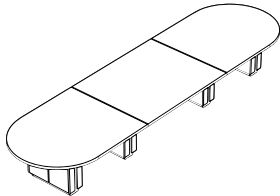
Accessories

Power block

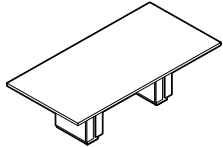
BOARDROOM TABLES



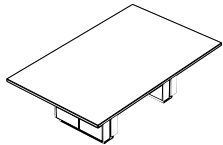
Boardroom Table - Racetrack



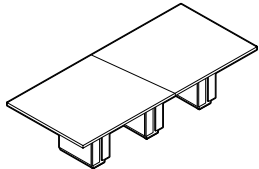
Boardroom Table - Racetrack



Boardroom Table - Rectangular



Boardroom Table - Rectangular



Boardroom Table - Rectangular

MODEL#	DIMENSIONS D x W x H (1.5" TOP)	FREIGHT CLASS	WT/LBS.	CUBIC FT.	1" TOP	1.5" TOP	GLAZE ADD	HP ADD
Z48192RTE	48 x 192 x 30	70	689	45.45	N/A	\$9530	N/A	\$2091
Z48216RTE	48 x 216 x 30	70	749	48.95	N/A	\$9974	N/A	\$2354
Z48240RTE	48 x 240 x 30	70	809	51.75	N/A	\$10601	N/A	\$2614
Z48264RTE	48 x 264 x 30	70	862	54.55	N/A	\$11227	N/A	\$2875
Z48288RTE	48 x 288 x 30	70	917	58.04	N/A	\$11227	N/A	\$3136

Racetrack Shaped Table includes FOUR BASES with wire access doors on each side of base and wire concealment runners between bases. Shipped in 7 cartons.

Z60192RTE	60 x 192 x 30	85	901.95	71.19	N/A	\$13999	N/A	\$3136
Z60216RTE	60 x 216 x 30	85	972.30	75.94	N/A	\$14784	N/A	\$3526
Z60240RTE	60 x 240 x 30	85	1057.35	80.98	N/A	\$15419	N/A	\$3920
Z60264RTE	60 x 264 x 30	85	1127.70	85.73	N/A	\$16031	N/A	\$4311
Z60288RTE	60 x 288 x 30	85	1198.05	90.49	N/A	\$17007	N/A	\$4704

Racetrack Shaped Table includes FOUR BASES with wire access doors on each side of base and wire concealment runners between bases. Shipped in 7 cartons.

Z4896REE	48 x 96 x 30	70	356	21.95	N/A	\$3900	N/A	\$967
----------	--------------	----	-----	-------	-----	---------------	-----	--------------

Rectangular Shaped Table includes TWO BASES with wire access doors on each side of base and wire concealment runners between bases. Shipped in 3 cartons.

Z6096REE	60 x 96 x 30	85	448	35.39	N/A	\$5831	N/A	\$1571
----------	--------------	----	-----	-------	-----	---------------	-----	---------------

Rectangular Shaped Table includes TWO BASES with wire access doors on each side of base and wire concealment runners between bases. Shipped in 3 cartons.

Z48120REE	48 x 120 x 30	70	472	23.48	N/A	\$5281	N/A	\$1208
Z48144REE	48 x 144 x 30	70	525	25.72	N/A	\$5653	N/A	\$1448
Z48168REE	48 x 168 x 30	70	583	37.25	N/A	\$7527	N/A	\$1831

Rectangular Shaped Table includes THREE BASES with wire access doors on each side of base and wire concealment runners between bases. Z48144REE and Z48120REE shipped in 4 cartons. Z48168REE shipped in 5 cartons.

Required Specifications

Top finish
Top/edge detail
Base finish
Base trim finish

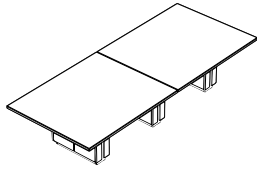
Optional Specifications

HP laminate
Additional grommet

Accessories

Power block

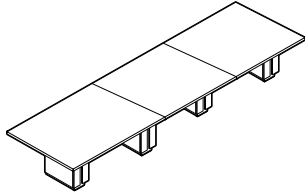
BOARDROOM TABLES



Boardroom Table - Rectangular

MODEL#	DIMENSIONS D x W x H (1.5" TOP)	FREIGHT CLASS	WT/LBS.	CUBIC FT.	1" TOP	1.5" TOP	GLAZE ADD	HP ADD
Z60120REE	60 x 120 x 30	85	618	48.50	N/A	\$8839	N/A	\$1961
Z60144REE	60 x 144 x 30	85	688	53.25	N/A	\$9460	N/A	\$2354
Z60168REE	60 x 168 x 30	85	769	58	N/A	\$10188	N/A	\$2745

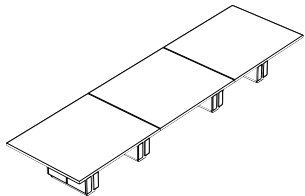
Rectangular Shaped Table includes THREE BASES with wire access doors on each side of base and wire concealment runners between bases. Shipped in 5 cartons.



Boardroom Table - Rectangular

Z48192REE	48 x 192 x 30	70	708	45.45	N/A	\$9419	N/A	\$2091
Z48216REE	48 x 216 x 30	70	768	48.95	N/A	\$9864	N/A	\$2354
Z48240REE	48 x 240 x 30	70	828	51.75	N/A	\$10489	N/A	\$2614
Z48264REE	48 x 264 x 30	70	882	54.55	N/A	\$11117	N/A	\$2875
Z48288REE	48 x 288 x 30	70	936	58.04	N/A	\$11117	N/A	\$3136

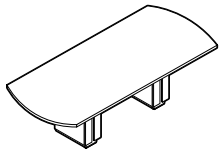
Rectangular Shaped Table includes FOUR BASES with wire access doors on each side of base and wire concealment runners between bases. Shipped in 7 cartons.



Boardroom Table - Rectangular

Z60192REE	60 x 192 x 30	85	941.85	71.12	N/A	\$12833	N/A	\$3136
Z60216REE	60 x 216 x 30	85	1003.80	75.94	N/A	\$13544	N/A	\$3526
Z60240REE	60 x 240 x 30	85	1088.85	80.98	N/A	\$14125	N/A	\$3920
Z60264REE	60 x 264 x 30	85	1159.20	85.73	N/A	\$14680	N/A	\$4311
Z60288REE	60 x 288 x 30	85	1229.55	90.49	N/A	\$15568	N/A	\$4704

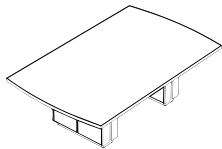
Rectangular Shaped Table includes FOUR BASES with wire access doors on each side of base and wire concealment runners between bases. Shipped in 7 cartons.



Boardroom Table - Bow End

Z4896BW	48 x 96 x 30	85	329	21.95	N/A	\$4039	N/A	\$967
---------	--------------	----	-----	-------	-----	---------------	-----	--------------

Bow End Table includes TWO BASES with wire access doors on each side of base and wire concealment runners between bases. Shipped in 3 cartons.



Boardroom Table - Bow End

Z6096BW	60 x 96 x 30	85	436	35.39	N/A	\$6361	N/A	\$1571
---------	--------------	----	-----	-------	-----	---------------	-----	---------------

Bow End Table includes TWO BASES with wire access doors on each side of base and wire concealment runners between bases. Shipped in 3 cartons.

Required Specifications

Top finish
Top/edge detail
Base finish
Base trim finish

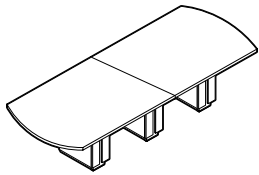
Optional Specifications

HP laminate
Additional grommet

Accessories

Power block

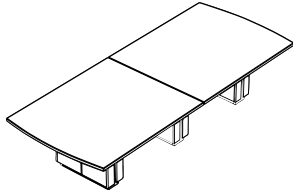
BOARDROOM TABLES



Boardroom Table - Bow End

MODEL#	DIMENSIONS D x W x H (1.5" TOP)	FREIGHT CLASS	WT/LBS.	CUBIC FT.	1" TOP	1.5" TOP	GLAZE ADD	HP ADD
Z48120BW	48 x 120 x 30	70	476	29.35	N/A	\$5378	N/A	\$1208
Z48144BW	48 x 144 x 30	70	513	25.72	N/A	\$5759	N/A	\$1448
Z48168BW	48 x 168 x 30	70	573	37.25	N/A	\$7560	N/A	\$1831

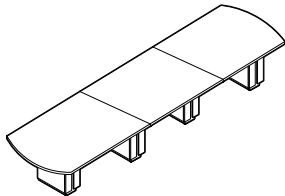
Bow End Table includes THREE BASES with wire access doors on each side of base and wire concealment runners between bases. Z48144BW and Z48120BW shipped in 4 cartons. Z48168BW shipped in 5 cartons.



Boardroom Table - Bow End

Z60120BW	60 x 120 x 30	85	602	48.50	N/A	\$9643	N/A	\$1961
Z60144BW	60 x 144 x 30	85	673	53.25	N/A	\$10321	N/A	\$2354
Z60168BW	60 x 168 x 30	85	753	58	N/A	\$11129	N/A	\$2745

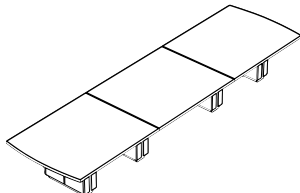
Bow End Table includes THREE BASES with wire access doors on each side of base and wire concealment runners between bases. Shipped in 5 cartons.



Boardroom Table - Bow End

Z48192BW	48 x 192 x 30	70	698	45.45	N/A	\$9454	N/A	\$2091
Z48216BW	48 x 216 x 30	70	758	48.95	N/A	\$9895	N/A	\$2354
Z48240BW	48 x 240 x 30	70	818	51.75	N/A	\$10522	N/A	\$2614
Z48264BW	48 x 264 x 30	70	872	54.55	N/A	\$11150	N/A	\$2875
Z48288BW	48 x 288 x 30	70	926	58.04	N/A	\$11150	N/A	\$3136

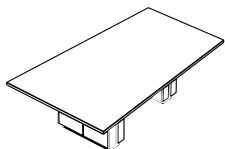
Bow End Table includes FOUR BASES with wire access doors on each side of base and wire concealment runners between bases. Shipped in 7 cartons.



Boardroom Table - Bow End

Z60192BW	60 x 192 x 30	85	917.70	71.19	N/A	\$13999	N/A	\$3136
Z60216BW	60 x 216 x 30	85	988.05	75.94	N/A	\$14784	N/A	\$3526
Z60240BW	60 x 240 x 30	85	1073.10	80.98	N/A	\$15419	N/A	\$3920
Z60264BW	60 x 264 x 30	85	1143.45	85.73	N/A	\$16031	N/A	\$4311
Z60288BW	60 x 288 x 30	85	1213.80	90.49	N/A	\$17007	N/A	\$4704

Bow End Table includes FOUR BASES with wire access doors on each side of base and wire concealment runners between bases. Shipped in 7 cartons.



Boardroom Table - Wedge

Z6096WE	60 x 96 x 30	70	398	26.17	N/A	\$6361	N/A	\$1571
---------	--------------	----	-----	-------	-----	---------------	-----	---------------

Wedge Table includes TWO BASES with wire access doors on each side of base. Wedge tapers from 60" w to 48" w. Shipped in 3 cartons.

Required Specifications

Top finish
Top/edge detail
Base finish
Base trim finish

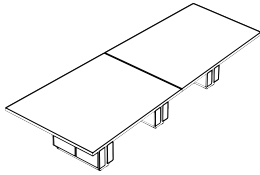
Optional Specifications

HP laminate
Additional grommet

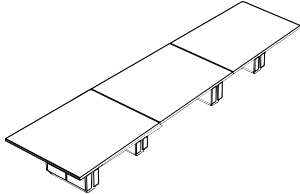
Accessories

Power block

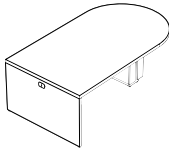
MEDIA TABLES



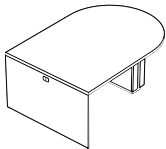
Boardroom Table - Wedge



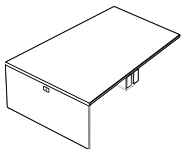
Boardroom Table - Wedge



Media Table - D Island



Media Table - D Island



Media Table - D Wedge

MODEL#	DIMENSIONS D x W x H (1.5" TOP)	FREIGHT CLASS	WT/LBS.	CUBIC FT.	1" TOP	1.5" TOP	GLAZE ADD	HP ADD
Z60120WE	60 x 120 x 30	85	544.95	36.50	N/A	\$9643	N/A	\$1961
Z60144WE	60 x 144 x 30	70	603.75	39.50	N/A	\$10321	N/A	\$2354
Z60168WE	60 x 168 x 30	70	673.05	42.50	N/A	\$11129	N/A	\$2745

Wedge Table includes THREE BASES with wire access doors on each side of base. Wedge tapers from 60" w to 48" w. Shipped in 5 cartons.

Z60192WE	60 x 192 x 30	85	824.25	63.71	N/A	\$13999	N/A	\$3136
Z60216WE	60 x 216 x 30	85	884.10	68.25	N/A	\$14784	N/A	\$3526
Z60240WE	60 x 240 x 30	85	948.15	72.94	N/A	\$15419	N/A	\$3920
Z60264WE	60 x 264 x 30	85	1006.95	77.48	N/A	\$16031	N/A	\$4311
Z60288WE	60 x 288 x 30	85	1065.75	81.96	N/A	\$17007	N/A	\$4704

Wedge Table includes FOUR BASES with wire access doors on each side of base. Wedge tapers from 60" w to 48" w. Shipped in 7 cartons.

Z4860DMIL	48 x 60 x 30	70	267	17.69	N/A	\$3965	N/A	\$788
Z4872DMIL	48 x 72 x 30	70	298.20	19.67	N/A	\$4251	N/A	\$943
Z4884DMIL	48 x 84 x 30	70	326.55	21.44	N/A	\$4528	N/A	\$1101
Z4896DMIL	48 x 96 x 30	85	347.55	23.41	N/A	\$4795	N/A	\$1255

D Media Island includes ONE BASE with wire access doors on each side of base and wire concealment runners between the base and the end panel. Grommet centered at the top of the end panel for wire pass through. Shipped in 3 cartons.

Z6060DMIL	60 x 60 x 30	85	323.93	23.17	N/A	\$4756	N/A	\$982
Z6072DMIL	60 x 72 x 30	85	359.10	25.66	N/A	\$5094	N/A	\$1179
Z6084DMIL	60 x 84 x 30	85	397.95	27.90	N/A	\$5433	N/A	\$1376
Z6096DMIL	60 x 96 x 30	85	433.65	30.39	N/A	\$5754	N/A	\$1571

D Media Island includes ONE BASE with wire access doors on each side of base and wire concealment runners between the base and the end panel. Grommet centered at the top of the end panel for wire pass through. Shipped in 3 cartons.

Z6060WMIL	60 x 60 x 30	85	306.60	20.69	N/A	\$4756	N/A	\$982
Z6072WMIL	60 x 72 x 30	85	338.10	22.90	N/A	\$5094	N/A	\$1179
Z6084WMIL	60 x 84 x 30	85	374.85	25.42	N/A	\$5433	N/A	\$1376
Z6096WMIL	60 x 96 x 30	85	407.40	27.90	N/A	\$5754	N/A	\$1571

Wedge Media Island includes ONE BASE with wire access doors on each side of base and wire concealment runners between the base and the end panel. Grommet centered at the top of the end panel for wire pass through. Wedge tapers from 60" w to 48" w. Shipped in 3 cartons.

Required Specifications

Top finish
Top/edge detail
Base finish
Base trim finish

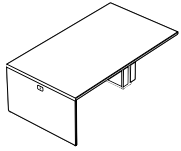
Optional Specifications

HP laminate
Additional grommet

Accessories

Power block

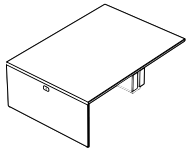
MEDIA TABLES



Media Table - Rectangular Island

MODEL#	DIMENSIONS D x W x H (1.5" TOP)	FREIGHT CLASS	WT/LBS.	CUBIC FT.	1" TOP	1.5" TOP	GLAZE ADD	HP ADD
Z4860RMIL	48 x 60 x 30	70	279.30	17.69	N/A	\$3651	N/A	\$788
Z4872RMIL	48 x 72 x 30	70	307.65	19.67	N/A	\$3913	N/A	\$943
Z4884RMIL	48 x 84 x 30	70	337.05	21.44	N/A	\$4163	N/A	\$1101
Z4896RMIL	48 x 96 x 30	70	357	23.41	N/A	\$4403	N/A	\$1255

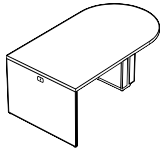
Rectangular Media Island includes ONE BASE with wire access doors on each side of base and wire concealment runners between the base and the end panel. Grommet centered at the top of the end panel for wire pass through. Shipped in 3 cartons.



Media Table - Rectangular Island

Z6060RMIL	60 x 60 x 30	70	339.15	22.22	N/A	\$4368	N/A	\$982
Z6072RMIL	60 x 72 x 30	85	373.80	25.66	N/A	\$4677	N/A	\$1179
Z6084RMIL	60 x 84 x 30	85	414.75	27.90	N/A	\$4984	N/A	\$1376
Z6096RMIL	60 x 96 x 30	85	449.40	30.39	N/A	\$5276	N/A	\$1571

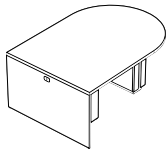
Rectangular Media Island includes ONE BASE with wire access doors on each side of base and wire concealment runners between the base and the end panel. Grommet centered at the top of the end panel for wire pass through. Shipped in 3 cartons.



Media Table - D Island, 36" H

Z4860DMIM	48 x 60 x 36.5	70	291.90	19.19	N/A	\$4339	N/A	\$788
Z4872DMIM	48 x 72 x 36.5	70	321.30	21.17	N/A	\$4625	N/A	\$943
Z4884DMIM	48 x 84 x 36.5	70	349.65	22.90	N/A	\$4893	N/A	\$1101
Z4896DMIM	48 x 96 x 36.5	85	370.65	24.91	N/A	\$5166	N/A	\$1255

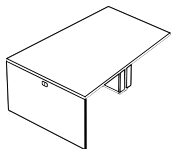
D Media Island includes ONE BASE with wire access doors on each side of base and wire concealment runners between the base and the end panel. Grommet centered at the top of the end panel for wire pass through. Shipped in 3 cartons.



Media Table - D Island, 36" H

Z6060DMIM	60 x 60 x 36.5	85	352.28	25.42	N/A	\$5128	N/A	\$982
Z6072DMIM	60 x 72 x 36.5	85	386.40	27.66	N/A	\$5460	N/A	\$1179
Z6084DMIM	60 x 84 x 36.5	85	426.30	30.15	N/A	\$5800	N/A	\$1376
Z6096DMIM	60 x 96 x 36.5	85	462	32.63	N/A	\$6119	N/A	\$1571

D Media Island includes ONE BASE with wire access doors on each side of base and wire concealment runners between the base and the end panel. Grommet centered at the top of the end panel for wire pass through. Shipped in 3 cartons.



Media Table - D Wedge, 36" H

Z6060WMIM	60 x 60 x 36.5	85	331.80	22.16	N/A	\$5128	N/A	\$982
Z6072WMIM	60 x 72 x 36.5	85	364.35	24.67	N/A	\$5460	N/A	\$1179
Z6084WMIM	60 x 84 x 36.5	70	424.20	26.92	N/A	\$5800	N/A	\$1376
Z6096WMIM	60 x 96 x 36.5	85	424.20	29.40	N/A	\$6119	N/A	\$1571

Wedge Media Island includes ONE BASE with wire access doors on each side of base and wire concealment runners between the base and the end panel. Grommet centered at the top of the end panel for wire pass through. Wedge tapers from 60" w to 48" w. Shipped in 3 cartons.

Required Specifications

Top finish
Top/edge detail
Base finish
Base trim finish

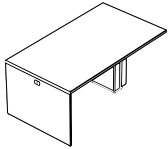
Optional Specifications

HP laminate
Additional grommet

Accessories

Power block

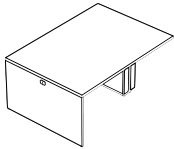
MEDIA TABLES



Media Table - Rectangular Island, 36”H

MODEL#	DIMENSIONS D x W x H (1.5" TOP)	FREIGHT CLASS	WT/LBS.	CUBIC FT.	1" TOP	1.5" TOP	GLAZE ADD	HP ADD
Z4860RMIM	48 x 60 x 36.5	70	301.35	19.19	N/A	\$3985	N/A	\$788
Z4872RMIM	48 x 72 x 36.5	70	330.75	21.17	N/A	\$4247	N/A	\$943
Z4884RMIM	48 x 84 x 36.5	70	360.15	22.90	N/A	\$4493	N/A	\$1101
Z4896RMIM	48 x 96 x 36.5	70	380.10	24.91	N/A	\$4742	N/A	\$1255

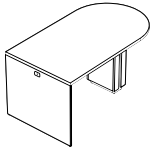
Rectangular Media Island includes ONE BASE with wire access doors on each side of base and wire concealment runners between the base and the end panel. Grommet centered at the top of the end panel for wire pass through. Shipped in 3 cartons.



Media Table - Rectangular Island, 36”H

Z6060RMIM	60 x 60 x 36.5	85	367.50	25.42	N/A	\$4704	N/A	\$982
Z6072RMIM	60 x 72 x 36.5	85	402.15	27.66	N/A	\$5004	N/A	\$1179
Z6084RMIM	60 x 84 x 36.5	85	442.05	30.15	N/A	\$5315	N/A	\$1376
Z6096RMIM	60 x 96 x 36.5	85	477.75	32.63	N/A	\$5609	N/A	\$1571

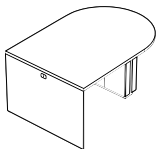
Rectangular Media Island includes ONE BASE with wire access doors on each side of base and wire concealment runners between the base and the end panel. Grommet centered at the top of the end panel for wire pass through. Shipped in 3 cartons.



Media Table - D Island, 42”H

Z4860DMIH	48 x 60 x 42.5	70	312.90	20.69	N/A	\$4612	N/A	\$788
Z4872DMIH	48 x 72 x 42.5	70	342.30	22.66	N/A	\$4898	N/A	\$943
Z4884DMIH	48 x 84 x 42.5	70	371.70	24.40	N/A	\$5174	N/A	\$1101
Z4896DMIH	48 x 96 x 42.5	85	391.65	26.41	N/A	\$5440	N/A	\$1255

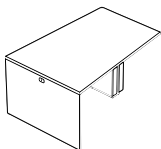
D Media Island includes ONE BASE with wire access doors on each side of base and wire concealment runners between the base and the end panel. Grommet centered at the top of the end panel for wire pass through. Shipped in 3 cartons.



Media Table - D Island, 42”H

Z6060DMIH	60 x 60 x 42.5	85	378	27.40	N/A	\$5399	N/A	\$982
Z6072DMIH	60 x 72 x 42.5	85	413.70	29.91	N/A	\$5733	N/A	\$1179
Z6084DMIH	60 x 84 x 42.5	85	453.60	32.40	N/A	\$6080	N/A	\$1376
Z6096DMIH	60 x 96 x 42.5	85	488.25	34.88	N/A	\$6392	N/A	\$1571

D Media Island includes ONE BASE with wire access doors on each side of base and wire concealment runners between the base and the end panel. Grommet centered at the top of the end panel for wire pass through. Shipped in 3 cartons.



Media Table - Wedge, 42”H

Z6060WMIH	60 x 60 x 42.5	85	355	23.92	N/A	\$5399	N/A	\$982
Z6072WMIH	60 x 72 x 42.5	85	387	26.17	N/A	\$5733	N/A	\$1179
Z6084WMIH	60 x 84 x 42.5	85	424	28.65	N/A	\$6080	N/A	\$1376
Z6096WMIH	60 x 96 x 42.5	85	457	31.14	N/A	\$6392	N/A	\$1571

Wedge Media Island includes ONE BASE with wire access doors on each side of base and wire concealment runners between the base and the end panel. Grommet centered at the top of the end panel for wire pass through. Wedge tapers from 60”w to 48”w. Shipped in 3 cartons.

Required Specifications

Top finish
Top/edge detail
Base finish
Base trim finish

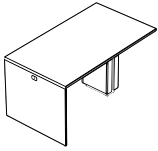
Optional Specifications

HP laminate
Additional grommet

Accessories

Power block

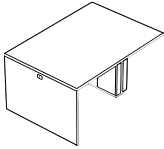
COLLABORATIVE TABLES



Media Table - Rectangular Island, 42" H

MODEL#	DIMENSIONS D x W x H (1.5" TOP)	FREIGHT CLASS	WT/LBS.	CUBIC FT.	1" TOP	1.5" TOP	GLAZE ADD	HP ADD
Z4860RMIH	48 x 60 x 42.5	70	324	20.69	N/A	\$4239	N/A	\$788
Z4872RMIH	48 x 72 x 42.5	70	353	22.66	N/A	\$4500	N/A	\$943
Z4884RMIH	48 x 84 x 42.5	70	382	24.40	N/A	\$4747	N/A	\$1101
Z4896RMIH	48 x 96 x 42.5	70	402	26.41	N/A	\$4991	N/A	\$1255

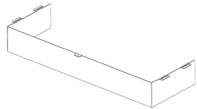
Rectangular Media Island includes ONE BASE with wire access doors on each side of base and wire concealment runners between the base and the end panel. Grommet centered at the top of the end panel for wire pass through. Shipped in 3 cartons.



Media Table - Rectangular Island, 42" H

Z6060RMIH	60 x 60 x 42.5	85	394	27.40	N/A	\$4957	N/A	\$982
Z6072RMIH	60 x 72 x 42.5	85	429	29.91	N/A	\$5257	N/A	\$1179
Z6084RMIH	60 x 84 x 42.5	85	469	32.40	N/A	\$5571	N/A	\$1376
Z6096RMIH	60 x 96 x 42.5	85	504	34.88	N/A	\$5856	N/A	\$1571

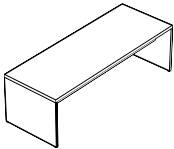
Rectangular Media Island includes ONE BASE with wire access doors on each side of base and wire concealment runners between the base and the end panel. Grommet centered at the top of the end panel for wire pass through. Shipped in 3 cartons.



Media Table - Base Cover

Z60BEC	12.2 x 34.5 x 4.3	250	5	1.50	\$551			
Z48BEC	12.2 x 22.5 x 4.3	250	5	1.50	\$505			

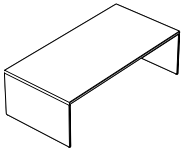
For use on Zira Media Tables, but can be used on any Zira Boardroom table of corresponding width. Acts as a "cap" at the upper part of a base to hide any wire or power block that may be visible to users. Available in Black or Tungsten finish.



Collaborative Table - 29" H

Z367229BT	36 x 72 x 30	70	237	12.93	N/A	\$1961	N/A	\$709
Z368429BT	36 x 84 x 30	70	237	14.70	N/A	\$2280	N/A	\$828
Z369629BT	36 x 96 x 30	70	289	16.44	N/A	\$2472	N/A	\$943

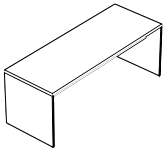
Collaborative table with full end panels. Wire management runners span the length of the table between end panels. Shipped in 3 cartons.



Collaborative Table - 29" H

Z487229BT	48 x 72 x 30	70	302	13.95	N/A	\$2464	N/A	\$943
Z488429BT	48 x 84 x 30	70	335	15.69	N/A	\$2654	N/A	\$1101
Z489629BT	48 x 96 x 30	70	360	17.43	N/A	\$2868	N/A	\$1255

Collaborative table with full end panels. Wire management runners span the length of the table between end panels. Shipped in 3 cartons.



Collaborative Table - 36" H

Z367236BT	36 x 72 x 36.5	70	249	13.20	N/A	\$2034	N/A	\$709
Z368436BT	36 x 84 x 36.5	70	275	14.94	N/A	\$2360	N/A	\$828
Z369636BT	36 x 96 x 36.5	70	301	16.68	N/A	\$2549	N/A	\$943

Collaborative table with full end panels. Wire management runners span the length of the table between end panels. Shipped in 3 cartons.

Required Specifications

Top finish
Top/edge detail
Base finish
Base trim finish

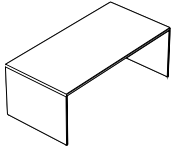
Optional Specifications

HP laminate
Additional grommet

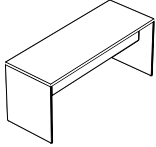
Accessories

Power block

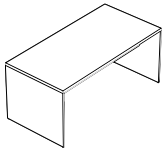
COLLABORATIVE TABLES



Collaborative Table - 36" H



Collaborative Table - 42" H



Collaborative Table - 42" H

MODEL#	DIMENSIONS D x W x H (1.5" TOP)	FREIGHT CLASS	WT/LBS.	CUBIC FT.	1" TOP	1.5" TOP	GLAZE ADD	HP ADD
Z487236BT	48 x 72 x 36.5	70	319	14.43	N/A	\$2555	N/A	\$943
Z488436BT	48 x 84 x 36.5	70	351	16.20	N/A	\$2752	N/A	\$1101
Z489636BT	48 x 96 x 36.5	70	376	17.93	N/A	\$2966	N/A	\$1255

Collaborative table with full end panels. Wire management runners span the length of the table between end panels. Shipped in 3 cartons.

Z367242BT	36 x 72 x 42.5	70	283	14.19	N/A	\$2276	N/A	\$709
Z368442BT	36 x 84 x 42.5	70	312	15.93	N/A	\$2627	N/A	\$828
Z369642BT	36 x 96 x 42.5	70	342	17.93	N/A	\$2842	N/A	\$943

Collaborative table with full end panels. Wire management runners span the length of the table between end panels. Shipped in 3 cartons.

Z487242BT	48 x 72 x 42.5	65	356	15.45	N/A	\$2816	N/A	\$943
Z488442BT	48 x 84 x 42.5	70	392	17.43	N/A	\$3032	N/A	\$1101
Z489642BT	48 x 96 x 42.5	70	421	19.19	N/A	\$3279	N/A	\$1255

Collaborative table with full end panels. Wire management runners span the length of the table between end panels. Shipped in 3 cartons.

Required Specifications

Top finish
Top/edge detail
Base finish
Base trim finish

Optional Specifications

HP laminate
Additional grommet

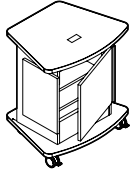
Accessories

Power block

ACCESSORIES

MODEL# DIMENSIONS FREIGHT CLASS WT/LBS. CUBIC FT. 1" TOP 1.5" TOP GLAZE ADD HP ADD

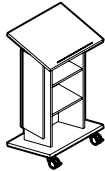
D x W x H (1.5" TOP)



Multimedia Cart*

Z2822MCE	22.25 x 28 x 29.5	125	86	13.50	\$928	\$1001	N/A	\$184
----------	-------------------	-----	----	-------	--------------	---------------	-----	--------------

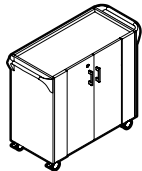
Multimedia cart features one non-locking hinged door on the back. Includes 3 fixed shelves, 1 grommet on top and 1 grommet in bottom panel for wire pass thru. 4 locking casters included.



Lectern*

Z2444LEC	18 x 24 x 44.3	150	100	17	\$902	\$962	N/A	\$184
----------	----------------	-----	-----	----	--------------	--------------	-----	--------------

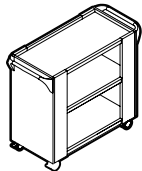
Features angled stand and storage with 2 fixed shelves. 2 locking casters included.



Serving Cart with Doors**

Z361836KD	18 x 36 x 36	125	150	20	\$1885	N/A	\$453	N/A
Z361829KD	18 x 36 x 29	125	113	16	\$1595	N/A	\$382	N/A

Cart features 2 doors with lock and 1 fixed height adjustable shelf. Top is recessed within side and end panels to act as a tray. Unique push handles are standard on both sides of the cart. 4 locking casters included.



Serving Cart*

Z361836KO	18 x 36 x 36	125	121	20	\$2045	N/A	N/A	N/A
Z361829KO	18 x 36 x 29	125	108	16	\$1710	N/A	N/A	N/A

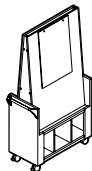
Cart features 1 fixed height adjustable shelf. Top is recessed within side and end panels to act as a tray. Decorative aluminum trim is standard on the lip of each shelf. Unique push handles are standard on both sides of the cart. 4 locking casters included.



Buffet Cart*

Z261836BK	18 x 26 x 36	150	79	15	\$1944	N/A	N/A	\$184
-----------	--------------	-----	----	----	---------------	-----	-----	--------------

Cart features 1 fixed shelf. Top is recessed within side and end panels to act as a tray. Unique push handles are standard. Decorative aluminum trim is standard on the lip of each shelf. Locking casters included. Height aligns with 36" buffets.



Visual Board*

Z361872VB	18 x 36 x 72.4	100	187	19.25	\$2954	N/A	N/A	N/A
-----------	----------------	-----	-----	-------	---------------	-----	-----	-----

Angled visual board with paper pad on one side and dry erase board on the opposite side. Unique push handles are standard. Locking casters included. Decorative aluminum trim is standard on the lip of each shelf. Height aligns with 36" buffets. Shipped RTA (ready to assemble).

- *Wallmounted Visual Boards are available in Desk Accessories section.*

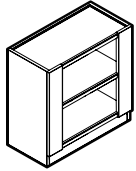
Required Specifications

Top finish Push bar finish*
 Base finish Handles
 Top/edge detail*
 Base trim finish (not Z3618xxKD)

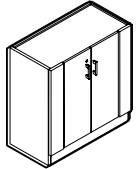
Optional Specifications

HP laminate
 Glazed door (only Z3618xxKD)
 Key #***

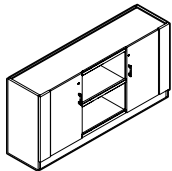
ACCESSORIES



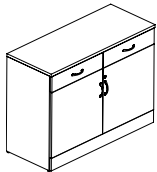
Buffet



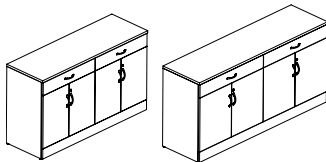
Buffet with Doors**



Buffet with Doors**



Buffet Credenza**



Buffet Credenza**

MODEL#	DIMENSIONS D x W x H (1.5" TOP)	FREIGHT CLASS	WT./LBS.	CUBIC FT.	1" TOP	1.5" TOP	GLAZE ADD	HP ADD
Z481836BO	18 x 48 x 36	125	152.50	22.50	\$1799	N/A	N/A	\$246
Z481829BO	18 x 48 x 29	125	135	18	\$1659	N/A	N/A	\$246
Z361836BO	18 x 36 x 36	125	126	18	\$1483	N/A	N/A	\$184
Z361829BO	18 x 36 x 29	100	112	14	\$1365	N/A	N/A	\$184

Buffet features 1 fixed height adjustable shelf. Top is recessed within side and end panels to act as a tray. Decorative aluminum trim is standard on the lip of each shelf.

Z481836BD	18 x 48 x 36	125	171	22.50	\$1872	N/A	\$398	\$246
Z481829BD	18 x 48 x 29	100	148	18	\$1672	N/A	\$454	\$246
Z361836BD	18 x 36 x 36	125	138.50	18	\$1664	N/A	\$453	\$184
Z361829BD	18 x 36 x 29	100	119	14	\$1399	N/A	\$382	\$184

Buffet features 2 doors with lock and 1 fixed height adjustable shelf. Top is recessed within side and end panels to act as a tray.

Z721836BU	18 x 72 x 36	125	242	33.50	\$2769	N/A	\$548	\$366
Z721829BU	18 x 72 x 29	125	211	27	\$2503	N/A	\$453	\$453
Z601836BU	18 x 60 x 36	125	188	28	\$2487	N/A	\$453	\$305
Z601829BU	18 x 60 x 29	125	163	22.50	\$2278	N/A	\$382	\$305

Buffet features 3 separate compartments. The two outer compartments come standard with locking doors and each features 1 fixed height adjustable shelf. The center compartment is open with 1 fixed height adjustable shelf. Decorative aluminum trim is standard on the lip of the open shelf. Top is recessed within side and end panels to act as a tray.

Z482036BD	20 x 48 x 36	100	199	24.70	\$2209	\$2338	\$953	\$415
-----------	--------------	-----	-----	-------	---------------	---------------	--------------	--------------

Buffet credenza with one locking storage compartment with two doors. Hinged doors cover one three-position height adjustable shelf. Two 6" drawers above storage compartment are non-locking.

Z722036BD	20 x 72 x 36	125	265	36.50	\$3203	\$3360	\$1902	\$668
Z602036BD	20 x 60 x 36	125	228	30.75	\$2777	\$2919	\$1747	\$542

Buffet credenza with two locking storage compartments side by side. Hinged doors cover 1 three-position height adjustable shelf. Two 6" drawers above storage compartment are non-locking.

Required Specifications

Top finish Top/edge detail*
 Base finish
 Handles
 Aluminum trim finish (only ZxxxxBO/BU)

Optional Specifications

HP laminate
 Glazed door**
 Key #***

Interconnecting Cables - Common Cable Lengths (in inches)

Female/Female	42FF-86 \$188	42FM-41 \$139
42FF-27 \$116	42FF-97 \$216	42FM-50 \$151
42FF-38 \$129	42FF-98 \$216	42FM-63 \$167
42FF-41 \$133	42FF-100 \$205	42FM-75 \$181
42FF-50 \$145	42FF-110 \$219	42FM-82 \$190
42FF-53 \$149		42FM-86 \$195
42FF-63 \$159	Female/Male	42FM-97 \$216
42FF-75 \$175	42FM-12 \$104	42FM-98 \$216
42FF-76 \$176	42FM-27 \$121	42FM-100 \$230
42FF-82 \$184	42FM-38 \$134	42FM-110 \$230

VILLA DAISYLINK OR OASIS MINI CABLE LENGTHS NEEDED FOR DAISY-CHAINING

Model #	Villa DaisyLink, Oasis Mini USB Oasis Mini A Oasis Mini B	Villa DaisyLink, Oasis Mini USB Oasis Mini A Oasis Mini B	Oasis Mini USB Oasis Mini A	Oasis Mini USB Oasis Mini A	Villa DaisyLink or Oasis Mini B	Villa DaisyLink or Oasis Mini B
Cutout Positions	V1, V3, M1, M3	V1, V3, M1, M3	M1, M2 & M3	M1, M2 & M3	V1, V2, V3, M1, M2, M3	V1, V2, V3, M1, M2, M3
Infeed Position	Left or Right	Center	Left or Right	Center	Left or Right	Center
Reference	Drawing 1A/1B	Drawing 2A/2B	Drawing 3	Drawing 4	Drawing 5	Drawing 6
Z4896BE Z4896RTE Z4896REE Z4896BW	(1) 42FF-53 SPECIFY INFEED	(1) 42FF-27 (1) 42FM-27 (1) DAISY-T SPECIFY INFEED	N/A	N/A	N/A	N/A
Z48120BE Z48120RTE Z48120REE Z48120BW	(1) 42FF-76 SPECIFY INFEED	(1) 42FF-38 (1) 42FM-38 (1) DAISY-T SPECIFY INFEED	(3) 42FF-41 SPECIFY INFEED	(3) 42FF-41 SPECIFY INFEED	(2) 42FF-41 SPECIFY INFEED	(2) 42FF-41 (1) 42FM-12 (1) DAISY-T SPECIFY INFEED
Z48144BE Z48144RTE Z48144REE Z48144BW	(1) 42FF-100 SPECIFY INFEED	(1) 42FF-50 (1) 42FM-50 (1) DAISY-T SPECIFY INFEED	(3) 42FF-53 SPECIFY INFEED	(3) 42FF-53 SPECIFY INFEED	(2) 42FF-53 SPECIFY INFEED	(2) 42FF-53 (1) 42FM-12 (1) DAISY-T SPECIFY INFEED
Z48168BE Z48168RTE Z48168REE Z48168BW	(1) 42FF-63 (1) 42FM-63 SPECIFY INFEED	1) 42FF-63 (1) 42FM-63 (1) DAISY-T SPECIFY INFEED	(3) 42FF-65 SPECIFY INFEED	(3) 42FF-65 SPECIFY INFEED	(2) 42FF-65 SPECIFY INFEED	(2) 42FF-65 (1) 42FM-12 (1) DAISY-T SPECIFY INFEED
Z48192BE Z48192RTE Z48192REE Z48192BW	(1) 42FF-75 (1) 42FM-75 SPECIFY INFEED	1) 42FF-75 (1) 42FM-75 (1) DAISY-T SPECIFY INFEED	(3) 42FF-77 SPECIFY INFEED	(3) 42FF-77 SPECIFY INFEED	(2) 42FF-77 SPECIFY INFEED	(2) 42FF-77 (1) 42FM-12 (1) DAISY-T SPECIFY INFEED
Z48216BE Z48216RTE Z48216REE Z48216BW	(1) 42FF-86 (1) 42FM-86 SPECIFY INFEED	1) 42FF-85 (1) 42FM-85 (1) DAISY-T SPECIFY INFEED	(3) 42FF-89 SPECIFY INFEED	(3) 42FF-89 SPECIFY INFEED	(2) 42FF-89 SPECIFY INFEED	(2) 42FF-89 (1) 42FM-12 (1) DAISY-T SPECIFY INFEED
Z48240BE Z48240RTE Z48240REE Z48240BW	(1) 42FF-98 (1) 42FM-98 SPECIFY INFEED	1) 42FF-97 (1) 42FM-97 (1) DAISY-T SPECIFY INFEED	(3) 42FF-101 SPECIFY INFEED	(3) 42FF-101 SPECIFY INFEED	(2) 42FF-101 SPECIFY INFEED	(2) 42FF-101 (1) 42FM-12 (1) DAISY-T SPECIFY INFEED
Z48264BE Z48264RTE Z48264REE Z48264BW	(1) 42FF-110 (1) 42FM-110 SPECIFY INFEED	(1) 42FF-110 (1) 42FM-110 (1) DAISY-T SPECIFY INFEED	(3) 42FF-113 SPECIFY INFEED	(3) 42FF-113 SPECIFY INFEED	(2) 42FF-113 SPECIFY INFEED	(2) 42FF-113 (1) 42FM-12 (1) DAISY-T SPECIFY INFEED
Z48288BE Z48288RTE Z48288REE Z48288BW	(1) 42FF-82 (2) 42FM-82 SPECIFY INFEED	(2) 42FF-41 (2) 42FM-41 (1) DAISY-T SPECIFY INFEED	(3) 42FF-63 (3) 42FM-63 SPECIFY INFEED	(3) 42FF-63 (3) 42FM-63 SPECIFY INFEED	(2) 42FF-63 (2) 42FM-63 SPECIFY INFEED	(2) 42FF-63 (2) 42FM-63 (1) DAISY-T SPECIFY INFEED

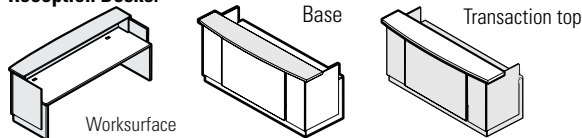
RECEPTION DESKS AND RETURNS

- Offered with **Straight** and **Bow** front
- Transactional tops available in 1" or 1 1/2" thick top with a variety of edge details
- Worksurface available in 1" thickness with A3 edge only

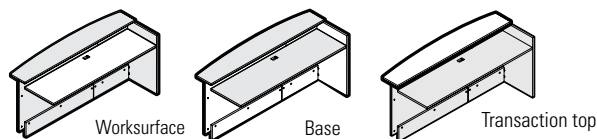
TOP AND BASE FINISHES

ACJ Absolute Acajou	FCL First Class
ASN Asian Night	NBL Noce Biondo
AWC Avant Cherry	NGL Noce Grigio
AWH Avant Honey	NEL Noce Leggero
BLK Black	NML Noce Medio
BZD Blizzard	QTM Quartered Mahogany
BRC Brushed Cobalt	SBY Sheer Beauty
CMB Clear Maple	SOG Storm Grey
CGY Custom Grey	SDT Stonedust
DES Dark Espresso	WHE Walnut Heights
DWT Designer White	WHC White Chocolate
FAS Fashionista	WCR Winter Cherry

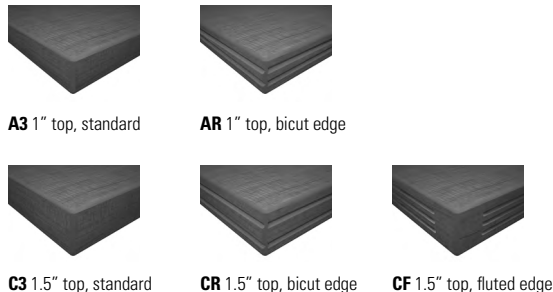
Reception Desks:



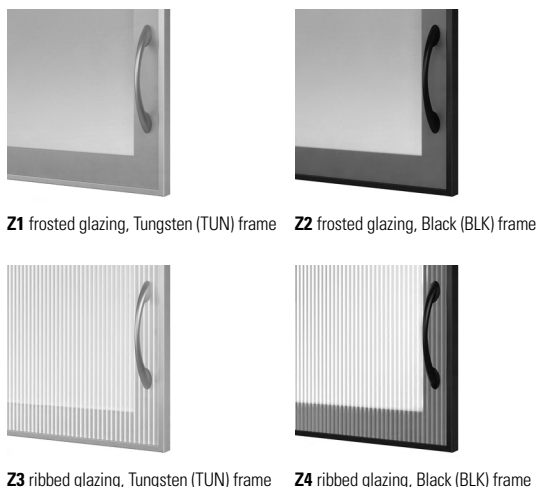
Reception Returns:



TRANSACTION TOP THICKNESS/EDGE DETAIL

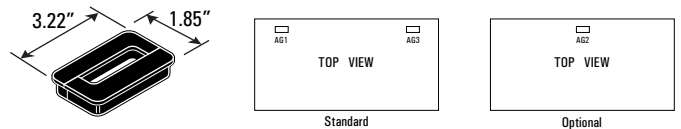


GLAZING (Center Panels)



GROMMETS - RECEPTION DESKS ONLY

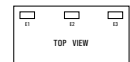
- Two grommets are standard in position **AG1** and **AG3**
- Standard grommets can be removed at an upcharge
- Optional grommets available in **AG2**



- Grommet hole dimensions are 3 1/4" wide x 1 7/8" deep.

POWER BLOCK

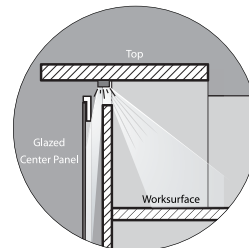
- A Power Block (model **PMSPDM**) may be ordered on transaction tops.
- A Power Block is a rectangular worksurface power/data module with one electrical duplex receptacle and two data (RJ45) receptacles. 9 foot black cord included. Power Block dimensions are 3 1/2" deep x 6 1/2" wide x 2 3/4" high.
- To purchase a Power Block, you must specify both the Power Block cut-out location and the Power Block model #. Order Power Block as PMSPDM, Add **\$330**. Power Blocks are available in standard worksurface locations (left, center or right). Order as E1, E2 or E3. Add **\$96**.



Power Block **PMSPDM** Add **\$330** Specify location **E1, E2 or E3** Add **\$96**

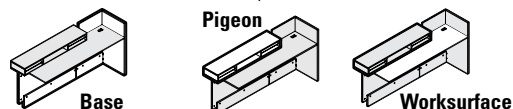
TASK LIGHT

- Illuminates worksurface and optional glazed center panel
- Specify LED task light separately. Use PLED50 for 60", 66" and 72" wide reception units. Use PLED50 or PLED100 for 84" and 96" wide units. See page 452 for details.



RECEPTION RETURNS - PIGEON

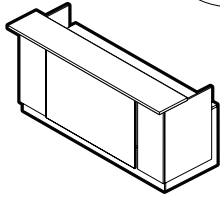
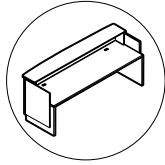
- Available in all laminates
- Worksurface available in 1" thickness with A3 edge only
- Collator shelves offered in Black (BLK) or Brushed Cobalt (BRC)
- One grommet is standard in position **AG3**
- Standard grommet can be removed at an upcharge
- Optional grommet available in position **AG2**, see upcharges above
- Power blocks are available in positions **E2 and E3**



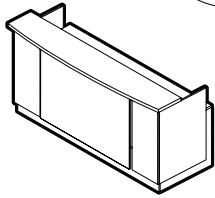
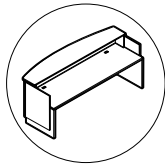
RECEPTION RETURNS - BOOKCASE

- Available in all laminates listed above
- Worksurface available in 1" thickness with A3 edge only
- One grommet is standard in position **AG2**
- Standard grommet can be removed at an upcharge
- Optional grommet available in position **AG3** for **54", 60" and 72" wide units only**
- Power blocks are available in positions **E2 and E3** for **54", 60" and 72" wide units only**

RECEPTION DESKS



Reception Desk



Reception Desk - Bow Front

MODEL#	DIMENSIONS D x W x H	FREIGHT CLASS	WT/LBS.	CUBIC FT.	1" TOP	1.5" TOP	GLAZE ADD	HP ADD
Z3096RDS	35.5 x 96 x 42.8-43.3	70	385	23.23	\$3581	\$3782	\$749	\$847
Z3084RDS	35.5 x 89.4 x 42.8-43.3	70	351	20.48	\$3182	\$3363	\$646	\$741
Z3072RDS	35.5 x 77.4 x 42.8-43.3	70	315	17.99	\$2935	\$3091	\$542	\$637
Z3066RDS	35.5 x 71.4 x 42.8-43.3	70	298	16.98	\$2788	\$2939	\$490	\$585
Z3060RDS	35.5 x 65.4 x 42.8-43.3	70	280	15.48	\$2657	\$2795	\$438	\$530
Z2496RDS	30 x 96 x 42.8-43.3	70	353	21.98	\$3375	\$3576	\$749	\$725
Z2484RDS	30 x 89.4 x 42.8-43.3	70	320	19.49	\$3008	\$3189	\$646	\$637
Z2472RDS	30 x 77.4 x 42.8-43.3	70	287	16.98	\$2770	\$2930	\$542	\$546
Z2466RDS	30 x 71.4 x 42.8-43.3	70	272	15.99	\$2625	\$2776	\$490	\$501
Z2460RDS	30 x 65.4 x 42.8-43.3	70	256	15	\$2502	\$2640	\$438	\$454

Z24xxRDS units are not freestanding; they must be connected to a return. Z30xxRDS units can be specified as freestanding. Standard with two grommets. Accommodates shells of all depths. Shipped RTA (ready to assemble) in 3 cartons.

- **Zxx96RDS** units feature a 90" w worksurface

Z3096RDB	35.5 x 96 x 42.8-43.3	70	382	23.23	\$3581	\$3782	\$749	\$847
Z3084RDB	35.5 x 89.4 x 42.8-43.3	70	348	20.48	\$3182	\$3363	\$646	\$741
Z3072RDB	35.5 x 77.4 x 42.8-43.3	70	312	17.99	\$2935	\$3091	\$542	\$637
Z3066RDB	35.5 x 71.4 x 42.8-43.3	70	295	16.98	\$2788	\$2939	\$490	\$585
Z3060RDB	35.5 x 65.4 x 42.8-43.3	70	277	15.99	\$2657	\$2795	\$438	\$530
Z2496RDB	30 x 96 x 42.8-43.3	70	350	21.98	\$3375	\$3556	\$749	\$725
Z2484RDB	30 x 89.4 x 42.8-43.3	70	317	19.49	\$3008	\$3189	\$646	\$637
Z2472RDB	30 x 77.4 x 42.8-43.3	70	284	16.98	\$2770	\$2930	\$542	\$546
Z2466RDB	30 x 71.4 x 42.8-43.3	70	269	15.99	\$2625	\$2776	\$490	\$501
Z2460RDB	30 x 65.4 x 42.8-43.3	70	253	15	\$2502	\$2640	\$438	\$454

Z24xxRDB units are not freestanding; they must be connected to a return. Z30xxRDB units can be specified as freestanding. Standard with two grommets. Accommodates shells of all depths. Shipped RTA (ready to assemble) in 3 cartons.

- **Zxx96RDB** units feature a 90" w worksurface

Required Specifications

Top finish
Top/edge detail
Base/surround finish
Transaction top finish

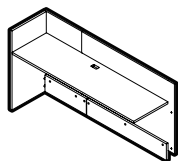
Optional Specifications

HP laminate
Additional grommet

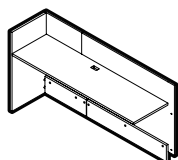
Accessories

Power block

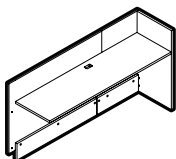
HIGH RECEPTION RETURNS



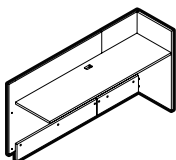
High Reception Return - LEFT



High Reception Return - LEFT



High Reception Return - RIGHT



High Reception Return - RIGHT

MODEL#	DIMENSIONS	FREIGHT CLASS	WT/LBS.	CUBIC FT.	1" TOP	1.5" TOP	GLAZE ADD	HP ADD
D x W x H								
Z2472HRRL	25 x 75.7 x 39.8	70	151	8.2	\$1340	N/A	N/A	\$366
Z2460HRRL	25 x 63.7 x 39.8	70	131.2	7	\$1171	N/A	N/A	\$305
Z2454HRRL	25 x 57.7 x 39.8	70	120.9	5.75	\$1063	N/A	N/A	\$275
Z2448HRRL	25 x 51.7 x 39.8	70	110.9	5.25	\$987	N/A	N/A	\$246
Z2442HRRL	25 x 45.7 x 39.8	70	100.8	4.8	\$910	N/A	N/A	\$214
Z2436HRRL	25 x 39.7 x 39.8	70	90.7	4.3	\$832	N/A	N/A	\$184

Not freestanding. Grommet in worksurface. Shipped RTA (ready to assemble). Accommodates shells of all depths. Connecting hardware included. Widths and depths listed are outside dimensions including outside surrounds. Model numbers reflect the primary worksurface dimensions.

Z2072HRRL	20.9 x 75.7 x 39.8	70	139	8.2	\$1181	N/A	N/A	\$305
Z2060HRRL	20.9 x 63.7 x 39.8	70	121	7	\$1030	N/A	N/A	\$256
Z2054HRRL	20.9 x 57.7 x 39.8	70	111	5.75	\$929	N/A	N/A	\$229
Z2048HRRL	20.9 x 51.7 x 39.8	70	102	5.25	\$863	N/A	N/A	\$206
Z2042HRRL	20.9 x 45.7 x 39.8	70	92	4.8	\$792	N/A	N/A	\$180
Z2036HRRL	20.9 x 39.7 x 39.8	70	83	4.3	\$722	N/A	N/A	\$156

Not freestanding. Grommet in worksurface. Shipped RTA (ready to assemble). Accommodates shells of **20" depths**. Connecting hardware included. Widths and depths listed are outside dimensions including outside surrounds. Model numbers reflect the primary worksurface dimensions.

Z2472HRRR	25 x 75.7 x 39.8	70	151	8.2	\$1340	N/A	N/A	\$366
Z2460HRRR	25 x 63.7 x 39.8	70	131.2	7	\$1171	N/A	N/A	\$305
Z2454HRRR	25 x 57.7 x 39.8	70	120.9	5.75	\$1063	N/A	N/A	\$275
Z2448HRRR	25 x 51.7 x 39.8	70	110.9	5.25	\$987	N/A	N/A	\$246
Z2442HRRR	25 x 45.7 x 39.8	70	100.8	4.8	\$910	N/A	N/A	\$214
Z2436HRRR	25 x 39.7 x 39.8	70	90.7	4.3	\$832	N/A	N/A	\$184

Not freestanding. Grommet in worksurface. Shipped RTA (ready to assemble). Accommodates shells of all depths. Connecting hardware included. Widths and depths listed are outside dimensions including outside surrounds. Model numbers reflect the primary worksurface dimensions.

Z2072HRRR	20.9 x 75.7 x 39.8	70	139	8.2	\$1181	N/A	N/A	\$305
Z2060HRRR	20.9 x 63.7 x 39.8	70	121	7	\$1030	N/A	N/A	\$256
Z2054HRRR	20.9 x 57.7 x 39.8	70	111	5.75	\$929	N/A	N/A	\$229
Z2048HRRR	20.9 x 51.7 x 39.8	70	102	5.25	\$863	N/A	N/A	\$206
Z2042HRRR	20.9 x 45.7 x 39.8	70	92	4.8	\$792	N/A	N/A	\$180
Z2036HRRR	20.9 x 39.7 x 39.8	70	83	4.3	\$722	N/A	N/A	\$156

Not freestanding. Grommet in worksurface. Shipped RTA (ready to assemble). Accommodates shells of **20" depths**. Connecting hardware included. Widths and depths listed are outside dimensions including outside surrounds. Model numbers reflect the primary worksurface dimensions.

Required Specifications

Top finish
Top/edge detail
Base/surround finish

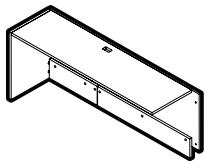
Optional Specifications

HP laminate
Additional grommet

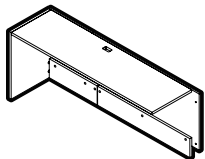
Accessories

Power block

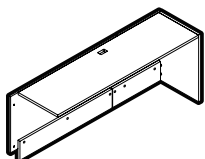
LOW RECEPTION RETURNS



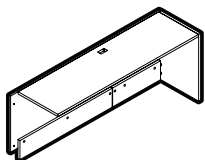
Low Reception Return - LEFT



Low Reception Return - LEFT



Low Reception Return - RIGHT



Low Reception Return - RIGHT

MODEL#	DIMENSIONS D x W x H	FREIGHT CLASS	WT/LBS.	CUBIC FT.	1" TOP	1.5" TOP	GLAZE ADD	HP ADD
Z2472LRRL	25 x 75.7 x 29.1	70	141	6.75	\$1302	N/A	N/A	\$366
Z2460LRRL	25 x 63.7 x 29.1	70	122	5.75	\$1124	N/A	N/A	\$305
Z2454LRRL	25 x 57.7 x 29.1	70	112.9	5.5	\$1029	N/A	N/A	\$275
Z2448LRRL	25 x 51.7 x 29.1	70	103.4	5	\$954	N/A	N/A	\$246
Z2442LRRL	25 x 45.7 x 29.1	70	94	4.5	\$877	N/A	N/A	\$214
Z2436LRRL	25 x 39.7 x 29.1	70	84.3	4	\$799	N/A	N/A	\$184

Not freestanding. Grommet in worksurface. Shipped RTA (ready to assemble). Accommodates shells of all depths. Connecting hardware included. Widths and depths listed are outside dimensions including outside surrounds. Model numbers reflect the primary worksurface dimensions.

Z2072LRRL	20.9 x 75.7 x 29.1	70	128.8	6.75	\$1145	N/A	N/A	\$305
Z2060LRRL	20.9 x 63.7 x 29.1	70	111.3	5.75	\$983	N/A	N/A	\$256
Z2054LRRL	20.9 x 57.7 x 29.1	70	102.8	5.5	\$900	N/A	N/A	\$229
Z2048LRRL	20.9 x 51.7 x 29.1	70	94.1	5	\$832	N/A	N/A	\$206
Z2042LRRL	20.9 x 45.7 x 29.1	70	85.3	4.5	\$763	N/A	N/A	\$180
Z2036LRRL	20.9 x 39.7 x 29.1	70	76.3	4	\$694	N/A	N/A	\$156

Not freestanding. Grommet in worksurface. Shipped RTA (ready to assemble). Accommodates shells of **20" depths**. Connecting hardware included. Widths and depths listed are outside dimensions including outside surrounds. Model numbers reflect the primary worksurface dimensions.

Z2472LRRR	25 x 75.7 x 29.1	70	141	6.75	\$1302	N/A	N/A	\$366
Z2460LRRR	25 x 63.7 x 29.1	70	122	5.75	\$1124	N/A	N/A	\$305
Z2454LRRR	25 x 57.7 x 29.1	70	112.9	5.5	\$1029	N/A	N/A	\$275
Z2448LRRR	25 x 51.7 x 29.1	70	103.4	5	\$954	N/A	N/A	\$246
Z2442LRRR	25 x 45.7 x 29.1	70	94	4.5	\$877	N/A	N/A	\$214
Z2436LRRR	25 x 39.7 x 29.1	70	84.3	4	\$799	N/A	N/A	\$184

Not freestanding. Grommet in worksurface. Shipped RTA (ready to assemble). Accommodates shells of all depths. Connecting hardware included. Widths and depths listed are outside dimensions including outside surrounds. Model numbers reflect the primary worksurface dimensions.

Z2072LRRR	20.9 x 75.7 x 29.1	70	128.8	6.75	\$1145	N/A	N/A	\$305
Z2060LRRR	20.9 x 63.7 x 29.1	70	111.3	5.75	\$983	N/A	N/A	\$256
Z2054LRRR	20.9 x 57.7 x 29.1	70	102.8	5.5	\$900	N/A	N/A	\$229
Z2048LRRR	20.9 x 51.7 x 29.1	70	94.1	5	\$832	N/A	N/A	\$206
Z2042LRRR	20.9 x 45.7 x 29.1	70	85.3	4.5	\$763	N/A	N/A	\$180
Z2036LRRR	20.9 x 39.7 x 29.1	70	76.3	4	\$694	N/A	N/A	\$156

Not freestanding. Grommet in worksurface. Shipped RTA (ready to assemble). Accommodates shells of **20" depths**. Connecting hardware included. Widths and depths listed are outside dimensions including outside surrounds. Model numbers reflect the primary worksurface dimensions.

Required Specifications

Top finish
Top/edge detail
Base/surround finish

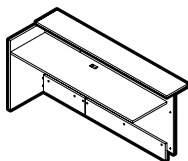
Optional Specifications

HP laminate
Additional grommet

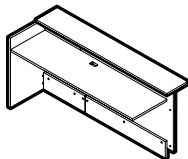
Accessories

Power block

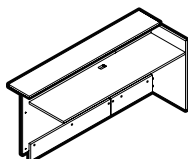
TRANSACTIONAL RETURNS



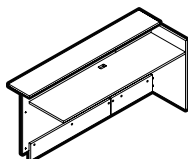
Transactional Return - LEFT



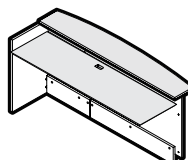
Transactional Return - LEFT



Transactional Return - RIGHT



Transactional Return - RIGHT



Transactional Return, Bow Front - LEFT

MODEL#	DIMENSIONS D x W x H	FREIGHT CLASS	WT/LBS.	CUBIC FT.	1" TOP	1.5" TOP	GLAZE ADD	HP ADD
Z2472TSRL	29.7 x 75.7 x 36.5-37	70	166	9.75	\$1593	\$1719	N/A	\$366
Z2460TSRL	29.7 x 63.7 x 36.5-37	70	144	8.75	\$1376	\$1484	N/A	\$305
Z2454TSRL	29.7 x 57.7 x 36.5-37	70	132	7.5	\$1250	\$1351	N/A	\$275
Z2448TSRL	29.7 x 51.7 x 36.5-37	70	121	7	\$1150	\$1238	N/A	\$246
Z2442TSRL	29.7 x 45.7 x 36.5-37	70	109	6.25	\$1055	\$1136	N/A	\$214
Z2436TSRL	29.7 x 39.7 x 36.5-37	70	96	5.5	\$956	\$1027	N/A	\$184

Not freestanding. Grommet in worksurface. Shipped RTA (ready to assemble). Accommodates shells of all depths. Connecting hardware included. Widths and depths listed are outside dimensions including transaction top overhang on the front and sides. Model numbers reflect the primary worksurface dimensions.

Z2072TSRL	25.6 x 75.7 x 36.5-37	70	153	8.25	\$1434	\$1560	N/A	\$305
Z2060TSRL	25.6 x 63.7 x 36.5-37	70	132	7.25	\$1231	\$1339	N/A	\$256
Z2054TSRL	25.6 x 57.7 x 36.5-37	70	120	6.25	\$1115	\$1216	N/A	\$229
Z2048TSRL	25.6 x 51.7 x 36.5-37	70	110	5.5	\$1023	\$1111	N/A	\$206
Z2042TSRL	25.6 x 45.7 x 36.5-37	70	100	5	\$931	\$1012	N/A	\$180
Z2036TSRL	25.6 x 39.7 x 36.5-37	70	89	4.4	\$845	\$916	N/A	\$156

Not freestanding. Grommet in worksurface. Shipped RTA (ready to assemble). Accommodates shells of 20" depths. Connecting hardware included. Widths and depths listed are outside dimensions including transaction top overhang on the front and sides. Model numbers reflect the primary worksurface dimensions.

Z2472TSRR	29.7 x 75.7 x 36.5-37	70	166	9.75	\$1593	\$1719	N/A	\$366
Z2460TSRR	29.7 x 63.7 x 36.5-37	70	144	8.75	\$1376	\$1484	N/A	\$305
Z2454TSRR	29.7 x 57.7 x 36.5-37	70	132	7.5	\$1250	\$1351	N/A	\$275
Z2448TSRR	29.7 x 51.7 x 36.5-37	70	121	7	\$1150	\$1238	N/A	\$246
Z2442TSRR	29.7 x 45.7 x 36.5-37	70	109	6.25	\$1055	\$1136	N/A	\$214
Z2436TSRR	29.7 x 39.7 x 36.5-37	70	96	5.5	\$956	\$1027	N/A	\$184

Not freestanding. Grommet in worksurface. Shipped RTA (ready to assemble). Accommodates shells of all depths. Connecting hardware included. Widths and depths listed are outside dimensions including transaction top overhang on the front and sides. Model numbers reflect the primary worksurface dimensions.

Z2072TSRR	25.6 x 75.7 x 36.5-37	70	153	8.25	\$1434	\$1560	N/A	\$305
Z2060TSRR	25.6 x 63.7 x 36.5-37	70	132	7.25	\$1231	\$1339	N/A	\$256
Z2054TSRR	25.6 x 57.7 x 36.5-37	70	120	6.25	\$1115	\$1216	N/A	\$229
Z2048TSRR	25.6 x 51.7 x 36.5-37	70	110	5.5	\$1023	\$1111	N/A	\$206
Z2042TSRR	25.6 x 45.7 x 36.5-37	70	100	5	\$931	\$1012	N/A	\$180
Z2036TSRR	25.6 x 39.7 x 36.5-37	70	89	4.4	\$845	\$916	N/A	\$156

Not freestanding. Grommet in worksurface. Shipped RTA (ready to assemble). Accommodates shells of 20" depths. Connecting hardware included. Widths and depths listed are outside dimensions including transaction top overhang on the front and sides. Model numbers reflect the primary worksurface dimensions.

Z2472TBRL	32.7 x 75.7 x 36.5-37	70	168.2	9.75	\$1593	\$1719	N/A	\$366
Z2460TBRL	32.7 x 63.7 x 36.5-37	70	145.3	8.5	\$1376	\$1484	N/A	\$305
Z2454TBRL	32.7 x 57.7 x 36.5-37	70	134.4	7.5	\$1250	\$1351	N/A	\$275
Z2448TBRL	32.7 x 51.7 x 36.5-37	70	122.2	7	\$1150	\$1238	N/A	\$246
Z2442TBRL	32.7 x 45.7 x 36.5-37	70	110.9	6.25	\$1055	\$1136	N/A	\$214
Z2436TBRL	32.7 x 39.7 x 36.5-37	70	98.4	5.5	\$956	\$1027	N/A	\$184

Not freestanding. Grommet in worksurface. Shipped RTA (ready to assemble). Accommodates shells of all depths. Connecting hardware included. Widths and depths listed are outside dimensions including transaction top overhang on the front and sides. Model numbers reflect the primary worksurface dimensions.

Required Specifications

Top finish
Base/surround finish
Transaction top finish

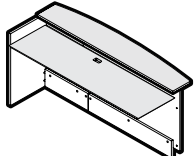
Optional Specifications

HP laminate
Additional grommet

Accessories

Power block

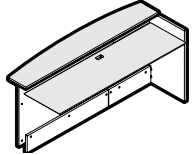
TRANSACTIONAL RETURNS



Transactional Return, Bow Front - LEFT

MODEL#	DIMENSIONS D x W x H	FREIGHT CLASS	WT/LBS.	CUBIC FT.	1" TOP	1.5" TOP	GLAZE ADD	HP ADD
Z2072TBRL	28.6 x 75.7 x 36.5-37	70	155.6	8.25	\$1434	\$1560	N/A	\$305
Z2060TBRL	28.6 x 63.7 x 36.5-37	70	134.2	7.5	\$1231	\$1339	N/A	\$256
Z2054TBRL	28.6 x 57.7 x 36.5-37	70	124	6.5	\$1115	\$1216	N/A	\$229
Z2048TBRL	28.6 x 51.7 x 36.5-37	70	112.6	6	\$1023	\$1111	N/A	\$206
Z2042TBRL	28.6 x 45.7 x 36.5-37	70	101.9	5.25	\$931	\$1012	N/A	\$180
Z2036TBRL	28.6 x 39.7 x 36.5-37	70	90.1	4.7	\$845	\$916	N/A	\$156

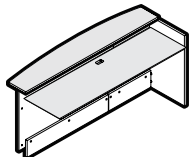
Not freestanding. Grommet in worksurface. Shipped RTA (ready to assemble). Accommodates shells of **20" depths**. Connecting hardware included. Widths and depths listed are outside dimensions including transaction top overhang on the front and sides. Model numbers reflect the primary worksurface dimensions.



Transactional Return, Bow Front - RIGHT

Z2472TBRR	32.7 x 75.7 x 36.5-37	70	168.2	9.75	\$1593	\$1719	N/A	\$366
Z2460TBRR	32.7 x 63.7 x 36.5-37	70	145.3	8.5	\$1376	\$1484	N/A	\$305
Z2454TBRR	32.7 x 57.7 x 36.5-37	70	134.4	7.5	\$1250	\$1351	N/A	\$275
Z2448TBRR	32.7 x 51.7 x 36.5-37	70	122.2	7	\$1150	\$1238	N/A	\$246
Z2442TBRR	32.7 x 45.7 x 36.5-37	70	110.9	6.25	\$1055	\$1136	N/A	\$214
Z2436TBRR	32.7 x 39.7 x 36.5-37	70	98.4	5.5	\$956	\$1027	N/A	\$184

Not freestanding. Grommet in worksurface. Shipped RTA (ready to assemble). Accommodates shells of all depths. Connecting hardware included. Widths and depths listed are outside dimensions including transaction top overhang on the front and sides. Model numbers reflect the primary worksurface dimensions.



Transactional Return, Bow Front - RIGHT

Z2072TBRR	28.6 x 75.7 x 36.5-37	70	155.6	8.25	\$1434	\$1560	N/A	\$305
Z2060TBRR	28.6 x 63.7 x 36.5-37	70	134.2	7.5	\$1231	\$1339	N/A	\$256
Z2054TBRR	28.6 x 57.7 x 36.5-37	70	124	6.5	\$1115	\$1216	N/A	\$229
Z2048TBRR	28.6 x 51.7 x 36.5-37	70	112.6	6	\$1023	\$1111	N/A	\$206
Z2042TBRR	28.6 x 45.7 x 36.5-37	70	101.9	5.25	\$931	\$1012	N/A	\$180
Z2036TBRR	28.6 x 39.7 x 36.5-37	70	90.1	4.7	\$845	\$916	N/A	\$156

Not freestanding. Grommet in worksurface. Shipped RTA (ready to assemble). Accommodates shells of **20" depths**. Connecting hardware included. Widths and depths listed are outside dimensions including transaction top overhang on the front and sides. Model numbers reflect the primary worksurface dimensions.

Required Specifications

Top finish
Transaction top finish
Base/surround finish

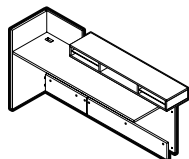
Optional Specifications

HP laminate
Additional grommet

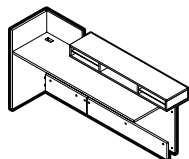
Accessories

Power block

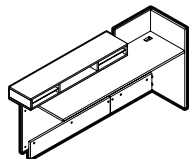
PIGEON RECEPTION RETURNS



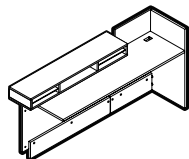
Pigeon Reception Return - LEFT*



Pigeon Reception Return - LEFT*



Pigeon Reception Return - RIGHT*



Pigeon Reception Return - RIGHT*

MODEL#	DIMENSIONS D x W x H	FREIGHT CLASS	WT/LBS.	CUBIC FT.	1"TOP	1.5" TOP	GLAZE ADD	HP ADD
Z2472PRRL	31 x 75.7 x 39.8	70	171.3	9.75	\$1805	N/A	N/A	\$366
Z2460PRRL	31 x 63.7 x 39.8	70	149	8.25	\$1586	N/A	N/A	\$305
Z2454PRRL	31 x 57.7 x 39.8	70	136.4	7.5	\$1475	N/A	N/A	\$275

Not freestanding. Grommet in worksurface. Shipped RTA (ready to assemble). Accommodates shells of all depths. Connecting hardware included. Widths and depths listed are outside dimensions including transaction top overhang on the front and sides. Model numbers reflect the primary worksurface dimensions.

Z2072PRRL	26.9 x 75.7 x 39.8	70	159	9.75	\$1650	N/A	N/A	\$305
Z2060PRRL	26.9 x 63.7 x 39.8	70	138.2	8.25	\$1444	N/A	N/A	\$256
Z2054PRRL	26.9 x 57.7 x 39.8	70	126.2	7.5	\$1342	N/A	N/A	\$229

Not freestanding. Grommet in worksurface. Shipped RTA (ready to assemble). Accommodates shells of **20" depths**. Connecting hardware included. Widths and depths listed are outside dimensions including transaction top overhang on the front and sides. Model numbers reflect the primary worksurface dimensions.

Z2472PRRR	31 x 75.7 x 39.8	70	171.3	9.75	\$1805	N/A	N/A	\$366
Z2460PRRR	31 x 63.7 x 39.8	70	149	8.25	\$1586	N/A	N/A	\$305
Z2454PRRR	31 x 57.7 x 39.8	70	136.4	7.5	\$1475	N/A	N/A	\$275

Not freestanding. Grommet in worksurface. Shipped RTA (ready to assemble). Accommodates shells of all depths. Connecting hardware included. Widths and depths listed are outside dimensions including transaction top overhang on the front and sides. Model numbers reflect the primary worksurface dimensions.

Z2072PRRR	26.9 x 75.7 x 39.8	70	159	9.75	\$1650	N/A	N/A	\$305
Z2060PRRR	26.9 x 63.7 x 39.8	70	138.2	8.25	\$1444	N/A	N/A	\$256
Z2054PRRR	26.9 x 57.7 x 39.8	70	126.2	7.5	\$1342	N/A	N/A	\$229

Not freestanding. Grommet in worksurface. Shipped RTA (ready to assemble). Accommodates shells of **20" depths**. Connecting hardware included. Widths and depths listed are outside dimensions including transaction top overhang on the front and sides. Model numbers reflect the primary worksurface dimensions.

Required Specifications

Top finish
Base/surround finish
Pigeon hole finish
Collator finish

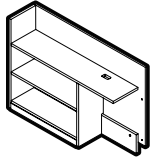
Optional Specifications

HP laminate
Additional grommet

Accessories

Power block

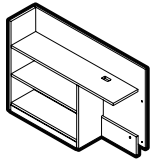
BOOKCASE RETURNS



Bookcase Reception Return - LEFT

MODEL#	DIMENSIONS D x W x H	FREIGHT CLASS	WT/LBS.	CUBIC FT.	1" TOP	1.5" TOP	GLAZE ADD	HP ADD
Z1272BRRL	13.7 x 75.7 x 39.8	70	158	7.5	\$1443	N/A	N/A	\$184
Z1260BRRL	13.7 x 63.7 x 39.8	70	139	6.25	\$1276	N/A	N/A	\$156

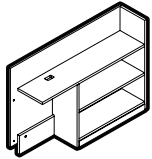
Not freestanding. Grommet in worksurface. Shipped RTA (ready to assemble). Accommodates shells of all depths. Connecting hardware included. Widths and depths listed are outside dimensions including outside surrounds. Model numbers reflect the primary worksurface dimensions.



Bookcase Reception Return - LEFT

Z1254BRRL	13.7 x 57.7 x 39.8	65	131	5.75	\$1181	N/A	N/A	\$139
Z1248BRRL	13.7 x 51.7 x 39.8	70	114	5.25	\$1051	N/A	N/A	\$125
Z1242BRRL	13.7 x 45.7 x 39.8	65	106	4.6	\$988	N/A	N/A	\$110
Z1236BRRL	13.7 x 39.7 x 39.8	65	98	4.1	\$926	N/A	N/A	\$94

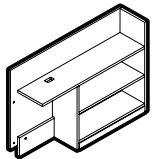
Not freestanding. Grommet in worksurface. Shipped RTA (ready to assemble). Accommodates shells of all depths. Connecting hardware included. Widths and depths listed are outside dimensions including outside surrounds. Model numbers reflect the primary worksurface dimensions.



Bookcase Reception Return - RIGHT

Z1272BRRR	13.7 x 75.7 x 39.8	70	158	7.5	\$1443	N/A	N/A	\$184
Z1260BRRR	13.7 x 63.7 x 39.8	70	139	6.25	\$1276	N/A	N/A	\$156

Not freestanding. Grommet in worksurface. Shipped RTA (ready to assemble). Accommodates shells of all depths. Connecting hardware included. Widths and depths listed are outside dimensions including outside surrounds. Model numbers reflect the primary worksurface dimensions.

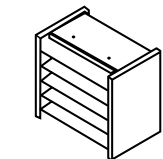


Bookcase Reception Return - RIGHT

Z1254BRRR	13.7 x 57.7 x 39.8	65	131	5.75	\$1181	N/A	N/A	\$139
Z1248BRRR	13.7 x 51.7 x 39.8	70	114	5.25	\$1051	N/A	N/A	\$125
Z1242BRRR	13.7 x 45.7 x 39.8	65	106	4.6	\$988	N/A	N/A	\$110
Z1236BRRR	13.7 x 39.7 x 39.8	65	98	4.1	\$926	N/A	N/A	\$94

Not freestanding. Grommet in worksurface. Shipped RTA (ready to assemble). Accommodates shells of all depths. Connecting hardware included. Widths and depths listed are outside dimensions including outside surrounds. Model numbers reflect the primary worksurface dimensions.

RECEPTION DESK VERTICAL STORAGE



Reception Desk - Vertical Storage*

MODEL#	DIMENSIONS	FREIGHT CLASS	WT/LBS.	CUBIC FT.	1" TOP	1.5" TOP	GLAZE ADD	HP ADD
ZRDVS13	8.6 x 13.4 x 12.2	70	12.50	.80	\$237	N/A	N/A	N/A

Collator shelves.

Required Specifications

Top finish
Base/surround finish
Pigeon hole finish*
Collator finish*

Optional Specifications

HP laminate
Additional grommet

Accessories

Power block

GENERAL INFORMATION

- Comprehensive range of personal storage in a variety of sizes and configurations starting at 27.5"/28"H single column widths up to 66.5"/67"H triple column widths.
- Configurations include units with 1, 2, 3, 4, 6, 8 or 9 compartments depending on size.
- Lockers adapt to any space plan; in personal or shared work spaces, individually tailored to suit storage needs. Ideal for flex spaces or used to define space and used as barriers between work areas and to help guide workplace foot traffic flow.
- Available in two depths with door front in thermally fused laminate to add warmth and complement desking products or millwork.
- Multiple door pull options to match Global Desking series
- Units have internal drill points for optional ganging.
- Ships fully assembled.

CONSTRUCTION

- Tops are available in 1" or 1.5" thick thermally fused laminate tops with a variety of edge details
- Side panels utilize 1" thick material
- Shelves and backs utilize 11/16" thick material.
- Tops are sealed with Global's preferred edge in matching color. Woodgrain surfaces feature edging with matching printed woodgrain
- Constructed of 45 lb. density particleboard with high performance thermally fused laminate
- Virtually no loose hardware
- Leveling glides are standard

LOCKS

- Locks are standard on all lockers. Finish will coordinate with handles and/or aluminum doors.
- Please note that Flared Brass (HW) handle defaults to Black locks

SHIPPING

- Shipped assembled, 1 per carton, unless otherwise noted.

PRODUCT CODE BREAKDOWN:

- ZL**- indicates Zira locker
- ##** - 3rd & 4th position indicates height
- ##** - 5th & 6th position indicates width
- F** - indicates 18"D overall / **L** - indicates 24"D overall
- #** - 8th position indicates the number of columns side to side
- #** - 9th position indicates the number of rows top to bottom
- L** or **R** - indicates doors installed for left or right hand hinge

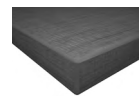
FINISH OPTIONS

- Must specify finish for top, case and doors separately

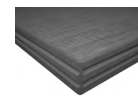
Thermally fused laminate finish options:

ACJ Absolute Acajou	FCL First Class
ASN Asian Night	NBL Noce Biondo
AWC Avant Cherry	NGL Noce Grigio
AWH Avant Honey	NEL Noce Leggero
BLK Black	NML Noce Medio
BZD Blizzard	QTM Quartered Mahogany
BRC Brushed Cobalt	SBY Sheer Beauty
CMB Clear Maple	SOG Storm Grey
CGY Custom Grey	SDT Stonedust
DES Dark Espresso	WHE Walnut Heights
DWT Designer White	WHC White Chocolate
FAS Fashionista	WCR Winter Cherry

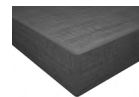
Top Thickness/Edge Detail



A3 1" top, standard flat edge



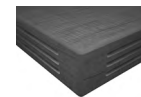
AR 1" top, bicut edge



C3 1.5" top, standard flat edge



CR 1.5" top, bicut edge



CF 1.5" top, fluted edge

HANDLES

- To order handles, please specify corresponding code to image as below (**HS, HO, HW, HX, HV, HU, HQ, HZ, or HR**):



HS Flared Silver



HV Square Edge Silver



HO Crescent Black



HW Flared Brass



HU Square Edge Black



HZ Dimpled Nickel



HX Flared Black



HQ Bar Silver



HR Bar Black

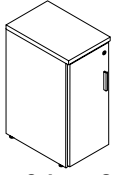
INTERIOR SHELF AND HANGING OPTIONS

- Hooks and hat shelves are standard in certain units. See individual product description for details
- When standard, hat shelf is 11/16" thick and includes 9" of clearance.
- A chrome coat hook is affixed to the left or right side wall of the opening (based on left and right handed units) on single row lockers 40.5" and up, and on double row lockers 53.5"h and up.
- When standard, a chrome coat hook is affixed to the door.

GANGING

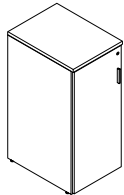
- **All units 12", 15" or 18" wide must be ganged to another locker or anchored to a fixed wall or adjacent cabinet for compliance with applicable ANSI/BIFMA X5.6 Storage standards.**
- Units ship factory ready for ganging and include pre-drills on cabinet interiors as well as the necessary hardware to connect unit to unit.

SINGLE COLUMN LOCKERS



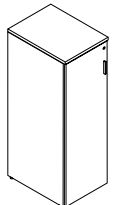
Left shown

One Column, One Row - 27.5/28" H



Left shown

One Column, One Row - 40.5/41" H



Left shown

One Column, One Row - 53.5/54" H

MODEL#	DIMENSIONS D x W x H	FREIGHT CLASS	WT/LBS.	CUBIC FT.	1" TOP	1.5" TOP
ZL2712F11L	18 x 12 x 27.5-28	92.5	52	5	\$702	\$720
ZL2712F11R	18 x 12 x 27.5-28	92.5	52	5	\$702	\$720

- Select suffix **(L)** for **left** hand / **(R)** for **right** hand opening.
- 12" wide lockers to be ganged or anchored for compliance with ANSI/BIFMA X5.6 storage standards.

ZL4012F11L	18 x 12 x 40.5-41	92.5	71	7.09	\$907	\$942
ZL4015F11L	18 x 15 x 40.5-41	100	74	8.75	\$980	\$1015
ZL4018F11L	18 x 18 x 40.5-41	100	86	10.25	\$1071	\$1106
ZL4012L11L	24 x 12 x 40.5-41	100	89	9.35	\$997	\$1032
ZL4015L11L	24 x 15 x 40.5-41	100	97	11.25	\$1088	\$1106
ZL4018L11L	24 x 18 x 40.5-41	125	105	13.25	\$1179	\$1218

ZL4012F11R	18 x 12 x 40.5-41	92.5	71	7.09	\$907	\$942
ZL4015F11R	18 x 15 x 40.5-41	100	74	8.75	\$980	\$1015
ZL4018F11R	18 x 18 x 40.5-41	100	86	10.25	\$1071	\$1106
ZL4012L11R	24 x 12 x 40.5-41	100	89	9.35	\$997	\$1032
ZL4015L11R	24 x 15 x 40.5-41	100	97	11.25	\$1088	\$1106
ZL4018L11R	24 x 18 x 40.5-41	125	105	13.25	\$1179	\$1218

- Select suffix **(L)** for **left** hand / **(R)** for **right** hand opening. Includes hat shelf and coat hook.
- 12", 15" or 18" wide lockers to be ganged or anchored for compliance with ANSI/BIFMA X5.6 storage standards.

ZL5312F11L	18 x 12 x 53.5-54	100	92	9.25	\$1161	\$1179
ZL5315F11L	18 x 15 x 53.5-54	100	101	11.25	\$1275	\$1309
ZL5318F11L	18 x 18 x 53.5-54	100	111	13	\$1399	\$1456
ZL5312L11L	24 x 12 x 53.5-54	100	115	12	\$1275	\$1309
ZL5315L11L	24 x 15 x 53.5-54	100	126	14.5	\$1366	\$1400
ZL5318L11L	24 x 18 x 53.5-54	100	136	17	\$1495	\$1546

ZL5312F11R	18 x 12 x 53.5-54	100	92	9.25	\$1161	\$1179
ZL5315F11R	18 x 15 x 53.5-54	100	101	11.25	\$1275	\$1309
ZL5318F11R	18 x 18 x 53.5-54	100	111	13	\$1399	\$1456
ZL5312L11R	24 x 12 x 53.5-54	100	115	12	\$1275	\$1309
ZL5315L11R	24 x 15 x 53.5-54	100	126	14.5	\$1366	\$1400
ZL5318L11R	24 x 18 x 53.5-54	100	136	17	\$1495	\$1546

- Select suffix **(L)** for **left** hand / **(R)** for **right** hand opening. Includes hat shelf and coat hook.
- 12", 15" or 18" wide lockers to be ganged or anchored for compliance with ANSI/BIFMA X5.6 storage standards.

Required Specifications

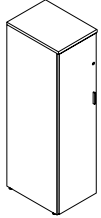
Top Finish
 Door Finish
 Top/Edge Detail
 Handles
 Base Finish

Optional Specifications

Key #

Accessories

SINGLE COLUMN LOCKERS



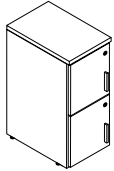
Left shown

One Column, One Row - 66.5/67" H

MODEL#	DIMENSIONS	FREIGHT CLASS	WT/LBS.	CUBIC FT.	1" TOP	1.5" TOP
D x W x H						
ZL6612F11L	18 x 12 x 66.5-67	100	111	11.5	\$1326	\$1349
ZL6615F11L	18 x 15 x 66.5-67	100	122	13.75	\$1422	\$1456
ZL6618F11L	18 x 18 x 66.5-67	125	127	16.25	\$1586	\$1620
ZL6612L11L	24 x 12 x 66.5-67	100	139	15	\$1473	\$1513
ZL6615L11L	24 x 15 x 66.5-67	100	151	18	\$1569	\$1620
ZL6618L11L	24 x 18 x 66.5-67	125	163	22	\$1717	\$1768
ZL6612F11R	18 x 12 x 66.5-67	100	111	11.5	\$1326	\$1349
ZL6615F11R	18 x 15 x 66.5-67	100	122	13.75	\$1422	\$1456
ZL6618F11R	18 x 18 x 66.5-67	125	127	16.25	\$1586	\$1620
ZL6612L11R	24 x 12 x 66.5-67	100	139	15	\$1473	\$1513
ZL6615L11R	24 x 15 x 66.5-67	100	151	18	\$1569	\$1620
ZL6618L11R	24 x 18 x 66.5-67	125	163	22	\$1717	\$1768

- Select suffix **(L)** for left hand / **(R)** for right hand opening. Includes hat shelf and coat hook.
- 12", 15" or 18" wide lockers to be ganged or anchored for compliance with ANSI/BIFMA X5.6 storage standards.

ONE COLUMN LOCKERS, TWO ROWS

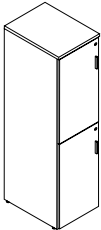


Left shown

One Column, Two Rows - 27.5/28" H

MODEL#	DIMENSIONS	FREIGHT CLASS	WT/LBS.	CUBIC FT.	1" TOP	1.5" TOP
ZL2712F12L	18 x 12 x 27.5-28	92.5	55	5	\$833	\$862
ZL2712F12R	18 x 12 x 27.5-28	92.5	55	5	\$833	\$862

- Select suffix **(L)** for left hand / **(R)** for right hand opening.
- 12" wide lockers to be ganged or anchored for compliance with ANSI/BIFMA X5.6 storage standards.



Left shown

One Column, Two Rows - 66.5/67" H

ZL6612F12L	18 x 12 x 66.5-67	100	112	11.5	\$1478	\$1508
ZL6618F12L	18 x 18 x 66.5-67	100	135	16.25	\$1727	\$1773
ZL6612L12L	24 x 12 x 66.5-67	100	140	15	\$1619	\$1654
ZL6618L12L	24 x 18 x 66.5-67	125	165	21.25	\$1881	\$1932
ZL6612F12R	18 x 12 x 66.5-67	100	112	11.5	\$1478	\$1508
ZL6618F12R	18 x 18 x 66.5-67	100	135	16.25	\$1727	\$1773
ZL6612L12R	24 x 12 x 66.5-67	100	140	15	\$1619	\$1654
ZL6618L12R	24 x 18 x 66.5-67	125	165	21.25	\$1881	\$1932

- Select suffix **(L)** for left hand / **(R)** for right hand opening. Includes coat hook in each opening
- 12" or 18" wide lockers to be ganged or anchored for compliance with ANSI/BIFMA X5.6 storage standards.

Required Specifications

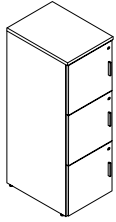
Top Finish _____ Base Finish _____
 Door Finish _____
 Top/Edge Detail _____
 Handles _____

Optional Specifications

Key # _____

Accessories

ONE COLUMN LOCKERS, THREE ROWS

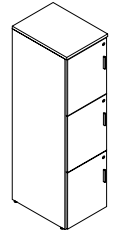


Left shown

One Column, Three Rows - 53.5/54" H

MODEL#	DIMENSIONS D x W x H	FREIGHT CLASS	WT/LBS.	CUBIC FT.	1" TOP	1.5" TOP
ZL5312F13L	18 x 12 x 53.5-54	92.5	96	9.25	\$1308	\$1337
ZL5318F13L	18 x 18 x 53.5-54	100	118	13.25	\$1563	\$1603
ZL5312L13L	24 x 12 x 53.5-54	100	121	12.25	\$1427	\$1462
ZL5318L13L	24 x 18 x 53.5-54	100	145	17.25	\$1694	\$1801
ZL5312F13R	18 x 12 x 53.5-54	92.5	96	9.25	\$1308	\$1337
ZL5318F13R	18 x 18 x 53.5-54	100	118	13.25	\$1563	\$1603
ZL5312L13R	24 x 12 x 53.5-54	100	121	12.25	\$1427	\$1462
ZL5318L13R	24 x 18 x 53.5-54	100	145	17.25	\$1694	\$1801

- Select suffix **(L)** for **left** hand / **(R)** for **right** hand.
- 12" or 18" wide lockers to be ganged or anchored for compliance with ANSI/BIFMA X5.6 storage standards.



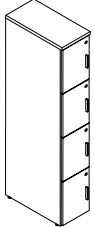
Left shown

One Column, Three Rows - 66.5/67" H

ZL6612F13L	18 x 12 x 66.5-67	92.5	115	11.5	\$1478	\$1508
ZL6618F13L	18 x 18 x 66.5-67	100	140	16.25	\$1750	\$1807
ZL6612L13L	24 x 12 x 66.5-67	100	144	15	\$1614	\$1649
ZL6618L13L	24 x 18 x 66.5-67	100	171	21.25	\$1909	\$1960
ZL6612F13R	18 x 12 x 66.5-67	92.5	115	11.5	\$1478	\$1508
ZL6618F13R	18 x 18 x 66.5-67	100	140	16.25	\$1750	\$1807
ZL6612L13R	24 x 12 x 66.5-67	100	144	15	\$1614	\$1649
ZL6618L13R	24 x 18 x 66.5-67	100	171	21.25	\$1909	\$1960

- Select suffix **(L)** for **left** hand / **(R)** for **right** hand opening.
- 12" or 18" wide lockers to be ganged or anchored for compliance with ANSI/BIFMA X5.6 storage standards.

ONE COLUMN LOCKERS, FOUR ROWS



Left shown

One Column, Four Rows - 66.5/67" H

MODEL#	DIMENSIONS	FREIGHT CLASS	WT/LBS.	CUBIC FT.	1" TOP	1.5" TOP
ZL6612F14L	18 x 12 x 66.5-67	92.5	119	11.5	\$1642	\$1672
ZL6612L14L	24 x 12 x 66.5-67	100	149	15	\$1784	\$1819
ZL6612F14R	18 x 12 x 66.5-67	92.5	119	11.5	\$1642	\$1672
ZL6612L14R	24 x 12 x 66.5-67	100	149	15	\$1784	\$1819

- Select suffix **(L)** for **left** hand / **(R)** for **right** hand opening.
- 12" wide lockers to be ganged or anchored for compliance with ANSI/BIFMA X5.6 storage standards.

Required Specifications

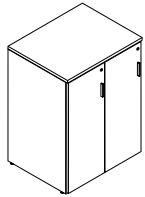
Top Finish
 Door Finish
 Top/Edge Detail
 Handles

Optional Specifications

Key #

Accessories

TWO COLUMN LOCKERS, ONE ROW



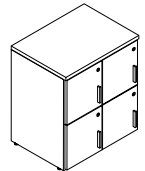
Left shown

Two Columns, One Row - 40.5/41" H

MODEL#	DIMENSIONS	FREIGHT CLASS	WT/LBS.	CUBIC FT.	1" TOP	1.5" TOP
D x W x H						
ZL4024F21L	18 x 24 x 40.5-41	100	118	13.25	\$1535	\$1591
ZL4030F21L	18 x 30 x 40.5-41	100	133	16.5	\$1659	\$1728
ZL4024L21L	24 x 24 x 40.5-41	100	149	17.25	\$1687	\$1750
ZL4030L21L	24 x 30 x 40.5-41	125	166	21.25	\$1818	\$1897
ZL4024F21R	18 x 24 x 40.5-41	100	118	13.25	\$1535	\$1591
ZL4030F21R	18 x 30 x 40.5-41	100	133	16.5	\$1659	\$1728
ZL4024L21R	24 x 24 x 40.5-41	100	149	17.25	\$1687	\$1750
ZL4030L21R	24 x 30 x 40.5-41	125	166	21.25	\$1818	\$1897

- Select suffix **(L)** for left hand / **(R)** for right hand opening. Includes coat hook in each opening

TWO COLUMN LOCKERS, TWO ROWS

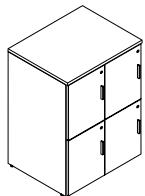


Left shown

Two Columns, Two Rows - 27.5/28" H

MODEL#	DIMENSIONS	FREIGHT CLASS	WT/LBS.	CUBIC FT.	1" TOP	1.5" TOP
ZL2724F22L	18 x 24 x 27.5-28	100	94	9.5	\$1427	\$1478
ZL2724F22R	18 x 24 x 27.5-28	100	94	9.5	\$1427	\$1478

- Select suffix **(L)** for left hand / **(R)** for right hand opening.

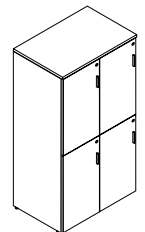


Left shown

Two Columns, Two Rows - 40.5/41" H

ZL4024F22L	18 x 24 x 40.5-41	100	125	13.25	\$1677	\$1728
ZL4030F22L	18 x 30 x 40.5-41	100	142	16.25	\$1818	\$1881
ZL4024L22L	24 x 24 x 40.5-41	100	158	17.25	\$1841	\$1904
ZL4030L22L	24 x 30 x 40.5-41	100	178	21.25	\$1993	\$2073
ZL4024F22R	18 x 24 x 40.5-41	100	125	13.25	\$1677	\$1728
ZL4030F22R	18 x 30 x 40.5-41	100	142	16.25	\$1818	\$1881
ZL4024L22R	24 x 24 x 40.5-41	100	158	17.25	\$1841	\$1904
ZL4030L22R	24 x 30 x 40.5-41	100	178	21.25	\$1993	\$2073

- Select suffix **(L)** for left hand / **(R)** for right hand opening.



Left shown

Two Columns, Two Rows - 66.5/67" H

ZL6624F22L	18 x 24 x 66.5-67	100	187	21.25	\$2503	\$2554
ZL6636F22L	18 x 36 x 66.5-67	125	235	31	\$2939	\$3013
ZL6636L22L	24 x 36 x 66.5-67	125	283	40	\$3159	\$3250
ZL6624F22R	18 x 24 x 66.5-67	100	187	21.25	\$2503	\$2554
ZL6636F22R	18 x 36 x 66.5-67	125	235	31	\$2939	\$3013
ZL6636L22R	24 x 36 x 66.5-67	125	283	40	\$3159	\$3250

- Select suffix **(L)** for left hand / **(R)** for right hand opening. Includes coat hook in each opening and on each door.

Required Specifications

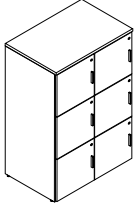
Top Finish _____ Base Finish _____
 Door Finish _____
 Top/Edge Detail _____
 Handles _____

Optional Specifications

Key # _____

Accessories

TWO COLUMN LOCKERS, THREE ROWS

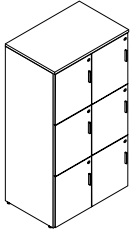


Left shown

Two Columns, Three Rows - 53.5/54" H

MODEL#	DIMENSIONS D x W x H	FREIGHT CLASS	WT/LBS.	CUBIC FT.	1" TOP	1.5" TOP
ZL5324F23L	18 x 24 x 53.5-54	100	163	17.25	\$2237	\$2294
ZL5330F23L	18 x 30 x 53.5-54	100	185	21.25	\$2429	\$2492
ZL5336F23L	18 x 36 x 53.5-54	100	207	25.25	\$2662	\$2741
ZL5324L23L	24 x 24 x 53.5-54	100	205	22.5	\$2447	\$2509
ZL5330L23L	24 x 30 x 53.5-54	100	230	27.5	\$2650	\$2730
ZL5336L23L	24 x 36 x 53.5-54	125	252	32.75	\$2887	\$2978
ZL5324F23R	18 x 24 x 53.5-54	100	163	17.25	\$2237	\$2294
ZL5330F23R	18 x 30 x 53.5-54	100	185	21.25	\$2429	\$2492
ZL5336F23R	18 x 36 x 53.5-54	100	207	25.25	\$2662	\$2741
ZL5324L23R	24 x 24 x 53.5-54	100	205	22.5	\$2447	\$2509
ZL5330L23R	24 x 30 x 53.5-54	100	230	27.5	\$2650	\$2730
ZL5336L23R	24 x 36 x 53.5-54	125	252	32.75	\$2887	\$2978

- Select suffix **(L)** for **left** hand / **(R)** for **right** hand.
- 12" or 18" wide lockers to be ganged or anchored for compliance with ANSI/BIFMA X5.6 storage standards.



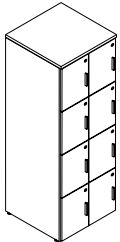
Left shown

Two Columns, Three Rows - 66.5-67" H

ZL6624F23L	18 x 24 x 66.5-67	100	194	21.25	\$2497	\$2548
ZL6630F23L	18 x 30 x 66.5-67	100	219	26	\$2712	\$2775
ZL6636F23L	18 x 36 x 66.5-67	125	246	31	\$2985	\$3064
ZL6624L23L	24 x 24 x 66.5-67	100	243	27.5	\$2730	\$2792
ZL6630L23L	24 x 30 x 66.5-67	100	271	33.75	\$2962	\$3036
ZL6636L23L	24 x 36 x 66.5-67	125	297	40	\$3228	\$3319
ZL6624F23R	18 x 24 x 66.5-67	100	194	21.25	\$2497	\$2548
ZL6630F23R	18 x 30 x 66.5-67	100	219	26	\$2712	\$2775
ZL6636F23R	18 x 36 x 66.5-67	125	246	31	\$2985	\$3064
ZL6624L23R	24 x 24 x 66.5-67	100	243	27.5	\$2730	\$2792
ZL6630L23R	24 x 30 x 66.5-67	100	271	33.75	\$2962	\$3036
ZL6636L23R	24 x 36 x 66.5-67	125	297	40	\$3228	\$3319

- Select suffix **(L)** for **left** hand / **(R)** for **right** hand.
- 12" or 18" wide lockers to be ganged or anchored for compliance with ANSI/BIFMA X5.6 storage standards.

TWO COLUMN LOCKERS, FOUR ROWS



Left shown

Two Columns, Four Rows - 66.5/67" H

MODEL#	DIMENSIONS	FREIGHT CLASS	WT/LBS.	CUBIC FT.	1" TOP	1.5" TOP
ZL6624F24L	18 x 24 x 66.5-67	100	201	21.25	\$2826	\$2877
ZL6624L24L	24 x 24 x 66.5-67	100	252	27.5	\$3069	\$3138
ZL6624F24R	18 x 24 x 66.5-67	100	201	21.25	\$2826	\$2877
ZL6624L24R	24 x 24 x 66.5-67	100	252	27.5	\$3069	\$3138

- Select suffix **(L)** for **left** hand / **(R)** for **right** hand opening.

Required Specifications

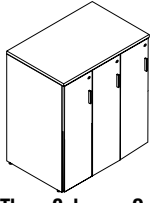
Top Finish
Door Finish
Top/Edge Detail
Handles
Base Finish

Optional Specifications

Key #

Accessories

THREE COLUMN LOCKERS, ONE ROW

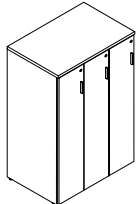


Left shown

Three Columns, One Row - 40.5/41" H

MODEL#	DIMENSIONS D x W x H	FREIGHT CLASS	WT/LBS.	CUBIC FT.	1" TOP	1.5" TOP
ZL4036F31L	18 x 36 x 40.5-41	100	165	19.5	\$2129	\$2209
ZL4036L31L	24 x 36 x 40.5-41	100	203	25.25	\$2305	\$2395
ZL4036F31R	18 x 36 x 40.5-41	100	165	19.5	\$2129	\$2209
ZL4036L31R	24 x 36 x 40.5-41	100	203	25.25	\$2305	\$2395

- Select suffix **(L)** for left hand / **(R)** for right hand opening. Includes coat hook in each opening

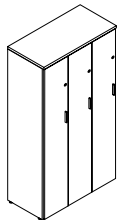


Left shown

Three Columns, One Row - 53.5/54" H

ZL5336F31L	18 x 36 x 53.5-54	100	215	25.25	\$2627	\$2707
ZL5336L31L	24 x 36 x 53.5-54	100	265	32.75	\$2882	\$2973
ZL5336F31R	18 x 36 x 53.5-54	100	215	25.25	\$2627	\$2707
ZL5336L31R	24 x 36 x 53.5-54	100	265	32.75	\$2882	\$2973

- Select suffix **(L)** for left hand / **(R)** for right hand opening. Includes hat shelf and coat hook in each opening.



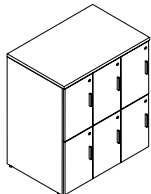
Left shown

Three Columns, One Row - 66.5/67" H

ZL6636F31L	18 x 36 x 66.5-67	100	258	31	\$2985	\$3059
ZL6636L31L	24 x 36 x 66.5-67	125	317	40	\$3267	\$3357
ZL6636F31R	18 x 36 x 66.5-67	100	258	31	\$2985	\$3059
ZL6636L31R	24 x 36 x 66.5-67	125	317	40	\$3267	\$3357

- Select suffix **(L)** for left hand / **(R)** for right hand opening. Includes hat shelf and coat hook in each opening.

THREE COLUMN LOCKERS, TWO ROWS

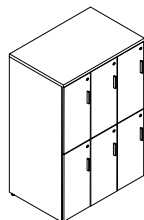


Left shown

Three Columns, Two Rows - 40.5/41" H

MODEL#	DIMENSIONS	FREIGHT CLASS	WT/LBS.	CUBIC FT.	1" TOP	1.5" TOP
ZL4036F32L	18 x 36 x 40.5-41	100	176	19.5	\$2339	\$2413
ZL4036L32L	24 x 36 x 40.5-41	100	218	25.25	\$2537	\$2627
ZL4036F32R	18 x 36 x 40.5-41	100	176	19.5	\$2339	\$2413
ZL4036L32R	24 x 36 x 40.5-41	100	218	25.25	\$2537	\$2627

- Select suffix **(L)** for left hand / **(R)** for right hand opening.



Left shown

Three Columns, Two Rows - 53.5/54" H

ZL5336F32L	18 x 36 x 53.5-54	100	219	25.25	\$3159	\$3233
ZL5336L32L	24 x 36 x 53.5-54	100	269	32.75	\$3392	\$3482
ZL5336F32R	18 x 36 x 53.5-54	100	219	25.25	\$3159	\$3233
ZL5336L32R	24 x 36 x 53.5-54	100	269	32.75	\$3392	\$3482

- Select suffix **(L)** for left hand / **(R)** for right hand opening. Includes coat hook in each opening and on each door.

Required Specifications

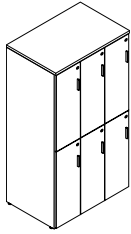
Top Finish _____ Base Finish _____
 Door Finish _____
 Top/Edge Detail _____
 Handles _____

Optional Specifications

Key # _____

Accessories

THREE COLUMN LOCKERS, TWO ROWS



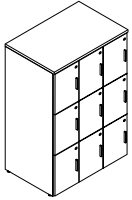
Left shown

Three Columns, Two Rows - 66.5/67" H

MODEL#	DIMENSIONS D x W x H	FREIGHT CLASS	WT/LBS.	CUBIC FT.	1" TOP	1.5" TOP
ZL6636F32L	18 x 36 x 66.5-67	100	262	31	\$3556	\$3630
ZL6636L32L	24 x 36 x 66.5-67	100	322	40	\$3833	\$3923
ZL6636F32R	18 x 36 x 66.5-67	100	262	31	\$3556	\$3630
ZL6636L32R	24 x 36 x 66.5-67	100	322	40	\$3833	\$3923

- Select suffix **(L)** for **left** hand / **(R)** for **right** hand opening. Includes coat hook in each opening and on each door.

THREE COLUMN LOCKERS, THREE ROWS

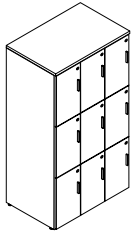


Left shown

Three Columns, Three Rows - 53.5/54" H

MODEL#	DIMENSIONS	FREIGHT CLASS	WT/LBS.	CUBIC FT.	1" TOP	1.5" TOP
ZL5336F33L	18 x 36 x 53.5-54	100	229	25.25	\$3154	\$3228
ZL5336L33L	24 x 36 x 53.5-54	100	283	32.75	\$3402	\$3493
ZL5336F33R	18 x 36 x 53.5-54	100	229	25.25	\$3154	\$3228
ZL5336L33R	24 x 36 x 53.5-54	100	283	32.75	\$3402	\$3493

- Select suffix **(L)** for **left** hand / **(R)** for **right** hand opening.



Left shown

Three Columns, Three Rows - 66.5/67" H

ZL6636F33L	18 x 36 x 66.5-67	100	272	31	\$3550	\$3624
ZL6636L33L	24 x 36 x 66.5-67	100	336	40	\$3850	\$3941
ZL6636F33R	18 x 36 x 66.5-67	100	272	31	\$3550	\$3624
ZL6636L33R	24 x 36 x 66.5-67	100	336	40	\$3850	\$3941

- Select suffix **(L)** for **left** hand / **(R)** for **right** hand opening.

Required Specifications

Top Finish _____ Base Finish _____
 Door Finish _____
 Top/Edge Detail _____
 Handles _____

Optional Specifications

Key # _____

Accessories