

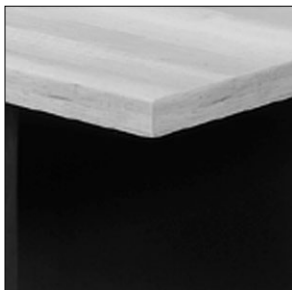

With over 370 components available in 400 color combinations, Adaptabilities provides the ultimate in flexibility and modularity. Rich laminate colors coordinate easily with any office or home decor. All surfaces are constructed from Global's exclusive premium grade, high performance laminate and preferred matching edges.

Adaptabilities features an extensive range of versatile components which can be configured into multi-user workstations suitable for intensive task functions, or for private executive suites requiring stately elegance and work-force functions. All laminate filing cabinets have a safety mechanism that prevents two drawers from being opened at the same time. File drawers have fully progressive ball bearing suspensions and accommodate letter and legal filing. For heavy duty usage, two, three and four drawer laminate files are available with steel drawer interiors.



Tops are 1" thick and a top over side, edge panel design.

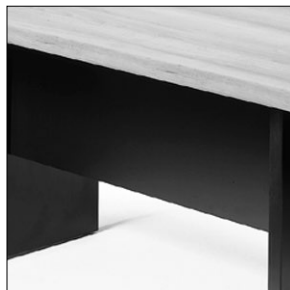

3/4 modesty panel available at no extra charge.



For heavy duty usage, two, three and four drawer laminate files are available with steel drawer interiors.

Features and Benefits

- 45lb. density particle board substructure with high performance thermally fused laminate
- 1" thick worksurfaces in thermally fused or high pressure laminate
- Worksurfaces feature 2mm edging in matching color.
- Full to floor or 3/4 pedestals available on most components
- All desks are size (incrementally) accurate
- 11/16" thick full modesty panel is standard
- 11/16" thick 3/4 modesty panel is available on most components
- Pencil tray included in box drawer
- File drawers can accommodate legal or letter documents
- Full progressive ball bearing suspension on file drawers
- All drawer fronts edge banded with side pull opening pedestals and standard with pedestal locks
- Compatible with **Divide** panel system for increased privacy and storage requirements

GENERAL INFORMATION

- Constructed of 45 lb. density particleboard with high performance thermally fused laminate
- Adaptabilities components are compatible with Divide transaction tops and partitioning panels. See pg. 496 for Divide specifications and prices.
- See pages 40-41 for keyboard drawers and additional accessory options.
- Adaptabilities desk and storage products have been tested and comply with all BIFMA mechanical tests.
- For environmental certifications, please visit globalfurnituregroup.com.

WORKSURFACES

- 1" thick high performance thermally fused laminate tops (**TFL**) sealed with Global's preferred edging in matching color. Woodgrain surfaces feature edging with matching printed woodgrain.
- High pressure tops (**HPL**) are available in all Adaptabilities laminate finishes at an extended lead time, upcharge applies. Please see model # for pricing and availability.
- Products specified with the high pressure laminate option are finished on the underside of the surface with a kraft paper backing.

CONSTRUCTION

- Constructed of 45 lb. density particleboard with high performance thermally fused laminate.
- Cabinets and wardrobes are 65" high to match overall height of a worksurface with hutch (worksurface 29" + hutch 36" = 65").
- 65" high end shelves are also available to match overall height.
- Models with monoposts are available with Black (**TBL**) or Tungsten (**TTU**) monoposts, please specify.
- Models with handles are available with Black (**HX**) or Silver (**HS**) handles, please specify.
- All drawer fronts edge banded with side pull opening pedestals and standard pedestal locks.
- Double wall pedestal housing with fully closed bottom.

MODESTY PANELS

- 11/16" thick full modesty panel is standard
- 11/16" thick ¾ modesty panel available on most components
- ¾ height modesty panels available on most models at no additional charge. Please specify (**3MP**). Corners must have both modesty panels as ¾ or full.
- **Note:** Woodgrain modesty panels 60" wide and up will have the grain pattern in a horizontal direction. All end panels and modesty panels 59" or less will have the grain pattern in a vertical direction.

STORAGE

- All lateral file drawer fronts feature the woodgrain running in a horizontal direction.
- Pencil tray included in box drawer
- File drawers can accommodate legal or letter documents
- Triple progressive ball bearing suspension on file drawers

LOCKS

- Optional locks available for all straight hutch unit doors. Add **\$126** each lock
- Front-to-back filing bars for all steel drawer files available separately. Order FBB file bars. See "FBB" on page 41.
- Key alike or specific key number optional for all products with locks
- Reserved for new orders greater than \$20,000 list, all Adaptabilities units with locks may be ordered with **CA** cap option and specific lock cores/keys can be ordered separately for field installation rather than specifying duplicate product lines with different key numbers.
- When **CA** option is specified, product will ship with a cap over the empty lock housing.
- Separately order the appropriate number of cores with keys; use product code **SIL-CORE-H-SHOE** for Silver core/key sets or product code **BLK-CORE-H-SHOE** for Black core/key sets. Specify quantity and lock number required. One order line per key number required. Key number range: 401-440. **Must be ordered at the same time product is ordered with CA lock cap option specified.**
- One core removal key is required. Recommend one core removal for every 25 cores ordered. Order as **REMOVE-K-H-SHOE**.
- No charge applies for separate lock cores or core removal keys only when ordered with product. If replacement lock core and key required, contact Customer Care for applicable product code and pricing.

SPECIAL SIZES

- Additional custom sized components available upon request.
- Secretarial height returns (26 ½") available at a 15% upcharge.
- Full to the floor pedestal configurations can be switched for a 15% upcharge.

1. SPECIFY MODEL NUMBER

2. SPECIFY MATERIAL TYPE

- **TFL** for product with thermally fused laminate tops
- **HPL** for product with high pressure laminate tops

3. SPECIFY FINISH

Top Finishes:

ACJ Absolute Acajou	FCL First Class
ASN Asian Night	NBL Noce Biondo
AWC Avant Cherry	NGL Noce Grigio
AWH Avant Honey	NEL Noce Leggero
BLK Black	NML Noce Medio
BZD Blizzard	QTM Quartered Mahogany
BRC Brushed Cobalt	SBY Sheer Beauty
CMB Clear Maple	SOG Storm Grey
CGY Custom Grey	SDT Stonedust
DES Dark Espresso	WHE Walnut Heights
DWT Designer White	WHC White Chocolate
FAS Fashionista	WCR Winter Cherry

Body Finishes (including pedestals):

ACJ Absolute Acajou	FCL First Class
ASN Asian Night	NBL Noce Biondo
AWC Avant Cherry	NGL Noce Grigio
AWH Avant Honey	NEL Noce Leggero
BLK Black	NML Noce Medio
BZD Blizzard	QTM Quartered Mahogany
BRC Brushed Cobalt	SBY Sheer Beauty
CMB Clear Maple	SOG Storm Grey
CGY Custom Grey	SDT Stonedust
DES Dark Espresso	WHE Walnut Heights
DWT Designer White	WHC White Chocolate
FAS Fashionista	WCR Winter Cherry

4. SPECIFY OPTIONS

Grommets

- Additional grommets available in standard worksurface locations (left, center or right).
- Order as: **AG1, AG2 or AG3. Add \$103.**



- Grommet hole dimensions are 3 1/4" wide x 1 7/8" deep.
- Actual grommet locations on the worksurface are depicted in the example drawings shown below. Dimensions shown are actual measurements (in inches).

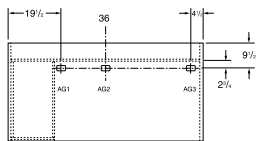

36 x 72 single pedestal left desks (A3672SPL)

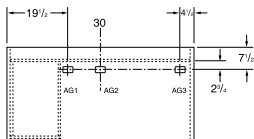

30 x 60 single pedestal left desks (A3060SPL)

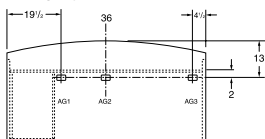

36 x 72 single pedestal left bow top desks (A3672SLB)

- Grommets may be placed at non-standard locations. Order as: **AGS - Add \$103.** A drawing must be supplied with vertical and horizontal dimensions to the center of the cut-out (as in drawing above). Please refer to CUSTOM GROMMET LOCATION FORM in the back reference section.
- Components that come standard with grommet may be ordered without a grommet. **Add \$57.**
- Grommets are available on modesty panels of extended corners and 5-sided corners 6 1/2" in where the two modesty panels meet at a 90° angle. Please specify FOGMPR for right grommet placement and FOGMPL for left grommet (placement is as shown on diagrams below). Cost is **\$103.**
- **Modesty panels are 1" off of ground**

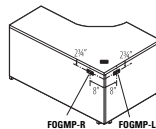

Left Extended Corner Unit

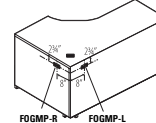

Right Extended Corner Unit

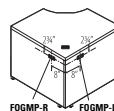

5-Sided Corner Unit

Power Block

- A Power Block (model PMSPDM) may be ordered on all worksurfaces.
- A Power Block is a rectangular worksurface power/data module with one electrical duplex receptacle and includes two data (CAT5) receptacles. 9 foot black cord included. Power Block dimensions are 3 1/2" deep x 6 1/2" wide x 2 3/4" high.
- To purchase a Power Block, you must specify both the Power Block cut-out location and the Power Block model #. Order Power Block as **PMSPDM, Add \$352.** Power Blocks are available in standard worksurface locations (left, center or right). Order as **E1, E2 or E3. Add \$103.**

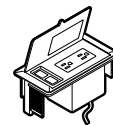

Power Block **PMSPDM Add \$352**

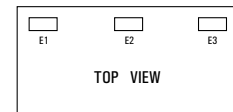

Specify location **E1, E2 or E3 Add \$103**

A ADAPTABILITIES®

DOUBLE PEDESTAL DESKS

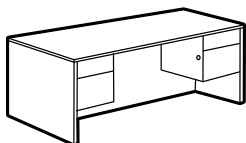

Double Pedestal Desk*

MODEL#	DIMENSIONS D x W x H	FREIGHT CLASS	WT./LBS.	CUBIC FT.	LIST PRICE	HP ADD
A3672DP	36 x 72 x 29.6	150	296	52.5	\$1924	\$567
A3072DP	29.69 x 72 x 29.6	125	263	43	\$1890	\$531
A3066DP	29.69 x 66 x 29.6	125	254	39.75	\$1874	\$531
A3060DP	29.69 x 60 x 29.6	125	247	36.25	\$1711	\$495

Standard with box/file pedestals on both sides. Pedestals lock. One pencil tray.

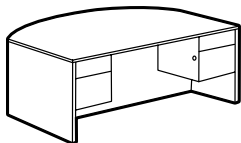

Double Pedestal Bow Top Desk*

A3672DPB	30-36 x 72 x 29.6	150	280	52.5	\$2291	\$567
----------	-------------------	-----	-----	------	---------------	--------------

Standard with box/file pedestals on both sides and bow top. Pedestals lock. One pencil tray.

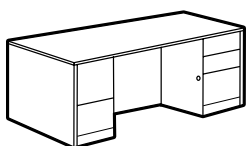

Full to Floor Double Pedestal Desk

A3672D4	36 x 72 x 29.6	125	330	52.5	\$2451	\$567
A3072D4	30 x 72 x 29.6	125	295	41.15	\$2408	\$567
A3066D4	29.69 x 66 x 29.6	125	285	39.75	\$2398	\$531
A3060D4	29.69 x 60 x 29.6	125	276	36.25	\$2234	\$495

Standard with full to floor box/box/file in right pedestal and file/file on left pedestal. Pedestals lock. On box/box/file pedestals, lower box drawer and file drawer lock. One pencil tray. Full to the floor pedestal configurations can be switched for a **15% upcharge**.

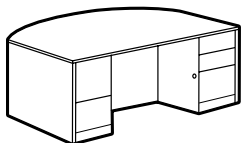

Full to Floor Double Pedestal Bow Top Desk

A3672DB4	32-36 x 72 x 29.6	150	311	52.5	\$2815	\$567
----------	-------------------	-----	-----	------	---------------	--------------

Standard with full to floor box/box/file in right pedestal and file/file on left pedestal. Bow top. Pedestals lock. On box/box/file pedestals, lower box drawer and file drawer lock. One pencil tray. Full to the floor pedestal configurations can be switched for a **15% upcharge**.

SINGLE PEDESTAL DESKS

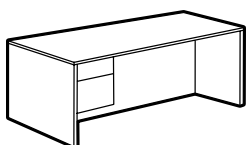

Single Pedestal Desk - LEFT*

MODEL#	DIMENSIONS	FREIGHT CLASS	WT./LBS.	CUBIC FT.	LIST PRICE	HP ADD
A3672SPL	36 x 72 x 29.6	150	245	52.5	\$1605	\$567
A3072SPL	29.69 x 72 x 29.6	150	216	43	\$1409	\$531
A3066SPL	29.69 x 66 x 29.6	150	207	39.75	\$1392	\$531
A3060SPL	29.69 x 60 x 29.6	150	197	36.25	\$1387	\$495
A3048SPL	29.69 x 48 x 29.6	125	177	29.25	\$1245	\$420
A2448SPL	24 x 48 x 29.6	125	150	24.25	\$1245	\$273

Standard with box/file pedestal. Pedestal locks. One pencil tray. Pedestal is on the **left**.

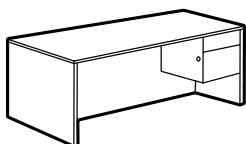

Single Pedestal Desk - RIGHT*

A3672SPR	36 x 72 x 29.6	150	245	52.5	\$1605	\$567
A3072SPR	29.69 x 72 x 29.6	150	216	43	\$1409	\$531
A3066SPR	29.69 x 66 x 29.6	150	207	39.75	\$1392	\$531
A3060SPR	29.69 x 60 x 29.6	150	197	36.25	\$1387	\$495
A3048SPR	29.69 x 48 x 29.6	125	177	29.25	\$1245	\$420
A2448SPR	24 x 48 x 29.6	125	150	24.25	\$1245	\$273

Standard with box/file pedestal. Pedestal locks. One pencil tray. Pedestal is on the **right**.

Required Specifications

Top finish
Base finish

Optional Specifications

Key #
Grommet/power block cut-out
HP laminate
Modesty panel, 3/4*

Accessories

Power block
Keyboard tray
Pencil tray

SINGLE PEDESTAL DESKS

MODEL# DIMENSIONS FREIGHT CLASS WT/LBS. CUBIC FT. LIST PRICE HP ADD

D x W x H

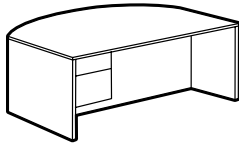

Single Pedestal Bow Top Desk - LEFT*

A3672SLB 30-36 x 72 x 29.6 150 233 52.5 \$1965 \$567

Standard with box/file pedestal on **left** and bow top. Pedestal locks. One pencil tray.

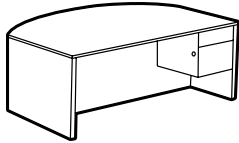

Single Pedestal Bow Top Desk - RIGHT*

A3672SRB 30-36 x 72 x 29.6 150 233 52.5 \$1965 \$567

Standard with box/file pedestal on **right** and bow top. Pedestal locks. One pencil tray.

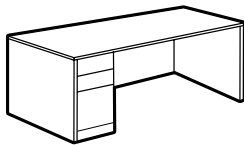

Full to Floor Single Pedestal Desk - LEFT

A3672S4L	36 x 72 x 29.6	150	261	52.5	\$1869	\$567
A3072S4L	29.69 x 72 x 29.6	150	232	43.75	\$1824	\$567
A3066S4L	29.69 x 66 x 29.6	150	221	39.5	\$1812	\$531
A3060S4L	29.69 x 60 x 29.6	150	211	36.25	\$1644	\$495
A3048S4L	29.69 x 48 x 29.6	125	191	29.5	\$1449	\$420
A2448S4L	24 x 48 x 29.6	125	164	24.25	\$1449	\$273

Standard with full to floor box/box/file pedestal on the **left**. One pencil tray. Lower box drawer and file drawer lock. Full to the floor pedestal configurations can be switched for a **15% upcharge**.

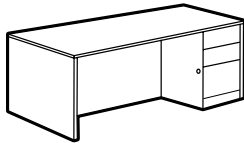

Full to Floor Single Pedestal Desk - RIGHT

A3672S4R	36 x 72 x 29.6	150	261	52.5	\$1869	\$567
A3072S4R	29.69 x 72 x 29.6	150	232	43.75	\$1824	\$567
A3066S4R	29.69 x 66 x 29.6	150	221	39.75	\$1812	\$531
A3060S4R	29.69 x 60 x 29.6	150	211	36.25	\$1644	\$495
A3048S4R	29.69 x 48 x 29.6	125	191	29.5	\$1449	\$420
A2448S4R	24 x 48 x 29.6	125	164	24.25	\$1449	\$273

Standard with full to floor box/box/file pedestal on the **right**. One pencil tray. Lower box drawer and file drawer lock. Full to the floor pedestal configurations can be switched for a **15% upcharge**.

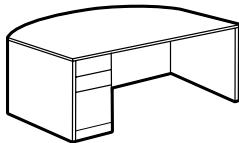

Full to Floor Single Pedestal Bow Top Desk - LEFT

A3672S4LB 32-36 x 72 x 29.6 150 247 52.5 \$2227 \$567

Standard with box/box/file pedestal on **left** and bow top. One pencil tray. Lower box drawer and file drawer lock. One pencil tray. Full to the floor pedestal configurations can be switched for a **15% upcharge**.

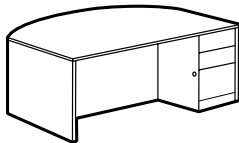

Full to Floor Single Pedestal Bow Top Desk - RIGHT

A3672S4RB 32-36 x 72 x 29.6 150 247 52.5 \$2227 \$567

Standard with box/box/file pedestal on **right** and bow top. One pencil tray. Lower box drawer and file drawer lock. One pencil tray. Full to the floor pedestal configurations can be switched for a **15% upcharge**.

Required Specifications

Top finish
Base finish

Optional Specifications

Key #
Grommet/power block cut-out
HP laminate
Modesty panel, 3/4*

Accessories

Power block
Keyboard tray
Pencil tray

RETURNS

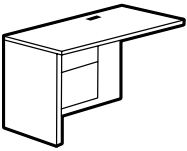

Flush Return - LEFT

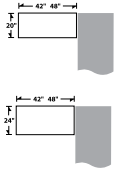

MODEL#	DIMENSIONS D x W x H	FREIGHT CLASS	WT/LBS.	CUBIC FT.	LIST PRICE	HP ADD
A2448FL	24 x 48 x 29.6	150	141	24	\$1174	\$291
A2442FL	24 x 42 x 29.6	125	131	21.25	\$1150	\$242
A2048FL	20 x 48 x 29.6	125	128	20.25	\$1104	\$242
A2042FL	20 x 42 x 29.6	125	119	18	\$1083	\$242

Standard with box/file drawer pedestal. One pencil tray. Pedestal locks. Grommet in worksurface. Pedestal is on the **left**.

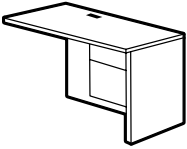

Flush Return - RIGHT

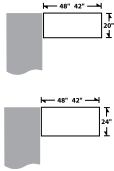

A2448FR	24 x 48 x 29.6	150	141	24	\$1174	\$291
A2442FR	24 x 42 x 29.6	125	131	21.25	\$1150	\$242
A2048FR	20 x 48 x 29.6	125	128	20.25	\$1104	\$242
A2042FR	20 x 42 x 29.6	125	119	18	\$1083	\$242

Standard with box/file drawer pedestal. One pencil tray. Pedestal locks. Grommet in worksurface. Pedestal is on the **right**.

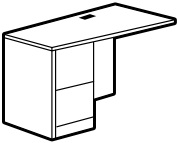

Full to Floor Flush Return - LEFT

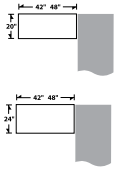

A2448L4	24 x 48 x 29.6	125	156	24.25	\$1435	\$291
A2442L4	24 x 42 x 29.6	125	146	21.5	\$1415	\$242
A2048L4	20 x 48 x 29.6	125	142	20.5	\$1368	\$242
A2042L4	20 x 42 x 29.6	125	133	18	\$1347	\$242

Standard with file/file drawer pedestal. One pencil tray. Pedestal locks. Grommet in worksurface. Pedestal is on the **left**. Full to the floor pedestal configurations can be switched for a **15% upcharge**.

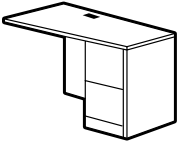

Full to Floor Flush Return - RIGHT

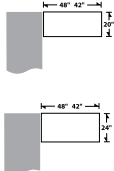

A2448R4	24 x 48 x 29.6	125	156	24.25	\$1435	\$291
A2442R4	24 x 42 x 29.6	125	146	21.5	\$1415	\$242
A2048R4	20 x 48 x 29.6	125	142	20.5	\$1368	\$242
A2042R4	20 x 42 x 29.6	125	133	18	\$1347	\$242

Standard with file/file drawer pedestal. One pencil tray. Pedestal locks. Grommet in worksurface. Pedestal is on the **right**. Full to the floor pedestal configurations can be switched for a **15% upcharge**.

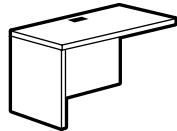

Flush Return - LEFT

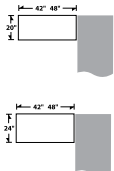

A2448EL	24 x 48 x 29.6	70	92	4.3	\$851	\$291
A2442EL	24 x 42 x 29.6	70	82	3.8	\$824	\$242
A2048EL	20 x 48 x 29.6	70	84	4.3	\$777	\$242
A2042EL	20 x 42 x 29.6	70	75	3.8	\$758	\$242

Return has no pedestal. Grommet in worksurface. Shipped RTA (ready to assemble).

- Cannot accept same depth storage shells due to 1" thick modesty

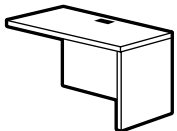

Flush Return - RIGHT

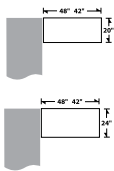

A2448ER	24 x 48 x 29.6	70	92	4.3	\$851	\$291
A2442ER	24 x 42 x 29.6	70	82	3.8	\$824	\$242
A2048ER	20 x 48 x 29.6	70	84	4.3	\$777	\$242
A2042ER	20 x 42 x 29.6	70	75	3.8	\$758	\$242

Return has no pedestal. Grommet in worksurface. Shipped RTA (ready to assemble).

- Cannot accept same depth storage shells due to 1" thick modesty

Required Specifications

Top finish
Base finish

Optional Specifications

Key #*
Grommet/power block cut-out
HP laminate

Accessories

Power block
Keyboard tray
Pencil tray

RETURNS

MODEL# DIMENSIONS FREIGHT CLASS WT/LBS. CUBIC FT. LIST PRICE HP ADD

D x W x H

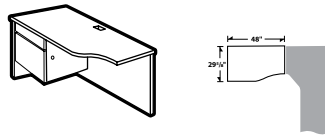

Space Saver Return - LEFT

A3048FSL 29.69 x 48 x 29.6 150 148 29 \$1245 \$420

Standard with box/file pedestal on the **left**, grommet in worksurface. One pencil tray. Pedestal locks. Connects to 24"D 5-sided corner unit and 2466/2472 NFL or NNL extended corner unit.



Space Saver Return - RIGHT

A3048FSR 29.69 x 48 x 29.6 150 148 29 \$1245 \$420

Standard with box/file pedestal on the **right**, grommet in worksurface. One pencil tray. Pedestal locks. Connects to 24"D 5-sided corner unit and 2466/2472 FNR or NNR extended corner unit.

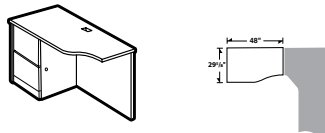

Space Saver Return - LEFT

A3048PAL 29.69 x 48 x 29.6 150 170 29 \$1506 \$420

Standard with file/file pedestal on the **left**, grommet in worksurface. One pencil tray. Pedestal locks. Connects to 24"D 5-sided corner unit and 2466/2472 NFL or NNL extended corner unit. Full to the floor pedestal configurations can be switched for a **15% upcharge**.



Space Saver Return - RIGHT

A3048PAR 29.69 x 48 x 29.6 150 170 29 \$1506 \$420

Standard with file/file pedestal on the **right**, grommet in worksurface. One pencil tray. Pedestal locks. Connects to 24"D 5-sided corner unit and 2466/2472 FNR or NNR extended corner unit. Full to the floor pedestal configurations can be switched for a **15% upcharge**.

FLUSH BRIDGE

MODEL# DIMENSIONS FREIGHT CLASS WT/LBS. CUBIC FT. LIST PRICE HP ADD

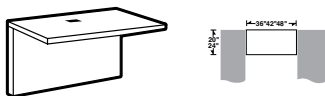

Flush Bridge*

A2448FB	24 x 48 x 29.6	70	75	4.3	\$641	\$291
A2442FB	24 x 42 x 29.6	70	65	3.8	\$615	\$242
A2436FB	24 x 36 x 29.6	70	58	3.3	\$615	\$184
A2048FB	20 x 48 x 29.6	70	71	4.3	\$615	\$242
A2042FB	20 x 42 x 29.6	70	54	3.3	\$589	\$242
A2036FB	20 x 36 x 29.6	70	54	3.3	\$589	\$125

Top surface, back panel and hardware to connect two units. Grommet in worksurface. Shipped RTA (ready to assemble).

CREDENZAS

MODEL# DIMENSIONS FREIGHT CLASS WT/LBS. CUBIC FT. LIST PRICE HP ADD

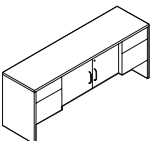

Center Storage Credenza

A2072C 20 x 72 x 29.6 100 243 30 \$2313 \$380

Standard with box/file pedestals on both sides and self-closing hinged center doors covering one adjustable shelf. Pedestals and doors lock. One pencil tray.

Required Specifications

Top finish
Base finish
Handles**

Optional Specifications

Key #
Additional grommet position (not A2072C)
HP laminate
Power block cut-out (not A2072C)

Accessories

Power block
Keyboard tray*
Pencil tray*

A ADAPTABILITIES®

CREDENZAS

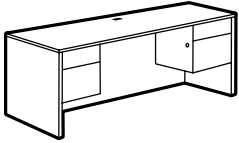

Kneespace Credenza

MODEL#	DIMENSIONS D x W x H	FREIGHT CLASS	WT/LBS.	CUBIC FT.	LIST PRICE	HP ADD
A2472CK	24 x 72 x 29.6	125	234	35.75	\$1936	\$397
A2466CK	24 x 66 x 29.6	125	225	32.75	\$1878	\$397
A2072CK	20 x 72 x 29.6	125	212	30.25	\$1767	\$380
A2066CK	20 x 66 x 29.6	125	204	27.75	\$1742	\$366
A2060CK	20 x 60 x 29.6	125	199	25.25	\$1697	\$335

Standard with box/file pedestals on both sides. Center is open. Pedestals lock. One pencil tray. Grommet in worksurface.

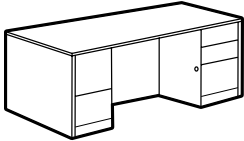

Full to Floor Kneespace Credenza

A2472D4	24 x 72 x 29.6	125	261	35.5	\$2452	\$397
A2466D4	24 x 66 x 29.6	125	252	33	\$2400	\$397
A2072D4	20 x 72 x 29.6	125	236	30	\$2291	\$380
A2066D4	20 x 66 x 29.6	100	228	27.75	\$2268	\$366
A2060D4	20 x 60 x 29.6	100	220	25.25	\$2256	\$335

Standard with full to floor box/box/file in right pedestal and file/file on left pedestal. Pedestals lock on box/box/file pedestals, lower box drawer and file drawer lock. One pencil tray. Grommet in worksurface.

- Full to the floor pedestal configurations can be switched for a **15% upcharge**.

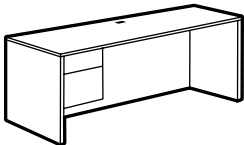

Single Pedestal Credenza - LEFT

A2472CSL	24 x 72 x 29.6	150	190	35.75	\$1640	\$397
A2466CSL	24 x 66 x 29.6	150	181	32.75	\$1584	\$397
A2072CSL	20 x 72 x 29.6	150	172	30.25	\$1479	\$380
A2066CSL	20 x 66 x 29.6	150	163	27.75	\$1455	\$366
A2060CSL	20 x 60 x 29.6	125	155	25.25	\$1406	\$335

Standard with box/file pedestal. Pedestal locks. One pencil tray. Pedestal is on the **left**. Grommet in worksurface.

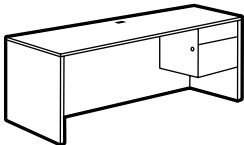

Single Pedestal Credenza - RIGHT

A2472CSR	24 x 72 x 29.6	150	190	35.75	\$1640	\$397
A2466CSR	24 x 66 x 29.6	150	181	32.75	\$1584	\$397
A2072CSR	20 x 72 x 29.6	150	171	30	\$1479	\$380
A2066CSR	20 x 66 x 29.6	150	163	27.75	\$1455	\$366
A2060CSR	20 x 60 x 29.6	125	155	25.25	\$1406	\$335

Standard with box/file pedestal. Pedestal locks. One pencil tray. Pedestal is on the **right**. Grommet in worksurface.

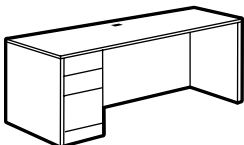

Full to Floor Single Pedestal Credenza - LEFT

A2472S4L	24 x 72 x 29.6	150	205	35.5	\$1869	\$397
A2466S4L	24 x 66 x 29.6	150	196	33	\$1812	\$397
A2072S4L	20 x 72 x 29.6	125	187	30	\$1644	\$380
A2066S4L	20 x 66 x 29.6	125	177	27.75	\$1615	\$380
A2060S4L	20 x 60 x 29.6	125	168	25.25	\$1575	\$335

Standard with full to floor box/box/file pedestal on the **left**. Lower box drawer and file drawer lock. Grommet in worksurface. One pencil tray.

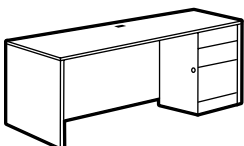

Full to Floor Single Pedestal Credenza - RIGHT

A2472S4R	24 x 72 x 29.6	150	205	35.5	\$1869	\$397
A2466S4R	24 x 66 x 29.6	150	196	33	\$1812	\$397
A2072S4R	20 x 72 x 29.6	125	187	30	\$1644	\$380
A2066S4R	20 x 66 x 29.6	125	177	27.75	\$1615	\$380
A2060S4R	20 x 60 x 29.6	125	168	25.25	\$1575	\$335

Standard with full to floor box/box/file pedestal on the **right**. Lower box drawer and file drawer lock. Grommet in worksurface. One pencil tray.

Required Specifications

Top finish
Base finish

Optional Specifications

Key #
Grommet/power block cut-out
HP laminate

Accessories

Power block
Keyboard tray
Pencil tray

CREDENZAS

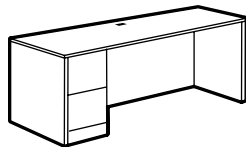

Full to Floor Single Pedestal Credenza- LEFT*

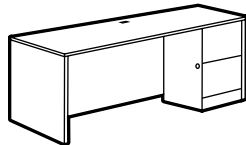

Full to Floor Single Pedestal Credenza- RIGHT*

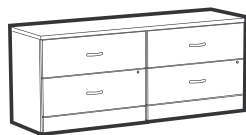

Lateral File Credenza

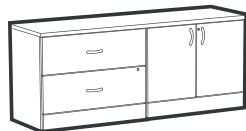

Lateral File/Storage Cabinet Credenza



Kneespace Lateral File Credenza - LEFT*



Kneespace Lateral File Credenza - RIGHT*

MODEL#	DIMENSIONS	FREIGHT CLASS	WT./LBS.	CUBIC FT.	LIST PRICE	HP ADD
--------	------------	---------------	----------	-----------	------------	--------

D x W x H

A2472S2L	24 x 72 x 29.6	150	205	35.5	\$1869	\$397
A2466S2L	24 x 66 x 29.6	150	196	33	\$1812	\$397
A2072S2L	20 x 72 x 29.6	125	187	30	\$1644	\$380
A2066S2L	20 x 66 x 29.6	125	177	27.75	\$1615	\$380
A2060S2L	20 x 60 x 29.6	125	168	25.25	\$1575	\$335

Standard with full to floor file/file pedestal on the **left**. Pedestal Locks. Grommet in worksurface.

A2472S2R	24 x 72 x 29.6	150	205	35.5	\$1869	\$397
A2466S2R	24 x 66 x 29.6	150	196	33	\$1812	\$397
A2072S2R	20 x 72 x 29.6	125	187	30	\$1644	\$380
A2066S2R	20 x 66 x 29.6	125	177	27.75	\$1615	\$380
A2060S2R	20 x 60 x 29.6	125	168	25.25	\$1575	\$335

Standard with full to floor file/file pedestal on the **right**. Pedestal locks. Grommet in worksurface.

A2472LF2	24 x 72 x 29.6	100	322	35.75	\$2825	\$397
A2072LF2	20 x 72 x 29.6	100	296	30.25	\$2768	\$380

Two 2-drawer lateral files side-by-side. Locking drawers, keyed alike. File bars included for side-to-side and front-to-back letter/legal filing capability. Anti-lock tilt suspension.

- Black handles are standard. Silver is available at no charge, please specify as **SI**.
- *File drawer construction is for accommodating hanging files NOT for stacking materials on the drawer bottom.*

A2472LS	24 x 72 x 29.6	100	297	35.75	\$2529	\$397
A2072LS	20 x 72 x 29.6	100	267	30.25	\$2469	\$380

One 2-drawer lateral file and one storage cabinet. Locking doors/drawers, keyed alike. Storage cabinet includes one adjustable shelf. File bars included for side-to-side and front-to-back letter/legal filing capability. Anti-lock tilt suspension.

- Black handles are standard. Silver is available at no charge, please specify as **SI**.
- *File drawer construction is for accommodating hanging files NOT for stacking materials on the drawer bottom.*

A2472LKL	24 x 72 x 29.6	125	239	35.75	\$2222	\$397
A2072LKL	20 x 72 x 29.6	125	216	30.25	\$2166	\$380

One 2-drawer lateral file on the **left**. Locking drawers. File bars included for side-to-side and front-to-back letter/legal filing capability. Anti-lock tilt suspension. Grommet in worksurface.

- Black handles are standard. Silver is available at no charge, please specify as **SI**.
- *File drawer construction is for accommodating hanging files NOT for stacking materials on the drawer bottom.*

A2472LKR	24 x 72 x 29.6	125	239	35.75	\$2222	\$397
A2072LKR	20 x 72 x 29.6	125	216	30.25	\$2166	\$380

One 2-drawer lateral file on the **right**. Locking drawers. File bars included for side-to-side and front-to-back letter/legal filing capability. Anti-lock tilt suspension. Grommet in worksurface.

- Black handles are standard. Silver is available at no charge, please specify as **SI**.
- *File drawer construction is for accommodating hanging files NOT for stacking materials on the drawer bottom.*

Required Specifications

Top finish
Base finish
Handles (not A2xxxS2L/A2xxxS2R)

Optional Specifications

Key #
Additional grommet
HP laminate
Power block cut-out*

Accessories

Power block*
Keyboard tray*
Pencil tray*

A ADAPTABILITIES®

CREDENZAS

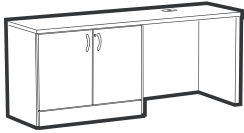

Kneespace Storage Cabinet Credenza - LEFT*

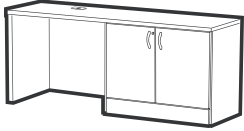

Kneespace Storage Cabinet Credenza - RIGHT*

MODEL#	DIMENSIONS	FREIGHT CLASS	WT/LBS.	CUBIC FT.	LIST PRICE	HP ADD
--------	------------	---------------	---------	-----------	------------	--------

D x W x H

A2472SKL	24 x 72 x 29.6	125	218	35.75	\$1755	\$397
A2072SKL	20 x 72 x 29.6	125	188	30.25	\$1696	\$380

One storage cabinet on the **left**. Locking doors. Storage cabinet has one adjustable shelf. Grommet in worksurface.

- Black handles are standard. Silver is available at no charge, please specify as **SI**.

A2472SKR	24 x 72 x 29.6	125	218	35.75	\$1755	\$397
A2072SKR	20 x 72 x 29.6	125	188	30.25	\$1696	\$380

One storage cabinet on the **right**. Locking doors. Storage cabinet has one adjustable shelf. Grommet in worksurface.

- Black handles are standard. Silver is available at no charge, please specify as **SI**.

5-SIDED CORNERS

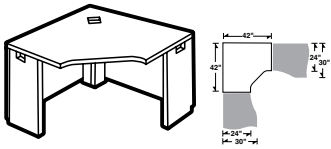

5-Sided Corner

MODEL#	DIMENSIONS	FREIGHT CLASS	WT/LBS.	CUBIC FT.	LIST PRICE	HP ADD
--------	------------	---------------	---------	-----------	------------	--------

A42245C	42 x 42 x 29.6	70	113	5.75	\$1099	\$531
---------	----------------	----	-----	------	---------------	--------------

Connects to **30" D** space saver connectable surfaces, **24" D** connectables, returns and bridge. Grommet in worksurface.

Narrow end panels on left and right. Predrilled to accept 22" keyboard trays. **Will not accept keyboard trays wider than 22"**. Shipped RTA (ready to assemble). *Not Freestanding*.

- **Modesty Panel is 1" off of ground.**
- Full End Panel(s) are available - add **15% upcharge**

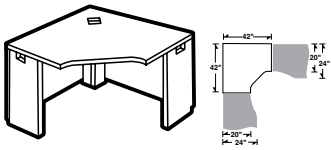

5-Sided Corner

A42205C	42 x 42 x 29.6	70	110	5.75	\$1067	\$531
---------	----------------	----	-----	------	---------------	--------------

Connects to **24" D** space saver connectable surfaces, **20" D** returns, lateral files, storage/lateral file credenzas, credenzas, bridges and end shelves. Grommet in worksurface. Narrow end panels on left and right. Predrilled to accept 22-28" keyboard trays. **Will not accept keyboard trays wider than 28"**. Shipped RTA (ready to assemble). *Not freestanding*.

Will not accept keyboard trays wider than 28". Shipped RTA (ready to assemble). *Not freestanding*.

- **Modesty Panel is 1" off of ground.**
- Full End Panel(s) are available - add **15% upcharge**

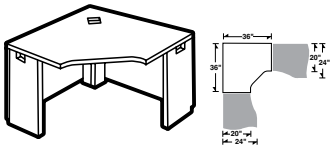

5-Sided Corner

A36205C	36 x 36 x 29.6	70	94	4.8	\$944	\$342
---------	----------------	----	----	-----	--------------	--------------

Connects to **24" D** space saver connectable surfaces, **20" D** returns, lateral files, storage/lateral file credenzas, credenzas, bridges and end shelves. Grommet in worksurface. Narrow end panels on left and right. Predrilled to accept 22" keyboard trays. **Will not accept keyboard trays wider than 22"**. Shipped RTA (ready to assemble). *Not freestanding*.

Will not accept keyboard trays wider than 22". Shipped RTA (ready to assemble). *Not freestanding*.

- **Modesty Panel is 1" off of ground.**
- Full End Panel(s) are available - add **15% upcharge**

Required Specifications

Top finish
Base finish
Handles*

Optional Specifications

Key #
Additional grommet position
HP laminate
Power block cut-out

Accessories

Power block
Keyboard tray
Pencil tray

LEFT EXTENDED CORNERS

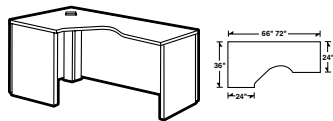

Left Extended Corner - Freestanding

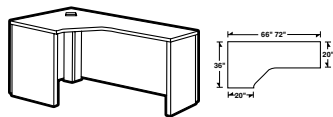

Left Extended Corner

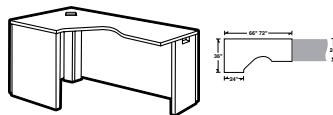

Left Extended Corner

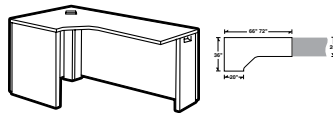

Left Extended Corner

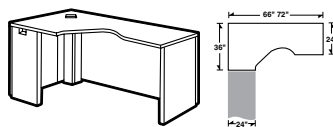

Left Extended Corner

MODEL#	DIMENSIONS	FREIGHT CLASS	WT/LBS.	CUBIC FT.	LIST PRICE	HP ADD
--------	------------	---------------	---------	-----------	------------	--------

D x W x H

A2472FFL	24-36 x 72 x 29.6	70	157	7	\$1409	\$567
A2466FFL	24-36 x 66 x 29.6	70	151	7	\$1409	\$567

Extended worksurface on right. **Full end panels on left and right. Cannot be connected on left or right, due to full end panel.** Corner has one grommet. Predrilled to accept 22" keyboard trays. **Will not accept keyboard trays wider than 22".** Shipped RTA (ready to assemble).

- **Modesty Panel is 1" off of ground.**
- **A2466FFL cannot accept pedestals.**

A2072FFL	20-36 x 72 x 29.6	70	147	7	\$1349	\$545
A2066FFL	20-36 x 66 x 29.6	70	141	7	\$1349	\$545

Extended worksurface on right. **Full end panels on left and right. Cannot be connected on left or right, due to full end panel.** Corner has one grommet. Predrilled to accept 22" keyboard trays. **Will not accept keyboard trays wider than 22".** Shipped RTA (ready to assemble).

- **Modesty Panel is 1" off of ground.**

A2472FNL	24-36 x 72 x 29.6	70	149	7	\$1365	\$567
A2466FNL	24-36 x 66 x 29.6	70	142	7	\$1365	\$567

Extended worksurface on right. **Narrow end panel on right. Full end panel on left.** Connects to 30"D space saver connectables, 24"D returns or 24"D connectable tables. **Full end panel cannot be connected.** Corner has one grommet. Predrilled to accept 22" keyboard trays. **Will not accept keyboard trays wider than 22".** Shipped RTA (ready to assemble).

- **Modesty Panel is 1" off of ground.**
- **A2466FNL cannot accept pedestals.**

A2072FNL	20-36 x 72 x 29.6	70	141	7	\$1300	\$545
A2066FNL	20-36 x 66 x 29.6	70	135	7	\$1300	\$545

Extended worksurface on right. **Narrow end panel on right. Full end panel on left.** Connects to 24"D space saver connectables, 20"D returns or 20"D connectable tables. **Full end panel cannot be connected.** Corner has one grommet. Predrilled to accept 22" keyboard trays. **Will not accept keyboard trays wider than 22".** Shipped RTA (ready to assemble).

- **Modesty Panel is 1" off of ground.**

A2472NFL	24-36 x 72 x 29.6	70	149	7	\$1365	\$567
A2466NFL	24-36 x 66 x 29.6	70	142	7	\$1365	\$567

Extended worksurface on right. **Narrow end panel on left. Full end panel on right.** Connects to 30"D space saver connectables, 24"D returns or 24"D connectable tables. **Full end panel cannot be connected.** Corner has one grommet. Predrilled to accept 22" keyboard trays. **Will not accept keyboard trays wider than 22".** Shipped RTA (ready to assemble).

- **Modesty Panel is 1" off of ground.**
- **A2466NFL cannot accept pedestals.**

Required Specifications

Top finish
Base finish

Optional Specifications

Additional grommet position
HP laminate
Power block cut-out

Accessories

Power block
Keyboard tray
Pencil tray

LEFT EXTENDED CORNERS

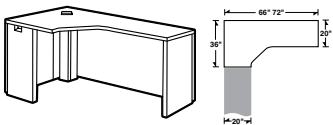

Left Extended Corner

MODEL#	DIMENSIONS D x W x H	FREIGHT CLASS	WT/LBS.	CUBIC FT.	LIST PRICE	HP ADD
A2072NFL	20-36 x 72 x 29.6	70	141	7	\$1300	\$567
A2066NFL	20-36 x 66 x 29.6	70	135	7	\$1300	\$545

Extended worksurface on right. **Narrow end panel on left. Full end panel on right.** Connects to 24"D space saver connectables and 20"D returns. **Full end panel cannot be connected.** Corner has one grommet. Predrilled to accept 22" keyboard trays. **Will not accept keyboard trays wider than 22"**. Shipped RTA (ready to assemble).

- Modesty Panel is 1" off of ground.

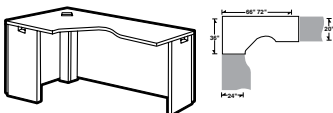

Left Extended Corner

A2472NNL	24-36 x 72 x 29.6	70	140	7	\$1320	\$567
A2466NNL	24-36 x 66 x 29.6	70	134	7	\$1320	\$567

Extended worksurface on right. **Narrow end panels on left and right.** Connects to 30"D space saver connectables, 24"D returns and 24"D connectable tables on either end. Corner has one grommet. Predrilled to accept 22" keyboard trays. **Will not accept keyboard trays wider than 22"**. Shipped RTA (ready to assemble).

- Modesty Panel is 1" off of ground.
- **A2466NNL** cannot accept pedestals.

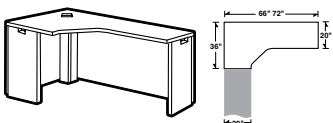

Left Extended Corner

A2072NNL	20-36 x 72 x 29.6	70	136	7	\$1284	\$567
A2066NNL	20-36 x 66 x 29.6	70	130	7	\$1284	\$545

Extended worksurface on right. **Narrow end panels on left and right.** Connects to 24"D space saver connectables and 20"D returns or bridge on either end. Corner has one grommet. Predrilled to accept 22" keyboard trays. **Will not accept keyboard trays wider than 22"**. Shipped RTA (ready to assemble).

- Modesty Panel is 1" off of ground.

RIGHT EXTENDED CORNERS

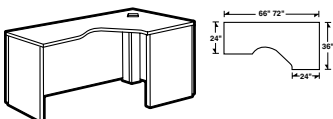

Right Extended Corner - Freestanding

MODEL#	DIMENSIONS	FREIGHT CLASS	WT/LBS.	CUBIC FT.	LIST PRICE	HP ADD
A2472FFR	24-36 x 72 x 29.6	70	157	7	\$1409	\$567
A2466FFR	24-36 x 66 x 29.6	70	151	7	\$1409	\$567

Extended worksurface on left. **Full end panels on left and right. Cannot be connected on left or right, due to full end panel.** Corner has one grommet. Predrilled to accept 22" keyboard trays. **Will not accept keyboard trays wider than 22"**. Shipped RTA (ready to assemble).

- Modesty Panel is 1" off of ground.
- **A2466FFR** cannot accept pedestals.

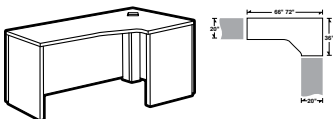

Right Extended Corner

A2072FFR	20-36 x 72 x 29.6	70	147	7	\$1349	\$545
A2066FFR	20-36 x 66 x 29.6	70	141	7	\$1349	\$545

Extended worksurface on left. **Full end panels on left and right. Cannot be connected on left or right, due to full end panel.** Corner has one grommet. Predrilled to accept 22" keyboard trays. **Will not accept keyboard trays wider than 22"**. Shipped RTA (ready to assemble).

- Modesty Panel is 1" off of ground.

Required Specifications

Top finish
Base finish

Optional Specifications

Additional grommet position
HP laminate
Power block cut-out

Accessories

Power block
Keyboard tray
Pencil tray

RIGHT EXTENDED CORNERS

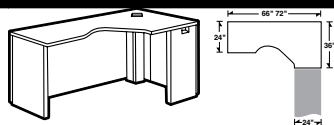

Right Extended Corner

MODEL#	DIMENSIONS	FREIGHT CLASS	WT/LBS.	CUBIC FT.	LIST PRICE	HP ADD
D x W x H						
A2472FNR	24-36 x 72 x 29.6	70	149	7	\$1365	\$584
A2466FNR	24-36 x 66 x 29.6	70	142	7	\$1365	\$567

Extended worksurface on left. **Narrow end panel on right. Full end panel on left.** Connects to 30"D space saver connectables, 24"D returns or 24"D connectable tables. **Full end panel cannot be connected.** Corner has one grommet. Predrilled to accept 22" keyboard trays. **Will not accept keyboard trays wider than 22"**. Shipped RTA (ready to assemble).

- **Modesty Panel is 1" off of ground.**
- **A2466FNR cannot accept pedestals.**

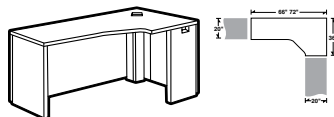

Right Extended Corner

A2072FNR	20-36 x 72 x 29.6	70	141	7	\$1300	\$545
A2066FNR	20-36 x 66 x 29.6	70	135	7	\$1300	\$545

Extended worksurface on left. **Narrow end panel on right. Full end panel on left.** Connects to 24"D space saver connectables, 20"D returns or 20"D connectable tables. **Full end panel cannot be connected.** Corner has one grommet. Predrilled to accept 22" keyboard trays. **Will not accept keyboard trays wider than 22"**. Shipped RTA (ready to assemble).

- **Modesty Panel is 1" off of ground.**

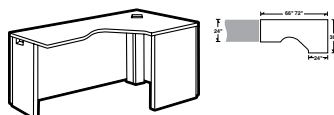

Right Extended Corner

A2472NFR	24-36 x 72 x 29.6	70	149	7	\$1365	\$567
A2466NFR	24-36 x 66 x 29.6	70	142	7	\$1365	\$567

Extended worksurface on left. **Narrow end panel on left. Full end panel on right.** Connects to 30"D space saver connectables, 24"D returns or 24"D connectable tables. **Full end panel cannot be connected.** Corner has one grommet. Predrilled to accept 22" keyboard trays. **Will not accept keyboard trays wider than 22"**. Shipped RTA (ready to assemble).

- **Modesty Panel is 1" off of ground.**
- **A2466NFR cannot accept pedestals.**

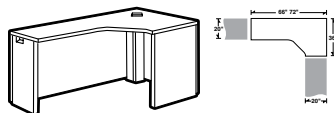

Right Extended Corner

A2072NFR	20-36 x 72 x 29.6	70	141	7	\$1300	\$567
A2066NFR	20-36 x 66 x 29.6	70	135	7	\$1300	\$545

Extended worksurface on left. **Narrow end panel on left. Full end panel on right.** Connects to 24"D space saver connectables and 20"D returns. **Full end panel cannot be connected.** Corner has one grommet. Predrilled to accept 22" keyboard trays. **Will not accept keyboard trays wider than 22"**. Shipped RTA (ready to assemble).

- **Modesty Panel is 1" off of ground.**

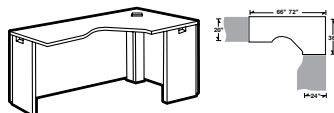

Right Extended Corner

A2472NNR	24-36 x 72 x 29.6	70	140	7	\$1320	\$567
A2466NNR	24-36 x 66 x 29.6	70	133	7	\$1320	\$567

Extended worksurface on left. **Narrow end panels on left and right.** Connects to 30"D space saver connectables, 24"D returns and 24"D connectable tables on either end. Corner has one grommet. Predrilled to accept 22" keyboard trays. **Will not accept keyboard trays wider than 22"**. Shipped RTA (ready to assemble).

- **Modesty Panel is 1" off of ground.**
- **A2466NNR cannot accept pedestals.**

Required Specifications

Top finish
Base finish

Optional Specifications

Additional grommet position
HP laminate
Power block cut-out

Accessories

Power block
Keyboard tray
Pencil tray

RIGHT EXTENDED CORNERS

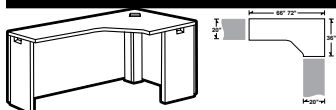

Right Extended Corner

MODEL#	DIMENSIONS	FREIGHT CLASS	WT/LBS.	CUBIC FT.	LIST PRICE	HP ADD
	D x W x H					
A2072NNR	20-36 x 72 x 29.6	70	136	7	\$1284	\$567
A2066NNR	20-36 x 66 x 29.6	70	130	7	\$1284	\$545

Extended worksurface on left. **Narrow end panels on left and right.** Connects to 24"D space saver connectables and 20"D returns or bridge on either end. Corner has one grommet. Predrilled to accept 22" keyboard trays. **Will not accept keyboard trays wider than 22"**. Shipped RTA (ready to assemble).

- Modesty Panel is 1" off of ground.

FREESTANDING TABLES

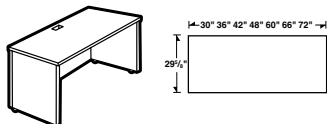

30" Deep Freestanding Table

MODEL#	DIMENSIONS	FREIGHT CLASS	WT/LBS.	CUBIC FT.	LIST PRICE	HP ADD
A3072T	29.69 x 72 x 29.6	65	148	6	\$1083	\$531
A3066T	29.69 x 66 x 29.6	65	140	6	\$1083	\$531
A3060T	29.69 x 60 x 29.6	65	131	5.25	\$989	\$495
A3048T	29.69 x 48 x 29.6	70	116	5.25	\$895	\$420
A3042T	29.69 x 42 x 29.6	70	108	5.25	\$895	\$380
A3036T	29.69 x 36 x 29.6	65	97	4.3	\$804	\$342
A3030T	29.69 x 30 x 29.6	65	88	3.6	\$758	\$305

Two full end panels. Cannot be connected on left or right side. Grommet in worksurface. Shipped RTA (ready to assemble).

- Modesty Panel is 1" off of ground

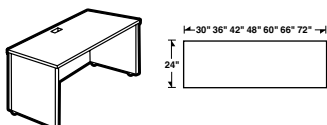

24" Deep Freestanding Table

A2472T	24 x 72 x 29.6	70	130	6	\$989	\$397
A2466T	24 x 66 x 29.6	70	123	6	\$989	\$397
A2460T	24 x 60 x 29.6	70	114	5.25	\$895	\$366
A2448T	24 x 48 x 29.6	65	99	4.3	\$804	\$291
A2442T	24 x 42 x 29.6	70	92	4.3	\$804	\$242
A2436T	24 x 36 x 29.6	70	84	4.2	\$711	\$184
A2430T	24 x 30 x 29.6	70	76	3.6	\$664	\$184

Two full end panels. Cannot be connected on left or right side. Grommet in worksurface. Shipped RTA (ready to assemble).

- Modesty Panel is 1" off of ground

CONNECTABLE TABLES - LEFT

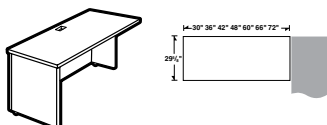

30" Deep Connectable Table - LEFT

MODEL#	DIMENSIONS	FREIGHT CLASS	WT/LBS.	CUBIC FT.	LIST PRICE	HP ADD
A3072L	29.69 x 72 x 29.6	65	140	6	\$1044	\$531
A3066L	29.69 x 66 x 29.6	70	132	6	\$1044	\$531
A3060L	29.69 x 60 x 29.6	65	123	5.25	\$956	\$495
A3048L	29.69 x 48 x 29.6	65	105	4.3	\$860	\$420
A3042L	29.69 x 42 x 29.6	65	98	4.3	\$860	\$380
A3036L	29.69 x 36 x 29.6	70	88	4.2	\$766	\$342
A3030L	29.69 x 30 x 29.6	70	80	3.6	\$722	\$305

Full end panel on left. Right narrow end panel connects to 30"D center/right connectable table, or at 90° angle to a freestanding table; and "D" islands or "P" islands with "T" and "H" bases. Grommet in worksurface. Shipped RTA (ready to assemble).

- Modesty Panel is 1" off of ground.

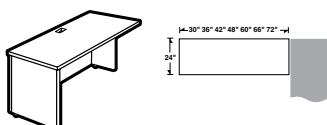

24" Deep Connectable Table - LEFT

A2472L	24 x 72 x 29.6	70	121	6	\$956	\$397
A2466L	24 x 66 x 29.6	70	115	6	\$956	\$397
A2460L	24 x 60 x 29.6	70	106	5.25	\$860	\$366
A2448L	24 x 48 x 29.6	70	90	4.3	\$766	\$291
A2442L	24 x 42 x 29.6	70	82	3.8	\$766	\$242
A2436L	24 x 36 x 29.6	70	74	3.3	\$676	\$184
A2430L	24 x 30 x 29.6	70	68	3.6	\$628	\$184

Full end panel on left. Right narrow end panel connects to 24"D center/right connectable table, or at 90° angle to a freestanding table; 24"D extended corners, 42" 5-sided corners or at the end of a straight run; "D" islands or "P" islands with "T" and "H" bases. Grommet in worksurface. Shipped RTA (ready to assemble).

- Modesty Panel is 1" off of ground.

Required Specifications

Top finish
Base finish

Optional Specifications

Additional grommet position
HP laminate
Power block cut-out

Accessories

Power block
Keyboard tray
Pencil tray

CONNECTABLE TABLES - RIGHT

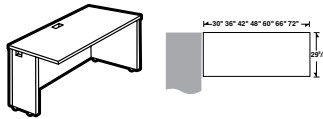

30" Deep Connectable Table - RIGHT

MODEL#	DIMENSIONS	FREIGHT CLASS	WT./LBS.	CUBIC FT.	LIST PRICE	HP ADD
D x W x H						
A3072R	29.69 x 72 x 29.6	65	140	6	\$1044	\$531
A3066R	29.69 x 66 x 29.6	70	132	6	\$1044	\$531
A3060R	29.69 x 60 x 29.6	65	123	5.25	\$956	\$495
A3048R	29.69 x 48 x 29.6	65	105	4.3	\$860	\$420
A3042R	29.69 x 42 x 29.6	65	98	4.3	\$860	\$380
A3036R	29.69 x 36 x 29.6	70	88	4.3	\$766	\$342
A3030R	29.69 x 30 x 29.6	70	80	3.6	\$722	\$305

Full end panel on **right**. Left narrow end panel connects to 30"D center/left connectable table, or at 90° angle to a freestanding table; "D" islands or "P" islands with "T" and "H" bases. Grommet in worksurface. Shipped RTA (ready to assemble).

- Modesty Panel is 1" off of ground

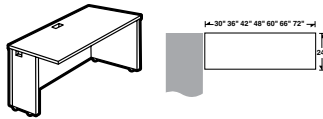

24" Deep Connectable Table - RIGHT

A2472R	24 x 72 x 29.6	70	121	6	\$956	\$409
A2466R	24 x 66 x 29.6	70	115	6	\$956	\$397
A2460R	24 x 60 x 29.6	70	105	5.25	\$860	\$366
A2448R	24 x 48 x 29.6	70	90	4.3	\$766	\$291
A2442R	24 x 42 x 29.6	70	82	3.8	\$766	\$242
A2436R	24 x 36 x 29.6	70	74	3.3	\$676	\$184
A2430R	24 x 30 x 29.6	70	67	3.6	\$628	\$184

Full end panel on **right**. Left narrow end panel connects to 24"D center/left connectable table, or at 90° angle to a freestanding table; 24"D extended corners, 42" 5-sided corners or at the end of a straight run; "D" islands or "P" islands with "T" and "H" bases. Grommet in worksurface. Shipped RTA (ready to assemble).

- Modesty Panel is 1" off of ground

CONNECTABLE TABLES

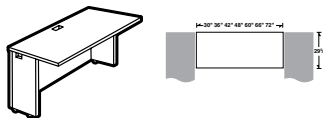

30" Deep Connectable Table

MODEL#	DIMENSIONS	FREIGHT CLASS	WT./LBS.	CUBIC FT.	LIST PRICE	HP ADD
A3072N	29.69 x 72 x 29.6	70	131	6	\$1012	\$531
A3066N	29.69 x 66 x 29.6	70	124	6	\$1012	\$531
A3060N	29.69 x 60 x 29.6	70	114	5.25	\$915	\$495
A3048N	29.69 x 48 x 29.6	65	97	4.3	\$824	\$420
A3042N	29.69 x 42 x 29.6	65	89	3.8	\$824	\$380
A3036N	29.69 x 36 x 29.6	65	80	3.3	\$731	\$342
A3030N	29.69 x 30 x 29.6	70	71	3.6	\$684	\$305

Narrow end panels on both sides connects to 30"D worksurfaces; "D" islands or "P" islands with "T" and "H" bases; or at 90° angle to freestanding table(s). Grommet in worksurface. Shipped RTA (ready to assemble).

- Modesty Panel is 1" off of ground

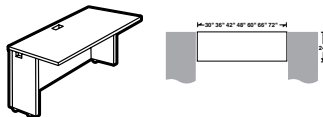

24" Deep Connectable Table

A2472N	24 x 72 x 29.6	70	113	6	\$915	\$397
A2466N	24 x 66 x 29.6	70	105	6	\$915	\$397
A2460N	24 x 60 x 29.6	70	100	4.5	\$824	\$366
A2448N	24 x 48 x 29.6	70	82	4.3	\$731	\$291
A2442N	24 x 42 x 29.6	70	73	3.8	\$731	\$242
A2436N	24 x 36 x 29.6	70	66	3.3	\$641	\$184
A2430N	24 x 30 x 29.6	70	59	3.6	\$589	\$184

Narrow end panels on both sides connects to 24"D worksurfaces; "D" islands or "P" islands with "T" and "H" bases; or at 90° angle to freestanding table(s). Grommet in worksurface. Shipped RTA (ready to assemble).

- Modesty Panel is 1" off of ground

SPACE SAVER CONNECTABLE TABLES - LEFT

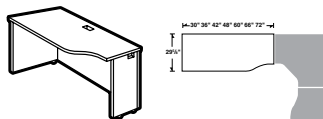

30" Deep Space Saver Connectable Table - LEFT

MODEL#	DIMENSIONS	FREIGHT CLASS	WT./LBS.	CUBIC FT.	LIST PRICE	HP ADD
A3072LK	29.69 x 72 x 29.6	70	133	6	\$1056	\$531
A3066LK	29.69 x 66 x 29.6	70	126	6	\$1056	\$531
A3060LK	29.69 x 60 x 29.6	70	117	5.25	\$965	\$495
A3048LK	29.69 x 48 x 29.6	65	100	4.3	\$871	\$420
A3042LK	29.69 x 42 x 29.6	65	92	3.8	\$871	\$380
A3036LK	29.69 x 36 x 29.6	70	83	4.3	\$777	\$342
A3030LK	29.69 x 30 x 29.6	70	74	3.6	\$731	\$305

Full end panel on left. Narrow right end panel connects to 24"D 5-sided corner unit. Grommet in worksurface. Shipped RTA (ready to assemble).

- Modesty Panel is 1" off of ground
- Keyboard and pencil trays for use on units 42" and above

Required Specifications

Top finish
Base finish

Optional Specifications

Additional grommet position
HP laminate
Power block cut-out

Accessories

Power block
Keyboard tray
Pencil tray

SPACE SAVER CONNECTABLE TABLES - LEFT

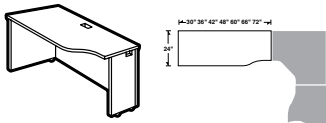

24" Deep Space Saver Connectable Table - LEFT

MODEL#	DIMENSIONS D x W x H	FREIGHT CLASS	WT./LBS.	CUBIC FT.	LIST PRICE	HP ADD
A2472LK	24 x 72 x 29.6	70	120	6	\$965	\$397
A2466LK	24 x 66 x 29.6	70	114	6	\$965	\$397
A2460LK	24 x 60 x 29.6	70	105	5.25	\$871	\$366
A2448LK	24 x 48 x 29.6	70	89	4.3	\$777	\$291
A2442LK	24 x 42 x 29.6	70	81	3.8	\$777	\$242
A2436LK	24 x 36 x 29.6	70	73	3.3	\$684	\$184
A2430LK	24 x 30 x 29.6	70	66	3.6	\$641	\$184

Full end panel on left. Narrow right end panel connects to 20"D 5-sided corner unit. Grommet in worksurface. Shipped RTA (ready to assemble).

- **Modesty Panel is 1" off of ground.**
- *Keyboard and pencil trays for use on units 42" and above*

SPACE SAVER CONNECTABLE TABLES - RIGHT

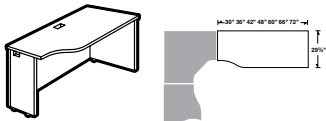

30" Deep Space Saver Connectable Table - RIGHT

MODEL#	DIMENSIONS	FREIGHT CLASS	WT./LBS.	CUBIC FT.	LIST PRICE	HP ADD
A3072RK	29.69 x 72 x 29.6	70	133	6	\$1056	\$531
A3066RK	29.69 x 66 x 29.6	70	126	6	\$1056	\$531
A3060RK	29.69 x 60 x 29.6	70	117	5.25	\$965	\$495
A3048RK	29.69 x 48 x 29.6	65	100	4.3	\$871	\$420
A3042RK	29.69 x 42 x 29.6	65	91	3.8	\$871	\$380
A3036RK	29.69 x 36 x 29.6	70	83	4.3	\$777	\$342
A3030RK	29.69 x 30 x 29.6	70	74	3.6	\$731	\$305

Full end panel on right. Narrow right end panel connects to 24"D 5-sided corner unit. Grommet in worksurface. Shipped RTA (ready to assemble).

- **Modesty Panel is 1" off of ground**
- *Keyboard and pencil trays for use on units 42" and above*

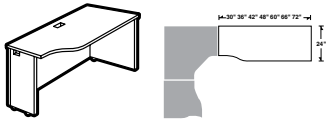

24" Deep Space Saver Connectable Table - RIGHT

A2472RK	24 x 72 x 29.6	70	120	6	\$965	\$397
A2466RK	24 x 66 x 29.6	70	114	6	\$965	\$397
A2460RK	24 x 60 x 29.6	70	105	5.25	\$871	\$366
A2448RK	30 x 48 x 29.6	70	89	4.3	\$777	\$291
A2442RK	24 x 42 x 29.6	70	81	3.8	\$777	\$242
A2436RK	24 x 36 x 29.6	70	73	3.3	\$684	\$184
A2430RK	24 x 30 x 29.6	70	66	3.6	\$641	\$184

Full end panel on right. Narrow right end panel connects to 20"D 5-sided corner unit. Grommet in worksurface. Shipped RTA (ready to assemble).

- **Modesty Panel is 1" off of ground.**
- *Keyboard and pencil trays for use on units 42" and above*

SPACE SAVER CONNECTABLE TABLES

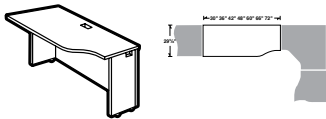

30" Deep Space Saver Connectable Table

MODEL#	DIMENSIONS	FREIGHT CLASS	WT./LBS.	CUBIC FT.	LIST PRICE	HP ADD
A3072LN	29.69 x 72 x 29.6	70	125	6	\$1024	\$531
A3066LN	29.69 x 66 x 29.6	70	117	6	\$1024	\$531
A3060LN	29.69 x 60 x 29.6	70	108	5.25	\$932	\$495
A3048LN	29.69 x 48 x 29.6	70	91	4.3	\$840	\$420
A3042LN	29.69 x 42 x 29.6	70	83	3.8	\$840	\$380
A3036LN	29.69 x 36 x 29.6	70	74	3.3	\$746	\$342
A3030LN	29.69 x 30 x 29.6	70	66	3.6	\$698	\$305

Narrow end panels on both sides. Connects the **right end only to 24"D 5-sided corner unit.** Left end allows the continuation of additional connectable center or left connectable worksurface. Grommet in worksurface. Shipped RTA (ready to assemble).

- **Modesty Panel is 1" off of ground.**
- *Keyboard and pencil trays for use on units 42" and above*

Required Specifications

Top finish
Base finish

Optional Specifications

Additional grommet position
HP laminate
Power block cut-out

Accessories

Power block
Keyboard tray
Pencil tray

SPACE SAVER CONNECTABLE TABLES

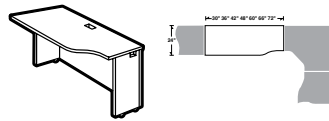

24" Deep Space Saver Connectable Table

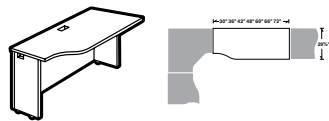

30" Deep Space Saver Connectable Table

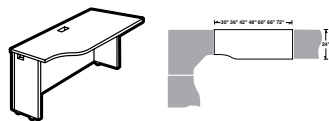

24" Deep Space Saver Connectable Table

MODEL#	DIMENSIONS	FREIGHT CLASS	WT/LBS.	CUBIC FT.	LIST PRICE	HP ADD
--------	------------	---------------	---------	-----------	------------	--------

D x W x H

A2472LN	24 x 72 x 29.6	70	112	6	\$932	\$397
A2466LN	24 x 66 x 29.6	70	105	6	\$932	\$397
A2460LN	24 x 60 x 29.6	70	96	5.25	\$840	\$366
A2448LN	24 x 48 x 29.6	70	81	4.3	\$746	\$291
A2442LN	24 x 42 x 29.6	70	73	3.8	\$746	\$242
A2436LN	24 x 36 x 29.6	70	65	3.3	\$654	\$184
A2430LN	24 x 30 x 29.6	70	58	3.6	\$608	\$184

Narrow end panels on both sides. Connects the **right end only to 20"D 5-sided corner unit.** Left end allows the continuation of additional connectable center or left connectable worksurface. Grommet in worksurface. Shipped RTA (ready to assemble).

- **Modesty Panel is 1" off of ground.**
- *Keyboard and pencil trays for use on units 42" and above*

A3072RN	29.69 x 72 x 29.6	70	125	6	\$1024	\$531
A3066RN	29.69 x 66 x 29.6	70	117	6	\$1024	\$531
A3060RN	29.69 x 60 x 29.6	70	108	5.25	\$932	\$495
A3048RN	29.69 x 48 x 29.6	70	91	4.3	\$840	\$420
A3042RN	29.69 x 42 x 29.6	70	83	3.8	\$840	\$380
A3036RN	29.69 x 36 x 29.6	70	74	3.3	\$746	\$342
A3030RN	29.69 x 30 x 29.6	70	66	3.6	\$698	\$305

Narrow end panels on both sides. Connects the **left end only to 24"D 5-sided corner unit.** Right end allows the continuation of additional connectable center or right connectable worksurface. Grommet in worksurface. Shipped RTA (ready to assemble).

- **Modesty Panel is 1" off of ground.**
- *Keyboard and pencil trays for use on units 42" and above*

A2472RN	24 x 72 x 29.6	70	112	6	\$932	\$397
A2466RN	24 x 66 x 29.6	70	105	6	\$932	\$397
A2460RN	24 x 60 x 29.6	70	96	5.25	\$840	\$366
A2448RN	24 x 48 x 29.6	70	81	4.3	\$746	\$291
A2442RN	24 x 42 x 29.6	70	72	3.8	\$746	\$242
A2436RN	24 x 36 x 29.6	70	59	3.3	\$654	\$184
A2430RN	24 x 30 x 29.6	85	53	3.6	\$608	\$184

Narrow end panels on both sides. Connects the **left end only to 20"D 5-sided corner unit.** Right end allows the continuation of additional connectable center or right connectable worksurface. Grommet in worksurface. Shipped RTA (ready to assemble).

- **Modesty Panel is 1" off of ground.**
- *Keyboard and pencil trays for use on units 42" and above*

"D" ISLANDS

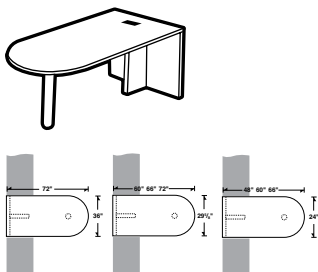

"D" Island - Full End Panel & Post (T-Base)

MODEL#	DIMENSIONS	FREIGHT CLASS	WT/LBS.	CUBIC FT.	LIST PRICE	HP ADD
--------	------------	---------------	---------	-----------	------------	--------

A3672FI	36 x 72 x 29.6	85	124	8.5	\$1150	\$567
A3072FI	29.69 x 72 x 29.6	85	107	7.5	\$1117	\$532
A3066FI	29.69 x 66 x 29.6	85	102	7.5	\$1056	\$531
A3060FI	29.69 x 60 x 29.6	85	96	6.76	\$1001	\$495
A2466FI	24 x 66 x 29.6	85	90	7.5	\$941	\$397
A2460FI	24 x 60 x 29.6	85	84	6.76	\$886	\$366
A2448FI	24 x 48 x 29.6	85	74	5.76	\$824	\$291

Connects to narrow end panel. Attaching hardware included. Not freestanding. Grommet in worksurface. Shipped RTA (ready to assemble).

- Post is shipped in separate carton. Standard in Black (**TBL**); Tungsten is available at no charge, please specify (**TTU**).

Required Specifications

Top finish
Base finish

Optional Specifications

Additional grommet position
HP laminate
Power block cut-out

Accessories

Power block
Keyboard tray
Pencil tray

A ADAPTABILITIES®

"D" ISLANDS

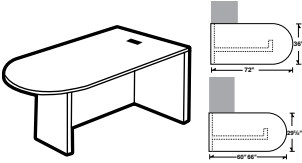

"D" Island LEFT - Full Modesty Panel (H-Base)

MODEL#	DIMENSIONS D x W x H	FREIGHT CLASS	WT/LBS.	CUBIC FT.	LIST PRICE	HP ADD
A3672FIL	36 x 72 x 29.6	70	139	7	\$1056	\$567
A3066FIL	29.69 x 66 x 29.6	70	116	6	\$941	\$531
A3060FIL	29.69 x 60 x 29.6	70	106	5.25	\$886	\$495

Connects to the left side of a worksurface. Accommodates all 19" pedestals (freestanding, mobile and hanging pedestals). Grommet in worksurface. Shipped RTA (ready to assemble).

- Modesty Panel is 1" off of ground.

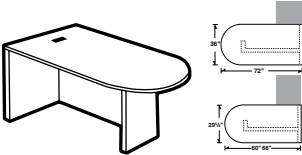

"D" Island RIGHT - Full Modesty Panel (H-Base)

A3672FIR	36 x 72 x 29.6	70	139	7	\$1056	\$567
A3066FIR	29.69 x 66 x 29.6	70	116	6	\$941	\$531
A3060FIR	29.69 x 60 x 29.6	70	106	5.25	\$886	\$495

Connects to the right side of a worksurface. Accommodates all 19" pedestals (freestanding, mobile and hanging pedestals). Grommet in worksurface. Shipped RTA (ready to assemble).

- Modesty Panel is 1" off of ground.

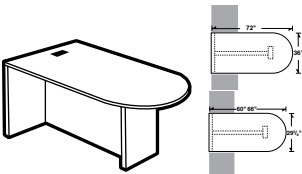

"D" Island Center - Full Modesty Panel (H-Base)

A3672FIC	36 x 72 x 29.6	70	139	7	\$1056	\$567
A3066FIC	29.69 x 66 x 29.6	70	116	6	\$941	\$531
A3060FIC	29.69 x 60 x 29.6	70	106	5.25	\$886	\$495

Connects in between two worksurfaces. Will not accommodate pedestals. Grommet in worksurface. Shipped RTA (ready to assemble).

- Modesty Panel is 1" off of ground.

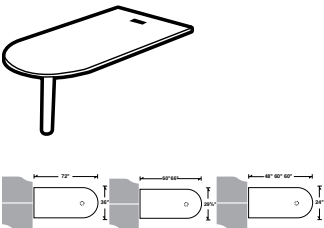

Attachable "D" Island with Post*

A3672I	36 x 72 x 29.6	92.5	88	8.5	\$1001	\$567
A3066I	29.69 x 66 x 29.6	100	71	7.5	\$886	\$531
A3060I	29.69 x 60 x 29.6	100	65	6.76	\$824	\$495
A2466I	24 x 66 x 29.6	100	63	7.5	\$766	\$397
A2460I	24 x 60 x 29.6	100	57	6.76	\$711	\$366
A2448I	24 x 48 x 29.6	100	47	5.76	\$654	\$291

Attaches to edge of worksurfaces. Attaching hardware included. Grommet in worksurface. Shipped RTA (ready to assemble).

- Post is shipped in separate carton. Standard in Black (**TBL**); Tungsten is available at no charge, please specify (**TTU**).

EXTENDED CORNER ISLANDS

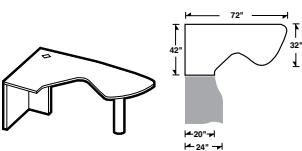

Extended Corner Island - RIGHT*

MODEL#	DIMENSIONS	FREIGHT CLASS	WT/LBS.	CUBIC FT.	LIST PRICE	HP ADD
A4272EIR	42-32 x 72 x 29.6	100	104	11.5	\$1379	\$757

Extended island worksurface on right. Connects to 20"D returns or 24"D space saver connectables on the left. **Not freestanding.** Predrilled to accept 22"-28" keyboard trays. Grommet in worksurface. Shipped RTA (ready to assemble).

- Post is shipped in separate carton. Standard in Black (**TBL**); Tungsten is available at no charge, please specify (**TTU**).

Required Specifications

Top finish
Base finish
Post finish*

Optional Specifications

Additional grommet position
HP laminate
Power block cut-out

Accessories

Power block
Keyboard tray
Pencil tray

EXTENDED CORNER ISLANDS

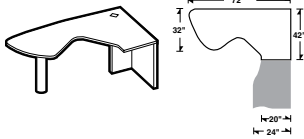

Extended Corner Island - LEFT*

MODEL#	DIMENSIONS	FREIGHT CLASS	WT/LBS.	CUBIC FT.	LIST PRICE	HP ADD
D x W x H						
A4272EIL	42-32 x 72 x 29.6	100	104	11.5	\$1379	\$757

Extended island worksurface on left. Connects to 20"D returns or 24"D space saver connectables on the right. **Not freestanding.** Predrilled to accept 22"-28" keyboard trays. Grommet in worksurface. Shipped RTA (ready to assemble).
 • Post is shipped in separate carton. Standard in Black (**TBL**); Tungsten is available at no charge, please specify (**TTU**).

"P" ISLANDS

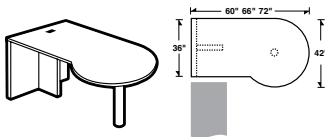

"P" Island LEFT - Full End Panel & Post (T-Base)*

MODEL#	DIMENSIONS	FREIGHT CLASS	WT/LBS.	CUBIC FT.	LIST PRICE	HP ADD
A3672FPL	36-42 x 72 x 29.6	85	128	9.26	\$1350	\$757
A3666FPL	36-42 x 66 x 29.6	85	122	8.76	\$1233	\$757
A3660FPL	36-42 x 60 x 29.6	85	116	8	\$1174	\$643

Connects to left side of worksurface. Attaching hardware included. **Not freestanding.** Grommet in worksurface. Shipped RTA (ready to assemble).
 • Post is shipped in separate carton. Standard in Black (**TBL**); Tungsten is available at no charge, please specify (**TTU**).

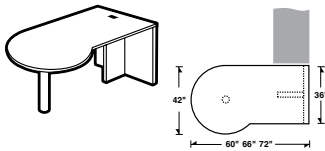

"P" Island RIGHT - Full End Panel & Post (T-Base)*

A3672FPR	36-42 x 72 x 29.6	85	128	9.26	\$1350	\$757
A3666FPR	36-42 x 66 x 29.6	85	122	8.76	\$1233	\$757
A3660FPR	36-42 x 60 x 29.6	85	116	8	\$1174	\$643

Connects to right side of worksurface. Attaching hardware included. **Not freestanding.** Grommet in worksurface. Shipped RTA (ready to assemble).
 • Post is shipped in separate carton. Standard in Black (**TBL**); Tungsten is available at no charge, please specify (**TTU**).

"P" ISLANDS WITH FULL MODESTY PANEL

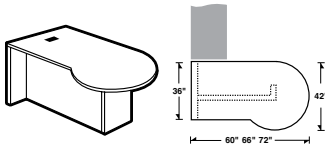

"P" Island LEFT - Full Modesty Panel (H-Base)

MODEL#	DIMENSIONS	FREIGHT CLASS	WT/LBS.	CUBIC FT.	LIST PRICE	HP ADD
A3672PL	36-42 x 72 x 29.6	70	143	7.75	\$1233	\$757
A3666PL	36-42 x 66 x 29.6	70	136	7.25	\$1117	\$757
A3660PL	36-42 x 60 x 29.6	70	126	6.5	\$1056	\$643

Connects to the left side of a worksurface. Accommodates all 19" pedestals (freestanding, mobile and hanging pedestals). Grommet in worksurface. Shipped RTA (ready to assemble).
 • Modesty Panel is 1" off of ground.

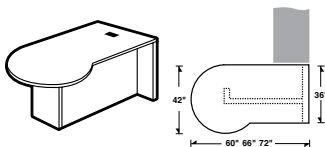

"P" Island RIGHT - Full Modesty Panel (H-Base)

A3672PR	36-42 x 72 x 29.6	70	143	7.75	\$1233	\$757
A3666PR	36-42 x 66 x 29.6	70	136	7.25	\$1117	\$757
A3660PR	36-42 x 60 x 29.6	70	126	6.5	\$1056	\$643

Connects to the right side of a worksurface. Accommodates all 19" pedestals (freestanding, mobile and hanging pedestals). Grommet in worksurface. Shipped RTA (ready to assemble).
 • Modesty Panel is 1" off of ground.

Required Specifications

Top finish
 Base finish
 Post finish*

Optional Specifications

Additional grommet position
 HP laminate
 Power block cut-out

Accessories

Power block
 Keyboard tray
 Pencil tray

A ADAPTABILITIES®

"P" ISLANDS (ATTACHABLE)

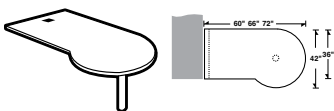

"P" Island LEFT with Post*

MODEL#	DIMENSIONS	FREIGHT CLASS	WT/LBS.	CUBIC FT.	LIST PRICE	HP ADD
A3672IPL	36-42 x 72 x 29.6	100	92	9.26	\$1174	\$757
A3666IPL	36-42 x 66 x 29.6	100	86	8.76	\$1056	\$757
A3660IPL	36-42 x 60 x 29.6	92.5	80	8	\$1001	\$643

Attaches to edge of worksurfaces. Attaching hardware included. Grommet in worksurface. Shipped RTA (ready to assemble).
 • Post is shipped in separate carton. Standard in Black (TBL); Tungsten is available at no charge, please specify (TTU).

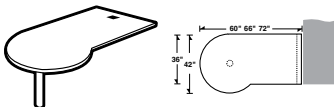

"P" Island RIGHT with Post*

A3672IPR	36-42 x 72 x 29.6	100	92	9.26	\$1174	\$757
A3666IPR	36-42 x 66 x 29.6	100	86	8.76	\$1056	\$757
A3660IPR	36-42 x 60 x 29.6	92.5	80	8	\$1001	\$643

Attaches to edge of worksurfaces. Attaching hardware included. Grommet in worksurface. Shipped RTA (ready to assemble).
 • Post is shipped in separate carton. Standard in Black (TBL); Tungsten is available at no charge, please specify (TTU).

RADIUS SPANNER ISLANDS

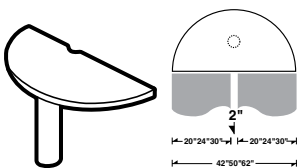

Radius Spanner Island with Panel Cut-Out*

MODEL#	DIMENSIONS	FREIGHT CLASS	WT/LBS.	CUBIC FT.	LIST PRICE	HP ADD
A62RS	31 x 62 x 29.6	100	59	6.76	\$1083	\$455
A50RS	25 x 50 x 29.6	125	46	5.76	\$941	\$380
A42RS	21 x 42 x 29.6	125	41	5.26	\$851	\$305

Used to connect two back-to-back units of same depth with a panel. Includes monopost. Requires "L" bracket (model **MLB90**) for connection to full end panels. Shipped RTA (ready to assemble).

- MLB90 must be ordered separately - see page 612.
- Post is shipped in separate carton. Standard in Black (TBL); Tungsten is available at no charge, please specify (TTU).
- **Cannot accept keyboard trays or pencil tray**

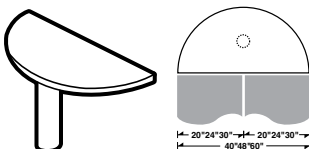

Radius Spanner Island*

A60RS	29.69 x 60 x 29.6	100	56	5.76	\$1083	\$380
A48RS	24 x 48 x 29.6	125	43	5.76	\$941	\$305
A40RS	20 x 40 x 29.6	125	40	5.26	\$851	\$305

Used to connect two back-to-back units of same depth. Includes monopost. Requires "L" bracket (model **MLB90**) for connection to full end panels. Shipped RTA (ready to assemble).

- MLB90 must be ordered separately - see page 612.
- Post is shipped in separate carton. Standard in Black (TBL); Tungsten is available at no charge, please specify (TTU).
- **Cannot accept keyboard trays or pencil tray**

RECEPTION DESKS

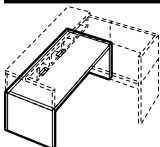

Lower Desk Unit**

MODEL#	DIMENSIONS	FREIGHT CLASS	WT/LBS.	CUBIC FT.	LIST PRICE	HP ADD
A3072RD	29.69 x 72 x 29.6	70	149	7	\$1174	\$531

No pedestals. Two grommets in worksurface. Shipped RTA (ready to assemble).
 • Cannot be used with Divide.

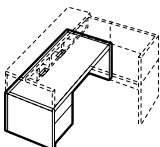

Single Pedestal Lower Desk Unit - LEFT**

A3072RDL	29.69 x 72 x 29.6	150	222	43.75	\$1697	\$531
A3060RDL	29.63 x 60 x 29	150	201	36	\$1466	\$495

Box/file pedestal on **left** with lock. Two grommets in worksurface.
 • Cannot be used with Divide.

Required Specifications

Top finish
 Base finish (not radius spanner islands)
 Post finish*

Optional Specifications

Additional grommet position*
 HP laminate*
 Power block cut-out*

Accessories

Power block*
 Keyboard tray**
 Pencil tray**

RECEPTION DESKS

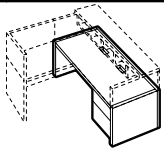

Single Pedestal Lower Desk Unit - RIGHT

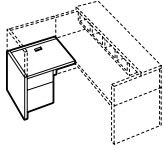

Reception Return - LEFT

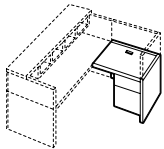

Reception Return - RIGHT



Reception Return - LEFT



Reception Return - RIGHT

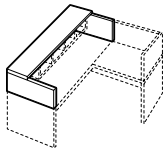

Transaction Counter

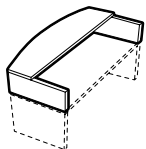

Bow Front Transaction Counter

MODEL#	DIMENSIONS	FREIGHT CLASS	WT/LBS.	CUBIC FT.	LIST PRICE	HP ADD
--------	------------	---------------	---------	-----------	------------	--------

D x W x H

A3072RDR	29.69 x 72 x 29.6	150	222	43.75	\$1697	\$531
A3060RDR	29.63 x 60 x 29	150	201	36	\$1466	\$495

Box/file pedestal on **right** with lock. Two grommets in worksurface.

- Cannot be used with Divide.

A2442RRL	24 x 42 x 29.6	125	131	21.25	\$1117	\$242
----------	----------------	-----	-----	-------	---------------	--------------

Box/file pedestal on **left** with lock. Grommet in worksurface.

- Cannot be used with Divide.
- **Cannot accept keyboard trays or pencil tray**

A2442RRR	24 x 42 x 29.6	125	131	21.25	\$1117	\$242
----------	----------------	-----	-----	-------	---------------	--------------

Box/file pedestal on **right** with lock. Grommet in worksurface.

- Cannot be used with Divide.
- **Cannot accept keyboard trays or pencil tray**

A2442KRL	24 x 42 x 29.6	70	83	3.8	\$824	\$242
----------	----------------	----	----	-----	--------------	--------------

No pedestal. Grommet in worksurface.

- Cannot be used with Divide.

A2442KRR	24 x 42 x 29.6	70	83	3.8	\$824	\$242
----------	----------------	----	----	-----	--------------	--------------

No pedestal. Grommet in worksurface.

- Cannot be used with Divide.

A3072URD	29.69 x 72 x 13.75	70	67	4.3	\$711	\$305
A3060URD	29.63 x 60 x 13.75	65	59	2.6	\$667	\$305

For main reception desk. Shipped RTA (ready to assemble). Depth of reception top is 12".

- Reception top units are to be used only with lower reception units. Tops have mini-fix fasteners to attach the reception top units.

A3072URB	29.69-36 x 72 x 13.75	70	72	4.3	\$963	\$380
----------	-----------------------	----	----	-----	--------------	--------------

For main reception desk. To be used on A3072RD, A3072RDL or A3072RDR. Shipped RTA (ready to assemble). Depth of reception bow top is 12-15".

- Reception top units are to be used only with desks listed. Tops have mini-fix fasteners to attach the reception top units.

Required Specifications

Top finish
Base finish

Optional Specifications

Additional grommet position*
HP laminate*
Power block cut-out*

Accessories

Power block*
Keyboard tray*
Pencil tray*

RECEPTION DESKS

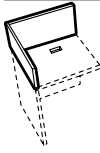

Return Screen Unit - LEFT

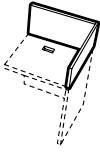

Return Screen Unit - RIGHT

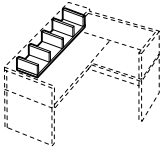

Desk Top Organizer

MODEL#	DIMENSIONS	FREIGHT CLASS	WT/LBS.	CUBIC FT.	LIST PRICE	HP ADD
--------	------------	---------------	---------	-----------	------------	--------

D x W x H

A2442URL	24 x 42 x 12.75	85	27	2	\$359	N/A
----------	-----------------	----	----	---	--------------	-----

To be used on top of left reception return (A2442RRL/KRL). Shipped RTA (ready to assemble).

- Reception top units are to be used only with returns listed. Tops have mini-fix fasteners to attach the reception top units.

A2442URR	24 x 42 x 12.75	85	27	2	\$359	N/A
----------	-----------------	----	----	---	--------------	-----

To be used on top of right reception return (A2442RRR/KRR). Shipped RTA (ready to assemble).

- Reception top units are to be used only with returns listed. Tops have mini-fix fasteners to attach the reception top units.

A1172ORD	11 x 52 x 6	100	22	2.6	\$241	N/A
----------	-------------	-----	----	-----	--------------	-----

To be used under transaction counter. Black (BK) finish only. Shipped RTA (ready to assemble).

WALL/PANEL MOUNT OVERSTORAGE UNITS

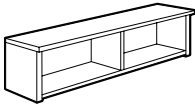

Overstorage Unit*

MODEL#	DIMENSIONS	FREIGHT CLASS	WT/LBS.	CUBIC FT.	LIST PRICE	HP ADD
--------	------------	---------------	---------	-----------	------------	--------

A00S60	15 x 60 x 16	70	86	5.25	\$883	N/A
A00S48	15 x 48 x 16	70	70	4.3	\$722	N/A
A00S42	15 x 42 x 16	70	62	3.8	\$711	N/A
A00S36	15 x 36 x 16	70	56	3.3	\$628	N/A
A00S30	15 x 30 x 16	70	48	3	\$587	N/A

Standard with pre-mounted "J" bracket for wall mount applications. One fixed shelf, closed back. Uses standard Adaptabilities hutch doors. Shipped RTA (ready to assemble).

- **NOTE:** Care should be taken to mount the units. Units should be mounted to wall studs using correct fasteners. Failure to do so may result in collapse of the unit and subsequent personal injury. **Mounting hardware not included.** Mounting hardware used should be based on wall material. Consult an installation professional for proper wall mounting.

OPEN HUTCHES

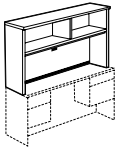

Open Hutch with Closed Back*

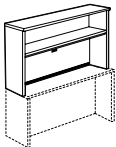
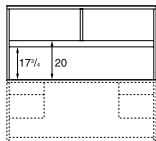

Open Hutch with Closed Back

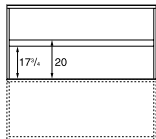

MODEL#	DIMENSIONS	FREIGHT CLASS	WT/LBS.	CUBIC FT.	LIST PRICE	HP ADD
--------	------------	---------------	---------	-----------	------------	--------

A72HOCB	15 x 72 x 36	125	175	28.25	\$1265	N/A
A71HOCB	15 x 71.69 x 36	125	175	28.25	\$1265	N/A
A66HOCB	15 x 66 x 36	125	164	26	\$1207	N/A
A60HOCB	15 x 60 x 36	125	151	23.75	\$1117	N/A

One fixed shelf and fixed shelf divider. Closed back features a grommet and flexible sweep for wire management. All hutches shipped pre-assembled. ***A71HOCB** for use when spanning 30" x 60/66" SPL/R and 20/24" x 42" FL/FR/L4/R4.

- Clearance from worksurface to valance is 17 3/4"; clearance from worksurface to hutch doors is 20".
- Woodgrain runs horizontal on both the upper and lower back panels.

A48HOCB	15 x 48 x 36	125	124	19	\$886	N/A
A42HOCB	15 x 42 x 36	125	111	16.75	\$886	N/A
A36HOCB	15 x 36 x 36	125	99	14.5	\$766	N/A
A30HOCB	15 x 30 x 36	125	88	12.25	\$711	N/A

One fixed shelf. Closed back features a grommet and flexible sweep for wire management. All hutches shipped pre-assembled.

- Clearance from worksurface to valance is 17 3/4"; clearance from worksurface to hutch doors is 20".
- Woodgrain runs horizontal on both the upper and lower back panels.

Required Specifications

Top finish
Base finish

Optional Specifications

Doors*

PIGEON-HOLE STORAGE

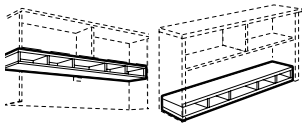

Horizontal Pigeon-Hole Storage

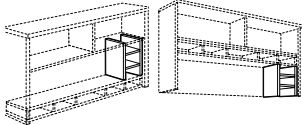

Vertical Pigeon-Hole Storage

MODEL#	DIMENSIONS D x W x H	FREIGHT CLASS	WT./LBS.	CUBIC FT.	LIST PRICE	HP ADD
AHS72	11.25 x 70 x 5.62	85	41	3	\$744	N/A
AHS71	11.25 x 69 x 5.62	70	43.5	2.3	\$744	N/A
AHS66	11.25 x 64 x 5.62	85	38	2.8	\$744	N/A
AHS60	11.25 x 58 x 5.62	85	35	2.5	\$610	N/A
AHS48	11.25 x 46 x 5.62	85	28	2	\$451	N/A
AHS42	11.25 x 40 x 5.62	85	24	2	\$451	N/A
AHS36	11.25 x 34 x 5.62	92.5	22	2	\$369	N/A

For additional storage. Can be **top** or **bottom** mounted. For use inside hutch. Shipped RTA (ready to assemble).

- **Cannot be used on A00S and C00S Overstorage Units.**
- Black finish is standard. Brushed Cobalt is available at no charge, please specify as **BRC**.

AVS14	11.25 x 13.37 x 14.37	85	13	0.9	\$465	N/A
-------	-----------------------	----	----	-----	--------------	-----

For use in conjunction with the Horizontal Pigeon-Hole Storage. Can be used under or over horizontal unit. Shipped RTA (ready to assemble).

- Black finish is standard. Brushed Cobalt is available at no charge, please specify as **BRC**.

CORNER HUTCHES

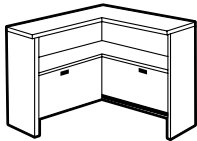

Corner Hutch with Closed Back

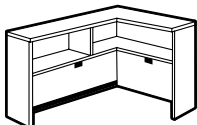

RIGHT Corner Hutch with Closed Back

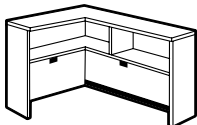

LEFT Corner Hutch with Closed Back

MODEL#	DIMENSIONS	FREIGHT CLASS	WT./LBS.	CUBIC FT.	LIST PRICE	HP ADD
A42CH	15 x 42 x 36	65	144	6.25	\$1489	N/A
A36CH	15 x 36 x 36	65	125	4.8	\$1255	N/A

One fixed shelf. Closed back features a grommet in both back panels and flexible sweep for wire management. Shipped RTA (ready to assemble).

- Woodgrain runs horizontal on both the upper and lower back panels.

A3672CHR	15 x 36-72 x 36	65	186	7	\$1640	N/A
A3666CHR	15 x 36-66 x 36	65	177	7	\$1580	N/A

One fixed shelf and shelf divider on left side. Closed back features a grommet in both back panels and flexible sweep for wire management on the left side. Shipped RTA (ready to assemble).

- Woodgrain runs horizontal on both the upper and lower back panels.

A3672CHL	15 x 36-72 x 36	65	186	7.25	\$1640	N/A
A3666CHL	15 x 36-66 x 36	65	177	7.25	\$1580	N/A

One fixed shelf and shelf divider on right side. Closed back features a grommet in both back panels and flexible sweep for wire management on the right side. Shipped RTA (ready to assemble).

- Woodgrain runs horizontal on both the upper and lower back panels.

Required Specifications

Top finish
Base finish

Optional Specifications

Doors

A ADAPTABILITIES®

HUTCH DOORS

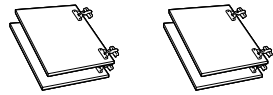

Four-Door Kit

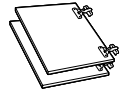

Two-Door Kit

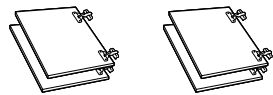

Corner Hutch Four-Door Kit

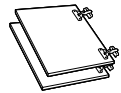

Corner Hutch Two-Door Kit

MODEL#	DIMENSIONS	FREIGHT CLASS	WT/LBS.	CUBIC FT.	LIST PRICE	HP ADD
--------	------------	---------------	---------	-----------	------------	--------

D x W x H

ADOOR72	.69 x 17.75 x 15	85	25	1.8	\$465	N/A
ADOOR71	.69 x 17.12 x 15	85	25	1.8	\$465	N/A
ADOOR66	.69 x 16.75 x 15	85	24	1.8	\$465	N/A
ADOOR60	.69 x 14.75 x 15	85	22	1.8	\$465	N/A

For use on 72", 71", 66" and 60"W straight hutches and overstorage units. Hinges included. Locks available. Add **\$146** each lock. Doors for units 60" wide or more require two locks.

ADOOR48	.69 x 23.5 x 15	92.5	18	1.8	\$302	N/A
ADOOR42	.69 x 20.5 x 15	100	17	1.8	\$302	N/A
ADOOR36	.69 x 17.5 x 15	100	15	1.8	\$302	N/A
ADOOR30	.69 x 14.5 x 15	125	13	1.8	\$302	N/A

For use on 48", 42" 36" and 30"W straight hutches and overstorage units. Hinges included. Locks available. Add **\$146** each lock. Doors for units 48" wide or less require one lock.

ADOOR72C	.69 x 56.5 x 15	70	27	1.8	\$589	N/A
ADOOR66C	.69 x 50.5 x 15	85	25	1.8	\$538	N/A

For use on 72" and 66"W corner hutches. Hinges included. Locks not available on corner hutch doors.

ADOOR42C	.69 x 26.5 x 15	92.5	20	1.8	\$512	N/A
ADOOR36C	.69 x 21.5 x 15	100	17	1.8	\$335	N/A

For use on 42" and 36"W corner hutches. Hinges included. Locks not available on corner hutch doors.

Required Specifications

Finish

TACKBOARDS FOR HUTCHES **MODEL#** **DIMENSIONS** **FREIGHT CLASS** **WT/LBS.** **CUBIC FT.** **FABRIC GRADE** **LIST PRICE**

D x W x H

TACKBOARD Notes: Tackboards can be upholstered in all of the following fabrics:

Grade 1: Jenny, Quilt, Terrace, Urban, Waterfall

Grade 2: Imprint, Lola

Grade 3: Anchorage, Merge

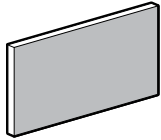

Tackboard

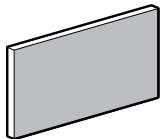

Tackboard

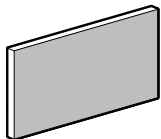

Tackboard

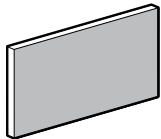

Tackboard

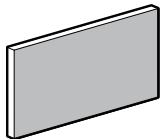

Tackboard

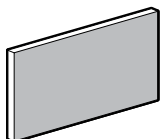

Tackboard

ATB7016	1 x 70 x 15	92.5	7	0.65	1	\$471	7	\$1113
					2	\$563	8	\$1281
					3	\$627	9	\$1472
					4	\$733	10	\$1693
					5	\$842	11	\$1945
					6	\$968	12	\$2237

For use on **A72HOCB** straight hutch. Includes mounting screws and covers.

ATB6916	1 x 69.5 x 15	92.5	7	0.65	1	\$471	7	\$1113
					2	\$563	8	\$1281
					3	\$628	9	\$1472
					4	\$733	10	\$1693
					5	\$842	11	\$1945
					6	\$968	12	\$2237

For use on **A71HOCB** straight hutch. Includes mounting screws and covers.

ATB6416	1 x 64 x 15	100	6.4	0.65	1	\$464	7	\$1053
					2	\$544	8	\$1211
					3	\$606	9	\$1393
					4	\$695	10	\$1599
					5	\$799	11	\$1839
					6	\$919	12	\$2116

For use on **A66HOCB** straight hutch. Includes mounting screws and covers.

ATB5816	1 x 58 x 15	92.5	5.8	0.54	1	\$452	7	\$1045
					2	\$532	8	\$1045
					3	\$591	9	\$1045
					4	\$686	10	\$1584
					5	\$789	11	\$1823
					6	\$908	12	\$2095

For use on **A60HOCB** straight hutch. Includes mounting screws and covers.

ATB4616	1 x 46 x 15	92.5	4.6	0.43	1	\$315	7	\$747
					2	\$380	8	\$859
					3	\$425	9	\$989
					4	\$493	10	\$1134
					5	\$567	11	\$1305
					6	\$651	12	\$1500

For use on **A48HOCB** straight hutch. Includes mounting screws and covers.

ATB4016	1 x 40 x 15	100	4	0.43	1	\$306	7	\$698
					2	\$360	8	\$803
					3	\$399	9	\$924
					4	\$461	10	\$1063
					5	\$528	11	\$1220
					6	\$607	12	\$1402

For use on **A42HOCB** straight hutch. Includes mounting screws and covers.

Required Specifications

Fabric

A ADAPTABILITIES®

TACKBOARDS FOR HUTCHES

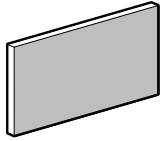

Tackboard

MODEL#	DIMENSIONS D x W x H	FREIGHT CLASS	WT/LBS.	CUBIC FT.	FABRIC GRADE	LIST PRICE
ATB3416	1 x 34 x 15	125	3.40	.43	1	\$297
					7	\$676
					2	\$349
					8	\$774
					3	\$389
					9	\$891
4	\$444					
10	\$1024					
5	\$513					
11	\$1177					
6	\$587					
12	\$1352					

For use on **A36HOCB** straight hutch. Includes mounting screws and covers.

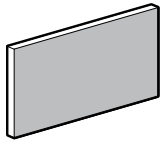

Tackboard

ATB2816	1 x 28 x 15	125	2.8	0.43	1	\$285
					7	\$612
					2	\$328
					8	\$705
					3	\$359
					9	\$774
4	\$403					
10	\$929					
5	\$463					
11	\$1069					
6	\$534					
12	\$1229					

For use on **A30HOCB** straight hutch. Includes mounting screws and covers.

TACKBOARDS FOR CORNER HUTCHES

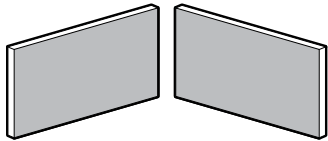

Tackboard

MODEL#	DIMENSIONS	FREIGHT CLASS	WT/LBS.	CUBIC FT.	GRADE	LIST PRICE
ATB72CH	1 x 33-72 x 15 70 w x 15¾ h	125	9.94	1.3	1	\$727
					7	\$1504
					2	\$820
					8	\$1730
					3	\$885
					9	\$1986
4	\$991					
10	\$2286					
5	\$1139					
11	\$2630					
6	\$1308					
12	\$3020					

For use on **A3672CHR/L** corner hutch. Includes mounting screws and covers.

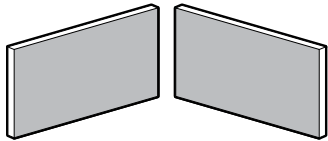

Tackboard

ATB66CH	1 x 33-64 x 15 64 w x 15¾ h	125	9.4	1.3	1	\$715
					7	\$1442
					2	\$795
					8	\$1657
					3	\$861
					9	\$1902
4	\$949					
10	\$2189					
5	\$1091					
11	\$2520					
6	\$1254					
12	\$2897					

For use on **A3666CHR/L** corner hutch. Includes mounting screws and covers.

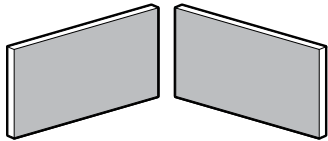

Tackboard

ATB42CH	1 x 39-40 x 15	100	7.7	0.85	1	\$571
					7	\$1138
					2	\$629
					8	\$1308
					3	\$681
					9	\$1502
4	\$749					
10	\$1729					
5	\$862					
11	\$1987					
6	\$991					
12	\$2286					

For use on **A42CH** corner hutch. Includes mounting screws and covers.

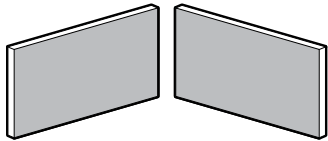

Tackboard

ATB36CH	1 x 33-34 x 15	125	6.6	0.85	1	\$547
					7	\$1094
					2	\$604
					8	\$1258
					3	\$642
					9	\$1446
4	\$720					
10	\$1665					
5	\$829					
11	\$1915					
6	\$953					
12	\$2200					

For use on **A36CH** corner hutch. Includes mounting screws and covers.

Required Specifications

Fabric - Tackboards
Finish - Transaction Top

WALL MOUNTED TACKBOARDS

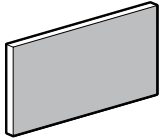

Wall Mounted Tackboard

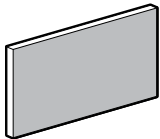

Wall Mounted Tackboard

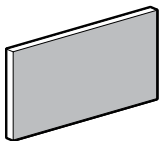

Wall Mounted Tackboard

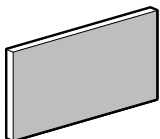

Wall Mounted Tackboard

MODEL#	DIMENSIONS D x W x H	FREIGHT CLASS	WT/LBS.	CUBIC FT.	FABRIC GRADE	LIST PRICE
AWHT3019	1.25 x 30 x 19	125	6.3	1	1	\$366
					7	\$844
					2	\$424
					8	\$969
					3	\$488
					9	\$1113
4	\$558					
10	\$1281					
5	\$641					
11	\$1472					
6	\$735					
12	\$1689					

For use under **A00S30** overstorage unit. Standard with pre-mounted "J" bracket for wall mount applications. There will be a 1.75" clearance between the top of the tackboard and bottom of the overhead, and a .25" clearance between the bottom of the tackboard and the worksurface.

- **NOTE:** Care should be taken to mount the units. Units should be mounted to wall studs using correct fasteners. Failure to do so may result in collapse of the unit and subsequent personal injury. **Mounting hardware not included.** Mounting hardware used should be based on wall material. Consult an installation professional for proper wall mounting.

AWHT3619	1.25 x 36 x 19	125	7.6	1	1	\$407
					7	\$941
					2	\$472
					8	\$1077
					3	\$541
					9	\$1237
4	\$619					
10	\$1422					
5	\$712					
11	\$1634					
6	\$818					
12	\$1877					

For use under **A00S36** overstorage unit. Standard with pre-mounted "J" bracket for wall mount applications. There will be a 1.75" clearance between the top of the tackboard and bottom of the overhead, and a .25" clearance between the bottom of the tackboard and the worksurface.

- **NOTE:** Care should be taken to mount the units. Units should be mounted to wall studs using correct fasteners. Failure to do so may result in collapse of the unit and subsequent personal injury. **Mounting hardware not included.** Mounting hardware used should be based on wall material. Consult an installation professional for proper wall mounting.

AWHT4219	1.25 x 42 x 19	100	8.9	1	1	\$472
					7	\$1090
					2	\$546
					8	\$1253
					3	\$627
					9	\$1438
4	\$720					
10	\$1654					
5	\$825					
11	\$1900					
6	\$949					
12	\$2183					

For use under **A00S42** overstorage unit. Standard with pre-mounted "J" bracket for wall mount applications. There will be a 1.75" clearance between the top of the tackboard and bottom of the overhead, and a .25" clearance between the bottom of the tackboard and the worksurface.

- **NOTE:** Care should be taken to mount the units. Units should be mounted to wall studs using correct fasteners. Failure to do so may result in collapse of the unit and subsequent personal injury. **Mounting hardware not included.** Mounting hardware used should be based on wall material. Consult an installation professional for proper wall mounting.

AWHT4819	1.25 x 48 x 19	92.5	10.1	1	1	\$514
					7	\$1184
					2	\$593
					8	\$1359
					3	\$682
					9	\$1560
4	\$784					
10	\$1794					
5	\$898					
11	\$2062					
6	\$1031					
12	\$2373					

For use under **A00S48** overstorage unit. Standard with pre-mounted "J" bracket for wall mount applications. There will be a 1.75" clearance between the top of the tackboard and bottom of the overhead, and a .25" clearance between the bottom of the tackboard and the worksurface.

- **NOTE:** Care should be taken to mount the units. Units should be mounted to wall studs using correct fasteners. Failure to do so may result in collapse of the unit and subsequent personal injury. **Mounting hardware not included.** Mounting hardware used should be based on wall material. Consult an installation professional for proper wall mounting.

Required Specifications

Fabric

WALL MOUNTED TACKBOARDS

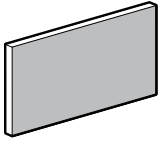

Wall Mounted Tackboard

MODEL#	DIMENSIONS D x W x H	FREIGHT CLASS	WT/LBS.	CUBIC FT.	FABRIC GRADE	LIST PRICE
AWHT6019	1.25 x 60 x 19	125	12.7	1.8	1	\$633
					7	\$1464
					2	\$731
					8	\$1681
					3	\$841
					9	\$1933
4	\$967					
10	\$2221					
5	\$1107					
11	\$2938					
6	\$1275					
12	\$2938					

For use under **A00S60** overstorage unit. Standard with pre-mounted "J" bracket for wall mount applications. There will be a 1.75" clearance between the top of the tackboard and bottom of the overhead, and a .25" clearance between the bottom of the tackboard and the worksurface.

- **NOTE:** Care should be taken to mount the units. Units should be mounted to wall studs using correct fasteners. Failure to do so may result in collapse of the unit and subsequent personal injury. **Mounting hardware not included.** Mounting hardware used should be based on wall material. Consult an installation professional for proper wall mounting.

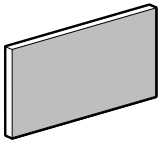

Wall Mounted Tackboard

AWHT6619	1.25 x 66 x 19	125	13.9	1.8	1	\$674
					7	\$1555
					2	\$780
					8	\$1787
					3	\$894
					9	\$2053
4	\$1027					
10	\$2358					
5	\$1180					
11	\$2712					
6	\$1353					
12	\$3118					

For use under **multiple** Adaptabilities wall mounted overstorage units. Standard with pre-mounted "J" bracket for wall mount applications. There will be a 1.75" clearance between the top of the tackboard and bottom of the overhead, and a .25" clearance between the bottom of the tackboard and the worksurface.

- **NOTE:** Care should be taken to mount the units. Units should be mounted to wall studs using correct fasteners. Failure to do so may result in collapse of the unit and subsequent personal injury. **Mounting hardware not included.** Mounting hardware used should be based on wall material. Consult an installation professional for proper wall mounting.

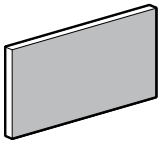

Wall Mounted Tackboard

AWHT7219	1.25 x 72 x 19	100	15.2	1.8	1	\$739
					7	\$1708
					2	\$852
					8	\$1961
					3	\$978
					9	\$2254
4	\$1125					
10	\$2590					
5	\$1292					
11	\$2977					
6	\$1484					
12	\$3421					

For use under **multiple** Adaptabilities wall mounted overstorage units. Standard with pre-mounted "J" bracket for wall mount applications. There will be a 1.75" clearance between the top of the tackboard and bottom of the overhead, and a .25" clearance between the bottom of the tackboard and the worksurface.

- **NOTE:** Care should be taken to mount the units. Units should be mounted to wall studs using correct fasteners. Failure to do so may result in collapse of the unit and subsequent personal injury. **Mounting hardware not included.** Mounting hardware used should be based on wall material. Consult an installation professional for proper wall mounting.

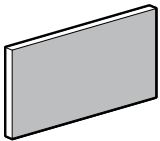

Wall Mounted Tackboard

AWHT7819	1.25 x 78 x 19	100	16.5	1.8	1	\$780
					7	\$1799
					2	\$900
					8	\$2068
					3	\$1032
					9	\$2376
4	\$1187					
10	\$2731					
5	\$1362					
11	\$3142					
6	\$1564					
12	\$3609					

For use under **multiple** Adaptabilities wall mounted overstorage units. Standard with pre-mounted "J" bracket for wall mount applications. There will be a 1.75" clearance between the top of the tackboard and bottom of the overhead, and a .25" clearance between the bottom of the tackboard and the worksurface.

- **NOTE:** Care should be taken to mount the units. Units should be mounted to wall studs using correct fasteners. Failure to do so may result in collapse of the unit and subsequent personal injury. **Mounting hardware not included.** Mounting hardware used should be based on wall material. Consult an installation professional for proper wall mounting.

Required Specifications

Fabric

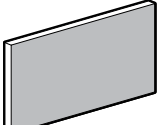
WALL MOUNTED TACKBOARD	MODEL#	DIMENSIONS	FREIGHT CLASS	WT/LBS.	CUBIC FT.	FABRIC GRD	LIST PRICE	GRD	
		D x W x H							
	AWHT8419	1.25 x 84 x 19	100	17.7	1.8	1	\$843	7	\$1950
						2	\$974	8	\$2241
						3	\$1118	9	\$2577
						4	\$1284	10	\$2963
						5	\$1476	11	\$3403
					6	\$1697	12	\$3914	

Wall Mounted Tackboard**

For use under **multiple** Adaptabilities wall mounted overstorage units. Standard with pre-mounted "J" bracket for wall mount applications. There will be a 1.75" clearance between the top of the tackboard and bottom of the overhead, and a .25" clearance between the bottom of the tackboard and the worksurface.

- **NOTE:** Care should be taken to mount the units. Units should be mounted to wall studs using correct fasteners. Failure to do so may result in collapse of the unit and subsequent personal injury. **Mounting hardware not included.** Mounting hardware used should be based on wall material. Consult an installation professional for proper wall mounting.

ACCESSORY PIECES	MODEL#	DIMENSIONS	FREIGHT CLASS	WT/LBS.	CUBIC FT.	LIST PRICE	HP ADD
	A2036MDL	20 x 36 x 29.6	92.5	162	15.5	\$2231	\$184
	A2436MDL	24 x 36 x 29.6	100	176	18.25	\$2265	\$184

Mixed Drawer Cabinet - LEFT*

Two box drawers on **right**, one file drawer on **left** and one lateral file drawer on bottom. File on lateral file drawers locking. 1 pencil tray. Front-to-back filing bars.

- Black handles are standard. Silver is available at no charge, please specify as **SI**.
- To comply with ANSI/BIFMA stability tests, the Lateral File Counter Weight Kit, model "LFCWKIT36" on page 41 MUST be used.
- *File drawer construction is for accommodating hanging files NOT for stacking materials on the drawer bottom.*
- Top file drawer supports hanging folders only. Does not accept hanging folders with plastic tabs.

	A2036MDR	20 x 36 x 29.6	92.5	162	15.5	\$2231	\$184
	A2436MDR	24 x 36 x 29.6	100	176	18.25	\$2265	\$184

Mixed Drawer Cabinet - RIGHT*

Two box drawers on **left**, one file drawer on **right** and one lateral file drawer on bottom. File on lateral file drawers locking. 1 pencil tray. Front-to-back filing bars.

- Black handles are standard. Silver is available at no charge, please specify as **SI**.
- To comply with ANSI/BIFMA stability tests, the Lateral File Counter Weight Kit, model "LFCWKIT36" on page 41 MUST be used.
- *File drawer construction is for accommodating hanging files NOT for stacking materials on the drawer bottom.*
- Top file drawer supports hanging folders only. Does not accept hanging folders with plastic tabs.

	A2036MDLS	19.25 x 36 x 28.6	100	137	15	\$2174	N/A
	A2436MDLS	23.25 x 36 x 28.6	100	150	18	\$2210	N/A

Mixed Drawer Cabinet Shell - LEFT*

For use **under 29"H limited single pedestal desks, workstations or limited single pedestal credenzas. Unfinished top, no back.** Two box drawers on **right**, one file drawer on **left** and one lateral file drawer on bottom. File and lateral file drawers locking. 1 pencil tray. Front-to-back filing bars.

- Black handles are standard. Silver is available at no charge, please specify as **SI**.
- *File drawer construction is for accommodating hanging files NOT for stacking materials on the drawer bottom.*
- *For 24" deep worksurfaces, order **A2436MDLS**. For 20" deep worksurfaces, order **A2036MDLS**.*
- Top file drawer supports hanging folders only. Does not accept hanging folders with plastic tabs.

Required Specifications

Fabric**
Top finish*
Handle finish*
Base finish*

Optional Specifications

Key # *

ACCESSORY PIECES



Mixed Drawer Cabinet Shell - RIGHT

MODEL#	DIMENSIONS D x W x H	FREIGHT CLASS	WT/LBS.	CUBIC FT.	LIST PRICE	HP ADD
A2036MDRS	19.25 x 36 x 28.6	100	137	15	\$2174	N/A
A2436MDRS	23.25 x 36 x 28.6	100	150	18	\$2210	N/A

For use **under 29"H limited single pedestal desks, workstations or limited single pedestal credenzas. Unfinished top, no back.** Two box drawers on **left**, one file drawer on **right** and one lateral file drawer on bottom. File and lateral file drawers locking. 1 pencil tray. Front-to-back filing bars.

- Black handles are standard. Silver is available at no charge, please specify as **SI**.
- File drawer construction is for accommodating hanging files **NOT** for stacking materials on the drawer bottom.
- For 24" deep worksurfaces, order **A2436MDRS**. For 20" deep worksurfaces, order **A2036MDRS**.
- Top file drawer supports hanging folders only. Does not accept hanging folders with plastic tabs.

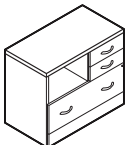

Mixed Storage Cabinet*

A2436MSC	24 x 36 x 29.6	100	163	18.25	\$1668	\$184
A2036MSC	20 x 36 x 29.6	100	147	15.5	\$1542	\$184

Features open storage compartment with access grommet on back. 2 box drawers and 1 lateral file drawer, all locking. 1 pencil tray. Front-to-back filing bars.

- To comply with ANSI/BIFMA stability tests, the Lateral File Counter Weight Kit, model "LFCWKIT36" on page 41 **MUST** be used.
- Black handles are standard. Silver is available at no charge, please specify as **SI**.
- File drawer construction is for accommodating hanging files **NOT** for stacking materials on the drawer bottom.



Mixed Storage Cabinet Shell

A2436MSCS	23.25 x 36 x 28	100	121	14.9	\$1627	N/A
A2036MSCS	19.25 x 36 x 28	125	136	17.45	\$1499	N/A

For use **under 29"H limited single pedestal desks, workstations or limited single pedestal credenzas. Unfinished top, no back.** Features open storage compartment with access grommet on back. 2 box drawers and 1 lateral file drawer, all locking. 1 pencil tray. Front-to-back filing bars.

- Black handles are standard. Silver is available at no charge, please specify as **SI**.
- File drawer construction is for accommodating hanging files **NOT** for stacking materials on the drawer bottom.
- For 24" deep worksurfaces, order **A2436MSCS**. For 20" deep worksurfaces, order **A2036MSCS**.



2 Drawer Lateral File*

A2036LF	20 x 36 x 29.6	100	145	15.5	\$1379	\$184
---------	----------------	-----	-----	------	---------------	--------------

Two full suspension drawers. Front-to-back and side-to-side letter/legal filing capability with lock. Anti-lock tilt suspension.

- To comply with ANSI/BIFMA stability tests, the Lateral File Counter Weight Kit, model "LFCWKIT36" on page 41 **MUST** be used.
- Black handles are standard. Silver is available at no charge, please specify as **SI**.
- File drawer construction is for accommodating hanging files **NOT** for stacking materials on the drawer bottom.

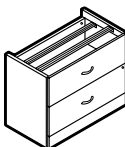

2 Drawer Lateral File Shell

A2436S2	24 x 36 x 28.6	125	114	18	\$1829	N/A
A2036S2	20 x 36 x 28.5	125	104	14.75	\$1829	N/A

For use **under 29"H limited single pedestal desks, workstations or limited single pedestal credenzas. No top or back.** Two full suspension locking drawers with **steel drawer interior**. Steel drawer construction includes metal sides and masonite bottoms. Side-to-side file bars included. Anti-lock tilt suspension.

- Black handles are standard. Silver is available at no charge, please specify as **SI**.
- To prevent overloading, steel drawers do not include a back panel
- For 24" deep worksurfaces, order **A2436S2**. For 20" deep worksurfaces, order **A2036S2**.
- For front-to-back file bars order **FBB**, "FBB" on page 41.

Required Specifications

Top finish*
Base finish
Handles

Optional Specifications

Key #
HP laminate*

ACCESSORY PIECES

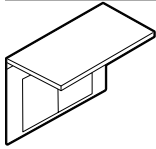

2 Drawer Lateral File Top and Back*

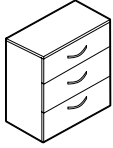

3 Drawer Lateral File*

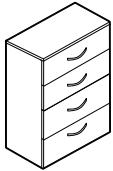

4 Drawer Lateral File*

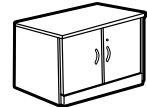

Storage Cabinet*

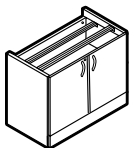

Storage Cabinet Shell

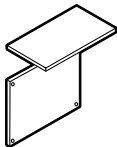

Storage Cabinet Top and Back*

MODEL#	DIMENSIONS	FREIGHT CLASS	WT/LBS.	CUBIC FT.	LIST PRICE	HP ADD
--------	------------	---------------	---------	-----------	------------	--------

D x W x H

ALF24TB	24 x 36 x 29.6	65	82	3.3	\$572	\$229
ALF20TB	20 x 36 x 29.6	65	78	3.3	\$572	\$229

For use with Lateral File Shell. Counterweights included. Shipped RTA (ready to assemble).

- Use **ALF24TB** for model A2436S2. Use **ALF20TB** for model A2036S2.

A2036S3	20 x 36 x 37.75	92.5	219	20	\$2641	\$184
---------	-----------------	------	-----	----	--------	-------

Three full suspension locking drawers with **steel drawer interior**. Steel drawer construction includes metal sides and masonite bottoms. Side-to-side file bars included. Anti-lock tilt suspension.

- Black handles are standard. Silver is available at no charge, please specify as **SI**.
- For front-to-back file bars order **FBB**; See "FBB" on page 41.
- To prevent overloading, steel drawers do not include a back panel

A2036S4	20 x 36 x 49.5	92.5	267	25.75	\$3347	\$184
---------	----------------	------	-----	-------	--------	-------

Four full suspension locking drawers with **steel drawer interior**. Steel drawer construction includes metal sides and masonite bottoms. Side-to-side file bars included. Anti-lock tilt suspension.

- Black handles are standard. Silver is available at no charge, please specify as **SI**.
- For front-to-back file bars order **FBB**; See "FBB" on page 41.
- To prevent overloading, steel drawers do not include a back panel

A2036SC	20 x 36 x 29.6	125	121	15.5	\$1056	\$184
---------	----------------	-----	-----	------	--------	-------

Self-closing hinged doors cover one adjustable shelf. Standard with lock.

- Black handles are standard. Silver is available at no charge, please specify as **SI**.

A2436SCS	23.25 x 36 x 28.6	150	106	18	\$912	N/A
A2036SCS	19.25 x 36 x 28.6	125	91	14.75	\$912	N/A

For use **under 29" H limited single pedestal desks, workstations or limited single pedestal credenzas. No top or back**. Self-closing hinged doors cover one adjustable shelf. Standard with lock.

- Black handles are standard. Silver is available at no charge, please specify as **SI**.
- For 24" deep worksurfaces, order **A2436SCS**. For 20" deep worksurfaces, order **A2036SCS**.

ASC24TB	24 x 36 x 29.6	85	49	3.3	\$386	\$229
ASC20TB	20 x 36 x 29.6	85	45	3.3	\$386	\$229

For use with **Storage Cabinet Shell**. Shipped RTA (ready to assemble).

- Use **ASC24TB** for model A2436SCS/MSCS; use **ASC20TB** for model A2036SCS/MSCS.

Required Specifications

Top finish*
Base finish
Handles

Optional Specifications

Key #
HP laminate*

ACCESSORY PIECES

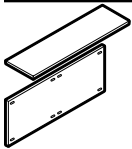

Credenza Top and Back*

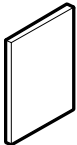

Full Leg



Personal Tower**

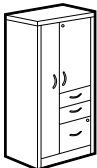

Personal Tower**

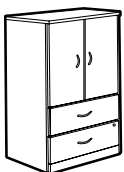

Vertical Storage/Lateral File Cabinet**

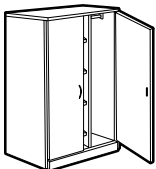

Storage Wardrobe Cabinet**

MODEL#	DIMENSIONS	FREIGHT CLASS	WT/LBS.	CUBIC FT.	LIST PRICE	HP ADD
--------	------------	---------------	---------	-----------	------------	--------

	D x W x H					
A2472TB	24 x 72 x 29.6	70	95	6	\$790	\$397
A2072TB	20 x 72 x 29.6	85	87	6	\$790	\$380

For use with the following: **two Lateral File Shells**, or **two Storage Cabinet Shells**, or **two Mixed Storage Cabinet Shells**, or any combination. May also be used with **one Lateral File Shell plus one Full Leg**, or **one Storage Cabinet/Mixed Storage Cabinet Shell plus one Full Leg**. Shipped RTA (ready to assemble).

- For 24" deep worksurfaces, order **A2472TB**. For 20" deep worksurfaces, order **A2072TB**.
- **Does not include hardware to attach to storage shells.**

A24FL	23.4 x 1 x 28.6	92.5	20	1.7	\$278	N/A
A20FL	19.3 x 1 x 28.6	65	16	0.6	\$278	N/A

For use at **either end of A24/2072TB Credenza Top and Back** to create a kneespace. Non-handed; can be used left or right. Shipped RTA (ready to assemble).

- For 24" deep worksurfaces, order **A24FL**. For 20" deep worksurfaces, order **A20FL**.
- **Does not include hardware for installation.**

A24PTFF	24 x 24 x 65.5	100	219	27	\$2748	N/A
A20PTFF	20 x 24 x 65.5	100	198	22.75	\$2748	N/A

Includes 7" wardrobe section with a hanging rod; storage section with one adjustable shelf; and file section with **two file drawers**. Locks are keyed alike. Upper lock secures wardrobe and storage section. Lower lock secures both file drawers.

- Black handles are standard. Silver is available at no charge, please specify as **SI**.

A24PTBBF	24 x 24 x 65.5	125	213	27	\$2748	N/A
A20PTBBF	20 x 24 x 65.5	100	193	22.75	\$2748	N/A

Includes 7" wardrobe section with a hanging rod; storage section with one adjustable shelf; and file section with **box-box-file drawers**. Locks are keyed alike. Upper lock secures wardrobe and storage section. Lower lock secures all drawers.

- Black handles are standard. Silver is available at no charge, please specify as **SI**.

A3665VSL	20 x 36 x 65.5	100	273	33	\$2569	N/A
----------	----------------	-----	-----	----	---------------	-----

Contains storage area with one adjustable shelf behind a self-closing hinged door, plus two full suspension file drawers. Lateral file drawers lock.

- File drawer construction is for accommodating hanging files NOT for stacking materials on the drawer bottom.
- Black handles are standard. Silver is available at no charge, please specify as **SI**.

A2436DI	24 x 36 x 65.5	70	254	11.5	\$3176	N/A
A3665DI	20 x 36 x 65.5	70	237	11.5	\$2803	N/A

Includes 16" hanging rod on one side and four adjustable shelves on the other. Lock. Shipped RTA (ready to assemble).

- Black handles are standard. Silver is available at no charge, please specify as **SI**.

Required Specifications

Top finish
Base finish
Handles (only personal towers)

Optional Specifications

Key #**
HP laminate*

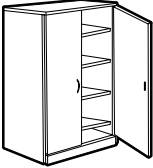
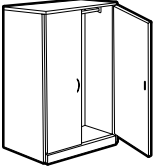
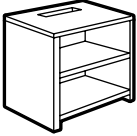
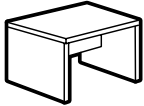
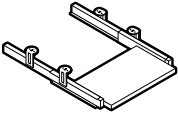
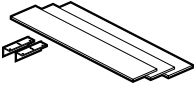
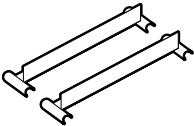
ACCESSORY PIECES	MODEL#	DIMENSIONS	FREIGHT CLASS	WT/LBS.	CUBIC FT.	LIST PRICE	HP ADD
 <p>Storage Cabinet**</p>	D x W x H						
	A2436SH	24 x 36 x 65.5	65	280	11.5	\$2797	N/A
	A3665SH	20 x 36 x 65.5	65	261	11.5	\$2452	N/A
<p>Includes four adjustable shelves. Lock. Shipped RTA (ready to assemble).</p> <ul style="list-style-type: none"> • Black handles are standard. Silver is available at no charge, please specify as SI. 							
 <p>Wardrobe Cabinet**</p>	A2436ROD	24 x 36 x 65.5	70	205	11.5	\$3027	N/A
	A3665ROD	20 x 36 x 65.5	70	198	11.5	\$2569	N/A
<p>Includes full width hanging rod. Lock. Shipped RTA (ready to assemble).</p> <ul style="list-style-type: none"> • Black handles are standard. Silver is available at no charge, please specify as SI. 							
 <p>Printer Table*</p>	A2430PT	24 x 30 x 29.6	65	108	4.3	\$1056	\$184
<p>Includes two fixed shelves, cut-back top shelf allows paper to fall onto lower shelf. Shipped RTA (ready to assemble).</p>							
 <p>Magazine Table*</p>	A2248MT	22 x 48 x 18.5	85	61	4.3	\$589	\$261
	A2222MT	22 x 22 x 18.5	85	40	3	\$477	\$139
<p>Shipped RTA (ready to assemble).</p>							
 <p>Pull-Out Keyboard</p>	APOKL28	17 x 28 x 3.5	85	13	0.9	\$359	N/A
	APOKL22	17 x 22 x 3.5	85	12	0.9	\$325	N/A
<p>Constructed of thermofused laminate. APOKL28 will accommodate keyboard and mousepad. APOKL28 will only fit on a single pedestal desk, freestanding table, or A42205C. Please specify color from available finishes listed on pg. 11.</p> <ul style="list-style-type: none"> • APOKL28 will not fit extended corners or A42245C, A36205C 5-sided corners. 							
 <p>Counter Weight Kit</p>	LFCWKIT36	6 x 33 x 1	60	40	0.25	\$804	N/A
<p>3 metal plates. Plates mount to the underside of any 36" wide Lateral File or Mixed Storage/Drawer cabinet. Includes mounting hardware. Must be ordered separately. Field installed.</p> <ul style="list-style-type: none"> • To comply with ANSI/BIFMA stability tests, the Lateral File Counter Weight Kit MUST be used with the appropriate Lateral Files and Mixed Storage Cabinets. 							
 <p>Front-to-Back Hanging File Bars</p>	FBB	-- x 15.2 x --	70	1	0.01	\$33	N/A
	FBB-50	-- x 15.2 x --	60	50	0.5	\$974	N/A
	FBB-100	-- x 15.2 x --	60	100	2.71	\$1783	N/A
<p>Includes two bars. Grey. FBB is one pair; FBB-50 is fifty pairs; FBB-100 is 100 pairs.</p> <ul style="list-style-type: none"> • Not recommended for "L" opening with receding door and roll-out shelves. 							

Required Specifications

Top finish
Base finish
Handles**

Optional Specifications

Key #**
HP laminate*

A ADAPTABILITIES®

BOOKCASES

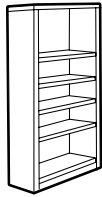

Bookcase - 72" High*

MODEL#	DIMENSIONS D x W x H	FREIGHT CLASS	WT/LBS.	CUBIC FT.	LIST PRICE	HP ADD
ABC72	12 x 36 x 72.5	125	170	23	\$1265	N/A

One fixed heavy duty shelf and **three adjustable shelves**. Shipped fully assembled.

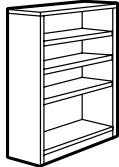

Bookcase - 65" High*

ABC65	12 x 36 x 65.5	125	150	21	\$1233	N/A
-------	----------------	-----	-----	----	---------------	-----

One fixed heavy duty shelf and **two adjustable shelves**. Shipped fully assembled.

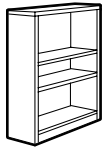

Bookcase - 48" High*

ABC48	12 x 36 x 48.5	125	116	15.75	\$941	N/A
-------	----------------	-----	-----	-------	--------------	-----

Two adjustable shelves. Shipped fully assembled.

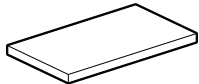

Bookcase Shelf

ABCSELF	11 x 34 x 1	100	13	1.5	\$294	N/A
---------	-------------	-----	----	-----	--------------	-----

Extra shelf for bookcases. 1" thick.

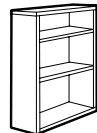
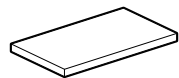

Table Top Bookcase

A3636TBC	15 x 36 x 36	125	111	17	\$809	N/A
ADOOR3636	.69 x 36 x 36	125	35	4.5	\$409	N/A

To be placed on top of 36" w lateral file or storage cabinet. Two adjustable shelves.

- For a set of doors, order **ADOOR3636**
- Locks available on ADOOR3636. Add \$101 each lock.



Bookcase Shelf

ATBC36SH	13.25 x 34 x 1	100	16	1.7	\$226	N/A
----------	----------------	-----	----	-----	--------------	-----

Extra shelf for TABLE TOP bookcases. 1" thick.

Required Specifications

Top finish*
Base finish*

END SHELVES

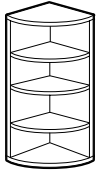

End Shelf - 65" High

MODEL#	DIMENSIONS D x W x H	FREIGHT CLASS	WT/LBS.	CUBIC FT.	LIST PRICE	HP ADD
A2465ESHL	24 x 24 x 65.5	65	136	5	\$1327	N/A
A2065ESHL	20 x 20 x 65.5	65	113	5	\$1117	N/A
A2465ESHR	24 x 24 x 65.5	65	136	5	\$1327	N/A
A2065ESHR	20 x 20 x 65.5	65	113	5	\$1117	N/A

For use at end of **wardrobe/storage, vertical storage cabinets, and personal towers**. Four fixed shelves. Shipped RTA (ready to assemble). **Specify left or right.**

- For 24" deep cabinet, order **A2465ESH**. For 20" deep cabinet, order **A2065ESH**.

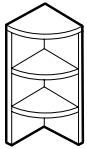

End Shelf - 36" High

A1536ESHL	15 x 15 x 36	85	44	3.3	\$538	N/A
A1536ESHR	15 x 15 x 36	85	44	3.3	\$538	N/A

For use at end of **hutches**. Two fixed shelves. To be used on top of **A3029ESHL/R, A2429ESHL/R or A2029ESHL/R**. Shipped RTA (ready to assemble). **Specify left or right.**

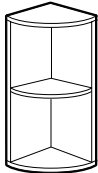

End Shelf - 29" High

A3029ESHL	30 x 30 x 29.6	70	104	5.25	\$941	\$305
A2429ESHL	24 x 24 x 29.6	70	77	4.3	\$766	\$155
A2029ESHL	20 x 20 x 29.6	70	60	3.8	\$654	\$125
A3029ESHR	30 x 30 x 29.6	70	104	5.25	\$941	\$305
A2429ESHR	24 x 24 x 29.6	70	77	4.3	\$766	\$155
A2029ESHR	20 x 20 x 29.6	70	60	3.8	\$654	\$125

For use at end of **worksurfaces**. Two fixed shelves. Shipped RTA (ready to assemble). **Specify left or right.**

- For 30" deep worksurface, order **A3029ESH**. For 24" deep worksurface, order **A2429ESH**.
For 20" deep worksurface, order **A2029ESH**.

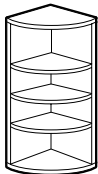

End Shelf - 49 1/2" High

A2049ESHL	20 x 20 x 49.5	65	94	3.8	\$985	N/A
A2049ESHR	20 x 20 x 49.5	65	94	3.8	\$985	N/A

For use at end of **A2036S4 4-high lateral file**. Four fixed shelves. Shipped RTA (ready to assemble). **Specify left or right.**

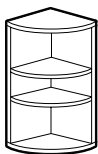

End Shelf - 37 1/4" High

A2037ESHL	20 x 20 x 38.2	70	77	5	\$716	N/A
A2037ESHR	20 x 20 x 38.2	70	77	5	\$716	N/A

For use at end of **A2036S3 3-high lateral file**. Three fixed shelves. Shipped RTA (ready to assemble). **Specify left or right.**

Required Specifications

Top finish
Base finish

Optional Specifications

HP Laminate (End Shelf, 29"h)

PEDESTALS



Freestanding Pedestal

MODEL#	DIMENSIONS D x W x H	FREIGHT CLASS	WT./LBS.	CUBIC FT.	LIST PRICE	HP ADD
AFPBBF19	19 x 16 x 28.6	100	68	7.25	\$1150	N/A
AFPBBF22	22 x 16 x 28.6	100	72	8.25	\$1177	N/A
AFPBBF28	28 x 16 x 28.6	100	88	10.25	\$1226	N/A

For use under a freestanding worksurface (20", 24" or 30"); attaches to worksurface top. No top and unfinished back. Two box and one file drawer. One pencil tray. File drawer and lower box drawer are locking.

- Cannot be used with **A2466** extended corners.
- When used with Connectable Tables (e.g. A2472T) bottom rear of pedestal will show because of the modesty on table units



Freestanding Pedestal

AFPFF19	19 x 16 x 28.6	100	67	7.25	\$1245	N/A
AFPFF22	22 x 16 x 28.6	100	75	8.25	\$1260	N/A
AFPFF28	28 x 16 x 28.6	100	89	10.25	\$1332	N/A

For use under a freestanding worksurface (20", 24" or 30"); attaches to worksurface top. No top and unfinished back. Two file drawers. Locking.

- Cannot be used with **A2466** extended corners.
- When used with Connectable Tables (e.g. A2472T) bottom rear of pedestal will show because of the modesty on table units

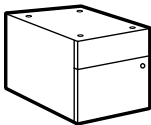

Hanging Pedestal

AHPBF18	18 x 16 x 18	92.5	48	4.5	\$804	N/A
---------	--------------	------	----	-----	--------------	-----

For use under a freestanding worksurface (20", 24" or 30"); attaches to worksurface top. No top and unfinished back. One box and one file drawer. One pencil tray. Locking. 18" high.

- Cannot be used with **A2466** extended corners.
- When used with Connectable Tables (e.g. A2472T) bottom rear of pedestal will show because of the modesty on table units



Mobile Pedestal*

AMPBBF19	19 x 16 x 28	85	96	6.5	\$1202	\$229
AMPBBF22	23 x 16 x 28	92.5	92	7.75	\$1215	\$236
AMPBBF28	29 x 16 x 28	92.5	105	9.5	\$1260	\$238

Pedestal on casters. Front casters lock. Fits under worksurfaces and is easily moved. Two box and one file drawer. One pencil tray. File drawer and lower box drawer are locking. Includes counterweight to prevent tipping.

- Cannot be used with **A2466** extended corners.

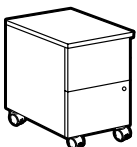

Mobile Pedestal*

AMPFF19	19 x 16 x 28	85	97	6.5	\$1293	\$229
AMPFF22	23 x 16 x 28	85	95	7.75	\$1312	\$238
AMPFF28	29 x 16 x 28	92.5	106	9.5	\$1379	\$238

Pedestal on casters. Front casters lock. Fits under worksurfaces and is easily moved. Two file drawers. Locking. Includes counterweight to prevent tipping.

- Cannot be used with **A2466** extended corners.

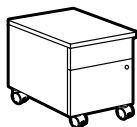

Mobile Pedestal*

AMPBF19	19 x 16 x 22	85	77	5.25	\$1056	\$229
AMPBF22	23 x 16 x 22	85	73	6	\$1083	\$238
AMPBF28	29 x 16 x 22	92.5	83	7.5	\$1111	\$238

Pedestal on casters. Front casters lock. Fits under worksurfaces and is easily moved. One box and one file drawer. One pencil tray. Locking. 22" high. Includes counterweight to prevent tipping.

Required Specifications

Top finish
Base finish*

Optional Specifications

Key #
HP laminate (mobile pedestal)
Handle

BOARDROOM TABLES



Boardroom Table - Round Top*

MODEL#	DIMENSIONS	FREIGHT CLASS	WT/LBS.	CUBIC FT.	LIST PRICE	HP ADD
D x W x H						
A48R	48 x 48 x 1.5	85	95	7.5	\$684	\$531
A42R	42 x 42 x 1.5	85	73	5.75	\$654	\$531
A36R	36 x 36 x 1.5	92.5	54	4.9	\$477	\$305

- Available with the **Bicut edge** at no upcharge. Please specify **"CR"**.
- **A48R** to be used with four monopost legs only, model **A5L**.
- **A42R** to be used with cross base **A2727XB only**
- **A36R** to be used with drum base **A18Z** or cross base **A2727XB**



Boardroom Table - Rectangular Top*

A48120RE	48 x 120 x 1.5	70	274	13	\$1466	\$1206
A4896RE	48 x 96 x 1.5	65	314	11.5	\$1117	\$983
A3672RE	36 x 72 x 1.5	65	175	7	\$824	\$567

For use with two drum bases, two "V" bases, one panel base OR four monoposts. Predrilled for "V" base and panel base.

Top comes in one piece, except for A48120RE (two pieces)

- Available with the **Bicut Edge** at no upcharge. Please Specify **"CR"**.
- **A48120RE** uses three drum bases, three "V" bases, one double panel base OR six monoposts.



Boardroom Table - Boat Shape Top*

A48144B	48 x 144 x 1.5	60	237	7.5	\$1697	\$1432
A48120B	48 x 120 x 1.5	60	198	6.3	\$1466	\$1206
A4896B	48 x 96 x 1.5	70	193	9.8	\$1150	\$983

For use with three drum bases, three "V" bases, one double panel base OR six monoposts. Predrilled for "V" base and panel base. **Top comes in two pieces, except for A4896B.**

- Available with the **Bicut Edge** at no upcharge. Please Specify **"CR"**.
- **A4896B** uses two drum bases, two "V" bases, one panel base OR four monoposts.



Boardroom Table - Racetrack Top*

A48144RT	48 x 144 x 1.5	60	251	7.5	\$1697	\$1432
A48120RT	48 x 120 x 1.5	60	204	6.3	\$1466	\$1206
A4896RT	48 x 96 x 1.5	70	200	9.8	\$1150	\$983
A3672RT	36 x 72 x 1.5	70	112	5.8	\$886	\$567

For use with three drum bases, three "V" bases, one double panel base OR six monoposts. Predrilled for "V" base and panel base. **Top comes in two pieces except for A4896RT and A3672RT.**

- Available with the **Bicut Edge** at no upcharge. Please Specify **"CR"**.
- **NOTE:** 48" x 120" and 48" x 144" woodgrain finish Adaptabilities tables will not have a perfect match of grain at the center where the two halves meet.
- **A4896RT** and **A3672RT** use two drum bases, two "V" bases, one panel base OR four monoposts.

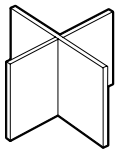

Cross Base

A2727XB	27 x 27 x 29.6	70	63	3.6	\$439	N/A
---------	----------------	----	----	-----	--------------	-----

Use as the base for **36" or 42" round tops (model A36R or A42R)**. Shipped RTA (ready to assemble).

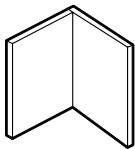

"V" Base

A1616V	16 x 16 x 28.6	60	39	1.1	\$374	N/A
A1616V2	16 x 16 x 28.6	60	74	2.2	\$739	N/A

Use as the base for **rectangular, boat shaped or racetrack tops**. Shipped RTA (ready to assemble).

- **A1616V2** is shipped 2 bases per carton.

Required Specifications

Finish
Edge detail*

Optional Specifications

HP laminate*

A ADAPTABILITIES®

BOARDROOM TABLES

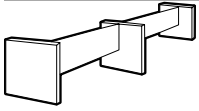

Panel Base

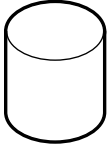

Drum Base

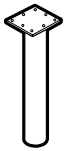

Mono Post

MODEL#	DIMENSIONS D x W x H	FREIGHT CLASS	WT./LBS.	CUBIC FT.	LIST PRICE	HP ADD
A2488PB	24 x 88 x 29.6	70	119	6	\$1174	N/A
A2445PB	24 x 45 x 28.6	70	76	4.3	\$766	N/A

Use as the base for **rectangular, boat shaped or racetrack tops**. Shipped RTA (ready to assemble).

- Use **A2488PB** for 120 - 144" wide tops.
- Use **A2445PB** for 72 - 96" wide tops.

A18Z	18 x 18 x 28.6	250	29	7.5	\$824	N/A
------	----------------	-----	----	-----	--------------	-----

Use as the base for **36" round top (model A36R) and 72", 96", 120" or 144" wide tops**.

Available in Black finish only.

- All Drum Bases require approx. 125 lb. of sand in each base for adequate stability. Sand not included.

A5L	4 x 4 x 28.6	100	13	1.5	\$359	N/A
-----	--------------	-----	----	-----	--------------	-----

Use as the base for **48" (model A48R) round tops and 72", 96", 120" or 144" wide tops**.

- Post is shipped in separate carton. Standard in Black (**TBL**); Tungsten is available at no charge, please specify (**TTU**).

BOARDROOM ACCESSORIES



Serving Cart*

MODEL#	DIMENSIONS	FREIGHT CLASS	WT./LBS.	CUBIC FT.	LIST PRICE	HP ADD
A2036SK	20 x 36 x 36.5	100	179	19	\$2452	\$184

Includes **two** side opening, self-closing hinged doors, **two box drawers**, one slide-out tray and storage shelf. On casters.

- Available with the **Bicut Edge** at no upcharge. Please Specify "**AR**".
- Black handles are standard. Silver is available at no charge, please specify as **SI**.

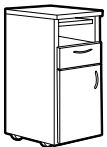

Serving Cart*

A2020SK	20 x 20 x 36	92.5	114	11	\$1538	\$125
---------	--------------	------	-----	----	---------------	--------------

Includes **one** side opening, self-closing hinged door, **one box drawer**, one slide-out tray and storage shelf. On casters.

- Available with the **Bicut Edge** at no upcharge. Please Specify "**CR**".
- Black handles are standard. Silver is available at no charge, please specify as **SI**.

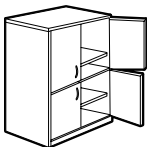

Audio/Visual Cabinet*

A2436AV	24 x 36 x 65.5	65	272	11.25	\$2803	N/A
---------	----------------	----	-----	-------	---------------	-----

Includes **four** side opening doors covering two adjustable and two fixed shelves. Wire access through one grommet on back panel. Holds up to 27"H TV monitor. Shipped RTA (ready to assemble).

- Black handles are standard. Silver is available at no charge, please specify as **SI**.

Required Specifications

Top finish *
Base finish
Handles*

Optional Specifications

Key #*
HP laminate*

BOARDROOM ACCESSORIES

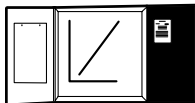

Visual Board

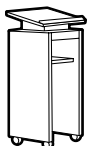

Lectern*

MODEL#	DIMENSIONS	FREIGHT CLASS	WT./LBS.	CUBIC FT.	LIST PRICE	HP ADD
--------	------------	---------------	----------	-----------	------------	--------

D x W x H						
AVB4848	4 x 48 x 48	70	135	9	\$1758	N/A

Includes white board and two side opening doors containing cork board on right door and 50-sheet paper writing pad on left door. Marker board can be used for projection.

- **NOTE:** Care should be taken to mount the units. Units should be mounted to wall studs using correct fasteners. Failure to do so may result in collapse of the unit and subsequent personal injury. Mounting hardware not included. Mounting hardware used should be based on wall material. Consult an installation professional for proper wall mounting.

A1844LC	18 x 24 x 44	70	92	4.8	\$941	\$125
---------	--------------	----	----	-----	--------------	--------------

Features angled stand, fixed storage shelf and casters (two rear casters, locking). Shipped RTA (ready to assemble).

Required Specifications

Top finish
Base finish

Optional Specifications

HP laminate*



The **Genoa**® series combines the value of laminate furniture with the contemporary styling of top over end panel design. This versatile offering of components and wide selection of laminate finish options is the perfect complement to any office environment.

For added security of confidential material, all desks and credenzas are equipped with one locking pedestal. Genoa's kneespace credenza easily accommodates a computer, books, binders and files to maximize space.

Genoa features quality construction with the added strength of dovetailed box and file drawers. Fully progressive ball bearing suspensions ensure years of smooth, trouble-free drawer service.

Genoa's classic styling and simplicity integrate easily with existing furnishings and any interior decor. For new offices or current office expansions, Genoa is clearly the affordable and practical choice.

Features and Benefits

- 45lb. density particle board substructure with high performance thermally fused laminate
- Available bow front desk provides extra legroom and work area for visitors
- ¾ modesty panel is standard
- Most components shipped fully assembled, 1 per carton
- Pencil tray included in box drawer
- Box drawers mounted on ¾ extension steel ball bearings
- All drawers feature French dovetail joint in front and lapjoint in back
- Drawers open with side pull
- Compatible with **Divide** panel system for increased privacy and storage requirements

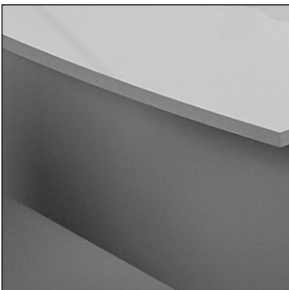

Bow front available on 36" x 72" desks



Contemporary top-over-end panel design



Drawer fronts are edge banded on all sides

GENERAL INFORMATION

- Constructed of 45 lb. density particle board with high performance thermally fused laminate
- Genoa components are compatible with **Divide** partitioning panels.
- Large offering of extended corners, full to floor pedestals, islands and storage options
- Double wall pedestal housing
- Genoa desk and storage products have been tested and comply with all BIFMA mechanical tests.
- For environmental certifications, please visit globalfurnituregroup.com

CONSTRUCTION

- 1" worksurfaces constructed of 45 lb. density particleboard with high performance thermally fused laminate
- Double wall pedestal housing
- Panel end style with top over side panel design
- 1" adjustable leveling glides standard on all units
- Standard with locks

MODESTY PANELS

- Recessed ¾ height modesty panel is standard. Full modesty panel available. **Add \$80.**
- All full to floor units, bridges and returns are standard with a full modesty panel

STORAGE

- All lateral file drawer fronts feature the woodgrain running in a horizontal direction
- Pencil tray included in box drawer
- All drawers feature French dovetail joint in front and lapjoint in back

FINISHES

LAMINATE FINISHES

ACJ Absolute Acajou	NBL Noce Biondo
ASN Asian Night	NGL Noce Grigio
AWC Avant Cherry	NEL Noce Leggero
AWH Avant Honey	NML Noce Medio
BLK Black	QTM Quartered Mahogany
BRC Brushed Cobalt	SOG Storm Grey
CMB Clear Maple	WHE Walnut Heights
DES Dark Espresso	WHC White Chocolate
DWT Designer White	WCR Winter Cherry

GROMMETS

- Grommets may be ordered on Genoa hutch back panel
- Additional grommets available in standard worksurface locations (left, center or right). Order as: **AG1, AG2 or AG3. Add \$103.**
- Grommet hole dimensions are 3 ¼" wide x 1 7/8" deep



- Actual grommet locations on the worksurface are depicted in the example drawings shown below. Dimensions shown are actual measurements (in inches).

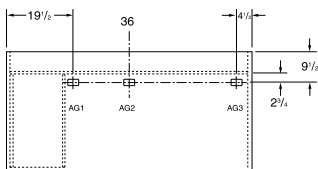

36 x 72 single pedestal left desks (3672SPL)

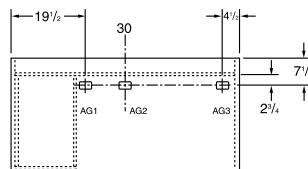

30 x 60 single pedestal left desks (3060SPL)

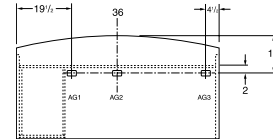

36 x 72 single pedestal left bow top desks (3672SLB)

- Grommets may be placed at non-standard locations. Order as: **AGS - Add \$103.** A drawing must be supplied with vertical and horizontal dimensions to the center of the cut-out (as in drawing above). Please refer to CUSTOM GROMMET LOCATION FORM in the back reference section.
- Components that come standard with grommet may be ordered without a grommet. **Add \$57.**
- Grommets are available on modesty panels of **5-sided corners** 6 ½" in where the two modesty panels meet at a 90° angle. Please specify **FOGMPR** for right grommet placement and **FOGMPL** for left grommet (placement is as shown on diagrams below). Cost is **\$103.**

*Modesty Panels are 1" off of ground

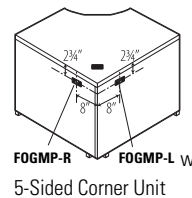

POWER BLOCK

- A Power Block (model **PMSPPDM**) may be ordered on all worksurfaces
- A Power Block is a rectangular worksurface power/data module with one electrical duplex receptacle and two data (RJ45) receptacles. 9 foot black cord included. Power Block dimensions are 3 ½" deep x 6 ½" wide x 2 ¾" high.
- To purchase a Power Block, you must specify both the Power Block cut-out location and the Power Block model #. Order Power Block as **PMSPPDM, Add \$352.** Power Blocks are available in standard worksurface locations (left, center or right). Order as **E1, E2 or E3. Add \$103.**

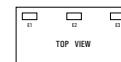

Power Block **PMSPPDM. Add \$352** Specify location **E1, E2 or E3. Add \$103.**

DOUBLE PEDESTAL DESKS

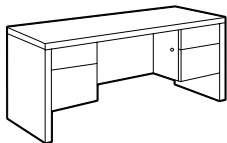

Double Pedestal Desk

MODEL#	DIMENSIONS D x W x H	FREIGHT CLASS	WT/LBS.	CUBIC FT.	LIST PRICE
G3672DP	36 x 72 x 29.4	150	286	50.5	\$1466
G3072DP	29.63 x 72 x 29	150	245	43.75	\$1429
G3066DP	29.69 x 66 x 29.4	150	235	39.25	\$1387
G3060DP	29.69 x 60 x 29.4	125	226	35.5	\$1163

Standard with box/file pedestals on both sides. Pedestals lock. One pencil tray.

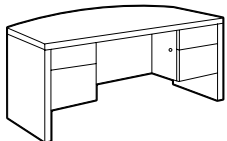

Double Pedestal Bow Top Desk

G3672DPB	32-36 x 72 x 29.4	150	256	50.5	\$1797
----------	-------------------	-----	-----	------	---------------

Standard with box/file pedestals on both sides and bow top. Pedestals lock. One pencil tray.

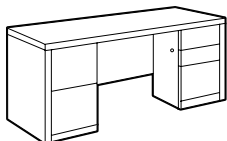

Full to Floor Double Pedestal Desk

G3072D4	29.69 x 72 x 29	125	277	43.75	\$1870
---------	-----------------	-----	-----	-------	---------------

Standard with full to floor box/box/file on right pedestal and file/file on left pedestal. Pedestals lock. One pencil tray.

SINGLE PEDESTAL DESKS

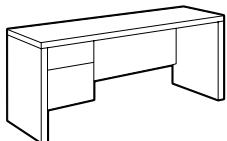

Single Pedestal Desk - LEFT

G3672SPL	36 x 72 x 29.4	150	235	50.5	\$1333
G3072SPL	30 x 72 x 29	150	192	43.75	\$1265
G3066SPL	29.69 x 66 x 29.4	150	192	39.25	\$1243
G3060SPL	29.69 x 60 x 29.4	150	183	35.5	\$1028
G3048SPL	29.69 x 48 x 29.4	150	166	28.75	\$1028
G2445SPL	24 x 45 x 29.4	150	137	23.5	\$804

Standard with box/file pedestal. Pedestal locks. One pencil tray. Pedestal is on the **left**.

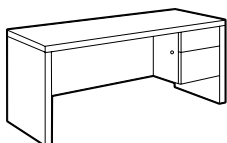

Single Pedestal Desk - RIGHT

G3672SPR	36 x 72 x 29.4	150	235	50.5	\$1333
G3072SPR	30 x 72 x 29	150	192	43.75	\$1265
G3066SPR	29.69 x 66 x 29.4	150	192	39.25	\$1243
G3060SPR	29.69 x 60 x 29.4	150	183	35.5	\$1028
G3048SPR	29.69 x 48 x 29.4	150	166	28.75	\$1028
G2445SPR	24 x 45 x 29.4	150	137	23.5	\$804

Standard with box/file pedestal. Pedestal locks. One pencil tray. Pedestal is on the **right**.

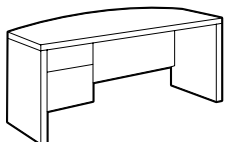

Single Pedestal Bow Top Desk - LEFT

G3672SLB	36-36 x 72 x 29	150	270	50	\$1645
----------	-----------------	-----	-----	----	---------------

Standard with box/file pedestal on **left** and bow top. Pedestal locks. One pencil tray.

Required Specifications

Finish

Optional Specifications

Full modesty
Grommet
Key #

Accessories

Power block
Keyboard tray
Pencil tray

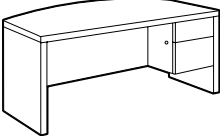
SINGLE PEDESTAL DESKS	MODEL#	DIMENSIONS	FREIGHT CLASS	WT/LBS.	CUBIC FT.	LIST PRICE
 <p>Single Pedestal Bow Top Desk - RIGHT</p>		D x W x H				
	G3672SRB	36 x 72 x 29	150	270	50	\$1645

Standard with box/file pedestal on **right** and bow top. Pedestal locks. One pencil tray.

RETURNS

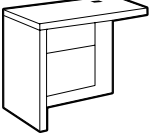
 <p>Typing Return - LEFT</p>	G2448SDL	24 x 48 x 26	150	137	23.5	\$828
	G2040SDL	20 x 40 x 26	125	111	17.5	\$804

Standard with box/file pedestal and lower **26" height**. Pedestal locks. Grommet in worksurface. Pedestal is on the **left**.

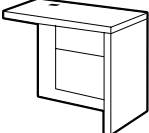
 <p>Typing Return - RIGHT</p>	G2448SDR	24 x 48 x 26	150	137	23.5	\$828
	G2040SDR	20 x 40 x 26	125	111	17.5	\$804

Standard with box/file pedestal and lower **26" height**. Pedestal locks. Grommet in worksurface. Pedestal is on the **right**.

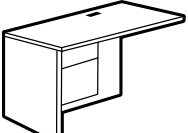
 <p>Flush Return - LEFT</p>	G2454FL	24 x 54 x 29	150	127	27	\$1005
	G2448FL	24 x 48 x 29.4	125	142	23.5	\$892
	G2442FL	24 x 42 x 29	150	111	21.5	\$860
	G2054FL	20 x 54 x 29	150	114	23	\$1005
	G2048FL	20 x 48 x 29	150	107	20.5	\$892
	G2042FL	20 x 42 x 29	150	100	18	\$860
	G2040FL	20 x 40 x 29.4	125	115	17.5	\$848
	G2036FL	20 x 36 x 29	125	93	15.5	\$848

Standard with box/file drawer pedestal. Pedestal locks. Grommet in worksurface. Pedestal is on the **left**.

- For 24" deep worksurfaces, order **G24__FL**. For 20" deep worksurfaces, order **G20__FL**.
- Keyboard and pencil trays for use on units 42" and above

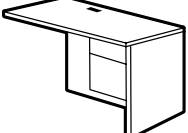
 <p>Flush Return - RIGHT</p>	G2454FR	24 x 54 x 29	150	127	27	\$1005
	G2448FR	24 x 48 x 29.4	125	142	23.5	\$892
	G2442FR	24 x 42 x 29	150	111	21.5	\$860
	G2054FR	20 x 54 x 29	150	114	23	\$1005
	G2048FR	20 x 48 x 29	150	107	20.5	\$892
	G2042FR	20 x 42 x 29	150	100	18	\$860
	G2040FR	20 x 40 x 29.4	125	115	17.5	\$848
	G2036FR	20 x 36 x 29	125	93	15.5	\$848

Standard with box/file drawer pedestal. Pedestal locks. Grommet in worksurface. Pedestal is on the **right**.

- For 24" deep worksurfaces, order **G24__FR**. For 20" deep worksurfaces, order **G20__FR**.
- Keyboard and pencil trays for use on units 42" and above

Required Specifications
Finish

Optional Specifications
Key #

Accessories
Power block
Keyboard tray
Pencil tray

RETURNS

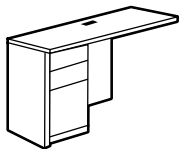

Full to Floor Flush Return - LEFT

MODEL#	DIMENSIONS D x W x H	FREIGHT CLASS	WT./LBS.	CUBIC FT.	LIST PRICE
G2448BL4	24 x 48 x 29.4	150	136	25	\$1294
G2442BL4	24 x 42 x 29.4	150	128	21.5	\$1277
G2436BL4	24 x 36 x 29.4	125	120	18	\$1251
G2048BL4	20 x 48 x 29	150	121	20.5	\$1260
G2042BL4	20 x 42 x 29	125	114	18	\$1230
G2036BL4	20 x 36 x 29	125	108	15.5	\$1207

Standard with box/box/file drawer pedestal. Lower box drawer and file drawer lock. Grommet in worksurface. Pedestal is on the **left**.

- For 24" deep worksurfaces, order **G24__BL4**. For 20" deep worksurfaces, order **G20__BL4**.
- Keyboard and pencil trays for use on units 42" and above

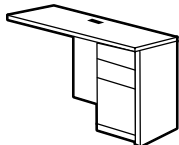

Full to Floor Flush Return - RIGHT

G2448BR4	24 x 48 x 29.4	150	136	25	\$1294
G2442BR4	24 x 42 x 29.4	150	128	21.5	\$1277
G2436BR4	24 x 36 x 29.4	125	120	18	\$1251
G2048BR4	20 x 48 x 29	150	121	20.5	\$1260
G2042BR4	20 x 42 x 29	125	114	18	\$1230
G2036BR4	20 x 36 x 29	125	108	15.5	\$1207

Standard with box/box/file drawer pedestal. Lower box drawer and file drawer lock. Grommet in worksurface. Pedestal is on the **right**.

- For 24" deep worksurfaces, order **G24__BR4**. For 20" deep worksurfaces, order **G20__BR4**.
- Keyboard and pencil trays for use on units 42" and above

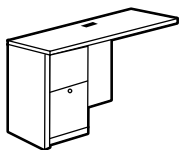

Full to Floor Flush Return - LEFT

G2448L4	24 x 48 x 29.4	150	132	25	\$1333
G2442L4	24 x 42 x 29.4	150	124	21.5	\$1307
G2436L4	24 x 36 x 29.4	125	116	18	\$1286
G2048L4	20 x 48 x 29	150	118	20.5	\$1294
G2042L4	20 x 42 x 29	125	111	18	\$1260
G2036L4	20 x 36 x 29	125	104	15.5	\$1243

Standard with file/file drawer pedestal. Pedestal locks. Grommet in worksurface. Pedestal is on the **left**.

- For 24" deep worksurfaces, order **G24__L4**. For 20" deep worksurfaces, order **G20__L4**.
- Keyboard and pencil trays for use on units 42" and above

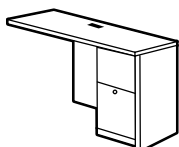

Full to Floor Flush Return - RIGHT

G2448R4	24 x 48 x 29.4	150	132	25	\$1333
G2442R4	24 x 42 x 29.4	150	124	21.5	\$1307
G2436R4	24 x 36 x 29.4	125	116	18	\$1286
G2048R4	20 x 48 x 29	150	118	20.5	\$1294
G2042R4	20 x 42 x 29	125	111	18	\$1260
G2036R4	20 x 36 x 29	125	104	15.5	\$1243

Standard with file/file drawer pedestal. Pedestal locks. Grommet in worksurface. Pedestal is on the **right**.

- For 24" deep worksurfaces, order **G24__R4**. For 20" deep worksurfaces, order **G20__R4**.
- Keyboard and pencil trays for use on units 42" and above

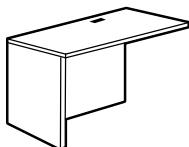

Flush Return - LEFT

G2454EL	24 x 54 x 29	70	87	5.25	\$828
G2448EL	24 x 48 x 29	70	96	4.5	\$716
G2442EL	24 x 42 x 29	70	71	3.8	\$716
G2054EL	20 x 54 x 29	85	78	5.25	\$785
G2048EL	20 x 48 x 29	70	70	4.2	\$739
G2042EL	20 x 42 x 29	70	56	3.3	\$716
G2040EL	20 x 40 x 29	70	78	4.5	\$691
G2036EL	20 x 36 x 29	70	56	3.3	\$691

Return has no pedestal. Grommet in worksurface. Shipped RTA (ready to assemble).

- For 24" deep worksurfaces, order **G24__EL**. For 20" deep worksurfaces, order **G20__EL**.

Required Specifications

Finish

Optional Specifications

Additional grommet
Key #

Accessories

Power block
Keyboard tray
Pencil tray

RETURNS **MODEL#** **DIMENSIONS** **FREIGHT CLASS** **WT./LBS.** **CUBIC FT.** **LIST PRICE**

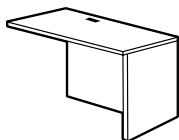

Flush Return - RIGHT

D x W x H						
G2454ER	24 x 54 x 29	70	87	5.25	\$828	
G2448ER	24 x 48 x 29	70	96	4.5	\$716	
G2442ER	24 x 42 x 29	70	71	3.8	\$716	
G2054ER	20 x 54 x 29	85	78	5.25	\$785	
G2048ER	20 x 48 x 29	70	70	4.2	\$739	
G2042ER	20 x 42 x 29	70	63	3.8	\$716	
G2040ER	20 x 40 x 29	70	78	4.5	\$691	
G2036ER	20 x 36 x 29	70	56	3.3	\$691	

Return has no pedestal. Grommet in worksurface. Shipped RTA (ready to assemble).

- For 24" deep worksurfaces, order **G24__ER**. For 20" deep worksurfaces, order **G20__ER**.

FLUSH BRIDGE



Flush Bridge

G2448FB	24 x 48 x 29.4	70	78	3.5	\$545
G2442FB	24 x 42 x 29	70	65	3.06	\$527
G2436FB	24 x 36 x 29.4	70	58	3.5	\$524
G2048FB	20 x 48 x 29	70	71	3.3	\$545
G2042FB	20 x 42 x 29	70	61	4	\$527

Top surface, back panel and hardware to connect two units. Grommet in worksurface. Shipped RTA (ready to assemble).

- **G2448/G2442** models will connect 66" and 72" units plus all D islands.
- **G2048/G2042** models will connect 60", 66" and 72" units plus all D islands and 5 sided corners.

CREDENZAS



Center Storage Credenza*

G2066C	20 x 66 x 29	100	225	27	\$1589
--------	--------------	-----	-----	----	---------------

Standard with box/file pedestals on both sides and self-closing hinged center doors covering one adjustable shelf. Right pedestal and doors lock. One pencil tray.

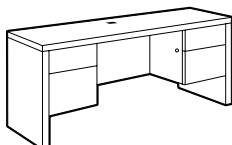

Kneespace Credenza*

G2072CK	20 x 72 x 29.4	125	209	29.5	\$1466
G2066CK	20 x 66 x 29.4	125	201	27	\$1387
G2060CK	20 x 60 x 29	125	193	24.5	\$1286

Standard with box/file pedestals on both sides. Center is open. Pedestals lock. One pencil tray. Grommet in worksurface.

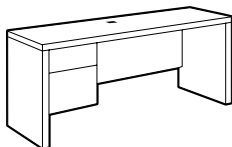

Single Pedestal Credenza - LEFT*

G2072CSL	20 x 72 x 29.4	150	171	29.5	\$1243
G2066CSL	20 x 66 x 29	150	163	27.75	\$1219
G2060CSL	20 x 60 x 29	125	155	24.5	\$1073

Standard with box/file pedestal. Pedestal locks. One pencil tray. Pedestal is on the **left**. Grommet in worksurface.

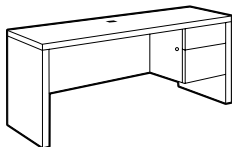

Single Pedestal Credenza - RIGHT*

G2072CSR	20 x 72 x 29.4	150	150	29.5	\$1243
G2066CSR	20 x 66 x 29	150	150	29.4	\$1219
G2060CSR	20 x 60 x 29	150	136	24.5	\$1073

Standard with box/file pedestal. Pedestal locks. One pencil tray. Pedestal is on the **right**. Grommet in worksurface.

Required Specifications

Finish

Optional Specifications

Full modesty*
Grommet
Key #

Accessories

Power block
Keyboard tray
Pencil tray

5-SIDE CORNERS

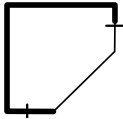
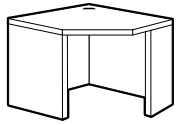

5-Sided Corner

MODEL#	DIMENSIONS D x W x H	FREIGHT CLASS	WT/LBS.	CUBIC FT.	LIST PRICE
G42205C9	20 x 42 x 29	70	123	5.75	\$1117
G36205C9	20 x 36 x 29	65	105	4.3	\$947

Connects to lateral file, storage cabinet, single pedestal credenza with half end panel, and flush bridge. Grommet in worksurface. Full and narrow end panels supplied. Can be assembled left or right. Shipped RTA (ready to assemble)

- $\frac{3}{4}$ Modesty Panel is not available

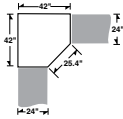
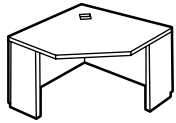

5-Sided Corner

G42245C	42 x 42 x 29.4	65	114	5	\$1133
---------	----------------	----	-----	---	---------------

Connects to **24"** returns, bridges and other **24"** units. Grommet in worksurface. Narrow end panels on left and right. Shipped RTA (ready to assemble).

- $\frac{3}{4}$ Modesty Panel is not available

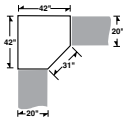
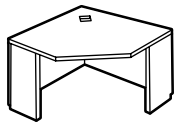

5-Sided Corner

G42205C	42 x 42 x 29.4	70	108	5	\$1097
G36205C	36 x 36 x 29.4	70	92	4.75	\$972

Connects to **20"** returns, bridges and other **20"** units. Grommet in worksurface. Narrow end panels on left and right. Shipped RTA (ready to assemble).

- $\frac{3}{4}$ Modesty Panel is not available

"D" ISLANDS

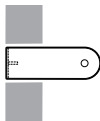
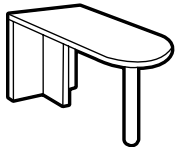

"D" Island - Full End Panel & Post

G3072FI	29.69 x 72 x 29.4	70	101	5	\$1083
G3066FI	29.69 x 66 x 29.4	70	96	4.6	\$1061
G3060FI	29.69 x 60 x 29.4	70	91	4.2	\$986

Connects to single pedestal credenza with half end panel or bridge to create a "T" grouping. **Not freestanding.** Connecting hardware for flush installation included. Shipped RTA (ready to assemble). Post is Black only.

Required Specifications
Finish

Optional Specifications
Grommet

Accessories
Power Block
Keyboard Tray
Pencil Tray
Doors*

HUTCHES

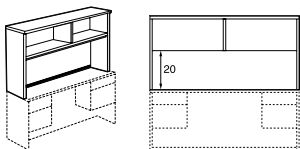

Open Hutch with Closed Back*

MODEL# DIMENSIONS FREIGHT CLASS WT./LBS. CUBIC FT. LIST PRICE

D x W x H

G72HOCB	15 x 72 x 36	70	138	7	\$1243
G71HOCB	15 x 71.5 x 36	70	137	7	\$1243
G69HOCB	15 x 69 x 36	70	135	7	\$1243
G66HOCB	15 x 66 x 36	70	133	7	\$1193
G60HOCB	15 x 60 x 36	65	123	5.25	\$1073

One 1" thick fixed shelf **and fixed shelf divider**. Closed back features a flexible sweep for wire management. Available in single color only. Rectangular grommet available on back panel - **Add \$103**. Shipped RTA (ready to assemble).

- **G71HOCB** for use when spanning 30" x 60/66" SPL/R and 20/24" x 42" FL/FR/L4/R4.
- **G69HOCB** for use when spanning 30" x 60/66" SPL/R and 20" x 40" FL/FR/EL/ER.
- Clearance from worksurface to hutch doors is 20".
- Woodgrain runs horizontal on both the upper and lower back panels.

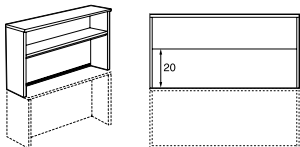

Open Hutch with Closed Back*

G48HOCB	15 x 48 x 36	65	100	4.2	\$860
G42HOCB	15 x 42 x 36	65	91	3.8	\$860
G40HOCB	15 x 40 x 36	65	88	3.8	\$860
G36HOCB	15 x 36 x 36	65	82	3.3	\$759

One 1" thick fixed shelf. Closed back features a flexible sweep for wire management. Available in single color only. Rectangular grommet available on back panel - **Add \$103**. Shipped RTA (ready to assemble).

- Clearance from worksurface to hutch doors is 20".
- Woodgrain runs horizontal on both the upper and lower back panels.

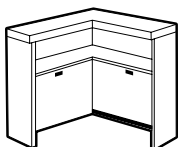

Corner Hutch with Closed Back*

G4242CH	15 x 42 x 36	70	137	6.25	\$1368
G3636CH	15 x 36 x 36	65	119	4.8	\$1243

One 1" thick fixed shelf. Closed back features a flexible sweep for wire management on lower right panel. Available in single color only. Rectangular grommet available on back panel - **Add \$103**. Shipped RTA (ready to assemble).

- Woodgrain runs horizontal on both the upper and lower back panels.

PIGEON HOLE STORAGE

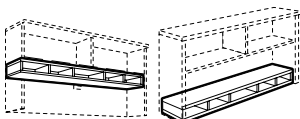

Horizontal Pigeon-Hole Storage

AHS72	11.25 x 70 x 5.62	85	41	3	\$744
AHS71	11.25 x 69 x 5.62	70	43.5	2.3	\$744
AHS66	11.25 x 64 x 5.62	85	38	2.8	\$744
AHS60	11.25 x 58 x 5.62	85	35	2.5	\$610
AHS48	11.25 x 46 x 5.62	85	28	2	\$451
AHS42	11.25 x 40 x 5.62	85	24	2	\$451
AHS36	11.25 x 34 x 5.62	92.5	22	2	\$369

For additional storage. Can be **top** or **bottom** mounted. For use inside **straight hutch** (end panels not finished). Shipped RTA (ready to assemble). **Black finish only**.

- Cannot be used on A00S and C00S Overstorage Units.

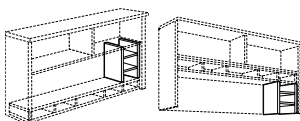

Vertical Pigeon-Hole Storage

AVS14	11.25 x 13.37 x 14.37	85	13	.90	\$465
-------	-----------------------	----	----	-----	--------------

For use in conjunction with the Horizontal Pigeon-Hole Storage. Can be used **under** or **over** horizontal unit. Shipped RTA (ready to assemble). **Black finish only**.

Required Specifications

Finish

Accessories

Doors*

HUTCH DOORS

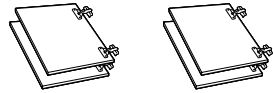

Four-Door Kit

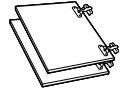

Two-Door Kit

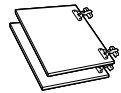

Corner Hutch Two-Door Kit

MODEL#	DIMENSIONS D x W x H	FREIGHT CLASS	WT/LBS.	CUBIC FT.	LIST PRICE
GDOOR72	.69 x 72 x 15	85	24	1.75	\$457
GDOOR71	0 x 17.5 x 15	85	24	1.75	\$457
GDOOR69	0 x 17 x 15	85	23	1.75	\$457
GDOOR66	.69 x 66 x 15	85	22	1.75	\$457
GDOOR60	.69 x 60 x 15	92.5	20	1.75	\$457

For use on 72", 71", 69", 66" and 60"W straight hutches. Hinges included. Locks available. Add **\$126** for each lock. Doors for units 60" wide or more require two locks.

GDOOR48	.69 x 48 x 15	100	17	1.75	\$288
GDOOR42	.69 x 42 x 15	100	16	1.75	\$288
GDOOR40	.69 x 40 x 15	100	15	1.75	\$288
GDOOR36	.69 x 36 x 15	100	14	1.75	\$288

For use on 48", 42" 40" and 36"W straight hutches. Hinges included. Locks available. Add **\$126** for each lock. Doors for units 48" wide or less require one lock.

GDOOR42C	0 x 26.5 x 15	92.5	19	1.75	\$491
GDOOR36C	0 x 21.5 x 15	100	16	1.75	\$320

For use on 42" and 36"W corner hutches. Hinges included. **Locks not available on corner hutch doors.**

TACKBOARDS FOR HUTCHES

TACKBOARD Notes: Tackboards can be upholstered in all of the following fabrics:

Grade 1: Jenny, Quilt, Terrace, Urban, Waterfall

Grade 2: Imprint, Lola

Grade 3: Anchorage, Merge

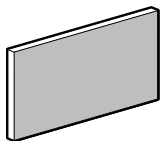

Tackboard

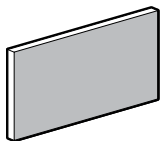

Tackboard

					FABRIC GRD	LIST PRICE	GRD	LIST
TB7018	1 x 70 x 18	92.5	12	1.1	1	\$571	7	\$1267
					2	\$662	8	\$1455
					3	\$728	9	\$1672
					4	\$833	10	\$1921
					5	\$957	11	\$2208
					6	\$1099	12	\$2541

For use on **G72HOCB** straight hutch. Includes mounting screws and covers.

TB6918	1 x 69.5 x 18	92.5	12	1.05	1	\$571	7	\$1267
					2	\$662	8	\$1455
					3	\$728	9	\$1672
					4	\$833	10	\$1921
					5	\$957	11	\$2208
					6	\$1099	12	\$2541

For use on **G71HOCB** straight hutch. Includes mounting screws and covers.

Required Specifications

Fabric (Tackboards)

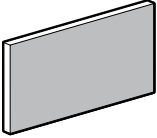
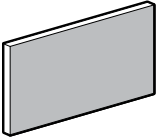
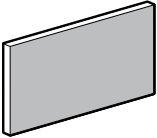
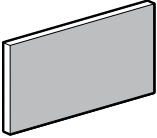
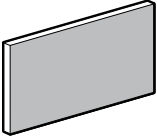
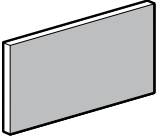
TACKBOARDS	MODEL#	DIMENSIONS	FREIGHT CLASS	WT./LBS.	CUBIC FT.	FABRIC GRD	LIST PRICE	GRD	LIST		
 Tackboard	TB6718	1 x 67.5 x 18	92.5	12	1.05						
						D x W x H					
							1	\$571	7	\$1267	
							2	\$662	8	\$1455	
							3	\$728	9	\$1672	
							4	\$833	10	\$1921	
	5	\$957	11	\$2208							
	6	\$1099	12	\$2541							
For use on G69HOCB straight hutch. Includes mounting screws and covers.											
 Tackboard	TB6418	1 x 64 x 18	92.5	11	1						
							1	\$514	7	\$1140	
							2	\$593	8	\$1308	
							3	\$658	9	\$1505	
							4	\$751	10	\$1730	
							5	\$865	11	\$1988	
	6	\$1099	12	\$2288							
For use on G66HOCB straight hutch. Includes mounting screws and covers.											
 Tackboard	TB5818	1 x 58 x 18	92.5	10	0.9						
							1	\$474	7	\$1043	
							2	\$546	8	\$1200	
							3	\$605	9	\$1380	
							4	\$685	10	\$1584	
							5	\$789	11	\$1821	
	6	\$908	12	\$2095							
For use on G60HOCB straight hutch. Includes mounting screws and covers.											
 Tackboard	TB4618	1 x 46 x 18	92.5	9	0.8						
							1	\$327	7	\$766	
							2	\$391	8	\$880	
							3	\$439	9	\$1011	
							4	\$505	10	\$1164	
							5	\$581	11	\$1339	
	6	\$665	12	\$1538							
For use on G48HOCB straight hutch. Includes mounting screws and covers.											
 Tackboard	TB4018	1 x 40 x 18	92.5	8	0.7						
							1	\$317	7	\$714	
							2	\$369	8	\$820	
							3	\$410	9	\$943	
							4	\$469	10	\$1084	
							5	\$540	11	\$1246	
	6	\$622	12	\$1435							
For use on G42HOCB straight hutch. Includes mounting screws and covers.											
 Tackboard	TB3818	1 x 38 x 18	92.5	7	0.7						
							1	\$317	7	\$707	
							2	\$368	8	\$813	
							3	\$408	9	\$937	
							4	\$466	10	\$1076	
							5	\$537	11	\$1236	
	6	\$615	12	\$1421							
For use on G40HOCB straight hutch. Includes mounting screws and covers.											

Required Specifications
Fabric

TACKBOARDS

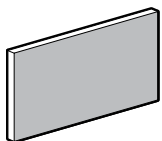

Tackboard

MODEL#	DIMENSIONS D x W x H	FREIGHT CLASS	WT/LBS.	CUBIC FT.	GRD	LIST PRICE	GRD	LIST PRICE
TB3418	1 x 34 x 18	92.5	6	0.6	1	\$306	7	\$687
					2	\$355	8	\$790
					3	\$397	9	\$906
					4	\$453	10	\$1042
					5	\$518	11	\$1196
					6	\$597	12	\$1377

For use on **G36HOCB** straight hutch. Includes mounting screws and covers.

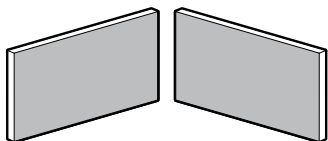

Tackboard

TB42CH	1 x 40 x 15.75	70	16	0.85	1	\$571	7	\$1138
					2	\$629	8	\$1308
					3	\$681	9	\$1502
					4	\$749	10	\$1729
					5	\$862	11	\$1987
					6	\$991	12	\$2286

For use on **G4242CH** corner hutch. Includes mounting screws and covers.

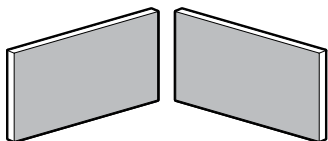

Tackboard

TB36CH	1 x 34 x 15.25	85	12	0.85	1	\$547	7	\$1094
					2	\$604	8	\$1258
					3	\$642	9	\$1446
					4	\$720	10	\$1665
					5	\$829	11	\$1915
					6	\$953	12	\$2200

For use on **G3636CH** corner hutch. Includes mounting screws and covers.

ACCESSORY PIECES

LIST PRICE

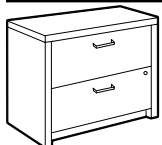

2 Drawer Lateral File*

G2036LF	20 x 36 x 29.4	100	145	15	\$1243
---------	----------------	-----	-----	----	--------

Two full suspension drawers. Front-to-back and side-to-side letter/legal filing capability with lock. Anti-lock tilt suspension.

- To comply with ANSI/BIFMA stability tests, the Lateral File Counter Weight Kit (model "LFCWKIT36") MUST be used.
- *Back of file is always Black.*
- *File drawer construction is for accommodating hanging files NOT for stacking materials on the drawer bottom.*

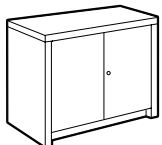

Storage Cabinet*

G2036SC	20 x 36 x 29.4	100	121	15	\$884
---------	----------------	-----	-----	----	-------

Hinged doors cover one adjustable shelf. Standard with lock.

- *Back of storage cabinet is always Black.*

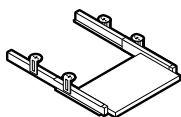

Pull-Out Keyboard

GPOKL28	17 x 28 x 3.5	85	13	0.9	\$320
GPOKL22	17 x 22 x 3.5	85	11	0.9	\$302

Constructed of thermally fused laminate.

Required Specifications

Fabric (tackboards)
Finish (accessories)

Optional Specifications

Key #*
Grommet (only G2036LF)

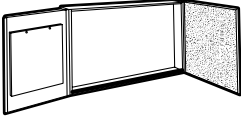
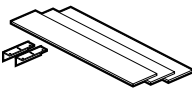
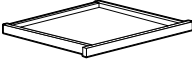
ACCESSORIES	MODEL#	DIMENSIONS	FREIGHT CLASS	WT./LBS.	CUBIC FT.	LIST PRICE
 <p>Visual Board</p> <p>Includes white board and two side opening doors containing cork board on right door and 50-sheet paper writing pad on left door. Marker board can be used for projection.</p> <ul style="list-style-type: none"> • NOTE: Care should be taken to mount the units. Units should be mounted to wall studs using correct fasteners. Failure to do so may result in collapse of the unit and subsequent personal injury. Mounting hardware not included. Mounting hardware used should be based on wall material. Consult an installation professional for proper wall mounting. 	GVB4848	D x W x H 4 x 48 x 48	85	122	9.25	\$1806
	 <p>Counter Weight Kit</p> <p>3 metal plates. Plates mount to the underside of any 36" wide Lateral File or Mixed Storage/Drawer cabinet. Includes mounting hardware. Must be ordered separately. Field installed.</p> <ul style="list-style-type: none"> • To comply with ANSI/BIFMA stability tests, the Lateral File Counter Weight Kit MUST be used with the appropriate Lateral Files and Mixed Storage Cabinets. 	LFCWKIT36	6 x 33 x 1	60	40	0.25
 <p>Center Drawer</p> <p>Laminate drawer front is attached to a 4-sided frame. Recommended for use on small L-shaped units, and on 30" x 60" and 66" desks.</p>		CD20	18 x 20 x 3	100	8	1
	<p>Required Specifications</p> <p>Finish (bookcases)</p>					

BOOKCASES

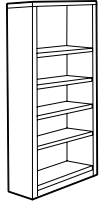

Bookcase - 84" High

MODEL#	DIMENSIONS D x W x H	FREIGHT CLASS	WT/LBS.	CUBIC FT.	LIST PRICE
GHBC84	12 x 36 x 84	125	198	26	\$1562

One fixed heavy duty shelf and **four adjustable shelves**. Shipped fully assembled.

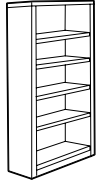

Bookcase - 72" High

GHBC72	12 x 36 x 72	100	173	20	\$1303
--------	--------------	-----	-----	----	---------------

One fixed heavy duty shelf and **four adjustable shelves**. Shipped fully assembled.

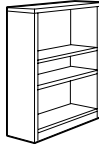

Bookcase - 48½" High

GHBC48	12 x 36 x 48	100	118	13.7	\$958
--------	--------------	-----	-----	------	--------------

Two adjustable heavy duty shelves. Shipped fully assembled.

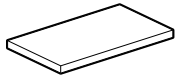

Bookcase Shelf

GHBCSHELF	11 x 34 x 1	100	13	1.60	\$294
-----------	-------------	-----	----	------	--------------

Extra shelf for bookcases. 1" thick.

Required Specifications

Finish



Office Spaces™ is a unique desking architecture addressing current and future private office trends. Elements in the series coordinate with products in the Spaces Collection. Modular in design, Office Spaces is self-supporting for easy reconfiguration or relocation. A progressive palette of finishes and materials supports the light look of this contemporary desking line.

Office Spaces was designed from the ground up to incorporate height adjustable surfaces in both rectangular and L-shaped configurations. The series offers new solutions for meeting rooms and guest offices that facilitate engagement and support collaboration. The seamless integration of work carts and trolleys from Collaborative Spaces extend the possibilities and applications with shared details, materials and finishes.

Features and Benefits

- Tops are 1" thick thermally fused laminate or 1-1/16" high pressure laminate
- Tops are constructed of 45 lb. density particle board
- Worksurfaces are sold separate from the base.
- Height range is 26"-52.5" measured from the floor to the top of the worksurface
- Height adjustable and fixed height legs share the same design, for a consistent visual across all applications.
- PET felt privacy and modesty panels and tackable backboards soften the overall look and feel.



PET felt wire manager



Fixed or height adjustable legs support worksurfaces and returns



Tackable PET felt backboard (varied pattern shown)

GENERAL INFORMATION

- Primary and return worksurfaces feature both square corners and ergonomic large radius corners for improved ergonomics.
- Worksurfaces supported by fixed or height adjustable legs, in 2 or 3-legged applications.
- Storage elements are available in a variety of sizes and configurations including wardrobes, file drawers, box drawers and cubbies for personal items.
- Backboards support media displays and include options for whiteboards, tackable PET felt or laminate surfaces, with or without shelves.
- Accessorize surfaces and storage with whiteboards, wire management, desktop electrical and more.
- For environmental certifications, please visit globalfurnituregroup.com.

CONSTRUCTION

- All worksurfaces are standard in high performance thermally fused laminate. Optional high pressure (HP) laminate available.
- High performance thermally fused laminate tops are 1" thick particle board and have a flat 3mm edge profile on all sides
- High pressure (HP) laminate tops are 1-1/16" thick laminate particle board and have a flat 3mm edge profile on all sides
- Laminate surfaces offer a selection of matching + coordinating edgeband. Specify separately from the surface finish.



- Products specified with the high pressure laminate option are finished on the underside of the surface with a kraft paper backing.
- Grommet location must be specified at the time of order or it will default to a no grommet option.
- Storage requires the top, top edge, chassis and door/drawer fronts finishes to be specified separately. Chassis and door/drawer edge finish will match corresponding chassis and door/drawer finish.
- Storage components require foot kit or storage undercarriage to be specified separately
- Power modules and grommets are not included and must be specified separately.
- Woodgrain runs horizontally on all backboards.
- Backboards will have a matching edge to the chosen laminate. If dry erase board is specified, Designer White (DWT) edging will be applied.
- Corner radius for 24"D worksurfaces is 12", where applicable
- Corner radius for 30"D worksurfaces is 15", where applicable

PET FELT COLORS

AMT	Amethyst	HVT	Harvest
APR	Apricot	LAP	Lapis
BLK	Black	MTS	Mist
BSK	Blue Smoke	NVY	Navy
BRI	Brick	PWT	Pewter
CNN	Carnation	RBV	Ruby
DEN	Denim	SHR	Shamrock
EMD	Emerald	SFR	Sunflower
GPH	Graphite	WHT	White

METAL LEG FINISHES:

BLK	Black	SIL	Silver
BZD	Blizzard	SDT	Stonedust
CHR	Charcoal	TIN	Ink
DWT	Designer White	TPE	Taupe
NEV	Nevada	TUN	Tungsten

LAMINATE FINISHES (thermally fused and high pressure laminates):

ACJ	Absolute Acajou	FCL	First Class
ASN	Asian Night	NBL	Noce Biondo
AWC	Avant Cherry	NGL	Noce Grigio
AWH	Avant Honey	NEL	Noce Leggero
BLK	Black	NML	Noce Medio
BZD	Blizzard	QTM	Quartered Mahogany
BRC	Brushed Cobalt	SBY	Sheer Beauty
CMB	Clear Maple	SDT	Stonedust
CGY	Custom Grey*	SOG	Storm Grey
DES	Dark Espresso	WHE	Walnut Heights
DWT	Designer White	WHC	White Chocolate
FAS	Fashionista	WCR	Winter Cherry

*Coordinates w/SIL edgeband finish

EDGE FINISHES

AAE	Absolute Acajou	NBL	Noce Biondo
ASE	Asian Night	NGL	Noce Grigio
ACE	Avant Cherry	NEL	Noce Leggero
AHE	Avant Honey	NML	Noce Medio
BLK	Black	QTM	Quartered Mahogany
BRC	Brushed Cobalt	SBY	Sheer Beauty
BZD	Blizzard	SIL	Silver*
CHR	Charcoal (<i>use w/SOG</i>)	SDT	Stonedust
CME	Clear Maple	TPE	Taupe
DEE	Dark Espresso	WHE	Walnut Heights
DWE	Designer White	CBE	White Chocolate
FAS	Fashionista	WCE	Winter Cherry
FCL	First Class		

*Coordinates w/CGY laminate

HOW TO SPECIFY:**Example: SKWSRW2460**

- SK** - Office Spaces
- WS** - Worksurface
- RW** - Rectangular worksurface
- 24** - Depth
- 60** - Width

All worksurface options:

- RW** - rectangular worksurface
- RRT** - rectangular worksurface with radius on top right
- RLT** - rectangular worksurface with radius on top left
- RTL** - rectangular worksurface with radius on top right and top left
- RTBL** - rectangular worksurface with radius at top right and bottom left
- RBTL** - rectangular worksurface with radius at top left and bottom right
- CT** - rectangular worksurface for conferencing
- CR** - racetrack worksurface for right return
- CL** - racetrack worksurface for left return
- CW** - racetrack worksurface
- DW** - D shaped worksurface
- RR** - right rectangular return
- RL** - left rectangular return
- RBR** - rectangular return with radius at bottom right
- RBL** - rectangular return with radius at bottom left
- RTR** - rectangular return with radius at top right
- RTL** - rectangular return with radius at top left

Material:

- LP** - Low Pressure laminate, 1" thick
- HP** - High Pressure laminate, 1-1/16" thick

Required specifications:

- Laminate finish
- Edge finish
- Cut-out location (see diagrams)

Example: SKWSFH2C18T24

- | | |
|---|---|
| SK - Office Spaces | |
| WS - Worksurface Support | <i>Other Options:</i> |
| FH - Fixed height legs | HA - Height adjustable |
| 2C - Two column | 3C - Three column |
| 18T24 - For 18" to 24" deep surfaces | 30T36 - 30" to 36" deep surfaces |

Required specifications:

- Metal paint finish

ABOUT OFFICE SPACES

A unique desking architecture addressing current and future private office trends in providing flexible footprints and a coordinating ecosystem of products.

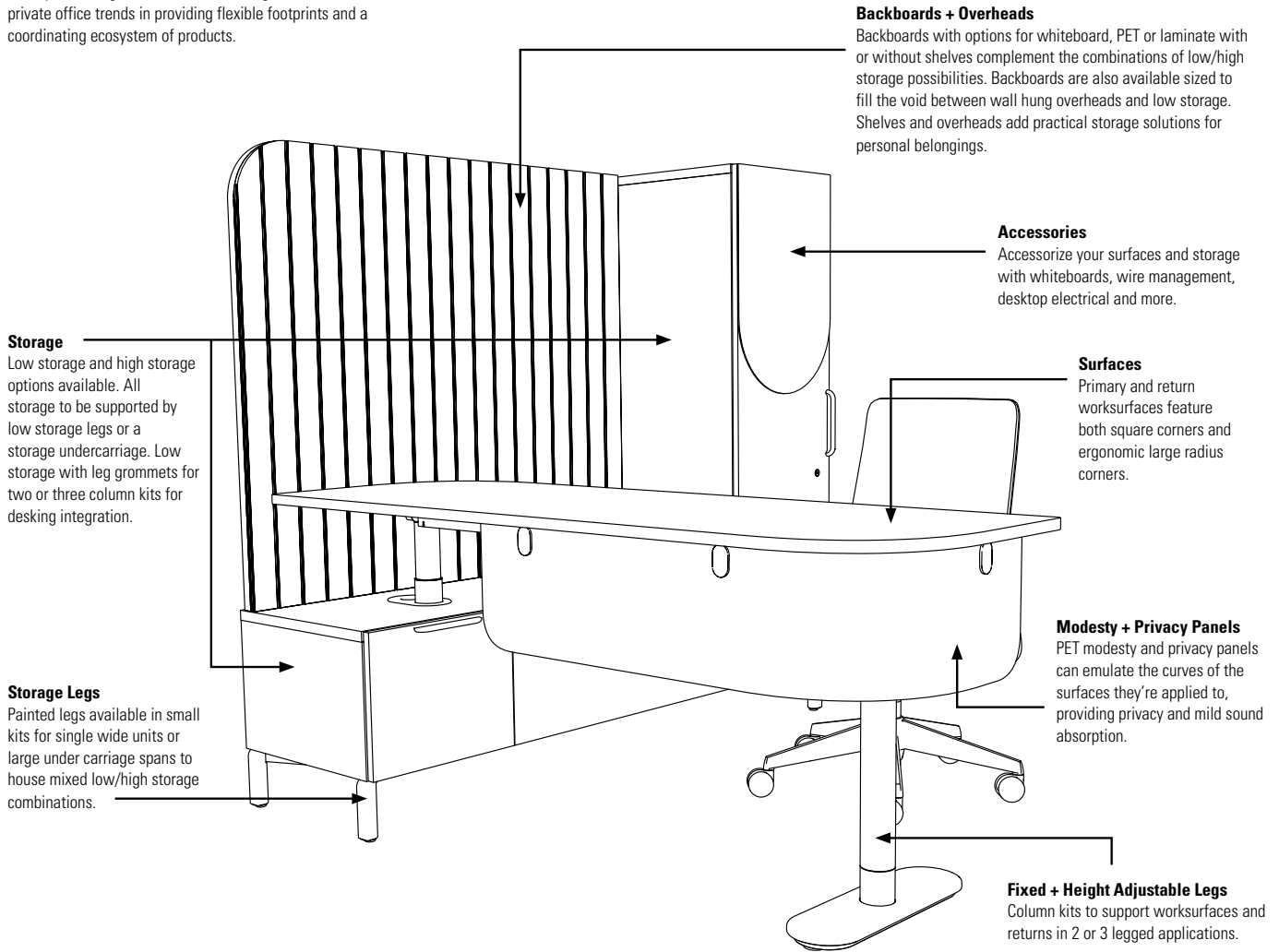



Worksurfaces

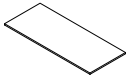

SKWSRW
Rectangular Worksurface

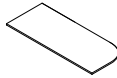

SKWSRRT
Rectangular Worksurface with Radius on Top Right



SKWSRTRL
Rectangular Worksurface with Radius on Top Right and Top Left

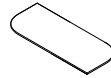

SKWSRTBL
Rectangular Worksurface with Radius at Top Right and Bottom Left

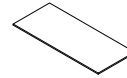

SKWSCT
Rectangular worksurface for conferencing



SKWSCW
Racetrack Worksurface for conferencing

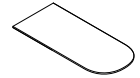

SKWSDW
D Shaped Worksurface for conferencing

Return Worksurfaces

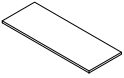

SKWSRR
Right Rectangular Return

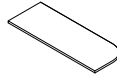

SKWSRTR
Rectangular Return with Radius at Top Right

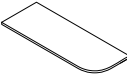

SKWSRTL
Rectangular Return with Radius at Top Left

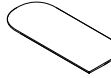

SKWSCR
Racetrack worksurface for right return

Fixed Height Column Kits

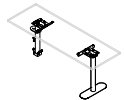

SKWSFH2C2
2 Column Kit

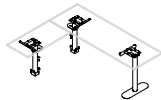

SKWSFH3C
3 Column Kit

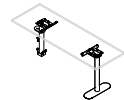

SKWSHA2C
2 Column Kit

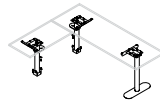

SKWSHA3C
3 Column kit

Support Channel

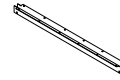

SKWSDC
Support Channel

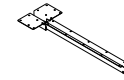

SKWSRDC
Return Support Channel Kit

Modesty Panel

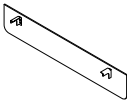

SKWABP
Modesty Panel

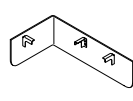

SKWACML
Corner Modesty Panel - Left (Right Available)

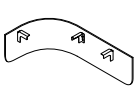

SKWARML
Curved Modesty Panel - Left (Right Available)

Privacy Panel

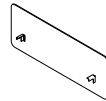

SKWAPP
Privacy Panel

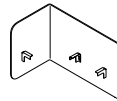

SKWACPL
Corner Privacy Panel - Left (Right Available)



SKWARPL
Curved Privacy Panel - Left (Right Available)

Electrical



SCTAPE
Nik Edge/Clamp Mount Power Module



SCTAPS
Nik In-Surface Power Module



SCTAPB
Nik Below Surface Power Module



SCTAPPB
Below Surface Power Bar



SCTAPC
Below Surface Power Bar

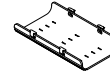

SCTACT
PET Felt Wire Manager



SKWESCT
Storage Cable Tube



SKSEPO
Storage Power Outlet

Backboards



SKBB
Backboard



SKBBR
Backboard - Right Radius Corner



SKBBL
Backboard - Left Radius Corner



SKBBC
Backboard - Radius Corners at Top

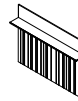

SKBS
Backboard with Shelf

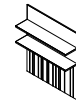

SKBD
Backboard with Double Shelves



SKBOS
Backboard below Overhead Storage

Overheads

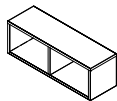

SKS00
Open Cubby Overhead

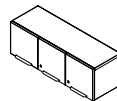

SKS0H
Hinged Door Overhead

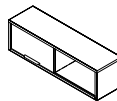

SKS0L
Laminate Sliding Door Overhead

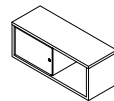

SKS0G
Glass Sliding Door Overhead

OFFICE SPACES - STATEMENT OF LINE

Legs

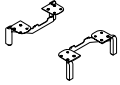

SKSLL
Low Storage Legs

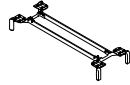

SKSLU
Storage Undercarriage

Low Storage (legs / undercarriage required, specify separately)

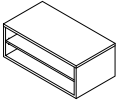

SKSLOS
Open Cubby with shelf

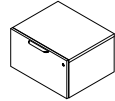

SKSLFD
File Drawer

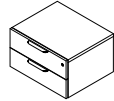

SKSLBB
Box/Box Drawers

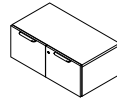

SKSLHD
Hinged Doors

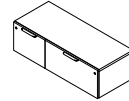

SKSLCHLR
Hinged Door, Lateral File

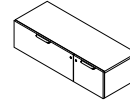

SKSLCHLL
Lateral File, Hinged door

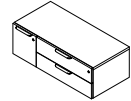

SKSLCHDR
Hinged Door, Box/
Box Drawers

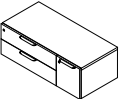

SKSLCHDL
Box/Box Drawers,
Hinged Door

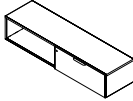

SKSLCOLR
Open Cubby, Lateral File

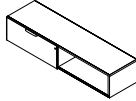

SKSLCOLL
Lateral File, Open
Cubby

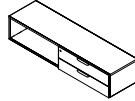

SKSLCODR
Open Cubby, Box/
Box Drawers

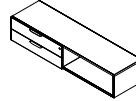

SKSLCODL
Box/Box Drawers,
Open Cubby

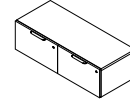

SKSLCFF
File/File Drawers

Low Storage with Leg Grommets (legs / undercarriage required, specify separately)

(one leg grommet for use with two fixed or height adjustable column kits - primary workspace or conferencing top; two leg grommet for use with three fixed or height adjustable column kits - primary top + return)

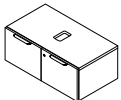

SKSLHDG
Hinged Doors with
Leg Grommet

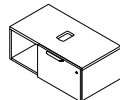

SKSLCHOL
Open Cubby, Hinged
Door with Leg
Grommet

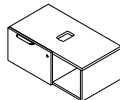

SKSLCHOR Hinged
Door with Leg
Grommet, Open
Cubby

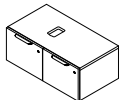

SKSLCHFR
Hinged Door with
Leg Grommet, File
Drawer

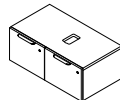

SKSLCHFL
Hinged Door with
Leg Grommet, File
Drawer

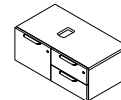

SKSLCHBR
Hinged Door with
Leg Grommet, Box/
Box Drawers

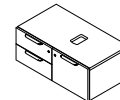

SKSLCHBL
Box/Box Drawers,
Hinged Door with
Leg Grommet

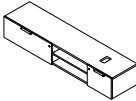

SKSLCHOFL
File Drawer, Open
Cubby, Hinged Door
with Leg Grommet

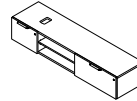

SKSLCHOFR
Hinged Door with
Leg Grommet, Open
Cubby, File Drawer

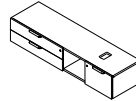

SKSLCHODL
Box/Box Drawer, Open
Cubby, Hinged Door
with Leg Grommet

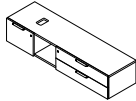

SKSLCHODR
Hinged Door with Leg
Grommet, Open Cubby,
Box/Box Drawer

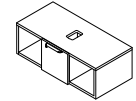

SKSLCOHO
Open Cubby, Hinged
Door with Leg
Grommet, Open Cubby

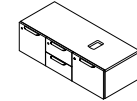

SKSLCHBFL
File Drawer, Box/Box
Drawers, Hinged Door
with Leg Grommet

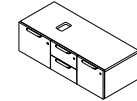

SKSLCHBFR
Hinged Door with Leg
Grommet, Box/Box
Drawers, File Drawer

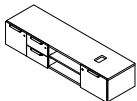

SKSLCHOBFL
File Drawer, Box/Box
Drawers, Open Cubby,
Hinged Door with Leg
Grommet

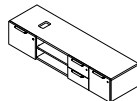

SKSLCHOBFR
Hinged Door with Leg
Grommet, Open
Cubby, Box/Box
Drawers, File Drawer

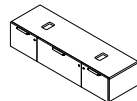

SKSLCHFH
Hinged Door with Leg
Grommet, File
Drawer, Hinged Door
with Leg Grommet

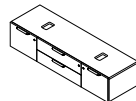

SKSLCHBH
Hinged Door with Leg
Grommet, Box/Box
Drawers, Hinged Door
with Leg Grommet

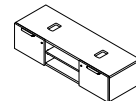

SKSLCHOH
Hinged Door with Leg
Grommet, Open
Cubby, Hinged Door
with Leg Grommet

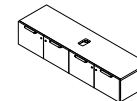

SKSLCHDG
Hinged Doors with
Leg Grommet

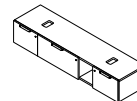

SKSLCHOFHL
Hinged Doors with Leg
Grommet, File Drawer,
Open Cubby, Hinged
Door with Leg
Grommet

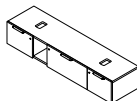

SKSLCHOFHR
Hinged Doors with Leg
Grommet, Open Cubby,
File Drawer, Hinged
Door with Leg Grommet

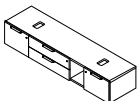

SKSLCHOBHL
Hinged Doors with
Leg Grommet, Box/
Box Drawers, Open
Cubby, Hinged Door
with Leg Grommet

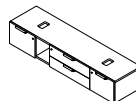

SKSLCHOBHR
Hinged Doors with Leg
Grommet, Open Cubby,
Box/Box Drawers,
Hinged Door with Leg
Grommet

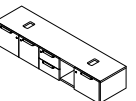

SKSLCHOBFHL
Hinged Doors with Leg
Grommet, File Drawer,
Box/Box Drawers,
Open Cubby, Hinged
Door with Leg
Grommet

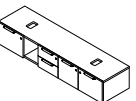

SKSLCHOBFHR
Hinged Doors with Leg
Grommet, Open Cubby,
Box/Box Drawers, File
Drawer, Hinged Door
with Leg Grommet

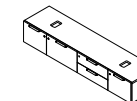

SKSLCHBFHL
Hinged Door with Leg
Grommet, File Drawer,
Box/Box Drawers,
Hinged Door with Leg
Grommet

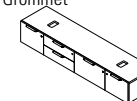

SKSLCHBFHR
Hinged Door with Leg
Grommet, Box/Box
Drawers, File Drawer,
Hinged Door with Leg
Grommet



High Storage (legs / undercarriage required, specify separately)



SKSHO
Open Cubby

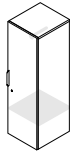

SKSHR
Hinged Door - Right

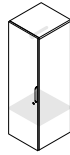

SKSHL
Hinged Door - Left



SKSHH
Hinged Door



SKSHRF
Hinged Door - Right
with File Drawer

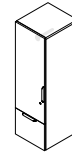

SKSHRL
Hinged Door - Left
with File Drawer

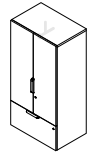

SKSHHF
Hinged Doors with
File Drawer

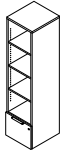

SKSHOF
Open Cubby with File
Drawer

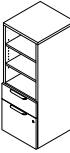

SKSHOBF
Open Cubby with Box,
File Drawer

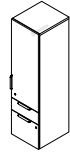

SKSHRBF
Hinged Door - Right
with Box File Drawer

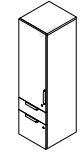

SKSHLBF
Hinged Door - Left
with Box File Drawer

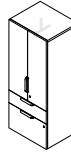

SKSHHBF
Hinged Doors - with
Box File Drawer

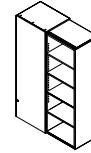

SKSHCSR
Sliding Door - Closed
Shelves Right

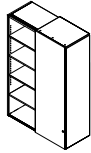

SKSHCSL
Sliding Door - Closed
Shelves Left

Storage Accessories

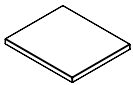

SKSAC
Low Storage Cushion

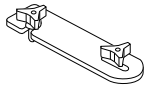

SKSAGC
Base Ganging Clip

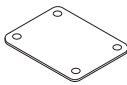

SKWSFP
Flush Plate



SKSADW
Magnetic Whiteboard



SCTVMT
TV Mount

HEIGHT ADJUSTABLE BASE SPECIFICATION

Construction:

- Leg column size: 70mm
- Leg and foot materials: steel
- Glide adjustment range: 18mm
- Operation speed: 1.4 inches/sec (35mm/sec)
- Anti-collision: 6-axis gyro built into control box
- Certifications: ANSI/BIFMA Compliant. UL component level certification.

Three stage leg design:

- Guide/actuator/motor housing design: steel/aluminum/plastic
- Lift capacity: 180 lbs./leg
- Noise level: <50dB

Control box specs NE2/N3:

Control box specs **NE2** for two column:

- Size: 11 5/8" x 1 7/8" x 3 3/4"
- Weight: 1.14 lbs.

Control box specs **N3** for three column:

- Size: 12 5/8" x 1 15/16" x 3 11/16"
- Weight: 1.54 lbs

- Voltage: 120V
- Temperatures: below 70°C.
- Color: Black
- Overload protection:
Work duty: 2 min. operation, requires 18 min. rest, otherwise code H01 will show.
Current limitations: single port not larger than 7A, total ports not larger than 15A.
- Type of plug: three prong
- Cord length: 1 meter

Handset K50C:

- Color: Black
- Two memory position presets
- PVC
- Plug style and cord length: RJ45
- Standby power consumption: < 0.1W
- Active power consumption: NE2 max 350W, N3 max 500W
- Certifications: UL component level certification
- Operating & Troubleshooting Guide: <https://heightadjust.com/>

HEIGHT ADJUSTABLE TABLE ELEVATIONS

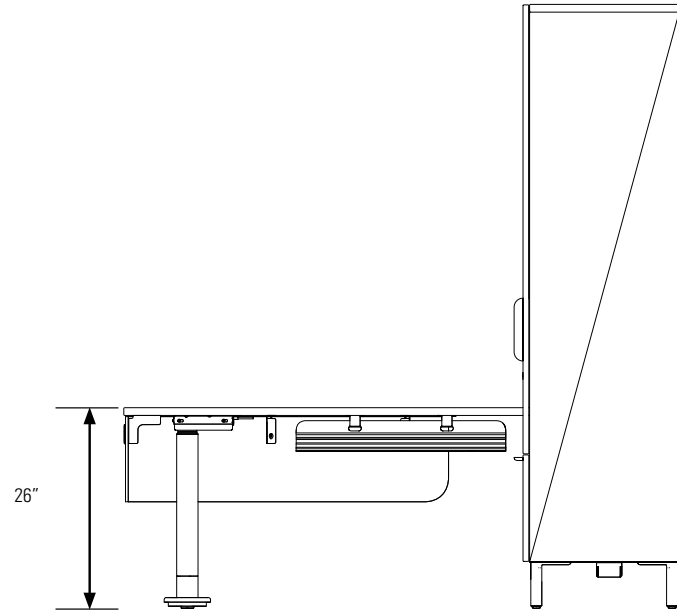
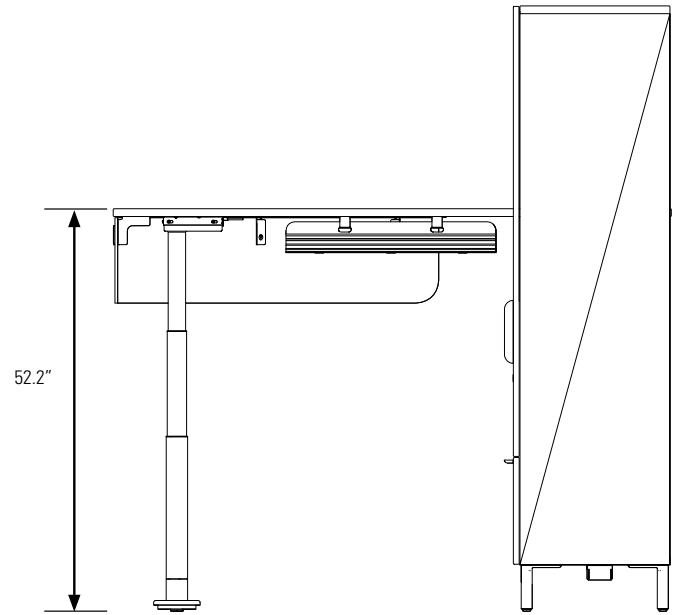



POWER MODULE SPECIFICATION

Worksurfaces	Code/Location
SKWSRW	NG - No Grommet
SKWSRRT	F1 - left position
SKWSRLT	F2/C2 - center position
SKWSRTRL	F3 - right position
SKWSRTBL	
SKWSRBTL	
SKWSCR	
SKWSCL	

Worksurface Grommet Options:

- **F1/F2/F3** - BG5. Available in White (**W**), Black (**B**) and Grey (**G**). Add **\$103**.

Worksurface Power Module Options:

- Cut-outs for SCTAPsx modules available in center position only. Specify **C2**, add **\$103**.

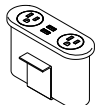

Worksurface Grommet Locations:

- Grommets available in standard worksurface locations (left, center or right). Order as **F1, F2 or F3**. Add **\$103** for each cut-out.
- Grommet hole dimensions are 3 1/4" wide x 1 7/8" deep.

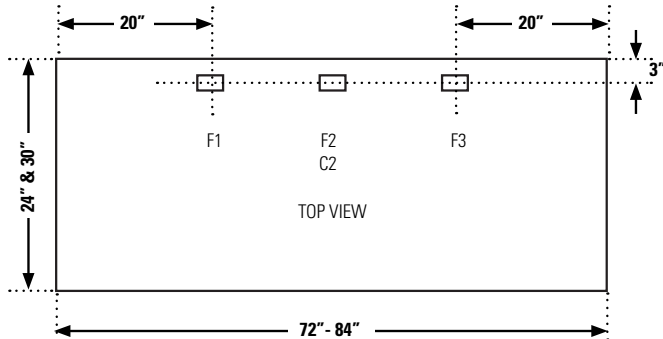
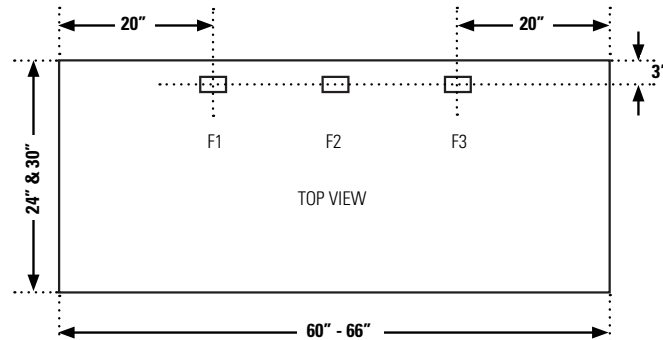
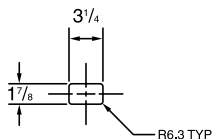

Conference Tops	Code/Location
SKWSCT	NG - No Grommet
SKWSCW	F1/C1 - left position
	F2/C2/O2 - center position
	F3/C3 - right position

Conference Top Grommet Options:

- **F1/F2/F3** - BG5. Available in White (**W**), Black (**B**) and Grey (**G**).

Conference Top Power Module Options:

- Cut-outs for SCTAPsx and SCTAOTx modules available, centered on depth in left, center and right locations. Order as **C1, C2 or C3**, add **\$103**.

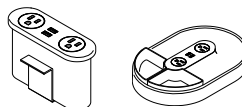

- Cut-outs for SCTAPTx / SCTAPRx modules available, centered on depth in center position only. Order as **O2**, add **\$103**.

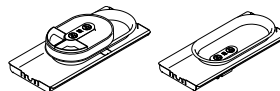

Conference Top Grommet Locations:

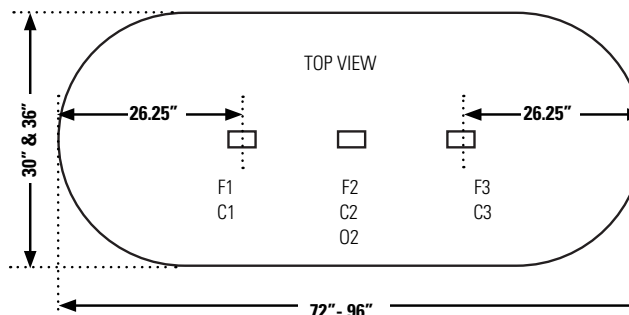
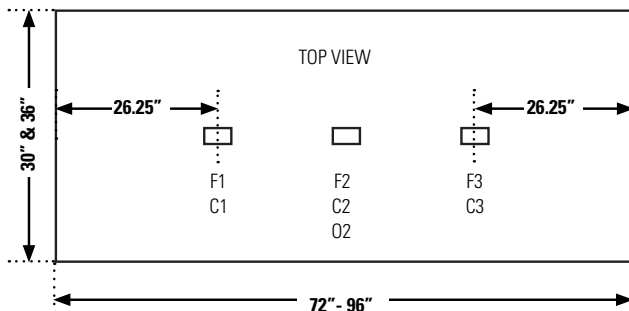

OFFICE SPACES - PLANNING

POWER ACCESSORY CUT-OUT LOCATIONS

D-Top/Return	Code/Location
SKWSDW	NG - No Grommet
SKWSRR	F2/C2 - center position. Add \$103 for each cut-out.
SKWSRL	
SKWSRBR	
SKWSRBL	
SKWSRTR	
SKWSRTL	
SKWSCT	

D-Top Power Module Options:

- Cut-outs for SCTAPsx and SCTAOTx modules available in center position only. Specify **C2**, add **\$103**.

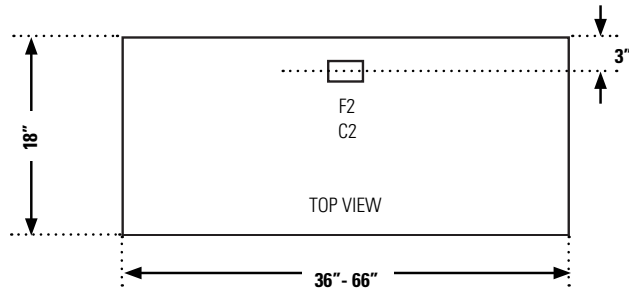
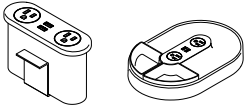

D-Top Grommet Options:

F2 - BG5. Available in White (**W**), Black (**B**) and Grey (**G**).

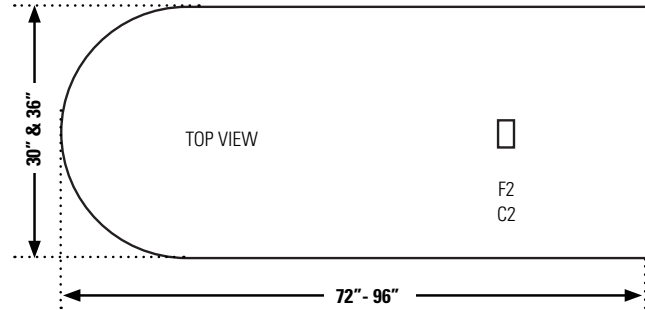



WORKSURFACE RADIUS + GRAIN DIRECTION

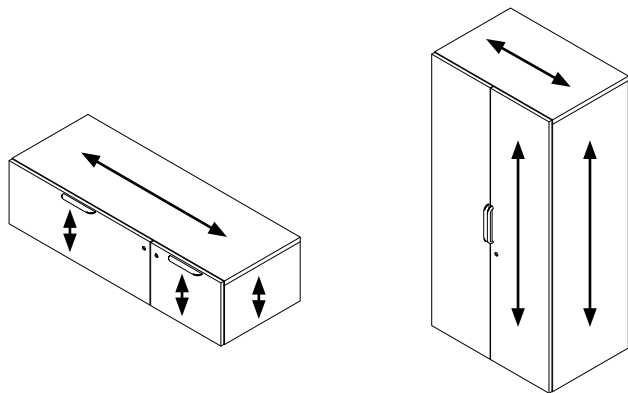
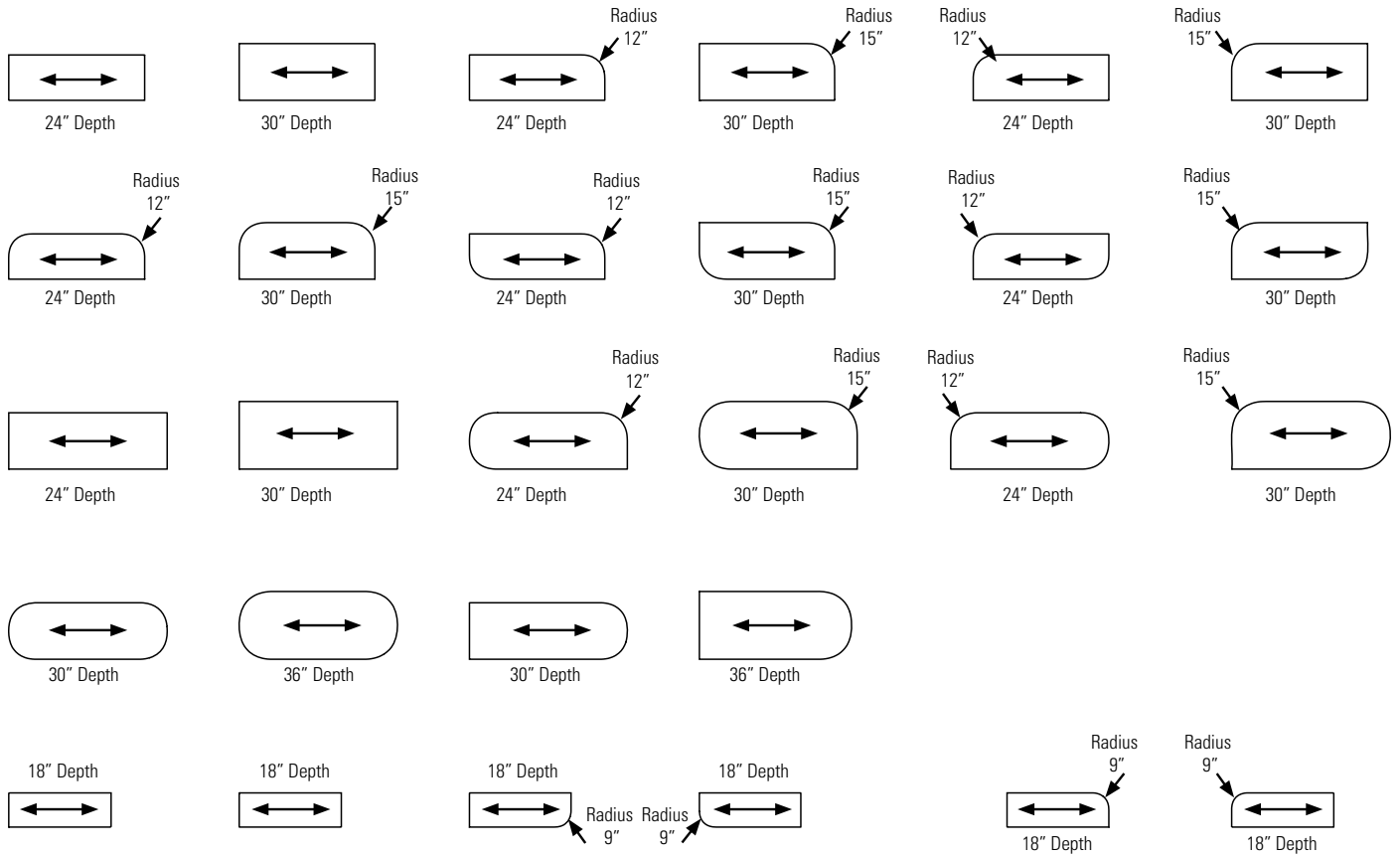

ELEVATIONS

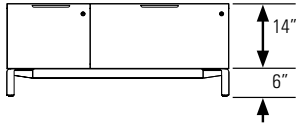

Low storage with undercarriage

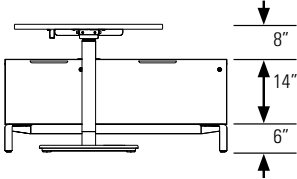

Low storage with leg grommel and fixed height leg

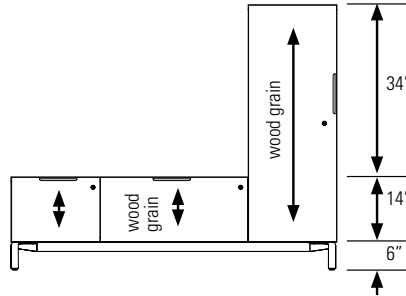

Low storage with 48" high storage on undercarriage

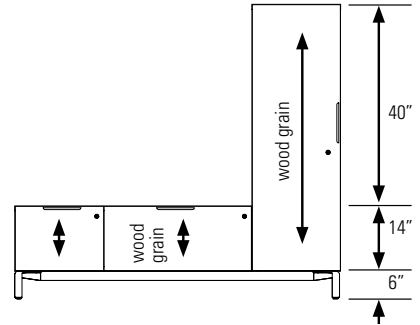

Low storage with 54" high storage on undercarriage

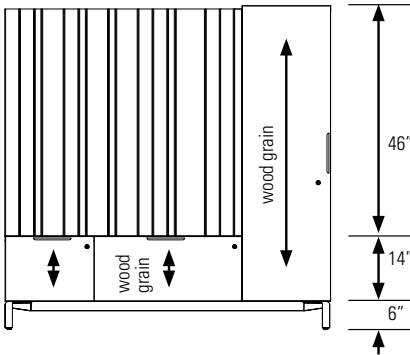

Low storage with 60" high storage on undercarriage with backboard

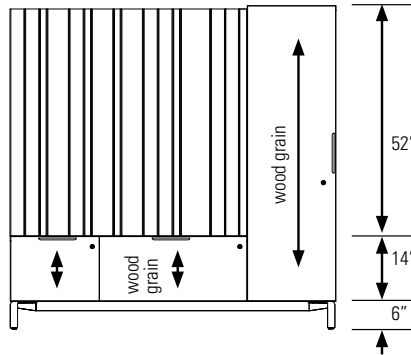

Low storage with 66" high storage on undercarriage with backboard

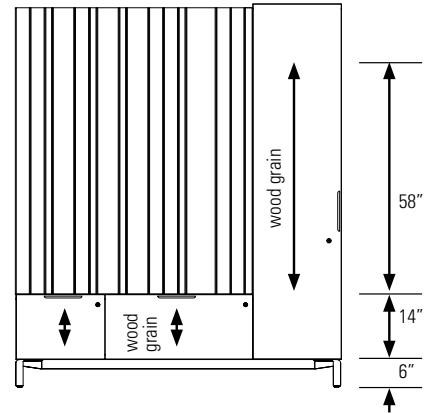

Low storage with 72" high storage on undercarriage with backboard

Note - PET Felt:

- Varied asymmetrical pattern (**VE-V**) repeats every 15" in a combination of 1.5", 3", 4.5" and 6" sections between grooves.
- Equal symmetrical pattern (**VE-E**) is consistent 3" center to center of grooves.



Modesty Panels - SKWABP, SKWACML/R, SKWARML/R

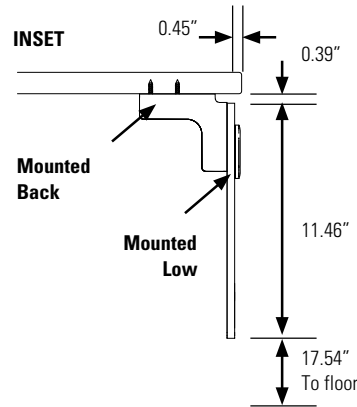
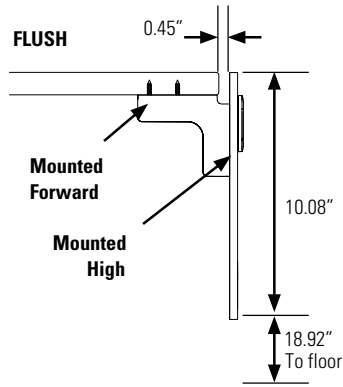

Backboard Radius Corners

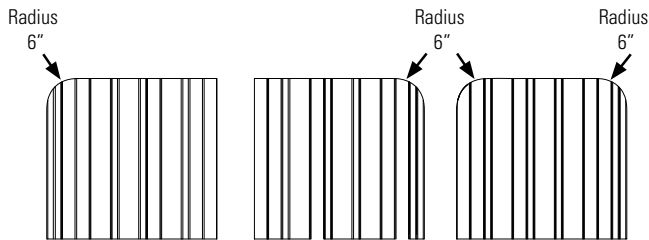

Lateral File Drawers Capacity

Lateral File Drawer:
36W & 42W
Legal Filing - front to back

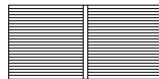

- Drawer file with plastic rail
- 30"W Size 9.44"H x 25.75"W x 16"L
- 36"W Size 9.44"H x 31.75"W x 16"L
- 42"W Size 9.44"H x 37.75"W x 16"L

Lateral File Drawer:
36W & 42W
Legal Filing - side to side
Letter Filing - front to back

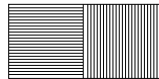

Lateral File Drawer:
30W, 36W & 42W
Letter Filing - front to back



Lateral File Drawer:
36W & 42W
Letter & Legal Filing - front to back

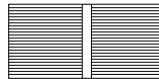

Lateral File Drawer:
30W, 36W & 42W
Legal Filing - side to side

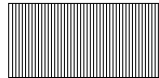

Pedestal Drawers Capacity

Box Drawer:
15.5W
Legal Filing - side to side



- 18"D Drawer Box Size 3.93"H x 13"W x 16"L
- 20.23.24.29.30.36"D Drawer Box Size 3.93"H x 13"W x 20"L

File Drawer:
15.5W
Letter Filing - front to back



- 18"D Drawer File with plastic rail Size 9.4"H x 13"W x 16"L
- 20"D and up Drawer File with plastic rail Size 9.4"H x 13"W x 20"L

File Drawer:
15.5W
Legal Filing - side to side



- 18"D Drawer File with plastic rail Size 9.4"H x 13"W x 16"L
- 20"D and up Drawer File with plastic rail Size 9.4"H x 13"W x 20"L

OFFICE SPACES - PLANNING

BASIC WORKSTATION

Office Spaces planning begins with the credenza, the storage undercarriage, the worksurface, the required support channels and the leg column kit type. The examples below feature fixed height leg column kits and all surface types in a right handed configuration, but any can be specified with height adjustable leg column kits and/or the opposite handedness.

To support surfaces, specify the required leg column kit, the low storage with leg grommet and support channel bars for primary surfaces (single bar up to 66", two required for 72" and above) and a return support kit for return surfaces. Primary worksurfaces cannot rest directly on the low storage or as a freestanding table desk.

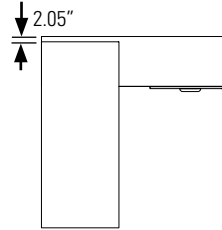
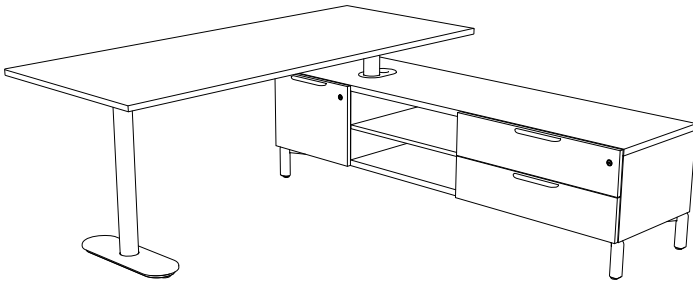

Specification:
SKWSRW3072, SKSLCHOEDR2072,
SKSLU2072,
SKWSFH2C30T36,
2 x SKWSDC72
Rectangular surfaces can be used
with a credenza on the left or right.

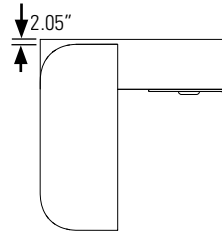
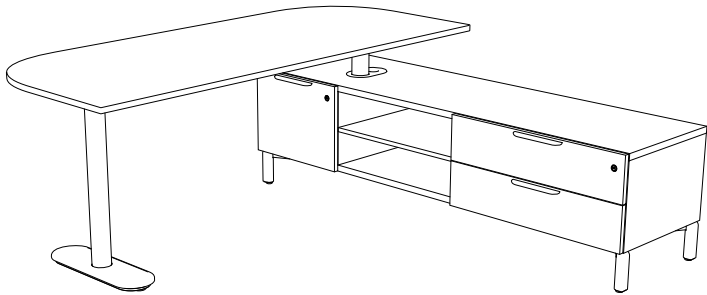

Specification:
SKWSRTRL3072, SKSLCHOEDR2072,
SKSLU2072,
SKWSFH2C30T36,
2 x SKWSDC72
Surfaces with curves at upper left/
right can be used with left or right
handed credenzas (right shown).

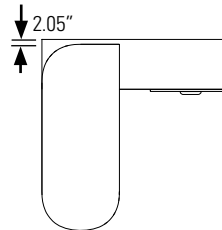
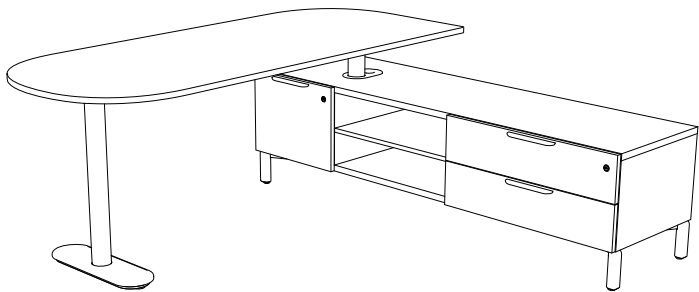

Specification:
SKWSCR3072, SKSLCHOEDR2072,
SKSLU2072, SKWSFH2C30T36,
2 x SKWSDC72
Racetrack surfaces can be
specified for use with left or right
handed credenza (right shown).



BASIC WORKSTATIONS

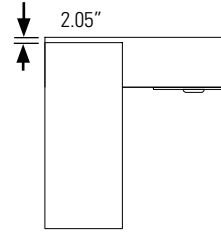
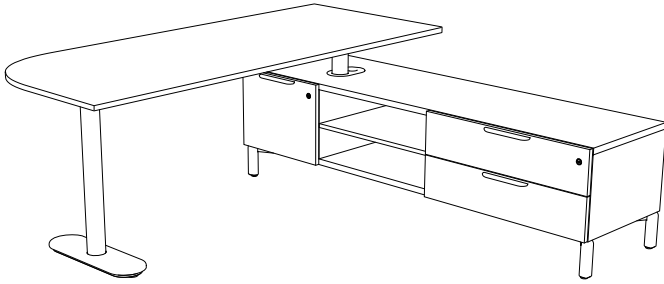

Specification:
 SKWSRLT3072,
 SKSLCHOEDR2072,
 SKSLU2072,
 SKWSFH2C30T36,
 2 x SKWSDC72

Surfaces with the curve at the upper left are used with credenza on the right (as shown). Opposite hand available.

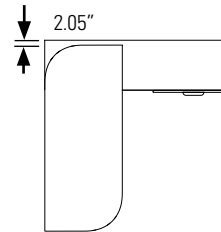
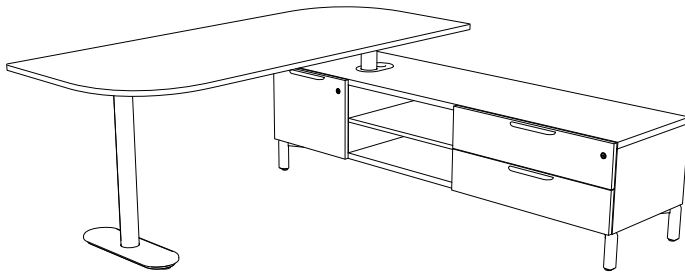

Specification:
 SKWSRTBL3072,
 SKSLCHOEDR2072, SKSLU2072,
 SKWSFH2C30T36,
 2 x SKWSDC72

Surfaces with curves at opposite sides can be used with left or right handed credenzas (right shown).

L-DESK SURFACES

To specify an "L" shaped configuration with Office Spaces, a credenza with two leg grommet, a three column fixed or height adjustable kit, two support channels and a return support channel kit are needed. The examples below feature fixed height column kits, a basic rectangular primary worksurface with various return shapes available.

They can also be specified with height adjustable column kits and/or opposite handedness. The primary surface can be specified as any shape as shown on the previous page. To support surfaces, credenzas must be specified with two leg grommets. Surfaces cannot rest on the credenza.

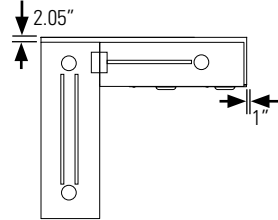
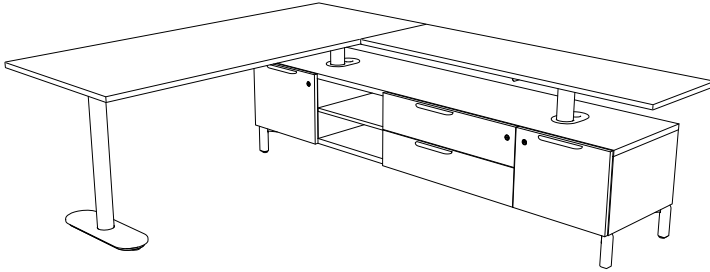

Specification:
 SKWSRW2472,
 SKWSRR1860,
 SKSLCHOBHR2084,
 SKSLU2084,
 SKWSFH3C18T24,
 2 x SKWSDC72,
 SKWSRDC60

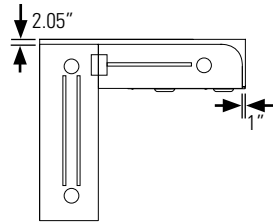
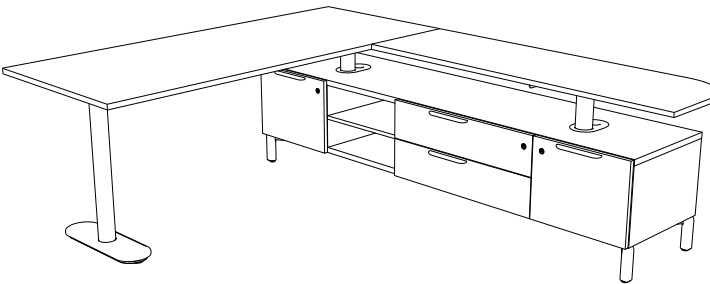

Specification:
 SKWSRW2472,
 SKWSRTR1860,
 SKSLCHOBHR2084,
 SKSLU2084,
 SKWSFH3C18T24,
 2 x SKWSDC72,
 SKWSRDC60

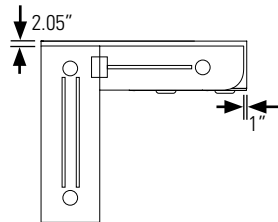
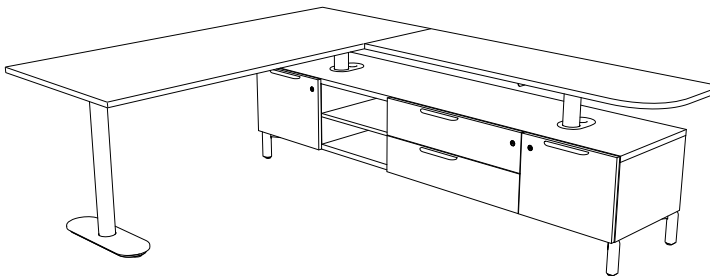

Specification:
 SKWSRW2472,
 SKWSRBR1860,
 SKSLCHOBHR2084,
 SKSLU2084,
 SKWSFH3C18T24,
 2 x SKWSDC72,
 SKWSRDC60



SHARED OFFICE/CONFERENCE

Shared spaces can be accomplished by using center grommet credenzas with Office Spaces conferencing surfaces. Conferencing surfaces are designed for use with two column kits only, fixed or height adjustable. They are not intended to be connected to returns.

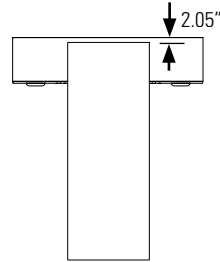
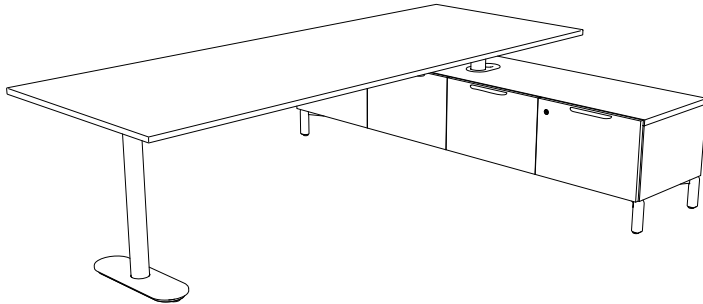

Specification:
 SKWSCT3696,
 SKSLCHDG2084,
 SKSLU2084,
 SKWSFH2C30T36,
 2 x SKWSDC84

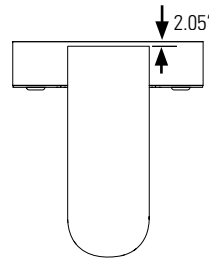
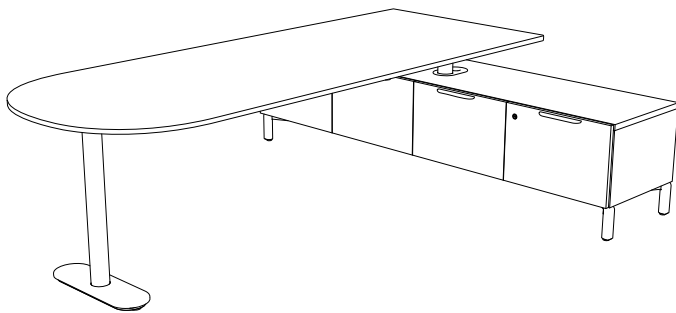

Specification:
 SKWSDW3696,
 SKSLCHDG2084,
 SKSLU2084,
 SKWSFH2C30T36,
 2 x SKWSDC84

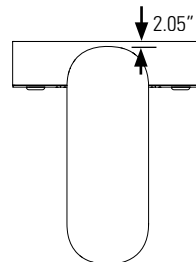
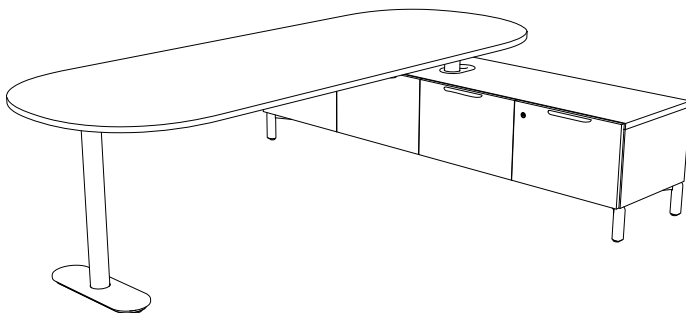

Specification:
 SKWSCW3696,
 SKSLCHDG2084,
 SKSLU2084,
 SKWSFH2C30T36,
 2 x SKWSDC84

STORAGE

SKSLL Storage Legs for single units.

SKSLU20 Storage Undercarriage

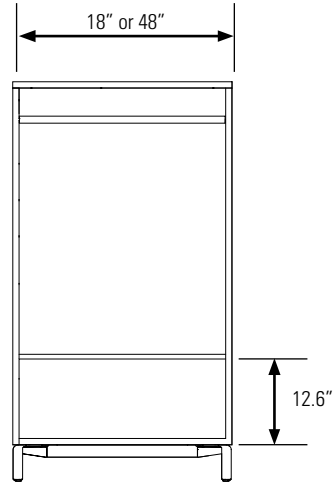
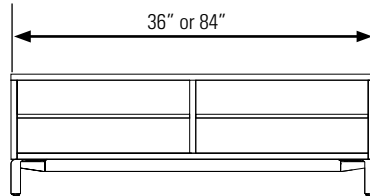
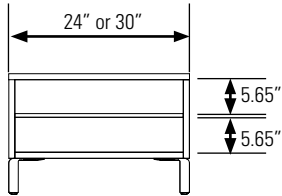

*Freestanding Storage 24 or 30\"w use SKSLL.

NOTE: High storage units of 24\"w or less must be ganged with a low unit or anchored to the wall.

*Use SKSLU20xx for Low storage 36\"w and greater and for all High Storage (18\"-48\"W). 18 & 24\" wide high storage not intended to be freestanding units; must be ganged to another unit OR anchored to a wall or other fixed element.

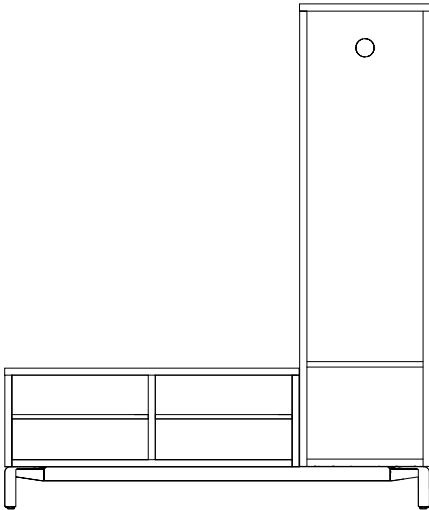

*Combining low and high storage is possible over a single undercarriage. No more than one low storage unit and one high storage can be combined on a single undercarriage.

18\" and 24\" wide high storage recommended for use in conjunction with low storage 36\" wide or greater.

NOTE: All storage units have a recessed back of 1.29\"

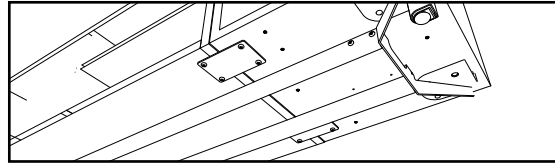

Flush Plate Detail

Flush plates (SKWSFP) are required when combining low and high storage over a single undercarriage.

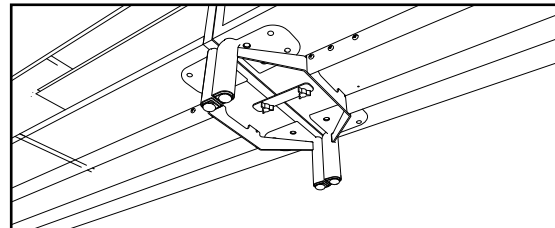

Ganging Clip Detail

A base ganging clip (SKSAGC) is recommended when positioning two separate undercarriage pieces side by side. The half-pill shaped legs align to form an oval column to emulate the curves seen through the Spaces Collection.



BACKBOARDS + OVERHEADS

Backboards add a decorative finished element to the space and with optional shelving or when used with overheads add personal storage options; they are wall mounted. Backboards include rails for mounting; hardware to fix to the wall is not included.

Backboards are intended to be mounted with bottom flush to the top of 20" low storage and aligned to the top of high storage.

Backboards are available in laminate (**LP**), dry erase whiteboard (**DE**), PET felt (**PT**), and patterned PET felt (**VE**).

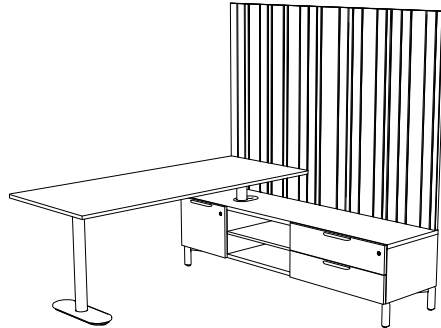

Specification:
SKWSRW3072,
SKSLCHOEDR2072,
SKSLU2072,
SKWSFH2C30T36,
2 x SKWSDC72,
SKBB5272VE-V

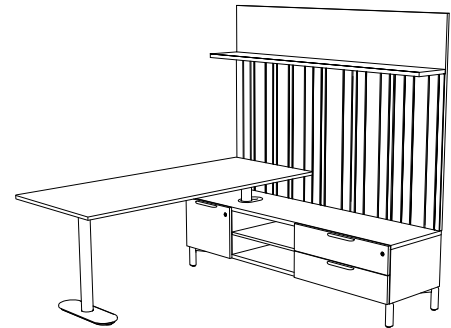

Specification:
SKWSRW3072,
SKSLCHOEDR2072,
SKSLU2072,
SKWSFH2C30T36,
2 x SKWSDC72,
SKBS5272VE-V

Note: when using backboard with two shelves, for use with fixed height column kits only

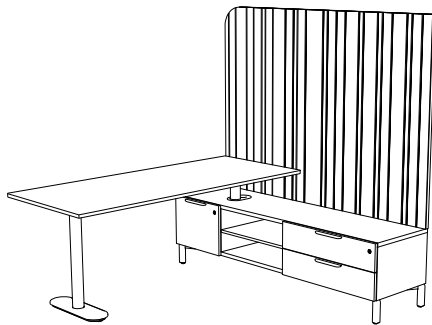

Specification:
SKWSRW3072,
SKSLCHOEDR2072,
SKSLU2072,
SKWSFH2C30T36,
2 x SKWSDC72,
SKBBL5272VE-V

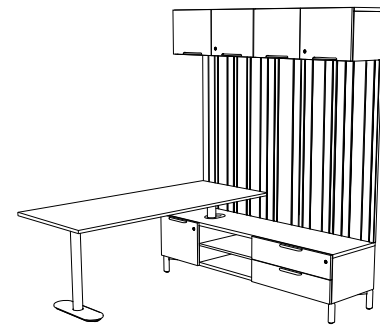

Specification:
SKWSRW3072,
SKSLCHOEDR2072,
SKSLU2072,
SKWSFH2C30T36,
2 x SKWSDC72,
SKBOS5272VE-V,
2 x SKSOH1436

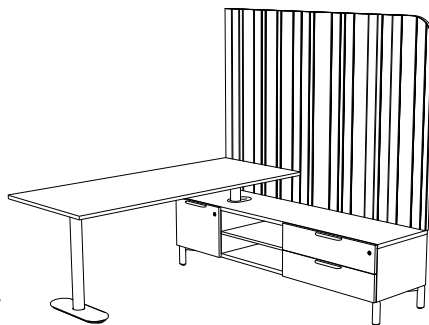

Specification:
SKWSRW3072,
SKSLCHOEDR2072,
SKSLU2072,
SKWSFH2C30T36,
2 x SKWSDC72,
SKBBR5272VE-V

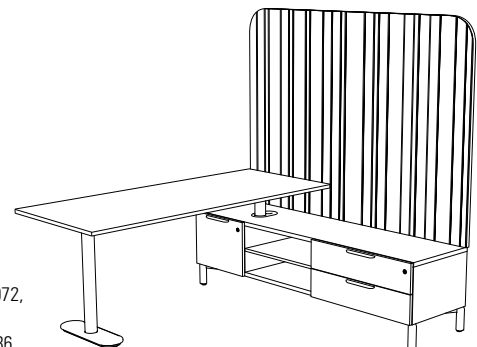

Specification:
SKWSRW3072,
SKSLCHOEDR2072,
SKSLU2072,
SKWSFH2C30T36,
2 x SKWSDC72,
SKBBC5272VE-V

- ⚠ Desk Height Must be limited
- ★ Desk Range Meets BIFMA Recommended Max Height

Double Shelf

Single Shelf

78"
Top Datum

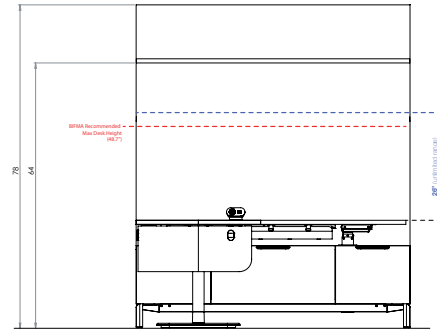
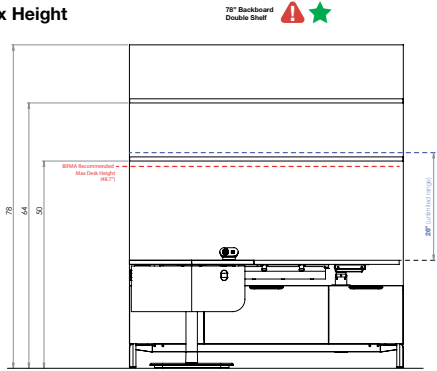

72"
Top Datum

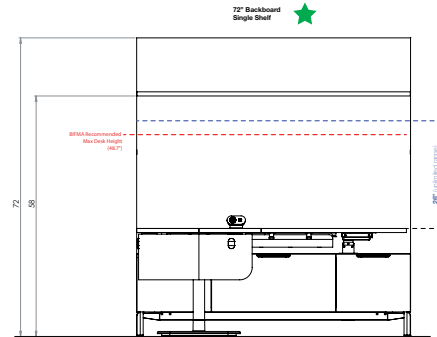
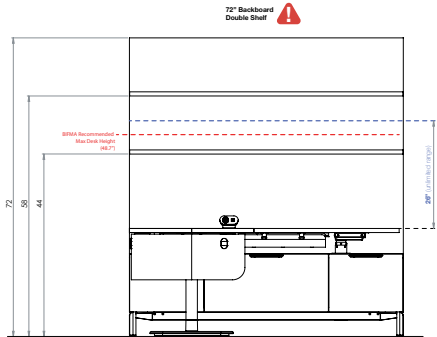

66"
Top Datum

N/A

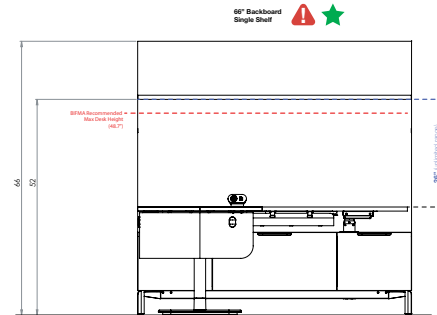

60"
Top Datum

N/A

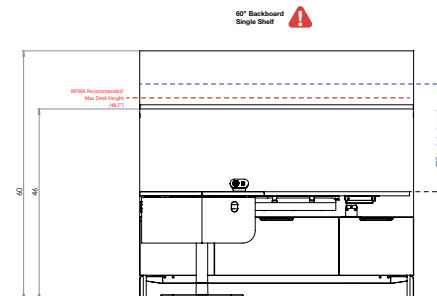



Overhead

78" Top Datum

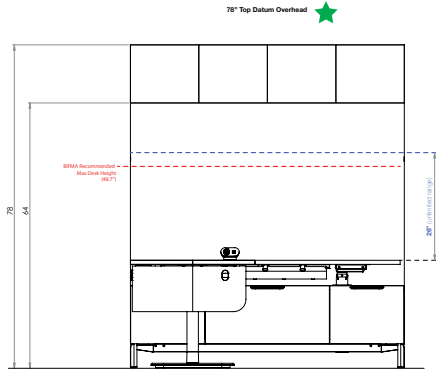

72" Top Datum

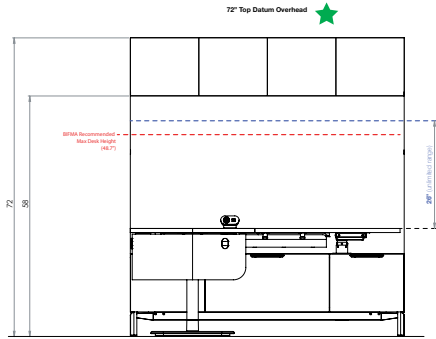

66" Top Datum

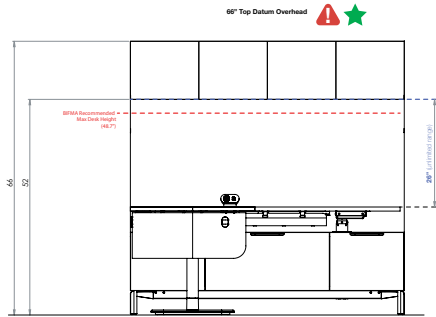

60" Top Datum

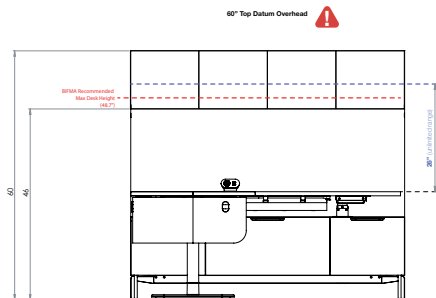

OFFICE SPACES - PLANNING

MODESTY + PRIVACY PANELS

Modesty and privacy panels can be added to rectangular or curved surfaces.

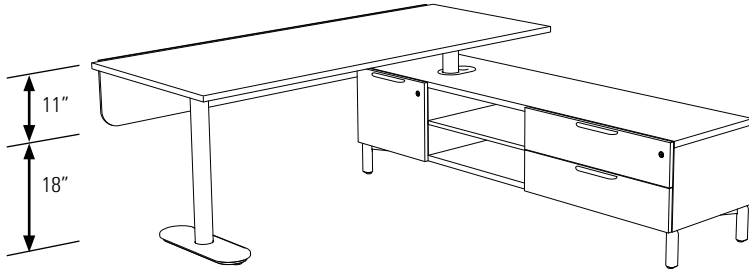

Specification:
SKWSRW3072,
SKSLCHOEDR2072,
SKSLU2072,
SKWSFH2C30T36,
2 x SKWSDC72,
SKWABP1172 (flush)

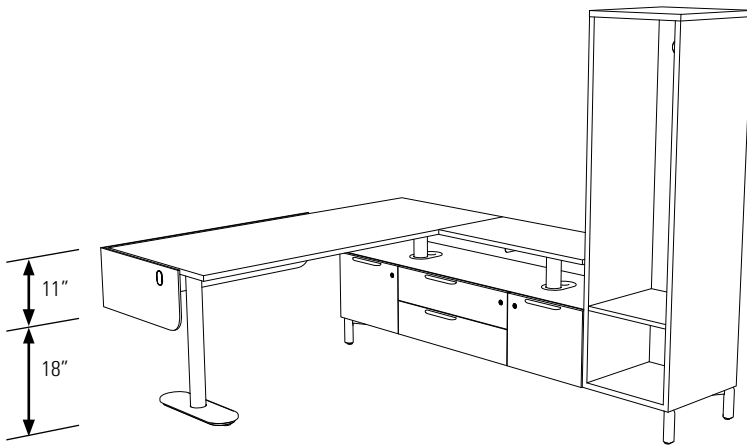

Specification:
SKWSRW3072,
SKWSRR1836,
SKSLCHBH2066,
SKSHO7218,
SKSLU2084,
SKWSFH3C30T36,
2 x SKWSDC72,
SKWACML1172D30

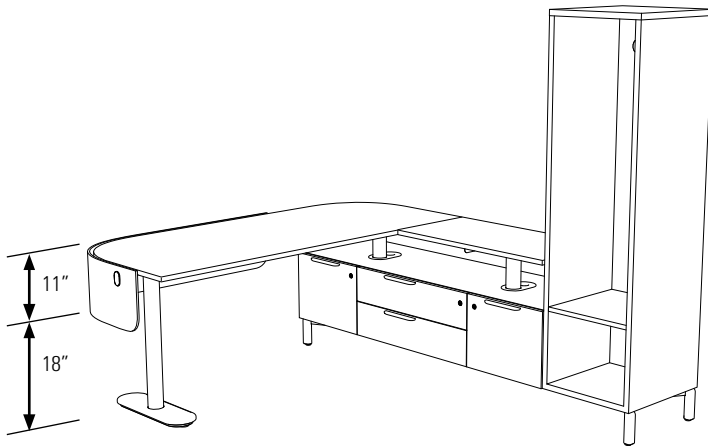

Specification:
SKWSRTRL3072,
SKWSRR1836,
SKSLCHBH2066,
SKSHO7218,
SKSLU2072,
SKWSFH3C30T36,
2 x SKWSDC72,
SKWARML1172D30



MODESTY + PRIVACY PANELS

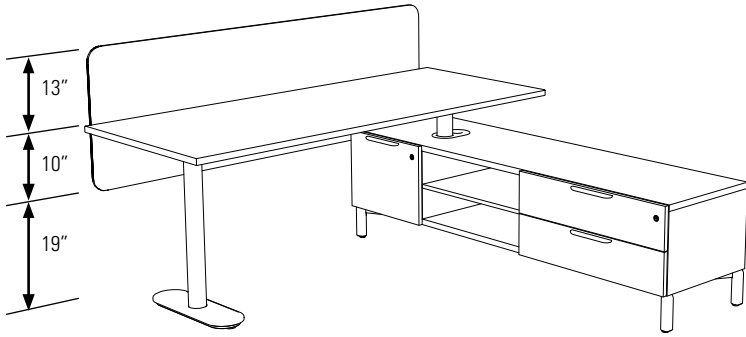

Specification:
 SKWSRW3072,
 SKSLCHOEDR2072,
 SKSLU2072,
 SKWSFH2C30T36,
 2 x SKWSDC72,
 SKWAPP2372

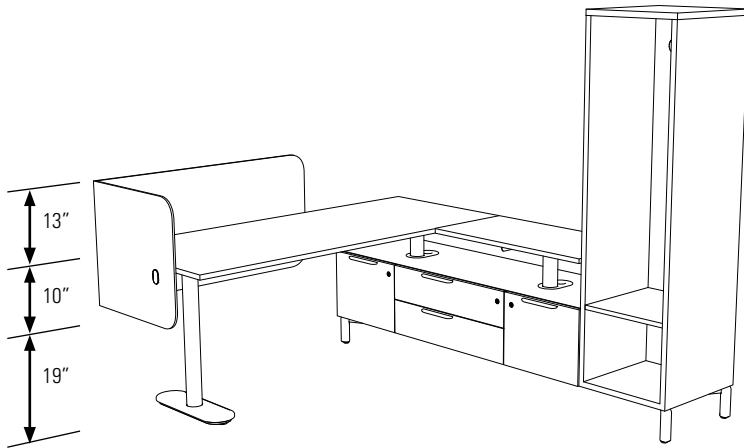

Specification:
 SKWSRW3072,
 SKWSRR1836,
 SKSLCHBH2066,
 SKSH07218,
 SKSLU2084,
 SKWSFH3C30T36,
 2 x SKWSDC72,
 SKWACPL2372D30

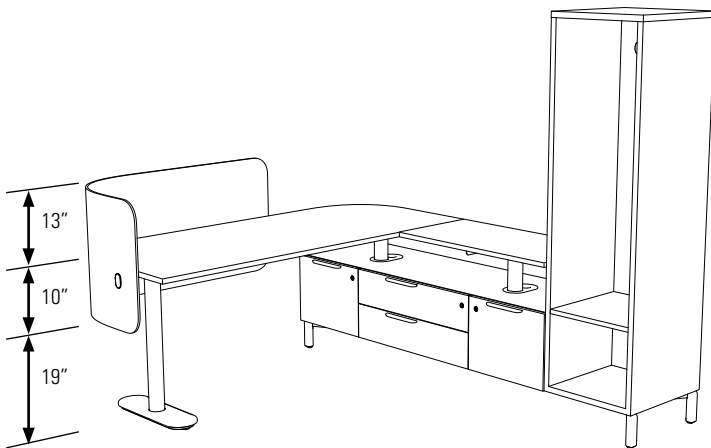

Specification:
 SKWSRTRL3072,
 SKWSRR1836,
 SKSLCHBH2066,
 SKSH07218,
 SKSLU2072,
 SKWSFH3C30T36,
 2 x SKWSDC72,
 SKWARPL2372D30

OFFICE SPACES - NOTES

ACCESSORIES

Leg grommets feature a large opening for the fixed height or height adjustable column (specified separately).

A second smaller diameter opening (1.8") allows for use of either **SKWESCT** - storage cable tube or **SKSEPO** - storage power outlet.

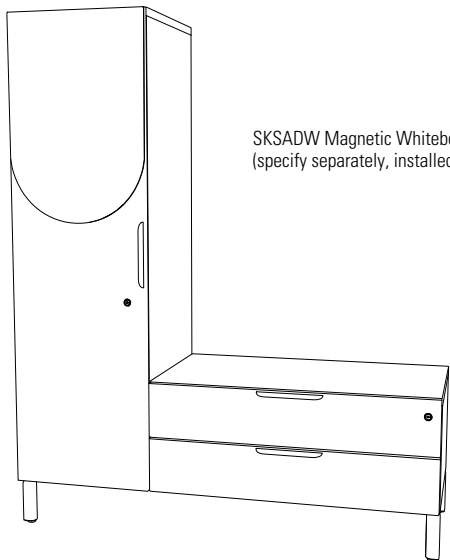
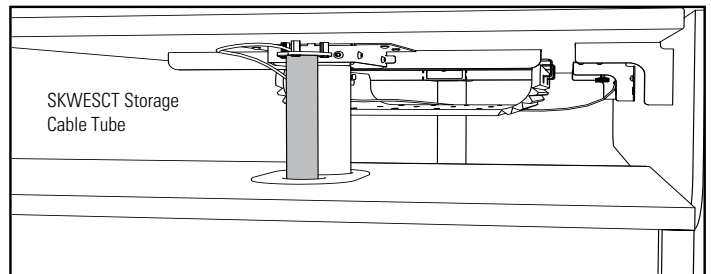
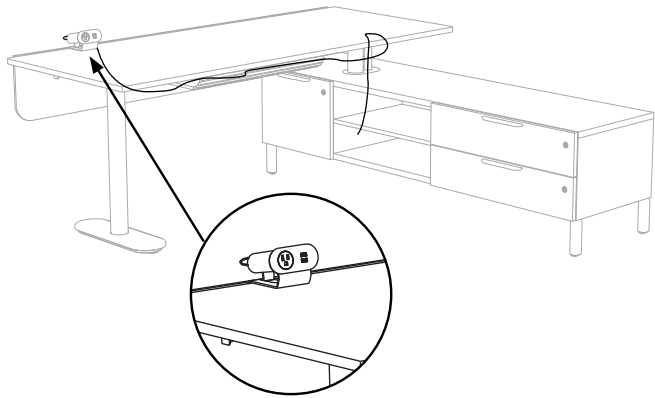
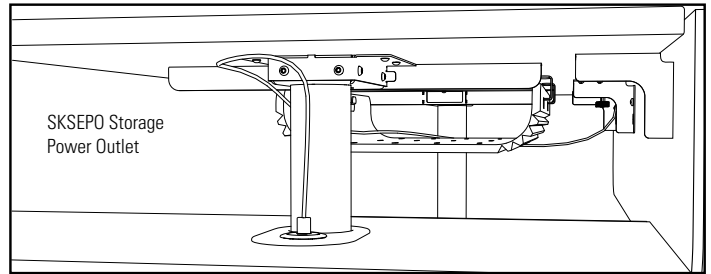
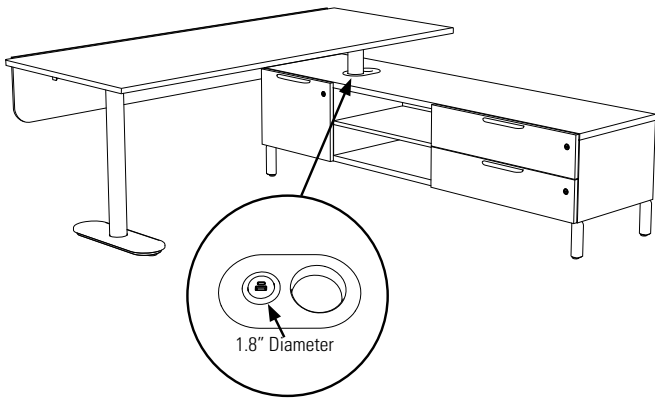

SKSADW Magnetic Whiteboard
(specify separately, installed on site)

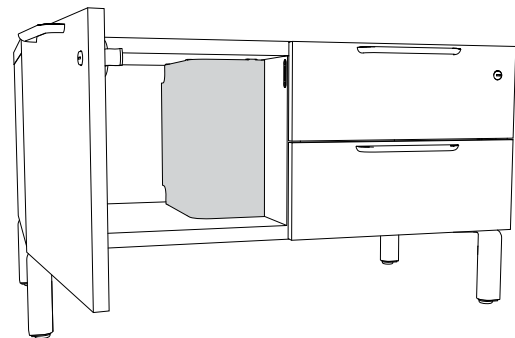

PET felt leg cover inside the low storage,
standard within the credenza where any leg
grommet is present.



WORKSURFACES	MODEL#	DIMENSIONS	FREIGHT CLASS	WT/LBS.	CUBIC FT.	LIST PRICE	HP ADD
--------------	--------	------------	---------------	---------	-----------	------------	--------

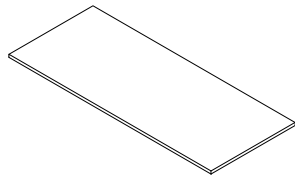

Rectangular Worksurface

	D x W x H						
SKWSRW2460	24 x 60 x 1	60	44.3	0.83	\$466	\$175	
SKWSRW2466	24 x 66 x 1	60	48.71	0.92	\$508	\$193	
SKWSRW2472	24 x 72 x 1	60	53.11	1	\$551	\$210	
SKWSRW2478	24 x 78 x 1	60	57.51	1.08	\$593	\$228	
SKWSRW2484	24 x 84 x 1	60	61.92	1.17	\$635	\$245	
SKWSRW3060	30 x 60 x 1	60	55.24	1.04	\$558	\$219	
SKWSRW3066	30 x 66 x 1	60	60.75	1.15	\$608	\$241	
SKWSRW3072	30 x 72 x 1	60	66.23	1.25	\$659	\$263	
SKWSRW3078	30 x 78 x 1	60	71.74	1.35	\$710	\$285	
SKWSRW3084	30 x 84 x 1	60	77.22	1.46	\$760	\$307	

Rectangular primary surface to be used with fixed height or height adjustable column kit. All surfaces with an unsupported length of 54" or greater require support channels. For standard leg application, 66" to 84" wide surfaces require 2 support channels.

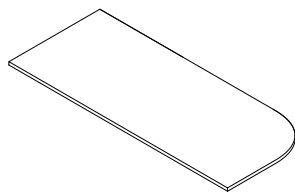

Rectangular Worksurface, Radius Top Right

SKWSRRT2460	24 x 60 x 1	60	44.86	0.83	\$493	\$188	
SKWSRRT2466	24 x 66 x 1	60	49.31	0.92	\$539	\$207	
SKWSRRT2472	24 x 72 x 1	60	53.77	1	\$584	\$225	
SKWSRRT2478	24 x 78 x 1	60	58.21	1.08	\$629	\$244	
SKWSRRT2484	24 x 84 x 1	60	62.66	1.17	\$674	\$263	
SKWSRRT3060	30 x 60 x 1	60	55.85	1.04	\$589	\$235	
SKWSRRT3066	30 x 66 x 1	60	61.4	1.15	\$643	\$258	
SKWSRRT3072	30 x 72 x 1	60	66.92	1.25	\$697	\$281	
SKWSRRT3078	30 x 78 x 1	60	72.46	1.35	\$751	\$305	
SKWSRRT3084	30 x 84 x 1	60	78.01	1.46	\$804	\$328	

Primary surface with curve at the top right to be used with fixed height or height adjustable column kit. Surface is intended to be used with a return or credenza on the left side. All surfaces with an unsupported length of 54" or greater require support channels. For standard leg application, 66" to 84" wide surfaces require 2 support channels.

- 12" radius on 24" deep surfaces; 15" radius on 30" deep surfaces.

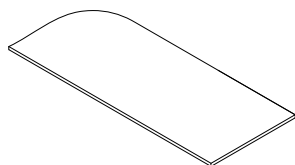

Rectangular Worksurface, Radius Top Left

SKWSRLT2460	24 x 60 x 1	60	44.86	0.83	\$493	\$188	
SKWSRLT2466	24 x 66 x 1	60	49.31	0.92	\$539	\$207	
SKWSRLT2472	24 x 72 x 1	60	53.77	1	\$584	\$225	
SKWSRLT2478	24 x 78 x 1	60	58.21	1.08	\$629	\$244	
SKWSRLT2484	24 x 84 x 1	60	62.66	1.17	\$674	\$263	
SKWSRLT3060	30 x 60 x 1	60	55.85	1.04	\$589	\$235	
SKWSRLT3066	30 x 66 x 1	60	61.4	1.15	\$643	\$258	
SKWSRLT3072	30 x 72 x 1	60	66.92	1.25	\$697	\$281	
SKWSRLT3078	30 x 78 x 1	60	72.46	1.35	\$751	\$305	
SKWSRLT3084	30 x 84 x 1	60	78.01	1.46	\$804	\$328	

Primary surface with curve at the top left to be used with fixed height or height adjustable column kit. Surface is intended to be used with a return or credenza on the right side. All surfaces with an unsupported length of 54" or greater require support channels. For standard leg application, 66" to 84" wide surfaces require 2 support channels.

- 12" radius on 24" deep surfaces; 15" radius on 30" deep surfaces.

Required specifications

Laminate finish
Edge finish

Optional specifications

HP laminate
Grommet (and grommet finish)
Power module cut-out

Accessories

PET felt modesty panel, privacy panel,
Nik power modules,
PET felt wire manager

WORKSURFACES **MODEL#** **DIMENSIONS** **FREIGHT CLASS** **WT/LBS.** **CUBIC FT.** **LIST PRICE** **HP ADD**

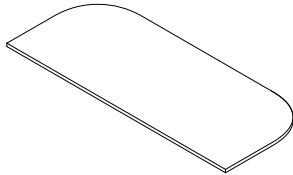

Rectangular Worksurface, Radius Top Right and Top Left

	D x W x H						
SKWSRTRL2460	24 x 60 x 1	60	44.84	0.83	\$493	\$188	
SKWSRTRL2466	24 x 66 x 1	60	49.28	0.92	\$539	\$207	
SKWSRTRL2472	24 x 72 x 1	60	53.74	1	\$584	\$225	
SKWSRTRL2478	24 x 78 x 1	60	58.19	1.08	\$629	\$244	
SKWSRTRL2484	24 x 84 x 1	60	62.63	1.17	\$674	\$263	
SKWSRTRL3060	30 x 60 x 1	60	55.82	1.04	\$589	\$235	
SKWSRTRL3066	30 x 66 x 1	60	61.36	1.15	\$643	\$258	
SKWSRTRL3072	30 x 72 x 1	60	66.88	1.25	\$697	\$281	
SKWSRTRL3078	30 x 78 x 1	60	72.43	1.35	\$751	\$305	
SKWSRTRL3084	30 x 84 x 1	60	77.97	1.46	\$804	\$328	

Primary surface with curve at the top corners to be used with fixed height or height adjustable column kit. All surfaces with an unsupported length of 54" or greater require support channels. For standard leg application, 66" to 84" wide surfaces require 2 support channels.

- 12" radius on 24" deep surfaces; 15" radius on 30" deep surface

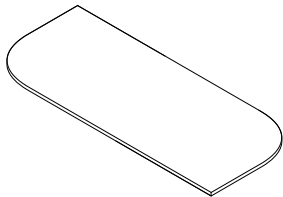

Rectangular Worksurface, Radius Top Right and Bottom Left

SKWSRTBL2460	24 x 60 x 1	60	44.83	0.83	\$526	\$188	
SKWSRTBL2466	24 x 66 x 1	60	49.28	0.92	\$539	\$207	
SKWSRTBL2472	24 x 72 x 1	60	53.74	1	\$622	\$225	
SKWSRTBL2478	24 x 78 x 1	60	58.19	1.08	\$629	\$244	
SKWSRTBL2484	24 x 84 x 1	60	62.63	1.17	\$674	\$263	
SKWSRTBL3060	30 x 60 x 1	60	55.82	1.04	\$589	\$235	
SKWSRTBL3066	30 x 66 x 1	60	61.36	1.15	\$643	\$258	
SKWSRTBL3072	30 x 72 x 1	60	66.88	1.25	\$697	\$281	
SKWSRTBL3078	30 x 78 x 1	60	72.43	1.35	\$751	\$305	
SKWSRTBL3084	30 x 84 x 1	60	77.97	1.46	\$804	\$328	

Primary surface with curve at the top right and bottom left to be used with fixed height or height adjustable column kit. Surface is intended to be used with a return or credenza on the left side. All surfaces with an unsupported length of 54" or greater require support channels. For standard leg application, 66" to 84" wide surfaces require 2 support channels.

- 12" radius on 24" deep surfaces; 15" radius on 30" deep surface

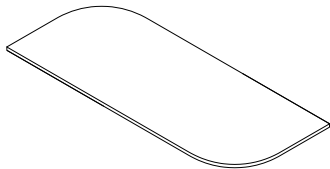

Rectangular Worksurface, Radius Top Left and Bottom Right

SKWSRBTL2460	24 x 60 x 1	60	44.83	0.83	\$493	\$188	
SKWSRBTL2466	24 x 66 x 1	60	49.28	0.92	\$539	\$207	
SKWSRBTL2472	24 x 72 x 1	60	53.74	1	\$584	\$225	
SKWSRBTL2478	24 x 78 x 1	60	58.19	1.08	\$629	\$244	
SKWSRBTL2484	24 x 84 x 1	60	62.63	1.17	\$674	\$263	
SKWSRBTL3060	30 x 60 x 1	60	55.82	1.04	\$589	\$235	
SKWSRBTL3066	30 x 66 x 1	60	61.36	1.15	\$643	\$258	
SKWSRBTL3072	30 x 72 x 1	60	66.88	1.25	\$697	\$281	
SKWSRBTL3078	30 x 78 x 1	60	72.43	1.35	\$751	\$305	
SKWSRBTL3084	30 x 84 x 1	60	77.97	1.46	\$804	\$328	

Primary surface with curve at the top left and bottom right to be used with fixed height or height adjustable column kit. Surface is intended to be used with a return or credenza on the right side. All surfaces with an unsupported length of 54" or greater require support channels. For standard leg application, 66" to 84" wide surfaces require 2 support channels.

- 12" radius on 24" deep surfaces; 15" radius on 30" deep surface

Required specifications

Laminate finish
Edge finish

Optional specifications

HP laminate
Grommet (and grommet finish)
Power module cut-out

Accessories

PET felt modesty panel, privacy panel,
Nik power modules,
PET felt wire manager

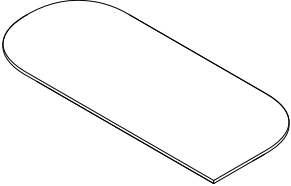
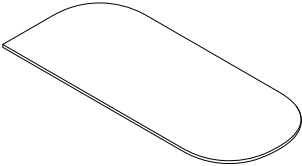
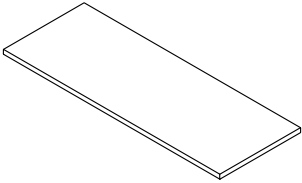
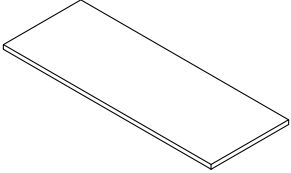

WORKSURFACES	MODEL#	DIMENSIONS	FREIGHT CLASS	WT/LBS.	CUBIC FT.	LIST PRICE	HP ADD
 <p>Racetrack Worksurface for Right Return</p>	D x W x H						
	SKWSCR3072	30 x 72 x 1	60	66.83	1.25	\$691	\$281
	SKWSCR3078	30 x 78 x 1	60	72.37	1.35	\$744	\$305
	SKWSCR3084	30 x 84 x 1	60	77.92	1.46	\$798	\$328
	SKWSCR3090	30 x 90 x 1	60	83.46	1.56	\$852	\$351
	SKWSCR3096	30 x 96 x 1	60	88.98	1.67	\$906	\$375
	SKWSCR3672	36 x 72 x 1	60	79.98	1.5	\$803	\$337
	SKWSCR3678	36 x 78 x 1	60	86.61	1.63	\$865	\$365
	SKWSCR3684	36 x 84 x 1	60	93.25	1.75	\$928	\$393
	SKWSCR3690	36 x 90 x 1	60	99.87	1.88	\$990	\$421
SKWSCR3696	36 x 96 x 1	60	106.49	2	\$1052	\$449	
<p>Racetrack primary surface to be used with fixed height or height adjustable column kit. Surface is intended to be used with a return or credenza on the right side. All surfaces with an unsupported length of 54" or greater require support channels. For standard leg application, 72" to 96" wide surfaces require 2 support channels.</p> <ul style="list-style-type: none"> • For 90" and 96" wide surfaces, use two SKWSDC84 support channels. • Radius for 30" deep worksurfaces is 15". 							
 <p>Racetrack Worksurface for Left Return</p>	SKWSCL3072	30 x 72 x 1	60	66.83	1.25	\$691	\$281
	SKWSCL3078	30 x 78 x 1	60	72.37	1.35	\$744	\$305
	SKWSCL3084	30 x 84 x 1	60	77.92	1.46	\$798	\$328
	SKWSCL3090	30 x 90 x 1	60	83.46	1.56	\$852	\$351
	SKWSCL3096	30 x 96 x 1	60	88.98	1.67	\$906	\$375
	SKWSCL3672	36 x 72 x 1	60	79.98	1.5	\$803	\$337
	SKWSCL3678	36 x 78 x 1	60	86.61	1.63	\$865	\$365
	SKWSCL3684	36 x 84 x 1	60	93.25	1.75	\$928	\$393
	SKWSCL3690	36 x 90 x 1	60	99.87	1.88	\$990	\$421
	SKWSCL3696	36 x 96 x 1	60	106.49	2	\$1052	\$449
<p>Racetrack primary surface to be used with fixed height or height adjustable column kit. Surface is intended to be used with a return or credenza on the left side. All surfaces with an unsupported length of 54" or greater require support channels. For standard leg application, 72" to 96" wide surfaces require 2 support channels.</p> <ul style="list-style-type: none"> • For 90" and 96" wide surfaces, use two SKWSDC84 support channels. • Radius for 30" deep worksurfaces is 15". 							
 <p>Rectangular Return, Right</p>	SKWSRR1836	18 x 36 x 1	60	20.08	0.38	\$237	\$78
	SKWSRR1842	18 x 42 x 1	60	23.41	0.44	\$271	\$92
	SKWSRR1848	18 x 48 x 1	60	26.71	0.5	\$305	\$105
	SKWSRR1854	18 x 54 x 1	60	30.04	0.56	\$340	\$118
	SKWSRR1860	18 x 60 x 1	60	33.34	0.63	\$374	\$131
	SKWSRR1866	18 x 66 x 1	60	36.66	0.69	\$408	\$144
<p>Connects to a primary surface to create an L-shaped configuration. Specify support channel separately as needed. Handedness determines grommet location(s).</p>							
 <p>Rectangular Return, Left</p>	SKWSRL1836	18 x 36 x 1	60	20.09	0.38	\$237	\$78
	SKWSRL1842	18 x 42 x 1	60	23.41	0.44	\$271	\$92
	SKWSRL1848	18 x 48 x 1	60	26.71	0.5	\$305	\$105
	SKWSRL1854	18 x 54 x 1	60	30.04	0.56	\$340	\$118
	SKWSRL1860	18 x 60 x 1	60	33.34	0.63	\$374	\$131
	SKWSRL1866	18 x 66 x 1	60	36.66	0.69	\$408	\$144
<p>Connects to a primary surface to create an L-shaped configuration. Specify support channel separately as needed. Handedness determines grommet location(s).</p>							

Required specifications

Laminate finish
Edge finish

Optional specifications

HP laminate
Grommet (and grommet finish)
Power module cut-out

Accessories

PET felt modesty panel, privacy panel,
Nik power modules,
PET felt wire manager

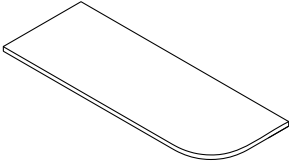
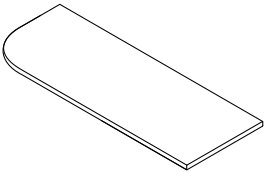
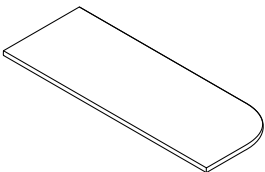
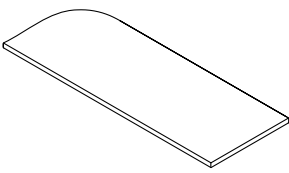
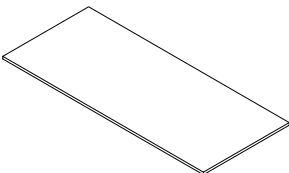
WORKSURFACES	MODEL#	DIMENSIONS	FREIGHT CLASS	WT/LBS.	CUBIC FT.	LIST PRICE	HP ADD	
 <p>Rectangular Return w/Radius Bottom Right</p>	D x W x H							
	SKWSRBR1842	18 x 42 x 1	60	23.82	0.44	\$288	\$99	
	SKWSRBR1848	18 x 48 x 1	60	27.16	0.5	\$325	\$113	
	SKWSRBR1854	18 x 54 x 1	60	30.53	0.56	\$361	\$127	
	SKWSRBR1860	18 x 60 x 1	60	33.89	0.63	\$398	\$141	
	SKWSRBR1866	18 x 66 x 1	60	37.24	0.69	\$434	\$155	
	<p>Connects to a primary surface on the left edge to create an L-shaped configuration. Specify support channel separately as needed.</p> <ul style="list-style-type: none"> • 12" radius on 24" deep surfaces; 15" radius on 30" deep surface 							
 <p>Rectangular Return w/Radius Bottom Left</p>	D x W x H							
	SKWSRBL1842	18 x 42 x 1	60	23.82	0.44	\$288	\$99	
	SKWSRBL1848	18 x 48 x 1	60	27.16	0.5	\$325	\$113	
	SKWSRBL1854	18 x 54 x 1	60	30.53	0.56	\$361	\$127	
	SKWSRBL1860	18 x 60 x 1	60	33.89	0.63	\$398	\$141	
	SKWSRBL1866	18 x 66 x 1	60	37.24	0.69	\$434	\$155	
	<p>Connects to a primary surface on the right edge to create an L-shaped configuration. Specify support channel separately as needed.</p> <ul style="list-style-type: none"> • 12" radius on 24" deep surfaces; 15" radius on 30" deep surface 							
 <p>Rectangular Return w/Radius Top Right</p>	D x W x H							
	SKWSRTR1842	18 x 42 x 1	60	23.82	0.44	\$288	\$99	
	SKWSRTR1848	18 x 48 x 1	60	27.16	0.5	\$325	\$113	
	SKWSRTR1854	18 x 54 x 1	60	30.53	0.56	\$361	\$127	
	SKWSRTR1860	18 x 60 x 1	60	33.89	0.63	\$398	\$141	
	SKWSRTR1866	18 x 66 x 1	60	37.24	0.69	\$434	\$155	
	<p>Connects to a primary surface on the left edge to create an L-shaped configuration. Specify support channel separately as needed.</p> <ul style="list-style-type: none"> • 12" radius on 24" deep surfaces; 15" radius on 30" deep surface 							
 <p>Rectangular Return w/Radius Top Left</p>	D x W x H							
	SKWSRTL1842	18 x 42 x 1	60	23.82	0.44	\$288	\$99	
	SKWSRTL1848	18 x 48 x 1	60	27.16	0.5	\$325	\$113	
	SKWSRTL1854	18 x 54 x 1	60	30.53	0.56	\$361	\$127	
	SKWSRTL1860	18 x 60 x 1	60	33.89	0.63	\$398	\$141	
	SKWSRTL1866	18 x 66 x 1	60	37.24	0.69	\$434	\$155	
	<p>Connects to a primary surface on the right edge to create an L-shaped configuration. Specify support channel separately as needed.</p> <ul style="list-style-type: none"> • 12" radius on 24" deep surfaces; 15" radius on 30" deep surface 							
 <p>Rectangular Worksurface for Conferencing</p>	SKWSCT3072	30 x 72 x 1	60	66.23	1.25	\$659	\$263	
	SKWSCT3078	30 x 78 x 1	60	71.74	1.35	\$710	\$285	
	SKWSCT3084	30 x 84 x 1	60	77.22	1.46	\$760	\$307	
	SKWSCT3090	30 x 90 x 1	60	82.72	1.56	\$811	\$329	
	SKWSCT3096	30 x 96 x 1	60	88.23	1.67	\$862	\$351	
	SKWSCT3672	36 x 72 x 1	60	79.37	1.5	\$767	\$316	
	SKWSCT3678	36 x 78 x 1	60	85.96	1.63	\$826	\$342	
	SKWSCT3684	36 x 84 x 1	60	92.54	1.75	\$885	\$369	
	SKWSCT3690	36 x 90 x 1	60	99.12	1.88	\$944	\$395	
	SKWSCT3696	36 x 96 x 1	60	105.71	2	\$1003	\$421	
		<p>Rectangular surface to be used for conferencing application that is semi-supported. Not for use with a return or a freestanding unit. All surfaces with an unsupported length of 54" or greater require support channels. For standard leg application, 72" to 84" wide surfaces require 2 support channels. Not predrilled to accept PET felt modesties and privacy panels.</p> <ul style="list-style-type: none"> • For 90" and 96" wide surfaces, use two SKWSDC84 support channels. 						

Required specifications

Laminate finish
Edge finish

Optional specifications

HP laminate
Grommet (and grommet finish)
Power module cut-out

Accessories

PET felt modesty panel, privacy panel,
Nik power modules,
PET felt wire manager



WORKSURFACES	MODEL#	DIMENSIONS	FREIGHT CLASS	WT/LBS.	CUBIC FT.	LIST PRICE	HP ADD
--------------	--------	------------	---------------	---------	-----------	------------	--------

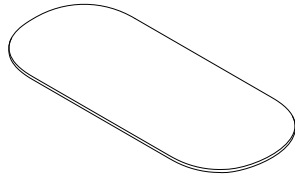

Racetrack Worksurface for Conferencing

	D x W x H						
SKWSCW3072	30 x 72 x 1	60	66.78	1.25	\$691	\$281	
SKWSCW3078	30 x 78 x 1	60	72.41	1.35	\$744	\$305	
SKWSCW3084	30 x 84 x 1	60	77.95	1.46	\$798	\$328	
SKWSCW3090	30 x 90 x 1	60	83.5	1.56	\$852	\$351	
SKWSCW3096	30 x 96 x 1	60	89.02	1.67	\$906	\$375	
SKWSCW3672	36 x 72 x 1	60	80.03	1.5	\$803	\$337	
SKWSCW3678	36 x 78 x 1	60	86.65	1.63	\$865	\$365	
SKWSCW3684	36 x 84 x 1	60	93.29	1.75	\$928	\$393	
SKWSCW3690	36 x 90 x 1	60	99.92	1.88	\$990	\$421	
SKWSCW3696	36 x 96 x 1	60	106.54	2	\$1052	\$449	

Racetrack surface to be used for conferencing application that is semi-supported. Not for use with a return or as a freestanding unit. All surfaces with an unsupported length of 54" or greater require support channels. For standard leg application, 72" to 96" wide surfaces require 2 support channels. Not predrilled to accept PET felt modesties and privacy panels. Corner radius not compatible with curved privacy panels or curved modesties.

- For 90" and 96" wide surfaces, use two SKWSDC84 support channels.

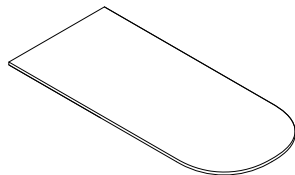

D-Shaped Worksurface for Conferencing

SKWSDW3072	30 x 72 x 1	60	66.87	1.25	\$691	\$281	
SKWSDW3078	30 x 78 x 1	60	72.41	1.35	\$744	\$305	
SKWSDW3084	30 x 84 x 1	60	77.87	1.46	\$798	\$328	
SKWSDW3090	30 x 90 x 1	60	83.41	1.56	\$852	\$351	
SKWSDW3096	30 x 96 x 1	60	88.93	1.67	\$906	\$375	
SKWSDW3672	36 x 72 x 1	60	79.92	1.5	\$803	\$337	
SKWSDW3678	36 x 78 x 1	60	86.55	1.63	\$865	\$365	
SKWSDW3684	36 x 84 x 1	60	93.19	1.75	\$928	\$393	
SKWSDW3690	36 x 90 x 1	60	99.81	1.88	\$990	\$421	
SKWSDW3696	36 x 96 x 1	60	106.43	2	\$1052	\$449	

Primary D shape surface to be used for conferencing application that is semi-supported. Not for use with a return or as a freestanding unit. All surfaces with an unsupported length of 54" or greater require support channels. For standard leg application, 72" to 96" wide surfaces require 2 support channels. Not predrilled to accept PET felt modesties and privacy panels. Corner radius not compatible with curved privacy panels or curved modesties.

- For 90" and 96" wide surfaces, use two SKWSDC84 support channels.

Required specifications

Laminate finish
Edge finish

Optional specifications

HP laminate
Grommet (and grommet finish)
Power module cut-out

Accessories

Nik power modules
PET felt wire manager

WORKSURFACE SUPPORTS

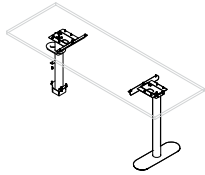

surface not included

Fixed Height 2 Column Kit

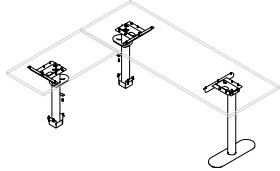

surface not included

Fixed Height 3 Column Kit

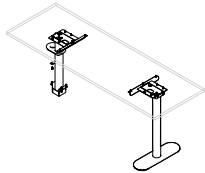

surface not included

Height Adjustable 2 Column Kit

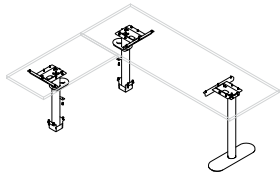

surface not included

Height Adjustable 3 Column Kit

MODEL#	DIMENSIONS	FREIGHT CLASS	WT/LBS.	CUBIC FT.	LIST PRICE
D x W x H					
SKWSFH2C18T24	6 x 20 x 28	150	81.31	15.4	\$1172
SKWSFH2C30T36	6 x 20 x 28	150	81.31	15.4	\$1187

For use with Office Spaces low storage units with a leg grommet. Kit includes two fixed height columns, one foot, one column basket, two leg brackets and two small column brackets. Support channels are not included and must be specified based on the surface size. Kit components are powder coated metal. Specify paint finish.

- For 18" and 24" deep worksurfaces, specify SKWSFH2C18T24
- For 30" and 36" deep worksurfaces, specify SKWSFH2C30T36

SKWSFH3C18T24	6 x 20 x 28	250	121.97	25.4	\$1544
SKWSFH3C30T36	6 x 20 x 28	250	121.97	25.4	\$1719

For use with Office Spaces low storage units with two leg grommets, forming an L shape configuration. Kit includes three fixed height columns, one foot, two column baskets, three leg brackets and two small column brackets for the primary surface. Support channels are not included and must be specified based on the surface size. Kit components are powder coated metal. Specify paint finish.

- For 18" and 24" deep worksurfaces, specify SKWSFH3C18T24.
- For 30" and 36" deep worksurfaces, specify SKWSFH3C30T36.

SKWSHA2C18T24	6 x 20 x 25-51.2	150	81.31	15.38	\$2411
SKWSHA2C30T36	6 x 20 x 25-51.2	150	81.31	15.4	\$2423

For use with Office Spaces low storage units with a leg grommet. Range from top of surface to floor is 26" to 52.2". Kit includes two height adjustable columns, one control box (2 port), one handset, one foot, one spacer, one column basket and two small column brackets. Support channels are not included and must be specified based on the surface size. Kit components are powder coated metal. Specify paint finish.

- For 18" and 24" deep worksurfaces, specify SKWSHA2C18T24.
- For 30" and 36" deep worksurfaces, specify SKWSHA2C30T36.

SKWSHA3C18T24	6 x 20 x 25-51.2	250	121.97	25.4	\$3504
SKWSHA3C30T36	6 x 20 x 25-51.2	250	121.97	25.4	\$3522

For use with Office Spaces low storage units with two leg grommets, forming an L shape configuration. Range from top of surface to floor is 26" to 52.2". Kit includes three height adjustable columns, one control box (3 port), one handset, one foot, one spacer, two column baskets, one small column bracket for the return surface and two small column brackets for the primary surface. Support channels are not included and must be specified based on the surface size. Kit components are powder coated metal. Specify paint finish.

- For 18" and 24" deep worksurfaces, specify SKWSHA3C18T24.
- For 30" and 36" deep worksurfaces, specify SKWSHA3C30T36.

Required specifications

Paint finish

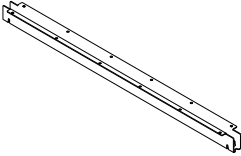
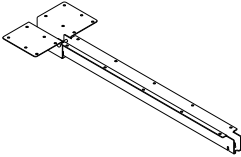

WORKSURFACE SUPPORTS	MODEL#	DIMENSIONS	FREIGHT CLASS	WT/LBS.	CUBIC FT.	LIST PRICE
 <p>Support Channel</p>		D x W x H				
	SKWSDC66	2 x 36 x 1.75	85	3.97	0.07	\$80
	SKWSDC72	2 x 42 x 1.75	85	4.63	0.09	\$96
	SKWSDC78	2 x 48 x 1.75	85	5.29	0.1	\$102
	SKWSDC84	2 x 54 x 1.75	85	5.95	0.11	\$111
<p>Used to support the primary surface. Specify two channels for each primary surface. Support channels are specified by the surface length. Available in Black (BLK) only.</p> <ul style="list-style-type: none"> For 90" and 96" wide surfaces, use two SKWSDC84 support channels. 						
 <p>Return Support Channel Kit</p>	SKWSRDC36	8.5 x 18 x 1.75	70	2.98	0.15	\$126
	SKWSRDC42	8.5 x 24 x 1.75	85	3.64	0.21	\$136
	SKWSRDC48	8.5 x 30 x 1.75	85	4.3	0.26	\$145
	SKWSRDC54	8.5 x 36 x 1.75	85	4.97	0.34	\$153
	SKWSRDC60	8.5 x 42 x 1.75	85	5.65	0.36	\$168
	SKWSRDC66	8.5 x 48 x 1.75	85	6.31	0.41	\$175
	<p>Supports a return in an L-shaped configuration. Kit includes the channel and the support bracket. Support channels are specified by the surface length. Available in Black (BLK) only.</p>					

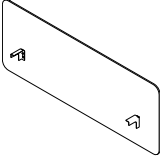
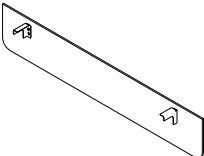
PRIMARY WORKSURFACE ACCESSORIES	MODEL#	DIMENSIONS	FREIGHT CLASS	WT/LBS.	CUBIC FT.	LIST PRICE
 <p>Privacy Panel*</p>	SKWAPP2360	4.75 x 35 x 23	400	3.03	3.6	\$172
	SKWAPP2366	4.75 x 41 x 23	400	3.18	3.98	\$182
	SKWAPP2372	4.75 x 47 x 23	400	3.37	4.36	\$192
	SKWAPP2378	4.75 x 53 x 23	400	3.55	4.74	\$201
	SKWAPP2384	4.75 x 59 x 23	400	3.73	5.12	\$211
<p>Felt privacy panel secures to the edge of the surface and provides privacy above and below the surface. Specify the privacy panel that matches the nominal surface length. The privacy panel extends past the surface by 0.45". Installed panel measures 13" from the top of the worksurface and 9" below the surface. Must align with pre-drilled holes on the underside of the primary surface. Brackets (set of 2) are powder coated metal. Specify standard metal paint finish and PET felt color.</p> <ul style="list-style-type: none"> Cannot be used in conjunction with modesty panel - SKWABP/SKWACMR/L/SKWARMR/L 						
 <p>Modesty Panel*</p>	SKWABP1160	4.75 x 35 x 10	300	2.53	1.72	\$140
	SKWABP1166	4.75 x 41 x 10	300	2.68	1.9	\$144
	SKWABP1172	4.75 x 47 x 10	300	2.87	2.09	\$148
	SKWABP1178	4.75 x 53 x 10	300	3.05	2.27	\$153
	SKWABP1184	4.75 x 59 x 10	300	3.23	2.45	\$157
<p>Felt modesty panel can be mounted flush (upper bracket location) or inset (low bracket location). Specify the modesty panel that matches the nominal surface length. The modesty panel is inset by 0.45" when installed in the low bracket position and flush in the upper bracket position. Must align with pre-drilled holes on the underside of the primary surface. Brackets (set of 2) are powder coated metal. Specify standard metal paint finish and PET felt color.</p> <ul style="list-style-type: none"> Cannot be used in conjunction with privacy panel - SKWAPP/SKWACPR/L/SKWARPR/L 						

Required specifications

- Paint finish*
- PET felt finish*

PRIMARY WORKSURFACE ACCESSORIES

MODEL#	DIMENSIONS	FREIGHT CLASS	WT/LBS.	CUBIC FT.	LIST PRICE
D x W x H					
SKWACPL2360D24	4.75 x 35.8 x 23	250	4.69	2.26	\$265
SKWACPL2366D24	4.75 x 41.8 x 23	300	5.06	2.64	\$275
SKWACPL2372D24	4.75 x 47.8 x 23	300	5.44	3.02	\$284
SKWACPL2378D24	4.75 x 53.8 x 23	300	5.81	3.4	\$294
SKWACPL2384D24	4.75 x 59.8 x 23	300	6.18	3.78	\$304
SKWACPL3160D24	4.75 x 35.8 x 30	300	5.75	2.95	\$284
SKWACPL3166D24	4.75 x 41.8 x 30	300	6.26	3.45	\$294
SKWACPL3172D24	4.75 x 47.8 x 30	300	6.76	3.94	\$303
SKWACPL3178D24	4.75 x 53.8 x 30	300	7.26	4.44	\$313
SKWACPL3184D24	4.75 x 59.8 x 30	300	7.76	4.93	\$323
SKWACPL2360D30	4.75 x 35.8 x 23	250	4.69	2.26	\$287
SKWACPL2366D30	4.75 x 41.8 x 23	300	5.06	2.64	\$297
SKWACPL2372D30	4.75 x 47.8 x 23	300	5.44	3.02	\$306
SKWACPL2378D30	4.75 x 53.8 x 23	300	5.81	3.4	\$316
SKWACPL2384D30	4.75 x 59.8 x 23	300	6.18	3.78	\$326
SKWACPL3160D30	4.75 x 35.8 x 30	300	5.75	2.95	\$306
SKWACPL3166D30	4.75 x 41.8 x 30	300	6.26	3.45	\$316
SKWACPL3172D30	4.75 x 47.8 x 30	300	6.76	3.94	\$325
SKWACPL3178D30	4.75 x 53.8 x 30	300	7.26	4.44	\$335
SKWACPL3184D30	4.75 x 59.8 x 30	300	7.76	4.93	\$345

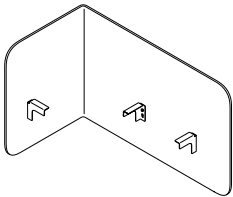

Corner Privacy Panel, Left

Felt privacy panel secures to the edge of the surface (SKWSRW) and provides privacy above and below the surface. It wraps around the corner on the left side of the primary surface. Specify the privacy panel that matches the nominal surface length and depth. 23" high dividers measure 13" from the top of the worksurface and 9" below the surface. 31" high dividers measure 21" from the top of the worksurface and 9" below the surface. Must align with pre-drilled holes on the underside of the primary surface. Brackets (set of 3) are powder coated metal. Specify standard metal paint finish and PET felt color.

- Cannot be used in conjunction with modesty panel - SKWABP/SKWACMR/L/SKWARMR/L

SKWACPR2360D24	4.75 x 35.8 x 23	250	4.69	2.26	\$265
SKWACPR2366D24	4.75 x 41.8 x 23	300	5.06	2.64	\$275
SKWACPR2372D24	4.75 x 47.8 x 23	300	5.44	3.02	\$284
SKWACPR2378D24	4.75 x 53.8 x 23	300	5.81	3.4	\$294
SKWACPR2384D24	4.75 x 59.8 x 23	300	6.18	3.78	\$304
SKWACPR3160D24	4.75 x 35.8 x 30	250	5.75	2.95	\$284
SKWACPR3166D24	4.75 x 41.8 x 30	300	6.26	3.45	\$294
SKWACPR3172D24	4.75 x 47.8 x 30	300	6.76	3.94	\$303
SKWACPR3178D24	4.75 x 53.8 x 30	300	7.26	4.44	\$313
SKWACPR3184D24	4.75 x 59.8 x 30	300	7.76	4.93	\$323
SKWACPR2360D30	4.75 x 35.8 x 23	250	4.69	2.26	\$287
SKWACPR2366D30	4.75 x 41.8 x 23	300	5.06	2.64	\$297
SKWACPR2372D30	4.75 x 47.8 x 23	300	5.44	3.02	\$306
SKWACPR2378D30	4.75 x 53.8 x 23	300	5.81	3.4	\$316
SKWACPR2384D30	4.75 x 59.8 x 23	300	6.18	3.78	\$326
SKWACPR3160D30	4.75 x 35.8 x 30	300	5.75	2.95	\$306
SKWACPR3166D30	4.75 x 41.8 x 30	300	6.26	3.45	\$316
SKWACPR3172D30	4.75 x 47.8 x 30	300	6.76	3.94	\$325
SKWACPR3178D30	4.75 x 53.8 x 30	300	7.26	4.44	\$335
SKWACPR3184D30	4.75 x 59.8 x 30	300	7.76	4.93	\$345

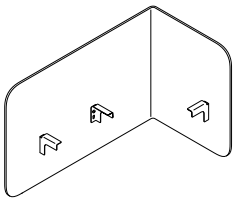

Corner Privacy Panel, Right

Felt privacy panel secures to the edge of the surface (SKWSRW) and provides privacy above and below the surface. It wraps around the corner on the right side of the primary surface. Specify the privacy panel that matches the nominal surface length and depth. 23" high dividers measure 13" from the top of the worksurface and 9" below the surface. 31" high dividers measure 21" from the top of the worksurface and 9" below the surface. Must align with pre-drilled holes on the underside of the primary surface. Brackets (set of 3) are powder coated metal. Specify standard metal paint finish and PET felt color.

- Cannot be used in conjunction with modesty panel - SKWABP/SKWACMR/L/SKWARMR/L

Required specifications

PET felt color
Paint finish



PRIMARY WORKSURFACE ACCESSORIES MODEL# DIMENSIONS FREIGHT CLASS WT/LBS. CUBIC FT. LIST PRICE

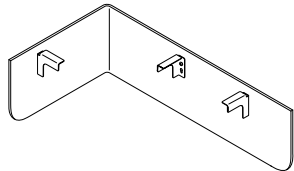

Corner Modesty Panel, Left

	D x W x H					
SKWACML1160D24	4.75 x 35.8 x 10	250	3.12	0.98	\$150	
SKWACML1166D24	4.75 x 41.8 x 10	250	3.3	1.15	\$156	
SKWACML1172D24	4.75 x 47.8 x 10	250	3.47	1.31	\$160	
SKWACML1178D24	4.75 x 53.8 x 10	250	3.65	1.48	\$165	
SKWACML1184D24	4.75 x 59.8 x 10	250	3.83	1.64	\$171	
SKWACML1160D30	4.75 x 35.8 x 10	250	3.12	0.98	\$160	
SKWACML1166D30	4.75 x 41.8 x 10	250	3.3	1.15	\$165	
SKWACML1172D30	4.75 x 47.8 x 10	250	3.47	1.31	\$169	
SKWACML1178D30	4.75 x 53.8 x 10	250	3.65	1.48	\$175	
SKWACML1184D30	4.75 x 59.8 x 10	250	3.83	1.64	\$179	

Felt modesty panel can be mounted flush (low bracket location) or inset (upper bracket location) and wraps around on the left side of the primary surface (SKWSRW). Specify the modesty panel that matches the nominal surface length and depth. Must align with pre-drilled holes on the underside of the primary surface. Brackets (set of 3) are powder coated metal. Specify standard metal paint finish and PET felt color.

- Cannot be used in conjunction with privacy panels (SKWAPP/SKWACPR/L/SKWAPR/L)

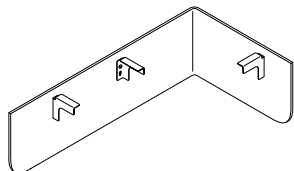

Corner Modesty Panel, Right

SKWACMR1160D24	4.75 x 35.8 x 10	250	3.12	0.98	\$150	
SKWACMR1166D24	4.75 x 41.8 x 10	250	3.3	1.15	\$156	
SKWACMR1172D24	4.75 x 47.8 x 10	250	3.47	1.31	\$160	
SKWACMR1178D24	4.75 x 53.8 x 10	250	3.65	1.48	\$165	
SKWACMR1184D24	4.75 x 59.8 x 10	250	3.83	1.64	\$171	
SKWACMR1160D30	4.75 x 35.8 x 10	250	3.12	0.98	\$160	
SKWACMR1166D30	4.75 x 41.8 x 10	250	3.3	1.15	\$165	
SKWACMR1172D30	4.75 x 47.8 x 10	250	3.47	1.31	\$169	
SKWACMR1178D30	4.75 x 53.8 x 10	250	3.65	1.48	\$175	
SKWACMR1184D30	4.75 x 59.8 x 10	250	3.83	1.64	\$179	

Felt modesty panel can be mounted flush (low bracket location) or inset (upper bracket location) and wraps around on the right side of the primary surface (SKWSRW). Specify the modesty panel that matches the nominal surface length and depth. Must align with pre-drilled holes on the underside of the primary surface. Brackets (set of 3) are powder coated metal. Specify standard metal paint finish and PET felt color.

- Cannot be used in conjunction with privacy panels (SKWAPP/SKWACPR/L/SKWAPR/L)

Required specifications

- PET felt color
- Paint finish

WORKSURFACE ACCESSORIES

MODEL# DIMENSIONS FREIGHT CLASS WT/LBS. CUBIC FT. LIST PRICE

D x W x H

SKWARPL2360D24	4.75 x 35.8 x 23	250	4.69	2.26	\$300
SKWARPL2366D24	4.75 x 41.8 x 23	300	5.06	2.64	\$310
SKWARPL2372D24	4.75 x 47.8 x 23	300	5.44	3.02	\$319
SKWARPL2378D24	4.75 x 53.8 x 23	300	5.81	3.4	\$329
SKWARPL2384D24	4.75 x 59.8 x 23	300	6.18	3.78	\$339
SKWARPL3160D24	4.75 x 35.8 x 30	300	5.75	2.95	\$319
SKWARPL3166D24	4.75 x 41.8 x 30	300	6.26	3.45	\$329
SKWARPL3172D24	4.75 x 47.8 x 30	300	6.76	3.94	\$338
SKWARPL3178D24	4.75 x 53.8 x 30	300	7.26	4.44	\$348
SKWARPL3184D24	4.75 x 59.8 x 30	300	7.76	4.93	\$358
SKWARPL2360D30	4.75 x 35.8 x 23	250	4.69	2.26	\$322
SKWARPL2366D30	4.75 x 41.8 x 23	300	5.06	2.64	\$332
SKWARPL2372D30	4.75 x 47.8 x 23	300	5.44	3.02	\$341
SKWARPL2378D30	4.75 x 53.8 x 23	300	5.81	3.4	\$351
SKWARPL2384D30	4.75 x 59.8 x 23	300	6.18	3.78	\$361
SKWARPL3160D30	4.75 x 35.8 x 30	300	5.75	2.95	\$341
SKWARPL3166D30	4.75 x 41.8 x 30	300	6.26	3.45	\$351
SKWARPL3172D30	4.75 x 47.8 x 30	300	6.76	3.94	\$359
SKWARPL3178D30	4.75 x 53.8 x 30	300	7.26	4.44	\$370
SKWARPL3184D30	4.75 x 59.8 x 30	300	7.76	4.93	\$380

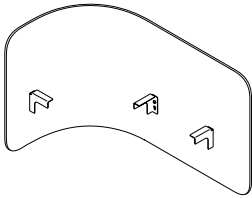

Curved Privacy Panel, Left

Felt privacy panel secures to the edge of the surface and provides privacy above and below the surface. It wraps around the corner on the left side of the primary surface (SKWSRLT). Must be used opposite a credenza in an L configuration. Specify the privacy panel that matches the nominal surface length and depth. Must align with pre-drilled holes in the primary surface.

Brackets (set of 3) are powder coated metal. Specify standard metal paint finish and PET felt color.

- Cannot be used in conjunction with modesty panel (SKWABP/SKWACMR/L/SKWARMR/L)

SKWARPR2360D24	4.75 x 35.8 x 23	250	4.69	2.26	\$300
SKWARPR2366D24	4.75 x 41.8 x 23	300	5.06	2.64	\$310
SKWARPR2372D24	4.75 x 47.8 x 23	300	5.44	3.02	\$319
SKWARPR2378D24	4.75 x 53.8 x 23	300	5.81	3.4	\$329
SKWARPR2384D24	4.75 x 59.8 x 23	300	6.18	3.78	\$339
SKWARPR3160D24	4.75 x 35.8 x 30	300	5.75	2.95	\$319
SKWARPR3166D24	4.75 x 41.8 x 30	300	6.26	3.45	\$329
SKWARPR3172D24	4.75 x 47.8 x 30	300	6.76	3.94	\$338
SKWARPR3178D24	4.75 x 53.8 x 30	300	7.26	4.44	\$348
SKWARPR3184D24	4.75 x 59.8 x 30	300	7.76	4.93	\$358
SKWARPR2360D30	4.75 x 35.8 x 23	250	4.69	2.26	\$322
SKWARPR2366D30	4.75 x 41.8 x 23	300	5.06	2.64	\$332
SKWARPR2372D30	4.75 x 47.8 x 23	300	5.44	3.02	\$341
SKWARPR2378D30	4.75 x 53.8 x 23	300	5.81	3.4	\$351
SKWARPR2384D30	4.75 x 59.8 x 23	300	6.18	3.78	\$361
SKWARPR3160D30	4.75 x 35.8 x 30	300	5.75	2.95	\$341
SKWARPR3166D30	4.75 x 41.8 x 30	300	6.26	3.45	\$351
SKWARPR3172D30	4.75 x 47.8 x 30	300	6.76	3.94	\$359
SKWARPR3178D30	4.75 x 53.8 x 30	300	7.26	4.44	\$370
SKWARPR3184D30	4.75 x 59.8 x 30	300	7.76	4.93	\$380

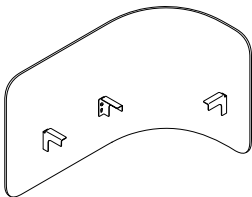

Curved Privacy Panel, Right

Felt privacy panel secures to the edge of the surface and provides privacy above and below the surface. It wraps around the corner on the right side of the primary surface (SKWSRRT). Must be used opposite a credenza in an L configuration. Specify the privacy panel that matches the nominal surface length and depth. Must align with pre-drilled holes in the primary surface.

Brackets (set of 3) are powder coated metal. Specify standard metal paint finish and PET felt color.

- Cannot be used in conjunction with modesty panel (SKWABP/SKWACMR/L/SKWARMR/L)

Required specifications

PET felt color

Paint finish



WORKSURFACE ACCESSORIES

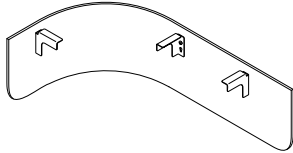

Curved Modesty Panel, Left

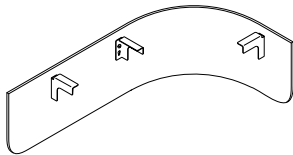

Curved Modesty Panel, Right

MODEL# DIMENSIONS FREIGHT CLASS WT/LBS. CUBIC FT. LIST PRICE

	D x W x H				
SKWARML1160D24	4.75 x 35.8 x 10	250	3.12	0.98	\$168
SKWARML1166D24	4.75 x 41.8 x 10	250	3.3	1.15	\$173
SKWARML1172D24	4.75 x 47.8 x 10	250	3.47	1.31	\$178
SKWARML1178D24	4.75 x 53.8 x 10	250	3.65	1.48	\$182
SKWARML1184D24	4.75 x 59.8 x 10	250	3.83	1.64	\$188
SKWARML1160D30	4.75 x 35.8 x 10	250	3.12	0.98	\$178
SKWARML1166D30	4.75 x 41.8 x 10	250	3.3	1.15	\$182
SKWARML1172D30	4.75 x 47.8 x 10	250	3.47	1.31	\$187
SKWARML1178D30	4.75 x 53.8 x 10	250	3.65	1.48	\$192
SKWARML1184D30	4.75 x 59.8 x 10	250	3.83	1.64	\$197

Felt modesty panel can be mounted flush (low bracket location) or inset (upper bracket location) and wraps around on the left side of the primary surface (SKWSRLT). Must be used opposite a credenza in an L configuration. Specify the modesty panel that matches the nominal surface length and depth. Must align with pre-drilled holes on the underside of the primary surface. Brackets (set of 3) are powder coated metal. Specify standard metal paint finish and PET felt color.

- Cannot be used in conjunction with privacy panel (SKWAPP/SKWACPR/L/SKWAPR/L)

SKWARMR1160D24	4.75 x 35.8 x 10	250	3.12	0.98	\$168
SKWARMR1166D24	4.75 x 41.8 x 10	250	3.3	1.15	\$173
SKWARMR1172D24	4.75 x 47.8 x 10	250	3.47	1.31	\$178
SKWARMR1178D24	4.75 x 53.8 x 10	250	3.65	1.48	\$182
SKWARMR1184D24	4.75 x 59.8 x 10	250	3.83	1.64	\$188
SKWARMR1160D30	4.75 x 35.8 x 10	250	3.12	0.98	\$178
SKWARMR1166D30	4.75 x 41.8 x 10	250	3.3	1.15	\$182
SKWARMR1172D30	4.75 x 47.8 x 10	250	3.47	1.31	\$187
SKWARMR1178D30	4.75 x 53.8 x 10	250	3.65	1.48	\$192
SKWARMR1184D30	4.75 x 59.8 x 10	250	3.83	1.64	\$181

Felt modesty panel can be mounted flush (low bracket location) or inset (upper bracket location) and wraps around on the right side of the primary surface (SKWSRRT). Must be used opposite a credenza in an L configuration. Specify the modesty panel that matches the nominal surface length and depth. Must align with pre-drilled holes on the underside of the primary surface. Brackets (set of 3) are powder coated metal. Specify standard metal paint finish and PET felt color.

- Cannot be used in conjunction with privacy panel (SKWAPP/SKWACPR/L/SKWAPR/L)

Required specifications

- PET felt color
- Paint finish

POWER ACCESSORIES

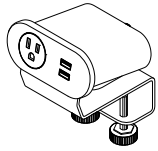

Nik Edge/Clamp Mount Power Module

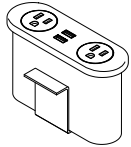

Nik In-Surface Power Module

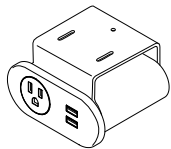

Nik Below Surface Power Module

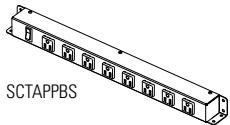

SCTAPPBS

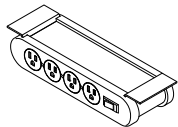

SCTAPPBD

Below Surface Power Bar

MODEL#	DIMENSIONS D x W x H	FREIGHT CLASS	WT/LBS.	CUBIC FT.	LIST PRICE
SCTAPEA	2.10 x 6 x 3.7	60	4	0.03	\$608
SCTAPEB	2.10 x 6 x 3.7	60	4	0.03	\$578
SCTAPEC	2.10 x 6 x 3.7	60	4	0.03	\$671
SCTAPED	2.10 x 6 x 3.7	60	4	0.03	\$795
SCTAPEE	2.10 x 6 x 3.7	60	4	0.03	\$593

Black with black receptacles, 10ft cord. Specify configuration, last letter of the code represents the following:

- A = 1 AC, 1 USB-A 1.5A charge port, 1 USB-A 2.4A quick charge port
- B = 2 AC
- C = 2 AC, 1 USB-A 1.5A charge port, 1 USB-A 2.4A quick charge port
- D = 1 AC, 1 USB-A 1.5A charge port, 1 USB-A 2.4A quick charge port, 1 60W USB-C charge port
- E = 3 AC

SCTAPSC	2.10 x 6 x 3.7	60	4	0.03	\$681
SCTAPSD	2.10 x 6 x 3.7	60	4	0.03	\$849
SCTAPSE	2.10 x 6 x 3.7	60	4	0.03	\$598

Black with black receptacles, 10ft cord. Corresponding cut-out option is C1, C2 or C3 (where applicable). Specify configuration, last letter of the code represents the following:

- C = 2 AC, 1 USB-A 1.5A charge port, 1 USB-A 2.4A quick charge port
- D = 1 AC, 1 USB-A 1.5A charge port, 1 USB-A 2.4A quick charge port, 1 60W USB-C charge port
- E = 3 AC

SCTAPBA	2.10 x 6 x 3.7	60	4	0.03	\$474
SCTAPBB	2.10 x 6 x 3.7	60	4	0.03	\$430
SCTAPBC	2.10 x 6 x 3.7	60	4	0.03	\$504
SCTAPBD	2.10 x 6 x 3.7	60	4	0.03	\$622
SCTAPBE	2.10 x 6 x 3.7	60	4	0.03	\$440

Black with black receptacles, 10ft cord. Undermounts at the edge of any worksurface. Specify configuration, last letter of the code represents the following:

- A = 1 AC, 1 USB-A 1.5A charge port, 1 USB-A 2.4A quick charge port
- B = 2 AC
- C = 2 AC, 1 USB-A 1.5A charge port, 1 USB-A 2.4A quick charge port
- D = 1 AC, 1 USB-A 1.5A charge port, 1 USB-A 2.4A quick charge port, 1 60W USB-C charge port
- E = 3 AC

SCTAPPBS	1.95 x 21 x 1.95	60	2.7	0.06	\$366
SCTAPPBD	4 x 10.6 x 2.3	60	2.7	0.06	\$898

Available in black only. 10ft cord.

- Single (SCTAPPBS) includes 8 outlets on a single side
- Double (SCTAPPBD) includes 4 outlets on each side of the bar. Built-in circuit breaker.



POWER ACCESSORIES **MODEL#** **DIMENSIONS** **FREIGHT CLASS** **WT/LBS.** **CUBIC FT.** **LIST PRICE**

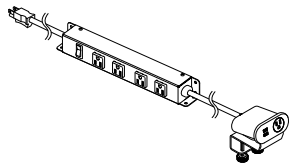

Below Surface Power Bar

	D x W x H					
SCTAPCA	4 x 10.6 x 3.7	60	6.7	0.09		\$1693
SCTAPCB	4 x 10.6 x 3.7	60	6.7	0.09		\$1632
SCTAPCC	4 x 10.6 x 3.7	60	6.7	0.09		\$1774
SCTAPCD	4 x 10.6 x 3.7	60	6.7	0.09		\$2055
SCTAPCE	4 x 10.6 x 3.7	60	6.7	0.09		\$1661

Integrated power bar and edge mount power module provides a code compliant all-in-one power solution with a single plug. The power bar includes AC outlets and built-in surge protection. The Nik Edge Clamp module is hardwired to the power bar via a 3' cord. Cord length is 6". Below surface power bar is black only. Specify configuration, last letter of the code represents the following:

- A = 1 AC, 1 USB-A 1.5A charge port, 1 USB-A 2.4A quick charge port
- B = 2 AC
- C = 2 AC, 1 USB-A 1.5A charge port, 1 USB-A 2.4A quick charge port
- D = 1 AC, 1 USB-A 1.5A charge port, 1 USB-A 2.4A quick charge port, 1 60W USB-C charge port
- E = 3 AC

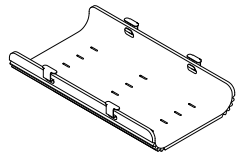

Collaborative Spaces PET Felt* Wire Manager

SCTACT	26 x 11 x 4	70	1.1	0.66		\$104
--------	-------------	----	-----	------	--	--------------

PET felt wire manager hangs from four brackets under the surface. Includes Black painted metal brackets. Aligns to pre-drilled holes on all surfaces. PET felt available in standard finishes.

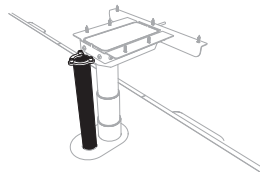

Storage Cable Tube

SKWESCT	2.36 x 2.13 x 15.5	70	0.39	0.05		\$96
---------	--------------------	----	------	------	--	-------------

Neoprene cable manager connects to the underside of the worksurface and into the small opening on the storage leg grommet.

- Cannot be used in conjunction with storage power outlet (**SKSEPO**).
- Capacity: 4 wires (eg. 2 data & 2 power).

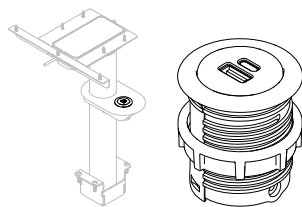

Storage Power Outlet

SKSEPOA	2 x 2 x 2.2	60	2.5	0.03		\$230
SKSEPOB	2 x 2 x 2.2	60	2.5	0.03		\$526

Storage power outlet to fit within the leg grommet outlet opening. Black finish only. Specify configuration, last letter of the code represents the following:

- A = 1 AC
- B = 1 USB-A and 1 USB-C
- Cannot be used in conjunction with storage cable tube (**SKWESCT**).

Required specifications

PET felt finish*

BACKBOARDS

Backboards Notes

Backboards are decorative, wall-mounted pieces that provide the office with a finished look. Rails included for mounting (hardware to affix to wall is not included). Backboards are meant to be mounted where the bottom of the board is flush with Office Spaces 20"h storage.

- Backboards radius is 6" (where applicable).
- Backboard curved corner (where applicable) is not intended to be used adjacent to high storage.
- Backboards are available in laminate (LP), white dry erase board (DE), PET felt (PT) and patterned PET felt (VE). Specify (V) for a varied asymmetrical pattern and (E) for an equal symmetrical pattern.
- Grain will run horizontally for any woodgrain laminate. Backboards specified with low pressure laminate will have a corresponding 3mm edging.
- Backboards with PET (PT) are mounted on a laminate panel. Specify standard PET and laminate finish.
- Backboards specified with dry erase board (DE) will have Designer White (DWT) 3mm edging.
- (DE) option not available on any backboard with a radius corner
- Backboards are intended to match the length of the credenza.

Backboards with shelves

- Shelf width will match the backboard and is 10" deep
- Shelves are non-adjustable and can support 171 lbs. evenly distributed
- Do not use height adjustable surfaces and column kits with double shelf backboards directly below.

Alignment is as follows:

- 34"h backboards will align with 54"h storage
- 40"h backboards will align with 60"h storage, single shelf clearance is 60", double shelf clearance is 12" (where applicable)
- 46"h backboards will align with 66"h storage, single shelf clearance is 32", double shelf clearance is 18" (where applicable)
- 52"h backboards will align with 72"h storage, single shelf clearance is 72", double shelf clearance is 24" (where applicable)
- 58"h backboards will align with 78"h storage, single shelf clearance is 44", double shelf clearance is 30" (where applicable)

Note: VE-V varied asymmetrical pattern is a combination of 1.5", 3", 4.5", 6" grooves in a random pattern. VE-E equal symmetrical pattern is a repeat of 3" grooves.

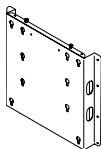

TV Mount

SCTVMT	1.5 x 1.5 x 3	70	6.43	0.29	\$200
--------	---------------	----	------	------	--------------

Can be used on collaborative table media unit (SCTAMTxx), media cart (SCCMxx) and Office Spaces backboards. TV and video conferencing units not included. Hardware for mounting TV included. Maximum TV size is 55". Note: TV frame must be securely attached to laminate panel. Care should be taken to attach TV frame using correct fasteners. Failure to do so may result in collapse of the unit and subsequent possible injury. Available in Black (BLK) only.

Required specifications

- PET felt finish
- Laminate finish
- Edge finish

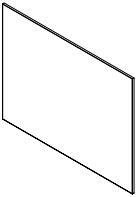
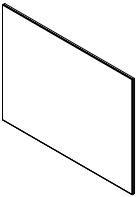
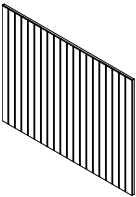
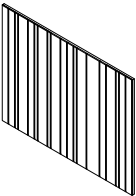

BACKBOARDS	MODEL#	DIMENSIONS	FREIGHT CLASS	WT/LBS.	CUBIC FT.	LP	DE	PT	VE
 <p>Low pressure laminate (LP) Dry erase whiteboard (DE)</p>		D x W x H							
	SKBB3436	2 x 36 x 34	65	37.94	1.42	\$350	\$474	\$528	\$612
	SKBB3442	2 x 42 x 34	65	44.23	1.65	\$356	\$501	\$564	\$662
	SKBB3448	2 x 48 x 34	65	50.54	1.89	\$361	\$527	\$598	\$711
	SKBB3454	2 x 54 x 34	65	56.87	2.13	\$367	\$553	\$634	\$760
	SKBB3460	2 x 60 x 34	65	63.16	2.36	\$372	\$579	\$669	\$809
	SKBB3466	2 x 66 x 34	65	69.48	2.6	\$378	\$606	\$704	\$859
	SKBB3472	2 x 72 x 34	65	75.77	2.83	\$384	\$633	\$740	\$908
	SKBB3478	2 x 78 x 34	65	82.08	3.07	\$389	\$658	\$775	\$957
	SKBB3484	2 x 84 x 34	65	88.38	3.31	\$395	\$685	\$810	\$1007
 <p>PET felt (PT)*</p>	SKBB4036	2 x 36 x 40	65	44.61	1.67	\$396	\$542	\$606	\$705
	SKBB4042	2 x 42 x 40	65	52.02	1.94	\$473	\$644	\$717	\$833
	SKBB4048	2 x 48 x 40	65	59.43	2.22	\$524	\$719	\$803	\$936
	SKBB4054	2 x 54 x 40	65	66.88	2.5	\$629	\$848	\$943	\$1092
	SKBB4060	2 x 60 x 40	65	74.29	2.78	\$680	\$924	\$1029	\$1194
	SKBB4066	2 x 66 x 40	65	81.71	3.06	\$731	\$999	\$1115	\$1297
	SKBB4072	2 x 72 x 40	65	89.12	3.33	\$782	\$1075	\$1201	\$1399
	SKBB4078	2 x 78 x 40	65	96.53	3.61	\$833	\$1150	\$1286	\$1501
	SKBB4084	2 x 84 x 40	65	103.94	3.89	\$1037	\$1378	\$1525	\$1757
	 <p>PET felt, equal pattern (VE-E)*</p>	SKBB4636	2 x 36 x 46	65	51.28	1.92	\$442	\$610	\$683
SKBB4642		2 x 42 x 46	65	59.8	2.24	\$526	\$722	\$807	\$940
SKBB4648		2 x 48 x 46	65	68.33	2.56	\$584	\$808	\$905	\$1057
SKBB4654		2 x 54 x 46	65	76.87	2.88	\$697	\$949	\$1058	\$1229
SKBB4660		2 x 60 x 46	65	85.41	3.19	\$755	\$1036	\$1156	\$1346
SKBB4666		2 x 66 x 46	65	93.92	3.51	\$813	\$1122	\$1254	\$1463
SKBB4672		2 x 72 x 46	65	102.45	3.83	\$872	\$1209	\$1353	\$1581
SKBB4678		2 x 78 x 46	65	110.98	4.15	\$930	\$1295	\$1451	\$1698
SKBB4684		2 x 84 x 46	65	119.49	4.47	\$1142	\$1535	\$1703	\$1970
 <p>PET felt, varied pattern (VE-V)*</p>		SKBB5236	2 x 36 x 52	65	57.96	2.17	\$488	\$678	\$760
	SKBB5242	2 x 42 x 52	65	67.59	2.53	\$579	\$801	\$897	\$1047
	SKBB5248	2 x 48 x 52	65	77.22	2.89	\$645	\$899	\$1008	\$1180
	SKBB5254	2 x 54 x 52	65	86.89	3.25	\$764	\$1049	\$1172	\$1366
	SKBB5260	2 x 60 x 52	65	96.52	3.61	\$830	\$1147	\$1283	\$1498
	SKBB5266	2 x 66 x 52	65	106.15	3.97	\$896	\$1245	\$1395	\$1631
	SKBB5272	2 x 72 x 52	65	115.78	4.33	\$962	\$1343	\$1506	\$1764
	SKBB5278	2 x 78 x 52	65	125.41	4.69	\$1027	\$1440	\$1616	\$1896
	SKBB5284	2 x 84 x 52	65	135.04	5.06	\$1247	\$1691	\$1882	\$2183
	<p>Backboard</p>	SKBB5836	2 x 36 x 58	65	64.63	2.42	\$533	\$745	\$837
SKBB5842		2 x 42 x 58	65	75.36	2.82	\$632	\$880	\$986	\$1154
SKBB5848		2 x 48 x 58	65	86.11	3.22	\$705	\$988	\$1110	\$1301
SKBB5854		2 x 54 x 58	65	96.89	3.63	\$832	\$1150	\$1287	\$1503
SKBB5860		2 x 60 x 58	65	107.63	4.03	\$905	\$1259	\$1411	\$1650
SKBB5866		2 x 66 x 58	65	118.38	4.43	\$979	\$1368	\$1535	\$1799
SKBB5872		2 x 72 x 58	65	129.13	4.83	\$1052	\$1477	\$1659	\$1946
SKBB5878		2 x 78 x 58	65	139.86	5.24	\$1125	\$1585	\$1782	\$2094
SKBB5884		2 x 84 x 58	65	150.61	5.64	\$1352	\$1847	\$2060	\$2395

Required specifications

- PET felt finish
- Laminate finish
- Edge finish*

BACKBOARDS - RIGHT RADIUS CORNER

MODEL#	DIMENSIONS	FREIGHT CLASS	WT/LBS.	CUBIC FT.	LP	DE	PT	VE
	D x W x H							
SKBBR3436	2 x 36 x 34	65	38.39	1.42	\$353	n/a	\$531	\$615
SKBBR3442	2 x 42 x 34	65	44.74	1.65	\$423	n/a	\$631	\$729
SKBBR3448	2 x 48 x 34	65	51.07	1.89	\$467	n/a	\$704	\$817
SKBBR3454	2 x 54 x 34	65	57.45	2.13	\$565	n/a	\$832	\$958
SKBBR3460	2 x 60 x 34	65	63.8	2.36	\$609	n/a	\$906	\$1046
SKBBR3466	2 x 66 x 34	65	70.13	2.6	\$653	n/a	\$979	\$1134
SKBBR3472	2 x 72 x 34	65	76.47	2.83	\$696	n/a	\$1052	\$1220
SKBBR3478	2 x 78 x 34	65	82.82	3.07	\$740	n/a	\$1125	\$1308
SKBBR3484	2 x 84 x 34	65	89.15	3.31	\$938	n/a	\$1353	\$1550
SKBBR4036	2 x 36 x 40	65	45.1	1.67	\$399	n/a	\$609	\$708
SKBBR4042	2 x 42 x 40	65	52.56	1.94	\$477	n/a	\$721	\$837
SKBBR4048	2 x 48 x 40	65	60.01	2.22	\$528	n/a	\$807	\$939
SKBBR4054	2 x 54 x 40	65	67.5	2.5	\$633	n/a	\$947	\$1096
SKBBR4060	2 x 60 x 40	65	74.94	2.78	\$684	n/a	\$1033	\$1198
SKBBR4066	2 x 66 x 40	65	82.39	3.06	\$735	n/a	\$1119	\$1301
SKBBR4072	2 x 72 x 40	65	89.86	3.33	\$787	n/a	\$1206	\$1404
SKBBR4078	2 x 78 x 40	65	97.31	3.61	\$838	n/a	\$1291	\$1506
SKBBR4084	2 x 84 x 40	65	104.76	3.89	\$1043	n/a	\$1531	\$1763
SKBBR4636	2 x 36 x 46	65	51.82	1.92	\$446	n/a	\$687	\$801
SKBBR4642	2 x 42 x 46	65	60.37	2.24	\$530	n/a	\$811	\$944
SKBBR4648	2 x 48 x 46	65	68.94	2.56	\$589	n/a	\$910	\$1062
SKBBR4654	2 x 54 x 46	65	77.54	2.88	\$701	n/a	\$1062	\$1233
SKBBR4660	2 x 60 x 46	65	86.11	3.19	\$760	n/a	\$1161	\$1351
SKBBR4666	2 x 66 x 46	65	94.66	3.51	\$818	n/a	\$1259	\$1468
SKBBR4672	2 x 72 x 46	65	103.23	3.83	\$877	n/a	\$1358	\$1586
SKBBR4678	2 x 78 x 46	65	111.79	4.15	\$936	n/a	\$1457	\$1704
SKBBR4684	2 x 84 x 46	65	120.36	4.47	\$1148	n/a	\$1709	\$1976
SKBBR5236	2 x 36 x 52	65	58.53	2.17	\$492	n/a	\$764	\$893
SKBBR5242	2 x 42 x 52	65	68.2	2.53	\$584	n/a	\$902	\$1052
SKBBR5248	2 x 48 x 52	65	77.87	2.89	\$649	n/a	\$1012	\$1184
SKBBR5254	2 x 54 x 52	65	87.59	3.25	\$769	n/a	\$1177	\$1371
SKBBR5260	2 x 60 x 52	65	97.26	3.61	\$835	n/a	\$1288	\$1503
SKBBR5266	2 x 66 x 52	65	106.93	3.97	\$901	n/a	\$1400	\$1636
SKBBR5272	2 x 72 x 52	65	116.61	4.33	\$968	n/a	\$1512	\$1770
SKBBR5278	2 x 78 x 52	65	126.28	4.69	\$1034	n/a	\$1623	\$1903
SKBBR5284	2 x 84 x 52	65	135.95	5.06	\$1253	n/a	\$1888	\$2189
SKBBR5836	2 x 36 x 58	65	65.24	2.42	\$538	n/a	\$842	\$985
SKBBR5842	2 x 42 x 58	65	76.03	2.82	\$637	n/a	\$991	\$1159
SKBBR5848	2 x 48 x 58	65	86.82	3.22	\$710	n/a	\$1115	\$1306
SKBBR5854	2 x 54 x 58	65	97.62	3.63	\$838	n/a	\$1293	\$1509
SKBBR5860	2 x 60 x 58	65	108.41	4.03	\$911	n/a	\$1417	\$1656
SKBBR5866	2 x 66 x 58	65	119.19	4.43	\$984	n/a	\$1540	\$1804
SKBBR5872	2 x 72 x 58	65	129.98	4.83	\$1058	n/a	\$1665	\$1952
SKBBR5878	2 x 78 x 58	65	140.77	5.24	\$1131	n/a	\$1788	\$2100
SKBBR5884	2 x 84 x 58	65	151.55	5.64	\$1358	n/a	\$2066	\$2401

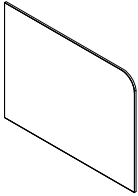

Low pressure laminate (LP)

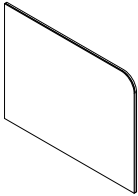

PET felt (PT)*

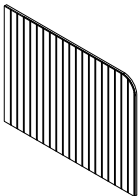

PET felt, equal pattern (VE-E)*

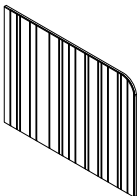

PET felt, varied pattern (VE-V)*

Backboard, Right Radius Corner

Required specifications

- PET felt finish
- Laminate finish
- Edge finish*

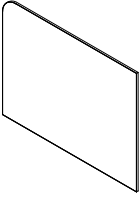
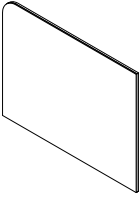
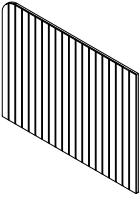
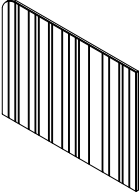

BACKBOARDS - LEFT RADIUS CORNER	MODEL#	DIMENSIONS	FREIGHT CLASS	WT/LBS.	CUBIC FT.	LP	DE	PT	VE
 <p>Low pressure laminate (LP)</p>		D x W x H							
	SKBBL3436	2 x 36 x 34	65	38.39	1.42	\$353	n/a	\$531	\$615
	SKBBL3442	2 x 42 x 34	65	44.74	1.65	\$423	n/a	\$631	\$729
	SKBBL3448	2 x 48 x 34	65	51.07	1.89	\$467	n/a	\$704	\$817
	SKBBL3454	2 x 54 x 34	65	57.45	2.13	\$565	n/a	\$832	\$958
	SKBBL3460	2 x 60 x 34	65	63.8	2.36	\$609	n/a	\$906	\$1046
	SKBBL3466	2 x 66 x 34	65	70.13	2.6	\$653	n/a	\$981	\$1134
	SKBBL3472	2 x 72 x 34	65	76.47	2.83	\$696	n/a	\$1052	\$1220
	SKBBL3478	2 x 78 x 34	65	82.82	3.07	\$740	n/a	\$1125	\$1308
	SKBBL3484	2 x 84 x 34	65	89.15	3.31	\$938	n/a	\$1353	\$1550
 <p>PET felt (PT)*</p>	SKBBL4036	2 x 36 x 40	65	45.1	1.67	\$399	n/a	\$609	\$708
	SKBBL4042	2 x 42 x 40	65	52.56	1.94	\$477	n/a	\$721	\$837
	SKBBL4048	2 x 48 x 40	65	60.01	2.22	\$528	n/a	\$807	\$939
	SKBBL4054	2 x 54 x 40	65	67.5	2.5	\$633	n/a	\$947	\$1096
	SKBBL4060	2 x 60 x 40	65	74.94	2.78	\$684	n/a	\$1033	\$1198
	SKBBL4066	2 x 66 x 40	65	82.39	3.06	\$735	n/a	\$1119	\$1301
	SKBBL4072	2 x 72 x 40	65	89.86	3.33	\$787	n/a	\$1206	\$1404
	SKBBL4078	2 x 78 x 40	65	97.31	3.61	\$838	n/a	\$1291	\$1506
	SKBBL4084	2 x 84 x 40	65	104.76	3.89	\$1043	n/a	\$1531	\$1763
	 <p>PET felt, equal pattern (VE-E)*</p>	SKBBL4636	2 x 36 x 46	65	51.82	1.92	\$446	n/a	\$687
SKBBL4642		2 x 42 x 46	65	60.37	2.24	\$530	n/a	\$811	\$944
SKBBL4648		2 x 48 x 46	65	68.94	2.56	\$589	n/a	\$910	\$1062
SKBBL4654		2 x 54 x 46	65	77.54	2.88	\$701	n/a	\$1062	\$1233
SKBBL4660		2 x 60 x 46	65	86.11	3.19	\$760	n/a	\$1161	\$1351
SKBBL4666		2 x 66 x 46	65	94.66	3.51	\$818	n/a	\$1259	\$1468
SKBBL4672		2 x 72 x 46	65	103.23	3.83	\$877	n/a	\$1358	\$1586
SKBBL4678		2 x 78 x 46	65	111.79	4.15	\$936	n/a	\$1457	\$1704
SKBBL4684		2 x 84 x 46	65	120.36	4.47	\$1148	n/a	\$1709	\$1976
 <p>PET felt, varied pattern (VE-V)*</p>		SKBBL5236	2 x 36 x 52	65	58.53	2.17	\$492	n/a	\$764
	SKBBL5242	2 x 42 x 52	65	68.2	2.53	\$584	n/a	\$902	\$1052
	SKBBL5248	2 x 48 x 52	65	77.87	2.89	\$649	n/a	\$1012	\$1184
	SKBBL5254	2 x 54 x 52	65	87.59	3.25	\$769	n/a	\$1177	\$1371
	SKBBL5260	2 x 60 x 52	65	97.26	3.61	\$835	n/a	\$1288	\$1503
	SKBBL5266	2 x 66 x 52	65	106.93	3.97	\$901	n/a	\$1400	\$1636
	SKBBL5272	2 x 72 x 52	65	116.61	4.33	\$968	n/a	\$1512	\$1770
	SKBBL5278	2 x 78 x 52	65	126.28	4.69	\$1034	n/a	\$1623	\$1903
	SKBBL5284	2 x 84 x 52	65	135.95	5.06	\$1253	n/a	\$1888	\$2189
	<p>Backboard, Left Radius Corner</p>	SKBBL5836	2 x 36 x 58	65	65.24	2.42	\$538	n/a	\$842
SKBBL5842		2 x 42 x 58	65	76.03	2.82	\$637	n/a	\$991	\$1159
SKBBL5848		2 x 48 x 58	65	86.82	3.22	\$710	n/a	\$1115	\$1306
SKBBL5854		2 x 54 x 58	65	97.62	3.63	\$838	n/a	\$1293	\$1509
SKBBL5860		2 x 60 x 58	65	108.41	4.03	\$911	n/a	\$1417	\$1656
SKBBL5866		2 x 66 x 58	65	119.19	4.43	\$984	n/a	\$1540	\$1804
SKBBL5872		2 x 72 x 58	65	129.98	4.83	\$1058	n/a	\$1665	\$1952
SKBBL5878		2 x 78 x 58	65	140.77	5.24	\$1131	n/a	\$1788	\$2100
SKBBL5884		2 x 84 x 58	65	151.55	5.64	\$1358	n/a	\$2066	\$2401

Required specifications

- PET felt finish
- Laminate finish
- Edge finish*

BACKBOARDS - RADIUS CORNERS AT TOP

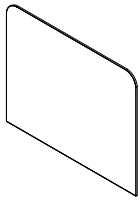

Low pressure laminate (LP)

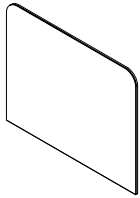

PET felt (PT)*

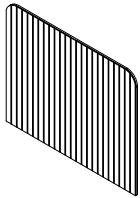

PET felt, equal pattern (VE-E)*

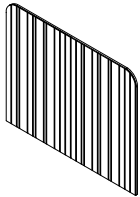

PET felt, varied pattern (VE-V)*

MODEL#	DIMENSIONS	FREIGHT CLASS	WT/LBS.	CUBIC FT.	LP	DE	PT	VE
D x W x H								
SKBBC3436	2 x 36 x 34	65	38.39	1.42	\$353	n/a	\$531	\$615
SKBBC3442	2 x 42 x 34	65	44.73	1.65	\$423	n/a	\$631	\$729
SKBBC3448	2 x 48 x 34	65	51.07	1.89	\$467	n/a	\$704	\$817
SKBBC3454	2 x 54 x 34	65	57.45	2.13	\$565	n/a	\$832	\$958
SKBBC3460	2 x 60 x 34	65	63.8	2.36	\$608	n/a	\$905	\$1045
SKBBC3466	2 x 66 x 34	65	70.13	2.6	\$652	n/a	\$978	\$1133
SKBBC3472	2 x 72 x 34	65	76.47	2.83	\$696	n/a	\$1052	\$1220
SKBBC3478	2 x 78 x 34	65	82.82	3.07	\$740	n/a	\$1126	\$1308
SKBBC3484	2 x 84 x 34	65	89.15	3.31	\$938	n/a	\$1353	\$1550
SKBBC4036	2 x 36 x 40	65	45.1	1.67	\$399	n/a	\$609	\$708
SKBBC4042	2 x 42 x 40	65	52.56	1.94	\$476	n/a	\$720	\$836
SKBBC4048	2 x 48 x 40	65	60.01	2.22	\$528	n/a	\$807	\$940
SKBBC4054	2 x 54 x 40	65	67.5	2.5	\$633	n/a	\$947	\$1096
SKBBC4060	2 x 60 x 40	65	74.94	2.78	\$684	n/a	\$1033	\$1198
SKBBC4066	2 x 66 x 40	65	82.39	3.06	\$735	n/a	\$1119	\$1301
SKBBC4072	2 x 72 x 40	65	89.86	3.33	\$787	n/a	\$1206	\$1404
SKBBC4078	2 x 78 x 40	65	97.31	3.61	\$838	n/a	\$1291	\$1506
SKBBC4084	2 x 84 x 40	65	104.76	3.89	\$1043	n/a	\$1531	\$1763
SKBBC4636	2 x 36 x 46	65	51.82	1.92	\$445	n/a	\$686	\$800
SKBBC4642	2 x 42 x 46	65	60.37	2.24	\$530	n/a	\$811	\$944
SKBBC4648	2 x 48 x 46	65	68.94	2.56	\$588	n/a	\$909	\$1061
SKBBC4654	2 x 54 x 46	65	77.54	2.88	\$701	n/a	\$1062	\$1233
SKBBC4660	2 x 60 x 46	65	86.11	3.19	\$760	n/a	\$1161	\$1351
SKBBC4666	2 x 66 x 46	65	94.66	3.51	\$818	n/a	\$1259	\$1468
SKBBC4672	2 x 72 x 46	65	103.23	3.83	\$877	n/a	\$1358	\$1587
SKBBC4678	2 x 78 x 46	65	111.79	4.15	\$936	n/a	\$1457	\$1705
SKBBC4684	2 x 84 x 46	65	120.36	4.47	\$1148	n/a	\$1709	\$1976
SKBBC5236	2 x 36 x 52	65	58.53	2.17	\$491	n/a	\$763	\$892
SKBBC5242	2 x 42 x 52	65	68.2	2.53	\$583	n/a	\$901	\$1051
SKBBC5248	2 x 48 x 52	65	77.87	2.89	\$649	n/a	\$1012	\$1184
SKBBC5254	2 x 54 x 52	65	87.59	3.25	\$769	n/a	\$1177	\$1371
SKBBC5260	2 x 60 x 52	65	97.26	3.61	\$835	n/a	\$1288	\$1503
SKBBC5266	2 x 66 x 52	65	106.92	3.97	\$901	n/a	\$1400	\$1636
SKBBC5272	2 x 72 x 52	65	116.61	4.33	\$967	n/a	\$1511	\$1769
SKBBC5278	2 x 78 x 52	65	126.28	4.69	\$1033	n/a	\$1622	\$1902
SKBBC5284	2 x 84 x 52	65	135.95	5.06	\$1253	n/a	\$1888	\$2189
SKBBC5836	2 x 36 x 58	65	65.24	2.42	\$538	n/a	\$842	\$985
SKBBC5842	2 x 42 x 58	65	76.03	2.82	\$637	n/a	\$991	\$1159
SKBBC5848	2 x 48 x 58	65	86.81	3.22	\$710	n/a	\$1115	\$1306
SKBBC5854	2 x 54 x 58	65	97.62	3.63	\$837	n/a	\$1292	\$1508
SKBBC5860	2 x 60 x 58	65	108.4	4.03	\$911	n/a	\$1417	\$1656
SKBBC5866	2 x 66 x 58	65	119.19	4.43	\$984	n/a	\$1540	\$1804
SKBBC5872	2 x 72 x 58	65	119.19	4.43	\$1058	n/a	\$1665	\$1952
SKBBC5878	2 x 78 x 58	65	140.76	5.24	\$1131	n/a	\$1788	\$2100
SKBBC5884	2 x 84 x 58	65	151.55	5.64	\$1358	n/a	\$2066	\$2401

Backboard, Radius Corners at Top

Required specifications

- PET felt finish
- Laminate finish
- Edge finish*

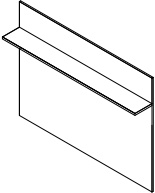
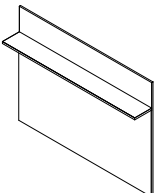
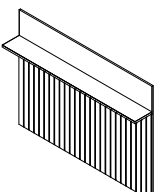
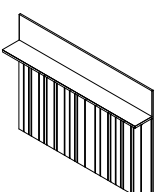

BACKBOARDS WITH SHELF	MODEL#	DIMENSIONS	FREIGHT CLASS	WT/LBS.	CUBIC FT.	LP	DE	PT	VE
 <p>Low pressure laminate (LP)</p>		D x W x H							
	SKBS4036	2 x 36 x 40	125	56.78	9.17	\$553	n/a	\$689	\$754
	SKBS4042	2 x 42 x 40	125	66.22	10.69	\$674	n/a	\$833	\$908
	SKBS4048	2 x 48 x 40	125	75.65	12.22	\$747	n/a	\$929	\$1015
	SKBS4054	2 x 54 x 40	125	85.11	13.75	\$879	n/a	\$1083	\$1180
	SKBS4060	2 x 60 x 40	125	94.54	15.28	\$953	n/a	\$1180	\$1287
	SKBS4066	2 x 66 x 40	125	103.98	16.81	\$1096	n/a	\$1346	\$1464
	SKBS4072	2 x 72 x 40	125	113.42	18.33	\$1169	n/a	\$1441	\$1570
	SKBS4078	2 x 78 x 40	125	122.84	19.86	\$1239	n/a	\$1534	\$1674
	SKBS4084	2 x 84 x 40	125	132.28	21.39	\$1389	n/a	\$1707	\$1857
 <p>PET felt (PT)*</p>	SKBS4636	2 x 36 x 46	125	63.46	10.54	\$599	n/a	\$767	\$846
	SKBS4642	2 x 42 x 46	125	74	12.3	\$727	n/a	\$923	\$1015
	SKBS4648	2 x 48 x 46	125	84.54	14.06	\$808	n/a	\$1031	\$1137
	SKBS4654	2 x 54 x 46	125	95.1	15.81	\$947	n/a	\$1198	\$1317
	SKBS4660	2 x 60 x 46	125	105.65	17.57	\$1028	n/a	\$1307	\$1439
	SKBS4666	2 x 66 x 46	125	116.19	19.33	\$1178	n/a	\$1485	\$1631
	SKBS4672	2 x 72 x 46	125	126.75	21.08	\$1259	n/a	\$1594	\$1753
	SKBS4678	2 x 78 x 46	125	137.29	22.84	\$1336	n/a	\$1699	\$1871
	SKBS4684	2 x 84 x 46	125	147.83	24.6	\$1494	n/a	\$1885	\$2070
	 <p>PET felt, equal pattern (VE-E)*</p>	SKBS5236	2 x 36 x 52	150	70.13	11.92	\$644	n/a	\$843
SKBS5242		2 x 42 x 52	150	81.79	13.9	\$780	n/a	\$1012	\$1122
SKBS5248		2 x 48 x 52	150	93.43	15.89	\$868	n/a	\$1133	\$1259
SKBS5254		2 x 54 x 52	150	105.11	17.88	\$1015	n/a	\$1313	\$1455
SKBS5260		2 x 60 x 52	150	116.77	19.86	\$1103	n/a	\$1434	\$1592
SKBS5266		2 x 66 x 52	150	128.42	21.85	\$1261	n/a	\$1626	\$1798
SKBS5272		2 x 72 x 52	150	140.08	23.83	\$1349	n/a	\$1747	\$1935
SKBS5278		2 x 78 x 52	150	151.72	25.82	\$1434	n/a	\$1865	\$2069
SKBS5284		2 x 84 x 52	150	163.38	27.81	\$1599	n/a	\$2063	\$2283
 <p>PET felt, varied pattern (VE-V)*</p>		SKBS5836	2 x 36 x 58	150	76.8	13.29	\$690	n/a	\$920
	SKBS5842	2 x 42 x 58	150	89.56	15.51	\$833	n/a	\$1102	\$1229
	SKBS5848	2 x 48 x 58	150	102.32	17.72	\$929	n/a	\$1236	\$1382
	SKBS5854	2 x 54 x 58	150	115.12	19.94	\$1083	n/a	\$1428	\$1592
	SKBS5860	2 x 60 x 58	150	127.88	22.15	\$1178	n/a	\$1562	\$1744
	SKBS5866	2 x 66 x 58	150	140.65	24.37	\$1344	n/a	\$1766	\$1966
	SKBS5872	2 x 72 x 58	150	153.43	26.58	\$1439	n/a	\$1899	\$2118
	SKBS5878	2 x 78 x 58	150	166.17	28.8	\$1531	n/a	\$2030	\$2266
	SKBS5884	2 x 84 x 58	150	178.95	31.01	\$1704	n/a	\$2241	\$2496

Backboard with Shelf

Required specifications

- PET felt finish
- Laminate finish
- Edge finish*

BACKBOARDS WITH DOUBLE SHELVES

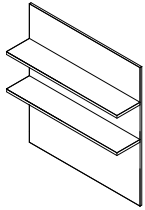

Low pressure laminate (LP)

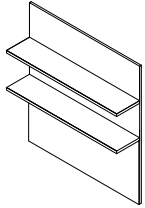

PET felt (PT)*

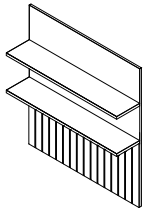

PET felt, equal pattern (VE-E)*

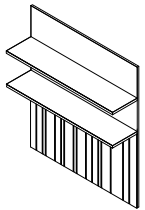

PET felt, varied pattern (VE-V)*

Backboard with Double Shelves

MODEL#	DIMENSIONS	FREIGHT CLASS	WT/LBS.	CUBIC FT.	LP	DE	PT	VE
	D x W x H							
SKBD4036	2 x 36 x 40	125	68.96	9.17	\$789	n/a	\$852	\$882
SKBD4042	2 x 42 x 40	125	80.42	10.69	\$981	n/a	\$1055	\$1089
SKBD4048	2 x 48 x 40	125	91.86	12.22	\$1077	n/a	\$1161	\$1201
SKBD4054	2 x 54 x 40	125	103.33	13.75	\$1289	n/a	\$1384	\$1428
SKBD4060	2 x 60 x 40	125	114.79	15.28	\$1385	n/a	\$1490	\$1540
SKBD4066	2 x 66 x 40	125	126.26	16.81	\$1621	n/a	\$1736	\$1791
SKBD4072	2 x 72 x 40	125	137.72	18.33	\$1717	n/a	\$1843	\$1902
SKBD4078	2 x 78 x 40	125	149.15	19.86	\$1806	n/a	\$1942	\$2007
SKBD4084	2 x 84 x 40	125	160.62	21.39	\$2056	n/a	\$2203	\$2272
SKBD4636	2 x 36 x 46	125	75.63	10.54	\$835	n/a	\$930	\$974
SKBD4642	2 x 42 x 46	125	88.2	12.3	\$1034	n/a	\$1144	\$1196
SKBD4648	2 x 48 x 46	125	100.75	14.06	\$1137	n/a	\$1263	\$1322
SKBD4654	2 x 54 x 46	125	113.32	15.81	\$1357	n/a	\$1499	\$1566
SKBD4660	2 x 60 x 46	125	125.9	17.57	\$1461	n/a	\$1618	\$1693
SKBD4666	2 x 66 x 46	125	138.47	19.33	\$1703	n/a	\$1876	\$1958
SKBD4672	2 x 72 x 46	125	151.05	21.08	\$1807	n/a	\$1996	\$2085
SKBD4678	2 x 78 x 46	125	163.6	22.84	\$1903	n/a	\$2107	\$2204
SKBD4684	2 x 84 x 46	125	176.17	24.6	\$2161	n/a	\$2381	\$2485
SKBD5236	2 x 36 x 52	125	82.3	11.92	\$881	n/a	\$1007	\$1066
SKBD5242	2 x 42 x 52	125	95.99	13.9	\$1087	n/a	\$1234	\$1303
SKBD5248	2 x 48 x 52	125	109.65	15.89	\$1198	n/a	\$1366	\$1445
SKBD5254	2 x 54 x 52	125	123.33	17.88	\$1425	n/a	\$1614	\$1703
SKBD5260	2 x 60 x 52	125	137.01	19.86	\$1536	n/a	\$1746	\$1845
SKBD5266	2 x 66 x 52	125	150.7	21.85	\$1786	n/a	\$2016	\$2126
SKBD5272	2 x 72 x 52	125	164.38	23.83	\$1897	n/a	\$2148	\$2267
SKBD5278	2 x 78 x 52	125	178.03	25.82	\$2001	n/a	\$2273	\$2402
SKBD5284	2 x 84 x 52	125	191.72	27.81	\$2265	n/a	\$2558	\$2697
SKBD5836	2 x 36 x 58	125	88.98	13.29	\$927	n/a	\$1084	\$1159
SKBD5842	2 x 42 x 58	125	103.76	15.51	\$1140	n/a	\$1323	\$1410
SKBD5848	2 x 48 x 58	125	118.54	17.72	\$1258	n/a	\$1468	\$1567
SKBD5854	2 x 54 x 58	125	133.34	19.94	\$1493	n/a	\$1729	\$1840
SKBD5860	2 x 60 x 58	125	148.13	22.15	\$1611	n/a	\$1873	\$1997
SKBD5866	2 x 66 x 58	125	162.93	24.37	\$1869	n/a	\$2157	\$2293
SKBD5872	2 x 72 x 58	125	177.73	26.58	\$1987	n/a	\$2301	\$2450
SKBD5878	2 x 78 x 58	125	192.48	28.8	\$2098	n/a	\$2438	\$2599
SKBD5884	2 x 84 x 58	125	207.28	31.01	\$2370	n/a	\$2736	\$2910

Required specifications

- PET felt finish
- Laminate finish
- Edge finish*

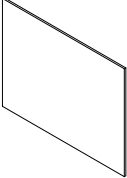
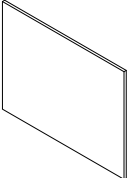
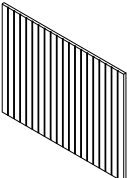
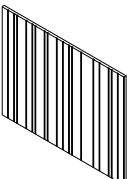

BACKBOARDS - BELOW OVERHEAD STORAGE

	MODEL#	DIMENSIONS	FREIGHT CLASS	WT/LBS.	CUBIC FT.	LP	DE	PT	VE
 <p>Low pressure laminate (LP) Dry erase whiteboard (DE)</p>		D x W x H							
	SKBOS4036	2 x 36 x 26	65	44.61	1.67	\$289	\$542	\$605	\$705
	SKBOS4042	2 x 42 x 26	65	52.02	1.94	\$349	\$644	\$717	\$833
	SKBOS4048	2 x 48 x 26	65	59.43	2.22	\$382	\$718	\$803	\$935
	SKBOS4054	2 x 54 x 26	65	66.88	2.5	\$470	\$848	\$943	\$1091
	SKBOS4060	2 x 60 x 26	65	74.29	2.78	\$504	\$924	\$1029	\$1194
	SKBOS4066	2 x 66 x 26	65	81.71	3.06	\$538	\$999	\$1115	\$1296
	SKBOS4072	2 x 72 x 26	65	89.12	3.33	\$571	\$1074	\$1200	\$1398
 <p>PET felt (PT)*</p>									
	SKBOS4636	2 x 36 x 32	65	51.28	1.92	\$335	\$610	\$683	\$797
	SKBOS4642	2 x 42 x 32	65	59.8	2.24	\$402	\$722	\$807	\$940
	SKBOS4648	2 x 48 x 32	65	68.33	2.56	\$443	\$809	\$905	\$1057
	SKBOS4654	2 x 54 x 32	65	76.87	2.88	\$538	\$949	\$1058	\$1229
	SKBOS4660	2 x 60 x 32	65	85.41	3.19	\$579	\$1035	\$1156	\$1346
	SKBOS4666	2 x 66 x 32	65	93.92	3.51	\$620	\$1122	\$1254	\$1463
	SKBOS4672	2 x 72 x 32	65	102.45	3.83	\$661	\$1208	\$1353	\$1581
 <p>PET felt, equal pattern (VE-E)*</p>									
	SKBOS5236	2 x 36 x 38	65	57.96	2.17	\$381	\$678	\$760	\$889
	SKBOS5242	2 x 42 x 38	65	67.59	2.53	\$455	\$801	\$897	\$1047
	SKBOS5248	2 x 48 x 38	65	77.22	2.89	\$504	\$899	\$1008	\$1180
	SKBOS5254	2 x 54 x 38	65	86.89	3.25	\$606	\$1050	\$1173	\$1366
	SKBOS5260	2 x 60 x 38	65	96.52	3.61	\$655	\$1148	\$1284	\$1499
	SKBOS5266	2 x 66 x 38	65	106.15	3.97	\$703	\$1245	\$1395	\$1631
	SKBOS5272	2 x 72 x 38	65	115.78	4.33	\$752	\$1343	\$1506	\$1764
 <p>PET felt, varied pattern (VE-V)*</p>									
	SKBOS5836	2 x 36 x 44	65	64.63	2.42	\$427	\$746	\$837	\$981
	SKBOS5842	2 x 42 x 44	65	75.36	2.82	\$508	\$880	\$986	\$1154
	SKBOS5848	2 x 48 x 44	65	86.11	3.22	\$564	\$988	\$1110	\$1302
	SKBOS5854	2 x 54 x 44	65	96.9	3.63	\$674	\$1151	\$1288	\$1503
	SKBOS5860	2 x 60 x 44	65	107.63	4.03	\$730	\$1259	\$1411	\$1651
	SKBOS5866	2 x 66 x 44	65	118.38	4.43	\$786	\$1368	\$1535	\$1799
	SKBOS5872	2 x 72 x 44	65	129.13	4.83	\$842	\$1477	\$1659	\$1946

Backboard for use below overhead storage

Required specifications

- PET felt finish
- Laminate finish
- Edge finish*

OVERHEAD STORAGE

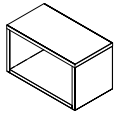

24" w - 33" w

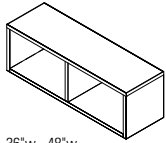

36" w - 48" w

Open Cubby Overhead

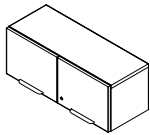

24" w - 39" w

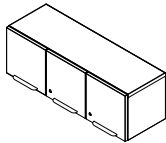

42" w

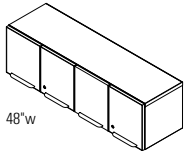

48" w

Hinged Door Overhead*

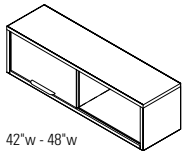

42" w - 48" w

Laminate Sliding Door Overhead*

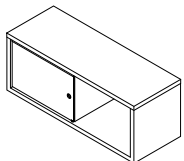

Glass Sliding Door Overhead

MODEL#	DIMENSIONS	FREIGHT CLASS	WT./LBS.	CUBIC FT.	LIST PRICE
	D x W x H				
SKSO01424	14 x 24 x 14	85	35.19	2.57	\$415
SKSO01430	14 x 30 x 14	85	41.78	3.22	\$488
SKSO01433	14 x 33 x 14	85	45.03	3.54	\$520
SKSO01436	14 x 36 x 14	85	52.68	3.86	\$604
SKSO01439	14 x 39 x 14	85	55.97	4.18	\$639
SKSO01442	14 x 42 x 14	85	59.29	4.5	\$694
SKSO01448	14 x 48 x 14	85	65.85	5.15	\$756

Wall mounted open cubby overhead. Must be installed flush with the top of high storage so that back board aligns. 24" to 33" wide units are a single open cubby. 36" to 48" wide units are a double open cubby with a center divider. Overheads include rails for mounting (hardware to affix to wall is not included). Specify laminate finish and edge finish for chassis. Specify paint finish for handles.

SKSOH1424	14 x 24 x 14	70	46.84	2.57	\$847
SKSOH1430	14 x 30 x 14	70	55.77	3.22	\$944
SKSOH1433	14 x 33 x 14	70	60.21	3.54	\$988
SKSOH1436	14 x 36 x 14	70	64.66	3.86	\$1046
SKSOH1439	14 x 39 x 14	70	69.11	4.18	\$1323
SKSOH1442	14 x 42 x 14	70	79.61	4.5	\$1439
SKSOH1448	14 x 48 x 14	70	93.53	5.15	\$1658

Wall mounted hinged door overhead. Must be installed flush with the top of high storage so that back board aligns. 24" to 39" wide units have two doors, 42" wide units have three doors, and 48" wide units have four doors. Overheads include rails for mounting (hardware to affix to wall is not included). Specify laminate finishes and edge finishes for chassis and doors. Specify paint finish for handles.

SKSOL1433	14 x 33 x 14	70	54.67	3.54	\$854
SKSOL1436	14 x 36 x 14	70	58.43	3.86	\$906
SKSOL1439	14 x 39 x 14	85	62.22	4.18	\$946
SKSOL1442	14 x 42 x 14	85	66.05	4.5	\$1006
SKSOL1448	14 x 48 x 14	85	73.6	5.15	\$1080

Wall mounted sliding door overhead. Must be installed flush with the top of high storage so that back board aligns. Sliding door is inset. One laminate non-locking door only. Overheads include rails for mounting (hardware to affix to wall is not included). Specify laminate finishes and edge finishes for chassis and door. Specify paint finish for handle.

SKSOG1433	14 x 33 x 14	85	49.16	3.54	\$1723
SKSOG1436	14 x 36 x 14	85	52.42	3.86	\$1806
SKSOG1439	14 x 39 x 14	85	55.7	4.18	\$1876
SKSOG1442	14 x 42 x 14	85	59.02	4.5	\$1966
SKSOG1448	14 x 48 x 14	85	65.58	5.15	\$2097

Wall mounted sliding door overhead. Must be installed flush with the top of high storage so that back board aligns. Sliding door is inset. One frosted glass non-locking door only. Includes a finger pull. Overheads include rails for mounting (hardware to affix to wall is not included). Specify laminate finish and edge finish for chassis.

Required specifications

- Laminate chassis finish
- Laminate front/door finish
- Paint finish* (handles)



LOW STORAGE	MODEL#	DIMENSIONS	FREIGHT CLASS	WT./LBS.	CUBIC FT.	LIST PRICE
-------------	--------	------------	---------------	----------	-----------	------------

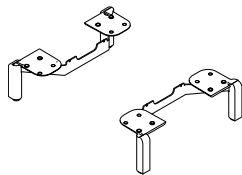

Low Storage Legs*

	D x W x H					
SKSLL	1.5 x 1.5 x 6	85	3.69	0.03		\$317

For use with 24" or 30" wide low storage units. *Cannot be used on 36" or longer width storage units or any high storage units.* Specify paint finish.

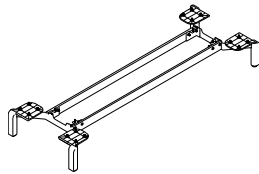

Storage Undercarriage*

SKSLU2018	20 x 18 x 6	150	10.21	2.1		\$764
SKSLU2024	20 x 24 x 6	150	10.9	2.3		\$796
SKSLU2030	20 x 30 x 6	150	11.25	2.5		\$827
SKSLU2036	20 x 36 x 6	85	11.53	2.5		\$837
SKSLU2042	20 x 42 x 6	85	12.56	2.92		\$852
SKSLU2048	20 x 48 x 6	85	13.59	3.33		\$883
SKSLU2054	20 x 54 x 6	85	14.62	3.75		\$915
SKSLU2060	20 x 60 x 6	85	15.65	4.17		\$946
SKSLU2066	20 x 66 x 6	85	16.68	4.58		\$977
SKSLU2072	20 x 72 x 6	85	17.71	5		\$1008
SKSLU2078	20 x 78 x 6	85	18.73	5.42		\$1039
SKSLU2084	20 x 84 x 6	85	19.76	5.83		\$1071

For use with all low storage units 36" and wider, all high storage units, or a mix thereof. **18" and 24" wide high storage must be ganged or anchored to another unit; cannot be freestanding.** Maximum number of units per undercarriage is one low and one high, or two low or two high. Specify paint finish.

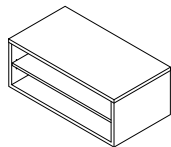

24" to 36"

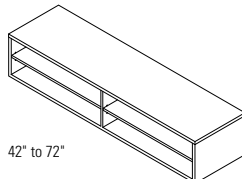

42" to 72"

Open Cubby w/Shelf, Low Storage

SKSLOS2024	20 x 24 x 14	70	58.29	3.76		\$611
SKSLOS2030	20 x 30 x 14	85	69.78	4.7		\$712
SKSLOS2036	20 x 36 x 14	85	81.2	5.64		\$815
SKSLOS2042	20 x 42 x 14	85	98.3	6.58		\$965
SKSLOS2048	20 x 48 x 14	85	109.75	7.52		\$1066
SKSLOS2054	20 x 54 x 14	85	121.2	8.46		\$1166
SKSLOS2060	20 x 60 x 14	85	132.72	9.4		\$1268
SKSLOS2066	20 x 66 x 14	85	144.18	10.34		\$1369
SKSLOS2072	20 x 72 x 14	85	155.69	11.29		\$1474

Open cubby low storage unit with an adjustable laminate shelf. Can be used as a standalone unit or with another low or high storage unit. 24" to 36" wide units are a single open cubby. 42" to 72" wide units are a double open cubby with a center divider. Specify laminate finish and edge finish for chassis.

- Legs or an undercarriage required on all storage and must be specified separately:
 - Specify SKSLL for 24" and 30" wide low storage units.
 - Specify SKSLU undercarriage for all low storage units 36" wide and greater, and all high storage units regardless of width.

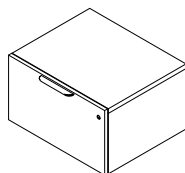

File Drawer, Low Storage*

SKSLFD2024	20 x 24 x 14	70	59.49	3.76		\$1375
SKSLFD2030	20 x 30 x 14	85	70.47	4.7		\$1517
SKSLFD2036	20 x 36 x 14	85	81.35	5.64		\$1646

Single file drawer low storage unit. Can be used as a standalone unit or with another low or high storage unit. Specify laminate finishes and edge finishes for chassis and drawer. Specify paint finish for handle.

- Legs or an undercarriage required on all storage and must be specified separately:
 - Specify SKSLL for 24" and 30" wide low storage units.
 - Specify SKSLU undercarriage for all low storage units 36" wide and greater, and all high storage units regardless of width.

Required specifications

- Laminate chassis finish
- Laminate door/drawer finish
- Paint finish*
- Legs/Undercarriage

LOW STORAGE

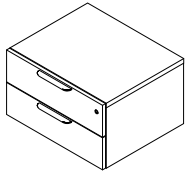

Box/Box Drawers

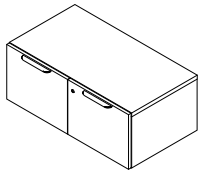

Hinged Doors

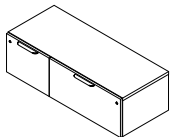

42" to 54" (42" shown)

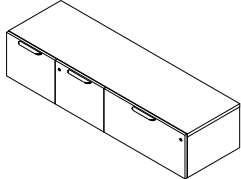

60" to 72" (60" shown)

Hinged Door/Lateral File

MODEL#	DIMENSIONS	FREIGHT CLASS	WT./LBS.	CUBIC FT.	LIST PRICE
D x W x H					
SKSLBB2024	20 x 24 x 14	70	59.49	3.76	\$1838
SKSLBB2030	20 x 30 x 14	70	71.06	4.7	\$1975
SKSLBB2036	20 x 36 x 14	85	81.97	5.64	\$2093

Two box drawer low storage unit. Can be used as a standalone unit or with another low or high storage unit. Specify laminate finishes and edge finishes for chassis and drawer. Specify paint finish for handle.

- Legs or an undercarriage required on all storage and must be specified separately:
 - Specify SKSLL for 24" and 30" wide low storage units.
 - Specify SKSLU undercarriage for all low storage units 36" wide and greater, and all high storage units regardless of width.

SKSLHD2024	20 x 24 x 14	70	70.02	3.76	\$1071
SKSLHD2030	20 x 30 x 14	70	83.89	4.7	\$1196
SKSLHD2036	20 x 36 x 14	70	97.66	5.64	\$1323

Hinged door low storage unit. Can be used as a standalone unit or with another low or high storage unit. Specify laminate finishes and edge finishes for chassis and drawer. Specify paint finish for handle.

- Legs or an undercarriage required on all storage and must be specified separately:
 - Specify SKSLL for 24" and 30" wide low storage units.
 - Specify SKSLU undercarriage for all low storage units 36" wide and greater, and all high storage units regardless of width.

SKSLCHLR2042	20 x 42 x 14	70	99.84	6.58	\$1993
SKSLCHLR2048	20 x 48 x 14	85	110.79	7.52	\$2097
SKSLCHLR2054	20 x 54 x 14	85	121.71	8.46	\$2227
SKSLCHLR2060	20 x 60 x 14	70	152.95	9.4	\$2608
SKSLCHLR2066	20 x 66 x 14	70	166.73	10.34	\$2734
SKSLCHLR2072	20 x 72 x 14	70	177.69	11.29	\$2865

Hinged door on the left and lateral file on the right low storage unit. Can be used as a standalone unit or with another low or high storage unit. Specify laminate finishes and edge finishes for chassis and doors/drawers. Specify paint finish for handle. Interior felt leg cover in Graphite (GPH) only.

- 2042, 2048, 2060 and 2066 units have a 30" lateral file, hinged door/door width is variable.
- 2054 and 2072 units have a 36" lateral file, hinged door/door width is variable.
- Specify SKSLU undercarriage for all low storage units 36" wide and greater, and all high storage units regardless of width.

Required specifications

- Laminate chassis finish
- Laminate door/drawer finish
- Paint finish
- Legs/Undercarriage



LOW STORAGE **MODEL#** **DIMENSIONS** **FREIGHT CLASS** **WT./LBS.** **CUBIC FT.** **LIST PRICE**

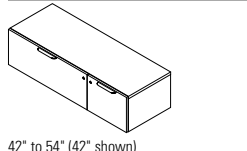

42" to 54" (42" shown)

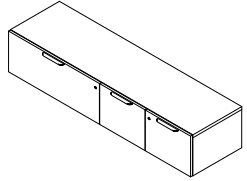

60" to 72" (60" shown)

Lateral File/Hinged Door

	D x W x H					
SKSLCHLL2042	20 x 42 x 14	70	99.84	6.58		\$1993
SKSLCHLL2048	20 x 48 x 14	85	110.79	7.52		\$2097
SKSLCHLL2054	20 x 54 x 14	85	121.71	8.46		\$2227
SKSLCHLL2060	20 x 60 x 14	70	152.95	9.4		\$2608
SKSLCHLL2066	20 x 66 x 14	70	166.73	10.34		\$2734
SKSLCHLL2072	20 x 72 x 14	70	177.69	11.29		\$2865

Hinged door on the right and lateral file on the left low storage unit. Can be used as a standalone unit or with another low or high storage unit. Specify laminate finishes and edge finishes for chassis and doors/drawers. Specify paint finish for handle. Interior felt leg cover in Graphite (**GPH**) only.

- 2042, 2048, 2060 and 2066 units have a 30" lateral file, hinged door/door width is variable.
- 2054 and 2072 units have a 36" lateral file, hinged door/door width is variable.
- Specify SKSLU undercarriage for all low storage units 36" wide and greater, and all high storage units regardless of width.

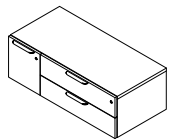

42" to 54" (42" shown)

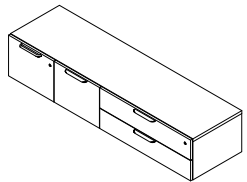

60" to 72" (60" shown)

Hinged Door/Box/Box File

SKSLCHDR2042	20 x 42 x 14	85	86.99	6.58		\$2132
SKSLCHDR2048	20 x 48 x 14	85	97.93	7.52		\$2236
SKSLCHDR2054	20 x 54 x 14	85	106.51	8.46		\$2324
SKSLCHDR2060	20 x 60 x 14	85	140.1	9.4		\$2747
SKSLCHDR2066	20 x 66 x 14	85	153.88	10.34		\$2873
SKSLCHDR2072	20 x 72 x 14	85	162.49	11.29		\$2961

Hinged door on the left and two box drawers on the right low storage unit. Can be used as a standalone unit or with another low or high storage unit. Specify laminate finishes and edge finishes for chassis and doors/drawers. Specify paint finish for handle. Interior felt leg cover in Graphite (**GPH**) only.

- 2042, 2048, 2060 and 2066 units have 30" box drawers, hinged door/door width is variable.
- 2054 and 2072 units have a 36" box drawers, hinged door/door width is variable.
- Specify SKSLU undercarriage for all low storage units 36" wide and greater, and all high storage units regardless of width.

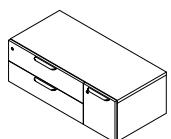

42" to 54" (42" shown)

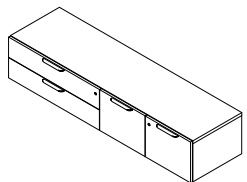

60" to 72" (60" shown)

Box/Box File/Hinged Door

SKSLCHDL2042	20 x 42 x 14	85	86.99	6.58		\$2132
SKSLCHDL2048	20 x 48 x 14	85	97.93	7.52		\$2236
SKSLCHDL2054	20 x 54 x 14	85	106.51	8.46		\$2324
SKSLCHDL2060	20 x 60 x 14	85	140.1	9.4		\$2747
SKSLCHDL2066	20 x 66 x 14	85	153.88	10.34		\$2873
SKSLCHDL2072	20 x 72 x 14	85	162.49	11.29		\$2961

Hinged door on the right and two box drawers on the left low storage unit. Can be used as a standalone unit or with another low or high storage unit. Specify laminate finishes and edge finishes for chassis and doors/drawers. Specify paint finish for handle. Interior felt leg cover in Graphite (**GPH**) only.

- 2042, 2048, 2060 and 2066 units have 30" box drawers, hinged door/door width is variable.
- 2054 and 2072 units have a 36" box drawers, hinged door/door width is variable.
- Specify SKSLU undercarriage for all low storage units 36" wide and greater, and all high storage units regardless of width.

Required specifications

- Laminate chassis finish
- Laminate door/drawer finish
- Paint finish
- Undercarriage

LOW STORAGE

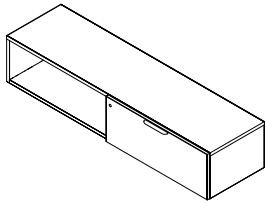

Open Cubby/Lateral File

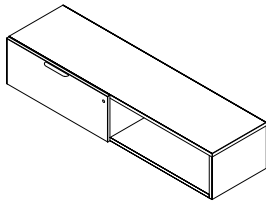

Lateral File/Open Cubby

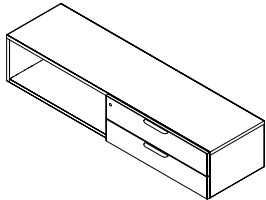

Open Cubby/Lateral File

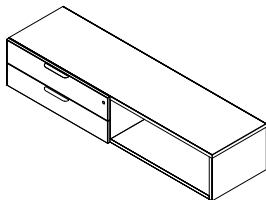

Lateral File/Open Cubby

MODEL#	DIMENSIONS	FREIGHT CLASS	WT/LBS.	CUBIC FT.	LIST PRICE
D x W x H					
SKSLCOLR2042	20 x 42 x 14	85	93.6	6.58	\$1725
SKSLCOLR2048	20 x 48 x 14	85	102.18	7.52	\$1805
SKSLCOLR2054	20 x 54 x 14	85	113.11	8.46	\$1935
SKSLCOLR2060	20 x 60 x 14	85	133.32	9.4	\$2076
SKSLCOLR2072	20 x 72 x 14	85	155.73	11.29	\$2309

Open cubby on the left and lateral file on the right low storage unit. Can be used as a standalone unit or with another low or high storage unit. Specify laminate finishes and edge finishes for chassis and drawer. Specify paint finish for handle. Interior felt leg cover in Graphite (**GPH**) only. An adjustable shelf is included for open cubby units 24" and wider.

- 2042, 2048, 2060 and 2066 units have a 30" lateral file, open cubby width is variable.
- 2054 and 2072 units have a 36" lateral file, open cubby width is variable
- Specify SKSLU undercarriage for all low storage units 36" wide and greater, and all high storage units regardless of width.

SKSLCOLL2042	20 x 42 x 14	85	93.6	6.58	\$1725
SKSLCOLL2048	20 x 48 x 14	85	102.18	7.52	\$1805
SKSLCOLL2054	20 x 54 x 14	85	113.11	8.46	\$1935
SKSLCOLL2060	20 x 60 x 14	85	133.32	9.4	\$2076
SKSLCOLL2072	20 x 72 x 14	85	155.73	11.29	\$2309

Open cubby on the right and lateral file on the left low storage unit. Can be used as a standalone unit or with another low or high storage unit. Specify laminate finishes and edge finishes for chassis and drawer. Specify paint finish for handle. Interior felt leg cover in Graphite (**GPH**) only. An adjustable shelf is included for open cubby units 24" and wider.

- 2042, 2048, 2060 and 2066 units have a 30" lateral file, open cubby width is variable.
- 2054 and 2072 units have a 36" lateral file, open cubby width is variable
- Specify SKSLU undercarriage for all low storage units 36" wide and greater, and all high storage units regardless of width.

SKSLCODR2042	20 x 42 x 14	85	80.75	6.58	\$1865
SKSLCODR2048	20 x 48 x 14	92.5	89.33	7.52	\$1944
SKSLCODR2054	20 x 54 x 14	92.5	97.91	8.46	\$2032
SKSLCODR2060	20 x 60 x 14	85	120.46	9.4	\$2215
SKSLCODR2072	20 x 72 x 14	85	140.53	11.29	\$2406

Open cubby on the left and lateral file on the right low storage unit. Can be used as a standalone unit or with another low or high storage unit. Specify laminate finishes and edge finishes for chassis and drawer. Specify paint finish for handle. Interior felt leg cover in Graphite (**GPH**) only. An adjustable shelf is included for open cubby units 24" and wider.

- 2042, 2048, 2060 and 2066 units have 30" box drawers, open cubby width is variable.
- 2054 and 2072 units have 36" box drawers, open cubby width is variable
- Specify SKSLU undercarriage for all low storage units 36" wide and greater, and all high storage units regardless of width.

SKSLCODL2042	20 x 42 x 14	85	80.75	6.58	\$1865
SKSLCODL2048	20 x 48 x 14	92.5	89.33	7.52	\$1944
SKSLCODL2054	20 x 54 x 14	92.5	97.91	8.46	\$2032
SKSLCODL2060	20 x 60 x 14	85	120.46	9.4	\$2215
SKSLCODL2072	20 x 72 x 14	85	140.53	11.29	\$2406

Open cubby on the left and lateral file on the right low storage unit. Can be used as a standalone unit or with another low or high storage unit. Specify laminate finishes and edge finishes for chassis and drawer. Specify paint finish for handle. Interior felt leg cover in Graphite (**GPH**) only. An adjustable shelf is included for open cubby units 24" and wider.

- 2042, 2048, 2060 and 2066 units have 30" box drawers, open cubby width is variable.
- 2054 and 2072 units have 36" box drawers, open cubby width is variable
- Specify SKSLU undercarriage for all low storage units 36" wide and greater, and all high storage units regardless of width.

Required specifications

- Laminate chassis finish
- Laminate door/drawer finish
- Paint finish
- Undercarriage

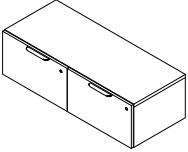
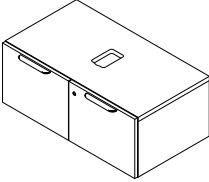
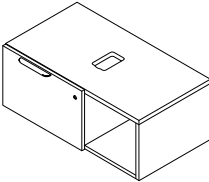
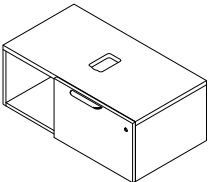

LOW STORAGE	MODEL#	DIMENSIONS	FREIGHT CLASS	WT./LBS.	CUBIC FT.	LIST PRICE
 <p>File/File Drawers</p>	D x W x H					
	SKSLCFF2048	20 x 48 x 14	70	115.86	7.52	\$2562
	SKSLCFF2060	20 x 60 x 14	85	137.82	9.4	\$2845
	SKSLCFF2072	20 x 72 x 14	85	159.67	11.29	\$3105
<p>File/file low storage unit. Can be used as a standalone unit or with another low or high storage unit. Specify laminate finishes and edge finishes for chassis and drawer. Specify paint finish for handle. Interior felt leg cover in Graphite (GPH) only. File drawers are of equal width.</p> <ul style="list-style-type: none"> • Undercarriage required on all storage and must be specified separately. Specify SKSLU undercarriage. 						
 <p>Hinged Doors w/Leg Grommet</p>	SKSLHDG2024	20 x 24 x 14	70	62.11	3.76	\$1090
	SKSLHDG2030	20 x 30 x 14	70	73.11	4.7	\$1193
	SKSLHDG2036	20 x 36 x 14	85	83.99	5.64	\$1296
	<p>Hinged door low storage unit with grommet for leg application. Can be used as a standalone unit or with another low or high storage unit. For use with 2 legged fixed or height adjustable column kits. Specify laminate finishes and edge finishes for chassis and drawer. Specify paint finish for handles. Interior felt leg cover in Graphite (GPH) only.</p> <ul style="list-style-type: none"> • Legs or an undercarriage required on all storage and must be specified separately: <ul style="list-style-type: none"> - Specify SKSLL for 24" and 30" wide low storage units. - Specify SKSLU undercarriage for all low storage units 36" wide and greater, and all high storage units regardless of width. 					
 <p>Hinged Door w/Leg Grommet/Open Cubby</p>	SKSLCHOR2030	20 x 30 x 14	70	72.13	4.7	\$1007
	SKSLCHOR2036	20 x 36 x 14	85	80.66	5.64	\$1085
	SKSLCHOR2042	20 x 42 x 14	70	100.32	6.58	\$1256
	SKSLCHOR2048	20 x 48 x 14	85	111.78	7.52	\$1357
	SKSLCHOR2054	20 x 54 x 14	85	123.26	8.46	\$1460
	<p>Hinged door with leg grommet on the left and open cubby on the right low storage unit. Can be used as a standalone unit or with another low or high storage unit. For use with 2 legged fixed or height adjustable column kits. Specify laminate finishes and edge finishes for chassis and drawer. Specify paint finish for handles. Interior felt leg cover in Graphite (GPH) only. An adjustable shelf is included for open cubby units 24" and wider.</p> <ul style="list-style-type: none"> • Legs or an undercarriage required on all storage and must be specified separately: <ul style="list-style-type: none"> - Specify SKSLL for 24" and 30" wide low storage units. - Specify SKSLU undercarriage for all low storage units 36" wide and greater, and all high storage units regardless of width. 					
 <p>Open Cubby/Hinged Door w/Leg Grommet</p>	SKSLCHOL2030	20 x 30 x 14	70	72.13	4.7	\$1007
	SKSLCHOL2036	20 x 36 x 14	70	72.13	4.7	\$1085
	SKSLCHOL2042	20 x 42 x 14	70	100.32	6.58	\$1256
	SKSLCHOL2048	20 x 48 x 14	85	111.78	7.52	\$1357
	SKSLCHOL2054	20 x 54 x 14	85	123.26	8.46	\$1460
	<p>Hinged door with leg grommet on the right and open cubby on the left low storage unit. Can be used as a standalone unit or with another low or high storage unit. For use with 2 legged fixed or height adjustable column kits. Specify laminate finishes and edge finishes for chassis and drawer. Specify paint finish for handles. Interior felt leg cover in Graphite (GPH) only. An adjustable shelf is included for open cubby units 24" and wider.</p> <ul style="list-style-type: none"> • Legs or an undercarriage required on all storage and must be specified separately: <ul style="list-style-type: none"> - Specify SKSLL for 24" and 30" wide low storage units. - Specify SKSLU undercarriage for all low storage units 36" wide and greater, and all high storage units regardless of width. 					

Required specifications

- Laminate chassis finish
- Laminate door/drawer finish
- Paint finish
- Legs/Undercarriage

LOW STORAGE

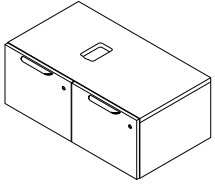

Hinged Door w/Leg Grommet/File Drawer

MODEL#	DIMENSIONS	FREIGHT CLASS	WT/LBS.	CUBIC FT.	LIST PRICE
D x W x H					
SKSLCHFR2036	20 x 36 x 14	70	90.42	5.64	\$1664
SKSLCHFR2042	20 x 42 x 14	70	101.58	6.58	\$2022
SKSLCHFR2048	20 x 48 x 14	85	112.53	7.52	\$2163
SKSLCHFR2054	20 x 54 x 14	85	123.45	8.46	\$2293

Hinged door with leg grommet on the left and file drawer on the right low storage unit. Can be used as a standalone unit or with another low or high storage unit. For use with 2 legged fixed or height adjustable column kits. Specify laminate finishes and edge finishes for chassis and doors. Specify paint finish for handles. Interior felt leg cover in Graphite (GPH) only. Hinged door side is 18" wide, file drawer width is variable.

- Storage undercarriage required on all storage 36" wide and greater, specified separately. Specify corresponding size SKSLU.

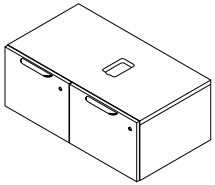

File Drawer/Hinged Door w/Leg Grommet

SKSLCHFL2036	20 x 36 x 14	70	90.42	5.64	\$1664
SKSLCHFL2042	20 x 42 x 14	70	101.58	6.58	\$2022
SKSLCHFL2048	20 x 48 x 14	85	112.53	7.52	\$2163
SKSLCHFL2054	20 x 54 x 14	85	123.45	8.46	\$2293

Hinged door with leg grommet on the right and file drawer on the left low storage unit. Can be used as a standalone unit or with another low or high storage unit. For use with 2 legged fixed or height adjustable column kits. Specify laminate finishes and edge finishes for chassis and doors. Specify paint finish for handles. Interior felt leg cover in Graphite (GPH) only. Hinged door side is 18" wide, file drawer width is variable.

- Storage undercarriage required on all storage 36" wide and greater, specified separately. Specify corresponding size SKSLU.

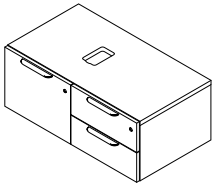

Hinged Door w/Leg Grommet/Box Drawers

SKSLCHBR2036	20 x 36 x 14	70	90.73	5.64	\$1877
SKSLCHBR2042	20 x 42 x 14	70	102.03	6.58	\$2484
SKSLCHBR2048	20 x 48 x 14	70	112.98	6.58	\$2620
SKSLCHBR2054	20 x 54 x 14	85	123.93	8.46	\$2739

Hinged door with leg grommet on the left and two box drawers on the right low storage unit. Can be used as a standalone unit or with another low or high storage unit. For use with 2 legged fixed or height adjustable column kits. Specify laminate finishes and edge finishes for chassis and doors. Specify paint finish for handles. Interior felt leg cover in Graphite (GPH) only. Hinged door side is 18" wide, box drawer width is variable.

- Storage undercarriage required on all storage 36" wide and greater, specified separately. Specify corresponding size SKSLU.

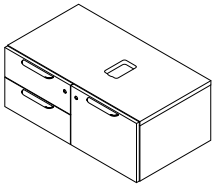

Box Drawers/Hinged Door w/Leg Grommet

SKSLCHBL2036	20 x 36 x 14	70	90.73	5.64	\$1877
SKSLCHBL2042	20 x 42 x 14	70	102.03	6.58	\$2484
SKSLCHBL2048	20 x 48 x 14	70	112.98	6.58	\$2620
SKSLCHBL2054	20 x 54 x 14	85	123.93	8.46	\$2739

Hinged door with leg grommet on the right and two box drawers on the left low storage unit. Can be used as a standalone unit or with another low or high storage unit. For use with 2 legged fixed or height adjustable column kits. Specify laminate finishes and edge finishes for chassis and doors. Specify paint finish for handles. Interior felt leg cover in Graphite (GPH) only. Hinged door side is 18" wide, box drawer width is variable.

- Storage undercarriage required on all storage 36" wide and greater, specified separately. Specify corresponding size SKSLU.

Required specifications

- Laminate chassis finish
- Laminate door/drawer finish
- Paint finish
- Undercarriage



LOW STORAGE **MODEL#** **DIMENSIONS** **FREIGHT CLASS** **WT/LBS.** **CUBIC FT.** **LIST PRICE**

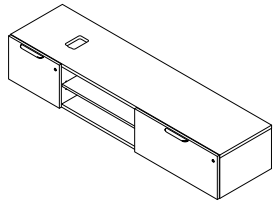

**Hinged Door w/Leg Grommet/
Open Cubby/File Drawer**

	D x W x H					
SKSLCHOFR2042	20 x 42 x 14	70	109.68	6.58		\$1820
SKSLCHOFR2048	20 x 48 x 14	70	118.26	7.52		\$1899
SKSLCHOFR2054	20 x 54 x 14	70	130.55	8.46		\$2280
SKSLCHOFR2060	20 x 60 x 14	85	139.19	9.4		\$2360
SKSLCHOFR2066	20 x 66 x 14	85	150.11	10.34		\$2501
SKSLCHOFR2072	20 x 72 x 14	85	161.07	11.29		\$2631
SKSLCHOEFR2072	20 x 72 x 14	85	169.07	11.29		\$2665
SKSLCHOFR2078	20 x 78 x 14	85	180.73	12.23		\$2769
SKSLCHOEFR2078	20 x 78 x 14	85	181.11	12.23		\$2728
SKSLCHOFR2084	20 x 84 x 14	85	191.64	13.17		\$2899
SKSLCHOEFR2084	20 x 84 x 14	85	192.04	13.17		\$2869

Hinged door with leg grommet on the left, open cubby at the center and file drawer on the right low storage unit. Can be used as a standalone unit or with another low or high storage unit. For use with 2 legged fixed or height adjustable column kits. Specify laminate finishes and edge finishes for chassis and drawer/door. Specify paint finish for handle. Interior felt leg cover in Graphite (**GPH**) only. Hinged door is 19" wide for all sizes. An adjustable shelf is included for open cubby units 24" and wider.

- 2042 and 2048 units have a 15" file drawer, open cubby width is variable.
- 2054, 2060 and E2078 units have a 24" file drawer, open cubby width is variable.
- 2066, E2072, 2078 and E2084 units have a 30" file drawer, open cubby width is variable.
- 2072 and 2084 units have a 36" file drawer, open cubby width is variable.
- Storage undercarriage required on all storage 36" wide and greater, specified separately. Specify corresponding size SKSLU.

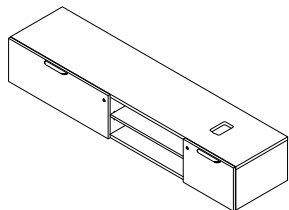

**File Drawer/Open Cubby/
Hinged Door w/Leg Grommet**

SKSLCHOFL2042	20 x 42 x 14	70	109.68	6.58		\$1820
SKSLCHOFL2048	20 x 48 x 14	70	118.26	7.52		\$1899
SKSLCHOFL2054	20 x 54 x 14	70	130.55	8.46		\$2280
SKSLCHOFL2060	20 x 60 x 14	85	139.19	9.4		\$2360
SKSLCHOFL2066	20 x 66 x 14	85	150.11	10.34		\$2501
SKSLCHOFL2072	20 x 72 x 14	85	161.07	11.29		\$2631
SKSLCHOEFL2072	20 x 72 x 14	85	169.07	11.29		\$2665
SKSLCHOFL2078	20 x 78 x 14	85	180.73	12.23		\$2769
SKSLCHOEFL2078	20 x 78 x 14	85	181.11	12.23		\$2728
SKSLCHOFL2084	20 x 84 x 14	85	191.64	13.17		\$2899
SKSLCHOEFL2084	20 x 84 x 14	85	192.04	13.17		\$2869

File drawer on the left, open cubby at the center and hinged door with leg grommet on the right low storage unit. Can be used as a standalone unit or with another low or high storage unit. For use with 2 legged fixed or height adjustable column kits. Specify laminate finishes and edge finishes for chassis and drawer/door. Specify paint finish for handle. Interior felt leg cover in Graphite (**GPH**) only. Hinged door is 19" wide for all sizes. An adjustable shelf is included for open cubby units 24" and wider.

- 2042 and 2048 units have a 15" file drawer, open cubby width is variable.
- 2054, 2060 and E2078 units have a 24" file drawer, open cubby width is variable.
- 2066, E2072, 2078 and E2084 units have a 30" file drawer, open cubby width is variable.
- 2072 and 2084 units have a 36" file drawer, open cubby width is variable.
- Storage undercarriage required on all storage 36" wide and greater, specified separately. Specify corresponding size SKSLU.

Required specifications

- Laminate chassis finish
- Laminate door/drawer finish
- Paint finish
- Undercarriage

LOW STORAGE

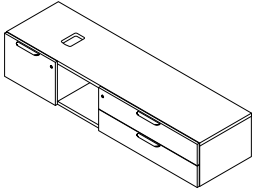

**Hinged Door w/Leg Grommet/
Open Cubby, Box/Box Drawers**

MODEL#	DIMENSIONS	FREIGHT CLASS	WT/LBS.	CUBIC FT.	LIST PRICE
D x W x H					
SKSLCHODR2042	20 x 42 x 14	70	110.31	6.58	\$2031
SKSLCHODR2048	20 x 48 x 14	70	118.89	7.52	\$2110
SKSLCHODR2054	20 x 54 x 14	70	131.33	8.46	\$2745
SKSLCHODR2060	20 x 60 x 14	85	139.98	9.4	\$2825
SKSLCHODR2066	20 x 66 x 14	85	150.9	10.34	\$2960
SKSLCHODR2072	20 x 72 x 14	85	161.88	11.29	\$3080
SKSLCHOEDR2072	20 x 72 x 14	70	170.14	11.29	\$3128
SKSLCHODR2078	20 x 78 x 14	85	181.52	12.23	\$3228
SKSLCHOEDR2078	20 x 78 x 14	85	182.18	12.23	\$3196
SKSLCHODR2084	20 x 84 x 14	85	192.46	13.17	\$3347
SKSLCHOEDR2084	20 x 84 x 14	85	193.12	13.17	\$3332

Hinged door with leg grommet on the left, open cubby at the center and two box drawers on the right low storage unit. Can be used as a standalone unit or with another low or high storage unit. For use with 2 legged fixed or height adjustable column kits. Specify laminate finishes and edge finishes for chassis and drawer/door. Specify paint finish for handle. Interior felt leg cover in Graphite (GPH) only. Hinged door is 19" wide for all sizes. An adjustable shelf is included for open cubby units 24" and wider.

- 2042 and 2048 units have 15" box drawers, open cubby width is variable.
- 2054, 2060 and E2078 units have 24" box drawers, open cubby width is variable.
- 2066, E2072, 2078 and E2084 units have 30" box drawers, open cubby width is variable.
- 2072 and 2084 units have 36" box drawers, open cubby width is variable.
- Storage undercarriage required on all storage 36" wide and greater, specified separately. Specify corresponding size SKSLU.

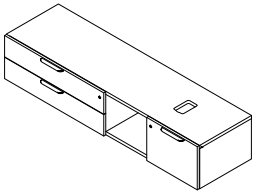

**Box/Box Drawers/Open Cubby/
Hinged Door w/Leg Grommet**

SKSLCHODL2042	20 x 42 x 14	70	110.31	6.58	\$2031
SKSLCHODL2048	20 x 48 x 14	70	118.89	7.52	\$2110
SKSLCHODL2054	20 x 54 x 14	70	131.33	8.46	\$2745
SKSLCHODL2060	20 x 60 x 14	85	139.98	9.4	\$2825
SKSLCHODL2066	20 x 66 x 14	85	150.9	10.34	\$2960
SKSLCHODL2072	20 x 72 x 14	85	161.88	11.29	\$3080
SKSLCHOEDL2072	20 x 72 x 14	70	170.14	11.29	\$3128
SKSLCHODL2078	20 x 78 x 14	85	181.52	12.23	\$3228
SKSLCHOEDL2078	20 x 78 x 14	85	182.18	12.23	\$3196
SKSLCHODL2084	20 x 84 x 14	85	192.46	13.17	\$3347
SKSLCHOEDL2084	20 x 84 x 14	85	193.12	13.17	\$3332

Two box drawers on the left, open cubby at the center and hinged door with leg grommet on the right low storage unit. Can be used as a standalone unit or with another low or high storage unit. For use with 2 legged fixed or height adjustable column kits. Specify laminate finishes and edge finishes for chassis and drawer/door. Specify paint finish for handle. Interior felt leg cover in Graphite (GPH) only. Hinged door is 19" wide for all sizes. An adjustable shelf is included for open cubby units 24" and wider.

- 2042 and 2048 units have 15" box drawers, open cubby width is variable.
- 2054, 2060 and E2078 units have 24" box drawers, open cubby width is variable.
- 2066, E2072, 2078 and E2084 units have 30" box drawers, open cubby width is variable.
- 2072 and 2084 units have 36" box drawers, open cubby width is variable.
- Storage undercarriage required on all storage 36" wide and greater, specified separately. Specify corresponding size SKSLU.

Required specifications

- Laminate chassis finish
- Laminate door/drawer finish
- Paint finish
- Undercarriage



LOW STORAGE **MODEL#** **DIMENSIONS** **FREIGHT CLASS** **WT./LBS.** **CUBIC FT.** **LIST PRICE**

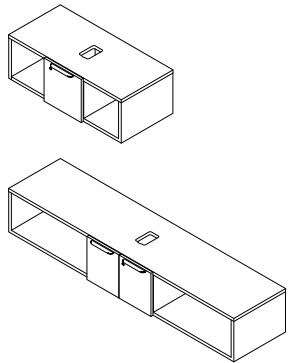

Open Cubby/Hinged Door w/Leg Grommet/Open Cubby

	D x W x H					
SKSLCOHO2042	20 x 42 x 14	85	94.55	6.58		\$1171
SKSLCOHO2048	20 x 48 x 14	85	108.42	7.52		\$1507
SKSLCOHO2054	20 x 54 x 14	85	119.38	8.46		\$1611
SKSLCOHO2060	20 x 60 x 14	85	128.02	9.4		\$1690
SKSLCOHO2066	20 x 66 x 14	85	136.57	10.34		\$1769
SKSLCOHO2072	20 x 72 x 14	85	145.18	11.29		\$1849
SKSLCOHO2078	20 x 78 x 14	85	164.8	12.23		\$2019
SKSLCOHO2084	20 x 84 x 14	85	173.85	13.17		\$2095

Open cubby on left and right, hinged door with leg grommet at the center low storage unit. Can be used as a standalone unit or with another low or high storage unit. For use with 2 legged fixed or height adjustable column kits. Specify laminate finishes and edge finishes for chassis and drawer/door. Specify paint finish for handle. Interior felt leg cover in Graphite (**GPH**) only. An adjustable shelf is included for open cubby units 24" and wider.

- 2042 has a 14" wide hinged door with leg grommet, open cubby widths are variable.
- 2048 and 2084 units have a 24" wide hinged door with leg grommet, open cubby widths are variable.
- 2054, 2060, 2066, 2072 and 2078 units have a 30" wide hinged door with leg grommet, remainder are the open cubbies.
- Storage undercarriage required on all storage 36" wide and greater, specified separately. Specify corresponding size SKSLU.

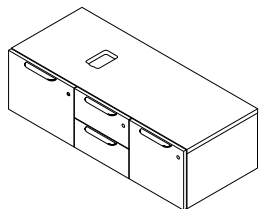

Hinged Door w/Leg Grommet/Box/Box Drawers/File Drawer

SKSLCHBFR2048	20 x 48 x 14	70	126.76	7.52		\$2658
SKSLCHBFR2066	20 x 66 x 14	70	160.09	10.34		\$3753
SKSLCHBFR2072	20 x 72 x 14	70	171.07	11.29		\$3895
SKSLCHBFR2078	20 x 78 x 14	85	182.04	12.23		\$4031
SKSLCHBFR2084	20 x 84 x 14	85	192.95	13.17		\$4161

Hinged door with leg grommet on the left, two box drawers at the center, and a file drawer on the right low storage unit. Can be used as a standalone unit or with another low or high storage unit. For use with 2 legged fixed or height adjustable column kits. Specify laminate finishes and edge finishes for chassis and drawer/doors. Specify paint finish for handle. Interior felt leg cover in Graphite (**GPH**) only. Hinged door is 19" wide for all sizes. An adjustable shelf is included for open cubby units 24" and wider.

- 2048 has 15" wide box and file drawers.
- 2066 and 2072 have 24" wide box drawers, 2078 and 2084 have 30" wide box drawers.
- 2066 has a 24" wide file drawer, 2072 and 2078 have 30" wide file drawer and 2084 has a 36" wide file drawer.
- Storage undercarriage required on all storage 36" wide and greater, specified separately. Specify corresponding size SKSLU.

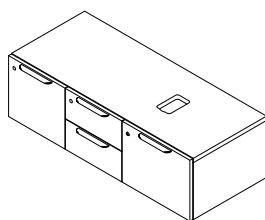

File Drawer/Box/Box Drawers Hinged Door w/Leg Grommet/

SKSLCHBFL2048	20 x 48 x 14	70	126.76	7.52		\$2658
SKSLCHBFL2066	20 x 66 x 14	70	160.09	10.34		\$3753
SKSLCHBFL2072	20 x 72 x 14	70	171.07	11.29		\$3895
SKSLCHBFL2078	20 x 78 x 14	85	182.04	12.23		\$4031
SKSLCHBFL2084	20 x 84 x 14	85	192.95	13.17		\$4161

Hinged door with leg grommet on the left, two box drawers at the center, and a file drawer on the right low storage unit. Can be used as a standalone unit or with another low or high storage unit. For use with 2 legged fixed or height adjustable column kits. Specify laminate finishes and edge finishes for chassis and drawer/doors. Specify paint finish for handle. Interior felt leg cover in Graphite (**GPH**) only. Hinged door is 19" wide for all sizes. An adjustable shelf is included for open cubby units 24" and wider.

- 2048 has 15" wide box and file drawers.
- 2066 and 2072 have 24" wide box drawers, 2078 and 2084 have 30" wide box drawers.
- 2066 has a 24" wide file drawer, 2072 and 2078 have 30" wide file drawer and 2084 has a 36" wide file drawer.
- Storage undercarriage required on all storage 36" wide and greater, specified separately. Specify corresponding size SKSLU.

Required specifications

- Laminate chassis finish
- Laminate door/drawer finish
- Paint finish
- Undercarriage

LOW STORAGE, SINGLE GROMMET

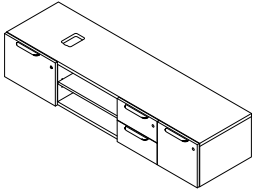

Hinged Door w/Leg Grommet/Open Cubby/Box/Box Drawers/File Drawer

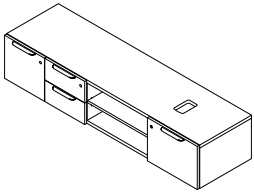

File Drawer/Box/Box Drawers/Open Cubby/Hinged Door w/Leg Grommet

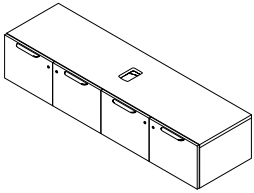

Hinged Doors w/Leg Grommet

MODEL#	DIMENSIONS D x W x H	FREIGHT CLASS	WT/LBS.	CUBIC FT.	LIST PRICE
SKSLCHOBFR2060	20 x 60 x 14	70	149.96	9.4	\$2867
SKSLCHOBFR2066	20 x 66 x 14	70	158.5	10.34	\$2946
SKSLCHOBFR2072	20 x 72 x 14	70	178.13	11.29	\$3116
SKSLCHOBFR2078	20 x 78 x 14	70	189.6	12.23	\$3217
SKSLCHOBFR2084	20 x 84 x 14	70	201.07	13.17	\$3320

Hinged door with leg grommet on the left, open cubby and two box drawers at the center, and a file drawer on the right low storage unit. Can be used as a standalone unit or with another low or high storage unit. For use with 2 legged fixed or height adjustable column kits. Specify laminate finishes and edge finishes for chassis and drawer/doors. Specify paint finish for handle. Interior felt leg cover in Graphite (**GPH**) only. Hinged door is 19" wide for all sizes. Box and file drawers are 15" wide for all sizes. Open cubby width is variable. An adjustable shelf is included for open cubby units 24" and wider.

- Storage undercarriage required on all storage 36" wide and greater, specified separately. Specify corresponding size SKSLU.

SKSLCHOBFL2060	20 x 60 x 14	70	149.96	9.4	\$2867
SKSLCHOBFL2066	20 x 66 x 14	70	158.5	10.34	\$2946
SKSLCHOBFL2072	20 x 72 x 14	70	178.13	11.29	\$3116
SKSLCHOBFL2078	20 x 78 x 14	70	189.6	12.23	\$3217
SKSLCHOBFL2084	20 x 84 x 14	70	201.07	13.17	\$3320

File drawer on right, open cubby and two box drawers at the center, and a hinged door with leg grommet on the right low storage unit. Can be used as a standalone unit or with another low or high storage unit. For use with 2 legged fixed or height adjustable column kits. Specify laminate finishes and edge finishes for chassis and drawer/doors. Specify paint finish for handle. Interior felt leg cover in Graphite (**GPH**) only. Hinged door is 19" wide for all sizes. Box and file drawers are 15" wide for all sizes. Open cubby width is variable. An adjustable shelf is included for open cubby units 24" and wider.

- Storage undercarriage required on all storage 36" wide and greater, specified separately. Specify corresponding size SKSLU.

SKSLCHDG2072	20 x 72 x 14	85	164.74	11.29	\$2457
SKSLCHDG2078	20 x 78 x 14	70	210.44	12.23	\$2982
SKSLCHDG2084	20 x 84 x 14	70	223.71	13.17	\$3103

Hinged door low storage unit with leg grommet at the center. Can be used as a standalone unit or with another low or high storage unit. For use with 2 legged fixed or height adjustable column kits. Specify laminate finishes and edge finishes for chassis and doors. Specify paint finish for handles. Interior felt leg cover in Graphite (**GPH**) only. 72" wide unit has 4 doors and the 78" and 84" wide units have 5 doors.

- Storage undercarriage required on all storage 36" wide and greater, specified separately. Specify corresponding size SKSLU.

Required specifications

- Laminate chassis finish
- Laminate door/drawer finish
- Paint finish
- Undercarriage



LOW STORAGE, DOUBLE GROMMETS **MODEL#** **DIMENSIONS** **FREIGHT CLASS** **WT./LBS.** **CUBIC FT.** **LIST PRICE**

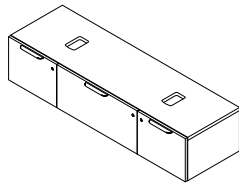

Hinged Door w/Leg Grommet/File Drawer/Hinged Door w/Leg Grommet

	D x W x H					
SKSLCHF2060	20 x 60 x 14	70	143.42	9.4		\$2666
SKSLCHF2066	20 x 66 x 14	85	154.33	10.34		\$2807
SKSLCHF2072	20 x 72 x 14	85	165.29	11.29		\$2938

Hinged door with leg grommet on the left, file drawer at the center, and a hinged door with leg grommet on the right low storage unit. Can be used as a standalone unit or with another low or high storage unit. For use with 3 legged fixed or height adjustable column kits. Specify laminate finishes and edge finishes for chassis and drawer/doors. Specify paint finish for handle. Interior felt leg cover in Graphite (**GPH**) only. Hinged door is 18" wide on each side for all sizes. File drawer width is variable.

- Storage undercarriage required on all storage 36" wide and greater, specified separately. Specify corresponding size SKSLU.

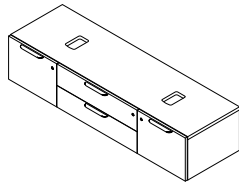

Hinged Door w/Leg Grommet/Box/Box Drawers/Hinged Door w/Leg Grommet

SKSLCHB2060	20 x 60 x 14	70	144.01	9.4		\$3129
SKSLCHB2066	20 x 66 x 14	85	154.93	10.34		\$3265
SKSLCHB2072	20 x 72 x 14	85	165.92	11.29		\$3385

Hinged door with leg grommet on the left, two box drawers at the center, and a hinged door with leg grommet on the right low storage unit. Can be used as a standalone unit or with another low or high storage unit. For use with 3 legged fixed or height adjustable column kits. Specify laminate finishes and edge finishes for chassis and drawer/doors. Specify paint finish for handle. Interior felt leg cover in Graphite (**GPH**) only. Hinged door is 18" wide on each side for all sizes. Box drawer width is variable.

- Storage undercarriage required on all storage 36" wide and greater, specified separately. Specify corresponding size SKSLU.

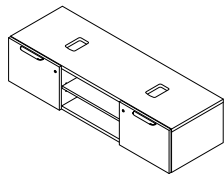

Hinged Door w/Leg Grommet/Open Cubby/Hinged Door w/Leg Grommet

SKSLCHO2060	20 x 60 x 14	70	142.21	9.4		\$1902
SKSLCHO2066	20 x 66 x 14	85	153.63	10.34		\$2003
SKSLCHO2072	20 x 72 x 14	85	165.13	11.29		\$2106

Hinged door with leg grommet on the left, an open cubby at the center, and a hinged door with leg grommet on the right low storage unit. Can be used as a standalone unit or with another low or high storage unit. For use with 3 legged fixed or height adjustable column kits. Specify laminate finishes and edge finishes for chassis and drawer/doors. Specify paint finish for handle. Interior felt leg cover in Graphite (**GPH**) only. Hinged door is 19" wide on each side for all sizes. Open cubby width is variable. An adjustable shelf is included for open cubby units 24" and wider.

- Storage undercarriage required on all storage 36" wide and greater, specified separately. Specify corresponding size SKSLU.

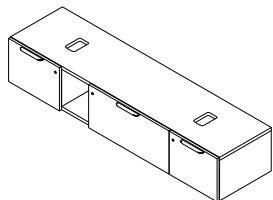

Hinged Door w/Leg Grommet/Open Cubby File Drawer/Hinged Door w/Leg Grommet

SKSLCHOF2078	20 x 78 x 14	85	177.52	12.23		\$3016
SKSLCHOF2084	20 x 84 x 14	85	186.08	13.17		\$3095

Hinged door with leg grommet on the left, open cubby and file drawer at the center, and a hinged door with leg grommet on the right low storage unit. Can be used as a standalone unit or with another low or high storage unit. For use with 3 legged fixed or height adjustable column kits. Specify laminate finishes and edge finishes for chassis and drawer/doors. Specify paint finish for handle. Interior felt leg cover in Graphite (**GPH**) only. Hinged door is 18" wide on each side for all sizes. Lateral file is 30" wide, open cubby width is variable.

- Storage undercarriage required on all storage 36" wide and greater, specified separately. Specify corresponding size SKSLU.

Required specifications

- Laminate chassis finish
- Laminate door/drawer finish
- Paint finish
- Undercarriage

LOW STORAGE, DOUBLE GROMMETS

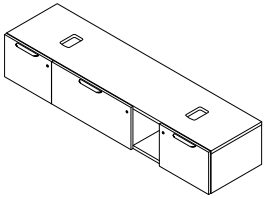

**Hinged Door w/Leg Grommet/File Drawer
Open Cubby/Hinged Door w/Leg Grommet**

MODEL#	DIMENSIONS D x W x H	FREIGHT CLASS	WT/LBS.	CUBIC FT.	LIST PRICE
SKSLCHOFHL2078	20 x 78 x 14	85	177.52	12.23	\$3016
SKSLCHOFHL2084	20 x 84 x 14	85	186.08	13.17	\$3095

Hinged door with leg grommet on the left, file drawer and open cubby at the center, and a hinged door with leg grommet on the right low storage unit. Can be used as a standalone unit or with another low or high storage unit. For use with 3 legged fixed or height adjustable column kits. Specify laminate finishes and edge finishes for chassis and drawer/doors. Specify paint finish for handle. Interior felt leg cover in Graphite (**GPH**) only. Hinged door is 18" wide on each side for all sizes. Lateral file is 30" wide, open cubby width is variable.

- Storage undercarriage required on all storage 36" wide and greater, specified separately. Specify corresponding size SKSLU.

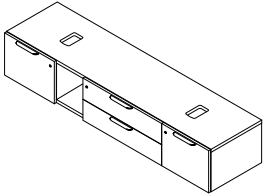

**Hinged Doors w/Leg Grommets/
Open Cubby/Box Drawers**

SKSLCHOBHR2078	20 x 78 x 14	85	178.11	12.23	\$3474
SKSLCHOBHR2084	20 x 84 x 14	85	186.68	13.17	\$3553

Hinged door with leg grommet on the left, open cubby and two box drawers at the center, and a hinged door with leg grommet on the right low storage unit. Can be used as a standalone unit or with another low or high storage unit. For use with 3 legged fixed or height adjustable column kits. Specify laminate finishes and edge finishes for chassis and drawer/doors. Specify paint finish for handle. Interior felt leg cover in Graphite (**GPH**) only. Hinged door is 18" wide on each side for all sizes. Box drawers are 30" wide, open cubby width is variable.

- Storage undercarriage required on all storage 36" wide and greater, specified separately. Specify corresponding size SKSLU.

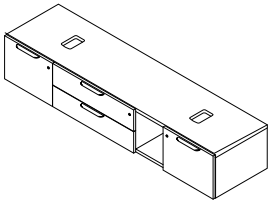

**Hinged Doors w/Leg Grommets/
Box Drawers/Open Cubby**

SKSLCHOBHL2078	20 x 78 x 14	85	178.11	12.23	\$3474
SKSLCHOBHL2084	20 x 84 x 14	85	186.68	13.17	\$3553

Hinged door with leg grommet on the left, two box drawers and open cubby at the center, and a hinged door with leg grommet on the right low storage unit. Can be used as a standalone unit or with another low or high storage unit. For use with 3 legged fixed or height adjustable column kits. Specify laminate finishes and edge finishes for chassis and drawer/doors. Specify paint finish for handle. Interior felt leg cover in Graphite (**GPH**) only. Hinged door is 18" wide on each side for all sizes. Box drawers are 30" wide, open cubby width is variable.

- Storage undercarriage required on all storage 36" wide and greater, specified separately. Specify corresponding size SKSLU.

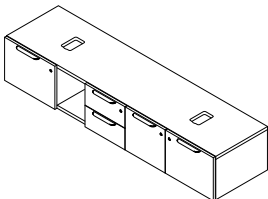

**Hinged Doors w/Leg Grommets/Open
Cubby/Box Drawers/File Drawer**

SKSLCHOBFHR2078	20 x 78 x 14	70	191.89	12.23	\$3512
SKSLCHOBFHR2084	20 x 84 x 14	70	200.45	13.17	\$3591

Hinged door with leg grommet on the left, open cubby, two box drawers and a file drawer at the center, and a hinged door with leg grommet on the right low storage unit. Can be used as a standalone unit or with another low or high storage unit. For use with 3 legged fixed or height adjustable column kits. Specify laminate finishes and edge finishes for chassis and drawer/doors. Specify paint finish for handle. Interior felt leg cover in Graphite (**GPH**) only. Hinged door is 18" wide on each side for all sizes. File and box drawers are 15" wide, open cubby width is variable.

- Storage undercarriage required on all storage 36" wide and greater, specified separately. Specify corresponding size SKSLU.

Required specifications

- Laminate chassis finish
- Laminate door/drawer finish
- Paint finish
- Undercarriage



LOW STORAGE, DOUBLE GROMMETS **MODEL#** **DIMENSIONS** **FREIGHT CLASS** **WT./LBS.** **CUBIC FT.** **LIST PRICE**

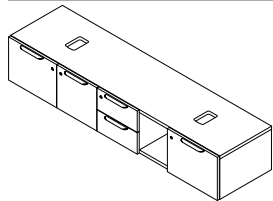

Hinged Doors w/Leg Grommets/File Drawer/Box Drawers/Open Cubby

	D x W x H				
SKSLCHOBFHL2078	20 x 78 x 14	70	191.89	12.23	\$3512
SKSLCHOBFHL2084	20 x 84 x 14	70	200.45	13.17	\$3591

Hinged door with leg grommet on the left, file drawer, two box drawers and open cubby at the center, and a hinged door with leg grommet on the right low storage unit. Can be used as a standalone unit or with another low or high storage unit. For use with 3 legged fixed or height adjustable column kits. Specify laminate finishes and edge finishes for chassis and drawer/doors. Specify paint finish for handle. Interior felt leg cover in Graphite (**GPH**) only. Hinged door is 18" wide on each side for all sizes. File and box drawers are 15" wide, open cubby width is variable.

- Storage undercarriage required on all storage 36" wide and greater, specified separately. Specify corresponding size SKSLU.

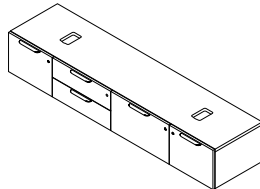

Hinged Doors w/Leg Grommets/Box Drawers/File Drawer

SKSLCHBFHR2084	20 x 84 x 14	70	202.04	13.17	\$4399
----------------	--------------	----	--------	-------	---------------

Hinged door with leg grommet on the left, two box drawers and a file drawer at the center, and a hinged door with leg grommet on the right low storage unit. Can be used as a standalone unit or with another low or high storage unit. For use with 3 legged fixed or height adjustable column kits. Specify laminate finishes and edge finishes for chassis and drawer/doors. Specify paint finish for handle. Interior felt leg cover in Graphite (**GPH**) only. 18" hinged door, 24" box/box drawers, 24" file drawer, 18" hinged door.

- Storage undercarriage required on all storage 36" wide and greater, specified separately. Specify corresponding size SKSLU.

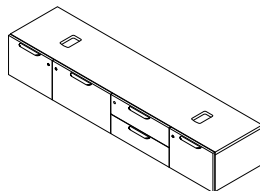

Hinged Doors w/Leg Grommets/Box Drawers/File Drawer

SKSLCHFBHL2084	20 x 84 x 14	70	202.04	13.17	\$4399
----------------	--------------	----	--------	-------	---------------

Hinged door with leg grommet on the left, file drawer and two box drawers at the center, and a hinged door with leg grommet on the right low storage unit. Can be used as a standalone unit or with another low or high storage unit. For use with 3 legged fixed or height adjustable column kits. Specify laminate finishes and edge finishes for chassis and drawer/doors. Specify paint finish for handle. Interior felt leg cover in Graphite (**GPH**) only. 18" hinged door, 24" file drawer, 24" box/box drawers, 18" hinged door.

- Storage undercarriage required on all storage 36" wide and greater, specified separately. Specify corresponding size SKSLU.

Required specifications

- Laminate chassis finish
- Laminate door/drawer finish
- Paint finish
- Undercarriage

HIGH STORAGE

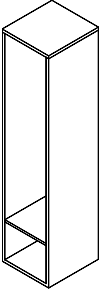

Open Cubby High Storage

MODEL#	DIMENSIONS	FREIGHT CLASS	WT/LBS.	CUBIC FT.	LIST PRICE
	D x W x H				
SKSH05418	20 x 18 x 48	92.5	99.58	9.65	\$1166
SKSH06018	20 x 18 x 54	92.5	108.77	10.85	\$1242
SKSH06618	20 x 18 x 60	100	118.02	12.06	\$1319
SKSH06624	20 x 24 x 60	100	138.51	16.08	\$1918
SKSH06630	20 x 30 x 60	125	157.76	20.1	\$2076
SKSH06636	20 x 36 x 60	125	176.93	24.11	\$2234
SKSH07218	20 x 18 x 66	100	127.21	13.26	\$1394
SKSH07224	20 x 24 x 66	100	148.71	17.68	\$2001
SKSH07230	20 x 30 x 66	125	168.98	22.1	\$2167
SKSH07236	20 x 36 x 66	125	189.14	26.52	\$2331
SKSH07818	20 x 18 x 72	100	136.43	14.47	\$1470
SKSH07824	20 x 24 x 72	100	158.92	19.29	\$2085
SKSH07830	20 x 30 x 72	125	180.2	24.11	\$2258
SKSH07836	20 x 36 x 72	125	201.36	28.93	\$2429

Open cubby high storage unit with bottom shelf and coat hook/coat rail. Units 18" wide have one coat hook and remaining units have a coat rail installed at the back panel. Specify laminate finish and edge finish for chassis. Specify paint finish for coat hook/coat rail. Shelf opening is 12.6".

- Specify a corresponding size SKSLU undercarriage separately. 18" and 24" wide units are not intended to be freestanding, must be specified in conjunction with a low storage unit on an appropriate undercarriage OR ganged or anchored to another unit or fixed element.

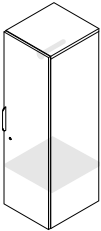

High Storage Hinged Door, Right

SKSHR5418	20 x 18 x 48	85	125.54	9.65	\$1616
SKSHR6018	20 x 18 x 54	85	137.74	10.85	\$1717
SKSHR6618	20 x 18 x 60	85	150.03	12.06	\$1819
SKSHR7218	20 x 18 x 66	85	162.24	13.26	\$1920
SKSHR7818	20 x 18 x 72	85	174.48	14.47	\$2022

Right hand hinged door high storage unit with bottom shelf and coat hook. Units have one coat hook installed at the back panel. Specify laminate finishes and edge finishes for chassis/door. Specify paint finish for coat hook. Shelf opening is 12.6".

- Specify a corresponding size SKSLU undercarriage separately. 18" wide units are not intended to be freestanding, must be specified in conjunction with a low storage unit on an appropriate undercarriage OR ganged or anchored to another unit or fixed element.

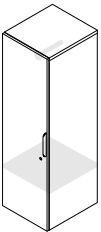

High Storage Hinged Door, Left

SKSHL5418	20 x 18 x 48	85	125.54	9.65	\$1616
SKSHL6018	20 x 18 x 54	85	137.74	10.85	\$1717
SKSHL6618	20 x 18 x 60	85	150.03	12.06	\$1819
SKSHL7218	20 x 18 x 66	85	162.24	13.26	\$1920
SKSHL7818	20 x 18 x 72	85	174.48	14.47	\$2022

Left hand hinged door high storage unit with bottom shelf and coat hook. Units have one coat hook installed at the back panel. Specify laminate finishes and edge finishes for chassis/door. Specify paint finish for coat hook. Shelf opening is 12.6".

- Specify a corresponding size SKSLU undercarriage separately. 18" wide units are not intended to be freestanding, must be specified in conjunction with a low storage unit on an appropriate undercarriage OR ganged or anchored to another unit or fixed element.

Required specifications

- Laminate chassis finish
- Laminate door/drawer finish
- Paint finish
- Legs/Undercarriage



HIGH STORAGE **MODEL#** **DIMENSIONS** **FREIGHT CLASS** **WT./LBS.** **CUBIC FT.** **LIST PRICE**

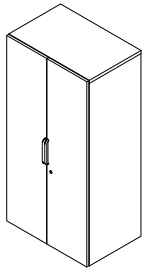

High Storage Hinged Door

	D x W x H					
SKSHH6624	20 x 24 x 60	92.5	181.77	16.08		\$2784
SKSHH6630	20 x 30 x 60	92.5	211.09	20.1		\$3023
SKSHH6636	20 x 36 x 60	100	240.37	24.11		\$3261
SKSHH7224	20 x 24 x 66	92.5	196.01	17.68		\$2911
SKSHH7230	20 x 30 x 66	92.5	227.37	22.1		\$3164
SKSHH7236	20 x 36 x 66	100	258.62	26.52		\$3417
SKSHH7824	20 x 24 x 72	92.5	210.22	19.29		\$3037
SKSHH7830	20 x 30 x 72	92.5	243.61	24.11		\$3306
SKSHH7836	20 x 36 x 72	100	276.87	28.93		\$3573

Double hinged door high storage unit with bottom shelf and coat hook/coat rail. Units have a coat rail installed at the back panel. Specify laminate finishes and edge finishes for chassis/door. Specify paint finish for coat hook. Shelf opening is 12.6".

- Specify a corresponding size SKSLU undercarriage separately. 24" wide units are not intended to be freestanding, must be specified in conjunction with a low storage unit on an appropriate undercarriage OR ganged or anchored to another unit or fixed element.

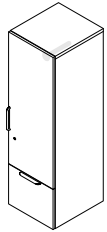

Hinged Door, Right w/File Drawer

SKSHRF5418	20 x 18 x 48	85	128.02	9.65		\$2202
SKSHRF6018	20 x 18 x 54	85	140.25	10.85		\$2307
SKSHRF6618	20 x 18 x 60	85	153.08	12.06		\$2485
SKSHRF7218	20 x 18 x 66	85	165.28	13.26		\$2590
SKSHRF7818	20 x 18 x 72	85	177.54	14.47		\$2695

Right hand hinged door high storage unit with bottom file drawer and coat hook. Units have one coat hook installed at the back panel. Specify laminate finishes and edge finishes for chassis/door. Specify paint finish for coat hook.

- Specify a corresponding size SKSLU undercarriage separately. 18" wide units are not intended to be freestanding, must be specified in conjunction with a low storage unit on an appropriate undercarriage OR ganged or anchored to another unit or fixed element.

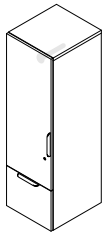

Hinged Door, Left w/File Drawer

SKSHRL5418	20 x 18 x 48	85	128.02	9.65		\$2202
SKSHRL6018	20 x 18 x 54	85	140.25	10.85		\$2307
SKSHRL6618	20 x 18 x 60	85	153.08	12.06		\$2485
SKSHRL7218	20 x 18 x 66	85	165.28	13.26		\$2590
SKSHRL7818	20 x 18 x 72	85	177.54	14.47		\$2695

Right hand hinged door high storage unit with bottom file drawer and coat hook. Units have one coat hook installed at the back panel. Specify laminate finishes and edge finishes for chassis/door. Specify paint finish for coat hook.

- Specify a corresponding size SKSLU undercarriage separately. 18" wide units are not intended to be freestanding, must be specified in conjunction with a low storage unit on an appropriate undercarriage OR ganged or anchored to another unit or fixed element.

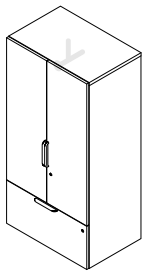

Hinged Doors w/File Drawer

SKSHHF6624	20 x 24 x 60	92.5	184.06	16.08		\$3534
SKSHHF6630	20 x 30 x 60	92.5	213.43	20.1		\$3818
SKSHHF6636	20 x 36 x 60	92.5	242.66	24.11		\$4090
SKSHHF7224	20 x 24 x 66	92.5	198.3	17.68		\$3661
SKSHHF7230	20 x 30 x 66	92.5	229.67	22.1		\$3959
SKSHHF7236	20 x 36 x 66	92.5	260.91	25.52		\$4246
SKSHHF7824	20 x 24 x 72	92.5	212.55	19.29		\$3788
SKSHHF7830	20 x 30 x 72	92.5	245.94	24.11		\$4101
SKSHHF7836	20 x 36 x 72	100	279.2	28.93		\$4402

Double hinged door high storage unit with bottom file drawer and coat rail. Units have a coat rail installed at the back panel. Specify laminate finishes and edge finishes for chassis/doors/drawer. Specify paint finish for coat rail.

- Specify a corresponding size SKSLU undercarriage separately. 24" wide units are not intended to be freestanding, must be specified in conjunction with a low storage unit on an appropriate undercarriage OR ganged or anchored to another unit or fixed element.

Required specifications
 Laminate chassis finish
 Laminate door/drawer finish
 Paint finish
 Legs/Undercarriage

HIGH STORAGE

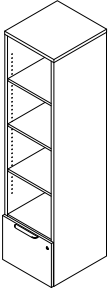

Open Cubby w/File Drawer

MODEL#	DIMENSIONS	FREIGHT CLASS	WT/LBS.	CUBIC FT.	LIST PRICE
D x W x H					
SKSHOF5418	20 x 18 x 48	85	123.83	9.65	\$1609
SKSHOF6018	20 x 18 x 54	85	133.02	10.85	\$1684
SKSHOF6618	20 x 18 x 60	92.5	142.27	12.06	\$1761
SKSHOF6624	20 x 24 x 60	92.5	169.8	16.08	\$2241
SKSHOF6630	20 x 30 x 60	100	197.16	20.1	\$2505
SKSHOF6636	20 x 36 x 60	100	224.45	24.11	\$2761
SKSHOF7218	20 x 18 x 66	92.5	151.46	13.26	\$1837
SKSHOF7224	20 x 24 x 66	92.5	180	17.68	\$2324
SKSHOF7230	20 x 30 x 66	100	208.38	22.1	\$2595
SKSHOF7236	20 x 36 x 66	100	236.66	26.52	\$2859
SKSHOF7818	20 x 18 x 72	92.5	168.36	14.47	\$1979
SKSHOF7824	20 x 24 x 72	92.5	200.75	19.29	\$2495
SKSHOF7830	20 x 30 x 72	100	233.01	24.11	\$2796
SKSHOF7836	20 x 36 x 72	100	265.18	28.93	\$3090

Open cubby high storage unit with bottom file drawer and adjustable shelves. 54" to 72" high storage units have two adjustable shelves and 78" high units have three adjustable shelves. Specify laminate finish and edge finish for chassis. Specify paint finish for handle.

- Specify a corresponding size SKSLU undercarriage separately. 18" and 24" wide units are not intended to be freestanding, must be specified in conjunction with a low storage unit on an appropriate undercarriage OR ganged or anchored to another unit or fixed element.

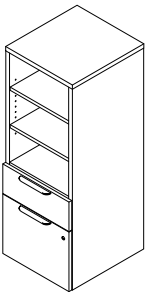

Open Cubby w/Box/File Drawer

SKSHOBF5418	20 x 18 x 48	85	127.21	9.65	\$1959
SKSHOBF6018	20 x 18 x 54	85	136.4	10.85	\$2035
SKSHOBF6618	20 x 18 x 60	85	145.65	12.06	\$2111
SKSHOBF6624	20 x 24 x 60	92.5	174.51	16.08	\$2855
SKSHOBF6630	20 x 30 x 60	92.5	203.06	20.1	\$3147
SKSHOBF6636	20 x 36 x 60	100	231.53	24.11	\$3423
SKSHOBF7218	20 x 18 x 66	92.5	154.84	13.26	\$2187
SKSHOBF7224	20 x 24 x 66	92.5	184.71	17.68	\$2938
SKSHOBF7230	20 x 30 x 66	100	214.28	22.1	\$3238
SKSHOBF7236	20 x 36 x 66	100	243.75	26.52	\$3521
SKSHOBF7818	20 x 18 x 72	92.5	171.74	14.47	\$2329
SKSHOBF7824	20 x 24 x 72	92.5	205.47	19.29	\$3109
SKSHOBF7830	20 x 30 x 72	100	238.92	24.11	\$3438
SKSHOBF7836	20 x 36 x 72	100	272.27	28.93	\$3752

Open cubby high storage unit with bottom box and file drawers and adjustable shelves. 54" to 72" high storage units have two adjustable shelves and 78" high units have three adjustable shelves. Specify laminate finish and edge finish for chassis. Specify paint finish for handle.

- Specify a corresponding size SKSLU undercarriage separately. 18" and 24" wide units are not intended to be freestanding, must be specified in conjunction with a low storage unit on an appropriate undercarriage OR ganged or anchored to another unit or fixed element.

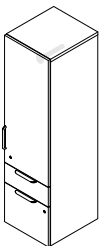

Hinged Door, Right w/Box/File Drawer

SKSHRBF6618	20 x 18 x 60	85	151.98	12.06	\$2657
SKSHRBF7218	20 x 18 x 66	85	164.46	13.26	\$2798
SKSHRBF7818	20 x 18 x 72	85	176.7	14.47	\$2903

Right hand hinged door high storage unit with bottom box and file drawers and coat hook. Units have one coat hook installed at the back panel. Specify laminate finish and edge finish for chassis. Specify paint finish for handle and coat hook.

- Specify a corresponding size SKSLU undercarriage separately. 18" wide units are not intended to be freestanding, must be specified in conjunction with a low storage unit on an appropriate undercarriage OR ganged or anchored to another unit or fixed element.

Required specifications

- Laminate chassis finish
- Laminate door/drawer finish
- Paint finish
- Legs/Undercarriage



HIGH STORAGE **MODEL#** **DIMENSIONS** **FREIGHT CLASS** **WT./LBS.** **CUBIC FT.** **LIST PRICE**

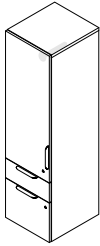

Hinged Door, Left w/Box/File Drawer

	D x W x H					
SKSHLBF6618	20 x 18 x 60	85	151.98	12.06		\$2657
SKSHLBF7218	20 x 18 x 66	85	164.46	13.26		\$2798
SKSHLBF7818	20 x 18 x 72	85	176.7	14.47		\$2903

Left hand hinged door high storage unit with bottom box and file drawers and coat hook. Units have one coat hook installed at the back panel. Specify laminate finish and edge finish for chassis. Specify paint finish for handle and coat hook.

- Specify a corresponding size SKSLU undercarriage separately. 18" wide units are not intended to be freestanding, must be specified in conjunction with a low storage unit on an appropriate undercarriage OR ganged or anchored to another unit or fixed element.

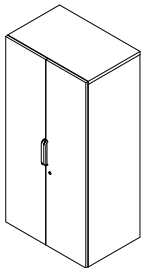

Hinged Doors w/Box/File Drawer

SKSHHBF6624	20 x 24 x 60	92.5	183.67	16.08		\$4026
SKSHHBF6630	20 x 30 x 60	92.5	213.03	20.1		\$4329
SKSHHBF6636	20 x 36 x 60	92.5	242.28	24.11		\$4613
SKSHHBF7224	20 x 24 x 66	92.5	198.47	17.68		\$4226
SKSHHBF7230	20 x 30 x 66	92.5	229.82	22.1		\$4544
SKSHHBF7236	20 x 36 x 66	100	261.09	26.52		\$4842
SKSHHBF7824	20 x 24 x 72	92.5	212.72	19.29		\$4353
SKSHHBF7830	20 x 30 x 72	92.5	246.1	24.11		\$4686
SKSHHBF7836	20 x 36 x 72	100	279.35	28.93		\$4998

Double hinged door high storage unit with bottom box and file drawers and coat rail. Specify laminate finishes and edge finishes for chassis/doors. Specify paint finish for handles and coat rail.

- Specify a corresponding size SKSLU undercarriage separately. 24" wide units are not intended to be freestanding, must be specified in conjunction with a low storage unit on an appropriate undercarriage OR ganged or anchored to another unit or fixed element.

Required specifications

- Laminate chassis finish
- Laminate door/drawer finish
- Paint finish
- Legs/Undercarriage

SLIDING DOOR STORAGE MODEL# DIMENSIONS FREIGHT CLASS WT./LBS. CUBIC FT. LIST PRICE

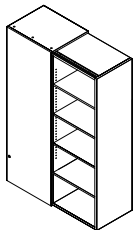

Sliding Door, Closed Shelves, Right

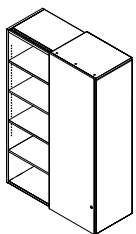

Sliding Door, Closed Shelves, Left

D x W x H

SKSHCSR6648	20 x 48 x 60	92.5	338.6	32.77	\$6678
SKSHCSR7248	20 x 48 x 66	92.5	359.85	35.98	\$6851
SKSHCSR7848	20 x 48 x 72	92.5	359.85	35.98	\$7023

Sliding door with shelving on the right, wardrobe on the left high storage unit. Can be used as a standalone unit or combined with another low or high storage unit. Specify laminate finish and edge finish for chassis. Specify paint finish for coat rail. Bottom shelf is fixed at 12.6", others are adjustable.

- Specify a corresponding size SKSLU undercarriage separately.

SKSHCSL6648	20 x 48 x 60	92.5	338.6	32.77	\$6678
SKSHCSL7248	20 x 48 x 66	92.5	359.85	35.98	\$6851
SKSHCSL7848	20 x 48 x 72	100	381.11	39.11	\$7023

Sliding door with shelving on the left, wardrobe on the right high storage unit. Can be used as a standalone unit or combined with another low or high storage unit. Specify laminate finish and edge finish for chassis. Specify paint finish for coat rail. Bottom shelf is fixed at 12.6", others are adjustable.

- Specify a corresponding size SKSLU undercarriage separately.

Required specifications

- Laminate chassis finish
- Laminate door/drawer finish
- Paint finish
- Legs/Undercarriage

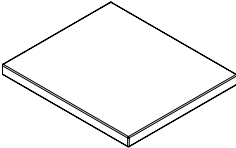
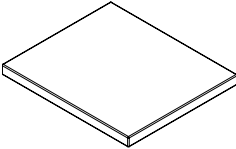
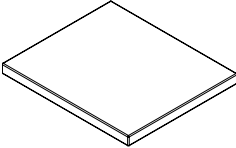
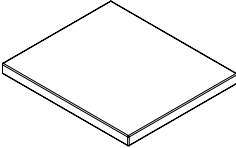
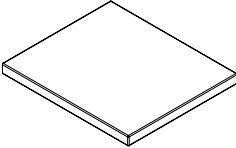
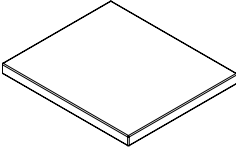

ACCESSORIES	MODEL#	DIMENSIONS	FREIGHT CLASS	WT/LBS.	CUBIC FT.	GRADE	LIST	GRADE	LIST
 Low Storage Cushion	SKSAC2014	14 x 20 x 1	85	2.5	0.18	D x W x H			
						1	\$593	7	\$801
						2	\$624	8	\$874
						3	\$647	9	\$930
						4	\$682	10	\$992
						5	\$733	11	\$1120
						6	\$756	12	\$1256
Cushion to fit atop the low storage units. Available in all Global seating fabrics. • Yardage required: 0.75									
 Low Storage Cushion	SKSAC2018	18 x 20 x 1	85	3	0.21	1	\$482	7	\$923
						2	\$546	8	\$998
						3	\$597	9	\$1084
						4	\$658	10	\$1186
						5	\$751	11	\$1303
						6	\$835	12	\$1471
						Cushion to fit atop the low storage units. Available in all Global seating fabrics. • Yardage required: 0.75			
 Low Storage Cushion	SKSAC2024	24 x 20 x 1	85	4	0.28	1	\$541	7	\$1053
						2	\$614	8	\$1144
						3	\$656	9	\$1246
						4	\$742	10	\$1356
						5	\$848	11	\$1493
						6	\$948	12	\$1691
						Cushion to fit atop the low storage units. Available in all Global seating fabrics. • Yardage required: 0.75			
 Low Storage Cushion	SKSAC2030	30 x 20 x 1	85	5	0.35	1	\$652	7	\$1230
						2	\$733	8	\$1340
						3	\$804	9	\$1453
						4	\$879	10	\$1579
						5	\$1003	11	\$1736
						6	\$1122	12	\$1970
						Cushion to fit atop the low storage units. Available in all Global seating fabrics. • Yardage required: 1			
 Low Storage Cushion	SKSAC2036	36 x 20 x 1	85	6	0.42	1	\$773	7	\$1504
						2	\$877	8	\$1634
						3	\$936	9	\$1780
						4	\$1060	10	\$1936
						5	\$1210	11	\$2133
						6	\$1354	12	\$2416
						Cushion to fit atop the low storage units. Available in all Global seating fabrics. • Yardage required: 1.25			
 Low Storage Cushion	SKSAC2042	42 x 20 x 1	85	7	0.49	1	\$901	7	\$1755
						2	\$1023	8	\$1906
						3	\$1093	9	\$2076
						4	\$1237	10	\$2259
						5	\$1411	11	\$2488
						6	\$1579	12	\$2817
						Cushion to fit atop the low storage units. Available in all Global seating fabrics. • Yardage required: 1.50			

Required specifications

Fabric

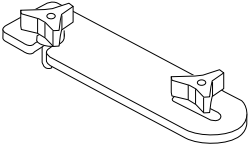
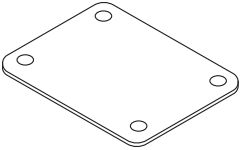
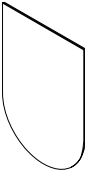
ACCESSORIES	MODEL#	DIMENSIONS	FREIGHT CLASS	WT/LBS.	CUBIC FT.	LIST PRICE
 <p>Base Ganging Clip</p> <p>Base ganging clip to be used between two storage units with separate metal bases. Recommended to create a tight connection between storage (not required).</p>	SKSAGC	0.1 x 5 x 2.5	70	0.22	0.01	\$32
	SKWSFP	0.1 x 5 x 2.5	60	10	0.03	\$23
 <p>Flush Plate</p> <p>Flush plate required between mixed height storage units that share the same metal undercarriage. Kit includes two plates. Black finish only.</p>	SKSADW	0.1 x 5 x 2.5	60	10	0.03	\$607
	SKSDPT	5.5 x 12.75 x 1	70	1	0.04	\$15
 <p>Magnetic Whiteboard</p> <p>Magnetic door whiteboard can be attached to any 18" wide storage unit. White magnetic whiteboard attaches to the metal backing. Black finish metal backing only. Hardware included. Will only fit on tower taller than 60" high.</p>	SKSADAHNDL	.63 x 7.87 x 1.14	70	1	0.05	\$19
	ADA Handle					



The design of Princeton reflects the personality of today's young, dynamic workforce. The freestanding, modular components build out from you and where you work. With over 500 available components, Princeton offers a flexible footprint that's simple to reconfigure. A variety of storage options allows you to do more with less space.

Princeton delivers contemporary design to the workplace; whether it be in Commercial and Corporate offices, Government offices, Small Businesses, Banking, Legal, Accounting, Hospitality or the professional home office. Every element, from the mix of materials and finishes to open storage pieces, floating modesties and overlapping surfaces, has been designed to provide visual appeal and intelligent function. Princeton is a freestanding and fully modular collection offering maximum flexibility; ease of installation and facilitates simple reconfigurations. The overlapping worksurface design also allows the footprint to adapt to smaller spaces by just a few inches.

Features and Benefits

- 1" thick worksurfaces in thermally fused or high pressure laminate
- Worksurfaces feature Global's preferred edging in matching color
- Counterweights standard on all mobile pedestals, lateral files and credenzas
- Handles & pulls in satin anodized finish standard on all credenza, pedestal drawers and cabinet doors
- Monoposts and hutch supports standard in tungsten finish
- Benches double as lateral filing
- Pull-out equipment shelves on select credenzas
- Energy efficient LED lighting for overhead storage cabinets
- Grommets and power blocks to accommodate power/data needs
- Choose glass or fabric equipment screens



Bench doubles as lateral filing



Pull out equipment shelf
(printer not included)



Bookshelf with accessory hook

GENERAL INFORMATION

- Over 500 components are available
- No cubicles or panels needed for configurations
- Product can be added and reconfigured as needed
- Princeton desk and storage products have been tested and comply with all BIFMA mechanical tests.
- For environmental certifications, please visit globalfurnituregroup.com.

WORKSURFACES

- 1" thick high performance thermally fused laminate tops (**TFL**) sealed with Global's preferred edging in matching color.
- High pressure tops (**HPL**) are available in all Princeton laminate finishes at an extended lead time, upcharge applies. Please see model # for pricing and availability.
- Products specified with the high pressure laminate option are finished on the underside of the surface with a kraft paper backing.
- Worksurfaces with metal legs which have a span of 54" and over are standard with metal support channel. Support channels come in Black (BLK) only.
24"D and 30"D - 1 - 2"H support channel
36"D - 2 - 2"H support channels

CONSTRUCTION

- Laminate end panel and metal leg products are **not intended** to be combined for the most visually compatible design. They are, however, interchangeable if required.
- All components have Global's preferred matching edge
- Leveling glides are standard on all floor units.
- End panels are 1.5" thick on laminate end panel desks and credenzas. Cabinet end panels are 11/16" thick.
- 1" x 2" metal frame legs finished in Tungsten (**TTU**), Black (**TBL**) or Designer White (**TDW**) for desks and returns (closed 'O' style leg)
- 1" x 2.5" metal frame legs finished in Tungsten (**TTU**), Black (**TBL**) or Designer White (**TDW**) for freestanding tables (open 'U' style leg)
- Constructed of 45 lb. density particleboard with high performance thermally fused laminate.
- Mobile pedestals and mobile lateral files come standard with front locking casters
- Counterweights are standard on all pedestals, lateral files, credenzas and cabinets
- Rolling table come standard with non-locking casters
- Laminate shelves are 11/16" thick and edged on all 4 sides.
- Tempered glass is 6mm thick with satin-etched finish on one side.
- Credenzas come standard with file bars for side-to-side and front-to-back letter and legal filing capability.
- Handles and pulls in satin anodized finish are standard on all credenza, pedestal drawers and cabinet doors.
- Pull-out equipment shelves are available on select credenzas.
- Grommets and power blocks are available to accommodate power/data needs.

EDGE DETAILS

- All worksurfaces and components have Global's preferred matching edge detail on all sides
- Edging cannot be specified separately. No substitutions.

STORAGE

- Mobile storage greater than 25.5"H may only be used with 29"H Princeton products with laminate end panels or gables. Princeton products with **metal legs** will not accommodate anything higher than 25.5".
- Roll-out shelf on credenza holds up to 80 lbs
- All cabinets with side open shelf area that aligns with 29"H or 27"H credenzas - fixed shelf is 1" thick
- Recycling/waste drawer accommodates 1 recycling basket and 1 waste basket

LAMINATE MODESTY PANELS

- Standard on all desks with laminate end panels, returns with laminate end panels and bridges for laminate end panel desks.
- Flush on Freestanding Returns with laminate end panels
- Recessed 4"D on 24"D desks with laminate end panels, 5"D on 30"D desks with laminate end panels and 6"D on 36"D desks with laminate end panels.
- Recessed 4"D on 24"D, 5"D on 30"D, and 6"D on 36"D flush and overlapping returns with laminate end panels.
- Recessed 4" on 24"D and 5"D on 30"D flush and overlapping bridges with laminate end panels.
- Desks and returns feature modesty panel that is flush with end panel
- Bottom of laminate modesty panel is 17 3/4" from floor.

GLASS DESKTOP PANELS

- Glass desktop panel is sold separately. See selection on page 143.
- Available for installation onto desks, returns, bridges and conference tops
- Made of 6mm tempered glass with satin-etched finish on one side
- On-site installation is required. Installation instructions will be provided.

FABRIC DESKTOP/MODESTY PANELS

- Fabric desktop/fabric modesty panels are sold separately. See selection on page 143.
- Available in:
 - Grade 2:** Lola
 - Grade 3:** Anchorage, Merge
- On-site installation is required. Installation instructions included with product.
- Non-tackable
- Bottom of fabric modesty panel is 15.5" from floor

CREDENZAS

- Available in 29", 27" and 23" heights
- 29"H connect to flush returns, flush conference tops and flush bridges
- 27"H connect to overlapping returns, overlapping conference tops and overlapping bridges
- Fixed drawer widths - see individual models for details
- Upper adjustable shelf must be removed when products with laminate modesty panels are installed (i.e. PN2448RFR flush return with laminate end panel or PN2436BF flush bridge for laminate end panel desk).
- Connection of flush or overlapping surfaces to credenzas is only possible over full height opening.
- All credenza tops are 1" thick
- Grommet location is 2.5" from the back edge to the cut out edge

LOCKS

- Standard on all credenzas, storage cabinets, lateral files, pedestals & benches
- Lock on all credenzas, cabinets and pedestals is always on the bottom drawer
- All components within a workstation or private office can be keyed alike. For up to 40 key numbers, the lead times are standard. For projects larger than 40 offices, additional lock numbers are available. Delivery will be extended an additional week at no upcharge.
- To order specified keying, tag each component of each workstation or office with a lock number between 401 and 440.
- Storage cabinets and pedestal with box/box/file drawer - only five drawer and lower box drawer are locking. Credenza file drawer lock secures both drawers.
- Key alike or specific key number optional for all products with locks
- Reserved for new orders greater than \$20,000 list, all Princeton units with locks may be ordered with **CA** cap option and specific lock cores/keys can be ordered separately for field installation rather than specifying duplicate product lines with different key numbers.
- When **CA** option is specified, product will ship with a cap over the empty lock housing.
- Separately order the appropriate number of cores with keys; use product code **SIL-CORE-H-SHOE** for Silver core/key sets. Specify quantity and lock number required. One order line per key number required. Key number range: 401-440. **Must be ordered at the same time product is ordered with CA lock cap option specified.**
- One core removal key is required. Recommend one core removal for every 25 cores ordered. Order as **REMOVE-K-H-SHOE**.
- No charge applies for separate lock cores or core removal keys only when ordered with product. If replacement lock core and key required, contact Customer Care for applicable product code and pricing.

HUTCHES & OVERHEAD STORAGE

- Available in 60", 72" and 84" widths
- Hutches with full back feature one small hole in each corner for wire pass through
- 15.75" height clearance between worksurface and underside of hutch
- Overhead Storage Cabinets have full width lower storage with center divider
- Hutches feature 1" x 2" steel support frame in Black (**TBL**), Designer White (**TDW**) or Tungsten (**TTU**).
- Laminate and tempered glass sliding doors available
- Hutches cannot be placed on desks with laminate end panels
- Wall hung mounting rails are provided; wall fastener hardware is not included.
- Locks are not available
- Energy efficient LED lighting available (page 172)

TABLES

- 1" x 2.5" open metal frame leg. Available finish options: Black (**TBL**), Designer White (**TDW**) or Tungsten (**TTU**).
- Available with 1" thick thermally fused laminate (**TFL**) top or with 1-1/16" thick high pressure (**HPL**) or ultra matte high pressure (**UML**) laminate top and Global's preferred edging in matching color.
- For **TFL** or **HPL** material type, refer to page 130 for finishes.
For **UML** material type, select one of the following finishes:

BLK Black	DWT Designer White
BZD Blizzard	SDT Stonedust
CGY Custom Grey	SOG Storm Grey
- 120" and 144" wide table tops with center leg are shipped in two pieces
- Tables which have a span of 54" or wider are standard with 2"H metal support channel(s); support channels are Black.
- Grommets and power block cutouts are available for most tables. Due to support channel location(s) for all 29" high tables, quote request required. Contact our Specials Department.
- Available standard with levelers or locking casters.
- Locking casters available in Grey finish only.
- Casters prevent tables from sitting flush against each other, vertically or horizontally

CONNECTION

- Metal flat plates and wood screws are provided for connection between two units.

KEYBOARDS

- Keyboard tray adapter kits are required to accommodate worksurface support channels on the following: freestanding desks with metal legs, returns with metal legs, bridges for desks and returns with metal legs, and returns with bookshelf.

TACKBOARDS

- Tackboards available for hutches and overhead units.
- Available to fit 60", 72" and 84" widths
- Available in:
Grade 1: Jenny, Quilt, Terrace, Urban, Waterfall
Grade 2: Imprint, Lola
Grade 3: Anchorage, Merge
- Contact customer care for COM selection.

CUSHIONS

- Sold separately.
- Cushions available in all Global seating fabrics, including bonded leather. Contact customer care for COM selection and procedure.
- Cushions are not available in leather, leather/mock leather or mesh.

SPECIAL SIZES

- Custom widths, depths and heights are available, but require a custom quote. Please contact Customer Care for more information.
- Custom orders must indicate the "custom quote number" and list price as provided by Customer Care.
- Changes to a custom quote are not permissible. Any revisions will necessitate a new quotation.

TASK LIGHTS

- Optional, energy efficient LED task lights (ultra slim design) are available for mounting under hutches and overheads
- Hutches and overhead storage cabinets are pre-drilled for easy installation
- Available in 12", 20" and 40" widths

WIRE MANAGEMENT

- 2"W x 2"H
- Plastic tray flexes to receive and hold electrical and data wires
- Quickly attaches with double-sided tape (included)
- Finished in Black only.

MONOPOST

- Standard support for conference tops; support for select desks and returns
- 4" square post with 10" square base

PLANTERS

- Plastic planter pots provided
- 8½" diameter x 8"H
- Available in Black (**BK**) or White (**WT**). Must specify at time of order.

SHIPPING

- Items are shipped easy to assemble unless otherwise noted
- Shipped in 1 carton unless otherwise noted
- Connecting hardware included

SPECIFICATIONS

- Specifications marked with an * are applicable to only those products which have the * symbol beside the product name.

1. SPECIFY MODEL NUMBER

2. SPECIFY MATERIAL TYPE

- **TFL** for product with thermally fused laminate tops
- **HPL** for product with high pressure laminate tops

3. SPECIFY FINISHES

Laminate Finishes

Top/base/door, drawer and cabinet fronts:

ACJ	Absolute Acajou
ASN	Asian Night
AWC	Avant Cherry
AWH	Avant Honey
BLK	Black
BZD	Blizzard
BRC	Brushed Cobalt
CMB	Clear Maple
CGY	Custom Grey
DES	Dark Espresso
DWT	Designer White
FAS	Fashionista
FCL	First Class
NBL	Noce Biondo
NGL	Noce Grigio
NEL	Noce Leggero
NML	Noce Medio
QTM	Quartered Mahogany
SBY	Sheer Beauty
SDT	Stonedust
WHE	Walnut Heights
WCR	Winter Cherry
WHC	White Chocolate

Monopost Finishes

4" square monopost is available in Tungsten (**TTU**), Black (**TBL**) or Designer White (**TDW**)

Planters

Planter pots are standard in white. Available in Black (**BK**) at no upcharge. Must specify at time of order.

Metal Frame Desk Legs

1" x 2" metal frame legs are available in Tungsten (**TTU**), Black (**TBL**) or Designer White (**TDW**)

Metal Frame Table Legs

1" x 2.5" metal frame legs are available in Tungsten (**TTU**), Black (**TBL**) or Designer White (**TDW**)

Metal Hutch Supports

1" x 2" metal supports are available in Tungsten (**TTU**), Black (**TBL**) or Designer White (**TDW**)

For detailed finish specification guidelines, please download the **Princeton Design Guide** at www.globalfurnituregroup.com

4. SPECIFY OPTIONS

GROMMETS

- One grommet in satin anodized finish is standard on many components, as specified
- Additional grommets may be available in other standard worksurface locations (left, center or right)
- Order as: **Left POG1, Center POG2 or Right POG3: Add \$103**

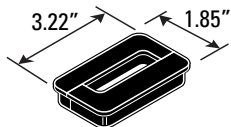

- Worksurface Grommet hole dimensions are 3.22" W x 1.85"D
- Standard grommet position is POG2 in desks, returns, bridges and conference tops
- Modesty panel pass through hole dimensions are 3.43"W x 2"H
- Grommets may be placed at non-standard locations. Order as **PCSG - Add \$103**. A drawing must be supplied with vertical and horizontal dimensions to the center of the cut-out (as in drawing above)
- Components that come standard with grommet may be ordered without a grommet. Order as **RSG - Add \$57**.
- Grommet only available at POG2 on the following 48"W worksurfaces:
 - Desks: PN2448DK, PN3048DK, PN3648DK
 - Returns, flush: PN2448RFR, PN2448RFL

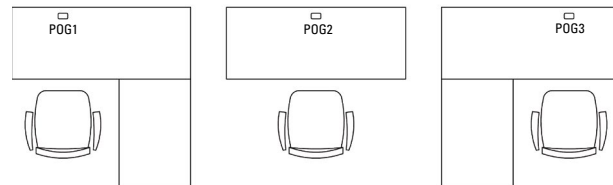
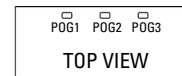

POWER BLOCK

- Power Block (model **PGDPS20**) with 1 power outlet, 12 foot long power cord, for mounting under worksurfaces or inside of laminate end panels
- Power Block (model **PGDPS21**) with 2 power outlets and 1 data opening, 12 foot long power cord, for mounting under worksurfaces or inside of laminate end panels
- Power Bar (model **PGDPS41**) with 4 power outlets and 1 data opening, 12 foot long power card, for mounting behind credenza pull-out shelf or at back of credenza opening
- Rectangular shape. Finished in Tungsten (TUN)
- Power Block dimensions:
 - PGDPS20: 2.5"D x 3.5"W x 2.25"H
 - PGDPS21: 2.5"D x 6.75"W x 2.25"H
- Power Bar dimensions:
 - PGDPS41: 2.5"D x 10.25"W x 2.22"H

FREESTANDING DESKS - LAMINATE END PANELS **MODEL#** **DIMENSIONS** **FREIGHT CLASS** **WT./LBS.** **CUBIC FT.** **LIST PRICE** **HP ADD**

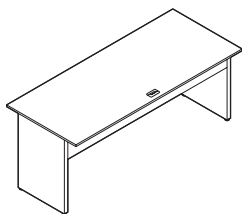

Freestanding Desk

		D x W x H						
PN2484DK	24 x 84 x 29	65	117	5	\$1101	\$128		
PN2478DK	24 x 78 x 29	70	111	5	\$1069	\$127		
PN2472DK	24 x 72 x 29	70	105	5	\$1026	\$126		
PN2466DK	24 x 66 x 29	65	101	4	\$1013	\$126		
PN2460DK	24 x 60 x 29	65	95	4	\$965	\$126		
PN2454DK	24 x 54 x 29	60	95	3	\$965	\$127		
PN2448DK	24 x 48 x 29	70	84	4	\$925	\$122		
PN3084DK	30 x 84 x 29	70	133	6.50	\$1118	\$131		
PN3078DK	30 x 78 x 29	70	127	6	\$1088	\$129		
PN3072DK	30 x 72 x 29	70	120	5.50	\$1053	\$129		
PN3066DK	30 x 66 x 29	65	114	5	\$1021	\$128		
PN3060DK	30 x 60 x 29	70	109	5	\$986	\$126		
PN3054DK	30 x 54 x 29	60	108	3.25	\$986	\$127		
PN3048DK	30 x 48 x 29	65	98	4	\$940	\$126		
PN3684DK	36 x 84 x 29	70	152	8	\$1176	\$146		
PN3678DK	36 x 78 x 29	70	145	7	\$1144	\$141		
PN3672DK	36 x 72 x 29	70	138	7	\$1124	\$138		
PN3666DK	36 x 66 x 29	70	130	6	\$1073	\$129		
PN3660DK	36 x 60 x 29	70	117	6	\$1038	\$127		
PN3654DK	36 x 54 x 29	60	120	4	\$1038	\$128		
PN3648DK	36 x 48 x 29	70	111.50	6.50	\$949	\$126		

Standard with inset end panel on both ends and 10" h modesty panel with pass through grommet. Connects to flush return with laminate end panel, bridges for laminate end panel desks, flush return with bookshelf, flush conference tops. Can be placed over 27" H freestanding returns or 23" H/27" H credenzas. Grommet in worksurface. Shipped in 2 cartons.

RETURNS - LAMINATE END PANELS **MODEL#** **DIMENSIONS** **FREIGHT CLASS** **WT./LBS.** **CUBIC FT.** **LIST PRICE** **HP ADD**

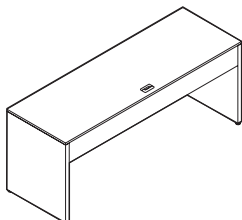

Freestanding Return- 29" H

PN248429R	24 x 84 x 29	65	131	5	\$1074	\$144
PN247829R	24 x 78 x 29	65	127	5	\$1044	\$139
PN247229R	24 x 72 x 29	65	123	5	\$1015	\$131
PN246629R	24 x 66 x 29	65	118	4	\$966	\$128
PN246029R	24 x 60 x 29	65	112	4	\$960	\$126

Standard with flush laminate 1.5" thick end panels. 10" h thick modesty panel without pass through grommet. Connects to flush return with laminate end panel, bridges for laminate end panel desks, flush return with bookshelf, flush conference tops. Can be placed over 27" H freestanding returns or 23" H/27" H credenzas. Grommet in worksurface.

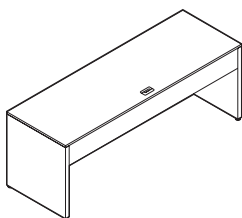

Freestanding Return- 27" H

PN248427R	24 x 84 x 27	65	129	5	\$1061	\$140
PN247827R	24 x 78 x 27	65	125	5	\$1028	\$136
PN247227R	24 x 72 x 27	65	120	5	\$1001	\$129
PN246627R	24 x 66 x 27	65	116	4	\$971	\$127
PN246027R	24 x 60 x 27	65	109	4	\$908	\$125

Standard with flush laminate 1.5" thick end panels. 10" h thick modesty panel without pass through grommet. Supports overlapping return with laminate end panel, overlapping bridge for laminate end panel desks, overlapping return with bookshelf, overlapping conference top. Can be placed under desk. Grommet in worksurface.

Required Specifications

Top finish
Base finish

Optional Specifications

HP laminate
POG1, POG3 - additional grommet
PCSG - custom grommet
RSG - remove grommet

Accessories

Power block Wire manager
Keyboard tray Desktop screen
Keyboard mechanism (not available on 27" H return)

RETURNS - LAMINATE END PANELS

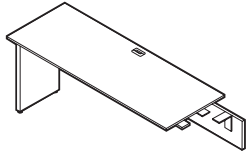

Flush Return - 29" H - LEFT

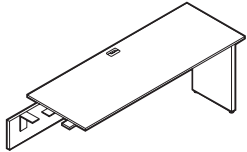

Flush Return - 29" H - RIGHT

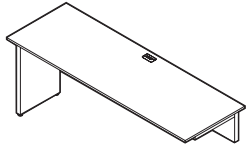

Overlapping Return - 29" H - LEFT

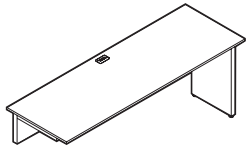

Overlapping Return - 29" H - RIGHT

MODEL#	DIMENSIONS D x W x H	FREIGHT CLASS	WT/LBS.	CUBIC FT.	LIST PRICE	HP ADD
PN2472RFL	24 x 72 x 29	70	95	5.50	\$889	\$138
PN2466RFL	24 x 66 x 29	70	90	5	\$858	\$131
PN2460RFL	24 x 60 x 29	70	84	4.50	\$809	\$127
PN2454RFL	24 x 54 x 29	70	78	4	\$788	\$128
PN2448RFL	24 x 48 x 29	70	72	4	\$752	\$125

Return has no pedestal. Standard with inset end panel on **left**. 10" h modesty panel with pass-through grommet. Connects to Freestanding Desk with laminate end panels, **29" H** Freestanding Returns and **29" H** Credenzas. Grommet in worksurface.

PN2472RFR	24 x 72 x 29	70	95	5.50	\$889	\$138
PN2466RFR	24 x 66 x 29	70	90	5	\$858	\$131
PN2460RFR	24 x 60 x 29	70	84	4.50	\$809	\$127
PN2454RFR	24 x 54 x 29	70	88	4	\$788	\$128
PN2448RFR	24 x 48 x 29	70	72	4	\$752	\$125

Return has no pedestal. Standard with inset end panel on **right**. 10" h modesty panel with pass-through grommet. Connects to Freestanding Desk with laminate end panels, **29" H** Freestanding Returns and **29" H** Credenzas. Grommet in worksurface.

PN2484ROL	24 x 84 x 29	70	118	6	\$986	\$114
PN2478ROL	24 x 78 x 29	65	126	5	\$917	\$113
PN2472ROL	24 x 72 x 29	70	104	5	\$887	\$107

Standard with inset laminate end panel on **left** and 10" h modesty panel with pass-through grommet. Overlaps **27" H** Credenza and **27" H** Freestanding Returns. Grommet in worksurface. 1" spacer included.

PN2484ROR	24 x 84 x 29	70	118	6	\$986	\$114
PN2478ROR	24 x 78 x 29	65	126	5	\$917	\$113
PN2472ROR	24 x 72 x 29	70	104	5	\$887	\$107

Standard with inset laminate end panel on **right** and 10" h modesty panel with pass-through grommet. Overlaps **27" H** Credenza and **27" H** Freestanding Returns. Grommet in worksurface. 1" spacer included.

Required Specifications

Top finish
Base finish

Optional Specifications

HP laminate
POG1, POG3 - additional grommet
PCSG - custom grommet
RSG - remove grommet

Accessories

Power block
Keyboard tray
Desktop screen
Wire manager
Keyboard mechanism

BRIDGES FOR LAMINATE END PANEL DESKS

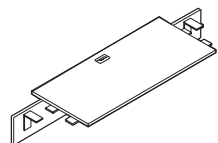

Flush Bridge

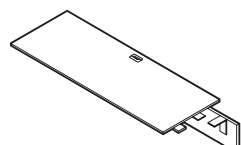

Overlapping Bridge - LEFT*

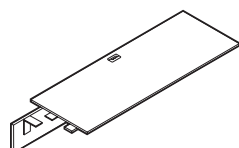

Overlapping Bridge - RIGHT*

MODEL#	DIMENSIONS D x W x H	FREIGHT CLASS	WT/LBS.	CUBIC FT.	LIST PRICE	HP ADD
PN2454BF	24 x 54 x 12	65	97	3.50	\$702	\$113
PN2448BF	24 x 48 x 12	70	77	4.50	\$639	\$93
PN2442BF	24 x 42 x 12	70	70	4	\$610	\$94
PN2436BF	24 x 36 x 12	70	63	4	\$573	\$92

Standard with 10" h modesty panel with pass-through grommet. Connects between any two: Freestanding Desk with laminate end panels, **29" H** Freestanding Returns, Conference top for U configurations or **29" H** Credenzas opening. Subtop finish is Granite with black edge. Grommet in worksurface.

PN2478BOL	24 x 78 x 12	65	119	4	\$840	\$126
PN2472BOL	24 x 72 x 12	70	96	5	\$797	\$116
PN2466BOL	24 x 66 x 12	70	90	4.50	\$769	\$107
PN2460BOL	24 x 60 x 12	70	83	4.50	\$759	\$103

Standard with 10" h modesty panel with pass-through grommet. Connects Freestanding Desk with laminate end panels, **29" H** Freestanding Returns, Conference top for U configurations on one end, and overlaps **27" H** Credenza or **27" H** Freestanding Return on other end. Subtop finish is Granite with black edge. Grommet in worksurface. Includes 1" spacer, one side only.

PN2478BOR	24 x 78 x 12	65	119	4	\$840	\$126
PN2472BOR	24 x 72 x 12	70	96	5	\$797	\$116
PN2466BOR	24 x 66 x 12	70	90	4.50	\$769	\$107
PN2460BOR	24 x 60 x 12	70	83	4.50	\$759	\$103

Standard with 10" h modesty panel with pass-through grommet. Connects Freestanding Desk with laminate end panels, **29" H** Freestanding Returns, Conference top for U configurations on one end, and overlaps **27" H** Credenza or **27" H** Freestanding Return on other end. Subtop finish is Granite with black edge. Grommet in worksurface. Includes 1" spacer, one side only.

Required Specifications

Top finish
Base finish

Optional Specifications

HP laminate
POG1, POG3 - additional grommet*
PCSG - custom grommet
RSG - remove grommet

Accessories

Power block
Keyboard tray
Desktop screen
Wire manager
Keyboard mechanism

FREESTANDING DESKS WITH METAL LEGS

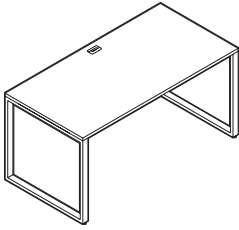

Freestanding Desk with Metal Legs

MODEL#	DIMENSIONS D x W x H	FREIGHT CLASS	WT/LBS.	CUBIC FT.	LIST PRICE	HP ADD
PN2484DM	24 x 84 x 29	250	111	43.41	\$1699	\$270
PN2478DM	24 x 78 x 29	250	109	41.92	\$1571	\$252
PN2472DM	24 x 72 x 29	250	106	38.92	\$1378	\$222
PN2466DM	24 x 66 x 29	250	102	31.44	\$1365	\$220
PN2460DM	24 x 60 x 29	250	91	29.94	\$1335	\$216
PN2454DM	24 x 54 x 29	250	88	29.94	\$1297	\$210
PN2448DM	24 x 48 x 29	250	76	28.44	\$1148	\$187
PN3084DM	30 x 84 x 29	250	137	53.89	\$1767	\$280
PN3078DM	30 x 78 x 29	250	124	52.40	\$1643	\$264
PN3072DM	30 x 72 x 29	250	117	47.90	\$1472	\$236
PN3066DM	30 x 66 x 29	250	110	38.92	\$1422	\$227
PN3060DM	30 x 60 x 29	250	104	38.17	\$1378	\$222
PN3054DM	30 x 54 x 29	250	99	37.43	\$1350	\$219
PN3048DM	30 x 48 x 29	250	82	35.93	\$1192	\$194
PN3684DM	36 x 84 x 29	250	154	65.87	\$2006	\$317
PN3678DM	36 x 78 x 29	250	139	62.87	\$1838	\$291
PN3672DM	36 x 72 x 29	250	132	59.88	\$1789	\$282
PN3666DM	36 x 66 x 29	250	123	47.16	\$1567	\$251
PN3660DM	36 x 60 x 29	250	117	46.41	\$1515	\$241
PN3654DM	36 x 54 x 29	250	106	44.91	\$1431	\$228
PN3648DM	36 x 48 x 29	250	92	44.91	\$1294	\$210

Standard with two 1" x 2" metal open frame legs with support channel(s). Connects to flush returns with metal leg, bridges for desks and returns with metal leg, flush return with bookshelf and flush conference tops. Grommet in worksurface. Shipped in 3 cartons.

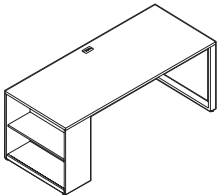

LEFT

Freestanding Desk with Bookshelf*

PN3060DBL	30 x 60 x 29	250	123	51.65	\$1494	\$252
PN3066DBL	30 x 66 x 29	250	129	52.40	\$1650	\$275
PN3072DBL	30 x 72 x 29	250	136	61.38	\$1699	\$278
PN3078DBL	30 x 78 x 29	250	150	65.87	\$1837	\$302
PN3084DBL	30 x 84 x 29	250	156	67.37	\$1936	\$340
PN3672DBL	36 x 72 x 29	250	154	73.35	\$1765	\$278
PN3678DBL	36 x 78 x 29	250	161	76.35	\$1916	\$302
PN3684DBL	36 x 84 x 29	250	176	79.34	\$2159	\$340

12"D Bookcase with adjustable shelf on **left**. One 1" x 2" metal open frame leg with support channel(s). Right side connects to flush returns with metal leg, bridges for desks and returns with metal leg, flush return with bookshelf, flush conference tops. Grommet in worksurface. Shipped in 3 cartons.

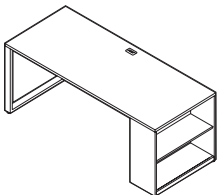

RIGHT

Freestanding Desk with Bookshelf*

PN3060DBR	30 x 60 x 29	250	123	51.65	\$1494	\$233
PN3066DBR	30 x 66 x 29	250	129	52.40	\$1650	\$255
PN3072DBR	30 x 72 x 29	250	136	61.38	\$1699	\$264
PN3078DBR	30 x 78 x 29	250	150	65.87	\$1837	\$277
PN3084DBR	30 x 84 x 29	250	156	67.37	\$1936	\$297
PN3672DBR	36 x 72 x 29	250	154	73.35	\$1765	\$270
PN3678DBR	36 x 78 x 29	250	161	76.35	\$1916	\$291
PN3684DBR	36 x 84 x 29	250	176	79.34	\$2159	\$305

12"D Bookcase with adjustable shelf on **right**. One 1" x 2" metal open frame leg with support channel(s). Left side connects to flush returns with metal leg, bridges for desks and returns with metal leg, flush return with bookshelf, flush conference tops. Grommet in worksurface. Shipped in 3 cartons.

Required Specifications

Top finish
Base finish*
Leg finish*

Optional Specifications

HP laminate
POG1, POG3 - additional grommet
PCSG - custom grommet
RSG - remove grommet

Accessories

Power block
Keyboard tray
Desktop screen
Keyboard tray mounting kit*
Wire manager
Keyboard mechanism

RETURNS WITH METAL LEGS

MODEL# DIMENSIONS FREIGHT CLASS WT./LBS. CUBIC FT. LIST PRICE HP ADD

D x W x H

PN2448FML	24 x 48 x 29	150	56	12	\$793	\$122
PN2454FML	24 x 54 x 29	150	68	13	\$952	\$146
PN2460FML	24 x 60 x 29	150	71	13	\$998	\$154
PN2466FML	24 x 66 x 29	150	82	14	\$1038	\$161
PN2472FML	24 x 72 x 29	150	86	20	\$1070	\$167
PN2478FML	24 x 78 x 29	150	89	21	\$1191	\$182

PN3048FML	30 x 48 x 29	150	61	15	\$842	\$129
PN3054FML	30 x 54 x 29	150	78	16	\$992	\$152
PN3060FML	30 x 60 x 29	150	82	16.50	\$1040	\$161
PN3066FML	30 x 66 x 29	150	89	17	\$1074	\$167
PN3072FML	30 x 72 x 29	150	96	23	\$1142	\$175
PN3078FML	30 x 78 x 29	250	103	26	\$1249	\$192

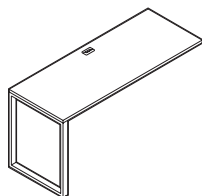

LEFT

Flush Return with Metal Leg

1" x 2" metal frame leg on **left**. Support channel(s) included for units 72"W and above. Connects to freestanding desk with metal legs, freestanding desk with bookshelf and metal leg, 29"H credenza opening. Grommet in worksurface. Shipped in 2 cartons.

PN2448FMR	24 x 48 x 29	150	56	12	\$793	\$122
PN2454FMR	24 x 54 x 29	150	68	13	\$952	\$146
PN2460FMR	24 x 60 x 29	150	71	13	\$998	\$154
PN2466FMR	24 x 66 x 29	150	82	14	\$1038	\$161
PN2472FMR	24 x 72 x 29	150	86	20	\$1070	\$167
PN2478FMR	24 x 78 x 29	150	89	21	\$1191	\$182

PN3048FMR	30 x 48 x 29	150	61	7.50	\$842	\$129
PN3054FMR	30 x 54 x 29	150	78	16	\$992	\$152
PN3060FMR	30 x 60 x 29	150	83	16.50	\$1040	\$161
PN3066FMR	30 x 66 x 29	150	89	17	\$1074	\$167
PN3072FMR	30 x 72 x 29	150	96	23	\$1142	\$175
PN3078FMR	30 x 78 x 29	250	103	26	\$1249	\$192

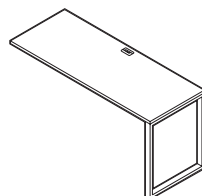

RIGHT

Flush Return with Metal Leg

1" x 2" metal frame leg on **right**. Support channel(s) included for units 72"W and above. Connects to freestanding desk with metal legs, freestanding desk with bookshelf and metal leg, 29"H credenza opening. Grommet in worksurface. Shipped in 2 cartons.

PN3048FTL	30 x 48 x 29	150	61	15	\$831	\$128
PN3054FTL	30 x 54 x 29	150	78	16	\$981	\$152
PN3060FTL	30 x 60 x 29	150	83	16.50	\$1040	\$161
PN3066FTL	30 x 66 x 29	150	89	17	\$1096	\$169
PN3072FTL	30 x 72 x 29	150	96	23	\$1142	\$175

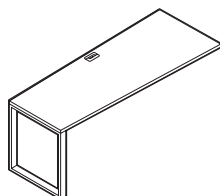

LEFT

Flush Wedge Return w/Metal Leg

1" x 2" metal frame leg on **left**. Support channel(s) included for units 72"W and above. 30"D has 24"D leg. 36"D has 30"D leg. Connects to freestanding desk with metal legs, freestanding desk with bookshelf and metal leg, 29"H credenza opening. Grommet in worksurface. Shipped in 2 cartons.

PN3048FTR	30 x 48 x 29	150	61	15	\$831	\$128
PN3054FTR	30 x 54 x 29	150	78	16	\$981	\$152
PN3060FTR	30 x 60 x 29	150	83	16.50	\$1040	\$161
PN3066FTR	30 x 66 x 29	150	89	17	\$1096	\$169
PN3072FTR	30 x 72 x 29	150	96	23	\$1142	\$175

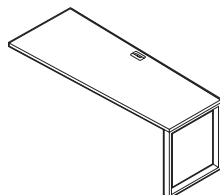

RIGHT

Flush Wedge Return w/Metal Leg

1" x 2" metal frame leg on **right**. Support channel(s) included for units 72"W and above. 30"D has 24"D leg. 36"D has 30"D leg. Connects to freestanding desk with metal legs, freestanding desk with bookshelf and metal leg, 29"H credenza opening. Grommet in worksurface. Shipped in 2 cartons.

Required Specifications

Top finish
Leg finish

Optional Specifications

HP laminate
POG1, POG3 - additional grommet
PCSG - custom grommet
RSG - remove grommet

Accessories

Power block
Keyboard tray
Desktop screen
Keyboard tray mounting kit
Wire manager
Keyboard mechanism

OVERLAPPING RETURNS WITH METAL LEGS

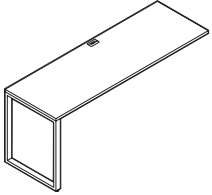

LEFT
Overlapping Return w/Metal Leg

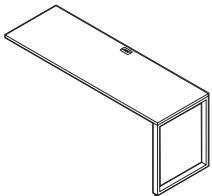

RIGHT
Overlapping Return w/Metal Leg

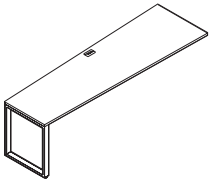

LEFT
Overlapping Wedge Return w/Metal Leg

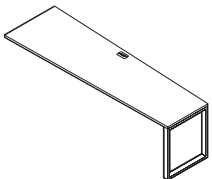

RIGHT
Overlapping Wedge Return w/Metal Leg

MODEL#	DIMENSIONS D x W x H	FREIGHT CLASS	WT/LBS.	CUBIC FT.	LIST PRICE	HP ADD
PN2460OML	24 x 60 x 29	150	71	13	\$890	\$138
PN2466OML	24 x 66 x 29	150	82	14	\$915	\$141
PN2472OML	24 x 72 x 29	150	86	20	\$947	\$146
PN2478OML	24 x 78 x 29	150	89	21	\$1128	\$173
PN2484OML	24 x 84 x 29	150	91	22	\$1305	\$200
PN3060OML	30 x 60 x 29	150	83	16.50	\$930	\$142
PN3066OML	30 x 66 x 29	150	89	17	\$963	\$149
PN3072OML	30 x 72 x 29	150	96	23	\$1019	\$156
PN3078OML	30 x 78 x 29	250	103	26	\$1208	\$187
PN3084OML	30 x 84 x 29	150	116	27	\$1352	\$207

1" x 2" metal frame leg on **left**. Support channel(s) included for 84"W unit only. Overlaps 27"H credenza opening. Grommet in worksurface. Shipped in 2 cartons.

PN2460OMR	24 x 60 x 29	150	71	13	\$890	\$138
PN2466OMR	24 x 66 x 29	150	82	14	\$915	\$141
PN2472OMR	24 x 72 x 29	150	86	20	\$947	\$146
PN2478OMR	24 x 78 x 29	150	89	21	\$1128	\$173
PN2484OMR	24 x 84 x 29	150	91	22	\$1305	\$200
PN3060OMR	30 x 60 x 29	150	83	16.50	\$930	\$142
PN3066OMR	30 x 66 x 29	150	89	17	\$963	\$149
PN3072OMR	30 x 72 x 29	150	96	23	\$1019	\$156
PN3078OMR	30 x 78 x 29	250	103	26	\$1208	\$187
PN3084OMR	30 x 84 x 29	150	137	27	\$1352	\$207

1" x 2" metal frame leg on **right**. Support channel(s) included for 84"W unit only. Overlaps 27"H credenza opening. Grommet in worksurface. Shipped in 2 cartons.

PN3060OTL	30 x 60 x 29	150	83	16.50	\$948	\$146
PN3066OTL	30 x 66 x 29	150	89	17	\$983	\$152
PN3072OTL	30 x 72 x 29	150	96	23	\$1028	\$158
PN3078OTL	30 x 78 x 29	250	103	26	\$1230	\$189
PN3084OTL	30 x 84 x 29	150	116	27	\$1373	\$210

1" x 2" metal frame leg on **left**. Support channel(s) included for 84"W unit only. 30"D has 24"D leg. 36"D has 30"D leg. Overlaps 27"H credenza opening. Grommet in worksurface. Includes 1" spacer. Shipped in 2 cartons.

PN3060OTR	30 x 60 x 29	150	83	16.50	\$948	\$146
PN3066OTR	30 x 66 x 29	150	89	17	\$983	\$152
PN3072OTR	30 x 72 x 29	150	96	23	\$1028	\$158
PN3078OTR	30 x 78 x 29	250	103	26	\$1230	\$189
PN3084OTR	30 x 84 x 29	150	116	27	\$1373	\$210

1" x 2" metal frame leg on **right**. Support channel(s) included for 84"W unit only. 30"D has 24"D leg. 36"D has 30"D leg. Overlaps 27"H credenza opening. Grommet in worksurface. Includes 1" spacer. Shipped in 2 cartons.

Required Specifications

Top finish
Leg finish

Optional Specifications

HP laminate
POG1, POG3 - additional grommet
PCSG - custom grommet
RSG - remove grommet

Accessories

Power block
Keyboard tray
Desktop screen
Keyboard tray mounting kit
Wire manager
Keyboard mechanism

OVERLAPPING RETURNS WITH METAL LEGS

MODEL#	DIMENSIONS	FREIGHT CLASS	WT/LBS.	CUBIC FT.	LIST PRICE	HP ADD
D x W x H						
PN2460SOL	24 x 60 x 29	250	83	23.95	\$1306	\$200
PN2466SOL	24 x 66 x 29	250	94	25.45	\$1347	\$207
PN2472SOL	24 x 72 x 29	250	98	34.43	\$1381	\$212
PN2478SOL	24 x 78 x 29	250	101	35.93	\$1501	\$228
PN2484SOL	24 x 84 x 29	250	103	37.43	\$1581	\$241
PN3060SOL	30 x 60 x 29	250	95	26.20	\$1389	\$213
PN3066SOL	30 x 66 x 29	250	101	26.95	\$1431	\$220
PN3072SOL	30 x 72 x 29	250	108	35.93	\$1466	\$223
PN3078SOL	30 x 78 x 29	250	115	40.42	\$1569	\$239
PN3084SOL	30 x 84 x 29	250	128	41.92	\$1674	\$255

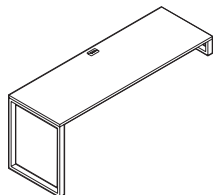

LEFT

Overlapping Return w/Metal Leg and Spacer for 23"H Credenza

1" x 2" metal frame leg on **left** and 5"H metal frame spacer on right. Support channel(s) included for units 78"W and above. Overlaps 23"H credenza. Grommet in worksurface. Shipped in 3 cartons.

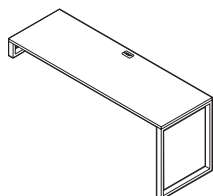

RIGHT

Overlapping Return w/Metal Leg and Spacer for 23"H Credenza

PN2460SOR	24 x 60 x 29	250	83	23.95	\$1306	\$200
PN2466SOR	24 x 66 x 29	250	94	25.45	\$1347	\$207
PN2472SOR	24 x 72 x 29	250	98	34.43	\$1381	\$212
PN2478SOR	24 x 78 x 29	250	101	35.93	\$1501	\$228
PN2484SOR	24 x 84 x 29	250	103	37.43	\$1581	\$241
PN3060SOR	30 x 60 x 29	250	95	26.20	\$1389	\$213
PN3066SOR	30 x 66 x 29	250	101	26.95	\$1431	\$220
PN3072SOR	30 x 72 x 29	250	108	35.93	\$1466	\$223
PN3078SOR	30 x 78 x 29	250	115	40.42	\$1569	\$239
PN3084SOR	30 x 84 x 29	250	128	41.92	\$1674	\$255

1" x 2" metal frame leg on **right** and 5"H metal frame spacer on left. Support channel(s) included for units 78"W and above. Overlaps 23"H credenza. Grommet in worksurface. Shipped in 3 cartons.

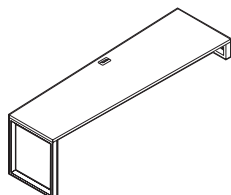

LEFT

Overlapping Wedge Return w/Metal Leg and Spacer for 23"H Credenza

PN3060TSL	30 x 60 x 29	250	95	26.20	\$1365	\$210
PN3066TSL	30 x 66 x 29	250	101	26.95	\$1416	\$219
PN3072TSL	30 x 72 x 29	250	108	35.93	\$1452	\$222
PN3078TSL	30 x 78 x 29	250	115	40.42	\$1555	\$238
PN3084TSL	30 x 84 x 29	250	128	41.92	\$1645	\$252

1" x 2" metal frame leg on **left** and 5"H metal frame spacer on right. Support channel(s) included for units 78"W and above. 24"D leg and 30"D spacer. Overlaps 23"H credenza. Grommet in worksurface. Shipped in 3 cartons.

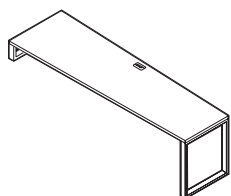

RIGHT

Overlapping Wedge Return w/Metal Leg and Spacer for 23"H Credenza

PN3060TSR	30 x 60 x 29	250	95	26.20	\$1365	\$210
PN3066TSR	30 x 66 x 29	250	101	26.95	\$1416	\$219
PN3072TSR	30 x 72 x 29	250	108	35.93	\$1452	\$222
PN3078TSR	30 x 78 x 29	250	115	40.42	\$1555	\$238
PN3084TSR	30 x 84 x 29	250	128	41.92	\$1645	\$252

1" x 2" metal frame leg on **right** and 5"H metal frame spacer on left. Support channel(s) included for units 78"W and above. 24"D leg and 30"D spacer. Overlaps 23"H credenza. Grommet in worksurface. Shipped in 3 cartons.

Required Specifications

Top finish
Leg finish

Optional Specifications

HP laminate
POG1, POG3 - additional grommet
PCSG - custom grommet
RSG - remove grommet

Accessories

Power block
Keyboard tray
Desktop screen
Keyboard tray mounting kit
Wire manager
Keyboard mechanism

BRIDGES FOR DESKS + RETURNS W/ METAL LEGS

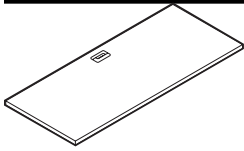

Flush Bridge for Metal Leg Configurations

MODEL#	DIMENSIONS D x W x H	FREIGHT CLASS	WT/LBS.	CUBIC FT.	LIST PRICE	HP ADD
PN2436BFM	24 x 36 x 1	70	31	2	\$374	\$86
PN2442BFM	24 x 42 x 1	70	40	2.50	\$382	\$89
PN2448BFM	24 x 48 x 1	85	44	3	\$401	\$91
PN2454BFM	24 x 54 x 1	70	51	3	\$545	\$121

Connects between any two: freestanding desk with metal legs, freestanding desk with bookshelf and metal leg, conference top for U configurations, 29"H credenza opening. Grommet in worksurface.

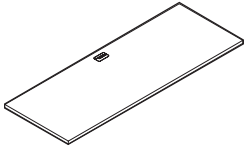

LEFT

Overlapping Bridge for Metal Leg Configurations

PN2460OBL	24 x 60 x 2	70	51	3	\$521	\$109
PN2466OBL	24 x 66 x 2	70	62	3.25	\$538	\$113
PN2472OBL	24 x 72 x 2	92.5	66	6.50	\$549	\$114
PN2478OBL	24 x 78 x 2	92.5	76	6.50	\$743	\$152

Connects freestanding desk with metal legs, freestanding desk with bookshelf and metal leg, conference top for U configurations flush on one end, and overlaps 27"H credenza opening on the other end. Includes 1" spacer. Grommet in worksurface.

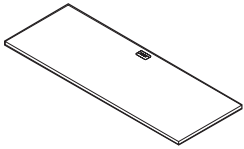

RIGHT

Overlapping Bridge for Metal Leg Configurations

PN2460OBR	24 x 60 x 2	70	51	3	\$521	\$109
PN2466OBR	24 x 66 x 2	70	62	3.25	\$538	\$113
PN2472OBR	24 x 72 x 2	92.5	66	6.50	\$549	\$114
PN2478OBR	24 x 78 x 2	92.5	76	6.50	\$743	\$152

Connects freestanding desk with metal legs, freestanding desk with bookshelf and metal leg, conference top for U configurations flush on one end, and overlaps 27"H credenza opening on the other end. Includes 1" spacer. Grommet in worksurface.

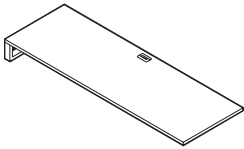

LEFT

Overlapping Bridge with Metal Spacer for 23"H Credenza*

PN2460OSL	24 x 60 x 6	125	63	9	\$859	\$190
PN2466OSL	24 x 66 x 6	125	74	9.50	\$900	\$199
PN2472OSL	24 x 72 x 6	150	78	16	\$931	\$206
PN2478OSL	24 x 78 x 6	150	88	16	\$1053	\$229

One 5"H metal frame spacer with support channel(s). Connects flush on **right** side to freestanding desk with metal legs, freestanding desk with bookshelf and metal leg, or conference top for U configurations. Overlaps 23"H credenza opening on the **left**. Grommet in worksurface. Shipped in 2 cartons.

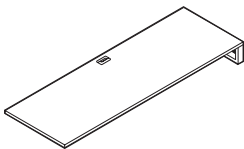

RIGHT

Overlapping Bridge with Metal Spacer for 23"H Credenza*

PN2460OSR	24 x 60 x 6	125	63	9	\$859	\$190
PN2466OSR	24 x 66 x 6	125	74	9.50	\$900	\$199
PN2472OSR	24 x 72 x 6	150	78	16	\$931	\$206
PN2478OSR	24 x 78 x 6	150	88	16	\$1053	\$229

One 5"H metal frame spacer with support channel(s). Connects flush on **left** side to freestanding desk with metal legs, freestanding desk with bookshelf and metal leg, or conference top for U configurations. Overlaps 23"H credenza opening on the **right**. Grommet in worksurface. Shipped in 2 cartons.

Required Specifications

Top finish
Leg finish*

Optional Specifications

HP laminate
POG1, POG3 - additional grommet
PCSG - custom grommet
RSG - remove grommet

Accessories

Power block
Keyboard tray
Desktop screen
Keyboard tray mounting kit
Wire manager
Keyboard mechanism

RETURNS WITH BOOKSHELF

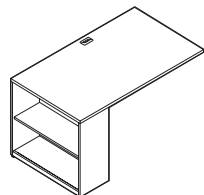

LEFT

Flush Return with Bookshelf

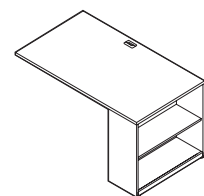

RIGHT

Flush Return with Bookshelf

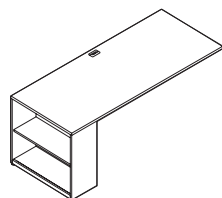

LEFT

Overlapping Return with Bookshelf

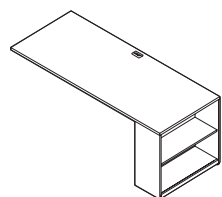

RIGHT

Overlapping Return with Bookshelf

MODEL#	DIMENSIONS D x W x H	FREIGHT CLASS	WT/LBS.	CUBIC FT.	LIST PRICE	HP ADD
PN2460FBL	24 x 60 x 29	150	86	20	\$1013	\$155
PN2466FBL	24 x 66 x 29	150	97	20.50	\$1153	\$176
PN2472FBL	24 x 72 x 29	250	101	27	\$1190	\$180
PN2478FBL	24 x 78 x 29	150	111	27	\$1259	\$194
PN2484FBL	24 x 84 x 29	250	106	29	\$1332	\$202
PN3060FBL	30 x 60 x 29	150	102	25.50	\$1073	\$167
PN3066FBL	30 x 66 x 29	150	108	26	\$1219	\$187
PN3072FBL	30 x 72 x 29	250	115	32	\$1257	\$193
PN3078FBL	30 x 78 x 29	250	129	35	\$1348	\$207
PN3084FBL	30 x 84 x 29	250	135	36	\$1476	\$224

12"D Bookcase with adjustable shelf on **left**. With support channel(s). Connects on **right** side to freestanding desk with metal legs or laminate end panels, 29"H freestanding returns, 29"H credenza opening. Laminate shelf is standard. Grommet in worksurface. Shipped in 2 cartons.

PN2460FBR	24 x 60 x 29	150	86	20	\$1013	\$155
PN2466FBR	24 x 66 x 29	150	97	20.50	\$1153	\$176
PN2472FBR	24 x 72 x 29	250	101	27	\$1190	\$180
PN2478FBR	24 x 78 x 29	150	111	27	\$1259	\$194
PN2484FBR	24 x 84 x 29	250	106	29	\$1332	\$202
PN3060FBR	30 x 60 x 29	150	102	25.50	\$1073	\$167
PN3066FBR	30 x 66 x 29	150	108	26	\$1219	\$187
PN3072FBR	30 x 72 x 29	250	115	32	\$1257	\$193
PN3078FBR	30 x 78 x 29	250	129	35	\$1348	\$207
PN3084FBR	30 x 84 x 29	250	135	36	\$1476	\$224

12"D Bookcase with adjustable shelf on **right**. With support channel(s). Connects on **left** side to freestanding desk with metal legs or laminate end panels, 29"H freestanding returns, 29"H credenza opening. Laminate shelf is standard. Grommet in worksurface. Shipped in 2 cartons.

PN2484RBL	24 x 84 x 29	250	106	29	\$1312	\$200
PN2490RBL	24 x 90 x 29	250	110	30	\$1458	\$223
PN2496RBL	24 x 96 x 29	250	123	31	\$1534	\$234
PN3084RBL	30 x 84 x 29	250	135	36	\$1365	\$210
PN3090RBL	30 x 90 x 29	250	142	42	\$1494	\$227
PN3096RBL	30 x 96 x 29	250	146	38.50	\$1575	\$240

12"D Bookcase with adjustable shelf on **left**. With support channel(s). **Right** side overlaps 27"H credenza opening, 27"H freestanding return. Laminate shelf is standard. Grommet in worksurface. Shipped in 2 cartons.

PN2484RBR	24 x 84 x 29	250	106	29	\$1312	\$200
PN2490RBR	24 x 90 x 29	250	110	30	\$1458	\$223
PN2496RBR	24 x 96 x 29	250	123	31	\$1534	\$234
PN3084RBR	30 x 84 x 29	250	135	36	\$1365	\$210
PN3090RBR	30 x 90 x 29	250	142	42	\$1494	\$227
PN3096RBR	30 x 96 x 29	250	146	38.50	\$1575	\$240

12"D Bookcase with adjustable shelf on **right**. With support channel(s). **Left** side overlaps 27"H credenza opening, 27"H freestanding return. Laminate shelf is standard. Grommet in worksurface. Shipped in 2 cartons.

Required Specifications

Top finish
Base finish

Optional Specifications

HP laminate
POG1, POG3 - additional grommet
PCSG - custom grommet
RSG - remove grommet

Accessories

Power block
Keyboard tray
Desktop screen
Keyboard tray mounting kit
Wire manager
Keyboard mechanism

CONFERENCE TOPS - FLUSH

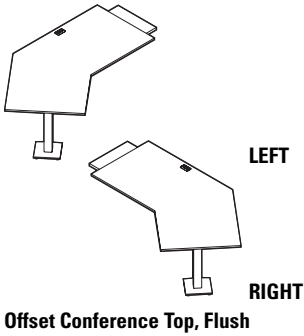

MODEL#	DIMENSIONS D x W x H	FREIGHT CLASS	WT/LBS.	CUBIC FT.	LIST PRICE	HP ADD
PN3066CFL	47 x 66 x 29	150	142	25	\$1303	\$170
PN3072CFL	47 x 72 x 29	92.5	52	5	\$1359	\$161

PN3066CFR	47 x 66 x 29	150	142	25	\$1303	\$170
PN3072CFR	47 x 72 x 29	92.5	52	5	\$1359	\$161

Specify PNxxxxCFL for **LEFT** or PNxxxxCFR for **RIGHT**.

Standard with square monopost and base. Connects to freestanding desks with metal legs or laminate end panels, 29"H freestanding returns, 29"H credenza opening. Subtop finish is Granite with black edge. Grommet in worksurface. Shipped in 2 cartons.

Recommended Maximum Modesty Panel Size:

PN3066CFR/CFL: 36"W (PN3613DMF)
 PN3072CFR/CFL: 42"W (PN4213DMF)

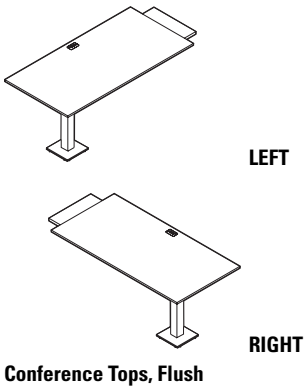

PN2448DFL	24 x 48 x 29	125	55	8.50	\$832	\$121
PN3048DFL	30 x 48 x 29	150	59	5.50	\$889	\$129
PN3060DFL	30 x 60 x 29	125	76	6	\$923	\$136

PN2448DFR	24 x 48 x 29	125	55	8.50	\$832	\$121
PN3048DFR	30 x 48 x 29	150	59	5.50	\$889	\$129
PN3060DFR	30 x 60 x 29	125	76	6	\$923	\$136

Specify PNxxxxDFL for **LEFT** or PNxxxxDFR for **RIGHT**.

Standard with square monopost with base. Connects to Freestanding Desks with metal legs or laminate end panels, 29"H Freestanding Returns or 29"H credenza opening. Subtop finish is Granite with black edge. Grommet in worksurface. Shipped in 2 cartons.

Recommended Maximum Modesty Panel Size:

PN2448DFR/DFL: 30"W (PN3013DMF)
 PN3048DFR/DFL: 30"W (PN3013DMF)
 PN3060DFR/DFL: 36"W (PN3613DMF)

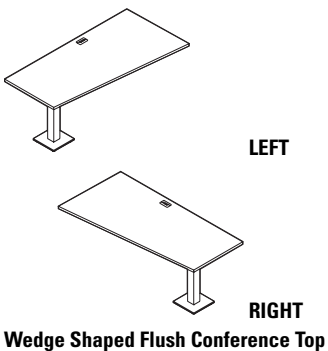

PN3048TFL	30 x 48 x 29	150	59	11	\$889	\$129
PN3060TFL	30 x 60 x 29	125	81	12.50	\$923	\$136

PN3048TFR	30 x 48 x 29	150	59	11	\$889	\$129
PN3060TFR	30 x 60 x 29	125	81	12.50	\$923	\$136

Specify PNxxxxTFL for **LEFT** or PNxxxxTFR for **RIGHT**.

Standard with square monopost with base. 30"D at connecting end, 24"D at monopost end. Connects to Freestanding Desks with metal legs or laminate end panels, 29"H Freestanding Returns or 29"H credenza opening. Subtop finish is Granite with black edge. Grommet in worksurface. Shipped in 2 cartons.

Recommended Maximum Modesty Panel Size:

PN3048TFR/TFL: 30"W (PN3013DMF)
 PN3060TFR/TFL: 36"W (PN3013DMF)

Required Specifications

Top finish
 Monopost finish

Optional Specifications

HP laminate
 PCSG - custom grommet
 RSG - remove grommet

Accessories

Power block
 Keyboard tray
 Desktop screen
 Keyboard tray mounting kit
 Wire manager
 Keyboard mechanism

CONFERENCE TOPS - OVERLAPPING

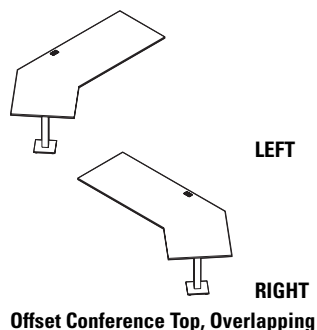

Offset Conference Top, Overlapping

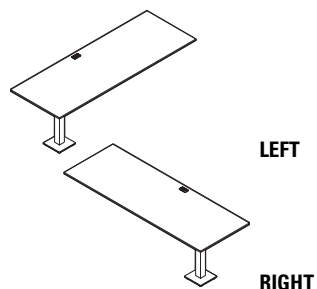

Conference Top, Overlapping

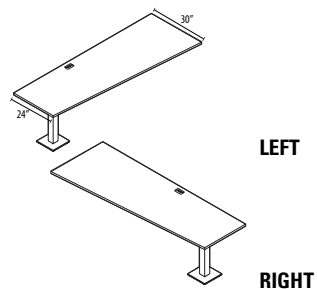

Wedge Shaped Overlapping Conference Top

MODEL#	DIMENSIONS D x W x H	FREIGHT CLASS	WT/LBS.	CUBIC FT.	LIST PRICE	HP ADD
PN3090COL	47 x 90 x 29	150	174	32	\$1469	\$158
PN3096COL	47 x 96 x 29	100	58.50	6.50	\$1484	\$168

PN3090COR	47 x 90 x 29	150	174	32	\$1469	\$158
PN3096COR	47 x 96 x 29	100	58.50	6.50	\$1484	\$168

Specify PNxxxxCOL for **LEFT** or PNxxxxCOR for **RIGHT**.

Standard with square monopost and base. Overlaps **27"H** credenza opening or **27"H** Freestanding Return. Subtop finish is Granite with black edge. Grommet in worksurface. 1" spacer included. Shipped in 2 cartons.

Recommended Maximum Modesty Panel Size:

PN3090COR/COL: 36"W (PN3613DMF)

PN3096COR/COL: 42"W (PN4213DMF)

PN3072DOL	30 x 72 x 29	150	94	19	\$1125	\$141
PN3078DOL	30 x 78 x 29	150	101	23	\$1146	\$142
PN3084DOL	30 x 84 x 29	92.5	44.50	4	\$1231	\$152

PN3072DOR	30 x 72 x 29	150	94	9.50	\$1125	\$141
PN3078DOR	30 x 78 x 29	150	101	23	\$1146	\$142
PN3084DOR	30 x 84 x 29	92.5	44.50	4	\$1231	\$152

Specify PNxxxxDOL for **LEFT** or PNxxxxDOR for **RIGHT**.

Standard with square monopost and base. Overlaps **27"H** credenza opening or **27"H** Freestanding Return. Subtop finish is Granite with black edge. Grommet in worksurface. 1" spacer included. Shipped in 2 cartons.

Recommended Maximum Modesty Panel Size:

PN3072DOR/DOL: 30"W (PN3013DMF)

PN3078DOR/DOL: 30"W (PN3013DMF)

PN3084DOR/DOL: 36"W (PN3613DMF)

PN3072TOL	30 x 72 x 29	150	94	19	\$1125	\$155
PN3084TOL	30 x 84 x 29	150	114	23	\$1231	\$171

PN3072TOR	30 x 72 x 29	150	94	19	\$1125	\$155
PN3084TOR	30 x 84 x 29	150	114	23	\$1231	\$171

Specify PNxxxxDOL for **LEFT** or PNxxxxDOR for **RIGHT**.

Standard with square monopost and base. 30"d at overlapping end, 24"d at monopost end. Overlaps **27"H** Credenza opening or **27"H** Freestanding Return. Grommet in worksurface. 1" spacer included. Shipped in 2 cartons.

Recommended Maximum Modesty Panel Size:

PN3072TOR/TOL: 30"W (PN3013DMF)

PN3084TOR/TOL: 36"W (PN3613DMF)

Required Specifications

Top finish
Monopost finish

Optional Specifications

HP laminate
PCSG - custom grommet
RSG - remove grommet

Accessories

Power block
Keyboard tray
Desktop screen
Keyboard tray mounting kit
Wire manager
Keyboard mechanism

CONFERENCE TOPS FOR U CONFIGURATIONS

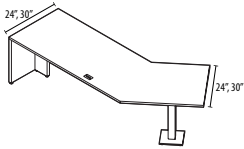

LEFT

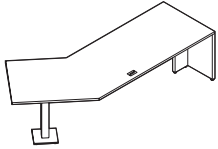

RIGHT

Offset Conference Top, for U Configurations*

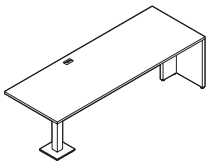

LEFT

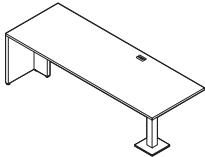

RIGHT

Conference Top for U Configurations*

MODEL#	DIMENSIONS	FREIGHT CLASS	WT/LBS.	CUBIC FT.	LIST PRICE	HP ADD
--------	------------	---------------	---------	-----------	------------	--------

	D x W x H					
PN3090CUL	47 x 90 x 29	125	194	32	\$1553	\$215
PN3096CUL	47 x 96 x 29	125	195	32	\$1571	\$216

PN3090CUR	47 x 90 x 29	125	194	32	\$1553	\$215
PN3096CUR	47 x 96 x 29	125	195	32	\$1571	\$216

Specify PNxxxxCUL for **LEFT** or PNxxxxCUR for **RIGHT**.

Standard with T base with square monopost and base. End panel is 1" thick. 1.5" thick support gable extends 12" for end panel. Not freestanding, must be connected. Connects to bridges. Grommet in worksurface. Shipped in 2 cartons.

Recommended Maximum Modesty Panel Size:

PN3090CUR/CUL: 60"W (PN6013DMF)

PN3096CUR/CUL: 66"W (PN6613DMF)

PN3072DUL	30 x 72 x 29	125	114	19	\$1321	\$180
PN3084DUL	30 x 84 x 29	150	134	23	\$1552	\$215

PN3072DUR	30 x 72 x 29	125	114	19	\$1321	\$180
PN3084DUR	30 x 84 x 29	150	134	23	\$1552	\$215

Specify PNxxxxDUL for **LEFT** or PNxxxxDUR for **RIGHT**.

Standard with T base with square monopost and base. End panel is 1" thick. 1.5" thick support gable extends 12" for end panel. Not freestanding, must be connected. Connects to bridges. Grommet in worksurface. Shipped in 2 cartons.

Recommended Maximum Modesty Panel Size:

PN3072DUR/DUL: 48"W (PN4813DMF)

PN3084DUR/DUL: 60"W (PN6013DMF)

DESKTOP/MODESTY PANELS

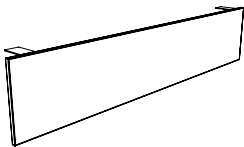

Laminate Modesty Panel

MODEL#	DIMENSIONS	FREIGHT CLASS	WT/LBS.	CUBIC FT.	LIST PRICE
--------	------------	---------------	---------	-----------	------------

PN3013DML	.69 x 30 x 13	85	10	.75	\$434
PN3613DML	.69 x 36 x 13	70	12	.75	\$470
PN4213DML	.69 x 42 x 13	70	14	.75	\$506
PN4813DML	.69 x 48 x 13	70	16	1	\$527
PN5413DML	.69 x 54 x 13	70	18	1	\$589
PN6013DML	.69 x 60 x 13	70	20	1.50	\$691
PN6613DML	.69 x 66 x 13	70	22	1.50	\$712
PN7213DML	.69 x 72 x 13	70	24	1.50	\$736
PN7813DML	.69 x 78 x 13	70	26	1.70	\$863
PN8413DML	.69 x 84 x 13	70	28	1.70	\$1070

Attaches to worksurface with black "L" brackets. Laminate modesty panels up to 54"w include two brackets. Panels 60" and wider have three brackets. Specify a nominal size 6" shorter than worksurface size. If using modesty with overlapping worksurface or lower storage, contact Customer Care.

Required Specifications

- Top finish*
- Base finish
- Monopost finish*

Optional Specifications

- HP laminate*
- POG1, POG3 - additional grommet*
- PCSG - custom grommet*
- RSG - remove grommet*

Accessories

- Power block*
- Keyboard tray*
- Desktop screen*
- Keyboard tray mounting kit*
- Wire manager*
- Keyboard mechanism*

DESKTOP AND MODESTY PANELS

Fabric Desktop/Modesty Panel*

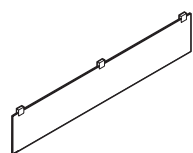

MODEL#	DIMENSIONS D x W x H	FREIGHT CLASS	WT./LBS.	CUBIC FT.	GRADE	LIST PRICE
PN3013DMF	.37 x 30 x 13	250	3	1	1	\$526
					2	\$567
					3	\$598
					4	\$644
PN3613DMF	.37 x 36 x 13	250	3.60	1	1	\$555
					2	\$606
					3	\$645
					4	\$699
PN4213DMF	.37 x 42 x 13	150	4.20	1	1	\$583
					2	\$634
					3	\$673
					4	\$727
PN4813DMF	.37 x 48 x 13	250	4.80	1.50	1	\$598
					2	\$660
					3	\$704
					4	\$771
PN5413DMF	.37 x 54 x 13	250	5.40	1.50	1	\$625
					2	\$695
					3	\$747
					4	\$824
PN6013DMF	.37 x 60 x 13	150	6	1.50	1	\$662
					2	\$732
					3	\$784
					4	\$861
PN6613DMF	.37 x 66 x 13	150	6.60	1.50	1	\$777
					2	\$855
					3	\$916
					4	\$1005
PN7213DMF	.37 x 72 x 13	150	7.20	1.75	1	\$827
					2	\$917
					3	\$982
					4	\$1082
PN7813DMF	.37 x 78 x 13	150	7.80	1.75	1	\$833
					2	\$929
					3	\$1006
					4	\$1116

Panels up to 54" w have two clamps. Panels 60" and wider have three clamps. **When used as a modesty panel, specify a nominal size 6" shorter than worksurface size.**

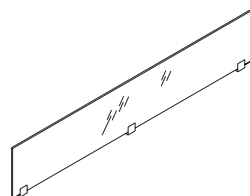

Frosted Glass Desktop Panel

PN3013DG	.25 x 30 x 13	85	10	.75		\$409
PN3613DG	.25 x 36 x 13	70	14	.75		\$428
PN4213DG	.25 x 42 x 13	70	16	.75		\$465
PN4813DG	.25 x 48 x 13	70	20	1		\$483
PN5413DG	.25 x 54 x 13	70	22	1		\$544
PN6013DG	.25 x 60 x 13	70	24	1.50		\$637
PN6613DG	.25 x 66 x 13	70	26	1.50		\$657
PN7213DG	.25 x 72 x 13	70	28	1.50		\$676

Panels up to 54" w have two clamps. Panels 60" and wider have three clamps.

Required Specifications

Fabric*

FELT PANELS

- 9mm thick panels offered in 9 finishes
- Made from 100% PET (polyester) fiber with a high content (50%) of post-recycled material, free of added chemicals, binders and adhesives
- Lightweight panels are tackable, impact and tear resistant, bacteria resistant, moisture resistant, and installation friendly
- Variation in fiber mix and color are inherent to the character of the product
- Clamps are included. Available in satin anodized finish only.

PET FELT COLORS:

AMT	Amethyst	HVT	Harvest
APR	Apricot	LAP	Lapis
BLK	Black	MTS	Mist
BSK	Blue Smoke	NVY	Navy
BRI	Brick	PWT	Pewter
CNN	Carnation	RBY	Ruby
DEN	Denim	SHR	Shamrock
EMD	Emerald	SFR	Sunflower
GPH	Graphite	WHT	White

FELT DESKTOP/MODESTY PANELS

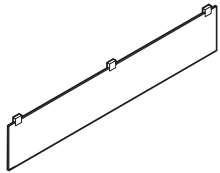

PET Felt Desktop/Modesty Panel, 1 pk.

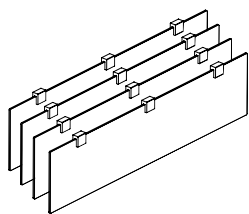

PET Felt Desktop/Modesty Panel, 4 pk.

MODEL# DIMENSIONS FREIGHT CLASS WT/LBS. CUBIC FT. LIST PRICE

MODEL#	DIMENSIONS	FREIGHT CLASS	WT/LBS.	CUBIC FT.	LIST PRICE
PN3013PT9-1	.36 x 30 x 12.5	150	2.48	.57	\$211
PN3613PT9-1	.36 x 36 x 12.5	250	2.74	.69	\$222
PN4213PT9-1	.36 x 42 x 12.5	250	2.99	.80	\$301
PN4813PT9-1	.36 x 48 x 12.5	150	3.85	.91	\$314
PN5413PT9-1	.36 x 54 x 12.5	250	4.11	1.03	\$381
PN6013PT9-1	.36 x 60 x 12.5	250	4.36	1.14	\$391
PN6613PT9-1	.36 x 66 x 12.5	150	5.22	1.25	\$470
PN7213PT9-1	.36 x 72 x 12.5	150	5.48	1.36	\$480
PN7813PT9-1	.36 x 78 x 12.5	250	5.73	1.48	\$488

PET Felt Desktop/Modesty Panel available in 9 finishes, please specify. 2, 3 or 4 clamps are included depending on screen size. Clamps available in satin anodized finish only. **When used as a modesty panel, specify a nominal size 6" shorter than worksurface size.**

- Up to 42" w - 2 clamps per panel
- 48"-60" w - 3 clamps per panel
- 66"-78" w - 4 clamps per panel

PN3013PT9-4	0.36 x 30 x 12.5	85	8.93	.60	\$804
PN3613PT9-4	0.36 x 36 x 12.5	85	9.86	.71	\$843
PN4213PT9-4	0.36 x 42 x 12.5	85	10.80	.83	\$1153
PN4813PT9-4	0.36 x 48 x 12.5	85	13.90	.98	\$1192
PN5413PT9-4	0.36 x 54 x 12.5	85	14.80	1.09	\$1458
PN6013PT9-4	0.36 x 60 x 12.5	85	15.70	1.20	\$1494
PN6613PT9-4	0.36 x 66 x 12.5	85	18.80	1.32	\$1802
PN7213PT9-4	0.36 x 72 x 12.5	85	19.70	1.43	\$1838
PN7813PT9-4	0.36 x 78 x 12.5	85	20.60	1.54	\$1874

PET Felt Desktop/Modesty Panel available in 9 finishes, please specify. 2, 3 or 4 clamps are included depending on screen size. Clamps available in satin anodized finish only. **When used as a modesty panel, specify a nominal size 6" shorter than worksurface size.**

- Up to 42" w - 2 clamps per panel
- 48"-60" w - 3 clamps per panel
- 66"-78" w - 4 clamps per panel

Required Specifications

Felt color

FELT DESKTOP/MODESTY PANELS

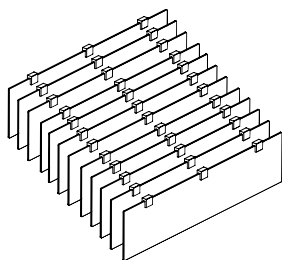

PET Felt Desktop/Modesty Panel, 12 pk.

MODEL#	DIMENSIONS D x W x H	FREIGHT CLASS	WT/LBS.	CUBIC FT.	LIST PRICE
PN3013PT9-12	0.36 x 30 x 12.5	85	25.30	1.92	\$2357
PN3613PT9-12	0.36 x 36 x 12.5	85	27.90	2.26	\$2471
PN4213PT9-12	0.36 x 42 x 12.5	92.5	30.50	2.60	\$3388
PN4813PT9-12	0.36 x 48 x 12.5	85	39.30	3.05	\$3498
PN5413PT9-12	0.36 x 54 x 12.5	85	41.90	3.39	\$4291
PN6013PT9-12	0.36 x 60 x 12.5	92.5	44.50	3.72	\$4387
PN6613PT9-12	0.36 x 66 x 12.5	85	53.20	4.18	\$5307
PN7213PT9-12	0.36 x 72 x 12.5	85	55.90	4.51	\$5401
PN7813PT9-12	0.36 x 78 x 12.5	85	58.50	4.85	\$5499

PET Felt Desktop/Modesty Panel available in 9 finishes, please specify. 2, 3 or 4 clamps are included depending on screen size. Clamps available in satin anodized finish only. **When used as a modesty panel, specify a nominal size 6" shorter than worksurface size.**

- Up to 42" w - 2 clamps per panel
- 48"-60" w - 3 clamps per panel
- 66"-78" w - 4 clamps per panel

Required Specifications

Felt color

29" H CRENZAS

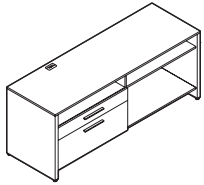

29" H Credenza - LEFT

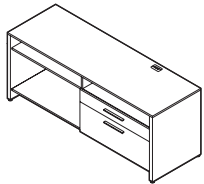

29" H Credenza - RIGHT

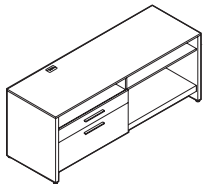

29" H Credenza w/Pull-Out Equipment Tray - LEFT

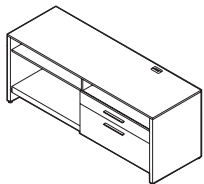

29" H Credenza w/Pull-Out Equipment Tray - RIGHT

MODEL#	DIMENSIONS	FREIGHT CLASS	WT/LBS.	CUBIC FT.	LIST PRICE	HP ADD
--------	------------	---------------	---------	-----------	------------	--------

D x W x H						
PN2984CRL	24 x 84 x 29	100	320	33.83	\$2199	\$256
PN2972CRL	24 x 72 x 29	92.5	290	29	\$2084	\$252
PN2966CRL	24 x 66 x 29	100	265	31	\$2062	\$254
PN2960CRL	24 x 60 x 29	92.5	242	24.17	\$2030	\$238

Standard with locking 34"W box and lateral file drawer on **left**. File bars included for front-to-back letter and legal filing capability. Lock on file drawer secures both drawers. Adjustable 5 position shelf. Wire management grommet on surface and internal pass-through behind equipment shelf. Connects to flush returns, flush bridges and flush conference tops. Shipped Fully Assembled.

PN2984CRR	24 x 84 x 29	100	320	33.83	\$2199	\$256
PN2972CRR	24 x 72 x 29	92.5	290	29	\$2084	\$252
PN2966CRR	24 x 66 x 29	100	265	31	\$2062	\$254
PN2960CRR	24 x 60 x 29	92.5	242	24.17	\$2030	\$238

Standard with locking 34"W box and lateral file drawer on **right**. File bars included for front-to-back letter and legal filing capability. Lock on file drawer secures both drawers. Adjustable 5 position shelf. Wire management grommet on surface and internal pass-through behind equipment shelf. Connects to flush returns, flush bridges and flush conference tops. Shipped Fully Assembled.

PN2984CPL	24 x 84 x 29	100	320	33.83	\$2483	\$270
PN2978CPL	24 x 78 x 29	100	310	36	\$2414	\$275
PN2972CPL	24 x 72 x 29	92.5	290	29	\$2355	\$267
PN2966CPL	24 x 66 x 29	100	270	31	\$2266	\$269
PN2960CPL	24 x 60 x 29	92.5	242	24.17	\$2208	\$244

Standard with locking 34"W box and lateral file drawer on **left**. File bars included for front-to-back letter and legal filing capability. Lock on file drawer secures both drawers. Adjustable 5 position shelf. Pull-out equipment shelf can support up to 80lbs. Wire management grommet on surface and internal pass-through behind equipment shelf. Connects to flush returns, flush bridges and flush conference tops. Shipped Fully Assembled.

PN2984CPR	24 x 84 x 29	100	320	33.83	\$2483	\$270
PN2978CPR	24 x 78 x 29	100	310	36	\$2414	\$275
PN2972CPR	24 x 72 x 29	92.5	290	29	\$2355	\$267
PN2966CPR	24 x 66 x 29	100	270	31	\$2266	\$269
PN2960CPR	24 x 60 x 29	92.5	242	24.17	\$2208	\$244

Standard with locking 34"W box and lateral file drawer on **right**. File bars included for front-to-back letter and legal filing capability. Lock on file drawer secures both drawers. Adjustable 5 position shelf. Pull-out equipment shelf can support up to 80lbs. Wire management grommet on surface and internal pass-through behind equipment shelf. Connects to flush returns, flush bridges and flush conference tops. Shipped Fully Assembled.

Required Specifications

Top finish
Base finish
Drawer front finish

Optional Specifications

HP laminate
RSG - remove grommet

29" H CREDENZAS

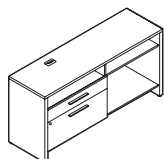

LEFT

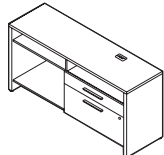

RIGHT

29" H Narrow Credenza*

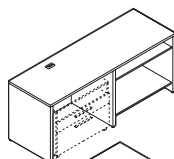

LEFT

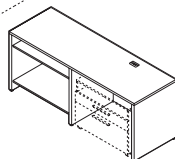

RIGHT

29" H Credenza for Mobile Lateral File

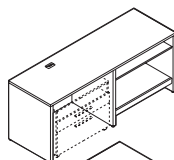

LEFT

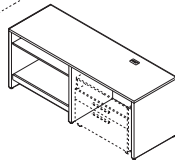

RIGHT

29" H Credenza for Mobile Lateral File w/Pull-Out Equipment Tray

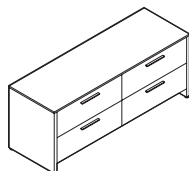

29" H Lateral File Credenza*

MODEL#	DIMENSIONS D x W x H	FREIGHT CLASS	WT/LBS.	CUBIC FT.	LIST PRICE	HP ADD
PN2954NCL	20 x 54 x 29	92.5	250	22	\$2008	\$276
PN2960NCL	20 x 60 x 29	92.5	260	24	\$2035	\$278

PN2954NCR	20 x 54 x 29	92.5	250	22	\$2008	\$276
PN2960NCR	20 x 60 x 29	92.5	260	24	\$2035	\$278

Specify PNxxxxNCL for **LEFT** or PNxxxxNCR for **RIGHT**.

20"D. Standard with 30"W box and lateral file drawer. Front-to-back letter and legal filing capability. Lock on file drawer secures both drawers. Adjustable 5 position shelf. Wire management grommet on surface and internal pass-through behind lower shelf. Connects to flush returns, flush bridges and flush conference tops. File bars included. Shipped Fully Assembled.

PN2972MCL	24 x 72 x 29	125	252	34	\$1643	\$226
PN2984MCL	24 x 84 x 29	125	268	39.50	\$1773	\$242

PN2972MCR	24 x 72 x 29	125	252	34	\$1643	\$226
PN2984MCR	24 x 84 x 29	125	268	39	\$1773	\$242

Specify PNxxxxMCL for **LEFT** or PNxxxxMCR for **RIGHT**.

Standard with 42" w space for lateral file. Adjustable 5 position shelf. Wire management grommet on surface and internal pass-through behind lower shelf. Connects to flush returns, flush bridges and flush conference tops. Accepts all mobile lateral file units. Shipped Fully Assembled.

PN2972MPL	24 x 72 x 29	125	258	34	\$1879	\$256
PN2984MPL	24 x 84 x 29	125	274	39.50	\$2003	\$275

PN2972MPR	24 x 72 x 29	125	258	34	\$1879	\$256
PN2984MPR	24 x 84 x 29	125	274	39.50	\$2003	\$275

Specify PNxxxxMPL for **LEFT** or PNxxxxMPR for **RIGHT**.

Standard with 42" w space for lateral file, adjustable 5 position shelf, and pull-out equipment shelf that can support up to 80lbs. Grommet in worksurface and internal pass-through behind equipment shelf. Connects to flush returns, flush bridges and flush conference tops. Accepts all mobile lateral file units. Shipped Fully Assembled.

PN2972LF	24 x 72 x 29	92.5	290	29	\$2479	\$320
----------	--------------	------	-----	----	--------	-------

Standard with four lateral file drawers. File bars included for front-to-back letter and legal filing capability. Lock on lower drawer secures both drawers. Anti-tip mechanism. Shipped Fully Assembled.

Required Specifications

Top finish
Base finish
Drawer front finish*

Optional Specifications

HP laminate
RSG - remove grommet
Grommet (PN2972LF)

29" H CREDENZAS

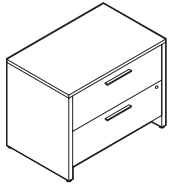

29" H Single Lateral File Credenza*

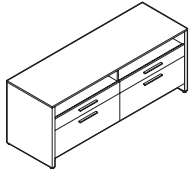

29" H Double Credenza*

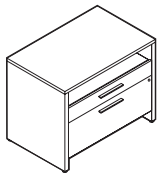

29" H Single Credenza*

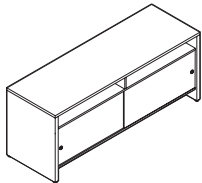

29" H Credenza w/Sliding Laminate Doors*

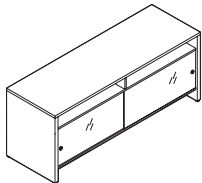

29" H Credenza w/Sliding Glass Doors

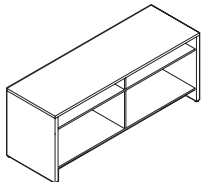

29" H Open Credenza

MODEL#	DIMENSIONS	FREIGHT CLASS	WT/LBS.	CUBIC FT.	LIST PRICE	HP ADD
--------	------------	---------------	---------	-----------	------------	--------

D x W x H

PN2937LFS	24 x 37 x 29	100	155	18	\$1681	\$229
-----------	--------------	-----	-----	----	---------------	--------------

Standard with two lateral file drawers. File bars included for front-to-back letter and legal filing capability. Lock on lower drawer secures both drawers. Anti-tip mechanism. Shipped Fully Assembled.

PN2972CRD	24 x 72 x 29	92.5	290	29	\$2385	\$299
-----------	--------------	------	-----	----	---------------	--------------

Standard with 34" w box and lateral file drawer on each side. File bars included for front-to-back letter and legal filing capability. Lock on file drawer secures both drawers. Shipped Fully Assembled.

PN2937CRS	24 x 37 x 29	100	145	18	\$1681	\$229
-----------	--------------	-----	-----	----	---------------	--------------

Standard with 34" w box and lateral file drawer. File bars included for front-to-back letter and legal filing capability. Lock on file drawer secures both drawers. Shipped Fully Assembled.

PN2960CLS	24 x 60 x 29	100	265	28.25	\$1945	\$267
PN2972CLS	24 x 72 x 29	100	289	34	\$2039	\$278
PN2984CLS	24 x 84 x 29	100	337	39.50	\$2225	\$304

Standard with sliding laminate doors in upper plastic track. Recessed brushed aluminum finger pulls. No lock. Shipped Fully Assembled.

PN2960CGS	24 x 60 x 29	100	265	28.25	\$2454	\$335
PN2972CGS	24 x 72 x 29	100	289	34	\$2715	\$371
PN2984CGS	24 x 84 x 29	100	337	39.50	\$3001	\$409

Standard with sliding glass doors in upper aluminum track. Satin etched 6mm glass. Brushed aluminum finger pulls. No lock. Shipped assembled in 2 cartons. Glass doors shipped separately.

PN2960CO	24 x 60 x 29	92.5	296	28.25	\$1636	\$224
PN2972CO	24 x 72 x 29	100	316	34	\$1734	\$239
PN2984CO	24 x 84 x 29	100	336	39.50	\$1923	\$265

Open storage with adjustable 5 position upper shelves with pass-throughs at back of lower shelves. Connects to flush returns, flush bridges and flush conference tops. Shipped Fully Assembled.

Required Specifications

Top finish
Base finish
Drawer front finish*

Optional Specifications

HP laminate
Grommet

29" H CREDENZAS

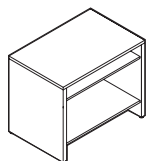

29" H Single Open Credenza**

MODEL#	DIMENSIONS	FREIGHT CLASS	WT./LBS.	CUBIC FT.	LIST PRICE	HP ADD
D x W x H						
PN2930CO	24 x 30 x 29	92.5	153	15	\$1053	\$146
PN2936CO	24 x 36 x 29	100	158	18	\$1101	\$152

Open storage with adjustable 5 position upper shelf with pass-through at back of lower shelf. Connects to flush returns, flush bridges and flush conference tops. Shipped Fully Assembled.

27" H CREDENZAS

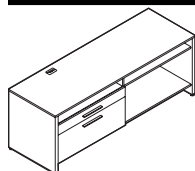

27" H Credenza - LEFT *

MODEL#	DIMENSIONS	FREIGHT CLASS	WT./LBS.	CUBIC FT.	LIST PRICE	HP ADD
PN2760CRL	24 x 60 x 27	92.5	241	22.50	\$2010	\$228
PN2766CRL	24 x 66 x 27	100	262	29	\$2042	\$241
PN2772CRL	24 x 72 x 27	92.5	290	27	\$2062	\$241
PN2778CRL	24 x 78 x 27	100	290	34	\$2125	\$253
PN2784CRL	24 x 84 x 27	92.5	335	31.50	\$2178	\$251

Standard with locking 34"W box and lateral file drawer on **left**. File bars included for front-to-back letter and legal filing capability. Lock on file drawer secures both drawers. Adjustable 5 position shelf. Wire management grommet on surface and internal pass-through behind equipment shelf. Supports overlapping returns, bridges, and conference tops that have a 1" spacer (example: PN24600MR). Cannot nest under 29"H products with metal legs. Shipped Fully Assembled.

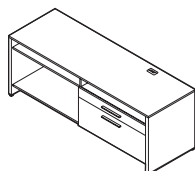

27" H Credenza - RIGHT *

PN2760CRR	24 x 60 x 27	92.5	241	22.50	\$2010	\$228
PN2766CRR	24 x 66 x 27	100	262	29	\$2042	\$241
PN2772CRR	24 x 72 x 27	92.5	290	27	\$2062	\$241
PN2778CRR	24 x 78 x 27	100	290	34	\$2125	\$253
PN2784CRR	24 x 84 x 27	92.5	335	31.50	\$2178	\$251

Standard with locking 34"W box and lateral file drawer on **right**. File bars included for front-to-back letter and legal filing capability. Lock on file drawer secures both drawers. Adjustable 5 position shelf. Wire management grommet on surface and internal pass-through behind equipment shelf. Supports overlapping returns, bridges, and conference tops that have a 1" spacer (example: PN24600MR). Cannot nest under 29"H products with metal legs. Shipped Fully Assembled.

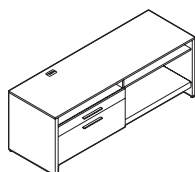

27" H Credenza w/Pull-Out Equipment Tray - LEFT*

PN2760CPL	24 x 60 x 27	92.5	241	22.50	\$2186	\$239
PN2766CPL	24 x 66 x 27	100	267	29	\$2249	\$255
PN2772CPL	24 x 72 x 27	92.5	290	27	\$2337	\$258
PN2778CPL	24 x 78 x 27	100	300	34	\$2396	\$270
PN2784CPL	24 x 84 x 27	92.5	335	31.50	\$2463	\$272

Standard with locking 34"W box and lateral file drawer on **left**. File bars included for front-to-back letter and legal filing capability. Lock on file drawer secures both drawers. Adjustable 5 position shelf. Pull-out equipment tray can support up to 80 lbs. Wire management grommet on surface and internal pass-through behind equipment shelf. Supports overlapping returns, bridges, and conference tops that have a 1" spacer (example: PN24600MR). Cannot nest under 29"H products with metal legs. Shipped Fully Assembled.

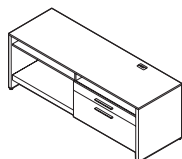

27" H Credenza w/Pull-Out Equipment Tray - RIGHT*

PN2760CPR	24 x 60 x 27	92.5	241	22.50	\$2186	\$239
PN2766CPR	24 x 66 x 27	100	267	29	\$2249	\$255
PN2772CPR	24 x 72 x 27	92.5	290	27	\$2337	\$258
PN2778CPR	24 x 78 x 27	100	300	34	\$2396	\$270
PN2784CPR	24 x 84 x 27	92.5	335	31.50	\$2463	\$272

Standard with locking 34"W box and lateral file drawer on **right**. File bars included for front-to-back letter and legal filing capability. Lock on file drawer secures both drawers. Adjustable 5 position shelf. Pull-out equipment tray can support up to 80 lbs. Wire management grommet on surface and internal pass-through behind equipment shelf. Supports overlapping returns, bridges, and conference tops that have a 1" spacer (example: PN24600MR). Cannot nest under 29"H products with metal legs. Shipped Fully Assembled.

Required Specifications

Top finish
Base finish
Drawer/door front finish*

Optional Specifications

HP laminate
Grommet**
RSG - remove grommet*

27" H CREDENZAS

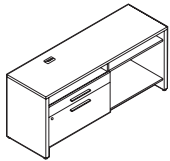

LEFT

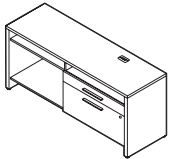

RIGHT

27" H Narrow Credenza*

MODEL#	DIMENSIONS D x W x H	FREIGHT CLASS	WT/LBS.	CUBIC FT.	LIST PRICE	HP ADD
PN2754NCL	20 x 54 x 27	92.5	250	22	\$1955	\$269
PN2760NCL	20 x 60 x 27	92.5	260	24	\$1980	\$272

PN2754NCR	20 x 54 x 27	92.5	250	22	\$1955	\$269
PN2760NCR	20 x 60 x 27	92.5	260	24	\$1980	\$272

Specify PNxxxxNCL for **LEFT** or PNxxxxNCR for **RIGHT**.

20"D. Standard with 30"W box and lateral file drawer. Front-to-back letter and legal filing capability. Lock on file drawer secures both drawers. Adjustable 5 position shelf. Wire management grommet on surface and internal pass-through at back of lower shelf. Supports overlapping returns, bridges, and conference tops that have a 1" spacer (example: PN24600MR). Cannot nest under 29"H products with metal legs. File bars included. Shipped Fully Assembled.

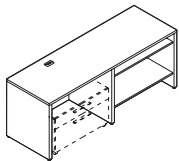

LEFT

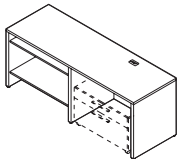

RIGHT

27" H Credenza for Mobile Lateral File

PN2772MCL	24 x 72 x 27	125	252	31.75	\$1621	\$223
PN2784MCL	24 x 84 x 27	125	268	37	\$1751	\$240

PN2772MCR	24 x 72 x 27	125	252	31.75	\$1621	\$223
PN2784MCR	24 x 84 x 27	125	268	37	\$1751	\$240

Specify PNxxxxMCL for **LEFT** or PNxxxxMCR for **RIGHT**.

Standard with 42"W space for lateral file. Adjustable 5 position shelf. Wire management grommet on surface and internal pass-through at back of lower shelf. Supports overlapping returns, bridges, and conference tops that have a 1" spacer (example: PN24600MR). Cannot nest under 29"H products with metal legs. Accepts mobile lateral file units: PN22MLBF with and without cushions, and PN25MLSBF without cushions. Shipped Fully Assembled.

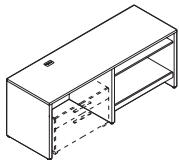

LEFT

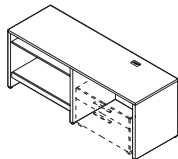

RIGHT

27" H Credenza for Mobile Lateral File w/Pull-Out Equipment Tray

PN2772MPL	24 x 72 x 27	100	258	31.75	\$1862	\$255
PN2784MPL	24 x 84 x 27	125	274	37	\$1980	\$272

PN2772MPR	24 x 72 x 27	100	258	31.75	\$1862	\$255
PN2784MPR	24 x 84 x 27	125	274	37	\$1980	\$272

Specify PNxxxxMPL for **LEFT** or PNxxxxMPR for **RIGHT**.

Standard with 42"W space for lateral file, adjustable 5 position shelf, and pull-out equipment shelf that can support up to 80lbs. Wire management grommet in surface and internal pass-through at back of pull-out equipment shelf. Supports overlapping returns, bridges, and conference tops that have a 1" spacer (example: PN24600MR). Cannot nest under 29"H products with metal legs. Accepts mobile lateral file units: PN22MLBF with and without cushions, and PN25MLSBF without cushions. Shipped Fully Assembled.

Required Specifications

Top finish
Base finish
Drawer/door front finish*

Optional Specifications

HP laminate
RSG - remove grommet

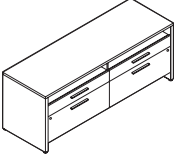
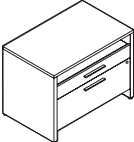
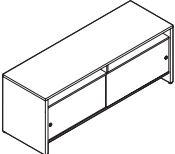
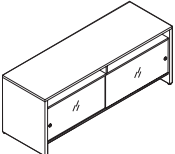
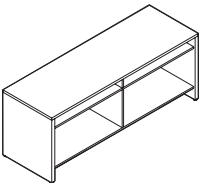
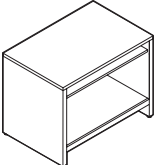
27"H CREDENZAS	MODEL#	DIMENSIONS	FREIGHT CLASS	WT/LBS.	CUBIC FT.	LIST PRICE	HP ADD
 <p>27"H Double Credenza*</p>		D x W x H					
	PN2772CRD	24 x 72 x 27	100	290	31.75	\$2340	\$299
<p>Standard with locking 34"W box and lateral file drawer on each side. File bars included for front-to-back letter and legal filing capability. Lock on file drawer secures both drawers. Shipped Fully Assembled.</p>							
 <p>27"H Single Credenza*</p>							
	PN2737CRS	24 x 37 x 27	100	145	18	\$1634	\$224
<p>Standard with 34"W box and lateral file drawer. Lock on file drawer secures both drawers. File bars included for front-to-back letter and legal filing capability. Shipped Fully Assembled.</p>							
 <p>27"H Credenza w/Sliding Laminate Doors*</p>							
	PN2760CLS	24 x 60 x 27	92.5	265	26.50	\$1925	\$265
	PN2772CLS	24 x 72 x 27	100	289	31.75	\$2020	\$277
	PN2784CLS	24 x 84 x 27	100	337	37	\$2206	\$302
<p>Standard with sliding laminate doors in upper plastic track. Recessed brushed aluminum finger pulls. No lock. Shipped Fully Assembled.</p>							
 <p>27"H Credenza w/Sliding Glass Doors</p>							
	PN2760CGS	24 x 60 x 27	92.5	265	26.50	\$2434	\$333
	PN2772CGS	24 x 72 x 27	100	289	31.75	\$2708	\$371
	PN2784CGS	24 x 84 x 27	100	337	37	\$2979	\$406
<p>Standard with sliding glass doors in upper aluminum track. Satin etched 6mm glass. Brushed aluminum finger pulls. No lock. Shipped assembled in 2 cartons. Glass doors shipped separately.</p>							
 <p>27"H Open Credenza</p>							
	PN2760CO	24 x 60 x 27	92.5	296	26.50	\$1636	\$224
	PN2772CO	24 x 72 x 27	100	316	31.75	\$1734	\$239
	PN2784CO	24 x 84 x 27	100	336	37	\$1923	\$265
<p>Open storage with adjustable 5 position upper shelves with pass-throughs at back of lower shelves. Supports overlapping returns, bridges, and conference tops that have a 1" spacer (example: PN24600MR). Cannot nest under 29"H products with metal legs. Shipped Fully Assembled.</p>							
 <p>27"H Single Open Credenza</p>							
	PN2730CO	24 x 30 x 27	92.5	153	14	\$1032	\$142
PN2736CO	24 x 36 x 27	100	158	16	\$1081	\$152	
<p>Open storage with adjustable 5 position upper shelf with pass-through at back of lower shelf. Supports overlapping returns, bridges, and conference tops that have a 1" spacer (example: PN24600MR). Cannot nest under 29"H products with metal legs. Shipped Fully Assembled.</p>							

Required Specifications

Top finish
Base finish
Drawer/door front finish*

Optional Specifications

HP laminate
Grommet

23" H CREDENZAS

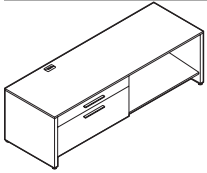

LEFT

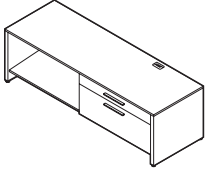

RIGHT

23" H Credenza*

MODEL#	DIMENSIONS D x W x H	FREIGHT CLASS	WT/LBS.	CUBIC FT.	LIST PRICE	HP ADD
PN2360CRL	24 x 60 x 23	100	190	19.17	\$1677	\$212
PN2366CRL	24 x 66 x 23	100	227	25	\$1715	\$222
PN2372CRL	24 x 72 x 23	100	228	23	\$1742	\$220
PN2378CRL	24 x 78 x 23	100	248	30	\$1780	\$227
PN2384CRL	24 x 84 x 23	100	266	26.83	\$1816	\$227

PN2360CRR	24 x 60 x 23	100	190	19.17	\$1677	\$212
PN2366CRR	24 x 66 x 23	100	227	25	\$1715	\$222
PN2372CRR	24 x 72 x 23	100	228	23	\$1742	\$220
PN2378CRR	24 x 78 x 23	100	248	30	\$1780	\$227
PN2384CRR	24 x 84 x 23	100	266	26.83	\$1816	\$227

Standard with 34"W box and lateral file drawer. File bars included for front-to-back letter and legal filing capability. Lock on file drawer secures both drawers. Wire management grommet on surface and internal pass-through at back of lower shelf. Supports Overlapping Return with metal leg and spacer for 23"H credenza, Overlapping Wedge Shaped Return with metal leg and spacer for 23"H credenza, and Overlapping Bridges with metal spacer for 23"H credenza. Shipped Fully Assembled.

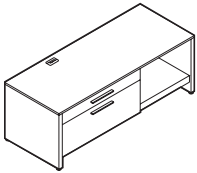

LEFT

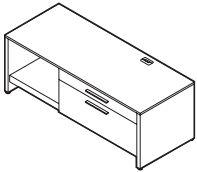

RIGHT

23" H Credenza w/Pull-Out Equipment Tray - RIGHT*

PN2360CPL	24 x 60 x 23	100	190	19.17	\$1902	\$223
PN2366CPL	24 x 66 x 23	100	233	25	\$1964	\$236
PN2372CPL	24 x 72 x 23	100	228	23	\$2026	\$233
PN2378CPL	24 x 78 x 23	100	254	30	\$2074	\$241
PN2384CPL	24 x 84 x 23	100	266	26.83	\$2112	\$241

PN2360CPR	24 x 60 x 23	100	190	19.17	\$1902	\$223
PN2366CPR	24 x 66 x 23	100	233	25	\$1964	\$236
PN2372CPR	24 x 72 x 23	100	228	23	\$2026	\$233
PN2378CPR	24 x 78 x 23	100	254	30	\$2074	\$241
PN2384CPR	24 x 84 x 23	100	266	26.83	\$2112	\$241

Standard with 34"W box and lateral file drawer. Pull-out equipment shelf can support up to 80lbs. Adjustable 5 position shelf. File bars included for front-to-back letter and legal filing capability. Lock on file drawer secures both drawers. Wire management grommet on surface and internal pass-through at back of lower shelf. Supports Overlapping Return with metal leg and spacer for 23"H credenza, Overlapping Wedge Shaped Return with metal leg and spacer for 23"H credenza, and Overlapping Bridges with metal spacer for 23"H credenza. Shipped Fully Assembled.

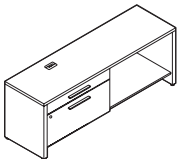

LEFT

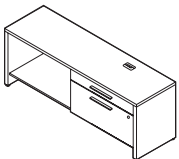

RIGHT

23" H Narrow Credenza

PN2354NCL	20 x 54 x 23	92.5	230	21	\$1640	\$224
PN2360NCL	20 x 60 x 23	92.5	240	23	\$1647	\$226

PN2354NCR	20 x 54 x 23	92.5	230	21	\$1640	\$224
PN2360NCR	20 x 60 x 23	92.5	240	23	\$1647	\$226

Specify PNxxxxNCL for **LEFT** or PNxxxxNCR for **RIGHT**.

20"D. Standard with 30"W box and lateral file drawer. File bars included for front-to-back letter and legal filing capability. Lock on file drawer secures both drawers. Wire management grommet on surface and internal pass-through at back of lower shelf. Supports Overlapping Return with metal leg and spacer for 23"H credenza, Overlapping Wedge Shaped Return with metal leg and spacer for 23"H credenza, and Overlapping Bridges with metal spacer for 23"H credenza. Shipped Fully Assembled.

Required Specifications

Top finish
Base finish
Drawer front finish

Optional Specifications

HP laminate
RSG - remove grommet

Accessories

Cushion

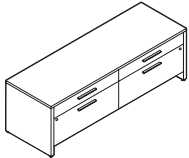
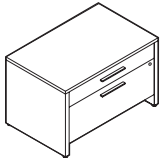
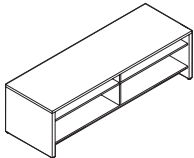
23"H CREDENZAS	MODEL#	DIMENSIONS	FREIGHT CLASS	WT/LBS.	CUBIC FT.	LIST PRICE	HP ADD
 <p>23"H Double Credenza*</p>		D x W x H					
	PN2372CRD	24 x 72 x 23	92.5	275	27	\$2159	\$297
<p>Standard with locking 34"W box and lateral file drawer on each side. File bars included for front-to-back letter and legal filing capability. Lock on file drawer secures both drawers. Shipped Fully Assembled.</p>							
 <p>23"H Single Credenza*</p>							
	PN2337CRS	24 x 37 x 23	100	125	15	\$1469	\$201
<p>Standard with 34" w box and lateral file drawer. File bars included for front-to-back letter and legal filing capability. Lock on file drawer secures both drawers. Shipped Fully Assembled.</p>							
 <p>23"H Open Credenza</p>							
	PN2360CO	24 x 60 x 23	85	276	23	\$1446	\$199
	PN2372CO	24 x 72 x 23	92.5	296	27.50	\$1567	\$216
	PN2384CO	24 x 84 x 23	100	316	32	\$1744	\$240
<p>Open storage with adjustable 5 position upper shelves with pass-throughs at back of lower shelves. Supports Overlapping Return with metal leg and spacer for 23"H credenza, Overlapping Wedge Shaped Return with metal leg and spacer for 23"H credenza, and Overlapping Bridges with metal spacer for 23"H credenza. Shipped Fully Assembled.</p>							

Required Specifications

Top finish
Base finish
Drawer front finish*

Optional Specifications

HP laminate
Grommet

Accessories

Cushion

CUSHIONS FOR 23"H CREDENZAS

MODEL#	DIMENSIONS	FREIGHT CLASS	WT/LBS.	CUBIC FT.	GRADE	LIST	GRADE	LIST
PN2430CU	24 x 30 x 2.5	150	13	2.40		D x W x H		
					1	\$330	7	\$712
					2	\$392	8	\$868
					3	\$436	9	\$945
					4	\$501	10	\$1091
					5	\$595	11	\$1290
PN2433CU	24 x 33 x 2.5	150	13	2.40	6	\$630	12	\$1536
					1	\$359	7	\$866
					2	\$437	8	\$1076
					3	\$497	9	\$1176
					4	\$586	10	\$1371
					5	\$713	11	\$1636
PN2436CU	24 x 36 x 2.5	250	7	2	6	\$756	12	\$1967
					1	\$382	7	\$951
					2	\$471	8	\$1187
					3	\$537	9	\$1301
					4	\$636	10	\$1521
					5	\$778	11	\$1817
PN2439CU	24 x 39 x 2.5	150	14	2.40	6	\$827	12	\$2189
					1	\$407	7	\$976
					2	\$496	8	\$1212
					3	\$562	9	\$1326
					4	\$661	10	\$1546
					5	\$803	11	\$1842
PN2442CU	24 x 42 x 2.5	150	14	2.40	6	\$852	12	\$2214
					1	\$426	7	\$995
					2	\$515	8	\$1231
					3	\$581	9	\$1345
					4	\$680	10	\$1565
					5	\$822	11	\$1861

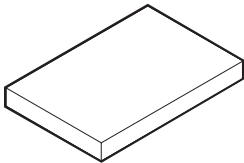

Cushion for 23"H Credenzas

Cushion attaches with Velcro strips. Fits **24"d** credenzas.

PN2027CU	20 x 27 x 2.5	150	12	2.40	1	\$291	7	\$608
					2	\$342	8	\$741
					3	\$380	9	\$805
					4	\$433	10	\$924
					5	\$513	11	\$1092
					6	\$542	12	\$1297
PN2030CU	20 x 30 x 2.5	150	12	2.40	1	\$315	7	\$632
					2	\$366	8	\$765
					3	\$404	9	\$829
					4	\$457	10	\$948
					5	\$537	11	\$1116
					6	\$566	12	\$1321

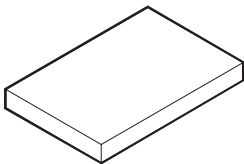

Cushion for 23"H Narrow Credenzas

Cushion attaches with Velcro strips. Fits **20"d** credenzas.

Required Specifications
Fabric

CUSHIONS FOR 23"H CREDENZAS

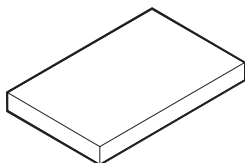

Cushion for 23"H Single Credenza**

MODEL#	DIMENSIONS	FREIGHT CLASS	WT./LBS.	CUBIC FT.	GRADE	LIST	GRADE	LIST
D x W x H								
PN2437CU	24 x 37 x 2.5	150	14	2.40	1	\$402	7	\$971
					2	\$491	8	\$1208
					3	\$557	9	\$1321
					4	\$656	10	\$1541
					5	\$798	11	\$1837
					6	\$847	12	\$2209

Cushion attaches with Velcro strips. Fits **PN2337CRS** credenza.

52"H STORAGE CABINETS

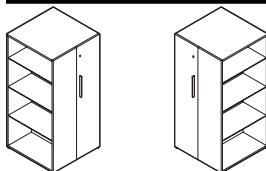

LEFT

RIGHT

52"H Tower Wardrobe w/Full Height Bookcase*

MODEL#	DIMENSIONS	FREIGHT CLASS	WT./LBS.	CUBIC FT.	LIST PRICE
PN52TWBL	24 x 24 x 52	125	129	17.33	\$1923
PN52TWBR	24 x 24 x 52	125	129	17.33	\$1923

Specify PN52TWBL for **LEFT** or PN52TWBR for **RIGHT**.

Locking wardrobe with full height bookcase. Three adjustable laminate shelves with fixed bottom laminate shelf. Coat rail. Shipped Fully Assembled.

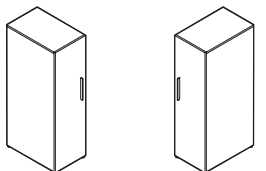

LEFT

RIGHT

52"H Wardrobe*

PN1652WDL	24 x 16 x 52	125	84	11.56	\$1145
PN1652WDR	24 x 16 x 52	125	84	11.56	\$1145

Specify PN1652WDL for **LEFT** or PN1652WDR for **RIGHT**.

Locking wardrobe with coat rail. Shipped Fully Assembled.

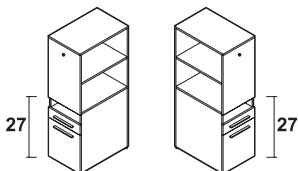

LEFT

RIGHT

52"H Storage Cabinet w/Bookshelf at 27"H*

PN57CSBFL	24 x 16 x 52	100	102	11.56	\$1644
PN57CSBFR	24 x 16 x 52	100	102	11.56	\$1644

Specify PN57CSBFL for **LEFT** or PN57CSBFR for **RIGHT**.

Open Shelf/Box/File Drawer. Lock on file drawer secures both drawers. One adjustable laminate shelf. Fixed bottom shelf aligns with **27"H** surfaces. Outside accessory hook. Shipped Fully Assembled.

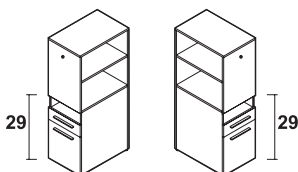

LEFT

RIGHT

52"H Storage Cabinet w/Bookshelf at 29"H

PN59CSBFL	24 x 16 x 52	100	102	11.56	\$1668
PN59CSBFR	24 x 16 x 52	100	102	11.56	\$1668

Specify PN59CSBFL for **LEFT** or PN59CSBFR for **RIGHT**.

Open Shelf/Box/File Drawer. Lock on file drawer secures both drawers. One adjustable laminate shelf. Fixed bottom shelf aligns with **29"H** surfaces. Outside accessory hook. Shipped fully assembled.

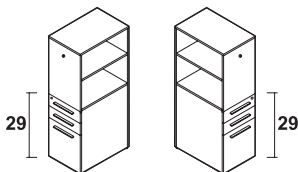

LEFT

RIGHT

52"H Storage Cabinet w/Bookshelf at 29"H

PN59CBBFL	24 x 16 x 52	100	102	11.56	\$1764
PN59CBBFR	24 x 16 x 52	100	102	11.56	\$1764

Specify PN59CBBFL for **LEFT** or PN59CBBFR for **RIGHT**.

Box/Box/File Drawer. Lock on upper box drawer secures both drawers. One adjustable laminate shelf. Fixed bottom shelf aligns with **29"H** surfaces. Outside accessory hook. Shipped fully assembled.

Required Specifications

- Top finish*
- Base finish*
- Drawer/door front finish*
- Fabric**

52" H STORAGE CABINETS

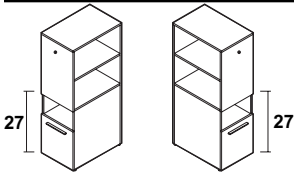

LEFT
52" H Recycling Cabinet
w/Bookshelf at 27" H

RIGHT

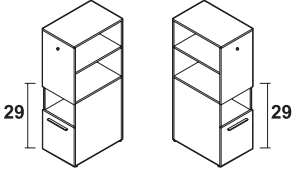

LEFT
52" H Recycling Cabinet
w/Bookshelf at 29" H

RIGHT

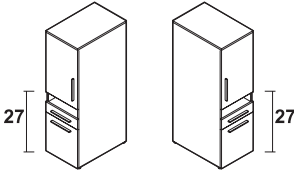

LEFT
52" H Storage Cabinet w/Door at 27" H

RIGHT

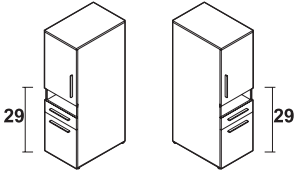

LEFT
52" H Storage Cabinet w/Door at 29" H

RIGHT

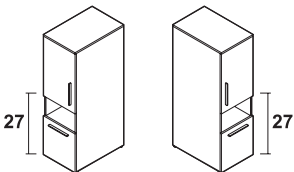

LEFT
52" H Recycling Cabinet w/Door at 27" H

RIGHT

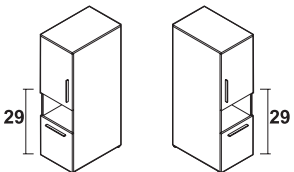

LEFT
52" H Recycling Cabinet w/Door at 29" H

RIGHT

MODEL#	DIMENSIONS D x W x H	FREIGHT CLASS	WT/LBS.	CUBIC FT.	LIST PRICE
PN57RCSL	24 x 16 x 52	100	102	11.56	\$1542
PN57RCSR	24 x 16 x 52	100	102	11.56	\$1542

Specify PN57RCSL for **LEFT** or PN57RCSR for **RIGHT**.

Drawer with one waste bin, one recycling bin and an open shelf above. One adjustable laminate shelf. Fixed bottom shelf aligns with **27" H** surfaces. Outside accessory hook. Shipped Fully Assembled.

PN59RCSL	24 x 16 x 52	100	102	11.56	\$1560
PN59RCSR	24 x 16 x 52	100	102	11.56	\$1560

Specify PN59RCSL for **LEFT** or PN59RCSR for **RIGHT**.

Drawer with one waste bin, one recycling bin and an open shelf above. One adjustable laminate shelf. Fixed bottom shelf aligns with **29" H** surfaces. Outside accessory hook. Shipped Fully Assembled.

PN57DSBFL	24 x 16 x 52	100	102	11.56	\$1809
PN57DSBFR	24 x 16 x 52	100	102	11.56	\$1809

Specify PN57DSBFL for **LEFT** or PN57DSBFR for **RIGHT**.

Open Shelf/Box/File Drawer. Lock on file drawer secures both drawers. Upper storage cabinet with locking door and one adjustable laminate shelf inside. Door aligns with **27" H** surfaces. Shipped Fully Assembled.

PN59DSBFL	24 x 16 x 52	100	102	11.56	\$1844
PN59DSBFR	24 x 16 x 52	100	102	11.56	\$1844

Specify PN59DSBFL for **LEFT** or PN59DSBFR for **RIGHT**.

Open Shelf/Box/File Drawer. Lock on file drawer secures both drawers. Upper storage cabinet with locking door and one adjustable laminate shelf inside. Door aligns with **29" H** surfaces. Shipped Fully Assembled.

PN57DRCSL	24 x 16 x 52	100	102	11.56	\$1602
PN57DRCSR	24 x 16 x 52	100	102	11.56	\$1602

Specify PN57DRCSL for **LEFT** or PN57DRCSR for **RIGHT**.

Upper storage cabinet with locking door. Drawer with one waste bin, one recycling bin, and an open shelf above. One adjustable laminate shelf inside locking cabinet door. Door aligns with **27" H** surfaces. Shipped Fully Assembled.

PN59DRCSL	24 x 16 x 52	100	102	11.56	\$1636
PN59DRCSR	24 x 16 x 52	100	102	11.56	\$1636

Specify PN59DRCSL for **LEFT** or PN59DRCSR for **RIGHT**.

Upper storage cabinet with locking door. Drawer with one waste bin, one recycling bin, and an open shelf above. One adjustable laminate shelf inside locking cabinet door. Door aligns with **29" H** surfaces. Shipped Fully Assembled.

Required Specifications

- Top finish
- Base finish
- Drawer/door front finish

52" H STORAGE CABINETS

MODEL# DIMENSIONS FREIGHT CLASS WT/LBS. CUBIC FT. LIST PRICE

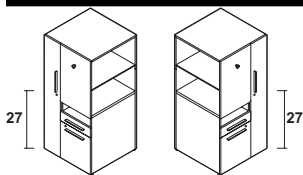

LEFT RIGHT
52" H Storage Tower w/Wardrobe, Shelf and Bookshelf at 27" H

	D x W x H				
PN57TSBFL	24 x 24 x 52	92.5	225	21	\$1976
PN57TSBFR	24 x 24 x 52	92.5	225	21	\$1976

Specify PN57TSBFL for **LEFT** or PN57TSBFR for **RIGHT**.

Open Shelf/Box/File drawer. Lock on file drawer secures both drawers. One adjustable laminate shelf. Fixed bottom shelf aligns with **27" H** surfaces. Outside accessory hook and locking wardrobe with coat rail. Shipped Fully Assembled.

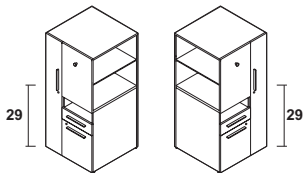

LEFT RIGHT
52" H Storage Tower w/Wardrobe, Shelf and Bookshelf at 29" H

PN59TSBFL	24 x 24 x 52	92.5	225	21	\$1673
PN59TSBFR	24 x 24 x 52	92.5	225	21	\$1673

Specify PN59TSBFL for **LEFT** or PN59TSBFR for **RIGHT**.

Open Shelf/Box/File drawer. Lock on file drawer secures both drawers. One adjustable laminate shelf. Fixed bottom shelf aligns with **29" H** surfaces. Outside accessory hook and locking wardrobe with coat rail. Shipped Fully Assembled.

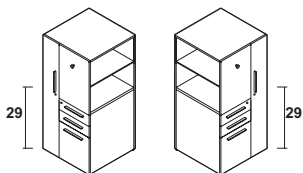

LEFT RIGHT
52" H Storage Tower w/Wardrobe, and Bookshelf at 29" H

PN59TBBFL	24 x 24 x 52	92.5	250	21	\$2282
PN59TBBFR	24 x 24 x 52	92.5	250	21	\$2282

Specify PN59TBBFL for **LEFT** or PN59TBBFR for **RIGHT**.

Box/Box/File drawer. Lock on upper box drawer secures file and lower box drawer. One adjustable laminate shelf. Fixed bottom shelf aligns with **29" H** surfaces. Outside accessory hook and locking wardrobe with coat rail. Shipped fully assembled.

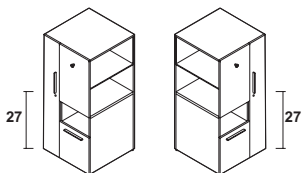

LEFT RIGHT
52" H Storage Tower w/Wardrobe, Shelf, Recycling and Bookshelf at 27" H

PN57RTSL	24 x 24 x 52	92.5	238	21	\$2121
PN57RTSR	24 x 24 x 52	92.5	238	21	\$2121

Specify PN57RTSL for **LEFT** or PN57RTSR for **RIGHT**.

Drawer with one waste and one recycling bin. Open shelf above. One adjustable laminate shelf. Fixed bottom shelf aligns with **27" H** surfaces. Outside accessory hook. Locking wardrobe with coat rail. Shipped Fully Assembled.

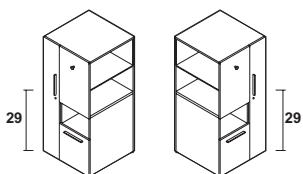

LEFT RIGHT
52" H Storage Tower w/Wardrobe, Shelf, Recycling and Bookshelf at 29" H

PN59RTSL	24 x 24 x 52	92.5	238	21	\$2121
PN59RTSR	24 x 24 x 52	92.5	238	21	\$2121

Specify PN59RTSL for **LEFT** or PN59RTSR for **RIGHT**.

Drawer with one waste and one recycling bin. Open shelf above. One adjustable laminate shelf. Fixed bottom shelf aligns with **29" H** surfaces. Outside accessory hook. Locking wardrobe with coat rail. Shipped Fully Assembled.

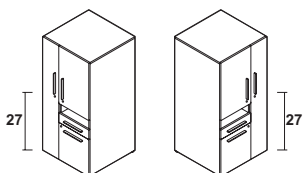

LEFT RIGHT
52" H Storage Tower w/Wardrobe, Shelf/Box/File and Door at 27" H

PN57SBFTL	24 x 24 x 52	92.5	234	21	\$2221
PN57SBFTR	24 x 24 x 52	92.5	234	21	\$2221

Specify PN57SBFTL for **LEFT** or PN57SBFTR for **RIGHT**.

Open Shelf/Box/File drawer. Lock on file drawer secures both drawers. Upper storage cabinet with locking door and one adjustable laminate shelf inside. Door aligns with **27" H** surfaces. Locking wardrobe with coat rail. Shipped Fully Assembled.

Required Specifications

- Top finish
- Base finish
- Drawer/door front finish

52" H STORAGE CABINETS

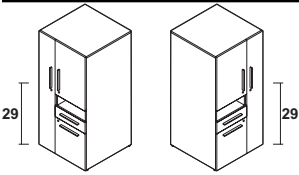

LEFT RIGHT
52" H Storage Tower w/Wardrobe, Shelf/Box/File and Door at 29" H

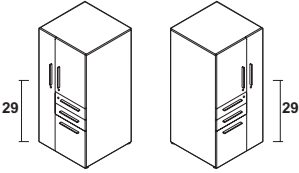

LEFT RIGHT
52" H Storage Tower w/Wardrobe, Shelf, Box/Box/File and Door at 29" H

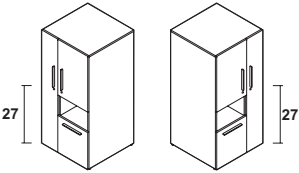

LEFT RIGHT
52" H Storage Tower w/Wardrobe, Shelf, Recycling and Door at 27" H

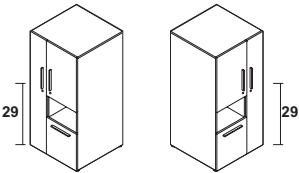

LEFT RIGHT
52" H Storage Tower w/Wardrobe, Shelf, Recycling and Door at 29" H

MODEL#	DIMENSIONS	FREIGHT CLASS	WT/LBS.	CUBIC FT.	LIST PRICE
	D x W x H				
PN59SBFTL	24 x 24 x 52	92.5	234	21	\$2221
PN59SBFTR	24 x 24 x 52	92.5	234	21	\$2221

Specify PN59SBFTL for **LEFT** or PN59SBFTR for **RIGHT**.

Open Shelf/Box/File drawer. Lock on file drawer secures both drawers. Upper storage cabinet with locking door and one adjustable laminate shelf inside. Door aligns with **29" H** surfaces. Locking wardrobe with coat rail. Shipped Fully Assembled.

PN59BBFTL	24 x 24 x 52	92.5	234	21	\$2341
PN59BBFTR	24 x 24 x 52	92.5	234	21	\$2341

Specify PN59BBFTL for **LEFT** or PN59BBFTR for **RIGHT**.

Box/Box/File drawer. Lock on upper box drawer secures file and lower box drawers. Upper storage cabinet with locking door and one adjustable laminate shelf inside. Door aligns with **29" H** surfaces. Locking wardrobe with coat rail. Shipped fully assembled.

PN57DRTSL	24 x 24 x 52	92.5	234	21	\$2260
PN57DRTSR	24 x 24 x 52	92.5	234	21	\$2260

Specify PN57DRTSL for **LEFT** or PN57DRTSR for **RIGHT**.

Drawer with one waste and one recycling bin. Open shelf above. Upper storage cabinet with locking door and one adjustable laminate shelf inside. Door aligns with **27" H** surfaces. Locking wardrobe with coat rail. Shipped Fully Assembled.

PN59DRTSL	24 x 24 x 52	92.5	234	21	\$2260
PN59DRTSR	24 x 24 x 52	92.5	234	21	\$2260

Specify PN59DRTSL for **LEFT** or PN59DRTSR for **RIGHT**.

Drawer with one waste and one recycling bin. Open shelf above. Upper storage cabinet with locking door and one adjustable laminate shelf inside. Door aligns with **29" H** surfaces. Locking wardrobe with coat rail. Shipped Fully Assembled.

Required Specifications

- Top finish
- Base finish
- Drawer/door front finish

66" H STORAGE CABINETS

MODEL# DIMENSIONS FREIGHT CLASS WT/LBS. CUBIC FT. LIST PRICE

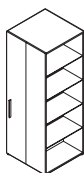
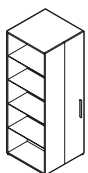

LEFT
RIGHT
66" H Tower Wardrobe w/Full Height Bookcase

	D x W x H				
PN66TWBL	24 x 24 x 66	125	165	22	\$2231
PN66TWBR	24 x 24 x 66	125	165	22	\$2231

Specify PN66TWBL for **LEFT** or PN66TWBR for **RIGHT**.

Locking wardrobe and full height bookcase. Four adjustable laminate shelves with fixed bottom laminate shelf. Coat rail. Shipped Fully Assembled.



LEFT
RIGHT
66" H Wardrobe

PN1666WDL	24 x 16 x 66	125	106	14.67	\$1294
PN1666WDR	24 x 16 x 66	125	106	14.67	\$1294

Specify PN1666WDL for **LEFT** or PN1666WDR for **RIGHT**.

Locking wardrobe with coat rail and fixed shelf above. Shipped Fully Assembled.

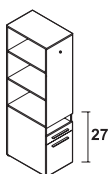
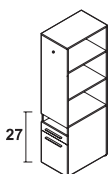

LEFT
RIGHT
66" H Storage Cabinet w/Bookshelf at 27" H

PN67CSBFL	24 x 16 x 66	100	130	14.67	\$1767
PN67CSBFR	24 x 16 x 66	100	130	14.67	\$1767

Specify PN67CSBFL for **LEFT** or PN67CSBFR for **RIGHT**.

Open Shelf/Box/File Drawer. Lock on file drawer secures both drawers. Two adjustable laminate shelves. Fixed bottom shelf aligns with **27" H** surfaces. Outside accessory hook. Shipped Fully Assembled.

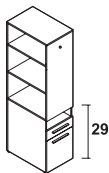
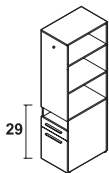

LEFT
RIGHT
66" H Storage Cabinet w/Bookshelf at 29" H

PN69CSBFL	24 x 16 x 66	100	130	14.67	\$1767
PN69CSBFR	24 x 16 x 66	100	130	14.67	\$1767

Specify PN69CSBFL for **LEFT** or PN69CSBFR for **RIGHT**.

Open Shelf/Box/File Drawer. Lock on file drawer secures both drawers. Two adjustable laminate shelves. Fixed bottom shelf aligns with **29" H** surfaces. Outside accessory hook. Shipped Fully Assembled.

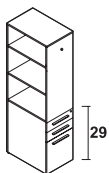
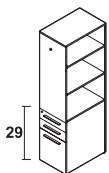

LEFT
RIGHT
66" H Storage Cabinet w/Bookshelf at 29" H

PN69CBBFL	24 x 16 x 66	100	130	14.67	\$1890
PN69CBBFR	24 x 16 x 66	100	130	14.67	\$1890

Specify PN69CBBFL for **LEFT** or PN69CBBFR for **RIGHT**.

Box/Box/File Drawer. Lock on upper box drawer secures file and lower box drawer. Two adjustable laminate shelves. Fixed bottom shelf aligns with **29" H** surfaces. Outside accessory hook. Shipped fully assembled.

Required Specifications

- Top finish
- Base finish
- Drawer/door front finish

66" H STORAGE CABINETS

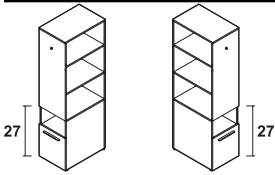

LEFT RIGHT
66" H Recycling Cabinet
w/Bookshelf at 27" H

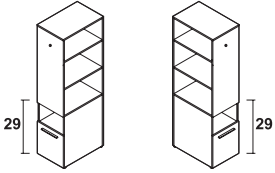

LEFT RIGHT
66" H Recycling Cabinet
w/Bookshelf at 29" H

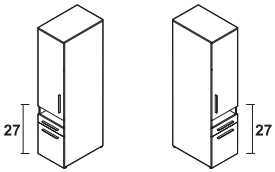

LEFT RIGHT
66" H Storage Cabinet w/Door at 27" H

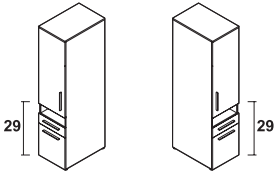

LEFT RIGHT
66" H Storage Cabinet w/Door at 29" H

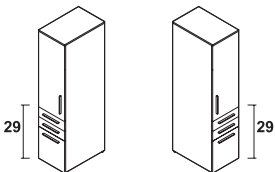

LEFT RIGHT
66" H Storage Cabinet w/Door at 29" H

MODEL#	DIMENSIONS D x W x H	FREIGHT CLASS	WT/LBS.	CUBIC FT.	LIST PRICE
PN67RCSL	24 x 16 x 66	100	130	14.67	\$1696
PN67RCSR	24 x 16 x 66	100	130	14.67	\$1696

Specify PN67RCSL for **LEFT** or PN67RCSR for **RIGHT**.

Drawer with one waste bin and one recycling bin. Open shelf above. Two adjustable laminate shelves. Fixed bottom shelf aligns with **27" H** surfaces. Outside accessory hook. Shipped Fully Assembled.

PN69RCSL	24 x 16 x 66	100	130	14.67	\$1696
PN69RCSR	24 x 16 x 66	100	130	14.67	\$1696

Specify PN69RCSL for **LEFT** or PN69RCSR for **RIGHT**.

Drawer with one waste bin and one recycling bin. Open shelf above. Two adjustable laminate shelves. Fixed bottom shelf aligns with **29" H** surfaces. Outside accessory hook. Shipped Fully Assembled.

PN67DSBFL	24 x 16 x 66	100	130	14.67	\$1874
PN67DSBFR	24 x 16 x 66	100	130	14.67	\$1874

Specify PN67DSBFL for **LEFT** or PN67DSBFR for **RIGHT**.

Open Shelf/Box/File Drawer. Lock on file drawer secures both drawers. Upper storage cabinet with locking door and two adjustable laminate shelves inside. Door aligns with **27" H** surfaces. Shipped Fully Assembled.

PN69DSBFL	24 x 16 x 66	100	130	14.67	\$1939
PN69DSBFR	24 x 16 x 66	100	130	14.67	\$1939

Specify PN69DSBFL for **LEFT** or PN69DSBFR for **RIGHT**.

Open Shelf/Box/File Drawer. Lock on file drawer secures both drawers. Upper storage cabinet with locking door and two adjustable laminate shelves inside. Door aligns with **29" H** surfaces. Shipped Fully Assembled.

PN69DBBFL	24 x 16 x 66	100	130	14.67	\$2058
PN69DBBFR	24 x 16 x 66	100	130	14.67	\$2058

Specify PN69DBBFL for **LEFT** or PN69DBBFR for **RIGHT**.

Box/Box/File Drawer. Lock on upper box drawer secures file and lower box drawer. Upper storage cabinet with locking door and two adjustable laminate shelves inside. Door aligns with **29" H** surfaces. Shipped Fully Assembled.

Required Specifications

- Top finish
- Base finish
- Drawer/door front finish

66"H STORAGE CABINETS

MODEL# DIMENSIONS FREIGHT CLASS WT/LBS. CUBIC FT. LIST PRICE

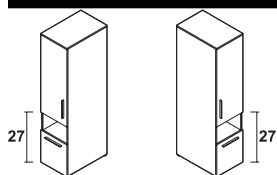

LEFT **RIGHT**
66"H Recycling Cabinet w/Door at 27"H

MODEL#	D x W x H	FREIGHT CLASS	WT/LBS.	CUBIC FT.	LIST PRICE
PN67DRCSL	24 x 16 x 66	100	130	14.67	\$1761
PN67DRCSR	24 x 16 x 66	100	130	14.67	\$1761

Specify PN67DRCSL for **LEFT** or PN67DRCSR for **RIGHT**.

Upper storage cabinet with locking door and two adjustable laminate shelves inside. Drawer with one waste bin, one recycling bin, and an open shelf above. Door aligns with **27"H** surfaces. Shipped Fully Assembled.

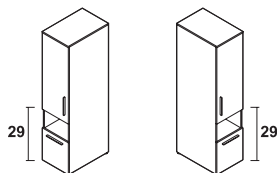

LEFT **RIGHT**
66"H Recycling Cabinet w/Door at 29"H

PN69DRCSL	24 x 16 x 66	100	130	14.67	\$1853
PN69DRCSR	24 x 16 x 66	100	130	14.67	\$1853

Specify PN69DRCSL for **LEFT** or PN69DRCSR for **RIGHT**.

Upper storage cabinet with locking door and two adjustable laminate shelves inside. Drawer with one waste bin, one recycling bin, and an open shelf above. Door aligns with **29"H** surfaces. Shipped fully assembled.

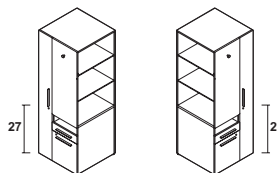

LEFT **RIGHT**
66"H Storage Tower w/Wardrobe, Shelf, Box/File and Bookshelf at 27"H

PN67TSBFL	24 x 24 x 66	92.5	260	26	\$2775
PN67TSBFR	24 x 24 x 66	92.5	260	26	\$2775

Specify PN67TSBFL for **LEFT** or PN67TSBFR for **RIGHT**.

Open Shelf/Box/File drawer. Lock on file drawer secures both drawers. Two adjustable laminate shelves. Fixed bottom shelf aligns with **27"H** surfaces. Outside accessory hook and locking wardrobe with coat rail. Shipped fully assembled.

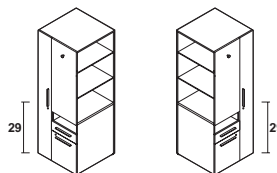

LEFT **RIGHT**
66"H Storage Tower w/Wardrobe, Shelf, Box/File and Bookshelf at 29"H

PN69TSBFL	24 x 24 x 66	92.5	260	26	\$2775
PN69TSBFR	24 x 24 x 66	92.5	260	26	\$2775

Specify PN69TSBFL for **LEFT** or PN69TSBFR for **RIGHT**.

Open Shelf/Box/File drawer. Lock on file drawer secures both drawers. Two adjustable laminate shelves. Fixed bottom shelf aligns with **29"H** surfaces. Outside accessory hook and locking wardrobe with coat rail. Shipped Fully Assembled.

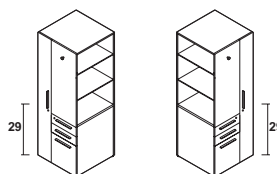

LEFT **RIGHT**
66"H Storage Tower w/Wardrobe, Shelf, Box/Box/File and Bookshelf at 29"H

PN69TBBFL	24 x 24 x 66	92.5	262	26	\$2923
PN69TBBFR	24 x 24 x 66	92.5	262	26	\$2923

Specify PN69TBBFL for **LEFT** or PN69TBBFR for **RIGHT**.

Box/Box/File drawer. Lock on upper box drawer secures file and lower box drawer. Two adjustable laminate shelves. Fixed bottom shelf aligns with **29"H** surfaces. Outside accessory hook and locking wardrobe with coat rail. Shipped fully assembled.

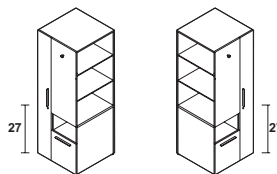

LEFT **RIGHT**
66"H Storage Tower w/Wardrobe, Shelf, Recycling and Bookshelf at 27"H

PN67RTSL	24 x 24 x 66	92.5	260	26	\$2788
PN67RTSR	24 x 24 x 66	92.5	260	26	\$2788

Specify PN67RTSL for **LEFT** or PN67RTSR for **RIGHT**.

Drawer with one waste and one recycling bin. Open shelf above. Two adjustable laminate shelves. Fixed bottom shelf aligns with **27"H** surfaces. Outside accessory hook. Locking wardrobe with coat rail. Shipped fully assembled.

Required Specifications

- Top finish
- Base finish
- Drawer/door front finish

66" H STORAGE CABINETS

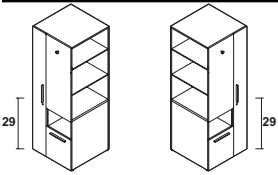

LEFT RIGHT

66" H Storage Tower w/Wardrobe, Shelf, Recycling and Bookshelf at 29" H

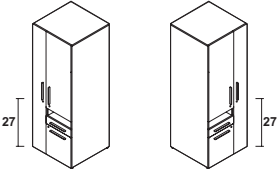

LEFT RIGHT

66" H Storage Tower w/Wardrobe, Shelf, Box/File and Door at 27" H

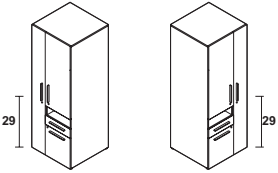

LEFT RIGHT

66" H Storage Tower w/Wardrobe, Shelf, Box/File and Door at 29" H

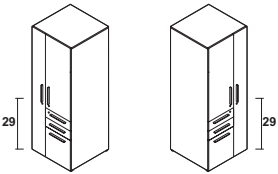

LEFT RIGHT

66" H Storage Tower w/Wardrobe, Box/Box/File and Door at 29" H

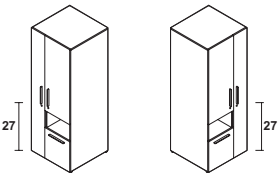

LEFT RIGHT

66" H Storage Tower w/Wardrobe, Large Shelf, Recycling and Door at 27" H

MODEL#	DIMENSIONS D x W x H	FREIGHT CLASS	WT./LBS.	CUBIC FT.	LIST PRICE
PN69RTSL	24 x 24 x 66	92.5	260	26	\$2788
PN69RTSR	24 x 24 x 66	92.5	260	26	\$2788

Specify PN69RTSL for **LEFT** or PN69RTSR for **RIGHT**.

Drawer with one waste and one recycling bin. Open shelf above. Two adjustable laminate shelves. Fixed bottom shelf aligns with **29" H** surfaces. Outside accessory hook. Locking wardrobe with coat rail. Shipped Fully Assembled.

PN67SBFTL	24 x 24 x 66	100	257	26	\$2878
PN67SBFTR	24 x 24 x 66	100	257	26	\$2878

Specify PN67SBFTL for **LEFT** or PN67SBFTR for **RIGHT**.

Open Shelf/Box/File Drawer. Lock on file drawer secures both drawers. Upper storage cabinet with locking door and two adjustable laminate shelves inside. Door aligns with **27" H** surfaces. Outside accessory hook. Locking wardrobe with coat rail. Shipped Fully Assembled.

PN69SBFTL	24 x 24 x 66	100	257	26	\$2878
PN69SBFTR	24 x 24 x 66	100	257	26	\$2878

Specify PN69SBFTL for **LEFT** or PN69SBFTR for **RIGHT**.

Open Shelf/Box/File Drawer. Lock on file drawer secures both drawers. Upper storage cabinet with locking door and two adjustable laminate shelves inside. Door aligns with **29" H** surfaces. Locking wardrobe with coat rail. Shipped Fully Assembled.

PN69BBFTL	24 x 24 x 66	100	257	26	\$3025
PN69BBFTR	24 x 24 x 66	100	257	26	\$3025

Specify PN69BBFTL for **LEFT** or PN69BBFTR for **RIGHT**.

Box/Box/File Drawer. Lock on upper box drawer secures file and lower box drawer. Upper storage cabinet with locking door and two adjustable laminate shelves inside. Door aligns with **29" H** surfaces. Locking wardrobe with coat rail. Shipped fully assembled.

PN67DRTSL	24 x 24 x 66	100	230	26	\$2949
PN67DRTSR	24 x 24 x 66	100	230	26	\$2949

Specify PN67DRTSL for **LEFT** or PN67DRTSR for **RIGHT**.

Drawer with one waste and one recycling bin. Open shelf above. Upper storage cabinet with locking door and two adjustable laminate shelves inside. Door aligns with **27" H** surfaces. Locking wardrobe with coat rail. Shipped Fully Assembled.

Required Specifications

- Top finish
- Base finish
- Drawer/door front finish

66" H STORAGE CABINETS

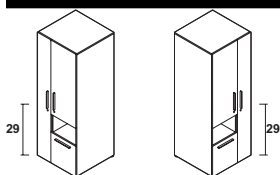

LEFT

RIGHT

66" H Storage Tower w/Wardrobe, Large Shelf, Recycling and Door at 29" H

MODEL#	DIMENSIONS	FREIGHT CLASS	WT/LBS.	CUBIC FT.	LIST PRICE
	D x W x H				
PN69DRTSL	24 x 24 x 66	100	230	26	\$2949
PN69DRTSR	24 x 24 x 66	100	230	26	\$2949

Specify PN69DRTSL for **LEFT** or PN69DRTSR for **RIGHT**.

Drawer with one waste and one recycling bin. Open shelf above. Upper storage cabinet with locking door and two adjustable laminate shelves inside. Door aligns with 29" H surfaces. Locking wardrobe with coat rail. Shipped Fully Assembled.

MOBILE PEDESTALS

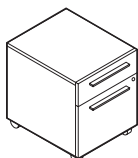

20.9" H Mobile Pedestal

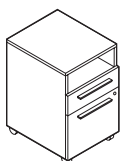

25.4" H Mobile Pedestal



25.4" H Mobile Pedestal



26.8" H Mobile Pedestal

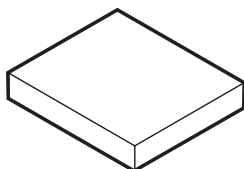

Pedestal Cushion*

MODEL#	DIMENSIONS	FREIGHT CLASS	WT/LBS.	CUBIC FT.	LIST PRICE	HP ADD
PN22MBF	22 x 16 x 20.9	85	79	5.75	\$1030	\$109

Box/File drawer. Lock on box drawer secures both drawers. Front casters are locking. Shipped Fully Assembled.

PN25MSBF	22 x 16 x 25.4	92.5	80	7	\$1092	\$118
----------	----------------	------	----	---	---------------	--------------

Open Shelf/Box/File drawer. Lock on file drawer secures both drawers. Front casters are locking. Shipped Fully Assembled.

PN25MBBF	22 x 16 x 25.4	92.5	95	8	\$1151	\$140
----------	----------------	------	----	---	---------------	--------------

Box/Box/File drawer. Lock on file drawer secures file and lower box drawer. Front casters are locking. Shipped Fully Assembled.

PN27MFF	22 x 16 x 26.8	85	101	8	\$1127	\$129
---------	----------------	----	-----	---	---------------	--------------

File/File. Lock on lower file drawer secures both drawers. Front casters are locking. Shipped assembled in 1 carton.

- 26.8" H mobile storage can only be used with 29" H Princeton products that have laminate end panels/gables. 29" H units with HAT channels have underside clearance of only 25.9" H.

PN1622CU	21 x 16 x 2.5	125	6	.90	1	\$206	7	\$461
					2	\$247	8	\$568
					3	\$278	9	\$619
					4	\$322	10	\$715
					5	\$384	11	\$848
					6	\$406	12	\$1011

For **PN22MBF** mobile pedestals.

Required Specifications

Top finish
Base finish
Drawer/door front finish
Fabric*

Optional Specifications

HP laminate

Accessories

Pedestal cushion

MOBILE LATERAL FILES

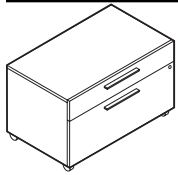

20.5”h Mobile Lateral File*

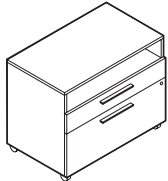

25.5”h Mobile Lateral File

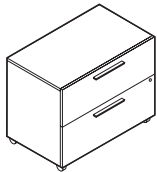

27”H Mobile Lateral File

MODEL#	DIMENSIONS D x W x H	FREIGHT CLASS	WT/LBS.	CUBIC FT.	LIST PRICE	HP ADD
PN22MLBF	22 x 35.5 x 20.5	100	132	14	\$1624	\$223

Box/File drawer. Lock on file drawer secures both drawers. File bars included for front-to-back letter and legal filing capability. Front casters are locking. Shipped Fully Assembled. Can fit under 29”H and 27”H credenzas for mobile lateral file with or without a cushion. Can fit under 23”H credenzas without cushion only.

PN25MLSBF	22 x 35.5 x 25.5	100	138	16	\$1699	\$234
-----------	------------------	-----	-----	----	---------------	--------------

Open Shelf/Box/File drawer. Lock on file drawer secures both drawers. File bars included for front-to-back letter and legal filing capability. Front casters are locking. Shipped Fully Assembled. Can fit under 29”H credenzas for mobile lateral file without cushion only.

PN27MLFF	22 x 35.5 x 27	92.5	170	16	\$1773	\$242
----------	----------------	------	-----	----	---------------	--------------

File/File drawer. Lock on bottom file drawer secures both drawers. File bars included for front-to-back letter and legal filing capability. Front casters are locking. Shipped Fully Assembled. Can fit under 29”H credenzas for mobile lateral file without cushion only.

- 27”H mobile pedestals can only be used with 29”H Princeton products that have laminate end panels/gables. Princeton products with metal legs will not accommodate 27”H mobile units.

CUSHIONS FOR MOBILE LATERAL FILE

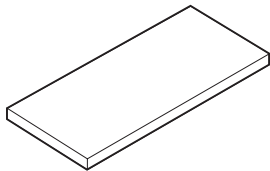

Mobile Lateral File Cushion**

MODEL#	DIMENSIONS	FREIGHT CLASS	WT/LBS.	CUBIC FT.	GRADE	LIST	GRADE	LIST
PN3622CU	21 x 35.5 x 2.5	150	14	2.40	1	\$413	7	\$920
					2	\$491	8	\$1130
					3	\$551	9	\$1230
					4	\$640	10	\$1425
					5	\$767	11	\$1690
					6	\$810	12	\$2021

For **PN22MLBF** mobile lateral files.

Required Specifications

Fabric**
 Top finish (Mobile Laterals)
 Base finish (Mobile Laterals)
 Door/drawer front finish (Mobile Laterals)

Optional Specifications

HP laminate (Mobile Laterals)

Accessories

Cushion*

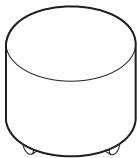
STOOLS	MODEL#	DIMENSIONS	FREIGHT CLASS	WT/LBS.	CUBIC FT.	LIST PRICE
 <p>Round Mobile Stool</p>		D x W x H				
	PN1920ST	19 x 19 x 19.5	250	20	5.50	\$793
<p>Laminate base for use with cushion. CANNOT BE USED WITHOUT CUSHION. Cushion sold separately. Six casters.</p> <ul style="list-style-type: none"> • NOTE: Maximum weight capacity is 200 lbs. • Recommended for carpet applications. 						

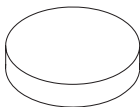
CUSHION FOR MOBILE STOOL	MODEL#	DIMENSIONS	FREIGHT CLASS	WT/LBS.	CUBIC FT.	GRADE	LIST	GRADE	LIST
 <p>Cushion for Round Mobile Stool*</p>	SEAT-PN1920ST	--	150	8	1.60	1	\$281	7	\$498
						2	\$316	8	\$571
						3	\$341	9	\$628
						4	\$375	10	\$690
						5	\$427	11	\$821
						6	\$449	12	\$959
<p>To be used with PN1920ST.</p>									

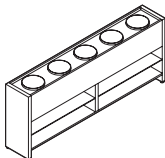
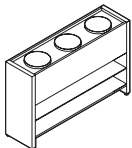
PLANTERS	MODEL#	DIMENSIONS	FREIGHT CLASS	WT/LBS.	CUBIC FT.	LIST PRICE
 <p>Five Pot Planter**</p>	PN7229PL	12 x 72 x 29	100	124	14.50	\$1502
	<p>Five plastic pots - specify Black (BK) or White (WT). Adjustable 3 position laminate shelves/open pass through. Shipped fully assembled.</p>					
 <p>Three Pot Planter**</p>	PN4229PL	12 x 42 x 29	92.5	86	8.46	\$1144
	<p>Three plastic pots - specify Black (BK) or White (WT). Adjustable 3 position laminate shelf/open pass through. Shipped fully assembled.</p>					

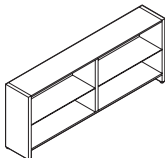
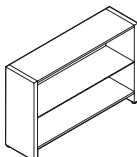
DIVIDER SHELVES	MODEL#	DIMENSIONS	FREIGHT CLASS	WT/LBS.	CUBIC FT.	LIST PRICE
 <p>72\"</p>	PN7229BGS	12 x 72 x 29	125	124	18	\$1243
	<p>Fixed laminate shelves/open pass through. Shipped fully assembled.</p>					
 <p>42\"</p>	PN4229BGS	12 x 42 x 29	125	86	11	\$1002
	<p>Fixed laminate shelf/open pass through. Shipped fully assembled.</p>					

Required Specifications

- Fabric*
- Planter pot finish**
- Top finish
- Base finish

BOOKSHELVES

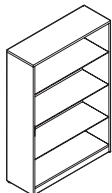

Bookshelf w/Laminate Shelves

MODEL#	DIMENSIONS D x W x H	FREIGHT CLASS	WT/LBS.	CUBIC FT.	LIST PRICE	HP ADD
PN2429BLS	12 x 24 x 29	70	37	2	\$764	\$122
PN2452BLS	12 x 24 x 52	70	60	3	\$968	N/A
PN2466BLS	12 x 24 x 66	70	74	4	\$1063	N/A
PN3029BLS	12 x 30 x 29	70	44	2	\$859	\$141
PN3052BLS	12 x 30 x 52	65	68	3	\$1003	N/A
PN3066BLS	12 x 30 x 66	70	79	4	\$1106	N/A
PN3629BLS	12 x 36 x 29	70	66	3	\$923	\$152
PN3652BLS	12 x 36 x 52	70	80	4	\$1056	N/A
PN3666BLS	12 x 36 x 66	70	106	5	\$1162	N/A

66"H models have four adjustable shelves. 52"H models have 3 adjustable shelves. 29"H models have 1 adjustable shelf. Shipped Fully Assembled.

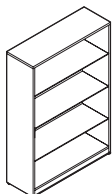

Bookshelf w/Glass Shelves

PN2429BGS	12 x 24 x 29	70	37	2	\$796	\$122
PN2452BGS	12 x 24 x 52	70	60	3	\$1177	N/A
PN2466BGS	12 x 24 x 66	70	74	4	\$1402	N/A
PN3029BGS	12 x 30 x 29	70	44	2	\$920	\$141
PN3052BGS	12 x 30 x 52	65	68	3	\$1270	N/A
PN3066BGS	12 x 30 x 66	70	79	4	\$1463	N/A
PN3629BGS	12 x 36 x 29	70	66	3	\$919	\$152
PN3652BGS	12 x 36 x 52	70	80	4	\$1380	N/A
PN3666BGS	12 x 36 x 66	70	106	5	\$1619	N/A

66"H models have four adjustable shelves. 52"H models have 3 adjustable shelves. 29"H models have 1 adjustable shelf. Shipped Fully Assembled.

DESKTOP AND OVERHEAD STORAGE

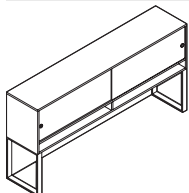

Hutch w/Laminate Doors*

MODEL#	DIMENSIONS	FREIGHT CLASS	WT/LBS.	CUBIC FT.	LIST PRICE
PN3560LCH	16 x 60 x 35	125	131	18	\$1951
PN3572LCH	16 x 72 x 35	125	135	21	\$2019
PN3584LCH	16 x 84 x 35	150	145	25	\$2166

Sliding laminate doors in upper plastic track. Recessed brushed aluminum finger pulls. No lock. Metal hutch supports. Laminate back board. 15.75" clearance between worksurface and underside. Shipped Partially Assembled.

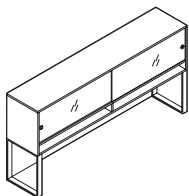

Hutch w/Glass Doors*

PN3560CH	16 x 60 x 35	125	120	19.44	\$2830
PN3572CH	16 x 72 x 35	125	144	23.33	\$3043
PN3584CH	16 x 84 x 35	150	145	25	\$3340

Sliding glass doors in upper aluminum track. Satin etched 6mm glass. Brushed aluminum finger pulls. No lock. Metal hutch supports. Laminate back board. 15.75" clearance between worksurface and underside. Shipped partially assembled in 2 cartons. Glass doors shipped separately.

Required Specifications

- Top finish
- Base finish
- Door finish (laminated doors)
- Hutch support finish*

Optional Specifications

- HP laminate (29"H bookshelves)

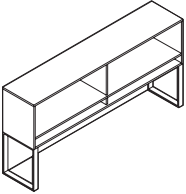
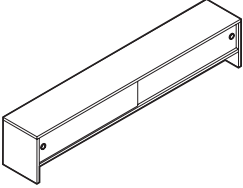
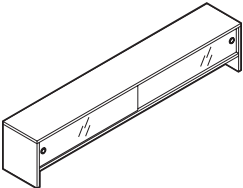
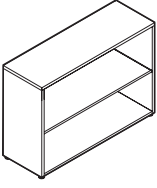
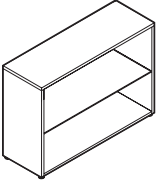
DESKTOP AND OVERHEAD STORAGE	MODEL#	DIMENSIONS	FREIGHT CLASS	WT/LBS.	CUBIC FT.	LIST PRICE
 <p>Open Hutch*</p>	D x W x H					
	PN3560CHO	16 x 60 x 35	125	124	18	\$1702
	PN3572CHO	16 x 72 x 35	125	128	21	\$1751
	PN3584CHO	16 x 84 x 35	150	138	25	\$1891
<p>Metal hutch supports. Laminate back board. 15.75" clearance between worksurface and underside. Shipped Partially Assembled.</p>						
 <p>Desktop Storage w/Laminate Doors</p>	PN1160LDS	11 x 60 x 12	100	54	6.50	\$1024
	PN1172LDS	11 x 72 x 12	100	62	7.75	\$1102
<p>Sliding laminate doors in upper plastic track. Recessed brushed aluminum finger pulls. No lock. Shipped Fully Assembled.</p>						
 <p>Desktop Storage w/Glass Doors</p>	PN1160DS	11 x 60 x 12	100	43	4.58	\$1644
	PN1172DS	11 x 72 x 12	100	51	5.50	\$1853
<p>Sliding glass doors in upper aluminum track. Satin etched 6mm glass. Recessed aluminum finger pulls. No lock. Shipped assembled in 2 cartons. Glass doors shipped separately.</p>						
 <p>Desktop Shelf - Two High w/Laminate Shelf</p>	PN2423LDB	12 x 24 x 23	60	45	1.50	\$484
	PN3023LDB	12 x 30 x 23	60	49	1.50	\$529
	PN3623LDB	12 x 36 x 23	65	53	2	\$535
	PN2425LDB	12 x 24 x 25	60	47	1.50	\$484
	PN3025LDB	12 x 30 x 25	65	51	2	\$529
	PN3625LDB	12 x 36 x 25	65	55	2	\$535
<p>One multiple-position adjustable laminate shelf. Shipped Fully Assembled.</p>						
 <p>Desktop Shelf - Two High w/Glass Shelf</p>	PN2423GDB	12 x 24 x 23	60	45	1.50	\$557
	PN3023GDB	12 x 30 x 23	60	49	1.50	\$610
	PN3623GDB	12 x 36 x 23	65	53	2	\$650
	PN2425GDB	12 x 24 x 25	60	47	1.50	\$557
	PN3025GDB	12 x 30 x 25	65	51	2	\$610
	PN3625GDB	12 x 36 x 25	65	55	2	\$650
<p>One multiple-position adjustable glass shelf. Shipped Fully Assembled.</p>						

Required Specifications

- Top finish
- Base finish
- Door finish (laminate doors)
- Hutch support finish*

DESKTOP AND OVERHEAD STORAGE

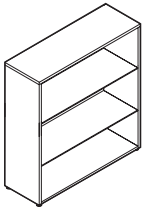

Desktop Shelf - Three High w/Laminate Shelves

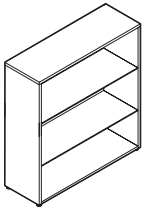

Desktop Shelf - Three High w/Glass Shelves

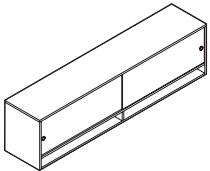

Large Overhead Storage w/Laminate Doors, Wall-Mounted

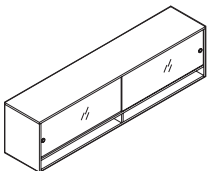

Large Overhead Storage w/Glass Doors Wall-Mounted

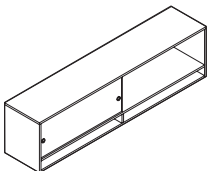

Large Overhead Storage w/Single Laminate Door, Wall-Mounted

MODEL#	DIMENSIONS D x W x H	FREIGHT CLASS	WT/LBS.	CUBIC FT.	LIST PRICE
PN2437LDB	12 x 24 x 37	65	58	2	\$604
PN3037LDB	12 x 30 x 37	70	64	3	\$643
PN3637LDB	12 x 36 x 37	65	71	3	\$668
PN2439LDB	12 x 24 x 39	65	58	2	\$604
PN3039LDB	12 x 30 x 39	70	64	3	\$643
PN3639LDB	12 x 36 x 39	65	71	3	\$668

Two multiple-position adjustable laminate shelves. Shipped Fully Assembled.

PN2437GDB	12 x 24 x 37	65	58	2	\$780
PN3037GDB	12 x 30 x 37	70	64	3	\$863
PN3637GDB	12 x 36 x 37	65	71	3	\$898
PN2439GDB	12 x 24 x 39	65	58	2	\$780
PN3039GDB	12 x 30 x 39	70	64	3	\$863
PN3639GDB	12 x 36 x 39	65	71	3	\$898

Two multiple-position adjustable glass shelves. Shipped Fully Assembled.

PN1960LWH	16 x 60 x 19	100	119	13.25	\$1438
PN1972LWH	16 x 72 x 19	100	138	16	\$1503
PN1984LWH	16 x 84 x 19	100	158	19	\$1656

Sliding laminate doors in upper plastic track. Recessed brushed aluminum finger pulls. No lock. Shipped Fully Assembled.
 • **NOTE:** Care should be taken to mount the units. Units should be mounted to wall studs using correct fasteners. Failure to do so may result in collapse of the unit and subsequent personal injury. **Mounting hardware not included.** Mounting hardware used should be based on wall material. Consult an installation professional for proper wall mounting.

PN1960WH	16 x 60 x 19	100	101	10.56	\$2246
PN1972WH	16 x 72 x 19	100	121	12.67	\$2515
PN1984WH	16 x 84 x 19	100	158	19	\$2757

Sliding glass doors in upper aluminum track. Satin etched 6mm glass. Brushed aluminum finger pulls. No lock. Shipped assembled in two cartons. Glass doors shipped separately.
 • **NOTE:** Care should be taken to mount the units. Units should be mounted to wall studs using correct fasteners. Failure to do so may result in collapse of the unit and subsequent personal injury. **Mounting hardware not included.** Mounting hardware used should be based on wall material. Consult an installation professional for proper wall mounting.

PN1960LS	16 x 60 x 19	100	117	13.25	\$1337
PN1972LS	16 x 72 x 19	100	136	16	\$1406
PN1984LS	16 x 84 x 19	100	156	19	\$1544

Sliding laminate door in upper plastic track. Recessed brushed aluminum finger pulls. No lock. Shipped Fully Assembled.
 • **NOTE:** Care should be taken to mount the units. Units should be mounted to wall studs using correct fasteners. Failure to do so may result in collapse of the unit and subsequent personal injury. **Mounting hardware not included.** Mounting hardware used should be based on wall material. Consult an installation professional for proper wall mounting.

Required Specifications

- Top finish
- Base finish
- Door finish (laminate doors)

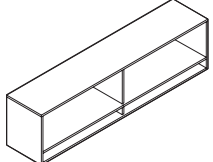
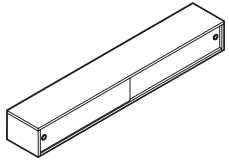
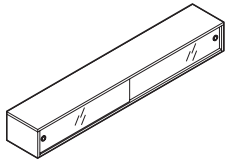
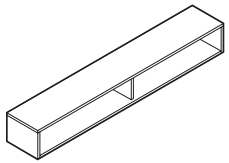
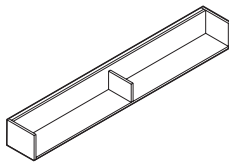
DESKTOP AND OVERHEAD STORAGE	MODEL#	DIMENSIONS	FREIGHT CLASS	WT/LBS.	CUBIC FT.	LIST PRICE
 <p>Large Overhead Storage, Wall-Mounted</p>	D x W x H					
	PN1960WHO	16 x 60 x 19	100	112	13.25	\$1211
	PN1972WHO	16 x 72 x 19	100	131	16	\$1259
	PN1984WHO	16 x 84 x 19	125	151	19	\$1401
<p>Open storage with center divider. Shipped Fully Assembled.</p> <p>• NOTE: Care should be taken to mount the units. Units should be mounted to wall studs using correct fasteners. Failure to do so may result in collapse of the unit and subsequent personal injury. Mounting hardware not included. Mounting hardware used should be based on wall material. Consult an installation professional for proper wall mounting.</p>						
 <p>Small Overhead Storage w/Laminate Doors, Wall-Mounted</p>	PN1260LWH	12 x 60 x 8	100	49	5.25	\$1055
	PN1272LWH	12 x 72 x 8	100	56	6.25	\$1144
	PN1284LWH	12 x 84 x 8	100	64	8	\$1202
	<p>Sliding laminate doors in upper plastic track. Recessed brushed aluminum finger pulls. No lock. Shipped Fully Assembled.</p> <p>• NOTE: Care should be taken to mount the units. Units should be mounted to wall studs using correct fasteners. Failure to do so may result in collapse of the unit and subsequent personal injury. Mounting hardware not included. Mounting hardware used should be based on wall material. Consult an installation professional for proper wall mounting.</p>					
 <p>Small Overhead Storage w/Glass Doors, Wall-Mounted</p>	PN1260WH	12 x 60 x 8	100	31	3.33	\$2063
	PN1272WH	12 x 72 x 8	100	38	4	\$2325
	PN1284WH	12 x 84 x 8	100	64	8	\$2457
	<p>Sliding glass doors in upper aluminum track. Satin etched 6mm glass. Brushed aluminum finger pulls. No lock. Shipped assembled in 2 cartons. Glass doors shipped separately.</p> <p>• NOTE: Care should be taken to mount the units. Units should be mounted to wall studs using correct fasteners. Failure to do so may result in collapse of the unit and subsequent personal injury. Mounting hardware not included. Mounting hardware used should be based on wall material. Consult an installation professional for proper wall mounting.</p>					
 <p>Small Overhead Storage, Wall-Mounted</p>	PN1260WHO	12 x 60 x 8	100	45	5.25	\$810
	PN1272WHO	12 x 72 x 8	100	52	6.25	\$910
	PN1284WHO	12 x 84 x 8	125	60	8	\$989
	<p>Open storage shelf with center divider. Shipped Fully Assembled.</p> <p>• NOTE: Care should be taken to mount the units. Units should be mounted to wall studs using correct fasteners. Failure to do so may result in collapse of the unit and subsequent personal injury. Mounting hardware not included. Mounting hardware used should be based on wall material. Consult an installation professional for proper wall mounting.</p>					
 <p>Wall-Mounted Shelf</p>	PN1260WHS	12 x 60 x 8	150	31	5.50	\$601
	PN1272WHS	12 x 72 x 8	125	37	6	\$651
	PN1284WHS	12 x 84 x 8	125	44	7	\$702
	<p>Open storage shelf with center divider. Shipped Fully Assembled.</p> <p>• NOTE: Care should be taken to mount the units. Units should be mounted to wall studs using correct fasteners. Failure to do so may result in collapse of the unit and subsequent personal injury. Mounting hardware not included. Mounting hardware used should be based on wall material. Consult an installation professional for proper wall mounting.</p>					

Required Specifications

- Top finish
- Base finish
- Door finish (laminated doors)

TACKBOARD NOTES

D x W x H

TACKBOARD Notes: Tackboards can be upholstered in all of the following fabrics:

Grade 1: Jenny, Quilt, Terrace, Urban, Waterfall

Grade 2: Imprint, Lola

Grade 3: Anchorage, Merge

TACKBOARDS

MODEL#	DIMENSIONS	FREIGHT CLASS	WT/LBS.	CUBIC FT.	FABRIC GRD.	LIST	GRD.	LIST
PN1556TBH	1 x 56 x 14.5	100	9.50	1	1	\$621	7	\$1631
					2	\$748	8	\$1876
					3	\$897	9	\$2153
					4	\$1072	10	\$2480
					5	\$1233	11	\$2849
					6	\$1415	12	\$3277
PN1568TBH	1 x 68 x 14.5	92.5	11	1	1	\$646	7	\$1694
					2	\$779	8	\$1951
					3	\$931	9	\$2242
					4	\$1117	10	\$2576
					5	\$1282	11	\$2964
					6	\$1476	12	\$3409
PN1580TBH	1 x 80 x 14.5	125	10	1.50	1	\$1027	7	\$2702
					2	\$1236	8	\$3105
					3	\$1479	9	\$3570
					4	\$1775	10	\$4106
					5	\$2042	11	\$4720
					6	\$2347	12	\$5430

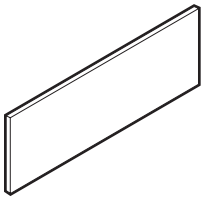

Tackboard for Hutches

Attaches with Velcro to Hutch backboard.

Required Specifications

Fabric

TACKBOARDS	MODEL#	DIMENSIONS	FREIGHT CLASS	WT/LBS.	CUBIC FT.	FABRIC GRD.	LIST	GRD.	LIST
		D x W x H							
	PN1560TBW	1 x 60 x 14.5	85	14	1	1	\$635	7	\$1667
						2	\$763	8	\$1921
						3	\$916	9	\$2209
						4	\$1099	10	\$2538
						5	\$1263	11	\$2919
						6	\$1451	12	\$3356
	PN1566TBW	.62 x 66 x 14.4	85	12	1	1	\$846	7	\$2227
						2	\$1019	8	\$2560
						3	\$1224	9	\$2943
						4	\$1466	10	\$3383
						5	\$1684	11	\$3892
						6	\$1936	12	\$4477
	PN1572TBW	1 x 72 x 14.5	70	16.50	1	1	\$741	7	\$1948
						2	\$893	8	\$2240
						3	\$1070	9	\$2578
						4	\$1281	10	\$2962
						5	\$1472	11	\$3407
						6	\$1694	12	\$3917
	PN1578TBW	.62 x 78 x 14.4	100	14	1.50	1	\$1068	7	\$2803
						2	\$1287	8	\$3224
						3	\$1539	9	\$3704
						4	\$1847	10	\$4258
						5	\$2122	11	\$4898
						6	\$2439	12	\$5632
	PN1584TBW	.62 x 84 x 14.4	92.5	15	1.50	1	\$1161	7	\$3049
						2	\$1396	8	\$3504
						3	\$1675	9	\$4032
						4	\$2005	10	\$4636
						5	\$2306	11	\$5331
						6	\$2652	12	\$6130

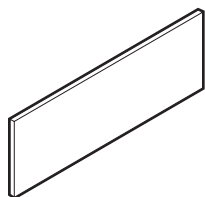

Tackboard for Overhead Storage

Attaches with adhesive-backed Velcro.

Required Specifications

Fabric

ELECTRICAL / DATA

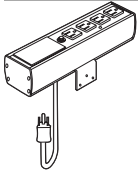

4 Outlet, 1 Telecom Blank Plate

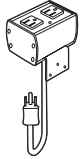

2 Outlet Power Block

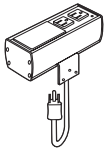

2 Outlet, 1 Telecom Blank Plate

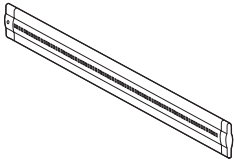

LED Task Light

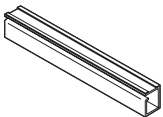

Wire Manager

MODEL#	DIMENSIONS	FREIGHT CLASS	WT/LBS.	CUBIC FT.	LIST PRICE
--------	------------	---------------	---------	-----------	------------

D x W x H

PGDPS41	2.5 x 10.25 x 2.22	70	1.50	.02	\$250
---------	--------------------	----	------	-----	--------------

4 power receptacles and 1 telecom blank plate. For mounting behind pull-out shelf or open space credenza. Tungsten (TUN) finish. 12 foot black cord. UL listed: UL153.

PGDPS20	2.5 x 3.58 x 2.22	70	1	.01	\$179
---------	-------------------	----	---	-----	--------------

2 power receptacles. For side mounted installation. Tungsten (TUN) finish. 12 foot black cord. UL listed: UL153.

PGDPS21	2.5 x 6.75 x 2.22	70	1.25	.01	\$232
---------	-------------------	----	------	-----	--------------

2 power receptacles and 1 telecom blank plate. For side mounted installation. Tungsten (TUN) finish. 12 foot black cord. UL listed: UL153.

PLED30	1.5 x 15.5 x .5	150	2	.50	\$522
PLED50	1.5 x 23.5 x .5	150	2	.50	\$601
PLED100	1.5 x 43.5 x .5	125	3	.50	\$697

Energy efficient LED. Ultra slim design. Suitable for hanging under Hutch or Wallhung units. 6' power cord. UL listed: UL153.

PEWM5.5	2 x 66 x 2	70	.60	.10	\$211
PEWM5	2 x 60 x 2	70	.60	.10	\$177
PEWM4.5	2 x 54 x 2	70	.50	.10	\$158
PEWM4	2 x 48 x 2	70	.50	.10	\$144
PEWM3.5	2 x 42 x 2	70	.40	.10	\$124
PEWM3	2 x 36 x 2	70	.40	.10	\$111
PEWM2.5	2 x 30 x 2	70	.30	.10	\$91
PEWM2	2 x 24 x 2	70	.30	.10	\$75
PEWM1.5	2 x 18 x 2	70	.20	.10	\$59
PEWM1	2 x 12 x 2	70	.20	.10	\$43

Plastic tray flexes to receive and hold electrical and data wires. Quickly attaches with two strips of double-sided tape. Black (**BLK**) only.

TABLES

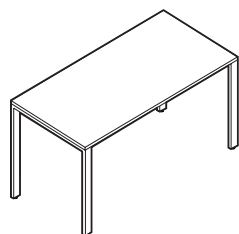

29" H Table

MODEL#	DIMENSIONS	FREIGHT CLASS	WT/LBS.	CUBIC FT.	LIST PRICE	HP ADD	UM ADD
D x W x H							
PN242429	24 x 24 x 29	150	53	10	\$1095	\$154	\$176
PN482429	24 x 48 x 29	125	71	10.50	\$1169	\$167	\$348
PN542429	24 x 54 x 29	125	83	13	\$1387	\$195	\$389
PN602429	24 x 60 x 29	125	86	13	\$1409	\$199	\$436
PN662429	24 x 66 x 29	125	90	14	\$1440	\$201	\$477
PN722429	24 x 72 x 29	150	97	21	\$1450	\$202	\$519
PN782429	24 x 78 x 29	150	101	21	\$1589	\$223	\$565
PN842429	24 x 84 x 29	150	106	22	\$1717	\$240	\$607
PN902429	24 x 90 x 29	150	110	23	\$1805	\$253	\$649
PN962429	24 x 96 x 29	150	123	24	\$1869	\$261	\$695
PN303029	30 x 30 x 29	150	66	12	\$1205	\$170	\$278
PN483029	30 x 48 x 29	150	77	13	\$1284	\$179	\$436
PN543029	30 x 54 x 29	150	94	16	\$1512	\$212	\$496
PN603029	30 x 60 x 29	125	99	16.50	\$1521	\$213	\$547
PN663029	30 x 66 x 29	125	105	17	\$1564	\$220	\$598
PN723029	30 x 72 x 29	150	112	23	\$1589	\$223	\$649
PN783029	30 x 78 x 29	150	119	26	\$1736	\$242	\$709
PN843029	30 x 84 x 29	150	132	27	\$1863	\$261	\$764
PN903029	30 x 90 x 29	150	139	33	\$1949	\$273	\$815
PN963029	30 x 96 x 29	150	143	29.50	\$1996	\$278	\$866
PN363629	36 x 36 x 29	150	80	15	\$1282	\$179	\$389
PN603629	36 x 60 x 29	150	113	20	\$1745	\$242	\$649
PN663629	36 x 66 x 29	150	119	21	\$1802	\$252	\$718
PN723629	36 x 72 x 29	150	128	29	\$1830	\$255	\$778
PN783629	36 x 78 x 29	150	135	31	\$1805	\$253	\$848
PN843629	36 x 84 x 29	150	150	32	\$1930	\$270	\$908
PN903629	36 x 90 x 29	150	161	33.50	\$2074	\$291	\$977
PN963629	36 x 96 x 29	150	164	35	\$2096	\$292	\$1038
PN424229	42 x 42 x 29	150	96	17	\$1479	\$208	\$538
PN604229	42 x 60 x 29	150	125	22	\$1824	\$255	\$764
PN664229	42 x 66 x 29	150	134	23	\$1882	\$265	\$838
PN724229	42 x 72 x 29	150	142	32	\$1920	\$269	\$908
PN784229	42 x 78 x 29	150	150	35	\$2133	\$299	\$987
PN844229	42 x 84 x 29	150	167	36	\$2326	\$323	\$1065
PN904229	42 x 90 x 29	150	176	38	\$2493	\$349	\$1144
PN964229	42 x 96 x 29	150	182	40	\$2543	\$354	\$1209
PN484829	48 x 48 x 29	150	114	21	\$1528	\$215	\$695
PN604829	48 x 60 x 29	150	138	26	\$1891	\$265	\$866
PN664829	48 x 66 x 29	150	147	27	\$1956	\$273	\$954
PN724829	48 x 72 x 29	150	158	38	\$1982	\$277	\$1038
PN784829	48 x 78 x 29	150	166	40	\$2243	\$314	\$1125
PN844829	48 x 84 x 29	150	184	42	\$2434	\$340	\$1209
PN904829	48 x 90 x 29	150	193	43	\$2598	\$359	\$1297
PN964829	48 x 96 x 29	150	202	45	\$2640	\$369	\$1385

Freestanding. 1" x 2.5" open metal frame legs with levelers, finished in Tungsten (TTU), Designer White (TDW) or Black (TBL). Metal support hat channel(s) provided on tables exceeding 54" in width. Shipped easy to assemble in 2 cartons.

Required Specifications

Material type - top
Top finish
Leg finish

Accessories

Wire manager
Desktop screen

TABLES **MODEL#** **DIMENSIONS** **FREIGHT CLASS** **WT/LBS.** **CUBIC FT.** **LIST PRICE** **HP ADD** **UM ADD**

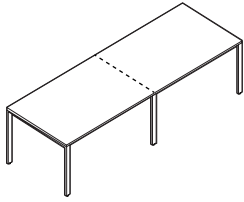

29" H Table with Center Leg

	D x W x H							
PN1203629	36 x 120 x 29	250	221	86.83	\$3190	\$444	\$1297	
PN1443629	36 x 144 x 29	250	246	97.31	\$3381	\$470	\$1556	
PN1204229	42 x 120 x 29	250	246	101.8	\$3319	\$460	\$1514	
PN1444229	42 x 144 x 29	250	287	110.7	\$3500	\$484	\$1815	
PN1204829	48 x 120 x 29	250	271	113.7	\$3515	\$486	\$1727	
PN1444829	48 x 144 x 29	250	291	116.7	\$3698	\$512	\$2075	

Freestanding. 1" x 2.5" open metal frame legs with levelers, finished in Tungsten (TTU), Designer White (TDW) or Black (TBL). 120" and 144"W with 2 piece top. Metal support hat channel(s) provided on tables exceeding 54" in width. Shipped easy to assemble in 4 cartons.

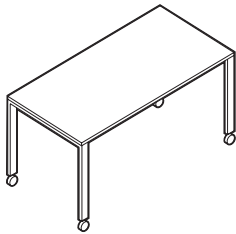

29" H Table with Casters

PN242429C	24 x 24 x 29	92.5	53	4.50	\$1130	\$161	\$176	
PN482429C	24 x 48 x 29	85	71	5.26	\$1200	\$170	\$348	
PN542429C	24 x 54 x 29	85	83	6.50	\$1436	\$201	\$389	
PN602429C	24 x 60 x 29	85	86	6.50	\$1463	\$206	\$436	
PN662429C	24 x 66 x 29	85	90	7	\$1489	\$210	\$477	
PN722429C	24 x 72 x 29	85	97	7	\$1514	\$213	\$519	
PN303029C	30 x 30 x 29	92.5	66	6	\$1244	\$175	\$278	
PN483029C	30 x 48 x 29	100	77	9.50	\$1313	\$186	\$436	
PN543029C	30 x 54 x 29	92.5	94	8	\$1562	\$220	\$496	
PN603029C	30 x 60 x 29	92.5	99	8.26	\$1575	\$221	\$547	
PN663029C	30 x 66 x 29	85	105	8.50	\$1609	\$224	\$598	
PN723029C	30 x 72 x 29	85	112	9	\$1663	\$233	\$649	
PN363629C	36 x 36 x 29	92.5	80	7.50	\$1306	\$182	\$389	
PN603629C	36 x 60 x 29	92.5	113	10	\$1647	\$229	\$649	
PN663629C	36 x 66 x 29	92.5	119	10.50	\$1690	\$236	\$718	
PN723629C	36 x 72 x 29	100	124	14.50	\$1930	\$270	\$778	
PN424229C	42 x 42 x 29	92.5	96	8.50	\$1513	\$213	\$538	
PN484829C	48 x 48 x 29	150	114	21	\$1565	\$220	\$695	

Freestanding. 1" x 2.5" open metal frame legs with casters, finished in Tungsten (TTU), Designer White (TDW) or Black (TBL). All casters are locking. Metal support hat channel(s) provided on tables exceeding 54" in width. Shipped easy to assemble in 2 cartons.

Required Specifications

Material type - top
Top finish
Leg finish

Accessories

Wire manager
Desktop screen

ZIRA™ - NOTES



Zira™ is a contemporary desking solution with extensive options to personalize your workspace. Components can be freestanding for single workstation configurations, or joined together to form multiple work groups. Create a work environment that meets your worksurface needs and storage requirements - then go ahead and personalize it!

Select from the following: hundreds of components for any size or shape office, storage components that can tower to 84" high, 20 laminate finishes, 5 edge options, 9 handle options in silver, black, nickel or brass finishes, 2 glazing options with 2 frame finishes on doors and modesty panels, and lastly, work surface grommets and power blocks for your electrical needs.

Zira is your most functional solution to work environment efficiency and organization.



Tops are available in a choice of 1" or 1 ½" thick with a variety of edge details and a top over side, edge panel design
* Shown with 1.5" thick top and Bicut Edge (CR).

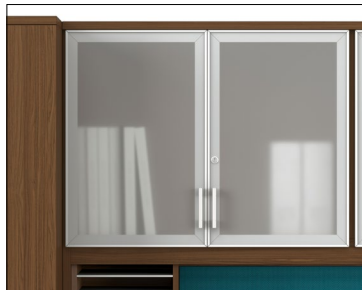

Optional Frosted or Ribbed glazing on doors and modesty panels. Available with Tungsten or Black frames.



Collator option is available for the convenient storage of day-to-day documents. Available in Black or Brushed Cobalt finish.

Features and Benefits

- Top, case chassis or base and drawer/door front finishes each specified separately to accommodate up to 3 color application on many components available
- 45 lb. density particle board substructure with high performance thermally fused laminate
- Top over side panel design
- Worksurfaces feature preferred edging in matching color
- Available in 1" or 1.5" thick top with a variety of edge details
- 11/16" thick full modesty panel is standard
- 11/16" thick ¾ modesty panel available on most components
- Pencil tray included in box drawer
- Lateral file drawers can accommodate legal or letter documents
- Premium full extension progressive ball bearing slides on file drawers & box drawers
- All drawer fronts edge banded with side pull opening pedestals and standard pedestal locks
- Compatible with Divide partitioning system for increased privacy and storage requirements

GENERAL INFORMATION

- Modular collection with over 5000 different standard components available
- Zira components are compatible with **Divide** partitioning panels.
- Handles, lock finish and trim color (if applicable) **MUST MATCH**
- Dimensionally compatible with the Adaptabilities series.
- For environmental certification, please visit globalfurnituregroup.com

WORKSURFACES

- Available in 1" or 1.5" thick thermally fused laminate tops (**TFL**) or 1-1/6" or 1.5" thick high pressure laminate tops (**HPL**) with a variety of edge details
- Tops are sealed with Global's preferred edge in matching color. Woodgrain surfaces feature edging with matching printed woodgrain.
- High pressure (**HPL**) tops are available in all Zira laminate finishes at an extended lead time, upcharge applies. Please see model # for pricing and availability.
- Products specified with the (**HPL**) option are finished on the underside of the surface with a kraft paper backing.

CONSTRUCTION

- Constructed of 45 lb. density particleboard with high performance thermally fused laminate
- All desks are size (incrementally) accurate
- Desk drawers/storage open with side pulls and feature a French dovetail joint in front, lap joint in back. Pulls are available for these units at an upcharge, see below. All other drawers/storage feature built-in pulls available in 9 different styles
- Virtually no loose hardware
- Models with Monopost are standard with 4" Square Monopost. Optional 5" Round and 4" Round Monopost are available at no upcharge. Available in Black (**TBL**) or Tungsten (**TU**) finish. Please Specify
- Leveling glides are standard on all floor units
- Premium full extension progressive ball bearing slides on file drawers & box drawers
- All drawer fronts edge banded with side pull opening pedestals and standard pedestal locks

HEIGHT ADJUSTABLE DESKS

- Zira height adjustable desks include a laminate chassis. **Height adjustable base mechanism sold separately.**
- Use **FTZ52SFNL** with all **ZHxx60Fxx**, **ZHxx66Fxx**, **ZHxx72Fxx** and **ZHxx60NP** models.
- Use **FTZ52LFNL** with all **ZHxx84Fxx** and **ZHxx66NP**, **ZHxx72NP** and **ZH3684NP** models.
- Use **FTZ539FSLNL** with all **ZH60xx24L/R** models.
- Steel constructed leg tubing and cross bar.
- Table frame designed with 3.15" x 1.97" rectangular outer leg with the larger tube attaching to a bracket within the pedestal.
- Powder coat finishes for bases is standard in Black (**BLK**) or Tungsten (**TUN**).
- Wire management channels available in Black (**BLK**) or Silver (**SIL**). Silver (**SIL**) complements Tungsten.
- Zira Height Adjustable desks have 2-stages and feature an adjustment range of 29.5"/30" – 49"/49.5".
- Lifts 350 pounds.
- Operates at 1.5" per second.
- All bases feature a dual actuator system with a motor driving each leg.

STANDARD RANGE COLUMNS

The 2-part lifting column is a perfect choice for a wide range of different desk applications in the office.

- Compact design where guide and actuator functions are an integrated unit
- Reinforced column and optimized motor housing design for extra strength and stability
- Max. load 800 N per column
- Max. speed 1.5"/second unloaded
- Standard installation dimension 25.4"
- Standard stroke length 19.7"
- Weight: Approximately 14.3 lbs. per column
- Column dimensions: 1.97" x 3.15" (outer profile) and 1.71" x 2.89" (inner profile)
- Motor housing dimensions: 6.97" x 3.82" x 1.81"
- Low noise level
- No visible gliding pads
- Standard Range Tables have 2-stages and feature an adjustment range of 27.5" – 45.5" (18" travel).

DESK MOUNT FRAME

- All metal parts are Black
- Cantilever length: 21.7"
- Includes all connecting hardware

CONTROL BOX

- Two leg tables come standard with a 200 W Control Box
 - Mains voltage 230 VAC, 50 Hz, or 120 VAC, 60 Hz
 - Ultra-compact; 8.25" long
 - Lightweight control box; weight is approximately 1 lb.
- Common features for the (200 W and 300 W):
- Ultra-low; only 1.5" high
- Environment: Operation Storage
 - Ambient temperature: 5 to 40 °C -10 to +50 °C
 - Relative humidity: 20 to 80 % at 30 °C 20 to 80 % at 30 °C
 - Atmospheric pressure: 700 to 1060 hPa 700 to 1060 hPa
- Compact high-power SMPS (Switch Mode Power Supply)
- Color: Black
- Protection against overload (EOP), by individual current limitation
- The control box is designed with a soft start/stop function
- Autodetection of the number and type of columns connected
- Cable grooves at the bottom to optimise cable management
- White plugs for easy recognition when mounting/dismounting
- PVC-Free™
- Low standby power consumption – only 0.1 W.
- Exchangeable standard mains cable

STANDARD HANDSET (S)

- Features Bluetooth® connection, two favorite positions and an LED reminder to prompt users to change position.
- Controller is activated by tilting the desk panel in the same direction as the desk is intended to drive.
- Pulsating orange and green LED lights remind users to change positions.
- Using the integrated Bluetooth® and downloading the Desk Control App, users can also be reminded via notifications on their computer or smart devices.
- Black only. Black cable with RJ45 modular plug. 63" long.
- PVC-Free™, featuring ZERO™. Very low power consumption in standby mode.
- Approved according to EN 60335-1 and UL962

DISPLAY HANDSET (D)

- Features Bluetooth® connection, four favorite positions, a display to guide users, and a light strip to prompt users to change position.
- Controller is activated by tilting the desk panel in the same direction as the desk is intended to drive.
- Display controller features a modern, discreet design with a glossy surface and integrated display to ensure a clean and minimalist design.
- The display provides guidance to users when operating the desk.
- Via pulsating orange and green lights, the light strip reminds users to change positions.
- Using the integrated Bluetooth® and downloading the Desk Control App, users can also be reminded via notifications on their computer or smart devices.
- Black only. Black cable with RJ45 modular plug. 63" long.
- PVC-Free™, featuring ZERO™. Very low power consumption in standby mode.
- Approved according to EN 60335-1 and UL962
- Specify **(D)**, add **\$63** list
- A basic handset without Bluetooth® capabilities is available and must be purchased separately, replacing the **S** or **D** handset in the field. See page 743 for details and pricing.

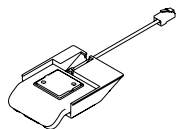
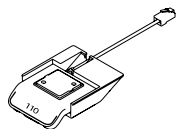
Standard handset (**S**)Display handset (**D**)**ANTI-COLLISION SENSOR**

- Features enhanced Anti-Collision protection which can limit material damage to a desk or an object if a collision occurs during driving of the desk.
- The sensor is a compact plug-in adapter based on gyroscope-technology, and it detects even slight tilting of the desk when the desk is driving up or down.
- Upon detected tilting, the system stops and drives in the opposite direction to avoid collision and damage to the desk or the object.
- The sensor can detect both hard and soft obstacles.
- The Anti-Collision Sensor is standard on all desks.
- Reacts to angle changes bigger than 0.7° per second
- Just plug it in – no mounting required
- ZERO™ power capable
- PVC-Free™

USAGE

- Ambient temperature: 41 to 104 °C
- Storage temperature: 32 to 113 °C

Approved according to:

- EN 62133 (Battery safety testing)
- UL 1642 (Lithium cells, standard test)
- UN 38.3 (transportation of Lithium batteries)
- UL 2054 (Household and commercial batteries)
- EN 60335-1 with CBH Advanced

MODESTY PANELS

- Laminate full modesty panel is standard. Laminate ¾ modesty panel is available on select models at no additional charge. Please specify **(3MP)**.
- Glazing options are available on the full modesty panel, ¾ modesty panel and the 12" modesty panel (where available). Please specify. See next page for options and codes.
- 11/16" thick full modesty panel is standard on most components
- 11/16" thick ¾ modesty panel available on most components
- **Note:** Woodgrain modesty panels 60" wide and up will have the grain pattern in the horizontal direction. All end panels and modesty panels 59" or less will have the grain pattern in the vertical direction

CUSTOM WIDTHS

- Custom widths are available for products that feature a worksurface as follows: desks, credenzas (applies to kneespace and single pedestal credenzas only), islands (excludes spanner islands), returns, bridges, extended corners and corners.
- Desks and credenzas that incorporate drawers and/or doors will be modified by changing the width of the worksurface and modesty panel, drawer and/or door dimensions are not affected.
- No upcharge for next size up
- Custom width does not apply to cabinets, hutches, pedestals or any other units.

STORAGE

- All lateral files feature a foolproof interlock device
- Pencil tray included in box drawer
- Lateral file drawers can accommodate legal or letter documents
- All drawers are locking unless otherwise noted
- Front-to-back filing bars for all steel drawer files available separately. Order FBB bars. See "FBB" on page 41.
- All desks, returns and credenzas with fixed storage are shipped standard with box/box/file, file/file or box/file 16" wide pedestals.
- Storage modules, wardrobe cabinets, personal towers, hutches and table top bookcases have 11/16" thick shelves
- End shelves, bookcases and table top end shelves have 1" thick shelves
- **All shelves are 3 position fixed/height adjustable.**
- Storage cabinets **less than 30" wide are not intended to be freestanding** and should be ganged or otherwise anchored. Ganging hardware and instructions are provided. Interior of all cabinets are pre-drilled for ganging connections; does require drill through on site.
- Adjustable shelves can be positioned to accept **binder** storage as follows:
 - For units **29" to 53" H** where applicable:
 - with one shelf - cannot accommodate binder row
 - with two shelves - can accommodate one row of binders
 - with three shelves - can accommodate two rows of binders
 - with four shelves - can accommodate three rows of binders
 - For units **65.5" to 84.5" H** where applicable:
 - with one shelf - can accommodate one row of binders
 - with two shelves - 65.5" and 72" H can accommodate one row of binders
- 84" H can accommodate two rows of binders
 - with three shelves - can accommodate two rows of binders
 - with four shelves - can accommodate three rows of binders
 - with five shelves - can accommodate four rows of binders
 - with six shelves - can accommodate five rows of binders

LOCKS

- Locks are standard on all storage modules. Finish will coordinate with handles and/or aluminum doors. For desk, return or table components, etc. please specify finish: Black (**BK**) or Silver (**SI**).
- Please note that Flared Brass (**HW**) handle defaults to Black locks, so trim options must be Black to match.
- Key alike or specific key number optional for all products with locks
- Reserved for new orders greater than \$20,000 list, all Zira units with locks may be ordered with **CA** cap option and specific lock cores/keys can be ordered separately for field installation rather than specifying duplicate product lines with different key numbers.
- When **CA** option is specified, product will ship with a cap over the empty lock housing.
- Separately order the appropriate number of cores with keys; use product code **SIL-CORE-H-SHOE** for Silver core/key sets or product code **BLK-CORE-H-SHOE** for Black core/key sets. Specify quantity and lock number required. One order line per key number required. Key number range: 401-440. **Must be ordered at the same time product is ordered with CA lock cap option specified.**
- One core removal key is required. Recommend one core removal for every 25 cores ordered. Order as **REMOVE-K-H-SHOE**.
- No charge applies for separate lock cores or core removal keys only when ordered with product. If replacement lock core and key required, contact Customer Care for applicable product code and pricing.

SHIPPING

- Shipped assembled, 1 per carton, unless otherwise noted. Other components are easy to assemble.

HUTCHES

- 71" hutches (actual width 71.69") are for use when a hutch is placed across the back of a 42" wide return and across the depth of a 30" deep surface top (actual depth 29.69").
- ZxxxxDK, ZxxxxDM and ZxxxxDML/DMR are exactly 30" deep. Therefore 72" hutches may be used.
- Hutches should not be placed on the approach side of any single pedestal and double pedestal desks with an overhang.

SPECIFICATIONS

- Specifications marked with an * are applicable to only those products which have the * symbol beside the product name.

Optional Glazing Specifications (doors and modesty panels)

- Frosted material is 3mm thick Acrylic P95
- Ribbed material is 4.3mm thick twin wall UV protected polycarbonate



Z1 frosted glazing, Tungsten (TUN) frame



Z2 frosted glazing, Black (BLK) frame



Z3 ribbed glazing, Tungsten (TUN) frame

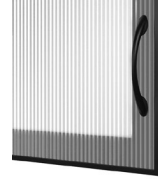

Z4 ribbed glazing, Black (BLK) frame



Full modesty panel - **Z1** frosted glazing, Tungsten (TUN) frame
¾ modesty (shown) - **Z1 + 3MP**
ZA - 12"H modesty (select models)



Full modesty panel - **Z2** frosted glazing, Black (BLK) frame
¾ modesty (shown) - **Z2 + 3MP**
ZB - 12"H modesty (select models)



Full modesty panel - **Z3** ribbed glazing, Tungsten (TUN) frame
¾ modesty (shown) - **Z3 + 3MP**
ZC - 12"H modesty (select models)



Full modesty panel - **Z4** ribbed glazing, Black (BLK) frame
¾ modesty (shown) - **Z4 + 3MP**
ZD - 12"H modesty (select models)

1. SPECIFY MODEL NUMBER

2. SPECIFY MATERIAL TYPE

- **TFL** for product with thermally fused laminate tops
- **HPL** for product with high pressure laminate tops

3. SPECIFY FINISH AND TOP THICKNESS/EDGE DETAIL

- All laminate units with a top and case chassis/base available in two finish options; all laminate units with a top, case chassis and door/drawer fronts available in up to three finish options. Each zone specified separately.
 - Collators: one tone in Black (**K**) or Brushed Cobalt (**T**)
 - Horizontal pigeon holes: one tone in all standard finishes
 - Kickplate will match chassis finish

Finishes:

ACJ Absolute Acajou	FCL First Class
ASN Asian Night	NBL Noce Biondo
AWC Avant Cherry	NGL Noce Grigio
AWH Avant Honey	NEL Noce Leggero
BLK Black	NML Noce Medio
BZD Blizzard	QTM Quartered Mahogany
BRC Brushed Cobalt	SBY Sheer Beauty
CMB Clear Maple	SOG Storm Grey
CGY Custom Grey	SDT Stonedust
DES Dark Espresso	WHE Walnut Heights
DWT Designer White	WHC White Chocolate
FAS Fashionista	WCR Winter Cherry

Top Thickness/Edge Detail

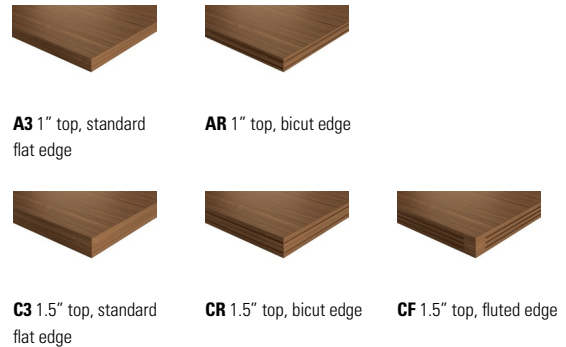

4. SPECIFY OPTIONS

BOX DRAWERS for lateral file drawers (no upcharge)

- Specify **B_** (Drawer Position **1-4** must be specified)

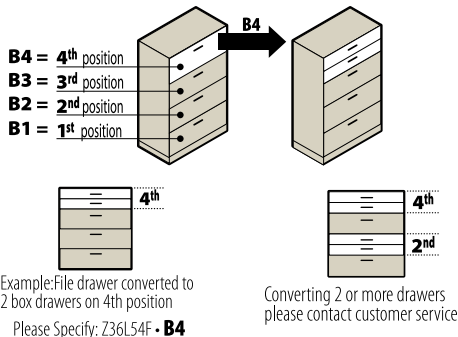

- *Not available on drawers with steel interiors*

MONOPOST

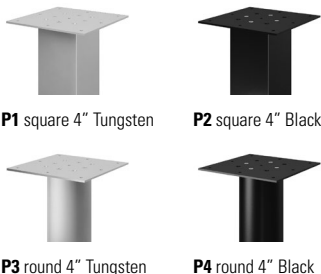

HANDLES

- Handles are standard on all lateral drawers and doors, and are included in the published list price. When ordering, please select handle from the list of options below.
- Integrated vertical finger pulls are the standard default for mobile pedestals, hanging pedestals, or where BBF or FF pedestals are part of a desk, return credenza or corner desk. Handles are optional on these units with a **list upcharge of \$58**. If a handle is not desired, specify lock finish: Black (**BK**) or Silver (**SI**).
- General guideline: when handles are shown in individual product line art within the price list, handles are included. When not shown in the individual product line art, a **list price upcharge of \$58** applies if a handle option is selected.
- To order handles, please specify corresponding code to image as below (**HS, HO, HW, HX, HV, HU, HQ, HZ, or HR**):



GROMMETS

- Additional grommets available in standard worksurface locations (left, center or right).
- Order as: **AG1, AG2 or AG3. Add \$103**
- Grommets may be placed at non-standard locations. Order as: **AGS - Add \$103.** A drawing must be supplied with vertical and horizontal dimensions to the center of the cut-out (as in drawing above). Please refer to **CUSTOM GROMMET LOCATION FORM** in the back reference section.
- Components that come standard with grommet as stated within the product descriptions or shown in the corresponding price list line art, may be ordered without a grommet. **Add \$57.**
- Option to remove standard grommet when required - specify **RSG - Add \$57.**
- Option to remove standard grommet position and add another position - specify **RSG** and **AG_** or **AGS**, upcharge applies. For **RSG + AG_** combination, **Add \$160.** For **RSG + AGS** combination, **Add \$160.**

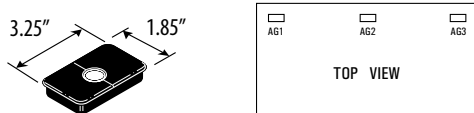

- Grommet hole dimensions are 3 1/4" wide x 1 7/8" deep.
- Actual grommet locations on the worksurface are depicted in the example drawings shown below. Dimensions shown are actual measurements (in inches).

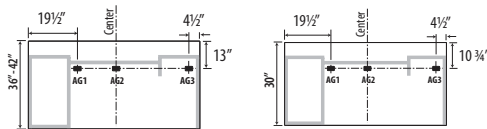

Straight Front, 36" - 42"D

Straight Front, 30"D

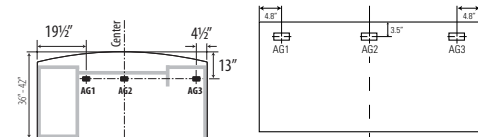

Bow Front

Universal Tops

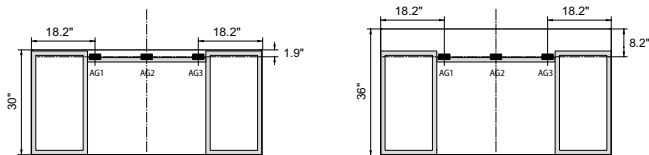

HA Double Ped

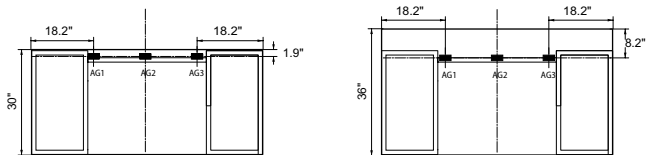

HA Single Ped

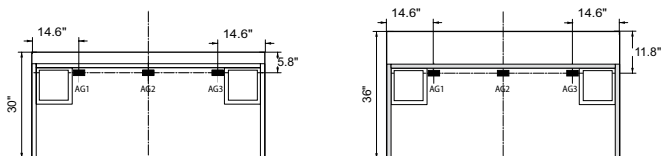

Freestanding HA

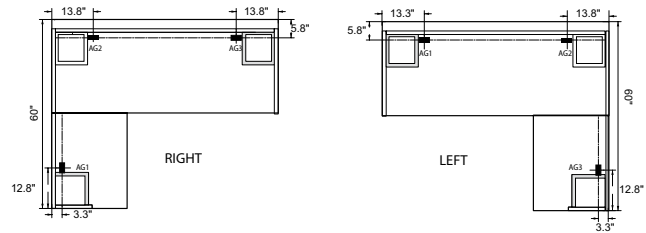

L HA desk

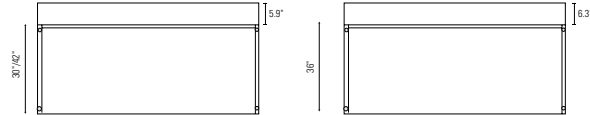

NHD desk

- Grommets are available on modesty panels of **extended corners** and **5-sided corners** 8" in where the two modesty panels meet at a 90° angle. Please specify **FOGMP-R** for right grommet placement and **FOGMP-L** for left grommet (placement is as shown on diagrams below). Cost is **\$103.**

*** Modesty Panels are 1" off of ground*

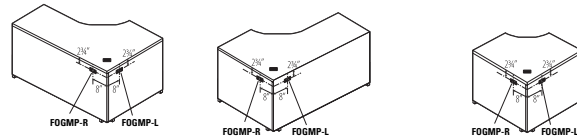

Left Extended Corner Unit

Right Extended Corner Unit

5-Sided Corner Unit

POWER BLOCK

- A Power Block (model **PMSPDM**) may be ordered on all worksurfaces.
- A Power Block is a rectangular worksurface power/data module with one electrical duplex receptacle and two data (RJ45) receptacles. 9 foot black cord included. Power Block dimensions are 3 1/2" deep x 6 1/2" wide x 2 3/4" high.
- To purchase a Power Block, you must specify both the Power Block cut-out location and the Power Block model #. Order Power Block as **PMSPDM, Add \$352.** Power Blocks are available in standard worksurface locations (left, center or right). Order as **E1, E2 or E3. Add \$103.**

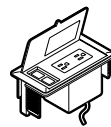

Power Block **PMSPDM** Add **\$352**

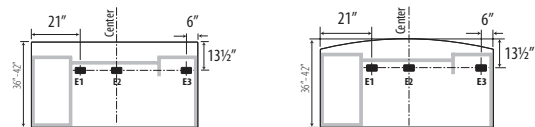

Straight Front

Bow Front

Specify location **E1, E2 or E3. Add \$103**

LAMINATE WOODGRAIN DIRECTIONS

- Worksurfaces have the woodgrain pattern run the full width of the tops.
- Modesty panels **60" or wider** will have the woodgrain pattern in a **horizontal** direction
- All end panels and modesy panels **less than 60" wide** will have the woodgrain pattern in a **vertical** direction.
- Hutch doors and cabinet doors will have the woodgrain pattern in a **vertical** direction.
- All lateral file drawer fronts will have the woodgrain pattern in a **horizontal** direction.

Height adjustable tables

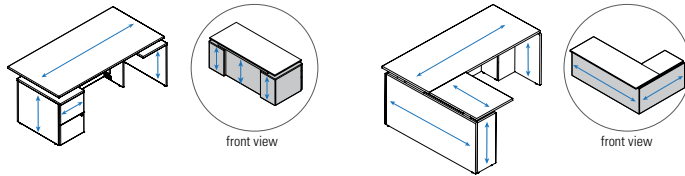

Top + modesty panel kits for height adjustable bases

42"-54"W modesty panels: vertical woodgrain direction
60"-84"W modesty panels: horizontal woodgrain direction

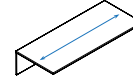

Freestanding desks

width: 60"-84"
all modesty panels: horizontal woodgrain direction

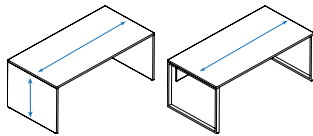

Pedestal desks

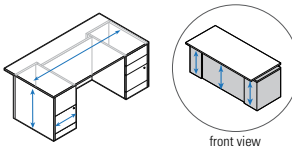

Extended corner desks

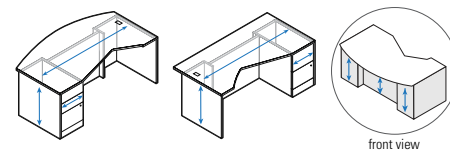

Returns

36"-54"W modesty panels: vertical woodgrain direction
60"-72"W modesty panels: horizontal woodgrain direction

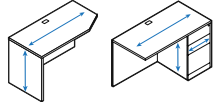

Modesty panels

48"-54"W: vertical woodgrain direction
60"-72"W: horizontal woodgrain direction

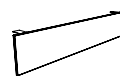

Bridges

width: up to 48"

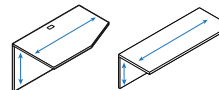

Credenzas

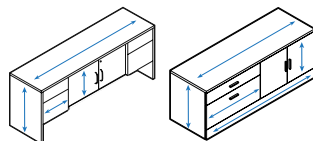

Freestanding + connectables tables

30"-48"W back panels: vertical woodgrain direction
60"-72"W back panels: horizontal woodgrain direction

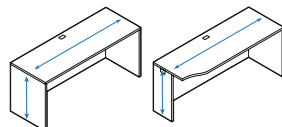

5-sided corners

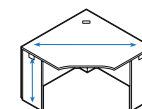

Extended corners

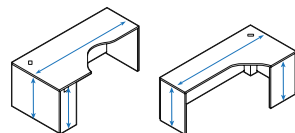

Islands

48"W modesty panels: vertical woodgrain direction
60"-72"W modesty panels: horizontal woodgrain direction

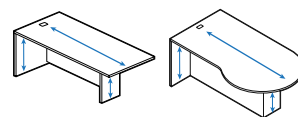

Extended corner islands

60"-84"W modesty panels: horizontal woodgrain direction

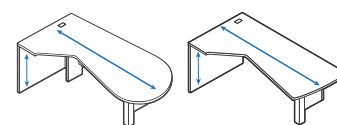

Pedestals



Storage shells



Top + back kits for 16.87" storage shells

30"-60"W modesty panels: vertical woodgrain direction
66"-96"W modesty panels: horizontal woodgrain direction



Storage modules

back panel: vertical woodgrain direction

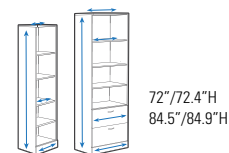
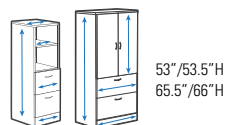
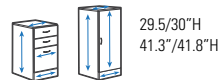

LAMINATE WOODGRAIN DIRECTIONS

Wardrobes + personal towers
back panel: vertical woodgrain direction

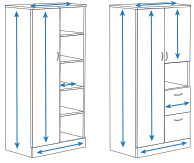

Overhead storage

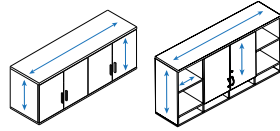

Hutches
back panel: vertical woodgrain direction

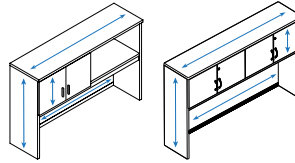

Pigeon-hole storage

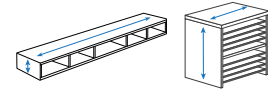

Bookcases

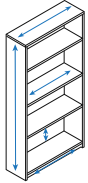
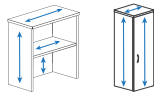

Table top bookcases



End shelves

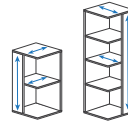
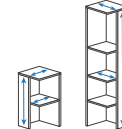
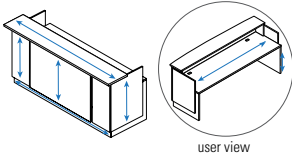

Table top end shelves



Reception desks



Low reception returns

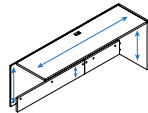

High reception returns

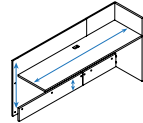

Transactional reception returns

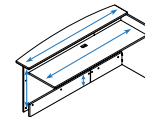

Pigeon reception returns

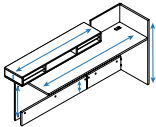

Bookcase reception returns

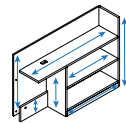

Reception desk vertical storage



Wall panels

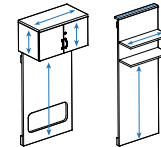

Boardroom tables

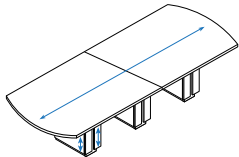

Media tables

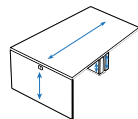

Buffets

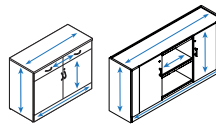

Buffet cart



Serving carts

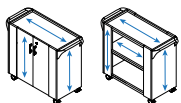

Visual board

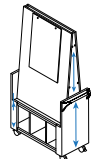

Multimedia cart



Lectern

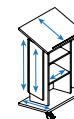

Binder Position of Storage Modules



Executive Height Adjustable Desks

Available widths: 60", 66", 72", 84"

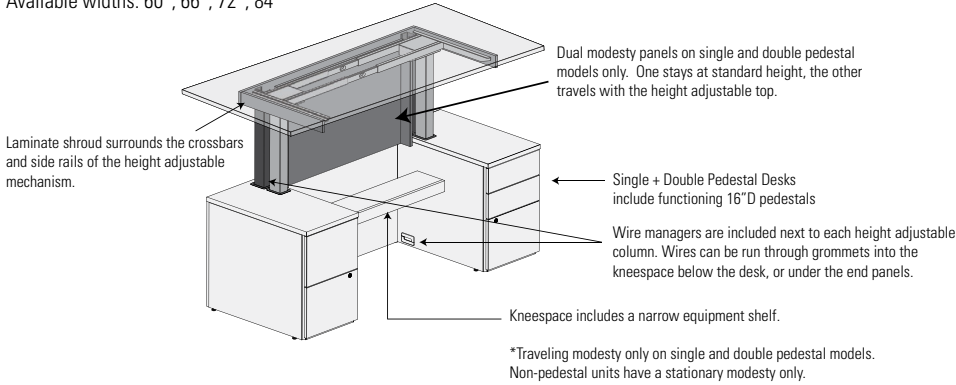

Returns

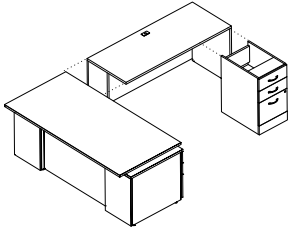

For "L" Shape Layouts

- Pre-configured
- With custom shell storage

Bridges

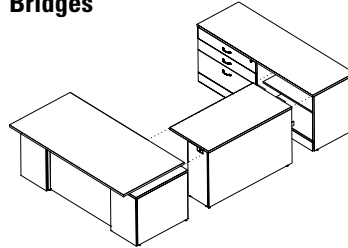

For "U" shape Layouts

Top conditions for Height Adjustable Desks

Top recesses are to minimize potential pinch points when adjacent to fixed surfaces.

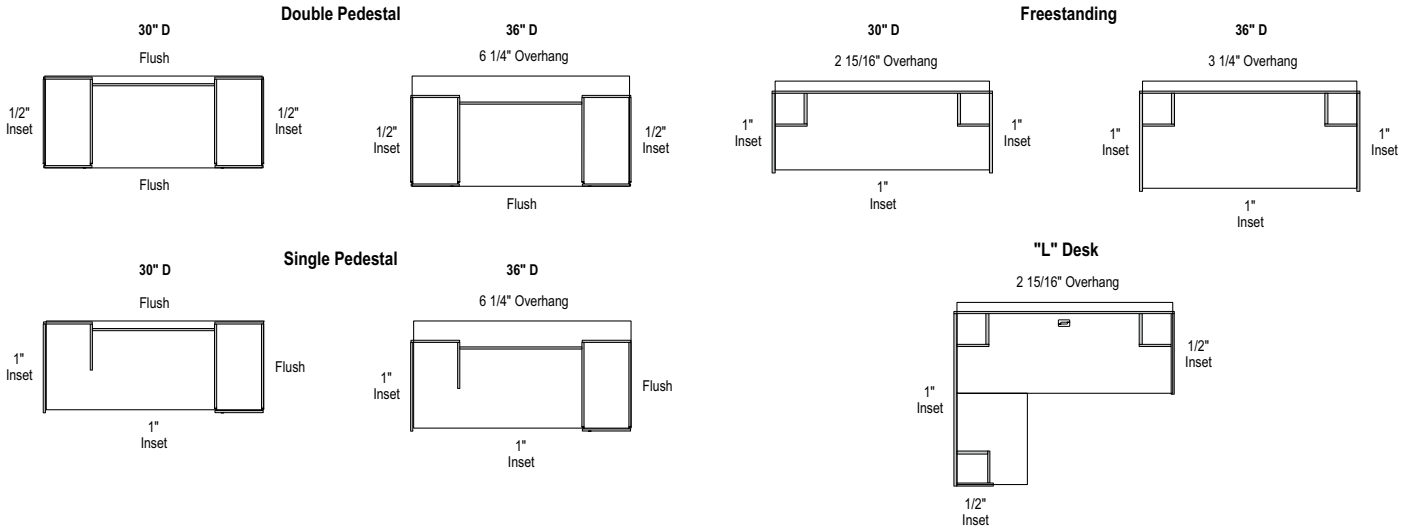

Wall Panels

Weight capacities for wall panels

- When mounting customer supplied flat screen or other to a wall panel, total weight including mounting hardware **should not exceed 140 lbs.** in total. Not approved for use with articulating or extendable mounting arms.
- Wall panels with floating shelves:
 - 1 mm space between shelves when units side by side.
 - **24"W** up to 50 lbs.; **30"W** up to 65 lbs.; **36"W** up to 75 lbs.; **42"W** up to 90 lbs. per floating shelf
 - Note: weight should be evenly distributed over surface
- Wall panels with overhead cabinet storage:
 - Note: weight should be evenly distributed over surface
 - **66"H - 24"W**: 30 lbs. top/55 lbs. inside bottom; **30"W**: 40 lbs. top/70 lbs. inside bottom; **36"W**: 45 lbs.top/85 lbs. inside bottom; **42"W**: 55 lbs. top/95 lbs. inside bottom.
 - **72"H - 24"W**: 30 lbs. top/65 lbs. inside bottom; **30"W**: 40 lbs. top/80 lbs. inside bottom; **36"W**: 50 lbs.top/95 lbs. inside bottom; **42"W**: 60 lbs. top/100 lbs. inside bottom.
 - **84"H - 24"W**: 30 lbs. top/65 lbs. shelf & inside bottom; **30"W**: 40 lbs. top/80 lbs. shelf & inside bottom; **36"W**: 50 lbs.top/95 lbs. shelf & inside bottom; **42"W**: 60 lbs. top/100 lbs. shelf & inside bottom.

Grommet locations for wall panels

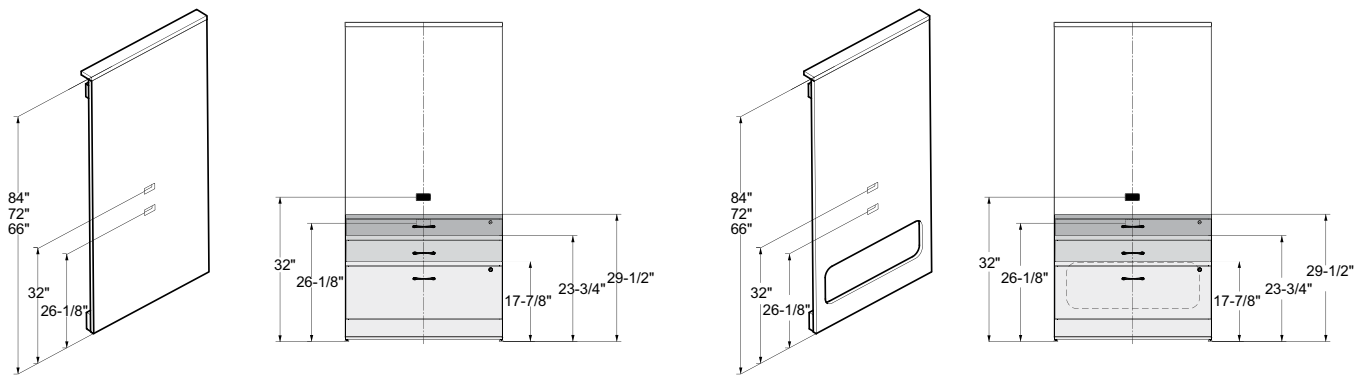

- AG1 grommet sits at 26-1/8" above the floor, just about 1-1/2 high storage, but below standard 29-1/2" storage
- AG2 grommet sits at 32" above the floor, above 29-1/2" storage
 - *Cove Mini power units are not for use in this application due to depth.
- When the wall with wire management access is specified, the wire management access opening will sit below all storage heights (see chart below).

Wall Width	Opening Width
42"	35.75"
36"	29.75"
30"	23.75"
24"	17.75"

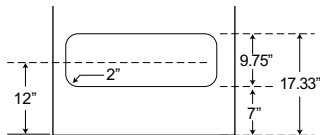

Desks / Extended Corner Desks - available width: 60", 66", 72" 84"

Modesty Treatments

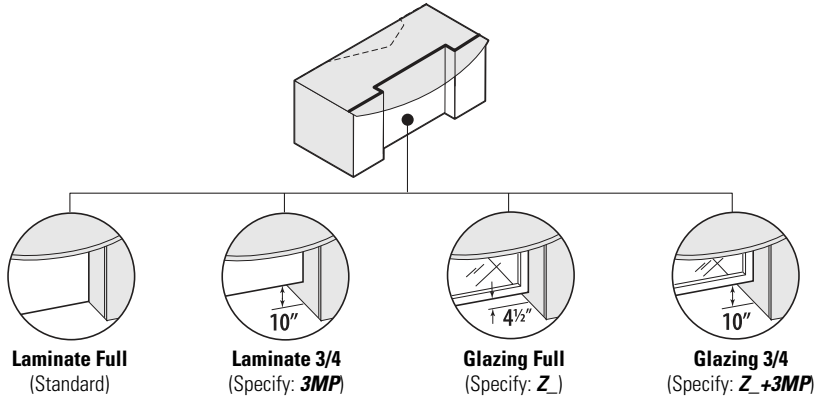

Overhang Dimensions

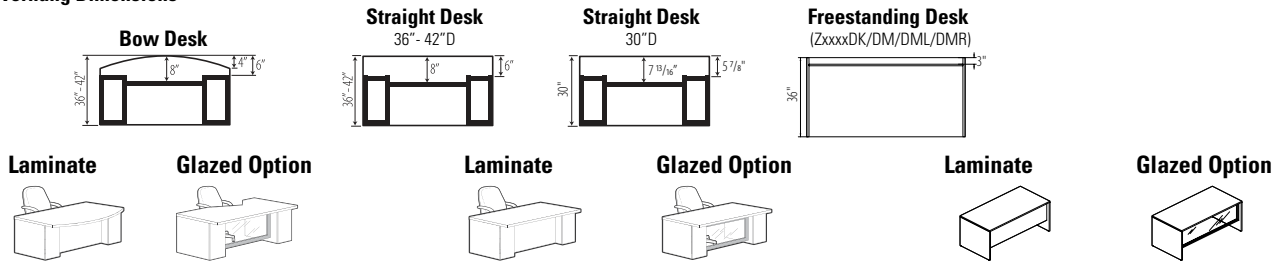

Returns - available width: 36", 42", 48", 54", 60", 66", 72"

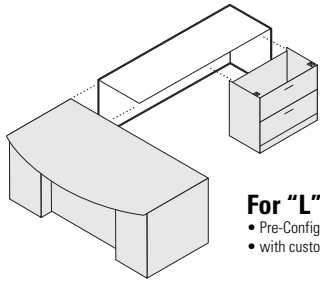

For "L" shape Layouts

- Pre-Configured
- with custom shell storage

Transitional Pigeon-Hole

Accepts all (same width) Transitional Pigeon-Holes.

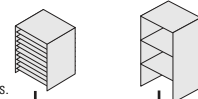
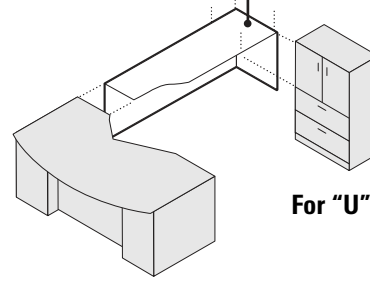

Table Top Bookcase

Accepts all (same width) Table Top Bookcases.



For "U" shape Layouts

Bridges - available width: 42", 48"

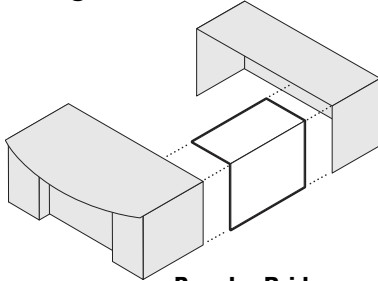

Regular Bridge

- join worksurface to worksurface

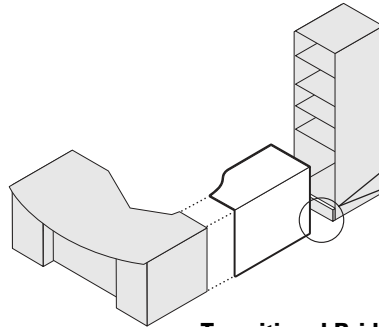

Transitional Bridge

- join worksurface to storage modules

Remove Existing Kickbase

Replace with supplied Kickbase (shorter)

Extended Corners - available widths: 60", 66", 72", 84"

Modesty Treatments

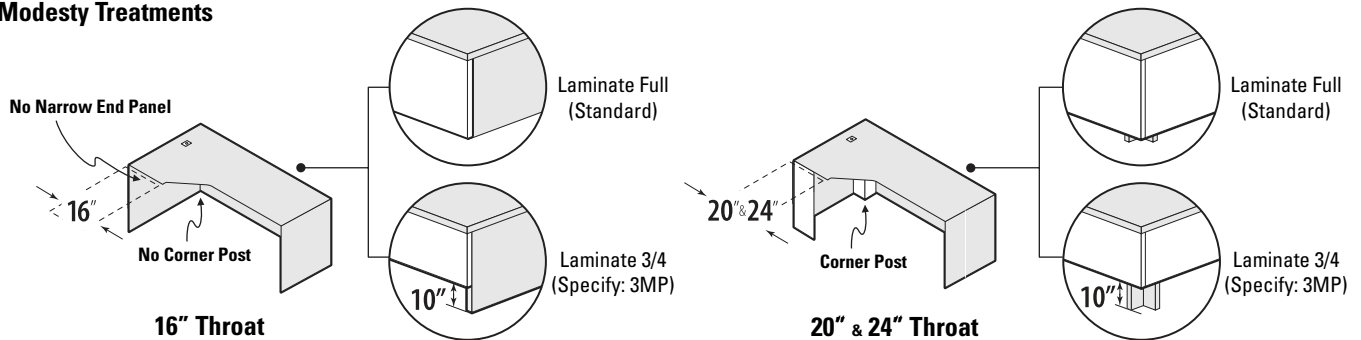

Shells - available width: 12", 15", 16", 18", 21", 30", 36"

For Extended Corners, Space Saver Returns and Connectables

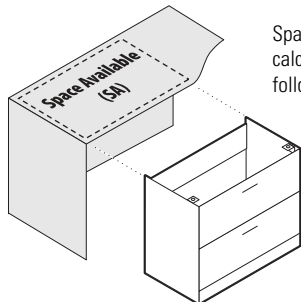

Space Available can be calculated with the following formulas:

Space Saver Returns

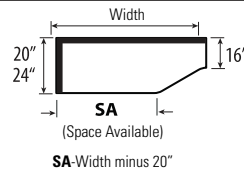

Space Saver Connectables

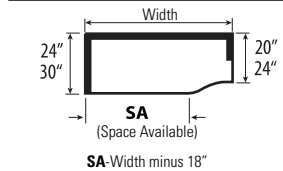

Extended Corners

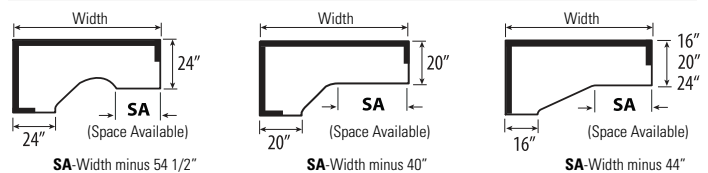

Extended Corner Islands - available width: 60", 66", 72" 84"

Modesty Treatments

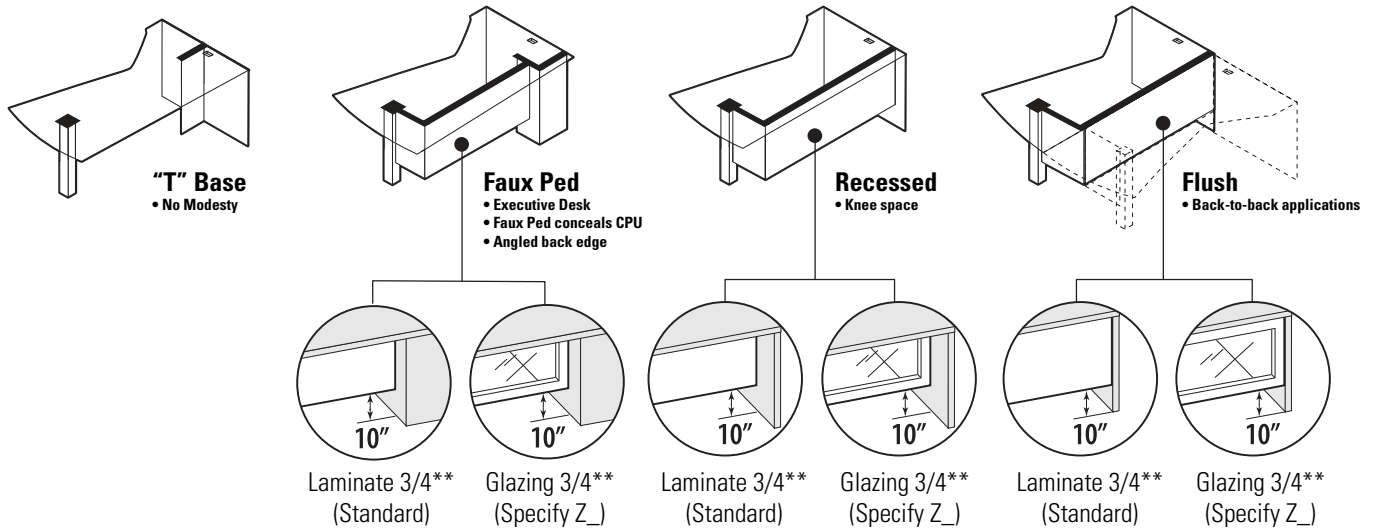

** Full modesty not available

Overhang Dimensions



Storage

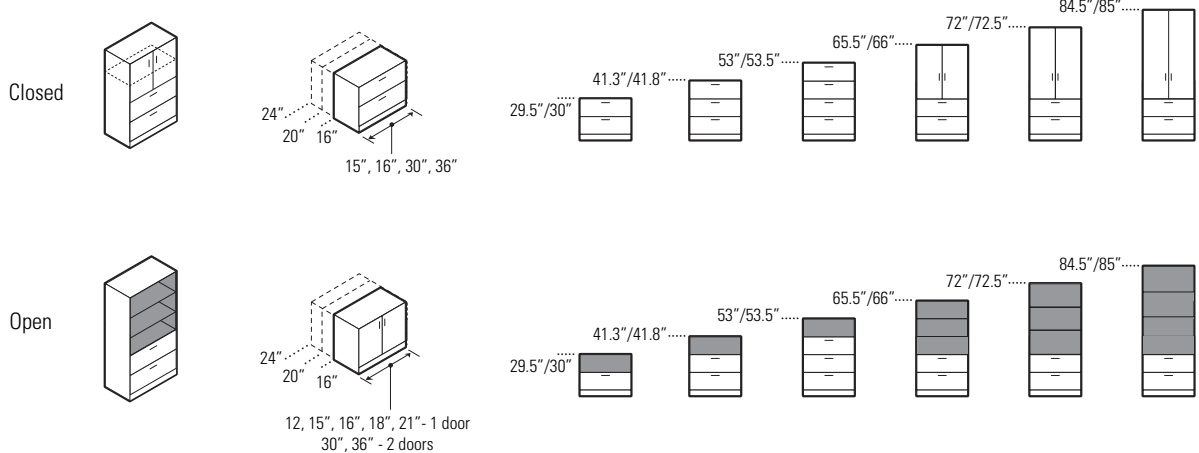

Wardrobe & Personal Towers

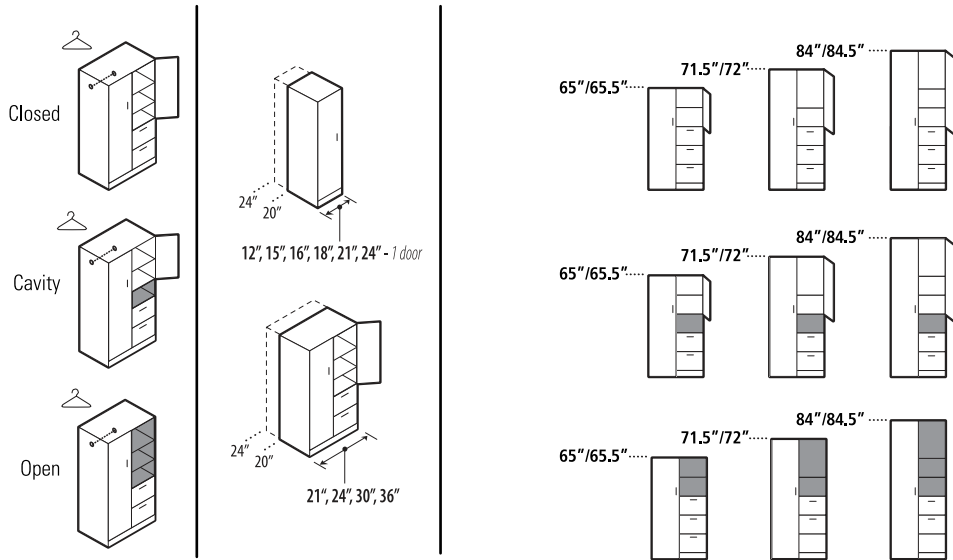

Drawer & Cavity Positions

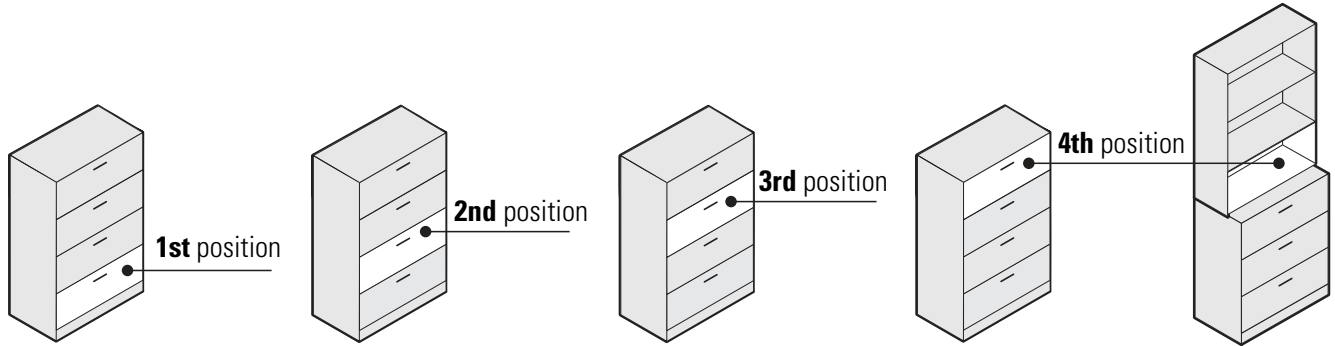

Box Drawer Option

Lateral file drawers can be converted to box/box drawers in any of the four standard positions

- B1** = 2 box drawers on 1st position
- B2** = 2 box drawers on 2nd position
- B3** = 2 box drawers on 3rd position
- B4** = 2 box drawers on 4th position

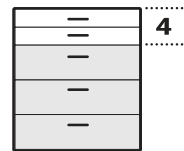
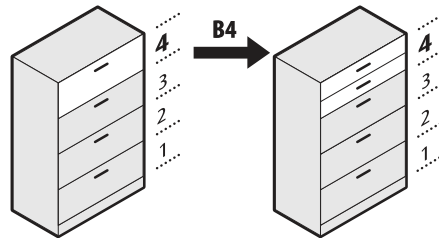

Example
File drawer converted to 2 box drawers on **4th** position

Please specify: Z36L54F - **B4**

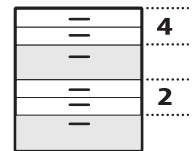

Converting 2 or more drawers please contact customer service.

Collator Positions

All storage units can be specified with an optional collator on 2nd, 3rd and/or 4th position.

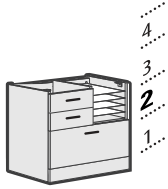

Collator on 2nd position
Specify: **2K - Black** or
2T - Brushed Cobalt

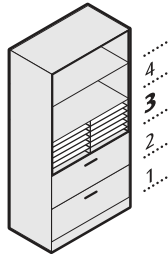

Collator on 3rd position
Specify: **3K - Black** or
3T - Brushed Cobalt

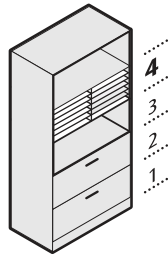

Collator on 4th position
Specify: **4K - Black** or
4T - Brushed Cobalt

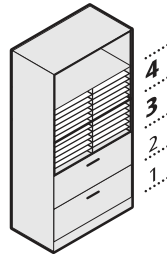

Collator on 3rd & 4th positions
Specify: **7K - Black** or
7T - Brushed Cobalt

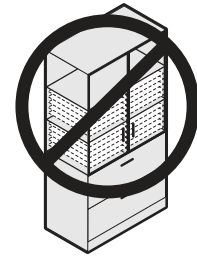

Collators do not fit behind doors

For 2K / 2T, 3K / 3T OR 4K / 4T - Add \$325

For 7K / 7T - Add \$573

Glazing

Glazing is available in the following options:

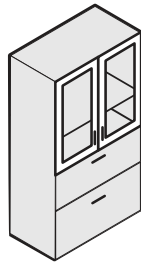

Tungsten Frame
Frosted Glazing
Z1

Please specify:
Z36L6E - **Z1**

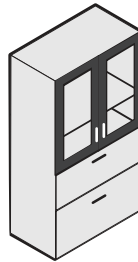

Black Frame
Frosted Glazing
Z2

Please specify:
Z36L6E - **Z2**

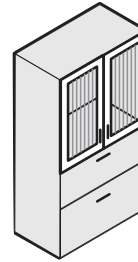

Tungsten Frame
Ribbed Glazing
Z3

Please specify:
Z36L6E - **Z3**

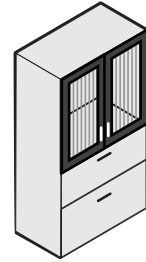

Black Frame
Ribbed Glazing
Z4

Please specify:
Z36L6E - **Z4**

Filing Options - For Filing Components

On 16" deep files, drawer interiors are only 13" deep. On 20" and 24" deep files, drawer interiors are 16" deep.
 Full to floor BBF, FF and BF pedestals are 16" wide with all pedestal desks, returns with pedestals and credenzas with pedestals.
 Full to floor BBF and FF storage shells 15" wide x 28.5" high are required under 36" wide Space Saver Return with 16" deep connection top. re: Zxx3616Rx.
 Filing hardware included with all laminate drawer models. Steel drawer models do NOT include FBB bars.

Side-To-Side

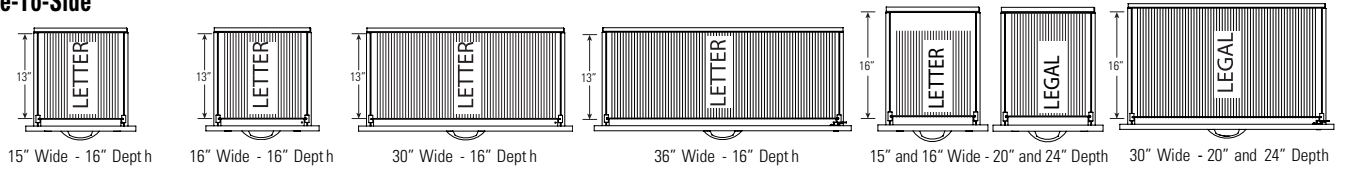

Front-To-Back

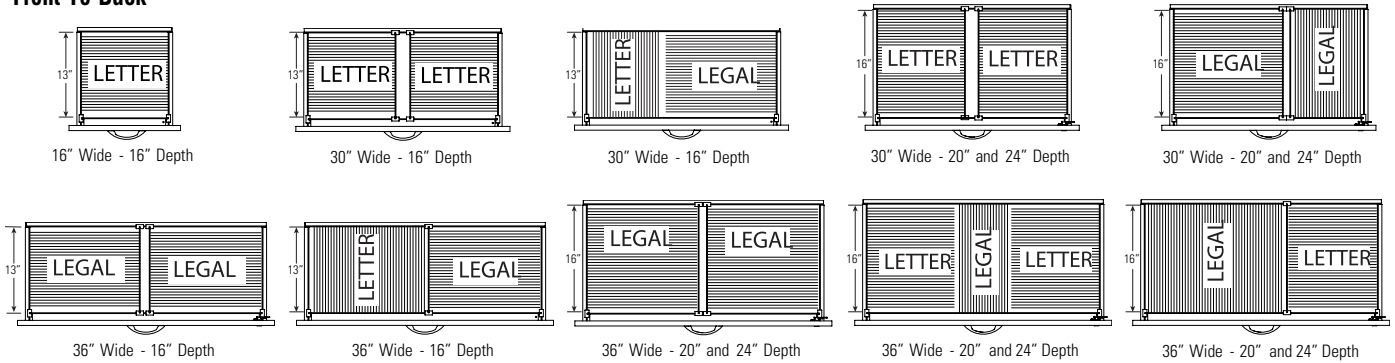

Height Map

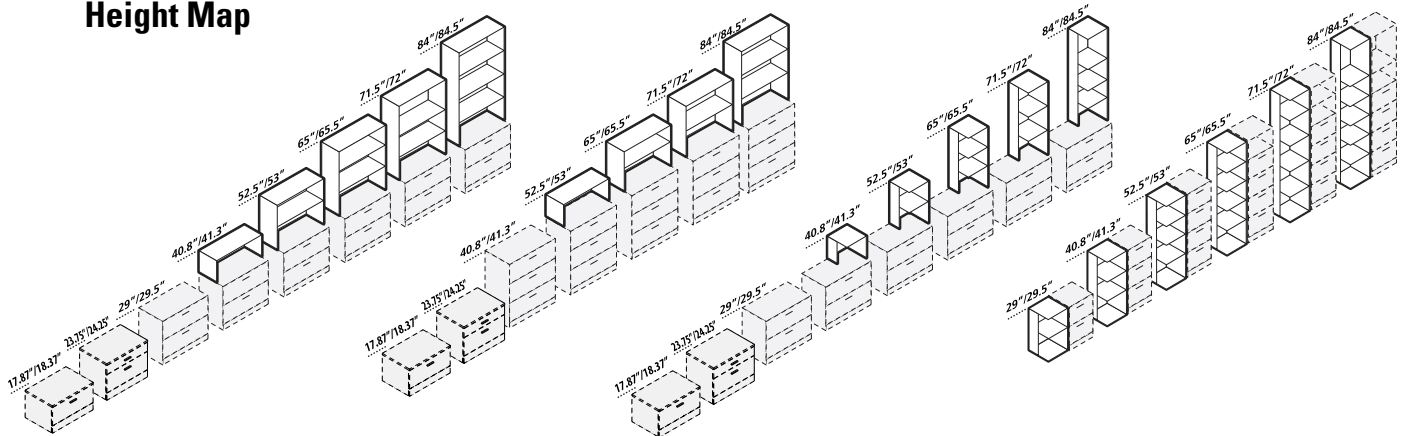

Drawer & Cavity Positions

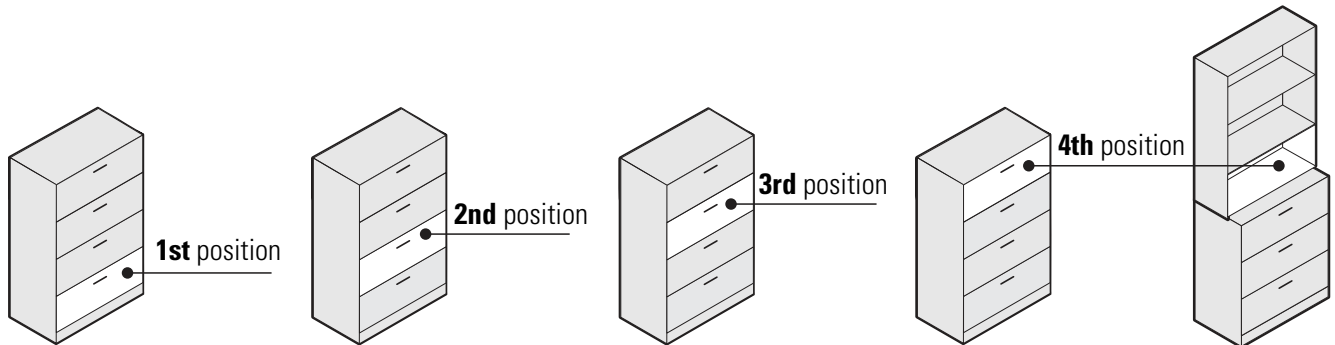

Collator Positions

For 12" to 21" wide units

****If no collator is desired, must specify when placing order.**

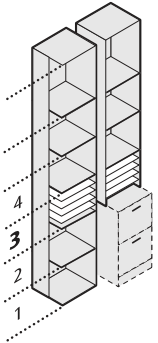

Collator on 3rd position
Specify: **3K - Black** or
3T - Brushed Cobalt

For 3K / 3T or 4K / 4T.....Add \$305

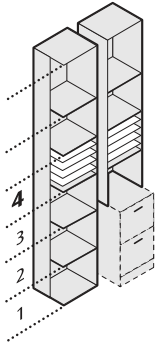

Collator on 4th position
Specify: **4K - Black** or
4T - Brushed Cobalt

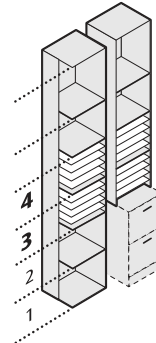

Collator on 3rd & 4th position
Specify: **7K - Black** or
7T - Brushed Cobalt

For 7K / 7T.....Add \$538

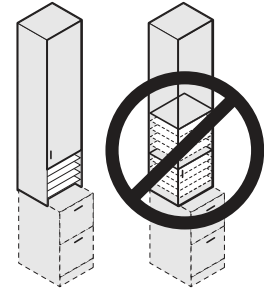

Collators do not fit behind door

Table Top Bookcase

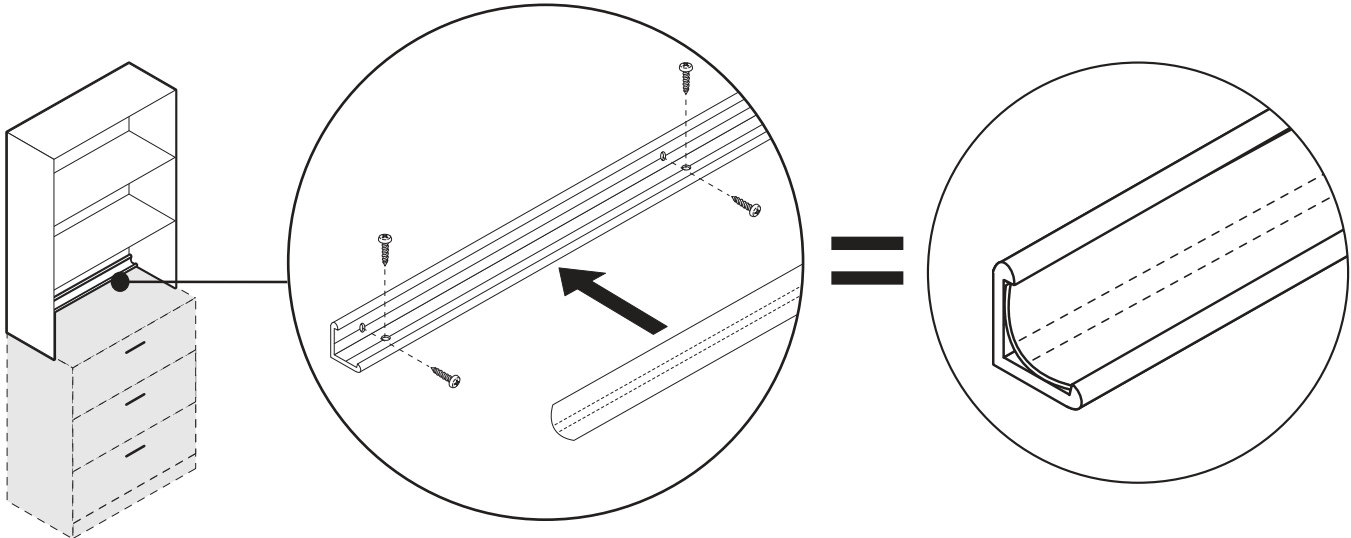

Hutches

Monitor clearance dimensions

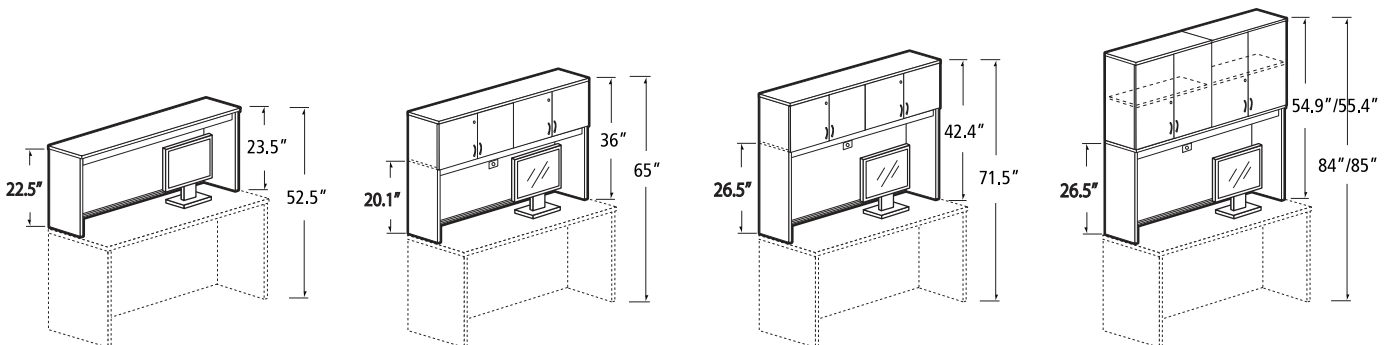

HEIGHT ADJUSTABLE DESKS

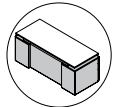

Front view - 30"D

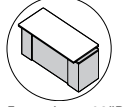

Front view - 36"D

Double Pedestal Desk for Height Adj. Base

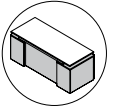

Front view - 30"D

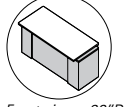

Front view - 36"D

Double Pedestal Desk for Height Adj. Base

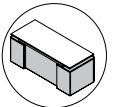

Front view - 30"D

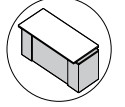

Front view - 36"D

Single Pedestal Desk for Height Adj. Base

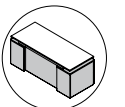

Front view - 30"D

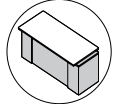

Front view - 36"D

Single Pedestal Desk for Height Adj. Base

MODEL#	DIMENSIONS D x W x H	FREIGHT CLASS	WT/LBS.	CUBIC FT.	1"TOP	1.5" TOP	GLAZE ADD	HP ADD
ZH3684F23	36 x 84 x 29.5-49.5	85	362	26.68	\$4163	\$4411	\$684	\$730
ZH3672F23	36 x 72 x 29.5-49.5	85	335	26.68	\$4131	\$4351	\$586	\$626
ZH3666F23	36 x 66 x 29.5-49.5	85	321	25.18	\$4019	\$4218	\$528	\$573
ZH3660F23	36 x 60 x 29.5-49.5	85	307	24.70	\$3880	\$4079	\$567	\$521
ZH3084F23	30 x 84 x 29.5-49.5	85	347	25.69	\$4262	\$4475	\$684	\$604
ZH3072F23	30 x 72 x 29.5-49.5	85	321	24.70	\$4058	\$4245	\$586	\$521
ZH3066F23	30 x 66 x 29.5-49.5	85	309	24.19	\$3948	\$4121	\$528	\$481
ZH3060F23	30 x 60 x 29.5-49.5	85	296	23.68	\$3834	\$3988	\$573	\$436

• Specify FTZ52SFNL for 60" - 72" wide desks and FTZ52LFNL for 84" wide desks.
 Height adjustable frame sold separately. Standard with file/file (FF) pedestal on **left** and box/box/file (BBF) pedestal on **right**.
30"D: Top is recessed 1/2" on either side over chassis, flush on user and guest side. **36"D**: Top is recessed 1/2" on either side over chassis, flush on user side, 6.25" overhang on guest side. BBF - file drawer and lower box drawer lock. FF - drawers lock. Unit has dual modesty panels - one stationary/one traveling. See notes on page 184 for illustration. *30"D desks are not compatible with monitor arm models MONxxxx/M775xxx. Shipped RTA (ready to assemble).*

ZH3684F32	36 x 84 x 29.5-49.5	85	362	26.68	\$4163	\$4411	\$684	\$730
ZH3672F32	36 x 72 x 29.5-49.5	85	335	26.68	\$4131	\$4351	\$586	\$626
ZH3666F32	36 x 66 x 29.5-49.5	85	321	25.18	\$4019	\$4218	\$528	\$573
ZH3660F32	36 x 60 x 29.5-49.5	85	307	24.70	\$3880	\$4079	\$567	\$521
ZH3084F32	30 x 84 x 29.5-49.5	85	347	25.69	\$4262	\$4475	\$684	\$604
ZH3072F32	30 x 72 x 29.5-49.5	85	321	24.70	\$4058	\$4245	\$586	\$521
ZH3066F32	30 x 66 x 29.5-49.5	85	309	24.19	\$3948	\$4121	\$528	\$481
ZH3060F32	30 x 60 x 29.5-49.5	85	296	23.68	\$3834	\$3988	\$573	\$436

• Specify FTZ52SFNL for 60" - 72" wide desks and FTZ52LFNL for 84" wide desks.
 Height adjustable frame sold separately. Standard with box/box/file (BBF) pedestal on **left** and file/file (FF) pedestal on **right**.
30"D: Top is recessed 1/2" on either side over chassis, flush on user and guest side. **36"D**: Top is recessed 1/2" on either side over chassis, flush on user side, 6.25" overhang on guest side. BBF - file drawer and lower box drawer lock. FF - drawers lock. Unit has dual modesty panels - one stationary/one traveling. See notes on page 184 for illustration. *30"D desks are not compatible with monitor arm models MONxxxx/M775xxx. Shipped RTA (ready to assemble).*

ZH3684F3S	36 x 84 x 29.5-49.5	85	325	26.68	\$3790	\$4029	\$684	\$730
ZH3672F3S	36 x 72 x 29.5-49.5	92.5	298	25.69	\$3737	\$3957	\$586	\$626
ZH3666F3S	36 x 66 x 29.5-49.5	92.5	284	25.18	\$3627	\$3826	\$528	\$573
ZH3660F3S	36 x 60 x 29.5-49.5	92.5	271	24.70	\$3487	\$3674	\$463	\$521
ZH3084F3S	30 x 84 x 29.5-49.5	85	310	25.69	\$3870	\$4083	\$684	\$604
ZH3072F3S	30 x 72 x 29.5-49.5	92.5	285	24.70	\$3665	\$3852	\$586	\$521
ZH3066F3S	30 x 66 x 29.5-49.5	92.5	272	24.19	\$3554	\$3727	\$528	\$481
ZH3060F3S	30 x 60 x 29.5-49.5	92.5	260	23.68	\$3443	\$3597	\$468	\$436

• Specify FTZ52SFNL for 60" - 72" wide desks and FTZ52LFNL for 84" wide desks.
 Height adjustable frame sold separately. Standard with box/box/file pedestal on **left**. **30"D**: Top is recessed 1" on non-ped side and user side over chassis; flush on ped side and guest side. **36"D**: Top is recessed 1" on non-ped side and user side over chassis; flush on ped side and 6.25" overhang on guest side. File drawer and lower box drawer lock. Unit has dual modesty panels - one stationary/one traveling. See notes on page 184 for illustration. *30"D desks are not compatible with monitor arm models MONxxxx/M775xxx. Shipped RTA (ready to assemble).*

ZH3684FS3	36 x 84 x 29.5-49.5	85	325	26.68	\$3790	\$4029	\$684	\$730
ZH3672FS3	36 x 72 x 29.5-49.5	92.5	298	25.69	\$3737	\$3957	\$586	\$626
ZH3666FS3	36 x 66 x 29.5-49.5	92.5	284	25.18	\$3627	\$3826	\$528	\$573
ZH3660FS3	36 x 60 x 29.5-49.5	92.5	271	24.70	\$3487	\$3674	\$463	\$521
ZH3084FS3	30 x 84 x 29.5-49.5	85	310	25.69	\$3870	\$4083	\$684	\$604
ZH3072FS3	30 x 72 x 29.5-49.5	92.5	285	24.70	\$3665	\$3852	\$586	\$521
ZH3066FS3	30 x 66 x 29.5-49.5	92.5	272	24.19	\$3554	\$3727	\$528	\$481
ZH3060FS3	30 x 60 x 29.5-49.5	92.5	260	23.68	\$3443	\$3597	\$468	\$436

• Specify FTZ52SFNL for 60" - 72" wide desks and FTZ52LFNL for 84" wide desks.
 Height adjustable frame sold separately. Standard with box/box/file pedestal on **right**. **30"D**: Top is recessed 1" on non-ped side and user side over chassis; flush on ped side and guest side. **36"D**: Top is recessed 1" on non-ped side and user side over chassis; flush on ped side and 6.25" overhang on guest side. File drawer and lower box drawer lock. Unit has dual modesty panels - one stationary/one traveling. See notes on page 184 for illustration. *30"D desks are not compatible with monitor arm models MONxxxx/M775xxx. Shipped RTA (ready to assemble).*

Required Specifications

Primary surface type + finish
 Top/edge detail, base finish,
 Wire management finish
 Default no handle, specify lock finish
 Drawer front finish

Must use with FTZ52SFNL or FTZ52LFNL (sold separately)

Optional Specifications

Key #, Handles, Modesty type
 Modesty finish glazed, otherwise will match base finish

Grommet position or power block cut-out

Accessories

Power block

HEIGHT ADJUSTABLE DESKS

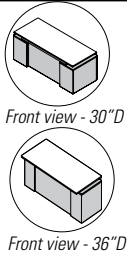

Single Pedestal Desk for Height Adj. Base**

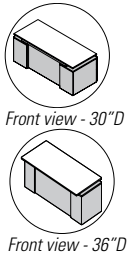

Single Pedestal Desk for Height Adj. Base**

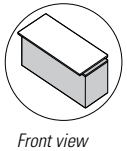

Height Adj. Desk - Freestanding



Height Adjustable Frame*

MODEL#	DIMENSIONS D x W x H	FREIGHT CLASS	WT/LBS.	CUBIC FT.	1" TOP	1.5" TOP	GLAZE ADD	HP ADD
ZH3684F2S	36 x 84 x 29.5-49.5	85	323	26.68	\$3737	\$3976	\$684	\$730
ZH3672F2S	36 x 72 x 29.5-49.5	92.5	296	26.68	\$3685	\$3898	\$586	\$626
ZH3666F2S	36 x 66 x 29.5-49.5	92.5	282	25.18	\$3566	\$3765	\$528	\$573
ZH3660F2S	36 x 60 x 29.5-49.5	92.5	268	24.70	\$3434	\$3613	\$463	\$521
ZH3084F2S	30 x 84 x 29.5-49.5	92.5	308	25.69	\$3816	\$4029	\$684	\$604
ZH3072F2S	30 x 72 x 29.5-49.5	92.5	283	24.70	\$3613	\$3792	\$586	\$521
ZH3066F2S	30 x 66 x 29.5-49.5	92.5	270	24.19	\$3502	\$3670	\$528	\$481
ZH3060F2S	30 x 60 x 29.5-49.5	92.5	258	23.68	\$3389	\$3543	\$463	\$436

• Specify FTZ52SFNL for 60" - 72" wide desks and FTZ52LFNL for 84" wide desks.

Height adjustable frame sold separately. Standard with file/file pedestal on **left. 30"D**: Top is recessed 1" on non-ped side and user side over chassis; flush on ped side and guest side. **36"D**: Top is recessed 1" on non-ped side and user side over chassis; flush on ped side and 6.25" overhang on guest side. Pedestal locks. Unit has dual modesty panels - one stationary/one traveling. See notes on page 184 for illustration. *30"D desks are not compatible with monitor arm models MONxxxx/M775xxx.* Shipped RTA (ready to assemble).

ZH3684FS2	36 x 84 x 29.5-49.5	85	323	26.68	\$3737	\$3976	\$684	\$730
ZH3672FS2	36 x 72 x 29.5-49.5	92.5	296	26.68	\$3685	\$3898	\$586	\$626
ZH3666FS2	36 x 66 x 29.5-49.5	92.5	282	25.18	\$3566	\$3765	\$528	\$573
ZH3660FS2	36 x 60 x 29.5-49.5	92.5	268	24.70	\$3434	\$3613	\$463	\$521
ZH3084FS2	30 x 84 x 29.5-49.5	92.5	308	25.69	\$3816	\$4029	\$684	\$604
ZH3072FS2	30 x 72 x 29.5-49.5	92.5	283	24.70	\$3613	\$3792	\$586	\$521
ZH3066FS2	30 x 66 x 29.5-49.5	92.5	270	24.19	\$3502	\$3670	\$528	\$481
ZH3060FS2	30 x 60 x 29.5-49.5	92.5	258	23.68	\$3389	\$3543	\$463	\$436

• Specify FTZ52SFNL for 60" - 72" wide desks and FTZ52LFNL for 84" wide desks.

Height adjustable frame sold separately. Standard with file/file pedestal on **right. 30"D**: Top is recessed 1" on non-ped side and user side over chassis; flush on ped side and guest side. **36"D**: Top is recessed 1" on non-ped side and user side over chassis; flush on ped side and 6.25" overhang on guest side. Pedestal locks. Unit has dual modesty panels - one stationary/one traveling. See notes on page 184 for illustration. *30"D desks are not compatible with monitor arm models MONxxxx/M775xxx.* Shipped RTA (ready to assemble).

ZH3684NP	36 x 84 x 29.5-49.5	70	231	10.48	\$2585	\$2833	N/A	\$730
ZH3672NP	36 x 72 x 29.5-49.5	125	206	27.69	\$2545	\$2758	N/A	\$626
ZH3666NP	36 x 66 x 29.5-49.5	65	198	8.47	\$2466	\$2665	N/A	\$573
ZH3660NP	36 x 60 x 29.5-49.5	65	198	8.47	\$2408	\$2587	N/A	\$521
ZH3072NP	30 x 72 x 29.5-49.5	70	188	8.71	\$2421	\$2608	N/A	\$521
ZH3066NP	30 x 66 x 29.5-49.5	70	178	7.96	\$2341	\$2514	N/A	\$481
ZH3060NP	30 x 60 x 29.5-49.5	70	168	7.49	\$2303	\$2457	N/A	\$436

• Specify FTZ52SFNL for 60" wide desks and FTZ52LFNL for 66" - 84" wide desks.

Height adjustable frame sold separately. **30"D** - Top is recessed 1" on user and both sides over chassis; 2.9375" overhang on guest side. **36"D** - Top is recessed 1" on user and both sides over chassis; 3.25" overhang on guest side. Shipped RTA (ready to assemble). Unit has a stationary modesty only. *30"D desks are not compatible with monitor arm models MONxxxx/M775xxx.*

FTZ52SFNL	22 x -- x 26	60	67	1.47	\$1212			
FTZ52LFNL	22 x -- x 26	60	67	1.47	\$1212			

- For models ending in F23/F32/F3S/FS3/F2S/FS2, specify FTZ52SFNL for 60" - 72" and FTZ52LFNL for 84" wide desks.
- For models ending in NP, specify FTZ52SFNL for 60" wide, and FTZ52LFNL for 66" - 84" wide desks

For use with Zira height adjustable desks. Lifts 350 lbs. Available in Black or Tungsten. Shipped RTA (ready to assemble). Standard with up/down controller with 2 memory positions, reminder settings + Bluetooth capability, specify **(S)**. For a display controller with height readout, 4 memory positions, reminder settings + Bluetooth capabilities, specify **(D)**, add **\$63** list.

• **Recommended torque range for installing all fasteners is 3-5 foot pounds and should not be exceeded. In addition, no impact drivers or high-torque equipment are to be used for any fasteners included in the table assembly kits, as this creates a high risk for damage that is not covered under warranty. The use of hand tools is highly recommended.**

Required Specifications

Primary surface type + finish
 Top/edge detail Base finish*
 Wire management finish
 Default no handle, specify lock finish

Drawer front finish**

Optional Specifications
 Key #**, Handles**, Modesty type
 Modesty finish glazed, otherwise will match base finish**

Grommet position or power block cut-out

Accessories
 Power block
 Must use with FTZ52SFNL or FTZ52LFNL (sold separately)

HEIGHT ADJUSTABLE DESKS

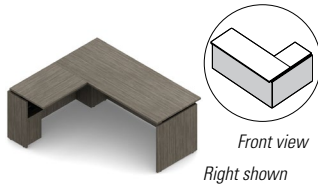

L Desk Shell for Height Adj. Base



Height Adjustable Frame*



Top and Modesty Panel Kit

MODEL#	DIMENSIONS	FREIGHT CLASS	WT/LBS.	CUBIC FT.	1" TOP	1.5" TOP	GLAZE ADD	HP ADD
	D x W x H							
ZH608424L	60 x 84 x 29.5-49.5	70	294	14.48	\$3411	\$3683	N/A	\$933
ZH607224L	60 x 72 x 29.5-49.5	70	273	13.24	\$3258	\$3506	N/A	\$829
ZH608424R	60 x 84 x 29.5-49.5	70	294	14.48	\$3411	\$3683	N/A	\$933
ZH607224R	60 x 72 x 29.5-49.5	70	273	13.24	\$3258	\$3506	N/A	\$829

- Specify FTZ539FSLNL separately.

Height adjustable frame sold separately. Specify ZH60xx24L for **LEFT** with return on the right side or ZH60xx24R for **RIGHT** with return on left side. Top on long return side is recessed 1" over chassis, 1/2" recessed on primary top (non-return side) and 2.9375" overhang on guest side. Return top is 24"D x 30"W. Shipped RTA (ready to assemble). *Not compatible with monitor arm models MONxxxx/M775xxx.*

FTZ539FSLNL	10 x -- x 26.8	60	101	1.47	\$1968			
-------------	----------------	----	-----	------	---------------	--	--	--

For use with Zira height adjustable L desks. Lifts 350 lbs. Available in Black, Designer White or Tungsten. Shipped RTA (ready to assemble).

- **Recommended torque range for installing all fasteners is 3-5 foot pounds and should not be exceeded. In addition, no impact drivers or high-torque equipment are to be used for any fasteners included in the table assembly kits, as this creates a high risk for damage that is not covered under warranty. The use of hand tools is highly recommended.**

ZH3084TB	29 x 82 x 16-16.5	85	99	6.75	\$1155	\$1465	\$725	\$604
ZH3072TB	29 x 70 x 16-16.5	85	85	6	\$1019	\$1286	\$639	\$521
ZH3066TB	29 x 64 x 16-16.5	85	79	5.50	\$953	\$1201	\$593	\$481
ZH3060TB	29 x 58 x 16-16.5	85	71	5	\$848	\$1074	\$581	\$436
ZH3054TB	29 x 52 x 16-16.5	85	64	4.50	\$783	\$990	\$507	\$397
ZH3048TB	29 x 46 x 16-16.5	85	57	4	\$717	\$896	\$468	\$351
ZH3042TB	29 x 40 x 16-16.5	85	50	3.75	\$644	\$805	\$423	\$304
ZH2484TB	23 x 82 x 16-16.5	85	74	5	\$1030	\$1282	\$618	\$487
ZH2472TB	23 x 70 x 16-16.5	70	86	5.50	\$913	\$1133	\$639	\$416
ZH2466TB	23 x 64 x 16-16.5	70	68	4.50	\$848	\$1055	\$593	\$383
ZH2460TB	23 x 58 x 16-16.5	85	61	4.25	\$758	\$945	\$581	\$351
ZH2454TB	23 x 52 x 16-16.5	85	55	3.75	\$698	\$866	\$507	\$333
ZH2448TB	23 x 46 x 16-16.5	85	49	3.50	\$639	\$793	\$468	\$278
ZH2442TB	23 x 40 x 16-16.5	85	43	3	\$567	\$714	\$436	\$248

For use with height adjustable mechanisms. Height adjustable frame not included. Shipped RTA (ready to assemble).

- Compatible with FreeFit + FOLI Height Adjustable bases (FOLI compatible with 48" w – 72" w tops)
- Cannot be used with FTZ52SFNL or FTZ52LFNL

Required Specifications

Primary surface type + finish
Top thickness/edge detail
Base finish
Wire management finish

Optional Specifications

Grommet position or power block cut-out

Accessories

Power block

BRIDGES COMPATIBLE W/ ZXXXXBBOL/R AND ZXXXXBLFL/R CREDENZAS **DIMENSIONS** **FREIGHT CLASS** **WT/LBS.** **CUBIC FT.** **1"TOP** **1.5" TOP** **GLAZE ADD** **HP ADD**



Bridge w/Full Laminate Modesty, Left

	D x W x H								
ZA2448RL	24 x 48 x 29.5-30	70	78	4.30	\$886	\$1038	N/A	\$278	
ZA2442RL	24 x 42 x 29.5-30	70	66	3.80	\$770	\$904	N/A	\$244	
ZA2436RL	24 x 36 x 29.5-30	70	59	3.30	\$717	\$833	N/A	\$210	
ZA2048RL	20 x 48 x 29.5-30	70	72	4.30	\$844	\$973	N/A	\$234	
ZA2042RL	20 x 42 x 29.5-30	70	62	3.80	\$736	\$849	N/A	\$202	
ZA2036RL	20 x 36 x 29.5-30	70	56	3.30	\$685	\$783	N/A	\$175	

For use with height adjustable desks - single pedestal and credenzas Z2xxxBBOL or Z2xxxBLFL. Connects to credenza on **left**. Shipped RTA (ready to assemble).



Bridge w/Full Laminate Modesty, Right

ZA2448RR	24 x 48 x 29.5-30	70	78	4.30	\$886	\$1038	N/A	\$278	
ZA2442RR	24 x 42 x 29.5-30	70	66	3.80	\$770	\$904	N/A	\$244	
ZA2436RR	24 x 36 x 29.5-30	70	59	3.30	\$717	\$833	N/A	\$210	
ZA2048RR	20 x 48 x 29.5-30	70	72	4.30	\$844	\$973	N/A	\$234	
ZA2042RR	20 x 42 x 29.5-30	70	62	3.80	\$736	\$849	N/A	\$202	
ZA2036RR	20 x 36 x 29.5-30	70	56	3.30	\$685	\$783	N/A	\$175	

For use with height adjustable desks - single pedestal and credenzas Z2xxxBBOR or Z2xxxBLFR. Connects to credenza on **right**. Shipped RTA (ready to assemble).

CREDENZAS COMPATIBLE W/BRIDGES ZAxxxxRL/RR **MODEL#** **DIMENSIONS** **FREIGHT CLASS** **WT/LBS.** **CUBIC FT.** **1"TOP** **1.5" TOP** **GLAZE ADD** **HP ADD**



Credenza

Z2472BBOL	24 x 72 x 29.5-30	125	261	35.75	\$2629	\$2771	N/A	\$416	
Z2460BBOL	24 x 60 x 29.5-30	125	231	30	\$2361	\$2480	N/A	\$349	
Z2072BBOL	20 x 72 x 29.5-30	125	234	30.25	\$2512	\$2631	N/A	\$349	
Z2060BBOL	20 x 60 x 29.5-30	100	207	25.25	\$2281	\$2381	N/A	\$291	

Compatible with bridges for HA desking; also suitable for freestanding or fixed height bridges and returns. Box/box/lateral file on **left** with open storage on the **right**. Connects to bridge on **right**. Adjustable shelf. Shipped assembled in 1 carton.



Credenza

Z2472BBOR	24 x 72 x 29.5-30	125	261	35.75	\$2629	\$2771	N/A	\$416	
Z2460BBOR	24 x 60 x 29.5-30	125	231	30	\$2361	\$2480	N/A	\$349	
Z2072BBOR	20 x 72 x 29.5-30	125	234	30.25	\$2512	\$2631	N/A	\$349	
Z2060BBOR	20 x 60 x 29.5-30	100	207	25.25	\$2281	\$2381	N/A	\$291	

Compatible with bridges for HA desking; also suitable for freestanding or fixed height bridges and returns. Box/box/lateral file on **right** with open storage on the **left**. Connects to bridge on **left**. Adjustable shelf. Shipped assembled in 1 carton.

Required Specifications

Primary surface type + finish
Top/edge detail
Base finish
Drawer front finish

Optional Specifications

Key #
Handles

CREDENZAS COMPATIBLE W/HT ADJ. BRIDGES



Credenza*

	DIMENSIONS	FREIGHT CLASS	WT/LBS.	CUBIC FT.	1"TOP	1.5" TOP	GLAZE ADD	HP ADD
	D x W x H							
Z2472BLFL	24 x 72 x 29.5-30	125	265	35.75	\$2588	\$2730	N/A	\$416
Z2460BLFL	24 x 60 x 29.5-30	125	235	30	\$2334	\$2453	N/A	\$349
Z2072BLFL	20 x 72 x 29.5-30	125	239	30.25	\$2471	\$2590	N/A	\$349
Z2060BLFL	20 x 60 x 29.5-30	100	212	25.25	\$2250	\$2350	N/A	\$291

Compatible with bridges for HA desking; also suitable for freestanding or fixed height bridges and returns. Two drawer lateral file on **left** with open storage on the **right**. Connects to bridge on **right**. Adjustable shelf. Shipped assembled in 1 carton.



Credenza*

Z2472BLFR	24 x 72 x 29.5-30	125	265	35.75	\$2588	\$2730	N/A	\$416
Z2460BLFR	24 x 60 x 29.5-30	125	235	30	\$2334	\$2453	N/A	\$349
Z2072BLFR	20 x 72 x 29.5-30	125	239	30.25	\$2471	\$2590	N/A	\$349
Z2060BLFR	20 x 60 x 29.5-30	100	212	25.25	\$2250	\$2350	N/A	\$291

Compatible with bridges for HA desking; also suitable for freestanding or fixed height bridges and returns. Two drawer lateral file on **right** with open storage on the **left**. Connects to bridge on **left**. Adjustable shelf. Shipped assembled in 1 carton.

FREESTANDING HA DESKS, SLIM BASES



Freestanding HA Desk, Slim Base

	DIMENSIONS	FREIGHT CLASS	WT/LBS.	CUBIC FT.	1"TOP	1.5" TOP	GLAZE ADD	HP ADD
ZH3684S2S	34 x 82 x 27.7-47.4	85	174	12.72	\$1797	\$2718	n/a	\$648
ZH3678S2S	34 x 76 x 27.7-47.4	85	169	12.46	\$1750	\$2635	n/a	\$604
ZH3672S2S	34 x 70 x 27.7-47.4	85	163	12.72	\$1709	\$2556	n/a	\$556
ZH3666S2S	34 x 64 x 27.7-47.4	85	157	11.71	\$1663	\$2468	n/a	\$513
ZH3660S2S	34 x 58 x 27.7-47.4	85	151	11.47	\$1616	\$2385	n/a	\$465
ZH3084S2S	28 x 82 x 27.7-47.4	85	149	10.72	\$1709	\$2514	n/a	\$545
ZH3078S2S	28 x 76 x 27.7-47.4	85	140	10.48	\$1593	\$2399	n/a	\$507
ZH3072S2S	28 x 70 x 27.7-47.4	85	136	10.21	\$1556	\$2399	n/a	\$465
ZH3066S2S	28 x 64 x 27.7-47.4	85	131	9.97	\$1477	\$2181	n/a	\$427
ZH3060S2S	28 x 58 x 27.7-47.4	85	125	9.73	\$1436	\$2107	n/a	\$390

Height adjustable mechanism sold separately. Top and each slim base shipped in individual cartons; easy to assemble. With 1" thick top, lowest height 27.2"H; with 1.5" thick top 27.7"H + travel range (19.7"). Modesty panel available, specify **ZH12xxMPS**. Depth clearance to HA mechanism for mounting keyboard trays 16".

- Specify **FTZ52LF24CL** for ZH30xxS2S (30"D) and **FTZ52LF30CL** for ZH36xxS2S (36"D).



HA Desk, Telescopic Slim Base

ZH3684S2T	34 x 82 x 27.7-47.4	70	241	14.97	\$2825	\$4098	n/a	\$648
ZH3678S2T	34 x 76 x 27.7-47.4	70	235	14.7	\$2774	\$4010	n/a	\$604
ZH3672S2T	34 x 70 x 27.7-47.4	70	235	14.7	\$2727	\$3922	n/a	\$556
ZH3666S2T	34 x 64 x 27.7-47.4	70	224	13.95	\$2681	\$3834	n/a	\$513
ZH3660S2T	34 x 58 x 27.7-47.4	70	218	13.71	\$2635	\$3746	n/a	\$465
ZH3084S2T	28 x 82 x 27.7-47.4	70	207	12.46	\$2528	\$3653	n/a	\$545
ZH3078S2T	28 x 76 x 27.7-47.4	70	202	12.22	\$2487	\$3575	n/a	\$507
ZH3072S2T	28 x 70 x 27.7-47.4	70	197	11.98	\$2450	\$3496	n/a	\$465
ZH3066S2T	28 x 64 x 27.7-47.4	70	192	11.71	\$2403	\$3422	n/a	\$427
ZH3060S2T	28 x 58 x 27.7-47.4	70	187	11.47	\$2362	\$3343	n/a	\$390

Height adjustable mechanism sold separately. Top and each slim base shipped in individual cartons; easy to assemble. Telescoping slim base keeps column concealed when the table is adjusted up/down. With 1" thick top, lowest height 27.2"H; with 1.5" thick top 27.7"H + travel range (19.7"). Modesty panel available, specify **ZH12xxMPT**. Depth clearance to HA mechanism for mounting keyboard trays 16".

- Specify **FTZ52LF24CL** for ZH30xxS2T (30"D) and **FTZ52LF30CL** for ZH36xxS2T (36"D).

Required Specifications

Primary surface type + finish
 Top/edge detail Base finish
 Lock finish*
 Drawer front finish*

Optional Specifications

Handles
 Key #
 Grommet position or power block cut-out

Accessories

Power block
 Keyboard

MODESTY FOR HA DESKS W/SLIM BASE	MODEL#	DIMENSIONS	FREIGHT CLASS	WT/LBS.	CUBIC FT.	1" TOP	1.5" TOP	GLAZE ADD	HP ADD
		D x W x H							
	ZH1284MPS	0.71 x 69.7 x 12	70	19	0.9	\$283	n/a	\$755	n/a
	ZH1278MPS	0.71 x 63.7 x 12	70	17	0.8	\$264	n/a	\$700	n/a
	ZH1272MPS	0.71 x 57.7 x 12	65	16	0.7	\$250	n/a	\$649	n/a
	ZH1266MPS	0.71 x 51.7 x 12	70	14	0.65	\$232	n/a	\$598	n/a
ZH1260MPS	0.71 x 45.7 x 12	70	13	0.6	\$213	n/a	\$547	n/a	

Modesty Panel for ZHxxxxS2S

For use with ZHxxxxS2S height adjustable desk with slim bases. Inherent small gap between bases and modesty to allow ease of travel. Specify product code that corresponds to nominal desk width. Modesty to be installed 2" set back from guest side edge to not impede with grommet(s). Shipped easy to assemble in 1 carton.



Modesty Panel for ZHxxxxS2T

ZH1284MPT	0.71 x 67.5 x 12	65	18	0.8	\$278	n/a	\$741	n/a
ZH1278MPT	0.71 x 61.5 x 12	65	17	0.75	\$264	n/a	\$690	n/a
ZH1272MPT	0.71 x 55.5 x 12	70	15	0.7	\$246	n/a	\$635	n/a
ZH1266MPT	0.71 x 49.5 x 12	65	14	0.6	\$232	n/a	\$584	n/a
ZH1260MPT	0.71 x 43.5 x 12	70	12	0.55	\$213	n/a	\$533	n/a

For use with ZHxxxxS2T height adjustable desk with telescopic slim bases. Inherent small gap between bases and modesty to allow ease of travel. Specify product code that corresponds to nominal desk width. Modesty to be installed 2" set back from guest side edge to not impede with grommet(s). Shipped easy to assemble in 1 carton.

HA BASE FOR ZH DESKS W/SLIM BASE	MODEL #	DIMENSIONS	FREIGHT CLASS	WT/LBS.	CUBIC FT.	LIST PRICE
	FTZ52LF24CL	24 x 58-82 x 26.7-46.4	60	67	1.47	\$1160
	FTZ52LF30CL	30 x 58-82 x 26.7-46.4	60	67	1.47	\$1169

Electric Height Adjustable Base*

- Specify FTZ52LF24CL for ZH30xxS2S/S2T and FTZ52LF30CL for ZH36xxS2S/S2T.

For use with ZHxxxxS2S and ZHxxxxS2T height adjustable desks with slim bases. Lifts 350 lbs. Available in Black or Tungsten. Shipped RTA (ready to assemble).

- **Recommended torque range for installing all fasteners is 3-5 foot pounds and should not be exceeded. In addition, no impact drivers or high-torque equipment are to be used for any fasteners included in the table assembly kits, as this creates a high risk for damage that is not covered under warranty. The use of hand tools is highly recommended.**

HA DESK FOR INTEGRATION W/CREDENZA, SLIM BASE - NOT FREESTANDING	DIMENSIONS	FREIGHT CLASS	WT/LBS.	CUBIC FT.	1" TOP	1.5" TOP	GLAZE ADD	HP ADD	
	ZH3684SSBL	34 x 84 x 27.7-47.4	70	137	8.74	\$1723	\$2625	n/a	\$648
	ZH3678SSBL	34 x 76 x 27.7-47.4	70	131	8.5	\$1681	\$2542	n/a	\$604
	ZH3672SSBL	34 x 70 x 27.7-47.4	70	125	8.24	\$1639	\$2459	n/a	\$556
	ZH3084SSBL	28 x 84 x 27.7-47.4	70	117	7.24	\$1570	\$2366	n/a	\$545
	ZH3078SSBL	28 x 76 x 27.7-47.4	70	112	7.24	\$1533	\$2297	n/a	\$507
	ZH3072SSBL	28 x 70 x 27.7-47.4	70	112	7.24	\$1491	\$2227	n/a	\$465

Height Adjustable Desk, Slim Base, Left
shown with cable management channel

Not freestanding. For use with ZHxxxxHBFR credenza (or other right hand storage for HA leg integration). Top and slim base shipped in individual cartons, easy to assemble. **Height adjustable mechanism sold separately**, order **FTZ52LFxxC1**. With 1" thick top, lowest height 27.2"H; with 1.5" thick top 27.7"H + travel range (19.7"). Includes wire manager column. Modesty panel available: when used with 24"D credenza specify **ZH12xxMMPC** modesty; when used with 20"D credenza specify **ZH12xxMMPC** modesty.

- Specify **FTZ52LF24C1** for ZH30xxSSBL (30"D) and **FTZ52LF30C1** for ZH36xxSSBL (36"D).
- Depth clearance to HA mechanism for mounting keyboard trays is 13-3/8" on 30"D models and 19-3/8" on 36"D models.

Required Specifications

Top surface material (TFL or HPL)
Top finish
Top/edge detail
Base finish

Grommet/wire management finish

Optional Specifications

Grommet position or power block cut-out

HA DESK FOR INTEGRATION W/CREDENZA, SLIM BASE - NOT FREESTANDING **DIMENSIONS** **FREIGHT CLASS** **WT/LBS.** **CUBIC FT.** **1" TOP** **1.5" TOP** **GLAZE ADD** **HP ADD**

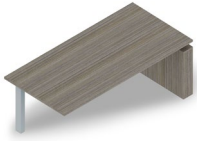

HA Desk w/Slim Base, Right
shown with cable management channel

	D x W x H								
ZH3684SSBR	34 x 84 x 27.7-47.4	70	137	8.74	\$1723	\$2625	n/a	\$648	
ZH3678SSBR	34 x 76 x 27.7-47.4	70	131	8.5	\$1681	\$2542	n/a	\$604	
ZH3672SSBR	34 x 70 x 27.7-47.4	70	125	8.24	\$1639	\$2459	n/a	\$556	
ZH3084SSBR	28 x 84 x 27.7-47.4	70	117	7.24	\$1570	\$2366	n/a	\$545	
ZH3078SSBR	28 x 76 x 27.7-47.4	70	112	7.24	\$1533	\$2297	n/a	\$507	
ZH3072SSBR	28 x 70 x 27.7-47.4	70	112	7.24	\$1491	\$2227	n/a	\$465	

Not freestanding. For use with ZHxxxxHBFL credenza (or other left hand storage for HA leg integration). Top and slim base shipped in individual cartons, easy to assemble. **Height adjustable mechanism sold separately**, order **FTZ52LFxxC1**. With 1" thick top, lowest height 27.2"H; with 1.5" thick top 27.7"H + travel range (19.7"). Includes wire manager column. Modesty panel available: when used with 24"D credenza specify **ZH12xxLMPC** modesty; when used with 20"D credenza specify **ZH12xxMMPC** modesty.

- Specify **FTZ52LF24C1** for ZH30xxSSBR (30"D) and **FTZ52LF30C1** for ZH36xxSSBR (36"D).
- Depth clearance to HA mechanism for mounting keyboard trays is 13-3/8" on 30"D models and 19-3/8" on 36"D models.



HA Desk w/Telescopic Slim Base, Left
shown with cable management channel

ZH3684STBL	34 x 84 x 27.7-47.4	70	166	10	\$2125	\$3153	n/a	\$648
ZH3678STBL	34 x 76 x 27.7-47.4	70	160	9.94	\$2079	\$3070	n/a	\$604
ZH3672STBL	34 x 70 x 27.7-47.4	70	155	9.24	\$2038	\$2987	n/a	\$556
ZH3084STBL	28 x 84 x 27.7-47.4	70	142	8.24	\$1936	\$2848	n/a	\$545
ZH3078STBL	28 x 76 x 27.7-47.4	70	137	8.36	\$1899	\$2774	n/a	\$507
ZH3072STBL	28 x 70 x 27.7-47.4	70	132	7.74	\$1857	\$2704	n/a	\$465

Not freestanding. For use with ZHxxxxHBFR credenza (or other right hand storage for HA leg integration). Top and slim base shipped in individual cartons, easy to assemble. Telescoping slim base keeps column concealed when the table is adjusted up/down. **Height adjustable mechanism sold separately**, order **FTZ52LFxxC1, 2 stage only**. With 1" thick top, lowest height 27.2"H; with 1.5" thick top 27.7"H + travel range (19.7"). Includes wire manager column. Modesty panel available: when used with 24"D credenza, specify **ZH12xxLMPC** modesty; when used with 20"D credenza, specify **ZH12xxMMPC** modesty.

- Specify **FTZ52LF24C1** for ZH30xxSTBL (30"D) and **FTZ52LF30C1** for ZH36xxSTBL (36"D).
- Depth clearance to HA mechanism for mounting keyboard trays is 13-3/8" on 30"D models and 19-3/8" on 36"D models.

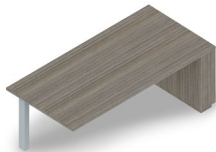

HA Desk w/ Telescopic Slim Base, Right
shown with cable management channel

ZH3684STBR	34 x 84 x 27.7-47.4	70	166	10	\$2125	\$3153	n/a	\$648
ZH3678STBR	34 x 76 x 27.7-47.4	70	160	9.94	\$2079	\$3070	n/a	\$604
ZH3672STBR	34 x 70 x 27.7-47.4	70	155	9.24	\$2038	\$2987	n/a	\$556
ZH3084STBR	28 x 84 x 27.7-47.4	70	142	8.24	\$1936	\$2848	n/a	\$545
ZH3078STBR	28 x 76 x 27.7-47.4	70	137	8.36	\$1899	\$2774	n/a	\$507
ZH3072STBR	28 x 70 x 27.7-47.4	70	132	7.74	\$1857	\$2704	n/a	\$465

Not freestanding. For use with ZHxxxxHBFL credenza (or other left hand storage for HA leg integration). Top and slim base shipped in individual cartons, easy to assemble. Telescoping slim base keeps column concealed when the table is adjusted up/down. **Height adjustable mechanism sold separately**, order **FTZ52LFxxC1, 2 stage only**. With 1" thick top, lowest height 27.2"H; with 1.5" thick top 27.7"H + travel range (19.7"). Includes wire manager column. Modesty panel available: when used with 24"D credenza, specify **ZH12xxLMPC** modesty; when used with 20"D credenza, specify **ZH12xxMMPC** modesty.

- Specify **FTZ52LF24C1** for ZH30xxSTBR (30"D) and **FTZ52LF30C1** for ZH36xxSTBR (36"D).
- Depth clearance to HA mechanism for mounting keyboard trays is 13-3/8" on 30"D models and 19-3/8" on 36"D models.

Required Specifications

Top surface material (TFL or HPL)
Top finish
Top/edge detail
Base finish

Grommet/wire management finish

Optional Specifications

Grommet position or power block cut-out

CREDENZAS FOR HA DESK INTEGRATION



Credenza for Ht. Adj. Leg - Left*
shown with cable management channel



Credenza for Ht. Adj. Leg - Right*
shown with cable management channel

MODEL#	DIMENSIONS D x W x H	FREIGHT CLASS	WT./LBS.	CUBIC FT.	1" TOP	1.5" TOP	GLAZE ADD	HP ADD
ZH2472HBFL	24 x 72 x 23.7	100	248	29.25	\$2028	n/a	n/a	\$390
ZH2460HBFL	24 x 60 x 23.7	100	218	24.5	\$1825	n/a	n/a	\$327
ZH2072HBFL	20 x 72 x 23.7	100	212	24.75	\$1903	n/a	n/a	\$327
ZH2060HBFL	20 x 60 x 23.7	100	184	20.75	\$1709	n/a	n/a	\$273

Box/lateral file on **left** with open storage on the **right**. Open side includes inset back to accommodate HA leg component.
For use with ZHxxxxSTBR or ZHxxxxSSBR. Height adjustable mechanism sold separately. Credenza shipped assembled in 1 carton.

ZH2472HBFR	24 x 72 x 23.7	100	248	29.25	\$2028	n/a	n/a	\$390
ZH2460HBFR	24 x 60 x 23.7	100	218	24.5	\$1825	n/a	n/a	\$327
ZH2072HBFR	20 x 72 x 23.7	100	212	24.75	\$1903	n/a	n/a	\$327
ZH2060HBFR	20 x 60 x 23.7	100	184	20.75	\$1709	n/a	n/a	\$273

Box/lateral file on **right** with open storage on the **left**. Open side includes inset back to accommodate HA leg component.
For use with ZHxxxxSTBL or ZHxxxxSSBL. Height adjustable mechanism sold separately. Credenza shipped assembled in 1 carton.

TOP AND BACK KITS FOR HA INTEGRATION



Top and Back Kit for HA Leg, Left



Top and Back Kit for HA Leg, Right

MODEL#	DIMENSIONS	FREIGHT CLASS	WT./LBS.	CUBIC FT.	1" TOP	1.5" TOP	GLAZE ADD	HP ADD
ZH2496HTBL	24.1 x 96 x 23.25	70	114	7	\$783	n/a	n/a	\$495
ZH2490HTBL	24.1 x 90 x 23.25	70	107	6.5	\$737	n/a	n/a	\$465
ZH2484HTBL	24.1 x 84 x 23.25	70	100	6.25	\$690	n/a	n/a	\$434
ZH2472HTBL	24.1 x 72 x 23.25	85	86	5.75	\$602	n/a	n/a	\$372
ZH2466HTBL	24.1 x 66 x 23.25	70	79	5.25	\$556	n/a	n/a	\$341
ZH2460HTBL	24.1 x 60 x 23.25	85	72	5	\$514	n/a	n/a	\$310
ZH2096HTBL	20 x 96 x 23.25	70	103	6	\$727	n/a	n/a	\$415
ZH2090HTBL	20 x 90 x 23.25	70	97	5.75	\$690	n/a	n/a	\$390
ZH2084HTBL	20 x 84 x 23.25	70	90	5.25	\$649	n/a	n/a	\$367
ZH2072HTBL	20 x 72 x 23.25	70	78	5	\$561	n/a	n/a	\$310
ZH2066HTBL	20 x 66 x 23.25	85	71	4.75	\$519	n/a	n/a	\$285
ZH2060HTBL	20 x 60 x 23.25	70	65	4.25	\$477	n/a	n/a	\$261

Tops include cut-outs for HA legs. For use with **ZHxxxxHSHNSL** + 23.3"H storage shells + **ZHxxxxSTBR** or **ZHxxxxSSBR**.
Height adjustable mechanism sold separately. Shipped RTA (ready to assemble).
• **Does not include hardware to attach to storage shells.**

ZH2496HTBR	24.1 x 96 x 23.25	70	114	7	\$783	n/a	n/a	\$495
ZH2490HTBR	24.1 x 90 x 23.25	70	107	6.5	\$737	n/a	n/a	\$465
ZH2484HTBR	24.1 x 84 x 23.25	70	100	6.25	\$690	n/a	n/a	\$434
ZH2472HTBR	24.1 x 72 x 23.25	85	86	5.75	\$602	n/a	n/a	\$372
ZH2466HTBR	24.1 x 66 x 23.25	70	79	5.25	\$556	n/a	n/a	\$341
ZH2460HTBR	24.1 x 60 x 23.25	85	72	5	\$514	n/a	n/a	\$310
ZH2096HTBR	20 x 96 x 23.25	70	103	6	\$727	n/a	n/a	\$415
ZH2090HTBR	20 x 90 x 23.25	70	97	5.75	\$690	n/a	n/a	\$390
ZH2084HTBR	20 x 84 x 23.25	70	90	5.25	\$649	n/a	n/a	\$367
ZH2072HTBR	20 x 72 x 23.25	70	78	5	\$561	n/a	n/a	\$310
ZH2066HTBR	20 x 66 x 23.25	85	71	4.75	\$519	n/a	n/a	\$285
ZH2060HTBR	20 x 60 x 23.25	70	65	4.25	\$477	n/a	n/a	\$261

Tops include cut-outs for HA legs. For use with **ZHxxxxHSHNSR** + 23.3"H storage shells + **ZHxxxxSTBL** or **ZHxxxxSSBL**.
Height adjustable mechanism sold separately. Shipped RTA (ready to assemble).
• **Does not include hardware to attach to storage shells.**

Required Specifications

Top surface material (TFL or HPL)
Top finish
Top/edge detail
Base finish

Grommet/wire management finish
Drawer front finish*

Optional Specifications

Grommet position or power block cut-out
Handles*

LOW STORAGE FOR HA DESK INTEGRATION



False Back Storage, Left



False Back Storage, Right



Open Storage, Left



Open Storage, Right

	DIMENSIONS	FREIGHT CLASS	WT/LBS.	CUBIC FT.	1" TOP	1.5" TOP	GLAZE ADD	HP ADD
	D x W x H							
ZH36L2HSHNSL	23.3 x 36 x 22.7	125	90	14.5	\$871	n/a	n/a	n/a
ZH30L2HSHNSL	23.3 x 30 x 22.7	125	81	12.25	\$811	n/a	n/a	n/a
ZH36M2HSHNSL	19.2 x 36 x 22.7	125	80	12.25	\$797	n/a	n/a	n/a
ZH30M2HSHNSL	19.2 x 30 x 22.7	125	69	10.25	\$709	n/a	n/a	n/a

For HA integration. For use with **ZHxxxxHTBL** + 23.3"H storage + **ZHxxxxSTBR** or **ZHxxxxSSBR** models. Height adjustable mechanism sold separately. Shipped assembled in 1 carton.

- For 23.3"D models, order 24.1"D top and back kit (**ZH24xxHTBL**)
- For 19.2"D models, order 20"D top and back kit (**ZH20xxHTBL**)

ZH36L2HSHNSR	23.3 x 36 x 22.7	125	90	14.5	\$871	n/a	n/a	n/a
ZH30L2HSHNSR	23.3 x 30 x 22.7	125	81	12.25	\$811	n/a	n/a	n/a
ZH36M2HSHNSR	19.2 x 36 x 22.7	125	80	12.25	\$797	n/a	n/a	n/a
ZH30M2HSHNSR	19.2 x 30 x 22.7	125	69	10.25	\$709	n/a	n/a	n/a

For HA integration. For use with **ZHxxxxHTBR** + 23.3"H storage + **ZHxxxxSTBL** or **ZHxxxxSSBL** models. Height adjustable mechanism sold separately. Shipped assembled in 1 carton.

- For 23.3"D models, order 24.1"D top and back kit (**ZH24xxHTBR**)
- For 19.2"D models, order 20"D top and back kit (**ZH20xxHTBR**)

ZH36L2HSHNL	24 x 36 x 23.7	125	112	15	\$1176	n/a	n/a	n/a
ZH30L2HSHNL	24 x 30 x 23.7	125	100	12.75	\$1065	n/a	n/a	n/a
ZH36M2HSHNL	20 x 36 x 23.7	125	98	12.75	\$1042	n/a	n/a	n/a
ZH30M2HSHNL	20 x 30 x 23.7	125	85	10.75	\$931	n/a	n/a	n/a

For use with **ZHxxxxSTBR** or **ZHxxxxSSBR** models. Inset back for HA mechanism integration. Height adjustable mechanism sold separately. Shipped assembled in 1 carton.

ZH36L2HSHNR	24 x 36 x 23.7	125	112	15	\$1176	n/a	n/a	n/a
ZH30L2HSHNR	24 x 30 x 23.7	125	100	12.75	\$1065	n/a	n/a	n/a
ZH36M2HSHNR	20 x 36 x 23.7	125	98	12.75	\$1042	n/a	n/a	n/a
ZH30M2HSHNR	20 x 30 x 23.7	125	85	10.75	\$931	n/a	n/a	n/a

For use with **ZHxxxxSTBL** or **ZHxxxxSSBL** models. Inset back for HA mechanism integration. Height adjustable mechanism sold separately. Shipped assembled in 1 carton.

Required Specifications

- Primary surface type + finish
- Top thickness/edge detail
- Base finish

MODESTY FOR NON-FREESTANDING HA DESK W/LOW CREDENZA DIMENSIONS FREIGHT CLASS WT/LBS. CUBIC FT. 1" TOP 1.5" TOP GLAZE ADD HP ADD



Modesty Panel for 24" D Credenzas

	D x W x H								
ZH1284LMPC	0.71 x 50.6 x 12	70	14	0.65	\$232	n/a	\$588	n/a	
ZH1278LMPC	0.71 x 44.6 x 12	65	13	0.55	\$213	n/a	\$538	n/a	
ZH1272LMPC	0.71 x 38.6 x 12	70	11	0.5	\$195	n/a	\$487	n/a	

Modesty panel only, to fit within (1) slim base or (1) telescoping base and credenza (ZHxxxxSTB/SSB(L/R)). Gap as needed between bases and credenza. Shipped ready to assemble in 1 carton.



Modesty Panel for 20" D Credenzas

ZH1284MMPC	0.71 x 54.7 x 12	70	15	0.7	\$246	n/a	\$630	n/a	
ZH1278MMPC	0.71 x 48.7 x 12	65	14	0.6	\$227	n/a	\$579	n/a	
ZH1272MMPC	0.71 x 42.7 x 12	70	12	0.55	\$209	n/a	\$524	n/a	

Modesty panel only, to fit within (1) slim base or (1) telescoping base and credenza (ZHxxxxSTB/SSB(L/R)). Gap as needed between bases and credenza. Shipped ready to assemble in 1 carton.

HA BASES FOR NON-FREESTANDING ZH DESKING/INTEGRATED W/CREDENZA DIMENSIONS FREIGHT CLASS WT/LBS. CUBIC FT. LIST PRICE



Electric Height Adjustable Base

FTZ52LF24C1	24 x 70-82 x 26.7-46.4	60	67	1.47	\$1102
FTZ52LF30C1	30 x 70-82 x 26.7-46.4	60	67	1.47	\$1106

- Specify FTZ52LF24C1 for use with ZH30xxSTBL/BR, ZH30xxSSBL/BR
- Specify FTZ52LF30C1 for use with ZH36xxSTBL/BR, ZH36xxSSBL/BR.

For use with ZHxxxxSTBL/BR and ZHxxxxSSBL/BR height adjustable desks with (1) slim base. Lifts 350 lbs. Available in Black or Tungsten. Shipped RTA (ready to assemble).

- **Recommended torque range for installing all fasteners is 3-5 foot pounds and should not be exceeded. In addition, no impact drivers or high-torque equipment are to be used for any fasteners included in the table assembly kits, as this creates a high risk for damage that is not covered under warranty. The use of hand tools is highly recommended.**

Required Specifications

Primary surface type + finish
Edge detail
Base finish
Trim finish

Optional Specifications

HP laminate Handles
Key # Modesty finish glazed
Modesty Type
Grommet position or power block cut-out

Accessories

Power block
Keyboard
Pencil drawer

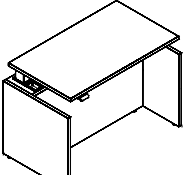
HEIGHT ADJUSTABLE WORKWALL CREDENZAS	MODEL#	DIMENSIONS	FREIGHT CLASS	WT/LBS.	CUBIC FT.	1" TOP	1.5" TOP	GLAZE ADD	HP ADD
		D x W x H (1.5" TOP)							
	ZH2484CBLN	24 x 84 x 30-49.7	70	185	11.98	\$2967	\$3228	n/a	\$600
	ZH2478CBLN	24 x 78 x 30-49.7	70	174	11.23	\$2845	\$3089	n/a	\$556
	ZH2472CBLN	24 x 72 x 30-49.7	70	164	10.48	\$2728	\$2950	n/a	\$517
	ZH2466CBLN	24 x 66 x 30-49.7	70	154	9.46	\$2612	\$2812	n/a	\$473
	ZH2460CBLN	24 x 60 x 30-49.7	70	143	8.71	\$2489	\$2678	n/a	\$428
	ZH2454CBLN	24 x 54 x 30-49.7	70	131	7.96	\$2345	\$2517	n/a	\$389
	ZH2448CBLN	24 x 48 x 30-49.7	70	121	7.22	\$2223	\$2373	n/a	\$345
ZH2442CBLN	24 x 42 x 30-49.7	70	111	6.47	\$2100	\$2234	n/a	\$300	

Height Adjustable Cantilevered Workwall Credenza - LEFT

Height adjustable mechanism sold separately; order model FTZ52CSFNL for 42"-54"W credenzas or FTZ52CLFNL for 60"-84"W credenzas. Power management on left side. Shipped easy to assemble in 3 cartons.

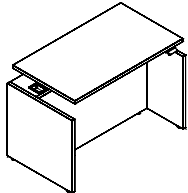

Height Adjustable Cantilevered Workwall Credenza - RIGHT

ZH2484CBRN	24 x 84 x 30-49.7	70	185	11.98	\$2967	\$3228	n/a	\$600
ZH2478CBRN	24 x 78 x 30-49.7	70	174	11.23	\$2845	\$3089	n/a	\$556
ZH2472CBRN	24 x 72 x 30-49.7	70	164	10.48	\$2728	\$2950	n/a	\$517
ZH2466CBRN	24 x 66 x 30-49.7	70	154	9.46	\$2612	\$2812	n/a	\$473
ZH2460CBRN	24 x 60 x 30-49.7	70	143	8.71	\$2489	\$2678	n/a	\$428
ZH2454CBRN	24 x 54 x 30-49.7	70	131	7.96	\$2345	\$2517	n/a	\$389
ZH2448CBRN	24 x 48 x 30-49.7	70	121	7.22	\$2223	\$2373	n/a	\$345
ZH2442CBRN	24 x 42 x 30-49.7	70	111	6.47	\$2100	\$2234	n/a	\$300

Height adjustable mechanism sold separately; order model FTZ52CSFNL for 42"-54"W credenzas or FTZ52CLFNL for 60"-84"W credenzas. Power management on right side. Shipped easy to assemble in 3 cartons.

HEIGHT ADJUSTABLE WORKWALL CREDENZAS FOR OVERLAPPING RETURNS	DIMENSIONS	FREIGHT CLASS	WT/LBS.	CUBIC FT.	1" TOP	1.5" TOP	GLAZE ADD	HP ADD
--	------------	---------------	---------	-----------	--------	----------	-----------	--------

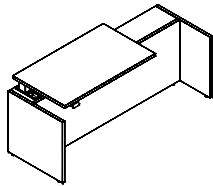

Height Adjustable Workwall Credenza for Overlapping Return - LEFT

ZH242496CROL	24 x 96 x 30-49.7	70	201	10.21	\$3173	\$3395	n/a	\$689
ZH242484CROL	24 x 84 x 30-49.7	70	179	8.98	\$2928	\$3117	n/a	\$600
ZH242478CROL	24 x 78 x 30-49.7	70	167	8.23	\$2812	\$2978	n/a	\$556
ZH242472CROL	24 x 72 x 30-49.7	70	157	7.72	\$2689	\$2839	n/a	\$517
ZH242466CROL	24 x 66 x 30-49.7	70	146	6.98	\$2567	\$2700	n/a	\$473

For use with 24"D overlapping returns Z24xxS0 for workwall credenzas. Height adjustable mechanism sold separately; order model FTZ52CSFNL for 66"-78"W credenzas or FTZ52CLFNL for 84"-96"W credenzas. Power management on left side. Height adjustable surface area width is less than 24". Shipped easy to assemble in 3 cartons.

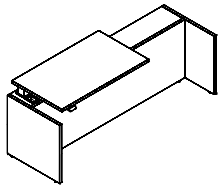

Height Adjustable Workwall Credenza for Overlapping Return - LEFT

ZH243096CROL	24 x 96 x 30-49.7	70	197	9.97	\$3134	\$3339	n/a	\$689
ZH243084CROL	24 x 84 x 30-49.7	70	174	8.71	\$2889	\$3056	n/a	\$600
ZH243078CROL	24 x 78 x 30-49.7	70	167	8.23	\$2762	\$2912	n/a	\$556
ZH243072CROL	24 x 72 x 30-49.7	70	153	7.49	\$2639	\$2773	n/a	\$517

For use with 30"D overlapping returns Z30xxS0 for workwall credenzas. Height adjustable mechanism sold separately; order model FTZ52CSFNL for 76"-84"W credenzas or FTZ52CLFNL for 96"W credenza. Power management on left side. Height adjustable surface area width is less than 30". Shipped easy to assemble in 3 cartons.

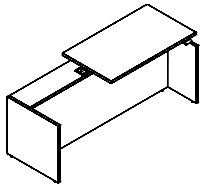

Height Adjustable Workwall Credenza for Overlapping Return - RIGHT

ZH242496CROR	24 x 96 x 30-49.7	70	201	10.21	\$3173	\$3395	n/a	\$689
ZH242484CROR	24 x 84 x 30-49.7	70	179	8.98	\$2928	\$3117	n/a	\$600
ZH242478CROR	24 x 78 x 30-49.7	70	167	8.23	\$2812	\$2978	n/a	\$556
ZH242472CROR	24 x 72 x 30-49.7	70	157	7.72	\$2689	\$2839	n/a	\$517
ZH242466CROR	24 x 66 x 30-49.7	70	146	6.98	\$2567	\$2700	n/a	\$473

For use with 24"D overlapping returns Z24xxS0 for workwall credenzas. Height adjustable mechanism sold separately; order model FTZ52CSFNL for 66"-78"W credenzas or FTZ52CLFNL for 84"-96"W credenzas. Power management on right side. Height adjustable surface area width is less than 24". Shipped easy to assemble in 3 cartons.

Required Specifications

Primary surface type + finish
Top thickness/edge detail
Base finish
Trim finish

Optional Specifications

Grommet position or power block cut-out

Accessories

Power block

HA WORKWALL CREDENZAS FOR OVERLAPPING RETURNS MODEL# DIMENSIONS FREIGHT CLASS WT/LBS. CUBIC FT. 1" TOP 1.5" TOP GLAZE ADD HP ADD

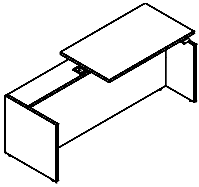

Height Adjustable Workwall Credenza for Overlapping Return - RIGHT*

MODEL#	DIMENSIONS D x W x H	FREIGHT CLASS	WT/LBS.	CUBIC FT.	1" TOP	1.5" TOP	GLAZE ADD	HP ADD
ZH243096CROR	24 x 96 x 30-49.7	70	197	9.97	\$3134	\$3339	n/a	\$689
ZH243084CROR	24 x 84 x 30-49.7	70	174	8.71	\$2889	\$3056	n/a	\$600
ZH243078CROR	24 x 78 x 30-49.7	70	167	8.23	\$2762	\$2912	n/a	\$556
ZH243072CROR	24 x 72 x 30-49.7	70	153	7.49	\$2639	\$2773	n/a	\$517

For use with 30"D overlapping returns Z30xxS0 for workwall credenzas. Height adjustable mechanism sold separately; order model FTZ52CSFNL for 66"-78"W credenzas or FTZ52CLFNL for 84"-96"W credenzas. Power management on right side. Height adjustable surface area width is less than 24". Shipped easy to assemble in 3 cartons.

OVERLAPPING RETURNS FOR WORKWALL CREDENZAS DIMENSIONS FREIGHT CLASS WT/LBS. CUBIC FT. 1" TOP 1.5" TOP GLAZE ADD HP ADD

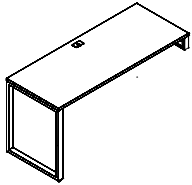

Overlapping Return for Workwall Credenza, 24"D**

Z2484S0	24 x 84 x 29.5-30	250	103	27.69	\$2139	\$2400	n/a	\$778
Z2478S0	24 x 78 x 29.5-30	92.5	99	8.98	\$2028	\$2262	n/a	\$723
Z2472S0	24 x 72 x 29.5-30	92.5	93	8.98	\$1889	\$2095	n/a	\$667
Z2466S0	24 x 66 x 29.5-30	92.5	88	8.47	\$1834	\$2012	n/a	\$612
Z2460S0	24 x 60 x 29.5-30	100	82	8.23	\$1778	\$1928	n/a	\$556

Fixed height. Assembled for left or right hand use with workwall credenzas ZH2424xxCROL and ZH2424xxCROR. Includes metal spacer and O-leg. Shipped easy to assemble in 3 cartons.

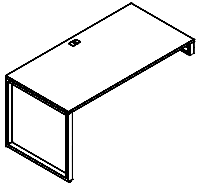

Overlapping Return for Workwall Credenza, 30"D**

Z3084S0	30 x 84 x 29.5-30	92.5	122	11.71	\$2250	\$2550	n/a	\$778
Z3078S0	30 x 78 x 29.5-30	92.5	115	11.23	\$2112	\$2384	n/a	\$723
Z3072S0	30 x 72 x 29.5-30	92.5	109	10.72	\$1973	\$2217	n/a	\$667
Z3066S0	30 x 66 x 29.5-30	92.5	103	10.21	\$1917	\$2134	n/a	\$612
Z3060S0	30 x 60 x 29.5-30	100	97	9.73	\$1862	\$2050	n/a	\$556

Fixed height. Assembled for left or right hand use with workwall credenzas ZH2430xxCROL and ZH2430xxCROR. Includes metal spacer and O-leg. Shipped easy to assemble in 3 cartons.

HA BASES FOR ZH DESKS INTEGRATED WITH CREDENZA DIMENSIONS FREIGHT CLASS WT/LBS. CUBIC FT. LIST PRICE

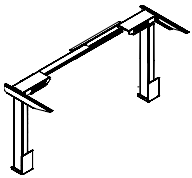

Electric Height Adjustable Base for Workwall Credenza

FTZ52CSFNL	24 x 42-54 x 28.5-48.2	70	43	2.2	\$1212
------------	------------------------	----	----	-----	--------

Only for use with 42"-54"W cantilevered workwall credenzas ZH24xxCBLN and ZH24xxCBRN, or 66"-78"W workwall credenzas ZH2424xxCROL and ZH2424xxCROR, or 72"-84"W workwall credenzas ZH2430xxCROL and ZH2430xxCROR. Shipped easy to assemble in 1 carton.

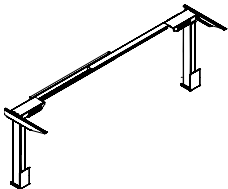

Electric Height Adjustable Base for Workwall Credenza

FTZ52CLFNL	24 x 60-84 x 28.5-48.2	70	45	2.2	\$1212
------------	------------------------	----	----	-----	--------

Only for use with 60"-84"W cantilevered workwall credenzas ZH24xxCBLN and ZH24xxCBRN, or 84"-96"W workwall credenzas ZH2424xxCROL, ZH2424xxCROR, ZH243096CROL and ZH243096CROR. Shipped easy to assemble in 1 carton.

Required Specifications

Primary surface type + finish
Edge detail
Base finish
Trim finish

Optional Specifications

HP laminate Handles
Key # Modesty finish glazed
Modesty Type
Grommet position or power block cut-out

Accessories

Power block
Keyboard
Pencil drawer

DOUBLE PEDESTAL DESKS



Double Pedestal Bow Top Desk

MODEL#	DIMENSIONS	FREIGHT CLASS	WT/LBS.	CUBIC FT.	1" TOP	1.5" TOP	GLAZE ADD	HP ADD	
D x W x H									
Z4284FB22	42 x 84 x 29.5-30	250	381.15	102.5	\$3028	\$3369	\$976	\$1081	
Z4272FB22	42 x 72 x 29.5-30	125	377	59	\$2912	\$3211	\$810	\$812	
Z3672FB22	36 x 72 x 29.5-30	125	317.1	50.75	\$2719	\$2984	\$810	\$611	
Z3666FB22	36 x 66 x 29.5-30	125	305.55	46.75	\$2665	\$2909	\$723	\$611	
Z3660FB22	36 x 60 x 29.5-30	125	295.05	42.5	\$2585	\$2809	\$639	\$509	

Standard with **freestanding** file/file pedestals on **left** and **right**. Pedestals lock. Bow top overhangs 2 ¼" at ends and 8" on center.

- 84" wide desks are shipped RTA (ready to assemble) in 3 cartons.



Double Pedestal Bow Top Desk

Z4284FB32	42 x 84 x 29.5-30	250	379.05	102.5	\$3069	\$3410	\$976	\$1081
Z4272FB32	42 x 72 x 29.5-30	125	375	59	\$2951	\$3250	\$810	\$812
Z3672FB32	36 x 72 x 29.5-30	125	315	50.75	\$2755	\$3022	\$810	\$611
Z3666FB32	36 x 66 x 29.5-30	125	303.45	46.75	\$2700	\$2942	\$723	\$611
Z3660FB32	36 x 60 x 29.5-30	125	292.95	42.5	\$2626	\$2850	\$639	\$509

Standard with **Freestanding** file/file pedestal on **right** and box/box/file pedestal on **left**. File drawer and lower box drawer lock. File pedestal locks. Bow top overhangs 2 ¼" at ends and 8" on center.

- 84" wide desks are shipped RTA (ready to assemble) in 3 cartons.



Double Pedestal Bow Top Desk

Z4284FB23	42 x 84 x 29.5-30	250	379.05	102.5	\$3069	\$3410	\$976	\$1081
Z4272FB23	42 x 72 x 29.5-30	125	375	59	\$2951	\$3250	\$810	\$812
Z3672FB23	36 x 72 x 29.5-30	125	315	50.75	\$2755	\$3022	\$810	\$611
Z3666FB23	36 x 66 x 29.5-30	125	303.45	46.75	\$2700	\$2942	\$723	\$611
Z3660FB23	36 x 60 x 29.5-30	125	292.95	42.5	\$2626	\$2850	\$639	\$509

Standard with **Freestanding** file/file pedestal on **left** and box/box/file pedestal on **right**. File drawer and lower box drawer lock. File pedestal locks. Bow top overhangs 2 ¼" at ends and 8" on center.

- 84" wide desks are shipped RTA (ready to assemble) in 3 cartons.



Double Pedestal Bow Top Desk

Z4284FB33	42 x 84 x 29.5-30	250	381.15	102.5	\$3106	\$3447	\$976	\$1081
Z4272FB33	42 x 72 x 29.5-30	125	378	59	\$2988	\$3288	\$810	\$812
Z3672FB33	36 x 72 x 29.5-30	125	317.1	50.75	\$2795	\$3062	\$810	\$611
Z3666FB33	36 x 66 x 29.5-30	125	305.55	46.75	\$2741	\$2983	\$723	\$611
Z3660FB33	36 x 60 x 29.5-30	125	295.05	42.5	\$2670	\$2909	\$639	\$509

Standard with **Freestanding** box/box/file pedestals on **left** and **right**. File drawer and lower box drawer lock. Bow top overhangs 2 ¼" at ends and 8" on center.

- 84" wide desks are shipped RTA (ready to assemble) in 3 cartons.



Double Pedestal Desk

Z4284F22	42 x 84 x 29.5-30	250	385.35	102.5	\$2923	\$3214	\$976	\$1081
Z4272F22	42 x 72 x 29.5-30	125	373	59	\$2815	\$3066	\$810	\$812
Z3684F22	36 x 84 x 29.5-30	250	366.12	176.6	\$2751	\$3003	\$976	\$812
Z3672F22	36 x 72 x 29.5-30	125	326.01	50.75	\$2626	\$2846	\$810	\$611
Z3666F22	36 x 66 x 29.5-30	125	314.77	46.75	\$2577	\$2778	\$723	\$611
Z3660F22	36 x 60 x 29.5-30	125	294.93	42.5	\$2529	\$2713	\$639	\$509
Z3072F22	29.7 x 72 x 29.5-30	125	326.01	50.75	\$2626	\$2845	\$810	\$611
Z3066F22	29.7 x 66 x 29.5-30	125	314.77	46.75	\$2577	\$2777	\$723	\$611
Z3060F22	29.7 x 60 x 29.5-30	125	294.93	42.5	\$2529	\$2711	\$639	\$509

Standard with **Freestanding** file/file pedestals on **left** and **right**. Pedestals lock.

- 84" wide desks are shipped RTA (ready to assemble) in 3 cartons.
- Hutches may not be placed on this desk

Required Specifications

Primary surface type + finish
 Top thickness/edge detail
 Base finish
 Drawer front finish
 Lock finish

Optional Specifications

Key #
 Modesty type
 Grommet position or power block cut-out
 Modesty finish glazed, otherwise will match base finish.
 Handles

Accessories

Power block
 Pencil drawer

DOUBLE PEDESTAL DESKS



Double Pedestal Desk

MODEL#	DIMENSIONS D x W x H	FREIGHT CLASS	WT/LBS.	CUBIC FT.	1" TOP	1.5" TOP	GLAZE ADD	HP ADD
Z4284F32	42 x 84 x 29.5-30	250	383.25	102.5	\$2961	\$3249	\$976	\$1081
Z4272F32	42 x 72 x 29.5-30	125	371	59	\$2854	\$3105	\$810	\$812
Z3684F32	36 x 84 x 29.5-30	250	364.54	176.6	\$2790	\$3042	\$976	\$812
Z3672F32	36 x 72 x 29.5-30	125	324.43	50.75	\$2666	\$2886	\$810	\$611
Z3666F32	36 x 66 x 29.5-30	125	313.18	46.75	\$2615	\$2816	\$723	\$611
Z3660F32	36 x 60 x 29.5-30	125	267.1	42.5	\$2567	\$2753	\$639	\$509
Z3072F32	29.69 x 72 x 29.5-30	125	324.43	50.75	\$2666	\$2886	\$810	\$611
Z3066F32	29.7 x 66 x 29.5-30	125	313.18	46.75	\$2615	\$2816	\$723	\$611
Z3060F32	29.7 x 60 x 29.5-30	125	267.1	42.5	\$2567	\$2751	\$639	\$509

Standard with **Freestanding** box/box/file pedestal on **left** and file/file pedestal on **right**. File drawer and lower box drawer lock. File pedestal locks.

- 84" wide desks are shipped RTA (ready to assemble) in 3 cartons.
- Hutches may not be placed on this desk



Double Pedestal Desk

Z4284F23	42 x 84 x 29.5-30	250	383.25	102.5	\$2961	\$3249	\$976	\$1081
Z4272F23	42 x 72 x 29.5-30	125	371	59	\$2854	\$3105	\$810	\$812
Z3684F23	36 x 84 x 29.5-30	250	364.54	176.6	\$2790	\$3042	\$976	\$812
Z3672F23	36 x 72 x 29.5-30	125	324.43	50.75	\$2666	\$2886	\$810	\$611
Z3666F23	36 x 66 x 29.5-30	125	313.18	46.75	\$2615	\$2816	\$723	\$611
Z3660F23	36 x 60 x 29.5-30	125	267.1	42.5	\$2567	\$2753	\$639	\$509
Z3 072F23	29.7 x 72 x 29.5-30	125	324.43	50.75	\$2666	\$2886	\$810	\$611
Z3066F23	29.7 x 66 x 29.5-30	125	313.18	46.75	\$2615	\$2816	\$723	\$611
Z3060F23	29.7 x 60 x 29.5-30	125	267.1	42.5	\$2567	\$2751	\$639	\$509

Standard with **Freestanding** file/file pedestal on **left** and box/box/file pedestal on **right**. File drawer and lower box drawer lock. File pedestal locks.

- 84" wide desks are shipped RTA (ready to assemble) in 3 cartons.
- Hutches may not be placed on this desk



Double Pedestal Desk

Z4284F33	42 x 84 x 29.5-30	250	381.15	102.5	\$3001	\$3289	\$976	\$1081
Z4272F33	42 x 72 x 29.5-30	125	370	59	\$2894	\$3144	\$810	\$812
Z3684F33	36 x 84 x 29.5-30	300	341.25	176.6	\$2829	\$3081	\$976	\$812
Z3672F33	36 x 72 x 29.5-30	125	316.05	50.75	\$2701	\$2921	\$810	\$611
Z3666F33	36 x 66 x 29.5-30	125	304.5	46.75	\$2654	\$2855	\$723	\$611
Z3660F33	36 x 60 x 29.5-30	125	261.45	42.5	\$2607	\$2793	\$639	\$509
Z3072F33	29.7 x 72 x 29.5-30	125	316.05	50.75	\$2701	\$2921	\$810	\$611
Z3066F33	29.7 x 66 x 29.5-30	125	304.5	46.75	\$2654	\$2849	\$723	\$611
Z3060F33	29.69 x 60 x 29.5-30	125	261.45	42.5	\$2607	\$2793	\$639	\$509

Standard with **Freestanding** box/box/file pedestals on **left** and **right**. File drawer and lower box drawer lock.

- 84" wide desks are shipped RTA (ready to assemble) in 3 cartons.
- Hutches may not be placed on this desk

Required Specifications

Primary surface type + finish
 Top thickness/edge detail
 Base finish
 Drawer front finish
 Lock finish

Optional Specifications

Key #
 Modesty type
 Grommet position or power block cut-out
 Modesty finish glazed, otherwise will match base finish.
 Handles

Accessories

Power block
 Pencil drawer

SINGLE PEDESTAL DESKS



Single Pedestal Bow Top Desk - LEFT

MODEL#	DIMENSIONS D x W x H	FREIGHT CLASS	WT./LBS.	CUBIC FT.	1" TOP	1.5" TOP	GLAZE ADD	HP ADD
Z4284FB2L	42 x 84 x 29.5-30	125	322.35	43.5	\$2317	\$2658	\$976	\$1081
Z4272FB2L	42 x 72 x 29.5-30	150	315	59	\$2199	\$2499	\$810	\$812
Z3672FB2L	36 x 72 x 29.5-30	150	281.35	50.75	\$2039	\$2304	\$810	\$611
Z3666FB2L	36 x 66 x 29.5-30	150	274.68	46.75	\$1982	\$2226	\$723	\$611
Z3660FB2L	36 x 60 x 29.5-30	125	259.86	42.5	\$1909	\$2133	\$639	\$509

Standard with **Freestanding** file/file pedestal on **left** and faux pedestal **right**. Pedestal locks. Bow top overhangs 2 ¼" at ends and 8" on center.

- 84" wide desks are shipped RTA (ready to assemble) in 2 cartons.



Single Pedestal Bow Top Desk - RIGHT

Z4284FB2R	42 x 84 x 29.5-30	125	322.35	43.50	\$2317	\$2658	\$976	\$1081
Z4272FB2R	42 x 72 x 29.5-30	150	315	59	\$2199	\$2499	\$810	\$812
Z3672FB2R	36 x 72 x 29.5-30	150	281.35	50.75	\$2039	\$2304	\$810	\$611
Z3666FB2R	36 x 66 x 29.5-30	150	274.68	46.75	\$1982	\$2226	\$723	\$611
Z3660FB2R	36 x 60 x 29.5-30	125	259.86	42.50	\$1909	\$2133	\$639	\$509

Standard with **Freestanding** faux pedestal **left** and file/file pedestal on **right**. Pedestal locks. Bow top overhangs 2 ¼" at ends and 8" on center.

- 84" wide desks are shipped RTA (ready to assemble) in 2 cartons.



Single Pedestal Bow Top Desk - LEFT

Z4284FB3L	42 x 84 x 29.5-30	125	320.25	43.50	\$2356	\$2696	\$976	\$1081
Z4272FB3L	42 x 72 x 29.5-30	150	313	59	\$2236	\$2535	\$810	\$812
Z3672FB3L	36 x 72 x 29.5-30	150	279.77	50.75	\$2077	\$2344	\$810	\$611
Z3666FB3L	36 x 66 x 29.5-30	150	273.10	46.75	\$2024	\$2266	\$723	\$611
Z3660FB3L	36 x 60 x 29.5-30	125	258.27	42.50	\$1969	\$2196	\$639	\$509

Standard with **Freestanding** box/box/file pedestal on **left** and faux pedestal **right**. File drawer and lower box drawer lock. Bow top overhangs 2 ¼" at ends and 8" on center.

- 84" wide desks are shipped RTA (ready to assemble) in 2 cartons.



Single Pedestal Bow Top Desk - RIGHT

Z4284FB3R	42 x 84 x 29.5-30	125	320.25	43.50	\$2356	\$2696	\$976	\$1081
Z4272FB3R	42 x 72 x 29.5-30	150	313	59	\$2236	\$2535	\$810	\$812
Z3672FB3R	36 x 72 x 29.5-30	150	279.77	50.75	\$2077	\$2344	\$810	\$611
Z3666FB3R	36 x 66 x 29.5-30	150	273.10	46.75	\$2024	\$2266	\$723	\$611
Z3660FB3R	36 x 60 x 29.5-30	125	258.27	42.50	\$1969	\$2196	\$639	\$509

Standard with **Freestanding** faux pedestal **left** and box/box/file pedestal on **right**. File drawer and lower box drawer lock. Bow top overhangs 2 ¼" at ends and 8" on center.

- 84" wide desks are shipped RTA (ready to assemble) in 2 cartons.



Single Pedestal Desk - LEFT

Z4284F2L	42 x 84 x 29.5-30	125	326.55	43.5	\$2209	\$2500	\$976	\$1081
Z4272F2L	42 x 72 x 29.5-30	150	327	59	\$2103	\$2354	\$810	\$812
Z3684F2L	36 x 84 x 29.5-30	250	290.85	118	\$2074	\$2326	\$976	\$812
Z3672F2L	36 x 72 x 29.5-30	150	265.65	50.75	\$1945	\$2165	\$810	\$611
Z3666F2L	36 x 66 x 29.5-30	150	254.1	46.75	\$1897	\$2098	\$723	\$611
Z3660F2L	36 x 60 x 29.5-30	150	243.6	42.5	\$1849	\$2036	\$639	\$509
Z3072F2L	29.69 x 72 x 29.5-30	150	265.65	50.75	\$1945	\$2165	\$810	\$611
Z3066F2L	29.7 x 66 x 29.5-30	150	254.1	46.75	\$1897	\$2097	\$723	\$611
Z3060F2L	29.7 x 60 x 29.5-30	150	243.6	42.5	\$1849	\$2036	\$639	\$509

Standard with **Freestanding** file/file pedestal on **left** and faux pedestal **right**. Pedestal locks.

- 84" wide desks are shipped RTA (ready to assemble) in 2 cartons.
- Hutches may not be placed on this desk

Required Specifications

Primary surface type + finish
 Top thickness/edge detail
 Base finish
 Drawer front finish
 Lock finish

Optional Specifications

Key #
 Modesty type
 Grommet position or power block cut-out
 Modesty finish glazed, otherwise will match base finish.
 Handles

Accessories

Power block
 Pencil drawer

SINGLE PEDESTAL DESKS



Single Pedestal Desk - RIGHT*

MODEL#	DIMENSIONS	FREIGHT CLASS	WT/LBS.	CUBIC FT.	1" TOP	1.5" TOP	GLAZE ADD	HP ADD
D x W x H								
Z4284F2R	42 x 84 x 29.5-30	125	326.55	43.50	\$2209	\$2500	\$976	\$1081
Z4272F2R	42 x 72 x 29.5-30	150	327	59	\$2103	\$2354	\$810	\$812
Z3684F2R	36 x 84 x 29.5-30	250	290.85	118	\$2074	\$2326	\$976	\$812
Z3672F2R	36 x 72 x 29.5-30	150	265.65	50.75	\$1945	\$2165	\$810	\$611
Z3666F2R	36 x 66 x 29.5-30	150	254.10	46.75	\$1897	\$2098	\$723	\$611
Z3660F2R	36 x 60 x 29.5-30	150	243.60	42.50	\$1849	\$2036	\$639	\$509
Z3072F2R	29.7 x 72 x 29.5-30	150	265.65	50.75	\$1945	\$2165	\$810	\$611
Z3066F2R	29.7 x 66 x 29.5-30	150	254.10	46.75	\$1897	\$2097	\$723	\$611
Z3060F2R	29.7 x 60 x 29.5-30	150	243.60	42.50	\$1849	\$2036	\$639	\$509

Standard with **Freestanding** faux pedestal on **left** and file/file pedestal **right**. Pedestal locks.

- 84" wide desks are shipped RTA (ready to assemble) in 2 cartons.
- Hutches may not be placed on this desk



Single Pedestal Desk - LEFT*

Z4284F3L	42 x 84 x 29.5-30	125	324.45	43.50	\$2250	\$2538	\$976	\$1081
Z4272F3L	42 x 72 x 29.5-30	150	324	59	\$2142	\$2393	\$810	\$812
Z3684F3L	36 x 84 x 29.5-30	250	288.75	118	\$2074	\$2326	\$976	\$812
Z3672F3L	36 x 72 x 29.5-30	150	263.55	50.75	\$1985	\$2205	\$810	\$611
Z3666F3L	36 x 66 x 29.5-30	150	252	46.75	\$1938	\$2139	\$723	\$611
Z3660F3L	36 x 60 x 29.5-30	150	241.50	42.50	\$1864	\$2048	\$639	\$509
Z3072F3L	29.7 x 72 x 29.5-30	150	253.55	50.75	\$1985	\$2205	\$810	\$611
Z3066F3L	29.7 x 66 x 29.5-30	150	252	46.75	\$1938	\$2138	\$723	\$611
Z3060F3L	29.7 x 60 x 29.5-30	150	241.50	42.50	\$1864	\$2048	\$639	\$509

Standard with **Freestanding** box/box/file pedestal on **left** and faux pedestal **right**. File drawer and lower box drawer lock.

- 84" wide desks are shipped RTA (ready to assemble) in 2 cartons.
- Hutches may not be placed on this desk



Single Pedestal Desk - RIGHT*

Z4284F3R	42 x 84 x 29.5-30	125	324.45	43.50	\$2250	\$2538	\$976	\$1081
Z4272F3R	42 x 72 x 29.5-30	150	324	59	\$2142	\$2393	\$810	\$812
Z3684F3R	36 x 84 x 29.5-30	250	288.75	118	\$2074	\$2326	\$976	\$812
Z3672F3R	36 x 72 x 29.5-30	150	263.55	50.75	\$1985	\$2205	\$810	\$611
Z3666F3R	36 x 66 x 29.5-30	150	252	46.75	\$1938	\$2139	\$723	\$611
Z3660F3R	36 x 60 x 29.5-30	150	241.50	42.50	\$1864	\$2048	\$639	\$509
Z3072F3R	29.7 x 72 x 29.5-30	150	253.55	50.75	\$1985	\$2205	\$810	\$611
Z3066F3R	29.7 x 66 x 29.5-30	150	252	46.75	\$1938	\$2138	\$723	\$611
Z3060F3R	29.7 x 60 x 29.5-30	150	241.50	42.50	\$1864	\$2048	\$639	\$509

Standard with **Freestanding** faux pedestal on **left** and box/box/file pedestal **right**. File drawer and lower box drawer lock.

- 84" wide desks are shipped RTA (ready to assemble) in 2 cartons.
- Hutches may not be placed on this desk



Non-Handed Desk

Z4284NHD	42 x 84 x 29.5-30	65	267	9.5	\$1686	\$2017	n/a	\$848
Z3684NHD	36 x 84 x 29.5-30	70	182	8.3	\$1530	\$1808	n/a	\$730
Z3672NHD	36 x 72 x 29.5-30	70	159	7.2	\$1379	\$1617	n/a	\$626
Z3666NHD	36 x 66 x 29.5-30	65	152	6.7	\$1300	\$1526	n/a	\$573
Z3660NHD	36 x 60 x 29.5-30	65	143	6.1	\$1228	\$1435	n/a	\$521
Z3072NHD	29.7 x 72 x 29.5-30	65	140	6.2	\$1255	\$1454	n/a	\$521
Z3066NHD	29.7 x 66 x 29.5-30	65	133	5.7	\$1163	\$1356	n/a	\$481
Z3060NHD	29.7 x 60 x 29.5-30	65	124	5.2	\$1097	\$1264	n/a	\$436

Two laminate end panels + recessed full modesty panel (laminated only). Accepts all standard Zira storage shells.

Shipped RTA (ready to assemble).

- Hutches may not be placed on this desk

Required Specifications

Primary surface type + finish
 Top thickness/edge detail
 Base finish
 Drawer front finish*
 Lock finish*

Optional Specifications

Key #
 Modesty type
 Grommet position or power block cut-out
 Modesty finish glazed, otherwise will match base finish.
 Handles*

Accessories

Power block
 Keyboard
 Pencil drawer

FREESTANDING DESKS



Freestanding Desk

MODEL#	DIMENSIONS D x W x H	FREIGHT CLASS	WT/LBS.	CUBIC FT.	1" TOP	1.5" TOP	GLAZE ADD	HP ADD
Z3684DK	36 x 84 x 29.5-30	70	168	8.25	\$1320	\$1592	n/a	\$726
Z3672DK	36 x 72 x 29.5-30	70	152	7.25	\$1207	\$1446	n/a	\$624
Z3666DK	36 x 66 x 29.5-30	70	144	6.75	\$1155	\$1375	n/a	\$572
Z3660DK	36 x 60 x 29.5-30	65	137	6	\$1104	\$1303	n/a	\$520
Z3072DK	30 x 72 x 29.5-30	70	130	6.25	\$1077	\$1276	n/a	\$520
Z3066DK	30 x 66 x 29.5-30	70	123	5.75	\$1026	\$1225	n/a	\$478
Z3060DK	30 x 60 x 29.5-30	70	117	5.25	\$973	\$1172	n/a	\$434

Two full laminate end panels. 12"H laminate modesty panel. Shipped RTA (ready to assemble).



Freestanding Desk - Metal Legs*

Z3684DM	36 x 84 x 29.5-30	100	167	18.44	\$2821	\$3099	n/a	\$726
Z3672DM	36 x 72 x 29.5-30	100	151	17.46	\$2715	\$2954	n/a	\$624
Z3666DM	36 x 66 x 29.5-30	100	143	16.95	\$2663	\$2883	n/a	\$520
Z3660DM	36 x 60 x 29.5-30	100	143	16.95	\$2663	\$2883	n/a	\$520
Z3072DM	30 x 72 x 29.5-30	100	133	14.70	\$2585	\$2784	n/a	\$520
Z3066DM	30 x 66 x 29.5-30	100	126	14.22	\$2533	\$2732	n/a	\$478
Z3060DM	30 x 60 x 29.5-30	100	120	13.95	\$2479	\$2678	n/a	\$434

Double metal legs. 12"H laminate modesty panel. Metal leg available in Black (**BLK**) or Tungsten (**TUN**). Shipped RTA (ready to assemble).



Freestanding Desk - Metal Legs*

Z3684DML	36 x 84 x 29.5-30	85	167	13.50	\$2073	\$2345	n/a	\$726
Z3672DML	36 x 72 x 29.5-30	85	151	12.04	\$1968	\$2202	n/a	\$624
Z3666DML	36 x 66 x 29.5-30	85	144	11.74	\$1916	\$2136	n/a	\$572
Z3660DML	36 x 60 x 29.5-30	85	135	11.24	\$1863	\$2062	n/a	\$520
Z3072DML	30 x 72 x 29.5-30	85	131	10.50	\$1838	\$2037	n/a	\$520
Z3066DML	30 x 66 x 29.5-30	85	125	10	\$1785	\$1984	n/a	\$478
Z3060DML	30 x 60 x 29.5-30	85	118	9.50	\$1734	\$1933	n/a	\$434

Single metal leg on **left** and laminate end panel on **right**. 12"H laminate modesty panel. Metal leg available in Black (**BLK**) or Tungsten (**TUN**). Shipped RTA (ready to assemble).



Freestanding Desk - Metal Legs*

Z3684DMR	36 x 84 x 29.5-30	85	167	13.50	\$2073	\$2345	n/a	\$726
Z3672DMR	36 x 72 x 29.5-30	85	151	12.04	\$1968	\$2202	n/a	\$624
Z3666DMR	36 x 66 x 29.5-30	85	144	11.74	\$1916	\$2136	n/a	\$572
Z3660DMR	36 x 60 x 29.5-30	85	135	11.24	\$1863	\$2062	n/a	\$520
Z3072DMR	30 x 72 x 29.5-30	85	131	10.50	\$1838	\$2037	n/a	\$520
Z3066DMR	30 x 66 x 29.5-30	85	125	10	\$1785	\$1984	n/a	\$478
Z3060DMR	30 x 60 x 29.5-30	85	118	9.50	\$1734	\$1933	n/a	\$434

Single metal leg on **right** and laminate end panel on **left**. 12"H laminate modesty panel. Metal leg available in Black (**BLK**) or Tungsten (**TUN**). Shipped RTA (ready to assemble).

Required Specifications

Primary surface type + finish
Top thickness/edge detail
Base finish
Leg finish (BLK or TUN)*

Optional Specifications

Grommet position or power block cut-out

Accessories

Power block
Keyboard
Pencil drawer

TRANSITIONAL TABLES



LEFT

Overlapping Table

MODEL#	DIMENSIONS D x W x H	FREIGHT CLASS	WT/LBS.	CUBIC FT.	1" TOP	1.5" TOP	GLAZE ADD	HP ADD
Z3684OML	36 x 84 x 29.5-30	100	132	13.50	\$1896	\$2168	n/a	\$726
Z3672OML	36 x 72 x 29.5-30	100	120	12.24	\$1811	\$2083	n/a	\$624
Z3666OML	36 x 66 x 29.5-30	100	112	11.74	\$1772	\$2044	n/a	\$572
Z3660OML	36 x 60 x 29.5-30	100	105	11.24	\$1739	\$2066	n/a	\$520
Z3072OML	30 x 72 x 29.5-30	100	104	10.50	\$1714	\$1972	n/a	\$520
Z3066OML	30 x 66 x 29.5-30	100	97	10	\$1674	\$1941	n/a	\$478
Z3060OML	30 x 60 x 29.5-30	100	90	9.50	\$1642	\$1909	n/a	\$434

Metal open frame leg with support channels on **left**. To be placed on top of 23.75"/24.25" high units.
Not freestanding. Metal leg available in Black (**BLK**) or Tungsten (**TUN**). Shipped RTA (ready to assemble).



RIGHT

Overlapping Table

Z3684OMR	36 x 84 x 29.5-30	100	132	13.50	\$1896	\$2168	n/a	\$726
Z3672OMR	36 x 72 x 29.5-30	100	120	12.24	\$1811	\$2083	n/a	\$624
Z3666OMR	36 x 66 x 29.5-30	100	112	11.74	\$1772	\$2044	n/a	\$572
Z3660OMR	36 x 60 x 29.5-30	100	105	11.24	\$1739	\$2066	n/a	\$520
Z3072OMR	30 x 72 x 29.5-30	100	104	10.50	\$1714	\$1972	n/a	\$520
Z3066OMR	30 x 66 x 29.5-30	100	97	10	\$1674	\$1941	n/a	\$478
Z3060OMR	30 x 60 x 29.5-30	100	90	9.50	\$1642	\$1909	n/a	\$434

Metal open frame leg with support channels on **right**. To be placed on top of 23.75"/24.25" high units.
Not freestanding. Metal leg available in Black (**BLK**) or Tungsten (**TUN**). Shipped RTA (ready to assemble).



LEFT

Overlapping Table

Z3684SOL	36 x 84 x 29.5-30	92.5	139	13.50	\$1916	\$2188	n/a	\$726
Z3672SOL	36 x 72 x 29.5-30	92.5	126	12.24	\$1832	\$2104	n/a	\$624
Z3666SOL	36 x 66 x 29.5-30	92.5	118	11.74	\$1792	\$2064	n/a	\$572
Z3660SOL	36 x 60 x 29.5-30	100	110	11.24	\$1759	\$2026	n/a	\$520
Z3072SOL	30 x 72 x 29.5-30	92.5	108	10.50	\$1734	\$1992	n/a	\$520
Z3066SOL	30 x 66 x 29.5-30	92.5	100	10	\$1694	\$1961	n/a	\$478
Z3060SOL	30 x 60 x 29.5-30	92.5	96	9.50	\$1661	\$1928	n/a	\$434

Metal open frame leg with support channels on **left**. To be placed on top of 17.87"/18.37" high units.
Not freestanding. Metal leg available in Black (**BLK**) or Tungsten (**TUN**). Shipped RTA (ready to assemble).



RIGHT

Overlapping Table

Z3684SOR	36 x 84 x 29.5-30	92.5	139	13.50	\$1916	\$2188	n/a	\$726
Z3672SOR	36 x 72 x 29.5-30	92.5	126	12.24	\$1832	\$2104	n/a	\$624
Z3666SOR	36 x 66 x 29.5-30	92.5	118	11.74	\$1792	\$2064	n/a	\$572
Z3660SOR	36 x 60 x 29.5-30	100	110	11.24	\$1759	\$2026	n/a	\$520
Z3072SOR	30 x 72 x 29.5-30	92.5	108	10.50	\$1734	\$1992	n/a	\$520
Z3066SOR	30 x 66 x 29.5-30	92.5	100	10	\$1694	\$1961	n/a	\$478
Z3060SOR	30 x 60 x 29.5-30	92.5	96	9.50	\$1661	\$1928	n/a	\$434

Metal open frame leg with support channels on **right**. To be placed on top of 17.87"/18.37" high units.
Not freestanding. Metal leg available in Black (**BLK**) or Tungsten (**TUN**). Shipped RTA (ready to assemble).

Required Specifications

Primary surface type + finish
Top thickness/edge detail
Base finish
Leg finish (BLK or TUN)

Optional Specifications

Grommet position or power block cut-out

Accessories

Power block
Keyboard
Pencil drawer

FLUSH RETURNS		MODEL#	DIMENSIONS	FREIGHT CLASS	WT./LBS.	CUBIC FT.	1" TOP	1.5" TOP	GLAZE ADD	HP ADD
		Z2448FL	24 x 48 x 29.5-30	125	155	24	\$1081	\$1190	N/A	\$300
		Z2442FL	24 x 42 x 29.5-30	125	144	21.25	\$1081	\$1176	N/A	\$252
		Z2048FL	20 x 48 x 29.5-30	125	140	20.25	\$1003	\$1098	N/A	\$252
		Z2042FL	20 x 42 x 29.5-30	125	130	18	\$1003	\$1098	N/A	\$252
		Standard with box/file drawer pedestal. One pencil tray. Pedestal locks. Grommet in worksurface. Pedestal is on the left . For use with right handed single pedestal desks, 20"/24" deep extended corners with narrow end panel or 20"/24" deep five-sided corners with narrow end panel.								
		Z2448FR	24 x 48 x 29.5-30	125	155	24	\$1081	\$1190	N/A	\$300
		Z2442FR	24 x 42 x 29.5-30	125	144	21.25	\$1081	\$1176	N/A	\$252
		Z2048FR	20 x 48 x 29.5-30	125	140	20.25	\$1003	\$1098	N/A	\$252
		Z2042FR	20 x 42 x 29.5-30	125	130	18	\$1003	\$1098	N/A	\$252
		Standard with box/file drawer pedestal. One pencil tray. Pedestal locks. Grommet in worksurface. Pedestal is on the right . For use with left handed single pedestal desks, 20"/24" deep extended corners with narrow end panel or 20"/24" deep five-sided corners with narrow end panel.								
		Z2448EL	24 x 48 x 29.5-30	65	107	4.3	\$765	\$874	N/A	\$300
		Z2442EL	24 x 42 x 29.5-30	65	96	3.8	\$765	\$860	N/A	\$252
		Z2048EL	20 x 48 x 29.5-30	65	97	4.3	\$707	\$804	N/A	\$252
		Z2042EL	20 x 42 x 29.5-30	65	86	3.8	\$707	\$804	N/A	\$252
		Return has no pedestal . Grommet in worksurface. Shipped RTA (ready to assemble). For use with right handed single pedestal desks, 20"/24" deep extended corners with narrow end panel or 20"/24" deep five-sided corners with narrow end panel.								
		Z2448ELSL	24 x 48 x 29.6-30	65	117	4.3	\$783	\$879	N/A	\$300
		Z2442ELSL	24 x 42 x 29.6-30	65	104	3.8	\$783	\$869	N/A	\$252
		Z2048ELSL	20 x 48 x 29.6-30	65	106	4.3	\$728	\$814	N/A	\$252
		Z2042ELSL	20 x 42 x 29.6-30	65	94	3.8	\$728	\$814	N/A	\$252
		Modesty is 12"H to provide wall access. Return has no pedestal . Grommet in worksurface. For use with right handed single pedestal desks, 20"/24" deep extended corners with narrow end panel or 20"/24" deep five-sided corners with narrow end panel. Shipped assembled in 1 carton.								
		Z2448ER	24 x 48 x 29.5-30	65	107	4.3	\$765	\$874	N/A	\$300
		Z2442ER	24 x 42 x 29.5-30	65	96	3.8	\$765	\$860	N/A	\$252
		Z2048ER	20 x 48 x 29.5-30	65	97	4.3	\$707	\$804	N/A	\$252
		Z2042ER	20 x 42 x 29.5-30	65	86	3.8	\$707	\$804	N/A	\$252
		Return has no pedestal . Grommet in worksurface. Shipped RTA (ready to assemble). For use with left handed single pedestal desks, 20"/24" deep extended corners with narrow end panel or 20"/24" deep five-sided corners with narrow end panel.								
		Z2448ERSL	24 x 48 x 29.6-30	65	117	4.3	\$783	\$879	N/A	\$300
		Z2442ERSL	24 x 42 x 29.6-30	65	104	3.8	\$783	\$869	N/A	\$252
		Z2048ERSL	20 x 48 x 29.6-30	65	106	4.3	\$728	\$814	N/A	\$252
		Z2042ERSL	20 x 42 x 29.6-30	65	94	3.8	\$728	\$814	N/A	\$252
		Modesty is 12"H to provide wall access. Return has no pedestal . Grommet in worksurface. For use with left handed single pedestal desks, 20"/24" deep extended corners with narrow end panel or 20"/24" deep five-sided corners with narrow end panel. Shipped assembled in 1 carton.								

Required Specifications

Primary surface type + finish
 Top thickness/edge detail
 Base finish
 Drawer front finish*
 Lock finish

Optional Specifications

Key #
 Modesty type (not Z2xxxELSL/Z2xxxERSL)
 Grommet position or power block cut-out
 Handles*

Accessories

Power block
 Pencil drawer

FLUSH RETURNS

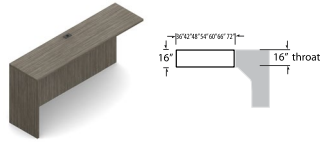

Flush Return - LEFT*

MODEL#	DIMENSIONS D x W x H	FREIGHT CLASS	WT/LBS.	CUBIC FT.	1" TOP	1.5" TOP	GLAZE ADD	HP ADD
Z1672RL	15.8 x 72 x 29.5-30	70	109.20	6	\$761	\$895	N/A	\$308
Z1666RL	15.8 x 66 x 29.5-30	70	101.85	5.75	\$729	\$854	N/A	\$308
Z1660RL	15.8 x 60 x 29.5-30	70	94.50	5.25	\$687	\$801	N/A	\$256
Z1654RL	15.8 x 54 x 29.5-30	70	87.15	5.25	\$651	\$758	N/A	\$256
Z1648RL	15.8 x 48 x 29.5-30	70	79.80	4.25	\$599	\$693	N/A	\$208
Z1642RL	15.8 x 42 x 29.5-30	70	70.35	4	\$536	\$623	N/A	\$208
Z1636RL	15.8 x 36 x 29.5-30	70	61.95	3.50	\$480	\$557	N/A	\$156

16" Throat. Return has **no pedestal**. Grommet in worksurface. Shipped RTA (ready to assemble). For use with extended corners, desks and islands with 16" throat.

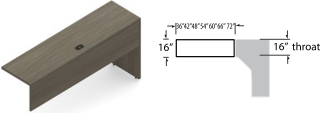

Flush Return w/Wall Access - LEFT

Z1672RLSL	15.8 x 72 x 29.5-30	70	109	6	\$778	\$899	N/A	\$308
Z1666RLSL	15.8 x 66 x 29.5-30	70	102	5.25	\$753	\$864	N/A	\$308
Z1660RLSL	15.8 x 60 x 29.5-30	70	95	5.25	\$713	\$819	N/A	\$256
Z1654RLSL	15.8 x 54 x 29.5-30	70	87	5.25	\$682	\$778	N/A	\$256
Z1648RLSL	15.8 x 48 x 29.5-30	70	80	4.25	\$637	\$723	N/A	\$208
Z1642RLSL	15.8 x 42 x 29.5-30	70	70	4	\$581	\$657	N/A	\$208
Z1636RLSL	15.8 x 36 x 29.5-30	70	62	3.5	\$526	\$596	N/A	\$156

Modesty is 12"H to provide wall access. 16" Throat. Return has **no pedestal**. Grommet in worksurface. For use with extended corners, desks and islands with 16" throat. Shipped easy to assemble in 1 carton.

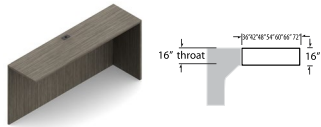

Flush Return - RIGHT*

Z1672RR	15.8 x 72 x 29.5-30	70	109.2	6	\$761	\$895	N/A	\$308
Z1666RR	15.8 x 66 x 29.5-30	70	101.85	5.75	\$729	\$854	N/A	\$308
Z1660RR	15.8 x 60 x 29.5-30	70	94.5	5.25	\$687	\$801	N/A	\$256
Z1654RR	15.8 x 54 x 29.5-30	70	87.15	5.25	\$651	\$758	N/A	\$256
Z1648RR	15.8 x 48 x 29.5-30	70	79.8	4.25	\$599	\$693	N/A	\$208
Z1642RR	15.8 x 42 x 29.5-30	70	70.35	4	\$536	\$623	N/A	\$208
Z1636RR	15.8 x 36 x 29.5-30	70	61.95	3.5	\$480	\$557	N/A	\$156

16" Throat. Return has **no pedestal**. Grommet in worksurface. Shipped RTA (ready to assemble). For use with extended corners, desks and islands with 16" throat.

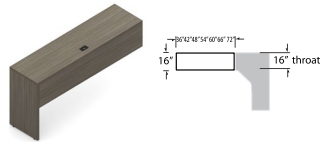

Flush Return w/Wall Access - RIGHT

Z1672RRSL	15.8 x 72 x 29.5-30	70	109	6	\$778	\$899	N/A	\$308
Z1666RRSL	15.8 x 66 x 29.5-30	70	102	5.25	\$753	\$864	N/A	\$308
Z1660RRSL	15.8 x 60 x 29.5-30	70	95	5.25	\$713	\$819	N/A	\$256
Z1654RRSL	15.8 x 54 x 29.5-30	70	87	5.25	\$682	\$778	N/A	\$256
Z1648RRSL	15.8 x 48 x 29.5-30	70	80	4.25	\$637	\$723	N/A	\$208
Z1642RRSL	15.8 x 42 x 29.5-30	70	70	4	\$581	\$657	N/A	\$208
Z1636RRSL	15.8 x 36 x 29.5-30	70	62	3.5	\$526	\$596	N/A	\$156

Modesty is 12"H to provide wall access. 16" Throat. Return has **no pedestal**. Grommet in worksurface. For use with extended corners, desks and islands with 16" throat. Shipped easy to assemble in 1 carton.



Non-Handed Return*

Z2448NHR	24 x 48 x 29.5-30	70	83	4.3	\$789	\$909	N/A	\$278
Z2442NHR	24 x 42 x 29.5-30	70	75	3.8	\$684	\$811	N/A	\$248
Z2048NHR	20 x 48 x 29.5-30	70	75	4.3	\$717	\$831	N/A	\$234
Z2042NHR	20 x 42 x 29.5-30	70	67	3.8	\$658	\$739	N/A	\$207

Non-handed (reversible) return. 24"D returns accept all standard 23.4" storage shells. 20"D returns accept all standard 19.3" storage shells. Full modesty panel (laminite only). Shipped ready to assemble in 1 carton.



Non-Handed Return w/Wall Access

Z2448NHRSL	24 x 48 x 29.5-30	70	83.6	4.78	\$844	\$960	N/A	\$278
Z2442NHRSL	24 x 42 x 29.5-30	70	75.4	3.83	\$748	\$869	N/A	\$248
Z2048NHRSL	20 x 48 x 29.5-30	70	75.56	4.3	\$778	\$884	N/A	\$234
Z2042NHRSL	20 x 42 x 29.5-30	70	67.96	3.83	\$723	\$798	N/A	\$207

Non-handed (reversible) return. 24"D returns accept all standard 23.4" storage shells. 20"d returns accept all standard 19.3" storage shells. 12"H modesty panel (laminite only) for wall access. Shipped ready to assemble in 1 carton.

Required Specifications

Primary surface type + finish
Top thickness/edge detail
Base finish

Optional Specifications

Modesty type*
Grommet position or power block cut-out

Accessories

Power block
Pencil drawer

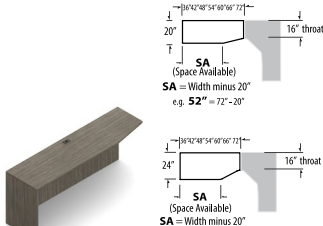
SPACE SAVER RETURNS	MODEL#	DIMENSIONS	FREIGHT CLASS	WT/LBS.	CUBIC FT.	1" TOP	1.5" TOP	GLAZE ADD	HP ADD
 <p>Space Saver Return - LEFT</p>		D x W x H							
	Z247216RL	24 x 72 x 29.5-30	65	135.45	6	\$905	\$1101	N/A	\$409
	Z246616RL	24 x 66 x 29.5-30	70	127.05	5.75	\$865	\$1045	N/A	\$409
	Z246016RL	24 x 60 x 29.5-30	70	117.60	5.25	\$811	\$980	N/A	\$340
	Z245416RL	24 x 54 x 29.5-30	70	108.15	5.25	\$765	\$919	N/A	\$340
	Z244816RL	24 x 48 x 29.5-30	65	99.75	4.25	\$702	\$841	N/A	\$275
	Z244216RL	24 x 42 x 29.5-30	70	88.20	4	\$629	\$754	N/A	\$275
	Z243616RL	24 x 36 x 29.5-30	70	77.70	3.50	\$571	\$683	N/A	\$208
	Z207216RL	20 x 72 x 29.5-30	70	122.85	6	\$828	\$995	N/A	\$409
	Z206616RL	20 x 66 x 29.5-30	70	114.45	5.75	\$789	\$941	N/A	\$409
	Z206016RL	20 x 60 x 29.5-30	70	106.05	5.25	\$742	\$882	N/A	\$340
	Z205416RL	20 x 54 x 29.5-30	70	97.65	5.25	\$698	\$825	N/A	\$340
	Z204816RL	20 x 48 x 29.5-30	70	90.30	4.25	\$642	\$758	N/A	\$275
	Z204216RL	20 x 42 x 29.5-30	70	79.80	4	\$576	\$683	N/A	\$275
	Z203616RL	20 x 36 x 29.5-30	70	70.35	3.50	\$520	\$611	N/A	\$208

16" Throat. Return has **no pedestal**. Grommet in worksurface. Shipped RTA (ready to assemble). For use with extended corners, desks and islands with 16"throat. Accepts same depth storage shells under worksurface.

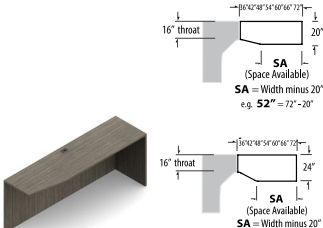
 <p>Space Saver Return - RIGHT</p>	Z247216RR	24 x 72 x 29.5-30	65	135.45	6	\$905	\$1101	N/A	\$409
	Z246616RR	24 x 66 x 29.5-30	70	127.05	5.75	\$865	\$1045	N/A	\$409
	Z246016RR	24 x 60 x 29.5-30	70	117.60	5.25	\$811	\$980	N/A	\$340
	Z245416RR	24 x 54 x 29.5-30	70	108.15	5.25	\$765	\$919	N/A	\$340
	Z244816RR	24 x 48 x 29.5-30	65	99.75	4.25	\$702	\$841	N/A	\$275
	Z244216RR	24 x 42 x 29.5-30	70	88.20	4	\$629	\$754	N/A	\$275
	Z243616RR	24 x 36 x 29.5-30	70	77.70	3.50	\$571	\$683	N/A	\$208
	Z207216RR	20 x 72 x 29.5-30	70	122.85	6	\$828	\$995	N/A	\$409
	Z206616RR	20 x 66 x 29.5-30	70	114.45	5.75	\$789	\$941	N/A	\$409
	Z206016RR	20 x 60 x 29.5-30	70	106.05	5.25	\$742	\$882	N/A	\$340
	Z205416RR	20 x 54 x 29.5-30	70	97.65	5.25	\$698	\$825	N/A	\$340
	Z204816RR	20 x 48 x 29.5-30	70	90.30	4.25	\$642	\$758	N/A	\$275
	Z204216RR	20 x 42 x 29.5-30	70	79.80	4	\$576	\$683	N/A	\$275
	Z203616RR	20 x 36 x 29.5-30	70	70.35	3.50	\$520	\$611	N/A	\$208

16" Throat. Return has **no pedestal**. Grommet in worksurface. Shipped RTA (ready to assemble). For use with extended corners, desks and islands with 16"throat. Accepts same depth storage shells under worksurface.

Required Specifications

Primary surface type + finish
Top thickness/edge detail
Base finish

Optional Specifications

Grommet position or power block cut-out

Accessories

Power block
Pencil drawer

FULL TO FLOOR RETURNS



Full to Floor Return, No Modesty - LEFT*

MODEL#	DIMENSIONS D x W x H	FREIGHT CLASS	WT/LBS.	CUBIC FT.	1" TOP	1.5" TOP	GLAZE ADD	HP ADD
Z2448NRL	24 x 48 x 29.5-30	150	127	24.25	\$1247	\$1360	N/A	\$278
Z2442NRL	24 x 42 x 29.5-30	150	123	21.25	\$1234	\$1332	N/A	\$244
Z2048NRL	20 x 48 x 29.5-30	150	114	20.50	\$1174	\$1269	N/A	\$234
Z2042NRL	20 x 42 x 29.5-30	125	111	18	\$1146	\$1232	N/A	\$202

Return has no modesty. File/file pedestal on **left**. Pedestal locks.



Full to Floor Return, No Modesty - RIGHT

Z2448NRR	24 x 48 x 29.5-30	150	127	24.25	\$1247	\$1360	N/A	\$278
Z2442NRR	24 x 42 x 29.5-30	150	123	21.25	\$1234	\$1332	N/A	\$244
Z2048NRR	20 x 48 x 29.5-30	150	114	20.50	\$1174	\$1269	N/A	\$234
Z2042NRR	20 x 42 x 29.5-30	125	111	18	\$1146	\$1232	N/A	\$202

Return has no modesty. File/file pedestal on **right**. Pedestal locks.

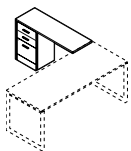

Full to Floor Return, No Modesty - LEFT

Z2448BNRL	24 x 48 x 29.5-30	150	130	24.25	\$1247	\$1360	N/A	\$278
Z2442BNRL	24 x 42 x 29.5-30	150	126	21.5	\$1234	\$1332	N/A	\$244
Z2048BNRL	20 x 48 x 29.5-30	150	117	20.5	\$1174	\$1269	N/A	\$234
Z2042BNRL	20 x 42 x 29.5-30	125	113	18	\$1146	\$1232	N/A	\$202

Return has no modesty. Box/box/file pedestal on **left**. Pedestal locks.

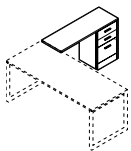

Full to Floor Return, No Modesty - RIGHT

Z2448BNRR	24 x 48 x 29.5-30	150	130	24.25	\$1247	\$1360	N/A	\$278
Z2442BNRR	24 x 42 x 29.5-30	150	126	21.5	\$1234	\$1332	N/A	\$244
Z2048BNRR	20 x 48 x 29.5-30	150	117	20.5	\$1174	\$1269	N/A	\$234
Z2042BNRR	20 x 42 x 29.5-30	125	113	18	\$1146	\$1232	N/A	\$202

Return has no modesty. Box/box/file pedestal on **right**. Pedestal locks.



Full to Floor Return - LEFT

Z2448SRL	24 x 48 x 29.5-30	150	135	24.25	\$1355	\$1468	N/A	\$278
Z2442SRL	24 x 42 x 29.5-30	125	130	21.25	\$1333	\$1431	N/A	\$244
Z2048SRL	20 x 48 x 29.5-30	125	123	20.5	\$1284	\$1379	N/A	\$234
Z2042SRL	20 x 42 x 29.5-30	125	119	18	\$1245	\$1331	N/A	\$202

File/file pedestal on **left**. 12"H modesty panel. Pedestal locks.



Full to Floor Return - RIGHT

Z2448SRR	24 x 48 x 29.5-30	150	135	24.25	\$1355	\$1468	N/A	\$278
Z2442SRR	24 x 42 x 29.5-30	125	130	21.25	\$1333	\$1431	N/A	\$244
Z2048SRR	20 x 48 x 29.5-30	125	123	20.5	\$1284	\$1379	N/A	\$234
Z2042SRR	20 x 42 x 29.5-30	125	119	18	\$1245	\$1331	N/A	\$202

File/file pedestal on **right**. 12"H modesty panel. Pedestal locks.

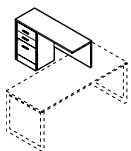

Full to Floor Return - LEFT

Z2448BSRL	24 x 48 x 29.5-30	150	138	24.25	\$1355	\$1468	N/A	\$278
Z2442BSRL	24 x 42 x 29.5-30	125	132	21.5	\$1333	\$1431	N/A	\$244
Z2048BSRL	20 x 48 x 29.5-30	125	125	20.5	\$1284	\$1379	N/A	\$234
Z2042BSRL	20 x 42 x 29.5-30	125	121	18	\$1245	\$1331	N/A	\$202

Box/box/file pedestal on **left**. 12"H modesty panel. Pedestal locks.

Required Specifications

Primary surface type + finish
 Top thickness/edge detail
 Lock finish
 Drawer front finish
 Base finish
 Handles

Optional Specifications

Key #
 Grommet position or power block cut-out

Accessories

Power block
 Keyboard
 Pencil drawer

FULL TO FLOOR RETURNS

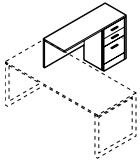

Full to Floor Return - RIGHT

MODEL#	DIMENSIONS	FREIGHT CLASS	WT/LBS.	CUBIC FT.	1"TOP	1.5" TOP	GLAZE ADD	HP ADD	
D x W x H									
Z2448BSRR	24 x 48 x 29.5-30	150	138	24.25	\$1355	\$1468	N/A	\$278	
Z2442BSRR	24 x 42 x 29.5-30	125	132	21.5	\$1333	\$1431	N/A	\$244	
Z2048BSRR	20 x 48 x 29.5-30	125	125	20.5	\$1284	\$1379	N/A	\$234	
Z2042BSRR	20 x 42 x 29.5-30	125	121	18	\$1245	\$1331	N/A	\$202	

Box/box/file pedestal on **right**. 12"H modesty panel. Pedestal locks.

FULL TO FLOOR FLUSH RETURNS

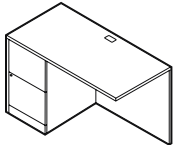

Full to Floor Flush Return - LEFT

MODEL#	DIMENSIONS	FREIGHT CLASS	WT/LBS.	CUBIC FT.	1"TOP	1.5" TOP	GLAZE ADD	HP ADD
Z24722L	24 x 72 x 29.5-30	150	206	35.75	\$1628	\$1728	N/A	\$409
Z24662L	24 x 66 x 29.5-30	150	195	32.75	\$1554	\$1652	N/A	\$409
Z24602L	24 x 60 x 29.5-30	125	184	30	\$1480	\$1580	N/A	\$376
Z24542L	24 x 54 x 29.5-30	150	165	29.75	\$1406	\$1506	N/A	\$376
Z24482L	24 x 48 x 29.5-30	125	156	24.25	\$1332	\$1432	N/A	\$300
Z20722L	20 x 72 x 29.5-30	150	169	30.25	\$1431	\$1531	N/A	\$409
Z20662L	20 x 66 x 29.5-30	150	162	27.75	\$1406	\$1506	N/A	\$409
Z20602L	20 x 60 x 29.5-30	125	153	25.25	\$1382	\$1480	N/A	\$340
Z20542L	20 x 54 x 29.5-30	150	136	23	\$1357	\$1455	N/A	\$340
Z20482L	20 x 48 x 29.5-30	125	129	20.5	\$1292	\$1382	N/A	\$252

Standard with file/file pedestal on **left**. Grommet in worksurface. One pencil tray. Pedestal locks.

- Does not accommodate storage shells.



Full to Floor Flush Return - LEFT

Z24723L	24 x 72 x 29.5-30	125	171	24.5	\$1796	\$1962	N/A	\$409
Z24663L	24 x 66 x 29.5-30	125	171	24.5	\$1764	\$1913	N/A	\$409
Z24603L	24 x 60 x 29.5-30	125	171	24.5	\$1650	\$1792	N/A	\$376
Z24543L	24 x 54 x 29.5-30	125	171	24.5	\$1594	\$1723	N/A	\$376
Z24483L	24 x 48 x 29.5-30	125	171	24.5	\$1503	\$1619	N/A	\$300
Z20723L	20 x 72 x 29.5-30	65	97	4.3	\$1644	\$1785	N/A	\$409
Z20663L	20 x 66 x 29.5-30	65	97	4.3	\$1589	\$1725	N/A	\$409
Z20603L	20 x 60 x 29.5-30	65	97	4.3	\$1562	\$1684	N/A	\$340
Z20543L	20 x 54 x 29.5-30	65	97	4.3	\$1498	\$1614	N/A	\$340
Z20483L	20 x 48 x 29.5-30	125	154	20.75	\$1463	\$1564	N/A	\$252

Standard with box/box/file pedestal on **left**. Grommet in worksurface. One pencil tray. File drawer and lower box drawer lock.

- Does not accommodate storage shells.

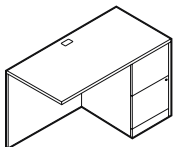

Full to Floor Flush Return - RIGHT

Z24722R	24 x 72 x 29.5-30	150	206	35.75	\$1628	\$1728	N/A	\$409
Z24662R	24 x 66 x 29.5-30	150	195	32.75	\$1554	\$1652	N/A	\$409
Z24602R	24 x 60 x 29.5-30	125	184	30	\$1480	\$1580	N/A	\$376
Z24542R	24 x 54 x 29.5-30	150	165	29.75	\$1406	\$1506	N/A	\$376
Z24482R	24 x 48 x 29.5-30	125	156	24.25	\$1332	\$1432	N/A	\$300
Z20722R	20 x 72 x 29.5-30	150	169	30.25	\$1431	\$1531	N/A	\$409
Z20662R	20 x 66 x 29.5-30	150	162	27.75	\$1406	\$1506	N/A	\$409
Z20602R	20 x 60 x 29.5-30	125	153	25.25	\$1382	\$1480	N/A	\$340
Z20542R	20 x 54 x 29.5-30	150	136	23	\$1357	\$1455	N/A	\$340
Z20482R	20 x 48 x 29.5-30	125	129	20.5	\$1292	\$1382	N/A	\$252

Standard with file/file pedestal on **right**. Grommet in worksurface. One pencil tray. Pedestal locks.

- Does not accommodate storage shells.

Required Specifications

Primary surface type + finish
 Top thickness/edge detail
 Base finish
 Drawer front finish

Lock finish

Optional Specifications

Key #
 Grommet position or power block cut-out
 Handles

Accessories

Power block
 Pencil drawer
 Keyboard

FULL TO FLOOR FLUSH RETURNS



Full to Floor Flush Return - RIGHT

MODEL#	DIMENSIONS	FREIGHT CLASS	WT/LBS.	CUBIC FT.	1"TOP	1.5" TOP	GLAZE ADD	HP ADD
D x W x H								
Z24723R	24 x 72 x 29.5-30	125	171	24.5	\$1796	\$1962	N/A	\$409
Z24663R	24 x 66 x 29.5-30	125	171	24.5	\$1764	\$1913	N/A	\$409
Z24603R	24 x 60 x 29.5-30	125	171	24.5	\$1650	\$1792	N/A	\$376
Z24543R	24 x 54 x 29.5-30	125	171	24.5	\$1594	\$1723	N/A	\$376
Z24483R	24 x 48 x 29.5-30	125	171	24.5	\$1503	\$1619	N/A	\$300
Z20723R	20 x 72 x 29.5-30	65	97	4.3	\$1644	\$1785	N/A	\$409
Z20663R	20 x 66 x 29.5-30	65	97	4.3	\$1589	\$1725	N/A	\$409
Z20603R	20 x 60 x 29.5-30	65	97	4.3	\$1562	\$1684	N/A	\$340
Z20543R	20 x 54 x 29.5-30	65	97	4.3	\$1498	\$1614	N/A	\$340
Z20483R	20 x 48 x 29.5-30	125	154	20.75	\$1463	\$1564	N/A	\$252

Standard with box/box/file pedestal on **right**. Grommet in worksurface. One pencil tray. File drawer and lower box drawer lock.

- Does not accommodate storage shells.

METAL LEG RETURNS



Return w/Metal Legs - LEFT*

MODEL#	DIMENSIONS	FREIGHT CLASS	WT/LBS.	CUBIC FT.	1"TOP	1.5" TOP	GLAZE ADD	HP ADD
Z3672MRL	36 x 72 x 29	100	116	11.74	\$1173	\$1386	N/A	\$665
Z3072MRL	30 x 72 x 29	92.5	100	10	\$1074	\$1260	N/A	\$547
Z3066MRL	30 x 66 x 29	100	94	9.74	\$1034	\$1200	N/A	\$547
Z3060MRL	30 x 60 x 29	100	88	9.24	\$986	\$1144	N/A	\$509
Z2472MRL	24 x 72 x 29	92.5	85	8.24	\$986	\$1135	N/A	\$409
Z2466MRL	24 x 66 x 29	92.5	80	8	\$948	\$1084	N/A	\$409
Z2460MRL	24 x 60 x 29	100	75	7.74	\$909	\$1038	N/A	\$376
Z2448MRL	24 x 48 x 29	100	56	5.74	\$784	\$885	N/A	\$300

Flush return attached to the edge of worksurface. Attaching hardware included. Leg shipped in separate carton. Shipped RTA (ready to assemble). **Not freestanding**. Metal leg available in Black (**BLK**) or Tungsten (**TUN**).

- Please note, glides need to be extended a small amount to accommodate the 29.5" height of standard Zira pieces.

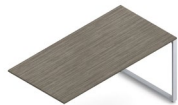

Return w/Metal Legs - RIGHT*

Z3672MRR	36 x 72 x 29	100	116	11.74	\$1173	\$1386	N/A	\$665
Z3072MRR	30 x 72 x 29	92.5	100	10	\$1074	\$1260	N/A	\$547
Z3066MRR	30 x 66 x 29	100	94	9.74	\$1034	\$1200	N/A	\$547
Z3060MRR	30 x 60 x 29	100	88	9.24	\$986	\$1144	N/A	\$509
Z2472MRR	24 x 72 x 29	92.5	85	8.24	\$986	\$1135	N/A	\$409
Z2466MRR	24 x 66 x 29	92.5	80	8	\$948	\$1084	N/A	\$409
Z2460MRR	24 x 60 x 29	100	75	7.74	\$909	\$1038	N/A	\$376
Z2448MRR	24 x 48 x 29	100	56	5.74	\$784	\$885	N/A	\$300

Flush return attached to the edge of worksurface. Attaching hardware included. Leg shipped in separate carton. Shipped RTA (ready to assemble). **Not freestanding**. Metal leg available in Black (**BLK**) or Tungsten (**TUN**).

- Please note, glides need to be extended a small amount to accommodate the 29.5" height of standard Zira pieces.

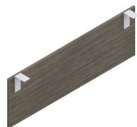

Melamine Modesty Panel

Z72LMP	.69 x 66 x 18.1	92.5	28	2.5	\$310	N/A	N/A	N/A
Z66LMP	.69 x 60 x 18.1	85	26	2	\$297	N/A	N/A	N/A
Z60LMP	.69 x 54 x 18.1	92.5	23	2	\$276	N/A	N/A	N/A
Z48LMP	.69 x 42 x 18.1	85	19	1.5	\$234	N/A	N/A	N/A

For returns with metal legs. Modular laminate modesty panel. Specify model # corresponding to worksurface length.

Required Specifications

Primary surface type + finish
 Top thickness/edge detail
 Base finish
 Drawer front finish

Lock finish

Optional Specifications

Key #
 Grommet position or power block cut-out
 Handles

Accessories

Power block
 Pencil drawer
 Keyboard

FLUSH BRIDGES

MODEL#	DIMENSIONS	FREIGHT CLASS	WT/LBS.	CUBIC FT.	1" TOP	1.5" TOP	GLAZE ADD	HP ADD
--------	------------	---------------	---------	-----------	--------	----------	-----------	--------

D x W x H

Z2448FB	24-36 x 48 x 29.5-30	70	91	4.3	\$668	\$777	N/A	\$275
Z2442FB	24-36 x 42 x 29.5-30	70	79	3.8	\$618	\$713	N/A	\$275
Z2436FB	24-36 x 36 x 29.5-30	70	69	3.3	\$618	\$713	N/A	\$208
Z2048FB	20-36 x 48 x 29.5-30	70	83	4.3	\$649	\$744	N/A	\$275
Z2042FB	20-36 x 42 x 29.5-30	70	72	3.8	\$601	\$696	N/A	\$275
Z2036FB	20-36 x 36 x 29.5-30	70	63	3.3	\$601	\$696	N/A	\$208

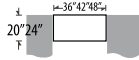

Flush Bridge

Top surface, back panel and hardware to create a "U" shape by connecting two units with full end panels. Grommet in worksurface. Shipped assembled in 1 carton.

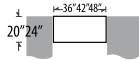

Flush Bridge w/Wall Access

Z2448FBSL	24 x 48 x 29.5-30	65	100	4.3	\$697	\$793	N/A	\$972
Z2442FBSL	24 x 42 x 29.5-30	65	86	3.8	\$652	\$738	N/A	\$927
Z2436FBSL	24 x 36 x 29.5-30	70	69	3.3	\$652	\$738	N/A	\$860
Z2048FBSL	20 x 48 x 29.5-30	70	92	4.3	\$677	\$763	N/A	\$952
Z2042FBSL	20 x 42 x 29.5-30	70	80	3.8	\$637	\$723	N/A	\$912
Z2036FBSL	20 x 36 x 29.5-30	70	63	3.3	\$637	\$723	N/A	\$845

Top surface, 12"H modesty panel (for wall access) and hardware to create a "U" shape by connecting two units with full end panels. Grommet in worksurface. Shipped assembled in 1 carton.

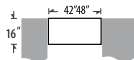

Flush Bridge

Z1648B	15.8-36 x 48 x 29.5-30	70	66.15	4.25	\$507	\$601	N/A	\$715
Z1642B	15.8-36 x 42 x 29.5-30	70	59.85	3.75	\$444	\$531	N/A	\$652

16" Throat. Top surface, back panel and hardware to create a "U" shape by connecting two units with a 16"throat and full end panels. Grommet in worksurface. Shipped assembled in 1 carton.

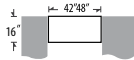

Flush Bridge w/Wall Access

Z1648BSL	15.8 x 48 x 29.5-30	70	66	4.25	\$551	\$637	N/A	\$759
Z1642BSL	15.8 x 42 x 29.5-30	100	30	3.75	\$495	\$571	N/A	\$703

16" Throat. Top surface, 12"H modesty (for wall access) and hardware to create a "U" shape by connecting two units with a 16"throat and full end panels. Shipped assembled in 1 carton.

Required Specifications

Primary surface type + finish
 Top thickness/edge detail
 Base finish
 Leg finish* (BLK or TUN)
 Lock finish

Optional Specifications

Handles
 Key #
 Modesty type
 Grommet position or power block cut-out

Accessories

Power block
 Pencil drawer

SPACE SAVER BRIDGES

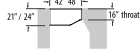

Space Saver Bridge - LEFT

MODEL#	DIMENSIONS D x W x H	FREIGHT CLASS	WT/LBS.	CUBIC FT.	1" TOP	1.5" TOP	GLAZE ADD	HP ADD
Z244816BL	24 x 48 x 29.5-30	70	82	4.25	\$593	\$732	N/A	\$275
Z244216BL	24 x 42 x 29.5-30	70	71	3.75	\$521	\$646	N/A	\$275
Z214816BL	21 x 48 x 29.5-30	70	76	4.25	\$550	\$666	N/A	\$275
Z214216BL	21 x 42 x 29.5-30	70	65	3.75	\$477	\$584	N/A	\$275

16" Throat. Top surface, back panel and hardware to connect extended corners, desks and islands with a 16" throat. Grommet in worksurface. Shipped easy to assemble in 1 carton.

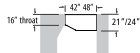

Space Saver Bridge - RIGHT

Z244816BR	24 x 48 x 29.5-30	70	82	4.25	\$593	\$732	N/A	\$275
Z244216BR	24 x 42 x 29.5-30	70	71	3.75	\$521	\$646	N/A	\$275
Z214816BR	21 x 48 x 29.5-30	70	76	4.25	\$550	\$666	N/A	\$275
Z214216BR	21 x 42 x 29.5-30	70	65	3.75	\$477	\$584	N/A	\$275

16" Throat. Top surface, back panel and hardware to connect extended corners, desks and islands with a 16" throat. Grommet in worksurface. Shipped easy to assemble in 1 carton.

TRANSITIONAL BRIDGES



Overlapping Bridge - LEFT*

MODEL#	DIMENSIONS	FREIGHT CLASS	WT/LBS.	CUBIC FT.	1" TOP	1.5" TOP	GLAZE ADD	HP ADD
Z2468TRL	24 x 68 x 5.9	85	64	5.25	\$629	\$795	N/A	\$395
Z2462TRL	24 x 62 x 5.9	85	59	4.70	\$586	\$736	N/A	\$358
Z2472TRL	24 x 72 x 5.9	85	64	5.25	\$639	\$805	N/A	\$416
Z2466TRL	24 x 66 x 5.9	85	62	4.70	\$601	\$753	N/A	\$382

For 20"/24"D, 23.75"/24.25"H Storage with No Modesty. Overlaps storage on **left**. Shipped easy to assemble in 1 carton.

- Use Z2462TRR and Z2468TRR for 20"D storage.
- Use Z2466TRR and Z2472TRR for 24"D storage.



Overlapping Bridge - RIGHT*

Z2468TRR	24 x 68 x 5.9	85	64	5.25	\$629	\$795	N/A	\$395
Z2462TRR	24 x 62 x 5.9	85	59	4.70	\$586	\$736	N/A	\$358
Z2472TRR	24 x 72 x 5.9	85	64	5.25	\$639	\$805	N/A	\$416
Z2466TRR	24 x 66 x 5.9	85	62	4.70	\$601	\$753	N/A	\$382

For 20"/24"D, 23.75"/24.25"H Storage with No Modesty. Overlaps storage on **right**. Shipped easy to assemble in 1 carton.

- Use Z2462TRR and Z2468TRR for 20"D storage.
- Use Z2466TRR and Z2472TRR for 24"D storage.



Flush Bridge

Z24483BR	24 x 48 x 13-13.5	70	55	3.50	\$668	\$777	N/A	\$275
Z24423BR	24 x 42 x 13-13.5	70	48	3.10	\$618	\$752	N/A	\$244
Z24363BR	24 x 36 x 13-13.5	70	43	2.70	\$618	\$734	N/A	\$210
Z20483BR	20 x 48 x 13-13.5	70	48	3	\$649	\$776	N/A	\$234
Z20423BR	20 x 42 x 13-13.5	70	43	2.70	\$601	\$714	N/A	\$202
Z20363BR	20 x 36 x 13-13.5	70	38	2.40	\$601	\$699	N/A	\$175

For use with storage models ZxxxxBBOL/R and ZxxxxBLFL/R. 12"H modesty panel. Shipped easy to assemble in 1 carton.

Required Specifications

Primary surface type + finish
Top thickness/edge detail
Base finish

Optional Specifications

Grommet position or power block cut-out

Accessories

Power block
Pencil drawer*

TRANSITIONAL BRIDGES

MODEL#	DIMENSIONS	FREIGHT CLASS	WT/LBS.	CUBIC FT.	1" TOP	1.5" TOP	GLAZE ADD	HP ADD
--------	------------	---------------	---------	-----------	--------	----------	-----------	--------

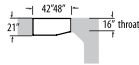

Transitional Bridge - LEFT

	D x W x H							
Z2148TRBL	21 x 48 x 29.5-30	70	75.83	4.25	\$572	\$688	N/A	\$275
Z2142TRBL	21 x 42 x 29.5-30	70	64.78	3.75	\$500	\$607	N/A	\$275

For 21" wide storage module. Top surface, back panel, shorter kickplate and hardware to connect 21" wide storage module with 16" throat. Grommet in worksurface. Shipped easy to assemble in 1 carton.

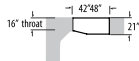

Transitional Bridge - RIGHT

Z2148TRBR	21 x 48 x 29.5-30	70	75.83	4.25	\$572	\$688	N/A	\$275
Z2142TRBR	21 x 42 x 29.5-30	70	64.78	3.75	\$500	\$607	N/A	\$275

For 21" wide storage module. Top surface, back panel, shorter kickplate and hardware to connect 21" wide storage module with 16" throat. Grommet in worksurface. Shipped easy to assemble in 1 carton.

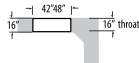

Transitional Bridge - LEFT

Z1648TRBL	16 x 48 x 29.5-30	70	68.58	4.25	\$529	\$623	N/A	\$208
Z1642TRBL	16 x 42 x 29.5-30	70	58.96	3.75	\$467	\$556	N/A	\$208

For 16" Wide Storage Module. Top surface, back panel and hardware to connect 16" wide storage module with 16" throat. Grommet in worksurface. Shipped easy to assemble in 1 carton.

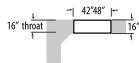

Transitional Bridge - RIGHT

Z1648TRBR	16 x 48 x 29.5-30	70	68.58	4.25	\$529	\$623	N/A	\$208
Z1642TRBR	16 x 42 x 29.5-30	70	58.96	3.75	\$467	\$556	N/A	\$208

For 16" Wide Storage Module. Top surface, back panel and hardware to connect 16" wide storage module with 16" throat. Grommet in worksurface. Shipped easy to assemble in 1 carton.

Required Specifications

Primary surface type + finish
Top thickness/edge detail
Base finish

Optional Specifications

Grommet position or power block cut-out

Accessories

Power block
Pencil drawer*

18"H CREDENZAS



Lateral File Credenza - LEFT

MODEL#	DIMENSIONS D x W x H	FREIGHT CLASS	WT/LBS.	CUBIC FT.	1" TOP	1.5" TOP	GLAZE ADD	HP ADD
Z2472LOFL	24 x 72 x 17.87-18.37	125	181	22.75	\$1732	\$1874	N/A	\$416
Z2460LOFL	24 x 60 x 17.87-18.37	100	160	19.25	\$1538	\$1657	N/A	\$349
Z2072LOFL	20 x 72 x 17.87-18.37	100	164	19.25	\$1614	\$1733	N/A	\$349
Z2060LOFL	20 x 60 x 17.87-18.37	100	143	16.25	\$1422	\$1520	N/A	\$291

1 high lateral file on the **left**, open storage on the **right**.



Lateral File Credenza - RIGHT

Z2472LOFR	24 x 72 x 17.87-18.37	125	181	22.75	\$1732	\$1874	N/A	\$416
Z2460LOFR	24 x 60 x 17.87-18.37	100	160	19.25	\$1538	\$1657	N/A	\$349
Z2072LOFR	20 x 72 x 17.87-18.37	100	164	19.25	\$1614	\$1733	N/A	\$349
Z2060LOFR	20 x 60 x 17.87-18.37	100	143	16.25	\$1422	\$1520	N/A	\$291

1 high lateral file on the **right**, open storage on the **left**.



Glazed door option

Lateral File Credenza - LEFT*

Z2472LSFL	24 x 72 x 17.87-18.37	100	197	22.75	\$2019	\$2161	\$430	\$416
Z2460LSFL	24 x 60 x 17.87-18.37	100	174	19.25	\$1820	\$1939	\$383	\$349
Z2072LSFL	20 x 72 x 17.87-18.37	100	178	19.25	\$1890	\$2009	\$430	\$349
Z2060LSFL	20 x 60 x 17.87-18.37	100	155	16.25	\$1696	\$1794	\$383	\$291

1 high lateral file on the **left**, closed storage on the **right**.



Glazed door option

Lateral File Credenza - RIGHT*

Z2472LSFR	24 x 72 x 17.87-18.37	100	197	22.75	\$2019	\$2161	\$430	\$416
Z2460LSFR	24 x 60 x 17.87-18.37	100	174	19.25	\$1820	\$1939	\$383	\$349
Z2072LSFR	20 x 72 x 17.87-18.37	100	178	19.25	\$1890	\$2009	\$430	\$349
Z2060LSFR	20 x 60 x 17.87-18.37	100	155	16.25	\$1696	\$1794	\$383	\$291

1 high lateral file on the **right**, closed storage on the **left**.



Mixed Storage Credenza - LEFT

Z2472LMOL	24 x 72 x 17.87-18.37	100	197	22.75	\$1995	\$2137	N/A	\$416
Z2460LMOL	24 x 60 x 17.87-18.37	100	176	19.25	\$1821	\$1940	N/A	\$349
Z2072LMOL	20 x 72 x 17.87-18.37	100	178	19.25	\$1869	\$1988	N/A	\$349
Z2060LMOL	20 x 60 x 17.87-18.37	100	157	16.25	\$1699	\$1799	N/A	\$291

1 high mixed drawers on the **left**, open storage on the **right**.



Mixed Storage Credenza - RIGHT

Z2472LMOR	24 x 72 x 17.87-18.37	100	197	22.75	\$1995	\$2137	N/A	\$416
Z2460LMOR	24 x 60 x 17.87-18.37	100	176	19.25	\$1821	\$1939	N/A	\$349
Z2072LMOR	20 x 72 x 17.87-18.37	100	178	19.25	\$1869	\$1988	N/A	\$349
Z2060LMOR	20 x 60 x 17.87-18.37	100	157	16.25	\$1699	\$1799	N/A	\$291

1 high mixed drawers on the **right**, open storage on the **left**.

Required Specifications

Primary surface type + finish
 Top thickness/edge detail
 Base finish
 Door/drawer front finish

Handles

Optional Specifications

Key #
 Glazed hinged doors*
 Box drawer - no upcharge

24"H CREDENZAS



Lateral File Credenza - LEFT



Lateral File Credenza - RIGHT



Glazed door option

Lateral File Credenza - LEFT*



Glazed door option

Lateral File Credenza - RIGHT*

MODEL#	DIMENSIONS	FREIGHT CLASS	WT/LBS.	CUBIC FT.	1" TOP	1.5" TOP	GLAZE ADD	HP ADD
D x W x H								
Z2472HBFL	24 x 72 x 23.75-24.25	125	229	29.25	\$2170	\$2312	N/A	\$416
Z2460HBFL	24 x 60 x 23.75-24.25	100	201	24.50	\$1923	\$2042	N/A	\$349
Z2072HBFL	20 x 72 x 23.75-24.25	100	207	24.75	\$2044	\$2163	N/A	\$349
Z2060HBFL	20 x 60 x 23.75-24.25	100	180	20.75	\$1801	\$1901	N/A	\$291

1.5 high box/lateral file on the **left**, open storage on the **right**.

Z2472HBFR	24 x 72 x 23.75-24.25	125	229	29.25	\$2170	\$2312	N/A	\$416
Z2460HBFR	24 x 60 x 23.75-24.25	100	201	24.50	\$1923	\$2042	N/A	\$349
Z2072HBFR	20 x 72 x 23.75-24.25	100	207	24.75	\$2044	\$2163	N/A	\$349
Z2060HBFR	20 x 60 x 23.75-24.25	100	180	20.75	\$1801	\$1901	N/A	\$291

1.5 high box/lateral file on the **right**, open storage on the **left**.

Z2472HFSL	24 x 72 x 23.75-24.25	100	251	29.25	\$2539	\$2681	\$589	\$416
Z2460HFSL	24 x 60 x 23.75-24.25	100	221	24.50	\$2265	\$2384	\$511	\$349
Z2072HFSL	20 x 72 x 23.75-24.25	100	227	24.75	\$2385	\$2504	\$589	\$349
Z2060HFSL	20 x 60 x 23.75-24.25	100	198	20.75	\$2132	\$2232	\$511	\$291

1.5 high box/lateral file on the **left**, closed storage on the **right**.

Z2472HFSL	24 x 72 x 23.75-24.25	100	251	29.25	\$2539	\$2681	\$589	\$416
Z2460HFSL	24 x 60 x 23.75-24.25	100	221	24.50	\$2265	\$2384	\$511	\$349
Z2072HFSL	20 x 72 x 23.75-24.25	100	227	24.75	\$2385	\$2504	\$589	\$349
Z2060HFSL	20 x 60 x 23.75-24.25	100	198	20.75	\$2132	\$2232	\$511	\$291

1.5 high box/lateral file on the **right**, closed storage on the **left**.

Required Specifications

Primary surface type + finish
 Top thickness/edge detail
 Base finish
 Door/drawer front finish

Handles

Optional Specifications

Key #
 Glazed hinged doors*
 Box drawer - no upcharge

CREDENZAS



Glazed door option

Center Storage Credenza**

MODEL#	DIMENSIONS D x W x H	FREIGHT CLASS	WT/LBS.	CUBIC FT.	1" TOP	1.5" TOP	GLAZE ADD	HP ADD
Z2072C	20 x 72 x 29.5-30	100	286	30	\$2193	\$2731	\$722	\$409

Standard with box/file pedestals on both sides and self-closing hinged center doors covering one adjustable shelf. Pedestals and doors lock, keyed alike. Two pencil trays.



Kneespace Credenza*

Z2472CK	24 x 72 x 29.5-30	125	262	35.50	\$1780	\$2082	N/A	\$409
Z2466CK	24 x 66 x 29.5-30	125	250	33	\$1780	\$2017	N/A	\$409
Z2072CK	20 x 72 x 29.5-30	125	235	30	\$1700	\$1873	N/A	\$409
Z2066CK	20 x 66 x 29.5-30	100	225	27.75	\$1700	\$1836	N/A	\$409
Z2060CK	20 x 60 x 29.5-30	100	219	25.25	\$1635	\$1744	N/A	\$340

Standard with box/file pedestals on both sides. Center is open. Pedestals lock, keyed alike. Two pencil trays. Grommet in worksurface.



Full to Floor Single Pedestal Credenza- LEFT*

Z2472CS2L	24 x 72 x 29.5-30	100	228	25.75	\$1674	\$1845	N/A	\$409
Z2466CS2L	24 x 66 x 29.5-30	125	217	32.75	\$1643	\$1801	N/A	\$409
Z2072CS2L	20 x 72 x 29-29.5	125	203	30.25	\$1534	\$1676	N/A	\$409
Z2066CS2L	20 x 66 x 29-29.5	125	193	27.75	\$1477	\$1605	N/A	\$409

Standard with full to floor file/file pedestal on the **left**. Pedestal locks. Grommet in worksurface.



Full to Floor Single Pedestal Credenza- RIGHT*

Z2472CS2R	24 x 72 x 29.5-30	100	228	25.75	\$1674	\$1845	N/A	\$409
Z2466CS2R	24 x 66 x 29.5-30	125	217	32.75	\$1643	\$1801	N/A	\$409
Z2072CS2R	20 x 72 x 29.5-30	125	203	30.25	\$1534	\$1676	N/A	\$409
Z2066CS2R	20 x 66 x 29.5-30	125	193	27.75	\$1477	\$1605	N/A	\$409

Standard with full to floor file/file pedestal on the **right**. Pedestal locks. Grommet in worksurface.



Full to Floor Single Pedestal Credenza- LEFT*

Z2472CS4L	24 x 72 x 29-29.5	125	228	35.75	\$1742	\$1913	N/A	\$409
Z2466CS4L	24 x 66 x 29-29.5	125	217	32.75	\$1714	\$1872	N/A	\$409
Z2072CS4L	20 x 72 x 29-29.5	125	203	30.25	\$1589	\$1728	N/A	\$409
Z2066CS4L	20 x 66 x 29-29.5	125	193	25.75	\$1534	\$1670	N/A	\$409

Standard with full to floor box/box/file pedestal on the **left**. File drawer and lower box drawer lock. One pencil tray. Grommet in worksurface.



Full to Floor Single Pedestal Credenza- RIGHT*

Z2472CS4R	24 x 72 x 29-29.5	125	228	35.75	\$1742	\$1913	N/A	\$409
Z2466CS4R	24 x 66 x 29-29.5	125	217	32.75	\$1714	\$1872	N/A	\$409
Z2072CS4R	20 x 72 x 29-29.5	125	203	30.25	\$1589	\$1730	N/A	\$409
Z2066CS4R	20 x 66 x 29-29.5	125	193	25.75	\$1534	\$1670	N/A	\$409

Standard with full to floor box/box/file pedestal on the **right**. File drawer and lower box drawer lock. One pencil tray. Grommet in worksurface.

Required Specifications









Primary surface type + finish
Top thickness/edge detail
Base finish
Lock finish
Door/drawer front finish

Optional Specifications

Key #
Glazed doors**
Modesty type (only Z2xxxxCK)
Grommet position or power block cut-out
Box drawer - no upcharge

Accessories

Keyboard**
Power block (not Z2072C)
Pencil drawer (Z2472S2L/R only)

CREENZAS	MODEL#	DIMENSIONS	FREIGHT CLASS	WT/LBS.	CUBIC FT.	1" TOP	1.5" TOP	GLAZE ADD	HP ADD	
  <p>Glazed door option</p> <p>Storage Cabinet Credenza**</p>		D x W x H								
	Z2472SCSC	24 x 72 x 29.5-30	100	345	35.75	\$2401	\$2568	\$1615	\$409	
	Z2072SCSC	20 x 72 x 29.5-30	92.5	315	30.25	\$2110	\$2288	\$1615	\$409	
Two storage cabinets side-by-side. Hinged doors cover one adjustable shelf. Locking doors keyed alike.										
 <p>Lateral File Credenza**</p>	Z2472LF2	24 x 72 x 29.5-30	100	345	35.75	\$2769	\$3159	N/A	\$409	
	Z2072LF2	20 x 72 x 29.5-30	92.5	315	30.25	\$2713	\$3157	N/A	\$409	
Two 2-drawer lateral files side-by-side. Locking drawers, keyed alike. File bars included for side-to-side and front-to-back letter and legal filing capability. Anti-lock tilt suspension										
  <p>Glazed door option</p> <p>Lateral File/Storage Cabinet Credenza**</p>	Z2472LS	24 x 72 x 29.5-30	100	321	35.75	\$2478	\$2854	\$810	\$409	
	Z2072LS	20 x 72 x 29.5-30	100	286	30.25	\$2421	\$2852	\$810	\$409	
One 2-drawer lateral file and one storage cabinet. Locking door/drawers, keyed alike. Storage cabinet includes one adjustable shelf. File bars included for side-to-side and front-to-back letter and legal filing capability. Anti-lock tilt suspension. <ul style="list-style-type: none"> • File drawer construction is for accommodating hanging files NOT for stacking materials on the drawer bottom. 										
  <p>Glazed door option</p> <p>Buffet Credenza**</p>	Z482036BD	20 x 48 x 36	125	163	22.50	\$2353	\$2491	\$1015	\$442	
	Buffet credenza with one locking storage compartment with two doors. Hinged doors cover one three-position height adjustable shelf. Two 6" drawers above storage compartment are non-locking.									
 <p>Buffet Credenza*</p>	Z722036BD	20 x 72 x 36	125	242	33.50	\$3412	\$3580	\$2026	\$712	
	Z602036BD	20 x 60 x 36	125	188	28	\$2958	\$3110	\$1861	\$578	
Buffet credenza with two locking storage compartments side by side. Hinged doors cover 1 three-position height adjustable shelf. Two 6" drawers above storage compartment are non-locking.										
 <p>Kneespace Lateral File Credenza - LEFT</p>	Z2472LKL	24 x 72 x 29.5-30	125	262	35.75	\$2178	\$2513	N/A	\$409	
	Z2072LKL	20 x 72 x 29.5-30	125	235	30.25	\$2123	\$2514	N/A	\$409	
One 2-drawer lateral file on the left . Locking drawers. File bars included for side-to-side and front-to-back letter/legal filing capability. Anti-lock tilt suspension. Grommet in worksurface. <ul style="list-style-type: none"> • File drawer construction is for accommodating hanging files NOT for stacking materials on the drawer bottom. 										

Required Specifications

Primary surface type + finish
 Top thickness/edge detail
 Base finish Lock finish
 Door/drawer front finish

Optional Specifications

Key # Glazed doors**
 Handles
 Grommet position or power block cut-out

Accessories

Keyboard**
 Power block (not Z2072C)
 Pencil drawer (Z2472S2L/R only)

CRENZAS	MODEL#	DIMENSIONS	FREIGHT CLASS	WT/LBS.	CUBIC FT.	1" TOP	1.5" TOP	GLAZE ADD	HP ADD
		D x W x H							
	Z2472LKR	24 x 72 x 29.5-30	125	262	35.75	\$2178	\$2513	N/A	\$409
	Z2072LKR	20 x 72 x 29.5-30	125	235	30.25	\$2123	\$2514	N/A	\$409



Kneespace Lateral File Credenza - RIGHT

One 2-drawer lateral file on the **right**. Locking drawers. File bars included for side-to-side and front-to-back letter/legal filing capability. Anti-lock tilt suspension. Grommet in worksurface.

- File drawer construction is for accommodating hanging files *NOT* for stacking materials on the drawer bottom.



Glazed door option

Kneespace Storage Cabinet Credenza- LEFT*

One storage cabinet on the **left**. Locking doors. Storage cabinet has one adjustable shelf. Grommet in worksurface.

Z2472SKL	24 x 72 x 29.5-30	125	241	35.75	\$1717	\$2066	\$810	\$409
Z2072SKL	20 x 72 x 29.5-30	125	207	30.25	\$1661	\$2063	\$810	\$409



Glazed door option

Kneespace Storage Cabinet Credenza- RIGHT*

One storage cabinet on the **right**. Locking doors. Storage cabinet has one adjustable shelf. Grommet in worksurface.

Z2472SKR	24 x 72 x 29.5-30	125	241	35.75	\$1717	\$2066	\$810	\$409
Z2072SKR	20 x 72 x 29.5-30	125	207	30.25	\$1661	\$2063	\$810	\$409

Required Specifications

Primary surface type + finish
 Top thickness/edge detail
 Base finish
 Door/drawer front finish

Handles

Optional Specifications

Key #
 Glazed door*
 Modesty finish glazed
 Grommet position or power block cut-out

Accessories

Power block

5-SIDED CORNERS	MODEL#	DIMENSIONS	FREIGHT CLASS	WT/LBS.	CUBIC FT.	1" TOP	1.5" TOP	GLAZE ADD	HP ADD
	Z42245C	42 x 42 x 29.5-30	65	133	5.75	\$1042	\$1265	N/A	\$547
	<p>Connects to 30" D space saver connectable surfaces, 24" D connectables, returns and bridge. Grommet in worksurface. Narrow end panels on left and right. Not freestanding. Shipped easy to assemble in 1 carton.</p> <ul style="list-style-type: none"> • Modesty panel is 1" off of ground. • Full end panel(s) are available - add 15% upcharge 								
	Split left modesty panel (two 8"H sections for wall access)								
	Z42245CSLL	42 x 42 x 29.5-30	65	132	5.75	\$1134	\$1356	N/A	\$547
	Split right modesty panel (two 8"H sections for wall access)								
	Z42245CSLR	42 x 42 x 29.5-30	65	132	5.75	\$1134	\$1356	N/A	\$547
<p>Connects to 30" D space saver connectable surfaces, 24" D connectables, returns and bridge. Grommet in worksurface. Narrow end panels on left and right. Not freestanding. Shipped easy to assemble in 1 carton.</p> <ul style="list-style-type: none"> • Other full height modesty panel is 1" off of ground 									
	Z42205C	42 x 42 x 29.5-30	70	129	5.75	\$1042	\$1265	N/A	\$547
	<p>Connects to 24" D space saver connectable surfaces, 20" D returns, lateral files, storage/lateral file credenzas, credenzas, and bridges. Grommet in worksurface. Narrow end panels on left and right. Not freestanding. Shipped easy to assemble in 1 carton.</p> <ul style="list-style-type: none"> • Modesty panel is 1" off of ground. • Full end panel(s) are available - add 15% upcharge 								
	Split left modesty panel (two 8"H sections for wall access)								
	Z42205CSLL	42 x 42 x 29.5-30	70	128	5.75	\$1134	\$1356	N/A	\$547
	Split right modesty panel (two 8"H sections for wall access)								
	Z42205CSLR	42 x 42 x 29.5-30	70	128	5.75	\$1134	\$1356	N/A	\$547
<p>Connects to 24" D space saver connectable surfaces, 20" D returns, lateral files, storage/lateral file credenzas, credenzas, and bridges. Grommet in worksurface. Narrow end panels on left and right. Not freestanding. Shipped easy to assemble in 1 carton.</p> <ul style="list-style-type: none"> • Other full height modesty panel is 1" off of ground 									
	Z42165C	42 x 42 x 29.5-30	70	124	5.75	\$1073	\$1235	N/A	\$544
	<p>Connects to 20" D space saver connectable surfaces, 16" D returns, lateral files, storage/lateral file credenzas, credenzas, and bridges. Grommet in worksurface. Narrow end panels on left and right. Not freestanding. Shipped easy to assemble in 1 carton.</p> <ul style="list-style-type: none"> • Modesty panel is 1" off of ground. • Full end panel(s) are available - add 15% upcharge 								

Required Specifications

Primary surface type + finish
 Top thickness/edge detail
 Base finish

Optional Specifications

Grommet position or power block cut-out

Accessories

Power block
 Keyboard (*Not available on Z36165C*)

5-SIDED CORNERS

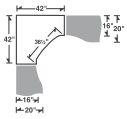

Left Right

5-Sided Corner w/Wall Access, 16" Throat

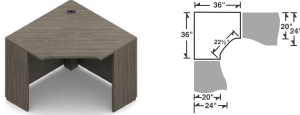

5-Sided Corner, 20" Throat*

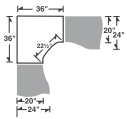

Left Right

5-Sided Corner w/Wall Access, 20" Throat

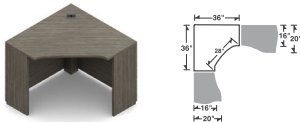

5-Sided Corner, 16" Throat*

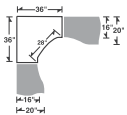

Left Right

5-Sided Corner w/Wall Access, 16" Throat

MODEL#	DIMENSIONS	FREIGHT CLASS	WT/LBS.	CUBIC FT.	1" TOP	1.5" TOP	GLAZE ADD	HP ADD
--------	------------	---------------	---------	-----------	--------	----------	-----------	--------

D x W x H

Split left modesty panel (two 8"H sections for wall access)

Z42165CSLL	42 x 42 x 29.5-30	70	124	5.75	\$1162	\$1323	N/A	\$544
------------	-------------------	----	-----	------	--------	--------	-----	-------

Split right modesty panel (two 8"H sections for wall access)

Z42165CSLR	42 x 42 x 29.5-30	70	124	5.75	\$1162	\$1323	N/A	\$544
------------	-------------------	----	-----	------	--------	--------	-----	-------

Connects to 20"D space saver connectable surfaces, 16"D returns, lateral files, storage/lateral file credenzas, credenzas, and bridges. Grommet in worksurface. Narrow end panels on left and right. **Not freestanding.** Shipped easy to assemble in 1 carton.
 • Other full height modesty panel is 1" off of ground

Z36205C	36 x 36 x 29.5-30	65	109	4.8	\$881	\$1009	N/A	\$354
---------	-------------------	----	-----	-----	-------	--------	-----	-------

Connects to 24"D space saver connectable surfaces, 20"D returns, lateral files, storage/lateral file credenzas, credenzas, and bridges. Grommet in worksurface. Narrow end panels on left and right. **Not freestanding.** Shipped easy to assemble in 1 carton.
 • Modesty Panel is 1" off of ground.
 • Full End Panel(s) are available - add 15% upcharge

Split left modesty panel (two 8"H sections for wall access)

Z36205CSLL	36 x 36 x 29.5-30	65	109	4.8	\$973	\$1100	N/A	\$354
------------	-------------------	----	-----	-----	-------	--------	-----	-------

Split right modesty panel (two 8"H sections for wall access)

Z36205CSLR	36 x 36 x 29.5-30	65	109	4.8	\$973	\$1100	N/A	\$354
------------	-------------------	----	-----	-----	-------	--------	-----	-------

Connects to 20"D space saver connectable surfaces, 16"D returns, lateral files, storage/lateral file credenzas, credenzas, and bridges. Grommet in worksurface. Narrow end panels on left and right. **Not freestanding.** Shipped easy to assemble in 1 carton.
 • Other full height modesty panel is 1" off of ground

Z36165C	36 x 36 x 29.5-30	70	105	4.8	\$939	\$1065	N/A	\$308
---------	-------------------	----	-----	-----	-------	--------	-----	-------

Connects to 20"D space saver connectable surfaces, 16"D returns, lateral files, storage/lateral file credenzas, credenzas, and bridges. Grommet in worksurface. Narrow end panels on left and right. **Not freestanding.** Shipped easy to assemble in 1 carton.
 • Modesty panel is 1" off of ground.
 • Full end panel(s) are available - add 15% upcharge

Split left modesty panel (two 8"H sections for wall access)

Z36165CSLL	36 x 36 x 29.5-30	70	105	4.8	\$1028	\$1156	N/A	\$308
------------	-------------------	----	-----	-----	--------	--------	-----	-------

Split right modesty panel (two 8"H sections for wall access)

Z36165CSLR	36 x 36 x 29.5-30	70	105	4.8	\$1028	\$1156	N/A	\$308
------------	-------------------	----	-----	-----	--------	--------	-----	-------

Connects to 20"D space saver connectable surfaces, 16"D returns, lateral files, storage/lateral file credenzas, credenzas, and bridges. Grommet in worksurface. Narrow end panels on left and right. **Not freestanding.** Shipped easy to assemble in 1 carton.
 • Other full height modesty panel is 1" off of ground

Required Specifications

Primary surface type + finish
 Top thickness/edge detail
 Base finish

Optional Specifications

Modesty type*
 Grommet position or power block cut-out

Accessories

Power block
 Keyboard

LEFT EXTENDED CORNER DESKS

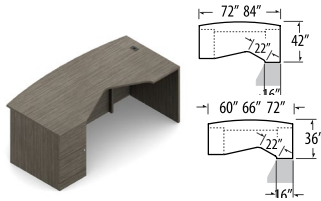

Single Pedestal Bow Top
Extended Corner Desk - LEFT*

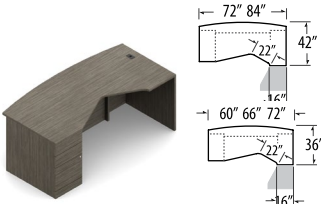

Single Pedestal Bow Top
Extended Corner Desk - LEFT*

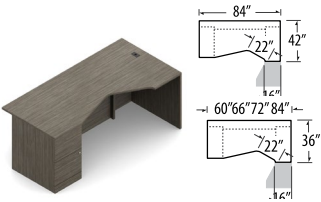

Single Pedestal Extended
Corner Desk - LEFT*

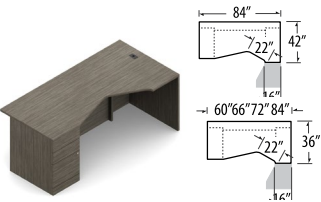

Single Pedestal Extended
Corner Desk - LEFT

MODEL#	DIMENSIONS	FREIGHT CLASS	WT/LBS.	CUBIC FT.	1" TOP	1.5" TOP	GLAZE ADD	HP ADD	
D x W x H									
Z4284EB2L	42 x 84 x 29.5-30	70	316.05	20.50	\$2222	\$2531	\$976	\$1081	
Z4272EB2L	42 x 72 x 29.5-30	150	331	59	\$2193	\$2460	\$810	\$812	
Z3672EB2L	36 x 72 x 29.5-30	150	273	50.75	\$1996	\$2230	\$810	\$611	
Z3666EB2L	36 x 66 x 29.5-30	150	260.40	46.75	\$1964	\$2179	\$723	\$611	
Z3660EB2L	36 x 60 x 29.5-30	125	257.25	42.50	\$1909	\$2104	\$639	\$509	

Extended worksurface on right. Standard with **Freestanding** full to floor file/file pedestal on **left** and faux pedestal on **right**. Pedestal locks. Connects to returns or bridges with a 16" throat. Corner has one grommet. Bow top overhangs 2¼" at ends and 6" on center.

- 84" wide desks are shipped RTA (ready to assemble) in 2 cartons.
- Hutches may not be placed on this desk.

Z4284EB3L	42 x 84 x 29.5-30	70	315	20.50	\$2243	\$2551	\$976	\$1081
Z4272EB3L	42 x 72 x 29.5-30	150	329	59	\$2219	\$2486	\$810	\$812
Z3672EB3L	36 x 72 x 29.5-30	150	270.90	50.75	\$2035	\$2269	\$810	\$611
Z3666EB3L	36 x 66 x 29.5-30	150	259.35	46.75	\$1977	\$2192	\$723	\$611
Z3660EB3L	36 x 60 x 29.5-30	125	255.15	42.50	\$1944	\$2139	\$639	\$509

Extended worksurface on right. Standard with **Freestanding** full to floor box/box/file pedestal on **left** and faux pedestal on **right**. File drawer and lower box drawer lock. Connects to returns or bridges with a 16" throat. Corner has one grommet. Bow top overhangs 2¼" at ends and 6" on center.

- 84" wide desks are shipped RTA (ready to assemble) in 2 cartons.
- Hutches may not be placed on this desk.

Z4284E2L	42 x 84 x 29.5-30	70	321.30	20.50	\$2313	\$2607	\$976	\$1081
Z3684E2L	36 x 84 x 29.5-30	250	311.85	118	\$2218	\$2512	\$976	\$812
Z3672E2L	36 x 72 x 29.5-30	150	278.25	50.75	\$1989	\$2210	\$810	\$611
Z3666E2L	36 x 66 x 29.5-30	150	265.65	46.75	\$1936	\$2138	\$723	\$611
Z3660E2L	36 x 60 x 29.5-30	125	259.35	42.50	\$1903	\$2087	\$639	\$509

Extended worksurface on right. Standard with **Freestanding** full to floor file/file pedestal on **left** and faux pedestal on **right**. Pedestal locks. Connects to returns or bridges with a 16" throat. Corner has one grommet. Top overhangs 2¼"

- 84" wide desks are shipped RTA (ready to assemble) in 2 cartons.
- Hutches may not be placed on this desk.

Z4284E3L	42 x 84 x 29.5-30	70	318.15	20.50	\$2235	\$2529	\$976	\$1081
Z3684E3L	36 x 84 x 29.5-30	250	309.75	118	\$2253	\$2546	\$976	\$812
Z3672E3L	36 x 72 x 29.5-30	150	275.10	50.75	\$2029	\$2250	\$810	\$611
Z3666E3L	36 x 66 x 29.5-30	150	263.55	46.75	\$1974	\$2176	\$723	\$611
Z3660E3L	36 x 60 x 29.5-30	125	257.25	42.50	\$1940	\$2122	\$639	\$509

Extended worksurface on right. Standard with **Freestanding** full to floor box/box/file pedestal on **left** and faux pedestal on **right**. File drawer and lower box drawer lock. Connects to returns or bridges with a 16" throat. Corner has one grommet. Top overhangs 2¼".

- 84" wide desks are shipped RTA (ready to assemble) in 2 cartons.
- Hutches may not be placed on this desk.

Required Specifications

Primary surface type + finish
Top thickness/edge detail
Lock finish
Drawer front finish

Base finish

Optional Specifications

Key #
Handles
Modesty panel type
Grommet position or power block cut-out

Modesty finish glazed, otherwise will match base finish

Accessories

Power block
Keyboard

RIGHT EXTENDED CORNER DESKS

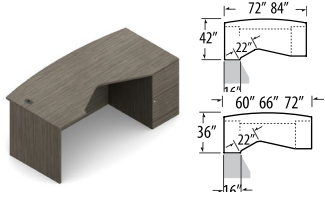

Single Pedestal Bow Top
Extended Corner Desk - RIGHT

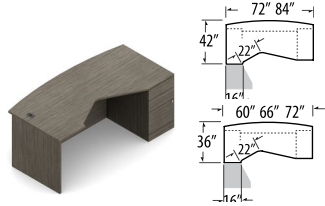

Single Pedestal Bow Top
Extended Corner Desk - RIGHT

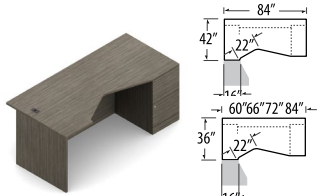

Single Pedestal Extended
Corner Desk - RIGHT

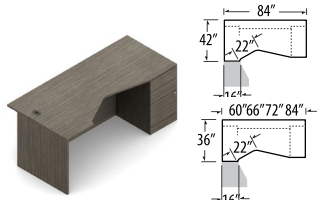

Single Pedestal Extended
Corner Desk - RIGHT

MODEL#	DIMENSIONS D x W x H	FREIGHT CLASS	WT/LBS.	CUBIC FT.	1" TOP	1.5" TOP	GLAZE ADD	HP ADD
Z4284EB2R	42 x 84 x 29.5-30	70	316.05	20.50	\$2222	\$2531	\$976	\$1081
Z4272EB2R	42 x 72 x 29.5-30	150	331	59	\$2193	\$2460	\$810	\$812
Z3672EB2R	36 x 72 x 29.5-30	150	273	50.75	\$1996	\$2230	\$810	\$611
Z3666EB2R	36 x 66 x 29.5-30	150	260.40	46.75	\$1964	\$2179	\$723	\$611
Z3660EB2R	36 x 60 x 29.5-30	125	257.25	42.50	\$1909	\$2104	\$639	\$509

Extended worksurface on right. Standard with faux pedestal on **left** and **Freestanding** full to floor file/file pedestal on **right**. Pedestal locks. Connects to returns or bridges with a 16" throat. Corner has one grommet. Bow top overhangs 2 1/4" at ends and 6" on center.

- 84" wide desks are shipped RTA (ready to assemble) in 2 cartons.
- Hutches may not be placed on this desk.

Z4284EB3R	42 x 84 x 29.5-30	70	315	20.50	\$2243	\$2551	\$976	\$1081
Z4272EB3R	42 x 72 x 29.5-30	150	329	59	\$2219	\$2486	\$810	\$812
Z3672EB3R	36 x 72 x 29.5-30	150	270.90	50.75	\$2035	\$2269	\$810	\$611
Z3666EB3R	36 x 66 x 29.5-30	150	259.35	46.75	\$1977	\$2192	\$723	\$611
Z3660EB3R	36 x 60 x 29.5-30	125	255.15	42.50	\$1944	\$2139	\$639	\$509

Extended worksurface on right. Standard with faux pedestal on **left** and **Freestanding** full to floor box/box/file pedestal on **right**. File drawer and lower box drawer lock. Connects to returns or bridges with a 16" throat. Corner has one grommet. Bow top overhangs 2 1/4" at ends and 6" on center.

- 84" wide desks are shipped RTA (ready to assemble) in 2 cartons.
- Hutches may not be placed on this desk.

Z4284E2R	42 x 84 x 29.5-30	70	321.30	20.50	\$2313	\$2607	\$976	\$1081
Z3684E2R	36 x 84 x 29.5-30	250	311.85	118	\$2218	\$2512	\$976	\$812
Z3672E2R	36 x 72 x 29.5-30	150	278.25	50.75	\$1989	\$2210	\$810	\$611
Z3666E2R	36 x 66 x 29.5-30	150	265.65	46.75	\$1936	\$2138	\$723	\$611
Z3660E2R	36 x 60 x 29.5-30	125	259.35	42.50	\$1903	\$2087	\$639	\$509

Extended worksurface on right. Standard with **Freestanding** full to floor file/file pedestal on **right** and faux pedestal on **left**. Pedestal locks. Connects to returns or bridges with a 16" throat. Corner has one grommet. Top overhangs 2 1/4"

- 84" wide desks are shipped RTA (ready to assemble) in 2 cartons.
- Hutches may not be placed on this desk.

Z4284E3R	42 x 84 x 29.5-30	70	318.15	20.50	\$2235	\$2529	\$976	\$1081
Z3684E3R	36 x 84 x 29.5-30	250	309.75	118	\$2253	\$2546	\$976	\$812
Z3672E3R	36 x 72 x 29.5-30	150	275.10	50.75	\$2029	\$2250	\$810	\$611
Z3666E3R	36 x 66 x 29.5-30	150	263.55	46.75	\$1974	\$2176	\$723	\$611
Z3660E3R	36 x 60 x 29.5-30	125	257.25	42.50	\$1940	\$2122	\$639	\$509

Extended worksurface on right. Standard with **Freestanding** full to floor box/box/file pedestal on **right** and faux pedestal on **left**. File drawer and lower box drawer lock. Connects to returns or bridges with a 16" throat. Corner has one grommet. Top overhangs 2 1/4"

- 84" wide desks are shipped RTA (ready to assemble) in 2 cartons.
- Hutches may not be placed on this desk.

Required Specifications

Primary surface type + finish
Top thickness/edge detail
Lock finish
Drawer front finish
Base finish

Optional Specifications

Key #
Modesty panel type
Grommet position or power block cut-out
Handles
Modesty finish glazed

Accessories

Power block
Keyboard

LEFT EXT CORNERS (DOES NOT CONNECT)

MODEL#	DIMENSIONS	FREIGHT CLASS	WT/LBS.	CUBIC FT.	1" TOP	1.5" TOP	GLAZE ADD	HP ADD
--------	------------	---------------	---------	-----------	--------	----------	-----------	--------

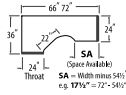

**Extended Corner, 24" Throat
Freestanding - LEFT**

Full end panels on left and right. Cannot be connected on left or right, due to full end panel.

Corner has one grommet. Shipped easy to assemble in 1 carton.

- Modesty panel is 1" off of ground.
- **Z2466FFL** cannot accept pedestals

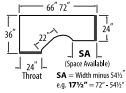

Z24xxFFLSLS Z24xxFFLSLW

**Extended Corner w/Wall Access
24" Throat, Freestanding - LEFT**

Split end panel on 36" D side (two 8"H sections for wall access)

Z2472FFLSLS	36 x 72 x 29.5-30	65	184	7	\$1417	\$1595	N/A	\$584
Z2466FFLSLS	36 x 66 x 29.5-30	65	172	7	\$1417	\$1584	N/A	\$584

Split modesty panel (two 8"H sections for wall access)

Z2472FFLSLW	36 x 72 x 29.5-30	65	172	7	\$1417	\$1595	N/A	\$584
Z2466FFLSLW	36 x 66 x 29.5-30	65	164	7	\$1417	\$1584	N/A	\$584

Z24xxFFLSLS have a full end panel on 20"D side and full height modesty panel. Z24xxFFLSLW have full end panels on left and right.

Cannot be connected on left or right. Corner has one grommet. Shipped easy to assemble in 1 carton.

- **Z2466FFLSLS** and **Z2466FFLSLW** cannot accept pedestals

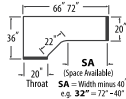

Extended Corner, 20" Throat - LEFT

Full end panels on left and right. Can be placed next to lateral files, storage cabinets, wardrobe units, credenzas and end shelves. Corner has one grommet. Shipped easy to assemble in 1 carton.

- Modesty panel is 1" off of ground.

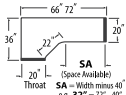

Z20xxFFLSLS Z20xxFFLSLW

**Extended Corner w/Wall Access
20" Throat, Freestanding - LEFT**

Split end panel on 36" D side (two 8"H sections for wall access)

Z2072FFLSLS	36 x 72 x 29.5-30	65	168	7	\$1378	\$1584	N/A	\$561
Z2066FFLSLS	36 x 66 x 29.5-30	65	161	7	\$1378	\$1545	N/A	\$561

Split modesty panel (two 8"H sections for wall access)

Z2072FFLSLW	36 x 72 x 29.5-30	65	163	7	\$1378	\$1584	N/A	\$561
Z2066FFLSLW	36 x 66 x 29.5-30	70	157	7	\$1378	\$1545	N/A	\$561

Z20xxFFLSLS have a full end panel on 20"D side and full height modesty panel. Z20xxFFLSLW have full end panels on left and right.

Can be placed next to lateral files, storage cabinets, wardrobe units, credenzas and end shelves. Corner has one grommet.

Shipped easy to assemble in 1 carton.

- **Z2066FFLSLS** and **Z2066FFLSLW** cannot accept pedestals

Required Specifications

Primary surface type + finish
Top thickness/edge detail
Base finish

Optional Specifications

Modesty type*
Grommet position or power block cut-out

Accessories

Power block
Keyboard

LEFT EXT CORNERS (CONNECTS ON EXTENDED SIDE)

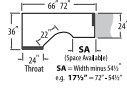

Extended Corner, 24" Throat - LEFT*

MODEL#	DIMENSIONS	FREIGHT CLASS	WT/LBS.	CUBIC FT.	1" TOP	1.5" TOP	GLAZE ADD	HP ADD
Z2472FNL	36 x 72 x 29.5-30	65	175	7	\$1291	\$1467	N/A	\$584
Z2466FNL	36 x 66 x 29.5-30	65	167	7	\$1291	\$1460	N/A	\$584

Narrow end panel on right. Full end panel on left. Connects to 30"D space saver connectables, 24"D returns, 24"D connectable tables or "D" and "P" islands with "T" or "H" bases. **Full end panel can be placed next to** lateral files, storage cabinets, wardrobe units, credenzas and end-shelves. Corner has one grommet. Shipped easy to assemble in 1 carton.

- Modesty panel is 1" off of ground.
- Z2466FNL cannot accept pedestals.

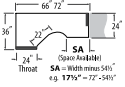

Z24xxFNLSLS

Z24xxFNLSLW

Extended Corner w/Wall Access
24" Throat - LEFT

Split end panel on 36"D side (two 8"H sections for wall access)

Z2472FNLSLS	36 x 72 x 29.5-30	65	172	7	\$1378	\$1556	N/A	\$584
Z2466FNLSLS	36 x 66 x 29.5-30	65	164	7	\$1378	\$1545	N/A	\$584

Split modesty panel (two 8"H sections for wall access)

Z2472FNLSLW	36 x 72 x 29.5-30	65	172	7	\$1378	\$1556	N/A	\$584
Z2466FNLSLW	36 x 66 x 29.5-30	65	164	7	\$1378	\$1556	N/A	\$584

Z24xxFNLSLS have a full height modesty panel. **Narrow end panel on right. Full end panel on left.** Connects to 30"D space saver connectables, 24"D returns, 24"D connectable tables or "D" and "P" islands with "T" or "H" bases. **Full end panel can be placed next to** lateral files, storage cabinets, wardrobe units, credenzas and end-shelves. Corner has one grommet. Shipped easy to assemble in 1 carton.

- Z2466FNLSLS and Z2466FNLSLW cannot accept pedestals

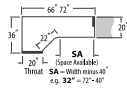

Extended Corner, 20" Throat - LEFT*

Z2072FNL	36 x 72 x 29.5-30	65	165	7	\$1253	\$1460	N/A	\$561
Z2066FNL	36 x 66 x 29.5-30	65	158	7	\$1253	\$1422	N/A	\$561

Narrow end panel on right. Full end panel on left. Connects to 24"D space saver connectables, 20"D returns, 20"D connectable tables or "D" and "P" islands with "T" or "H" bases. **Full end panel can be placed next to** lateral files, storage cabinets, wardrobe units, credenzas and end-shelves. Corner has one grommet. Shipped easy to assemble in 1 carton..

- Modesty panel is 1" off of ground.
- FNL end panels can be switched to make NFL.

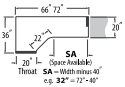

Z20xxFNLSLS

Z20xxFNLSLW

Extended Corner w/Wall Access
20" Throat - LEFT

Split end panel on 36"D side (two 8"H sections for wall access)

Z2072FNLSLS	36 x 72 x 29.5-30	65	163	7	\$1339	\$1556	N/A	\$584
Z2066FNLSLS	36 x 66 x 29.5-30	70	157	7	\$1339	\$1545	N/A	\$584

Split modesty panel (two 8"H sections for wall access)

Z2072FNLSLW	36 x 72 x 29.5-30	65	163	7	\$1339	\$1556	N/A	\$584
Z2066FNLSLW	36 x 66 x 29.5-30	70	157	7	\$1339	\$1556	N/A	\$584

Z20xxFNLSLS have a full height modesty panel. **Narrow end panel on right. Full end panel on left.** Connects to 24"D space saver connectables, 20"D returns, 20"D connectable tables or "D" and "P" islands with "T" or "H" bases. **Full end panel can be placed next to** lateral files, storage cabinets, wardrobe units, credenzas and end-shelves. Corner has one grommet. Shipped easy to assemble in 1 carton.

Required Specifications

Primary surface type + finish
Top thickness/edge detail
Base finish

Optional Specifications

Modesty type*
Grommet position or power block cut-out

Accessories

Power block
Keyboard

LEFT EXTENDED CORNERS (CONNECTS ON THROAT SIDE)

MODEL# DIMENSIONS FREIGHT CLASS WT/LBS. CUBIC FT. 1" TOP 1.5" TOP GLAZE ADD HP ADD

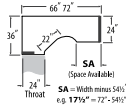

Extended Corner, 24" Throat - LEFT*

	D x W x H								
Z2472NFL	36 x 72 x 29.5-30	65	175	7	\$1291	\$1467	N/A	\$584	
Z2466NFL	36 x 66 x 29.5-30	65	167	7	\$1291	\$1460	N/A	\$584	

Narrow end panel on left. Full end panel on right. Connects to 30"D space saver connectables, 30"D space saver returns, 24"D returns or 24"D connectable tables. **Full end panel can be placed next to** lateral files, storage cabinets, wardrobe units, credenzas and end-shelves. Corner has one grommet. Shipped RTA (ready to assemble).

- Modesty panel is 1" off of ground.
- Z2466NFL cannot accept pedestals.

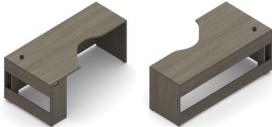
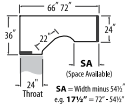

Z24xxNFLSLS Z24xxNFLSLW
Extended Corner w/Wall Access
24" Throat - LEFT

Split end panel on 36"D side (two 8"H sections for wall access)

Z2472NFLSLS	36 x 72 x 29.5-30	65	172	7	\$1378	\$1556	N/A	\$584	
Z2466NFLSLS	36 x 66 x 29.5-30	65	164	7	\$1378	\$1545	N/A	\$584	

Split modesty panel (two 8"H sections for wall access)

Z2472NFLSLW	36 x 72 x 29.5-30	65	172	7	\$1378	\$1556	N/A	\$584	
Z2466NFLSLW	36 x 66 x 29.5-30	65	164	7	\$1378	\$1545	N/A	\$584	

Z24xxNFLSLS have a full height modesty panel. **Narrow end panel on left. Full end panel on right.** Connects to 30"D space saver connectables, 30"D space saver returns, 24"D returns or 24"D connectable tables. **Full end panel can be placed next to** lateral files, storage cabinets, wardrobe units, credenzas and end-shelves. Corner has one grommet. Shipped easy to assemble in 1 carton.

- Z2466NFLSLS and Z2466NFLSLW cannot accept pedestals

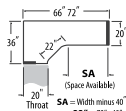

Extended Corner, 20" Throat - LEFT*

Z2072NFL	36 x 72 x 29.5-30	65	165	7	\$1253	\$1460	N/A	\$584	
Z2066NFL	36 x 66 x 29.5-30	65	158	7	\$1253	\$1422	N/A	\$561	

Narrow end panel on left. Full end panel on right. Connects to 24"D space saver connectables and 20"D returns. **Full end panel can be placed next to** lateral files, storage cabinets, wardrobe units, credenzas and end-shelves. Corner has one grommet. Shipped easy to assemble in 1 carton.

- Modesty panel is 1" off of ground.
- NFL end panels can be switched to make FNL.

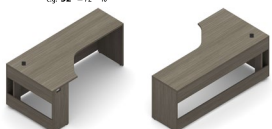
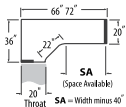

Z20xxNFLSLS Z20xxNFLSLW
Extended Corner w/Wall Access
20" Throat - LEFT

Split end panel on 36"D side (two 8"H sections for wall access)

Z2072NFLSLS	36 x 72 x 29.5-30	65	163	7	\$1339	\$1545	N/A	\$584	
Z2066NFLSLS	36 x 66 x 29.5-30	70	157	7	\$1339	\$1506	N/A	\$561	

Split modesty panel (two 8"H sections for wall access)

Z2072NFLSLW	36 x 72 x 29.5-30	65	163	7	\$1339	\$1545	N/A	\$584	
Z2066NFLSLW	36 x 66 x 29.5-30	70	157	7	\$1339	\$1506	N/A	\$561	

Z20xxNFLSLS have a full height modesty panel. **Narrow end panel on left. Full end panel on right.** Connects to 24"D space saver connectables and 20"D returns. **Full end panel can be placed next to** lateral files, storage cabinets, wardrobe units, credenzas and end-shelves. Corner has one grommet. Shipped easy to assemble in 1 carton.

Required Specifications

Primary surface type + finish
Top thickness/edge detail
Base finish

Optional Specifications

Modesty type*
Grommet position or power block cut-out

Accessories

Power block
Keyboard

LEFT EXTENDED CORNERS (CONNECTS ON THROAT SIDE)

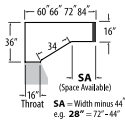
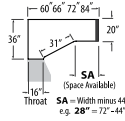
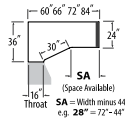

Extended Corner, 16" Throat - LEFT*

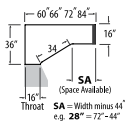
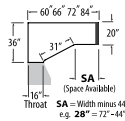
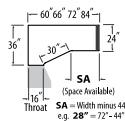

Extended Corner w/Wall Access, 16" Throat - LEFT

MODEL#	DIMENSIONS	FREIGHT CLASS	WT/LBS.	CUBIC FT.	1" TOP	1.5" TOP	GLAZE ADD	HP ADD
	D x W x H							
Z2484ECFL	36 x 84 x 29.5-30	65	196.35	8	\$1294	\$1600	N/A	\$812
Z2472ECFL	36 x 72 x 29.5-30	65	176.40	7.50	\$1158	\$1427	N/A	\$611
Z2466ECFL	36 x 66 x 29.5-30	70	168	7.50	\$1102	\$1352	N/A	\$611
Z2460ECFL	36 x 60 x 29.5-30	65	158.55	6	\$1047	\$1276	N/A	\$509
Z2084ECFL	36 x 84 x 29.5-30	65	184.80	8	\$1291	\$1599	N/A	\$812
Z2072ECFL	36 x 72 x 29.5-30	70	168	7.50	\$1153	\$1423	N/A	\$611
Z2066ECFL	36 x 66 x 29.5-30	70	159.60	7.50	\$1097	\$1348	N/A	\$611
Z2060ECFL	36 x 60 x 29.5-30	65	151.20	6	\$1028	\$1252	N/A	\$509
Z1684ECFL	36 x 84 x 29.5-30	70	175.35	8	\$1286	\$1594	N/A	\$812
Z1672ECFL	36 x 72 x 29.5-30	70	159.60	7.50	\$1149	\$1419	N/A	\$611
Z1666ECFL	36 x 66 x 29.5-30	70	153.30	7.50	\$1093	\$1344	N/A	\$611
Z1660ECFL	36 x 60 x 29.5-30	65	147	6	\$1020	\$1243	N/A	\$509

No narrow end panel on left front. Full height modesty panel. Full end panels on left and right. Connects to returns and bridges with 16" throat on the left. Full end panel can be placed next to lateral files, storage cabinets, wardrobe units, credenzas and end-shelves. Corner has one grommet. Does not accept pencil drawers. Shipped easy to assemble in 1 carton.

Z2484ECFLSLW	36 x 84 x 29.5-30	65	196	8	\$1384	\$1695	N/A	\$812
Z2472ECFLSLW	36 x 72 x 29.5-30	65	176	7.5	\$1250	\$1523	N/A	\$611
Z2466ECFLSLW	36 x 66 x 29.5-30	70	168	7.5	\$1195	\$1445	N/A	\$611
Z2460ECFLSLW	36 x 60 x 29.5-30	65	159	6	\$1139	\$1367	N/A	\$509
Z2084ECFLSLW	36 x 84 x 29.5-30	65	185	8	\$1378	\$1689	N/A	\$812
Z2072ECFLSLW	36 x 72 x 29.5-30	70	168	7.5	\$1245	\$1517	N/A	\$611
Z2066ECFLSLW	36 x 66 x 29.5-30	70	160	7.5	\$1189	\$1439	N/A	\$611
Z2060ECFLSLW	36 x 60 x 29.5-30	65	151	6	\$1123	\$1350	N/A	\$509
Z1684ECFLSLW	36 x 84 x 29.5-30	70	175	8	\$1373	\$1684	N/A	\$812
Z1672ECFLSLW	36 x 72 x 29.5-30	70	160	7.5	\$1239	\$1512	N/A	\$611
Z1666ECFLSLW	36 x 66 x 29.5-30	70	153	7.5	\$1184	\$1434	N/A	\$611
Z1660ECFLSLW	36 x 60 x 29.5-30	65	147	6	\$1112	\$1339	N/A	\$509

Split modesty with two 8"H sections for wall access. No narrow end panel on left front. Full end panels on left and right. Connects to returns and bridges with 16" throat on the left. Full end panel can be placed next to lateral files, storage cabinets, wardrobe units, credenzas and end-shelves. Corner has one grommet. Does not accept pencil drawers. Shipped easy to assemble in 1 carton.

Required Specifications

Primary surface type + finish
Top thickness/edge detail
Base finish

Optional Specifications

Modesty type*
Grommet position or power block cut-out

Accessories

Power block
Keyboard

LEFT EXT CORNERS (CONNECTS ON BOTH SIDES)

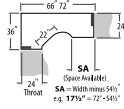

Extended Corner, 24" Throat - LEFT*

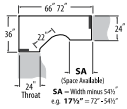

Z24xxNNLSLS Z24xxNNLSLW

Extended Corner w/Wall Access, 24" Throat - LEFT

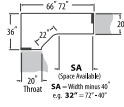

Extended Corner, 20" Throat - LEFT

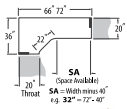

Z20xxNNLSLS Z20xxNNLSLW

Extended Corner w/Wall Access, 20" Throat - LEFT

MODEL#	D x W x H	DIMENSIONS	FREIGHT CLASS	WT/LBS.	CUBIC FT.	1" TOP	1.5" TOP	GLAZE ADD	HP ADD
Z2472NNL	36 x 72 x 29.5-30		65	166	7	\$1253	\$1429	N/A	\$584
Z2466NNL	36 x 66 x 29.5-30		65	158	7	\$1253	\$1422	N/A	\$584

Narrow end panels on left and right. Connects to 30"D space saver connectables, 30"D space saver returns, 24"D returns or 24"D connectable tables or "D" and "P" islands with "T" or "H" bases on either end. Corner has one grommet. Shipped easy to assemble in 1 carton.

- Modesty panel is 1" off of ground.
- Z2466NNL cannot accept pedestals.

Split end panel on 36"D side (two 8"H sections for wall access)

Z2472NNLSLS	36 x 72 x 29.5-30	65	172	7	\$1339	\$1517	N/A	\$584
Z2466NNLSLS	36 x 66 x 29.5-30	65	164	7	\$1339	\$1506	N/A	\$584

Split modesty panel (two 8"H sections for wall access)

Z2472NNLSLW	36 x 72 x 29.5-30	65	172	7	\$1339	\$1517	N/A	\$584
Z2466NNLSLW	36 x 66 x 29.5-30	65	164	7	\$1339	\$1506	N/A	\$584

Z24xxNNLSLS have a full height modesty panel. **Narrow end panels on left and right.** Connects to 30"D space saver connectables, 30"D space saver returns, 24"D returns or 24"D connectable tables or "D" and "P" islands with "T" or "H" bases on either end. Corner has one grommet. Shipped easy to assemble in 1 carton.

- Modesty panel is 1" off of ground.
- Z2466NNLSLS and Z2466NNLSLW cannot accept pedestals.

Z2072NNL	36 x 72 x 29.5-30	65	160	7	\$1215	\$1422	N/A	\$584
Z2066NNL	36 x 66 x 29.5-30	70	152	7	\$1215	\$1385	N/A	\$561

Narrow end panels on left and right. Connects to 24"D space saver connectables and 20"D returns, bridges or "D" and "P" islands with "T" or "H" bases on either end. Corner has one grommet. Shipped easy to assemble in 1 carton.

- Modesty panel is 1" off of ground.

Split end panel on 36"D side (two 8"H sections for wall access)

Z2072NNLSLS	36 x 72 x 29.5-30	65	163	7	\$1300	\$1506	N/A	\$584
Z2066NNLSLS	36 x 66 x 29.5-30	70	157	7	\$1300	\$1467	N/A	\$561

Split modesty panel (two 8"H sections for wall access)

Z2072NNLSLW	36 x 72 x 29.5-30	65	163	7	\$1300	\$1506	N/A	\$584
Z2066NNLSLW	36 x 66 x 29.5-30	70	157	7	\$1300	\$1467	N/A	\$561

Z20xxNNLSLS have a full height modesty panel. **Narrow end panels on left and right.** Connects to 24"D space saver connectables and 20"D returns, bridges or "D" and "P" islands with "T" or "H" bases on either end. Corner has one grommet. Shipped easy to assemble in 1 carton.

Required Specifications

Primary surface type + finish
Top thickness/edge detail
Base finish

Optional Specifications

Modesty type*
Grommet position or power block cut-out

Accessories

Power block
Keyboard

LEFT EXTENDED CORNERS (CONNECTS ON BOTH SIDES)

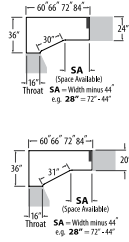

Extended Corner, 16" Throat - LEFT*

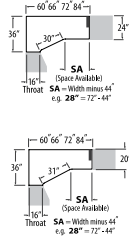

Extended Corner w/Wall Access, 16" Throat - LEFT

MODEL#	DIMENSIONS	FREIGHT CLASS	WT/LBS.	CUBIC FT.	1" TOP	1.5" TOP	GLAZE ADD	HP ADD
	D x W x H							
Z2484ECNL	36 x 84 x 29.5-30	65	186.90	8	\$1257	\$1565	N/A	\$812
Z2472ECNL	36 x 72 x 29.5-30	70	168	7.50	\$1120	\$1392	N/A	\$611
Z2466ECNL	36 x 66 x 29.5-30	70	158.55	7.50	\$1064	\$1314	N/A	\$611
Z2460ECNL	36 x 60 x 29.5-30	65	150.15	6	\$996	\$1219	N/A	\$509
Z2084ECNL	36 x 84 x 29.5-30	70	178.50	8	\$1253	\$1561	N/A	\$812
Z2072ECNL	36 x 72 x 29.5-30	70	161.70	7.50	\$1117	\$1386	N/A	\$611
Z2066ECNL	36 x 66 x 29.5-30	70	153.30	7.50	\$1061	\$1311	N/A	\$611
Z2060ECNL	36 x 60 x 29.5-30	65	145.95	6	\$991	\$1215	N/A	\$509

No narrow end panel on left front. Narrow end panel on right. Connects to returns and bridges with 16" throat on the left. **Full end panel can be placed next to** lateral files, storage cabinets, wardrobe units, credenzas and end-shelves. Corner has one grommet. **Does not accept pencil drawers.** Shipped easy to assemble in 1 carton.

Z2484ECNLSLW	36 x 84 x 29.5-30	65	187	8	\$1345	\$1656	N/A	\$812
Z2472ECNLSLW	36 x 72 x 29.5-30	70	168	7.5	\$1212	\$1484	N/A	\$611
Z2466ECNLSLW	36 x 66 x 29.5-30	70	159	7.5	\$1156	\$1406	N/A	\$611
Z2460ECNLSLW	36 x 60 x 29.5-30	65	150	6	\$1089	\$1317	N/A	\$509
Z2084ECNLSLW	36 x 84 x 29.5-30	70	179	8	\$1339	\$1650	N/A	\$812
Z2072ECNLSLW	36 x 72 x 29.5-30	70	162	7.5	\$1206	\$1517	N/A	\$812
Z2066ECNLSLW	36 x 66 x 29.5-30	70	153	7.5	\$1150	\$1400	N/A	\$611
Z2060ECNLSLW	36 x 60 x 29.5-30	65	146	6	\$1084	\$1312	N/A	\$509

Split modesty with two 8"H sections for wall access. **No narrow end panel on left front. Narrow end panel on right.** Connects to returns and bridges with 16" throat on the left. **Full end panel can be placed next to** lateral files, storage cabinets, wardrobe units, credenzas and end-shelves. Corner has one grommet. **Does not accept pencil drawers.** Shipped easy to assemble in 1 carton.

RIGHT EXT CORNERS (DOES NOT CONNECT)

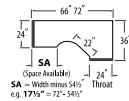

Extended Corner, 24" Throat - RIGHT Freestanding*

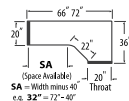

Extended Corner, 20" Throat - RIGHT*

MODEL#	DIMENSIONS	FREIGHT CLASS	WT/LBS.	CUBIC FT.	1" TOP	1.5" TOP	GLAZE ADD	HP ADD
Z2472FFR	36 x 72 x 29.5-30	65	184	7	\$1329	\$1505	N/A	\$584
Z2466FFR	36 x 66 x 29.5-30	65	175	7	\$1329	\$1499	N/A	\$584

Full end panels on left and right. Cannot be connected on left or right, due to full end panel.

Corner has one grommet. Shipped easy to assemble in 1 carton.

- Modesty panel is 1" off of ground.
- **Z2466FFR** cannot accept pedestals

Z2072FFR	36 x 72 x 29.5-30	65	171	7	\$1291	\$1498	N/A	\$561
Z2066FFR	36 x 66 x 29.5-30	65	164	7	\$1291	\$1460	N/A	\$561

Full end panels on left and right. Can be placed next to lateral files, storage cabinets, wardrobe units, credenzas and end-shelves. Corner has one grommet. Shipped easy to assemble in 1 carton.

- Modesty panel is 1" off of ground.

Required Specifications

Primary surface type + finish
Top thickness/edge detail
Base finish

Optional Specifications

Modesty type*
Grommet position or power block cut-out

Accessories

Power block
Keyboard
Pencil drawer

RIGHT EXTENDED CORNERS (CONNECTS ON THROAT SIDE)

MODEL#	DIMENSIONS	FREIGHT CLASS	WT/LBS.	CUBIC FT.	1" TOP	1.5" TOP	GLAZE ADD	HP ADD
--------	------------	---------------	---------	-----------	--------	----------	-----------	--------

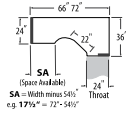

Extended Corner, 24" Throat - RIGHT

D x W x H								
Z2472FNR	36 x 72 x 29.5-30	65	175	7	\$1291	\$1467	N/A	\$584
Z2466FNR	36 x 66 x 29.5-30	65	167	7	\$1291	\$1460	N/A	\$584

Narrow end panel on right front. Full end panel on left. Connects to 30"D space saver connectables, 24"D returns, 24"D connectable tables or "D" and "P" islands with "T" or "H" bases. **Full end panel can be placed next to** lateral files, storage cabinets, wardrobe units, credenzas and end-shelves. Corner has one grommet. Shipped easy to assemble in 1 carton.

- Modesty panel is 1" off of ground.
- Z2466FNR cannot accept pedestals.

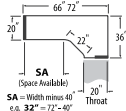

Extended Corner, 20" Throat - RIGHT

Z2072FNR	36 x 72 x 29.5-30	65	165	7	\$1253	\$1460	N/A	\$561
Z2066FNR	36 x 66 x 29.5-30	65	158	7	\$1253	\$1422	N/A	\$561

Narrow end panel on right front. Full end panel on left. Connects to 24"D space saver connectables, 20"D returns, 20"D connectable tables or "D" and "P" islands with "T" or "H" bases. **Full end panel can be placed next to** lateral files, storage cabinets, wardrobe units, credenzas and end-shelves. Corner has one grommet. Shipped easy to assemble in 1 carton.

- Modesty panel is 1" off of ground.
- FNR end panels can be switched to make NFR.

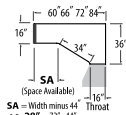
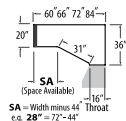
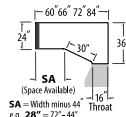

Extended Corner, 16" Throat - RIGHT

Z2484ECFR	36 x 84 x 29.5-30	65	196.35	8	\$1294	\$1600	N/A	\$812
Z2472ECFR	36 x 72 x 29.5-30	65	176.40	7.50	\$1158	\$1427	N/A	\$611
Z2466ECFR	36 x 66 x 29.5-30	70	168	7.50	\$1102	\$1352	N/A	\$611
Z2460ECFR	36 x 60 x 29.5-30	65	158.55	6	\$1047	\$1276	N/A	\$509
Z2084ECFR	36 x 84 x 29.5-30	65	184.80	8	\$1291	\$1599	N/A	\$812
Z2072ECFR	36 x 72 x 29.5-30	70	168	7.50	\$1153	\$1423	N/A	\$611
Z2066ECFR	36 x 66 x 29.5-30	70	159.60	7.50	\$1097	\$1348	N/A	\$611
Z2060ECFR	36 x 60 x 29.5-30	65	151.20	6	\$1028	\$1252	N/A	\$509
Z1684ECFR	36 x 84 x 29.5-30	70	175.35	8	\$1286	\$1594	N/A	\$812
Z1672ECFR	36 x 72 x 29.5-30	70	159.60	7.50	\$1149	\$1419	N/A	\$611
Z1666ECFR	36 x 66 x 29.5-30	70	153.30	7.50	\$1093	\$1344	N/A	\$611
Z1660ECFR	36 x 60 x 29.5-30	65	147	6	\$1020	\$1243	N/A	\$509

No narrow end panel on right front. Full end panel on left. Connects to returns and bridges with 16" throat on the right. **Full end panel can be placed next to** lateral files, storage cabinets, wardrobe units, credenzas and end-shelves. Corner has one grommet. **Does not accept pencil drawers.** Shipped easy to assemble in 1 carton.

Required Specifications

Primary surface type + finish
Top thickness/edge detail
Base finish

Optional Specifications

Modesty panel type
Grommet position or power block cut-out

Accessories

Power block
Keyboard (Not available on 16" throat)
Pencil drawer (Not available on 16" throat)

RIGHT EXTENDED CORNERS (CONNECTS ON EXTENDED SIDE)

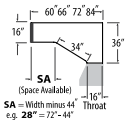
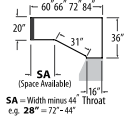
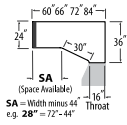

Extended Corner w/Wall Access, 16" Throat - RIGHT

MODEL#	DIMENSIONS	FREIGHT CLASS	WT/LBS.	CUBIC FT.	1" TOP	1.5" TOP	GLAZE ADD	HP ADD
D x W x H								
Z2484ECFRSLW	36 x 84 x 29.5-30	65	196	8	\$1384	\$1695	N/A	\$812
Z2472ECFRSLW	36 x 72 x 29.5-30	65	176	7.5	\$1250	\$1523	N/A	\$611
Z2466ECFRSLW	36 x 66 x 29.5-30	70	168	7.5	\$1195	\$1445	N/A	\$611
Z2460ECFRSLW	36 x 60 x 29.5-30	65	159	6	\$1139	\$1367	N/A	\$509
Z2084ECFRSLW	36 x 84 x 29.5-30	65	185	8	\$1378	\$1689	N/A	\$812
Z2072ECFRSLW	36 x 72 x 29.5-30	70	168	7.5	\$1245	\$1517	N/A	\$611
Z2066ECFRSLW	36 x 66 x 29.5-30	65	151	6	\$1189	\$1439	N/A	\$611
Z2060ECFRSLW	36 x 60 x 29.5-30	65	151	6	\$1123	\$1350	N/A	\$509
Z1684ECFRSLW	36 x 84 x 29.5-30	70	175	8	\$1373	\$1684	N/A	\$812
Z1672ECFRSLW	36 x 72 x 29.5-30	70	160	7.5	\$1239	\$1512	N/A	\$611
Z1666ECFRSLW	36 x 66 x 29.5-30	70	153	7.5	\$1184	\$1434	N/A	\$611
Z1660ECFRSLW	36 x 60 x 29.5-30	65	147	6	\$1112	\$1339	N/A	\$509

Split modesty with two 8"H sections for wall access. **No narrow end panel on right front. Full end panels on left and right.** Connects to returns and bridges with 16" throat on the right. **Full end panel can be placed next to** lateral files, storage cabinets, wardrobe units, credenzas and end-shelves. Corner has one grommet. **Does not accept pencil drawers.** Shipped easy to assemble in 1 carton.

RIGHT EXTENDED CORNERS (CONNECTS ON EXTENDED SIDE)

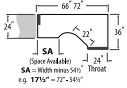

Extended Corner, 24" Throat - RIGHT*

MODEL#	DIMENSIONS	FREIGHT CLASS	WT/LBS.	CUBIC FT.	1" TOP	1.5" TOP	GLAZE ADD	HP ADD
Z2472NFR	36 x 72 x 29.5-30	65	175	7	\$1291	\$1467	N/A	\$584
Z2466NFR	36 x 66 x 29.5-30	65	167	7	\$1291	\$1460	N/A	\$584

Narrow end panel on left. Full end panel on right. Connects to 30"D space saver connectables, 24"D returns, 24"D connectable tables, or "D" and "P" islands with "T" or "H" bases. **Full end panel can be placed next to** lateral files, storage cabinets, wardrobe units, credenzas and end-shelves. Corner has one grommet. Shipped easy to assemble in 1 carton.

- Modesty panel is 1" off of ground.
- **Z2466NFR** cannot accept pedestals.

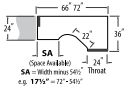

Z24xxNFRSLS Z24xxNFRSLW

Extended Corner w/Wall Access 24" Throat - RIGHT

Split end panel on 36"D side (two 8"H sections for wall access)

Z2472NFRSLS	36 x 72 x 29.5-30	65	172	7	\$1378	\$1556	N/A	\$584
Z2466NFRSLS	36 x 66 x 29.5-30	65	164	7	\$1378	\$1545	N/A	\$584

Split modesty panel (two 8"H sections for wall access)

Z2472NFRSLW	36 x 72 x 29.5-30	65	172	7	\$1378	\$1556	N/A	\$584
Z2466NFRSLW	36 x 66 x 29.5-30	65	164	7	\$1378	\$1545	N/A	\$584

Z24xxNFRSLS have a full height modesty panel. **Narrow end panel on left. Full end panel on right.** Connects to 30"D space saver connectables, 24"D returns, 24"D connectable tables, or "D" and "P" islands with "T" or "H" bases. **Full end panel can be placed next to** lateral files, storage cabinets, wardrobe units, credenzas and end-shelves. Corner has one grommet. Shipped easy to assemble in 1 carton.

- **Z2466NFRSLS** and **Z2466NFRSLW** cannot accept pedestals

Required Specifications

Primary surface type + finish
Top thickness/edge detail
Base finish

Optional Specifications

Modesty panel type*
Grommet position or power block cut-out

Accessories

Power block
Keyboard (Not available on 16" throat)
Pencil drawer (Not available on 16" throat)

RIGHT EXTENDED CORNERS (CONNECTS ON EXTENDED SIDE) MODEL# DIMENSIONS FREIGHT CLASS WT/LBS. CUBIC FT. 1" TOP 1.5" TOP GLAZE ADD HP ADD

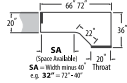

Extended Corner, 20" Throat - RIGHT

MODEL#	DIMENSIONS	FREIGHT CLASS	WT/LBS.	CUBIC FT.	1" TOP	1.5" TOP	GLAZE ADD	HP ADD
Z2072NFR	36 x 72 x 29.5-30	65	165	7	\$1253	\$1460	N/A	\$584
Z2066NFR	36 x 66 x 29.5-30	65	158	7	\$1253	\$1422	N/A	\$561

Narrow end panel on left. Full end panel on right. Connects to 24"D space saver connectables, 20"D returns or "D" and "P" islands with "T" or "H" bases. **Full end panel can be placed next to** lateral files, storage cabinets, wardrobe units, credenzas and end-shelves. Corner has one grommet. Shipped easy to assemble in 1 carton.

- Modesty panel is 1" off of ground.
- NFR end panels can be switched to make FNR.

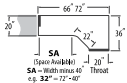

Z20xxNFRSLS

Z20xxNFRSLW

Extended Corner w/Wall Access 20" Throat - RIGHT

Split end panel on 36"D side (two 8"H sections for wall access)

Z2072NFRSLS	36 x 72 x 29.5-30	65	163	7	\$1339	\$1545	N/A	\$584
Z2066NFRSLS	36 x 66 x 29.5-30	70	157	7	\$1339	\$1506	N/A	\$561

Split modesty panel (two 8"H sections for wall access)

Z2072NFRSLW	36 x 72 x 29.5-30	65	163	7	\$1339	\$1545	N/A	\$584
Z2066NFRSLW	36 x 66 x 29.5-30	70	157	7	\$1339	\$1506	N/A	\$561

Z20xxNFRSLS have a full height modesty panel. **Narrow end panel on left. Full end panel on right.** Connects to 24"D space saver connectables and 20"D returns or "D" and "P" islands with "T" or "H" bases. **Full end panel can be placed next to** lateral files, storage cabinets, wardrobe units, credenzas and end-shelves. Corner has one grommet. Shipped easy to assemble in 1 carton.

RIGHT EXTENDED CORNERS (CONNECTS ON BOTH SIDES) MODEL# DIMENSIONS FREIGHT CLASS WT/LBS. CUBIC FT. 1" TOP 1.5" TOP GLAZE ADD HP ADD

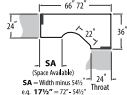

Extended Corner, 24" Throat - RIGHT

Z2472NNR	36 x 72 x 29.5-30	65	166	7	\$1253	\$1429	N/A	\$584
Z2466NNR	36 x 66 x 29.5-30	65	158	7	\$1253	\$1422	N/A	\$584

Narrow end panels on left and right. Connects to 30"D space saver connectables, 30"D space saver returns, 24"D returns, 24"D connectable tables or "D" and "P" islands with "T" or "H" bases on either end. Corner has one grommet. Shipped easy to assemble in 1 carton.

- Modesty panel is 1" off of ground.
- Z2466NNR cannot accept pedestals.

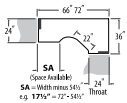

Z24xxNNRSLS

Z24xxNNRSLW

Extended Corner w/Wall Access, 24" Throat - RIGHT

Split end panel on 36"D side (two 8"H sections for wall access)

Z2472NNRSLS	36 x 72 x 29.5-30	65	172	7	\$1339	\$1517	N/A	\$584
Z2466NNRSLS	36 x 66 x 29.5-30	65	164	7	\$1339	\$1506	N/A	\$584

Split modesty panel (two 8"H sections for wall access)

Z2472NNRSLW	36 x 72 x 29.5-30	65	172	7	\$1339	\$1517	N/A	\$584
Z2466NNRSLW	36 x 66 x 29.5-30	65	164	7	\$1339	\$1506	N/A	\$584

Z24xxNNRSLS have a full height modesty panel. **Narrow end panels on left and right.** Connects to 30"D space saver connectables, 30"D space saver returns, 24"D returns or 24"D connectable tables or "D" and "P" islands with "T" or "H" bases on either end. Corner has one grommet. Shipped easy to assemble in 1 carton.

- Z2466NNRSLS and Z2466NNRSLW cannot accept pedestals.

Required Specifications

Primary surface type + finish
Top thickness/edge detail
Base finish

Optional Specifications

Modesty panel type*
Grommet position or power block cut-out

Accessories

Power block
Keyboard
Pencil drawer

RIGHT EXTENDED CORNERS (CONNECTS ON BOTH SIDES)

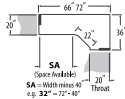

Extended Corner, 20" Throat - RIGHT

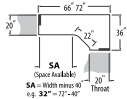

Z20xxNNRSLS Z20xxNNRSLW

Extended Corner w/Wall Access, 20" Throat - RIGHT

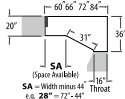
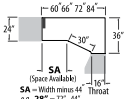

Extended Corner, 16" Throat - RIGHT*

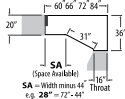
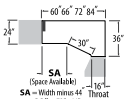

Extended Corner w/Wall Access, 16" Throat - RIGHT

MODEL#	DIMENSIONS	FREIGHT CLASS	WT./LBS.	CUBIC FT.	1" TOP	1.5" TOP	GLAZE ADD	HP ADD
Z2072NNR	36 x 72 x 29.5-30	65	160	7	\$1215	\$1422	N/A	\$584
Z2066NNR	36 x 66 x 29.5-30	70	152	7	\$1215	\$1369	N/A	\$561

Narrow end panels on left and right. Connects to 24"D space saver connectables and 20"D returns, bridges or "D" and "P" islands with "T" or "H" bases one either end. Corner has one grommet. Shipped easy to assemble in 1 carton.

• Modesty panel is 1" off of ground.

Split end panel on 36"D side (two 8"H sections for wall access)

Z2072NNRSLS	36 x 72 x 29.5-30	65	163	7	\$1300	\$1506	N/A	\$584
Z2066NNRSLS	36 x 66 x 29.5-30	70	157	7	\$1300	\$1467	N/A	\$561

Split modesty panel (two 8"H sections for wall access)

Z2072NNRSLW	36 x 72 x 29.5-30	65	163	7	\$1300	\$1506	N/A	\$584
Z2066NNRSLW	36 x 66 x 29.5-30	70	157	7	\$1300	\$1456	N/A	\$561

Z20xxNNRSLS have a full height modesty panel. **Narrow end panels on left and right.** Connects to 24"D space saver connectables and 20"D returns, bridges or "D" and "P" islands with "T" or "H" bases on either end. Corner has one grommet. Shipped easy to assemble in 1 carton.

Z2484ECNR	36 x 84 x 29.5-30	65	186.90	8	\$1257	\$1565	N/A	\$812
Z2472ECNR	36 x 72 x 29.5-30	70	168	7.50	\$1120	\$1392	N/A	\$611
Z2466ECNR	36 x 66 x 29.5-30	70	158.55	7.50	\$1064	\$1314	N/A	\$611
Z2460ECNR	36 x 60 x 29.5-30	65	150.15	6	\$996	\$1219	N/A	\$509
Z2084ECNR	36 x 84 x 29.5-30	70	178.50	8	\$1253	\$1561	N/A	\$812
Z2072ECNR	36 x 72 x 29.5-30	70	161.70	7.50	\$1117	\$1386	N/A	\$611
Z2066ECNR	36 x 66 x 29.5-30	70	153.30	7.50	\$1061	\$1311	N/A	\$611
Z2060ECNR	36 x 60 x 29.5-30	65	145.95	6	\$991	\$1215	N/A	\$509

No narrow end panel on right. Narrow end panel on left. Connects to returns and bridges with 16" throat on the right. **Full end panel can be placed next to lateral files, storage cabinets, wardrobe units, credenzas and end-shelves.** Corner has one grommet. **Does not accept pencil drawers.** Shipped RTA (ready to assemble).

Z2484ECNRSLW	36 x 84 x 29.5-30	65	187	8	\$1345	\$1656	N/A	\$812
Z2472ECNRSLW	36 x 72 x 29.5-30	70	168	7.5	\$1212	\$1484	N/A	\$611
Z2466ECNRSLW	36 x 66 x 29.5-30	70	159	7.5	\$1156	\$1406	N/A	\$611
Z2460ECNRSLW	36 x 60 x 29.5-30	65	150	6	\$1089	\$1317	N/A	\$509
Z2084ECNRSLW	36 x 84 x 29.5-30	70	179	8	\$1339	\$1650	N/A	\$812
Z2072ECNRSLW	36 x 72 x 29.5-30	70	162	7.5	\$1206	\$1478	N/A	\$611
Z2066ECNRSLW	36 x 66 x 29.5-30	70	153	7.5	\$1150	\$1400	N/A	\$611
Z2060ECNRSLW	36 x 60 x 29.5-30	65	146	6	\$1084	\$1312	N/A	\$509

Split modesty with two 8"H sections for wall access. **No narrow end panel on right. Narrow end panel on left.** Connects to returns and bridges with 16" throat on the right. **Full end panel can be placed next to lateral files, storage cabinets, wardrobe units, credenzas and end-shelves.** Corner has one grommet. **Does not accept pencil drawers.** Shipped easy to assemble in 1 carton.

Required Specifications

Primary surface type + finish
Top thickness/edge detail
Base finish

Optional Specifications

Modesty panel type*
Grommet position or power block cut-out

Accessories

Power block
Keyboard (Not available on 16" throat)
Pencil drawer (Not available on 16" throat)

FREESTANDING TABLES

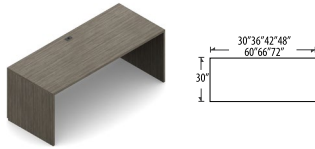

30" Deep Freestanding Table*

MODEL#	DIMENSIONS D x W x H	FREIGHT CLASS	WT/LBS.	CUBIC FT.	1" TOP	1.5" TOP	GLAZE ADD	HP ADD
Z3072T	29.7 x 72 x 29.5-30	65	176	6	\$1099	\$1271	N/A	\$547
Z3066T	29.7 x 66 x 29.5-30	65	166	6	\$1099	\$1261	N/A	\$547
Z3060T	29.7 x 60 x 29.5-30	60	159	5.25	\$1003	\$1155	N/A	\$509
Z3048T	29.7 x 48 x 29.5-30	65	135	5.25	\$908	\$1044	N/A	\$431
Z3042T	29.7 x 42 x 29.5-30	65	125	5.25	\$908	\$1034	N/A	\$391
Z3036T	29.7 x 36 x 29.5-30	65	111	4.30	\$802	\$918	N/A	\$354
Z3030T	29.7 x 30 x 29.5-30	65	100	3.60	\$752	\$847	N/A	\$316

Two full end panels. Cannot be connected on left or right side. Grommet in worksurface.
Shipped easy to assemble in 1 carton.

- Modesty panel is 1" off of ground.

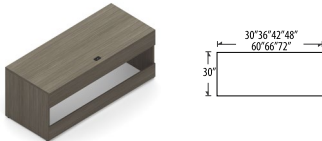

30" Deep Freestanding Table w/Wall Access

Z3072TSL	29.7 x 72 x 29.5-30	65	199	6.75	\$1189	\$1362	N/A	\$547
Z3066TSL	29.7 x 66 x 29.5-30	65	184	6.5	\$1189	\$1350	N/A	\$547
Z3060TSL	29.7 x 60 x 29.5-30	60	169	5.25	\$1095	\$1250	N/A	\$509
Z3048TSL	29.7 x 48 x 29.5-30	65	142	5.25	\$1000	\$1134	N/A	\$431
Z3042TSL	29.7 x 42 x 29.5-30	65	129	5.25	\$1000	\$1128	N/A	\$391
Z3036TSL	29.7 x 36 x 29.5-30	65	116	4.3	\$895	\$1012	N/A	\$354
Z3030TSL	29.7 x 30 x 29.5-30	65	104	3.6	\$850	\$945	N/A	\$316

Split modesty with two 8"H sections for wall access. **Two full end panels. Cannot be connected on left or right side.** Grommet in worksurface. Shipped easy to assemble in 1 carton.

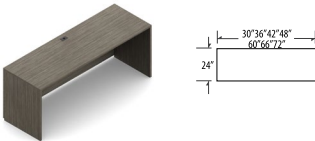

24" Deep Freestanding Table

Z2472T	24 x 72 x 29.5-30	65	152	6	\$987	\$1149	N/A	\$409
Z2466T	24 x 66 x 29.5-30	65	144	6	\$987	\$1149	N/A	\$409
Z2460T	24 x 60 x 29.5-30	65	133	5.25	\$898	\$1023	N/A	\$376
Z2448T	24 x 48 x 29.5-30	65	114	4.3	\$811	\$920	N/A	\$300
Z2442T	24 x 42 x 29.5-30	65	105	4.3	\$811	\$906	N/A	\$252
Z2436T	24 x 36 x 29.5-30	65	95	4.2	\$725	\$805	N/A	\$190
Z2430T	24 x 30 x 29.5-30	65	85	3.6	\$687	\$748	N/A	\$190

Two full end panels. Cannot be connected on left or right side. Grommet in worksurface.
Shipped easy to assemble in 1 carton.

- Modesty panel is 1" off of ground.

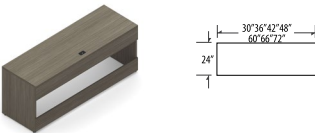

24" Deep Freestanding Table w/Wall Access

Z2472TSL	24 x 72 x 29.5-30	65	173	6	\$1078	\$1239	N/A	\$409
Z2466TSL	24 x 66 x 29.5-30	65	160	6	\$1078	\$1239	N/A	\$409
Z2460TSL	24 x 60 x 29.5-30	65	147	5.25	\$989	\$1117	N/A	\$376
Z2448TSL	24 x 48 x 29.5-30	65	123	4.3	\$906	\$1012	N/A	\$300
Z2442TSL	24 x 42 x 29.5-30	65	112	4.3	\$906	\$1000	N/A	\$252
Z2436TSL	24 x 36 x 29.5-30	65	100	4.2	\$823	\$900	N/A	\$190
Z2430TSL	24 x 30 x 29.5-30	65	89	3.6	\$784	\$845	N/A	\$190

Split modesty with two 8"H sections for wall access. **Two full end panels. Cannot be connected on left or right side.** Grommet in worksurface. Shipped easy to assemble in 1 carton.

Required Specifications

Primary surface type + finish
Top thickness/edge detail
Base finish

Optional Specifications

Modesty panel type*
Grommet position or power block cut-out

Accessories

Pencil drawer
Power block
Keyboard

CONNECTABLE TABLES - LEFT

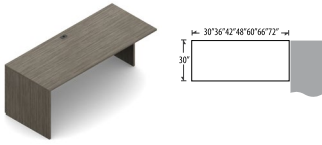

30" Deep Connectable Table - LEFT*

MODEL#	DIMENSIONS	FREIGHT CLASS	WT./LBS.	CUBIC FT.	1" TOP	1.5" TOP	GLAZE ADD	HP ADD
	D x W x H							
Z3072L	29.7 x 72 x 29.5-30	65	168	6	\$1061	\$1233	N/A	\$547
Z3066L	29.7 x 66 x 29.5-30	65	158	6	\$1061	\$1223	N/A	\$547
Z3060L	29.7 x 60 x 29.5-30	65	150	5.25	\$965	\$1117	N/A	\$509
Z3048L	29.7 x 48 x 29.5-30	65	124	4.30	\$868	\$1004	N/A	\$431
Z3042L	29.7 x 42 x 29.5-30	65	115	4.30	\$868	\$994	N/A	\$391
Z3036L	29.7 x 36 x 29.5-30	65	103	4.20	\$765	\$883	N/A	\$354
Z3030L	29.7 x 30 x 29.5-30	65	92	3.60	\$716	\$811	N/A	\$316

Full end panel on left. Right narrow end panel connects to **30"D** center/right connectable table, or at 90° angle to a freestanding table; and "D" islands or "P" islands with "T" and "H" bases. Grommet in worksurface.

Shipped easy to assemble in 1 carton.

- Modesty Panel is 1" off of ground.

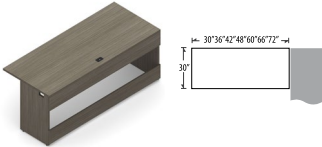

30" Deep Connectable Table w/Wall Access - LEFT

Z3072LSL	29.7 x 72 x 29.5-30	60	197	6	\$1150	\$1323	N/A	\$547
Z3066LSL	29.7 x 66 x 29.5-30	60	183	6	\$1150	\$1312	N/A	\$547
Z3060LSL	29.7 x 60 x 29.5-30	60	169	5.25	\$1056	\$1212	N/A	\$509
Z3048LSL	29.7 x 48 x 29.5-30	60	142	4.3	\$962	\$1095	N/A	\$431
Z3042LSL	29.7 x 42 x 29.5-30	60	129	4.3	\$962	\$1089	N/A	\$391
Z3036LSL	29.7 x 36 x 29.5-30	65	116	4.2	\$862	\$978	N/A	\$354
Z3030LSL	29.7 x 30 x 29.5-30	65	104	3.6	\$812	\$906	N/A	\$316

Split modesty with two 8"H sections for wall access. **Full end panel on left.** Right narrow end panel connects to **30"D** center/right connectable table, or at 90° angle to a freestanding table; and "D" islands or "P" islands with "T" and "H" bases. Grommet in worksurface. Shipped easy to assemble in 1 carton.

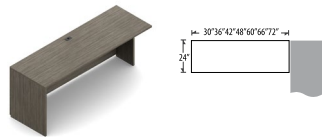

24" Deep Connectable Table - LEFT

Z2472L	24 x 72 x 29.5-30	65	144	6	\$938	\$1105	N/A	\$409
Z2466L	24 x 66 x 29.5-30	65	135	6	\$938	\$1082	N/A	\$409
Z2460L	24 x 60 x 29.5-30	65	125	5.25	\$848	\$974	N/A	\$376
Z2448L	24 x 48 x 29.5-30	65	106	4.3	\$773	\$882	N/A	\$300
Z2442L	24 x 42 x 29.5-30	65	95	3.8	\$773	\$868	N/A	\$252
Z2436L	24 x 36 x 29.5-30	65	86	3.3	\$679	\$757	N/A	\$190
Z2430L	24 x 30 x 29.5-30	70	77	3.6	\$639	\$701	N/A	\$190

Full end panel on left. Right narrow end panel connects to **24"D** center/right connectable table, or at 90° angle to a freestanding table; height adjustable desk; 24"D extended corners or at the end of a straight run; "D" islands or "P" islands with "T" and "H" bases. Grommet in worksurface. Shipped easy to assemble in 1 carton.

- Units 48" and under require storage for stability.

- Modesty Panel is 1" off of ground.

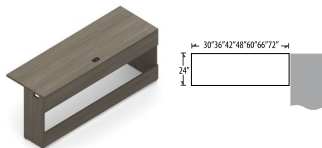

24" Deep Connectable Table w/Wall Access - LEFT

Z2472LSL	24 x 72 x 29.5-30	65	164	6	\$1028	\$1189	N/A	\$409
Z2466LSL	24 x 66 x 29.5-30	65	152	6	\$1028	\$1173	N/A	\$409
Z2460LSL	24 x 60 x 29.5-30	65	139	5.25	\$945	\$1073	N/A	\$376
Z2448LSL	24 x 48 x 29.5-30	65	115	4.3	\$867	\$973	N/A	\$300
Z2442LSL	24 x 42 x 29.5-30	65	103	3.8	\$867	\$962	N/A	\$252
Z2436LSL	24 x 36 x 29.5-30	65	92	3.6	\$773	\$850	N/A	\$190
Z2430LSL	24 x 30 x 29.5-30	65	80	3.3	\$739	\$800	N/A	\$190

Split modesty with two 8"H sections for wall access. **Full end panel on left.** Right narrow end panel connects to **24"D** center/right connectable table, or at 90° angle to a freestanding table; and "D" islands or "P" islands with "T" and "H" bases. Grommet in worksurface. Shipped easy to assemble in 1 carton.

- Units 48" and under require storage for stability

Required Specifications

Primary surface type + finish
Top thickness/edge detail
Base finish

Optional Specifications

Modesty panel type*
Grommet position or power block cut-out

Accessories

Power block
Keyboard
Pencil drawer

CONNECTABLE TABLES - RIGHT

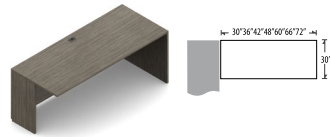

30" Deep Connectable Table - RIGHT

MODEL#	DIMENSIONS D x W x H	FREIGHT CLASS	WT/LBS.	CUBIC FT.	1" TOP	1.5" TOP	GLAZE ADD	HP ADD
Z3072R	29.7 x 72 x 29.5-30	65	168	6	\$1061	\$1233	N/A	\$547
Z3066R	29.7 x 66 x 29.5-30	65	158	6	\$1061	\$1223	N/A	\$547
Z3060R	29.7 x 60 x 29.5-30	65	150	5.25	\$965	\$1117	N/A	\$509
Z3048R	29.7 x 48 x 29.5-30	65	124	4.30	\$868	\$1004	N/A	\$431
Z3042R	29.7 x 42 x 29.5-30	65	115	4.30	\$868	\$994	N/A	\$391
Z3036R	29.7 x 36 x 29.5-30	65	103	4.20	\$765	\$883	N/A	\$354
Z3030R	29.7 x 30 x 29.5-30	65	92	3.60	\$716	\$811	N/A	\$316

Full end panel on right. Left narrow end panel connects to **30"D** center/right connectable table, or at 90° angle to a freestanding table; and "D" islands or "P" islands with "T" and "H" bases. Grommet in worksurface. Shipped easy to assemble in 1 carton.

- Modesty panel is 1" off of ground.

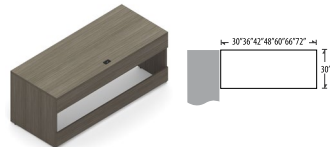

30" Deep Connectable Table w/Wall Access - RIGHT

Z3072RSL	29.7 x 72 x 29.5-30	60	197	6	\$1150	\$1323	N/A	\$547
Z3066RSL	29.7 x 66 x 29.5-30	60	183	6	\$1150	\$1312	N/A	\$547
Z3060RSL	29.7 x 60 x 29.5-30	60	169	5.25	\$1056	\$1212	N/A	\$509
Z3048RSL	29.7 x 48 x 29.5-30	60	142	4.3	\$962	\$1095	N/A	\$431
Z3042RSL	29.7 x 42 x 29.5-30	60	129	4.3	\$962	\$1089	N/A	\$391
Z3036RSL	29.7 x 36 x 29.5-30	65	116	4.2	\$862	\$978	N/A	\$354
Z3030RSL	29.7 x 30 x 29.5-30	65	104	3.6	\$812	\$906	N/A	\$316

Split modesty with two 8"H sections for wall access. **Full end panel on right.** Left narrow end panel connects to **30"D** center/right connectable table, or at 90° angle to a freestanding table; and "D" islands or "P" islands with "T" and "H" bases. Grommet in worksurface. Shipped easy to assemble in 1 carton.

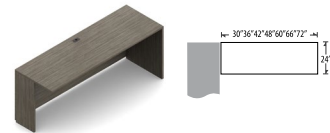

24" Deep Connectable Table - RIGHT*

Z2472R	24 x 72 x 29.5-30	65	144	6	\$938	\$1105	N/A	\$409
Z2466R	24 x 66 x 29.5-30	65	135	6	\$938	\$1082	N/A	\$409
Z2460R	24 x 60 x 29.5-30	65	125	5.25	\$848	\$974	N/A	\$376
Z2448R	24 x 48 x 29.5-30	65	106	4.30	\$773	\$882	N/A	\$300
Z2442R	24 x 42 x 29.5-30	65	95	3.80	\$773	\$868	N/A	\$252
Z2436R	24 x 36 x 29.5-30	65	86	3.30	\$679	\$757	N/A	\$190
Z2430R	24 x 30 x 29.5-30	70	77	3.60	\$639	\$701	N/A	\$190

Full end panel on right. Left narrow end panel connects to **24"D** center/right connectable table, or at 90° angle to a freestanding table; height adjustable desk; 24"D extended corners or at the end of a straight run; "D" islands or "P" islands with "T" and "H" bases. Grommet in worksurface. Shipped easy to assemble in 1 carton.

- Units 48" and under require storage for stability.
- Modesty panel is 1" off of ground.

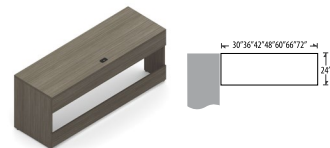

24" Deep Connectable Table w/Wall Access - RIGHT

Z2472RSL	24 x 72 x 29.5-30	65	164	6	\$1028	\$1189	N/A	\$409
Z2466RSL	24 x 66 x 29.5-30	65	152	6	\$1028	\$1173	N/A	\$409
Z2460RSL	24 x 60 x 29.5-30	65	139	5.25	\$945	\$1073	N/A	\$376
Z2448RSL	24 x 48 x 29.5-30	65	115	4.3	\$867	\$973	N/A	\$300
Z2442RSL	24 x 42 x 29.5-30	65	103	3.8	\$867	\$962	N/A	\$252
Z2436RSL	24 x 36 x 29.5-30	65	92	3.6	\$773	\$850	N/A	\$190
Z2430RSL	24 x 30 x 29.5-30	65	80	3.3	\$739	\$800	N/A	\$190

Split modesty with two 8"H sections for wall access. **Full end panel on right.** Left narrow end panel connects to **24"D** center/right connectable table, or at 90° angle to a freestanding table; and "D" islands or "P" islands with "T" and "H" bases. Grommet in worksurface. Shipped easy to assemble in 1 carton.

- Units 48" and under require storage for stability

Required Specifications

Primary surface type + finish
Top thickness/edge detail
Base finish

Optional Specifications

Modesty panel type*
Grommet position or power block cut-out

Accessories

Power block
Keyboard
Pencil drawer

CONNECTABLE TABLES

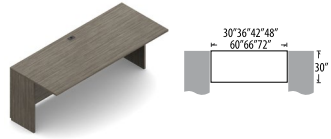

30" Deep Connectable Table

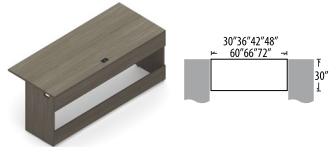

30" Deep Connectable Table w/Wall Access

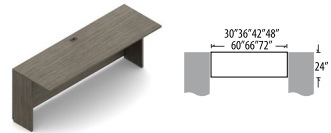

24" Deep Connectable Table

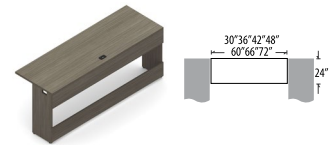

24" Deep Connectable Table w/Wall Access

MODEL#	DIMENSIONS	FREIGHT CLASS	WT./LBS.	CUBIC FT.	1" TOP	1.5" TOP	GLAZE ADD	HP ADD
	D x W x H							
Z3072N	29.7 x 72 x 29.5-30	65	159	6	\$1021	\$1194	N/A	\$547
Z3066N	29.7 x 66 x 29.5-30	65	149	6	\$1021	\$1188	N/A	\$547
Z3060N	29.7 x 60 x 29.5-30	65	142	5.25	\$915	\$1069	N/A	\$509
Z3048N	29.7 x 48 x 29.5-30	65	116	4.30	\$802	\$937	N/A	\$431
Z3042N	29.7 x 42 x 29.5-30	65	106	3.80	\$802	\$927	N/A	\$391
Z3036N	29.7 x 36 x 29.5-30	65	94	3.30	\$716	\$834	N/A	\$354
Z3030N	29.7 x 30 x 29.5-30	65	83	3.60	\$679	\$774	N/A	\$316

Narrow end panels on both sides connect to 30"D worksurfaces, "D" islands or "P" islands with "T" and "H" bases; or at 90° angle to freestanding table(s). Grommet in worksurface. Shipped easy to assemble in 1 carton.

• Modesty panel is 1" off of ground.

Z3072NSL	29.7 x 72 x 29.5-30	60	181	6	\$1112	\$1284	N/A	\$547
Z3066NSL	29.7 x 66 x 29.5-30	65	167	6	\$1112	\$1273	N/A	\$547
Z3060NSL	29.7 x 60 x 29.5-30	65	153	5.3	\$1012	\$1167	N/A	\$509
Z3048NSL	29.7 x 48 x 29.5-30	65	126	4.3	\$895	\$1028	N/A	\$431
Z3042NSL	29.7 x 42 x 29.5-30	65	113	3.8	\$895	\$1023	N/A	\$391
Z3036NSL	29.7 x 36 x 29.5-30	65	100	3.6	\$812	\$928	N/A	\$354
Z3030NSL	29.7 x 30 x 29.5-30	65	88	3.3	\$773	\$867	N/A	\$316

Split modesty with two 8"H sections for wall access. Narrow end panels on both sides connect to 30"D worksurfaces, "D" islands or "P" islands with "T" and "H" bases; or at 90° angle to freestanding table(s). Grommet in worksurface. Shipped easy to assemble in 1 carton.

Z2472N	24 x 72 x 29.5-30	65	135	6	\$890	\$1052	N/A	\$409
Z2466N	24 x 66 x 29.5-30	70	127	6	\$890	\$1032	N/A	\$409
Z2460N	24 x 60 x 29.5-30	65	116	4.5	\$802	\$927	N/A	\$376
Z2448N	24 x 48 x 29.5-30	65	97	4.3	\$725	\$834	N/A	\$300
Z2442N	24 x 42 x 29.5-30	65	87	3.8	\$725	\$815	N/A	\$252
Z2436N	24 x 36 x 29.5-30	65	77	3.3	\$628	\$706	N/A	\$190
Z2430N	24 x 30 x 29.5-30	70	68	3.6	\$589	\$650	N/A	\$190

Narrow end panels on both sides connect to 24"D worksurfaces, "D" islands or "P" islands with "T" and "H" bases; or at 90° angle to freestanding table(s). Grommet in worksurface. Shipped easy to assemble in 1 carton.

• Modesty Panel is 1" off of ground.

Z2472NSL	24 x 72 x 29.5-30	65	156	6	\$984	\$1145	N/A	\$409
Z2466NSL	24 x 66 x 29.5-30	65	143	6	\$984	\$1128	N/A	\$409
Z2460NSL	24 x 60 x 29.5-30	65	131	4.5	\$895	\$1023	N/A	\$376
Z2448NSL	24 x 48 x 29.5-30	65	106	4.3	\$823	\$928	N/A	\$300
Z2442NSL	24 x 42 x 29.5-30	65	95	3.8	\$823	\$917	N/A	\$252
Z2436NSL	24 x 36 x 29.5-30	65	83	3.6	\$728	\$806	N/A	\$190
Z2430NSL	24 x 30 x 29.5-30	70	72	3.3	\$689	\$750	N/A	\$190

Split modesty with two 8"H sections for wall access. Narrow end panels on both sides connect to 24"D worksurfaces, "D" islands or "P" islands with "T" and "H" bases; or at 90° angle to freestanding table(s). Grommet in worksurface. Shipped easy to assemble in 1 carton.

Required Specifications

Primary surface type + finish
Top thickness/edge detail
Base finish

Optional Specifications

Modesty panel type*
Grommet position or power block cut-out

Accessories

Power block
Keyboard
Pencil drawer

SPACE SAVER CONNECTABLE TABLES - LEFT

MODEL#	DIMENSIONS	FREIGHT CLASS	WT/LBS.	CUBIC FT.	1" TOP	1.5" TOP	GLAZE ADD	HP ADD
--------	------------	---------------	---------	-----------	--------	----------	-----------	--------

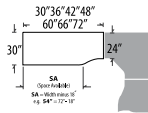

30" Deep Space Saver Connectable Table - LEFT*

D x W x H								
Z3072LK	29.7 x 72 x 29.5-30	65	161	6	\$1081	\$1267	N/A	\$547
Z3066LK	29.7 x 66 x 29.5-30	65	151	6	\$1081	\$1257	N/A	\$547
Z3060LK	29.7 x 60 x 29.5-30	65	144	5.25	\$987	\$1156	N/A	\$509
Z3048LK	29.7 x 48 x 29.5-30	65	118	4.30	\$890	\$1037	N/A	\$431
Z3042LK	29.7 x 42 x 29.5-30	65	107	3.80	\$890	\$1029	N/A	\$391
Z3036LK	29.7 x 36 x 29.5-30	70	96	4.30	\$784	\$912	N/A	\$354
Z3030LK	29.7 x 30 x 29.5-30	65	85	3.60	\$736	\$849	N/A	\$316

Full end panel on left. Narrow right end panel connects to any corner unit with a 24" throat. Grommet in worksurface. Shipped easy to assemble in 1 carton.

- Modesty panel is 1" off of ground.

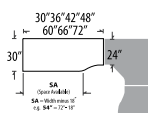

30" Deep Space Saver Connectable Table w/Wall Access - LEFT*

Z3072LKSL	29.7 x 72 x 29.5-30	60	185	6	\$1173	\$1362	N/A	\$547
Z3066LKSL	29.7 x 66 x 29.5-30	65	171	6	\$1173	\$1350	N/A	\$547
Z3060LKSL	29.7 x 60 x 29.5-30	65	157	5.25	\$1078	\$1245	N/A	\$509
Z3048LKSL	29.7 x 48 x 29.5-30	60	130	4.3	\$984	\$1134	N/A	\$431
Z3042LKSL	29.7 x 42 x 29.5-30	65	117	4.3	\$984	\$1123	N/A	\$391
Z3036LKSL	29.7 x 36 x 29.5-30	65	104	3.8	\$878	\$1006	N/A	\$354
Z3030LKSL	29.7 x 30 x 29.5-30	65	91	3.6	\$834	\$945	N/A	\$316

Split modesty with two 8"H sections for wall access. **Full end panel on left.** Narrow right end panel connects to any corner unit with a 24" throat. Grommet in worksurface. Shipped easy to assemble in 1 carton.

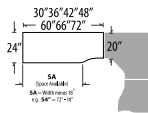

24" Deep Space Saver Connectable Table - LEFT*

Z2472LK	24 x 72 x 29.5-30	65	140	6	\$965	\$1141	N/A	\$409
Z2466LK	24 x 66 x 29.5-30	70	134	6	\$965	\$1123	N/A	\$409
Z2460LK	24 x 60 x 29.5-30	65	123	5.25	\$881	\$1020	N/A	\$376
Z2448LK	24 x 48 x 29.5-30	65	104	4.3	\$802	\$922	N/A	\$300
Z2442LK	24 x 42 x 29.5-30	65	94	3.8	\$802	\$914	N/A	\$252
Z2436LK	24 x 36 x 29.5-30	65	85	3.3	\$707	\$800	N/A	\$190
Z2430LK	24 x 30 x 29.5-30	70	75	3.6	\$668	\$743	N/A	\$190

Full end panel on left. Narrow right end panel connects to any corner unit with a 20" throat. Grommet in worksurface. Shipped easy to assemble in 1 carton.

- Modesty panel is 1" off of ground.

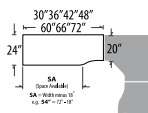

24" Deep Space Saver Connectable Table w/Wall Access - LEFT*

Z2472LKSL	24 x 72 x 29.5-30	65	164	6	\$1056	\$1234	N/A	\$409
Z2466LKSL	24 x 66 x 29.5-30	65	152	6	\$1056	\$1217	N/A	\$409
Z2460LKSL	24 x 60 x 29.5-30	65	139	5.25	\$973	\$1112	N/A	\$376
Z2448LKSL	24 x 48 x 29.5-30	65	115	4.3	\$895	\$1017	N/A	\$300
Z2442LKSL	24 x 42 x 29.5-30	65	103	3.8	\$895	\$1006	N/A	\$252
Z2436LKSL	24 x 36 x 29.5-30	60	90	0.6	\$800	\$895	N/A	\$190
Z2430LKSL	24 x 30 x 29.5-30	65	80	3.3	\$767	\$839	N/A	\$190

Split modesty with two 8"H sections for wall access. **Full end panel on left.** Narrow right end panel connects to any corner unit with a 20" throat. Grommet in worksurface. Shipped easy to assemble in 1 carton.

Required Specifications

Primary surface type + finish
Top thickness/edge detail
Base finish

Optional Specifications

Modesty panel type*
Grommet position or power block cut-out

Accessories

Power block
Keyboard
Pencil drawer

SPACE SAVER CONNECTABLE TABLES - RIGHT

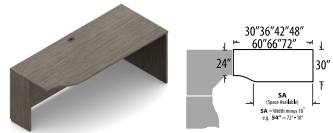

30" Deep Space Saver Connectable Table - RIGHT*

MODEL#	DIMENSIONS	FREIGHT CLASS	WT/LBS.	CUBIC FT.	1" TOP	1.5" TOP	GLAZE ADD	HP ADD
Z3072RK	29.7 x 72 x 29.5-30	65	161	6	\$1081	\$1267	N/A	\$547
Z3066RK	29.7 x 66 x 29.5-30	65	151	6	\$1081	\$1257	N/A	\$547
Z3060RK	29.7 x 60 x 29.5-30	65	144	5.25	\$987	\$1156	N/A	\$509
Z3048RK	29.7 x 48 x 29.5-30	65	119	4.30	\$890	\$1037	N/A	\$431
Z3042RK	29.7 x 42 x 29.5-30	65	107	3.80	\$890	\$1029	N/A	\$391
Z3036RK	29.7 x 36 x 29.5-30	70	96	4.30	\$784	\$912	N/A	\$354
Z3030RK	29.7 x 30 x 29.5-30	65	85	3.60	\$736	\$849	N/A	\$316

Full end panel on right. Narrow left end panel connects to any corner unit with a 24" throat. Grommet in worksurface. Shipped easy to assemble in 1 carton.

• Modesty panel is 1" off of ground.

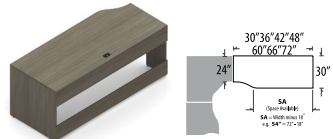

30" Deep Space Saver Connectable Table w/Wall Access - RIGHT*

Z3072RKSL	29.7 x 72 x 29.5-30	60	185	6	\$1173	\$1362	N/A	\$547
Z3066RKSL	29.7 x 66 x 29.5-30	65	171	6	\$1173	\$1350	N/A	\$547
Z3060RKSL	29.7 x 60 x 29.5-30	65	157	5.25	\$1078	\$1245	N/A	\$509
Z3048RKSL	29.7 x 48 x 29.5-30	60	130	4.3	\$984	\$1134	N/A	\$431
Z3042RKSL	29.7 x 42 x 29.5-30	65	117	4.3	\$984	\$1123	N/A	\$391
Z3036RKSL	29.7 x 36 x 29.5-30	65	104	3.8	\$878	\$1006	N/A	\$354
Z3030RKSL	29.7 x 30 x 29.5-30	65	91	3.6	\$834	\$945	N/A	\$316

Split modesty with two 8"H sections for wall access. **Full end panel on right.** Narrow left end panel connects to any corner unit with a 24" throat. Grommet in worksurface. Shipped easy to assemble in 1 carton.

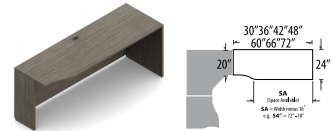

24" Deep Space Saver Connectable Table - RIGHT*

Z2472RK	24 x 72 x 29.5-30	65	142	6	\$965	\$1141	N/A	\$409
Z2466RK	24 x 66 x 29.5-30	70	134	6	\$965	\$1123	N/A	\$409
Z2460RK	24 x 60 x 29.5-30	65	123	5.25	\$881	\$1020	N/A	\$376
Z2448RK	24 x 48 x 29.5-30	65	104	4.30	\$802	\$922	N/A	\$300
Z2442RK	24 x 42 x 29.5-30	65	94	3.80	\$802	\$914	N/A	\$252
Z2436RK	24 x 36 x 29.5-30	65	85	3.30	\$707	\$800	N/A	\$190
Z2430RK	24 x 30 x 29.5-30	70	75	3.60	\$668	\$743	N/A	\$190

Full end panel on right. Narrow left end panel connects to any corner unit with a 20" throat. Grommet in worksurface. Shipped easy to assemble in 1 carton.

• Modesty panel is 1" off of ground.

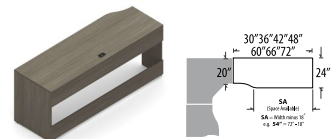

24" Deep Space Saver Connectable Table w/Wall Access - RIGHT*

Z2472RKSL	24 x 72 x 29.5-30	65	164	6	\$1056	\$1234	N/A	\$409
Z2466RKSL	24 x 66 x 29.5-30	65	152	6	\$1056	\$1217	N/A	\$409
Z2460RKSL	24 x 60 x 29.5-30	65	139	5.25	\$973	\$1112	N/A	\$376
Z2448RKSL	24 x 48 x 29.5-30	65	115	4.3	\$895	\$1017	N/A	\$300
Z2442RKSL	24 x 42 x 29.5-30	65	103	3.8	\$895	\$1006	N/A	\$252
Z2436RKSL	24 x 36 x 29.5-30	60	90	0.6	\$800	\$895	N/A	\$190
Z2430RKSL	24 x 30 x 29.5-30	65	80	3.3	\$767	\$839	N/A	\$190

Split modesty with two 8"H sections for wall access. **Full end panel on right.** Narrow left end panel connects to any corner unit with a 20" throat. Grommet in worksurface. Shipped easy to assemble in 1 carton.

Required Specifications

Primary surface type + finish
Top thickness/edge detail
Base finish

Optional Specifications

Modesty panel type*
Grommet position or power block cut-out

Accessories

Power block
Keyboard
Pencil drawer

SPACE SAVER CONNECTABLE TABLES

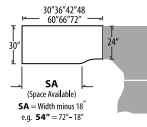

30" Deep Space Saver Connectable Table*

MODEL#	DIMENSIONS	FREIGHT CLASS	WT/LBS.	CUBIC FT.	1" TOP	1.5" TOP	GLAZE ADD	HP ADD
Z3072LN	29.7 x 72 x 29.5-30	65	153	6	\$1042	\$1228	N/A	\$547
Z3066LN	29.7 x 66 x 29.5-30	65	143	6	\$1042	\$1218	N/A	\$547
Z3060LN	29.7 x 60 x 29.5-30	65	136	5.25	\$938	\$1108	N/A	\$509
Z3048LN	29.7 x 48 x 29.5-30	65	110	4.3	\$819	\$968	N/A	\$431
Z3042LN	29.7 x 42 x 29.5-30	65	100	3.8	\$819	\$959	N/A	\$391
Z3036LN	29.7 x 36 x 29.5-30	65	88	3.3	\$736	\$865	N/A	\$354
Z3030LN	29.7 x 30 x 29.5-30	70	77	3.6	\$696	\$809	N/A	\$316

Narrow end panels on both sides. Connects the **right end only** to any corner unit with a 24" throat. Left end allows the continuation of additional 30" connectable center or left connectable worksurface. Grommet in worksurface.

Shipped easy to assemble in 1 carton.

- Modesty panel is 1" off of ground.

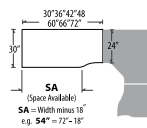

30" Deep Space Saver Connectable Table w/Wall Access

Z3072LNLSL	29.7 x 72 x 29.5-30	65	177	6	\$1134	\$1323	N/A	\$547
Z3066LNLSL	29.7 x 66 x 29.5-30	65	163	6	\$1134	\$1312	N/A	\$547
Z3060LNLSL	29.7 x 60 x 29.5-30	65	148	5.25	\$1028	\$1195	N/A	\$509
Z3048LNLSL	29.7 x 48 x 29.5-30	65	122	4.3	\$917	\$1067	N/A	\$431
Z3042LNLSL	29.7 x 42 x 29.5-30	65	109	3.8	\$917	\$1056	N/A	\$391
Z3036LNLSL	29.7 x 36 x 29.5-30	65	96	3.6	\$834	\$962	N/A	\$354
Z3030LNLSL	29.7 x 30 x 29.5-30	65	83	3.3	\$795	\$906	N/A	\$316

Split modesty with two 8"H sections for wall access. **Narrow end panels on both sides.** Connects the **right end only** to any corner unit with a 24" throat. Left end allows the continuation of additional 30" connectable center or left connectable worksurface. Grommet in worksurface. Shipped easy to assemble in 1 carton.

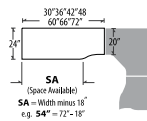

24" Deep Space Saver Connectable Table*

Z2472LN	24 x 72 x 29.5-30	70	134	6	\$915	\$1093	N/A	\$409
Z2466LN	24 x 66 x 29.5-30	70	125	6	\$915	\$1075	N/A	\$409
Z2460LN	24 x 60 x 29.5-30	70	115	5.25	\$831	\$980	N/A	\$376
Z2448LN	24 x 48 x 29.5-30	70	96	4.3	\$752	\$873	N/A	\$300
Z2442LN	24 x 42 x 29.5-30	70	85	3.8	\$752	\$865	N/A	\$252
Z2436LN	24 x 36 x 29.5-30	65	76	3.3	\$659	\$751	N/A	\$190
Z2430LN	24 x 30 x 29.5-30	70	67	3.6	\$618	\$694	N/A	\$190

Narrow end panels on both sides. Connects the **right end only** to any corner unit with a 20" throat. Left end allows the continuation of additional 24" connectable center or left connectable worksurface. Grommet in worksurface. Shipped easy to assemble in 1 carton.

- Modesty panel is 1" off of ground.

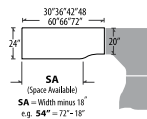

24" Deep Space Saver Connectable Table w/Wall Access

Z2472LNLSL	24 x 72 x 29.5-30	65	156	6	\$1012	\$1189	N/A	\$547
Z2466LNLSL	24 x 66 x 29.5-30	65	143	6	\$1012	\$1173	N/A	\$547
Z2460LNLSL	24 x 60 x 29.5-30	60	131	2.25	\$923	\$1073	N/A	\$509
Z2448LNLSL	24 x 48 x 29.5-30	65	106	4.3	\$850	\$973	N/A	\$431
Z2442LNLSL	24 x 42 x 29.5-30	65	95	3.8	\$850	\$962	N/A	\$391
Z2436LNLSL	24 x 36 x 29.5-30	65	83	3.6	\$756	\$850	N/A	\$354
Z2430LNLSL	24 x 30 x 29.5-30	70	72	3.3	\$717	\$789	N/A	\$316

Split modesty with two 8"H sections for wall access. **Narrow end panels on both sides.** Connects the **right end only** to any corner unit with a 20" throat. Left end allows the continuation of additional 24" connectable center or left connectable worksurface. Grommet in worksurface. Shipped easy to assemble in 1 carton.

Required Specifications

Primary surface type + finish
Top thickness/edge detail
Base finish

Optional Specifications

Modesty panel type*
Grommet position or power block cut-out

Accessories

Power block
Keyboard
Pencil drawer

SPACE SAVER CONNECTABLE TABLES

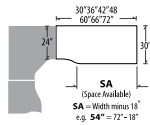

30" Deep Space Saver Connectable Table*

MODEL#	DIMENSIONS	FREIGHT CLASS	WT./LBS.	CUBIC FT.	1" TOP	1.5" TOP	GLAZE ADD	HP ADD
Z3072RN	29.7 x 72 x 29.5-30	65	153	6	\$1042	\$1228	N/A	\$547
Z3066RN	29.7 x 66 x 29.5-30	65	143	6	\$1042	\$1218	N/A	\$547
Z3060RN	29.7 x 60 x 29.5-30	65	136	5.25	\$938	\$1108	N/A	\$509
Z3048RN	29.7 x 48 x 29.5-30	65	110	4.3	\$819	\$968	N/A	\$431
Z3042RN	29.7 x 42 x 29.5-30	65	99	3.8	\$819	\$959	N/A	\$391
Z3036RN	29.7 x 36 x 29.5-30	65	88	3.3	\$736	\$865	N/A	\$354
Z3030RN	29.7 x 30 x 29.5-30	70	77	3.6	\$696	\$809	N/A	\$316

Narrow end panels on both sides. Connects the **left end only** to any corner unit with a 24" throat. Right end allows the continuation of additional 30" connectable center or right connectable worksurface. Grommet in worksurface. Shipped easy to assemble in 1 carton.

- Modesty panel is 1" off of ground.

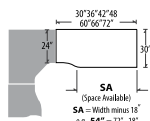

30" Deep Space Saver Connectable Table w/Wall Access

Z3072RNSL	29.7 x 72 x 29.5-30	65	177	6	\$1134	\$1323	N/A	\$547
Z3066RNSL	29.7 x 66 x 29.5-30	65	163	6	\$1134	\$1312	N/A	\$547
Z3060RNSL	29.7 x 60 x 29.5-30	65	148	5.25	\$1028	\$1195	N/A	\$509
Z3048RNSL	29.7 x 48 x 29.5-30	65	122	4.3	\$917	\$1067	N/A	\$431
Z3042RNSL	29.7 x 42 x 29.5-30	65	109	3.8	\$917	\$1056	N/A	\$391
Z3036RNSL	29.7 x 36 x 29.5-30	65	96	3.6	\$834	\$962	N/A	\$354
Z3030RNSL	29.7 x 30 x 29.5-30	65	83	3.3	\$795	\$906	N/A	\$316

Split modesty with two 8"H sections for wall access. **Narrow end panels on both sides.** Connects the **left end only** to any corner unit with a 24" throat. Right end allows the continuation of additional 30" connectable center or right connectable worksurface. Grommet in worksurface. Shipped easy to assemble in 1 carton.

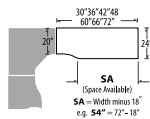

24" Deep Space Saver Connectable Table*

Z2472RN	24 x 72 x 29.5-30	70	134	6	\$915	\$1093	N/A	\$409
Z2466RN	24 x 66 x 29.5-30	70	125	6	\$915	\$1075	N/A	\$409
Z2460RN	24 x 60 x 29.5-30	70	115	5.25	\$831	\$980	N/A	\$376
Z2448RN	24 x 48 x 29.5-30	70	95	4.3	\$752	\$873	N/A	\$300
Z2442RN	24 x 42 x 29.5-30	70	85	3.8	\$752	\$865	N/A	\$252
Z2436RN	24 x 36 x 29.5-30	65	76	3.3	\$659	\$751	N/A	\$190
Z2430RN	24 x 30 x 29.5-30	70	67	3.6	\$618	\$694	N/A	\$190

Narrow end panels on both sides. Connects the **left end only** to any corner unit with a 20" throat. Right end allows the continuation of additional 24" connectable center or right connectable worksurface. Grommet in worksurface. Shipped easy to assemble in 1 carton.

- Modesty panel is 1" off of ground.

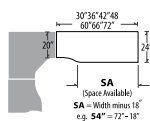

24" Deep Space Saver Connectable Table w/Wall Access

Z2472RNSL	24 x 72 x 29.5-30	65	156	6	\$1012	\$1189	N/A	\$547
Z2466RNSL	24 x 66 x 29.5-30	65	143	6	\$1012	\$1173	N/A	\$547
Z2460RNSL	24 x 60 x 29.5-30	60	131	2.25	\$923	\$1073	N/A	\$509
Z2448RNSL	24 x 48 x 29.5-30	65	106	4.3	\$850	\$973	N/A	\$431
Z2442RNSL	24 x 42 x 29.5-30	65	95	3.8	\$850	\$962	N/A	\$391
Z2436RNSL	24 x 36 x 29.5-30	65	83	3.6	\$756	\$850	N/A	\$354
Z2430RNSL	24 x 30 x 29.5-30	70	72	3.3	\$717	\$789	N/A	\$316

Split modesty with two 8"H sections for wall access. **Narrow end panels on both sides.** Connects the **left end only** to any corner unit with a 20" throat. Right end allows the continuation of additional 24" connectable center or right connectable worksurface. Grommet in worksurface. Shipped easy to assemble in 1 carton.

Required Specifications

Primary surface type + finish
Top thickness/edge detail
Base finish

Optional Specifications

Modesty panel type*
Grommet position or power block cut-out

Accessories

Power block
Keyboard
Pencil drawer

EXTENDED CORNER ISLANDS

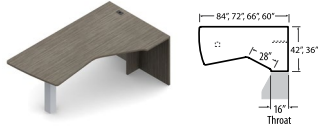

**Extended Corner Island - LEFT
Full End Panel & Post (T-Base)**



**Extended Corner Island - RIGHT
Full End Panel & Post (T-Base)**

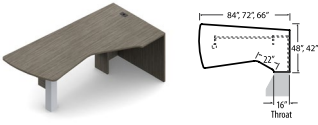

**Extended Corner Island - LEFT
Faux Pedestal and Post***



**Extended Corner Island - RIGHT
Faux Pedestal and Post***

MODEL#	DIMENSIONS	FREIGHT CLASS	WT/LBS.	CUBIC FT.	1" TOP	1.5" TOP	GLAZE ADD	HP ADD
D x W x H								
Z4284EDTL	42 x 84 x 29.5-30	70	180.6	10.76	\$1307	\$1647	N/A	\$1081
Z4272EDTL	42 x 72 x 29.5-30	70	164.85	9.5	\$1230	\$1532	N/A	\$812
Z3672EDTL	36 x 72 x 29.5-30	70	139.65	8.76	\$1122	\$1334	N/A	\$611
Z3666EDTL	36 x 66 x 29.5-30	70	133.35	8.76	\$1074	\$1284	N/A	\$611
Z3660EDTL	36 x 60 x 29.5-30	70	127.05	6.5	\$1024	\$1236	N/A	\$509

Extended island worksurface on **left**. Connects to returns or bridges with a 16" throat on the right. **Not freestanding**.
Grommet in worksurface. Shipped easy to assemble in 2 cartons.

- Post is shipped in separate carton.

Z4284EDTR	42 x 84 x 29.5-30	70	180.6	10.76	\$1307	\$1647	N/A	\$1081
Z4272EDTR	42 x 72 x 29.5-30	70	164.85	9.5	\$1230	\$1532	N/A	\$812
Z3672EDTR	36 x 72 x 29.5-30	70	139.65	8.76	\$1122	\$1334	N/A	\$611
Z3666EDTR	36 x 66 x 29.5-30	70	133.35	8.76	\$1074	\$1284	N/A	\$611
Z3660EDTR	36 x 60 x 29.5-30	70	127.05	6.5	\$1024	\$1236	N/A	\$509

Extended island worksurface on **right**. Connects to returns or bridges with a 16" throat on the left. **Not freestanding**.
Grommet in worksurface. Shipped easy to assemble in 2 cartons.

- Post is shipped in separate carton.

Z4884EDFL	48 x 84 x 29.5-30	70	214.2	12	\$1635	\$2015	\$735	\$1081
Z4872EDFL	48 x 72 x 29.5-30	70	192.15	10.76	\$1516	\$1847	\$608	\$812
Z4284EDFL	42 x 84 x 29.5-30	70	186.9	10.76	\$1535	\$1875	\$735	\$1081
Z4272EDFL	42 x 72 x 29.5-30	70	168	8.76	\$1429	\$1726	\$608	\$812
Z4266EDFL	42 x 66 x 29.5-30	70	158.55	8.76	\$1372	\$1648	\$544	\$812

Extended island worksurface on **left**. Connects to returns or bridges with a 16" throat on the right. **Not freestanding**.
Faux pedestal on the **right** is ideal for concealing a CPU. ¾ modesty panel is standard. Grommet in worksurface. Shipped easy to assemble in 2 cartons.



Laminate Modesty:

Glazed Modesty:

Z4884EDFR	48 x 84 x 29.5-30	70	214.2	12	\$1635	\$2015	\$735	\$1081
Z4872EDFR	48 x 72 x 29.5-30	70	192.15	10.76	\$1516	\$1847	\$608	\$812
Z4284EDFR	42 x 84 x 29.5-30	70	186.9	10.76	\$1535	\$1875	\$735	\$1081
Z4272EDFR	42 x 72 x 29.5-30	70	168	8.76	\$1429	\$1726	\$608	\$812
Z4266EDFR	42 x 66 x 29.5-30	70	158.55	8.76	\$1372	\$1648	\$544	\$812

Extended island worksurface on **right**. Connects to returns or bridges with a 16" throat on the right. **Not freestanding**.
Faux pedestal on the **left** is ideal for concealing a CPU. ¾ modesty panel is standard. Grommet in worksurface. Shipped easy to assemble in 2 cartons.

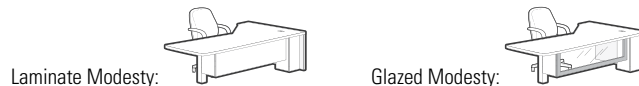

Laminate Modesty:

Glazed Modesty:

Required Specifications

Primary surface type + finish
Top thickness/edge detail
Base finish
Monopost style/finish

Optional Specifications

Modesty finish glazed*
Grommet position or power block cut-out

Accessories

Power block
Keyboard
Pencil drawer

EXT CORNER ISLANDS - RECESSED MODESTY

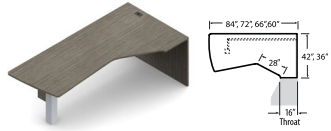

**Extended Corner Island - LEFT
Recessed Modesty and Post**

MODEL#	DIMENSIONS D x W x H	FREIGHT CLASS	WT/LBS.	CUBIC FT.	1" TOP	1.5" TOP	GLAZE ADD	HP ADD
Z4284EDRL	42 x 84 x 29.5-30	70	199	10.76	\$1450	\$1791	\$863	\$1081
Z4272EDRL	42 x 72 x 29.5-30	70	180	9.5	\$1362	\$1663	\$786	\$812
Z3672EDRL	36 x 72 x 29.5-30	70	154	8.76	\$1206	\$1462	\$786	\$611
Z3666EDRL	36 x 66 x 29.5-30	70	144	8.76	\$1162	\$1400	\$723	\$611
Z3660EDRL	36 x 60 x 29.5-30	70	136	6.5	\$1117	\$1338	\$661	\$509

Extended island worksurface on **left**. Connects to returns or bridges with a 16" throat on the right. **Not freestanding.** Grommet in worksurface. $\frac{3}{4}$ **recessed** modesty panel is standard. Shipped easy to assemble in 2 cartons.



**Extended Corner Island - RIGHT
Recessed Modesty and Post**

Z4284EDRR	42 x 84 x 29.5-30	70	199	10.76	\$1450	\$1791	\$863	\$1081
Z4272EDRR	42 x 72 x 29.5-30	70	180	9.50	\$1362	\$1663	\$786	\$812
Z3672EDRR	36 x 72 x 29.5-30	70	154	8.76	\$1206	\$1462	\$786	\$611
Z3666EDRR	36 x 66 x 29.5-30	70	144	8.76	\$1162	\$1400	\$723	\$611
Z3660EDRR	36 x 60 x 29.5-30	70	136	6.50	\$1117	\$1338	\$661	\$509

Extended island worksurface on **right**. Connects to returns or bridges with a 16" throat on the left. **Not freestanding.** Grommet in worksurface. $\frac{3}{4}$ **recessed** modesty panel is standard. Shipped easy to assemble in 2 cartons.

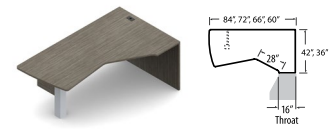
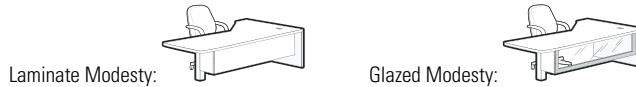

**Extended Corner Island - LEFT
Flush Modesty and Post**

Z4284EDML	42 x 84 x 29.5-30	70	208.95	10.76	\$1471	\$1812	\$863	\$1081
Z4272EDML	42 x 72 x 29.5-30	70	183.75	9.50	\$1378	\$1679	\$786	\$812
Z3672EDML	36 x 72 x 29.5-30	70	158.55	8.76	\$1219	\$1471	\$786	\$611
Z3666EDML	36 x 66 x 29.5-30	70	150.15	8.76	\$1169	\$1436	\$723	\$611
Z3660EDML	36 x 60 x 29.5-30	70	141.75	6.50	\$1139	\$1347	\$661	\$509

Extended island worksurface on **left**. Connects to returns or bridges with a 16" throat on the right. **Not freestanding.** Grommet in worksurface. $\frac{3}{4}$ **flush** modesty panel is standard. Shipped easy to assemble in 2 cartons.



**Extended Corner Island - RIGHT
Flush Modesty and Post**

Z4284EDMR	42 x 84 x 29.5-30	70	208.95	10.76	\$1471	\$1812	\$863	\$1081
Z4272EDMR	42 x 72 x 29.5-30	70	183.75	9.50	\$1378	\$1679	\$786	\$812
Z3672EDMR	36 x 72 x 29.5-30	70	158.55	8.76	\$1219	\$1471	\$786	\$611
Z3666EDMR	36 x 66 x 29.5-30	70	150.15	8.76	\$1169	\$1436	\$723	\$611
Z3660EDMR	36 x 60 x 29.5-30	70	141.75	6.50	\$1139	\$1347	\$661	\$509

Extended island worksurface on **right**. Connects to returns or bridges with a 16" throat on the left. **Not freestanding.** Grommet in worksurface. $\frac{3}{4}$ **flush** modesty panel is standard. Shipped easy to assemble in 2 cartons.

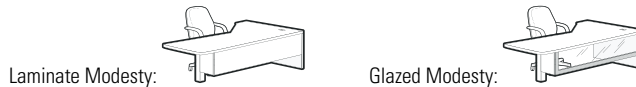

Required Specifications

Primary surface type + finish
Top thickness/edge detail
Base finish
Monopost style/finish

Optional Specifications

Modesty finish glazed
Grommet position or power block cut-out

Accessories

Power block
Keyboard
Pencil drawer

EXT CORNER "P" ISLANDS

MODEL#	DIMENSIONS	FREIGHT CLASS	WT/LBS.	CUBIC FT.	1" TOP	1.5" TOP	GLAZE ADD	HP ADD
--------	------------	---------------	---------	-----------	--------	----------	-----------	--------

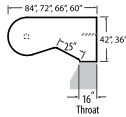

Extended Corner "P" Island - LEFT Full End Panel & Post (T-Base)

D x W x H								
Z4284EPTL	42 x 84 x 29.5-30	70	178.50	10.76	\$1299	\$1639	N/A	\$1081
Z3684EPTL	36 x 84 x 29.5-30	100	153.30	19	\$1198	\$1500	N/A	\$812
Z3672EPTL	36 x 72 x 29.5-30	70	144.90	8.76	\$1104	\$1328	N/A	\$611
Z3666EPTL	36 x 66 x 29.5-30	70	138.60	8.76	\$1059	\$1300	N/A	\$611
Z3660EPTL	36 x 60 x 29.5-30	70	129.15	6.50	\$1020	\$1244	N/A	\$509

Extended island worksurface on **left**. Connects to returns or bridges with a 16" throat on the right. **Not freestanding**.
 Grommet in worksurface. Shipped easy to assemble in 2 cartons.

- Post is shipped in separate carton.

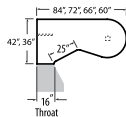

Extended Corner "P" Island - RIGHT Full End Panel & Post (T-Base)

Z4284EPTR	42 x 84 x 29.5-30	70	178.50	10.76	\$1299	\$1639	N/A	\$1081
Z3684EPTR	36 x 84 x 29.5-30	100	153.30	19	\$1198	\$1500	N/A	\$812
Z3672EPTR	36 x 72 x 29.5-30	70	144.90	8.76	\$1104	\$1328	N/A	\$611
Z3666EPTR	36 x 66 x 29.5-30	70	138.60	8.76	\$1059	\$1300	N/A	\$611
Z3660EPTR	36 x 60 x 29.5-30	70	129.15	6.50	\$1020	\$1244	N/A	\$509

Extended island worksurface on **right**. Connects to returns or bridges with a 16" throat on the left. **Not freestanding**.
 Grommet in worksurface. Shipped easy to assemble in 2 cartons.

- Post is shipped in separate carton.

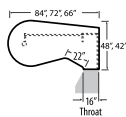

Extended Corner "P" Island - LEFT Faux Pedestal and Post*

Z4884EPFL	48 x 84 x 29.5-30	70	217	12	\$1635	\$2011	\$735	\$1081
Z4872EPFL	48 x 72 x 29.5-30	70	194	10.50	\$1515	\$1845	\$608	\$812
Z4284EPFL	42 x 84 x 29.5-30	70	191	10.76	\$1535	\$1874	\$735	\$1081
Z4272EPFL	42 x 72 x 29.5-30	70	172	8.76	\$1428	\$1725	\$608	\$812
Z4266EPFL	42 x 66 x 29.5-30	70	160	8.76	\$1370	\$1645	\$544	\$812

Extended island worksurface on **left**. Connects to returns or bridges with a 16" throat on the right. **Not freestanding**.
 Faux pedestal on the **right** is ideal for concealing a CPU. ¾ modesty panel is standard. Grommet in worksurface. Shipped easy to assemble in 2 cartons.

Laminate Modesty:

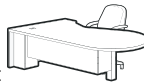

Glazed Modesty:

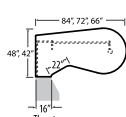
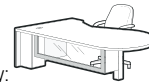

Extended Corner "P" Island - RIGHT Faux Pedestal and Post*

Z4884EPFR	48 x 84 x 29.5-30	70	217	12	\$1635	\$2011	\$735	\$1081
Z4872EPFR	48 x 72 x 29.5-30	70	194	10.50	\$1515	\$1845	\$608	\$812
Z4284EPFR	42 x 84 x 29.5-30	70	191	10.76	\$1535	\$1874	\$735	\$1081
Z4272EPFR	42 x 72 x 29.5-30	70	172	8.76	\$1428	\$1725	\$608	\$812
Z4266EPFR	42 x 66 x 29.5-30	70	160	8.76	\$1370	\$1645	\$544	\$812

Extended island worksurface on **left**. Connects to returns or bridges with a 16" throat on the right. **Not freestanding**.
 Faux pedestal on the **right** is ideal for concealing a CPU. ¾ modesty panel is standard. Grommet in worksurface. Shipped easy to assemble in 2 cartons.

Laminate Modesty:



Glazed Modesty:



Required Specifications

- Primary surface type + finish
- Top thickness/edge detail
- Base finish
- Monopost style/finish

Optional Specifications

- Modesty finish glazed*
- Grommet position or power block cut-out

Accessories

- Power block
- Keyboard
- Pencil drawer

EXTENDED CORNER ISLANDS (WITH RECESSED MODESTY)



Extended Corner "P" Island - LEFT
Recessed Modesty and Post



Extended Corner "P" Island - RIGHT
Recessed Modesty and Post

MODEL#	DIMENSIONS	FREIGHT CLASS	WT/LBS.	CUBIC FT.	1" TOP	1.5" TOP	GLAZE ADD	HP ADD
D x W x H								
Z4284EPRL	42 x 84 x 29.5-30	70	199.50	10.76	\$1447	\$1787	\$863	\$1081
Z3684EPRL	36 x 84 x 29.5-30	70	173.25	9.50	\$1312	\$1645	\$863	\$812
Z3672EPRL	36 x 72 x 29.5-30	70	156.45	8.76	\$1206	\$1462	\$786	\$611
Z3666EPRL	36 x 66 x 29.5-30	70	149.10	8.76	\$1175	\$1417	\$723	\$611
Z3660EPRL	36 x 60 x 29.5-30	70	140.70	6.50	\$1125	\$1349	\$661	\$509

Extended island worksurface on **left**. Connects to returns or bridges with a 16" throat on the right. **Not freestanding.** Grommet in worksurface. $\frac{3}{4}$ recessed modesty panel is standard. Shipped easy to assemble in 2 cartons..

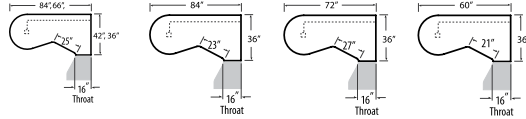

Laminate Modesty:



Glazed Modesty:

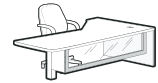

Z4284EPRR	42 x 84 x 29.5-30	70	199.50	10.76	\$1447	\$1787	\$863	\$1081
Z3684EPRR	36 x 84 x 29.5-30	70	173.25	9.50	\$1312	\$1645	\$863	\$812
Z3672EPRR	36 x 72 x 29.5-30	70	156.45	8.76	\$1206	\$1462	\$786	\$611
Z3666EPRR	36 x 66 x 29.5-30	70	149.10	8.76	\$1175	\$1417	\$723	\$611
Z3660EPRR	36 x 60 x 29.5-30	70	140.70	6.50	\$1125	\$1349	\$661	\$509

Extended island worksurface on **right**. Connects to returns or bridges with a 16" throat on the right. **Not freestanding.** Grommet in worksurface. $\frac{3}{4}$ recessed modesty panel is standard. Shipped easy to assemble in 2 cartons.

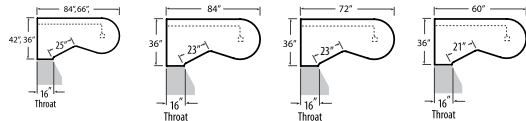

Laminate Modesty:

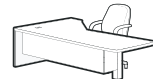

Glazed Modesty:

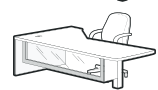

Required Specifications

- Primary surface type + finish
- Top thickness/edge detail
- Base finish
- Monopost finish*

Optional Specifications

- Modesty panel type
- Grommet position or power block cut-out

Accessories

- Power block
- Keyboard
- Pencil drawer

EXTENDED CORNER ISLANDS (WITH FLUSH MODESTY)



**Extended Corner "P" Island - LEFT
Flush Modesty and Post**

MODEL#	DIMENSIONS	FREIGHT CLASS	WT/LBS.	CUBIC FT.	1" TOP	1.5" TOP	GLAZE ADD	HP ADD
D x W x H								
Z4284EPML	42 x 84 x 29.5-30	70	200	10.76	\$1463	\$1803	\$863	\$1081
Z3684EPML	36 x 84 x 29.5-30	70	172	9.50	\$1325	\$1627	\$863	\$812
Z3672EPML	36 x 72 x 29.5-30	70	156	8.76	\$1216	\$1471	\$786	\$611
Z3666EPML	36 x 66 x 29.5-30	70	150	8.76	\$1168	\$1381	\$723	\$611
Z3660EPML	36 x 60 x 29.5-30	70	141	6.50	\$1133	\$1356	\$661	\$509

Extended island worksurface on **left**. Connects to returns or bridges with a 16" throat on the right. **Not freestanding.** Grogmet in worksurface. **¾ flush** modesty panel is standard. Shipped easy to assemble in 2 cartons.

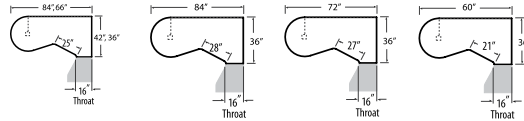

Laminate Modesty:



Glazed Modesty:

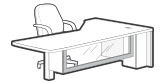

**Extended Corner "P" Island - RIGHT
Flush Modesty and Post**

Z4284EPMR	42 x 84 x 29.5-30	70	200	10.76	\$1463	\$1803	\$863	\$1081
Z3684EPMR	36 x 84 x 29.5-30	70	172	9.50	\$1325	\$1627	\$863	\$812
Z3672EPMR	36 x 72 x 29.5-30	70	156	8.76	\$1216	\$1471	\$786	\$611
Z3666EPMR	36 x 66 x 29.5-30	70	150	8.76	\$1168	\$1381	\$723	\$611
Z3660EPMR	36 x 60 x 29.5-30	70	141	6.50	\$1133	\$1356	\$661	\$509

Extended island worksurface on **left**. Connects to returns or bridges with a 16" throat on the right. **Not freestanding.** Grogmet in worksurface. **¾ flush** modesty panel is standard. Shipped easy to assemble in 2 cartons.

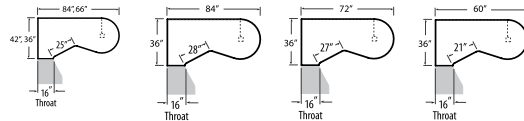

Laminate Modesty:



Glazed Modesty:

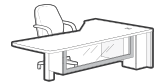

Required Specifications

- Primary surface type + finish
- Top thickness/edge detail
- Base finish
- Monopost finish

Optional Specifications

- Glazing - modesty panel
- Grogmet position or power block cut-out

Accessories

- Power block
- Keyboard
- Pencil drawer

"D" ISLANDS

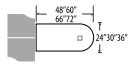

"D" Island with Monopost

MODEL#	DIMENSIONS	FREIGHT CLASS	WT/LBS.	CUBIC FT.	1" TOP	1.5" TOP	GLAZE ADD	HP ADD
D x W x H								
Z3672I	36 x 72 x 29.5-30	70	144	8.50	\$841	\$1069	N/A	\$584
Z3066I	29.7 x 66 x 29.5-30	70	115	7.50	\$784	\$964	N/A	\$547
Z3060I	29.7 x 60 x 29.5-30	70	104	6.76	\$784	\$956	N/A	\$509
Z2466I	24 x 66 x 29.5-30	85	101	7.50	\$716	\$876	N/A	\$409
Z2460I	24 x 60 x 29.5-30	85	92	6.76	\$679	\$821	N/A	\$376
Z2448I	24 x 48 x 29.5-30	85	74	5.76	\$628	\$754	N/A	\$300

Attaches to edge of worksurfaces. Attaching hardware included. Includes grommet as shown. Shipped RTA (ready to assemble).

- Post is shipped in separate carton.

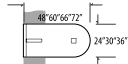

"D" Island - Full End Panel and Monopost (T-Base)

Z3672FI	36 x 72 x 29.5-30	85	123	8.50	\$1030	\$1258	N/A	\$584
Z3072FI	29.7 x 72 x 29.5-30	85	106	7.50	\$1030	\$1220	N/A	\$549
Z3066FI	29.7 x 66 x 29.5-30	85	101	7.50	\$938	\$1118	N/A	\$547
Z3060FI	29.7 x 60 x 29.5-30	85	94	6.76	\$881	\$1053	N/A	\$509
Z2466FI	24 x 66 x 29.5-30	85	90	7.50	\$868	\$1030	N/A	\$409
Z2460FI	24 x 60 x 29.5-30	85	84	6.76	\$831	\$975	N/A	\$376
Z2448FI	24 x 48 x 29.5-30	85	74	5.76	\$784	\$909	N/A	\$300

Attaches to edge of worksurfaces. Attaching hardware included. Includes grommet as shown. **Not freestanding.** Shipped RTA (ready to assemble).

- Post is shipped in separate carton.

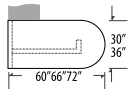

"D" Island LEFT - Full Modesty Panel (H-Base)

Z3672FIL	36 x 72 x 29.5-30	65	171	7	\$973	\$1201	N/A	\$584
Z3066FIL	29.7 x 66 x 29.5-30	65	140	6	\$868	\$1112	N/A	\$547
Z3060FIL	29.7 x 60 x 29.5-30	65	128	5.25	\$791	\$963	N/A	\$509

Connects to the left side of a worksurface. Attaching hardware included. Accommodates all 19" pedestals (mobile and hanging pedestals and 19.3" deep storage shells). Includes grommet as shown. **Not freestanding.** Shipped RTA (ready to assemble).

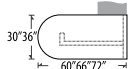

"D" Island RIGHT - Full Modesty Panel (H-Base)

Z3672FIR	36 x 72 x 29.5-30	65	171	7	\$973	\$1201	N/A	\$584
Z3066FIR	29.7 x 66 x 29.5-30	65	140	6	\$868	\$1112	N/A	\$547
Z3060FIR	29.7 x 60 x 29.5-30	65	128	5.25	\$791	\$963	N/A	\$509

Connects to the right side of a worksurface. Attaching hardware included. Accommodates all 19" pedestals (mobile and hanging pedestals and 19.3" deep storage shells). Includes grommet as shown. **Not freestanding.** Shipped RTA (ready to assemble).

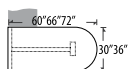

"D" Island CENTER - Full Modesty Panel (H-Base)

Z3672FIC	36 x 72 x 29.5-30	65	171	7	\$973	\$1201	N/A	\$584
Z3066FIC	29.7 x 66 x 29.5-30	65	140	6	\$868	\$1112	N/A	\$547
Z3060FIC	29.7 x 60 x 29.5-30	65	123	5.25	\$791	\$963	N/A	\$509

Connects in between two worksurfaces. Attaching hardware included. **Will not accommodate pedestals.** Includes grommet as shown. **Not freestanding.** Shipped RTA (ready to assemble).

Required Specifications









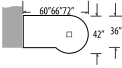

- Primary surface type + finish
- Top thickness/edge detail
- Base finish
- Monopost finish

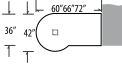
Optional Specifications

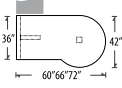
- Remove standard grommet (RSG)

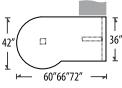
Accessories

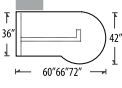
- Power block
- Keyboard
- Pencil drawer

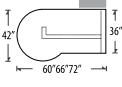
"P" ISLANDS		MODEL#	DIMENSIONS	FREIGHT CLASS	WT/LBS.	CUBIC FT.	1" TOP	1.5" TOP	GLAZE ADD	HP ADD	
		D x W x H									
 	Z3672IPL	42 x 72 x 29.5-30	85	128	9.26	\$958	\$1192	N/A	\$779		
	Z3666IPL	42 x 66 x 29.5-30	85	119	8.76	\$958	\$1138	N/A	\$779		
	Z3660IPL	42 x 60 x 29.5-30	85	110	8	\$868	\$1048	N/A	\$664		
	<p>Attaches to edge of worksurfaces. Attaching hardware included. Includes grommet as shown. Shipped RTA (ready to assemble).</p> <ul style="list-style-type: none"> • Post is shipped in separate carton. 										
 	Z3672IPR	42 x 72 x 29.5-30	85	128	9.26	\$958	\$1192	N/A	\$779		
	Z3666IPR	42 x 66 x 29.5-30	85	119	8.76	\$958	\$1138	N/A	\$779		
	Z3660IPR	42 x 60 x 29.5-30	85	110	8	\$868	\$1048	N/A	\$664		
	<p>Attaches to edge of worksurfaces. Attaching hardware included. Includes grommet as shown. Shipped RTA (ready to assemble).</p> <ul style="list-style-type: none"> • Post is shipped in separate carton. 										
 	Z3672FPL	42 x 72 x 29.5-30	70	163	9.26	\$1148	\$1382	N/A	\$779		
	Z3666FPL	42 x 66 x 29.5-30	70	155	8.76	\$1148	\$1338	N/A	\$779		
	Z3660FPL	42 x 60 x 29.5-30	70	145	8	\$1061	\$1241	N/A	\$664		
	<p>Connects to left side of worksurface. Attaching hardware included. Not freestanding. Includes grommet as shown. Shipped RTA (ready to assemble).</p> <ul style="list-style-type: none"> • Post is shipped in separate carton. 										
 	Z3672FPR	42 x 72 x 29.5-30	70	163	9.26	\$1148	\$1382	N/A	\$779		
	Z3666FPR	42 x 66 x 29.5-30	70	155	8.76	\$1148	\$1338	N/A	\$779		
	Z3660FPR	42 x 60 x 29.5-30	70	145	8	\$1061	\$1241	N/A	\$664		
	<p>Connects to right side of worksurface. Attaching hardware included. Not freestanding. Includes grommet as shown. Shipped RTA (ready to assemble).</p> <ul style="list-style-type: none"> • Post is shipped in separate carton. 										
 	Z3672PL	42 x 72 x 29.5-30	65	178	7.75	\$1081	\$1314	N/A	\$779		
	Z3666PL	42 x 66 x 29.5-30	65	167	7.25	\$987	\$1167	N/A	\$779		
	Z3660PL	42 x 60 x 29.5-30	65	155	6.50	\$908	\$1090	N/A	\$664		
	<p>Connects to the left side of a worksurface. Attaching hardware included. Accommodates all 19" pedestals (freestanding, mobile and hanging pedestals). Includes grommet as shown. Shipped RTA (ready to assemble).</p>										
 	Z3672PR	42 x 72 x 29.5-30	65	178	7.75	\$1081	\$1314	N/A	\$779		
	Z3666PR	42 x 66 x 29.5-30	65	167	7.25	\$987	\$1167	N/A	\$779		
	Z3660PR	42 x 60 x 29.5-30	65	155	6.50	\$908	\$1090	N/A	\$664		
	<p>Connects to the left side of a worksurface. Attaching hardware included. Accommodates all 19" pedestals (freestanding, mobile and hanging pedestals). Includes grommet as shown. Shipped RTA (ready to assemble).</p>										

Required Specifications

Primary surface type + finish
 Top thickness/edge detail
 Base finish
 Monopost finish

Optional Specifications

Remove standard grommet (RSG)

Accessories

Power block
 Keyboard
 Pencil drawer

RECTANGULAR ISLANDS



Rectangular Island w/Monopost

MODEL#	DIMENSIONS D x W x H	FREIGHT CLASS	WT/LBS.	CUBIC FT.	1" TOP	1.5" TOP	GLAZE ADD	HP ADD
Z3672RI	36 x 72 x 29.5-30	125	90	14.50	\$831	\$1058	N/A	\$665
Z3066RI	30 x 66 x 29.5-30	150	72	12.50	\$776	\$954	N/A	\$547
Z3060RI	30 x 60 x 29.5-30	125	66	10.50	\$776	\$947	N/A	\$512
Z2466RI	24 x 66 x 29.5-30	150	63	15	\$708	\$875	N/A	\$409
Z2460RI	24 x 60 x 29.5-30	150	57	13	\$671	\$813	N/A	\$380
Z2448RI	24 x 48 x 29.5-30	150	47	11.50	\$625	\$753	N/A	\$304

Attaches to edge of worksurfaces. Attaching hardware included. Includes grommet as shown. Shipped RTA (ready to assemble). **Not freestanding.**

- Post is shipped in separate carton.



Rectangular Island LEFT - Full Modesty Panel (H-Base)

Z3672RFIL	36 x 72 x 29.5-30	70	145	7.25	\$963	\$1190	N/A	\$665
Z3084RFIL	29.69 x 84 x 29.5-30	70	146	7.25	\$959	\$1185	N/A	\$659
Z3066RFIL	29.69 x 66 x 29.5-30	70	121	6.25	\$860	\$1109	N/A	\$547
Z3060RFIL	29.69 x 60 x 29.5-30	70	110	5.25	\$784	\$955	N/A	\$512
Z2472RFIL	24 x 72 x 29.5-30	70	116	6.25	\$736	\$912	N/A	\$416
Z2466RFIL	24 x 66 x 29.5-30	70	109	5.75	\$699	\$877	N/A	\$409
Z2460RFIL	24 x 60 x 29.5-30	70	99	5.25	\$665	\$807	N/A	\$380
Z2448RFIL	24 x 48 x 29.5-30	70	85	4.20	\$629	\$740	N/A	\$304

Connects to the **left** side of a worksurface. Attaching hardware included. 36" and 30"D accommodates all 19" pedestals (freestanding, mobile and hanging pedestals). Includes grommet as shown. Shipped RTA (ready to assemble). **Not freestanding.**



Rectangular Island RIGHT - Full Modesty Panel (H-Base)

Z3672RFIR	36 x 72 x 29.5-30	70	145	7.25	\$963	\$1190	N/A	\$665
Z3084RFIR	29.69 x 84 x 29.5-30	70	146	7.25	\$959	\$1185	N/A	\$659
Z3066RFIR	29.69 x 66 x 29.5-30	70	121	6.25	\$860	\$1109	N/A	\$547
Z3060RFIR	29.69 x 60 x 29.5-30	70	110	5.25	\$784	\$955	N/A	\$512
Z2472RFIR	24 x 72 x 29.5-30	70	116	6.25	\$736	\$912	N/A	\$416
Z2466RFIR	24 x 66 x 29.5-30	70	109	5.75	\$699	\$877	N/A	\$409
Z2460RFIR	24 x 60 x 29.5-30	70	99	5.25	\$665	\$807	N/A	\$380
Z2448RFIR	24 x 48 x 29.5-30	70	85	4.20	\$629	\$740	N/A	\$304

Connects to the **right** side of a worksurface. Attaching hardware included. 36" and 30"D accommodates all 19" pedestals (freestanding, mobile and hanging pedestals). Includes grommet as shown. Shipped RTA (ready to assemble). **Not freestanding.**

Required Specifications

- Primary surface type + finish
- Top thickness/edge detail
- Leg finish

UNIVERSAL TOPS	MODEL#	DIMENSIONS	FREIGHT CLASS	WT/LBS.	CUBIC FT.	1" TOP	1.5" TOP	GLAZE ADD	HP ADD
		D x W x H							
ZUT1696		16 x 96 x 1	100	42	5	\$593	\$792	N/A	\$356
ZUT1690		16 x 90 x 1	100	39	4.75	\$560	\$747	N/A	\$331
ZUT1684		16 x 84 x 1	100	37	4.50	\$507	\$679	N/A	\$310
ZUT1678		16 x 78 x 1	100	34	4.25	\$487	\$647	N/A	\$292
ZUT1672		16 x 72 x 1	85	31	2.25	\$455	\$602	N/A	\$267
ZUT1666		16 x 66 x 1	85	29	2	\$423	\$557	N/A	\$248
ZUT1660		16 x 60 x 1	85	26	1.75	\$391	\$511	N/A	\$226
ZUT1654		16 x 54 x 1	85	24	1.75	\$351	\$465	N/A	\$199
ZUT1648		16 x 48 x 1	85	21	1.50	\$319	\$419	N/A	\$179
ZUT1642		16 x 42 x 1	85	18	1.25	\$285	\$374	N/A	\$161
ZUT1636		16 x 36 x 1	85	16	1.25	\$248	\$323	N/A	\$135
ZUT1630		16 x 30 x 1	85	13	1	\$213	\$274	N/A	\$114
ZUT1896		18 x 96 x 1	100	47	5.50	\$604	\$798	N/A	\$397
ZUT1890		18 x 90 x 1	100	44	5.25	\$573	\$752	N/A	\$376
ZUT1884		18 x 84 x 1	100	41	4.75	\$534	\$707	N/A	\$351
ZUT1878		18 x 78 x 1	100	38	4.50	\$501	\$655	N/A	\$323
ZUT1872		18 x 72 x 1	70	35	2.25	\$468	\$615	N/A	\$299
ZUT1866		18 x 66 x 1	85	32	2.25	\$428	\$563	N/A	\$278
ZUT1860		18 x 60 x 1	85	29	2	\$397	\$518	N/A	\$252
ZUT1854		18 x 54 x 1	85	26	1.75	\$356	\$470	N/A	\$226
ZUT1848		18 x 48 x 1	85	23	1.75	\$331	\$431	N/A	\$199
ZUT1842		18 x 42 x 1	85	20	1.50	\$299	\$388	N/A	\$179
ZUT1836		18 x 36 x 1	85	18	1.25	\$252	\$327	N/A	\$154
ZUT1830		18 x 30 x 1	85	15	1.25	\$220	\$282	N/A	\$127
ZUT2096		20 x 96 x 1	100	52	6	\$613	\$812	N/A	\$442
ZUT2090		20 x 90 x 1	100	49	5.50	\$581	\$768	N/A	\$416
ZUT2084		20 x 84 x 1	100	45	5.25	\$540	\$712	N/A	\$391
ZUT2078		20 x 78 x 1	100	42	4.75	\$477	\$637	N/A	\$364
ZUT2072		20 x 72 x 1	70	39	2.50	\$477	\$624	N/A	\$331
ZUT2066		20 x 66 x 1	70	36	2.25	\$436	\$576	N/A	\$304
ZUT2060		20 x 60 x 1	85	32	2.25	\$402	\$522	N/A	\$278
ZUT2054		20 x 54 x 1	85	29	2	\$371	\$479	N/A	\$252
ZUT2048		20 x 48 x 1	85	26	1.75	\$339	\$432	N/A	\$226
ZUT2042		20 x 42 x 1	70	23	1.50	\$304	\$385	N/A	\$199
ZUT2036		20 x 36 x 1	85	20	1.50	\$258	\$333	N/A	\$168
ZUT2030		20 x 30 x 1	85	16	1.25	\$226	\$288	N/A	\$141
ZUT2496		24 x 96 x 1	100	62	6.75	\$704	\$937	N/A	\$528
ZUT2490		24 x 90 x 1	100	58	6.25	\$665	\$885	N/A	\$496
ZUT2484		24 x 84 x 1	100	55	6	\$618	\$824	N/A	\$463
ZUT2478		24 x 78 x 1	100	51	5.50	\$581	\$774	N/A	\$428
ZUT2472		24 x 72 x 1	100	47	5.25	\$540	\$708	N/A	\$397
ZUT2466		24 x 66 x 1	100	43	4.75	\$501	\$669	N/A	\$364
ZUT2460		24 x 60 x 1	100	39	4.50	\$463	\$609	N/A	\$331
ZUT2454		24 x 54 x 1	100	35	4	\$423	\$557	N/A	\$299
ZUT2448		24 x 48 x 1	70	31	2	\$383	\$503	N/A	\$267
ZUT2442		24 x 42 x 1	70	27	1.75	\$339	\$447	N/A	\$234
ZUT2436		24 x 36 x 1	70	23	1.50	\$299	\$393	N/A	\$199
ZUT2430		24 x 30 x 1	85	20	1.50	\$258	\$333	N/A	\$168

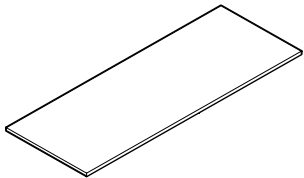

Laminate Tops

Laminate tops for placement over Zira storage.

- Contact Global for pricing on special size tops.
- **No drilling or hardware included.**

Required Specifications

Primary surface type + finish
Top thickness/edge detail

Optional Specifications

Grommet position or power block cut-out

Accessories

Power block

UNIVERSAL TOPS

MODEL#	DIMENSIONS	FREIGHT CLASS	WT/LBS.	CUBIC FT.	1" TOP	1.5" TOP	GLAZE ADD	HP ADD
D x W x H								
ZUT3096	29.7 x 96 x 1	100	77	8	\$829	\$1126	N/A	\$658
ZUT3090	29.7 x 90 x 1	100	72	7.50	\$783	\$1061	N/A	\$618
ZUT3084	29.7 x 84 x 1	100	67	7.25	\$737	\$995	N/A	\$581
ZUT3078	29.7 x 78 x 1	100	62	6.75	\$684	\$923	N/A	\$540
ZUT3072	29.7 x 72 x 1	100	58	6.25	\$665	\$889	N/A	\$496
ZUT3066	29.7 x 66 x 1	100	53	5.75	\$593	\$792	N/A	\$455
ZUT3060	29.7 x 60 x 1	100	48	5.25	\$547	\$726	N/A	\$416
ZUT3054	29.7 x 54 x 1	100	43	4.75	\$501	\$661	N/A	\$376
ZUT3048	29.7 x 48 x 1	70	38	2.50	\$450	\$604	N/A	\$331
ZUT3042	29.7 x 42 x 1	70	34	2.25	\$402	\$529	N/A	\$292
ZUT3036	29.7 x 36 x 1	85	29	2	\$351	\$465	N/A	\$252
ZUT3030	29.7 x 30 x 1	85	24	1.75	\$304	\$398	N/A	\$213
ZUT3696	36 x 96 x 1	92.5	93	9.25	\$966	\$1316	N/A	\$789
ZUT3690	36 x 90 x 1	100	87	8.75	\$908	\$1239	N/A	\$744
ZUT3684	36 x 84 x 1	100	81	8.25	\$837	\$1147	N/A	\$691
ZUT3678	36 x 78 x 1	100	76	7.75	\$797	\$1080	N/A	\$644
ZUT3672	36 x 72 x 1	100	70	7.25	\$744	\$1009	N/A	\$593
ZUT3666	36 x 66 x 1	100	64	6.75	\$671	\$909	N/A	\$547
ZUT3660	36 x 60 x 1	100	58	6.25	\$626	\$846	N/A	\$496
ZUT3654	36 x 54 x 1	100	52	5.50	\$581	\$774	N/A	\$450
ZUT3648	36 x 48 x 1	100	47	5	\$521	\$700	N/A	\$397
ZUT3642	36 x 42 x 1	100	41	4.50	\$468	\$622	N/A	\$351
ZUT3636	36 x 36 x 1	100	35	4	\$411	\$545	N/A	\$299
ZUT3630	36 x 30 x 1	100	29	3.50	\$351	\$465	N/A	\$252
ZUT4296	42 x 96 x 1	92.5	108	10	\$1091	\$1500	N/A	\$921
ZUT4290	42 x 90 x 1	92.5	102	10	\$1030	\$1413	N/A	\$868
ZUT4284	42 x 84 x 1	92.5	95	9.50	\$946	\$1302	N/A	\$810
ZUT4278	42 x 78 x 1	92.5	88	8.75	\$908	\$1239	N/A	\$750
ZUT4272	42 x 72 x 1	100	81	8.25	\$842	\$1152	N/A	\$691
ZUT4266	42 x 66 x 1	92.5	75	7.50	\$783	\$1061	N/A	\$639
ZUT4260	42 x 60 x 1	100	68	7	\$717	\$975	N/A	\$581
ZUT4254	42 x 54 x 1	100	61	6.25	\$653	\$886	N/A	\$521
ZUT4248	42 x 48 x 1	100	54	5.75	\$593	\$800	N/A	\$463
ZUT4242	42 x 42 x 1	100	48	5.25	\$528	\$707	N/A	\$411
ZUT4236	42 x 36 x 1	100	41	4.50	\$450	\$649	N/A	\$351
ZUT4230	42 x 30 x 1	100	34	4	\$364	\$499	N/A	\$292
ZUT4896	48 x 96 x 1	92.5	124	11.25	\$1228	\$1696	N/A	\$1052
ZUT4890	48 x 90 x 1	92.5	116	10.50	\$1163	\$1598	N/A	\$987
ZUT4884	48 x 84 x 1	92.5	108	10.50	\$1085	\$1494	N/A	\$921
ZUT4878	48 x 78 x 1	92.5	101	10	\$1012	\$1388	N/A	\$855
ZUT4872	48 x 72 x 1	92.5	93	9.25	\$946	\$1297	N/A	\$789
ZUT4866	48 x 66 x 1	92.5	85	8.50	\$873	\$1196	N/A	\$725
ZUT4860	48 x 60 x 1	92.5	77	7.25	\$810	\$1102	N/A	\$658
ZUT4854	48 x 54 x 1	100	70	7.25	\$737	\$1002	N/A	\$593
ZUT4848	48 x 48 x 1	100	62	6.50	\$658	\$897	N/A	\$528
ZUT4842	48 x 42 x 1	100	54	5.75	\$593	\$800	N/A	\$463
ZUT4836	48 x 36 x 1	100	47	5	\$521	\$694	N/A	\$397
ZUT4830	48 x 30 x 1	100	36	4.25	\$442	\$589	N/A	\$331

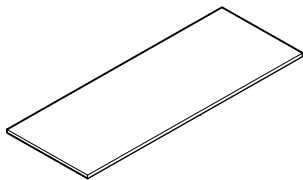

Laminate Tops

Laminate tops for placement over Zira storage.

- Contact Global for pricing on special size tops.
- No drilling or hardware included.

Required Specifications
 Primary surface type + finish
 Top thickness/edge detail

Optional Specifications
 Grommet position or power block cut-out

Accessories
 Power block

UNIVERSAL TOPS	MODEL#	DIMENSIONS	FREIGHT CLASS	WT/LBS.	CUBIC FT.	1" TOP	1.5" TOP	GLAZE ADD	HP ADD
		D x W x H							
	ZUT5496	54 x 96 x 1	92.5	139	12.50	\$1365	\$1886	N/A	\$1183
	ZUT5490	54 x 90 x 1	92.5	131	11.75	\$1287	\$1782	N/A	\$1111
	ZUT5484	54 x 84 x 1	92.5	122	11	\$1216	\$1677	N/A	\$1040
	ZUT5478	54 x 78 x 1	92.5	113	10.25	\$1144	\$1566	N/A	\$966
	ZUT5472	54 x 72 x 1	92.5	105	9.50	\$1064	\$1461	N/A	\$887
	ZUT5466	54 x 66 x 1	92.5	96	9.50	\$992	\$1348	N/A	\$816
	ZUT5460	54 x 60 x 1	100	87	8.75	\$913	\$1243	N/A	\$744
	ZUT5454	54 x 54 x 1	100	78	8	\$816	\$1113	N/A	\$671
	ZUT5448	54 x 48 x 1	100	70	7.25	\$737	\$1002	N/A	\$593
	ZUT5442	54 x 42 x 1	100	61	6.25	\$653	\$886	N/A	\$521
	ZUT5436	54 x 36 x 1	100	52	5.50	\$501	\$694	N/A	\$450
	ZUT5430	54 x 30 x 1	100	44	4.75	\$501	\$669	N/A	\$376
	ZUT6096	60 x 96 x 1	92.5	155	14	\$1503	\$2082	N/A	\$1313
	ZUT6090	60 x 90 x 1	92.5	145	13	\$1417	\$1964	N/A	\$1234
	ZUT6084	60 x 84 x 1	92.5	135	12.25	\$1333	\$1847	N/A	\$1150
	ZUT6078	60 x 78 x 1	92.5	126	11.50	\$1255	\$1729	N/A	\$1071
	ZUT6072	60 x 72 x 1	92.5	116	10.50	\$1150	\$1585	N/A	\$987
	ZUT6066	60 x 66 x 1	92.5	106	9.75	\$1064	\$1466	N/A	\$908
	ZUT6060	60 x 60 x 1	92.5	97	8.75	\$987	\$1351	N/A	\$823
	ZUT6054	60 x 54 x 1	100	87	8.75	\$913	\$1243	N/A	\$744
	ZUT6048	60 x 48 x 1	100	77	7.75	\$810	\$1102	N/A	\$658
	ZUT6042	60 x 42 x 1	100	68	7	\$717	\$975	N/A	\$581
	ZUT6036	60 x 36 x 1	100	58	6.25	\$658	\$878	N/A	\$496
	ZUT6030	60 x 30 x 1	100	49	5.25	\$547	\$726	N/A	\$416

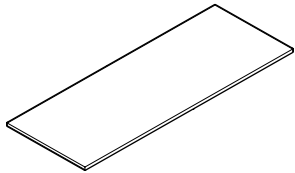

Laminate Tops

Laminate tops for placement over Zira storage.

- Contact Global for pricing on special size tops.
- No drilling or hardware included.

Required Specifications

Primary surface type + finish
Top thickness/edge detail

Optional Specifications

Grommet position or power block cut-out

Accessories

Power block

UNIVERSAL TOPS FOR HA BASES

MODEL#	DIMENSIONS D x W x H	FREIGHT CLASS	WT/LBS.	CUBIC FT.	1" TOP	1.5" TOP	GLAZE ADD	HP ADD
ZPHAT2382	23 x 82 x 1	85	55	3.75	\$514	\$922	N/A	\$434
ZPHAT2376	23 x 76 x 1	85	51	3.5	\$482	\$862	N/A	\$401
ZPHAT2370	23 x 70 x 1	100	39	4.5	\$534	\$707	N/A	\$371
ZPHAT2364	23 x 64 x 1	100	39	4.5	\$487	\$655	N/A	\$343
ZPHAT2358	23 x 58 x 1	70	35	2.25	\$450	\$597	N/A	\$310
ZPHAT2352	23 x 52 x 1	70	32	2	\$411	\$545	N/A	\$278
ZPHAT2346	23 x 46 x 1	85	29	2	\$371	\$491	N/A	\$248
ZPHAT2340	23 x 40 x 1	85	25	1.75	\$331	\$431	N/A	\$213
ZPHAT2334	23 x 34 x 1	85	21	1.5	\$292	\$381	N/A	\$187
ZPHAT2982	29 x 82 x 1	70	69	4.25	\$612	\$1102	N/A	\$545
ZPHAT2976	29 x 76 x 1	70	64	4	\$565	\$1028	N/A	\$507
ZPHAT2970	29 x 70 x 1	100	43	5	\$632	\$852	N/A	\$468
ZPHAT2964	29 x 64 x 1	100	49	5.5	\$586	\$784	N/A	\$854
ZPHAT2958	29 x 58 x 1	100	45	5	\$534	\$721	N/A	\$391
ZPHAT2952	29 x 52 x 1	70	40	2.5	\$487	\$655	N/A	\$351
ZPHAT2946	29 x 46 x 1	70	35	2.25	\$442	\$589	N/A	\$310
ZPHAT2940	29 x 40 x 1	70	31	2	\$391	\$525	N/A	\$272
ZPHAT2934	29 x 34 x 1	85	26	1.75	\$343	\$457	N/A	\$234
ZPHAT3582	35 x 82 x 1	70	83	5	\$704	\$1288	N/A	\$648
ZPHAT3576	35 x 76 x 1	70	77	4.75	\$658	\$1204	N/A	\$604
ZPHAT3570	35 x 70 x 1	70	71	4.25	\$612	\$1116	N/A	\$556
ZPHAT3564	35 x 64 x 1	70	65	4	\$565	\$1028	N/A	\$513
ZPHAT3558	35 x 58 x 1	70	59	3.75	\$519	\$940	N/A	\$465
ZPHAT3552	35 x 52 x 1	70	53	3.25	\$473	\$857	N/A	\$422
ZPHAT3546	35 x 46 x 1	70	47	3	\$426	\$769	N/A	\$372
ZPHAT3540	35 x 40 x 1	85	41	2.75	\$380	\$686	N/A	\$329
ZPHAT3534	35 x 34 x 1	70	35	2.25	\$334	\$598	N/A	\$280

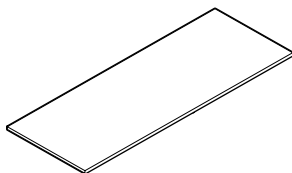

Laminate Tops for HA base

Laminate tops for placement over height adjustable tables.

- Contact Global for pricing on special size tops.
- **No drilling or hardware included.**

Required Specifications

Primary surface type + finish
Top thickness/edge detail

Optional Specifications

Grommet position or power block cut-out

Accessories

Power block

UNIVERSAL RETURN TOPS FOR HA BASES

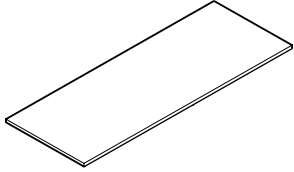

Return Top for HA base

MODEL#	DIMENSIONS D x W x H	FREIGHT CLASS	WT/LBS.	CUBIC FT.	1" TOP	1.5" TOP	GLAZE ADD	HP ADD
ZPHAR2359	23 x 59 x 1	85	40	2.75	\$380	\$681	N/A	\$310
ZPHAR2353	23 x 53 x 1	85	36	2.5	\$348	\$621	N/A	\$280
ZPHAR2347	23 x 47 x 1	85	32	2.25	\$315	\$556	N/A	\$250
ZPHAR2341	23 x 41 x 1	85	28	2	\$278	\$496	N/A	\$219
ZPHAR2335	23 x 35 x 1	85	24	1.75	\$250	\$431	N/A	\$186
ZPHAR2959	29 x 59 x 1	70	50	3.25	\$450	\$811	N/A	\$390
ZPHAR2953	29 x 53 x 1	70	45	2.75	\$408	\$737	N/A	\$353
ZPHAR2947	29 x 47 x 1	70	40	2.5	\$371	\$663	N/A	\$310
ZPHAR2941	29 x 41 x 1	70	35	2.25	\$334	\$588	N/A	\$274
ZPHAR2935	29 x 35 x 1	70	30	2	\$292	\$519	N/A	\$236

Laminate tops for placement over height adjustable tables.

- Contact Global for pricing on special size tops.
- **No drilling or hardware included.**

Required Specifications

Primary surface type + finish
Top thickness/edge detail

Optional Specifications

Grommet position or power block cut-out
(center position only)

Accessories

Power block

FILE TOPS

MODEL#	DIMENSIONS	FREIGHT CLASS	WT/LBS.	CUBIC FT.	1" TOP	1.5" TOP	GLAZE ADD	HP ADD
D x W x H								
ZUFT1896	18.11 x 96.10 x 1	100	47	5.50	\$604	\$798	N/A	\$402
ZUFT1890	18.11 x 90.12 x 1	100	44	5.25	\$573	\$752	N/A	\$376
ZUFT1884	18.11 x 84.09 x 1	100	41	4.75	\$534	\$707	N/A	\$351
ZUFT1878	18.11 x 78.11 x 1	100	38	4.50	\$501	\$655	N/A	\$331
ZUFT1872	18.11 x 72.13 x 1	70	35	2.25	\$468	\$615	N/A	\$304
ZUFT1866	18.11 x 66.10 x 1	85	32	2.25	\$428	\$563	N/A	\$278
ZUFT1860	18.11 x 60.12 x 1	85	29	2	\$397	\$518	N/A	\$252
ZUFT1854	18.11 x 54.09 x 1	70	27	1.75	\$356	\$470	N/A	\$234
ZUFT1848	18.11 x 48.11 x 1	85	24	1.75	\$319	\$427	N/A	\$207
ZUFT1842	18.11 x 42.13 x 1	85	21	1.50	\$285	\$378	N/A	\$179
ZUFT1836	18.11 x 36.10 x 1	85	18	1.25	\$252	\$314	N/A	\$154
ZUFT1830	18.11 x 30.12 x 1	85	15	1.25	\$220	\$282	N/A	\$127
ZUFT1996	19.25 x 96.10 x 1	100	50	5.75	\$613	\$812	N/A	\$428
ZUFT1990	19.25 x 90.12 x 1	100	47	5.50	\$581	\$768	N/A	\$402
ZUFT1984	19.25 x 84.09 x 1	100	44	5	\$540	\$712	N/A	\$376
ZUFT1978	19.25 x 78.11 x 1	100	41	4.75	\$507	\$667	N/A	\$351
ZUFT1972	19.25 x 72.13 x 1	70	38	2.50	\$477	\$624	N/A	\$323
ZUFT1966	19.25 x 66.10 x 1	70	34	2.25	\$436	\$571	N/A	\$299
ZUFT1960	19.25 x 60.12 x 1	70	31	2	\$402	\$522	N/A	\$272
ZUFT1954	19.25 x 54.09 x 1	85	27	2	\$371	\$479	N/A	\$248
ZUFT1948	19.25 x 48.11 x 1	85	25	1.75	\$331	\$431	N/A	\$220
ZUFT1942	19.25 x 42.13 x 1	85	22	1.50	\$299	\$388	N/A	\$194
ZUFT1936	19.25 x 36.10 x 1	70	19	1.25	\$258	\$333	N/A	\$168
ZUFT1930	19.25 x 30.12 x 1	85	16	1.25	\$226	\$288	N/A	\$141

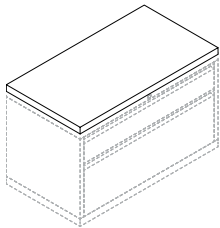

Lateral File Tops

Laminate tops for placement over 1900 Series Lateral Files + Storage. **No drilling or hardware included.**

- Contact Global for pricing on special size tops.

ZUFT3696	36.14 x 96.10 x 1	100	93	9.50	\$966	\$1316	N/A	\$797
ZUFT3690	36.14 x 90.12 x 1	92.5	88	8.75	\$908	\$1239	N/A	\$750
ZUFT3684	36.14 x 84.09 x 1	92.5	82	7.75	\$837	\$1147	N/A	\$697
ZUFT3678	36.14 x 78.11 x 1	100	76	7.75	\$797	\$1080	N/A	\$653
ZUFT3672	36.14 x 72.13 x 1	100	70	7.25	\$744	\$981	N/A	\$600
ZUFT3666	36.14 x 66.10 x 1	100	64	6.75	\$671	\$909	N/A	\$547
ZUFT3660	36.14 x 60.12 x 1	100	59	6.25	\$626	\$846	N/A	\$501
ZUFT3654	36.14 x 54.09 x 1	100	53	5.50	\$581	\$774	N/A	\$450
ZUFT3648	36.14 x 48.11 x 1	100	47	5	\$521	\$700	N/A	\$402
ZUFT3642	36.14 x 42.13 x 1	100	41	4.50	\$468	\$622	N/A	\$351
ZUFT3636	36.14 x 36.10 x 1	70	35	2.25	\$411	\$545	N/A	\$304
ZUFT3630	36.14 x 30.12 x 1	85	29	2	\$356	\$465	N/A	\$252
ZUFT3896	38.62 x 96.10 x 1	92.5	100	10	\$1077	\$1486	N/A	\$848
ZUFT3890	38.62 x 90.12 x 1	100	94	9.50	\$1012	\$1395	N/A	\$797
ZUFT3884	38.62 x 84.09 x 1	100	87	8.75	\$953	\$1309	N/A	\$744
ZUFT3878	38.62 x 78.11 x 1	100	81	8.25	\$887	\$1226	N/A	\$691
ZUFT3872	38.62 x 72.13 x 1	100	75	7.75	\$829	\$1133	N/A	\$639
ZUFT3866	38.62 x 66.10 x 1	100	69	7	\$764	\$1047	N/A	\$586
ZUFT3860	38.62 x 60.12 x 1	100	62	6.50	\$704	\$960	N/A	\$534
ZUFT3854	38.62 x 54.09 x 1	100	56	6	\$644	\$870	N/A	\$481
ZUFT3848	38.62 x 48.11 x 1	100	50	5.25	\$581	\$787	N/A	\$428
ZUFT3842	38.62 x 42.13 x 1	100	44	4.75	\$515	\$701	N/A	\$376
ZUFT3836	38.62 x 36.10 x 1	100	38	4.25	\$455	\$607	N/A	\$323
ZUFT3830	38.62 x 30.12 x 1	100	31	3.75	\$391	\$525	N/A	\$272

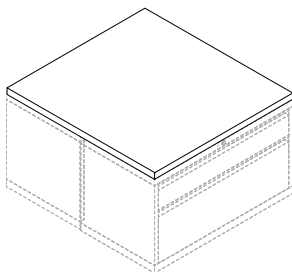

Lateral File Tops - Back to Back

Laminate tops for placement over back-to-back metal filing + storage. **No drilling or hardware included.**

- Use ZUFT36xx models for 18" D laterals back-to-back
- Use ZUFT38xx models for 19.25" D laterals back-to-back
- Contact Global for pricing on special size tops.

Required Specifications

Primary surface type + finish
Top thickness/edge detail

Optional Specifications

Grommet position or power block cut-out

Accessories

Power block

PEDESTALS	MODEL#	DIMENSIONS	FREIGHT CLASS	WT/LBS.	CUBIC FT.	1" TOP	1.5" TOP	GLAZE ADD	HP ADD
		D x W x H							
	ZMPFF28	29 x 16 x 28	92.5	106	10.25	\$1370	N/A	N/A	\$238
	ZMPFF22	23 x 16 x 28	92.5	95	8.25	\$1301	N/A	N/A	\$238
Mobile Pedestal with Overhang*	File/File drawers on fully progressive ball bearing slides, accommodate letter and legal size hanging files. Pedestal top features 1" overhang with built-in grip for ease of mobility. Includes counterweight to prevent tipping. Drawers are locking. Only front casters are locking.								
	ZMPFF19	19 x 16 x 28	85	97	7.25	\$1231	N/A	N/A	\$238
Mobile Pedestal*	File/File drawers on fully progressive ball bearing slides, accommodate letter and legal size hanging files. Drawers are locking. Only front casters are locking.								
	ZMPBBF28	29 x 16 x 28	92.5	105	10.25	\$1256	N/A	N/A	\$238
	ZMPBBF22	23 x 16 x 28	92.5	92	8.25	\$1208	N/A	N/A	\$236
Mobile Pedestal with Overhang*	Box/Box/File drawers on fully progressive ball bearing slides, accommodate letter and legal size hanging files. Pedestal top features 1" overhang with built-in grip for ease of mobility. Includes counterweight to prevent tipping. File drawer and lower box drawer are locking. Only front casters are locking.								
	ZMPBBF19	19 x 16 x 28	85	96	7.25	\$1146	N/A	N/A	\$238
Mobile Pedestal*	Box/Box/File drawers on fully progressive ball bearing slides, accommodate letter and legal size hanging files. File drawer and lower box drawer are locking. Only front casters are locking.								
	ZMPBF28	29 x 16 x 22	92.5	83	8.25	\$1104	N/A	N/A	\$238
	ZMPBF22	23 x 16 x 22	92.5	73	6.75	\$1076	N/A	N/A	\$238
Mobile Pedestal with Overhang*	Box/File drawers on fully progressive ball bearing slides, accommodate letter and legal size hanging files. Pedestal top features 1" overhang with built-in grip for ease of mobility. Includes counterweight to prevent tipping. Drawers are locking. Only front casters are locking.								
	ZMPBF19	19 x 16 x 22	85	77	6.25	\$1011	N/A	N/A	\$238
Mobile Pedestal*	Box/File drawers on fully progressive ball bearing slides, accommodate letter and legal size hanging files. Drawers are locking. Only front casters are locking.								
	ZHPBF18	19 x 16 x 18	92.5	48	4.50	\$752	N/A	N/A	N/A
Hanging Pedestal	Box/File drawers on fully progressive ball bearing slides, accommodate letter and legal size hanging files. Drawers are locking.								

Required Specifications

Primary surface type + finish
 Top thickness/edge detail*
 Base finish
 Drawer front finish

Lock finish

Optional Specifications

Key #
 Handles

STORAGE SHELLS - 16.87" HIGH



Open Storage Shell



Lateral File Shell*



Glazed door option

Closed Storage Shell**



Split Drawer Storage Shell* - LEFT



Split Drawer Storage Shell* - RIGHT

MODEL#	DIMENSIONS D x W x H	FREIGHT CLASS	WT/LBS.	CUBIC FT.	1" TOP	1.5" TOP	GLAZE ADD	HP ADD
Z36L21SNS	24 x 36 x 16.87	150	62	11.25	\$681	N/A	N/A	N/A
Z30L21SNS	24 x 30 x 16.87	150	55	9.50	\$611	N/A	N/A	N/A
Z36M21SNS	20 x 36 x 16.87	150	56	9.50	\$628	N/A	N/A	N/A
Z30M21SNS	20 x 30 x 16.87	125	49	8	\$561	N/A	N/A	N/A

For use under **Zxxxx1TB 17.37" H** top and back kit. **No top or back.**

Z36L21ES	24 x 36 x 16.87	125	82	11.25	\$996	N/A	N/A	N/A
Z30L21ES	24 x 30 x 16.87	100	77	9.50	\$870	N/A	N/A	N/A
Z36M21ES	20 x 36 x 16.87	100	78	9.50	\$960	N/A	N/A	N/A
Z30M21ES	20 x 30 x 16.87	100	73	8	\$831	N/A	N/A	N/A

For use under **Zxxxx1TB 17.37" H** top and back kit. **No top or back.** For filing capabilities, see page 200.

- Lateral file drawer construction is for accommodating hanging files NOT for stacking materials on the drawer bottom.

Z36L21SHS	24 x 36 x 16.87	125	71	11.25	\$906	N/A	\$434	N/A
Z30L21SHS	24 x 30 x 16.87	125	62	9.50	\$817	N/A	\$386	N/A
Z36M21SHS	20 x 36 x 16.87	125	65	9.50	\$854	N/A	\$434	N/A
Z30M21SHS	20 x 30 x 16.87	125	57	8	\$769	N/A	\$385	N/A

For use under **Zxxxx1TB 17.37" H** top and back kit. **No top or back.** Laminate doors are standard. Standard with lock.

Z36L21XSL	24 x 36 x 16.87	125	81	11.25	\$923	N/A	N/A	N/A
Z30L21XSL	24 x 30 x 16.87	125	72	9.50	\$842	N/A	N/A	N/A
Z36M21XSL	20 x 36 x 16.87	100	78	9.50	\$886	N/A	N/A	N/A
Z30M21XSL	20 x 30 x 16.87	100	69	8	\$806	N/A	N/A	N/A

For use under **Zxxxx1TB 17.37" H** top and back kit. **No top or back.** Pull out drawer includes filing space on **left** and storage on **right**. Front-to-back letter capability.

- Lateral file drawer construction is for accommodating hanging files NOT for stacking materials on the drawer bottom.

Z36L21XSR	24 x 36 x 16.87	125	81	11.25	\$923	N/A	N/A	N/A
Z30L21XSR	24 x 30 x 16.87	125	72	9.50	\$842	N/A	N/A	N/A
Z36M21XSR	20 x 36 x 16.87	100	78	9.50	\$886	N/A	N/A	N/A
Z30M21XSR	20 x 30 x 16.87	100	69	8	\$806	N/A	N/A	N/A

For use under **Zxxxx1TB 17.37" H** top and back kit. **No top or back.** Pull out drawer includes filing space on **right** and storage on **left**. Front-to-back letter capability.

- Lateral file drawer construction is for accommodating hanging files NOT for stacking materials on the drawer bottom.

Required Specifications

Base finish
Drawer front finish*
Handles*

Optional Specifications

Key #*
Glazed doors**

TOP AND BACK KITS FOR 16.87" H SHELLS

MODEL#	DIMENSIONS D x W x H	FREIGHT CLASS	WT/LBS.	CUBIC FT.	1" TOP	1.5" TOP	GLAZE ADD	HP ADD
Z24961TB	24 x 96 x 17.37-17.87	70	104	6.75	\$855	\$1044	N/A	\$554
Z24901TB	24 x 90 x 17.37-17.87	70	97	6.25	\$812	\$988	N/A	\$520
Z24841TB	24 x 84 x 17.37-17.87	70	91	6	\$764	\$931	N/A	\$484
Z24781TB	24 x 78 x 17.37-17.87	70	86	5.50	\$716	\$868	N/A	\$451
Z24721TB	24 x 72 x 17.37-17.87	85	78	5.25	\$665	\$807	N/A	\$416
Z24661TB	24 x 66 x 17.37-17.87	70	72	4.75	\$615	\$746	N/A	\$382
Z24601TB	24 x 60 x 17.37-17.87	85	66	4.50	\$564	\$683	N/A	\$349
Z24541TB	24 x 54 x 17.37-17.87	85	59	4	\$511	\$619	N/A	\$314
Z24481TB	24 x 48 x 17.37-17.87	85	55	3.75	\$470	\$565	N/A	\$278
Z24421TB	24 x 42 x 17.37-17.87	85	47	3.25	\$416	\$502	N/A	\$244
Z24361TB	24 x 36 x 17.37-17.87	85	40	3	\$359	\$433	N/A	\$210
Z24301TB	24 x 30 x 17.37-17.87	85	34	2.50	\$310	\$371	N/A	\$175
Z20961TB	20 x 96 x 17.37-17.87	70	93	6	\$788	\$944	N/A	\$463
Z20901TB	20 x 90 x 17.37-17.87	70	86	5.50	\$739	\$886	N/A	\$434
Z20841TB	20 x 84 x 17.37-17.87	70	76	4.75	\$695	\$834	N/A	\$403
Z20781TB	20 x 78 x 17.37-17.87	70	80	5.25	\$657	\$785	N/A	\$376
Z20721TB	20 x 72 x 17.37-17.87	70	69	4.50	\$608	\$727	N/A	\$349
Z20661TB	20 x 66 x 17.37-17.87	70	64	4.25	\$561	\$670	N/A	\$319
Z20601TB	20 x 60 x 17.37-17.87	70	58	3.75	\$516	\$616	N/A	\$291
Z20541TB	20 x 54 x 17.37-17.87	70	53	3.50	\$471	\$562	N/A	\$262
Z20481TB	20 x 48 x 17.37-17.87	70	50	3.25	\$434	\$514	N/A	\$234
Z20421TB	20 x 42 x 17.37-17.87	70	42	2.75	\$382	\$453	N/A	\$202
Z20361TB	20 x 36 x 17.37-17.87	85	35	2.50	\$330	\$391	N/A	\$175
Z20301TB	20 x 30 x 17.37-17.87	85	28	2.25	\$283	\$334	N/A	\$147



Credenza Top and Back Kit

For use with 16.87" high storage shells. Shipped RTA (ready to assemble).

- Does not include hardware to attach to storage shells.

Required Specifications

Primary surface type + finish
 Top thickness/edge detail
 Base finish

STORAGE SHELLS - 22.75" HIGH



1.5H Open Storage Shell



1.5H Open/Lateral File Shell*



1.5H Box/Lateral File Shell*



1.5H Mixed Storage Shell - LEFT*



1.5H Mixed Storage Shell - RIGHT*



Glazed door option

1.5H Closed Storage Shell**

MODEL#	DIMENSIONS D x W x H	FREIGHT CLASS	WT./LBS.	CUBIC FT.	1" TOP	1.5" TOP	GLAZE ADD	HP ADD
Z36L2HSHNS	24 x 36 x 22.75	150	83	14.50	\$843	N/A	N/A	N/A
Z30L2HSHNS	24 x 30 x 22.75	125	75	12.25	\$762	N/A	N/A	N/A
Z24L2HSHNS	24 x 24 x 22.75	125	66	10	\$678	N/A	N/A	N/A
Z36M2HSHNS	20 x 36 x 22.75	150	73	12.25	\$769	N/A	N/A	N/A
Z30M2HSHNS	20 x 30 x 22.75	125	64	10.50	\$687	N/A	N/A	N/A
Z24M2HSHNS	20 x 24 x 22.75	125	55	8.50	\$614	N/A	N/A	N/A

For use under ZxxxxHTB 23.25"H top and back kit. **No top or back.**

Z36L2HFS	24 x 36 x 22.75	125	102	14.50	\$1158	N/A	N/A	N/A
Z30L2HFS	24 x 30 x 22.75	125	97	12.25	\$1020	N/A	N/A	N/A
Z36M2HFS	20 x 36 x 22.75	125	95	12.25	\$1102	N/A	N/A	N/A
Z30M2HFS	20 x 30 x 22.75	100	88	10.50	\$959	N/A	N/A	N/A

For use under ZxxxxHTB 23.25"H top and back kit. **No top or back.** Open shelf and lateral file storage. For filing capabilities, see page 200.

- Lateral file drawer construction is for accommodating hanging files NOT for stacking materials on the drawer bottom

Z36L2HES	24 x 36 x 22.75	125	103	14.50	\$1218	N/A	N/A	N/A
Z30L2HES	24 x 30 x 22.75	100	99	12.25	\$1081	N/A	N/A	N/A
Z36M2HES	20 x 36 x 22.75	100	98	12.25	\$1177	N/A	N/A	N/A
Z30M2HES	20 x 30 x 22.75	100	92	10.50	\$1032	N/A	N/A	N/A

For use under ZxxxxHTB 23.25"H top and back kit. **No top or back.** Box drawer and lateral file storage. For filing capabilities, see page 200.

- Lateral file drawer construction is for accommodating hanging files NOT for stacking materials on the drawer bottom

Z36L2HXSL	24 x 36 x 22.75	125	110	14.50	\$1313	N/A	N/A	N/A
Z30L2HXSL	24 x 30 x 22.75	100	105	12.25	\$1176	N/A	N/A	N/A
Z36M2HXSL	20 x 36 x 22.75	100	104	12.25	\$1240	N/A	N/A	N/A
Z30M2HXSL	20 x 30 x 22.75	100	97	10.50	\$1097	N/A	N/A	N/A

For use under ZxxxxHTB 23.25"H top and back kit. **No top or back.** Open shelf on **right**, box drawer on **left** and lateral file storage below. For filing capabilities, see page 200.

- Lateral file drawer construction is for accommodating hanging files NOT for stacking materials on the drawer bottom

Z36L2HXSR	24 x 36 x 22.75	125	110	14.50	\$1313	N/A	N/A	N/A
Z30L2HXSR	24 x 30 x 22.75	100	105	12.25	\$1176	N/A	N/A	N/A
Z36M2HXSR	20 x 36 x 22.75	100	104	12.25	\$1240	N/A	N/A	N/A
Z30M2HXSR	20 x 30 x 22.75	100	97	10.50	\$1097	N/A	N/A	N/A

For use under ZxxxxHTB 23.25"H top and back kit. **No top or back.** Open shelf on **left**, box drawer on **right** and lateral file storage below. For filing capabilities, see page 200.

- Lateral file drawer construction is for accommodating hanging files NOT for stacking materials on the drawer bottom

Z36L2HSHS	24 x 36 x 22.75	125	96	14.50	\$1112	N/A	\$538	N/A
Z30L2HSHS	24 x 30 x 22.75	125	86	12.25	\$1005	N/A	\$479	N/A
Z36M2HSHS	20 x 36 x 22.75	125	86	12.25	\$1040	N/A	\$538	N/A
Z30M2HSHS	20 x 30 x 22.75	125	75	10.50	\$930	N/A	\$479	N/A

For use under ZxxxxHTB 23.25"H top and back kit. **No top or back.** Laminate doors are standard. Standard with lock.

Required Specifications

Base finish
Handles*
Drawer front finish

Optional Specifications

Key #*
Glazed doors**

STORAGE SHELLS - 22.75" HIGH



1.5H Split Drawer Storage Shell* - LEFT

MODEL#	DIMENSIONS	FREIGHT CLASS	WT/LBS.	CUBIC FT.	1" TOP	1.5" TOP	GLAZE ADD	HP ADD	
D x W x H									
Z36L2HCSL	24 x 36 x 22.75	125	110	14.50	\$1251	N/A	N/A	N/A	
Z30L2HCSL	24 x 30 x 22.75	100	101	12.25	\$1167	N/A	N/A	N/A	
Z36M2HCSL	20 x 36 x 22.75	100	104	12.25	\$1176	N/A	N/A	N/A	
Z30M2HCSL	20 x 30 x 22.75	100	92	10.50	\$1086	N/A	N/A	N/A	

For use **under ZxxxxHTB 23.25" H** top and back kit. **No top or back.** Open shelf on **right**, box drawer on **left**. Pull out drawer includes filing space on **left** and storage on **right**. Front-to-back letter capability.

- Lateral file drawer construction is for accommodating hanging files **NOT** for stacking materials on the drawer bottom.



1.5H Split Drawer Storage Shell* - RIGHT

Z36L2HCSR	24 x 36 x 22.75	125	110	14.50	\$1251	N/A	N/A	N/A
Z30L2HCSR	24 x 30 x 22.75	100	101	12.25	\$1167	N/A	N/A	N/A
Z36M2HCSR	20 x 36 x 22.75	100	104	12.25	\$1176	N/A	N/A	N/A
Z30M2HCSR	20 x 30 x 22.75	100	92	10.50	\$1086	N/A	N/A	N/A

For use **under ZxxxxHTB 23.25" H** top and back kit. **No top or back.** Open shelf on **left**, box drawer on **right**. Pull out drawer includes filing space on **right** and storage on **left**. Front-to-back letter capability.

- Lateral file drawer construction is for accommodating hanging files **NOT** for stacking materials on the drawer bottom.

TOP AND BACK KITS FOR 22.75" H SHELLS

MODEL#	DIMENSIONS	FREIGHT CLASS	WT/LBS.	CUBIC FT.	1" TOP	1.5" TOP	GLAZE ADD	HP ADD
Z2496HTB	24 x 96 x 23.25-23.75	70	114	6.75	\$905	\$1094	N/A	\$554
Z2490HTB	24 x 90 x 23.25-23.75	70	107	6.25	\$859	\$1035	N/A	\$520
Z2484HTB	24 x 84 x 23.25-23.75	70	100	6	\$806	\$973	N/A	\$484
Z2478HTB	24 x 78 x 23.25-23.75	70	94	5.50	\$757	\$911	N/A	\$451
Z2472HTB	24 x 72 x 23.25-23.75	70	87	5.25	\$702	\$844	N/A	\$416
Z2466HTB	24 x 66 x 23.25-23.75	70	80	4.75	\$650	\$781	N/A	\$382
Z2460HTB	24 x 66 x 23.25-23.75	70	72	4.50	\$598	\$717	N/A	\$349
Z2454HTB	24 x 54 x 23.25-23.75	70	65	4	\$540	\$648	N/A	\$314
Z2448HTB	24 x 48 x 23.25-23.75	85	55	3.75	\$494	\$589	N/A	\$278
Z2442HTB	24 x 42 x 23.25-23.75	70	51	3.25	\$438	\$524	N/A	\$244
Z2436HTB	24 x 36 x 23.25-23.75	85	44	3	\$381	\$455	N/A	\$210
Z2430HTB	24 x 30 x 23.25-23.75	85	37	2.50	\$330	\$391	N/A	\$175
Z2096HTB	20 x 96 x 23.25-23.75	70	103	6.25	\$845	\$1001	N/A	\$463
Z2090HTB	20 x 90 x 23.25-23.75	70	97	6	\$799	\$946	N/A	\$434
Z2084HTB	20 x 84 x 23.25-23.75	70	91	5.75	\$751	\$890	N/A	\$403
Z2078HTB	20 x 78 x 23.25-23.75	70	86	5.25	\$703	\$831	N/A	\$376
Z2072HTB	20 x 72 x 23.25-23.75	70	78	5	\$657	\$776	N/A	\$349
Z2066HTB	20 x 66 x 23.25-23.75	70	71	4.50	\$601	\$710	N/A	\$319
Z2060HTB	20 x 66 x 23.25-23.75	70	65	4.25	\$554	\$652	N/A	\$291
Z2054HTB	20 x 54 x 23.25-23.75	70	59	3.75	\$505	\$596	N/A	\$262
Z2048HTB	20 x 48 x 23.25-23.75	70	55	3.50	\$463	\$543	N/A	\$234
Z2042HTB	20 x 42 x 23.25-23.75	70	47	3	\$409	\$480	N/A	\$202
Z2036HTB	20 x 36 x 23.25-23.75	85	40	2.75	\$353	\$414	N/A	\$175
Z2030HTB	20 x 30 x 23.25-23.75	85	33	2.25	\$305	\$356	N/A	\$147

For use with 22.75" high storage shells. Shipped RTA (ready to assemble).

- Does not include hardware to attach to storage shells.



Credenza Top and Back Kit**

Required Specifications

Primary surface type + finish**
 Top thickness/edge detail
 Base finish
 Drawer front finish

Handles*

Optional Specifications

Key #*

STORAGE SHELLS - 28" HIGH



Storage Shell*



Glazed door option



Storage Shell - LEFT*

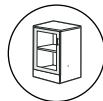

Glazed door option



Storage Shell - RIGHT*

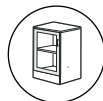

Glazed door option



30-36" wide



15-16" wide

File/File Shell

MODEL#	DIMENSIONS D x W x H	FREIGHT CLASS	WT/LBS.	CUBIC FT.	1" TOP	1.5" TOP	GLAZE ADD	HP ADD
Z36L2SHS	23.4 x 36 x 28-28.5	150	100	18.50	\$1042	N/A	\$812	N/A
Z30L2SHS	23.4 x 30 x 28-28.5	150	88	15.50	\$930	N/A	\$745	N/A
Z36M2SHS	19.3 x 36 x 28-28.5	150	89	15.50	\$912	N/A	\$812	N/A
Z30M2SHS	19.3 x 30 x 28-28.5	150	78	13.25	\$828	N/A	\$745	N/A

For use **under 29" H** returns, extended corners, freestanding and connectable tables of the same depth. **No top or back. One adjustable shelf.** Standard with lock.

Z21L2SHSL	23.4 x 21 x 28-28.5	125	70	11	\$718	N/A	\$461	N/A
Z18L2SHSL	23.4 x 18 x 28-28.5	125	64	9.75	\$688	N/A	\$421	N/A
Z16L2SHSL	23.4 x 16 x 28-28.5	125	60	9	\$647	N/A	\$412	N/A
Z15L2SHSL	23.4 x 15 x 28-28.5	125	59	8.25	\$626	N/A	\$371	N/A
Z12L2SHSL	23.4 x 12 x 28-28.5	125	53	6.75	\$584	N/A	\$335	N/A
Z21M2SHSL	19.3 x 21 x 28-28.5	125	61	9.50	\$615	N/A	\$461	N/A
Z18M2SHSL	19.3 x 18 x 28-28.5	125	56	8.25	\$587	N/A	\$421	N/A
Z16M2SHSL	19.3 x 16 x 28-28.5	125	52	7	\$557	N/A	\$412	N/A
Z15M2SHSL	19.3 x 15 x 28-28.5	125	52	6.75	\$528	N/A	\$371	N/A
Z12M2SHSL	19.3 x 12 x 28-28.5	100	47	5.75	\$496	N/A	\$335	N/A

For use **under 29" H** returns, extended corners, freestanding and connectable tables of the same depth. **No top or back. One adjustable shelf.** Standard with lock.

Z21L2SHSR	23.4 x 21 x 28-28.5	125	70	11	\$718	N/A	\$461	N/A
Z18L2SHSR	23.4 x 18 x 28-28.5	125	64	9.75	\$688	N/A	\$421	N/A
Z16L2SHSR	23.4 x 16 x 28-28.5	125	60	9	\$647	N/A	\$412	N/A
Z15L2SHSR	23.4 x 15 x 28-28.5	125	59	8.25	\$626	N/A	\$371	N/A
Z12L2SHSR	23.4 x 12 x 28-28.5	125	53	6.75	\$584	N/A	\$335	N/A
Z21M2SHSR	19.3 x 21 x 28-28.5	125	61	9.50	\$615	N/A	\$461	N/A
Z18M2SHSR	19.3 x 18 x 28-28.5	125	56	8.25	\$587	N/A	\$421	N/A
Z16M2SHSR	19.3 x 16 x 28-28.5	125	52	7	\$557	N/A	\$412	N/A
Z15M2SHSR	19.3 x 15 x 28-28.5	125	52	6.75	\$528	N/A	\$371	N/A
Z12M2SHSR	19.3 x 12 x 28-28.5	100	47	5.75	\$496	N/A	\$335	N/A

For use **under 29" H** returns, extended corners, freestanding and connectable tables of the same depth. **No top or back. One adjustable shelf.** Standard with lock.

Z36L2ES	23.4 x 36 x 28-28.5	125	121	18.50	\$1565	N/A	N/A	N/A
Z30L2ES	23.4 x 30 x 28-28.5	125	110	15.50	\$1435	N/A	N/A	N/A
Z16L2ES	23.4 x 16 x 28-28.5	100	75	9	\$865	N/A	N/A	N/A
Z15L2ES	23.4 x 15 x 28-28.5	100	75	8.25	\$843	N/A	N/A	N/A
Z36M2ES	19.3 x 36 x 28-28.5	125	114	15.50	\$1441	N/A	N/A	N/A
Z30M2ES	19.3 x 30 x 28-28.5	125	102	13.25	\$1348	N/A	N/A	N/A
Z16M2ES	19.3 x 16 x 28-28.5	100	69	7	\$790	N/A	N/A	N/A
Z15M2ES	19.3 x 15 x 28-28.5	92.5	68	6.75	\$770	N/A	N/A	N/A

For use **under 29" H** returns, extended corners, freestanding and connectable tables of the same depth. **No top or back. Two file drawers.** Lock secures all drawers. For filing capabilities, see page 200.

- 15" wide models have only side-to-side filing capability
- Lateral file drawer construction is for accommodating hanging files NOT for stacking materials on the drawer bottom.

Required Specifications

Base finish
Handles
Door/drawer front finish

Optional Specifications

Glazed doors - storage shell doors*
Key #

STORAGE SHELLS - 28" HIGH



Box/Box/File Shell*

MODEL#	DIMENSIONS	FREIGHT CLASS	WT/LBS.	CUBIC FT.	1" TOP	1.5" TOP	GLAZE ADD	HP ADD
D x W x H								
Z16L2BFS	23.4 x 16 x 28-28.5	100	77	9	\$996	N/A	N/A	N/A
Z15L2BFS	23.4 x 15 x 28-28.5	100	77	8.25	\$975	N/A	N/A	N/A
Z16M2BFS	19.3 x 16 x 28-28.5	92.5	71	7	\$903	N/A	N/A	N/A
Z15M2BFS	19.3 x 15 x 28-28.5	92.5	71	6.75	\$886	N/A	N/A	N/A

For use **under 29"H** returns, extended corners, freestanding and connectable tables of the same depth. **No top or back. Two box and one file drawer.** One pencil tray. Lock secures all drawers.

- 15" wide models have only side-to-side filing capability



30-36" wide 15-16" wide

File Shell with Open Shelf*

Z36L2FS	23.4 x 36 x 28-28.5	150	109	18.50	\$1219	N/A	N/A	N/A
Z30L2FS	23.4 x 30 x 28-28.5	125	98	15.50	\$1095	N/A	N/A	N/A
Z16L2FS	23.4 x 16 x 28-28.5	125	68	9	\$729	N/A	N/A	N/A
Z15L2FS	23.4 x 15 x 28-28.5	100	67	8.25	\$719	N/A	N/A	N/A
Z36M2FS	19.3 x 36 x 28-28.5	125	99	15.50	\$1085	N/A	N/A	N/A
Z30M2FS	19.3 x 30 x 28-28.5	125	89	13.25	\$998	N/A	N/A	N/A
Z16M2FS	19.3 x 16 x 28-28.5	100	59	7	\$614	N/A	N/A	N/A
Z15M2FS	19.3 x 15 x 28-28.5	100	57	6.75	\$601	N/A	N/A	N/A

For use **under 29"H** returns, extended corners, freestanding and connectable tables of the same depth. **No top or back. One file drawer.** Lock secures file drawer. For filing capabilities, see page 200.

- 15" wide models have only side-to-side filing capability
- Lateral file drawer construction is for accommodating hanging files NOT for stacking materials on the drawer bottom.



30-36" wide 12-21" wide

Open Shelving Shell

Z36L2SHSN	23.4 x 36 x 28-28.5	150	84.03	18.50	\$745	N/A	N/A	N/A
Z30L2SHSN	23.4 x 30 x 28-28.5	150	74.69	15.50	\$661	N/A	N/A	N/A
Z21L2SHSN	23.4 x 21 x 28-28.5	150	60.69	11	\$556	N/A	N/A	N/A
Z18L2SHSN	23.4 x 18 x 28-28.5	150	56.02	9.75	\$536	N/A	N/A	N/A
Z16L2SHSN	23.4 x 16 x 28-28.5	150	52.90	9	\$498	N/A	N/A	N/A
Z15L2SHSN	23.4 x 15 x 28-28.5	125	52.35	8.25	\$486	N/A	N/A	N/A
Z12L2SHSN	23.4 x 12 x 28-28.5	125	47.68	6.75	\$456	N/A	N/A	N/A
Z36M2SHSN	19.3 x 36 x 28-28.5	150	73.03	15.50	\$617	N/A	N/A	N/A
Z30M2SHSN	19.3 x 30 x 28-28.5	150	64.69	13.25	\$561	N/A	N/A	N/A
Z21M2SHSN	19.3 x 21 x 28-28.5	150	51.69	9.50	\$452	N/A	N/A	N/A
Z18M2SHSN	19.3 x 18 x 28-28.5	150	48.02	8.25	\$435	N/A	N/A	N/A
Z16M2SHSN	19.3 x 16 x 28-28.5	125	44.90	7	\$407	N/A	N/A	N/A
Z15M2SHSN	19.3 x 15 x 28-28.5	125	45.35	6.75	\$391	N/A	N/A	N/A
Z12M2SHSN	19.3 x 12 x 28-28.5	125	41.68	5.75	\$367	N/A	N/A	N/A

For use **under 29"H** returns, extended corners, freestanding and connectable tables of the same depth. **No top or back. One adjustable shelf.**



Mixed Storage Shell - LEFT*

Z36L2XSL	23.4 x 36 x 28-28.5	100	152	18.50	\$1886	N/A	N/A	N/A
Z30L2XSL	23.4 x 30 x 28-28.5	100	136	15.50	\$1725	N/A	N/A	N/A
Z36M2XSL	19.3 x 36 x 28-28.5	100	139	15.50	\$1777	N/A	N/A	N/A
Z30M2XSL	19.3 x 30 x 28-28.5	100	124	13.25	\$1651	N/A	N/A	N/A

For use **under 29"H** returns, extended corners, freestanding and connectable tables of the same depth. **No top or back.** Two box drawers on **left**, one file drawer on **right** accommodates letter filing side to side, and one lateral file drawer on bottom (see filing orientations on page 120). Right lock secures one file drawer, the left lock secures two box and the lateral file. One pencil tray. For filing capabilities, see page 200.

- Lateral file drawer construction is for accommodating hanging files NOT for stacking materials on the drawer bottom.
- Top file drawer supports hanging folders only. Does not accept hanging folders with plastic tabs.

Required Specifications

Base finish
Handles*
Door/drawer front finish*

Optional Specifications

Box Drawer Option (no upcharge - not available on Open Shelving Shell)
Key #

STORAGE SHELLS - 28" HIGH



Mixed Storage Shell - RIGHT**



Mixed Storage Shell with Open Shelf - LEFT*



Mixed Storage Shell with Open Shelf - RIGHT*



* Accepts collator



* Accepts collator

MODEL#	DIMENSIONS D x W x H	FREIGHT CLASS	WT/LBS.	CUBIC FT.	1" TOP	1.5" TOP	GLAZE ADD	HP ADD
Z36L2XSR	23.4 x 36 x 28.5	100	152	18.50	\$1886	N/A	N/A	N/A
Z30L2XSR	23.4 x 30 x 28.5	100	136	15.50	\$1725	N/A	N/A	N/A
Z36M2XSR	19.3 x 36 x 28.5	100	139	15.50	\$1777	N/A	N/A	N/A
Z30M2XSR	19.3 x 30 x 28.5	100	124	13.25	\$1651	N/A	N/A	N/A

For use **under 29" H** returns, extended corners, freestanding and connectable tables of the same depth. **No top or back.** Two box drawers on **right**, one file drawer on **left** accommodates letter filing side to side, and one lateral file drawer on bottom (see filing orientations on page 120). Right lock secures two box and lateral file, the left lock secures one file drawer. One pencil tray. For filing capabilities, see page 200.

- Lateral file drawer construction is for accommodating hanging files NOT for stacking materials on the drawer bottom.
- Top file drawer supports hanging folders only. Does not accept hanging folders with plastic tabs.

Z36L2XNSL	23.4 x 36 x 28.5	125	133	18.50	\$1593	N/A	N/A	N/A
Z30L2XNSL	23.4 x 30 x 28.5	125	121	15.50	\$1450	N/A	N/A	N/A
Z36M2XNSL	19.3 x 36 x 28.5	125	121	15.50	\$1484	N/A	N/A	N/A
Z30M2XNSL	19.3 x 30 x 28.5	100	109	13.25	\$1381	N/A	N/A	N/A

For use **under 29" H** returns, extended corners, freestanding and connectable tables of the same depth. **No top or back.** Two box drawers on **left**, one open shelf on **right** and one lateral file drawer on bottom. Lock secures all drawers. One pencil tray. For filing capabilities, see page 200.

- Lateral file drawer construction is for accommodating hanging files NOT for stacking materials on the drawer bottom.

Z36L2XNSR	23.4 x 36 x 28-28.5	125	133	18.50	\$1593	N/A	N/A	N/A
Z30L2XNSR	23.4 x 30 x 28-28.5	125	121	15.50	\$1450	N/A	N/A	N/A
Z36M2XNSR	19.3 x 36 x 28-28.5	125	121	15.50	\$1484	N/A	N/A	N/A
Z30M2XNSR	19.3 x 30 x 28-28.5	100	109	13.25	\$1381	N/A	N/A	N/A

For use **under 29" H** returns, extended corners, freestanding and connectable tables of the same depth. **No top or back.** Two box drawers on **right**, one open shelf on **left** and one lateral file drawer on bottom. Lock secures all drawers. One pencil tray. For filing capabilities, see page 200.

- Lateral file drawer construction is for accommodating hanging files NOT for stacking materials on the drawer bottom.

Required Specifications

Base finish
Handles
Door/drawer front finish*

Optional Specifications

Box drawer - no upcharge
Collator (open shelves)

TOP AND BACK KITS FOR 28.5" H STORAGE SHELLS

MODEL#	DIMENSIONS	FREIGHT CLASS	WT/LBS.	CUBIC FT.	1" TOP	1.5" TOP	GLAZE ADD	HP ADD
D x W x H								
Z2496TB	24 x 96 x 29-29.5	70	126	7.75	\$991	\$1180	N/A	\$554
Z2490TB	24 x 90 x 29-29.5	70	118	7.25	\$935	\$1111	N/A	\$520
Z2484TB	24 x 84 x 29-29.5	70	111	6.75	\$881	\$1048	N/A	\$484
Z2478TB	24 x 78 x 29-29.5	70	104	6.25	\$819	\$973	N/A	\$451
Z2472TB	24 x 72 x 29-29.5	70	117	5.90	\$726	\$898	N/A	\$409
Z2466TB	24 x 66 x 29-29.5	70	117	5.90	\$699	\$857	N/A	\$409
Z2460TB	24 x 60 x 29-29.5	70	117	5.90	\$637	\$779	N/A	\$340
Z2454TB	24 x 54 x 29-29.5	70	72	4.50	\$586	\$694	N/A	\$314
Z2448TB	24 x 48 x 29-29.5	70	66	4	\$536	\$631	N/A	\$278
Z2442TB	24 x 42 x 29-29.5	70	57	3.75	\$479	\$565	N/A	\$244
Z2436TB	24 x 36 x 29-29.5	70	49	3.25	\$403	\$477	N/A	\$210
Z2430TB	24 x 30 x 29-29.5	85	41	2.75	\$358	\$419	N/A	\$175
Z2096TB	20 x 96 x 29-29.5	85	116	7.75	\$935	\$1091	N/A	\$463
Z2090TB	20 x 90 x 29-29.5	70	102	6.75	\$882	\$1029	N/A	\$434
Z2084TB	20 x 84 x 29-29.5	70	102	6.75	\$829	\$968	N/A	\$403
Z2078TB	20 x 78 x 29-29.5	70	95	6.25	\$773	\$901	N/A	\$376
Z2072TB	20 x 72 x 29-29.5	70	106	6	\$699	\$841	N/A	\$409
Z2066TB	20 x 66 x 29-29.5	70	106	6	\$685	\$806	N/A	\$409
Z2060TB	20 x 60 x 29-29.5	70	106	6	\$601	\$729	N/A	\$340
Z2054TB	20 x 54 x 29-29.5	85	66	4.50	\$555	\$646	N/A	\$262
Z2048TB	20 x 48 x 29-29.5	70	61	4	\$506	\$586	N/A	\$234
Z2042TB	20 x 42 x 29-29.5	85	52	3.75	\$452	\$523	N/A	\$202
Z2036TB	20 x 36 x 29-29.5	85	45	3.25	\$382	\$443	N/A	\$175
Z2030TB	20 x 30 x 29-29.5	85	38	2.75	\$340	\$391	N/A	\$147

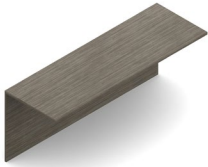

Credenza Top and Back Kits - for 28.5" H Storage Shells

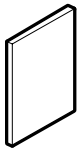

Full Leg

For use with 28.5" high storage shells. Shipped RTA (ready to assemble).

- **Does not include hardware to attach to storage shells.**

Z24FL	23.4 x 1 x 28.5	92.5	20	1.70	\$278	N/A	N/A	N/A
Z20FL	19.3 x 1 x 28.5	65	16	.60	\$278	N/A	N/A	N/A

For use at **either end of 29" H top and back kits**. Non-handed; can be used left or right. Shipped RTA (ready to assemble).

- For 24" deep worksurfaces, order **Z24FL**.
- For 20" deep worksurfaces, order **Z20FL**.
- **Does not include hardware for installation.**

Required Specifications

Primary surface type + finish
 Top thickness/edge detail
 Base finish

STORAGE MODULES - 17.87"/18.37" HIGH



Open Storage



Lateral File*



Glazed door option

Storage Cabinet*



Split Drawer Storage* - LEFT



Split Drawer Storage* - RIGHT

MODEL#	DIMENSIONS D x W x H	FREIGHT CLASS	WT/LBS.	CUBIC FT.	1" TOP	1.5" TOP	GLAZE ADD	HP ADD
Z36L21SHN	24 x 36 x 17.87-18.37	125	82	11.75	\$802	\$876	N/A	\$210
Z30L21SHN	24 x 30 x 17.87-18.37	125	74	10	\$736	\$797	N/A	\$175
Z36M21SHN	20 x 36 x 17.87-18.37	125	71	10	\$728	\$789	N/A	\$175
Z30M21SHN	20 x 30 x 17.87-18.37	125	62	8.50	\$655	\$706	N/A	\$147

Open Shelf.

Z36L21E	24 x 36 x 17.87-18.37	100	103	11.75	\$1185	\$1259	N/A	\$210
Z30L21E	24 x 30 x 17.87-18.37	100	97	10	\$1012	\$1073	N/A	\$175
Z36M21E	20 x 36 x 17.87-18.37	100	95	10	\$1125	\$1186	N/A	\$175
Z30M21E	20 x 30 x 17.87-18.37	92.5	88	8.50	\$945	\$996	N/A	\$147

One file drawer. Lock secures drawer. For filing capabilities, see page 200.

- Lateral file drawer construction is for accommodating hanging files NOT for stacking materials on the drawer bottom

Z36L21SH	24 x 36 x 17.87-18.37	125	90	11.75	\$1027	\$1101	\$434	\$210
Z30L21SH	24 x 30 x 17.87-18.37	100	81	10	\$944	\$1005	\$385	\$175
Z36M21SH	20 x 36 x 17.87-18.37	100	80	10	\$952	\$1013	\$434	\$175
Z30M21SH	20 x 30 x 17.87-18.37	100	69	8.50	\$863	\$914	\$385	\$147

Laminate doors are standard. Standard with lock.

Z36L21XHL	24 x 36 x 17.87-18.37	100	102	11.75	\$1113	\$1187	N/A	\$210
Z30L21XHL	24 x 30 x 17.87-18.37	100	92	10	\$989	\$1050	N/A	\$175
Z36M21XHL	20 x 36 x 17.87-18.37	100	95	10	\$1054	\$1115	N/A	\$175
Z30M21XHL	20 x 30 x 17.87-18.37	100	83	8.50	\$923	\$974	N/A	\$147

Pull out drawer includes filing space on **left** and storage on **right**. Lock secures drawer. For filing capabilities, see page 200.

- Lateral file drawer construction is for accommodating hanging files NOT for stacking materials on the drawer bottom

Z36L21XHR	24 x 36 x 17.87-18.37	100	102	11.75	\$1113	\$1187	N/A	\$210
Z30L21XHR	24 x 30 x 17.87-18.37	100	92	10	\$989	\$1050	N/A	\$175
Z36M21XHR	20 x 36 x 17.87-18.37	100	95	10	\$1054	\$1115	N/A	\$175
Z30M21XHR	20 x 30 x 17.87-18.37	100	83	8.50	\$923	\$974	N/A	\$147

Pull out drawer includes filing space on **right** and storage on **left**. Lock secures drawer. For filing capabilities, see page 200.

- Lateral file drawer construction is for accommodating hanging files NOT for stacking materials on the drawer bottom

Required Specifications

Primary surface type + finish
 Top thickness/edge detail
 Base finish
 Lock finish*
 Drawer front finish*

Optional Specifications

Key #*
 Handles*
 Glazed doors (only Z3xx21SH)

STORAGE MODULES - 23.75" / 24.25" HIGH



1.5H Open Storage



1.5H Open/Lateral File Storage*



1.5H Box/Lateral File Storage**



1.5H Mixed Storage - LEFT*



1.5H Mixed Storage - RIGHT*



Closed Storage**

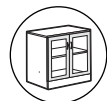

Glazed door option

MODEL#	DIMENSIONS	FREIGHT CLASS	WT/LBS.	CUBIC FT.	1" TOP	1.5" TOP	GLAZE ADD	HP ADD
D x W x H								
Z36L2HSHN	24 x 36 x 23.75-24.25	125	106	15	\$987	\$1061	N/A	\$210
Z30L2HSHN	24 x 30 x 23.75-24.25	125	94	12.75	\$894	\$955	N/A	\$175
Z36M2HSHN	20 x 36 x 23.75-24.25	125	92	12.75	\$889	\$950	N/A	\$175
Z30M2HSHN	20 x 30 x 23.75-24.25	125	80	10.75	\$798	\$849	N/A	\$147

One adjustable shelf.

Z36L2HFN	24 x 36 x 23.75-24.25	100	127	15	\$1368	\$1442	N/A	\$210
Z30L2HFN	24 x 30 x 23.75-24.25	100	118	12.75	\$1169	\$1230	N/A	\$175
Z36M2HFN	20 x 36 x 23.75-24.25	100	116	12.75	\$1286	\$1347	N/A	\$175
Z30M2HFN	20 x 30 x 23.75-24.25	100	106	10.75	\$1087	\$1138	N/A	\$147

Open shelf on top. Lateral file below. Lock secures drawer. For filing capabilities, see page 200.

- Lateral file drawer construction is for accommodating hanging files NOT for stacking materials on the drawer bottom

Z36L2HE	24 x 36 x 23.75-24.25	100	126	15	\$1446	\$1520	N/A	\$210
Z30L2HE	24 x 30 x 23.75-24.25	100	118	12.75	\$1446	\$1507	N/A	\$175
Z36M2HE	20 x 36 x 23.75-24.25	100	118	12.75	\$1380	\$1441	N/A	\$175
Z30M2HE	20 x 30 x 23.75-24.25	92.5	108	10.75	\$1174	\$1225	N/A	\$147

Box drawer on top. Lateral file below. Lock secures both drawers. For filing capabilities, see page 200.

- Lateral file drawer construction is for accommodating hanging files NOT for stacking materials on the drawer bottom

Z36L2HXNL	24 x 36 x 23.75-24.25	100	132	15	\$1493	\$1567	N/A	\$210
Z30L2HXNL	24 x 30 x 23.75-24.25	100	123	12.75	\$1297	\$1358	N/A	\$175
Z36M2HXNL	20 x 36 x 23.75-24.25	100	121	12.75	\$1415	\$1476	N/A	\$175
Z30M2HXNL	20 x 30 x 23.75-24.25	92.5	111	10.75	\$1217	\$1268	N/A	\$147

Open shelf on **right**, box drawer on **left** and lateral file storage below. Lock secures both drawers. For filing capabilities, see page 200.

- Lateral file drawer construction is for accommodating hanging files NOT for stacking materials on the drawer bottom

Z36L2HXNR	24 x 36 x 23.75-24.25	100	132	15	\$1493	\$1567	N/A	\$210
Z30L2HXNR	24 x 30 x 23.75-24.25	100	123	12.75	\$1297	\$1358	N/A	\$175
Z36M2HXNR	20 x 36 x 23.75-24.25	100	121	12.75	\$1415	\$1476	N/A	\$175
Z30M2HXNR	20 x 30 x 23.75-24.25	92.5	111	10.75	\$1217	\$1268	N/A	\$147

Open shelf on **left**, box drawer on **right** and lateral file storage below. Lock secures both drawers. For filing capabilities, see page 200.

- Lateral file drawer construction is for accommodating hanging files NOT for stacking materials on the drawer bottom

Z36L2HSH	24 x 36 x 23.75-24.25	125	119	15	\$1254	\$1328	\$538	\$210
Z30L2HSH	24 x 30 x 23.75-24.25	100	105	12.75	\$1136	\$1197	\$479	\$175
Z36M2HSH	20 x 36 x 23.75-24.25	100	105	12.75	\$1157	\$1218	\$538	\$175
Z30M2HSH	20 x 30 x 23.75-24.25	100	91	10.75	\$1041	\$1092	\$479	\$147

Laminate doors are standard. Includes one adjustable shelf. Standard with lock.

Required Specifications

Primary surface type + finish
 Top thickness/edge detail
 Base finish
 Drawer front finish*
 Lock finish*

Optional Specifications

Key #*
 Glazed doors**
 Box drawer† - no upcharge

STORAGE MODULES - 23.75" / 24.25" HIGH



1.5H Split Drawer Storage - LEFT



1.5H Split Drawer Storage - RIGHT

MODEL#	DIMENSIONS D x W x H	FREIGHT CLASS	WT/LBS.	CUBIC FT.	1" TOP	1.5" TOP	GLAZE ADD	HP ADD
Z36L2HXHL	24 x 36 x 23.75-24.25	100	132	15	\$1433	\$1507	N/A	\$210
Z30L2HXHL	24 x 30 x 23.75-24.25	100	118	12.75	\$1286	\$1347	N/A	\$175
Z36M2HXHL	20 x 36 x 23.75-24.25	100	121	12.75	\$1355	\$1416	N/A	\$175
Z30M2HXHL	20 x 30 x 23.75-24.25	100	107	10.75	\$1206	\$1257	N/A	\$147

Open shelf on **right**, box drawer on **left**. Pull out drawer includes filing space on **left** and storage on **right**.

Z36L2HXHR	24 x 36 x 23.75-24.25	100	132	15	\$1433	\$1507	N/A	\$210
Z30L2HXHR	24 x 30 x 23.75-24.25	100	118	12.75	\$1286	\$1347	N/A	\$175
Z36M2HXHR	20 x 36 x 23.75-24.25	100	121	12.75	\$1355	\$1416	N/A	\$175
Z30M2HXHR	20 x 30 x 23.75-24.25	100	107	10.75	\$1206	\$1257	N/A	\$147

Open shelf on **left**, box drawer on **right**. Pull out drawer includes filing space on **right** and storage on **left**.

STORAGE MODULES - 29.5" / 30" HIGH



Storage Cabinet with Doors*



Glazed door option

MODEL#	DIMENSIONS	FREIGHT CLASS	WT/LBS.	CUBIC FT.	1" TOP	1.5" TOP	GLAZE ADD	HP ADD
Z36L2SH	24 x 36 x 29.5-30	125	142.80	18.50	\$1390	\$1476	\$812	\$208
Z30L2SH	24 x 30 x 29.5-30	125	123.90	15.50	\$1251	\$1323	\$745	\$173
Z36M2SH	20 x 36 x 29.5-30	100	126	15.50	\$1275	\$1350	\$812	\$208
Z30M2SH	20 x 30 x 29.5-30	100	109.20	13.25	\$1157	\$1219	\$745	\$173
Z36S2SH	16 x 36 x 29.5-30	100	110.25	12.50	\$1177	\$1249	\$812	\$156
Z30S2SH	16 x 30 x 29.5-30	100	93.45	10.50	\$1040	\$1089	\$745	\$140

Laminate doors are standard. **Includes one adjustable shelf.** Standard with lock.

Z21L2SHL	24 x 21 x 29.5-30	100	94.50	11	\$1020	\$1080	\$461	\$140
Z18L2SHL	24 x 18 x 29.5-30	100	85.05	9.75	\$962	\$1013	\$421	\$108
Z16L2SHL	24 x 16 x 29.5-30	100	79.80	9	\$923	\$972	\$412	\$81
Z15L2SHL	24 x 15 x 29.5-30	100	76.65	8.25	\$854	\$895	\$371	\$81
Z12L2SHL	24 x 12 x 29.5-30	92.5	68.25	6.75	\$809	\$845	\$335	\$74
Z21M2SHL	20 x 21 x 29.5-30	100	84	9.50	\$905	\$956	\$461	\$108
Z18M2SHL	20 x 18 x 29.5-30	100	75.60	8.25	\$857	\$903	\$421	\$108
Z16M2SHL	20 x 16 x 29.5-30	100	69.30	7	\$812	\$857	\$412	\$81
Z15M2SHL	20 x 15 x 29.5-30	100	66.15	6.75	\$773	\$811	\$371	\$74
Z12M2SHL	20 x 12 x 29.5-30	92.5	60	5.75	\$719	\$751	\$335	\$74
Z21S2SHL	16 x 21 x 29.5-30	100	71.40	7.50	\$828	\$868	\$461	\$74
Z18S2SHL	16 x 18 x 29.5-30	100	64.05	6.75	\$791	\$832	\$421	\$74
Z16S2SHL	16 x 16 x 29.5-30	100	58.80	6	\$758	\$799	\$412	\$74
Z15S2SHL	16 x 15 x 29.5-30	100	56.70	5.75	\$715	\$751	\$371	\$74
Z12S2SHL	16 x 12 x 29.5-30	92.5	50.40	4.75	\$665	\$697	\$335	\$74

Laminate doors are standard. **Includes one adjustable shelf.** Standard with lock.



Storage Cabinet with Door - LEFT*

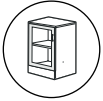

Glazed door option

Required Specifications

Primary surface type + finish
 Top thickness/edge detail
 Base finish
 Door/drawer front finish*
 Lock finish*

Optional Specifications

Glazed doors*
 Key #

STORAGE MODULES - 29.5" / 30" HIGH

MODEL#	DIMENSIONS	FREIGHT CLASS	WT/LBS.	CUBIC FT.	1" TOP	1.5" TOP	GLAZE ADD	HP ADD
--------	------------	---------------	---------	-----------	--------	----------	-----------	--------

D x W x H

Z21L2SHR	24 x 21 x 29.5-30	100	94.50	11	\$1020	\$1080	\$461	\$140
Z18L2SHR	24 x 18 x 29.5-30	100	85.05	9.75	\$962	\$1013	\$421	\$108
Z16L2SHR	24 x 16 x 29.5-30	100	79.80	9	\$923	\$972	\$412	\$81
Z15L2SHR	24 x 15 x 29.5-30	100	76.65	8.25	\$854	\$895	\$371	\$81
Z12L2SHR	24 x 12 x 29.5-30	92.5	68.25	6.75	\$809	\$845	\$335	\$74
Z21M2SHR	20 x 21 x 29.5-30	100	84	9.50	\$905	\$956	\$461	\$108
Z18M2SHR	20 x 18 x 29.5-30	100	75.60	8.25	\$857	\$903	\$421	\$108
Z16M2SHR	20 x 16 x 29.5-30	100	69.30	7	\$812	\$857	\$412	\$81
Z15M2SHR	20 x 15 x 29.5-30	100	66.15	6.75	\$773	\$811	\$371	\$74
Z12M2SHR	20 x 12 x 29.5-30	92.5	60	5.75	\$719	\$751	\$335	\$74
Z21S2SHR	16 x 21 x 29.5-30	100	71.40	7.50	\$828	\$868	\$461	\$74
Z18S2SHR	16 x 18 x 29.5-30	100	64.05	6.75	\$791	\$832	\$421	\$74
Z16S2SHR	16 x 16 x 29.5-30	100	58.80	6	\$758	\$799	\$412	\$74
Z15S2SHR	16 x 15 x 29.5-30	100	56.70	5.75	\$715	\$751	\$371	\$74
Z12S2SHR	16 x 12 x 29.5-30	92.5	50.40	4.75	\$665	\$697	\$335	\$74

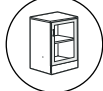

Glazed door option

Storage Cabinet with Door - RIGHT**

Laminate doors are standard. Includes one adjustable shelf. Standard with lock

Z36L2SHN	24 x 36 x 29.5-30	125	127	18.50	\$1096	\$1182	N/A	\$208
Z30L2SHN	24 x 30 x 29.5-30	125	111	15.50	\$986	\$1060	N/A	\$173
Z21L2SHN	24 x 21 x 29.5-30	125	86	11	\$857	\$917	N/A	\$140
Z18L2SHN	24 x 18 x 29.5-30	100	78	9.75	\$810	\$861	N/A	\$108
Z16L2SHN	24 x 16 x 29.5-30	100	73	9	\$773	\$822	N/A	\$81
Z15L2SHN	24 x 15 x 29.5-30	100	71	8.25	\$717	\$758	N/A	\$74
Z12L2SHN	24 x 12 x 29.5-30	100	63	6.75	\$680	\$716	N/A	\$74
Z36M2SHN	20 x 36 x 29.5-30	125	111.95	15.50	\$978	\$1052	N/A	\$156
Z30M2SHN	20 x 30 x 29.5-30	125	97.14	13.25	\$890	\$954	N/A	\$140
Z21M2SHN	20 x 21 x 29.5-30	125	74.40	9.50	\$742	\$793	N/A	\$108
Z18M2SHN	20 x 18 x 29.5-30	100	67.53	8.25	\$703	\$749	N/A	\$90
Z16M2SHN	20 x 16 x 29.5-30	100	62.59	7	\$664	\$709	N/A	\$74
Z15M2SHN	20 x 15 x 29.5-30	100	60.65	6.75	\$635	\$673	N/A	\$74
Z12M2SHN	20 x 12 x 29.5-30	100	55	5.75	\$588	\$622	N/A	\$74
Z36S2SHN	16 x 36 x 29.5-30	125	96.24	12.50	\$883	\$955	N/A	\$156
Z30S2SHN	16 x 30 x 29.5-30	125	82.82	10.50	\$770	\$819	N/A	\$140
Z21S2SHN	16 x 21 x 29.5-30	100	62.70	7.50	\$664	\$704	N/A	\$108
Z18S2SHN	16 x 18 x 29.5-30	100	55.99	6.75	\$641	\$686	N/A	\$90
Z16S2SHN	16 x 16 x 29.5-30	100	52.22	6	\$610	\$651	N/A	\$74
Z15S2SHN	16 x 15 x 29.5-30	100	50.34	5.75	\$576	\$611	N/A	\$74
Z12S2SHN	16 x 12 x 29.5-30	100	44.68	4.75	\$535	\$567	N/A	\$74

One adjustable shelf.



30-36" wide



12-21" wide

Open Storage Cabinet



30-36" wide



12-21" wide

File Module with Open Shelf**

Z36L2FN	24 x 36 x 29.5-30	100	153.30	18.50	\$1569	\$1654	N/A	\$208
Z30L2FN	24 x 30 x 29.5-30	100	134.40	15.50	\$1417	\$1491	N/A	\$173
Z16L2FN	24 x 16 x 29.5-30	100	87.15	9	\$991	\$1040	N/A	\$108
Z15L2FN	24 x 15 x 29.5-30	92.5	82.95	8.25	\$933	\$974	N/A	\$90
Z36M2FN	20 x 36 x 29.5-30	100	135.45	15.50	\$1450	\$1524	N/A	\$208
Z30M2FN	20 x 30 x 29.5-30	100	118.65	13.25	\$1334	\$1396	N/A	\$173
Z16M2FN	20 x 16 x 29.5-30	92.5	75.60	7	\$884	\$929	N/A	\$108
Z15M2FN	20 x 15 x 29.5-30	92.5	72.45	6.75	\$845	\$883	N/A	\$90
Z36S2FN	16 x 36 x 29.5-30	100	114.45	12.50	\$1312	\$1384	N/A	\$156
Z30S2FN	16 x 30 x 29.5-30	100	97.65	10.50	\$1162	\$1211	N/A	\$140
Z16S2FN	16 x 16 x 29.5-30	92.5	63	6	\$819	\$860	N/A	\$81
Z15S2FN	16 x 15 x 29.5-30	92.5	60.90	5.75	\$784	\$819	N/A	\$74

Open shelf and one file drawer on bottom. Lock secures file drawer. For filing capabilities, see page 200.

- 15" wide models have only side-to-side filing capability
- Lateral file drawer construction is for accommodating hanging files NOT for stacking materials on the drawer bottom

Required Specifications

Primary surface type + finish
 Top thickness/edge detail
 Base finish
 Door/drawer front finish*
 Lock finish*

Optional Specifications

Glazed doors**
 Key #

Box drawer† - no upcharge (30"-36" wide models only)

STORAGE MODULES - 29.5" / 30" HIGH



30-36" wide



12-21" wide

Two File Module†



Two File Module



Box/Box/File Module†



Mixed Storage Cabinet - LEFT†

MODEL#	DIMENSIONS D x W x H	FREIGHT CLASS	WT/LBS.	CUBIC FT.	1" TOP	1.5" TOP	GLAZE ADD	HP ADD
Z36L2E	24 x 36 x 29.5-30	100	164.85	18.50	\$1923	\$2008	N/A	\$208
Z30L2E	24 x 30 x 29.5-30	100	145.95	15.50	\$1759	\$1833	N/A	\$173
Z16L2E	24 x 16 x 29.5-30	92.5	95.55	9	\$1133	\$1182	N/A	\$108
Z15L2E	24 x 15 x 29.5-30	92.5	91.35	8.25	\$1069	\$1110	N/A	\$90
Z36M2E	20 x 36 x 29.5-30	100	149.10	15.50	\$1817	\$1892	N/A	\$208
Z30M2E	20 x 30 x 29.5-30	92.5	133.35	13.25	\$1685	\$1749	N/A	\$173
Z16M2E	20 x 16 x 29.5-30	85	85.05	7	\$1028	\$1073	N/A	\$108
Z15M2E	20 x 15 x 29.5-30	85	81.90	6.75	\$992	\$1030	N/A	\$90
Z36S2E	16 x 36 x 29.5-30	92.5	128.10	12.50	\$1704	\$1776	N/A	\$156
Z30S2E	16 x 30 x 29.5-30	92.5	110.25	10.50	\$1549	\$1598	N/A	\$140
Z16S2E	16 x 16 x 29.5-30	85	73.50	6	\$1020	\$1061	N/A	\$81
Z15S2E	16 x 15 x 29.5-30	85	71.40	5.75	\$986	\$1022	N/A	\$74

Two file drawers. Lock secures all drawers. For filing capabilities, see page 200.

- 15" wide models have only side-to-side filing capability
- Lateral file drawer construction is for accommodating hanging files NOT for stacking materials on the drawer bottom

Z36L2SE	24 x 36 x 29.5-30	100	180	18.50	\$2325	\$2410	N/A	\$208
Z36M2SE	20 x 36 x 29.5-30	92.5	164	15.50	\$2171	\$2246	N/A	\$208

Two lateral file drawers with steel drawer interior. Steel drawer construction includes metal sides and masonite bottoms. Lock secures all drawers. Front-to-back and side-to-side letter/legal filing capability. For filing capabilities, see page 200.

- Front-to-back filing bars sold separately. Order **FBB** bars. See "FBB" on page 41.
- Lateral file drawer construction is for accommodating hanging files NOT for stacking materials on the drawer bottom
- To prevent overloading, steel drawers do not include a back panel

Z16L2BF	24 x 16 x 29.5-30	92.5	97.65	9	\$1275	\$1324	N/A	\$108
Z15L2BF	24 x 15 x 29.5-30	92.5	93.45	8.25	\$1217	\$1258	N/A	\$108
Z16M2BF	20 x 16 x 29.5-30	85	87.15	7	\$1169	\$1214	N/A	\$108
Z15M2BF	20 x 15 x 29.5-30	85	84	6.75	\$1139	\$1177	N/A	\$108
Z16S2BF	16 x 16 x 29.5-30	85	73.50	6	\$1090	\$1131	N/A	\$81
Z15S2BF	16 x 15 x 29.5-30	85	71.40	5.75	\$1041	\$1077	N/A	\$81

Two box and one file drawer. One pencil tray. Lock secures all drawers.

Z36L2XL	24 x 36 x 29.5-30	92.5	187	18.50	\$2192	\$2269	N/A	\$208
Z30L2XL	24 x 30 x 29.5-30	92.5	166	15.50	\$1998	\$2072	N/A	\$173
Z36M2XL	20 x 36 x 29.5-30	92.5	177	15.50	\$2059	\$2133	N/A	\$208
Z30M2XL	20 x 30 x 29.5-30	92.5	152	13.25	\$1895	\$1959	N/A	\$173
Z36S2XL	16 x 36 x 29.5-30	92.5	145	12.50	\$1766	\$1833	N/A	\$156
Z30S2XL	16 x 30 x 29.5-30	92.5	124	10.50	\$1582	\$1640	N/A	\$140

Two box drawers on **left**, one file drawer on **right** which accommodates letter filing side to side, and one lateral file drawer on bottom. Right lock secures one file drawer, the left lock secures two box and lateral file. One pencil tray. For filing capabilities, see page 200.

- Lateral file drawer construction is for accommodating hanging files NOT for stacking materials on the drawer bottom
- Top file drawer supports hanging folders only. Does not accept hanging folders with plastic tabs.

Required Specifications

Primary surface type + finish
 Top thickness/edge detail
 Base finish
 Door/drawer front finish*
 Lock finish*

Optional Specifications

Key #
 Box drawer* - no upcharge (30" - 36" wide models only)

STORAGE MODULES - 29.5" / 30" HIGH



Mixed Storage Cabinet - RIGHT

MODEL#	DIMENSIONS D x W x H	FREIGHT CLASS	WT/LBS.	CUBIC FT.	1" TOP	1.5" TOP	GLAZE ADD	HP ADD
Z36L2XR	24 x 36 x 29.5-30	92.5	187	18.50	\$2192	\$2269	N/A	\$208
Z30L2XR	24 x 30 x 29.5-30	92.5	166	15.50	\$1998	\$2072	N/A	\$173
Z36M2XR	20 x 36 x 29.5-30	92.5	177	15.50	\$2059	\$2133	N/A	\$208
Z30M2XR	20 x 30 x 29.5-30	92.5	152	13.25	\$1895	\$1959	N/A	\$173
Z36S2XR	16 x 36 x 29.5-30	92.5	145	12.50	\$1766	\$1833	N/A	\$156
Z30S2XR	16 x 30 x 29.5-30	92.5	124	10.50	\$1582	\$1640	N/A	\$140

Two box drawers on **right**, one file drawer on **left** which accommodates letter filing side to side, and one lateral file drawer on bottom. Right lock secures two box and lateral file, the left lock secures one file drawer. One pencil tray. For filing capabilities, see page 200.

- Lateral file drawer construction is for accommodating hanging files NOT for stacking materials on the drawer bottom
- Top file drawer supports hanging folders only. Does not accept hanging folders with plastic tabs.



Mixed Drawer Cabinet with Open Shelf - LEFT*



* Accepts collator

Z36L2XNL	24 x 36 x 29.5-30	100	176.40	18.50	\$1897	\$1983	N/A	\$208
Z30L2XNL	24 x 30 x 29.5-30	92.5	155.40	15.50	\$1743	\$1817	N/A	\$173
Z36M2XNL	20 x 36 x 29.5-30	92.5	157.50	15.50	\$1776	\$1850	N/A	\$208
Z30M2XNL	20 x 30 x 29.5-30	92.5	138.60	13.25	\$1643	\$1707	N/A	\$173
Z36S2XNL	16 x 36 x 29.5-30	92.5	128.10	12.50	\$1592	\$1654	N/A	\$156
Z30S2XNL	16 x 30 x 29.5-30	92.5	114.45	10.50	\$1443	\$1488	N/A	\$140

Two box drawers on **left**, open shelf on **right** and one lateral file drawer on bottom. Right lock secures two box and one file drawer, the left lock secures the lateral file. One pencil tray. For filing capabilities, see page 200.

- Lateral file drawer construction is for accommodating hanging files NOT for stacking materials on the drawer bottom



Mixed Drawer Cabinet with Open Shelf - RIGHT*

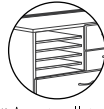

* Accepts collator

Z36L2XNR	24 x 36 x 29.5-30	100	176.40	18.50	\$1897	\$1983	N/A	\$208
Z30L2XNR	24 x 30 x 29.5-30	92.5	155.40	15.50	\$1743	\$1817	N/A	\$173
Z36M2XNR	20 x 36 x 29.5-30	92.5	157.50	15.50	\$1776	\$1850	N/A	\$208
Z30M2XNR	20 x 30 x 29.5-30	92.5	138.60	13.25	\$1643	\$1707	N/A	\$173
Z36S2XNR	16 x 36 x 29.5-30	92.5	128.10	12.50	\$1592	\$1654	N/A	\$156
Z30S2XNR	16 x 30 x 29.5-30	92.5	114.45	10.50	\$1443	\$1488	N/A	\$140

Two box drawers on **right**, open shelf on **left** and one lateral file drawer on bottom. Right lock secures two box and one file drawer, the left lock secures the lateral file. One pencil tray. For filing capabilities, see page 200.

- Lateral file drawer construction is for accommodating hanging files NOT for stacking materials on the drawer bottom

Required Specifications

Primary surface type + finish
 Top thickness/edge detail
 Base finish
 Door/drawer front finish*
 Lock finish*

Optional Specifications

Key #
 Collator*
 Box drawer* - no upcharge (30"-36" wide models only)

STORAGE MODULES - 41.3"/41.8" HIGH



Glazed door option

Storage Cabinet with Doors

MODEL#	DIMENSIONS D x W x H	FREIGHT CLASS	WT/LBS.	CUBIC FT.	1" TOP	1.5" TOP	GLAZE ADD	HP ADD
Z36L4SH	24 x 36 x 41.3-41.8	125	185.85	25	\$1695	\$1781	\$1083	\$208
Z30L4SH	24 x 30 x 41.3-41.8	125	161.70	21.25	\$1552	\$1624	\$945	\$173
Z36M4SH	20 x 36 x 41.3-41.8	125	165.90	21.25	\$1582	\$1657	\$1083	\$208
Z30M4SH	20 x 30 x 41.3-41.8	125	143.85	18	\$1432	\$1496	\$945	\$173
Z36S4SH	16 x 36 x 41.3-41.8	100	142.80	17.50	\$1433	\$1505	\$1083	\$156
Z30S4SH	16 x 30 x 41.3-41.8	100	121.80	14.50	\$1286	\$1335	\$945	\$90

Laminate doors are standard. **Includes two 3-position fixed/height adjustable shelves.** Standard with lock.



Glazed door option

Storage Cabinet with Door - LEFT

Z21L4SHL	24 x 21 x 41.3-41.8	100	123.90	15.25	\$1257	\$1318	\$597	\$140
Z18L4SHL	24 x 18 x 41.3-41.8	100	112.35	13.25	\$1185	\$1234	\$536	\$108
Z16L4SHL	24 x 16 x 41.3-41.8	100	105	12	\$1113	\$1164	\$529	\$108
Z15L4SHL	24 x 15 x 41.3-41.8	100	100.80	11.25	\$1068	\$1108	\$470	\$108
Z12L4SHL	24 x 12 x 41.3-41.8	100	89.25	9.25	\$989	\$1025	\$424	\$74
Z21M4SHL	20 x 21 x 41.3-41.8	100	116.55	13	\$1134	\$1185	\$597	\$140
Z18M4SHL	20 x 18 x 41.3-41.8	100	98.70	11.25	\$1073	\$1118	\$536	\$108
Z16M4SHL	20 x 16 x 41.3-41.8	100	91.35	10.25	\$1007	\$1052	\$529	\$90
Z15M4SHL	20 x 15 x 41.3-41.8	100	88.20	9.50	\$965	\$1001	\$470	\$90
Z12M4SHL	20 x 12 x 41.3-41.8	100	78.75	8	\$897	\$929	\$424	\$74
Z21S4SHL	16 x 21 x 41.3-41.8	100	94.50	10.50	\$1013	\$1054	\$597	\$108
Z18S4SHL	16 x 18 x 41.3-41.8	100	84	9.50	\$972	\$1013	\$536	\$90
Z16S4SHL	16 x 16 x 41.3-41.8	100	76.65	8.50	\$911	\$952	\$529	\$90
Z15S4SHL	16 x 15 x 41.3-41.8	100	73.50	8	\$862	\$898	\$470	\$90
Z12S4SHL	16 x 12 x 41.3-41.8	92.5	65.10	6.50	\$798	\$829	\$424	\$74

Laminate doors are standard. **Includes two 3-position fixed/height adjustable shelves.** Standard with lock.



Glazed door option

Storage Cabinet with Door - RIGHT

Z21L4SHR	24 x 21 x 41.3-41.8	100	123.90	15.25	\$1257	\$1318	\$597	\$140
Z18L4SHR	24 x 18 x 41.3-41.8	100	112.35	13.25	\$1185	\$1234	\$536	\$108
Z16L4SHR	24 x 16 x 41.3-41.8	100	105	12	\$1113	\$1164	\$529	\$108
Z15L4SHR	24 x 15 x 41.3-41.8	100	100.80	11.25	\$1068	\$1108	\$470	\$108
Z12L4SHR	24 x 12 x 41.3-41.8	100	89.25	9.25	\$989	\$1025	\$424	\$74
Z21M4SHR	20 x 21 x 41.3-41.8	100	116.55	13	\$1134	\$1185	\$597	\$140
Z18M4SHR	20 x 18 x 41.3-41.8	100	98.70	11.25	\$1073	\$1118	\$536	\$108
Z16M4SHR	20 x 16 x 41.3-41.8	100	91.35	10.25	\$1007	\$1052	\$529	\$90
Z15M4SHR	20 x 15 x 41.3-41.8	100	88.20	9.50	\$965	\$1001	\$470	\$90
Z12M4SHR	20 x 12 x 41.3-41.8	100	78.75	8	\$897	\$929	\$424	\$74
Z21S4SHR	16 x 21 x 41.3-41.8	100	94.50	10.50	\$1013	\$1054	\$597	\$108
Z18S4SHR	16 x 18 x 41.3-41.8	100	84	9.50	\$972	\$1013	\$536	\$90
Z16S4SHR	16 x 16 x 41.3-41.8	100	76.65	8.50	\$911	\$952	\$529	\$90
Z15S4SHR	16 x 15 x 41.3-41.8	100	73.50	8	\$862	\$898	\$470	\$90
Z12S4SHR	16 x 12 x 41.3-41.8	92.5	65.10	6.50	\$798	\$829	\$424	\$74

Laminate doors are standard. **Includes two 3-position fixed/height adjustable shelves.** Standard with lock.

Required Specifications

Primary surface type + finish
 Top thickness/edge detail
 Base finish
 Door/drawer front finish
 Lock finish
 Handles

Optional Specifications

Glazed doors
 Key #

STORAGE MODULES - 41.3"/41.8" HIGH

MODEL#	DIMENSIONS	FREIGHT CLASS	WT/LBS.	CUBIC FT.	1" TOP	1.5" TOP	GLAZE ADD	HP ADD
D x W x H								
Z36L4SHN	24 x 36 x 41.3-41.8	125	162.55	25	\$1335	\$1420	N/A	\$208
Z30L4SHN	24 x 30 x 41.3-41.8	125	142.46	21.25	\$1231	\$1305	N/A	\$173
Z21L4SHN	24 x 21 x 41.3-41.8	125	111.80	15.25	\$1056	\$1116	N/A	\$140
Z18L4SHN	24 x 18 x 41.3-41.8	125	101.23	13.25	\$998	\$1049	N/A	\$108
Z16L4SHN	24 x 16 x 41.3-41.8	125	94.53	12	\$931	\$980	N/A	\$108
Z15L4SHN	24 x 15 x 41.3-41.8	100	91.70	11.25	\$900	\$941	N/A	\$108
Z12L4SHN	24 x 12 x 41.3-41.8	100	81.13	9.25	\$838	\$874	N/A	\$74
Z36M4SHN	20 x 36 x 41.3-41.8	125	141.59	21.25	\$1222	\$1296	N/A	\$208
Z30M4SHN	20 x 30 x 41.3-41.8	125	123.94	18	\$1111	\$1175	N/A	\$173
Z21M4SHN	20 x 21 x 41.3-41.8	125	102.19	13	\$933	\$984	N/A	\$140
Z18M4SHN	20 x 18 x 41.3-41.8	125	86.54	11.25	\$890	\$935	N/A	\$108
Z16M4SHN	20 x 16 x 41.3-41.8	125	81.01	10.25	\$824	\$869	N/A	\$108
Z15M4SHN	20 x 15 x 41.3-41.8	100	78.24	9.50	\$799	\$835	N/A	\$108
Z12M4SHN	20 x 12 x 41.3-41.8	100	69.95	8	\$744	\$776	N/A	\$74
Z36S4SHN	16 x 36 x 41.3-41.8	125	119.57	17.50	\$1070	\$1144	N/A	\$156
Z30S4SHN	16 x 30 x 41.3-41.8	125	111.72	14.50	\$965	\$1016	N/A	\$140
Z21S4SHN	16 x 21 x 41.3-41.8	125	81.04	10.50	\$812	\$852	N/A	\$108
Z18S4SHN	16 x 18 x 41.3-41.8	125	72.91	9.50	\$786	\$831	N/A	\$90
Z16S4SHN	16 x 16 x 41.3-41.8	125	67.49	8.50	\$728	\$769	N/A	\$90
Z15S4SHN	16 x 15 x 41.3-41.8	100	64.78	8	\$696	\$731	N/A	\$90
Z12S4SHN	16 x 12 x 41.3-41.8	100	57.71	6.50	\$644	\$676	N/A	\$74



12-21" wide



30-36" wide

Open Storage Cabinet**



* Accepts collator 11" high
** Accepts collator 11.3" high

Includes two 3-position fixed/height adjustable shelves.



12-21" wide



30-36" wide

Two File Module with Open Shelf**



* Accepts collator 11" high
** Accepts collator 11.3" high

Z36L4EN	24 x 36 x 41.3-41.8	125	199.50	25	\$2157	\$2242	N/A	\$208
Z30L4EN	24 x 30 x 41.3-41.8	100	178.50	21.25	\$2060	\$2132	N/A	\$173
Z16L4EN	24 x 16 x 41.3-41.8	100	116.55	12	\$1294	\$1345	N/A	\$108
Z15L4EN	24 x 15 x 41.3-41.8	100	112.35	11.25	\$1258	\$1299	N/A	\$108
Z36M4EN	20 x 36 x 41.3-41.8	100	182	21.25	\$2058	\$2132	N/A	\$208
Z30M4EN	20 x 30 x 41.3-41.8	100	163	18	\$1951	\$2013	N/A	\$173
Z16M4EN	20 x 16 x 41.3-41.8	92.5	105	10.25	\$1191	\$1236	N/A	\$108
Z15M4EN	20 x 15 x 41.3-41.8	92.5	101	9.50	\$1158	\$1194	N/A	\$108
Z36S4EN	16 x 36 x 41.3-41.8	100	153.30	17.50	\$1887	\$1959	N/A	\$156
Z30S4EN	16 x 30 x 41.3-41.8	100	131.25	14.50	\$1717	\$1766	N/A	\$140
Z16S4EN	16 x 16 x 41.3-41.8	92.5	85.05	8.50	\$1093	\$1134	N/A	\$90
Z15S4EN	16 x 15 x 41.3-41.8	92.5	82.95	8	\$1067	\$1102	N/A	\$90

Open fixed shelf and two file drawers on bottom. Lock secures all drawers. For filing capabilities, see page 200.

- Lateral file drawer construction is for accommodating hanging files NOT for stacking materials on the drawer bottom.



12-21" wide



30-36" wide

Three File Module†

Z36L43F	24 x 36 x 41.3-41.8	100	210	25	\$2535	\$2620	N/A	\$208
Z30L43F	24 x 30 x 41.3-41.8	100	190.05	21.25	\$2408	\$2482	N/A	\$173
Z16L43F	24 x 16 x 41.3-41.8	92.5	126	12	\$1489	\$1538	N/A	\$90
Z15L43F	24 x 15 x 41.3-41.8	92.5	120.75	11.25	\$1449	\$1490	N/A	\$90
Z36M43F	20 x 36 x 41.3-41.8	100	198.45	21.25	\$2467	\$2541	N/A	\$208
Z30M43F	20 x 30 x 41.3-41.8	100	177.45	18	\$2304	\$2368	N/A	\$173
Z16M43F	20 x 16 x 41.3-41.8	92.5	114.45	10.25	\$1389	\$1434	N/A	\$90
Z15M43F	20 x 15 x 41.3-41.8	92.5	110.25	9.50	\$1354	\$1390	N/A	\$90
Z36S43F	16 x 36 x 41.3-41.8	100	165.90	17.50	\$2226	\$2298	N/A	\$156
Z30S43F	16 x 30 x 41.3-41.8	92.5	148.05	14.50	\$2051	\$2102	N/A	\$140
Z16S43F	16 x 16 x 41.3-41.8	92.5	94.50	8.50	\$1314	\$1355	N/A	\$90
Z15S43F	16 x 15 x 41.3-41.8	92.5	91.35	8	\$1271	\$1307	N/A	\$90

Three file drawers. Lock secures all drawers. For filing capabilities, see page 200.

- Lateral file drawer construction is for accommodating hanging files NOT for stacking materials on the drawer bottom.

Required Specifications

Primary surface type + finish
Top thickness/edge detail
Base finish
Door/drawer front finish
Lock finish†
Handles†

Optional Specifications

Glazed doors
Key #
Collator**

STORAGE MODULES - 41.3"/41.8" HIGH



Three File Module

MODEL#	DIMENSIONS D x W x H	FREIGHT CLASS	WT./LBS.	CUBIC FT.	1" TOP	1.5" TOP	GLAZE ADD	HP ADD
Z36L4S3F	24 x 36 x 41.3-41.8	100	233	25	\$3122	\$3207	N/A	\$208
Z36M4S3F	20 x 36 x 41.3-41.8	92.5	221	21.25	\$3028	\$3103	N/A	\$173

Three lateral file drawers with steel drawer interior. Steel drawer construction includes metal sides and masonite bottoms. Lock secures all drawers Front-to-back and side-to-side letter/legal filing capability. For filing capabilities, see page 200.

- Front-to-back filing bars sold separately. Order **FBB** bars. See "FBB" on page 41
- Lateral file drawer construction is for accommodating hanging files NOT for stacking materials on the drawer bottom.
- To prevent overloading, steel drawers do not include a back panel

STORAGE MODULES - 53" / 53.5" HIGH



Glazed door option

Storage Cabinet with Doors**

MODEL#	DIMENSIONS	FREIGHT CLASS	WT./LBS.	CUBIC FT.	1" TOP	1.5" TOP	GLAZE ADD	HP ADD
Z36L5SH	24 x 36 x 53-53.5	125	229.95	31.25	\$2044	\$2129	\$1327	\$208
Z30L5SH	24 x 30 x 53-53.5	125	199.50	27	\$1862	\$1936	\$1153	\$173
Z36M5SH	20 x 36 x 53-53.5	125	203.70	27	\$1904	\$1978	\$1327	\$208
Z30M5SH	20 x 30 x 53-53.5	100	184.80	22.75	\$1671	\$1733	\$1153	\$173
Z36S5SH	16 x 36 x 53-53.5	100	175.35	21.75	\$1783	\$1855	\$1327	\$156
Z30S5SH	16 x 30 x 53-53.5	100	152.25	18.50	\$1563	\$1612	\$1153	\$140

Laminate doors are standard. **Includes three 3-position fixed/height adjustable shelves.** Standard with lock.

Z21L5SHL	24 x 21 x 53-53.5	125	154.35	19.50	\$1472	\$1533	\$736	\$140
Z18L5SHL	24 x 18 x 53-53.5	100	139.65	17	\$1402	\$1453	\$661	\$108
Z16L5SHL	24 x 16 x 53-53.5	100	130.20	15.50	\$1327	\$1378	\$654	\$108
Z15L5SHL	24 x 15 x 53-53.5	100	124.95	14.25	\$1266	\$1307	\$575	\$108
Z12L5SHL	24 x 12 x 53-53.5	100	110.25	11.75	\$1178	\$1214	\$518	\$74
Z21M5SHL	20 x 21 x 53-53.5	100	142.80	16.50	\$1347	\$1398	\$736	\$140
Z18M5SHL	20 x 18 x 53-53.5	100	122.85	14.25	\$1275	\$1321	\$661	\$108
Z16M5SHL	20 x 16 x 53-53.5	100	113.40	13	\$1208	\$1253	\$654	\$108
Z15M5SHL	20 x 15 x 53-53.5	100	109.20	12.25	\$1148	\$1186	\$575	\$108
Z12M5SHL	20 x 12 x 53-53.5	100	96.60	10	\$1064	\$1098	\$518	\$74
Z21S5SHL	16 x 21 x 53-53.5	100	116.55	13.25	\$1253	\$1293	\$736	\$108
Z18S5SHL	16 x 18 x 53-53.5	100	103.95	11.50	\$1191	\$1232	\$661	\$90
Z16S5SHL	16 x 16 x 53-53.5	100	96.60	10.50	\$1128	\$1169	\$654	\$90
Z15S5SHL	16 x 15 x 53-53.5	100	91.35	9.75	\$1086	\$1121	\$575	\$90
Z12S5SHL	16 x 12 x 53-53.5	100	79.80	8.25	\$998	\$1030	\$518	\$74

Laminate doors are standard. **Includes three 3-position fixed/height adjustable shelves.** Standard with lock.



Glazed door option

Storage Cabinet with Door - LEFT**

Z21L5SHR	24 x 21 x 53-53.5	125	154.35	19.50	\$1472	\$1533	\$736	\$140
Z18L5SHR	24 x 18 x 53-53.5	100	139.65	17	\$1402	\$1453	\$661	\$108
Z16L5SHR	24 x 16 x 53-53.5	100	130.20	15.50	\$1327	\$1378	\$654	\$108
Z15L5SHR	24 x 15 x 53-53.5	100	124.95	14.25	\$1266	\$1307	\$575	\$108
Z12L5SHR	24 x 12 x 53-53.5	100	110.25	11.75	\$1178	\$1214	\$518	\$74
Z21M5SHR	20 x 21 x 53-53.5	100	142.80	16.50	\$1347	\$1398	\$736	\$140
Z18M5SHR	20 x 18 x 53-53.5	100	122.85	14.25	\$1275	\$1321	\$661	\$108
Z16M5SHR	20 x 16 x 53-53.5	100	113.40	13	\$1208	\$1253	\$654	\$108
Z15M5SHR	20 x 15 x 53-53.5	100	109.20	12.25	\$1148	\$1186	\$575	\$108
Z12M5SHR	20 x 12 x 53-53.5	100	96.60	10	\$1064	\$1098	\$518	\$74
Z21S5SHR	16 x 21 x 53-53.5	100	116.55	13.25	\$1253	\$1293	\$736	\$108
Z18S5SHR	16 x 18 x 53-53.5	100	103.95	11.50	\$1191	\$1232	\$661	\$90
Z16S5SHR	16 x 16 x 53-53.5	100	96.60	10.50	\$1128	\$1169	\$654	\$90
Z15S5SHR	16 x 15 x 53-53.5	100	91.35	9.75	\$1086	\$1121	\$575	\$90
Z12S5SHR	16 x 12 x 53-53.5	100	79.80	8.25	\$998	\$1030	\$518	\$74

Laminate doors are standard. **Includes three 3-position fixed/height adjustable shelves.** Standard with lock.



Glazed door option

Storage Cabinet with Door - RIGHT**

Required Specifications

- Primary surface type + finish
- Top thickness/edge detail
- Base finish
- Door/drawer front finish
- Lock finish†
- Handles†

Optional Specifications

- Glazed doors*
- Collator***

Box drawer† - no upcharge (30"- 36" wide models only)

STORAGE MODULES - 53" / 53.5" HIGH



30-36" wide



12-21" wide

Open Storage Cabinet*



* Accepts collator 11" high
** Accepts collator 11.3" high

MODEL#	DIMENSIONS	FREIGHT CLASS	WT/LBS.	CUBIC FT.	1" TOP	1.5" TOP	GLAZE ADD	HP ADD
D x W x H								
Z36L5SHN	24 x 36 x 53-53.5	125	198.49	31.25	\$1591	\$1677	N/A	\$208
Z30L5SHN	24 x 30 x 53-53.5	125	173.45	27	\$1486	\$1560	N/A	\$173
Z21L5SHN	24 x 21 x 53-53.5	125	136.43	19.50	\$1222	\$1283	N/A	\$140
Z18L5SHN	24 x 18 x 53-53.5	125	124.44	17	\$1174	\$1225	N/A	\$108
Z16L5SHN	24 x 16 x 53-53.5	125	116.10	15.50	\$1097	\$1146	N/A	\$108
Z15L5SHN	24 x 15 x 53-53.5	125	112.45	14.25	\$1061	\$1102	N/A	\$108
Z12L5SHN	24 x 12 x 53-53.5	100	100.46	11.75	\$991	\$1027	N/A	\$74
Z36M5SHN	20 x 36 x 53-53.5	125	172.27	27	\$1448	\$1523	N/A	\$208
Z30M5SHN	20 x 30 x 53-53.5	125	158.08	22.75	\$1294	\$1358	N/A	\$173
Z21M5SHN	20 x 21 x 53-53.5	125	123.68	16.50	\$1093	\$1144	N/A	\$140
Z18M5SHN	20 x 18 x 53-53.5	125	106.61	14.25	\$1044	\$1090	N/A	\$108
Z16M5SHN	20 x 16 x 53-53.5	125	99.43	13	\$976	\$1021	N/A	\$108
Z15M5SHN	20 x 15 x 53-53.5	125	95.84	12.25	\$943	\$981	N/A	\$108
Z12M5SHN	20 x 12 x 53-53.5	100	85.07	10	\$876	\$910	N/A	\$74
Z36S5SHN	16 x 36 x 53-53.5	125	145.01	21.75	\$1265	\$1337	N/A	\$156
Z30S5SHN	16 x 30 x 53-53.5	125	126.96	18.50	\$1139	\$1188	N/A	\$140
Z21S5SHN	16 x 21 x 53-53.5	125	98.33	13.25	\$961	\$1002	N/A	\$108
Z18S5SHN	16 x 18 x 53-53.5	125	88.78	11.50	\$921	\$966	N/A	\$90
Z16S5SHN	16 x 16 x 53-53.5	125	82.76	10.50	\$860	\$901	N/A	\$90
Z15S5SHN	16 x 15 x 53-53.5	100	78.18	9.75	\$846	\$881	N/A	\$90
Z12S5SHN	16 x 12 x 53-53.5	100	69.69	8.25	\$784	\$816	N/A	\$74

Includes three 3-position fixed/height adjustable shelves



Two File Module with Doors**



Glazed door option

Z36L5E	24 x 36 x 53-53.5	100	250.95	31.25	\$2772	\$2858	\$812	\$208
Z30L5E	24 x 30 x 53-53.5	100	222.60	27	\$2585	\$2659	\$712	\$173
Z36M5E	20 x 36 x 53-53.5	100	229.95	27	\$2644	\$2719	\$844	\$208
Z30M5E	20 x 30 x 53-53.5	100	201.60	22.75	\$2408	\$2472	\$745	\$173
Z36S5E	16 x 36 x 53-53.5	100	193.20	21.75	\$2333	\$2405	\$844	\$156
Z30S5E	16 x 30 x 53-53.5	100	170.10	18.50	\$2146	\$2195	\$745	\$140

Two lateral file drawers on bottom. Laminate doors are standard. **Includes one 3-position fixed/height adjustable shelf.** Upper lock secures storage compartment. Lower lock secures two file drawers. For filing capabilities, see page 200.

- Lateral file drawer construction is for accommodating hanging files NOT for stacking materials on the drawer bottom.



Two File Module with Door - LEFT



Glazed door option

Z16L5EL	24 x 16 x 53-53.5	100	144.90	15.50	\$1611	\$1660	\$413	\$108
Z15L5EL	24 x 15 x 53-53.5	100	139.65	14.25	\$1551	\$1592	\$371	\$108
Z16M5EL	20 x 16 x 53-53.5	92.5	130.20	13	\$1498	\$1543	\$412	\$108
Z15M5EL	20 x 15 x 53-53.5	92.5	126	12.25	\$1438	\$1476	\$371	\$108
Z16S5EL	16 x 16 x 53-53.5	92.5	109.20	10.50	\$1374	\$1415	\$412	\$90
Z15S5EL	16 x 15 x 53-53.5	92.5	105	9.75	\$1349	\$1385	\$371	\$90

Two file drawers on bottom. Laminate door is standard. **Includes one 3-position fixed/height adjustable shelf.** Upper lock secures storage compartment. Lower lock secures two file drawers.



Two File Module with Door - RIGHT



Glazed door option

Z16L5ER	24 x 16 x 53-53.5	100	144.90	15.50	\$1611	\$1660	\$413	\$108
Z15L5ER	24 x 15 x 53-53.5	100	139.65	14.25	\$1551	\$1592	\$371	\$108
Z16M5ER	20 x 16 x 53-53.5	92.5	130.20	13	\$1498	\$1543	\$412	\$108
Z15M5ER	20 x 15 x 53-53.5	92.5	126	12.25	\$1438	\$1476	\$371	\$108
Z16S5ER	16 x 16 x 53-53.5	92.5	109.20	10.50	\$1374	\$1415	\$412	\$90
Z15S5ER	16 x 15 x 53-53.5	92.5	105	9.75	\$1349	\$1385	\$371	\$90

Two file drawers on bottom. Laminate door is standard. **Includes one 3-position fixed/height adjustable shelf.** Upper lock secures storage compartment. Lower lock secures two file drawers.

Required Specifications

Primary surface type + finish
Top thickness/edge detail
Base finish
Lock finish**

Door/drawer front finish** (unless glazed door specified, then drawer front only)
Handles**

Optional Specifications

Key #**
Box drawer† - no upcharge (30" - 36" wide models only)
Collator*

STORAGE MODULES - 53" / 53.5" HIGH



30-36" wide



15-16" wide



* Accepts collator 11" high
** Accepts collator 11.3" high

Two File Module with Open Shelves**

MODEL#	DIMENSIONS D x W x H	FREIGHT CLASS	WT./LBS.	CUBIC FT.	1" TOP	1.5" TOP	GLAZE ADD	HP ADD
Z36L5EN	24 x 36 x 53-53.5	125	235.45	31.25	\$2476	\$2562	N/A	\$208
Z30L5EN	24 x 30 x 53-53.5	125	209.86	27	\$2317	\$2389	N/A	\$173
Z16L5EN	24 x 16 x 53-53.5	100	137.89	15.50	\$1460	\$1509	N/A	\$108
Z15L5EN	24 x 15 x 53-53.5	100	133.80	14.25	\$1415	\$1456	N/A	\$108
Z36M5EN	20 x 36 x 53-53.5	125	213.43	27	\$2351	\$2425	N/A	\$208
Z30M5EN	20 x 30 x 53-53.5	100	188.19	22.75	\$2138	\$2202	N/A	\$173
Z16M5EN	20 x 16 x 53-53.5	100	123.33	13	\$1347	\$1392	N/A	\$108
Z15M5EN	20 x 15 x 53-53.5	100	119.29	12.25	\$1300	\$1336	N/A	\$108
Z36S5EN	16 x 36 x 53-53.5	100	178.82	21.75	\$2037	\$2109	N/A	\$156
Z30S5EN	16 x 30 x 53-53.5	100	158.12	18.50	\$1877	\$1926	N/A	\$140
Z16S5EN	16 x 16 x 53-53.5	100	102.46	10.50	\$1222	\$1263	N/A	\$90
Z15S5EN	16 x 15 x 53-53.5	92.5	98.48	9.75	\$1214	\$1249	N/A	\$90

Two open shelves and two file drawers on bottom. **Includes one 3-position fixed/height adjustable shelf.** Lock secures all drawers. For filing capabilities, see page 200.

- Lateral file drawer construction is for accommodating hanging files NOT for stacking materials on the drawer bottom.



30-36" wide



15-16" wide

Four File Module*

Z36L54F	24 x 36 x 53-53.5	100	256.20	31.25	\$3125	\$3210	N/A	\$208
Z30L54F	24 x 30 x 53-53.5	100	234.15	27	\$2997	\$3071	N/A	\$173
Z16L54F	24 x 16 x 53-53.5	92.5	155.40	15.50	\$1794	\$1843	N/A	\$108
Z15L54F	24 x 15 x 53-53.5	92.5	148.05	14.25	\$1734	\$1775	N/A	\$108
Z36M54F	20 x 36 x 53-53.5	100	239.40	27	\$3028	\$3102	N/A	\$208
Z30M54F	20 x 30 x 53-53.5	100	218.40	22.75	\$2844	\$2908	N/A	\$173
Z16M54F	20 x 16 x 53-53.5	92.5	141.75	13	\$1694	\$1739	N/A	\$108
Z15M54F	20 x 15 x 53-53.5	92.5	136.50	12.25	\$1635	\$1671	N/A	\$108
Z36S54F	16 x 36 x 53-53.5	100	205	21.75	\$2710	\$2782	N/A	\$156
Z30S54F	16 x 30 x 53-53.5	100	180	18.50	\$2469	\$2518	N/A	\$140
Z16S54F	16 x 16 x 53-53.5	92.5	122	10.50	\$1664	\$1705	N/A	\$90
Z15S54F	16 x 15 x 53-53.5	92.5	116	9.75	\$1603	\$1639	N/A	\$90

Four file drawers. Lock secures all drawers. For filing capabilities, see page 200.

- Lateral file drawer construction is for accommodating hanging files NOT for stacking materials on the drawer bottom.



Four File Module

Z36L5S4F	24 x 36 x 53-53.5	100	286	31.25	\$3737	\$3822	N/A	\$208
Z36M5S4F	20 x 36 x 53-53.5	100	269	27	\$3815	\$3890	N/A	\$208

Four file drawers with steel drawer interior. Steel drawer construction includes metal sides and masonite bottoms. Lock secures all drawers. Front-to-back and side-to-side letter/legal filing capability. For filing capabilities, see page 200.

- Front-to-back filing bars sold separately. Order **FBB** bars. See "FBB" on page 41.
- Lateral file drawer construction is for accommodating hanging files NOT for stacking materials on the drawer bottom.
- To prevent overloading, steel drawers do not include a back panel



Storage Cabinet with Doors**



Glazed door option

Z36L6SH	24 x 36 x 65.5-66	125	273	39	\$2421	\$2507	\$1571	N/A
Z30L6SH	24 x 30 x 65.5-66	125	238.35	32.75	\$2117	\$2191	\$1359	N/A
Z36M6SH	20 x 36 x 65.5-66	125	246.75	33.25	\$2247	\$2322	\$1571	N/A
Z30M6SH	20 x 30 x 65.5-66	125	212.10	27.75	\$1960	\$2022	\$1359	N/A
Z36S6SH	16 x 36 x 65.5-66	125	210	26.50	\$2033	\$2105	\$1571	N/A
Z30S6SH	16 x 30 x 65.5-66	100	183.75	22.50	\$1747	\$1798	\$1359	N/A

Laminate doors are standard. **Includes four 3-position fixed/height adjustable shelves.** Standard with lock.

Required Specifications

Primary surface type + finish
Top thickness/edge detail
Base finish
Lock finish**

Door/drawer front finish** (unless glazed door specified, then drawer front only)
Handles**

Optional Specifications

Key # Collator*
Box drawer† - no upcharge (30" - 36" wide models only)
Glazed door**

STORAGE MODULES - 53" / 53.5" HIGH

MODEL#	DIMENSIONS	FREIGHT CLASS	WT/LBS.	CUBIC FT.	1" TOP	1.5" TOP	GLAZE ADD	HP ADD
--------	------------	---------------	---------	-----------	--------	----------	-----------	--------



Glazed door option

Storage Cabinet with Door - LEFT*

	D x W x H							
Z21L6SHL	24 x 21 x 65.5-66	125	185.85	23.50	\$1735	\$1796	\$871	N/A
Z18L6SHL	24 x 18 x 65.5-66	100	168	20.50	\$1620	\$1671	\$784	N/A
Z16L6SHL	24 x 16 x 65.5-66	100	156.45	18.75	\$1528	\$1577	\$776	N/A
Z15L6SHL	24 x 15 x 65.5-66	100	149.10	17.50	\$1481	\$1522	\$679	N/A
Z12L6SHL	24 x 12 x 65.5-66	100	133.35	14.50	\$1346	\$1384	\$610	N/A
Z21M6SHL	20 x 21 x 65.5-66	100	170.10	20	\$1552	\$1603	\$871	N/A
Z18M6SHL	20 x 18 x 65.5-66	100	148.05	17.25	\$1481	\$1526	\$784	N/A
Z16M6SHL	20 x 16 x 65.5-66	100	137.55	15.75	\$1394	\$1439	\$776	N/A
Z15M6SHL	20 x 15 x 65.5-66	100	133.35	14.75	\$1329	\$1367	\$679	N/A
Z12M6SHL	20 x 12 x 65.5-66	100	116.55	12.25	\$1231	\$1265	\$610	N/A
Z21S6SHL	16 x 21 x 65.5-66	100	140.70	16	\$1432	\$1472	\$871	N/A
Z18S6SHL	16 x 18 x 65.5-66	100	126	14	\$1326	\$1367	\$784	N/A
Z16S6SHL	16 x 16 x 65.5-66	100	116.55	13	\$1247	\$1288	\$776	N/A
Z15S6SHL	16 x 15 x 65.5-66	100	111.30	12	\$1185	\$1221	\$679	N/A
Z12S6SHL	16 x 12 x 65.5-66	100	96.60	10	\$1087	\$1119	\$610	N/A

Laminate doors are standard. Includes four 3-position fixed/height adjustable shelves. Standard with lock.



Glazed door option

Storage Cabinet with Door - RIGHT*

Z21L6SHR	24 x 21 x 65.5-66	125	185.85	23.50	\$1735	\$1796	\$871	N/A
Z18L6SHR	24 x 18 x 65.5-66	100	168	20.50	\$1620	\$1671	\$784	N/A
Z16L6SHR	24 x 16 x 65.5-66	100	156.45	18.75	\$1528	\$1577	\$776	N/A
Z15L6SHR	24 x 15 x 65.5-66	100	149.10	17.50	\$1481	\$1522	\$679	N/A
Z12L6SHR	24 x 12 x 65.5-66	100	133.35	14.50	\$1346	\$1384	\$610	N/A
Z21M6SHR	20 x 21 x 65.5-66	100	170.10	20	\$1552	\$1603	\$871	N/A
Z18M6SHR	20 x 18 x 65.5-66	100	148.05	17.25	\$1481	\$1526	\$784	N/A
Z16M6SHR	20 x 16 x 65.5-66	100	137.55	15.75	\$1394	\$1439	\$776	N/A
Z15M6SHR	20 x 15 x 65.5-66	100	133.35	14.75	\$1329	\$1367	\$679	N/A
Z12M6SHR	20 x 12 x 65.5-66	100	116.55	12.25	\$1231	\$1265	\$610	N/A
Z21S6SHR	16 x 21 x 65.5-66	100	140.70	16	\$1432	\$1472	\$871	N/A
Z18S6SHR	16 x 18 x 65.5-66	100	126	14	\$1326	\$1367	\$784	N/A
Z16S6SHR	16 x 16 x 65.5-66	100	116.55	13	\$1247	\$1288	\$776	N/A
Z15S6SHR	16 x 15 x 65.5-66	100	111.30	12	\$1185	\$1221	\$679	N/A
Z12S6SHR	16 x 12 x 65.5-66	100	96.60	10	\$1087	\$1119	\$610	N/A

Laminate doors are standard. Includes four 3-position fixed/height adjustable shelves. Standard with lock.



30-36" wide



12-21" wide



* Accepts collator 11" high

Open Storage Cabinet**

Z36L6SHN	24 x 36 x 65.5-66	125	234.42	39	\$1876	\$1962	N/A	N/A
Z30L6SHN	24 x 30 x 65.5-66	125	205.50	32.75	\$1662	\$1736	N/A	N/A
Z21L6SHN	24 x 21 x 65.5-66	125	163.17	23.50	\$1443	\$1504	N/A	N/A
Z18L6SHN	24 x 18 x 65.5-66	125	148.71	20.50	\$1354	\$1405	N/A	N/A
Z16L6SHN	24 x 16 x 65.5-66	125	139.77	18.75	\$1260	\$1309	N/A	N/A
Z15L6SHN	24 x 15 x 65.5-66	125	134.25	17.50	\$1248	\$1289	N/A	N/A
Z12L6SHN	24 x 12 x 65.5-66	100	119.79	14.50	\$1133	\$1169	N/A	N/A
Z36M6SHN	20 x 36 x 65.5-66	125	206.11	33.25	\$1697	\$1771	N/A	N/A
Z30M6SHN	20 x 30 x 65.5-66	125	178.58	27.75	\$1502	\$1564	N/A	N/A
Z21M6SHN	20 x 21 x 65.5-66	125	146.22	20	\$1260	\$1311	N/A	N/A
Z18M6SHN	20 x 18 x 65.5-66	125	127.73	17.25	\$1217	\$1263	N/A	N/A
Z16M6SHN	20 x 16 x 65.5-66	125	119.95	15.75	\$1130	\$1175	N/A	N/A
Z15M6SHN	20 x 15 x 65.5-66	125	116.59	14.75	\$1096	\$1134	N/A	N/A
Z12M6SHN	20 x 12 x 65.5-66	100	102.30	12.25	\$1020	\$1052	N/A	N/A
Z36S6SHN	16 x 36 x 65.5-66	125	172.54	26.50	\$1488	\$1560	N/A	N/A
Z30S6SHN	16 x 30 x 65.5-66	125	151.66	22.50	\$1292	\$1343	N/A	N/A
Z21S6SHN	16 x 21 x 65.5-66	125	117.71	16	\$1138	\$1179	N/A	N/A
Z18S6SHN	16 x 18 x 65.5-66	125	105.70	14	\$1061	\$1102	N/A	N/A
Z16S6SHN	16 x 16 x 65.5-66	125	99.09	13	\$987	\$1028	N/A	N/A
Z15S6SHN	16 x 15 x 65.5-66	125	94.73	12	\$952	\$988	N/A	N/A
Z12S6SHN	16 x 12 x 65.5-66	100	83.76	10	\$876	\$908	N/A	N/A

Includes four 3-position fixed/height adjustable shelves.

Required Specifications

Primary surface type + finish
Top thickness/edge detail
Base finish
Lock finish*

Door/drawer front finish* (unless glazed door specified, then drawer front only)
Handles

Optional Specifications

Key #*
Glazed doors*
Collator**

STORAGE MODULES - 65.5" / 66" HIGH



Glazed door option

Two File Module with Doors**

MODEL#	DIMENSIONS D x W x H	FREIGHT CLASS	WT./LBS.	CUBIC FT.	1" TOP	1.5" TOP	GLAZE ADD	HP ADD
Z36L6E	24 x 36 x 65.5-66	125	294	39	\$3054	\$3140	\$1088	N/A
Z30L6E	24 x 30 x 65.5-66	125	260.40	32.75	\$2792	\$2866	\$952	N/A
Z36M6E	20 x 36 x 65.5-66	100	269.85	33.25	\$2924	\$2998	\$1088	N/A
Z30M6E	20 x 30 x 65.5-66	100	236.25	27.75	\$2644	\$2708	\$952	N/A
Z36S6E	16 x 36 x 65.5-66	100	225	26.50	\$2502	\$2576	\$1088	N/A
Z30S6E	16 x 30 x 65.5-66	100	197	22.50	\$2394	\$2443	\$952	N/A

Two lateral file drawers on bottom. Laminate doors are standard. **Includes two 3-position fixed/height adjustable shelves.** Upper lock secures storage compartment. Lower lock secures two file drawers. For filing capabilities, see page 200.

- Lateral file drawer construction is for accommodating hanging files NOT for stacking materials on the drawer bottom.



Glazed door option

Two File Module with Door - LEFT

Z16L6EL	24 x 16 x 65.5-66	100	171.15	18.75	\$1809	\$1860	\$532	N/A
Z15L6EL	24 x 15 x 65.5-66	100	163.80	17.50	\$1766	\$1807	\$473	N/A
Z16M6EL	20 x 16 x 65.5-66	100	153.30	15.75	\$1682	\$1727	\$532	N/A
Z15M6EL	20 x 15 x 65.5-66	92.5	148.05	14.75	\$1620	\$1658	\$473	N/A
Z16S6EL	16 x 16 x 65.5-66	100	129.15	13	\$1536	\$1577	\$532	N/A
Z15S6EL	16 x 15 x 65.5-66	92.5	123.90	12	\$1488	\$1524	\$473	N/A

Two file drawers on bottom. Laminate door is standard. **Includes two 3-position fixed/height adjustable shelves.** Upper lock secures storage compartment. Lower lock secures two file drawers.



Glazed door option

Two File Module with Door - RIGHT

Z16L6ER	24 x 16 x 65.5-66	100	171.15	18.75	\$1809	\$1860	\$532	N/A
Z15L6ER	24 x 15 x 65.5-66	100	163.80	17.50	\$1766	\$1807	\$473	N/A
Z16M6ER	20 x 16 x 65.5-66	100	153.30	15.75	\$1682	\$1727	\$532	N/A
Z15M6ER	20 x 15 x 65.5-66	92.5	148.05	14.75	\$1620	\$1658	\$473	N/A
Z16S6ER	16 x 16 x 65.5-66	100	129.15	13	\$1536	\$1577	\$532	N/A
Z15S6ER	16 x 15 x 65.5-66	92.5	123.90	12	\$1488	\$1524	\$473	N/A

Two file drawers on bottom. Laminate door is standard. **Includes three 3-position fixed/height adjustable shelves.** Upper lock secures storage compartment. Lower lock secures two file drawers.



30-36" wide



12-21" wide



* Accepts collator 11" high

Two File Module with Open Shelves†

Z36L6EN	24 x 36 x 65.5-66	125	271.38	39	\$2667	\$2753	N/A	N/A
Z30L6EN	24 x 30 x 65.5-66	125	240.85	32.75	\$2445	\$2519	N/A	N/A
Z16L6EN	24 x 16 x 65.5-66	100	161.56	18.75	\$1624	\$1673	N/A	N/A
Z15L6EN	24 x 15 x 65.5-66	100	155.60	17.50	\$1601	\$1642	N/A	N/A
Z36M6EN	20 x 36 x 65.5-66	125	243.07	33.25	\$2536	\$2610	N/A	N/A
Z30M6EN	20 x 30 x 65.5-66	125	213.93	27.75	\$2299	\$2363	N/A	N/A
Z16M6EN	20 x 16 x 65.5-66	100	142.80	15.75	\$1499	\$1544	N/A	N/A
Z15M6EN	20 x 15 x 65.5-66	100	137.94	14.75	\$1454	\$1492	N/A	N/A
Z36S6EN	16 x 36 x 65.5-66	125	202.15	26.50	\$2112	\$2186	N/A	N/A
Z30S6EN	16 x 30 x 65.5-66	125	177.56	22.50	\$2046	\$2095	N/A	N/A
Z16S6EN	16 x 16 x 65.5-66	100	118.78	13	\$1350	\$1391	N/A	N/A
Z15S6EN	16 x 15 x 65.5-66	100	113.98	12	\$1323	\$1359	N/A	N/A

Three open shelves and two file drawers on bottom. **Includes two 3-position fixed/height adjustable shelves.** Lock secures all drawers. For filing capabilities, see page 200.

- Lateral file drawer construction is for accommodating hanging files NOT for stacking materials on the drawer bottom.

Required Specifications

Primary surface type + finish
Top thickness/edge detail
Base finish
Lock finish*

Door/drawer front finish* (unless glazed door specified, then drawer front only)
Handles

Optional Specifications

Key #*
Glazed doors*
Collator**

WARDROBE MODULES - 65.5" / 66" HIGH



Wardrobe Cabinet

MODEL#	DIMENSIONS D x W x H	FREIGHT CLASS	WT/LBS.	CUBIC FT.	1" TOP	1.5" TOP	GLAZE ADD	HP ADD
Z36L6WA	24 x 36 x 65.5-66	150	216.30	39	\$2074	\$2159	N/A	N/A
Z30L6WA	24 x 30 x 65.5-66	150	192.15	32.75	\$1867	\$1941	N/A	N/A
Z36M6WA	20 x 36 x 65.5-66	125	200.55	33.25	\$1987	\$2061	N/A	N/A
Z30M6WA	20 x 30 x 65.5-66	125	173.25	27.75	\$1759	\$1823	N/A	N/A

Laminate doors are standard. Full length hanging rod included. Standard with lock.



Wardrobe Cabinet - LEFT

Z24L6WAL	24 x 24 x 65.5-66	125	165.90	26.75	\$1713	\$1774	N/A	N/A
Z21L6WAL	24 x 21 x 65.5-66	125	152.25	23.50	\$1577	\$1637	N/A	N/A
Z18L6WAL	24 x 18 x 65.5-66	125	139.65	20.50	\$1400	\$1451	N/A	N/A
Z16L6WAL	24 x 16 x 65.5-66	125	132.30	18.75	\$1370	\$1421	N/A	N/A
Z15L6WAL	24 x 15 x 65.5-66	125	128.10	17.50	\$1314	\$1355	N/A	N/A
Z12L6WAL	24 x 12 x 65.5-66	125	115.50	14.50	\$1215	\$1251	N/A	N/A
Z24M6WAL	20 x 24 x 65.5-66	125	149.10	22.50	\$1473	\$1524	N/A	N/A
Z21M6WAL	20 x 21 x 65.5-66	125	143.85	20	\$1429	\$1478	N/A	N/A
Z18M6WAL	20 x 18 x 65.5-66	125	124.95	17.25	\$1293	\$1338	N/A	N/A
Z16M6WAL	20 x 16 x 65.5-66	125	116.55	15.75	\$1260	\$1305	N/A	N/A
Z15M6WAL	20 x 15 x 65.5-66	125	113.40	14.75	\$1186	\$1224	N/A	N/A
Z12M6WAL	20 x 12 x 65.5-66	100	102.90	12.25	\$1130	\$1162	N/A	N/A

Laminate doors are standard. Full length hanging rod included. Standard with lock.



Wardrobe Cabinet - RIGHT

Z24L6WAR	24 x 24 x 65.5-66	125	165.90	26.75	\$1713	\$1774	N/A	N/A
Z21L6WAR	24 x 21 x 65.5-66	125	152.25	23.50	\$1577	\$1637	N/A	N/A
Z18L6WAR	24 x 18 x 65.5-66	125	139.65	20.50	\$1400	\$1451	N/A	N/A
Z16L6WAR	24 x 16 x 65.5-66	125	132.30	18.75	\$1370	\$1421	N/A	N/A
Z15L6WAR	24 x 15 x 65.5-66	125	128.10	17.50	\$1314	\$1355	N/A	N/A
Z12L6WAR	24 x 12 x 65.5-66	125	115.50	14.50	\$1215	\$1251	N/A	N/A
Z24M6WAR	20 x 24 x 65.5-66	125	149.10	22.50	\$1473	\$1524	N/A	N/A
Z21M6WAR	20 x 21 x 65.5-66	125	143.85	20	\$1429	\$1478	N/A	N/A
Z18M6WAR	20 x 18 x 65.5-66	125	124.95	17.25	\$1293	\$1338	N/A	N/A
Z16M6WAR	20 x 16 x 65.5-66	125	116.55	15.75	\$1260	\$1305	N/A	N/A
Z15M6WAR	20 x 15 x 65.5-66	125	113.40	14.75	\$1186	\$1224	N/A	N/A
Z12M6WAR	20 x 12 x 65.5-66	100	102.90	12.25	\$1130	\$1162	N/A	N/A

Laminate doors are standard. Full length hanging rod included. Standard with lock.



Wardrobe Cabinet/Shelving Combo with Doors - LEFT*



Glazed door option

Z36L6DIL	24 x 36 x 65.5-66	125	269.85	39	\$2477	\$2563	\$1571	N/A
Z30L6DIL	24 x 30 x 65.5-66	125	240.45	32.75	\$2194	\$2266	\$1359	N/A
Z24L6DIL	24 x 24 x 65.5-66	125	208.95	26.75	\$2047	\$2109	\$1228	N/A
Z21L6DIL	24 x 21 x 65.5-66	100	193.20	23.50	\$1923	\$1984	\$1217	N/A
Z36M6DIL	20 x 36 x 65.5-66	125	243.60	33.25	\$2330	\$2404	\$1571	N/A
Z30M6DIL	20 x 30 x 65.5-66	100	226.80	27.75	\$2035	\$2099	\$1359	N/A
Z24M6DIL	20 x 24 x 65.5-66	100	184.80	22.50	\$1825	\$1876	\$1228	N/A
Z21M6DIL	20 x 21 x 65.5-66	100	171.15	20	\$1773	\$1824	\$1217	N/A

Laminate doors are standard. Storage compartment on **left includes four 3-position fixed/height adjustable shelves**. Wardrobe compartment on **right** includes hanging rod. Two locks secure storage and wardrobe compartments.

Required Specifications

Primary surface type + finish
Top thickness/edge detail
Base finish
Lock finish

Door/drawer front finish* (unless glazed door specified, then drawer front only)
Handles

Optional Specifications

Key #
Glazed doors*

WARDROBE MODULES - 65.5" / 66" HIGH



Wardrobe Cabinet/Shelving Combo with Doors - RIGHT

MODEL#	DIMENSIONS D x W x H	FREIGHT CLASS	WT./LBS.	CUBIC FT.	1" TOP	1.5" TOP	GLAZE ADD	HP ADD
Z36L6DIR	24 x 36 x 65.5-66	125	269.85	39	\$2477	\$2563	\$1571	N/A
Z30L6DIR	24 x 30 x 65.5-66	125	240.45	32.75	\$2194	\$2266	\$1359	N/A
Z24L6DIR	24 x 24 x 65.5-66	125	208.95	26.75	\$2047	\$2109	\$1228	N/A
Z21L6DIR	24 x 21 x 65.5-66	100	193.20	23.50	\$1923	\$1984	\$1217	N/A
Z36M6DIR	20 x 36 x 65.5-66	125	243.60	33.25	\$2330	\$2404	\$1571	N/A
Z30M6DIR	20 x 30 x 65.5-66	100	226.80	27.75	\$2035	\$2099	\$1359	N/A
Z24M6DIR	20 x 24 x 65.5-66	100	184.80	22.50	\$1825	\$1876	\$1228	N/A
Z21M6DIR	20 x 21 x 65.5-66	100	171.15	20	\$1773	\$1824	\$1217	N/A

Laminate doors are standard. Storage compartment on **right includes four 3-position fixed/height adjustable shelves**. Wardrobe compartment on **left** includes hanging rod. Two locks secure storage and wardrobe compartments.



Wardrobe Cabinet/Open Shelving Combo - LEFT*

Z36L6DINL	24 x 36 x 65.5-66	125	251.50	39	\$2213	\$2299	\$785	N/A
Z30L6DINL	24 x 30 x 65.5-66	125	224.46	32.75	\$1977	\$2051	\$680	N/A
Z24L6DINL	24 x 24 x 65.5-66	125	196.37	26.75	\$1864	\$1925	\$611	N/A
Z21L6DINL	24 x 21 x 65.5-66	125	183.37	23.50	\$1740	\$1801	\$608	N/A
Z36M6DINL	20 x 36 x 65.5-66	125	223.19	33.25	\$2070	\$2145	\$785	N/A
Z30M6DINL	20 x 30 x 65.5-66	125	197.54	27.75	\$1818	\$1882	\$680	N/A
Z24M6DINL	20 x 24 x 65.5-66	125	174.14	22.50	\$1643	\$1694	\$611	N/A
Z21M6DINL	20 x 21 x 65.5-66	125	159.07	20	\$1589	\$1640	\$608	N/A

Laminate door is standard. Storage compartment on **left includes four 3-position fixed/height adjustable shelves**. Wardrobe compartment on **right** includes hanging rod. Single lock secures storage and wardrobe compartments.



Wardrobe Cabinet/Open Shelving Combo - RIGHT*

Z36L6DINR	24 x 36 x 65.5-66	125	251.50	39	\$2213	\$2299	\$785	N/A
Z30L6DINR	24 x 30 x 65.5-66	125	224.46	32.75	\$1977	\$2051	\$680	N/A
Z24L6DINR	24 x 24 x 65.5-66	125	196.37	26.75	\$1864	\$1925	\$611	N/A
Z21L6DINR	24 x 21 x 65.5-66	125	183.37	23.50	\$1740	\$1801	\$608	N/A
Z36M6DINR	20 x 36 x 65.5-66	125	223.19	33.25	\$2070	\$2145	\$785	N/A
Z30M6DINR	20 x 30 x 65.5-66	125	197.54	27.75	\$1818	\$1882	\$680	N/A
Z24M6DINR	20 x 24 x 65.5-66	125	174.14	22.50	\$1643	\$1694	\$611	N/A
Z21M6DINR	20 x 21 x 65.5-66	125	159.07	20	\$1589	\$1640	\$608	N/A

Laminate door is standard. Storage compartment on **right includes four 3-position fixed/height adjustable shelves**. Wardrobe compartment on **left** includes hanging rod. Single lock secures storage and wardrobe compartments.

PERSONAL TOWERS - 65.5" / 66" HIGH



Personal Tower with Doors - LEFT

MODEL#	DIMENSIONS	FREIGHT CLASS	WT./LBS.	CUBIC FT.	1" TOP	1.5" TOP	GLAZE ADD	HP ADD
Z36L6EL	24 x 36 x 65.5-66	125	290.85	39	\$2717	\$2802	\$1320	N/A
Z30L6EL	24 x 30 x 65.5-66	100	266.70	32.75	\$2514	\$2588	\$1202	N/A
Z24L6EL	24 x 24 x 65.5-66	100	243.24	26.75	\$2411	\$2472	\$1053	N/A
Z36M6EL	20 x 36 x 65.5-66	125	256.20	33.25	\$2571	\$2645	\$1320	N/A
Z30M6EL	20 x 30 x 65.5-66	100	229.95	27.75	\$2349	\$2413	\$1202	N/A
Z24M6EL	20 x 24 x 65.5-66	100	217	22.50	\$2252	\$2303	\$1053	N/A

Two file drawers on bottom. Laminate doors are standard. Storage compartment on **left includes two 3-position fixed/height adjustable shelves**. Wardrobe compartment on **right** includes hanging rod. Two upper locks, one per each hinged door, and one lower lock secures drawers, all keyed alike.



Personal Tower with Doors - RIGHT

Z36L6ER	24 x 36 x 65.5-66	125	290.85	39	\$2717	\$2802	\$1320	N/A
Z30L6ER	24 x 30 x 65.5-66	100	266.70	32.75	\$2514	\$2588	\$1202	N/A
Z24L6ER	24 x 24 x 65.5-66	100	243.24	26.75	\$2411	\$2472	\$1053	N/A
Z36M6ER	20 x 36 x 65.5-66	125	256.20	33.25	\$2571	\$2645	\$1320	N/A
Z30M6ER	20 x 30 x 65.5-66	100	229.95	27.75	\$2349	\$2413	\$1202	N/A
Z24M6ER	20 x 24 x 65.5-66	100	217	22.50	\$2252	\$2303	\$1053	N/A

Two file drawers on bottom. Laminate doors are standard. Storage compartment on **right includes four 3-position fixed/height adjustable shelves**. Wardrobe compartment on **left** includes hanging rod. Two upper locks, one per each hinged door, and one lower lock secures drawers, all keyed alike.

Required Specifications

Primary surface type + finish
Top thickness/edge detail
Base finish
Lock finish

Door/drawer front finish (unless glazed door specified, then drawer front only)
Handles

Optional Specifications

Key #
Glazed doors
Collator*

PERSONAL TOWERS - 65.5" / 66" HIGH

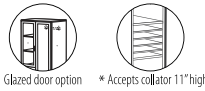

Personal Tower with Doors and cavity - LEFT*

MODEL#	DIMENSIONS D x W x H	FREIGHT CLASS	WT./LBS.	CUBIC FT.	1" TOP	1.5" TOP	GLAZE ADD	HP ADD
Z36L6ECL	24 x 36 x 65.5-66	125	288.74	39	\$2682	\$2768	\$1258	N/A
Z30L6ECL	24 x 30 x 65.5-66	100	264.24	32.75	\$2480	\$2554	\$1144	N/A
Z24L6ECL	24 x 24 x 65.5-66	100	239.24	26.75	\$2378	\$2439	\$992	N/A
Z36M6ECL	20 x 36 x 65.5-66	125	252.03	33.25	\$2526	\$2600	\$1258	N/A
Z30M6ECL	20 x 30 x 65.5-66	100	226.82	27.75	\$2301	\$2363	\$1144	N/A
Z24M6ECL	20 x 24 x 65.5-66	100	213	22.50	\$2221	\$2272	\$992	N/A

Two file drawers on bottom. Laminate doors are standard. Storage compartment on left includes one 3-position fixed/height adjustable shelf. Wardrobe compartment on right includes hanging rod. Two upper locks, one per each hinged door, and one lower lock secures drawers, all keyed alike.

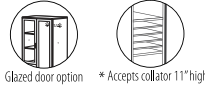

Personal Tower with Doors and cavity - RIGHT*

Z36L6ECR	24 x 36 x 65.5-66	125	288.74	39	\$2682	\$2768	\$1258	N/A
Z30L6ECR	24 x 30 x 65.5-66	100	264.24	32.75	\$2480	\$2554	\$1144	N/A
Z24L6ECR	24 x 24 x 65.5-66	100	239.24	26.75	\$2378	\$2439	\$992	N/A
Z36M6ECR	20 x 36 x 65.5-66	125	252.03	33.25	\$2526	\$2600	\$1258	N/A
Z30M6ECR	20 x 30 x 65.5-66	100	226.82	27.75	\$2301	\$2363	\$1144	N/A
Z24M6ECR	20 x 24 x 65.5-66	100	213	22.50	\$2221	\$2272	\$992	N/A

Two file drawers on bottom. Laminate doors are standard. Storage compartment on right includes one 3-position fixed/height adjustable shelf. Wardrobe compartment on left includes hanging rod. Two upper locks, one per each hinged door, and one lower lock secures drawers, all keyed alike.

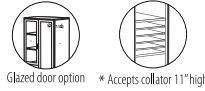

Personal Tower w/Open Shelves - LEFT*

Z36L6ENL	24 x 36 x 65.5-66	125	280.48	39	\$2535	\$2620	\$790	N/A
Z30L6ENL	24 x 30 x 65.5-66	125	257.36	32.75	\$2330	\$2404	\$676	N/A
Z24L6ENL	24 x 24 x 65.5-66	100	230.24	26.75	\$2231	\$2292	\$524	N/A
Z36M6ENL	20 x 36 x 65.5-66	125	243.77	33.25	\$2375	\$2449	\$790	N/A
Z30M6ENL	20 x 30 x 65.5-66	125	219.94	27.75	\$2152	\$2216	\$676	N/A
Z24M6ENL	20 x 24 x 65.5-66	100	204	22.50	\$2040	\$2108	\$524	N/A

Two file drawers on bottom. Laminate doors are standard on wardrobe section. Storage compartment on left includes two 3-position fixed/height adjustable shelves. Wardrobe compartment on right includes hanging rod. Upper lock secures storage and wardrobe compartments. Lower lock secures all drawers.

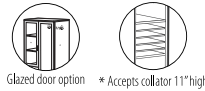

Personal Tower w/Open Shelves - RIGHT*

Z36L6ENR	24 x 36 x 65.5-66	125	280.48	39	\$2535	\$2620	\$790	N/A
Z30L6ENR	24 x 30 x 65.5-66	125	257.36	32.75	\$2330	\$2404	\$676	N/A
Z24L6ENR	24 x 24 x 65.5-66	100	230.24	26.75	\$2231	\$2292	\$524	N/A
Z36M6ENR	20 x 36 x 65.5-66	125	243.77	33.25	\$2375	\$2449	\$790	N/A
Z30M6ENR	20 x 30 x 65.5-66	125	219.94	27.75	\$2152	\$2216	\$676	N/A
Z24M6ENR	20 x 24 x 65.5-66	100	204	22.50	\$2040	\$2108	\$524	N/A

Two file drawers on bottom. Laminate doors is standard on wardrobe section. Storage compartment on right includes two 3-position fixed/height adjustable shelves. Wardrobe compartment on left includes hanging rod. Upper lock secures storage and wardrobe compartments. Lower lock secures all drawers.



Personal Tower with Doors - LEFT

Z36L6BFL	24 x 36 x 65.5-66	125	294	39	\$2857	\$2942	\$1320	N/A
Z30L6BFL	24 x 30 x 65.5-66	100	268.80	32.75	\$2654	\$2728	\$1202	N/A
Z24L6BFL	24 x 24 x 65.5-66	100	244.24	26.75	\$2522	\$2584	\$1053	N/A
Z36M6BFL	20 x 36 x 65.5-66	125	258.30	33.25	\$2721	\$2795	\$1320	N/A
Z30M6BFL	20 x 30 x 65.5-66	100	232.05	27.75	\$2496	\$2560	\$1202	N/A
Z24M6BFL	20 x 24 x 65.5-66	100	218	22.50	\$2367	\$2418	\$1053	N/A

Two box and one file drawer on bottom. Laminate doors are standard. Storage compartment on left includes two 3-position fixed/height adjustable shelves. Wardrobe compartment on right includes hanging rod. Two upper locks, one per each hinged door, and one lower lock secures drawers, all keyed alike.

Required Specifications

Primary surface type + finish
Top thickness/edge detail
Base finish
Lock finish

Door/drawer front finish (unless glazed door specified, then drawer front only)
Handles

Optional Specifications

Key #
Glazed doors
Collator*

PERSONAL TOWERS - 65.5" / 66" HIGH



Glazed door option

Personal Tower with Doors - RIGHT

MODEL#	DIMENSIONS D x W x H	FREIGHT CLASS	WT./LBS.	CUBIC FT.	1" TOP	1.5" TOP	GLAZE ADD	HP ADD
Z36L6BFR	24 x 36 x 65.5-66	125	294	39	\$2857	\$2942	\$1320	N/A
Z30L6BFR	24 x 30 x 65.5-66	100	268.80	32.75	\$2654	\$2728	\$1202	N/A
Z24L6BFR	24 x 24 x 65.5-66	100	244.24	26.75	\$2522	\$2584	\$1053	N/A
Z36M6BFR	20 x 36 x 65.5-66	125	258.30	33.25	\$2721	\$2795	\$1320	N/A
Z30M6BFR	20 x 30 x 65.5-66	100	232.05	27.75	\$2496	\$2560	\$1202	N/A
Z24M6BFR	20 x 24 x 65.5-66	100	218	22.50	\$2367	\$2418	\$1053	N/A

Two box and one file drawer on bottom. Laminate doors are standard. Storage compartment on **right** includes **two 3-position fixed/height adjustable shelves**. Wardrobe compartment on **left** includes hanging rod. Two upper locks, one per each hinged door, and one lower lock secures drawers, all keyed alike.



Glazed door option



* Accepts collator 11" high

Personal Tower with Doors*

Z36L6BFCL	24 x 36 x 65.5-66	125	291.89	39	\$2825	\$2911	\$1258	N/A
Z30L6BFCL	24 x 30 x 65.5-66	100	266.34	32.75	\$2623	\$2697	\$1144	N/A
Z24L6BFCL	24 x 24 x 65.5-66	100	240.24	26.75	\$2490	\$2552	\$992	N/A
Z36M6BFCL	20 x 36 x 65.5-66	125	254.13	33.25	\$2666	\$2740	\$1258	N/A
Z30M6BFCL	20 x 30 x 65.5-66	100	228.92	27.75	\$2439	\$2503	\$1144	N/A
Z24M6BFCL	20 x 24 x 65.5-66	100	214	22.50	\$2334	\$2385	\$992	N/A

Two box and one file drawer on bottom. Laminate doors are standard. Storage compartment on **left** includes **one 3-position fixed/height adjustable shelf**. Wardrobe compartment on **right** includes hanging rod. Two upper locks, one per each hinged door, and one lower lock secures drawers, all keyed alike.



Glazed door option



* Accepts collator 11" high

Personal Tower with Doors and Cavity - RIGHT*

Z36L6BFCCR	24 x 36 x 65.5-66	125	291.89	39	\$2825	\$2911	\$1258	N/A
Z30L6BFCCR	24 x 30 x 65.5-66	100	266.34	32.75	\$2623	\$2697	\$1144	N/A
Z24L6BFCCR	24 x 24 x 65.5-66	100	240.24	26.75	\$2490	\$2552	\$992	N/A
Z36M6BFCCR	20 x 36 x 65.5-66	125	254.13	33.25	\$2666	\$2740	\$1258	N/A
Z30M6BFCCR	20 x 30 x 65.5-66	100	228.92	27.75	\$2439	\$2503	\$1144	N/A
Z24M6BFCCR	20 x 24 x 65.5-66	100	214	22.50	\$2334	\$2385	\$992	N/A

Two box and one file drawer on bottom. Laminate doors are standard. Storage compartment on **left** includes **one 3-position fixed/height adjustable shelf**. Wardrobe compartment on **right** includes hanging rod. Two upper locks, one per each hinged door, and one lower lock secures drawers, all keyed alike.



Glazed door option



* Accepts collator 11" high

Personal Tower with Open Shelves - LEFT*

Z36L6BFNLL	24 x 36 x 65.5-66	125	280	39	\$2677	\$2762	\$790	N/A
Z30L6BFNLL	24 x 30 x 65.5-66	125	257	32.75	\$2473	\$2547	\$676	N/A
Z24L6BFNLL	24 x 24 x 65.5-66	100	232	26.75	\$2346	\$2407	\$524	N/A
Z36M6BFNLL	20 x 36 x 65.5-66	125	242	33.25	\$2538	\$2612	\$790	N/A
Z30M6BFNLL	20 x 30 x 65.5-66	125	219	27.75	\$2314	\$2378	\$676	N/A
Z24M6BFNLL	20 x 24 x 65.5-66	100	206	22.50	\$2207	\$2258	\$524	N/A

Two box and one file drawer on bottom. Laminate doors are standard. Storage compartment on **left** includes **two 3-position fixed/height adjustable shelves**. Wardrobe compartment on **right** includes hanging rod. Upper lock secures storage and wardrobe compartments. Lower lock secures all drawers.



Glazed door option



* Accepts collator 11" high

Personal Tower with Open Shelves - RIGHT*

Z36L6BFNRR	24 x 36 x 65.5-66	125	280	39	\$2677	\$2762	\$790	N/A
Z30L6BFNRR	24 x 30 x 65.5-66	125	257	32.75	\$2473	\$2547	\$676	N/A
Z24L6BFNRR	24 x 24 x 65.5-66	100	232	26.75	\$2346	\$2407	\$524	N/A
Z36M6BFNRR	20 x 36 x 65.5-66	125	242	33.25	\$2538	\$2612	\$790	N/A
Z30M6BFNRR	20 x 30 x 65.5-66	125	219	27.75	\$2314	\$2378	\$676	N/A
Z24M6BFNRR	20 x 24 x 65.5-66	100	206	22.50	\$2207	\$2258	\$524	N/A

Two box and one file drawer on bottom. Laminate doors are standard. Storage compartment on **right** includes **two 3-position fixed/height adjustable shelves**. Wardrobe compartment on **left** includes hanging rod. Upper lock secures storage and wardrobe compartments. Lower lock secures all drawers.

Required Specifications

Primary surface type + finish
Top thickness/edge detail
Base finish
Lock finish

Door/drawer front finish (unless glazed door specified, then drawer front only)
Handles

Optional Specifications

Key #
Glazed doors
Box drawer - no upcharge (30"-36" wide models only)
Collator*

STORAGE MODULES - 72"/72.5" HIGH



Glazed door option

Storage Cabinet with Doors

MODEL#	DIMENSIONS D x W x H	FREIGHT CLASS	WT./LBS.	CUBIC FT.	1" TOP	1.5" TOP	GLAZE ADD	HP ADD
Z36L7SH	24 x 36 x 71.9-72.4	125	295.05	43.25	\$2529	\$2614	\$1694	N/A
Z30L7SH	24 x 30 x 71.9-72.4	125	253.05	36.25	\$2207	\$2281	\$1466	N/A
Z36M7SH	20 x 36 x 71.9-72.4	125	261.45	36.75	\$2348	\$2422	\$1694	N/A
Z30M7SH	20 x 30 x 71.9-72.4	125	225.75	30.50	\$2035	\$2097	\$1466	N/A
Z36S7SH	16 x 36 x 71.9-72.4	125	225.75	29.50	\$2105	\$2177	\$1694	N/A
Z30S7SH	16 x 30 x 71.9-72.4	125	195.30	25	\$1849	\$1898	\$1466	N/A

Laminate doors are standard. **Includes four 3-position fixed/height adjustable shelves.** Standard with lock.



Glazed door option

Storage Cabinet with Door - LEFT

Z21L7SHL	24 x 21 x 71.9-72.4	125	196.35	26	\$1828	\$1889	\$941	N/A
Z18L7SHL	24 x 18 x 71.9-72.4	125	178.50	22.75	\$1704	\$1755	\$844	N/A
Z16L7SHL	24 x 16 x 71.9-72.4	100	166.95	20.75	\$1602	\$1653	\$839	N/A
Z15L7SHL	24 x 15 x 71.9-72.4	100	160.65	19.25	\$1533	\$1574	\$728	N/A
Z12L7SHL	24 x 12 x 71.9-72.4	100	136.50	16	\$1407	\$1445	\$654	N/A
Z21M7SHL	20 x 21 x 71.9-72.4	100	174.30	21.25	\$1635	\$1684	\$941	N/A
Z18M7SHL	20 x 18 x 71.9-72.4	100	156.45	19.25	\$1561	\$1607	\$844	N/A
Z16M7SHL	20 x 16 x 71.9-72.4	100	147	17.50	\$1466	\$1511	\$839	N/A
Z15M7SHL	20 x 15 x 71.9-72.4	100	139.65	16.25	\$1399	\$1435	\$728	N/A
Z12M7SHL	20 x 12 x 71.9-72.4	100	123.90	13.25	\$1284	\$1316	\$654	N/A
Z21S7SHL	16 x 21 x 71.9-72.4	100	150.15	18	\$1509	\$1550	\$941	N/A
Z18S7SHL	16 x 18 x 71.9-72.4	100	134.40	15.50	\$1402	\$1447	\$844	N/A
Z16S7SHL	16 x 16 x 71.9-72.4	100	124.95	14	\$1346	\$1387	\$839	N/A
Z15S7SHL	16 x 15 x 71.9-72.4	100	118.65	12.50	\$1293	\$1328	\$728	N/A
Z12S7SHL	16 x 12 x 71.9-72.4	100	103.95	11	\$1136	\$1168	\$654	N/A

Laminate doors are standard. **Includes four 3-position fixed/height adjustable shelves.** Standard with lock.



Glazed door option

Storage Cabinet with Door - RIGHT

Z21L7SHR	24 x 21 x 71.9-72.4	125	196.35	26	\$1828	\$1889	\$941	N/A
Z18L7SHR	24 x 18 x 71.9-72.4	125	178.50	22.75	\$1704	\$1755	\$844	N/A
Z16L7SHR	24 x 16 x 71.9-72.4	100	166.95	20.75	\$1602	\$1653	\$839	N/A
Z15L7SHR	24 x 15 x 71.9-72.4	100	160.65	19.25	\$1533	\$1574	\$728	N/A
Z12L7SHR	24 x 12 x 71.9-72.4	100	136.50	16	\$1407	\$1445	\$654	N/A
Z21M7SHR	20 x 21 x 71.9-72.4	100	174.30	21.25	\$1635	\$1684	\$941	N/A
Z18M7SHR	20 x 18 x 71.9-72.4	100	156.45	19.25	\$1561	\$1607	\$844	N/A
Z16M7SHR	20 x 16 x 71.9-72.4	100	147	17.50	\$1466	\$1511	\$839	N/A
Z15M7SHR	20 x 15 x 71.9-72.4	100	139.65	16.25	\$1399	\$1435	\$728	N/A
Z12M7SHR	20 x 12 x 71.9-72.4	100	123.90	13.25	\$1284	\$1316	\$654	N/A
Z21S7SHR	16 x 21 x 71.9-72.4	100	150.15	18	\$1509	\$1550	\$941	N/A
Z18S7SHR	16 x 18 x 71.9-72.4	100	134.40	15.50	\$1402	\$1447	\$844	N/A
Z16S7SHR	16 x 16 x 71.9-72.4	100	124.95	14	\$1346	\$1387	\$839	N/A
Z15S7SHR	16 x 15 x 71.9-72.4	100	118.65	12.50	\$1293	\$1328	\$728	N/A
Z12S7SHR	16 x 12 x 71.9-72.4	100	103.95	11	\$1136	\$1168	\$654	N/A

Laminate doors are standard. **Includes four 3-position fixed/height adjustable shelves.** Standard with lock.

Required Specifications

Primary surface type + finish
Top thickness/edge detail
Base finish
Lock finish

Door/drawer front finish (unless glazed door specified, then drawer front only)
Handle

Optional Specifications

Key #
Glazed doors

STORAGE MODULES - 72"/72.5" HIGH



18", 21" wide 30", 36" wide



12", 15", 16" wide



* Accepts collator 11" high

Open Storage Cabinet**



Glazed door option

Two File Module with Doors*



Glazed door option

Two File Module with Door - LEFT*



Glazed door option

Two File Module with Door - RIGHT*

MODEL#	DIMENSIONS D x W x H	FREIGHT CLASS	WT./LBS.	CUBIC FT.	1" TOP	1.5" TOP	GLAZE ADD	HP ADD
Z36L7SHN	24 x 36 x 71.9-72.4	150	249.61	43.25	\$1976	\$2062	N/A	N/A
Z30L7SHN	24 x 30 x 71.9-72.4	150	216.23	36.25	\$1751	\$1825	N/A	N/A
Z21L7SHN	24 x 21 x 71.9-72.4	125	171.94	26	\$1517	\$1578	N/A	N/A
Z18L7SHN	24 x 18 x 71.9-72.4	125	156.83	22.75	\$1428	\$1479	N/A	N/A
Z16L7SHN	24 x 16 x 71.9-72.4	125	147.10	20.75	\$1325	\$1374	N/A	N/A
Z15L7SHN	24 x 15 x 71.9-72.4	125	141.72	19.25	\$1286	\$1327	N/A	N/A
Z12L7SHN	24 x 12 x 71.9-72.4	125	121.35	16	\$1190	\$1316	N/A	N/A
Z36M7SHN	20 x 36 x 71.9-72.4	150	217.09	36.75	\$1794	\$1868	N/A	N/A
Z30M7SHN	20 x 30 x 71.9-72.4	125	188.26	30.50	\$1579	\$1643	N/A	N/A
Z21M7SHN	20 x 21 x 71.9-72.4	125	148.69	21.25	\$1202	\$1251	N/A	N/A
Z18M7SHN	20 x 18 x 71.9-72.4	125	134.80	19.25	\$1278	\$1324	N/A	N/A
Z16M7SHN	20 x 16 x 71.9-72.4	125	127.29	17.50	\$1186	\$1231	N/A	N/A
Z15M7SHN	20 x 15 x 71.9-72.4	125	121.96	16.25	\$1151	\$1189	N/A	N/A
Z12M7SHN	20 x 12 x 71.9-72.4	100	109.11	13.25	\$1064	\$1096	N/A	N/A
Z36S7SHN	16 x 36 x 71.9-72.4	125	181.43	29.50	\$1552	\$1626	N/A	N/A
Z30S7SHN	16 x 30 x 71.9-72.4	125	158.19	25	\$1395	\$1444	N/A	N/A
Z21S7SHN	16 x 21 x 71.9-72.4	125	124.38	18	\$1199	\$1239	N/A	N/A
Z18S7SHN	16 x 18 x 71.9-72.4	125	112.77	15.50	\$1124	\$1169	N/A	N/A
Z16S7SHN	16 x 16 x 71.9-72.4	125	105.37	14	\$1064	\$1105	N/A	N/A
Z15S7SHN	16 x 15 x 71.9-72.4	100	100.10	12.50	\$1050	\$1085	N/A	N/A
Z12S7SHN	16 x 12 x 71.9-72.4	100	89.53	11	\$917	\$949	N/A	N/A

Four adjustable shelves.

Z36L7E	24 x 36 x 71.9-72.4	125	316.05	43.25	\$3225	\$3310	\$1334	N/A
Z30L7E	24 x 30 x 71.9-72.4	125	276.15	36.25	\$2945	\$3019	\$1162	N/A
Z36M7E	20 x 36 x 71.9-72.4	125	285.60	36.75	\$3053	\$3127	\$1334	N/A
Z30M7E	20 x 30 x 71.9-72.4	100	249.90	30.50	\$2783	\$2847	\$1162	N/A
Z36S7E	16 x 36 x 71.9-72.4	100	244.65	29.50	\$2790	\$2864	\$1334	N/A
Z30S7E	16 x 30 x 71.9-72.4	100	213.15	25	\$2515	\$2564	\$1162	N/A

Two lateral file drawers. Laminate doors are standard. **Includes two adjustable shelves.** Upper lock secures storage compartment. Lower lock secures two file drawers. For filing capabilities, see page 200.

- Lateral file drawer construction is for accommodating hanging files NOT for stacking materials on the drawer bottom.

Z16L7EL	24 x 16 x 71.9-72.4	100	181.65	20.75	\$1903	\$1954	\$658	N/A
Z15L7EL	24 x 15 x 71.9-72.4	100	176.40	19.25	\$1828	\$1869	\$578	N/A
Z16M7EL	20 x 16 x 71.9-72.4	100	162.75	17.50	\$1767	\$1812	\$658	N/A
Z15M7EL	20 x 15 x 71.9-72.4	100	155.40	16.25	\$1697	\$1735	\$578	N/A
Z16S7EL	16 x 16 x 71.9-72.4	100	137.55	14	\$1645	\$1686	\$658	N/A
Z15S7EL	16 x 15 x 71.9-72.4	92.5	132.30	12.50	\$1609	\$1644	\$578	N/A

Two file drawers on bottom. Laminate door is standard. **Includes two 3-position fixed/height adjustable shelves.** Upper lock secures storage compartment. Lower lock secures two file drawers.

Z16L7ER	24 x 16 x 71.9-72.4	100	181.65	20.75	\$1903	\$1954	\$658	N/A
Z15L7ER	24 x 15 x 71.9-72.4	100	176.40	19.25	\$1828	\$1869	\$578	N/A
Z16M7ER	20 x 16 x 71.9-72.4	100	162.75	17.50	\$1767	\$1812	\$658	N/A
Z15M7ER	20 x 15 x 71.9-72.4	100	155.40	16.25	\$1697	\$1735	\$578	N/A
Z16S7ER	16 x 16 x 71.9-72.4	100	137.55	14	\$1645	\$1686	\$658	N/A
Z15S7ER	16 x 15 x 71.9-72.4	92.5	132.30	12.50	\$1609	\$1644	\$578	N/A

Two file drawers on bottom. Laminate door is standard. **Includes two 3-position fixed/height adjustable shelves.** Upper lock secures storage compartment. Lower lock secures two file drawers.

Required Specifications

Primary surface type + finish
Top thickness/edge detail
Base finish
Lock finish

Door/drawer front finish* (unless glazed door specified, then drawer front only)
Handles*

Optional Specifications

Key #*
Glazed doors* Collator**
Box drawer* - no upcharge (30" - 36" wide models only)

STORAGE MODULES - 72"/72.5" HIGH



30", 36" wide



15", 16" wide



* Accepts collator 11" high

Two File Module with Open Shelves*

MODEL#	DIMENSIONS	FREIGHT CLASS	WT/LBS.	CUBIC FT.	1" TOP	1.5" TOP	GLAZE ADD	HP ADD
D x W x H								
Z36L7EN	24 x 36 x 71.9-72.4	125	286.57	43.25	\$2799	\$2885	N/A	N/A
Z30L7EN	24 x 30 x 71.9-72.4	125	252.63	36.25	\$2577	\$2651	N/A	N/A
Z16L7EN	24 x 16 x 71.9-72.4	100	168.90	20.75	\$1690	\$1739	N/A	N/A
Z15L7EN	24 x 15 x 71.9-72.4	100	164.12	19.25	\$1640	\$1681	N/A	N/A
Z36M7EN	20 x 36 x 71.9-72.4	125	257.21	36.75	\$2633	\$2708	N/A	N/A
Z30M7EN	20 x 30 x 71.9-72.4	125	225.71	30.50	\$2413	\$2477	N/A	N/A
Z16M7EN	20 x 16 x 71.9-72.4	100	150.13	17.50	\$1553	\$1598	N/A	N/A
Z15M7EN	20 x 15 x 71.9-72.4	100	144.36	16.25	\$1512	\$1548	N/A	N/A
Z36S7EN	16 x 36 x 71.9-72.4	125	216.29	29.50	\$2368	\$2440	N/A	N/A
Z30S7EN	16 x 30 x 71.9-72.4	125	189.34	25	\$2146	\$2195	N/A	N/A
Z16S7EN	16 x 16 x 71.9-72.4	100	125.06	14	\$1433	\$1474	N/A	N/A
Z15S7EN	16 x 15 x 71.9-72.4	100	120.40	12.50	\$1419	\$1455	N/A	N/A

Three open shelves and two file drawers on bottom. **Includes two 3-position fixed/height adjustable shelves.** Lock secures all drawers. For filing capabilities, see page 200.

- Lateral file drawer construction is for accommodating hanging files NOT for stacking materials on the drawer bottom.

WARDROBE CABINETS - 72"/72.5" HIGH



Wardrobe Cabinet

MODEL#	DIMENSIONS	FREIGHT CLASS	WT/LBS.	CUBIC FT.	1" TOP	1.5" TOP	GLAZE ADD	HP ADD
Z36L7WA	24 x 36 x 71.9-72.4	150	252	43.25	\$2299	\$2384	N/A	N/A
Z30L7WA	24 x 30 x 71.9-72.4	125	218.40	36.25	\$2146	\$2220	N/A	N/A
Z36M7WA	20 x 36 x 71.9-72.4	125	226.80	36.75	\$2161	\$2235	N/A	N/A
Z30M7WA	20 x 30 x 71.9-72.4	125	196.35	30.50	\$1919	\$1983	N/A	N/A

Laminate doors are standard. Full length hanging rod included. **Includes one 3-position fixed/height adjustable shelf** above hanging rod. Standard with lock.



Wardrobe Cabinet - LEFT

Z24L7WAL	24 x 24 x 71.9-72.4	125	191.10	29.75	\$1742	\$1803	N/A	N/A
Z21L7WAL	24 x 21 x 71.9-72.4	125	178.50	26	\$1680	\$1741	N/A	N/A
Z18L7WAL	24 x 18 x 71.9-72.4	125	158.55	22.75	\$1543	\$1594	N/A	N/A
Z16L7WAL	24 x 16 x 71.9-72.4	125	149.10	20.75	\$1481	\$1530	N/A	N/A
Z15L7WAL	24 x 15 x 71.9-72.4	125	144.90	19.25	\$1408	\$1449	N/A	N/A
Z12L7WAL	24 x 12 x 71.9-72.4	100	130.20	16	\$1313	\$1349	N/A	N/A
Z24M7WAL	20 x 24 x 71.9-72.4	125	171.15	25.25	\$1611	\$1664	N/A	N/A
Z21M7WAL	20 x 21 x 71.9-72.4	125	154.35	21.25	\$1544	\$1595	N/A	N/A
Z18M7WAL	20 x 18 x 71.9-72.4	125	139.65	19.25	\$1428	\$1473	N/A	N/A
Z16M7WAL	20 x 16 x 71.9-72.4	125	131.25	17.50	\$1362	\$1407	N/A	N/A
Z15M7WAL	20 x 15 x 71.9-72.4	125	126	16.25	\$1293	\$1331	N/A	N/A
Z12M7WAL	20 x 12 x 71.9-72.4	100	113.40	13.25	\$1214	\$1246	N/A	N/A

Laminate doors are standard. Full length hanging rod included. **Includes one 3-position fixed/height adjustable shelf** above hanging rod. Standard with lock.



Wardrobe Cabinet - RIGHT

Z24L7WAR	24 x 24 x 71.9-72.4	125	191.10	29.75	\$1742	\$1803	N/A	N/A
Z21L7WAR	24 x 21 x 71.9-72.4	125	178.50	26	\$1680	\$1741	N/A	N/A
Z18L7WAR	24 x 18 x 71.9-72.4	125	158.55	22.75	\$1543	\$1594	N/A	N/A
Z16L7WAR	24 x 16 x 71.9-72.4	125	149.10	20.75	\$1481	\$1530	N/A	N/A
Z15L7WAR	24 x 15 x 71.9-72.4	125	144.90	19.25	\$1408	\$1449	N/A	N/A
Z12L7WAR	24 x 12 x 71.9-72.4	100	130.20	16	\$1313	\$1349	N/A	N/A
Z24M7WAR	20 x 24 x 71.9-72.4	125	171.15	25.25	\$1611	\$1664	N/A	N/A
Z21M7WAR	20 x 21 x 71.9-72.4	125	154.35	21.25	\$1544	\$1595	N/A	N/A
Z18M7WAR	20 x 18 x 71.9-72.4	125	139.65	19.25	\$1428	\$1473	N/A	N/A
Z16M7WAR	20 x 16 x 71.9-72.4	125	131.25	17.50	\$1362	\$1407	N/A	N/A
Z15M7WAR	20 x 15 x 71.9-72.4	125	126	16.25	\$1293	\$1331	N/A	N/A
Z12M7WAR	20 x 12 x 71.9-72.4	100	113.40	13.25	\$1214	\$1246	N/A	N/A

Laminate doors are standard. Full length hanging rod included. **Includes one 3-position fixed/height adjustable shelf** above hanging rod. Standard with lock.

Required Specifications

Primary surface type + finish
Top thickness/edge detail
Base finish
Lock finish

Door/drawer front finish
Handles*

Optional Specifications

Key #
Collator*
Box drawer* - no upcharge (30" - 36" wide models only)

WARDROBE CABINETS - 72"/72.5" HIGH



Wardrobe Cabinet/Shelving Combo with Doors - LEFT

MODEL#	DIMENSIONS D x W x H	FREIGHT CLASS	WT/LBS.	CUBIC FT.	1" TOP	1.5" TOP	GLAZE ADD	HP ADD
Z36L7DIL	24 x 36 x 71.9-72.4	125	300.30	43.25	\$2710	\$2796	\$1694	N/A
Z30L7DIL	24 x 30 x 71.9-72.4	125	262.50	36.25	\$2368	\$2442	\$1466	N/A
Z24L7DIL	24 x 24 x 71.9-72.4	125	232.05	29.75	\$2154	\$2215	\$1320	N/A
Z21L7DIL	24 x 21 x 71.9-72.4	125	200.55	26	\$2091	\$2151	\$1308	N/A
Z36M7DIL	20 x 36 x 71.9-72.4	125	276.15	36.75	\$2544	\$2618	\$1694	N/A
Z30M7DIL	20 x 30 x 71.9-72.4	125	241.50	30.50	\$2208	\$2272	\$1466	N/A
Z24M7DIL	20 x 24 x 71.9-72.4	100	214.20	25.25	\$2025	\$2076	\$1320	N/A
Z21M7DIL	20 x 21 x 71.9-72.4	100	196.35	21.25	\$1944	\$1995	\$1308	N/A

Laminate doors are standard. Storage compartment on **left includes four 3-position fixed/height adjustable shelves**. Wardrobe compartment on **right** includes hanging rod and one adjustable shelf above rod. Storage and wardrobe compartments lock independently. Each door lock keyed alike.



Wardrobe Cabinet/Shelving Combo with Doors - RIGHT

Z36L7DIR	24 x 36 x 71.9-72.4	125	300.30	43.25	\$2710	\$2796	\$1694	N/A
Z30L7DIR	24 x 30 x 71.9-72.4	125	262.50	36.25	\$2368	\$2442	\$1466	N/A
Z24L7DIR	24 x 24 x 71.9-72.4	125	232.05	29.75	\$2154	\$2215	\$1320	N/A
Z21L7DIR	24 x 21 x 71.9-72.4	125	200.55	26	\$2091	\$2151	\$1308	N/A
Z36M7DIR	20 x 36 x 71.9-72.4	125	276.15	36.75	\$2544	\$2618	\$1694	N/A
Z30M7DIR	20 x 30 x 71.9-72.4	125	241.50	30.50	\$2208	\$2272	\$1466	N/A
Z24M7DIR	20 x 24 x 71.9-72.4	100	214.20	25.25	\$2025	\$2076	\$1320	N/A
Z21M7DIR	20 x 21 x 71.9-72.4	100	196.35	21.25	\$1944	\$1995	\$1308	N/A

Laminate doors are standard. Storage compartment on **right includes four 3-position fixed/height adjustable shelves**. Wardrobe compartment on **left** includes hanging rod and one adjustable shelf above rod. Storage and wardrobe compartments lock independently. Each door lock keyed alike.

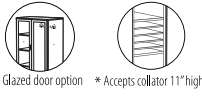

Wardrobe Cabinet/Open Shelving Combo - LEFT*

Z36L7DINL	24 x 36 x 71.9-72.4	125	277.47	43.25	\$2445	\$2531	\$845	N/A
Z30L7DINL	24 x 30 x 71.9-72.4	125	244.53	36.25	\$2152	\$2226	\$731	N/A
Z24L7DINL	24 x 24 x 71.9-72.4	125	217.88	29.75	\$1960	\$2021	\$658	N/A
Z21L7DINL	24 x 21 x 71.9-72.4	125	189.33	26	\$1893	\$1954	\$651	N/A
Z36M7DINL	20 x 36 x 71.9-72.4	125	254.41	36.75	\$2279	\$2353	\$845	N/A
Z30M7DINL	20 x 30 x 71.9-72.4	125	222.86	30.50	\$1990	\$2054	\$731	N/A
Z24M7DINL	20 x 24 x 71.9-72.4	100	202.22	25.25	\$1828	\$1879	\$658	N/A
Z21M7DINL	20 x 21 x 71.9-72.4	100	183.93	21.25	\$1748	\$1799	\$651	N/A

Laminate door is standard on wardrobe section. Storage compartment on **left includes four 3-position fixed/height adjustable shelves**. Wardrobe compartment on **right** includes hanging rod and one adjustable shelf above rod. Single lock secures wardrobe compartment.

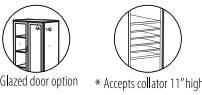

Wardrobe Cabinet/Open Shelving Combo - RIGHT*

Z36L7DINR	24 x 36 x 71.9-72.4	125	277.47	43.25	\$2445	\$2531	\$845	N/A
Z30L7DINR	24 x 30 x 71.9-72.4	125	244.53	36.25	\$2152	\$2226	\$731	N/A
Z24L7DINR	24 x 24 x 71.9-72.4	125	217.88	29.75	\$1960	\$2021	\$658	N/A
Z21L7DINR	24 x 21 x 71.9-72.4	125	189.33	26	\$1893	\$1954	\$651	N/A
Z36M7DINR	20 x 36 x 71.9-72.4	125	254.41	36.75	\$2279	\$2353	\$845	N/A
Z30M7DINR	20 x 30 x 71.9-72.4	125	222.86	30.50	\$1990	\$2054	\$731	N/A
Z24M7DINR	20 x 24 x 71.9-72.4	100	202.22	25.25	\$1828	\$1879	\$658	N/A
Z21M7DINR	20 x 21 x 71.9-72.4	100	183.93	21.25	\$1748	\$1799	\$651	N/A

Laminate door is standard on wardrobe section. Storage compartment on **right includes four 3-position fixed/height adjustable shelves**. Wardrobe compartment on **left** includes hanging rod and one adjustable shelf above rod. Single lock secures wardrobe compartment.

Required Specifications

Primary surface type + finish
Top thickness/edge detail
Base finish
Lock finish

Door/drawer front finish (unless glazed door specified, then drawer front only)
Handles

Optional Specifications

Key #
Glazed doors
Collator*

PERSONAL TOWERS - 72"/72.5" HIGH



Glazed door option

Personal Tower with Doors - LEFT

MODEL#	DIMENSIONS D x W x H	FREIGHT CLASS	WT/LBS.	CUBIC FT.	1" TOP	1.5" TOP	GLAZE ADD	HP ADD
Z36L7EL	24 x 36 x 71.9-72.4	125	324.45	43.25	\$2970	\$3055	\$1502	N/A
Z30L7EL	24 x 30 x 71.9-72.4	125	289.80	36.25	\$2724	\$2798	\$1379	N/A
Z24L7EL	24 x 24 x 71.9-72.4	100	260.76	29.75	\$2595	\$2657	\$1220	N/A
Z36M7EL	20 x 36 x 71.9-72.4	125	288.75	36.75	\$2777	\$2852	\$1502	N/A
Z30M7EL	20 x 30 x 71.9-72.4	100	259.35	30.50	\$2547	\$2611	\$1379	N/A
Z24M7EL	20 x 24 x 71.9-72.4	100	231.65	25.25	\$2424	\$2475	\$1220	N/A

Two file drawers on bottom. Laminate doors are standard. Storage compartment on **left includes two 3-position fixed/height adjustable shelves**. Wardrobe compartment on **right** includes hanging rod and one adjustable shelf above rod. Two upper locks, one per each hinged door, and one lower lock secures drawers, all keyed alike.



Glazed door option

Personal Tower with Doors - RIGHT

Z36L7ER	24 x 36 x 71.9-72.4	125	324.45	43.25	\$2970	\$3055	\$1502	N/A
Z30L7ER	24 x 30 x 71.9-72.4	125	289.80	36.25	\$2724	\$2798	\$1379	N/A
Z24L7ER	24 x 24 x 71.9-72.4	100	260.76	29.75	\$2595	\$2657	\$1220	N/A
Z36M7ER	20 x 36 x 71.9-72.4	125	288.75	36.75	\$2777	\$2852	\$1502	N/A
Z30M7ER	20 x 30 x 71.9-72.4	100	259.35	30.50	\$2547	\$2611	\$1379	N/A
Z24M7ER	20 x 24 x 71.9-72.4	100	231.65	25.25	\$2424	\$2475	\$1220	N/A

Two file drawers on bottom. Laminate doors are standard. Storage compartment on **right includes two 3-position fixed/height adjustable shelves**. Wardrobe compartment on **left** includes hanging rod and one adjustable shelf above rod. Two upper locks, one per each hinged door, and one lower lock secures drawers, all keyed alike.



Glazed door option * Accepts collator 11" high

Personal Tower with Doors* and cavity - LEFT

Z36L7ECL	24 x 36 x 71.9-72.4	125	320.24	43.25	\$2951	\$3037	\$1368	N/A
Z30L7ECL	24 x 30 x 71.9-72.4	125	287.34	36.25	\$2707	\$2781	\$1242	N/A
Z24L7ECL	24 x 24 x 71.9-72.4	100	257.23	29.75	\$2567	\$2628	\$1083	N/A
Z36M7ECL	20 x 36 x 71.9-72.4	125	285.63	36.75	\$2732	\$2806	\$1368	N/A
Z30M7ECL	20 x 30 x 71.9-72.4	100	256.22	30.50	\$2504	\$2566	\$1242	N/A
Z24M7ECL	20 x 24 x 71.9-72.4	100	228.11	25.25	\$2379	\$2430	\$1083	N/A

Two file drawers on bottom. Laminate doors are standard. Storage compartment on **left includes one 3-position fixed/height adjustable shelf**. Wardrobe compartment on **right** includes hanging rod and one adjustable shelf above rod. Two upper locks, one per each hinged door, and one lower lock secures drawers, all keyed alike.



Glazed door option * Accepts collator 11" high

Personal Tower with Doors* and cavity - RIGHT

Z36L7ECR	24 x 36 x 71.9-72.4	125	320.24	43.25	\$2951	\$3037	\$1368	N/A
Z30L7ECR	24 x 30 x 71.9-72.4	125	287.34	36.25	\$2707	\$2781	\$1242	N/A
Z24L7ECR	24 x 24 x 71.9-72.4	100	257.23	29.75	\$2567	\$2628	\$1083	N/A
Z36M7ECR	20 x 36 x 71.9-72.4	125	285.63	36.75	\$2732	\$2806	\$1368	N/A
Z30M7ECR	20 x 30 x 71.9-72.4	100	256.22	30.50	\$2504	\$2566	\$1242	N/A
Z24M7ECR	20 x 24 x 71.9-72.4	100	228.11	25.25	\$2379	\$2430	\$1083	N/A

Two file drawers on bottom. Laminate doors are standard. Storage compartment on **left includes one 3-position fixed/height adjustable shelf**. Wardrobe compartment on **right** includes hanging rod and one adjustable shelf above rod. Two upper locks, one per each hinged door, and one lower lock secures drawers, all keyed alike.



Glazed door option * Accepts collator 11" high

Personal Tower with Open Shelves - LEFT*

Z36L7ENL	24 x 36 x 71.9-72.4	125	309.60	43.25	\$2801	\$2887	\$851	N/A
Z30L7ENL	24 x 30 x 71.9-72.4	125	278.48	36.25	\$2562	\$2636	\$726	N/A
Z24L7ENL	24 x 24 x 71.9-72.4	100	247.90	29.75	\$2435	\$2496	\$568	N/A
Z36M7ENL	20 x 36 x 71.9-72.4	125	274.99	36.75	\$2598	\$2672	\$851	N/A
Z30M7ENL	20 x 30 x 71.9-72.4	100	247.36	30.50	\$2371	\$2435	\$726	N/A
Z24M7ENL	20 x 24 x 71.9-72.4	100	218.79	25.25	\$2263	\$2316	\$568	N/A

Two file drawers on bottom. Laminate door is standard on wardrobe section. Storage compartment on **left includes two 3-position fixed/height adjustable shelves**. Wardrobe compartment on **right** includes hanging rod and one adjustable shelf above rod. Single lock secures wardrobe compartment. Lower lock secures all drawers.

Required Specifications

Primary surface type + finish
Top thickness/edge detail
Base finish
Lock finish

Door/drawer front finish (unless glazed door specified, then drawer front only)
Handles

Optional Specifications

Key #
Glazed doors Collator*
Box drawer* - no upcharge (30" - 36" wide models only)

PERSONAL TOWERS - 72"/72.5" HIGH

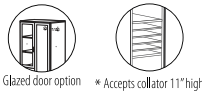

Personal Tower with Open Shelves - RIGHT*

MODEL#	DIMENSIONS D x W x H	FREIGHT CLASS	WT/LBS.	CUBIC FT.	1" TOP	1.5" TOP	GLAZE ADD	HP ADD
Z36L7ENR	24 x 36 x 71.9-72.4	125	309.60	43.25	\$2801	\$2887	\$851	N/A
Z30L7ENR	24 x 30 x 71.9-72.4	125	278.48	36.25	\$2562	\$2636	\$726	N/A
Z24L7ENR	24 x 24 x 71.9-72.4	100	247.90	29.75	\$2435	\$2496	\$568	N/A
Z36M7ENR	20 x 36 x 71.9-72.4	125	274.99	36.75	\$2598	\$2672	\$851	N/A
Z30M7ENR	20 x 30 x 71.9-72.4	100	247.36	30.50	\$2371	\$2435	\$726	N/A
Z24M7ENR	20 x 24 x 71.9-72.4	100	218.79	25.25	\$2263	\$2316	\$568	N/A

Two file drawers on bottom. Laminate door is standard on wardrobe section. Storage compartment on **right** includes **two 3-position fixed/height adjustable shelves**. Wardrobe compartment on **left** includes hanging rod and one adjustable shelf above rod. Single lock secures wardrobe compartment. Lower lock secures all drawers.



Personal Tower with Doors - LEFT

Z36L7BFL	24 x 36 x 71.9-72.4	125	326.55	43.25	\$3119	\$3204	\$1502	N/A
Z30L7BFL	24 x 30 x 71.9-72.4	100	292.95	36.25	\$2880	\$2954	\$1379	N/A
Z24L7BFL	24 x 24 x 71.9-72.4	100	262.10	29.75	\$2710	\$2771	\$1220	N/A
Z36M7BFL	20 x 36 x 71.9-72.4	125	291.90	36.75	\$2924	\$2998	\$1502	N/A
Z30M7BFL	20 x 30 x 71.9-72.4	100	262.50	30.50	\$2729	\$2791	\$1299	N/A
Z24M7BFL	20 x 24 x 71.9-72.4	100	232.98	25.25	\$2538	\$2589	\$1220	N/A

Two box and one file drawer on bottom. Laminate doors are standard. Storage compartment on **left** includes **two 3-position fixed/height adjustable shelves**. Wardrobe compartment on **right** includes hanging rod and one adjustable shelf above rod. Two upper locks, one per each hinged door, and one lower lock secures drawers, all keyed alike.



Personal Tower with Doors - RIGHT

Z36L7BFR	24 x 36 x 71.9-72.4	125	326.55	43.25	\$3119	\$3204	\$1502	N/A
Z30L7BFR	24 x 30 x 71.9-72.4	100	292.95	36.25	\$2880	\$2954	\$1379	N/A
Z24L7BFR	24 x 24 x 71.9-72.4	100	262.10	29.75	\$2710	\$2771	\$1220	N/A
Z36M7BFR	20 x 36 x 71.9-72.4	125	291.90	36.75	\$2924	\$2998	\$1502	N/A
Z30M7BFR	20 x 30 x 71.9-72.4	100	262.50	30.50	\$2729	\$2791	\$1299	N/A
Z24M7BFR	20 x 24 x 71.9-72.4	100	232.98	25.25	\$2538	\$2589	\$1220	N/A

Two box and one file drawer on bottom. Laminate doors are standard. Storage compartment on **right** includes **two 3-position fixed/height adjustable shelves**. Wardrobe compartment on **left** includes hanging rod and one adjustable shelf above rod. Two upper locks, one per each hinged door, and one lower lock secures drawers, all keyed alike.

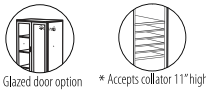

Personal Tower with Doors and Cavity - LEFT*

Z36L7BFCL	24 x 36 x 71.9-72.4	125	317.68	43.25	\$3084	\$3135	\$1368	N/A
Z30L7BFCL	24 x 30 x 71.9-72.4	125	287	36.25	\$2849	\$2890	\$1242	N/A
Z24L7BFCL	24 x 24 x 71.9-72.4	100	258.59	29.75	\$2666	\$2727	\$1083	N/A
Z36M7BFCL	20 x 36 x 71.9-72.4	125	288.78	36.75	\$2871	\$2945	\$1368	N/A
Z30M7BFCL	20 x 30 x 71.9-72.4	100	259.37	30.50	\$2673	\$2737	\$1242	N/A
Z24M7BFCL	20 x 24 x 71.9-72.4	100	229.45	25.25	\$2492	\$2543	\$1083	N/A

Two box and one file drawer on bottom. Laminate doors are standard. Storage compartment on **left** includes **one 3-position fixed/height adjustable shelves**. Wardrobe compartment on **right** includes hanging rod and one adjustable shelf above rod. Two upper locks, one per each hinged door, and one lower lock secures drawers, all keyed alike.

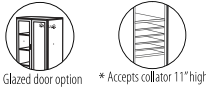

Personal Tower with Doors and Cavity - RIGHT*

Z36L7BFCD	24 x 36 x 71.9-72.4	125	317.68	43.25	\$3084	\$3135	\$1368	N/A
Z30L7BFCD	24 x 30 x 71.9-72.4	125	287	36.25	\$2849	\$2890	\$1242	N/A
Z24L7BFCD	24 x 24 x 71.9-72.4	100	258.59	29.75	\$2666	\$2727	\$1083	N/A
Z36M7BFCD	20 x 36 x 71.9-72.4	125	288.78	36.75	\$2871	\$2945	\$1368	N/A
Z30M7BFCD	20 x 30 x 71.9-72.4	100	259.37	30.50	\$2673	\$2737	\$1242	N/A
Z24M7BFCD	20 x 24 x 71.9-72.4	100	229.45	25.25	\$2492	\$2543	\$1083	N/A

Two box and one file drawer on bottom. Laminate doors are standard. Storage compartment on **left** includes **one 3-position fixed/height adjustable shelves**. Wardrobe compartment on **right** includes hanging rod and one adjustable shelf above rod. Two upper locks, one per each hinged door, and one lower lock secures drawers, all keyed alike.

Required Specifications

Primary surface type + finish
Top thickness/edge detail
Base finish
Lock finish

Door/drawer front finish (unless glazed door specified, then drawer front only)
Handles

Optional Specifications

Key #
Glazed doors
Box drawer* - no upcharge (30" - 36" wide models only)
Collator*

PERSONAL TOWERS - 72"/72.5" HIGH



Glazed door option * Accepts collator 11" high

Personal Tower w/Open Shelves - LEFT*

MODEL#	DIMENSIONS	FREIGHT CLASS	WT/LBS.	CUBIC FT.	1"TOP	1.5" TOP	GLAZE ADD	HP ADD	
D x W x H									
Z36L7BFNL	24 x 36 x 71.9-72.4	125	309	43.25	\$2942	\$3000	\$851	N/A	
Z30L7BFNL	24 x 30 x 71.9-72.4	125	277	36.25	\$2700	\$2745	\$726	N/A	
Z24L7BFNL	24 x 24 x 71.9-72.4	100	249.24	29.75	\$2487	\$2548	\$568	N/A	
Z36M7BFNL	20 x 36 x 71.9-72.4	125	274	36.75	\$2719	\$2794	\$851	N/A	
Z30M7BFNL	20 x 30 x 71.9-72.4	100	246	30.50	\$2520	\$2584	\$726	N/A	
Z24M7BFNL	20 x 24 x 71.9-72.4	100	220.12	25.25	\$2315	\$2366	\$568	N/A	

Two box and one file drawer on bottom. Laminate doors are standard. Storage compartment on **left** includes **two 3-position fixed/height adjustable shelves**. Wardrobe compartment on **right** includes hanging rod and **one adjustable shelf** above rod. Upper lock secures wardrobe compartment. Lower lock secures all drawers.



Glazed door option * Accepts collator 11" high

Personal Tower w/Open Shelves - RIGHT*

Z36L7BFNR	24 x 36 x 71.9-72.4	125	309	43.25	\$2942	\$3000	\$851	N/A
Z30L7BFNR	24 x 30 x 71.9-72.4	125	277	36.25	\$2700	\$2745	\$726	N/A
Z24L7BFNR	24 x 24 x 71.9-72.4	100	249.24	29.75	\$2487	\$2548	\$568	N/A
Z36M7BFNR	20 x 36 x 71.9-72.4	125	274	36.75	\$2719	\$2794	\$851	N/A
Z30M7BFNR	20 x 30 x 71.9-72.4	100	246	30.50	\$2520	\$2584	\$726	N/A
Z24M7BFNR	20 x 24 x 71.9-72.4	100	220.12	25.25	\$2315	\$2366	\$568	N/A

Two box and one file drawer on bottom. Laminate doors are standard. Storage compartment on **right** includes **two 3-position fixed/height adjustable shelves**. Wardrobe compartment on **left** includes hanging rod and **one adjustable shelf** above rod. Upper lock secures wardrobe compartment. Lower lock secures all drawers.

STORAGE MODULES - 84.5"/85" HIGH



Glazed door option

Storage Cabinet with Doors

MODEL#	DIMENSIONS	FREIGHT CLASS	WT/LBS.	CUBIC FT.	1"TOP	1.5" TOP	GLAZE ADD	HP ADD
Z36L8SH	24 x 36 x 84.4-84.9	125	332.85	50	\$2893	\$2979	\$2060	N/A
Z30L8SH	24 x 30 x 84.4-84.9	125	290.85	42	\$2566	\$2640	\$1763	N/A
Z36M8SH	20 x 36 x 84.4-84.9	125	299.25	42.25	\$2667	\$2741	\$2060	N/A
Z30M8SH	20 x 30 x 84.4-84.9	125	259.35	35.50	\$2385	\$2449	\$1763	N/A
Z36S8SH	16 x 36 x 84.4-84.9	125	259.35	34	\$2403	\$2475	\$2060	N/A
Z30S8SH	16 x 30 x 84.4-84.9	125	224.70	29	\$2142	\$2193	\$1763	N/A

Laminate doors are standard. **Includes five 3-position fixed/height adjustable shelves**. Standard with lock.



Glazed door option

Storage Cabinet with Door - LEFT

Z21L8SHL	24 x 21 x 84.4-84.9	125	226.80	30.25	\$2093	\$2154	\$1150	N/A
Z18L8SHL	24 x 18 x 84.4-84.9	125	205.80	26.25	\$1969	\$2020	\$1027	N/A
Z16L8SHL	24 x 16 x 84.4-84.9	125	186.90	24	\$1847	\$1896	\$1020	N/A
Z15L8SHL	24 x 15 x 84.4-84.9	100	181.65	22.50	\$1823	\$1864	\$877	N/A
Z12L8SHL	24 x 12 x 84.4-84.9	100	163.80	18.50	\$1697	\$1733	\$784	N/A
Z21M8SHL	20 x 21 x 84.4-84.9	125	201.60	25.50	\$1890	\$1939	\$1150	N/A
Z18M8SHL	20 x 18 x 84.4-84.9	100	180.60	22.25	\$1811	\$1856	\$1027	N/A
Z16M8SHL	20 x 16 x 84.4-84.9	100	169.05	20.25	\$1697	\$1742	\$1020	N/A
Z15M8SHL	20 x 15 x 84.4-84.9	100	162.75	19	\$1627	\$1663	\$877	N/A
Z12M8SHL	20 x 12 x 84.4-84.9	100	144.90	15.75	\$1507	\$1539	\$784	N/A
Z21S8SHL	16 x 21 x 84.4-84.9	100	172.20	21	\$1728	\$1768	\$1150	N/A
Z18S8SHL	16 x 18 x 84.4-84.9	100	154.35	18	\$1617	\$1658	\$1027	N/A
Z16S8SHL	16 x 16 x 84.4-84.9	100	142.80	16.50	\$1516	\$1557	\$1020	N/A
Z15S8SHL	16 x 15 x 84.4-84.9	100	137.55	15.50	\$1446	\$1481	\$877	N/A
Z12S8SHL	16 x 12 x 84.4-84.9	100	120.75	13	\$1334	\$1365	\$784	N/A

Laminate doors are standard. **Includes five 3-position fixed/height adjustable shelves**. Standard with lock.

Required Specifications

Primary surface type + finish
Top thickness/edge detail
Base finish
Lock finish

Door/drawer front finish (unless glazed door specified, then drawer front only)
Handles

Optional Specifications

Key #
Glazed doors
Collator*

STORAGE MODULES - 84.5"/85" HIGH

MODEL#	DIMENSIONS	FREIGHT CLASS	WT./LBS.	CUBIC FT.	1" TOP	1.5" TOP	GLAZE ADD	HP ADD
D x W x H								
Z21L8SHR	24 x 21 x 84.4-84.9	125	226.80	30.25	\$2093	\$2154	\$1150	N/A
Z18L8SHR	24 x 18 x 84.4-84.9	125	205.80	26.25	\$1969	\$2020	\$1027	N/A
Z16L8SHR	24 x 16 x 84.4-84.9	125	186.90	24	\$1847	\$1896	\$1020	N/A
Z15L8SHR	24 x 15 x 84.4-84.9	100	181.65	22.50	\$1823	\$1864	\$877	N/A
Z12L8SHR	24 x 12 x 84.4-84.9	100	163.80	18.50	\$1697	\$1733	\$784	N/A
Z21M8SHR	20 x 21 x 84.4-84.9	125	201.60	25.50	\$1890	\$1939	\$1150	N/A
Z18M8SHR	20 x 18 x 84.4-84.9	100	180.60	22.25	\$1811	\$1856	\$1027	N/A
Z16M8SHR	20 x 16 x 84.4-84.9	100	169.05	20.25	\$1697	\$1742	\$1020	N/A
Z15M8SHR	20 x 15 x 84.4-84.9	100	162.75	19	\$1627	\$1663	\$877	N/A
Z12M8SHR	20 x 12 x 84.4-84.9	100	144.90	15.75	\$1507	\$1539	\$784	N/A
Z21S8SHR	16 x 21 x 84.4-84.9	100	172.20	21	\$1728	\$1768	\$1150	N/A
Z18S8SHR	16 x 18 x 84.4-84.9	100	154.35	18	\$1617	\$1658	\$1027	N/A
Z16S8SHR	16 x 16 x 84.4-84.9	100	142.80	16.50	\$1516	\$1557	\$1020	N/A
Z15S8SHR	16 x 15 x 84.4-84.9	100	137.55	15.50	\$1446	\$1481	\$877	N/A
Z12S8SHR	16 x 12 x 84.4-84.9	100	120.75	13	\$1334	\$1365	\$784	N/A



Glazed door option

Storage Cabinet with Door - RIGHT

Laminate doors are standard. **Includes five 3-position fixed/height adjustable shelves.** Standard with lock.

Z36L8SHN	24 x 36 x 84.4-84.9	150	281.34	50	\$2249	\$2334	N/A	N/A
Z30L8SHN	24 x 30 x 84.4-84.9	150	247.23	42	\$2003	\$2077	N/A	N/A
Z21L8SHN	24 x 21 x 84.4-84.9	125	227.72	30.25	\$1732	\$1792	N/A	N/A
Z18L8SHN	24 x 18 x 84.4-84.9	125	206.74	26.25	\$1642	\$1693	N/A	N/A
Z16L8SHN	24 x 16 x 84.4-84.9	125	189.25	24	\$1523	\$1574	N/A	N/A
Z15L8SHN	24 x 15 x 84.4-84.9	100	182.61	22.50	\$1499	\$1540	N/A	N/A
Z12L8SHN	24 x 12 x 84.4-84.9	100	164.78	18.50	\$1438	\$1476	N/A	N/A
Z36M8SHN	20 x 36 x 84.4-84.9	150	245.68	42.25	\$2022	\$2096	N/A	N/A
Z30M8SHN	20 x 30 x 84.4-84.9	125	215.06	35.50	\$1823	\$1887	N/A	N/A
Z21M8SHN	20 x 21 x 84.4-84.9	125	170.18	25.50	\$1531	\$1582	N/A	N/A
Z18M8SHN	20 x 18 x 84.4-84.9	125	154.86	22.25	\$1481	\$1527	N/A	N/A
Z16M8SHN	20 x 16 x 84.4-84.9	125	145.71	20.25	\$1375	\$1420	N/A	N/A
Z15M8SHN	20 x 15 x 84.4-84.9	125	140.60	19	\$1339	\$1375	N/A	N/A
Z12M8SHN	20 x 12 x 84.4-84.9	100	126.34	15.75	\$1248	\$1280	N/A	N/A
Z36S8SHN	16 x 36 x 84.4-84.9	125	206.87	34	\$1759	\$1831	N/A	N/A
Z30S8SHN	16 x 30 x 84.4-84.9	125	180.79	29	\$1580	\$1629	N/A	N/A
Z21S8SHN	16 x 21 x 84.4-84.9	125	141.67	21	\$1369	\$1409	N/A	N/A
Z18S8SHN	16 x 18 x 84.4-84.9	125	127.58	18	\$1227	\$1268	N/A	N/A
Z16S8SHN	16 x 16 x 84.4-84.9	125	119.59	16.50	\$1191	\$1232	N/A	N/A
Z15S8SHN	16 x 15 x 84.4-84.9	125	115.59	15.50	\$1159	\$1194	N/A	N/A
Z12S8SHN	16 x 12 x 84.4-84.9	125	102.56	13	\$1073	\$1105	N/A	N/A



* Accepts collator 11" high

30", 36" wide

Five adjustable shelves.



12-16" wide

18-21"

Open Storage Cabinet**

Z36L8E	24 x 36 x 84.4-84.9	125	365.40	50	\$3588	\$3673	\$1537	N/A
Z30L8E	24 x 30 x 84.4-84.9	125	306.60	42	\$3268	\$3340	\$1327	N/A
Z36M8E	20 x 36 x 84.4-84.9	125	323.40	42.25	\$3373	\$3447	\$1537	N/A
Z30M8E	20 x 30 x 84.4-84.9	100	284.55	35.50	\$3106	\$3170	\$1327	N/A
Z36S8E	16 x 36 x 84.4-84.9	100	285	34	\$3080	\$3154	\$1537	N/A
Z30S8E	16 x 30 x 84.4-84.9	100	244.65	29	\$2784	\$2833	\$1327	N/A



Glazed door option

Two File Module with Doors*

Two lateral file drawers. Laminate doors are standard. **Includes three adjustable shelves.** Upper lock secures storage compartment. Lower lock secures two file drawers. For filing capabilities, see page 200.

- Lateral file drawer construction is for accommodating hanging files NOT for stacking materials on the drawer bottom.

Required Specifications

Primary surface type + finish
Top thickness/edge detail
Base finish
Lock finish

Door/drawer front finish* (unless glazed door specified, then drawer front only)
Handles*

Optional Specifications

Key #*
Glazed doors*
Collator**

STORAGE MODULES - 84.5"/85" HIGH



Glazed door option

Two File Module with Door - LEFT

MODEL#	DIMENSIONS	FREIGHT CLASS	WT/LBS.	CUBIC FT.	1" TOP	1.5" TOP	GLAZE ADD	HP ADD
D x W x H								
Z16L8EL	24 x 16 x 84.4-84.9	100	205.80	24	\$2137	\$2188	\$759	N/A
Z15L8EL	24 x 15 x 84.4-84.9	100	192.15	22.50	\$2077	\$2118	\$661	N/A
Z16M8EL	20 x 16 x 84.4-84.9	100	185.85	20.25	\$2003	\$2048	\$759	N/A
Z15M8EL	20 x 15 x 84.4-84.9	100	179.55	19	\$1925	\$1963	\$661	N/A
Z16S8EL	16 x 16 x 84.4-84.9	100	156.45	16.50	\$1820	\$1861	\$759	N/A
Z15S8EL	16 x 15 x 84.4-84.9	100	149.10	15.50	\$1761	\$1796	\$661	N/A

Two file drawers on bottom. Laminate door is standard. **Includes three 3-position fixed/height adjustable shelves.** Upper lock secures storage compartment. Lower lock secures two file drawers.



Glazed door option

Two File Module with Door - RIGHT

Z16L8ER	24 x 16 x 84.4-84.9	100	205.80	24	\$2137	\$2188	\$759	N/A
Z15L8ER	24 x 15 x 84.4-84.9	100	192.15	22.50	\$2077	\$2118	\$661	N/A
Z16M8ER	20 x 16 x 84.4-84.9	100	185.85	20.25	\$2003	\$2048	\$759	N/A
Z15M8ER	20 x 15 x 84.4-84.9	100	179.55	19	\$1925	\$1963	\$661	N/A
Z16S8ER	16 x 16 x 84.4-84.9	100	156.45	16.50	\$1820	\$1861	\$759	N/A
Z15S8ER	16 x 15 x 84.4-84.9	100	149.10	15.50	\$1761	\$1796	\$661	N/A

Two file drawers on bottom. Laminate door is standard. **Includes three 3-position fixed/height adjustable shelves.** Upper lock secures storage compartment. Lower lock secures two file drawers.



30", 36" wide



15", 16" wide



* Accepts collator 11" high

Two File Module with Open Shelves*

Z36L8EN	24 x 36 x 84.4-84.9	125	329.85	50	\$3076	\$3161	N/A	N/A
Z30L8EN	24 x 30 x 84.4-84.9	125	276.28	42	\$2816	\$2890	N/A	N/A
Z16L8EN	24 x 16 x 84.4-84.9	125	191.52	24	\$1877	\$1928	N/A	N/A
Z15L8EN	24 x 15 x 84.4-84.9	125	177.51	22.50	\$1849	\$1890	N/A	N/A
Z36M8EN	20 x 36 x 84.4-84.9	125	285.79	42.25	\$2860	\$2934	N/A	N/A
Z30M8EN	20 x 30 x 84.4-84.9	125	253.56	35.50	\$2660	\$2724	N/A	N/A
Z16M8EN	20 x 16 x 84.4-84.9	100	169.60	20.25	\$1743	\$1788	N/A	N/A
Z15M8EN	20 x 15 x 84.4-84.9	100	164.05	19	\$1696	\$1734	N/A	N/A
Z36S8EN	16 x 36 x 84.4-84.9	125	247	34	\$2378	\$2450	N/A	N/A
Z30S8EN	16 x 30 x 84.4-84.9	125	213	29	\$2145	\$2194	N/A	N/A
Z16S8EN	16 x 16 x 84.4-84.9	100	139.28	16.50	\$1561	\$1602	N/A	N/A
Z15S8EN	16 x 15 x 84.4-84.9	100	133.79	15.50	\$1531	\$1566	N/A	N/A

Four open shelves and two file drawers on bottom. **Includes two 3-position fixed/height adjustable shelves.** Lock secures all drawers. For filing capabilities, see page 200.

- Lateral file drawer construction is for accommodating hanging files NOT for stacking materials on the drawer bottom.

Required Specifications

Primary surface type + finish
Top thickness/edge detail
Base finish
Lock finish

Door/drawer front finish (unless glazed door specified, then drawer front only)
Handles

Optional Specifications

Glazed doors
Collator*
Key #

WARDROBE CABINETS - 84.5"/85" HIGH



Wardrobe Cabinet

MODEL#	DIMENSIONS D x W x H	FREIGHT CLASS	WT./LBS.	CUBIC FT.	1" TOP	1.5" TOP	GLAZE ADD	HP ADD
Z36L8WA	24 x 36 x 84.4-84.9	150	290.85	50	\$2683	\$2768	N/A	N/A
Z30L8WA	24 x 30 x 84.4-84.9	125	256.20	42	\$2410	\$2484	N/A	N/A
Z36M8WA	20 x 36 x 84.4-84.9	125	264.60	42.25	\$2508	\$2582	N/A	N/A
Z30M8WA	20 x 30 x 84.4-84.9	125	231	35.50	\$2266	\$2330	N/A	N/A

Laminate doors are standard. Full length hanging rod included. **One adjustable shelf** above hanging rod. Standard with lock.



Wardrobe Cabinet - LEFT

Z24L8WAL	24 x 24 x 84.4-84.9	125	220.50	34.25	\$2011	\$2072	N/A	N/A
Z21L8WAL	24 x 21 x 84.4-84.9	125	192.15	30.25	\$1938	\$1998	N/A	N/A
Z18L8WAL	24 x 18 x 84.4-84.9	125	184.80	26.25	\$1806	\$1857	N/A	N/A
Z16L8WAL	24 x 16 x 84.4-84.9	125	172.20	24	\$1723	\$1772	N/A	N/A
Z15L8WAL	24 x 15 x 84.4-84.9	125	161.70	22.50	\$1674	\$1715	N/A	N/A
Z12L8WAL	24 x 12 x 84.4-84.9	100	150.15	18.50	\$1538	\$1576	N/A	N/A
Z24M8WAL	20 x 24 x 84.4-84.9	125	197.40	28.50	\$1874	\$1925	N/A	N/A
Z21M8WAL	20 x 21 x 84.4-84.9	125	182.70	25.50	\$1805	\$1856	N/A	N/A
Z18M8WAL	20 x 18 x 84.4-84.9	125	164.85	22.25	\$1673	\$1718	N/A	N/A
Z16M8WAL	20 x 16 x 84.4-84.9	125	154.35	20.25	\$1594	\$1639	N/A	N/A
Z15M8WAL	20 x 15 x 84.4-84.9	125	149.10	19	\$1530	\$1568	N/A	N/A
Z12M8WAL	20 x 12 x 84.4-84.9	100	133.35	15.75	\$1429	\$1461	N/A	N/A

Laminate doors are standard. Full length hanging rod included. **One adjustable shelf** above hanging rod. Standard with lock.



Wardrobe Cabinet - RIGHT

Z24L8WAR	24 x 24 x 84.4-84.9	125	220.50	34.25	\$2011	\$2072	N/A	N/A
Z21L8WAR	24 x 21 x 84.4-84.9	125	192.15	30.25	\$1938	\$1998	N/A	N/A
Z18L8WAR	24 x 18 x 84.4-84.9	125	184.80	26.25	\$1806	\$1857	N/A	N/A
Z16L8WAR	24 x 16 x 84.4-84.9	125	172.20	24	\$1723	\$1772	N/A	N/A
Z15L8WAR	24 x 15 x 84.4-84.9	125	161.70	22.50	\$1674	\$1715	N/A	N/A
Z12L8WAR	24 x 12 x 84.4-84.9	100	150.15	18.50	\$1538	\$1576	N/A	N/A
Z24M8WAR	20 x 24 x 84.4-84.9	125	197.40	28.50	\$1874	\$1925	N/A	N/A
Z21M8WAR	20 x 21 x 84.4-84.9	125	182.70	25.50	\$1805	\$1856	N/A	N/A
Z18M8WAR	20 x 18 x 84.4-84.9	125	164.85	22.25	\$1673	\$1718	N/A	N/A
Z16M8WAR	20 x 16 x 84.4-84.9	125	154.35	20.25	\$1594	\$1639	N/A	N/A
Z15M8WAR	20 x 15 x 84.4-84.9	125	149.10	19	\$1530	\$1568	N/A	N/A
Z12M8WAR	20 x 12 x 84.4-84.9	100	133.35	15.75	\$1429	\$1461	N/A	N/A

Laminate doors are standard. Full length hanging rod included. **One adjustable shelf** above hanging rod. Standard with lock.



Wardrobe Cabinet/Shelving Combo with Doors - LEFT*



Glazed door option

Z36L8DIL	24 x 36 x 84.4-84.9	125	339	50	\$3103	\$3188	\$2060	N/A
Z30L8DIL	24 x 30 x 84.4-84.9	125	301	42	\$2724	\$2798	\$1763	N/A
Z24L8DIL	24 x 24 x 84.4-84.9	125	269	34.25	\$2464	\$2525	\$1617	N/A
Z21L8DIL	24 x 21 x 84.4-84.9	100	252	30.25	\$2385	\$2421	\$1603	N/A
Z36M8DIL	20 x 36 x 84.4-84.9	125	306	42.25	\$2921	\$2995	\$2060	N/A
Z30M8DIL	20 x 30 x 84.4-84.9	125	266	35.50	\$2574	\$2638	\$1763	N/A
Z24M8DIL	20 x 24 x 84.4-84.9	100	233	28.50	\$2322	\$2375	\$1617	N/A
Z21M8DIL	20 x 21 x 84.4-84.9	100	215	25.50	\$2207	\$2269	\$1603	N/A

Laminate doors are standard. Storage compartment on **left includes five adjustable shelves**. Wardrobe compartment on **right** includes hanging rod and **one adjustable shelf** above rod. Two locks secure storage and wardrobe.



Wardrobe Cabinet/Shelving Combo with Doors - RIGHT*



Glazed door option

Z36L8DIR	24 x 36 x 84.4-84.9	125	339	50	\$3103	\$3188	\$2060	N/A
Z30L8DIR	24 x 30 x 84.4-84.9	125	301	42	\$2724	\$2798	\$1763	N/A
Z24L8DIR	24 x 24 x 84.4-84.9	125	269	34.25	\$2464	\$2525	\$1617	N/A
Z21L8DIR	24 x 21 x 84.4-84.9	100	252	30.25	\$2385	\$2421	\$1603	N/A
Z36M8DIR	20 x 36 x 84.4-84.9	125	306	42.25	\$2921	\$2995	\$2060	N/A
Z30M8DIR	20 x 30 x 84.4-84.9	125	266	35.50	\$2574	\$2638	\$1763	N/A
Z24M8DIR	20 x 24 x 84.4-84.9	100	233	28.50	\$2322	\$2375	\$1617	N/A
Z21M8DIR	20 x 21 x 84.4-84.9	100	215	25.50	\$2207	\$2269	\$1603	N/A

Laminate doors are standard. Storage compartment on **right includes five adjustable shelves**. Wardrobe compartment on **left** includes hanging rod and **one adjustable shelf** above rod. Two locks secure storage and wardrobe.

Required Specifications

Primary surface type + finish
Top thickness/edge detail
Base finish
Lock finish

Door front finish* (unless glazed door specified, then drawer front only)
Handles

Optional Specifications

Key #
Glazed doors*

WARDROBE CABINETS - 84.5"/85" HIGH

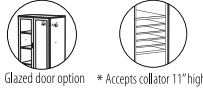

Glazed door option * Accepts collator 11" high

Wardrobe Cabinet/Open Shelving Combo - LEFT

MODEL#	DIMENSIONS	FREIGHT CLASS	WT./LBS.	CUBIC FT.	1" TOP	1.5" TOP	GLAZE ADD	HP ADD	
D x W x H									
Z36L8DINL	24 x 36 x 84.4-84.9	125	312	50	\$2778	\$2863	\$1027	N/A	
Z30L8DINL	24 x 30 x 84.4-84.9	125	278	42	\$2438	\$2512	\$877	N/A	
Z24L8DINL	24 x 24 x 84.4-84.9	125	245	34.25	\$2232	\$2293	\$784	N/A	
Z21L8DINL	24 x 21 x 84.4-84.9	125	236	30.25	\$2174	\$2201	\$779	N/A	
Z36M8DINL	20 x 36 x 84.4-84.9	125	275	42.25	\$2595	\$2669	\$1027	N/A	
Z30M8DINL	20 x 30 x 84.4-84.9	125	243	35.50	\$2293	\$2357	\$877	N/A	
Z24M8DINL	20 x 24 x 84.4-84.9	125	215	28.50	\$2090	\$2141	\$784	N/A	
Z21M8DINL	20 x 21 x 84.4-84.9	125	199	25.50	\$1997	\$2048	\$779	N/A	

Laminate door is standard on wardrobe section. Storage compartment on **left includes five adjustable shelves**. Wardrobe compartment on **right** includes hanging rod and **one adjustable shelf** above rod. Single lock secures wardrobe compartment.

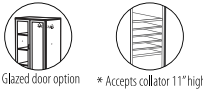

Glazed door option * Accepts collator 11" high

Wardrobe Cabinet/Open Shelving Combo - RIGHT

Z36L8DINR	24 x 36 x 84.4-84.9	125	312	50	\$2778	\$2863	\$1027	N/A
Z30L8DINR	24 x 30 x 84.4-84.9	125	278	42	\$2438	\$2512	\$877	N/A
Z24L8DINR	24 x 24 x 84.4-84.9	125	245	34.25	\$2232	\$2293	\$784	N/A
Z21L8DINR	24 x 21 x 84.4-84.9	125	236	30.25	\$2174	\$2201	\$779	N/A
Z36M8DINR	20 x 36 x 84.4-84.9	125	275	42.25	\$2595	\$2669	\$1027	N/A
Z30M8DINR	20 x 30 x 84.4-84.9	125	243	35.50	\$2293	\$2357	\$877	N/A
Z24M8DINR	20 x 24 x 84.4-84.9	125	215	28.50	\$2090	\$2141	\$784	N/A
Z21M8DINR	20 x 21 x 84.4-84.9	125	199	25.50	\$1997	\$2048	\$779	N/A

Laminate door is standard on wardrobe section. Storage compartment on **right includes five adjustable shelves**. Wardrobe compartment on **left** includes hanging rod and **one adjustable shelf** above rod. Single lock secures wardrobe compartment.

PERSONAL TOWERS - 84.5"/85" HIGH



Glazed door option

Personal Tower with Doors - LEFT

MODEL#	DIMENSIONS	FREIGHT CLASS	WT./LBS.	CUBIC FT.	1" TOP	1.5" TOP	GLAZE ADD	HP ADD
Z36L8EL	24 x 36 x 84.4-84.9	125	368.55	50	\$3315	\$3401	\$1785	N/A
Z30L8EL	24 x 30 x 84.4-84.9	125	334.95	42	\$3026	\$3100	\$1630	N/A
Z24L8EL	24 x 24 x 84.4-84.9	100	299.24	34.25	\$2925	\$2987	\$1406	N/A
Z36M8EL	20 x 36 x 84.4-84.9	125	332.85	42.25	\$3133	\$3207	\$1785	N/A
Z30M8EL	20 x 30 x 84.4-84.9	100	298.20	35.50	\$2889	\$2953	\$1630	N/A
Z24M8EL	20 x 24 x 84.4-84.9	100	266	29	\$2755	\$2806	\$1406	N/A

Two file drawers on bottom. Laminate doors are standard. Storage compartment on **left includes three adjustable shelves**. Wardrobe compartment on **right** includes hanging rod and **one adjustable shelf** above rod. Two upper locks secure storage and wardrobe compartments. Lower lock secures all drawers.



Glazed door option

Personal Tower with Doors - RIGHT

Z36L8ER	24 x 36 x 84.4-84.9	125	368.55	50	\$3315	\$3401	\$1785	N/A
Z30L8ER	24 x 30 x 84.4-84.9	125	334.95	42	\$3026	\$3100	\$1630	N/A
Z24L8ER	24 x 24 x 84.4-84.9	100	299.24	34.25	\$2925	\$2987	\$1406	N/A
Z36M8ER	20 x 36 x 84.4-84.9	125	332.85	42.25	\$3133	\$3207	\$1785	N/A
Z30M8ER	20 x 30 x 84.4-84.9	100	298.20	35.50	\$2889	\$2953	\$1630	N/A
Z24M8ER	20 x 24 x 84.4-84.9	100	266	29	\$2755	\$2806	\$1406	N/A

Two file drawers on bottom. Laminate doors are standard. Storage compartment on **right includes three adjustable shelves**. Wardrobe compartment on **left** includes hanging rod and **one adjustable shelf** above rod. Two upper locks secure storage and wardrobe compartments. Lower lock secures all drawers.

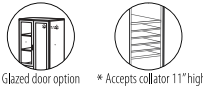

Glazed door option * Accepts collator 11" high

Personal Tower with Doors cavity - LEFT

Z36L8ECL	24 x 36 x 84.4-84.9	125	366.44	50	\$3283	\$3368	\$1686	N/A
Z30L8ECL	24 x 30 x 84.4-84.9	125	332.49	42	\$2995	\$3069	\$1530	N/A
Z24L8ECL	24 x 24 x 84.4-84.9	100	295.24	34.25	\$2881	\$2942	\$1307	N/A
Z36M8ECL	20 x 36 x 84.4-84.9	125	328.68	42.25	\$3084	\$3158	\$1686	N/A
Z30M8ECL	20 x 30 x 84.4-84.9	100	295.07	35.50	\$2841	\$2903	\$1530	N/A
Z24M8ECL	20 x 24 x 84.4-84.9	100	263	29	\$2710	\$2761	\$1307	N/A

Two file drawers on bottom. Laminate doors are standard. Storage compartment on **left includes two 3-position fixed/and height adjustable shelves**. Wardrobe compartment on **right** includes hanging rod and **one adjustable shelf** above rod. Two upper locks secure storage and wardrobe compartments. Lower lock secures all drawers.

Required Specifications

Primary surface type + finish
Top thickness/edge detail
Base finish
Lock finish

Door front finish* (unless glazed door specified, then drawer front only)
Handles

Optional Specifications

Glazed doors
Collator (Open Shelves)
Box drawer - no upcharge* (30"-36" wide models only)

PERSONAL TOWERS - 84.5"/85" HIGH



Glazed door option

* Accepts collator 11" high

Personal Tower with Doors and cavity - RIGHT

MODEL#	DIMENSIONS D x W x H	FREIGHT CLASS	WT/LBS.	CUBIC FT.	1" TOP	1.5" TOP	GLAZE ADD	HP ADD
Z36L8ECR	24 x 36 x 84.4-84.9	125	366.44	50	\$3283	\$3368	\$1686	N/A
Z30L8ECR	24 x 30 x 84.4-84.9	125	332.49	42	\$2995	\$3069	\$1530	N/A
Z24L8ECR	24 x 24 x 84.4-84.9	100	295.24	34.25	\$2881	\$2942	\$1307	N/A
Z36M8ECR	20 x 36 x 84.4-84.9	125	328.68	42.25	\$3084	\$3158	\$1686	N/A
Z30M8ECR	20 x 30 x 84.4-84.9	100	295.07	35.50	\$2841	\$2903	\$1530	N/A
Z24M8ECR	20 x 24 x 84.4-84.9	100	263	29	\$2710	\$2761	\$1307	N/A

Two file drawers on bottom. Laminate doors are standard. Storage compartment on right includes two 3-position fixed/height adjustable shelves. Wardrobe compartment on left includes hanging rod and one adjustable shelf above rod. Two upper locks secure storage and wardrobe compartments. Lower lock secures all drawers.



Glazed door option

* Accepts collator 11" high

Personal Tower with Open Shelves - LEFT

Z36L8ENL	24 x 36 x 84.4-84.9	125	351.72	50	\$3104	\$3189	\$1032	N/A
Z30L8ENL	24 x 30 x 84.4-84.9	125	320.22	42	\$2815	\$2889	\$873	N/A
Z24L8ENL	24 x 24 x 84.4-84.9	100	283.24	34.25	\$2670	\$2731	\$653	N/A
Z36M8ENL	20 x 36 x 84.4-84.9	125	313.96	42.25	\$2907	\$2981	\$1027	N/A
Z30M8ENL	20 x 30 x 84.4-84.9	125	282.80	35.50	\$2665	\$2727	\$877	N/A
Z24M8ENL	20 x 24 x 84.4-84.9	100	249	29	\$2502	\$2553	\$653	N/A

Two file drawers on bottom. Laminate door is standard on wardrobe section. Storage compartment on left includes three 3-position fixed/height adjustable shelves. Wardrobe compartment on right includes hanging rod and one adjustable shelf above rod. Upper lock secures wardrobe compartment. Lower lock secures all drawers.



Glazed door option

* Accepts collator 11" high

Personal Tower with Open Shelves - RIGHT

Z36L8ENR	24 x 36 x 84.4-84.9	125	351.72	50	\$3104	\$3189	\$1032	N/A
Z30L8ENR	24 x 30 x 84.4-84.9	125	320.22	42	\$2815	\$2889	\$873	N/A
Z24L8ENR	24 x 24 x 84.4-84.9	100	283.24	34.25	\$2670	\$2731	\$653	N/A
Z36M8ENR	20 x 36 x 84.4-84.9	125	313.96	42.25	\$2907	\$2981	\$1027	N/A
Z30M8ENR	20 x 30 x 84.4-84.9	125	282.80	35.50	\$2665	\$2727	\$877	N/A
Z24M8ENR	20 x 24 x 84.4-84.9	100	249	29	\$2502	\$2553	\$653	N/A

Two file drawers on bottom. Laminate door is standard on wardrobe section. Storage compartment on right includes three 3-position fixed/height adjustable shelves. Wardrobe compartment on right includes hanging rod and one adjustable shelf above rod. Upper lock secures wardrobe compartment. Lower lock secures all drawers.



Glazed door option

Personal Tower with Doors - LEFT

Z36L8BFL	24 x 36 x 84.4-84.9	125	371.70	50	\$3470	\$3555	\$1785	N/A
Z30L8BFL	24 x 30 x 84.4-84.9	100	337.05	42	\$3197	\$3271	\$1630	N/A
Z24L8BFL	24 x 24 x 84.4-84.9	100	301.24	34.25	\$3042	\$3103	\$1406	N/A
Z36M8BFL	20 x 36 x 84.4-84.9	125	334.95	42.25	\$3274	\$3348	\$1785	N/A
Z30M8BFL	20 x 30 x 84.4-84.9	100	300.30	35.50	\$3042	\$3106	\$1630	N/A
Z24M8BFL	20 x 24 x 84.4-84.9	100	268	29	\$2871	\$2922	\$1406	N/A

Two box and one file drawer on bottom. Laminate doors are standard. Storage compartment on left includes three 3-position fixed/height adjustable shelves. Wardrobe compartment on right includes hanging rod and one adjustable shelf above rod. Two upper locks secure storage and wardrobe compartments. Lower lock secures all drawers.

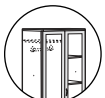

Glazed door option

Personal Tower with Doors - RIGHT

Z36L8BFR	24 x 36 x 84.4-84.9	125	371.70	50	\$3470	\$3555	\$1785	N/A
Z30L8BFR	24 x 30 x 84.4-84.9	100	337.05	42	\$3197	\$3271	\$1630	N/A
Z24L8BFR	24 x 24 x 84.4-84.9	100	301.24	34.25	\$3042	\$3103	\$1406	N/A
Z36M8BFR	20 x 36 x 84.4-84.9	125	334.95	42.25	\$3274	\$3348	\$1785	N/A
Z30M8BFR	20 x 30 x 84.4-84.9	100	300.30	35.50	\$3042	\$3106	\$1630	N/A
Z24M8BFR	20 x 24 x 84.4-84.9	100	268	29	\$2871	\$2922	\$1406	N/A

Two box and one file drawer on bottom. Laminate doors are standard. Storage compartment on right includes three 3-position fixed/height adjustable shelves. Wardrobe compartment on left includes hanging rod and one adjustable shelf above rod. Two upper locks secure storage and wardrobe compartments. Lower lock secures all drawers.

Required Specifications

Primary surface type + finish
Top thickness/edge detail
Base finish
Lock finish

Door/drawer front finish* (unless glazed door specified, then drawer front only)
Handles

Optional Specifications

Glazed doors
Collator (Open Shelves)
Box drawer - no upcharge* (30"-36" wide models only)

PERSONAL TOWERS - 84.5"/85" HIGH

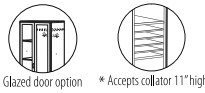

Personal Tower with Doors and Cavity - LEFT

MODEL#	DIMENSIONS	FREIGHT CLASS	WT./LBS.	CUBIC FT.	1"TOP	1.5" TOP	GLAZE ADD	HP ADD	
D x W x H									
Z36L8BFCL	24 x 36 x 84.4-84.9	125	369.59	50	\$3424	\$3510	\$1686	N/A	
Z30L8BFCL	24 x 30 x 84.4-84.9	125	334.59	42	\$3148	\$3222	\$1530	N/A	
Z24L8BFCL	24 x 24 x 84.4-84.9	100	297.24	34.25	\$2995	\$3057	\$1307	N/A	
Z36M8BFCL	20 x 36 x 84.4-84.9	125	330.78	42.25	\$3227	\$3301	\$1686	N/A	
Z30M8BFCL	20 x 30 x 84.4-84.9	100	299.27	35.50	\$2995	\$3059	\$1530	N/A	
Z24M8BFCL	20 x 24 x 84.4-84.9	100	265	29	\$2825	\$2876	\$1307	N/A	

Two box and one file drawer on bottom. Laminate doors are standard. Storage compartment on **left** includes **two 3-position fixed/height adjustable shelves**. Wardrobe compartment on **left** includes hanging rod and **one adjustable shelf** above rod. Two upper locks secure storage and wardrobe compartments. Lower lock secures all drawers.

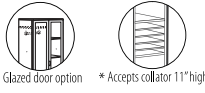

Personal Tower with Doors and Cavity - RIGHT

Z36L8BFCL	24 x 36 x 84.4-84.9	125	369.59	50	\$3424	\$3510	\$1686	N/A
Z30L8BFCL	24 x 30 x 84.4-84.9	125	334.59	42	\$3148	\$3222	\$1530	N/A
Z24L8BFCL	24 x 24 x 84.4-84.9	100	297.24	34.25	\$2995	\$3057	\$1307	N/A
Z36M8BFCL	20 x 36 x 84.4-84.9	125	330.78	42.25	\$3227	\$3301	\$1686	N/A
Z30M8BFCL	20 x 30 x 84.4-84.9	100	299.27	35.50	\$2995	\$3059	\$1530	N/A
Z24M8BFCL	20 x 24 x 84.4-84.9	100	265	29	\$2825	\$2876	\$1307	N/A

Two box and one file drawer on bottom. Laminate doors are standard. Storage compartment on **right** includes **two 3-position fixed/height adjustable shelves**. Wardrobe compartment on **left** includes hanging rod and **one adjustable shelf** above rod. Two upper locks secure storage and wardrobe compartments. Lower lock secures all drawers.

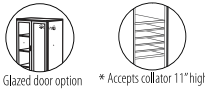

Personal Tower with Open Shelves - LEFT

Z36L8BFNL	24 x 36 x 84.4-84.9	125	354.87	50	\$3242	\$3328	\$1032	N/A
Z30L8BFNL	24 x 30 x 84.4-84.9	125	322.32	42	\$2972	\$3046	\$873	N/A
Z24L8BFNL	24 x 24 x 84.4-84.9	100	285.24	34.25	\$2787	\$2848	\$653	N/A
Z36M8BFNL	20 x 36 x 84.4-84.9	125	316.06	42.25	\$3047	\$3136	\$1027	N/A
Z30M8BFNL	20 x 30 x 84.4-84.9	100	287	35.50	\$2815	\$2879	\$877	N/A
Z24M8BFNL	20 x 24 x 84.4-84.9	100	251	29	\$2614	\$2665	\$653	N/A

Two box and one file drawer on bottom. Laminate door is standard on wardrobe section. Storage compartment on **left** includes **three 3-position fixed/height adjustable shelves**. Wardrobe compartment on **right** includes hanging rod and **one adjustable shelf** above rod. Upper lock secures wardrobe compartment. Lower lock secures all drawers.

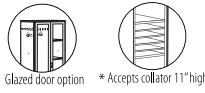

Personal Tower w/Open Shelves - RIGHT

Z36L8BFNR	24 x 36 x 84.4-84.9	125	354.87	50	\$3242	\$3328	\$1032	N/A
Z30L8BFNR	24 x 30 x 84.4-84.9	125	322.32	42	\$2972	\$3046	\$873	N/A
Z24L8BFNR	24 x 24 x 84.4-84.9	100	285.24	34.25	\$2787	\$2848	\$653	N/A
Z36M8BFNR	20 x 36 x 84.4-84.9	125	316.06	42.25	\$3047	\$3136	\$1027	N/A
Z30M8BFNR	20 x 30 x 84.4-84.9	100	287	35.50	\$2815	\$2879	\$877	N/A
Z24M8BFNR	20 x 24 x 84.4-84.9	100	251	29	\$2614	\$2665	\$653	N/A

Two box and one file drawer on bottom. Laminate door is standard on wardrobe section. Storage compartment on **right** includes **three 3-position fixed/height adjustable shelves**. Wardrobe compartment on **left** includes hanging rod and **one adjustable shelf** above rod. Upper lock secures wardrobe compartment. Lower lock secures all drawers.

CLOSED FRONT OVERHEAD STORAGE - 33"H



Closed Front Overhead Storage with Doors - 32.5"/33"H

MODEL#	DIMENSIONS	FREIGHT CLASS	WT./LBS.	CUBIC FT.	1"TOP	1.5" TOP	GLAZE ADD	HP ADD
Z42S33OS	16 x 42 x 32.5-33	100	135.98	16.25	\$1215	\$1296	\$1177	N/A
Z36S33OS	16 x 36 x 32.5-33	100	119.70	14	\$1102	\$1174	\$1063	N/A
Z30S33OS	16 x 30 x 32.5-33	100	104.42	11.75	\$987	\$1033	\$927	N/A
Z24S33OS	16 x 24 x 32.5-33	100	81.13	9.75	\$884	\$933	\$811	N/A

Includes steel hanging rail for wall mount applications. Includes one fixed shelf. Doors lock.

• **NOTE:** Care should be taken to mount the units. Units should be mounted to wall studs using correct fasteners. Failure to do so may result in collapse of the unit and subsequent personal injury. **Fastening hardware not included.** Mounting hardware used should be based on wall material. Consult an installation professional for proper wall mounting.

Required Specifications

Primary surface type + finish
Top thickness/edge detail
Base finish
Lock finish

Door/drawer front finish* (unless glazed door specified, then drawer front only)
Handles

Optional Specifications

Key # Glazed doors
Collator (Open Shelves)
Box drawer - no upcharge* (30"-36" wide models only)

OVERHEAD STORAGE - 33"H



Glazed door option

Closed Front Overhead Storage with Pigeon Hole - 32.5"/33"H

MODEL#	DIMENSIONS D x W x H	FREIGHT CLASS	WT/LBS.	CUBIC FT.	1"TOP	1.5" TOP	GLAZE ADD	HP ADD
Z42S33OP	16 x 42 x 32.5-33	100	140	16.25	\$1550	\$1635	\$777	N/A
Z36S33OP	16 x 36 x 32.5-33	100	122	14	\$1339	\$1415	\$708	N/A
Z30S33OP	16 x 30 x 32.5-33	100	105	12	\$1200	\$1262	\$629	N/A
Z24S33OP	16 x 24 x 32.5-33	100	88	9.75	\$1077	\$1135	\$572	N/A

Includes steel hanging rail for wall mount applications. Includes one fixed shelf. Doors lock.

• **NOTE:** Care should be taken to mount the units. Units should be mounted to wall studs using correct fasteners. Failure to do so may result in collapse of the unit and subsequent personal injury. **Fastening hardware not included.** Mounting hardware used should be based on wall material. Consult an installation professional for proper wall mounting.



Glazed door option

Closed Front Overhead Storage with Pigeon Hole - 32.5"/33"H

Z72S33OS	16 x 72 x 32.5-33	100	230	26	\$2510	\$2621	\$1416	N/A
Z66S33OS	16 x 66 x 32.5-33	100	215	24	\$2412	\$2513	\$1390	N/A
Z60S33OS	16 x 60 x 32.5-33	100	199	22	\$2224	\$2317	\$1259	N/A
Z54S33OS	16 x 54 x 32.5-33	100	184	21	\$2113	\$2202	\$1234	N/A

Includes steel hanging rail for wall mount applications. Includes one fixed shelf. Doors lock.

• **NOTE:** Care should be taken to mount the units. Units should be mounted to wall studs using correct fasteners. Failure to do so may result in collapse of the unit and subsequent personal injury. **Fastening hardware not included.** Mounting hardware used should be based on wall material. Consult an installation professional for proper wall mounting.



Glazed door option

Overhead Storage, 2 Outer Doors with Pigeon Hole - 32.5"/33"H

Z72S33SOS	16 x 72 x 32.5-33	100	215	26	\$2270	\$2381	\$710	N/A
Z66S33SOS	16 x 66 x 32.5-33	100	201	24	\$2168	\$2269	\$697	N/A
Z60S33SOS	16 x 60 x 32.5-33	100	187	22	\$2037	\$2130	\$684	N/A
Z54S33SOS	16 x 54 x 32.5-33	100	173	21	\$1895	\$1984	\$618	N/A

6 compartments. **Doors on outer compartments only.** Includes steel hanging rail for wall mount applications. Includes one fixed shelf. Doors lock.

• **NOTE:** Care should be taken to mount the units. Units should be mounted to wall studs using correct fasteners. Failure to do so may result in collapse of the unit and subsequent personal injury. **Fastening hardware not included.** Mounting hardware used should be based on wall material. Consult an installation professional for proper wall mounting.



Glazed door option

Overhead Storage, 2 Center Doors with Pigeon Hole - 32.5"/33"H

Z72S33OSO	16 x 72 x 32.5-33	100	214	26	\$2226	\$2337	\$710	N/A
Z66S33OSO	16 x 66 x 32.5-33	100	200	24	\$2130	\$2231	\$697	N/A
Z60S33OSO	16 x 60 x 32.5-33	100	186	22	\$1998	\$2091	\$632	N/A
Z54S33OSO	16 x 54 x 32.5-33	100	172	21	\$1890	\$1979	\$618	N/A

6 compartments. **Doors on inner compartments only.** Includes steel hanging rail for wall mount applications. Includes one fixed shelf. Doors lock.

• **NOTE:** Care should be taken to mount the units. Units should be mounted to wall studs using correct fasteners. Failure to do so may result in collapse of the unit and subsequent personal injury. **Fastening hardware not included.** Mounting hardware used should be based on wall material. Consult an installation professional for proper wall mounting.



Glazed door option

Overhead Storage, 1 Door - LEFT with Pigeon Hole - 32.5"/33"H

Z36S33OSL	16 x 36 x 32.5-33	100	119	14	\$1254	\$1330	\$355	N/A
Z30S33OSL	16 x 30 x 32.5-33	100	104	11.75	\$1144	\$1206	\$317	N/A
Z24S33OSL	16 x 24 x 32.5-33	100	88	9.75	\$1027	\$1085	\$277	N/A

Includes steel hanging rail for wall mount applications. Includes one fixed shelf. Door locks. Open storage on **right**.

• **NOTE:** Care should be taken to mount the units. Units should be mounted to wall studs using correct fasteners. Failure to do so may result in collapse of the unit and subsequent personal injury. **Fastening hardware not included.** Mounting hardware used should be based on wall material. Consult an installation professional for proper wall mounting.

Required Specifications

Top finish
Top thickness/edge detail
Base finish
Lock finish

Door front finish, if laminate
Handles

Optional Specifications

Key #
Glazed doors

OVERHEAD STORAGE - 33"H



Glazed door option

Overhead Storage, 1 Door - RIGHT with Pigeon Hole - 32.5"/33"H

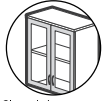

Glazed door option

Overhead Storage, 1 Door - LEFT with Pigeon Hole - 32.5"/33"H



Glazed door option

Overhead Storage, 1 Door - RIGHT with Pigeon Hole - 32.5"/33"H*

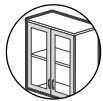

Glazed door option

Overhead Storage, 1 Door - LEFT with Pigeon Hole - 32.5"/33"H*

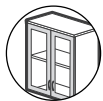

Glazed door option

Overhead Storage, 1 Door - RIGHT with Pigeon Hole - 32.5"/33"H*



Overhead Storage, Glass Doors with Pigeon Hole - 32.5"/33"H

MODEL#	DIMENSIONS	FREIGHT CLASS	WT/LBS.	CUBIC FT.	1" TOP	1.5" TOP	GLAZE ADD	HP ADD
D x W x H								
Z36S33OSR	16 x 36 x 32.5-33	100	119	14	\$1254	\$1330	\$355	N/A
Z30S33OSR	16 x 30 x 32.5-33	100	104	11.75	\$1144	\$1206	\$317	N/A
Z24S33OSR	16 x 24 x 32.5-33	100	88	9.75	\$1027	\$1085	\$277	N/A

Includes steel hanging rail for wall mount applications. Includes one fixed shelf. Door locks. Open storage on left.
 • **NOTE:** Care should be taken to mount the units. Units should be mounted to wall studs using correct fasteners. Failure to do so may result in collapse of the unit and subsequent personal injury. **Fastening hardware not included.** Mounting hardware used should be based on wall material. Consult an installation professional for proper wall mounting.

Z48S33OSL	16 x 48 x 32.5-33	100	135	16.25	\$1621	\$1710	\$400	N/A
Z42S33OSL	16 x 42 x 32.5-33	100	135	16.25	\$1443	\$1528	\$391	N/A

Includes steel hanging rail for wall mount applications. Includes one fixed shelf. Door locks. Open storage on right.
 • **NOTE:** Care should be taken to mount the units. Units should be mounted to wall studs using correct fasteners. Failure to do so may result in collapse of the unit and subsequent personal injury. **Fastening hardware not included.** Mounting hardware used should be based on wall material. Consult an installation professional for proper wall mounting.

Z48S33OSR	16 x 48 x 32.5-33	100	135	16.25	\$1621	\$1710	\$400	N/A
Z42S33OSR	16 x 42 x 32.5-33	100	135	16.25	\$1443	\$1528	\$391	N/A

Includes steel hanging rail for wall mount applications. Includes one fixed shelf. Door locks. Open storage on left.
 • **NOTE:** Care should be taken to mount the units. Units should be mounted to wall studs using correct fasteners. Failure to do so may result in collapse of the unit and subsequent personal injury. **Fastening hardware not included.** Mounting hardware used should be based on wall material. Consult an installation professional for proper wall mounting.

Z72S33OSL	16 x 72 x 32.5-33	125	207	26	\$2181	\$2292	\$709	N/A
Z66S33OSL	16 x 66 x 32.5-33	100	193	24	\$2080	\$2181	\$699	N/A
Z60S33OSL	16 x 60 x 32.5-33	100	179	22	\$1927	\$2020	\$635	N/A
Z54S33OSL	16 x 54 x 32.5-33	125	166	21	\$1823	\$1912	\$616	N/A

Includes steel hanging rail for wall mount applications. Includes one fixed shelf. Doors lock. Open storage on right.
 • **NOTE:** Care should be taken to mount the units. Units should be mounted to wall studs using correct fasteners. Failure to do so may result in collapse of the unit and subsequent personal injury. **Fastening hardware not included.** Mounting hardware used should be based on wall material. Consult an installation professional for proper wall mounting.

Z72S33OSR	16 x 72 x 32.5-33	125	207	26	\$2181	\$2292	\$709	N/A
Z66S33OSR	16 x 66 x 32.5-33	100	193	24	\$2080	\$2181	\$699	N/A
Z60S33OSR	16 x 60 x 32.5-33	100	179	22	\$1927	\$2020	\$635	N/A
Z54S33OSR	16 x 54 x 32.5-33	125	166	21	\$1823	\$1912	\$616	N/A

Includes steel hanging rail for wall mount applications. Includes one fixed shelf. Doors lock. Open storage on left.
 • **NOTE:** Care should be taken to mount the units. Units should be mounted to wall studs using correct fasteners. Failure to do so may result in collapse of the unit and subsequent personal injury. **Fastening hardware not included.** Mounting hardware used should be based on wall material. Consult an installation professional for proper wall mounting.

Z36S33OSD	16 x 36 x 32.5-33	100	127	14	\$2660	\$2736	N/A	N/A
Z30S33OSD	16 x 30 x 32.5-33	100	110	12	\$2340	\$2402	N/A	N/A
Z24S33OSD	16 x 24 x 32.5-33	100	91	9.75	\$2074	\$2132	N/A	N/A

Includes steel hanging rail for wall mount applications. Includes one fixed shelf. Sliding glass doors do not lock. Shipped easy to assemble in 2 cartons. Glass doors shipped separately. Finger pull is silver.
 • **NOTE:** Care should be taken to mount the units. Units should be mounted to wall studs using correct fasteners. Failure to do so may result in collapse of the unit and subsequent personal injury. **Fastening hardware not included.** Mounting hardware used should be based on wall material. Consult an installation professional for proper wall mounting.

Required Specifications

Top finish
 Top thickness/edge detail
 Base finish
 Lock finish

Door front finish*, if laminate
 Handles*

Optional Specifications

Key #*
 Glazed doors*

OVERHEAD STORAGE



Overhead Storage, Glass Doors with Pigeon Hole - 32.5"/33"H

MODEL#	DIMENSIONS D x W x H	FREIGHT CLASS	WT/LBS.	CUBIC FT.	1" TOP	1.5" TOP	GLAZE ADD	HP ADD
Z72S330SD	16 x 72 x 32.5-33	100	224	26	\$4688	\$4799	N/A	N/A
Z66S330SD	16 x 66 x 32.5-33	100	208	24	\$4383	\$4484	N/A	N/A
Z60S330SD	16 x 60 x 32.5-33	100	193	22	\$4055	\$4148	N/A	N/A
Z54S330SD	16 x 54 x 32.5-33	100	178	21	\$3777	\$3866	N/A	N/A
Z48S330SD	16 x 48 x 32.5-33	100	162	17.70	\$3451	\$3540	N/A	N/A
Z42S330SD	16 x 42 x 32.5-33	100	145	16.25	\$3084	\$3169	N/A	N/A

Includes steel hanging rail for wall mount applications. Includes one fixed shelf. Sliding glass doors do not lock.

Shipped easy to assemble in 2 cartons. Glass doors shipped separately. Finger pull is silver.

- **NOTE:** Care should be taken to mount the units. Units should be mounted to wall studs using correct fasteners. Failure to do so may result in collapse of the unit and subsequent personal injury. **Fastening hardware not included.** Mounting hardware used should be based on wall material. Consult an installation professional for proper wall mounting.

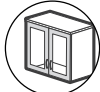

Glazed door option

Closed Front Overhead Storage with Doors - 20"/20.5"H*

Z42S200S	16 x 42 x 20-20.5	100	93.99	10.50	\$868	\$948	\$841	N/A
Z36S200S	16 x 36 x 20-20.5	100	82.70	9	\$796	\$868	\$768	N/A
Z30S200S	16 x 30 x 20-20.5	100	72.42	7.50	\$718	\$764	\$682	N/A
Z24S200S	16 x 24 x 20-20.5	100	56.13	6.25	\$675	\$726	\$610	N/A

Includes steel hanging rail for wall mount applications. Doors lock.

- **NOTE:** Care should be taken to mount the units. Units should be mounted to wall studs using correct fasteners. Failure to do so may result in collapse of the unit and subsequent personal injury. **Fastening hardware not included.** Mounting hardware used should be based on wall material. Consult an installation professional for proper wall mounting.

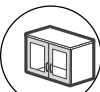

Glazed door option

Overhead Storage w/1 door - LEFT* 20"/20.5"H

Z48S200SL	16 x 48 x 20-20.5	125	95	12.50	\$987	\$1076	\$342	N/A
Z42S200SL	16 x 42 x 20-20.5	100	85	10.50	\$872	\$957	\$317	N/A
Z36S200SL	16 x 36 x 20-20.5	100	76	9	\$799	\$875	\$291	N/A
Z30S200SL	16 x 30 x 20-20.5	100	67	7.60	\$732	\$794	\$250	N/A
Z24S200SL	16 x 24 x 20-20.5	100	58	6.50	\$679	\$737	\$228	N/A

Door on **left**. Includes steel hanging rail for wall mount applications. Includes one fixed shelf. Door locks.

- **NOTE:** Care should be taken to mount the units. Units should be mounted to wall studs using correct fasteners. Failure to do so may result in collapse of the unit and subsequent personal injury. **Fastening hardware not included.** Mounting hardware used should be based on wall material. Consult an installation professional for proper wall mounting.

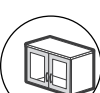

Glazed door option

Overhead Storage w/1 door - RIGHT* 20"/20.5"H*

Z48S200SR	16 x 48 x 20-20.5	125	95	12.50	\$987	\$1076	\$342	N/A
Z42S200SR	16 x 42 x 20-20.5	100	85	10.50	\$872	\$957	\$317	N/A
Z36S200SR	16 x 36 x 20-20.5	100	76	9	\$799	\$875	\$291	N/A
Z30S200SR	16 x 30 x 20-20.5	100	67	7.60	\$732	\$794	\$250	N/A
Z24S200SR	16 x 24 x 20-20.5	100	58	6.50	\$679	\$737	\$228	N/A

Door on **right**. Includes steel hanging rail for wall mount applications. Includes one fixed shelf. Door locks.

- **NOTE:** Care should be taken to mount the units. Units should be mounted to wall studs using correct fasteners. Failure to do so may result in collapse of the unit and subsequent personal injury. **Fastening hardware not included.** Mounting hardware used should be based on wall material. Consult an installation professional for proper wall mounting.

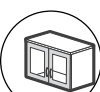

Glazed door option

Closed Front Overhead Storage w/Center Divider- 20/20.5"H*

Z72S200S	16 x 72 x 20-20.5	100	149	18	\$1662	\$1773	\$1146	N/A
Z66S200S	16 x 66 x 20-20.5	100	139	16.50	\$1584	\$1685	\$1121	N/A
Z60S200S	16 x 60 x 20-20.5	100	129	15	\$1462	\$1555	\$1026	N/A
Z54S200S	16 x 54 x 20-20.5	100	119	13.75	\$1392	\$1481	\$999	N/A

Includes steel hanging rail for wall mount applications. Includes one fixed shelf. Doors lock.

- **NOTE:** Care should be taken to mount the units. Units should be mounted to wall studs using correct fasteners. Failure to do so may result in collapse of the unit and subsequent personal injury. **Fastening hardware not included.** Mounting hardware used should be based on wall material. Consult an installation professional for proper wall mounting.





Required Specifications

Top finish
Top thickness/edge detail
Base finish
Lock finish

Door front finish*, if laminate
Handles*

Optional Specifications

Key #*
Glazed doors*

OVERHEAD STORAGE	MODEL#	DIMENSIONS	FREIGHT CLASS	WT/LBS.	CUBIC FT.	1" TOP	1.5" TOP	GLAZE ADD	HP ADD	
 Glazed door option		D x W x H								
	Z72S20SOS	16 x 72 x 20-20.5	125	137	18	\$1429	\$1540	\$579	N/A	
	Z66S20SOS	16 x 66 x 20-20.5	125	128	16.50	\$1352	\$1453	\$565	N/A	
	Z60S20SOS	16 x 60 x 20-20.5	100	120	15	\$1272	\$1365	\$554	N/A	
	Z54S20SOS	16 x 54 x 20-20.5	100	110	13.75	\$1186	\$1275	\$505	N/A	
4 compartments. Doors on outer compartments only. Includes steel hanging rail for wall mount applications. Doors lock. <ul style="list-style-type: none"> NOTE: Care should be taken to mount the units. Units should be mounted to wall studs using correct fasteners. Failure to do so may result in collapse of the unit and subsequent personal injury. Fastening hardware not included. Mounting hardware used should be based on wall material. Consult an installation professional for proper wall mounting. 										
 Glazed door option		D x W x H								
	Z72S20OSO	16 x 72 x 20-20.5	125	137	18	\$1446	\$1557	\$575	N/A	
	Z66S20OSO	16 x 66 x 20-20.5	125	128	16.50	\$1370	\$1471	\$561	N/A	
	Z60S20OSO	16 x 60 x 20-20.5	100	120	15	\$1288	\$1381	\$515	N/A	
	Z54S20OSO	16 x 54 x 20-20.5	100	110	13.75	\$1203	\$1292	\$501	N/A	
4 compartments. Doors on inner compartments only. Includes steel hanging rail for wall mount applications. Doors lock. <ul style="list-style-type: none"> NOTE: Care should be taken to mount the units. Units should be mounted to wall studs using correct fasteners. Failure to do so may result in collapse of the unit and subsequent personal injury. Fastening hardware not included. Mounting hardware used should be based on wall material. Consult an installation professional for proper wall mounting. 										
 Glazed door option		D x W x H								
	Z72S200SL	16 x 72 x 20-20.5	125	132	18	\$1386	\$1497	\$576	N/A	
	Z66S200SL	16 x 66 x 20-20.5	125	123	16.50	\$1310	\$1411	\$563	N/A	
	Z60S200SL	16 x 60 x 20-20.5	125	114	15	\$1211	\$1304	\$516	N/A	
	Z54S200SL	16 x 54 x 20-20.5	125	105	13.75	\$1144	\$1233	\$502	N/A	
2 doors on left cavity. Includes steel hanging rail for wall mount applications. Includes one fixed shelf. Doors lock. <ul style="list-style-type: none"> NOTE: Care should be taken to mount the units. Units should be mounted to wall studs using correct fasteners. Failure to do so may result in collapse of the unit and subsequent personal injury. Fastening hardware not included. Mounting hardware used should be based on wall material. Consult an installation professional for proper wall mounting. 										
 Glazed door option		D x W x H								
	Z72S200SR	16 x 72 x 20-20.5	125	132	18	\$1386	\$1497	\$576	N/A	
	Z66S200SR	16 x 66 x 20-20.5	125	123	16.50	\$1310	\$1411	\$563	N/A	
	Z60S200SR	16 x 60 x 20-20.5	125	114	15	\$1211	\$1304	\$516	N/A	
	Z54S200SR	16 x 54 x 20-20.5	125	105	13.75	\$1144	\$1233	\$502	N/A	
2 doors on right cavity. Includes steel hanging rail for wall mount applications. Includes one fixed shelf. Doors lock. <ul style="list-style-type: none"> NOTE: Care should be taken to mount the units. Units should be mounted to wall studs using correct fasteners. Failure to do so may result in collapse of the unit and subsequent personal injury. Fastening hardware not included. Mounting hardware used should be based on wall material. Consult an installation professional for proper wall mounting. 										
 Overhead Storage, w/Glass Doors 20/20.5\" data-bbox="85 795 285 825"/>		D x W x H								
	Z72S200SD	16 x 72 x 20-20.5	100	145	18	\$3505	\$3616	N/A	N/A	
	Z66S200SD	16 x 66 x 20-20.5	100	135	16	\$3264	\$3365	N/A	N/A	
	Z60S200SD	16 x 60 x 20-20.5	100	125	15	\$3010	\$3103	N/A	N/A	
	Z54S200SD	16 x 54 x 20-20.5	100	115	13.75	\$2880	\$2969	N/A	N/A	
	Z48S200SD	16 x 48 x 20-20.5	100	104	12.50	\$2547	\$2636	N/A	N/A	
	Z42S200SD	16 x 42 x 20-20.5	100	93	10.50	\$2275	\$2360	N/A	N/A	
	Z36S200SD	16 x 36 x 20-20.5	100	83	9	\$2011	\$2087	N/A	N/A	
	Z30S200SD	16 x 30 x 20-20.5	100	75	7.60	\$1801	\$1863	N/A	N/A	
	Z24S200SD	16 x 24 x 20-20.5	100	63	6.40	\$1668	\$1726	N/A	N/A	
	Includes steel hanging rail for wall mount applications. Sliding glass doors do not lock. Shipped easy to assemble in 2 cartons. Glass doors shipped separately. Finger pull is silver. <ul style="list-style-type: none"> NOTE: Care should be taken to mount the units. Units should be mounted to wall studs using correct fasteners. Failure to do so may result in collapse of the unit and subsequent personal injury. Fastening hardware not included. Mounting hardware used should be based on wall material. Consult an installation professional for proper wall mounting. 									

Required Specifications

Top finish
 Top thickness/edge detail
 Base finish
 Lock finish

Door front finish*, if laminate
 Handles*

Optional Specifications

Key #*
 Glazed doors*

CLOSED FRONT OVERHEAD STORAGE - 16"H

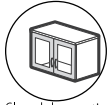

Glazed door option

Closed Front Overhead Storage* with Doors - 16"/16.5"H*

MODEL#	DIMENSIONS	FREIGHT CLASS	WT/LBS.	CUBIC FT.	1"TOP	1.5" TOP	GLAZE ADD	HP ADD
	D x W x H							
Z48S16OS	15 x 48 x 16-16.5	92.5	98.63	9.25	\$866	\$942	\$811	N/A
Z42S16OS	15 x 42 x 16-16.5	92.5	87.42	7.75	\$751	\$818	\$785	N/A
Z36S16OS	15 x 36 x 16-16.5	92.5	77.22	6.75	\$685	\$745	\$709	N/A
Z30S16OS	15 x 30 x 16-16.5	92.5	64.02	5.75	\$626	\$677	\$622	N/A

Standard with pre-mounted "J" bracket for wall mount applications. Doors lock.

- **NOTE:** Care should be taken to mount the units. Units should be mounted to wall studs using correct fasteners. Failure to do so may result in collapse of the unit and subsequent personal injury. **Fastening hardware not included.** Mounting hardware used should be based on wall material. Consult an installation professional for proper wall mounting.



Glazed door option

Closed Front Overhead Storage* with Doors - 16"/16.5" High, 60" Wide

Z60S16OS	15 x 60 x 16-16.5	92.5	118.03	11	\$1138	\$1229	\$1235	N/A
----------	-------------------	------	--------	----	---------------	---------------	---------------	-----

Standard with pre-mounted "J" bracket for wall mount applications. Doors lock.

- **NOTE:** Care should be taken to mount the units. Units should be mounted to wall studs using correct fasteners. Failure to do so may result in collapse of the unit and subsequent personal injury. **Fastening hardware not included.** Mounting hardware used should be based on wall material. Consult an installation professional for proper wall mounting.

OVERHEAD STORAGE W/OPEN FRONTS - 33"



Open Front Overhead Storage w/Pigeon Hole - 32.5"/33"H

MODEL#	DIMENSIONS	FREIGHT CLASS	WT/LBS.	CUBIC FT.	1"TOP	1.5" TOP	GLAZE ADD	HP ADD
Z42S33OPN	16 x 42 x 32.5-33	125	116	16.25	\$1190	\$1275	N/A	N/A
Z36S33OPN	16 x 36 x 32.5-33	125	101	14	\$1013	\$1089	N/A	N/A
Z30S33OPN	16 x 30 x 32.5-33	125	88	12	\$910	\$972	N/A	N/A
Z24S33OPN	16 x 24 x 32.5-33	125	74	9.75	\$812	\$870	N/A	N/A

Includes steel hanging rail for wall mount applications. Includes one fixed shelf.

- **NOTE:** Care should be taken to mount the units. Units should be mounted to wall studs using correct fasteners. Failure to do so may result in collapse of the unit and subsequent personal injury. **Fastening hardware not included.** Mounting hardware used should be based on wall material. Consult an installation professional for proper wall mounting.



Open Front Overhead Storage w/Pigeon Hole - 32.5"/33"H

Z72S33ON	16 x 72 x 32.5-33	125	194	26	\$1966	\$2067	N/A	N/A
Z66S33ON	16 x 66 x 32.5-33	125	181	24	\$1847	\$1940	N/A	N/A
Z60S33ON	16 x 60 x 32.5-33	125	169	22	\$1713	\$1802	N/A	N/A
Z54S33ON	16 x 54 x 32.5-33	125	157	21	\$1605	\$1694	N/A	N/A

6 compartments. Includes steel hanging rail for wall mount applications. Includes one fixed shelf.

- **NOTE:** Care should be taken to mount the units. Units should be mounted to wall studs using correct fasteners. Failure to do so may result in collapse of the unit and subsequent personal injury. **Fastening hardware not included.** Mounting hardware used should be based on wall material. Consult an installation professional for proper wall mounting.



Open Front Overhead Storage w/Pigeon Hole - 32.5"/33"H

Z72S33OSN	16 x 72 x 32.5-33	125	187	26	\$1853	\$1954	N/A	N/A
Z66S33OSN	16 x 66 x 32.5-33	125	174	24	\$1759	\$1852	N/A	N/A
Z60S33OSN	16 x 60 x 32.5-33	125	162	22	\$1643	\$1732	N/A	N/A
Z54S33OSN	16 x 54 x 32.5-33	125	149	21	\$1535	\$1624	N/A	N/A

4 compartments. Includes steel hanging rail for wall mount applications. Includes one fixed shelf.

- **NOTE:** Care should be taken to mount the units. Units should be mounted to wall studs using correct fasteners. Failure to do so may result in collapse of the unit and subsequent personal injury. **Fastening hardware not included.** Mounting hardware used should be based on wall material. Consult an installation professional for proper wall mounting.

Required Specifications

Top finish
Top thickness/edge detail
Base finish
Lock finish*

Door front finish*, if laminate
Handles*

Optional Specifications

Key #*
Glazed doors*

OVERHEAD STORAGE W/OPEN FRONTS - 33"	MODEL#	DIMENSIONS	FREIGHT CLASS	WT/LBS.	CUBIC FT.	1"TOP	1.5" TOP	GLAZE ADD	HP ADD
		D x W x H							
	Z42S33OSN	16 x 42 x 32.5-33	125	108.98	16.25	\$823	\$904	N/A	N/A
	Z36S33OSN	16 x 36 x 32.5-33	125	96.70	14	\$746	\$818	N/A	N/A
	Z30S33OSN	16 x 30 x 32.5-33	125	84.42	11.75	\$668	\$714	N/A	N/A
Z24S33OSN	16 x 24 x 32.5-33	125	67.20	9.75	\$616	\$667	N/A	N/A	

Open Front Overhead Storage
33"/33.5"H

Includes steel hanging rail for wall mount applications. Includes one fixed shelf.

- **NOTE:** Care should be taken to mount the units. Units should be mounted to wall studs using correct fasteners. Failure to do so may result in collapse of the unit and subsequent personal injury. **Fastening hardware not included.** Mounting hardware used should be based on wall material. Consult an installation professional for proper wall mounting.

OVERHEAD STORAGE W/OPEN FRONTS - 33"	MODEL#	DIMENSIONS	FREIGHT CLASS	WT/LBS.	CUBIC FT.	1"TOP	1.5" TOP	GLAZE ADD	HP ADD
	Z42S20OSN	16 x 42 x 20-20.5	125	77.98	10.50	\$575	\$656	N/A	N/A
	Z36S20OSN	16 x 36 x 20-20.5	125	69.70	9	\$521	\$593	N/A	N/A
	Z30S20OSN	16 x 30 x 20-20.5	100	60.42	7.50	\$468	\$514	N/A	N/A
	Z24S20OSN	16 x 24 x 20-20.5	125	48.13	6.25	\$423	\$474	N/A	N/A

Open Front Overhead Storage
20"/20.5" High

Includes steel hanging rail for wall mount applications.

- **NOTE:** Care should be taken to mount the units. Units should be mounted to wall studs using correct fasteners. Failure to do so may result in collapse of the unit and subsequent personal injury. **Fastening hardware not included.** Mounting hardware used should be based on wall material. Consult an installation professional for proper wall mounting.

	Z72S200N	16 x 72 x 20-20.5	125	122	18	\$1154	\$1265	N/A	N/A
	Z66S200N	16 x 66 x 20-20.5	125	114	16.50	\$1081	\$1182	N/A	N/A
	Z60S200N	16 x 60 x 20-20.5	125	106	15	\$1007	\$1100	N/A	N/A
	Z54S200N	16 x 54 x 20-20.5	125	99	13.75	\$941	\$1030	N/A	N/A

Open Front Overhead Storage
20/20.5"H

4 compartments. Includes steel hanging rail for wall mount applications.

- **NOTE:** Care should be taken to mount the units. Units should be mounted to wall studs using correct fasteners. Failure to do so may result in collapse of the unit and subsequent personal injury. **Fastening hardware not included.** Mounting hardware used should be based on wall material. Consult an installation professional for proper wall mounting.

	Z72S200SN	16 x 72 x 20-20.5	125	117	18	\$1114	\$1225	N/A	N/A
	Z66S200SN	16 x 66 x 20-20.5	125	109	16.50	\$1040	\$1141	N/A	N/A
	Z60S200SN	16 x 60 x 20-20.5	125	101	15	\$965	\$1058	N/A	N/A
	Z54S200SN	16 x 54 x 20-20.5	125	94	13.75	\$898	\$987	N/A	N/A

Open Front Overhead Storage
w/Center Divider - 20"/20.5"H

Standard with pre-mounted "J" bracket for wall mount applications.

- **NOTE:** Care should be taken to mount the units. Units should be mounted to wall studs using correct fasteners. Failure to do so may result in collapse of the unit and subsequent personal injury. **Fastening hardware not included.** Mounting hardware used should be based on wall material. Consult an installation professional for proper wall mounting.

OVERHEAD STORAGE W/OPEN FRONTS - 16"	MODEL#	DIMENSIONS	FREIGHT CLASS	WT/LBS.	CUBIC FT.	1"TOP	1.5" TOP	GLAZE ADD	HP ADD
	Z48S16OSN	15 x 48 x 16-16.5	100	79.63	9.25	\$575	\$651	N/A	N/A
	Z42S16OSN	15 x 42 x 16-16.5	100	70.42	7.75	\$501	\$569	N/A	N/A
	Z36S16OSN	15 x 36 x 16-16.5	100	63.22	6.75	\$461	\$521	N/A	N/A
	Z30S16OSN	15 x 30 x 16-16.5	100	54.02	5.75	\$421	\$470	N/A	N/A

Open Front Overhead Storage
16"/16.5"H

Standard with pre-mounted "J" bracket for wall mount applications.

- **NOTE:** Care should be taken to mount the units. Units should be mounted to wall studs using correct fasteners. Failure to do so may result in collapse of the unit and subsequent personal injury. **Fastening hardware not included.** Mounting hardware used should be based on wall material. Consult an installation professional for proper wall mounting.

Required Specifications

- Top finish
- Base finish
- Top/Edge Detail

OVERHEAD STORAGE W/OPEN FRONTS - 16"H



Open Front Overhead Storage
16"/16.5" High, 60" Wide

MODEL#	DIMENSIONS	FREIGHT CLASS	WT/LBS.	CUBIC FT.	1"TOP	1.5" TOP	GLAZE ADD	HP ADD
Z60S160SN	15 x 60 x 16-16.5	100	98.03	11	\$709	\$800	N/A	N/A

Standard with pre-mounted "J" bracket for wall mount applications.

- **NOTE:** Care should be taken to mount the units. Units should be mounted to wall studs using correct fasteners. Failure to do so may result in collapse of the unit and subsequent personal injury. **Fastening hardware not included.** Mounting hardware used should be based on wall material. Consult an installation professional for proper wall mounting.

OPEN HUTCHES



Open Hutch w/Closed Back - 23.5"H

MODEL#	DIMENSIONS	FREIGHT CLASS	WT/LBS.	CUBIC FT.	1"TOP	1.5" TOP	GLAZE ADD	HP ADD
Z84S23HN	15 x 84 x 23-23.5	150	129	23	\$1038	\$1163	N/A	N/A
Z72S23HN	15 x 72 x 23-23.5	150	114	19.75	\$910	\$1032	N/A	N/A
Z71S23HN	15 x 71.7 x 23-23.5	150	113	19.75	\$910	\$1019	N/A	N/A
Z66S23HN	15 x 66 x 23-23.5	150	106	18.25	\$837	\$934	N/A	N/A
Z60S23HN	15 x 60 x 23-23.5	125	99	16.50	\$739	\$831	N/A	N/A
Z48S23HN	15 x 48 x 23-23.5	125	84	13.50	\$639	\$715	N/A	N/A
Z42S23HN	15 x 42 x 23-23.5	125	76	11.75	\$595	\$662	N/A	N/A
Z36S23HN	15 x 36 x 23-23.5	125	68	10.25	\$549	\$610	N/A	N/A
Z30S23HN	15 x 30 x 23-23.5	125	61	8.50	\$509	\$567	N/A	N/A

Closed back features one grommet and flexible sweep for wire management. All hutches shipped pre-assembled.

- Clearance from worksurface to valance is 20.25".
- Woodgrain runs horizontal on both the upper and lower back panels.



Open Hutch w/Closed Back - 36"H

Z84S36HN	15 x 84 x 35.5-36	125	206	33	\$1346	\$1471	N/A	N/A
Z72S36HN	15 x 72 x 35.5-36	125	181	28.25	\$1232	\$1341	N/A	N/A
Z71S36HN	15 x 71.7 x 35.5-36	125	173	28.25	\$1220	\$1331	N/A	N/A
Z66S36HN	15 x 66 x 35.5-36	125	161	26	\$1153	\$1254	N/A	N/A
Z60S36HN	15 x 60 x 35.5-36	125	150	23.75	\$1080	\$1171	N/A	N/A
Z54S36HN	15 x 54 x 35.5-36	125	128	21	\$1080	\$1171	N/A	N/A

One fixed shelf **and fixed shelf divider**. Closed back features one grommet and flexible sweep for wire management. All hutches shipped pre-assembled.

- Clearance from worksurface to valance is 17.75".
- Woodgrain runs horizontal on both the upper and lower back panels.



Open Hutch w/Closed Back - 36"H

Z48S36HN	15 x 48 x 35.5-36	125	123	19	\$891	\$967	N/A	N/A
Z42S36HN	15 x 42 x 35.5-36	125	112	16.75	\$824	\$891	N/A	N/A
Z36S36HN	15 x 36 x 35.5-36	125	100	14.50	\$756	\$816	N/A	N/A
Z30S36HN	15 x 30 x 35.5-36	125	89	12.25	\$688	\$737	N/A	N/A

One fixed shelf. Closed back features one grommet and flexible sweep for wire management. All hutches shipped pre-assembled.

- Clearance from worksurface to valance is 17.75".
- Woodgrain runs horizontal on both the upper and lower back panels.



Open Hutch w/Closed Back - 36"H

Z72S36OHN	15 x 72 x 35.5-36	150	162	27.75	\$1419	\$1533	N/A	N/A
Z66S36OHN	15 x 66 x 35.5-36	150	152	25.50	\$1347	\$1454	N/A	N/A
Z60S36OHN	15 x 60 x 35.5-36	125	142	23.25	\$1266	\$1361	N/A	N/A
Z54S36OHN	15 x 54 x 35.5-36	125	133	21	\$1186	\$1275	N/A	N/A

Four compartments. Closed back features one grommet and flexible sweep for wire management. All hutches shipped pre-assembled.





- Clearance from worksurface to valance is 17.75".
- Woodgrain runs horizontal on both the upper and lower back panels.

Required Specifications

- Top finish
- Base finish
- Top/Edge Detail

Accessories

- Tackboard
- Pigeon-hole storage

OPEN HUTCHES	MODEL#	DIMENSIONS	FREIGHT CLASS	WT/LBS.	CUBIC FT.	1" TOP	1.5" TOP	GLAZE ADD	HP ADD
 <p>Open Hutch w/Closed Back - 42.4\"</p>	D x W x H								
	Z84S42HN	15 x 84 x 41.9-42.4	150	223	38.50	\$1434	\$1559	N/A	N/A
	Z72S42HN	15 x 72 x 41.9-42.4	150	196	33	\$1327	\$1436	N/A	N/A
	Z71S42HN	15 x 71.7 x 41.9-42.4	150	188	33	\$1320	\$1429	N/A	N/A
	Z66S42HN	15 x 66 x 41.9-42.4	150	175	30.75	\$1242	\$1339	N/A	N/A
	Z60S42HN	15 x 60 x 41.9-42.4	150	164	27.75	\$1162	\$1253	N/A	N/A
Z54S42HN	15 x 54 x 41.9-42.4	150	140	24.50	\$1162	\$1253	N/A	N/A	
<p>One fixed shelf and fixed shelf divider. Closed back features one grommet and flexible sweep for wire management. All hutches shipped pre-assembled.</p> <ul style="list-style-type: none"> • Clearance from worksurface to valance is 24.25". • Woodgrain runs horizontal on both the upper and lower back panels. 									
 <p>Open Hutch w/Closed Back - 42.4\"</p>	Z72S42OHN	15 x 72 x 41.9-42.4	150	177	32.50	\$1584	\$1689	N/A	N/A
	Z66S42OHN	15 x 66 x 41.9-42.4	150	166	29.75	\$1452	\$1547	N/A	N/A
	Z60S42OHN	15 x 60 x 41.9-42.4	150	155	27.25	\$1365	\$1454	N/A	N/A
	Z54S42OHN	15 x 54 x 41.9-42.4	150	145	24.50	\$1280	\$1357	N/A	N/A
	<p>Four compartments. Closed back features one grommet and flexible sweep for wire management. All hutches shipped pre-assembled.</p> <ul style="list-style-type: none"> • Clearance from worksurface to valance is 24.25". • Woodgrain runs horizontal on both the upper and lower back panels. 								
 <p>Open Hutch w/Closed Back - 42.4\"</p>	Z48S42HN	15 x 48 x 41.9-42.4	125	134	22.25	\$965	\$1041	N/A	N/A
	Z42S42HN	15 x 42 x 41.9-42.4	125	123	19.50	\$891	\$959	N/A	N/A
	Z36S42HN	15 x 36 x 41.9-42.4	125	110	17	\$816	\$876	N/A	N/A
	Z30S42HN	15 x 30 x 41.9-42.4	125	105	14.25	\$740	\$791	N/A	N/A
<p>One fixed shelf. Closed back features one grommet and flexible sweep for wire management. All hutches shipped pre-assembled.</p> <ul style="list-style-type: none"> • Clearance from worksurface to valance is 24.25". • Woodgrain runs horizontal on both the upper and lower back panels. 									
 <p>Open Hutch w/Closed Back 54.9\"/55.4\"H</p>	Z84S55HN	15 x 84 x 54.4-54.9	150	306	62.37	\$2352	\$2480	N/A	N/A
	Z72S55HN	15 x 72 x 54.4-54.9	150	272	53.65	\$2194	\$2307	N/A	N/A
	Z71S55HN	15 x 71.7 x 54.4-54.9	150	271	53.65	\$2183	\$2297	N/A	N/A
	Z66S55HN	15 x 66 x 54.4-54.9	150	254	49.40	\$2109	\$2221	N/A	N/A
	Z60S55HN	15 x 60 x 54.4-54.9	150	238	45.15	\$1888	\$1982	N/A	N/A
	Z54S55HN	15 x 54 x 54.4-54.9	100	190	19.75	\$2427	\$2521	N/A	N/A
<p>One fixed shelf and one adjustable shelf (per compartment). Closed back features one grommet and flexible sweep for wire management. Top portion ships pre-assembled. Lower portion ships RTA.</p> <ul style="list-style-type: none"> • Clearance from worksurface to valance is 24.25". • Woodgrain runs horizontal on both the upper and lower back panels. 									
 <p>Open Hutch w/Closed Back 54.9\"/55.4\"H</p>	Z48S55HN	15 x 48 x 54.4-54.9	150	183	36	\$1421	\$1497	N/A	N/A
	Z42S55HN	15 x 42 x 54.4-54.9	150	168	31.50	\$1314	\$1382	N/A	N/A
	Z36S55HN	15 x 36 x 54.4-54.9	150	149	27.26	\$1198	\$1258	N/A	N/A
	Z30S55HN	15 x 30 x 54.4-54.9	150	132	23	\$1087	\$1140	N/A	N/A
<p>One fixed shelf and one adjustable shelf. Closed back features one grommet and flexible sweep for wire management. Shipped RTA (ready to assemble).</p> <ul style="list-style-type: none"> • Clearance from worksurface to valance is 24.25". • Woodgrain runs horizontal on both the upper and lower back panels. 									

Required Specifications

Top finish
Base finish
Top/Edge Detail

Accessories

Tackboard
Pigeon-hole storage

OPEN HUTCHES



Open Hutch w/Closed Back
54.9"/55.4"H

MODEL#	DIMENSIONS	FREIGHT CLASS	WT/LBS.	CUBIC FT.	1"TOP	1.5" TOP	GLAZE ADD	HP ADD
D x W x H								
Z72S550HN	15 x 72 x 54.4-54.9	100	242	26	\$2334	\$2445	N/A	N/A
Z66S550HN	15 x 66 x 54.4-54.9	100	228	24	\$2199	\$2300	N/A	N/A
Z60S550HN	15 x 60 x 54.4-54.9	100	214	22	\$2070	\$2162	N/A	N/A
Z54S550HN	15 x 54 x 54.4-54.9	92.5	199	19.76	\$1943	\$2028	N/A	N/A

Four compartments. Closed back features one grommet and flexible sweep for wire management.

Top portion ships pre-assembled. Lower portion ships RTA.

- Clearance from worksurface to valance is 24.25".
- Woodgrain runs horizontal on both the upper and lower back panels.

CLOSED HUTCHES

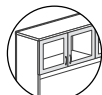

Glazed door option

Hutch w/2 Outer Doors - 36"H*

MODEL#	DIMENSIONS	FREIGHT CLASS	WT/LBS.	CUBIC FT.	1"TOP	1.5" TOP	GLAZE ADD	HP ADD
Z72S36HOH	15 x 72 x 35.5-36	125	172	27.75	\$1663	\$1777	\$502	N/A
Z66S36HOH	15 x 66 x 35.5-36	125	161	25.50	\$1589	\$1696	\$488	N/A
Z60S36HOH	15 x 60 x 35.5-36	125	151	23.25	\$1488	\$1585	\$451	N/A
Z54S36HOH	15 x 54 x 35.5-36	125	140	21	\$1406	\$1495	\$437	N/A

4 compartments. **Doors on outer compartments only.** Closed back features one grommet and flexible sweep for wire management. Doors lock. All hutches shipped pre-assembled.

- Clearance from worksurface to valance is 17.75".
- Woodgrain runs horizontal on both the upper and lower back panels.

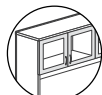

Glazed door option

Hutch w/2 Inner Doors - 36"H*

Z72S36OHO	15 x 72 x 35.5-36	125	173	27.75	\$1661	\$1782	\$507	N/A
Z66S36OHO	15 x 66 x 35.5-36	125	162	25.50	\$1592	\$1699	\$495	N/A
Z60S36OHO	15 x 60 x 35.5-36	125	151	23.25	\$1509	\$1604	\$477	N/A
Z54S36OHO	15 x 54 x 35.5-36	125	141	21	\$1409	\$1498	\$442	N/A

4 compartments. **Doors on inner compartments only.** Closed back features one grommet and flexible sweep for wire management. Doors lock. All hutches shipped pre-assembled.

- Clearance from worksurface to valance is 17.75".
- Woodgrain runs horizontal on both the upper and lower back panels.

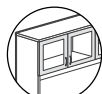

Glazed door option

Hutch w/2 Doors - LEFT, 36"H*

Z72S36HSL	15 x 72 x 35.5-36	125	169	27.75	\$1629	\$1742	\$501	N/A
Z66S36HSL	15 x 66 x 35.5-36	125	157	25.50	\$1551	\$1658	\$484	N/A
Z60S36HSL	15 x 60 x 35.5-36	125	146	23.25	\$1452	\$1549	\$452	N/A
Z54S36HSL	15 x 54 x 35.5-36	125	135	21	\$1370	\$1460	\$438	N/A

4 compartments. Doors on **left** side, open storage on **right**. Closed back features one grommet and flexible sweep for wire management. Doors lock. All hutches shipped pre-assembled.

- Clearance from worksurface to valance is 17.75".
- Woodgrain runs horizontal on both the upper and lower back panels.

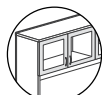

Glazed door option

Hutch w/2 Doors - RIGHT, 36"H*

Z72S36HSR	15 x 72 x 35.5-36	125	169	27.75	\$1629	\$1742	\$501	N/A
Z66S36HSR	15 x 66 x 35.5-36	125	157	25.50	\$1551	\$1658	\$484	N/A
Z60S36HSR	15 x 60 x 35.5-36	125	146	23.25	\$1452	\$1549	\$452	N/A
Z54S36HSR	15 x 54 x 35.5-36	125	135	21	\$1370	\$1460	\$438	N/A

4 compartments. Doors on **right** side, open storage on **left**. Closed back features one grommet and flexible sweep for wire management. Doors lock. All hutches shipped pre-assembled.

- Clearance from worksurface to valance is 17.75".
- Woodgrain runs horizontal on both the upper and lower back panels.

Required Specifications

- Top finish
- Top thickness/edge detail
- Base finish
- Lock finish*

Door front finish*, if laminate
Handles*

Optional Specifications

- Key #**
- Glazed doors*

Accessories

- Tackboard
- Pigeon-hole storage

CLOSED HUTCHES



Hutch w/Sliding Glass Doors - 36"H

MODEL#	DIMENSIONS D x W x H	FREIGHT CLASS	WT/LBS.	CUBIC FT.	1"TOP	1.5" TOP	GLAZE ADD	HP ADD
Z72S36HSD	15 x 72 x 35.5-36	125	178	27.75	\$3549	\$3663	N/A	N/A
Z66S36HSD	15 x 66 x 35.5-36	125	166	25.50	\$3313	\$3420	N/A	N/A
Z60S36HSD	15 x 60 x 35.5-36	125	154	23.25	\$3075	\$3172	N/A	N/A
Z54S36HSD	15 x 54 x 35.5-36	125	143	21	\$2843	\$2940	N/A	N/A

Sliding glass doors do not lock. Closed back features one grommet and flexible sweep for wire management. Shipped easy to assemble in 2 cartons. Glass doors shipped separately. Finger pull is silver.

- Clearance from worksurface to valance is 17.75".
- Woodgrain runs horizontal on both the upper and lower back panels.

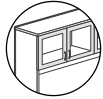

Glazed door option

Closed Hutch with Doors - 36"H*

Z84S36H	15 x 84 x 35.5-36	125	231	33	\$1844	\$1970	\$1477	N/A
Z72S36H	15 x 72 x 35.5-36	125	201	28.25	\$1717	\$1828	\$1349	N/A
Z71S36H	15 x 71.7 x 35.5-36	125	193	28.25	\$1702	\$1813	\$1347	N/A
Z66S36H	15 x 66 x 35.5-36	125	179	26	\$1618	\$1719	\$1284	N/A
Z60S36H	15 x 60 x 35.5-36	125	167	23.75	\$1509	\$1600	\$1206	N/A

One fixed shelf **and fixed shelf divider**. Closed back features one grommet and flexible sweep for wire management. Doors lock. All hutches shipped pre-assembled.

- Clearance from worksurface to valance is 17.75".
- Woodgrain runs horizontal on both the upper and lower back panels.

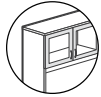

Glazed door option

Closed Hutch with Doors - 36"H*

Z48S36H	15 x 48 x 35.5-36	125	136	19	\$1183	\$1259	\$766	N/A
Z42S36H	15 x 42 x 35.5-36	125	124	16.75	\$1073	\$1141	\$742	N/A
Z36S36H	15 x 36 x 35.5-36	125	110	14.50	\$983	\$1043	\$679	N/A
Z30S36H	15 x 30 x 35.5-36	100	98	12.25	\$895	\$946	\$608	N/A

One fixed shelf. Closed back features one grommet and flexible sweep for wire management. Doors lock. All hutches shipped pre-assembled.

- Clearance from worksurface to valance is 17.75".
- Woodgrain runs horizontal on both the upper and lower back panels.

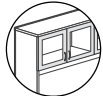

Glazed door option

Hutch w/2 Outer Doors - 42.4"H*

Z72S42HOH	15 x 72 x 41.9-42.4	150	187	32.50	\$1830	\$1935	\$502	N/A
Z66S42HOH	15 x 66 x 41.9-42.4	150	176	29.75	\$1694	\$1789	\$488	N/A
Z60S42HOH	15 x 60 x 41.9-42.4	125	164	27.25	\$1591	\$1680	\$451	N/A
Z54S42HOH	15 x 54 x 41.9-42.4	125	153	24.50	\$1502	\$1580	\$437	N/A

4 compartments. **Doors on outer compartments only**. Closed back features one grommet and flexible sweep for wire management. Doors lock. All hutches shipped pre-assembled.

- Clearance from worksurface to valance is 24.25".
- Woodgrain runs horizontal on both the upper and lower back panels.

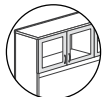

Glazed door option

Hutch w/2 Inner Doors - 42.4"H*

Z72S42OHO	15 x 72 x 41.9-42.4	150	188	32.50	\$1833	\$1938	\$507	N/A
Z66S42OHO	15 x 66 x 41.9-42.4	150	176	29.75	\$1696	\$1791	\$495	N/A
Z60S42OHO	15 x 60 x 41.9-42.4	125	165	27.25	\$1609	\$1696	\$477	N/A
Z54S42OHO	15 x 54 x 41.9-42.4	125	153	24.50	\$1506	\$1584	\$442	N/A

4 compartments. **Doors on inner compartments only**. Closed back features one grommet and flexible sweep for wire management. Doors lock. All hutches shipped pre-assembled.

- Clearance from worksurface to valance is 24.25".
- Woodgrain runs horizontal on both the upper and lower back panels.

Required Specifications

Top finish
Top thickness/edge detail
Base finish
Lock finish*

Door front finish*, if laminate
Handles*

Optional Specifications

Key #*
Glazed doors*

Accessories

Tackboard
Pigeon-hole storage

CLOSED HUTCHES

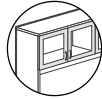

Glazed door option

Hutch w/2 Doors - LEFT, 42.4" H*

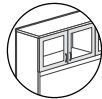

Glazed door option

Hutch w/2 Doors - RIGHT, 42.4" H*



Hutch w/Sliding Glass Doors - 42.4" H

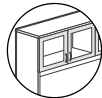

Glazed door option

Closed Hutch with Doors - 42.4" High

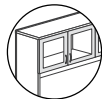

Glazed door option

Closed Hutch with Doors - 42.4" High

MODEL#	DIMENSIONS D x W x H	FREIGHT CLASS	WT/LBS.	CUBIC FT.	1" TOP	1.5" TOP	GLAZE ADD	HP ADD
Z72S42HSL	15 x 72 x 41.9-42.4	150	184	32.50	\$1793	\$1898	\$501	N/A
Z66S42HSL	15 x 66 x 41.9-42.4	150	171	29.75	\$1656	\$1753	\$484	N/A
Z60S42HSL	15 x 60 x 41.9-42.4	150	159	27.25	\$1552	\$1639	\$452	N/A
Z54S42HSL	15 x 54 x 41.9-42.4	125	148	24.50	\$1463	\$1541	\$438	N/A

4 compartments. Doors on **left** side, open storage on **right**. Closed back features one grommet and flexible sweep for wire management. Doors lock. All hutches shipped pre-assembled.

- Clearance from worksurface to valance is 24.25".
- Woodgrain runs horizontal on both the upper and lower back panels.

Z72S42HSR	15 x 72 x 41.9-42.4	150	184	32.50	\$1793	\$1898	\$501	N/A
Z66S42HSR	15 x 66 x 41.9-42.4	150	171	29.75	\$1656	\$1753	\$484	N/A
Z60S42HSR	15 x 60 x 41.9-42.4	150	159	27.25	\$1552	\$1639	\$452	N/A
Z54S42HSR	15 x 54 x 41.9-42.4	125	148	24.50	\$1463	\$1541	\$438	N/A

4 compartments. Doors on **right** side, open storage on **left**. Closed back features one grommet and flexible sweep for wire management. Doors lock. All hutches shipped pre-assembled.

- Clearance from worksurface to valance is 24.25".
- Woodgrain runs horizontal on both the upper and lower back panels.

Z72S42HSD	15 x 72 x 41.9-42.4	150	193	32.50	\$3707	\$3812	N/A	N/A
Z66S42HSD	15 x 66 x 41.9-42.4	125	180	29.75	\$3417	\$3512	N/A	N/A
Z60S42HSD	15 x 60 x 41.9-42.4	125	168	27.25	\$3173	\$3262	N/A	N/A
Z54S42HSD	15 x 54 x 41.9-42.4	125	156	24.50	\$2939	\$3016	N/A	N/A

Sliding glass doors do not lock. Closed back features one grommet and flexible sweep for wire management. Shipped easy to assemble in 2 cartons. Glass doors shipped separately. Finger pull is silver.

- Clearance from worksurface to valance is 24.25".
- Woodgrain runs horizontal on both the upper and lower back panels.

Z84S42H	15 x 84 x 41.9-42.4	125	247	38.50	\$2048	\$2174	\$1477	N/A
Z72S42H	15 x 72 x 41.9-42.4	125	217	33	\$1817	\$1926	\$1349	N/A
Z71S42H	15 x 71.7 x 41.9-42.4	125	207	33	\$1805	\$1914	\$1347	N/A
Z66S42H	15 x 66 x 41.9-42.4	125	194	30.75	\$1704	\$1805	\$1284	N/A
Z60S42H	15 x 60 x 41.9-42.4	125	180	27.75	\$1592	\$1683	\$1206	N/A

One fixed shelf **and fixed shelf divider**. Closed back features one grommet and flexible sweep for wire management. Doors lock. All hutches shipped pre-assembled.

- Clearance from worksurface to valance is 24.25".
- Woodgrain runs horizontal on both the upper and lower back panels.

Z48S42H	15 x 48 x 41.9-42.4	125	148	22.25	\$1257	\$1333	\$766	N/A
Z42S42H	15 x 42 x 41.9-42.4	125	134	19.50	\$1139	\$1207	\$742	N/A
Z36S42H	15 x 36 x 41.9-42.4	125	120	17	\$1042	\$1103	\$679	N/A
Z30S42H	15 x 30 x 41.9-42.4	125	106	14.25	\$958	\$1007	\$608	N/A

One fixed shelf. Closed back features one grommet and flexible sweep for wire management. Doors lock. All hutches shipped pre-assembled.

- Clearance from worksurface to valance is 24.25".
- Woodgrain runs horizontal on both the upper and lower back panels.

Required Specifications

Top finish
Top thickness/edge detail
Base finish
Lock finish*

Door front finish*, if laminate
Handles*

Optional Specifications

Key #**
Glazed doors*

Accessories

Tackboard
Pigeon-hole storage

CLOSED HUTCHES

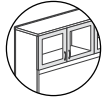

Glazed door option

Hutch w/2 Outer Doors - 55"H*

MODEL#	DIMENSIONS D x W x H	FREIGHT CLASS	WT/LBS.	CUBIC FT.	1" TOP	1.5" TOP	GLAZE ADD	HP ADD
Z72S55HOH	15 x 72 x 54.4-54.9	92.5	262	26	\$2665	\$2774	\$718	N/A
Z66S55HOH	15 x 66 x 54.4-54.9	92.5	246	24	\$2527	\$2628	\$704	N/A
Z60S55HOH	15 x 60 x 54.4-54.9	92.5	229	22	\$2362	\$2529	\$639	N/A
Z54S55HOH	15 x 54 x 54.4-54.9	92.5	213	19.76	\$2232	\$2387	\$627	N/A

4 compartments. **Doors on outer compartments only.** Closed back features one grommet and flexible sweep for wire management. Doors lock. Top portion ships pre-assembled. Lower portion ships RTA.

- Clearance from worksurface to valance is 24.25".
- Woodgrain runs horizontal on both the upper and lower back panels.

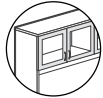

Glazed door option

Hutch w/2 Inner Doors - 55"H*

Z72S55OHO	15 x 72 x 54.4-54.9	92.5	263	26	\$2667	\$2778	\$722	N/A
Z66S55OHO	15 x 66 x 54.4-54.9	92.5	247	24	\$2530	\$2631	\$709	N/A
Z60S55OHO	15 x 60 x 54.4-54.9	92.5	230	22	\$2398	\$2490	\$643	N/A
Z54S55OHO	15 x 54 x 54.4-54.9	92.5	214	19.76	\$2234	\$2319	\$629	N/A

4 compartments. **Doors on inner compartments only.** Closed back features one grommet and flexible sweep for wire management. Doors lock. Top portion ships pre-assembled. Lower portion ships RTA.

- Clearance from worksurface to valance is 24.25".
- Woodgrain runs horizontal on both the upper and lower back panels.

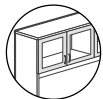

Glazed door option

Hutch w/2 Doors - LEFT, 55"H*

Z72S55HSL	15 x 72 x 54.4-54.9	100	258	26	\$2574	\$2685	\$694	N/A
Z66S55HSL	15 x 66 x 54.4-54.9	100	237	24	\$2457	\$2558	\$681	N/A
Z60S55HSL	15 x 60 x 54.4-54.9	92.5	221	22	\$2281	\$2374	\$639	N/A
Z54S55HSL	15 x 54 x 54.4-54.9	92.5	204	19.76	\$2164	\$2250	\$627	N/A

4 compartments. Doors on **left** side, open storage on **right**. Closed back features one grommet and flexible sweep for wire management. Doors lock. Top portion ships pre-assembled. Lower portion ships RTA.

- Clearance from worksurface to valance is 24.25".
- Woodgrain runs horizontal on both the upper and lower back panels.

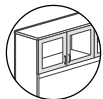

Glazed door option

Hutch w/2 Doors - RIGHT, 55"H*

Z72S55HSR	15 x 72 x 54.4-54.9	100	258	26	\$2574	\$2685	\$694	N/A
Z66S55HSR	15 x 66 x 54.4-54.9	100	237	24	\$2457	\$2558	\$681	N/A
Z60S55HSR	15 x 60 x 54.4-54.9	92.5	221	22	\$2281	\$2374	\$639	N/A
Z54S55HSR	15 x 54 x 54.4-54.9	92.5	204	19.76	\$2164	\$2250	\$627	N/A

4 compartments. Doors on **right** side, open storage on **left**. Closed back features one grommet and flexible sweep for wire management. Doors lock. Top portion ships pre-assembled. Lower portion ships RTA.

- Clearance from worksurface to valance is 24.25".
- Woodgrain runs horizontal on both the upper and lower back panels.



Hutch w/Sliding Glass Doors - 55"H

Z72S55HSD	15 x 72 x 54.4-54.9	92.5	271	26	\$5037	\$5146	N/A	N/A
Z66S55HSD	15 x 66 x 54.4-54.9	92.5	253	24	\$4709	\$4809	N/A	N/A
Z60S55HSD	15 x 60 x 54.4-54.9	92.5	235	22	\$4358	\$4450	N/A	N/A
Z54S55HSD	15 x 54 x 54.4-54.9	92.5	217	19.75	\$4036	\$4121	N/A	N/A

Sliding glass doors do not lock. Closed back features one grommet and flexible sweep for wire management. Shipped easy to assemble in 3 cartons. Glass doors shipped separately. Finger pull is silver.

- Clearance from worksurface to valance is 24.25".
- Woodgrain runs horizontal on both the upper and lower back panels.

Required Specifications

- Top finish
- Top thickness/edge detail
- Base finish
- Lock finish*

Door front finish*, if laminate

Handles*

Optional Specifications

- Key #*
- Glazed doors*

Accessories

- Tackboard
- Pigeon-hole storage

CLOSED HUTCHES

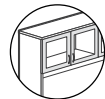

Glazed door option

Closed Hutch w/Doors - 55"H*

MODEL#	DIMENSIONS D x W x H	FREIGHT CLASS	WT/LBS.	CUBIC FT.	1"TOP	1.5" TOP	GLAZE ADD	HP ADD
Z84S55H	15 x 84 x 54.4-54.9	150	349	62.37	\$3106	\$3234	\$2145	N/A
Z72S55H	15 x 72 x 54.4-54.9	150	308	53.65	\$2799	\$2926	\$1939	N/A
Z71S55H	15 x 71.7 x 54.4-54.9	150	307	53.65	\$2790	\$2904	\$1916	N/A
Z66S55H	15 x 66 x 54.4-54.9	150	287	49.40	\$2640	\$2753	\$1825	N/A
Z60S55H	15 x 60 x 54.4-54.9	150	269	45.15	\$2427	\$2521	\$1697	N/A

One fixed shelf and one adjustable shelf (per compartment). Closed back features one grommet and flexible sweep for wire management. Doors lock. Shipped RTA (ready to assemble).

- Clearance from worksurface to valance is 24.25".
- Woodgrain runs horizontal on both the upper and lower back panels.

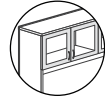

Glazed door option

Closed Hutch w/Doors - 55"H*

Z48S55H	15 x 48 x 54.4-54.9	150	207	36	\$1806	\$1867	\$1185	N/A
Z42S55H	15 x 42 x 54.4-54.9	150	188	31.50	\$1646	\$1714	\$1074	N/A
Z36S55H	15 x 36 x 54.4-54.9	125	167	27.26	\$1500	\$1560	\$972	N/A
Z30S55H	15 x 30 x 54.4-54.9	125	148	23	\$1356	\$1405	\$851	N/A

One fixed shelf and one adjustable shelf. Closed back features one grommet and flexible sweep for wire management. Doors lock. Shipped RTA (ready to assemble).

- Clearance from worksurface to valance is 24.25".
- Woodgrain runs horizontal on both the upper and lower back panels.

PIGEON-HOLE STORAGE

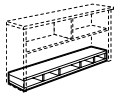

Horizontal Pigeon-Hole Storage

MODEL#	DIMENSIONS	FREIGHT CLASS	WT/LBS.	CUBIC FT.	1"TOP	1.5" TOP	GLAZE ADD	HP ADD
ZHS84	12 x 82 x 5.66	70	49	3	\$895	N/A	N/A	N/A
ZHS72	12 x 70 x 5.66	70	49	3	\$806	N/A	N/A	N/A
ZHS71	12 x 69.6 x 5.66	70	49	3	\$806	N/A	N/A	N/A
ZHS66	12 x 63.9 x 5.66	70	46	2.80	\$762	N/A	N/A	N/A
ZHS60	12 x 58 x 5.66	70	42	2.50	\$728	N/A	N/A	N/A
ZHS48	12 x 45.9 x 5.66	70	33	2	\$545	N/A	N/A	N/A
ZHS42	12 x 40 x 5.66	85	29	2	\$511	N/A	N/A	N/A
ZHS36	12 x 33.9 x 5.66	85	26	2	\$480	N/A	N/A	N/A

For additional storage. Can be **top** or **bottom** mounted. For use inside hutch. Shipped RTA (ready to assemble).

- *Cannot be used on overstorage units.*
- Available in all standard laminate finishes (see page 179).

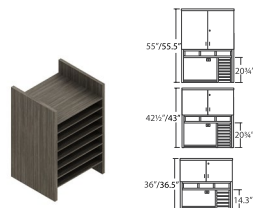

Vertical Pigeon-Hole Storage

ZVS21	11.8 x 13.42 x 20.75	70	30	1.80	\$402	N/A	N/A	N/A
ZVS14	11.8 x 13.42 x 14.3	85	24	1.80	\$327	N/A	N/A	N/A

For use in conjunction with the horizontal pigeon-hole storage. Can be used **under** or **over** horizontal unit. Not freestanding. Shipped RTA (ready to assemble).

Vertical pigeon-hole shell - available in all standard laminate finishes (see page 179).

- Collator shelves - available in Black (**K**) or Brushed Cobalt (**T**) finish. Please specify.

Use Brushed Cobalt to match Silver finish handles.

- When used together with tackboard and hutch, valance must be removed.

Required Specifications

Top finish
Top thickness/edge detail
Base finish
Lock finish*

Door front finish*, if laminate

Handles*

Optional Specifications

Key #**
Glazed doors*

Accessories

Tackboard
Pigeon-hole storage

PIGEON-HOLE STORAGE

MODEL#	DIMENSIONS	FREIGHT CLASS	WT/LBS.	CUBIC FT.	1" TOP	1.5" TOP	GLAZE ADD	HP ADD
--------	------------	---------------	---------	-----------	--------	----------	-----------	--------

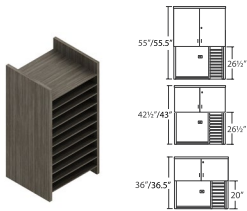

Vertical Pigeon-Hole Storage

	D x W x H							
ZVS26	11.8 x 13.42 x 25.4-25.9	70	36	1.80	\$482	N/A	N/A	N/A
ZVS20	11.8 x 13.42 x 19-19.5	70	29	1.80	\$386	N/A	N/A	N/A

Used alone with a hutch. **Not freestanding.** Shipped easy to assemble in 1 carton.

- Vertical pigeon-hole shell - available in all standard laminate finishes (see page 179).
- Collator shelves - available in Black (K) or Brushed Cobalt (T) finish. Please specify.
Use Brushed Cobalt to match Silver finish handles.
- When used together with tackboard and hutch, valance must be removed.

TRANSITIONAL PIGEON-HOLE STORAGE

MODEL#	DIMENSIONS	FREIGHT CLASS	WT/LBS.	CUBIC FT.	1" TOP	1.5" TOP	GLAZE ADD	HP ADD
--------	------------	---------------	---------	-----------	--------	----------	-----------	--------



Transitional Pigeon-Hole Storage
11.75" H

Z24L12PH	24 x 24 x 11.25-11.75	65	63	2.70	\$796	\$877	N/A	N/A
Z20L12PH	24 x 20 x 11.25-11.75	70	56	2.70	\$702	\$773	N/A	N/A
Z16L12PH	24 x 16 x 11.25-11.75	65	46	1.60	\$643	\$704	N/A	N/A
Z24M12PH	20 x 24 x 11.25-11.75	70	55	2.70	\$702	\$773	N/A	N/A
Z20M12PH	20 x 20 x 11.25-11.75	70	48	2.70	\$624	\$682	N/A	N/A
Z16M12PH	20 x 16 x 11.25-11.75	65	40	1.60	\$565	\$614	N/A	N/A
Z24S12PH	16 x 24 x 11.25-11.75	65	43	1.60	\$647	\$707	N/A	N/A
Z20S12PH	16 x 20 x 11.25-11.75	65	38	1.60	\$568	\$616	N/A	N/A
Z16S12PH	16 x 16 x 11.25-11.75	70	33	1.60	\$532	\$573	N/A	N/A

Designed to fit on top of returns and transition worksurface to match 40.8"/41.3" high storage modules. Pigeon-hole shell and four collator shelves. Shipped RTA (ready to assemble).

- Pigeon-Hole Shell - Available in all standard laminate finishes (page 179).
- Collator Shelves - Available in Black (K) or Brushed Cobalt (T) finish. Please Specify.
Use Brushed Cobalt to match silver finish handles.



Transitional Pigeon-Hole Storage
23.5" H

Z24L23PH	24 x 24 x 23-23.5	60	101	2.70	\$1432	\$1513	N/A	N/A
Z20L23PH	24 x 20 x 23-23.5	60	88	2.70	\$1253	\$1321	N/A	N/A
Z16L23PH	24 x 16 x 23-23.5	65	76	2.70	\$1175	\$1236	N/A	N/A
Z24M23PH	20 x 24 x 23-23.5	60	87	2.70	\$1256	\$1324	N/A	N/A
Z20M23PH	20 x 20 x 23-23.5	65	76	2.70	\$1099	\$1157	N/A	N/A
Z16M23PH	20 x 16 x 23-23.5	60	64	1.60	\$1010	\$1059	N/A	N/A
Z24S23PH	16 x 24 x 23-23.5	65	74	2.70	\$1188	\$1248	N/A	N/A
Z20S23PH	16 x 20 x 23-23.5	65	65	2.70	\$1038	\$1087	N/A	N/A
Z16S23PH	16 x 16 x 23-23.5	60	54	1.60	\$948	\$993	N/A	N/A

Designed to fit on top of returns and transition worksurface to match 52.5"/53" high storage modules. Pigeon-hole shell and eight collator shelves. Shipped RTA (ready to assemble).

- Pigeon-Hole Shell - Available in all standard laminate finishes (page 179).
- Collator Shelves - Available in Black (K) or Brushed Cobalt (T) finish. Please Specify.
Use Brushed Cobalt to match silver finish handles.

Required Specifications

- Top finish
- Wall finish
- Top thickness/edge detail
- Shelf finish

Optional Specifications

- End filler cap
- Grommet

FLOATING SHELVES



Floating Shelf - 20" H

MODEL#	DIMENSIONS D x W x H	FREIGHT CLASS	WT/LBS.	CUBIC FT.	1" TOP	1.5" TOP	GLAZE ADD	HP ADD
ZFS4220	14.25 x 42 x 20	70	55	2.75	\$650	\$691	N/A	N/A
ZFS3620	14.25 x 36 x 20	70	47	2.40	\$584	\$621	N/A	N/A
ZFS3020	14.25 x 30 x 20	70	39	2	\$497	\$529	N/A	N/A
ZFS2420	14.25 x 24 x 20	70	33	1.90	\$438	\$470	N/A	N/A

To match 71.9/72.4"H units. Standard with pre-mounted "J" bracket for wall mount applications. End cap required at the end of a run of floating shelves. End cap sold separately, see page 319.

• **NOTE:** Care should be taken to mount the units. Units should be mounted to wall studs using correct fasteners. Failure to do so may result in collapse of the unit and subsequent personal injury. **Fastening hardware not included.** Mounting hardware used should be based on wall material. Consult an installation professional for proper wall mounting.



Double Floating Shelf - 32.5" H

ZF2S4232	14.25 x 42 x 32.5	65	85	3.30	\$927	\$968	N/A	N/A
ZF2S3632	14.25 x 36 x 32.5	65	73	2.90	\$830	\$867	N/A	N/A
ZF2S3032	14.25 x 30 x 32.5	65	60	2.50	\$708	\$740	N/A	N/A
ZF2S2432	14.25 x 24 x 32.5	70	50	2.40	\$627	\$659	N/A	N/A

To match 84.4/84.9"H units. Standard with pre-mounted "J" bracket for wall mount applications. End cap required at the end of a run of floating shelves. End cap sold separately, see page 319.

• **NOTE:** Care should be taken to mount the units. Units should be mounted to wall studs using correct fasteners. Failure to do so may result in collapse of the unit and subsequent personal injury. **Fastening hardware not included.** Mounting hardware used should be based on wall material. Consult an installation professional for proper wall mounting.

WALLS W/OVERHEAD STORAGE



Glazed door option

Wall w/Closed Storage - 66" H*

MODEL#	DIMENSIONS	FREIGHT CLASS	WT/LBS.	CUBIC FT.	1" TOP	1.5" TOP	GLAZE ADD	HP ADD
Z4266WS	16 x 42 x 65.5-66	85	122	8.26	\$1561	\$1629	\$549	N/A
Z3666WS	16 x 36 x 65.5-66	85	113	8.80	\$1314	\$1374	\$505	N/A
Z3066WS	16 x 30 x 65.5-66	85	97	7.50	\$1314	\$1353	\$452	N/A
Z2466WS	16 x 24 x 65.5-66	92.5	79	6.60	\$1159	\$1200	\$407	N/A

Standard with pre-mounted "J" bracket for wall mount applications. Doors lock. End cap required at the end of a run of wall units. End cap sold separately, see page 319.

• **NOTE:** Care should be taken to mount the units. Units should be mounted to wall studs using correct fasteners. Failure to do so may result in collapse of the unit and subsequent personal injury. **Mounting hardware not included.** Mounting hardware used should be based on wall material. Consult an installation professional for proper wall mounting.



Glazed door option

Wall w/Closed Storage - 66" H*

Z4266WSO	16 x 42 x 65.5-66	125	112	18.60	\$1664	\$1732	\$549	N/A
Z3666WSO	16 x 36 x 65.5-66	125	100	16.20	\$1514	\$1574	\$505	N/A
Z3066WSO	16 x 30 x 65.5-66	125	85	13.50	\$1320	\$1375	\$452	N/A
Z2466WSO	16 x 24 x 65.5-66	92.5	70	6.20	\$1171	\$1212	\$407	N/A

Standard with pre-mounted "J" bracket for wall mount applications. Doors lock. Large cutout provides direct access to wall for access to electrical. End cap required at the end of a run of wall units. End cap sold separately, see page 319.

• **NOTE:** Care should be taken to mount the units. Units should be mounted to wall studs using correct fasteners. Failure to do so may result in collapse of the unit and subsequent personal injury. **Mounting hardware not included.** Mounting hardware used should be based on wall material. Consult an installation professional for proper wall mounting.



Glazed door option

Wall w/Closed Storage - 72" H*

Z4272WS	16 x 42 x 71.9-72.4	85	134	10.20	\$1664	\$1749	\$629	N/A
Z3672WS	16 x 36 x 71.9-72.4	85	119	9.46	\$1603	\$1678	\$575	N/A
Z3072WS	16 x 30 x 71.9-72.4	85	102	8.10	\$1408	\$1470	\$515	N/A
Z2472WS	16 x 24 x 71.9-72.4	85	84	6.60	\$1235	\$1287	\$468	N/A

Standard with pre-mounted "J" bracket for wall mount applications. Doors lock. End cap required at the end of a run of wall units. End cap sold separately, see page 319.

• **NOTE:** Care should be taken to mount the units. Units should be mounted to wall studs using correct fasteners. Failure to do so may result in collapse of the unit and subsequent personal injury. **Mounting hardware not included.** Mounting hardware used should be based on wall material. Consult an installation professional for proper wall mounting.

Required Specifications

Top finish
 Top thickness/edge detail
 Wall finish
 Shelf or door finish, if laminate doors
 Handles*

Optional Specifications

Key #*
 Glazed doors*
 Grommet position*
 End filler cap

WALLS W/OVERHEAD STORAGE

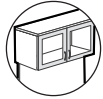

Glazed door option

Wall w/Closed Storage - 72"H*

MODEL#	DIMENSIONS	FREIGHT CLASS	WT/LBS.	CUBIC FT.	1"TOP	1.5" TOP	GLAZE ADD	HP ADD	
D x W x H									
Z4272WSO	16 x 42 x 71.9-72.4	85	120	9.30	\$1681	\$1766	\$629	N/A	
Z3672WSO	16 x 36 x 71.9-72.4	85	105	8.66	\$1617	\$1692	\$575	N/A	
Z3072WSO	16 x 30 x 71.9-72.4	85	91	7.50	\$1420	\$1506	\$515	N/A	
Z2472WSO	16 x 24 x 71.9-72.4	92.5	74	6.20	\$1247	\$1299	\$468	N/A	

Standard with pre-mounted "J" bracket for wall mount applications. Doors lock. Large cutout provides direct access to wall for access to electrical. End cap required at the end of a run of wall units. End cap sold separately, see page 319.

• **NOTE:** Care should be taken to mount the units. Units should be mounted to wall studs using correct fasteners. Failure to do so may result in collapse of the unit and subsequent personal injury. **Mounting hardware not included.** Mounting hardware used should be based on wall material. Consult an installation professional for proper wall mounting.

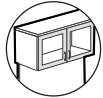

Glazed door option

Wall w/Closed Storage - 84"H*

Z4284WS	16 x 42 x 84.4-84.9	85	134	10.20	\$2058	\$2143	\$873	N/A
Z3684WS	16 x 36 x 84.4-84.9	85	119	9.46	\$1955	\$2044	\$797	N/A
Z3084WS	16 x 30 x 84.4-84.9	85	102	8.10	\$1718	\$1780	\$708	N/A
Z2484WS	16 x 24 x 84.4-84.9	85	84	6.60	\$1514	\$1566	\$643	N/A

Standard with pre-mounted "J" bracket for wall mount applications. Doors lock. End cap required at the end of a run of wall units. End cap sold separately, see page 319.

• **NOTE:** Care should be taken to mount the units. Units should be mounted to wall studs using correct fasteners. Failure to do so may result in collapse of the unit and subsequent personal injury. **Mounting hardware not included.** Mounting hardware used should be based on wall material. Consult an installation professional for proper wall mounting.

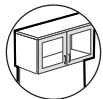

Glazed door option

Wall w/Closed Storage - 84"H*

Z4284WSO	16 x 42 x 84.4-84.9	85	120	9.30	\$2073	\$2158	\$873	N/A
Z3684WSO	16 x 36 x 84.4-84.9	85	105	8.66	\$1969	\$2058	\$797	N/A
Z3084WSO	16 x 30 x 84.4-84.9	85	91	7.50	\$1731	\$1793	\$708	N/A
Z2484WSO	16 x 24 x 84.4-84.9	92.5	74	6.20	\$1523	\$1575	\$643	N/A

Standard with pre-mounted "J" bracket for wall mount applications. Doors lock. Large cutout provides direct access to wall for access to electrical. End cap required at the end of a run of wall units. End cap sold separately, see page 319.

• **NOTE:** Care should be taken to mount the units. Units should be mounted to wall studs using correct fasteners. Failure to do so may result in collapse of the unit and subsequent personal injury. **Mounting hardware not included.** Mounting hardware used should be based on wall material. Consult an installation professional for proper wall mounting.

WALLS W/FLOATING SHELVES



Wall w/Floating Shelf* - 66"H

MODEL#	DIMENSIONS	FREIGHT CLASS	WT/LBS.	CUBIC FT.	1"TOP	1.5" TOP	GLAZE ADD	HP ADD
ZF1S4266	14.25 x 42 x 65.5-66	70	117	7.50	\$1216	\$1257	N/A	N/A
ZF1S3666	14.25 x 36 x 65.5-66	70	103	6.60	\$1059	\$1096	N/A	N/A
ZF1S3066	14.25 x 30 x 65.5-66	70	86	5.70	\$913	\$950	N/A	N/A
ZF1S2466	14.25 x 24 x 65.5-66	85	69	4.70	\$783	\$814	N/A	N/A

Standard with pre-mounted "J" bracket for wall mount applications. End cap required at the end of a run of floating shelves. End cap sold separately, see page 319.

• **NOTE:** Care should be taken to mount the units. Units should be mounted to wall studs using correct fasteners. Failure to do so may result in collapse of the unit and subsequent personal injury. **Fastening hardware not included.** Mounting hardware used should be based on wall material. Consult an installation professional for proper wall mounting.



Wall w/Floating Shelf* - 66"H

ZF1S42660	14.25 x 42 x 65.5-66	85	110	7.50	\$1228	\$1269	N/A	N/A
ZF1S36660	14.25 x 36 x 65.5-66	85	97	6.60	\$1071	\$1108	N/A	N/A
ZF1S30660	14.25 x 30 x 65.5-66	85	81	5.70	\$921	\$958	N/A	N/A
ZF1S24660	14.25 x 24 x 65.5-66	85	66	4.70	\$789	\$820	N/A	N/A

Standard with pre-mounted "J" bracket for wall mount applications. Large cutout provides direct access to wall for access to electrical. End cap required at the end of a run of floating shelves. End cap sold separately, see page 319.

• **NOTE:** Care should be taken to mount the units. Units should be mounted to wall studs using correct fasteners. Failure to do so may result in collapse of the unit and subsequent personal injury. **Fastening hardware not included.** Mounting hardware used should be based on wall material. Consult an installation professional for proper wall mounting.

Required Specifications

Top finish
 Top thickness/edge detail
 Wall finish
 Shelf or door finish, if laminate doors
 Handles*

Optional Specifications

Key #*
 Glazed doors*
 Grommet position*
 End filler cap

WALLS W/FLOATING SHELVES



Wall w/Floating Shelf* - 72"H

MODEL#	DIMENSIONS D x W x H	FREIGHT CLASS	WT/LBS.	CUBIC FT.	1" TOP	1.5" TOP	GLAZE ADD	HP ADD
ZF1S4272	14.25 x 42 x 71.9-72.4	70	127	8	\$1280	\$1321	N/A	N/A
ZF1S3672	14.25 x 36 x 71.9-72.4	70	110	7.10	\$1118	\$1155	N/A	N/A
ZF1S3072	14.25 x 30 x 71.9-72.4	70	92	6.10	\$987	\$1024	N/A	N/A
ZF1S2472	14.25 x 24 x 71.9-72.4	85	74	5	\$837	\$868	N/A	N/A

Standard with pre-mounted "J" bracket for wall mount applications. End cap required at the end of a run of floating shelves. End cap sold separately, see page 319.

- **NOTE:** Care should be taken to mount the units. Units should be mounted to wall studs using correct fasteners. Failure to do so may result in collapse of the unit and subsequent personal injury. **Fastening hardware not included.** Mounting hardware used should be based on wall material. Consult an installation professional for proper wall mounting.



Wall w/Floating Shelf* - 72"H

ZF1S42720	14.25 x 42 x 71.9-72.4	70	120	8	\$1294	\$1335	N/A	N/A
ZF1S36720	14.25 x 36 x 71.9-72.4	85	104	7.10	\$1130	\$1167	N/A	N/A
ZF1S30720	14.25 x 30 x 71.9-72.4	85	87	6.10	\$999	\$1036	N/A	N/A
ZF1S24720	14.25 x 24 x 71.9-72.4	85	71	5	\$842	\$873	N/A	N/A

Standard with pre-mounted "J" bracket for wall mount applications. Large cutout provides direct access to wall for access to electrical. End cap required at the end of a run of floating shelves. End cap sold separately, see page 319.

- **NOTE:** Care should be taken to mount the units. Units should be mounted to wall studs using correct fasteners. Failure to do so may result in collapse of the unit and subsequent personal injury. **Fastening hardware not included.** Mounting hardware used should be based on wall material. Consult an installation professional for proper wall mounting.



Wall w/Floating Shelves - 84"H

ZF2S4284	14.25 x 42 x 84.4-84.9	70	158	9.50	\$1503	\$1544	N/A	N/A
ZF2S3684	14.25 x 36 x 84.4-84.9	70	136	8.40	\$1294	\$1343	N/A	N/A
ZF2S3084	14.25 x 30 x 84.4-84.9	70	113	7.10	\$1144	\$1175	N/A	N/A
ZF2S2484	14.25 x 24 x 84.4-84.9	85	91	6.25	\$992	\$1023	N/A	N/A

Standard with pre-mounted "J" bracket for wall mount applications. End cap required at the end of a run of floating shelves. End cap sold separately, see page 319.

- **NOTE:** Care should be taken to mount the units. Units should be mounted to wall studs using correct fasteners. Failure to do so may result in collapse of the unit and subsequent personal injury. **Fastening hardware not included.** Mounting hardware used should be based on wall material. Consult an installation professional for proper wall mounting.



Wall w/Floating Shelves - 84"H

ZF2S42840	14.25 x 42 x 84.4-84.9	70	148	9.50	\$1516	\$1557	N/A	N/A
ZF2S36840	14.25 x 36 x 84.4-84.9	70	128	8.40	\$1313	\$1354	N/A	N/A
ZF2S30840	14.25 x 30 x 84.4-84.9	85	106	7.10	\$1242	\$1273	N/A	N/A
ZF2S24840	14.25 x 24 x 84.4-84.9	85	86	6.25	\$999	\$1030	N/A	N/A

Standard with pre-mounted "J" bracket for wall mount applications. Large cutout provides direct access to wall for access to electrical. End cap required at the end of a run of floating shelves. End cap sold separately, see page 319.

- **NOTE:** Care should be taken to mount the units. Units should be mounted to wall studs using correct fasteners. Failure to do so may result in collapse of the unit and subsequent personal injury. **Fastening hardware not included.** Mounting hardware used should be based on wall material. Consult an installation professional for proper wall mounting.



Wall w/Floating Shelves - 66"H

ZF2S4266	14.25 x 42 x 65.5-66	70	132	7.50	\$1254	\$1295	N/A	N/A
ZF2S3666	14.25 x 36 x 65.5-66	70	115	6.60	\$1088	\$1125	N/A	N/A
ZF2S3066	14.25 x 30 x 65.5-66	70	96	5.70	\$945	\$977	N/A	N/A
ZF2S2466	14.25 x 24 x 65.5-66	70	77	4.70	\$809	\$841	N/A	N/A

Standard with pre-mounted "J" bracket for wall mount applications. End cap required at the end of a run of floating shelves. End cap sold separately, see page 319.

- **NOTE:** Care should be taken to mount the units. Units should be mounted to wall studs using correct fasteners. Failure to do so may result in collapse of the unit and subsequent personal injury. **Fastening hardware not included.** Mounting hardware used should be based on wall material. Consult an installation professional for proper wall mounting.

Required Specifications

Top finish
Wall finish
Top/Edge Detail
Shelf finish

Optional Specifications

End filler cap
Grommet

WALLS W/FLOATING SHELVES



Wall w/Floating Shelves - 66"H

MODEL#	DIMENSIONS	FREIGHT CLASS	WT/LBS.	CUBIC FT.	1" TOP	1.5" TOP	GLAZE ADD	HP ADD
D x W x H								
ZF2S42660	14.25 x 42 x 65.5-66	70	125	7.50	\$1270	\$1311	N/A	N/A
ZF2S36660	14.25 x 36 x 65.5-66	70	109	6.60	\$1101	\$1138	N/A	N/A
ZF2S30660	14.25 x 30 x 65.5-66	70	91	5.70	\$958	\$990	N/A	N/A
ZF2S24660	14.25 x 24 x 65.5-66	70	74	4.70	\$816	\$848	N/A	N/A

Standard with pre-mounted "J" bracket for wall mount applications. Large cutout provides direct access to wall for access to electrical. End cap required at the end of a run of floating shelves. End cap sold separately, see page 319.

• **NOTE:** Care should be taken to mount the units. Units should be mounted to wall studs using correct fasteners. Failure to do so may result in collapse of the unit and subsequent personal injury. **Fastening hardware not included.** Mounting hardware used should be based on wall material. Consult an installation professional for proper wall mounting.



Wall w/Floating Shelves - 72"H

ZF2S4272	14.25 x 42 x 71.9-72.4	70	142	8	\$1320	\$1361	N/A	N/A
ZF2S3672	14.25 x 36 x 71.9-72.4	70	122	7.10	\$1148	\$1185	N/A	N/A
ZF2S3072	14.25 x 30 x 71.9-72.4	70	102	6.10	\$1017	\$1049	N/A	N/A
ZF2S2472	14.25 x 24 x 71.9-72.4	70	82	5	\$860	\$892	N/A	N/A

Standard with pre-mounted "J" bracket for wall mount applications. End cap required at the end of a run of floating shelves. End cap sold separately, see page 319.

• **NOTE:** Care should be taken to mount the units. Units should be mounted to wall studs using correct fasteners. Failure to do so may result in collapse of the unit and subsequent personal injury. **Fastening hardware not included.** Mounting hardware used should be based on wall material. Consult an installation professional for proper wall mounting.



Wall w/Floating Shelves - 72"H

ZF2S42720	14.25 x 42 x 71.9-72.4	70	135	8	\$1335	\$1376	N/A	N/A
ZF2S36720	14.25 x 36 x 71.9-72.4	70	116	7.10	\$1162	\$1199	N/A	N/A
ZF2S30720	14.25 x 30 x 71.9-72.4	70	97	6.10	\$1028	\$1060	N/A	N/A
ZF2S24720	14.25 x 24 x 71.9-72.4	70	79	5	\$868	\$900	N/A	N/A

Standard with pre-mounted "J" bracket for wall mount applications. Large cutout provides direct access to wall for access to electrical. End cap required at the end of a run of floating shelves. End cap sold separately, see page 319.

• **NOTE:** Care should be taken to mount the units. Units should be mounted to wall studs using correct fasteners. Failure to do so may result in collapse of the unit and subsequent personal injury. **Fastening hardware not included.** Mounting hardware used should be based on wall material. Consult an installation professional for proper wall mounting.



Wall w/Floating Shelves - 84"H

ZF3S4284	14.25 x 42 x 84.4-84.9	70	173	9.50	\$1542	\$1574	N/A	N/A
ZF3S3684	14.25 x 36 x 84.4-84.9	70	148	8.40	\$1335	\$1372	N/A	N/A
ZF3S3084	14.25 x 30 x 84.4-84.9	70	116	7.10	\$1174	\$1206	N/A	N/A
ZF3S2484	14.25 x 24 x 84.4-84.9	70	99	6.25	\$1019	\$1051	N/A	N/A

Standard with pre-mounted "J" bracket for wall mount applications. End cap required at the end of a run of floating shelves. End cap sold separately, see page 319.

• **NOTE:** Care should be taken to mount the units. Units should be mounted to wall studs using correct fasteners. Failure to do so may result in collapse of the unit and subsequent personal injury. **Fastening hardware not included.** Mounting hardware used should be based on wall material. Consult an installation professional for proper wall mounting.



Wall w/Floating Shelves - 84"H

ZF3S42840	14.25 x 42 x 84.4-84.9	70	163	9.50	\$1558	\$1599	N/A	N/A
ZF3S36840	14.25 x 36 x 84.4-84.9	70	140	8.40	\$1350	\$1387	N/A	N/A
ZF3S30840	14.25 x 30 x 84.4-84.9	70	116	7.10	\$1274	\$1306	N/A	N/A
ZF3S24840	14.25 x 24 x 84.4-84.9	70	94	6.25	\$1025	\$1057	N/A	N/A

Standard with pre-mounted "J" bracket for wall mount applications. Large cutout provides direct access to wall for access to electrical. End cap required at the end of a run of floating shelves. End cap sold separately, see page 319.

• **NOTE:** Care should be taken to mount the units. Units should be mounted to wall studs using correct fasteners. Failure to do so may result in collapse of the unit and subsequent personal injury. **Fastening hardware not included.** Mounting hardware used should be based on wall material. Consult an installation professional for proper wall mounting.

Required Specifications

Top finish
Wall finish
Top/Edge Detail
Shelf finish

Optional Specifications

End filler cap
Grommet

WALL PANELS



Wall Panel - 66”H

MODEL#	DIMENSIONS D x W x H	FREIGHT CLASS	WT/LBS.	CUBIC FT.	1”TOP	1.5” TOP	GLAZE ADD	HP ADD
ZWHP4266	3.5 x 42 x 65.5-66	85	99	7.50	\$1077	\$1118	N/A	N/A
ZWHP3666	3.5 x 36 x 65.5-66	85	90	6.60	\$857	\$894	N/A	N/A
ZWHP3066	3.5 x 30 x 65.5-66	85	75	5.70	\$743	\$775	N/A	N/A
ZWHP2466	3.5 x 24 x 65.5-66	85	61	4.70	\$636	\$668	N/A	N/A

Standard with pre-mounted “J” bracket for wall mount applications. End cap required at the end of a run of floating shelves. End cap sold separately, see page 319.

- **NOTE:** Care should be taken to mount the units. Units should be mounted to wall studs using correct fasteners. Failure to do so may result in collapse of the unit and subsequent personal injury. **Fastening hardware not included.** Mounting hardware used should be based on wall material. Consult an installation professional for proper wall mounting.



Wall Panel - 66”H

ZWHP42660	3.5 x 42 x 65.5-66	85	90	7.50	\$1093	\$1134	N/A	N/A
ZWHP36660	3.5 x 36 x 65.5-66	85	82	6.60	\$870	\$907	N/A	N/A
ZWHP30660	3.5 x 30 x 65.5-66	85	69	5.70	\$756	\$788	N/A	N/A
ZWHP24660	3.5 x 24 x 65.5-66	92.5	56	4.70	\$643	\$675	N/A	N/A

Standard with pre-mounted “J” bracket for wall mount applications. Large cutout provides direct access to wall for access to electrical. End cap required at the end of a run of floating shelves. End cap sold separately, see page 319.

- **NOTE:** Care should be taken to mount the units. Units should be mounted to wall studs using correct fasteners. Failure to do so may result in collapse of the unit and subsequent personal injury. **Fastening hardware not included.** Mounting hardware used should be based on wall material. Consult an installation professional for proper wall mounting.



Wall Panel - 72”H

ZWHP4272	3.5 x 42 x 71.9-72.4	85	113	8	\$1053	\$1094	N/A	N/A
ZWHP3672	3.5 x 36 x 71.9-72.4	85	97	7.10	\$917	\$954	N/A	N/A
ZWHP3072	3.5 x 30 x 71.9-72.4	85	81	6.10	\$815	\$847	N/A	N/A
ZWHP2472	3.5 x 24 x 71.9-72.4	85	67	5	\$687	\$719	N/A	N/A

Standard with pre-mounted “J” bracket for wall mount applications. End cap required at the end of a run of floating shelves. End cap sold separately, see page 319.

- **NOTE:** Care should be taken to mount the units. Units should be mounted to wall studs using correct fasteners. Failure to do so may result in collapse of the unit and subsequent personal injury. **Fastening hardware not included.** Mounting hardware used should be based on wall material. Consult an installation professional for proper wall mounting.



Wall Panel - 72”H

ZWHP42720	3.5 x 42 x 71.9-72.4	85	104	8	\$1069	\$1110	N/A	N/A
ZWHP36720	3.5 x 36 x 71.9-72.4	85	89	7.10	\$930	\$967	N/A	N/A
ZWHP30720	3.5 x 30 x 71.9-72.4	85	75	6.10	\$827	\$859	N/A	N/A
ZWHP24720	3.5 x 24 x 71.9-72.4	85	62	5	\$696	\$728	N/A	N/A

Standard with pre-mounted “J” bracket for wall mount applications. Large cutout provides direct access to wall for access to electrical. End cap required at the end of a run of floating shelves. End cap sold separately, see page 319.

- **NOTE:** Care should be taken to mount the units. Units should be mounted to wall studs using correct fasteners. Failure to do so may result in collapse of the unit and subsequent personal injury. **Fastening hardware not included.** Mounting hardware used should be based on wall material. Consult an installation professional for proper wall mounting.



Wall Panel - 84”H

ZWHP4284	3.5 x 42 x 84.4-84.9	85	128	9.50	\$1122	\$1163	N/A	N/A
ZWHP3684	3.5 x 36 x 84.4-84.9	85	111	8.40	\$989	\$1026	N/A	N/A
ZWHP3084	3.5 x 30 x 84.4-84.9	85	92	7.10	\$881	\$913	N/A	N/A
ZWHP2484	3.5 x 24 x 84.4-84.9	85	75	6.25	\$760	\$792	N/A	N/A

Standard with pre-mounted “J” bracket for wall mount applications. End cap required at the end of a run of floating shelves. End cap sold separately, see page 319.

- **NOTE:** Care should be taken to mount the units. Units should be mounted to wall studs using correct fasteners. Failure to do so may result in collapse of the unit and subsequent personal injury. **Fastening hardware not included.** Mounting hardware used should be based on wall material. Consult an installation professional for proper wall mounting.

Required Specifications

Top finish
Wall finish
Top/Edge Detail

Optional Specifications

End filler cap
Grommet

WALL PANELS	MODEL#	DIMENSIONS	FREIGHT CLASS	WT/LBS.	CUBIC FT.	1" TOP	1.5" TOP	GLAZE ADD	HP ADD
		D x W x H							
	ZWHP42840	3.5 x 42 x 84.4-84.9	85	119	9.50	\$1138	\$1179	N/A	N/A
	ZWHP36840	3.5 x 36 x 84.4-84.9	85	103	8.40	\$1002	\$1039	N/A	N/A
	ZWHP30840	3.5 x 30 x 84.4-84.9	85	92	7.10	\$891	\$923	N/A	N/A
	ZWHP24840	3.5 x 24 x 84.4-84.9	92.5	70	6.25	\$768	\$800	N/A	N/A

Wall Panel - 84"H

Standard with pre-mounted "J" bracket for wall mount applications. Large cutout provides direct access to wall for access to electrical. End cap required at the end of a run of floating shelves. End cap sold separately, see page 319.

• **NOTE:** Care should be taken to mount the units. Units should be mounted to wall studs using correct fasteners. Failure to do so may result in collapse of the unit and subsequent personal injury. **Fastening hardware not included.** Mounting hardware used should be based on wall material. Consult an installation professional for proper wall mounting.

END FILLER CAPS	MODEL#	DIMENSIONS	FREIGHT CLASS	WT/LBS.	CUBIC FT.	1" TOP	1.5" TOP	GLAZE ADD	HP ADD
-----------------	--------	------------	---------------	---------	-----------	--------	----------	-----------	--------



ZEFC19	.75 x 2.5 x 17	70	1.50	.25	\$179	N/A	N/A	N/A
--------	----------------	----	------	-----	--------------	-----	-----	-----

For ZFSxxxx 20"H floating shelf.



ZEFC32	.75 x 2.5 x 30	300	2	2	\$292	N/A	N/A	N/A
--------	----------------	-----	---	---	--------------	-----	-----	-----

For ZF2Sxxxx 32.5"H floating shelf.



ZEFC49	.75 x 2.5 x 47	250	3	1.20	\$383	N/A	N/A	N/A
--------	----------------	-----	---	------	--------------	-----	-----	-----

For Zxx66WS/Zxx66WSO 65.5/66"H walls with overhead.



ZEFC52	.75 x 2.5 x 50	250	4	1.30	\$411	N/A	N/A	N/A
--------	----------------	-----	---	------	--------------	-----	-----	-----

For Zxx72WS/Zxx72WSO/Zxx84WS/Zxx84WSO 71.9/72.4"H or 84.4/84.9"H walls with overhead.



ZEFC66	.75 x 2.5 x 64	300	4	4	\$501	N/A	N/A	N/A
--------	----------------	-----	---	---	--------------	-----	-----	-----

For ZF1Sxx66/ZF1Sxx66O/ZF2Sxx66/ZF2Sxx66O/ZWHPxx66/ZWHPxx66O 65.5/66"H wall panels, with or without shelves.

Required Specifications

Top finish
Wall finish
Top/Edge Detail

Optional Specifications

End filler cap
Grommet

END FILLER CAPS

MODEL# DIMENSIONS FREIGHT CLASS WT/LBS. CUBIC FT. 1" TOP 1.5" TOP GLAZE ADD HP ADD

D x W x H

ZEFC72	.75 x 2.5 x 70.5	300	4	4	\$540	N/A	N/A	N/A
--------	------------------	-----	---	---	--------------	-----	-----	-----



End Cap

For ZF1Sxx72/ZF1Sxx720/ZF2Sxx72/ZF2Sxx720/ZWHPxx72/ZWHPxx720 71.9/72.4"H wall panels, with or without shelves.

ZEFC84	.75 x 2.5 x 83	300	5	4.50	\$632	N/A	N/A	N/A
--------	----------------	-----	---	------	--------------	-----	-----	-----



End Cap

For ZF1Sxx84/ZF1Sxx840/ZF2Sxx84/ZF2Sxx840/ZF3Sxx84/ZFSxx840/ZWHPxx84/ZWHPxx840 84.4/84.9"H wall panels, with or without shelves.

Required Specifications

Finish

TACKBOARDS FOR HUTCHES

D x W x H

TACKBOARD Notes: Tackboards can be upholstered in all of the following fabrics:

Grade 1: Jenny, Quilt, Terrace, Urban, Waterfall

Grade 2: Imprint, Lola

Grade 3: Anchorage, Merge

TACKBOARDS - 23" / 23.5" HIGH

MODEL#	DIMENSIONS	FREIGHT CLASS	WT/LBS.	CUBIC FT.	FAB GRD	LIST	FAB GRD	LIST
ZTB8217	.62 x 82 x 16.5-17	150	8.20	2	1	\$824	7	\$2147
					2	\$992	8	\$2471
					3	\$1186	9	\$2843
					4	\$1417	10	\$3267
					5	\$1628	11	\$3754
					6	\$1869	12	\$4315

For use on **Z84S23HN** hutch. Includes mounting screws.

ZTB7017	.62 x 70 x 16.5-17	150	7	1.30	1	\$547	7	\$1430
					2	\$660	8	\$1643
					3	\$790	9	\$1889
					4	\$940	10	\$2174
					5	\$1083	11	\$2498
					6	\$1244	12	\$2873

For use on **Z72S23HN** hutch. Includes mounting screws.

ZTB6917	.62 x 69 x 16.5-17	150	7	1.30	1	\$544	7	\$1418
					2	\$657	8	\$1632
					3	\$787	9	\$1877
					4	\$935	10	\$2157
					5	\$1073	11	\$2482
					6	\$1234	12	\$2853

For use on **Z71S23HN** hutch. Includes mounting screws.

ZTB6417	.62 x 64 x 16.5-17	150	6.40	1.30	1	\$539	7	\$1399
					2	\$649	8	\$1610
					3	\$773	9	\$1851
					4	\$921	10	\$2130
					5	\$1059	11	\$2447
					6	\$1218	12	\$2815

For use on **Z66S23HN** hutch. Includes mounting screws.

ZTB5817	.62 x 58 x 16.5-17	150	5.80	1.08	1	\$526	7	\$1371
					2	\$633	8	\$1576
					3	\$760	9	\$1814
					4	\$905	10	\$2085
					5	\$1040	11	\$2399
					6	\$1194	12	\$2758

For use on **Z60S23HN** hutch. Includes mounting screws.

Required Specifications

Fabric

TACKBOARDS - 23" / 23.5" HIGH



Tackboard



Tackboard



Tackboard



Tackboard

MODEL#	DIMENSIONS	FREIGHT CLASS	WT/LBS.	CUBIC FT.	FAB GRD	LIST	FAB GRD	LIST
	D x W x H							
ZTB4617	.62 x 46 x 16.5-17	150	4.60	.85	1	\$353	7	\$918
					2	\$427	8	\$1052
					3	\$509	9	\$1211
					4	\$604	10	\$1391
					5	\$692	11	\$1597
					6	\$795	12	\$1837

For use on **Z48S23HN** hutch. Includes mounting screws.

ZTB4017	.62 x 40 x 16.5-17	150	4	.85	1	\$339	7	\$878
					2	\$409	8	\$1010
					3	\$489	9	\$1161
					4	\$577	10	\$1334
					5	\$664	11	\$1535
					6	\$762	12	\$1766

For use on **Z42S23HN** hutch. Includes mounting screws.

ZTB3417	.62 x 34 x 16.5-17	150	3.40	.85	1	\$329	7	\$846
					2	\$399	8	\$973
					3	\$475	9	\$1118
					4	\$558	10	\$1287
					5	\$642	11	\$1478
					6	\$738	12	\$1698

For use on **Z36S23HN** hutch. Includes mounting screws.

ZTB2817	.62 x 28 x 16.5-17	250	2.80	.85	1	\$315	7	\$818
					2	\$384	8	\$941
					3	\$457	9	\$1082
					4	\$541	10	\$1244
					5	\$621	11	\$1431
					6	\$712	12	\$1646

For use on **Z30S23HN** hutch. Includes mounting screws.

TACKBOARDS FOR HUTCHES - 36" / 36.5" HIGH

FABRIC GRADE LIST PRICE



Tackboard



Tackboard

ZTB8216	.62 x 82 x 15-15.5	150	8.20	2	1	\$824	7	\$2147
					2	\$992	8	\$2471
					3	\$1186	9	\$2843
					4	\$1417	10	\$3267
					5	\$1628	11	\$3754
					6	\$1869	12	\$4315

For use on **Z84S36H and Z84S36HN** hutches. Includes mounting screws.

ZTB7016	.62 x 70 x 15-15.5	150	7	1.30	1	\$547	7	\$1430
					2	\$660	8	\$1643
					3	\$790	9	\$1889
					4	\$940	10	\$2174
					5	\$1083	11	\$2498
					6	\$1244	12	\$2873

For use on **Z72S36xxx** hutches. Includes mounting screws.

Required Specifications
Fabric

TACKBOARDS - 36" / 36.5" HIGH

MODEL#	DIMENSIONS	FREIGHT CLASS	WT/LBS.	CUBIC FT.	FAB GRD	LIST	FAB GRD	LIST
--------	------------	---------------	---------	-----------	---------	------	---------	------

D x W x H

ZTB6916	.62 x 69.5 x 15-15.5	150	7	1.30	1	\$544	7	\$1418
					2	\$657	8	\$1632
					3	\$787	9	\$1877
					4	\$935	10	\$2157
					5	\$1073	11	\$2482
					6	\$1234	12	\$2853

For use on **Z71S36H and Z71S36HN** hutches. Includes mounting screws.

ZTB6416	.62 x 64 x 15-15.5	150	6.40	1.30	1	\$539	7	\$1399
					2	\$649	8	\$1610
					3	\$773	9	\$1851
					4	\$921	10	\$2130
					5	\$1059	11	\$2447
					6	\$1218	12	\$2815

For use on **Z66S36xxx** hutches. Includes mounting screws.

ZTB5816	.62 x 58 x 15-15.5	150	5.80	1.08	1	\$526	7	\$1371
					2	\$633	8	\$1576
					3	\$760	9	\$1814
					4	\$905	10	\$2085
					5	\$1040	11	\$2399
					6	\$1194	12	\$2758

For use on **Z60S36xxx** hutches. Includes mounting screws.

ZTB4616	.62 x 46 x 15-15.5	150	4.60	.85	1	\$353	7	\$918
					2	\$427	8	\$1052
					3	\$509	9	\$1211
					4	\$604	10	\$1391
					5	\$692	11	\$1597
					6	\$795	12	\$1837

For use on **Z48S36H and Z48S36HN** hutches. Includes mounting screws.

ZTB4016	.62 x 40 x 15-15.5	150	4	.85	1	\$339	7	\$878
					2	\$409	8	\$1010
					3	\$489	9	\$1161
					4	\$577	10	\$1334
					5	\$664	11	\$1535
					6	\$762	12	\$1766

For use on **Z42S36H and Z42S36HN** hutch. Includes mounting screws.

ZTB3416	.62 x 34 x 15-15.5	150	3.40	.85	1	\$329	7	\$846
					2	\$399	8	\$973
					3	\$475	9	\$1118
					4	\$558	10	\$1287
					5	\$642	11	\$1478
					6	\$738	12	\$1698

For use on **Z36S36H and Z36S36HN** hutch. Includes mounting screws.

Required Specifications

Fabric

TACKBOARDS - 42.4", 42.9" & 54.9", 55.4" HIGH

Tackboard

MODEL#	DIMENSIONS D x W x H	FREIGHT CLASS	WT/LBS.	CUBIC FT.	FAB GRD	LIST	FAB GRD	LIST
ZTB2816	.62 x 28 x 15-15.5	250	2.80	.85	1	\$315	7	\$818
					2	\$384	8	\$941
					3	\$457	9	\$1082
					4	\$541	10	\$1244
					5	\$621	11	\$1431
					6	\$712	12	\$1646

For use on **Z30S36H and Z30S36HN** hutch. Includes mounting screws.

Tackboard

ZTB8221	.62 x 82 x 20.5-21	150	12.80	2.30	1	\$1003	7	\$2616
					2	\$1202	8	\$3009
					3	\$1442	9	\$3458
					4	\$1721	10	\$3978
					5	\$1977	11	\$4574
					6	\$2275	12	\$5259

For use on **Z84S42H, Z84S42HN, Z84S55H and Z84S55HN** hutches. Includes mounting screws.

Tackboard

ZTB7021	.62 x 70 x 20.5-21	125	11	1.50	1	\$675	7	\$1752
					2	\$808	8	\$2015
					3	\$968	9	\$2315
					4	\$1153	10	\$2665
					5	\$1326	11	\$3064
					6	\$1523	12	\$3520

For use on **Z72S42xxx and Z72S55xxx** hutches. Includes mounting screws.

Tackboard

ZTB6921	.62 x 69 x 20.5-21	125	10.70	1.50	1	\$661	7	\$1730
					2	\$799	8	\$1987
					3	\$954	9	\$2286
					4	\$1138	10	\$2629
					5	\$1307	11	\$3024
					6	\$1503	12	\$3475

For use on **Z71S42H, Z71S42HN, Z71S55H and Z71S55HN** hutches. Includes mounting screws.

Tackboard

ZTB6421	.62 x 64 x 20.5-21	125	10	1.50	1	\$625	7	\$1631
					2	\$753	8	\$1879
					3	\$905	9	\$2157
					4	\$1075	10	\$2484
					5	\$1235	11	\$2853
					6	\$1418	12	\$3281

For use on **Z66S42xxx and Z66S55xxx** hutches. Includes mounting screws.

Tackboard

ZTB5821	.62 x 58 x 20.5-21	125	9	1.50	1	\$620	7	\$1615
					2	\$751	8	\$1856
					3	\$897	9	\$2136
					4	\$1064	10	\$2454
					5	\$1223	11	\$2823
					6	\$1405	12	\$3243

For use on **Z60S42xxx and Z60S55xxx** hutches. Includes mounting screws.

Required Specifications
Fabric

TACKBOARDS - 42.4", 42.9" & 54.9", 55.4" HIGH



Tackboard

MODEL#	DIMENSIONS	FREIGHT CLASS	WT/LBS.	CUBIC FT.	FAB GRD	LIST	FAB GRD	LIST
ZTB4621	.62 x 46 x 20.5-21	125	7.20	1	1	\$384	7	\$999
					2	\$464	8	\$1146
					3	\$554	9	\$1319
					4	\$657	10	\$1514
					5	\$754	11	\$1743
					6	\$868	12	\$2003

For use on **Z48S42H, Z48S42HN, Z48S55H and Z48S55HN** hutches. Includes mounting screws.



Tackboard

ZTB4021	.62 x 40 x 20.5-21	125	6.20	1	1	\$370	7	\$967
					2	\$447	8	\$1110
					3	\$539	9	\$1279
					4	\$635	10	\$1467
					5	\$732	11	\$1687
					6	\$841	12	\$1940

For use on **Z42S42H, Z42S42HN, Z42S55H and Z42S55HN** hutches. Includes mounting screws.



Tackboard

ZTB3421	.62 x 34 x 20.5-21	150	5.30	1	1	\$366	7	\$948
					2	\$441	8	\$1092
					3	\$529	9	\$1254
					4	\$624	10	\$1441
					5	\$719	11	\$1656
					6	\$827	12	\$1906

For use on **Z36S42H, Z36S42HN, Z36S55H and Z36S55HN** hutches. Includes mounting screws.



Tackboard

ZTB2821	.62 x 28 x 20.5-21	150	4.50	1	1	\$362	7	\$938
					2	\$436	8	\$1077
					3	\$519	9	\$1236
					4	\$617	10	\$1423
					5	\$706	11	\$1635
					6	\$814	12	\$1881

For use on **Z30S42H, Z30S42HN, Z30S55H and Z30S55HN** hutches. Includes mounting screws.

14" WALL-MOUNTED TACKBOARDS



Wall Mounted Tackboard

MODEL#	DIMENSIONS	FREIGHT CLASS	WT/LBS.	CUBIC FT.	FAB GRD	LIST	FAB GRD	LIST
ZWHT3014	1.25 x 30 x 13.5-14	150	4.70	1	1	\$355	7	\$819
					2	\$412	8	\$937
					3	\$473	9	\$1078
					4	\$541	10	\$1238
					5	\$620	11	\$1423
					6	\$712	12	\$1632

For use under **Z30S200S/OSN/OSD/OSR/OSL/OSO/SOS** for a finished height of **65"/65.5"**. Standard with pre-mounted "J" bracket for wall mount applications.

- **NOTE:** Care should be taken to mount the units. Units should be mounted to wall studs using correct fasteners. Failure to do so may result in collapse of the unit and subsequent personal injury. **Mounting hardware not included.** Mounting hardware used should be based on wall material. Consult an installation professional for proper wall mounting.

Required Specifications

Fabric

14" WALL-MOUNTED TACKBOARDS



Wall Mounted Tackboard

MODEL#	DIMENSIONS D x W x H	FREIGHT CLASS	WT/LBS.	CUBIC FT.	FAB GRD	LIST	FAB GRD	LIST
ZWHT3614	1.25 x 36 x 13.5-14	150	5.60	1	1	\$391	7	\$905
					2	\$455	8	\$1037
					3	\$519	9	\$1192
					4	\$598	10	\$1369
					5	\$684	11	\$1575
					6	\$787	12	\$1808

For use under **Z36S200S/OSN/OSD/OSR/OSL/OSO/SOS** for a finished height of **65"/65.5"**. Standard with pre-mounted "J" bracket for wall mount applications.

• **NOTE:** Care should be taken to mount the units. Units should be mounted to wall studs using correct fasteners. Failure to do so may result in collapse of the unit and subsequent personal injury. **Mounting hardware not included.** Mounting hardware used should be based on wall material. Consult an installation professional for proper wall mounting.



Wall Mounted Tackboard

ZWHT4214	1.25 x 42 x 13.5-14	125	6.50	1	1	\$458	7	\$1053
					2	\$529	8	\$1209
					3	\$607	9	\$1389
					4	\$695	10	\$1596
					5	\$797	11	\$1832
					6	\$919	12	\$2108

For use under **Z42S200S/OSN/OSD/OSR/OSL/OSO/SOS** for a finished height of **65"/65.5"**. Standard with pre-mounted "J" bracket for wall mount applications.

• **NOTE:** Care should be taken to mount the units. Units should be mounted to wall studs using correct fasteners. Failure to do so may result in collapse of the unit and subsequent personal injury. **Mounting hardware not included.** Mounting hardware used should be based on wall material. Consult an installation professional for proper wall mounting.



Wall Mounted Tackboard

ZWHT4814	1.25 x 48 x 13.5-14	125	7.50	1	1	\$495	7	\$1140
					2	\$572	8	\$1310
					3	\$655	9	\$1507
					4	\$753	10	\$1730
					5	\$864	11	\$1988
					6	\$992	12	\$2284

For use under **Z48S200S/OSN/OSD/OSR/OSL/OSO/SOS** for a finished height of **65"/65.5"**. Standard with pre-mounted "J" bracket for wall mount applications.

• **NOTE:** Care should be taken to mount the units. Units should be mounted to wall studs using correct fasteners. Failure to do so may result in collapse of the unit and subsequent personal injury. **Mounting hardware not included.** Mounting hardware used should be based on wall material. Consult an installation professional for proper wall mounting.



Wall Mounted Tackboard

ZWHT6014	1.25 x 60 x 13.5-14	150	9.30	1.80	1	\$616	7	\$1421
					2	\$710	8	\$1631
					3	\$816	9	\$1875
					4	\$938	10	\$2156
					5	\$1077	11	\$2477
					6	\$1237	12	\$2848

For use under **Z60S200S/OSN/OSD/OSR/OSL/OSO/SOS** for a finished height of **65"/65.5"**. Standard with pre-mounted "J" bracket for wall mount applications.

• **NOTE:** Care should be taken to mount the units. Units should be mounted to wall studs using correct fasteners. Failure to do so may result in collapse of the unit and subsequent personal injury. **Mounting hardware not included.** Mounting hardware used should be based on wall material. Consult an installation professional for proper wall mounting.

Required Specifications
Fabric

14" WALL-MOUNTED TACKBOARDS



Wall Mounted Tackboard

MODEL#	DIMENSIONS	FREIGHT CLASS	WT/LBS.	CUBIC FT.	FAB GRD	LIST	FAB GRD	LIST
ZWHT6614	1.25 x 66 x 13.5-14	150	10.30	1.80	1	\$654	7	\$1511
					2	\$754	8	\$1734
					3	\$865	9	\$1990
					4	\$993	10	\$2289
					5	\$1141	11	\$2631
					6	\$1314	12	\$3024

For use under **ZxxS200S/OSN/OSD/OSR/OSL/OSO/SOS** for a finished height of **65"/65.5"**. Standard with pre-mounted "J" bracket for wall mount applications.

- NOTE:** Care should be taken to mount the units. Units should be mounted to wall studs using correct fasteners. Failure to do so may result in collapse of the unit and subsequent personal injury. **Mounting hardware not included.** Mounting hardware used should be based on wall material. Consult an installation professional for proper wall mounting.



Wall Mounted Tackboard

ZWHT7214	1.25 x 72 x 13.5-14	125	11.20	1.80	1	\$717	7	\$1657
					2	\$829	8	\$1902
					3	\$951	9	\$2188
					4	\$1095	10	\$2512
					5	\$1255	11	\$2888
					6	\$1443	12	\$3322

For use under **ZxxS200S/OSN/OSD/OSR/OSL/OSO/SOS** for a finished height of **65"/65.5"**. Standard with pre-mounted "J" bracket for wall mount applications.

- NOTE:** Care should be taken to mount the units. Units should be mounted to wall studs using correct fasteners. Failure to do so may result in collapse of the unit and subsequent personal injury. **Mounting hardware not included.** Mounting hardware used should be based on wall material. Consult an installation professional for proper wall mounting.



Wall Mounted Tackboard

ZWHT7814	1.25 x 78 x 13.5-14	125	12.10	1.80	1	\$757	7	\$1747
					2	\$875	8	\$2007
					3	\$1006	9	\$2305
					4	\$1150	10	\$2650
					5	\$1324	11	\$3045
					6	\$1519	12	\$3499

For use under **ZxxS200S/OSN/OSD/OSR/OSL/OSO/SOS** for a finished height of **65"/65.5"**. Standard with pre-mounted "J" bracket for wall mount applications.

- NOTE:** Care should be taken to mount the units. Units should be mounted to wall studs using correct fasteners. Failure to do so may result in collapse of the unit and subsequent personal injury. **Mounting hardware not included.** Mounting hardware used should be based on wall material. Consult an installation professional for proper wall mounting.



Wall Mounted Tackboard

ZWHT8414	1.25 x 84 x 13.5-14	125	13.10	1.80	1	\$817	7	\$1891
					2	\$944	8	\$2174
					3	\$1086	9	\$2498
					4	\$1248	10	\$2872
					5	\$1432	11	\$3299
					6	\$1645	12	\$3795

For use under **ZxxS200S/OSN/OSD/OSR/OSL/OSO/SOS** for a finished height of **65"/65.5"**. Standard with pre-mounted "J" bracket for wall mount applications.

- NOTE:** Care should be taken to mount the units. Units should be mounted to wall studs using correct fasteners. Failure to do so may result in collapse of the unit and subsequent personal injury. **Mounting hardware not included.** Mounting hardware used should be based on wall material. Consult an installation professional for proper wall mounting.

Required Specifications
Fabric

18" WALL-MOUNTED TACKBOARDS



Wall Mounted Tackboard

MODEL#	DIMENSIONS D x W x H	FREIGHT CLASS	WT/LBS.	CUBIC FT.	FAB GRD	LIST	FAB GRD	LIST
ZWHT3018	1.25 x 30 x 17.5-18	125	6	1	1	\$366	7	\$844
					2	\$426	8	\$969
					3	\$488	9	\$1114
					4	\$560	10	\$1281
					5	\$642	11	\$1472
					6	\$735	12	\$1689

For use under **Z30S160S/OSN** for a finished height of **65"/65.5"**. Standard with pre-mounted "J" bracket for wall mount applications.

- **NOTE:** Care should be taken to mount the units. Units should be mounted to wall studs using correct fasteners. Failure to do so may result in collapse of the unit and subsequent personal injury. **Mounting hardware not included.** Mounting hardware used should be based on wall material. Consult an installation professional for proper wall mounting.



Wall Mounted Tackboard

ZWHT3618	1.25 x 36 x 17.5-18	125	7.20	1	1	\$406	7	\$934
					2	\$471	8	\$1074
					3	\$540	9	\$1234
					4	\$618	10	\$1419
					5	\$711	11	\$1630
					6	\$817	12	\$1872

For use under **Z36S160S/OSN** for a finished height of **65"/65.5"**. Standard with pre-mounted "J" bracket for wall mount applications.

- **NOTE:** Care should be taken to mount the units. Units should be mounted to wall studs using correct fasteners. Failure to do so may result in collapse of the unit and subsequent personal injury. **Mounting hardware not included.** Mounting hardware used should be based on wall material. Consult an installation professional for proper wall mounting.



Wall Mounted Tackboard

ZWHT4218	1.25 x 42 x 17.5-18	100	8.40	1	1	\$471	7	\$1087
					2	\$545	8	\$1250
					3	\$624	9	\$1434
					4	\$719	10	\$1646
					5	\$824	11	\$1891
					6	\$944	12	\$2175

For use under **Z42S160S/OSN** for a finished height of **65"/65.5"**. Standard with pre-mounted "J" bracket for wall mount applications.

- **NOTE:** Care should be taken to mount the units. Units should be mounted to wall studs using correct fasteners. Failure to do so may result in collapse of the unit and subsequent personal injury. **Mounting hardware not included.** Mounting hardware used should be based on wall material. Consult an installation professional for proper wall mounting.



Wall Mounted Tackboard

ZWHT4818	1.25 x 48 x 17.5-18	100	9.60	1	1	\$513	7	\$1181
					2	\$592	8	\$1356
					3	\$682	9	\$1558
					4	\$782	10	\$1790
					5	\$897	11	\$2057
					6	\$1029	12	\$2361

For use under **Z48S160S/OSN** for a finished height of **65"/65.5"**. Standard with pre-mounted "J" bracket for wall mount applications.

- **NOTE:** Care should be taken to mount the units. Units should be mounted to wall studs using correct fasteners. Failure to do so may result in collapse of the unit and subsequent personal injury. **Mounting hardware not included.** Mounting hardware used should be based on wall material. Consult an installation professional for proper wall mounting.

Required Specifications

Fabric

18" WALL-MOUNTED TACKBOARDS

MODEL#	DIMENSIONS	FREIGHT CLASS	WT/LBS.	CUBIC FT.	FAB GRD	LIST	FAB GRD	LIST	
ZWHT6018	1.25 x 60 x 17.5-18	125	12	1.80					
					D x W x H				
					1	\$630	7	\$1457	
					2	\$726	8	\$1674	
					3	\$837	9	\$1921	
					4	\$960	10	\$2209	
5	\$1102	11	\$2542						
6	\$1266	12	\$2919						

Wall Mounted Tackboard

For use under **Z60S160S/OSN** for a finished height of **65"/65.5"**. Standard with pre-mounted "J" bracket for wall mount applications.

- **NOTE:** Care should be taken to mount the units. Units should be mounted to wall studs using correct fasteners. Failure to do so may result in collapse of the unit and subsequent personal injury. **Mounting hardware not included.** Mounting hardware used should be based on wall material. Consult an installation professional for proper wall mounting.

ZWHT6618	1.25 x 66 x 17.5-18	125	13.20	1.80				
					1	\$671	7	\$1551
					2	\$776	8	\$1781
					3	\$892	9	\$2046
					4	\$1024	10	\$2352
					5	\$1174	11	\$2704
6	\$1350	12	\$3107					

Wall Mounted Tackboard

For use under **ZxxS160S/OSN** for a finished height of **65"/65.5"**. Standard with pre-mounted "J" bracket for wall mount applications.

- **NOTE:** Care should be taken to mount the units. Units should be mounted to wall studs using correct fasteners. Failure to do so may result in collapse of the unit and subsequent personal injury. **Mounting hardware not included.** Mounting hardware used should be based on wall material. Consult an installation professional for proper wall mounting.

ZWHT7218	1.25 x 72 x 17.5-18	100	14.40	1.80				
					1	\$737	7	\$1702
					2	\$851	8	\$1954
					3	\$975	9	\$2249
					4	\$1122	10	\$2582
					5	\$1287	11	\$2970
6	\$1479	12	\$3415					

Wall Mounted Tackboard

For use under **ZxxS160S/OSN** for a finished height of **65"/65.5"**. Standard with pre-mounted "J" bracket for wall mount applications.

- **NOTE:** Care should be taken to mount the units. Units should be mounted to wall studs using correct fasteners. Failure to do so may result in collapse of the unit and subsequent personal injury. **Mounting hardware not included.** Mounting hardware used should be based on wall material. Consult an installation professional for proper wall mounting.

ZWHT7818	1.25 x 78 x 17.5-18	100	15.60	1.80				
					1	\$777	7	\$1792
					2	\$898	8	\$2059
					3	\$1029	9	\$2365
					4	\$1184	10	\$2721
					5	\$1357	11	\$3127
6	\$1560	12	\$3593					

Wall Mounted Tackboard

For use under **ZxxS160S/OSN** for a finished height of **65"/65.5"**. Standard with pre-mounted "J" bracket for wall mount applications.

- **NOTE:** Care should be taken to mount the units. Units should be mounted to wall studs using correct fasteners. Failure to do so may result in collapse of the unit and subsequent personal injury. **Mounting hardware not included.** Mounting hardware used should be based on wall material. Consult an installation professional for proper wall mounting.

Required Specifications

Fabric

18" WALL-MOUNTED TACKBOARDS



Wall Mounted Tackboard

MODEL#	DIMENSIONS	FREIGHT CLASS	WT/LBS.	CUBIC FT.	FAB GRD	LIST	FAB GRD	LIST
ZWHT8418	1.25 x 84 x 17.5-18	100	16.80	1.80	1	\$841	7	\$1944
					2	\$969	8	\$2233
					3	\$1116	9	\$2567
					4	\$1281	10	\$2950
					5	\$1471	11	\$3392
					6	\$1689	12	\$3899

For use under **ZxxS160S/OSN** for a finished height of **65"/65.5"**. Standard with pre-mounted "J" bracket for wall mount applications.

• **NOTE:** Care should be taken to mount the units. Units should be mounted to wall studs using correct fasteners. Failure to do so may result in collapse of the unit and subsequent personal injury. **Mounting hardware not included.** Mounting hardware used should be based on wall material. Consult an installation professional for proper wall mounting.



Wall Mounted Tackboard

ZWHT3021	1.25 x 30 x 20.5-21	125	7	1	1	\$374	7	\$861
					2	\$435	8	\$990
					3	\$497	9	\$1136
					4	\$570	10	\$1306
					5	\$655	11	\$1501
					6	\$753	12	\$1723

For use under **Z30S210S/OSN/OSD/OSR/OSL/OSO/SOS** for a finished height of **71.5"/72"**. Standard with pre-mounted "J" bracket for wall mount applications. For use under **Z30S330S/OSN** for a finished height of **84"/84.5"**

• **NOTE:** Care should be taken to mount the units. Units should be mounted to wall studs using correct fasteners. Failure to do so may result in collapse of the unit and subsequent personal injury. **Mounting hardware not included.** Mounting hardware used should be based on wall material. Consult an installation professional for proper wall mounting.



Wall Mounted Tackboard

ZWHT3621	1.25 x 36 x 20.5-21	100	8.40	1	1	\$414	7	\$954
					2	\$482	8	\$1097
					3	\$549	9	\$1259
					4	\$633	10	\$1446
					5	\$725	11	\$1664
					6	\$833	12	\$1912

For use under **Z36S210S/OSN/OSD/OSR/OSL/OSO/SOS** for a finished height of **71.5"/72"**. Standard with pre-mounted "J" bracket for wall mount applications. For use under **Z36S330S/OSN** for a finished height of **84"/84.5"**

• **NOTE:** Care should be taken to mount the units. Units should be mounted to wall studs using correct fasteners. Failure to do so may result in collapse of the unit and subsequent personal injury. **Mounting hardware not included.** Mounting hardware used should be based on wall material. Consult an installation professional for proper wall mounting.



Wall Mounted Tackboard

ZWHT4221	1.25 x 42 x 20.5-21	100	9.80	1	1	\$478	7	\$1106
					2	\$553	8	\$1269
					3	\$635	9	\$1460
					4	\$730	10	\$1677
					5	\$837	11	\$1927
					6	\$963	12	\$2214

For use under **Z42S210S/OSN/OSD/OSR/OSL/OSO/SOS** for a finished height of **71.5"/72"**. Standard with pre-mounted "J" bracket for wall mount applications. For use under **Z42S330S/OSN** for a finished height of **84"/84.5"**

• **NOTE:** Care should be taken to mount the units. Units should be mounted to wall studs using correct fasteners. Failure to do so may result in collapse of the unit and subsequent personal injury. **Mounting hardware not included.** Mounting hardware used should be based on wall material. Consult an installation professional for proper wall mounting.



Wall Mounted Tackboard

ZWHT4821	1.25 x 48 x 20.5-21	92.5	11.20	1	1	\$520	7	\$1200
					2	\$600	8	\$1379
					3	\$690	9	\$1587
					4	\$793	10	\$1818
					5	\$910	11	\$2092
					6	\$1044	12	\$2403

For use under **Z48S210S/OSN/OSD/OSR/OSL/OSO/SOS** for a finished height of **71.5"/72"**. Standard with pre-mounted "J" bracket for wall mount applications. For use under **Z48S330S/OSN** for a finished height of **84"/84.5"**

• **NOTE:** Care should be taken to mount the units. Units should be mounted to wall studs using correct fasteners. Failure to do so may result in collapse of the unit and subsequent personal injury. **Mounting hardware not included.** Mounting hardware used should be based on wall material. Consult an installation professional for proper wall mounting.

Required Specifications

Fabric

21" WALL-MOUNTED TACKBOARDS

MODEL#	DIMENSIONS	FREIGHT CLASS	WT./LBS.	CUBIC FT.	FAB GRD	LIST	FAB GRD	LIST
--------	------------	---------------	----------	-----------	---------	------	---------	------

D x W x H



Wall Mounted Tackboard

ZWHT6021	1.25 x 60 x 20.5-21	125	14	1.80	1	\$644	7	\$1486
					2	\$742	8	\$1711
					3	\$854	9	\$1963
					4	\$981	10	\$2255
					5	\$1127	11	\$2592
					6	\$1294	12	\$2981

For use under **Z60S210S/OSN/OSD/OSR/OSL/OSO/SOS** for a finished height of **71.5"/72"**. Standard with pre-mounted "J" bracket for wall mount applications. For use under **Z60S330S/OSN** for a finished height of **84"/84.5"**

• **NOTE:** Care should be taken to mount the units. Units should be mounted to wall studs using correct fasteners. Failure to do so may result in collapse of the unit and subsequent personal injury. **Mounting hardware not included.** Mounting hardware used should be based on wall material. Consult an installation professional for proper wall mounting.



Wall Mounted Tackboard

ZWHT6621	1.25 x 66 x 20.5-21	100	15.40	1.80	1	\$683	7	\$1578
					2	\$790	8	\$1813
					3	\$906	9	\$2085
					4	\$1041	10	\$2397
					5	\$1198	11	\$2756
					6	\$1373	12	\$3167

For use under **Z66S210S/OSN/OSD/OSR/OSL/OSO/SOS** for a finished height of **71.5"/72"**. Standard with pre-mounted "J" bracket for wall mount applications. For use under **Z66S330S/OSN** for a finished height of **84"/84.5"**

• **NOTE:** Care should be taken to mount the units. Units should be mounted to wall studs using correct fasteners. Failure to do so may result in collapse of the unit and subsequent personal injury. **Mounting hardware not included.** Mounting hardware used should be based on wall material. Consult an installation professional for proper wall mounting.



Wall Mounted Tackboard

ZWHT7221	1.25 x 72 x 20.5-21	100	16.80	1.80	1	\$750	7	\$1732
					2	\$866	8	\$1987
					3	\$993	9	\$2286
					4	\$1141	10	\$2627
					5	\$1313	11	\$3019
					6	\$1508	12	\$3472

For use under **Z72S210S/OSN/OSD/OSR/OSL/OSO/SOS** for a finished height of **71.5"/72"**. Standard with pre-mounted "J" bracket for wall mount applications. For use under **Z72S330S/OSN** for a finished height of **84"/84.5"**

• **NOTE:** Care should be taken to mount the units. Units should be mounted to wall studs using correct fasteners. Failure to do so may result in collapse of the unit and subsequent personal injury. **Mounting hardware not included.** Mounting hardware used should be based on wall material. Consult an installation professional for proper wall mounting.



Wall Mounted Tackboard

ZWHT7821	1.25 x 78 x 20.5-21	92.5	18.20	1.80	1	\$789	7	\$1821
					2	\$911	8	\$2097
					3	\$1047	9	\$2409
					4	\$1203	10	\$2768
					5	\$1382	11	\$3183
					6	\$1587	12	\$3660

For use under **Z78S210S/OSN/OSD/OSR/OSL/OSO/SOS** for a finished height of **71.5"/72"**. Standard with pre-mounted "J" bracket for wall mount applications. For use under **Z78S330S/OSN** for a finished height of **84"/84.5"**

• **NOTE:** Care should be taken to mount the units. Units should be mounted to wall studs using correct fasteners. Failure to do so may result in collapse of the unit and subsequent personal injury. **Mounting hardware not included.** Mounting hardware used should be based on wall material. Consult an installation professional for proper wall mounting.



Wall Mounted Tackboard

ZWHT8421	1.25 x 84 x 20.5-21	92.5	19.60	1.80	1	\$859	7	\$1983
					2	\$990	8	\$2277
					3	\$1139	9	\$2618
					4	\$1304	10	\$3010
					5	\$1502	11	\$3459
					6	\$1725	12	\$3975

For use under **Z84S210S/OSN/OSD/OSR/OSL/OSO/SOS** for a finished height of **71.5"/72"**. Standard with pre-mounted "J" bracket for wall mount applications. For use under **Z84S330S/OSN** for a finished height of **84"/84.5"**

• **NOTE:** Care should be taken to mount the units. Units should be mounted to wall studs using correct fasteners. Failure to do so may result in collapse of the unit and subsequent personal injury. **Mounting hardware not included.** Mounting hardware used should be based on wall material. Consult an installation professional for proper wall mounting.

Required Specifications

Fabric

25" WALL-MOUNTED TACKBOARDS



MODEL#	DIMENSIONS	FREIGHT CLASS	WT/LBS.	CUBIC FT.	FAB GRD	LIST	FAB GRD	LIST
	D x W x H							
ZWHT3025	1.25 x 30 x 24.5-25	100	8.30	1	1	\$385	7	\$886
					2	\$447	8	\$1018
					3	\$511	9	\$1169
					4	\$585	10	\$1346
					5	\$672	11	\$1544
					6	\$773	12	\$1774

For use under **Z30S160S/OSN** for a finished height of **71.5"/72"**. Standard with pre-mounted "J" bracket for wall mount applications.

- **NOTE:** Care should be taken to mount the units. Units should be mounted to wall studs using correct fasteners. Failure to do so may result in collapse of the unit and subsequent personal injury. **Mounting hardware not included.** Mounting hardware used should be based on wall material. Consult an installation professional for proper wall mounting.



ZWHT3625	1.25 x 36 x 24.5-25	92.5	10	1	1	\$426	7	\$985
					2	\$495	8	\$1130
					3	\$567	9	\$1298
					4	\$652	10	\$1494
					5	\$745	11	\$1714
					6	\$858	12	\$1970

For use under **Z36S160S/OSN** for a finished height of **71.5"/72"**. Standard with pre-mounted "J" bracket for wall mount applications.

- **NOTE:** Care should be taken to mount the units. Units should be mounted to wall studs using correct fasteners. Failure to do so may result in collapse of the unit and subsequent personal injury. **Mounting hardware not included.** Mounting hardware used should be based on wall material. Consult an installation professional for proper wall mounting.



ZWHT4225	1.25 x 42 x 24.5-25	92.5	11.70	1	1	\$495	7	\$1140
					2	\$572	8	\$1310
					3	\$655	9	\$1507
					4	\$753	10	\$1730
					5	\$864	11	\$1988
					6	\$992	12	\$2284

For use under **Z42S160S/OSN** for a finished height of **71.5"/72"**. Standard with pre-mounted "J" bracket for wall mount applications.

- **NOTE:** Care should be taken to mount the units. Units should be mounted to wall studs using correct fasteners. Failure to do so may result in collapse of the unit and subsequent personal injury. **Mounting hardware not included.** Mounting hardware used should be based on wall material. Consult an installation professional for proper wall mounting.



ZWHT4825	1.25 x 48 x 24.5-25	85	13.30	1	1	\$537	7	\$1240
					2	\$621	8	\$1424
					3	\$713	9	\$1634
					4	\$818	10	\$1878
					5	\$940	11	\$2158
					6	\$1079	12	\$2481

For use under **Z48S160S/OSN** for a finished height of **71.5"/72"**. Standard with pre-mounted "J" bracket for wall mount applications.

- **NOTE:** Care should be taken to mount the units. Units should be mounted to wall studs using correct fasteners. Failure to do so may result in collapse of the unit and subsequent personal injury. **Mounting hardware not included.** Mounting hardware used should be based on wall material. Consult an installation professional for proper wall mounting.



ZWHT6025	1.25 x 60 x 24.5-25	100	16.70	1.80	1	\$662	7	\$1528
					2	\$763	8	\$1757
					3	\$878	9	\$2019
					4	\$1005	10	\$2321
					5	\$1158	11	\$2666
					6	\$1330	12	\$3066

For use under **Z60S160S/OSN** for a finished height of **71.5"/72"**. Standard with pre-mounted "J" bracket for wall mount applications.

- **NOTE:** Care should be taken to mount the units. Units should be mounted to wall studs using correct fasteners. Failure to do so may result in collapse of the unit and subsequent personal injury. **Mounting hardware not included.** Mounting hardware used should be based on wall material. Consult an installation professional for proper wall mounting.

Required Specifications
Fabric

25" WALL-MOUNTED TACKBOARDS



Wall Mounted Tackboard

MODEL#	DIMENSIONS	FREIGHT CLASS	WT/LBS.	CUBIC FT.	FAB GRD	LIST	FAB GRD	LIST
ZWHT6625	1.25 x 66 x 24.5-25	92.5	18.30	1.80	D x W x H			
					1	\$704	7	\$1625
					2	\$814	8	\$1867
					3	\$933	9	\$2147
					4	\$1071	10	\$2468
					5	\$1231	11	\$2836
					6	\$1414	12	\$3260

For use under **ZxxS160S/OSN** for a finished height of **71.5"/72"**. Standard with pre-mounted "J" bracket for wall mount applications.

- **NOTE:** Care should be taken to mount the units. Units should be mounted to wall studs using correct fasteners. Failure to do so may result in collapse of the unit and subsequent personal injury. **Mounting hardware not included.** Mounting hardware used should be based on wall material. Consult an installation professional for proper wall mounting.



Wall Mounted Tackboard

ZWHT7225	1.25 x 72 x 24.5-25	92.5	20	1.80	1	\$773	7	\$1785
					2	\$893	8	\$2049
					3	\$1024	9	\$2353
					4	\$1176	10	\$2708
					5	\$1351	11	\$3110
					6	\$1553	12	\$3576

For use under **ZxxS160S/OSN** for a finished height of **71.5"/72"**. Standard with pre-mounted "J" bracket for wall mount applications.

- **NOTE:** Care should be taken to mount the units. Units should be mounted to wall studs using correct fasteners. Failure to do so may result in collapse of the unit and subsequent personal injury. **Mounting hardware not included.** Mounting hardware used should be based on wall material. Consult an installation professional for proper wall mounting.



Wall Mounted Tackboard

ZWHT7825	1.25 x 78 x 24.5-25	85	21.70	1.80	1	\$813	7	\$1881
					2	\$939	8	\$2159
					3	\$1077	9	\$2483
					4	\$1236	10	\$2853
					5	\$1422	11	\$3280
					6	\$1635	12	\$3770

For use under **ZxxS160S/OSN** for a finished height of **71.5"/72"**. Standard with pre-mounted "J" bracket for wall mount applications.

- **NOTE:** Care should be taken to mount the units. Units should be mounted to wall studs using correct fasteners. Failure to do so may result in collapse of the unit and subsequent personal injury. **Mounting hardware not included.** Mounting hardware used should be based on wall material. Consult an installation professional for proper wall mounting.



Wall Mounted Tackboard

ZWHT8425	1.25 x 84 x 24.5-25	85	23.30	1.80	1	\$883	7	\$2037
					2	\$1018	8	\$2341
					3	\$1168	9	\$2691
					4	\$1344	10	\$3093
					5	\$1543	11	\$3553
					6	\$1772	12	\$4087

For use under **ZxxS160S/OSN** for a finished height of **71.5"/72"**. Standard with pre-mounted "J" bracket for wall mount applications.

- **NOTE:** Care should be taken to mount the units. Units should be mounted to wall studs using correct fasteners. Failure to do so may result in collapse of the unit and subsequent personal injury. **Mounting hardware not included.** Mounting hardware used should be based on wall material. Consult an installation professional for proper wall mounting.

Required Specifications

Fabric

BOOKCASES



Bookcase - 72" High

MODEL#	DIMENSIONS D x W x H	FREIGHT CLASS	WT./LBS.	CUBIC FT.	1" TOP	1.5" TOP	GLAZE ADD	HP ADD
ZHBC72	12 x 36 x 71.9-72.4	125	176	23	\$1225	\$1297	N/A	N/A

One fixed shelf.



Bookcase - 65.5" High

ZHBC65	12 x 36 x 65.5-66	125	156	21	\$1186	\$1257	N/A	N/A
--------	-------------------	-----	-----	----	---------------	---------------	-----	-----

One fixed shelf and two adjustable shelves.



Bookcase - 48.5" High

ZHBC48	12 x 36 x 48.5-49	125	122	15.75	\$898	\$969	N/A	N/A
--------	-------------------	-----	-----	-------	--------------	--------------	-----	-----

Two adjustable shelves.



Bookcase Shelf

ZHSHELF	11 x 34 x .5-1	100	13	1.50	\$315	N/A	N/A	N/A
---------	----------------	-----	----	------	--------------	-----	-----	-----

Extra shelf for bookcases. 1" thick.

TABLE TOP BOOKCASES

NOTE: UNITS UNDER 30"W MUST BE SECURELY FASTENED TO THE WALL OR GANGED TO AN ADJACENT UNIT 30"W OR WIDER



Table Top Bookcase 11.75"/12.25" High

Z36S12TN	16 x 36 x 11.25-11.75	100	44.91	5.25	\$358	\$430	N/A	N/A
Z30S12TN	16 x 30 x 11.25-11.75	100	39.33	4.30	\$329	\$391	N/A	N/A

To be placed **on top of 29"/29.5" high units to achieve 40.8"/41.8" final height** or placed on top of **40.8"/41.3" high units to achieve 52.5"/53.5" final height.**

Z21S12TN	16 x 21 x 11.25-11.75	100	28.87	3.10	\$275	\$324	N/A	N/A
Z18S12TN	16 x 18 x 11.25-11.75	92.5	27.13	2.70	\$264	\$309	N/A	N/A
Z16S12TN	16 x 16 x 11.25-11.75	92.5	24.57	2.40	\$251	\$292	N/A	N/A
Z15S12TN	16 x 15 x 11.25-11.75	92.5	24.34	2.30	\$240	\$276	N/A	N/A
Z12S12TN	16 x 12 x 11.25-11.75	92.5	21.55	1.90	\$227	\$258	N/A	N/A

To be placed **on top of 29"/29.5" high units to achieve 40.8"/41.8" final height** or placed on top of **40.8"/41.3" high units to achieve 52.5"/53.5" final height.**



* Accepts collator 11" high











Table Top Bookcase 11.75"/12.25" High

Required Specifications

Top finish
Base finish
Top/Edge Detail

Optional Specifications

Collator (open shelf)

TABLE TOP BOOKCASES		MODEL#	DIMENSIONS	FREIGHT CLASS	WT./LBS.	CUBIC FT.	1" TOP	1.5" TOP	GLAZE ADD	HP ADD	
  Glazed door option	Closed Table Top Bookcase 47.7" High		D x W x H								
		Z36S48T	16 x 36 x 47.2-47.7	125	149	20.25	\$1460	\$1532	\$1537	N/A	
		Z30S48T	16 x 30 x 47.2-47.7	125	130	17	\$1333	\$1395	\$1327	N/A	
		Designed to be placed on top of 17.87"/18.37" high units to achieve 65.5"/66" final height. Laminate doors are standard. Includes one adjustable shelf. Standard with lock.									
  Glazed door option	Closed Table Top Bookcase 41" High										
		Z36S41T	16 x 36 x 41.35-41.85	125	128	17.75	\$1200	\$1272	\$1334	N/A	
		Z30S41T	16 x 30 x 41.35-41.85	125	111	15	\$1256	\$1318	\$1162	N/A	
		Designed to be placed on top of 23.75"/24.25" high units to achieve 65.5"/66" final height. Laminate doors are standard. Includes one adjustable shelf. Standard with lock.									
  Glazed door option	Closed Table Top Bookcase 54" High										
		Z36S54T	16 x 36 x 53.63-54.13	125	163	22.75	\$1723	\$1795	\$1537	N/A	
		Z30S54T	16 x 30 x 53.63-54.13	125	142	19	\$1333	\$1395	\$1327	N/A	
		Designed to be placed on top of 17.87"/18.37" high units to achieve 71.9"/72.4" final height. Laminate doors are standard. Includes one adjustable shelf. Standard with lock.									
  Glazed door option	Closed Table Top Bookcase 48" High										
		Z36S49T	16 x 36 x 47.76-48.26	125	141	20.25	\$1531	\$1603	\$1014	N/A	
		Z30S49T	16 x 30 x 47.76-48.26	125	123	17.25	\$1373	\$1434	\$906	N/A	
		Designed to be placed on top of 23.75"/24.25" high units to achieve 71.9"/72.4" final height. Laminate doors are standard. Includes one adjustable shelf. Standard with lock.									
  Glazed door option	Closed Table Top Bookcase 61" High										
		Z36S61T	16 x 36 x 60.25-60.75	125	176	25.25	\$1808	\$1880	\$1206	N/A	
		Z30S61T	16 x 30 x 60.25-60.75	125	153	21.25	\$1616	\$1677	\$1076	N/A	
		Designed to be placed on top of 23.75"/24.25" high units to achieve 84.4"/84.9" final height. Laminate doors are standard. Includes one adjustable shelf. Standard with lock.									

Required Specifications

- Top finish
- Top thickness edge detail
- Base finish
- Door front finish if laminate

Optional Specifications

- Handles
- Key #
- Glazed doors

TABLE TOP BOOKCASES

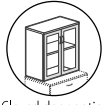

Glazed door option

Table Top Bookcase 23.5"/24" High*

MODEL#	DIMENSIONS D x W x H	FREIGHT CLASS	WT/LBS.	CUBIC FT.	1" TOP	1.5" TOP	GLAZE ADD	HP ADD
Z36S23T	16 x 36 x 23-23.5	100	87.45	9.50	\$857	\$929	\$844	N/A
Z30S23T	16 x 30 x 23-23.5	100	75.78	8	\$780	\$842	\$745	N/A

Designed to be placed on top of 29"/29.5" high units to achieve 52.5"/53.5" final height. DO NOT USE ON TOP OF 40.8"/41.3" HIGH UNITS. Laminate doors are standard. Includes one adjustable shelf. Standard with lock.



Glazed door option

Table Top Bookcase w/Door - LEFT*
23.5"/24" High

Z21S23TL	16 x 21 x 23-23.5	92.5	58.83	5.75	\$611	\$659	\$461	N/A
Z18S23TL	16 x 18 x 23-23.5	92.5	54.65	5	\$588	\$629	\$421	N/A
Z16S23TL	16 x 16 x 23-23.5	92.5	46.71	4.50	\$522	\$563	\$412	N/A
Z15S23TL	16 x 15 x 23-23.5	92.5	46.06	4.20	\$496	\$532	\$371	N/A
Z12S23TL	16 x 12 x 23-23.5	92.5	40.77	3.50	\$463	\$494	\$335	N/A

Designed to be placed on top of 29"/29.5" high units to achieve 52.5"/53.5" final height. DO NOT USE ON TOP OF 40.8"/41.3" HIGH UNITS. Laminate door is standard. Includes one adjustable shelf. Standard with lock.



Glazed door option

Table Top Bookcase w/Door - RIGHT*
23.5"/24" High

Z21S23TR	16 x 21 x 23-23.5	92.5	58.83	5.75	\$611	\$659	\$461	N/A
Z18S23TR	16 x 18 x 23-23.5	92.5	54.65	5	\$588	\$629	\$421	N/A
Z16S23TR	16 x 16 x 23-23.5	92.5	46.71	4.50	\$522	\$563	\$412	N/A
Z15S23TR	16 x 15 x 23-23.5	92.5	46.06	4.20	\$496	\$532	\$371	N/A
Z12S23TR	16 x 12 x 23-23.5	92.5	40.77	3.50	\$463	\$494	\$335	N/A

Designed to be placed on top of 29"/29.5" high units to achieve 52.5"/53.5" final height. DO NOT USE ON TOP OF 40.8"/41.3" HIGH UNITS. Laminate door is standard. Includes one adjustable shelf. Standard with lock.



Table Top Bookcase 23.5"/24" High

Z36S23TN	16 x 36 x 23-23.5	125	69.06	9.50	\$561	\$633	N/A	N/A
Z30S23TN	16 x 30 x 23-23.5	125	60.33	8	\$515	\$576	N/A	N/A

Designed to be placed on top of 29"/29.5" high units to achieve 52.5"/53.5" final height. DO NOT USE ON TOP OF 40.8"/41.3" HIGH UNITS. Includes one adjustable shelf.



* Accepts collarator 11" high

Table Top Bookcase 23.5"/24" High**

Z21S23TN	16 x 21 x 23-23.5	100	47.77	5.75	\$438	\$486	N/A	N/A
Z18S23TN	16 x 18 x 23-23.5	100	44.98	5	\$431	\$472	N/A	N/A
Z16S23TN	16 x 16 x 23-23.5	100	38.22	4.50	\$366	\$407	N/A	N/A
Z15S23TN	16 x 15 x 23-23.5	100	37	4.20	\$351	\$386	N/A	N/A
Z12S23TN	16 x 12 x 23-23.5	100	34.15	3.50	\$327	\$359	N/A	N/A

Designed to be placed on top of 29"/29.5" high units to achieve 52.5"/53.5" final height. DO NOT USE ON TOP OF 40.8"/41.3" HIGH UNITS. Includes one adjustable shelf.



Glazed door option

Table Top Bookcase w/Doors*
36"/36.5" High

Z36S36T	16 x 36 x 35.5-36	100	124.30	14.25	\$1101	\$1173	\$1088	N/A
Z30S36T	16 x 30 x 35.5-36	100	106.67	12	\$953	\$1014	\$952	N/A

Designed to be placed on top of 29"/29.5" high units to achieve 65"/66" final height. Laminate doors are standard. Includes two adjustable shelves. Standard with lock.

Required Specifications

Primary surface type + finish
Top thickness/edge detail
Base finish
Door front finish if laminate*

Handles*

Optional Specifications

Key #*
Collator**
Glazed doors*

TABLE TOP BOOKCASES		MODEL#	DIMENSIONS	FREIGHT CLASS	WT./LBS.	CUBIC FT.	1" TOP	1.5" TOP	GLAZE ADD	HP ADD	
		D x W x H									
	<p>Glazed door option</p>	Z21S36TL	16 x 21 x 35.5-36	100	82.99	8.75	\$780	\$829	\$598	N/A	
		Z18S36TL	16 x 18 x 35.5-36	100	74.72	7.50	\$746	\$787	\$540	N/A	
		Z16S36TL	16 x 16 x 35.5-36	92.5	67.82	6.75	\$682	\$723	\$532	N/A	
		Z15S36TL	16 x 15 x 35.5-36	92.5	66.46	6.50	\$649	\$685	\$473	N/A	
		Z12S36TL	16 x 12 x 35.5-36	92.5	59.30	5.25	\$602	\$633	\$426	N/A	
Table Top Bookcase w/Doors* 36\"/> 		Designed to be placed on top of 29\"/> 									
	<p>Glazed door option</p>	Z21S36TR	16 x 21 x 35.5-36	100	82.99	8.75	\$780	\$829	\$598	N/A	
		Z18S36TR	16 x 18 x 35.5-36	100	74.72	7.50	\$746	\$787	\$540	N/A	
		Z16S36TR	16 x 16 x 35.5-36	92.5	67.82	6.75	\$682	\$723	\$532	N/A	
		Z15S36TR	16 x 15 x 35.5-36	92.5	66.46	6.50	\$649	\$685	\$473	N/A	
		Z12S36TR	16 x 12 x 35.5-36	92.5	59.30	5.25	\$602	\$633	\$426	N/A	
Table Top Bookcase w/Doors* 36\"/> 		Designed to be placed on top of 29\"/> 									
	<p>Glazed door option</p>	Z36S36TC	16 x 36 x 35.5-36	100	116.98	14.25	\$1040	\$1112	\$961	N/A	
		Z30S36TC	16 x 30 x 35.5-36	100	100.58	12	\$900	\$962	\$838	N/A	
Table Top Bookcase w/Doors and Cavity - 36\"/> 		Designed to be placed on top of 29\"/> 									
	<p>Glazed door option * Accepts collator 11"high</p>	Z21S36TCL	16 x 21 x 35.5-36	100	78.72	8.75	\$743	\$792	\$534	N/A	
		Z18S36TCL	16 x 18 x 35.5-36	100	71.07	7.50	\$716	\$761	\$481	N/A	
		Z16S36TCL	16 x 16 x 35.5-36	100	64.57	6.75	\$650	\$691	\$473	N/A	
		Z15S36TCL	16 x 15 x 35.5-36	100	63.42	6.50	\$625	\$660	\$420	N/A	
		Z12S36TCL	16 x 12 x 35.5-36	92.5	56.87	5.25	\$581	\$613	\$376	N/A	
Table Top Bookcase with Doors and Cavity - 36\"/> 		Designed to be placed on top of 29\"/> 									
	<p>Glazed door option * Accepts collator 11"high</p>	Z21S36TCR	16 x 21 x 35.5-36	100	78.72	8.75	\$743	\$792	\$534	N/A	
		Z18S36TCR	16 x 18 x 35.5-36	100	71.07	7.50	\$716	\$761	\$481	N/A	
		Z16S36TCR	16 x 16 x 35.5-36	100	64.57	6.75	\$650	\$691	\$473	N/A	
		Z15S36TCR	16 x 15 x 35.5-36	100	63.42	6.50	\$625	\$660	\$420	N/A	
		Z12S36TCR	16 x 12 x 35.5-36	92.5	56.87	5.25	\$581	\$613	\$376	N/A	
Table Top Bookcase with Doors and Cavity - 36\"/> 		Designed to be placed on top of 29\"/> 									
		Z36S36TN	16 x 36 x 35.5-36	125	95.31	14.25	\$740	\$814	N/A	N/A	
		Z30S36TN	16 x 30 x 35.5-36	125	82.38	12	\$630	\$692	N/A	N/A	
Table Top Bookcase 36\"/> 		Designed to be placed on top of 29\"/> 									

Required Specifications

Primary surface type + finish
 Top thickness/edge detail
 Base finish Handles*
 Door front finish if laminate*

Optional Specifications

Key #*
 Collator**
 Glazed doors*

TABLE TOP BOOKCASES



* Accepts collator 11" high

Table Top Bookcase 36"/36.5" High*

MODEL#	DIMENSIONS D x W x H	FREIGHT CLASS	WT/LBS.	CUBIC FT.	1" TOP	1.5" TOP	GLAZE ADD	HP ADD
Z21S36TN	16 x 21 x 35.5-36	125	65.62	8.75	\$572	\$621	N/A	N/A
Z18S36TN	16 x 18 x 35.5-36	125	59.68	7.50	\$557	\$602	N/A	N/A
Z16S36TN	16 x 16 x 35.5-36	100	56	6.75	\$494	\$535	N/A	N/A
Z15S36TN	16 x 15 x 35.5-36	100	53.74	6.50	\$478	\$514	N/A	N/A
Z12S36TN	16 x 12 x 35.5-36	125	48.85	6.25	\$446	\$477	N/A	N/A

Designed to be placed on top of 29"/29.5" high units to achieve 65"/66" final height. Includes two adjustable shelves.



Glazed door option

Table Top Bookcase with Doors**
24.25"/24.75" High

Z36S24T	16 x 36 x 23.75-24.25	100	89.26	10	\$859	\$931	\$961	N/A
Z30S24T	16 x 30 x 23.75-24.25	100	77.47	8.25	\$784	\$845	\$838	N/A

Designed to be placed on top of 40.8"/41.3" high units to achieve 65"/66" final height. DO NOT USE ON TOP OF 29"/29.5 HIGH UNITS. Laminate doors are standard. Includes one adjustable shelf. Standard with lock.

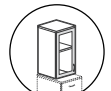

Glazed door option

Table Top Bookcase w/Door - LEFT**
24.25"/24.75" High

Z21S24TL	16 x 21 x 23.75-24.25	100	59.24	6	\$611	\$660	\$534	N/A
Z18S24TL	16 x 18 x 23.75-24.25	92.5	56.11	5.25	\$589	\$630	\$481	N/A
Z16S24TL	16 x 16 x 23.75-24.25	92.5	48.13	4.60	\$523	\$564	\$473	N/A
Z15S24TL	16 x 15 x 23.75-24.25	92.5	46.35	4.30	\$497	\$533	\$420	N/A
Z12S24TL	16 x 12 x 23.75-24.25	85	44.32	3.60	\$464	\$495	\$376	N/A

Designed to be placed on top of 40.8"/41.3" high units to achieve 65"/66" final height. DO NOT USE ON TOP OF 29"/29.5 HIGH UNITS. Laminate door is standard. Includes one adjustable shelf. Standard with lock.

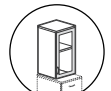

Glazed door option

Table Top Bookcase w/Door - RIGHT**
24.25"/24.75" High

Z21S24TR	16 x 21 x 23.75-24.25	100	59.24	6	\$611	\$660	\$534	N/A
Z18S24TR	16 x 18 x 23.75-24.25	92.5	56.11	5.25	\$589	\$630	\$481	N/A
Z16S24TR	16 x 16 x 23.75-24.25	92.5	48.13	4.60	\$523	\$564	\$473	N/A
Z15S24TR	16 x 15 x 23.75-24.25	92.5	46.35	4.30	\$497	\$533	\$420	N/A
Z12S24TR	16 x 12 x 23.75-24.25	85	44.32	3.60	\$464	\$495	\$376	N/A

Designed to be placed on top of 40.8"/41.3" high units to achieve 65"/66" final height. DO NOT USE ON TOP OF 29"/29.5 HIGH UNITS. Laminate door is standard. Includes one adjustable shelf. Standard with lock.



Table Top Bookcase
24.25"/24.75" High

Z36S24TN	16 x 36 x 23.75-24.25	125	70.11	10	\$561	\$635	N/A	N/A
Z30S24TN	16 x 30 x 23.75-24.25	125	61.38	8.25	\$515	\$577	N/A	N/A

Designed to be placed on top of 40.8"/41.3" high units to achieve 65"/66" final height. DO NOT USE ON TOP OF 29"/29.5 HIGH UNITS. Includes one adjustable shelf.



* Accepts collator 11" high

Table Top Bookcase*
24.25"/24.75" High

Z21S24TN	16 x 21 x 23.75-24.25	125	47.77	6	\$438	\$487	N/A	N/A
Z18S24TN	16 x 18 x 23.75-24.25	100	46.03	5.25	\$431	\$476	N/A	N/A
Z16S24TN	16 x 16 x 23.75-24.25	100	39.27	4.60	\$367	\$408	N/A	N/A
Z15S24TN	16 x 15 x 23.75-24.25	100	37.99	4.30	\$351	\$387	N/A	N/A
Z12S24TN	16 x 12 x 23.75-24.25	92.5	37.30	3.60	\$329	\$360	N/A	N/A

Designed to be placed on top of 40.8"/41.3" high units to achieve 65"/66" final height. DO NOT USE ON TOP OF 29"/29.5 HIGH UNITS. Includes one adjustable shelf.











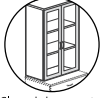

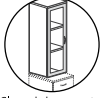
Required Specifications

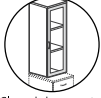
Primary surface type + finish
Top thickness/edge detail
Base finish
Door front finish if laminate**

Handles**

Optional Specifications

Key #**
Collator*
Glazed doors**

TABLE TOP BOOKCASES		MODEL#	DIMENSIONS	FREIGHT CLASS	WT/LBS.	CUBIC FT.	1" TOP	1.5" TOP	GLAZE ADD	HP ADD
  <p>Glazed door option</p>	<p>Table Top Bookcase with Doors 42.4"/42.9" High</p>		D x W x H							
		Z36S42T	16 x 36 x 41.9-42.4	100	137.40	16.75	\$1200	\$1272	\$1334	N/A
		Z30S42T	16 x 30 x 41.9-42.4	100	119.06	14	\$1047	\$1109	\$1162	N/A
<p>Designed to be placed on top of 29"/29.5" high units to achieve 71.5"/72.5" final height. DO NOT USE ON TOP OF 40.8"/41.3" HIGH UNITS. Laminate doors are standard. Includes two adjustable shelves. Standard with lock.</p>										
  <p>Glazed door option</p>	<p>Table Top Bookcase with Door - LEFT 42.4"/42.9" High</p>	Z21S42TL	16 x 21 x 41.9-42.4	300	119	70	\$850	\$899	\$739	N/A
		Z18S42TL	16 x 18 x 41.9-42.4	85	117	8.75	\$816	\$857	\$664	N/A
		Z16S42TL	16 x 16 x 41.9-42.4	300	112	62	\$736	\$777	\$658	N/A
		Z15S42TL	16 x 15 x 41.9-42.4	250	109	54	\$698	\$733	\$578	N/A
		Z12S42TL	16 x 12 x 41.9-42.4	250	105	49	\$649	\$681	\$521	N/A
		<p>Designed to be placed on top of 29"/29.5" high units to achieve 71.5"/72.5" final height. DO NOT USE ON TOP OF 40.8"/41.3" HIGH UNITS. Laminate door is standard. Includes two adjustable shelves. Standard with lock.</p>								
  <p>Glazed door option</p>	<p>Table Top Bookcase with Door - RIGHT 42.4"/42.9" High</p>	Z21S42TR	16 x 21 x 41.9-42.4	300	119	70	\$850	\$899	\$739	N/A
		Z18S42TR	16 x 18 x 41.9-42.4	85	117	8.75	\$816	\$857	\$664	N/A
		Z16S42TR	16 x 16 x 41.9-42.4	300	112	62	\$736	\$777	\$658	N/A
		Z15S42TR	16 x 15 x 41.9-42.4	250	109	54	\$698	\$733	\$578	N/A
		Z12S42TR	16 x 12 x 41.9-42.4	250	105	49	\$649	\$681	\$521	N/A
		<p>Designed to be placed on top of 29"/29.5" high units to achieve 71.5"/72.5" final height. DO NOT USE ON TOP OF 40.8"/41.3" HIGH UNITS. Laminate door is standard. Includes two adjustable shelves. Standard with lock.</p>								
  <p>Glazed door option</p>	<p>Table Top Bookcase with Doors and Cavity 42.4"/42.9" High</p>	Z36S42TC	16 x 36 x 41.9-42.4	125	130.09	16.75	\$1162	\$1234	\$1050	N/A
		Z30S42TC	16 x 30 x 41.9-42.4	100	112.97	14	\$1015	\$1077	\$913	N/A
<p>Designed to be placed on top of 29"/29.5" high units to achieve 71.5"/72.5" final height. DO NOT USE ON TOP OF 40.8"/41.3" HIGH UNITS. Laminate doors are standard. Includes one adjustable shelf. Standard with lock.</p>										
   <p>Glazed door option * Accepts collator 11"high</p>	<p>Table Top Bookcase with Door and* Cavity 42.4"/42.9" High - LEFT</p>	Z21S42TCL	16 x 21 x 41.9-42.4	100	87.84	10	\$831	\$879	\$583	N/A
		Z18S42TCL	16 x 18 x 41.9-42.4	100	79.83	8.75	\$798	\$839	\$524	N/A
		Z16S42TCL	16 x 16 x 41.9-42.4	100	73.75	8	\$716	\$757	\$520	N/A
		Z15S42TCL	16 x 15 x 41.9-42.4	100	70.71	7.50	\$682	\$717	\$457	N/A
		Z12S42TCL	16 x 12 x 41.9-42.4	92.5	62.70	6	\$632	\$664	\$412	N/A
<p>Designed to be placed on top of 29"/29.5" high units to achieve 71.5"/72.5" final height. DO NOT USE ON TOP OF 40.8"/41.3" HIGH UNITS. Laminate door is standard. Includes one adjustable shelf. Standard with lock.</p>										
   <p>Glazed door option * Accepts collator 11"high</p>	<p>Table Top Bookcase with Door and* Cavity 42.4"/42.9" High - RIGHT</p>	Z21S42TCR	16 x 21 x 41.9-42.4	100	87.84	10	\$831	\$879	\$583	N/A
		Z18S42TCR	16 x 18 x 41.9-42.4	100	79.83	8.75	\$798	\$839	\$524	N/A
		Z16S42TCR	16 x 16 x 41.9-42.4	100	73.75	8	\$716	\$757	\$520	N/A
		Z15S42TCR	16 x 15 x 41.9-42.4	100	70.71	7.50	\$682	\$717	\$457	N/A
		Z12S42TCR	16 x 12 x 41.9-42.4	92.5	62.70	6	\$632	\$664	\$412	N/A
<p>Designed to be placed on top of 29"/29.5" high units to achieve 71.5"/72.5" final height. DO NOT USE ON TOP OF 40.8"/41.3" HIGH UNITS. Laminate door is standard. Includes one adjustable shelf. Standard with lock.</p>										

Required Specifications

Primary surface type + finish
 Top thickness/edge detail
 Base finish Handles
 Door front finish if laminate

Optional Specifications

Key #
 Collator*
 Glazed doors

TABLE TOP BOOKCASES



Table Top Bookcase
42.4"/42.9" High

MODEL#	DIMENSIONS D x W x H	FREIGHT CLASS	WT/LBS.	CUBIC FT.	1" TOP	1.5" TOP	GLAZE ADD	HP ADD
Z36S42TN	16 x 36 x 41.9-42.4	125	103.71	16.75	\$806	\$878	N/A	N/A
Z30S42TN	16 x 30 x 41.9-42.4	125	90.78	14	\$701	\$763	N/A	N/A

Designed to be placed **on top of 29"/29.5" high units to achieve 71.5"/72.5" final height.** DO NOT USE ON TOP OF 40.8"/41.3" HIGH UNITS. **Includes two adjustable shelves.** Standard with lock.



* Accepts collator 11" high

Table Top Bookcase*
42.4"/42.9" High

Z21S42TN	16 x 21 x 41.9-42.4	125	71.92	10	\$625	\$674	N/A	N/A
Z18S42TN	16 x 18 x 41.9-42.4	125	65.98	8.75	\$611	\$652	N/A	N/A
Z16S42TN	16 x 16 x 41.9-42.4	125	61.32	8	\$528	\$569	N/A	N/A
Z15S42TN	16 x 15 x 41.9-42.4	125	58.99	7.50	\$515	\$551	N/A	N/A
Z12S42TN	16 x 12 x 41.9-42.4	100	53.05	6	\$480	\$511	N/A	N/A

Designed to be placed **on top of 29"/29.5" high units to achieve 71.5"/72.5" final height.** DO NOT USE ON TOP OF 40.8"/41.3" HIGH UNITS. **Includes two adjustable shelves.** Standard with lock.



Glazed door option

Table Top Bookcase with Doors**
30.7"/31.2" High

Z36S31T	16 x 36 x 30.2-30.7	100	104.19	12.25	\$944	\$1016	\$1050	N/A
Z30S31T	16 x 30 x 30.2-30.7	100	89.36	10.50	\$845	\$907	\$913	N/A

Designed to be placed **on top of 40.8"/41.8" high units to achieve 71.5"/72.5" final height.** Laminate doors are standard. **Includes one adjustable shelf.** Standard with lock.

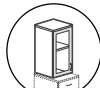

Glazed door option

Table Top Bookcase with Door**
30.7"/31.2" High - LEFT

Z21S31TL	16 x 21 x 30.2-30.7	100	69.88	7.50	\$676	\$725	\$583	N/A
Z18S31TL	16 x 18 x 30.2-30.7	92.5	65.22	6.50	\$618	\$659	\$524	N/A
Z16S31TL	16 x 16 x 30.2-30.7	92.5	59.18	5.75	\$589	\$630	\$520	N/A
Z15S31TL	16 x 15 x 30.2-30.7	92.5	56.15	5.50	\$563	\$598	\$457	N/A
Z12S31TL	16 x 12 x 30.2-30.7	92.5	50.39	4.40	\$524	\$556	\$412	N/A

Designed to be placed **on top of 40.8"/41.8" high units to achieve 71.5"/72.5" final height.** Laminate door is standard. **Includes one adjustable shelf.** Standard with lock.



Glazed door option

Table Top Bookcase with Door**
30.7"/31.2" High - RIGHT

Z21S31TR	16 x 21 x 30.2-30.7	100	69.88	7.50	\$676	\$725	\$583	N/A
Z18S31TR	16 x 18 x 30.2-30.7	92.5	65.22	6.50	\$618	\$659	\$524	N/A
Z16S31TR	16 x 16 x 30.2-30.7	92.5	59.18	5.75	\$589	\$630	\$520	N/A
Z15S31TR	16 x 15 x 30.2-30.7	92.5	56.15	5.50	\$563	\$598	\$457	N/A
Z12S31TR	16 x 12 x 30.2-30.7	92.5	50.39	4.40	\$524	\$556	\$412	N/A

Designed to be placed **on top of 40.8"/41.8" high units to achieve 71.5"/72.5" final height.** Laminate door is standard. **Includes one adjustable shelf.** Standard with lock.



Table Top Bookcase
30.7"/31.2" High

Z36S31TN	16 x 36 x 30.2-30.7	125	79.56	12.25	\$615	\$687	N/A	N/A
Z30S31TN	16 x 30 x 30.2-30.7	125	68.73	10.50	\$554	\$615	N/A	N/A

Designed to be placed **on top of 40.8"/41.8" high units to achieve 71.5"/72.5" final height.** **Includes one adjustable shelf.**







Required Specifications

Primary surface type + finish
Top thickness/edge detail
Base finish
Door front finish if laminate**

Handles**

Optional Specifications

Key #**
Collator*
Glazed doors**

TABLE TOP BOOKCASES	MODEL#	DIMENSIONS	FREIGHT CLASS	WT./LBS.	CUBIC FT.	1" TOP	1.5" TOP	GLAZE ADD	HP ADD
 <p>Table Top Bookcase* 30.7"/31.2" High</p> <p><i>* Accepts collator 11" high</i></p>		D x W x H							
	Z21S31TN	16 x 21 x 30.2-30.7	125	55.12	7.50	\$484	\$532	N/A	N/A
	Z18S31TN	16 x 18 x 30.2-30.7	100	52.33	6.50	\$444	\$485	N/A	N/A
	Z16S31TN	16 x 16 x 30.2-30.7	100	47.67	5.75	\$420	\$461	N/A	N/A
	Z15S31TN	16 x 15 x 30.2-30.7	100	45.34	5.50	\$406	\$441	N/A	N/A
Z12S31TN	16 x 12 x 30.2-30.7	100	41.50	4.40	\$378	\$409	N/A	N/A	
<p>Designed to be placed on top of 40.8"/41.8" high units to achieve 71.5"/72.5" final height. Includes one adjustable shelf.</p>									
 <p>Table Top Bookcase with Doors 54.9"/55.4" High</p> <p>Glazed door option</p>	Z36S55T	16 x 36 x 54.4-54.9	100	174.25	21.50	\$1460	\$1532	\$1537	N/A
	Z30S55T	16 x 30 x 54.4-54.9	100	152.16	18	\$1333	\$1395	\$1327	N/A
<p>Designed to be placed on top of 29"/29.5" high units to achieve 84"/85" final height. Includes three adjustable shelves. Standard with lock.</p>									
 <p>Table Top Bookcase with Door - LEFT 54.9"/55.4" High</p> <p>Glazed door option</p>	Z21S55TL	16 x 21 x 54.4-54.9	100	116.26	13	\$1036	\$1085	\$857	N/A
	Z18S55TL	16 x 18 x 54.4-54.9	100	104.66	11.25	\$973	\$1018	\$766	N/A
	Z16S55TL	16 x 16 x 54.4-54.9	100	97.67	10	\$927	\$968	\$759	N/A
	Z15S55TL	16 x 15 x 54.4-54.9	100	94.17	9.50	\$884	\$919	\$661	N/A
	Z12S55TL	16 x 12 x 54.4-54.9	92.5	83.67	7.75	\$819	\$850	\$589	N/A
<p>Designed to be placed on top of 29"/29.5" high units to achieve 84"/85" final height. Laminate door is standard. Includes three adjustable shelves. Standard with lock.</p>									
 <p>Table Top Bookcase with Door - RIGHT 54.9"/55.4" High</p> <p>Glazed door option</p>	Z21S55TR	16 x 21 x 54.4-54.9	100	116.26	13	\$1036	\$1085	\$857	N/A
	Z18S55TR	16 x 18 x 54.4-54.9	100	104.66	11.25	\$973	\$1018	\$766	N/A
	Z16S55TR	16 x 16 x 54.4-54.9	100	97.67	10	\$927	\$968	\$759	N/A
	Z15S55TR	16 x 15 x 54.4-54.9	100	94.17	9.50	\$884	\$919	\$661	N/A
	Z12S55TR	16 x 12 x 54.4-54.9	92.5	83.67	7.75	\$819	\$850	\$589	N/A
<p>Designed to be placed on top of 29"/29.5" high units to achieve 84"/85" final height. Laminate door is standard. Includes three adjustable shelves. Standard with lock.</p>									
 <p>Table Top Bookcase with Doors and Cavity 54.9"/55.4" High</p> <p>Glazed door option</p>	Z36S55TC	16 x 36 x 54.4-54.9	125	166.94	21.50	\$1421	\$1493	\$1339	N/A
	Z30S55TC	16 x 30 x 54.4-54.9	100	146.06	18	\$1299	\$1361	\$1167	N/A
<p>Designed to be placed on top of 29"/29.5" high units to achieve 84"/85" final height. Laminate doors are standard. Includes two adjustable shelves. Standard with lock.</p>									
 <p>Table Top Bookcase with Door - LEFT and Cavity 54.9"/55.4" High*</p> <p>Glazed door option <i>* Accepts collator 11" high</i></p>	Z21S55TCL	16 x 21 x 54.4-54.9	100	112	13	\$1001	\$1049	\$742	N/A
	Z18S55TCL	16 x 18 x 54.4-54.9	100	101.01	11.25	\$943	\$984	\$666	N/A
	Z16S55TCL	16 x 16 x 54.4-54.9	100	94.42	10	\$892	\$937	\$659	N/A
	Z15S55TCL	16 x 15 x 54.4-54.9	100	91.12	9.50	\$851	\$887	\$581	N/A
	Z12S55TCL	16 x 12 x 54.4-54.9	92.5	81.24	7.75	\$791	\$822	\$523	N/A
<p>Designed to be placed on top of 29"/29.5" high units to achieve 84"/85" final height. Laminate door is standard. Includes two adjustable shelves. Standard with lock.</p>									

Required Specifications

Primary surface type + finish
 Top thickness/edge detail
 Base finish Handles
 Door front finish if laminate

Optional Specifications

Key #
 Collator*
 Glazed doors

TABLE TOP BOOKCASES



Glazed door option



* Accepts collator 11" high

Table Top Bookcase with Door - RIGHT and Cavity - 54.9"/55.4" High*



Table Top Bookcase 54.9"/55.4" High



* Accepts collator 11" high

Table Top Bookcase* 54.9"/55.4" High



Glazed door option

Table Top Bookcase with Doors 43.2"/43.7" High

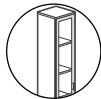

Glazed door option

Table Top Bookcase with Door 43.2"/43.7" High

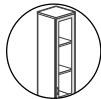

Glazed door option

Table Top Bookcase with Door 43.2"/43.7" High

MODEL#	DIMENSIONS D x W x H	FREIGHT CLASS	WT./LBS.	CUBIC FT.	1" TOP	1.5" TOP	GLAZE ADD	HP ADD
Z21S55TCR	16 x 21 x 54.4-54.9	100	112	13	\$1001	\$1049	\$742	N/A
Z18S55TCR	16 x 18 x 54.4-54.9	100	101.01	11.25	\$943	\$984	\$666	N/A
Z16S55TCR	16 x 16 x 54.4-54.9	100	94.42	10	\$892	\$937	\$659	N/A
Z15S55TCR	16 x 15 x 54.4-54.9	100	91.12	9.50	\$851	\$887	\$581	N/A
Z12S55TCR	16 x 12 x 54.4-54.9	92.5	81.24	7.75	\$791	\$822	\$523	N/A

Designed to be placed **on top of 29"/29.5" high units to achieve 84"/85" final height.** Laminate door is standard. **Includes two adjustable shelves.** Standard with lock.

Z36S55TN	16 x 36 x 54.4-54.9	125	129.96	21.50	\$972	\$1044	N/A	N/A
Z30S55TN	16 x 30 x 54.4-54.9	125	114.93	18	\$905	\$966	N/A	N/A

Designed to be placed **on top of 29"/29.5" high units to achieve 84"/85" final height. Includes three adjustable shelves.**

Z21S55TN	16 x 21 x 54.4-54.9	125	89.77	13	\$758	\$806	N/A	N/A
Z18S55TN	16 x 18 x 54.4-54.9	125	81.73	11.25	\$722	\$763	N/A	N/A
Z16S55TN	16 x 16 x 54.4-54.9	125	77.07	10	\$675	\$716	N/A	N/A
Z15S55TN	16 x 15 x 54.4-54.9	125	74.74	9.50	\$659	\$695	N/A	N/A
Z12S55TN	16 x 12 x 54.4-54.9	100	67.75	7.75	\$615	\$646	N/A	N/A

Designed to be placed **on top of 29"/29.5" high units to achieve 84"/85" final height. Includes three adjustable shelves.**

Z36S43T	16 x 36 x 42.7-43.2	100	139.22	17	\$1226	\$1298	\$1339	N/A
Z30S43T	16 x 30 x 42.7-43.2	100	120.76	14.50	\$1047	\$1109	\$1167	N/A

Designed to be placed **on top of 40.8"/41.3" high units to achieve 84"/85" final height.** Laminate doors are standard. **DO NOT USE ON TOP OF 29"/29.5 HIGH UNITS. Includes two adjustable shelves.** Standard with lock.

Z21S43TL	16 x 21 x 42.7-43.2	100	93.62	10.25	\$868	\$916	\$742	N/A
Z18S43TL	16 x 18 x 42.7-43.2	100	84.94	9	\$831	\$872	\$666	N/A
Z16S43TL	16 x 16 x 42.7-43.2	100	78.42	8	\$745	\$786	\$659	N/A
Z15S43TL	16 x 15 x 42.7-43.2	92.5	75.16	7.50	\$701	\$736	\$581	N/A
Z12S43TL	16 x 12 x 42.7-43.2	92.5	66.48	6.25	\$650	\$682	\$523	N/A

Designed to be placed **on top of 40.8"/41.8" high units to achieve 71.5"/72.5" final height.** Laminate door is standard. **DO NOT USE ON TOP OF 29"/29.5 HIGH UNITS. Includes two adjustable shelves.** Standard with lock.

Z21S43TR	16 x 21 x 42.7-43.2	100	93.62	10.25	\$868	\$916	\$742	N/A
Z18S43TR	16 x 18 x 42.7-43.2	100	84.94	9	\$831	\$872	\$666	N/A
Z16S43TR	16 x 16 x 42.7-43.2	100	78.42	8	\$745	\$786	\$659	N/A
Z15S43TR	16 x 15 x 42.7-43.2	92.5	75.16	7.50	\$701	\$736	\$581	N/A
Z12S43TR	16 x 12 x 42.7-43.2	92.5	66.48	6.25	\$650	\$682	\$523	N/A

Designed to be placed **on top of 40.8"/41.8" high units to achieve 71.5"/72.5" final height.** Laminate door is standard. **DO NOT USE ON TOP OF 29"/29.5 HIGH UNITS. Includes two adjustable shelves.** Standard with lock.











Required Specifications

Primary surface type + finish
 Top thickness/edge detail
 Base finish
 Door front finish if laminate

Handles

Optional Specifications

Key #
 Collator*
 Glazed doors

TABLE TOP BOOKCASES	MODEL#	DIMENSIONS	FREIGHT CLASS	WT/LBS.	CUBIC FT.	1" TOP	1.5" TOP	GLAZE ADD	HP ADD	
  <p>Glazed door option</p> <p>Table Top Bookcase with Doors and Cavity - 43.2"/43.7" High**</p>		D x W x H								
	Z36S43TC	16 x 36 x 42.7-43.2	125	131.91	17	\$1186	\$1258	\$1054	N/A	
	Z30S43TC	16 x 30 x 42.7-43.2	125	114.67	14.50	\$1038	\$1099	\$898	N/A	
<p>Designed to be placed on top of 40.8"/41.3" high units to achieve 84"/85" final height. Laminate doors are standard. DO NOT USE ON TOP OF 29"/29.5 HIGH UNITS. Includes two adjustable shelves. Standard with lock.</p>										
   <p>Glazed door option * Accepts collator 11" high</p> <p>Table Top Bookcase with Door and Cavity - 43.2"/43.7" High - LEFT**</p>										
	Z21S43TCL	16 x 21 x 42.7-43.2	100	89.36	10.25	\$845	\$894	\$582	N/A	
	Z18S43TCL	16 x 18 x 42.7-43.2	100	81.29	9	\$811	\$852	\$523	N/A	
	Z16S43TCL	16 x 16 x 42.7-43.2	100	75.17	8	\$726	\$767	\$518	N/A	
	Z15S43TCL	16 x 15 x 42.7-43.2	100	72.11	7.50	\$684	\$719	\$457	N/A	
	Z12S43TCL	16 x 12 x 42.7-43.2	92.5	64.05	6.25	\$635	\$667	\$412	N/A	
<p>Designed to be placed on top of 40.8"/41.3" high units to achieve 84"/85" final height. Laminate door is standard. DO NOT USE ON TOP OF 29"/29.5 HIGH UNITS. Includes one adjustable shelf. Standard with lock.</p>										
   <p>Glazed door option * Accepts collator 11" high</p> <p>Table Top Bookcase with Door and Cavity - 43.2"/43.7" High - RIGHT**</p>										
	Z21S43TCR	16 x 21 x 42.7-43.2	100	89.36	10.25	\$845	\$894	\$582	N/A	
	Z18S43TCR	16 x 18 x 42.7-43.2	100	81.29	9	\$811	\$852	\$523	N/A	
	Z16S43TCR	16 x 16 x 42.7-43.2	100	75.17	8	\$726	\$767	\$518	N/A	
	Z15S43TCR	16 x 15 x 42.7-43.2	100	72.11	7.50	\$684	\$719	\$457	N/A	
	Z12S43TCR	16 x 12 x 42.7-43.2	92.5	64.05	6.25	\$635	\$667	\$412	N/A	
<p>Designed to be placed on top of 40.8"/41.3" high units to achieve 84"/85" final height. Laminate door is standard. DO NOT USE ON TOP OF 29"/29.5 HIGH UNITS. Includes one adjustable shelf. Standard with lock.</p>										
 <p>Table Top Bookcase 43.2"/43.7" High</p>										
	Z36S43TN	16 x 36 x 42.7-43.2	125	104.76	17	\$830	\$902	N/A	N/A	
	Z30S43TN	16 x 30 x 42.7-43.2	125	91.83	14.50	\$719	\$781	N/A	N/A	
<p>Designed to be placed on top of 40.8"/41.3" high units to achieve 84"/85" final height. DO NOT USE ON TOP OF 29"/29.5 HIGH UNITS. Includes two adjustable shelves.</p>										
  <p>* Accepts collator 11" high</p> <p>Table Top Bookcase* 43.2"/43.7" High</p>										
	Z21S43TN	16 x 21 x 42.7-43.2	125	72.97	10.25	\$641	\$690	N/A	N/A	
	Z18S43TN	16 x 18 x 42.7-43.2	125	67.03	9	\$624	\$665	N/A	N/A	
	Z16S43TN	16 x 16 x 42.7-43.2	125	62.37	8	\$536	\$577	N/A	N/A	
	Z15S43TN	16 x 15 x 42.7-43.2	100	60.04	7.50	\$516	\$552	N/A	N/A	
	Z12S43TN	16 x 12 x 42.7-43.2	100	54.10	6.25	\$481	\$512	N/A	N/A	
<p>Designed to be placed on top of 40.8"/41.3" high units to achieve 84"/85" final height. DO NOT USE ON TOP OF 29"/29.5 HIGH UNITS. Includes two adjustable shelves.</p>										

Required Specifications

Primary surface type + finish
 Top thickness/edge detail
 Base finish Handles
 Door front finish if laminate

Optional Specifications

Key #
 Collator*
 Glazed doors**

END SHELVES



End Shelf - LEFT 29"/29.5" High*

MODEL#	DIMENSIONS D x W x H	FREIGHT CLASS	WT/LBS.	CUBIC FT.	1" TOP	1.5" TOP	GLAZE ADD	HP ADD
Z24L2ESHL	24 x 24 x 29.5-30	70	99.75	4.75	\$711	\$772	N/A	\$140
Z20M2ESHL	20 x 20 x 29.5-30	70	76.65	3.75	\$589	\$635	N/A	\$90
Z16S2ESHL	16 x 16 x 29.5-30	65	53.55	2.25	\$501	\$542	N/A	\$90

For use at **LEFT end of 29"/29.5"H units. One adjustable shelf.** Shipped RTA (ready to assemble).



End Shelf - RIGHT 29"/29.5" High*

Z24L2ESHR	24 x 24 x 29.5-30	70	99.75	4.75	\$711	\$772	N/A	\$140
Z20M2ESHR	20 x 20 x 29.5-30	70	76.65	3.75	\$589	\$635	N/A	\$90
Z16S2ESHR	16 x 16 x 29.5-30	65	53.55	2.25	\$501	\$542	N/A	\$90

For use at **RIGHT end of 29"/29.5"H units. One adjustable shelf.** Shipped RTA (ready to assemble).



* Accepts collator 11" high

End Shelf - LEFT 40.8"/41.3" High**

Z24L4ESHL	24 x 24 x 41.3-41.8	65	130.20	4.75	\$912	\$974	N/A	N/A
Z20M4ESHL	20 x 20 x 41.3-41.8	60	101	3.25	\$766	\$812	N/A	N/A
Z16S4ESHL	16 x 16 x 41.3-41.8	65	73.87	2.50	\$651	\$692	N/A	N/A

For use at **LEFT end of 40.8"/41.3"H units. Two adjustable shelves.** Shipped RTA (ready to assemble).

- Collator only available on **Z16S4ESHL**



* Accepts collator 11" high

End Shelf - RIGHT 40.8"/41.3" High**

Z24L4ESHR	24 x 24 x 41.3-41.8	65	130.20	4.75	\$912	\$974	N/A	N/A
Z20M4ESHR	20 x 20 x 41.3-41.8	60	101	3.25	\$766	\$812	N/A	N/A
Z16S4ESHR	16 x 16 x 41.3-41.8	65	73.87	2.50	\$651	\$692	N/A	N/A

For use at **RIGHT end of 40.8"/41.3"H units. Two adjustable shelves.** Shipped RTA (ready to assemble).

- Collator only available on **Z16S4ESHR**



* Accepts collator 11" high

End Shelf - LEFT 52.5"/53" High**

Z24L5ESHL	24 x 24 x 53-53.5	60	162.75	4.75	\$1130	\$1191	N/A	N/A
Z20M5ESHL	20 x 20 x 53-53.5	60	125.69	4	\$932	\$978	N/A	N/A
Z16S5ESHL	16 x 16 x 53-53.5	65	91.35	3.25	\$786	\$831	N/A	N/A

For use at **LEFT end of 52.5"/53"H units. Three adjustable shelves.** Shipped RTA (ready to assemble).

- Collator only available on **Z16S5ESHL**



* Accepts collator 11" high

End Shelf - RIGHT 52.5"/53" High**

Z24L5ESHR	24 x 24 x 53-53.5	60	162.75	4.75	\$1130	\$1191	N/A	N/A
Z20M5ESHR	20 x 20 x 53-53.5	60	125.69	4	\$932	\$978	N/A	N/A
Z16S5ESHR	16 x 16 x 53-53.5	65	91.35	3.25	\$786	\$831	N/A	N/A

For use at **RIGHT end of 52.5"/53"H units. Three adjustable shelves.** Shipped RTA (ready to assemble).













- Collator only available on **Z16S5ESHR**

Required Specifications

Top finish
Base finish
Top/Edge Detail

Optional Specifications

Collator**
Glazed doors*

END SHELVES	MODEL#	DIMENSIONS	FREIGHT CLASS	WT/LBS.	CUBIC FT.	1" TOP	1.5" TOP	GLAZE ADD	HP ADD	
  <p>* Accepts collator 11" high</p> <p>End Shelf - LEFT 65"/65.5" High</p>		D x W x H								
	Z24L6ESHL	24 x 24 x 65.5-66	60	196	6	\$1321	\$1383	N/A	N/A	
	Z20M6ESHL	20 x 20 x 65.5-66	60	152	5	\$1099	\$1145	N/A	N/A	
	Z16S6ESHL	16 x 16 x 65.5-66	65	111.30	4.25	\$938	\$979	N/A	N/A	
<p>For use at LEFT end of 65"/65.5"H units. Four adjustable shelves. Shipped RTA (ready to assemble).</p> <ul style="list-style-type: none"> • Collator only available on Z16S6ESHL 										
  <p>* Accepts collator 11" high</p> <p>End Shelf - RIGHT 65"/65.5" High</p>										
	Z24L6ESHR	24 x 24 x 65.5-66	60	196	6	\$1321	\$1383	N/A	N/A	
	Z20M6ESHR	20 x 20 x 65.5-66	60	152	5	\$1099	\$1145	N/A	N/A	
	Z16S6ESHR	16 x 16 x 65.5-66	65	111.30	4.25	\$938	\$979	N/A	N/A	
<p>For use at RIGHT end of 65"/65.5"H units. Four adjustable shelves. Shipped RTA (ready to assemble).</p> <ul style="list-style-type: none"> • Collator only available on Z16S6ESHR 										
  <p>* Accepts collator 11" high</p> <p>End Shelf - LEFT 71.5"/72" High</p>										
	Z24L7ESHL	24 x 24 x 71.9-72.4	60	206.85	6.50	\$1387	\$1448	N/A	N/A	
	Z20M7ESHL	20 x 20 x 71.9-72.4	65	160.65	5.75	\$1158	\$1204	N/A	N/A	
	Z16S7ESHL	16 x 16 x 71.9-72.4	65	117.60	4.75	\$986	\$1027	N/A	N/A	
<p>For use at LEFT end of 71.5"/72"H units. Four adjustable shelves. Shipped RTA (ready to assemble).</p> <ul style="list-style-type: none"> • Collator only available on Z16S7ESHL 										
  <p>* Accepts collator 11" high</p> <p>End Shelf - RIGHT 71.5"/72" High</p>										
	Z24L7ESHR	24 x 24 x 71.9-72.4	60	206.85	6.50	\$1387	\$1448	N/A	N/A	
	Z20M7ESHR	20 x 20 x 71.9-72.4	65	160.65	5.75	\$1158	\$1204	N/A	N/A	
	Z16S7ESHR	16 x 16 x 71.9-72.4	65	117.60	4.75	\$986	\$1027	N/A	N/A	
<p>For use at RIGHT end of 71.5"/72"H units. Four adjustable shelves. Shipped RTA (ready to assemble).</p> <ul style="list-style-type: none"> • Collator only available on Z16S7ESHR 										
  <p>* Accepts collator 11" high</p> <p>End Shelf - LEFT 84"/84.5" High</p>										
	Z24L8ESHL	24 x 24 x 84.4-84.9	60	241.50	7.75	\$1592	\$1653	N/A	N/A	
	Z20M8ESHL	20 x 20 x 84.4-84.9	65	185.85	6.50	\$1327	\$1373	N/A	N/A	
	Z16S8ESHL	16 x 16 x 84.4-84.9	65	136.50	5.50	\$1127	\$1168	N/A	N/A	
<p>For use at LEFT end of 84"/84.5"H units. Five adjustable shelves. Shipped RTA (ready to assemble).</p> <ul style="list-style-type: none"> • Collator only available on Z16S8ESHL 										
  <p>* Accepts collator 11" high</p> <p>End Shelf - RIGHT 84"/84.5" High</p>										
	Z24L8ESHR	24 x 24 x 84.4-84.9	60	241.50	7.75	\$1592	\$1653	N/A	N/A	
	Z20M8ESHR	20 x 20 x 84.4-84.9	65	185.85	6.50	\$1327	\$1373	N/A	N/A	
	Z16S8ESHR	16 x 16 x 84.4-84.9	65	136.50	5.50	\$1127	\$1168	N/A	N/A	
<p>For use at RIGHT end of 84"/84.5"H units. Five adjustable shelves. Shipped RTA (ready to assemble).</p> <ul style="list-style-type: none"> • Collator only available on Z16S8ESHR 										

Required Specifications

Top finish
Base finish
Top/Edge Detail

Optional Specifications

Collator

TABLE TOP END SHELVES

MODEL# DIMENSIONS FREIGHT CLASS WT/LBS. CUBIC FT. 1" TOP 1.5" TOP GLAZE ADD HP ADD

D x W x H

Z16S12DL	16 x 16 x 11.25-11.75	70	26	1.60	\$255	\$296	N/A	N/A
----------	-----------------------	----	----	------	-------	-------	-----	-----



* Accepts collator 11" high

Table Top End Shelf - LEFT
11.75"/12.25" High

To be placed **on top of 29"/29.5" units**. For use at **LEFT end of 40.8"/41.8"H units**. Shipped RTA (ready to assemble).

Z16S12DR	16 x 16 x 11.25-11.75	70	26	1.60	\$255	\$296	N/A	N/A
----------	-----------------------	----	----	------	-------	-------	-----	-----



* Accepts collator 11" high

Table Top End Shelf - RIGHT
11.75"/12.25" High

To be placed **on top of 29"/29.5" units**. For use at **RIGHT end of 40.8"/41.8"H units**. Shipped RTA (ready to assemble).

Z16S23DL	16 x 16 x 23-23.5	65	42	1.60	\$391	\$436	N/A	N/A
----------	-------------------	----	----	------	-------	-------	-----	-----



* Accepts collator 11" high

Table Top End Shelf - LEFT
23.5"/24" High

To be placed **on top of 29"/29.5" units**. For use at **LEFT end of 52.5"/53"H units**. Shipped RTA (ready to assemble).
One adjustable shelf.

Z16S23DR	16 x 16 x 23-23.5	65	42	1.60	\$391	\$436	N/A	N/A
----------	-------------------	----	----	------	-------	-------	-----	-----



* Accepts collator 11" high

Table Top End Shelf - RIGHT
23.5"/24" High

To be placed **on top of 29"/29.5" units**. For use at **RIGHT end of 52.5"/53"H units**. Shipped RTA (ready to assemble).
One adjustable shelf.

Z16S36DL	16 x 16 x 35.5-36	70	62.84	2.80	\$545	\$586	N/A	N/A
----------	-------------------	----	-------	------	-------	-------	-----	-----



* Accepts collator 11" high

Table Top End Shelf - LEFT
36"/36.5" High

To be placed **on top of 29"/29.5" units**. For use at **LEFT end of 65"/65.5"H units**. Shipped RTA (ready to assemble).
Two adjustable shelves.

Z16S36DR	16 x 16 x 35.5-36	70	62.84	2.80	\$545	\$586	N/A	N/A
----------	-------------------	----	-------	------	-------	-------	-----	-----



* Accepts collator 11" high

Table Top End Shelf - RIGHT
36"/36.5" High

To be placed **on top of 29"/29.5" units**. For use at **RIGHT end of 65"/65.5"H units**. Shipped RTA (ready to assemble).
Two adjustable shelves.

Required Specifications

- Top finish
- Base finish
- Top/Edge Detail

Optional Specifications

- Collator

TABLE TOP END SHELVES		MODEL#	DIMENSIONS	FREIGHT CLASS	WT/LBS.	CUBIC FT.	1" TOP	1.5" TOP	GLAZE ADD	HP ADD
	<p>* Accepts collator 11" high</p>		D x W x H							
		Z16S42DL	16-36 x 16 x 41.9-42.4	65	70	2.80	\$588	\$629	N/A	N/A
<p>Table Top End Shelf - LEFT* 42.4"/42.9" High</p>		<p>To be placed on top of 29"/29.5" units. For use at LEFT end of 71.5"/72"H units. Shipped RTA (ready to assemble). Two adjustable shelves.</p>								
	<p>* Accepts collator 11" high</p>									
		Z16S42DR	16-36 x 16 x 41.9-42.4	65	70	2.80	\$588	\$629	N/A	N/A
<p>Table Top End Shelf - RIGHT* 42.4"/42.9" High</p>		<p>To be placed on top of 29"/29.5" units. For use at RIGHT end of 71.5"/72"H units. Shipped RTA (ready to assemble). Two adjustable shelves.</p>								
	<p>* Accepts collator 11" high</p>									
		Z16S55DL	16-36 x 16 x 54.4-54.9	60	89	2.80	\$726	\$771	N/A	N/A
<p>Table Top End Shelf - LEFT* 54.9"/55.4" High</p>		<p>To be placed on top of 29"/29.5" units. For use at LEFT end of 84"/84.5"H units. Shipped RTA (ready to assemble). Three adjustable shelves.</p>								
	<p>* Accepts collator 11" high</p>									
		Z16S55DR	16-36 x 16 x 54.4-54.9	60	89	2.80	\$726	\$771	N/A	N/A
<p>Table Top End Shelf - RIGHT* 54.9"/55.4" High</p>		<p>To be placed on top of 29"/29.5" units. For use at RIGHT end of 84"/84.5"H units. Shipped RTA (ready to assemble). Three adjustable shelves.</p>								

Required Specifications

- Top finish
- Base finish
- Top/Edge Detail

Optional Specifications

- Collator

ACCESSORIES

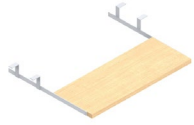

Pull-Out Keyboard

MODEL#	DIMENSIONS D x W x H	FREIGHT CLASS	WT/LBS.	CUBIC FT.	LIST PRICE
APOKL28	17 x 28 x 3.5	85	13	.90	\$359
APOKL22	17 x 22 x 3.5	85	12	.90	\$325

APOKL28 will accommodate keyboard and mousepad. **APOKL28** will only fit on a single pedestal desk, freestanding table, or **Z42205C**.

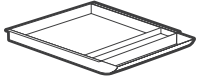

Pencil Drawer

W1518PDR	18 x 15 x 2.25	92.5	4	0.4	\$292
----------	----------------	------	---	-----	--------------

Black ABS plastic. Provides space for writing instruments and small items at the workspace. Attaches to underside of any 24"D and 30"D worksurface with included roller slides. Shipped RTA (ready to assemble).



L Bracket

MLB90	--	70	1	.01	\$64
-------	----	----	---	-----	-------------

Used to attach worksurfaces to end panels.



LEFT
RIGHT
Skateboard

Z1425SKL (left)	13.9-36 x 25 x 3.2-3.7	100	13	1.50	\$146
---------------------------	------------------------	-----	----	------	--------------

Z1425SKR (right)	13.9-36 x 25 x 3.2-3.7	100	13	1.50	\$146
----------------------------	------------------------	-----	----	------	--------------

Mobile CPU holder designed to fit inside 'faux' pedestals of a single pedestal desk.

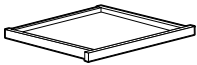

Center Drawer

CD20	18 x 20 x 3	100	8	1	\$228
------	-------------	-----	---	---	--------------

Laminate drawer front is attached to a 4-sided frame. Recommended for use on small L-shaped units, and on 30" x 60" and 66" desks.

Required Specifications

Finish

zira boardroom + reception



Zira Boardroom + Reception

330

TOP AND BASE FINISHES

- Thermally fused laminate (**TFL**) and high pressure laminate (**HPL**) available in all finishes.
- Ultra matte high pressure (**UML**) available on select finishes* only.

ACJ Absolute Acajou	FCL First Class
ASN Asian Night	NBL Noce Biondo
AWC Avant Cherry	NGL Noce Grigio
AWH Avant Honey	NEL Noce Leggero
BLK Black*	NML Noce Medio
BZD Blizzard*	QTM Quartered Mahogany
BRC Brushed Cobalt	SBY Sheer Beauty
CMB Clear Maple	SDT Stonedust*
CGY Custom Grey*	SOG Storm Grey*
DES Dark Espresso	WHE Walnut Heights
DWT Designer White*	WHC White Chocolate
FAS Fashionista	WCR Winter Cherry

BASE TRIM FINISHES

BRC Brushed Cobalt
BLK Black

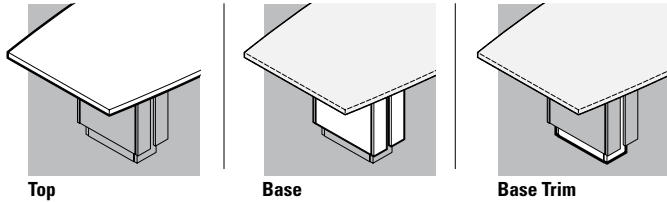

TOP THICKNESS/EDGE DETAIL



C3 1.5" top, standard **CR** 1.5" top, bicut edge **CF** 1.5" top, fluted edge

BASES

- 2 doors on base for wire management access from both sides
- Because of base sizes, custom width less than 96" cannot be accommodated.

TOPS

- 1.5" thick tops are made of 45 lb. density particleboard core with thermally fused laminate surfaces (**TFL**), optional high pressure laminate (**HPL**) or ultra matte high pressure (**UML**) laminate surfaces with kraft paper bottom surfaces.
- Tops are sealed with Global's preferred edge in matching color. Woodgrain surfaces feature edging with corresponding printed woodgrain.
- 96" tops are standard in one piece. All tops 120", 144" and 168" tops are standard in two equal size pieces. Woodgrain laminate finishes may NOT align where the two tops join. Tops 192" and larger are standard in 3 equal pieces.
- 96" tops are standard with **two bases**
- Tops 120", 144" and 168" are standard with **three bases**
- Tops 192" and larger are standard with **four bases**
- **Four** top shapes: **boat shaped**, **bow end**, **rectangular** and **racetrack**

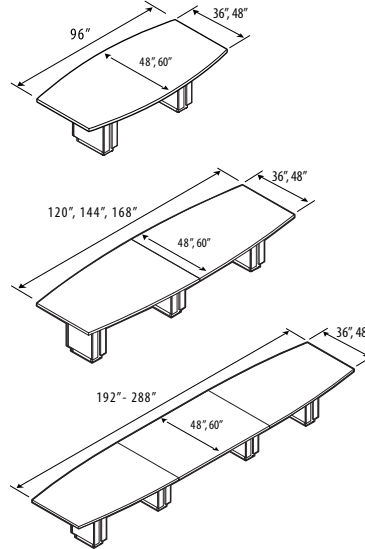

POWER BLOCK OPTIONS AND CUT-OUT LOCATIONS

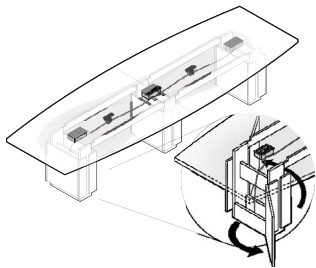

PRODUCT CODE DIAGRAM

PMSPPDM



PRTMCS401B
PRTMCS401T
PRTMCS401W
PRTMCS421B
PRTMCS421T
PRTMCS421W



PRTMCD602B
PRTMCD602T
PRTMCD602W
PRTMCD622B
PRTMCD622T
PRTMCD622W
PRTMCD642B
PRTMCD642T
PRTMCD642W

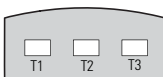

VILLA



OASIS MINI A

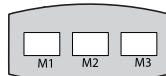

OASIS MINI B

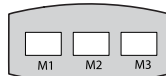

CUT-OUTS

- **Boardroom** and **collaborative** tables offer optional cut-outs for in-surface mounted power modules in three standard locations (left, center or right) as shown above for all table shapes excluding square boardroom tables. Order as **E1, M1, R1, T1, V1**, etc. **Add \$103** for each cut-out.
- Cut-out options for **square boardroom tables** in centered position only. Order as **E2, M2, R2, T2**, or **V2**. **Add \$103** for each cut-out.
- Cut-out options for **media tables** in position 1 only. Order as **E1, M1, R1, T1**, or **V1**. **Add \$103** for each cut-out.
- Select power block from **Productivity Solutions**, beginning on page 491.
- Match power block desired with cut-out code and location from above grid.
- Optional custom sized cut-out available in standard locations (left, center or right) for all table shapes. Submit appropriate form beginning on page 865 with order. **Add \$314** for each cut-out.

AUDIOVISUAL

Three components:
Multimedia Cart

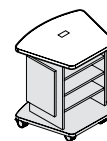
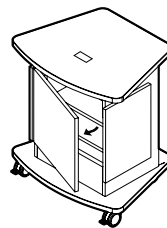

Top

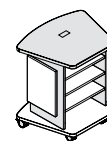

Base

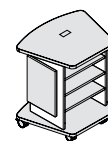

Base trim

Lectern

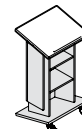
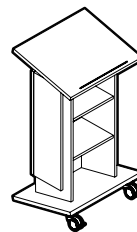

Top



Base



Base Trim

Visual Board

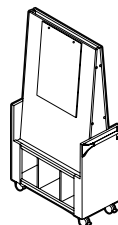

Lower Portion

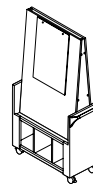

Push Bar & Casters

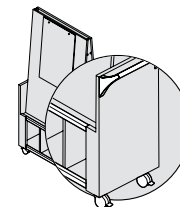

Visual Board

Multimedia Cart and Lectern:

- Available in all standard laminates
- Color of casters will match base trim
- Offered in the following **top thickness and edge details**:

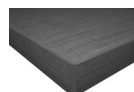

A3 1" top, standard

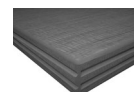

AR 1" top, bicut edge

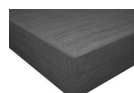

C3 1.5" top, standard



CR 1.5" top, bicut edge

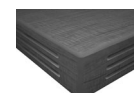

CF 1.5" top, fluted edge

Visual Board:

- Available in all laminates listed above
- Push Bar available in Black (**BLK**) or Tungsten (**TUN**)
- Color of casters and aluminum trim will match push bar
- Visual Board comes standard in white color

BUFFET

Three components: **Buffet Carts, Buffets** and **Serving Carts**

- Top and/or base available in all laminates
- Push Bar on Buffet Carts and Serving Carts and Aluminum Trim on Open and Mixed Buffets available in Black (BLK) or Tungsten (TUN)
- Optional glazing available on Serving Carts with doors and Buffets with doors

Buffet Carts

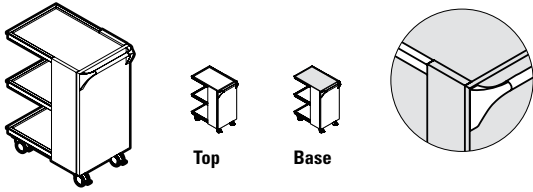

Serving Cart with Doors

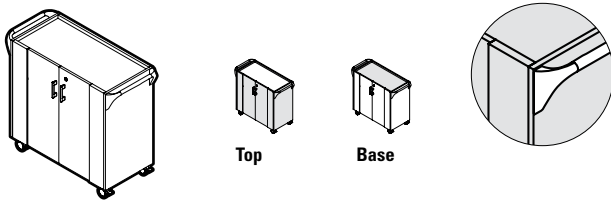

Serving Cart - Open

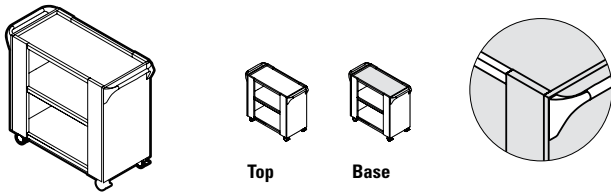

Buffet - Open

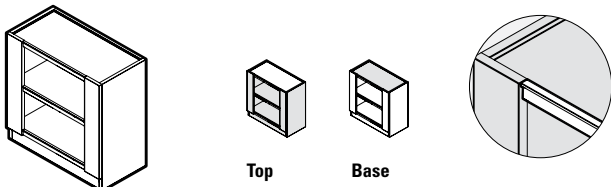

Buffet with Doors

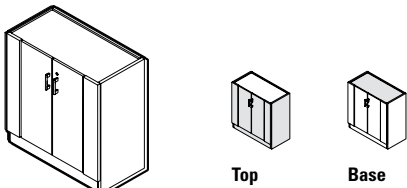

Buffet - Mixed

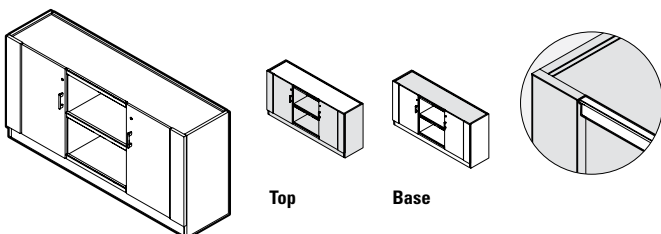

Glazing (Doors - Serving Cart and Buffets)



Z1 frosted glazing, Tungsten (TUN) frame Z2 frosted glazing, Black (BLK) frame

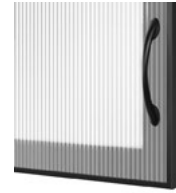

Z3 ribbed glazing, Tungsten (TUN) frame Z4 ribbed glazing, Black (BLK) frame

Handles

- Handles are standard on models with doors. Each handle is identified by the letters "HU", "HV", "HW", "HX", "HS", "HZ", "HO", "HQ", and "HR". To specify a handle, please specify the code after the model number.



HS Flared Silver



HV Square Edge Silver



HO Crescent Black



HW Flared Brass



HU Square Edge Black



HZ Dimpled Nickel



HX Flared Black



HQ Bar Silver



HR Bar Black

- Use the following for determining the size of a table and the number of chairs needed for a conference area. All estimates are based on an average chair width of 23" with a 4" clearance between chairs. Adjust accordingly for a different chair size.

Top Size	Rectangular	Bow End	Boat	Racetrack
48x96	6-8	6-8	6-8	6-8
48x120	8-10	8-10	8-10	8-10
48x144	10-12	10-12	10-12	10-12
48x168	12-14	12-14	12-14	12-14
48x192	14-16	14-16	14-16	14-16
48x216	16-18	16-18	16-18	16-18
48x240	18-20	18-20	18-20	18-20
48x264	20-22	20-22	20-22	20-22
48x288	22-24	22-24	22-24	22-24

BOARDROOM TABLES



Boardroom Table - Square

MODEL#	DIMENSIONS D x W x H (1.5" TOP)	FREIGHT CLASS	WT/LBS.	CUBIC FT.	1" TOP	1.5" TOP	HPL ADD	UML ADD
Z3636SQ	36 x 36 x 30	85	129	10	N/A	\$2562	\$380	\$454
Z4242SQ	42 x 42 x 30	85	165.50	13.50	N/A	\$2916	\$520	\$621
Z4848SQ	48 x 48 x 30	85	190	14.24	N/A	\$3159	\$671	\$806
Z5454SQ	54 x 54 x 30	85	262	21.24	N/A	\$3534	\$851	\$1024
Z6060SQ	60 x 60 x 30	85	300	22.74	N/A	\$3777	\$1046	\$1260

Square Table includes one base with wire access doors on each side of base. Shipped easy to assemble in 2 cartons.



Boardroom Table - Squircle

Z3636QR	36 x 36 x 30.1	100	125	14.5	N/A	\$2532	\$356	\$454
Z4242QR	42 x 42 x 30.1	100	160	18	N/A	\$3150	\$488	\$621
Z4848QR	48 x 48 x 30.1	100	181	19.24	N/A	\$3444	\$630	\$806
Z5454QR	54 x 54 x 30.1	92.5	257	21.5	N/A	\$4319	\$799	\$1024
Z6060QR	60 x 60 x 30.1	85	288	23.24	N/A	\$4681	\$982	\$1260

Includes one base with wire access doors on each side of base. Shipped easy to assemble in 2 cartons.



Boardroom Table - Boat Shaped

Z4896BE	48 x 96 x 30	70	342	21.95	N/A	\$4175	\$1030	\$1343
---------	--------------	----	-----	-------	-----	---------------	---------------	---------------

Boat Shaped Table includes TWO BASES with wire access doors on each side of base and wire concealment runners between bases. Shipped in 3 cartons.



Boardroom Table - Boat Shaped

Z6096BE	60 x 96 x 30	85	432	35.39	N/A	\$6775	\$1674	\$2014
---------	--------------	----	-----	-------	-----	---------------	---------------	---------------

Boat Shaped Table includes TWO BASES with wire access doors on each side of base and wire concealment runners between bases. Shipped in 3 cartons.



Boardroom Table - Boat Shaped

Z48120BE	48 x 120 x 30	70	452	23.48	N/A	\$6002	\$1287	\$1681
Z48144BE	48 x 144 x 30	70	502	25.72	N/A	\$6060	\$1543	\$2014
Z48168BE	48 x 168 x 30	85	557	37.25	N/A	\$8087	\$1951	\$2352

Boat Shaped Table includes THREE BASES with wire access doors on each side of base and wire concealment runners between bases. Z48144BE and Z48120BE shipped in 4 cartons. Z48168BE shipped in 5 cartons.



Boardroom Table - Boat Shaped

Z60120BE	60 x 120 x 30	85	599	48.50	N/A	\$10270	\$2089	\$2519
Z60144BE	60 x 144 x 30	85	664.65	53.25	N/A	\$10992	\$2508	\$3019
Z60168BE	60 x 168 x 30	85	741.30	58	N/A	\$11853	\$2924	\$3524

Boat Shaped Table includes THREE BASES with wire access doors on each side of base and wire concealment runners between bases. Shipped in 5 cartons.

Required Specifications

Primary surface type + finish
Top/edge detail
Base finish
Base trim finish

Optional Specifications

Cut-out for power block

Accessories

Power block

BOARDROOM TABLES **MODEL#** **DIMENSIONS** **FREIGHT CLASS** **WT./LBS.** **CUBIC FT.** **1" TOP** **1.5" TOP** **HPL ADD** **UML ADD**



Boardroom Table - Boat Shaped

	D x W x H (1.5" TOP)								
Z48192BE	48 x 192 x 30	70	688	45.66	N/A	\$10100	\$2227	\$2686	
Z48216BE	48 x 216 x 30	70	746	48.67	N/A	\$10575	\$2508	\$3019	
Z48240BE	48 x 240 x 30	70	803	51.68	N/A	\$11243	\$2784	\$3357	
Z48264BE	48 x 264 x 30	70	855	54.69	N/A	\$11908	\$3062	\$3690	
Z48288BE	48 x 288 x 30	70	906	57.69	N/A	\$11908	\$3340	\$4028	

Boat Shaped Table includes FOUR BASES with wire access doors on each side of base and wire concealment runners between bases. Shipped in 7 cartons.



Boardroom Table - Boat Shaped

Z60192BE	60 x 192 x 30	85	912.45	71.19	N/A	\$14909	\$3340	\$4028	
Z60216BE	60 x 216 x 30	85	980.70	75.94	N/A	\$15745	\$3756	\$4528	
Z60240BE	60 x 240 x 30	85	1062.60	80.98	N/A	\$16422	\$4175	\$5033	
Z60264BE	60 x 264 x 30	85	1129.80	85.73	N/A	\$17074	\$4592	\$5538	
Z60288BE	60 x 288 x 30	85	1198.05	90.49	N/A	\$18113	\$5010	\$6038	

Boat Shaped Table includes FOUR BASES with wire access doors on each side of base and wire concealment runners between bases. Shipped in 7 cartons.



Boardroom Table - Racetrack

Z4896RTE	48 x 96 x 30	70	336	21.95	N/A	\$4059	\$1030	\$1343	
----------	--------------	----	-----	-------	-----	---------------	---------------	---------------	--

Racetrack Shaped Table includes TWO BASES with wire access doors on each side of base and wire concealment runners between bases. Shipped in 3 cartons.



Boardroom Table - Racetrack

Z6096RTE	60 x 96 x 30	92.5	417	35.39	N/A	\$6775	\$1674	\$2014	
----------	--------------	------	-----	-------	-----	---------------	---------------	---------------	--

Racetrack Shaped Table includes TWO BASES with wire access doors on each side of base and wire concealment runners between bases. Shipped in 3 cartons.



Boardroom Table - Racetrack

Z48120RTE	48 x 120 x 30	70	453	28.28	N/A	\$5644	\$1287	\$1681	
Z48144RTE	48 x 144 x 30	70	506	25.72	N/A	\$6016	\$1543	\$2014	
Z48168RTE	48 x 168 x 30	70	563	37.25	N/A	\$8136	\$1951	\$2352	

Racetrack Shaped Table includes THREE BASES with wire access doors on each side of base and wire concealment runners between bases. Z48144RTE and Z48120RTE shipped in 4 cartons. Z48168RTE shipped in 5 cartons.

Required Specifications

Primary surface type + finish
Top/edge detail
Base finish
Base trim finish

Optional Specifications

Cut-out for power block

Accessories

Power block

BOARDROOM TABLES



Boardroom Table - Racetrack

MODEL#	DIMENSIONS D x W x H (1.5" TOP)	FREIGHT CLASS	WT/LBS.	CUBIC FT.	1" TOP	1.5" TOP	HPL ADD	UML ADD
Z60120RTE	60 x 120 x 30	85	585.90	48.50	N/A	\$10270	\$2089	\$2519
Z60144RTE	60 x 144 x 30	85	656.25	53.25	N/A	\$10992	\$2508	\$3019
Z60168RTE	60 x 168 x 30	85	737.10	58	N/A	\$11853	\$2924	\$3524

Racetrack Shaped Table includes THREE BASES with wire access doors on each side of base and wire concealment runners between bases. Shipped in 5 cartons.



Boardroom Table - Racetrack

Z48192RTE	48 x 192 x 30	70	689	45.45	N/A	\$10150	\$2227	\$2686
Z48216RTE	48 x 216 x 30	70	749	48.95	N/A	\$10623	\$2508	\$3019
Z48240RTE	48 x 240 x 30	70	809	51.75	N/A	\$11291	\$2784	\$3357
Z48264RTE	48 x 264 x 30	70	862	54.55	N/A	\$11957	\$3062	\$3690
Z48288RTE	48 x 288 x 30	70	917	58.04	N/A	\$11957	\$3340	\$4028

Racetrack Shaped Table includes FOUR BASES with wire access doors on each side of base and wire concealment runners between bases. Shipped in 7 cartons.



Boardroom Table - Racetrack

Z60192RTE	60 x 192 x 30	85	901.95	71.19	N/A	\$14909	\$3340	\$4028
Z60216RTE	60 x 216 x 30	85	972.30	75.94	N/A	\$15745	\$3756	\$4528
Z60240RTE	60 x 240 x 30	85	1057.35	80.98	N/A	\$16422	\$4175	\$5033
Z60264RTE	60 x 264 x 30	85	1127.70	85.73	N/A	\$17074	\$4592	\$5538
Z60288RTE	60 x 288 x 30	85	1198.05	90.49	N/A	\$18113	\$5010	\$6038

Racetrack Shaped Table includes FOUR BASES with wire access doors on each side of base and wire concealment runners between bases. Shipped in 7 cartons.



Boardroom Table - Rectangular

Z4896REE	48 x 96 x 30	70	356	21.95	N/A	\$4154	\$1030	\$1343
----------	--------------	----	-----	-------	-----	---------------	---------------	---------------

Rectangular Shaped Table includes TWO BASES with wire access doors on each side of base and wire concealment runners between bases. Shipped in 3 cartons.



Boardroom Table - Rectangular

Z6096REE	60 x 96 x 30	85	448	35.39	N/A	\$6211	\$1674	\$2014
----------	--------------	----	-----	-------	-----	---------------	---------------	---------------

Rectangular Shaped Table includes TWO BASES with wire access doors on each side of base and wire concealment runners between bases. Shipped in 3 cartons.



Boardroom Table - Rectangular

Z48120REE	48 x 120 x 30	70	472	23.48	N/A	\$5625	\$1287	\$1681
Z48144REE	48 x 144 x 30	70	525	25.72	N/A	\$6021	\$1543	\$2014
Z48168REE	48 x 168 x 30	70	583	37.25	N/A	\$8017	\$1951	\$2352

Rectangular Shaped Table includes THREE BASES with wire access doors on each side of base and wire concealment runners between bases. Z48144REE and Z48120REE shipped in 4 cartons. Z48168REE shipped in 5 cartons.

Required Specifications

Primary surface type + finish
Top/edge detail
Base finish
Base trim finish

Optional Specifications

Cut-out for power block

Accessories

Power block

BOARDROOM TABLES **MODEL#** **DIMENSIONS** **FREIGHT CLASS** **WT/LBS.** **CUBIC FT.** **1" TOP** **1.5" TOP** **HPL ADD** **UML ADD**



Boardroom Table - Rectangular

	D x W x H (1.5" TOP)								
Z60120REE	60 x 120 x 30	85	618	48.50	N/A	\$9414	\$2089	\$2519	
Z60144REE	60 x 144 x 30	85	688	53.25	N/A	\$10075	\$2508	\$3019	
Z60168REE	60 x 168 x 30	85	769	58	N/A	\$10851	\$2924	\$3524	

Rectangular Shaped Table includes THREE BASES with wire access doors on each side of base and wire concealment runners between bases. Shipped in 5 cartons.



Boardroom Table - Rectangular

Z48192REE	48 x 192 x 30	70	708	45.45	N/A	\$10032	\$2227	\$2686	
Z48216REE	48 x 216 x 30	70	768	48.95	N/A	\$10506	\$2508	\$3019	
Z48240REE	48 x 240 x 30	70	828	51.75	N/A	\$11171	\$2784	\$3357	
Z48264REE	48 x 264 x 30	70	882	54.55	N/A	\$11840	\$3062	\$3690	
Z48288REE	48 x 288 x 30	70	936	58.04	N/A	\$11840	\$3340	\$4028	

Rectangular Shaped Table includes FOUR BASES with wire access doors on each side of base and wire concealment runners between bases. Shipped in 7 cartons.



Boardroom Table - Rectangular

Z60192REE	60 x 192 x 30	85	941.85	71.12	N/A	\$13668	\$3340	\$4028	
Z60216REE	60 x 216 x 30	85	1003.80	75.94	N/A	\$14425	\$3756	\$4528	
Z60240REE	60 x 240 x 30	85	1088.85	80.98	N/A	\$15044	\$4175	\$5033	
Z60264REE	60 x 264 x 30	85	1159.20	85.73	N/A	\$15635	\$4592	\$5538	
Z60288REE	60 x 288 x 30	85	1229.55	90.49	N/A	\$16580	\$5010	\$6038	

Rectangular Shaped Table includes FOUR BASES with wire access doors on each side of base and wire concealment runners between bases. Shipped in 7 cartons.



Boardroom Table - Bow End

Z4896BW	48 x 96 x 30	85	329	21.95	N/A	\$4302	\$1030	\$1343	
---------	--------------	----	-----	-------	-----	---------------	---------------	---------------	--

Bow End Table includes TWO BASES with wire access doors on each side of base and wire concealment runners between bases. Shipped in 3 cartons.



Boardroom Table - Bow End

Z6096BW	60 x 96 x 30	85	436	35.39	N/A	\$6775	\$1674	\$2014	
---------	--------------	----	-----	-------	-----	---------------	---------------	---------------	--

Bow End Table includes TWO BASES with wire access doors on each side of base and wire concealment runners between bases. Shipped in 3 cartons.

Required Specifications

Primary surface type + finish
Top/edge detail
Base finish
Base trim finish

Optional Specifications

Cut-out for power block

Accessories

Power block

BOARDROOM TABLES



Boardroom Table - Bow End

MODEL#	DIMENSIONS D x W x H (1.5" TOP)	FREIGHT CLASS	WT/LBS.	CUBIC FT.	1" TOP	1.5" TOP	HPL ADD	UML ADD
Z48120BW	48 x 120 x 30	70	476	29.35	N/A	\$5728	\$1287	\$1681
Z48144BW	48 x 144 x 30	70	513	25.72	N/A	\$6134	\$1543	\$2014
Z48168BW	48 x 168 x 30	70	573	37.25	N/A	\$8052	\$1951	\$2352

Bow End Table includes THREE BASES with wire access doors on each side of base and wire concealment runners between bases. Z48144BW and Z48120BW shipped in 4 cartons. Z48168BW shipped in 5 cartons.



Boardroom Table - Bow End

Z60120BW	60 x 120 x 30	85	602	48.50	N/A	\$10270	\$2089	\$2519
Z60144BW	60 x 144 x 30	85	673	53.25	N/A	\$10992	\$2508	\$3019
Z60168BW	60 x 168 x 30	85	753	58	N/A	\$11853	\$2924	\$3524

Bow End Table includes THREE BASES with wire access doors on each side of base and wire concealment runners between bases. Shipped in 5 cartons.



Boardroom Table - Bow End

Z48192BW	48 x 192 x 30	70	698	45.45	N/A	\$10069	\$2227	\$2686
Z48216BW	48 x 216 x 30	70	758	48.95	N/A	\$10539	\$2508	\$3019
Z48240BW	48 x 240 x 30	70	818	51.75	N/A	\$11206	\$2784	\$3357
Z48264BW	48 x 264 x 30	70	872	54.55	N/A	\$11875	\$3062	\$3690
Z48288BW	48 x 288 x 30	70	926	58.04	N/A	\$11875	\$3340	\$4028

Bow End Table includes FOUR BASES with wire access doors on each side of base and wire concealment runners between bases. Shipped in 7 cartons.



Boardroom Table - Bow End

Z60192BW	60 x 192 x 30	85	917.70	71.19	N/A	\$14909	\$3340	\$4028
Z60216BW	60 x 216 x 30	85	988.05	75.94	N/A	\$15745	\$3756	\$4528
Z60240BW	60 x 240 x 30	85	1073.10	80.98	N/A	\$16422	\$4175	\$5033
Z60264BW	60 x 264 x 30	85	1143.45	85.73	N/A	\$17074	\$4592	\$5538
Z60288BW	60 x 288 x 30	85	1213.80	90.49	N/A	\$18113	\$5010	\$6038

Bow End Table includes FOUR BASES with wire access doors on each side of base and wire concealment runners between bases. Shipped in 7 cartons.



Boardroom Table - Wedge

Z6096WE	60 x 96 x 30	70	398	26.17	N/A	\$6775	\$1674	\$2014
---------	--------------	----	-----	-------	-----	---------------	---------------	---------------

Wedge Table includes TWO BASES with wire access doors on each side of base. Wedge tapers from 60" w to 48" w. Shipped in 3 cartons.

Required Specifications

Primary surface type + finish
Top/edge detail
Base finish
Base trim finish

Optional Specifications

Cut-out for power block

Accessories

Power block

BOARDROOM TABLES	MODEL#	DIMENSIONS	FREIGHT CLASS	WT/LBS.	CUBIC FT.	1" TOP	1.5" TOP	HPL ADD	UML ADD
		D x W x H (1.5" TOP)							
	Z60120WE	60 x 120 x 30	85	544.95	36.50	N/A	\$10270	\$2089	\$2519
	Z60144WE	60 x 144 x 30	70	603.75	39.50	N/A	\$10992	\$2508	\$3019
	Z60168WE	60 x 168 x 30	70	673.05	42.50	N/A	\$11853	\$2924	\$3524

Boardroom Table - Wedge

Wedge table includes THREE BASES with wire access doors on each side of base. Wedge tapers from 60" w to 48" w. Shipped in 5 cartons.

	Z60192WE	60 x 192 x 30	85	824.25	63.71	N/A	\$14909	\$3340	\$4028
	Z60216WE	60 x 216 x 30	85	884.10	68.25	N/A	\$15745	\$3756	\$4528
	Z60240WE	60 x 240 x 30	85	948.15	72.94	N/A	\$16422	\$4175	\$5033
	Z60264WE	60 x 264 x 30	85	1006.95	77.48	N/A	\$17074	\$4592	\$5538
	Z60288WE	60 x 288 x 30	85	1065.75	81.96	N/A	\$18113	\$5010	\$6038

Boardroom Table - Wedge

Wedge table includes FOUR BASES with wire access doors on each side of base. Wedge tapers from 60" w to 48" w. Shipped in 7 cartons.

BOARDROOM TABLES, SLIM BASE	MODEL#	DIMENSIONS	FREIGHT CLASS	WT/LBS.	CUBIC FT.	1" TOP	1.5" TOP	HPL ADD	UML ADD
		D x W x H (1.5" TOP)							

	ZS3636QR	36 x 36 x 30.1	85	111	9.24	N/A	\$2228	\$356	\$454
	ZS4242QR	42 x 42 x 30.1	92.5	144	13.24	N/A	\$2542	\$488	\$621
	ZS4848QR	48 x 48 x 30.1	92.5	168	14.24	N/A	\$2846	\$630	\$806
	ZS5454QR	54 x 54 x 30.1	85	243	18.74	N/A	\$3612	\$799	\$1024
	ZS6060QR	60 x 60 x 30.1	85	276	20.24	N/A	\$3989	\$982	\$1260

Boardroom Table - Squire, Slim Base

Includes one base with hinged door for wire access. Shipped easy to assemble in 2 cartons.

	ZS3636SQ	36 x 36 x 30.1	85	112	9.24	N/A	\$2405	\$356	\$454
	ZS4242SQ	42 x 42 x 30.1	92.5	145	13.24	N/A	\$2738	\$92	\$621
	ZS4848SQ	48 x 48 x 30.1	92.5	169	14.24	N/A	\$2966	\$630	\$806
	ZS5454SQ	54 x 54 x 30.1	85	244	18.74	N/A	\$3318	\$799	\$1024
	ZS6060SQ	60 x 60 x 30.1	85	277	20.24	N/A	\$3546	\$982	\$1260

Boardroom Table - Square, Slim Base*

Includes one base with hinged door for wire access. Optional with 3" radius corners (3R), add \$348. Shipped easy to assemble in 2 cartons.

	ZS4896REE	48 x 96 x 30.1	70	326	18.44	N/A	\$3900	\$967	\$1343
	ZS6096REE	60 x 96 x 30.1	70	426	25.45	N/A	\$5831	\$1571	\$2014

Rect. Boardroom Table, Slim Base*

48"D tables include two bases each with a single hinged door for wire access. 60"D bases have two hinged doors per base. Optional with 3" radius corners (3R), add \$348. Shipped easy to assemble in 3 cartons.

	ZS4896BW	48 x 96 x 30.1	70	326	18.44	N/A	\$4039	\$967	\$1343
	ZS6096BW	60 x 96 x 30.1	70	426	25.45	N/A	\$6361	\$1571	\$2014

Bow End Boardroom Table, Slim Base

48"D tables include two bases each with a single hinged door for wire access. 60"D bases have two hinged doors per base. Shipped easy to assemble in 3 cartons.

Required Specifications

Primary surface type + finish
Top/edge detail
Base finish
Base trim finish

Optional Specifications

Cut-out for power block
3" radius corners (3R)*

Accessories

Power block

BOARDROOM TABLES, SLIM BASE



Boat Boardroom Table, Slim Base

MODEL#	DIMENSIONS D x W x H (1.5" TOP)	FREIGHT CLASS	WT/LBS.	CUBIC FT.	1" TOP	1.5" TOP	HPL ADD	UML ADD
ZS4896BE	48 x 96 x 30.1	70	326	18.44	N/A	\$3920	\$967	\$1343
ZS6096BE	60 x 96 x 30.1	70	426	25.45	N/A	\$6361	\$1571	\$2014

48"D tables include two bases, each with a single hinged door for wire access. 60"D bases have two hinged doors per base. Shipped easy to assemble in 3 cartons.



Racetrack Boardroom Table, Slim Base

ZS4896RTE	48 x 96 x 30.1	70	326	18.44	N/A	\$3811	\$967	\$1343
ZS6096RTE	60 x 96 x 30.1	70	426	25.45	N/A	\$6361	\$1571	\$2014

48"D tables include two bases, each with a single hinged door for wire access. 60"D bases have two hinged doors per base. Optional 3" radius corners, upcharge applies. Shipped easy to assemble in 3 cartons.



Wedge Boardroom Table, Slim Base*

ZS6096WE	60 x 96 x 30.1	70	426	25.45	N/A	\$6361	\$1571	\$2014
----------	----------------	----	-----	-------	-----	---------------	---------------	---------------

48"D tables include two bases, each with a single hinged door for wire access. 60"D bases have two hinged doors per base. Optional with 3" radius corners (**3R**), add **\$348**. Shipped easy to assemble in 3 cartons.



Rectangular Boardroom Table, Slim Base

ZS48120REE	48 x 120 x 30.1	70	426	24	N/A	\$5281	\$1208	\$1681
ZS48144REE	48 x 144 x 30.1	70	480	25.24	N/A	\$5653	\$1448	\$2014
ZS48168REE	48 x 168 x 30.1	70	572	32.75	N/A	\$7527	\$1831	\$2352
ZS60120REE	60 x 120 x 30.1	70	585	35	N/A	\$8839	\$1961	\$2519
ZS60144REE	60 x 144 x 30.1	70	655	38.5	N/A	\$9460	\$2354	\$3019
ZS60168REE	60 x 168 x 30.1	70	734	41.75	N/A	\$10188	\$2745	\$3524

48"D tables include three bases, each with a single hinged door for wire access. 60"D bases have two hinged doors per base. Shipped easy to assemble, 48"D - 4 cartons; 60"D - 5 cartons.



Bow End Boardroom Table, Slim Base

ZS48120BW	48 x 120 x 30.1	70	416	24	N/A	\$5378	\$1208	\$1681
ZS48144BW	48 x 144 x 30.1	70	470	26.24	N/A	\$5759	\$1448	\$2014
ZS48168BW	48 x 168 x 30.1	70	562	32.75	N/A	\$7560	\$1831	\$2352
ZS60120BW	60 x 120 x 30.1	70	569	35	N/A	\$9643	\$1961	\$2519
ZS60144BW	60 x 144 x 30.1	70	639	38.5	N/A	\$10321	\$2354	\$3019
ZS60168BW	60 x 168 x 30.1	70	718	41.25	N/A	\$11129	\$2745	\$3524

48"D tables include three bases each with a single hinged door for wire access. 60"D bases have two hinged doors per base. Shipped easy to assemble, 48"D - 4 cartons; 60"D - 5 cartons.

Required Specifications

Primary surface type + finish
Top/edge detail
Base finish
Base trim finish

Optional Specifications

Cut-out for power block
3" radius corners (3R)*

Accessories

Power block

BOARDROOM TABLES, SLIM BASE

MODEL#	DIMENSIONS	FREIGHT CLASS	WT/LBS.	CUBIC FT.	1" TOP	1.5" TOP	HPL ADD	UML ADD
--------	------------	---------------	---------	-----------	--------	----------	---------	---------

D x W x H (1.5" TOP)



Boat Boardroom Table, Slim Base

ZS48120BE	48 x 120 x 30.1	70	407	24	N/A	\$5635	\$1208	\$1681
ZS48144BE	48 x 144 x 30.1	65	458	20.2	N/A	\$5690	\$1448	\$2014
ZS48168BE	48 x 168 x 30.1	70	545	32.75	N/A	\$7593	\$1831	\$2352
ZS60120BE	60 x 120 x 30.1	70	565	35	N/A	\$9643	\$1961	\$2519
ZS60144BE	60 x 144 x 30.1	70	632	38.5	N/A	\$10321	\$2354	\$3019
ZS60168BE	60 x 168 x 30.1	70	707	41.75	N/A	\$11129	\$2745	\$3524

48"D tables include three bases each with a single hinged door for wire access. 60"D bases have two hinged doors per base. Shipped easy to assemble, 48"D - 4 cartons; 60"D - 5 cartons.



Racetrack Boardroom Table, Slim Base

ZS48120RTE	48 x 120 x 30.1	70	406	24	N/A	\$5299	\$1208	\$1681
ZS48144RTE	48 x 144 x 30.1	70	461	26.24	N/A	\$5648	\$1448	\$2014
ZS48168RTE	48 x 168 x 30.1	70	552	32.75	N/A	\$7639	\$1831	\$2352
ZS60120RTE	60 x 120 x 30.1	70	624	35	N/A	\$9643	\$1961	\$2519
ZS60144RTE	60 x 144 x 30.1	85	553	38.5	N/A	\$10321	\$2354	\$3019
ZS60168RTE	60 x 168 x 30.1	70	703	41.75	N/A	\$11129	\$2745	\$3524

48"D tables include three bases each with a single hinged door for wire access. 60"D bases have two hinged doors per base. Shipped easy to assemble, 48"D - 4 cartons; 60"D - 5 cartons.



Wedge Boardroom Table, Slim Base*

ZS60120WE	60 x 120 x 30.1	85	513	36.71	N/A	\$9643	\$1961	\$2519
ZS60144WE	60 x 144 x 30.1	85	572	39.94	N/A	\$10321	\$2354	\$3019
ZS60168WE	60 x 168 x 30.1	85	641	43.17	N/A	\$11129	\$2745	\$3524

Includes three bases - two with a single hinged door each for wire access, one with two hinged doors. Optional with 3" radius corners (3R), add \$348. Shipped easy to assemble in 6 cartons.



Rectangular Boardroom Table, Slim Base*

ZS48192REE	48 x 192 x 30.1	70	691	39.23	N/A	\$9419	\$2091	\$2686
ZS48216REE	48 x 216 x 30.1	70	754	42.24	N/A	\$9864	\$2354	\$3019
ZS48240REE	48 x 240 x 30.1	70	741	45.24	N/A	\$10489	\$2614	\$3357
ZS48264REE	48 x 264 x 30.1	70	875	48.25	N/A	\$11117	\$2875	\$3690
ZS48288REE	48 x 288 x 30.1	70	930	51.26	N/A	\$11117	\$3136	\$4028

Includes four bases, each with a single hinged door for wire access. Optional with 3" radius corners (3R), add \$348. Shipped easy to assemble in 7 cartons.



Rectangular Boardroom Table, Slim Base*

ZS60192REE	60 x 192 x 30.1	70	889	51.26	N/A	\$12833	\$3136	\$4028
ZS60216REE	60 x 216 x 30.1	70	960	54.76	N/A	\$13544	\$3526	\$4528
ZS60240REE	60 x 240 x 30.1	70	1045	57.97	N/A	\$14125	\$3920	\$5033
ZS60264REE	60 x 264 x 30.1	70	1115	61.47	N/A	\$14680	\$4311	\$5538
ZS60288REE	60 x 288 x 30.1	70	1185	64.69	N/A	\$15568	\$4704	\$6038

Includes four bases, each with two hinged doors for wire access. Optional with 3" radius corners (3R), add \$348. Shipped easy to assemble in 7 cartons.

Required Specifications

Primary surface type + finish
Top/edge detail
Base finish
Base trim finish

Optional Specifications

Cut-out for power block
3" radius corners (3R)*

Accessories

Power block

BOARDROOM TABLES, SLIM BASE



Bow End Boardroom Table, Slim Base

MODEL#	DIMENSIONS D x W x H (1.5" TOP)	FREIGHT CLASS	WT/LBS.	CUBIC FT.	1" TOP	1.5" TOP	HPL ADD	UML ADD
ZS48192BW	48 x 192 x 30.1	70	681	39.23	N/A	\$9454	\$2091	\$2686
ZS48216BW	48 x 216 x 30.1	70	744	42.24	N/A	\$9895	\$2354	\$3019
ZS48240BW	48 x 240 x 30.1	70	807	45.24	N/A	\$10522	\$2614	\$3357
ZS48264BW	48 x 264 x 30.1	70	863	48.25	N/A	\$11150	\$2875	\$3690
ZS48288BW	48 x 288 x 30.1	70	919	51.26	N/A	\$11150	\$3136	\$4028

Includes four bases, each with a single hinged door for wire access. Shipped easy to assemble in 7 cartons.



Bow End Boardroom Table, Slim Base

ZS60192BW	60 x 192 x 30.1	70	873	51.26	N/A	\$13999	\$3136	\$4028
ZS60216BW	60 x 216 x 30.1	70	944	54.76	N/A	\$14784	\$3526	\$4528
ZS60240BW	60 x 240 x 30.1	70	1029	57.97	N/A	\$15419	\$3920	\$5033
ZS60264BW	60 x 264 x 30.1	70	1099	61.47	N/A	\$16031	\$4311	\$5538
ZS60288BW	60 x 288 x 30.1	70	1169	64.69	N/A	\$17007	\$4704	\$6038

Includes four bases, each with two hinged doors for wire access. Shipped easy to assemble in 7 cartons.



Racetrack Boardroom Table, Slim Base

ZS48192RTE	48 x 192 x 30.1	70	671	39.23	N/A	\$9530	\$2091	\$2686
ZS48216RTE	48 x 216 x 30.1	70	733	42.24	N/A	\$9974	\$2354	\$3019
ZS48240RTE	48 x 240 x 30.1	70	797	45.24	N/A	\$10601	\$2614	\$3357
ZS48264RTE	48 x 264 x 30.1	70	853	48.25	N/A	\$11227	\$2875	\$3690
ZS48288RTE	48 x 288 x 30.1	70	909	51.26	N/A	\$11227	\$3136	\$4028

Includes four bases, each with a single hinged door for wire access. Shipped easy to assemble in 7 cartons.



Racetrack Boardroom Table, Slim Base

ZS60192RTE	60 x 192 x 30.1	70	858	51.26	N/A	\$13999	\$3136	\$4028
ZS60216RTE	60 x 216 x 30.1	70	928	54.76	N/A	\$14784	\$3526	\$4528
ZS60240RTE	60 x 240 x 30.1	70	1013	57.97	N/A	\$15419	\$3920	\$5033
ZS60264RTE	60 x 264 x 30.1	70	1083	61.47	N/A	\$16031	\$4311	\$5538
ZS60288RTE	60 x 288 x 30.1	70	1154	64.69	N/A	\$17007	\$4704	\$6038

Includes four bases, each with two hinged doors for wire access. Shipped easy to assemble in 7 cartons.



Wedge Boardroom Table, Slim Base*

ZS60192WE	60 x 192 x 30.1	92.5	782	71.19	N/A	\$13999	\$3136	\$4028
ZS60216WE	60 x 216 x 30.1	92.5	841	78.46	N/A	\$14784	\$3526	\$4528
ZS60240WE	60 x 240 x 30.1	92.5	905	85.45	N/A	\$15419	\$3920	\$5033
ZS60264WE	60 x 264 x 30.1	92.5	965	92.45	N/A	\$16031	\$4311	\$5538
ZS60288WE	60 x 288 x 30.1	92.5	1024	99.44	N/A	\$17007	\$4704	\$6038

Includes four bases, each with two hinged doors for wire access. Optional with 3" radius corners (3R), add \$348. Shipped easy to assemble in 7 cartons.

Required Specifications







Primary surface type + finish
Top/edge detail
Base finish
Base trim finish

Optional Specifications

Cut-out for power block
3" radius corners (3R)*

Accessories

Power block

MEDIA TABLES	MODEL#	DIMENSIONS D x W x H (1.5" TOP)	FREIGHT CLASS	WT/LBS.	CUBIC FT.	1" TOP	1.5" TOP	HPL ADD	UML ADD
	Z4860DMIL	48 x 60 x 30	70	267	17.69	N/A	\$4223	\$840	\$1010
	Z4872DMIL	48 x 72 x 30	70	298.20	19.67	N/A	\$4528	\$1005	\$1209
	Z4884DMIL	48 x 84 x 30	70	326.55	21.44	N/A	\$4823	\$1173	\$1413
	Z4896DMIL	48 x 96 x 30	85	347.55	23.41	N/A	\$5107	\$1337	\$1612
Media Table - D Island	D Media Island includes ONE BASE with wire access doors on each side of base and wire concealment runners between the base and the end panel. Grommet centered at the top of the end panel for wire pass through. Shipped in 3 cartons.								
	Z6060DMIL	60 x 60 x 30	85	323.93	23.17	N/A	\$5066	\$1046	\$1260
	Z6072DMIL	60 x 72 x 30	85	359.10	25.66	N/A	\$5426	\$1256	\$1510
	Z6084DMIL	60 x 84 x 30	85	397.95	27.90	N/A	\$5787	\$1466	\$1764
	Z6096DMIL	60 x 96 x 30	85	433.65	30.39	N/A	\$6129	\$1674	\$2014
Media Table - D Island	D Media Island includes ONE BASE with wire access doors on each side of base and wire concealment runners between the base and the end panel. Grommet centered at the top of the end panel for wire pass through. Shipped in 3 cartons.								
	Z6060WMIL	60 x 60 x 30	85	306.60	20.69	N/A	\$5066	\$1046	\$1260
	Z6072WMIL	60 x 72 x 30	85	338.10	22.90	N/A	\$5426	\$1256	\$1510
	Z6084WMIL	60 x 84 x 30	85	374.85	25.42	N/A	\$5787	\$1466	\$1764
	Z6096WMIL	60 x 96 x 30	85	407.40	27.90	N/A	\$6129	\$1674	\$2014
Media Table - Wedge	Wedge Media Island includes ONE BASE with wire access doors on each side of base and wire concealment runners between the base and the end panel. Grommet centered at the top of the end panel for wire pass through. Wedge tapers from 60" w to 48" w. Shipped in 3 cartons.								
	Z4860RMIL	48 x 60 x 30	70	279.30	17.69	N/A	\$3889	\$840	\$1010
	Z4872RMIL	48 x 72 x 30	70	307.65	19.67	N/A	\$4168	\$1005	\$1209
	Z4884RMIL	48 x 84 x 30	70	337.05	21.44	N/A	\$4434	\$1173	\$1413
	Z4896RMIL	48 x 96 x 30	70	357	23.41	N/A	\$4690	\$1337	\$1612
Media Table - Rectangular Island	Rectangular Media Island includes ONE BASE with wire access doors on each side of base and wire concealment runners between the base and the end panel. Grommet centered at the top of the end panel for wire pass through. Shipped in 3 cartons.								
	Z6060RMIL	60 x 60 x 30	70	339.15	22.22	N/A	\$4652	\$1046	\$1260
	Z6072RMIL	60 x 72 x 30	85	373.80	25.66	N/A	\$4982	\$1256	\$1510
	Z6084RMIL	60 x 84 x 30	85	414.75	27.90	N/A	\$5308	\$1466	\$1764
	Z6096RMIL	60 x 96 x 30	85	449.40	30.39	N/A	\$5619	\$1674	\$2014
Media Table - Rectangular Island	Rectangular Media Island includes ONE BASE with wire access doors on each side of base and wire concealment runners between the base and the end panel. Grommet centered at the top of the end panel for wire pass through. Shipped in 3 cartons.								
	Z4860DMIM	48 x 60 x 36.5	70	291.90	19.19	N/A	\$4622	\$840	\$1010
	Z4872DMIM	48 x 72 x 36.5	70	321.30	21.17	N/A	\$4926	\$1005	\$1209
	Z4884DMIM	48 x 84 x 36.5	70	349.65	22.90	N/A	\$5212	\$1173	\$1413
	Z4896DMIM	48 x 96 x 36.5	85	370.65	24.91	N/A	\$5502	\$1337	\$1612
Media Table - D Island, 36" H	D Media Island includes ONE BASE with wire access doors on each side of base and wire concealment runners between the base and the end panel. Grommet centered at the top of the end panel for wire pass through. Shipped in 3 cartons.								

Required Specifications

Primary surface type + finish
Top/edge detail
Base finish
Base trim finish

Optional Specifications

Cut-out for power block

Accessories

Power block

MEDIA TABLES



Media Table - D Island, 36" H

MODEL#	DIMENSIONS D x W x H (1.5" TOP)	FREIGHT CLASS	WT/LBS.	CUBIC FT.	1" TOP	1.5" TOP	HPL ADD	UML ADD
Z6060DMIM	60 x 60 x 36.5	85	352.28	25.42	N/A	\$5462	\$1046	\$1260
Z6072DMIM	60 x 72 x 36.5	85	386.4	27.66	N/A	\$5815	\$1256	\$1510
Z6084DMIM	60 x 84 x 36.5	85	426.3	30.15	N/A	\$6177	\$1466	\$1764
Z6096DMIM	60 x 96 x 36.5	85	462	32.63	N/A	\$6517	\$1674	\$2014

D Media Island includes ONE BASE with wire access doors on each side of base and wire concealment runners between the base and the end panel. Grommet centered at the top of the end panel for wire pass through. Shipped in 3 cartons.



Media Table - Wedge, 36" H

Z6060WMIM	60 x 60 x 36.5	85	331.8	22.16	N/A	\$5462	\$1046	\$1260
Z6072WMIM	60 x 72 x 36.5	85	364.35	24.67	N/A	\$5815	\$1256	\$1510
Z6084WMIM	60 x 84 x 36.5	70	424.2	26.92	N/A	\$6177	\$1466	\$1764
Z6096WMIM	60 x 96 x 36.5	85	424.2	29.4	N/A	\$6517	\$1674	\$2014

Includes ONE BASE with wire access doors on each side of base and wire concealment runners between the base and the end panel. Grommet centered at the top of the end panel for wire pass through. Wedge tapers from 60" w to 48" w. Shipped in 3 cartons.



Media Table - Rectangular Island, 36" H

Z4860RMIM	48 x 60 x 36.5	70	301.35	19.19	N/A	\$4245	\$840	\$1010
Z4872RMIM	48 x 72 x 36.5	70	330.75	21.17	N/A	\$4524	\$1005	\$1209
Z4884RMIM	48 x 84 x 36.5	70	360.15	22.9	N/A	\$4786	\$1173	\$1413
Z4896RMIM	48 x 96 x 36.5	70	380.1	24.91	N/A	\$5051	\$1337	\$1612

Includes ONE BASE with wire access doors on each side of base and wire concealment runners between the base and the end panel. Grommet centered at the top of the end panel for wire pass through. Shipped in 3 cartons.



Media Table - Rectangular Island, 36" H

Z6060RMIM	60 x 60 x 36.5	85	367.5	25.42	N/A	\$5010	\$1046	\$1260
Z6072RMIM	60 x 72 x 36.5	85	402.15	27.66	N/A	\$5330	\$1256	\$1510
Z6084RMIM	60 x 84 x 36.5	85	442.05	30.15	N/A	\$5661	\$1466	\$1764
Z6096RMIM	60 x 96 x 36.5	85	477.75	32.63	N/A	\$5974	\$1674	\$2014

Includes ONE BASE with wire access doors on each side of base and wire concealment runners between the base and the end panel. Grommet centered at the top of the end panel for wire pass through. Shipped in 3 cartons.



Media Table - D Island, 42" H

Z4860DMIH	48 x 60 x 42.5	70	312.9	20.69	N/A	\$4912	\$840	\$1010
Z4872DMIH	48 x 72 x 42.5	70	342.3	22.66	N/A	\$5217	\$1005	\$1209
Z4884DMIH	48 x 84 x 42.5	70	371.7	24.4	N/A	\$5511	\$1173	\$1413
Z4896DMIH	48 x 96 x 42.5	85	391.65	26.41	N/A	\$5794	\$1337	\$1612

Includes ONE BASE with wire access doors on each side of base and wire concealment runners between the base and the end panel. Grommet centered at the top of the end panel for wire pass through. Shipped in 3 cartons.



Media Table - D Island, 42" H

Z6060DMIH	60 x 60 x 42.5	85	378	27.4	N/A	\$5750	\$1046	\$1260
Z6072DMIH	60 x 72 x 42.5	85	413.7	29.91	N/A	\$6106	\$1256	\$1510
Z6084DMIH	60 x 84 x 42.5	85	453.6	32.4	N/A	\$6476	\$1466	\$1764
Z6096DMIH	60 x 96 x 42.5	85	488.25	34.88	N/A	\$6808	\$1674	\$2014

Includes ONE BASE with wire access doors on each side of base and wire concealment runners between the base and the end panel. Grommet centered at the top of the end panel for wire pass through. Shipped in 3 cartons.

Required Specifications

Primary surface type + finish
Top/edge detail
Base finish
Base trim finish

Optional Specifications

Cut-out for power block

Accessories

Power block

MEDIA TABLES **MODEL#** **DIMENSIONS** **FREIGHT CLASS** **WT/LBS.** **CUBIC FT.** **1" TOP** **1.5" TOP** **HPL ADD** **UML ADD**



Media Table - Wedge, 42\"/>

	D x W x H (1.5" TOP)								
Z6060WMIH	60 x 60 x 42.5	85	355	23.92	N/A	\$5750	\$1046	\$1260	
Z6072WMIH	60 x 72 x 42.5	85	387	26.17	N/A	\$6106	\$1256	\$1510	
Z6084WMIH	60 x 84 x 42.5	85	424	28.65	N/A	\$6476	\$1466	\$1764	
Z6096WMIH	60 x 96 x 42.5	85	457	31.14	N/A	\$6808	\$1674	\$2014	

Includes ONE BASE with wire access doors on each side of base and wire concealment runners between the base and the end panel. Grommet centered at the top of the end panel for wire pass through. Wedge tapers from 60" w to 48" w. Shipped in 3 cartons.



Media Table - Rectangular Island, 42\"/>

Z4860RMIH	48 x 60 x 42.5	70	324	20.69	N/A	\$4515	\$840	\$1010	
Z4872RMIH	48 x 72 x 42.5	70	353	22.66	N/A	\$4793	\$1005	\$1209	
Z4884RMIH	48 x 84 x 42.5	70	382	24.4	N/A	\$5056	\$1173	\$1413	
Z4896RMIH	48 x 96 x 42.5	70	402	26.41	N/A	\$5316	\$1337	\$1612	

Includes ONE BASE with wire access doors on each side of base and wire concealment runners between the base and the end panel. Grommet centered at the top of the end panel for wire pass through. Shipped in 3 cartons.



Media Table - Rectangular Island, 42\"/>

Z6060RMIH	60 x 60 x 42.5	85	394	27.4	N/A	\$5280	\$1046	\$1260	
Z6072RMIH	60 x 72 x 42.5	85	429	29.91	N/A	\$5599	\$1256	\$1510	
Z6084RMIH	60 x 84 x 42.5	85	469	32.4	N/A	\$5934	\$1466	\$1764	
Z6096RMIH	60 x 96 x 42.5	85	504	34.88	N/A	\$6237	\$1674	\$2014	

Includes ONE BASE with wire access doors on each side of base and wire concealment runners between the base and the end panel. Grommet centered at the top of the end panel for wire pass through. Shipped in 3 cartons.

Required Specifications

Primary surface type + finish
 Top/edge detail
 Base finish
 Base trim finish

Optional Specifications

Cut-out for power block
 3" radius corners (3R)*

Accessories

Power block

MEDIA TABLES, SLIM BASE - 30" H



Media Table - D Island, Slim Base

MODEL#	DIMENSIONS D x W x H (1.5" TOP)	FREIGHT CLASS	WT/LBS.	CUBIC FT.	1" TOP	1.5" TOP	HPL ADD	UML ADD
ZS4860DMIL	48 x 60 x 30.1	70	258	13.23	N/A	\$3965	\$788	\$1010
ZS4872DMIL	48 x 72 x 30.1	70	287	14.49	N/A	\$4251	\$943	\$1209
ZS4884DMIL	48 x 84 x 30.1	70	316	15.99	N/A	\$4528	\$1101	\$1413
ZS4896DMIL	48 x 96 x 30.1	70	337	17.22	N/A	\$4795	\$1255	\$1612

Includes one base with single hinged door for wire access and wire concealment runners between base and end panel. Grommet centered at the top of the end panel for wire pass through. Shipped easy to assemble, 3 cartons.



Media Table - D Island, Slim Base

ZS6060DMIL	60 x 60 x 30.1	70	313	17.49	N/A	\$4756	\$982	\$1260
ZS6072DMIL	60 x 72 x 30.1	70	348	19.22	N/A	\$5094	\$1179	\$1510
ZS6084DMIL	60 x 84 x 30.1	70	387	20.96	N/A	\$5433	\$1376	\$1764
ZS6096DMIL	60 x 96 x 30.1	70	423	22.72	N/A	\$5754	\$1571	\$2014

Includes one base with two hinged doors for wire access and wire concealment runners between base and end panel. Grommet centered at the top of the end panel for wire pass through. Shipped easy to assemble, 3 cartons.



Media Table - Wedge, Slim Base*

ZS6060WMIL	60 x 60 x 30.1	70	295	15.48	N/A	\$4756	\$982	\$1260
ZS6072WMIL	60 x 72 x 30.1	70	327	16.98	N/A	\$5094	\$1179	\$1510
ZS6084WMIL	60 x 84 x 30.1	70	364	18.71	N/A	\$5433	\$1376	\$1764
ZS6096WMIL	60 x 96 x 30.1	70	397	20.48	N/A	\$5754	\$1571	\$2014

Includes one base with single hinged door for wire access and wire concealment runners between base and end panel. Grommet centered at the top of the end panel for wire pass through. Optional with 3" radius corners (**3R**), add **\$348**. Shipped easy to assemble, 3 cartons.



Media Table - Rectangular, Slim Base*

ZS4860RMIL	48 x 60 x 30.1	70	268	13.23	N/A	\$3651	\$788	\$1010
ZS4872RMIL	48 x 72 x 30.1	70	297	14.49	N/A	\$3913	\$943	\$1209
ZS4884RMIL	48 x 84 x 30.1	70	326	15.99	N/A	\$4163	\$1101	\$1413
ZS4896RMIL	48 x 96 x 30.1	70	347	17.22	N/A	\$4403	\$1255	\$1612

Includes one base with single hinged door for wire access and wire concealment runners between base and end panel. Grommet centered at the top of the end panel for wire pass through. Optional 3" radius corners, upcharge applies. Shipped easy to assemble, 3 cartons.



Media Table - Rectangular, Slim Base*

ZS6060RMIL	60 x 60 x 30.1	70	328	17.49	N/A	\$4368	\$982	\$1260
ZS6072RMIL	60 x 72 x 30.1	70	363	19.22	N/A	\$4677	\$1179	\$1510
ZS6084RMIL	60 x 84 x 30.1	70	403	20.96	N/A	\$4984	\$1376	\$1764
ZS6096RMIL	60 x 96 x 30.1	70	438	22.72	N/A	\$5276	\$1571	\$2014

Includes one base with two hinged doors for wire access and wire concealment runners between base and end panel. Grommet centered at the top of the end panel for wire pass through. Optional with 3" radius corners (**3R**), add **\$348**. Shipped easy to assemble, 3 cartons.

Required Specifications

Primary surface type + finish
Top/edge detail
Base finish
Base trim finish

Optional Specifications

Cut-out for power block
3" radius corners (**3R**)*

Accessories

Power block

MEDIA TABLES, SLIM BASE - 36" H



Media Table - D Island, Slim Base - 36" H

MODEL#	DIMENSIONS D x W x H (1.5" TOP)	FREIGHT CLASS	WT/LBS.	CUBIC FT.	1" TOP	1.5" TOP	HPL ADD	UML ADD
ZS4860DMIM	48 x 60 x 36.5	70	278	14.49	N/A	\$4339	\$788	\$1010
ZS4872DMIM	48 x 72 x 36.5	70	308	15.72	N/A	\$4625	\$943	\$1209
ZS4884DMIM	48 x 84 x 36.5	250	336	90.39	N/A	\$4893	\$1101	\$1413
ZS4896DMIM	48 x 96 x 36.5	70	357	18.47	N/A	\$5166	\$1255	\$1612

Includes one base with single hinged door for wire access and wire concealment runners between base and end panel. Grommet centered at the top of the end panel for wire pass through. Shipped easy to assemble, 3 cartons.



Media Table - D Island, Slim Base - 36" H

ZS6060DMIM	60 x 60 x 36.5	70	338	19.46	N/A	\$5128	\$982	\$1260
ZS6072DMIM	60 x 72 x 36.5	70	373	20.96	N/A	\$5460	\$1179	\$1510
ZS6084DMIM	60 x 84 x 36.5	70	412	22.72	N/A	\$5800	\$1376	\$1764
ZS6096DMIM	60 x 96 x 36.5	70	448	24.46	N/A	\$6119	\$1571	\$2014

Includes one base with two hinged doors for wire access and wire concealment runners between base and end panel. Grommet centered at the top of the end panel for wire pass through. Shipped easy to assemble, 3 cartons.



Media Table-Wedge, Slim Base - 36" H*

ZS6060WMIM	60 x 60 x 36.5	70	318	16.74	N/A	\$5128	\$982	\$1260
ZS6072WMIM	60 x 72 x 36.5	70	350	18.47	N/A	\$5460	\$1179	\$1510
ZS6084WMIM	60 x 84 x 36.5	70	386	20.21	N/A	\$5800	\$1376	\$1764
ZS6096WMIM	60 x 96 x 36.5	70	419	21.71	N/A	\$6119	\$1571	\$2014

Includes one base with single hinged door for wire access and wire concealment runners between base and end panel. Grommet centered at the top of the end panel for wire pass through. Optional with 3" radius corners (3R), add **\$348**. Shipped easy to assemble, 3 cartons.



Media Table - Rectangular, Slim Base - 36" H

ZS4860RMIM	48 x 60 x 36.5	70	288	14.49	N/A	\$3985	\$788	\$1010
ZS4872RMIM	48 x 72 x 36.5	70	318	15.72	N/A	\$4247	\$943	\$1209
ZS4884RMIM	48 x 84 x 36.5	70	347	17.22	N/A	\$4493	\$1101	\$1413
ZS4896RMIM	48 x 96 x 36.5	70	367	18.47	N/A	\$4742	\$1255	\$1612

Includes one base with single hinged door for wire access and wire concealment runners between base and end panel. Grommet centered at the top of the end panel for wire pass through. Optional with 3" radius corners (3R), add **\$348**. Shipped easy to assemble, 3 cartons.



Media Table - Rectangular, Slim Base - 36" H

ZS6060RMIM	60 x 60 x 36.5	70	354	16.74	N/A	\$4704	\$982	\$1260
ZS6072RMIM	60 x 72 x 36.5	70	389	18.47	N/A	\$5004	\$1179	\$1510
ZS6084RMIM	60 x 84 x 36.5	70	428	20.21	N/A	\$5315	\$1376	\$1764
ZS6096RMIM	60 x 96 x 36.5	70	464	21.71	N/A	\$5609	\$1571	\$2014

Includes one base with two hinged doors for wire access and wire concealment runners between base and end panel. Grommet centered at the top of the end panel for wire pass through. Optional with 3" radius corners (3R), add **\$348**. Shipped easy to assemble, 3 cartons.

Required Specifications

Primary surface type + finish
Top/edge detail
Base finish
Base trim finish

Optional Specifications

Cut-out for power block
3" radius corners (3R)*

Accessories

Power block

MEDIA TABLES, SLIM BASE - 42" H



Media Table - D Island, Slim Base - 42" H

MODEL#	DIMENSIONS D x W x H (1.5" TOP)	FREIGHT CLASS	WT/LBS.	CUBIC FT.	1" TOP	1.5" TOP	HPL ADD	UML ADD
ZS4860DMIH	48 x 60 x 42.5	70	297	15.48	N/A	\$4612	\$788	\$1010
ZS4872DMIH	48 x 72 x 42.5	70	326	16.98	N/A	\$4898	\$943	\$1209
ZS4884DMIH	48 x 84 x 42.5	70	355	18.23	N/A	\$5174	\$1101	\$1413
ZS4896DMIH	48 x 96 x 42.5	70	376	19.73	N/A	\$5440	\$1255	\$1612

Includes one base with single hinged door for wire access and wire concealment runners between base and end panel. Grommet centered at the top of the end panel for wire pass through. Shipped easy to assemble, 3 cartons.



Media Table - D Island, Slim Base - 42" H

ZS6060DMIH	60 x 60 x 42.5	70	362	20.96	N/A	\$5399	\$982	\$1260
ZS6072DMIH	60 x 72 x 42.5	70	397	22.72	N/A	\$5733	\$1179	\$1510
ZS6084DMIH	60 x 84 x 42.5	70	436	24.46	N/A	\$6080	\$1376	\$1764
ZS6096DMIH	60 x 96 x 42.5	70	472	25.96	N/A	\$6392	\$1571	\$2014

Includes one base with two hinged doors for wire access and wire concealment runners between base and end panel. Grommet centered at the top of the end panel for wire pass through. Shipped easy to assemble, 3 cartons.



Media Table - Wedge, Slim Base - 42" H

ZS6060WMIH	60 x 60 x 42.5	70	339	17.96	N/A	\$5399	\$982	\$1260
ZS6072WMIH	60 x 72 x 42.5	70	371	19.73	N/A	\$5733	\$1179	\$1510
ZS6084WMIH	60 x 84 x 42.5	70	407	21.47	N/A	\$6080	\$1376	\$1764
ZS6096WMIH	60 x 96 x 42.5	70	440	22.96	N/A	\$6392	\$1571	\$2014

Includes one base with single hinged door for wire access and wire concealment runners between base and end panel. Grommet centered at the top of the end panel for wire pass through. Optional with 3" radius corners (3R), add **\$348**. Shipped easy to assemble, 3 cartons.



Media Table - Rectangular, Slim Base - 42" H

ZS4860RMIH	48 x 60 x 42.5	70	307	15.48	N/A	\$4239	\$788	\$1010
ZS4872RMIH	48 x 72 x 42.5	70	337	16.98	N/A	\$4500	\$943	\$1209
ZS4884RMIH	48 x 84 x 42.5	70	365	18.23	N/A	\$4747	\$1101	\$1413
ZS4896RMIH	48 x 96 x 42.5	70	386	19.73	N/A	\$4991	\$1255	\$1612

Includes one base with single hinged door for wire access and wire concealment runners between base and end panel. Grommet centered at the top of the end panel for wire pass through. Optional with 3" radius corners (3R), add **\$348**. Shipped easy to assemble, 3 cartons.



Media Table - Rectangular, Slim Base - 42" H

ZS6060RMIH	60 x 60 x 42.5	70	378	20.96	N/A	\$4957	\$982	\$1260
ZS6072RMIH	60 x 72 x 42.5	70	413	22.72	N/A	\$5257	\$1179	\$1510
ZS6084RMIH	60 x 84 x 42.5	70	452	24.46	N/A	\$5571	\$1376	\$1764
ZS6096RMIH	60 x 96 x 42.5	70	488	25.96	N/A	\$5856	\$1571	\$2014

Includes one base with two hinged doors for wire access and wire concealment runners between base and end panel. Grommet centered at the top of the end panel for wire pass through. Optional with 3" radius corners (3R), add **\$348**. Shipped easy to assemble, 3 cartons.

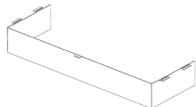

Media Table - Base Cover

Z60BEC	12.2 x 34.5 x 4.3	250	5	1.50	\$587
Z48BEC	12.2 x 22.5 x 4.3	250	5	1.50	\$538

For use on Zira Media Tables, but can be used on any Zira Boardroom table of corresponding width. Acts as a "cap" at the upper part of a base to hide any wire or power block that may be visible to users. Available in Black or Tungsten finish.

Required Specifications

Primary surface type + finish
Top/edge detail
Base finish
Base trim finish

Optional Specifications

Cut-out for power block
3" radius corners (3R)*

Accessories

Power block

COLLABORATIVE TABLES

MODEL# DIMENSIONS FREIGHT CLASS WT./LBS. CUBIC FT. 1" TOP 1.5" TOP HPL ADD UML ADD

D x W x H (1.5" TOP)



Collaborative Table - 30" H

Z367229BT	36 x 72 x 30	70	237	12.93	N/A	\$2089	\$756	\$908
Z368429BT	36 x 84 x 30	70	237	14.70	N/A	\$2429	\$882	\$1061
Z369629BT	36 x 96 x 30	70	289	16.44	N/A	\$2633	\$1005	\$1209

Collaborative table with full end panels. Wire management runners span the length of the table between end panels. Shipped in 3 cartons.



Collaborative Table - 30" H

Z487229BT	48 x 72 x 30	70	302	13.95	N/A	\$2625	\$1005	\$1209
Z488429BT	48 x 84 x 30	70	335	15.69	N/A	\$2827	\$1173	\$1413
Z489629BT	48 x 96 x 30	70	360	17.43	N/A	\$3055	\$1337	\$1612

Collaborative table with full end panels. Wire management runners span the length of the table between end panels. Shipped in 3 cartons.



Collaborative Table - 36.5" H

Z367236BT	36 x 72 x 36.5	70	249	13.20	N/A	\$2167	\$756	\$908
Z368436BT	36 x 84 x 36.5	70	275	14.94	N/A	\$2514	\$882	\$1061
Z369636BT	36 x 96 x 36.5	70	301	16.68	N/A	\$2715	\$1005	\$1209

Collaborative table with full end panels. Wire management runners span the length of the table between end panels. Shipped in 3 cartons.



Collaborative Table - 36.5" H

Z487236BT	48 x 72 x 36.5	70	319	14.43	N/A	\$2722	\$1005	\$1209
Z488436BT	48 x 84 x 36.5	70	351	16.20	N/A	\$2931	\$1173	\$1413
Z489636BT	48 x 96 x 36.5	70	376	17.93	N/A	\$3159	\$1337	\$1612

Collaborative table with full end panels. Wire management runners span the length of the table between end panels. Shipped in 3 cartons.



Collaborative Table - 42.5" H

Z367242BT	36 x 72 x 42.5	70	283	14.19	N/A	\$2424	\$756	\$908
Z368442BT	36 x 84 x 42.5	70	312	15.93	N/A	\$2798	\$882	\$1061
Z369642BT	36 x 96 x 42.5	70	342	17.93	N/A	\$3027	\$1005	\$1209

Collaborative table with full end panels. Wire management runners span the length of the table between end panels. Shipped in 3 cartons.



Collaborative Table - 42.5" H

Z487242BT	48 x 72 x 42.5	65	356	15.45	N/A	\$3000	\$1005	\$1209
Z488442BT	48 x 84 x 42.5	70	392	17.43	N/A	\$3230	\$1173	\$1413
Z489642BT	48 x 96 x 42.5	70	421	19.19	N/A	\$3493	\$1337	\$1612

Collaborative table with full end panels. Wire management runners span the length of the table between end panels. Shipped in 3 cartons.

Required Specifications

Primary surface type + finish
Top/edge detail
Base finish
Base trim finish

Optional Specifications

Cut-out for power block

Accessories

Power block

AUDIOVISUAL	MODEL#	DIMENSIONS	FREIGHT CLASS	WT/LBS.	CUBIC FT.	1" TOP	1.5" TOP	HPL ADD	UML ADD
-------------	--------	------------	---------------	---------	-----------	--------	----------	---------	---------

D x W x H (1.5" TOP)



Multimedia Cart*

Z2822MCE	22.25 x 28 x 29.5	125	86	13.50	\$989	\$1067	\$196	N/A
----------	-------------------	-----	----	-------	--------------	---------------	--------------	-----

Multimedia cart features one non-locking hinged door on the back. Includes 3 fixed shelves, 1 grommet on top and 1 grommet in bottom panel for wire pass thru. 4 locking casters included.



Lectern*

Z2444LEC	18 x 24 x 44.3	150	100	17	\$961	\$1025	\$196	N/A
----------	----------------	-----	-----	----	--------------	---------------	--------------	-----

Features angled stand and storage with 2 fixed shelves. 2 locking casters included.



Visual Board*

Z361872VB	18 x 36 x 72.4	100	187	19.25	\$3147	N/A	N/A	N/A
-----------	----------------	-----	-----	-------	---------------	-----	-----	-----

Angled visual board with paper pad on one side and dry erase board on the opposite side. Unique push handles are standard. Locking casters included. Decorative aluminum trim is standard on the lip of each shelf. Height aligns with 36" buffets. Shipped RTA (ready to assemble).







- *Wallmounted Visual Boards are available in Desk Accessories section.*

Required Specifications

Primary surface type + finish Base finish
 Top/edge detail (only Z482036BD) Handles*
 Push bar finish
 Base trim finish (not Z3618xxKD)

Optional Specifications

Glazed door**
 Key #**

ACCESSORIES	MODEL#	DIMENSIONS D x W x H (1.5" TOP)	FREIGHT CLASS	WT/LBS.	CUBIC FT.	1" TOP	1.5" TOP	GLAZE ADD	HPLADD
 <p>Serving Cart with Doors**</p>	Z361836KD	18 x 36 x 36	125	150	20	\$2008	N/A	\$483	N/A
	Z361829KD	18 x 36 x 29	125	113	16	\$1699	N/A	\$407	N/A
<p>Cart features 2 doors with lock and 1 fixed height adjustable shelf. Top is recessed within side and end panels to act as a tray. Unique push handles are standard on both sides of the cart. 4 locking casters included.</p>									
 <p>Serving Cart*</p>	Z361836KO	18 x 36 x 36	125	121	20	\$2178	N/A	N/A	N/A
	Z361829KO	18 x 36 x 29	125	108	16	\$1822	N/A	N/A	N/A
<p>Cart features 1 fixed height adjustable shelf. Top is recessed within side and end panels to act as a tray. Decorative aluminum trim is standard on the lip of each shelf. Unique push handles are standard on both sides of the cart. 4 locking casters included.</p>									
 <p>Buffet Cart*</p>	Z261836BK	18 x 26 x 36	150	79	15	\$2071	N/A	N/A	\$196
	<p>Cart features 1 fixed shelf. Top is recessed within side and end panels to act as a tray. Unique push handles are standard. Decorative aluminum trim is standard on the lip of each shelf. Locking casters included. Height aligns with 36" buffets.</p>								
 <p>Buffet</p>	Z481836BO	18 x 48 x 36	125	152.50	22.50	\$1916	N/A	N/A	\$262
	Z481829BO	18 x 48 x 29	125	135	18	\$1767	N/A	N/A	\$262
	Z361836BO	18 x 36 x 36	125	126	18	\$1580	N/A	N/A	\$196
	Z361829BO	18 x 36 x 29	100	112	14	\$1454	N/A	N/A	\$196
<p>Buffet features 1 fixed height adjustable shelf. Top is recessed within side and end panels to act as a tray. Decorative aluminum trim is standard on the lip of each shelf.</p>									
 <p>Buffet with Doors**</p>	Z481836BD	18 x 48 x 36	125	171	22.50	\$1994	N/A	\$424	\$262
	Z481829BD	18 x 48 x 29	100	148	18	\$1781	N/A	\$484	\$262
	Z361836BD	18 x 36 x 36	125	138.50	18	\$1773	N/A	\$483	\$196
	Z361829BD	18 x 36 x 29	100	119	14	\$1490	N/A	\$407	\$196
<p>Buffet features 2 doors with lock and 1 fixed height adjustable shelf. Top is recessed within side and end panels to act as a tray.</p>									
 <p>Buffet with Doors**</p>	Z721836BU	18 x 72 x 36	125	242	33.50	\$2949	N/A	\$584	\$390
	Z721829BU	18 x 72 x 29	125	211	27	\$2666	N/A	\$483	\$483
	Z601836BU	18 x 60 x 36	125	188	28	\$2649	N/A	\$483	\$325
	Z601829BU	18 x 60 x 29	125	163	22.50	\$2427	N/A	\$407	\$325
<p>Buffet features 3 separate compartments. The two outer compartments come standard with locking doors and each features 1 fixed height adjustable shelf. The center compartment is open with 1 fixed shelf. Decorative aluminum trim is standard on the lip of the open shelf. Top is recessed within side and end panels to act as a tray.</p>									

Required Specifications

Primary surface type + finish
 Top/edge detail* Handles
 Base finish
 Aluminum trim finish (only ZxxxxBO/BU)

Optional Specifications

Glazed door**
 Key #**

AUDIOVISUAL



Buffet Credenza**



Buffet Credenza**

MODEL#	DIMENSIONS D x W x H (1.5" TOP)	FREIGHT CLASS	WT/LBS.	CUBIC FT.	1" TOP	1.5" TOP	HPL ADD	UML ADD
Z482036BD	20 x 48 x 36	100	199	24.70	\$2353	\$2491	\$1015	\$442

Buffet credenza with one locking storage compartment with two doors. Hinged doors cover one three-position height adjustable shelf. Two 6" drawers above storage compartment are non-locking.

Z722036BD	20 x 72 x 36	125	265	36.50	\$3412	\$3580	\$2026	\$712
Z602036BD	20 x 60 x 36	125	228	30.75	\$2958	\$3110	\$1861	\$578

Buffet credenza with two locking storage compartments side by side. Hinged doors cover 1 three-position height adjustable shelf. Two 6" drawers above storage compartment are non-locking.

Required Specifications

Primary surface type + finish Base finish
 Top/edge detail (only Z482036BD) Handles*
 Push bar finish
 Base trim finish (not Z3618xxKD)

Optional Specifications

Glazed door**
 Key #***

ACCESSORIES	MODEL#	DIMENSIONS	FREIGHT CLASS	WT/LBS.	CUBIC FT.	1" TOP	1.5" TOP	GLAZE ADD	HPLADD
D x W x H (1.5" TOP)									

Interconnecting Cables - Common Cable Lengths (in inches)

Female/Female

42FF-27	\$124
42FF-38	\$138
42FF-41	\$142
42FF-50	\$155
42FF-53	\$159
42FF-63	\$170
42FF-65	\$174
42FF-75	\$187
42FF-76	\$188
42FF-77	\$189
42FF-82	\$196
42FF-85	\$200
42FF-86	\$201
42FF-89	\$206

42FF-97	\$231
42FF-98	\$231
42FF-100	\$219
42FF-101	\$222
42FF-103	\$222
42FF-110	\$234
42FF-113	\$240

Female/Male

42FM-12	\$111
42FM-27	\$129
42FM-38	\$143
42FM-41	\$149
42FM-50	\$161
42FM-63	\$178
42FM-75	\$193
42FM-82	\$203
42FM-85	\$175
42FM-86	\$208
42FM-97	\$231
42FM-98	\$231
42FM-100	\$245
42FM-110	\$245

OASIS MINI A, B & USB CABLE LENGTHS NEEDED FOR DAISY-CHAINING

Model #	Villa DaisyLink, Oasis Mini USB Oasis Mini A Oasis Mini B	Villa DaisyLink, Oasis Mini USB Oasis Mini A Oasis Mini B	Oasis Mini USB Oasis Mini A	Oasis Mini USB Oasis Mini A	Villa DaisyLink or Oasis Mini B	Villa DaisyLink or Oasis Mini B
Cut-out Positions	V1, V3, M1, M3	V1, V3, M1, M3	M1, M2 & M3	M1, M2 & M3	V1, V2, V3, M1, M2, M3	V1, V2, V3, M1, M2, M3
Infeed Position	Left or Right	Center	Left or Right	Center	Left or Right	Center
Reference	Drawing 1A/1B	Drawing 2A/2B	Drawing 3	Drawing 4	Drawing 5	Drawing 6
Z4896BE Z4896RTE Z4896REE Z4896BW	(1) 42FF-53 SPECIFY INFEED	(1) 42FF-27 (1) 42FM-27 (1) DAISY-T SPECIFY INFEED	N/A	N/A	N/A	N/A
Z48120BE Z48120RTE Z48120REE Z48120BW	(1) 42FF-76 SPECIFY INFEED	(1) 42FF-38 (1) 42FM-38 (1) DAISY-T SPECIFY INFEED	(3) 42FF-41 SPECIFY INFEED	(3) 42FF-41 SPECIFY INFEED	(2) 42FF-41 SPECIFY INFEED	(2) 42FF-41 (1) 42FM-12 (1) DAISY-T SPECIFY INFEED
Z48144BE Z48144RTE Z48144REE Z48144BW	(1) 42FF-100 SPECIFY INFEED	(1) 42FF-50 (1) 42FM-50 (1) DAISY-T SPECIFY INFEED	(3) 42FF-53 SPECIFY INFEED	(3) 42FF-53 SPECIFY INFEED	(2) 42FF-53 SPECIFY INFEED	(2) 42FF-53 (1) 42FM-12 (1) DAISY-T SPECIFY INFEED
Z48168BE Z48168RTE Z48168REE Z48168BW	(1) 42FF-63 (1) 42FM-63 SPECIFY INFEED	(1) 42FF-63 (1) 42FM-63 (1) DAISY-T SPECIFY INFEED	(3) 42FF-65 SPECIFY INFEED	(3) 42FF-65 SPECIFY INFEED	(2) 42FF-65 SPECIFY INFEED	(2) 42FF-65 (1) 42FM-12 (1) DAISY-T SPECIFY INFEED
Z48192BE Z48192RTE Z48192REE Z48192BW	(1) 42FF-75 (1) 42FM-75 SPECIFY INFEED	(1) 42FF-75 (1) 42FM-75 (1) DAISY-T SPECIFY INFEED	(3) 42FF-77 SPECIFY INFEED	(3) 42FF-77 SPECIFY INFEED	(2) 42FF-77 SPECIFY INFEED	(2) 42FF-77 (1) 42FM-12 (1) DAISY-T SPECIFY INFEED
Z48216BE Z48216RTE Z48216REE Z48216BW	(1) 42FF-86 (1) 42FM-86 SPECIFY INFEED	(1) 42FF-85 (1) 42FM-85 (1) DAISY-T SPECIFY INFEED	(3) 42FF-89 SPECIFY INFEED	(3) 42FF-89 SPECIFY INFEED	(2) 42FF-89 SPECIFY INFEED	(2) 42FF-89 (1) 42FM-12 (1) DAISY-T SPECIFY INFEED

Required Specifications

Primary surface type + finish
 Top/edge detail* Handles
 Base finish
 Aluminum trim finish (only ZxxxxBO/BU)

Optional Specifications

Glazed door**
 Key #**

Model #	Oasis Mini A & Oasis Mini B	Oasis Mini A & Oasis Mini B	Oasis Mini A	Oasis Mini A	Oasis Mini B	Oasis Mini B
Z48240BE Z48240RTE Z48240REE Z48240BW	(1) 42FF-98 (1) 42FM-98 SPECIFY INFEED	1) 42FF-97 (1) 42FM-97 (1) DAISY-T SPECIFY INFEED	(3) 42FF-101 SPECIFY INFEED	(3) 42FF-101 SPECIFY INFEED	(2) 42FF-101 SPECIFY INFEED	(2) 42FF-101 (1) 42FM-12 (1) DAISY-T SPECIFY INFEED
Z48264BE Z48264RTE Z48264REE Z48264BW	(1) 42FF-110 (1) 42FM-110 SPECIFY INFEED	(1) 42FF-110 (1) 42FM-110 (1) DAISY-T SPECIFY INFEED	(3) 42FF-113 SPECIFY INFEED	(3) 42FF-113 SPECIFY INFEED	(2) 42FF-113 SPECIFY INFEED	(2) 42FF-113 (1) 42FM-12 (1) DAISY-T SPECIFY INFEED
Z48288BE Z48288RTE Z48288REE Z48288BW	(1) 42FF-82 (2) 42FM-82 SPECIFY INFEED	(2) 42FF-41 (2) 42FM-41 (1) DAISY-T SPECIFY INFEED	(3) 42FF-63 (3) 42FM-63 SPECIFY INFEED	(3) 42FF-63 (3) 42FM-63 SPECIFY INFEED	(2) 42FF-63 (2) 42FM-63 SPECIFY INFEED	(2) 42FF-63 (2) 42FM-63 (1) DAISY-T SPECIFY INFEED

RECEPTION DESKS AND RETURNS

- Offered with **Straight** and **Bow** front
- Transactional tops available in 1" or 1 1/2" thick top with a variety of edge details
- Worksurface available in 1" thickness with A3 edge only

TOP AND BASE FINISHES

ACJ Absolute Acajou	FCL First Class
ASN Asian Night	NBL Noce Biondo
AWC Avant Cherry	NGL Noce Grigio
AWH Avant Honey	NEL Noce Leggero
BLK Black	NML Noce Medio
BZD Blizzard	QTM Quartered Mahogany
BRC Brushed Cobalt	SBY Sheer Beauty
CMB Clear Maple	SOG Storm Grey
CGY Custom Grey	SDT Stonedust
DES Dark Espresso	WHE Walnut Heights
DWT Designer White	WHC White Chocolate
FAS Fashionista	WCR Winter Cherry

Reception Desks:

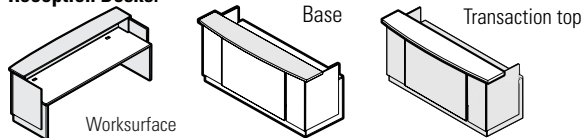

Reception Returns:

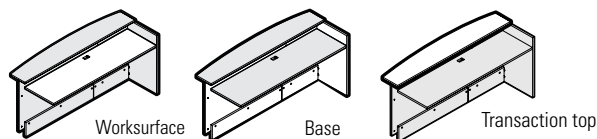

TRANSACTION TOP THICKNESS/EDGE DETAIL

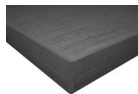

A3 1" top, standard

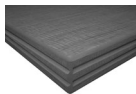

AR 1" top, bicut edge

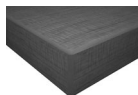

C3 1.5" top, standard



CR 1.5" top, bicut edge

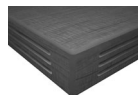

CF 1.5" top, fluted edge

GLAZING (Center Panels)



Z1 frosted glazing, Tungsten (TUN) frame



Z2 frosted glazing, Black (BLK) frame



Z3 ribbed glazing, Tungsten (TUN) frame



Z4 ribbed glazing, Black (BLK) frame

GROMMETS - RECEPTION DESKS ONLY

- Two grommets are standard in position **AG1** and **AG3**
- Standard grommets can be removed at an upcharge
- Optional grommets available in **AG2**

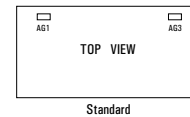
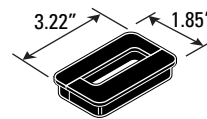

Standard

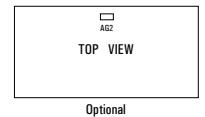

Optional

- Grommet hole dimensions are 3 1/4" wide x 1 7/8" deep.

POWER BLOCK

- A Power Block (model **PMSPDM**) may be ordered on transaction tops.
- A Power Block is a rectangular worksurface power/data module with one electrical duplex receptacle and two data (RJ45) receptacles. 9 foot black cord included. Power Block dimensions are 3 1/2" deep x 6 1/2" wide x 2 3/4" high.
- To purchase a Power Block, you must specify both the Power Block cut-out location and the Power Block model #. Order Power Block as **PMSPDM**, Add **\$352**. Power Blocks are available in standard worksurface locations (left, center or right). Order as **E1**, **E2** or **E3**. Add **\$103**.

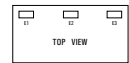

Power Block **PMSPDM** Add **\$352**

Specify location **E1**, **E2** or **E3** Add **\$103**

TASK LIGHT

- Illuminates worksurface and optional glazed center panel
- Specify LED task light separately. Use PLED50 for 60", 66" and 72" wide reception units. Use PLED50 or PLED100 for 84" and 96" wide units. See page 594 for details.

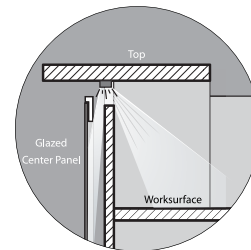

RECEPTION RETURNS - PIGEON

- Available in all laminates
- Worksurface available in 1" thickness with A3 edge only
- Collator shelves offered in Black (BLK) or Brushed Cobalt (BRC)
- One grommet is standard in position **AG3**
- Standard grommet can be removed at an upcharge
- Optional grommet available in position **AG2**, see upcharges above
- Power blocks are available in positions **E2** and **E3**

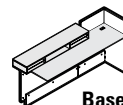

Base

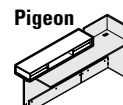

Pigeon

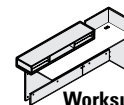

Worksurface

RECEPTION RETURNS - BOOKCASE

- Available in all laminates listed above
- Worksurface available in 1" thickness with A3 edge only
- One grommet is standard in position **AG2**
- Standard grommet can be removed at an upcharge
- Optional grommet available in position **AG3** for **54"**, **60"** and **72"** wide units only
- Power blocks are available in positions **E2** and **E3** for **54"**, **60"** and **72"** wide units only

RECEPTION DESKS

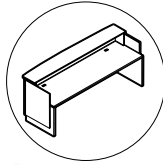

Reception Desk

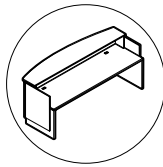

Reception Desk - Bow Front

MODEL#	DIMENSIONS D x W x H	FREIGHT CLASS	WT/LBS.	CUBIC FT.	1" TOP	1.5" TOP	GLAZE ADD	HP ADD
Z3096RDS	35.5 x 96 x 42.8-43.3	70	385	23.23	\$3814	\$4029	\$798	\$903
Z3084RDS	35.5 x 89.4 x 42.8-43.3	70	351	20.48	\$3389	\$3582	\$688	\$790
Z3072RDS	35.5 x 77.4 x 42.8-43.3	70	315	17.99	\$3126	\$3293	\$578	\$679
Z3066RDS	35.5 x 71.4 x 42.8-43.3	70	298	16.98	\$2970	\$3131	\$522	\$624
Z3060RDS	35.5 x 65.4 x 42.8-43.3	70	280	15.48	\$2830	\$2977	\$467	\$565
Z2496RDS	30 x 96 x 42.8-43.3	70	353	21.98	\$3595	\$3810	\$798	\$773
Z2484RDS	30 x 89.4 x 42.8-43.3	70	320	19.49	\$3204	\$3397	\$688	\$679
Z2472RDS	30 x 77.4 x 42.8-43.3	70	287	16.98	\$2951	\$3122	\$578	\$582
Z2466RDS	30 x 71.4 x 42.8-43.3	70	272	15.99	\$2796	\$2957	\$522	\$534
Z2460RDS	30 x 65.4 x 42.8-43.3	70	256	15	\$2665	\$2812	\$467	\$484

Z24xxRDS units are not freestanding; they must be connected to a return. Z30xxRDS units can be specified as freestanding. Standard with two grommets. Accommodates shells of all depths. Shipped RTA (ready to assemble) in 3 cartons.

- **Zxx96RDS** units feature a 90" w worksurface

Z3096RDB	35.5 x 96 x 42.8-43.3	70	382	23.23	\$3814	\$4029	\$798	\$903
Z3084RDB	35.5 x 89.4 x 42.8-43.3	70	348	20.48	\$3389	\$3582	\$688	\$790
Z3072RDB	35.5 x 77.4 x 42.8-43.3	70	312	17.99	\$3126	\$3293	\$578	\$679
Z3066RDB	35.5 x 71.4 x 42.8-43.3	70	295	16.98	\$2970	\$3131	\$522	\$624
Z3060RDB	35.5 x 65.4 x 42.8-43.3	70	277	15.99	\$2830	\$2977	\$467	\$565
Z2496RDB	30 x 96 x 42.8-43.3	70	350	21.98	\$3595	\$3788	\$798	\$773
Z2484RDB	30 x 89.4 x 42.8-43.3	70	317	19.49	\$3204	\$3397	\$688	\$679
Z2472RDB	30 x 77.4 x 42.8-43.3	70	284	16.98	\$2951	\$3122	\$578	\$582
Z2466RDB	30 x 71.4 x 42.8-43.3	70	269	15.99	\$2796	\$2957	\$522	\$534
Z2460RDB	30 x 65.4 x 42.8-43.3	70	253	15	\$2665	\$2812	\$467	\$484

Z24xxRDB units are not freestanding; they must be connected to a return. Z30xxRDB units can be specified as freestanding. Standard with two grommets. Accommodates shells of all depths. Shipped RTA (ready to assemble) in 3 cartons.

- **Zxx96RDB** units feature a 90" w worksurface

Required Specifications

Top finish
Top/edge detail
Base/surround finish
Transaction top finish

Optional Specifications

HP laminate
Additional grommet
Glazed center panel

Accessories

Power block

HIGH RECEPTION RETURNS



High Reception Return - LEFT



High Reception Return - LEFT



High Reception Return - RIGHT



High Reception Return - RIGHT

MODEL#	DIMENSIONS D x W x H	FREIGHT CLASS	WT/LBS.	CUBIC FT.	1" TOP	1.5" TOP	GLAZE ADD	HP ADD
Z2472HRRL	25 x 75.7 x 39.8	70	151	8.2	\$1428	N/A	N/A	\$390
Z2460HRRL	25 x 63.7 x 39.8	70	131.2	7	\$1248	N/A	N/A	\$325
Z2454HRRL	25 x 57.7 x 39.8	70	120.9	5.75	\$1133	N/A	N/A	\$293
Z2448HRRL	25 x 51.7 x 39.8	70	110.9	5.25	\$1052	N/A	N/A	\$262
Z2442HRRL	25 x 45.7 x 39.8	70	100.8	4.8	\$970	N/A	N/A	\$228
Z2436HRRL	25 x 39.7 x 39.8	70	90.7	4.3	\$887	N/A	N/A	\$196

Not freestanding, must be connected to a reception desk. Grommet in worksurface. Shipped RTA (ready to assemble). Accommodates shells of all depths. Connecting hardware included. Widths and depths listed are outside dimensions including outside surrounds. Model numbers reflect the primary worksurface dimensions.

Z2072HRRL	20.9 x 75.7 x 39.8	70	139	8.2	\$1258	N/A	N/A	\$325
Z2060HRRL	20.9 x 63.7 x 39.8	70	121	7	\$1097	N/A	N/A	\$273
Z2054HRRL	20.9 x 57.7 x 39.8	70	111	5.75	\$990	N/A	N/A	\$244
Z2048HRRL	20.9 x 51.7 x 39.8	70	102	5.25	\$920	N/A	N/A	\$220
Z2042HRRL	20.9 x 45.7 x 39.8	70	92	4.8	\$844	N/A	N/A	\$192
Z2036HRRL	20.9 x 39.7 x 39.8	70	83	4.3	\$769	N/A	N/A	\$167

Not freestanding, must be connected to a reception desk. Grommet in worksurface. Shipped RTA (ready to assemble). Accommodates shells of **20" depths**. Connecting hardware included. Widths and depths listed are outside dimensions including outside surrounds. Model numbers reflect the primary worksurface dimensions.

Z2472HRRR	25 x 75.7 x 39.8	70	151	8.2	\$1428	N/A	N/A	\$390
Z2460HRRR	25 x 63.7 x 39.8	70	131.2	7	\$1248	N/A	N/A	\$325
Z2454HRRR	25 x 57.7 x 39.8	70	120.9	5.75	\$1133	N/A	N/A	\$293
Z2448HRRR	25 x 51.7 x 39.8	70	110.9	5.25	\$1052	N/A	N/A	\$262
Z2442HRRR	25 x 45.7 x 39.8	70	100.8	4.8	\$970	N/A	N/A	\$228
Z2436HRRR	25 x 39.7 x 39.8	70	90.7	4.3	\$887	N/A	N/A	\$196

Not freestanding, must be connected to a reception desk. Grommet in worksurface. Shipped RTA (ready to assemble). Accommodates shells of all depths. Connecting hardware included. Widths and depths listed are outside dimensions including outside surrounds. Model numbers reflect the primary worksurface dimensions.

Z2072HRRR	20.9 x 75.7 x 39.8	70	139	8.2	\$1258	N/A	N/A	\$325
Z2060HRRR	20.9 x 63.7 x 39.8	70	121	7	\$1097	N/A	N/A	\$273
Z2054HRRR	20.9 x 57.7 x 39.8	70	111	5.75	\$990	N/A	N/A	\$244
Z2048HRRR	20.9 x 51.7 x 39.8	70	102	5.25	\$920	N/A	N/A	\$220
Z2042HRRR	20.9 x 45.7 x 39.8	70	92	4.8	\$844	N/A	N/A	\$192
Z2036HRRR	20.9 x 39.7 x 39.8	70	83	4.3	\$769	N/A	N/A	\$167

Not freestanding, must be connected to a reception desk. Grommet in worksurface. Shipped RTA (ready to assemble). Accommodates shells of **20" depths**. Connecting hardware included. Widths and depths listed are outside dimensions including outside surrounds. Model numbers reflect the primary worksurface dimensions.

Required Specifications

Top finish
Top/edge detail
Base/surround finish

Optional Specifications

HP laminate
Additional grommet

Accessories

Power block

LOW RECEPTION RETURNS



Low Reception Return - LEFT



Low Reception Return - LEFT



Low Reception Return - RIGHT



Low Reception Return - RIGHT

MODEL#	DIMENSIONS	FREIGHT CLASS	WT/LBS.	CUBIC FT.	1" TOP	1.5" TOP	GLAZE ADD	HP ADD
D x W x H								
Z2472LRRL	25 x 75.7 x 29.1	70	141	6.75	\$1387	N/A	N/A	\$390
Z2460LRRL	25 x 63.7 x 29.1	70	122	5.75	\$1198	N/A	N/A	\$325
Z2454LRRL	25 x 57.7 x 29.1	70	112.9	5.5	\$1096	N/A	N/A	\$293
Z2448LRRL	25 x 51.7 x 29.1	70	103.4	5	\$1017	N/A	N/A	\$262
Z2442LRRL	25 x 45.7 x 29.1	70	94	4.5	\$935	N/A	N/A	\$228
Z2436LRRL	25 x 39.7 x 29.1	70	84.3	4	\$851	N/A	N/A	\$196

Not freestanding, must be connected to a reception desk. Grommet in worksurface. Shipped RTA (ready to assemble). Accommodates shells of all depths. Connecting hardware included. Widths and depths listed are outside dimensions including outside surrounds. Model numbers reflect the primary worksurface dimensions.

Z2072LRRL	20.9 x 75.7 x 29.1	70	128.8	6.75	\$1220	N/A	N/A	\$325
Z2060LRRL	20.9 x 63.7 x 29.1	70	111.3	5.75	\$1047	N/A	N/A	\$273
Z2054LRRL	20.9 x 57.7 x 29.1	70	102.8	5.5	\$959	N/A	N/A	\$244
Z2048LRRL	20.9 x 51.7 x 29.1	70	94.1	5	\$887	N/A	N/A	\$220
Z2042LRRL	20.9 x 45.7 x 29.1	70	85.3	4.5	\$813	N/A	N/A	\$192
Z2036LRRL	20.9 x 39.7 x 29.1	70	76.3	4	\$740	N/A	N/A	\$167

Not freestanding, must be connected to a reception desk. Grommet in worksurface. Shipped RTA (ready to assemble). Accommodates shells of **20" depths**. Connecting hardware included. Widths and depths listed are outside dimensions including outside surrounds. Model numbers reflect the primary worksurface dimensions.

Z2472LRRR	25 x 75.7 x 29.1	70	141	6.75	\$1387	N/A	N/A	\$390
Z2460LRRR	25 x 63.7 x 29.1	70	122	5.75	\$1198	N/A	N/A	\$325
Z2454LRRR	25 x 57.7 x 29.1	70	112.9	5.5	\$1096	N/A	N/A	\$293
Z2448LRRR	25 x 51.7 x 29.1	70	103.4	5	\$1017	N/A	N/A	\$262
Z2442LRRR	25 x 45.7 x 29.1	70	94	4.5	\$935	N/A	N/A	\$228
Z2436LRRR	25 x 39.7 x 29.1	70	84.3	4	\$851	N/A	N/A	\$196

Not freestanding, must be connected to a reception desk. Grommet in worksurface. Shipped RTA (ready to assemble). Accommodates shells of all depths. Connecting hardware included. Widths and depths listed are outside dimensions including outside surrounds. Model numbers reflect the primary worksurface dimensions.

Z2072LRRR	20.9 x 75.7 x 29.1	70	128.8	6.75	\$1220	N/A	N/A	\$325
Z2060LRRR	20.9 x 63.7 x 29.1	70	111.3	5.75	\$1047	N/A	N/A	\$273
Z2054LRRR	20.9 x 57.7 x 29.1	70	102.8	5.5	\$959	N/A	N/A	\$244
Z2048LRRR	20.9 x 51.7 x 29.1	70	94.1	5	\$887	N/A	N/A	\$220
Z2042LRRR	20.9 x 45.7 x 29.1	70	85.3	4.5	\$813	N/A	N/A	\$192
Z2036LRRR	20.9 x 39.7 x 29.1	70	76.3	4	\$740	N/A	N/A	\$167

Not freestanding, must be connected to a reception desk. Grommet in worksurface. Shipped RTA (ready to assemble). Accommodates shells of **20" depths**. Connecting hardware included. Widths and depths listed are outside dimensions including outside surrounds. Model numbers reflect the primary worksurface dimensions.

Required Specifications

Top finish
Top/edge detail
Base/surround finish

Optional Specifications

HP laminate
Additional grommet

Accessories

Power block

TRANSACTIONAL RETURNS



Transaction Return - LEFT



Transaction Return - LEFT



Transaction Return - RIGHT



Transaction Return - RIGHT



Transaction Return, Bow Front - LEFT

MODEL#	DIMENSIONS D x W x H	FREIGHT CLASS	WT/LBS.	CUBIC FT.	1" TOP	1.5" TOP	GLAZE ADD	HP ADD
Z2472TSRL	29.7 x 75.7 x 36.5-37	70	166	9.75	\$1697	\$1832	N/A	\$390
Z2460TSRL	29.7 x 63.7 x 36.5-37	70	144	8.75	\$1466	\$1582	N/A	\$325
Z2454TSRL	29.7 x 57.7 x 36.5-37	70	132	7.5	\$1332	\$1440	N/A	\$293
Z2448TSRL	29.7 x 51.7 x 36.5-37	70	121	7	\$1225	\$1319	N/A	\$262
Z2442TSRL	29.7 x 45.7 x 36.5-37	70	109	6.25	\$1124	\$1211	N/A	\$228
Z2436TSRL	29.7 x 39.7 x 36.5-37	70	96	5.5	\$1019	\$1095	N/A	\$196

Not freestanding, must be connected to a reception desk. Grommet in worksurface. Shipped RTA (ready to assemble). Accommodates shells of all depths. Connecting hardware included. Widths and depths listed are outside dimensions including transaction top overhang on the front and sides. Model numbers reflect the primary worksurface dimensions.

Z2072TSRL	25.6 x 75.7 x 36.5-37	70	153	8.25	\$1528	\$1663	N/A	\$325
Z2060TSRL	25.6 x 63.7 x 36.5-37	70	132	7.25	\$1312	\$1428	N/A	\$273
Z2054TSRL	25.6 x 57.7 x 36.5-37	70	120	6.25	\$1188	\$1296	N/A	\$244
Z2048TSRL	25.6 x 51.7 x 36.5-37	70	110	5.5	\$1090	\$1184	N/A	\$220
Z2042TSRL	25.6 x 45.7 x 36.5-37	70	100	5	\$992	\$1079	N/A	\$192
Z2036TSRL	25.6 x 39.7 x 36.5-37	70	89	4.4	\$900	\$976	N/A	\$167

Not freestanding, must be connected to a reception desk. Grommet in worksurface. Shipped RTA (ready to assemble). Accommodates shells of **20" depths**. Connecting hardware included. Widths and depths listed are outside dimensions including transaction top overhang on the front and sides. Model numbers reflect the primary worksurface dimensions.

Z2472TSRR	29.7 x 75.7 x 36.5-37	70	166	9.75	\$1697	\$1832	N/A	\$390
Z2460TSRR	29.7 x 63.7 x 36.5-37	70	144	8.75	\$1466	\$1582	N/A	\$325
Z2454TSRR	29.7 x 57.7 x 36.5-37	70	132	7.5	\$1332	\$1440	N/A	\$293
Z2448TSRR	29.7 x 51.7 x 36.5-37	70	121	7	\$1225	\$1319	N/A	\$262
Z2442TSRR	29.7 x 45.7 x 36.5-37	70	109	6.25	\$1124	\$1211	N/A	\$228
Z2436TSRR	29.7 x 39.7 x 36.5-37	70	96	5.5	\$1019	\$1095	N/A	\$196

Not freestanding, must be connected to a reception desk. Grommet in worksurface. Shipped RTA (ready to assemble). Accommodates shells of all depths. Connecting hardware included. Widths and depths listed are outside dimensions including transaction top overhang on the front and sides. Model numbers reflect the primary worksurface dimensions.

Z2072TSRR	25.6 x 75.7 x 36.5-37	70	153	8.25	\$1528	\$1663	N/A	\$325
Z2060TSRR	25.6 x 63.7 x 36.5-37	70	132	7.25	\$1312	\$1428	N/A	\$273
Z2054TSRR	25.6 x 57.7 x 36.5-37	70	120	6.25	\$1188	\$1296	N/A	\$244
Z2048TSRR	25.6 x 51.7 x 36.5-37	70	110	5.5	\$1090	\$1184	N/A	\$220
Z2042TSRR	25.6 x 45.7 x 36.5-37	70	100	5	\$992	\$1079	N/A	\$192
Z2036TSRR	25.6 x 39.7 x 36.5-37	70	89	4.4	\$900	\$976	N/A	\$167

Not freestanding, must be connected to a reception desk. Grommet in worksurface. Shipped RTA (ready to assemble). Accommodates shells of **20" depths**. Connecting hardware included. Widths and depths listed are outside dimensions including transaction top overhang on the front and sides. Model numbers reflect the primary worksurface dimensions.

Z2472TBRL	32.7 x 75.7 x 36.5-37	70	168.2	9.75	\$1697	\$1832	N/A	\$390
Z2460TBRL	32.7 x 63.7 x 36.5-37	70	145.3	8.5	\$1466	\$1582	N/A	\$325
Z2454TBRL	32.7 x 57.7 x 36.5-37	70	134.4	7.5	\$1332	\$1440	N/A	\$293
Z2448TBRL	32.7 x 51.7 x 36.5-37	70	122.2	7	\$1225	\$1319	N/A	\$262
Z2442TBRL	32.7 x 45.7 x 36.5-37	70	110.9	6.25	\$1124	\$1211	N/A	\$228
Z2436TBRL	32.7 x 39.7 x 36.5-37	70	98.4	5.5	\$1019	\$1095	N/A	\$196

Not freestanding, must be connected to a reception desk. Grommet in worksurface. Shipped RTA (ready to assemble). Accommodates shells of all depths. Connecting hardware included. Widths and depths listed are outside dimensions including transaction top overhang on the front and sides. Model numbers reflect the primary worksurface dimensions.

Required Specifications

Top finish
Base/surround finish
Transaction top finish

Optional Specifications

HP laminate
Additional grommet

Accessories

Power block

TRANSACTIONAL RETURNS



Transaction Return, Bow Front - LEFT

MODEL#	DIMENSIONS D x W x H	FREIGHT CLASS	WT/LBS.	CUBIC FT.	1" TOP	1.5" TOP	GLAZE ADD	HP ADD
Z2072TBRL	28.6 x 75.7 x 36.5-37	70	155.6	8.25	\$1528	\$1663	N/A	\$325
Z2060TBRL	28.6 x 63.7 x 36.5-37	70	134.2	7.5	\$1312	\$1428	N/A	\$273
Z2054TBRL	28.6 x 57.7 x 36.5-37	70	124	6.5	\$1188	\$1296	N/A	\$244
Z2048TBRL	28.6 x 51.7 x 36.5-37	70	112.6	6	\$1090	\$1184	N/A	\$220
Z2042TBRL	28.6 x 45.7 x 36.5-37	70	101.9	5.25	\$992	\$1079	N/A	\$192
Z2036TBRL	28.6 x 39.7 x 36.5-37	70	90.1	4.7	\$900	\$976	N/A	\$167

Not freestanding, must be connected to a reception desk. Grommet in worksurface. Shipped RTA (ready to assemble). Accommodates shells of **20" depths**. Connecting hardware included. Widths and depths listed are outside dimensions including transaction top overhang on the front and sides. Model numbers reflect the primary worksurface dimensions.



Transaction Return, Bow Front - RIGHT

Z2472TBRR	32.7 x 75.7 x 36.5-37	70	168.2	9.75	\$1697	\$1832	N/A	\$390
Z2460TBRR	32.7 x 63.7 x 36.5-37	70	145.3	8.5	\$1466	\$1582	N/A	\$325
Z2454TBRR	32.7 x 57.7 x 36.5-37	70	134.4	7.5	\$1332	\$1440	N/A	\$293
Z2448TBRR	32.7 x 51.7 x 36.5-37	70	122.2	7	\$1225	\$1319	N/A	\$262
Z2442TBRR	32.7 x 45.7 x 36.5-37	70	110.9	6.25	\$1124	\$1211	N/A	\$228
Z2436TBRR	32.7 x 39.7 x 36.5-37	70	98.4	5.5	\$1019	\$1095	N/A	\$196

Not freestanding, must be connected to a reception desk. Grommet in worksurface. Shipped RTA (ready to assemble). Accommodates shells of all depths. Connecting hardware included. Widths and depths listed are outside dimensions including transaction top overhang on the front and sides. Model numbers reflect the primary worksurface dimensions.



Transaction Return, Bow Front - RIGHT

Z2072TBRR	28.6 x 75.7 x 36.5-37	70	155.6	8.25	\$1528	\$1663	N/A	\$325
Z2060TBRR	28.6 x 63.7 x 36.5-37	70	134.2	7.5	\$1312	\$1428	N/A	\$273
Z2054TBRR	28.6 x 57.7 x 36.5-37	70	124	6.5	\$1188	\$1296	N/A	\$244
Z2048TBRR	28.6 x 51.7 x 36.5-37	70	112.6	6	\$1090	\$1184	N/A	\$220
Z2042TBRR	28.6 x 45.7 x 36.5-37	70	101.9	5.25	\$992	\$1079	N/A	\$192
Z2036TBRR	28.6 x 39.7 x 36.5-37	70	90.1	4.7	\$900	\$976	N/A	\$167

Not freestanding, must be connected to a reception desk. Grommet in worksurface. Shipped RTA (ready to assemble). Accommodates shells of **20" depths**. Connecting hardware included. Widths and depths listed are outside dimensions including transaction top overhang on the front and sides. Model numbers reflect the primary worksurface dimensions.

Required Specifications

Top finish
Transaction top finish
Base/surround finish

Optional Specifications

HP laminate
Additional grommet

Accessories

Power block

PIGEON RECEPTION RETURNS



Pigeon Reception Return - LEFT*

MODEL#	DIMENSIONS D x W x H	FREIGHT CLASS	WT/LBS.	CUBIC FT.	1" TOP	1.5" TOP	GLAZE ADD	HP ADD
Z2472PRRL	31 x 75.7 x 39.8	70	171.3	9.75	\$1923	N/A	N/A	\$390
Z2460PRRL	31 x 63.7 x 39.8	70	149	8.25	\$1690	N/A	N/A	\$325
Z2454PRRL	31 x 57.7 x 39.8	70	136.4	7.5	\$1571	N/A	N/A	\$293

Not freestanding, must be connected to a reception desk. Grommet in worksurface. Shipped RTA (ready to assemble). Accommodates shells of all depths. Connecting hardware included. Widths and depths listed are outside dimensions including transaction top overhang on the front and sides. Model numbers reflect the primary worksurface dimensions.



Pigeon Reception Return - LEFT*

Z2072PRRL	26.9 x 75.7 x 39.8	70	159	9.75	\$1758	N/A	N/A	\$325
Z2060PRRL	26.9 x 63.7 x 39.8	70	138.2	8.25	\$1538	N/A	N/A	\$273
Z2054PRRL	26.9 x 57.7 x 39.8	70	126.2	7.5	\$1430	N/A	N/A	\$244

Not freestanding, must be connected to a reception desk. Grommet in worksurface. Shipped RTA (ready to assemble). Accommodates shells of **20" depths**. Connecting hardware included. Widths and depths listed are outside dimensions including transaction top overhang on the front and sides. Model numbers reflect the primary worksurface dimensions.



Pigeon Reception Return - RIGHT*

Z2472PRRR	31 x 75.7 x 39.8	70	171.3	9.75	\$1923	N/A	N/A	\$390
Z2460PRRR	31 x 63.7 x 39.8	70	149	8.25	\$1690	N/A	N/A	\$325
Z2454PRRR	31 x 57.7 x 39.8	70	136.4	7.5	\$1571	N/A	N/A	\$293

Not freestanding, must be connected to a reception desk. Grommet in worksurface. Shipped RTA (ready to assemble). Accommodates shells of all depths. Connecting hardware included. Widths and depths listed are outside dimensions including transaction top overhang on the front and sides. Model numbers reflect the primary worksurface dimensions.



Pigeon Reception Return - RIGHT*

Z2072PRRR	26.9 x 75.7 x 39.8	70	159	9.75	\$1758	N/A	N/A	\$325
Z2060PRRR	26.9 x 63.7 x 39.8	70	138.2	8.25	\$1538	N/A	N/A	\$273
Z2054PRRR	26.9 x 57.7 x 39.8	70	126.2	7.5	\$1430	N/A	N/A	\$244

Not freestanding, must be connected to a reception desk. Grommet in worksurface. Shipped RTA (ready to assemble). Accommodates shells of **20" depths**. Connecting hardware included. Widths and depths listed are outside dimensions including transaction top overhang on the front and sides. Model numbers reflect the primary worksurface dimensions.

Required Specifications

- Top finish
- Base/surround finish
- Pigeon hole finish
- Collator finish

Optional Specifications

- HP laminate
- Additional grommet

Accessories

- Power block

TRANSACTIONAL RETURNS



Bookcase Reception Return - LEFT

MODEL#	DIMENSIONS D x W x H	FREIGHT CLASS	WT/LBS.	CUBIC FT.	1" TOP	1.5" TOP	GLAZE ADD	HP ADD
Z1272BRRL	13.7 x 75.7 x 39.8	70	158	7.5	\$1537	N/A	N/A	\$196
Z1260BRRL	13.7 x 63.7 x 39.8	70	139	6.25	\$1359	N/A	N/A	\$167

Not freestanding, must be connected to a reception desk. Grommet in worksurface. Shipped RTA (ready to assemble). Accommodates shells of all depths. Connecting hardware included. Widths and depths listed are outside dimensions including outside surrounds. Model numbers reflect the primary worksurface dimensions.



Bookcase Reception Return - LEFT

Z1254BRRL	13.7 x 57.7 x 39.8	65	131	5.75	\$1258	N/A	N/A	\$149
Z1248BRRL	13.7 x 51.7 x 39.8	70	114	5.25	\$1120	N/A	N/A	\$134
Z1242BRRL	13.7 x 45.7 x 39.8	65	106	4.6	\$1053	N/A	N/A	\$118
Z1236BRRL	13.7 x 39.7 x 39.8	65	98	4.1	\$987	N/A	N/A	\$101

Not freestanding, must be connected to a reception desk. Grommet in worksurface. Shipped RTA (ready to assemble). Accommodates shells of all depths. Connecting hardware included. Widths and depths listed are outside dimensions including outside surrounds. Model numbers reflect the primary worksurface dimensions.



Bookcase Reception Return - RIGHT

Z1272BRRR	13.7 x 75.7 x 39.8	70	158	7.5	\$1537	N/A	N/A	\$196
Z1260BRRR	13.7 x 63.7 x 39.8	70	139	6.25	\$1359	N/A	N/A	\$167

Not freestanding, must be connected to a reception desk. Grommet in worksurface. Shipped RTA (ready to assemble). Accommodates shells of all depths. Connecting hardware included. Widths and depths listed are outside dimensions including outside surrounds. Model numbers reflect the primary worksurface dimensions.



Bookcase Reception Return - RIGHT

Z1254BRRR	13.7 x 57.7 x 39.8	65	131	5.75	\$1258	N/A	N/A	\$149
Z1248BRRR	13.7 x 51.7 x 39.8	70	114	5.25	\$1120	N/A	N/A	\$134
Z1242BRRR	13.7 x 45.7 x 39.8	65	106	4.6	\$1053	N/A	N/A	\$118
Z1236BRRR	13.7 x 39.7 x 39.8	65	98	4.1	\$987	N/A	N/A	\$101

Not freestanding, must be connected to a reception desk. Grommet in worksurface. Shipped RTA (ready to assemble). Accommodates shells of all depths. Connecting hardware included. Widths and depths listed are outside dimensions including outside surrounds. Model numbers reflect the primary worksurface dimensions.

RECEPTION DESK VERTICAL STORAGE



Reception Desk - Vertical Storage*

MODEL#	DIMENSIONS	FREIGHT CLASS	WT/LBS.	CUBIC FT.	1" TOP	1.5" TOP	GLAZE ADD	HP ADD
ZRDVS13	8.6 x 13.4 x 12.2	70	12.50	.80	\$253	N/A	N/A	N/A

Collator shelves for use under Zira Reception transaction top. Shipped assembled in 1 carton.

Required Specifications

Top finish
Transaction top finish
Base/surround finish

Optional Specifications

HP laminate
Additional grommet

Accessories

Power block

RECEPTION DESKS W/LAMINATE OVERLAY	MODEL#	DIMENSIONS	FREIGHT CLASS	WT/LBS.	CUBIC FT.	1" TOP	1.5" TOP	GLAZE ADD	HP ADD
	D x W x H								
	Z3696RFSL	36 x 96 x 44.7	70	307	15.72	\$5273	n/a	n/a	\$740
	Z3690RFSL	36 x 90 x 44.7	70	297	14.73	\$5051	n/a	n/a	\$698
	Z3684RFSL	36 x 84 x 44.7	70	297	13.74	\$4339	n/a	n/a	\$648
	Z3678RFSL	36 x 78 x 44.7	70	248	12.72	\$4152	n/a	n/a	\$604
	Z3672RFSL	36 x 72 x 44.7	70	235	11.74	\$3960	n/a	n/a	\$556
	Z3096RFSL	29.7 x 96 x 44.7	70	287	15.21	\$5096	n/a	n/a	\$617
	Z3090RFSL	29.7 x 90 x 44.7	70	279	14.49	\$4910	n/a	n/a	\$580
	Z3084RFSL	29.7 x 84 x 44.7	70	245	13.23	\$4208	n/a	n/a	\$545
	Z3078RFSL	29.7 x 78 x 44.7	70	232	12.72	\$4026	n/a	n/a	\$507
	Z3072RFSL	29.7 x 72 x 44.7	70	221	12.25	\$3859	n/a	n/a	\$465

Reception Desk, Laminate Overlay, Left

Not freestanding; for use with ZxxxxFRRL returns. 1" thick worksurface with matching edge. Transaction top is 1.5" thick only, edge profile optional. Shipped RTA (ready to assemble) in 3 cartons.

- Slatting detail is 17.9"W for 72", 78" and 84" wide units; 30"W for 90" and 96" wide units.
- Z30xx models will not accommodate both a monitor and a keyboard; undermount keyboard is recommended.

	Z3696RFSLR	36 x 96 x 44.7	70	307	15.72	\$5273	n/a	n/a	\$740
	Z3690RFSLR	36 x 90 x 44.7	70	297	14.73	\$5051	n/a	n/a	\$698
	Z3684RFSLR	36 x 84 x 44.7	70	297	13.74	\$4339	n/a	n/a	\$648
	Z3678RFSLR	36 x 78 x 44.7	70	248	12.72	\$4152	n/a	n/a	\$604
	Z3672RFSLR	36 x 72 x 44.7	70	235	11.74	\$3960	n/a	n/a	\$556
	Z3096RFSLR	29.7 x 96 x 44.7	70	287	15.21	\$5096	n/a	n/a	\$617
	Z3090RFSLR	29.7 x 90 x 44.7	70	279	14.49	\$4910	n/a	n/a	\$580
	Z3084RFSLR	29.7 x 84 x 44.7	70	245	13.23	\$4208	n/a	n/a	\$545
	Z3078RFSLR	29.7 x 78 x 44.7	70	232	12.72	\$4026	n/a	n/a	\$507
	Z3072RFSLR	29.7 x 72 x 44.7	70	221	12.25	\$3859	n/a	n/a	\$465

Reception Desk, Laminate Overlay, Right

Not freestanding; for use with ZxxxxFRRL returns. 1" thick worksurface with matching edge. Transaction top is 1.5" thick only, edge profile optional. Shipped RTA (ready to assemble) in 3 cartons.

- Slatting detail is 17.9"W for 72", 78" and 84" wide units; 30"W for 90" and 96" wide units.
- Z30xx models will not accommodate both a monitor and a keyboard; undermount keyboard tray is recommended.

DOUBLE RECEPTION DESK W/LAMINATE OVERLAY	MODEL#	DIMENSIONS	FREIGHT CLASS	WT/LBS.	CUBIC FT.	1" TOP	1.5" TOP	GLAZE ADD	HP ADD
	Z36120RFDL	36 x 120 x 44.7	70	308	14.97	\$6096	n/a	n/a	\$1538
	Z36114RFDL	36 x 114 x 44.7	70	294	13.98	\$5905	n/a	n/a	\$1463
	Z36108RFDL	36 x 108 x 44.7	70	281	13.23	\$5637	n/a	n/a	\$1385
	Z36102RFDL	36 x 102 x 44.7	70	268	12.49	\$5450	n/a	n/a	\$1311
	Z3696RFDL	36 x 96 x 44.7	70	237	11.23	\$5197	n/a	n/a	\$617
	Z30120RFDL	29.7 x 120 x 44.7	70	286	14.22	\$5935	n/a	n/a	\$1385
	Z30114RFDL	29.7 x 114 x 44.7	70	274	13.47	\$5753	n/a	n/a	\$1315
	Z30108RFDL	29.7 x 108 x 44.7	70	261	12.72	\$5495	n/a	n/a	\$1246
	Z30102RFDL	29.7 x 102 x 44.7	70	249	11.98	\$5314	n/a	n/a	\$1181
	Z3096RFDL	29.7 x 96 x 44.7	70	254	11.74	\$5071	n/a	n/a	\$617

Double Reception Desk, Laminate Overlay

Not freestanding; for use with a left and right hand ZxxxxFRRL(R/L) return. 1" thick worksurface with matching edge. Transaction top is 1.5" thick only, edge profile optional. Slatting detail is 30"W. Shipped RTA (ready to assemble) in 3 cartons.

- Z30xx models will not accommodate both a monitor and a keyboard; undermount keyboard tray is recommended.

Required Specifications

Top surface material (TFL or HPL)
 Top finish
 Top/edge detail
 Base/surround finish

Transaction top finish
 Glazing (GF or RG)

Optional Specifications

Grommet or cut-out

Accessories

Power block

RECEPTION RETURNS



Reception Return, w/Overhang - Left

MODEL#	DIMENSIONS D x W x H	FREIGHT CLASS	WT/LBS.	CUBIC FT.	1" TOP	1.5" TOP	GLAZE ADD	HP ADD
Z3996FRRL	39 x 96 x 29.9	70	211	11.74	\$2066	n/a	n/a	\$740
Z3990FRRL	39 x 90 x 29.9	70	201	11.26	\$1990	n/a	n/a	\$698
Z3984FRRL	39 x 84 x 29.9	70	192	10.76	\$1925	n/a	n/a	\$648
Z3978FRRL	39 x 78 x 29.9	70	182	10	\$1844	n/a	n/a	\$604
Z3972FRRL	39 x 72 x 29.9	70	172	9.5	\$1763	n/a	n/a	\$556

ADA Compliant. Not freestanding; for use with ZxxxxRFSLR or RFDL models. 1" thick worksurface with matching straight edge. ADA accessible; worksurface overhang depth to overlay is 11-7/8", elsewhere it is 18-5/8".
Shipped RTA (ready to assemble) in 2 cartons.



Reception Return, w/Overhang - Right

Z3996FRRR	39 x 96 x 29.9	70	211	11.74	\$2066	n/a	n/a	\$740
Z3990FRRR	39 x 90 x 29.9	70	201	11.26	\$1990	n/a	n/a	\$698
Z3984FRRR	39 x 84 x 29.9	70	192	10.76	\$1925	n/a	n/a	\$648
Z3978FRRR	39 x 78 x 29.9	70	182	10	\$1844	n/a	n/a	\$604
Z3972FRRR	39 x 72 x 29.9	70	172	9.5	\$1763	n/a	n/a	\$556

ADA Compliant. Not freestanding; for use with ZxxxxRFSLL or RFDL models. 1" thick worksurface with matching straight edge. ADA accessible; worksurface overhang depth to overlay is 11-7/8", elsewhere it is 18-5/8".
Shipped RTA (ready to assemble) in 2 cartons.



Reception Return, Flush Front - Left

Z2796FRRL	27 x 96 x 29.9	70	179	10.26	\$1859	n/a	n/a	\$495
Z2790FRRL	27 x 90 x 29.9	70	171	9.76	\$1793	n/a	n/a	\$465
Z2784FRRL	27 x 84 x 29.9	70	163	9.5	\$1738	n/a	n/a	\$434
Z2778FRRL	27 x 78 x 29.9	70	155	9	\$1672	n/a	n/a	\$401
Z2772FRRL	27 x 72 x 29.9	60	147	4.25	\$1607	n/a	n/a	\$372

Not freestanding; for use with ZxxxxRFSLR or RFDL models. 1" thick worksurface with matching straight edge.
Shipped RTA (ready to assemble) in 2 cartons.



Reception Return, Flush Front - Right

Z2796FRRR	27 x 96 x 29.9	70	179	10.26	\$1859	n/a	n/a	\$495
Z2790FRRR	27 x 90 x 29.9	70	171	9.76	\$1793	n/a	n/a	\$465
Z2784FRRR	27 x 84 x 29.9	70	163	9.5	\$1738	n/a	n/a	\$434
Z2778FRRR	27 x 78 x 29.9	70	155	9	\$1672	n/a	n/a	\$401
Z2772FRRR	27 x 72 x 29.9	60	147	4.25	\$1607	n/a	n/a	\$372

Not freestanding; for use with ZxxxxRFSLL or RFDL models. 1" thick worksurface with matching straight edge.
Shipped RTA (ready to assemble) in 2 cartons.

Required Specifications

Top surface material (TFL or HPL)
Top/overlay finish
Base finish

Optional Specifications

Grommet or cut-out

Accessories

Power block

FREESTANDING RECEPTION DESKS



Reception Desk, Freestanding

MODEL#	DIMENSIONS	FREIGHT CLASS	WT/LBS.	CUBIC FT.	1" TOP	1.5" TOP	GLAZE ADD	HP ADD
D x W x H								
Z2496RD	24 x 96 x 47.5	65	262	10.5	\$3500	n/a	n/a	\$495
Z2484RD	24 x 84 x 47.5	65	238	9.24	\$3278	n/a	n/a	\$434
Z2472RD	24 x 72 x 47.5	65	217	8.5	\$3112	n/a	n/a	\$372
Z2466RD	24 x 66 x 47.5	65	206	8	\$3006	n/a	n/a	\$341
Z2460RD	24 x 60 x 47.5	65	196	7.5	\$2920	n/a	n/a	\$310

Freestanding unit; does not accept returns. 1" thick worksurface and transaction top with matching A3 edge only. Shipped RTA (ready to assemble) in 2 cartons.

- Slating detail is 17.9"W for 60"-84" wide units; 30"W for 96" wide units.

L-SHAPED RECEPTION DESKS W/ RIGHT HAND RETURNS

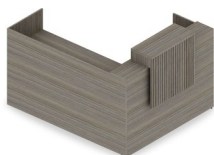

L-Shaped Reception Desk, Freestanding w/Right Hand Return

60" wide:								
Z24607224R	96 x 60 x 47.5	65	314	12.28	\$4758	n/a	n/a	\$682
Z24606024R	84 x 60 x 47.5	65	297	11.47	\$4551	n/a	n/a	\$620
Z24605424R	78 x 60 x 47.5	65	288	11.17	\$4460	n/a	n/a	\$590
Z24604824R	72 x 60 x 47.5	65	279	10.87	\$4369	n/a	n/a	\$560
Z24604224R	66 x 60 x 47.5	65	271	10.57	\$4278	n/a	n/a	\$529
Z24603624R	60 x 60 x 47.5	65	262	10.18	\$4167	n/a	n/a	\$496
66" wide:								
Z24667224R	96 x 66 x 47.5	65	324	12.66	\$4869	n/a	n/a	\$713
Z24666024R	84 x 66 x 47.5	65	306	11.98	\$4667	n/a	n/a	\$651
Z24665424R	78 x 66 x 47.5	65	298	11.56	\$4571	n/a	n/a	\$621
Z24664824R	72 x 66 x 47.5	65	289	11.26	\$4460	n/a	n/a	\$591
Z24664224R	66 x 66 x 47.5	65	280	10.96	\$4394	n/a	n/a	\$560
Z24663624R	60 x 66 x 47.5	65	271	10.57	\$4278	n/a	n/a	\$527
72" wide:								
Z24727224R	96 x 72 x 47.5	65	334	12.96	\$4960	n/a	n/a	\$744
Z24726024R	84 x 72 x 47.5	65	316	12.16	\$4783	n/a	n/a	\$682
Z24725424R	78 x 72 x 47.5	65	309	11.86	\$4687	n/a	n/a	\$652
Z24724824R	72 x 72 x 47.5	65	299	11.56	\$4596	n/a	n/a	\$622
Z24724224R	66 x 72 x 47.5	65	290	11.26	\$4511	n/a	n/a	\$591
Z24723624R	60 x 72 x 47.5	65	282	10.87	\$4369	n/a	n/a	\$558
84" wide:								
Z24847224R	96 x 84 x 47.5	65	354	13.56	\$5167	n/a	n/a	\$806
Z24846024R	84 x 84 x 47.5	65	337	12.75	\$5006	n/a	n/a	\$744
Z24845424R	78 x 84 x 47.5	65	328	12.46	\$4915	n/a	n/a	\$714
Z24844824R	72 x 84 x 47.5	65	319	12.16	\$4829	n/a	n/a	\$684
Z24844224R	66 x 84 x 47.5	65	311	11.86	\$4733	n/a	n/a	\$653
Z24843624R	60 x 84 x 47.5	65	302	11.47	\$4622	n/a	n/a	\$620

Primary and return surfaces are 24"D nominally. 1" thick worksurface and transaction top with matching A3 edge only.

Freestanding unit with right hand return. Return is standard with center grommet, not optional. Shipped RTA (ready to assemble) in 3 cartons.

- Slating detail is 17.9"W for 60"-84" wide units; 30"W for 96" wide units.

Required Specifications

Primary surface type + finish
Base finish
Transaction top finish

Optional Specifications

Grommet or cut-out (primary surface)

Accessories

Power block

L-SHAPED RECEPTION DESKS W/ LEFT HAND RETURN	MODEL#	DIMENSIONS	FREIGHT CLASS	WT/LBS.	CUBIC FT.	1" TOP	1.5" TOP	GLAZE ADD	HP ADD
--	--------	------------	---------------	---------	-----------	--------	----------	-----------	--------

D x W x H

60" wide:

Z24607224L	96 x 60 x 47.5	65	314	12.28	\$4758	n/a	n/a	\$682
Z24606024L	84 x 60 x 47.5	65	297	11.47	\$4551	n/a	n/a	\$620
Z24605424L	78 x 60 x 47.5	65	288	11.17	\$4460	n/a	n/a	\$590
Z24604824L	72 x 60 x 47.5	65	279	10.87	\$4369	n/a	n/a	\$560
Z24604224L	66 x 60 x 47.5	65	271	10.57	\$4278	n/a	n/a	\$529
Z24603624L	60 x 60 x 47.5	65	262	10.18	\$4167	n/a	n/a	\$496

66" wide:

Z24667224L	96 x 66 x 47.5	65	324	12.66	\$4869	n/a	n/a	\$713
Z24666024L	84 x 66 x 47.5	65	306	11.98	\$4667	n/a	n/a	\$651
Z24665424L	78 x 66 x 47.5	65	298	11.56	\$4571	n/a	n/a	\$621
Z24664824L	72 x 66 x 47.5	65	289	11.26	\$4460	n/a	n/a	\$591
Z24664224L	66 x 66 x 47.5	65	280	10.96	\$4394	n/a	n/a	\$560
Z24663624L	60 x 66 x 47.5	65	271	10.57	\$4278	n/a	n/a	\$527

72" wide:

Z24727224L	96 x 72 x 47.5	65	334	12.96	\$4960	n/a	n/a	\$744
Z24726024L	84 x 72 x 47.5	65	316	12.16	\$4783	n/a	n/a	\$682
Z24725424L	78 x 72 x 47.5	65	309	11.86	\$4687	n/a	n/a	\$652
Z24724824L	72 x 72 x 47.5	65	299	11.56	\$4596	n/a	n/a	\$622
Z24724224L	66 x 72 x 47.5	65	290	11.26	\$4511	n/a	n/a	\$591
Z24723624L	60 x 72 x 47.5	65	282	10.87	\$4369	n/a	n/a	\$558

84" wide:

Z24847224L	96 x 84 x 47.5	65	354	13.56	\$5167	n/a	n/a	\$806
Z24846024L	84 x 84 x 47.5	65	337	12.75	\$5006	n/a	n/a	\$744
Z24845424L	78 x 84 x 47.5	65	328	12.46	\$4915	n/a	n/a	\$714
Z24844824L	72 x 84 x 47.5	65	319	12.16	\$4829	n/a	n/a	\$684
Z24844224L	66 x 84 x 47.5	65	311	11.86	\$4733	n/a	n/a	\$653
Z24843624L	60 x 84 x 47.5	65	302	11.47	\$4622	n/a	n/a	\$620



L-Shaped Reception Desk, Freestanding w/Left Hand Return

Primary and return surfaces are 24"D nominally. 1" thick worksurface and transaction top with matching A3 edge only.

Freestanding unit with left hand return. Return is standard with center grommet, not optional. Shipped RTA (ready to assemble) in 3 cartons.

- Slating detail is 17.9"W for 60"-84" wide units; 30"W for 96" wide units.

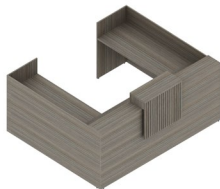

U-Shaped Reception Desk, Freestanding w/Left & Right Hand Returns

Z24967224D	96 x 96 x 47.5	65	505	20.4	\$7031	n/a	n/a	\$1239
Z24966024D	96 x 84 x 47.5	65	469	18.88	\$6596	n/a	n/a	\$1115
Z24965424D	96 x 78 x 47.5	65	452	18.2	\$6415	n/a	n/a	\$1055
Z24964824D	96 x 72 x 47.5	65	434	17.6	\$6238	n/a	n/a	\$995
Z24964224D	96 x 66 x 47.5	65	417	16.88	\$6096	n/a	n/a	\$933
Z24963624D	96 x 60 x 47.5	65	399	16.2	\$5804	n/a	n/a	\$867

Primary and return surfaces are 24"D nominally. 1" thick worksurface and transaction top with matching A3 edge only.

Slating detail is 30" wide. Freestanding unit with **left and right hand returns**. Returns each have one standard with center grommet, not optional. Shipped RTA (ready to assemble) in 4 cartons.

Required Specifications

Primary surface type + finish
Base finish
Transaction top finish

Optional Specifications

Grommet or cut-out (primary surface)

Accessories

Power block

GENERAL INFORMATION

- Comprehensive range of personal storage in a variety of sizes and configurations starting at 27.5"/28"H single column widths up to 66.5"/67"H triple column widths.
- Configurations include units with 1, 2, 3, 4, 6, 8 or 9 compartments depending on size.
- Lockers adapt to any space plan; in personal or shared work spaces, individually tailored to suit storage needs. Ideal for flex spaces or used to define space and used as barriers between work areas and to help guide workplace foot traffic flow.
- Available in two depths with door front in thermally fused laminate to add warmth and complement desking products or millwork.
- Multiple door pull options to match Global Desking series
- Units have internal drill points for optional ganging.
- Ships fully assembled.

CONSTRUCTION

- Tops are available in 1" or 1.5" thick thermally fused laminate tops with a variety of edge details
- Side panels utilize 1" thick material
- Shelves and backs utilize 11/16" thick material.
- Tops are sealed with Global's preferred edge in matching color. Woodgrain surfaces feature edging with matching printed woodgrain
- Constructed of 45 lb. density particleboard with high performance thermally fused laminate
- Virtually no loose hardware
- Leveling glides are standard

LOCKS

- Locks are standard on all lockers. Finish will coordinate with handles and/or aluminum doors.
- Please note that Flared Brass (HW) handle defaults to Black locks

SHIPPING

- Shipped assembled, 1 per carton, unless otherwise noted.

PRODUCT CODE BREAKDOWN:

- ZL**- indicates Zira locker
- ##** - 3rd & 4th position indicates height
- ##** - 5th & 6th position indicates width
- F** - indicates 18"D overall / **L** - indicates 24"D overall
- #** - 8th position indicates the number of columns side to side
- #** - 9th position indicates the number of rows top to bottom
- L** or **R** - indicates doors installed for left or right hand hinge

FINISH OPTIONS

- Must specify finish for top, case and doors separately

Thermally fused laminate finish options:

ACJ Absolute Acajou	FCL First Class
ASN Asian Night	NBL Noce Biondo
AWC Avant Cherry	NGL Noce Grigio
AWH Avant Honey	NEL Noce Leggero
BLK Black	NML Noce Medio
BZD Blizzard	QTM Quartered Mahogany
BRC Brushed Cobalt	SBY Sheer Beauty
CMB Clear Maple	SOG Storm Grey
CGY Custom Grey	SDT Stonedust
DES Dark Espresso	WHE Walnut Heights
DWT Designer White	WHC White Chocolate
FAS Fashionista	WCR Winter Cherry

Top Thickness/Edge Detail

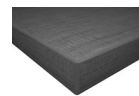

A3 1" top, standard flat edge

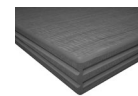

AR 1" top, bicut edge

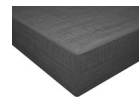

C3 1.5" top, standard flat edge



CR 1.5" top, bicut edge

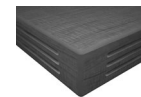

CF 1.5" top, fluted edge

HANDLES

- To order handles, please specify corresponding code to image as below (**HS, HO, HW, HX, HV, HU, HQ, HZ, or HR**):



HS Flared Silver



HV Square Edge Silver



HO Crescent Black



HW Flared Brass



HU Square Edge Black



HZ Dimpled Nickel



HX Flared Black



HQ Bar Silver



HR Bar Black

INTERIOR SHELF AND HANGING OPTIONS

- Hooks and hat shelves are standard in certain units. See individual product description for details
- When standard, hat shelf is 11/16" thick and includes 9" of clearance.
- A chrome coat hook is affixed to the left or right side wall of the opening (based on left and right handed units) on single row lockers 40.5" and up, and on double row lockers 53.5"h and up.
- When standard, a chrome coat hook is affixed to the door.

GANGING

- **All units 12", 15" or 18" wide must be ganged to another locker or anchored to a fixed wall or adjacent cabinet for compliance with applicable ANSI/BIFMA X5.6 Storage standards.**
- Units ship factory ready for ganging and include pre-drills on cabinet interiors as well as the necessary hardware to connect unit to unit.

SINGLE COLUMN LOCKERS

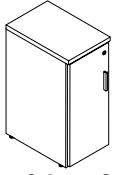

Left shown

One Column, One Row - 27.5/28" H

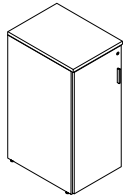

Left shown

One Column, One Row - 40.5/41" H

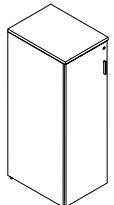

Left shown

One Column, One Row - 53.5/54" H

MODEL#	DIMENSIONS D x W x H	FREIGHT CLASS	WT./LBS.	CUBIC FT.	1" TOP	1.5" TOP
ZL2712F11L	18 x 12 x 27.5-28	92.5	52	5	\$748	\$768
ZL2712F11R	18 x 12 x 27.5-28	92.5	52	5	\$748	\$768

- Select suffix **(L)** for **left** hand / **(R)** for **right** hand opening.
- 12" wide lockers to be ganged or anchored for compliance with ANSI/BIFMA X5.6 storage standards.

ZL4012F11L	18 x 12 x 40.5-41	92.5	71	7.09	\$966	\$1004
ZL4015F11L	18 x 15 x 40.5-41	100	74	8.75	\$1044	\$1082
ZL4018F11L	18 x 18 x 40.5-41	100	86	10.25	\$1141	\$1179
ZL4012L11L	24 x 12 x 40.5-41	100	89	9.35	\$1062	\$1100
ZL4015L11L	24 x 15 x 40.5-41	100	97	11.25	\$1159	\$1179
ZL4018L11L	24 x 18 x 40.5-41	125	105	13.25	\$1256	\$1298

ZL4012F11R	18 x 12 x 40.5-41	92.5	71	7.09	\$966	\$1004
ZL4015F11R	18 x 15 x 40.5-41	100	74	8.75	\$1044	\$1082
ZL4018F11R	18 x 18 x 40.5-41	100	86	10.25	\$1141	\$1179
ZL4012L11R	24 x 12 x 40.5-41	100	89	9.35	\$1062	\$1100
ZL4015L11R	24 x 15 x 40.5-41	100	97	11.25	\$1159	\$1179
ZL4018L11R	24 x 18 x 40.5-41	125	105	13.25	\$1256	\$1298

- Select suffix **(L)** for **left** hand / **(R)** for **right** hand opening. Includes hat shelf and coat hook.
- 12", 15" or 18" wide lockers to be ganged or anchored for compliance with ANSI/BIFMA X5.6 storage standards.

ZL5312F11L	18 x 12 x 53.5-54	100	92	9.25	\$1237	\$1257
ZL5315F11L	18 x 15 x 53.5-54	100	101	11.25	\$1358	\$1395
ZL5318F11L	18 x 18 x 53.5-54	100	111	13	\$1490	\$1551
ZL5312L11L	24 x 12 x 53.5-54	100	115	12	\$1358	\$1395
ZL5315L11L	24 x 15 x 53.5-54	100	126	14.5	\$1455	\$1492
ZL5318L11L	24 x 18 x 53.5-54	100	136	17	\$1593	\$1648

ZL5312F11R	18 x 12 x 53.5-54	100	92	9.25	\$1237	\$1257
ZL5315F11R	18 x 15 x 53.5-54	100	101	11.25	\$1358	\$1395
ZL5318F11R	18 x 18 x 53.5-54	100	111	13	\$1490	\$1551
ZL5312L11R	24 x 12 x 53.5-54	100	115	12	\$1358	\$1395
ZL5315L11R	24 x 15 x 53.5-54	100	126	14.5	\$1455	\$1492
ZL5318L11R	24 x 18 x 53.5-54	100	136	17	\$1593	\$1648

- Select suffix **(L)** for **left** hand / **(R)** for **right** hand opening. Includes hat shelf and coat hook.
- 12", 15" or 18" wide lockers to be ganged or anchored for compliance with ANSI/BIFMA X5.6 storage standards.

Required Specifications

Top Finish
 Door Finish
 Top/Edge Detail
 Handles
 Base Finish

Optional Specifications

Key #

Accessories

SINGLE COLUMN LOCKERS

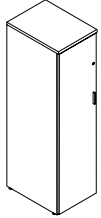

Left shown

One Column, One Row - 66.5/67" H

MODEL#	DIMENSIONS	FREIGHT CLASS	WT/LBS.	CUBIC FT.	1" TOP	1.5" TOP
D x W x H						
ZL6612F11L	18 x 12 x 66.5-67	100	111	11.5	\$1413	\$1438
ZL6615F11L	18 x 15 x 66.5-67	100	122	13.75	\$1515	\$1552
ZL6618F11L	18 x 18 x 66.5-67	125	127	16.25	\$1690	\$1727
ZL6612L11L	24 x 12 x 66.5-67	100	139	15	\$1569	\$1612
ZL6615L11L	24 x 15 x 66.5-67	100	151	18	\$1671	\$1726
ZL6618L11L	24 x 18 x 66.5-67	125	163	22	\$1829	\$1884
ZL6612F11R	18 x 12 x 66.5-67	100	111	11.5	\$1413	\$1438
ZL6615F11R	18 x 15 x 66.5-67	100	122	13.75	\$1515	\$1552
ZL6618F11R	18 x 18 x 66.5-67	125	127	16.25	\$1690	\$1727
ZL6612L11R	24 x 12 x 66.5-67	100	139	15	\$1569	\$1612
ZL6615L11R	24 x 15 x 66.5-67	100	151	18	\$1671	\$1726
ZL6618L11R	24 x 18 x 66.5-67	125	163	22	\$1829	\$1884

- Select suffix **(L)** for left hand / **(R)** for right hand opening. Includes hat shelf and coat hook.
- 12", 15" or 18" wide lockers to be ganged or anchored for compliance with ANSI/BIFMA X5.6 storage standards.

ONE COLUMN LOCKERS, TWO ROWS

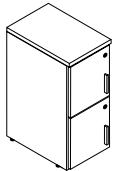

Left shown

One Column, Two Rows - 27.5/28" H

MODEL#	DIMENSIONS	FREIGHT CLASS	WT/LBS.	CUBIC FT.	1" TOP	1.5" TOP
ZL2712F12L	18 x 12 x 27.5-28	92.5	55	5	\$888	\$919
ZL2712F12R	18 x 12 x 27.5-28	92.5	55	5	\$888	\$919

- Select suffix **(L)** for left hand / **(R)** for right hand opening.
- 12" wide lockers to be ganged or anchored for compliance with ANSI/BIFMA X5.6 storage standards.

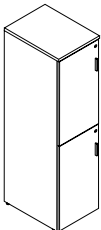

Left shown

One Column, Two Rows - 66.5/67" H

ZL6612F12L	18 x 12 x 66.5-67	100	112	11.5	\$1575	\$1607
ZL6618F12L	18 x 18 x 66.5-67	100	135	16.25	\$1840	\$1889
ZL6612L12L	24 x 12 x 66.5-67	100	140	15	\$1725	\$1763
ZL6618L12L	24 x 18 x 66.5-67	125	165	21.25	\$2004	\$2059
ZL6612F12R	18 x 12 x 66.5-67	100	112	11.5	\$1575	\$1607
ZL6618F12R	18 x 18 x 66.5-67	100	135	16.25	\$1840	\$1889
ZL6612L12R	24 x 12 x 66.5-67	100	140	15	\$1725	\$1763
ZL6618L12R	24 x 18 x 66.5-67	125	165	21.25	\$2004	\$2059

- Select suffix **(L)** for left hand / **(R)** for right hand opening. Includes coat hook in each opening
- 12" or 18" wide lockers to be ganged or anchored for compliance with ANSI/BIFMA X5.6 storage standards.

Required Specifications

Top Finish Base Finish
 Door Finish
 Top/Edge Detail
 Handles

Optional Specifications

Key #

Accessories

ONE COLUMN LOCKERS, THREE ROWS

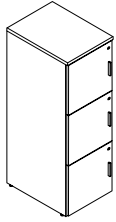

Left shown

One Column, Three Rows - 53.5/54" H

MODEL#	DIMENSIONS D x W x H	FREIGHT CLASS	WT/LBS.	CUBIC FT.	1" TOP	1.5" TOP
ZL5312F13L	18 x 12 x 53.5-54	92.5	96	9.25	\$1394	\$1425
ZL5318F13L	18 x 18 x 53.5-54	100	118	13.25	\$1665	\$1708
ZL5312L13L	24 x 12 x 53.5-54	100	121	12.25	\$1520	\$1558
ZL5318L13L	24 x 18 x 53.5-54	100	145	17.25	\$1805	\$1919
ZL5312F13R	18 x 12 x 53.5-54	92.5	96	9.25	\$1394	\$1425
ZL5318F13R	18 x 18 x 53.5-54	100	118	13.25	\$1665	\$1708
ZL5312L13R	24 x 12 x 53.5-54	100	121	12.25	\$1520	\$1558
ZL5318L13R	24 x 18 x 53.5-54	100	145	17.25	\$1805	\$1919

- Select suffix **(L)** for **left** hand / **(R)** for **right** hand.
- 12" or 18" wide lockers to be ganged or anchored for compliance with ANSI/BIFMA X5.6 storage standards.

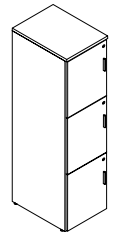

Left shown

One Column, Three Rows - 66.5/67" H

ZL6612F13L	18 x 12 x 66.5-67	92.5	115	11.5	\$1575	\$1607
ZL6618F13L	18 x 18 x 66.5-67	100	140	16.25	\$1864	\$1925
ZL6612L13L	24 x 12 x 66.5-67	100	144	15	\$1719	\$1757
ZL6618L13L	24 x 18 x 66.5-67	100	171	21.25	\$2034	\$2089
ZL6612F13R	18 x 12 x 66.5-67	92.5	115	11.5	\$1575	\$1607
ZL6618F13R	18 x 18 x 66.5-67	100	140	16.25	\$1864	\$1925
ZL6612L13R	24 x 12 x 66.5-67	100	144	15	\$1719	\$1757
ZL6618L13R	24 x 18 x 66.5-67	100	171	21.25	\$2034	\$2089

- Select suffix **(L)** for **left** hand / **(R)** for **right** hand opening.
- 12" or 18" wide lockers to be ganged or anchored for compliance with ANSI/BIFMA X5.6 storage standards.

ONE COLUMN LOCKERS, FOUR ROWS

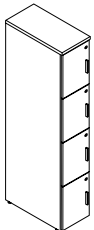

Left shown

One Column, Four Rows - 66.5/67" H

MODEL#	DIMENSIONS	FREIGHT CLASS	WT/LBS.	CUBIC FT.	1" TOP	1.5" TOP
ZL6612F14L	18 x 12 x 66.5-67	92.5	119	11.5	\$1749	\$1781
ZL6612L14L	24 x 12 x 66.5-67	100	149	15	\$1900	\$1938
ZL6612F14R	18 x 12 x 66.5-67	92.5	119	11.5	\$1749	\$1781
ZL6612L14R	24 x 12 x 66.5-67	100	149	15	\$1900	\$1938

- Select suffix **(L)** for **left** hand / **(R)** for **right** hand opening.
- 12" wide lockers to be ganged or anchored for compliance with ANSI/BIFMA X5.6 storage standards.

Required Specifications

Top Finish _____ Base Finish _____
 Door Finish _____
 Top/Edge Detail _____
 Handles _____

Optional Specifications

Key # _____

Accessories

TWO COLUMN LOCKERS, ONE ROW

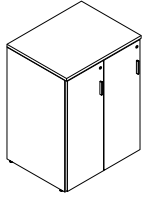

Left shown

Two Columns, One Row - 40.5/41" H

MODEL#	DIMENSIONS	FREIGHT CLASS	WT/LBS.	CUBIC FT.	1" TOP	1.5" TOP
D x W x H						
ZL4024F21L	18 x 24 x 40.5-41	100	118	13.25	\$1635	\$1695
ZL4030F21L	18 x 30 x 40.5-41	100	133	16.5	\$1767	\$1841
ZL4024L21L	24 x 24 x 40.5-41	100	149	17.25	\$1797	\$1865
ZL4030L21L	24 x 30 x 40.5-41	125	166	21.25	\$1937	\$2022
ZL4024F21R	18 x 24 x 40.5-41	100	118	13.25	\$1635	\$1695
ZL4030F21R	18 x 30 x 40.5-41	100	133	16.5	\$1767	\$1841
ZL4024L21R	24 x 24 x 40.5-41	100	149	17.25	\$1797	\$1865
ZL4030L21R	24 x 30 x 40.5-41	125	166	21.25	\$1937	\$2022

- Select suffix **(L)** for left hand / **(R)** for right hand opening. Includes coat hook in each opening

TWO COLUMN LOCKERS, TWO ROWS

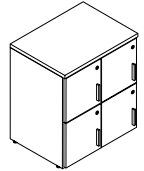

Left shown

Two Columns, Two Rows - 27.5/28" H

MODEL#	DIMENSIONS	FREIGHT CLASS	WT/LBS.	CUBIC FT.	1" TOP	1.5" TOP
ZL2724F22L	18 x 24 x 27.5-28	100	94	9.5	\$1520	\$1575
ZL2724F22R	18 x 24 x 27.5-28	100	94	9.5	\$1520	\$1575

- Select suffix **(L)** for left hand / **(R)** for right hand opening.

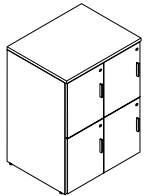

Left shown

Two Columns, Two Rows - 40.5/41" H

ZL4024F22L	18 x 24 x 40.5-41	100	125	13.25	\$1787	\$1842
ZL4030F22L	18 x 30 x 40.5-41	100	142	16.25	\$1937	\$2005
ZL4024L22L	24 x 24 x 40.5-41	100	158	17.25	\$1961	\$2029
ZL4030L22L	24 x 30 x 40.5-41	100	178	21.25	\$2123	\$2209
ZL4024F22R	18 x 24 x 40.5-41	100	125	13.25	\$1787	\$1842
ZL4030F22R	18 x 30 x 40.5-41	100	142	16.25	\$1937	\$2005
ZL4024L22R	24 x 24 x 40.5-41	100	158	17.25	\$1961	\$2029
ZL4030L22R	24 x 30 x 40.5-41	100	178	21.25	\$2123	\$2209

- Select suffix **(L)** for left hand / **(R)** for right hand opening.

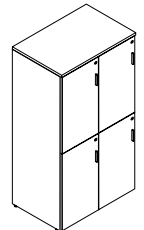

Left shown

Two Columns, Two Rows - 66.5/67" H

ZL6624F22L	18 x 24 x 66.5-67	100	187	21.25	\$2666	\$2721
ZL6636F22L	18 x 36 x 66.5-67	125	235	31	\$3131	\$3210
ZL6636L22L	24 x 36 x 66.5-67	125	283	40	\$3365	\$3462
ZL6624F22R	18 x 24 x 66.5-67	100	187	21.25	\$2666	\$2721
ZL6636F22R	18 x 36 x 66.5-67	125	235	31	\$3131	\$3210
ZL6636L22R	24 x 36 x 66.5-67	125	283	40	\$3365	\$3462

- Select suffix **(L)** for left hand / **(R)** for right hand opening. Includes coat hook in each opening and on each door.

Required Specifications

Top Finish _____ Base Finish _____
 Door Finish _____
 Top/Edge Detail _____
 Handles _____

Optional Specifications

Key # _____

Accessories

TWO COLUMN LOCKERS, THREE ROWS

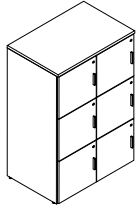

Left shown

Two Columns, Three Rows - 53.5/54" H

MODEL#	DIMENSIONS D x W x H	FREIGHT CLASS	WT/LBS.	CUBIC FT.	1" TOP	1.5" TOP
ZL5324F23L	18 x 24 x 53.5-54	100	163	17.25	\$2383	\$2444
ZL5330F23L	18 x 30 x 53.5-54	100	185	21.25	\$2587	\$2655
ZL5336F23L	18 x 36 x 53.5-54	100	207	25.25	\$2836	\$2921
ZL5324L23L	24 x 24 x 53.5-54	100	205	22.5	\$2607	\$2674
ZL5330L23L	24 x 30 x 53.5-54	100	230	27.5	\$2823	\$2909
ZL5336L23L	24 x 36 x 53.5-54	125	252	32.75	\$3075	\$3172
ZL5324F23R	18 x 24 x 53.5-54	100	163	17.25	\$2383	\$2444
ZL5330F23R	18 x 30 x 53.5-54	100	185	21.25	\$2587	\$2655
ZL5336F23R	18 x 36 x 53.5-54	100	207	25.25	\$2836	\$2921
ZL5324L23R	24 x 24 x 53.5-54	100	205	22.5	\$2607	\$2674
ZL5330L23R	24 x 30 x 53.5-54	100	230	27.5	\$2823	\$2909
ZL5336L23R	24 x 36 x 53.5-54	125	252	32.75	\$3075	\$3172

- Select suffix **(L)** for **left** hand / **(R)** for **right** hand.
- 12" or 18" wide lockers to be ganged or anchored for compliance with ANSI/BIFMA X5.6 storage standards.

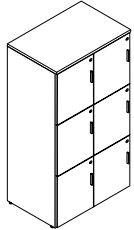

Left shown

Two Columns, Three Rows - 66.5/67" H

ZL6624F23L	18 x 24 x 66.5-67	100	194	21.25	\$2660	\$2715
ZL6630F23L	18 x 30 x 66.5-67	100	219	26	\$2889	\$2957
ZL6636F23L	18 x 36 x 66.5-67	125	246	31	\$3180	\$3265
ZL6624L23L	24 x 24 x 66.5-67	100	243	27.5	\$2908	\$2975
ZL6630L23L	24 x 30 x 66.5-67	100	271	33.75	\$3155	\$3234
ZL6636L23L	24 x 36 x 66.5-67	125	297	40	\$3438	\$3535
ZL6624F23R	18 x 24 x 66.5-67	100	194	21.25	\$2660	\$2715
ZL6630F23R	18 x 30 x 66.5-67	100	219	26	\$2889	\$2957
ZL6636F23R	18 x 36 x 66.5-67	125	246	31	\$3180	\$3265
ZL6624L23R	24 x 24 x 66.5-67	100	243	27.5	\$2908	\$2975
ZL6630L23R	24 x 30 x 66.5-67	100	271	33.75	\$3155	\$3234
ZL6636L23R	24 x 36 x 66.5-67	125	297	40	\$3438	\$3535

- Select suffix **(L)** for **left** hand / **(R)** for **right** hand.
- 12" or 18" wide lockers to be ganged or anchored for compliance with ANSI/BIFMA X5.6 storage standards.

TWO COLUMN LOCKERS, FOUR ROWS

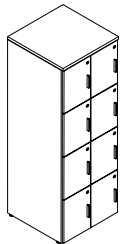

Left shown

Two Columns, Four Rows - 66.5/67" H

MODEL#	DIMENSIONS	FREIGHT CLASS	WT/LBS.	CUBIC FT.	1" TOP	1.5" TOP
ZL6624F24L	18 x 24 x 66.5-67	100	201	21.25	\$3010	\$3065
ZL6624L24L	24 x 24 x 66.5-67	100	252	27.5	\$3269	\$3343
ZL6624F24R	18 x 24 x 66.5-67	100	201	21.25	\$3010	\$3065
ZL6624L24R	24 x 24 x 66.5-67	100	252	27.5	\$3269	\$3343

- Select suffix **(L)** for **left** hand / **(R)** for **right** hand opening.

Required Specifications

Top Finish
Door Finish
Top/Edge Detail
Handles
Base Finish

Optional Specifications

Key #

Accessories

THREE COLUMN LOCKERS, ONE ROW

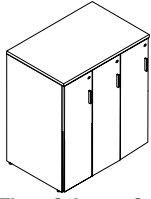

Left shown

Three Columns, One Row - 40.5/41" H

MODEL#	DIMENSIONS D x W x H	FREIGHT CLASS	WT/LBS.	CUBIC FT.	1" TOP	1.5" TOP
ZL4036F31L	18 x 36 x 40.5-41	100	165	19.5	\$2268	\$2354
ZL4036L31L	24 x 36 x 40.5-41	100	203	25.25	\$2455	\$2551
ZL4036F31R	18 x 36 x 40.5-41	100	165	19.5	\$2268	\$2354
ZL4036L31R	24 x 36 x 40.5-41	100	203	25.25	\$2455	\$2551

- Select suffix **(L)** for left hand / **(R)** for right hand opening. Includes coat hook in each opening

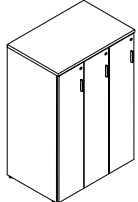

Left shown

Three Columns, One Row - 53.5/54" H

ZL5336F31L	18 x 36 x 53.5-54	100	215	25.25	\$2798	\$2884
ZL5336L31L	24 x 36 x 53.5-54	100	265	32.75	\$3070	\$3167
ZL5336F31R	18 x 36 x 53.5-54	100	215	25.25	\$2798	\$2884
ZL5336L31R	24 x 36 x 53.5-54	100	265	32.75	\$3070	\$3167

- Select suffix **(L)** for left hand / **(R)** for right hand opening. Includes hat shelf and coat hook in each opening.

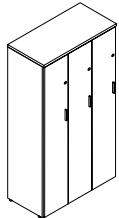

Left shown

Three Columns, One Row - 66.5/67" H

ZL6636F31L	18 x 36 x 66.5-67	100	258	31	\$3180	\$3259
ZL6636L31L	24 x 36 x 66.5-67	125	317	40	\$3480	\$3576
ZL6636F31R	18 x 36 x 66.5-67	100	258	31	\$3180	\$3259
ZL6636L31R	24 x 36 x 66.5-67	125	317	40	\$3480	\$3576

- Select suffix **(L)** for left hand / **(R)** for right hand opening. Includes hat shelf and coat hook in each opening.

THREE COLUMN LOCKERS, TWO ROWS

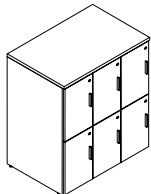

Left shown

Three Columns, Two Rows - 40.5/41" H

MODEL#	DIMENSIONS	FREIGHT CLASS	WT/LBS.	CUBIC FT.	1" TOP	1.5" TOP
ZL4036F32L	18 x 36 x 40.5-41	100	176	19.5	\$2492	\$2571
ZL4036L32L	24 x 36 x 40.5-41	100	218	25.25	\$2702	\$2798
ZL4036F32R	18 x 36 x 40.5-41	100	176	19.5	\$2492	\$2571
ZL4036L32R	24 x 36 x 40.5-41	100	218	25.25	\$2702	\$2798

- Select suffix **(L)** for left hand / **(R)** for right hand opening.

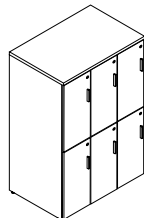

Left shown

Three Columns, Two Rows - 53.5/54" H

ZL5336F32L	18 x 36 x 53.5-54	100	219	25.25	\$3365	\$3444
ZL5336L32L	24 x 36 x 53.5-54	100	269	32.75	\$3613	\$3709
ZL5336F32R	18 x 36 x 53.5-54	100	219	25.25	\$3365	\$3444
ZL5336L32R	24 x 36 x 53.5-54	100	269	32.75	\$3613	\$3709

- Select suffix **(L)** for left hand / **(R)** for right hand opening. Includes coat hook in each opening and on each door.

Required Specifications

Top Finish _____ Base Finish _____
 Door Finish _____
 Top/Edge Detail _____
 Handles _____

Optional Specifications

Key # _____

Accessories

THREE COLUMN LOCKERS, TWO ROWS

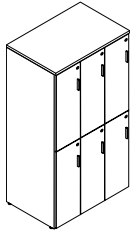

Left shown

Three Columns, Two Rows - 66.5/67"H

MODEL#	DIMENSIONS D x W x H	FREIGHT CLASS	WT/LBS.	CUBIC FT.	1"TOP	1.5" TOP
ZL6636F32L	18 x 36 x 66.5-67	100	262	31	\$3788	\$3867
ZL6636L32L	24 x 36 x 66.5-67	100	322	40	\$4083	\$4179
ZL6636F32R	18 x 36 x 66.5-67	100	262	31	\$3788	\$3867
ZL6636L32R	24 x 36 x 66.5-67	100	322	40	\$4083	\$4179

- Select suffix **(L)** for **left** hand / **(R)** for **right** hand opening. Includes coat hook in each opening and on each door.

THREE COLUMN LOCKERS, THREE ROWS

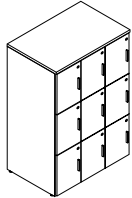

Left shown

Three Columns, Three Rows - 53.5/54"H

MODEL#	DIMENSIONS	FREIGHT CLASS	WT/LBS.	CUBIC FT.	1"TOP	1.5" TOP
ZL5336F33L	18 x 36 x 53.5-54	100	229	25.25	\$3360	\$3439
ZL5336L33L	24 x 36 x 53.5-54	100	283	32.75	\$3624	\$3721
ZL5336F33R	18 x 36 x 53.5-54	100	229	25.25	\$3360	\$3439
ZL5336L33R	24 x 36 x 53.5-54	100	283	32.75	\$3624	\$3721

- Select suffix **(L)** for **left** hand / **(R)** for **right** hand opening.

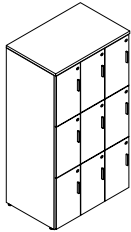

Left shown

Three Columns, Three Rows - 66.5/67"H

ZL6636F33L	18 x 36 x 66.5-67	100	272	31	\$3781	\$3860
ZL6636L33L	24 x 36 x 66.5-67	100	336	40	\$4101	\$4198
ZL6636F33R	18 x 36 x 66.5-67	100	272	31	\$3781	\$3860
ZL6636L33R	24 x 36 x 66.5-67	100	336	40	\$4101	\$4198

- Select suffix **(L)** for **left** hand / **(R)** for **right** hand opening.

Required Specifications

Top Finish _____ Base Finish _____
 Door Finish _____
 Top/Edge Detail _____
 Handles _____

Optional Specifications

Key # _____

Accessories