



bridges II connect share achieve

Our desire was to develop an environment for collaborative teamwork which would facilitate connection, or bridging of people and ideas. A set of components which would even serve as a catalyst, inviting team members out of their cocooned comfort zones and encouraging them to engage, co-create. With Bridges II you can develop an environment of collaborative teamwork through workspace configuration that enhances line communication and bridges people with a spectrum of ideas and interfaces. Bridges II features a set of components that facilitate communication and streamline interaction through product that efficiently adapts and creatively configures. The product focuses on advancing engagement and collaborative creation through quick adaptations necessary to meet the needs of a fast paced and ever changing work environment. With flexible building components, Bridges II fits numerous applications, from boardrooms to multi-person workstations. It is easy to customize and reconfigure to fit specific requirements.

Features and Benefits

- High performance thermally fused laminate tops are 1" thick
- High pressure laminate tops are 1-1/16" thick
- Flat 3mm edge profile on all sides
- Worksurfaces provided with pilot holes for alignment
- Numerous Power/Data accessories
- Interconnected storage units can form a spine to create space division, storage, cable management and worksurface support
- Leg Options:
 - Height adjustable round legs
 - Fixed height rectangular legs



Rectangular Leg

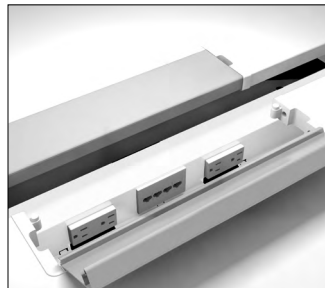

Power Trough



Round Leg

GENERAL INFORMATION**Flexible Building components**

- Single leg tables (freestanding or mobile)
- Training Rooms
- Boardrooms
- Libraries
- 1 person general and private office
- 2 person workstation
- 3 person workstation
- 6+ person workstation
- Storage spine-based workstation

Easy to customize and reconfigure to fit specific requirements. From the facility manager's perspective, all workstations can be standardized to form a linear worksurface and power/data services, and their respective function or purpose can be governed by the type, quantity and placement of adjacent components like dividers, storage cabinets, shelves and accessories. These adjacent components can be easily reconfigured with minimal down time - without having to invite electrical and IT crews.

Compatible with various environments

- Clean, simple, elegant design language, with finishes suggesting comfortable, even domestic flavor. Understated to designer combinations, like anodized aluminum and white, give a hint of subtle sophistication.

Choice of **two functionally and visually different leg** supports

- Casters or levelers
- Height adjustable round legs
- Fixed height rectangular legs
- Optional anodized aluminum finish (Rectangular legs only). Refer to individual models for upcharge.

Various **power/data delivery** levels to choose from

- Wire basket to organize cable access under worksurfaces and storage units
- Vertical cable manager integrated into rectangular leg
- Worksurface edge-mounted power/data units (easy to reconfigure, plug into wall/floor outlets), or power troughs
- Single-sided and double-sided below worksurface power/data trough (desktop/floor standing computers and office equipment)
- Worksurface access door (access to below worksurface power outlets and data terminals)
- Above worksurface power/data trough provides immediate access for laptops, tablets and phones
- Storage integrated power/data unit
- Horizontal cable management under storage units with optional wire basket

Interconnected storage units can form a spine to create space division, storage, cable management and worksurface support. Storage leg can be configured to act as a ganging bracket.

- For environmental certifications, please visit globalfurnituregroup.com.

B BRIDGES II™ - NOTES

WORKSURFACES

- Standard in high performance thermally fused laminate. Optional high pressure (HP) laminate available.
- High performance thermally fused laminate tops are 1" thick particle board and have a flat 3mm edge profile on all sides
- High pressure (HP) laminate tops are 1-1/16" thick laminate particle board and have a flat 3mm edge profile on all sides
- Laminate surfaces offer a selection of matching + coordinating edgeband. Specify separately from the surface finish.



- Products specified with the high pressure laminate option are finished on the underside of the surface with a kraft paper backing.
- Doors and Drawer Fronts feature a matching 3mm edge. All other surfaces feature a matching self edge.

TABLES

- All multiple linear workstations are standard with levelers
- Tops square for flush surface-to-surface abutment and to accept desk mounted accessories
- Worksurfaces provided with pilot holes for alignment purposes

CODES

- This price list uses a numbering system with meaningful alphanumeric characters to create a simple-to-understand product number. This makes specifying the product much easier and more accurate.

Example of a worksurface:

Product code: BRTWS2472AWC + HP

BRT = Bridges II

WS = Type of Worksurface

2472 = Size: Depth x Width

AWC = High Pressure Laminate

HP = Finish

RECTANGULAR LEG

- For single and shared worksurface support
- Bridges II Rectangular legs are available with: Locking Casters (**BRTLCS**) or Levelers (**BRTLVS**)

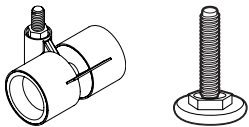

- Casters and Levelers **CANNOT** be retrofitted
- Levelers have a 2" height range, with 5/16" thread
- Levelers are available in Black only
- Casters are 45mm high with 8mm thread, available in White body / Grey tire combination only
- Leg frame is offered in 8 standard paint finishes and anodized aluminum finish
- Paint finish is a durable, environmentally friendly epoxy powder coating
- When anodized finish is selected, crossbeam is always White

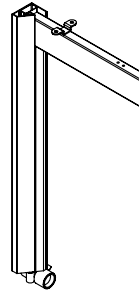

ROUND LEG

- For single and shared worksurface support
- Tubular steel legs are adjustable in 1" increments
- Height adjustment allows the user to easily set the height of a table
- Legs have a height adjustment of 24" - 32" in 1" increments with levelers and 27" - 35" with casters
- Bridges II Round legs are available with: Locking Casters (**BRTLCS**) or Levelers (**BRTLVR**)

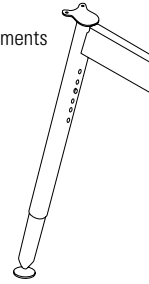
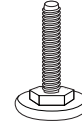

- Casters and Levelers CAN be retrofitted
- Levelers have a 1" height range, with 3/8-16" thread
- Levelers are available in Chrome only
- Casters available in Tungsten/Black combination only
- Casters are 3" diameter with an overall height of 3 3/4" with 3/8-16" thread
- Inner legs are available in Chrome only
- Leg frame is offered in 8 standard paint finishes
- Paint finish is a durable, environmentally friendly epoxy powder coating

FINISHES

Metal Frame Finishes:

BLK	Black
CHR	Charcoal
DWT	Designer White
FOG	Fog
NEV	Nevada
SIL	Silver
TPE	Taupe
TUN	Tungsten
ANO*	Anodized Aluminum - Upcharge applies. Refer to models for upcharge.

*ANO is a process, not a paint finish.

Laminate Top Finishes:

ACJ	Absolute Acajou
ASN	Asian Night
AWC	Avant Cherry
AWH	Avant Honey
BLK	Black - Coordinates with BLK Metal Frame Finish
BZD	Blizzard
BRC	Brushed Cobalt - Coordinates with TUN Metal Frame Finish
CMB	Clear Maple
CGY	Custom Grey - Coordinates with SIL Metal Frame Finish
DES	Dark Espresso
DWT	Designer White - Coordinates with DWT Metal Frame Finish
FAS	Fashionista
FCL	First Class
NBL	Noce Biondo
NGL	Noce Grigio
NEL	Noce Leggero
NML	Noce Medio
QTM	Quartered Mahogany
SBY	Sheer Beauty
SDT	Stonedust
SOG	Storm Grey - Coordinates with CHR Metal Frame Finish
STG	String - Coordinates with NEV Metal Frame Finish
WHE	Walnut Heights
WHC	White Chocolate
WCR	Winter Cherry

Edgeband Finishes:

AAE	Absolute Acajou
ASE	Asian Night
ACE	Avant Cherry
AHE	Avant Honey
BLK	Black
BRC	Brushed Cobalt
BZD	Blizzard
CHR	Charcoal (<i>use w/SOG</i>)
CGY	Custom Grey -
CME	Clear Maple
DEE	Dark Espresso
DWE	Designer White
FAS	Fashionista
FCL	First Class
NEV	Nevada (<i>use w/STG</i>)
QTM	Quartered Mahogany
SBY	Sheer Beauty
SIL	Silver
SDT	Stonedust
TPE	Taupe
WHE	Walnut Heights
CBE	White Chocolate
WCE	Winter Cherry

Chassis/Accent Finishes:

ACJ	Absolute Acajou
ASN	Asian Night
AWC	Avant Cherry
AWH	Avant Honey
BLK	Black - Coordinates with BLK Metal Frame Finish
BRC	Brushed Cobalt - Coordinates with TUN Metal Frame Finish
BZD	Blizzard
CGY	Custom Grey - Coordinates with SIL Metal Frame Finish
CMB	Clear Maple
DES	Dark Espresso
DWT	Designer White - Coordinates with DWT Metal Frame Finish
FAS	Fashionista
FCL	First Class
NBL	Noce Biondo
NGL	Noce Grigio
NEL	Noce Leggero
NML	Noce Medio
QTM	Quartered Mahogany
SBY	Sheer Beauty
SOG	Storm Grey - Coordinates with CHR Metal Frame Finish
SDT	Stonedust
STG	String - Coordinates with NEV Metal Frame Finish
WHC	White Chocolate
WHE	Walnut Heights
WCR	Winter Cherry

Metal Beam Finishes:

BLK	Black
CHR	Charcoal
DWT	Designer White
FOG	Fog
NEV	Nevada
SIL	Silver
TPE	Taupe
TUN	Tungsten

FABRIC TABLE DIVIDERS / SEAT PRIVACY PARTITIONS

Bridges II Fabric Table Dividers are available in: **Anchorage, Lola, Merge**

COLLABORATIVE SEATING

- All standard seating fabrics and grades apply.

30"W UNITS STORAGE CAPACITY CHART

Side to Side

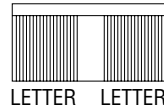

Side to Side Letter/Front to Back Legal

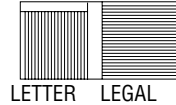
**36"W UNITS STORAGE CAPACITY CHART**

Side to Side Letter

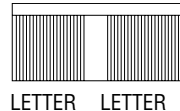

Side to Side Legal

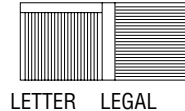

Side to Side Letter/Front to Back Legal

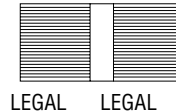

RECTANGULAR LEG PACKAGES

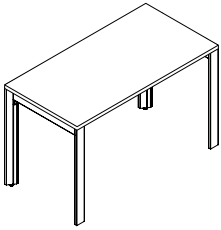

Single Line 1 Person Pod with Levelers

MODEL#	DIMENSIONS	FREIGHT CLASS	WT/LBS.	CUBIC FT.	LIST PRICE	HP ADD
	D x W x H					
BRTS1P2484L	24 x 84 x 29	70	75	4.92	\$1584	\$154
BRTS1P2478L	24 x 78 x 29	85	72	4.82	\$1538	\$148
BRTS1P2472L	24 x 72 x 29	85	69	4.73	\$1484	\$153
BRTS1P2466L	24 x 66 x 29	85	66	4.65	\$1468	\$136
BRTS1P2463L	24 x 62.5 x 29	85	63	4.57	\$1457	\$132
BRTS1P2460L	24 x 60 x 29	85	60	4.48	\$1441	\$131
BRTS1P2454L	24 x 54 x 29	85	57	4.4	\$1391	\$114
BRTS1P2451L	24 x 50.5 x 29	85	54	4.3	\$1353	\$109
BRTS1P2448L	24 x 48 x 29	85	51	4.2	\$1317	\$104
BRTS1P2442L	24 x 42 x 29	92.5	48	4.1	\$1260	\$85
BRTS1P2436L	24 x 36 x 29	92.5	45	4	\$1181	\$73
BRTS1P3084L	30 x 84 x 29	70	84	5.2	\$1661	\$165
BRTS1P3078L	30 x 78 x 29	70	81	5.1	\$1597	\$153
BRTS1P3072L	30 x 72 x 29	70	78	5.01	\$1559	\$151
BRTS1P3066L	30 x 66 x 29	70	75	4.9	\$1522	\$145
BRTS1P3063L	30 x 62.5 x 29	70	72	4.8	\$1510	\$140
BRTS1P3060L	30 x 60 x 29	85	69	4.73	\$1495	\$136
BRTS1P3054L	30 x 54 x 29	85	66	4.6	\$1461	\$113
BRTS1P3051L	30 x 50.5 x 29	85	63	4.5	\$1434	\$119
BRTS1P3048L	30 x 48 x 29	85	60	4.41	\$1410	\$114
BRTS1P3042L	30 x 42 x 29	85	57	4.3	\$1379	\$112
BRTS1P3036L	30 x 36 x 29	85	54	4.2	\$1274	\$77

Single Line Table Assemblies consist of one worksurface, two leg assemblies, and one supporting structural beam.

- Anodized Aluminum Leg - Add **\$154**. list upcharge

Required Specifications

Top finish
Edge finish
Metal finish (legs)
Beam finish

Optional Specifications

Anodized Aluminum Leg
HP laminate

RECTANGULAR LEG PACKAGES

MODEL#	DIMENSIONS	FREIGHT CLASS	WT/LBS.	CUBIC FT.	LIST PRICE	HP ADD
	D x W x H					
BRTS1P2484C	24 x 84 x 29	70	75	4.92	\$1661	\$154
BRTS1P2478C	24 x 78 x 29	85	72	4.82	\$1615	\$148
BRTS1P2472C	24 x 72 x 29	85	69	4.73	\$1571	\$145
BRTS1P2466C	24 x 66 x 29	85	66	4.65	\$1546	\$136
BRTS1P2463C	24 x 62.5 x 29	85	63	4.57	\$1533	\$132
BRTS1P2460C	24 x 60 x 29	85	60	4.48	\$1520	\$131
BRTS1P2454C	24 x 54 x 29	85	57	4.4	\$1468	\$114
BRTS1P2451C	24 x 50.5 x 29	85	54	4.3	\$1432	\$109
BRTS1P2448C	24 x 48 x 29	85	51	4.2	\$1394	\$104
BRTS1P2442C	24 x 42 x 29	92.5	48	4.1	\$1335	\$85
BRTS1P2436C	24 x 36 x 29	92.5	45	4	\$1261	\$73
BRTS1P3084C	30 x 84 x 29	70	84	5.2	\$1753	\$153
BRTS1P3078C	30 x 78 x 29	70	81	5.1	\$1674	\$153
BRTS1P3072C	30 x 72 x 29	70	78	5.01	\$1636	\$129
BRTS1P3066C	30 x 66 x 29	70	75	4.9	\$1600	\$145
BRTS1P3063C	30 x 62.5 x 29	70	72	4.8	\$1588	\$140
BRTS1P3060C	30 x 60 x 29	85	69	4.73	\$1572	\$136
BRTS1P3054C	30 x 54 x 29	85	66	4.6	\$1539	\$113
BRTS1P3051C	30 x 50.5 x 29	85	63	4.5	\$1512	\$119
BRTS1P3048C	30 x 48 x 29	85	60	4.41	\$1487	\$114
BRTS1P3042C	30 x 42 x 29	85	57	4.3	\$1458	\$112
BRTS1P3036C	30 x 36 x 29	85	54	4.2	\$1352	\$77

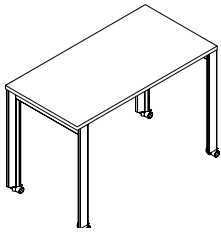

Single Line 1 Person Pod with Casters

Single Line Table Assemblies consist of one worksurface, two leg assemblies, and one supporting structural beam. 40mm white locking casters with grey tires; steel horizontal beams, aluminum legs.

- Anodized Aluminum Leg - Add **\$154**. list upcharge

Required Specifications

Top finish
Edge finish
Metal finish (legs)
Beam finish

Optional Specifications

Anodized Aluminum Leg
HP laminate

RECTANGULAR LEG PACKAGES

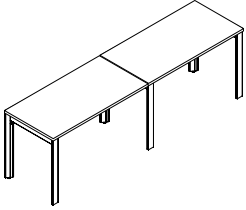

Single Line 2 Person Pod with Levelers

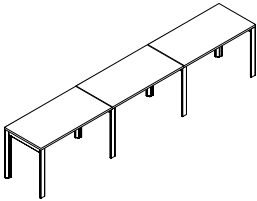

Single Line 3 Person Pod with Levelers

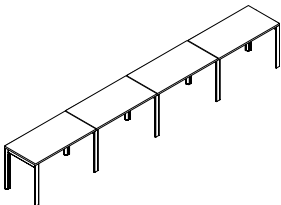

Single Line 4 Person Pod with Levelers

MODEL#	DIMENSIONS D x W x H	FREIGHT CLASS	WT/LBS.	CUBIC FT.	LIST PRICE	HP ADD
BRTS2P2484L	24 x 168 x 29	70	149	7.41	\$2775	\$306
BRTS2P2478L	24 x 156 x 29	70	140	7.27	\$2681	\$291
BRTS2P2472L	24 x 144 x 29	70	131	7.13	\$2598	\$283
BRTS2P2466L	24 x 132 x 29	70	122	6.95	\$2543	\$267
BRTS2P2460L	24 x 120 x 29	70	113	6.71	\$2488	\$260
BRTS2P2454L	24 x 108 x 29	70	104	6.45	\$2386	\$226
BRTS2P2448L	24 x 96 x 29	70	95	6.21	\$2240	\$203
BRTS2P3084L	30 x 168 x 29	70	173	8.25	\$2911	\$329
BRTS2P3078L	30 x 156 x 29	70	164	7.97	\$2783	\$303
BRTS2P3072L	30 x 144 x 29	70	155	7.69	\$2725	\$294
BRTS2P3066L	30 x 132 x 29	70	140	7.41	\$2633	\$283
BRTS2P3060L	30 x 120 x 29	70	131	7.13	\$2581	\$267
BRTS2P3054L	30 x 108 x 29	70	122	6.85	\$2507	\$226
BRTS2P3048L	30 x 96 x 29	70	113	6.57	\$2406	\$226
BRTS3P2484L	24 x 252 x 29	70	219	9.74	\$3969	\$457
BRTS3P2478L	24 x 234 x 29	70	206	9.53	\$3828	\$434
BRTS3P2472L	24 x 216 x 29	70	192	9.32	\$3701	\$423
BRTS3P2466L	24 x 198 x 29	70	179	9.11	\$3617	\$401
BRTS3P2460L	24 x 180 x 29	70	165	8.89	\$3539	\$368
BRTS3P2454L	24 x 162 x 29	70	152	8.68	\$3386	\$335
BRTS3P2448L	24 x 144 x 29	70	138	8.47	\$3165	\$301
BRTS3P3084L	30 x 252 x 29	65	263	11.59	\$4163	\$492
BRTS3P3078L	30 x 234 x 29	70	246	11.16	\$3970	\$454
BRTS3P3072L	30 x 216 x 29	70	229	10.72	\$3854	\$442
BRTS3P3066L	30 x 198 x 29	70	212	10.3	\$3743	\$423
BRTS3P3060L	30 x 180 x 29	70	195	9.87	\$3666	\$401
BRTS3P3054L	30 x 162 x 29	70	178	9.44	\$3557	\$335
BRTS3P3048L	30 x 144 x 29	70	161	9.01	\$3406	\$335
BRTS4P2484L	24 x 336 x 29	70	291	13.67	\$5157	\$610
BRTS4P2478L	24 x 312 x 29	70	273	13.18	\$4972	\$578
BRTS4P2472L	24 x 288 x 29	70	254	12.69	\$4832	\$571
BRTS4P2466L	24 x 264 x 29	70	236	12.2	\$4693	\$532
BRTS4P2460L	24 x 240 x 29	70	217	11.71	\$4585	\$516
BRTS4P2454L	24 x 216 x 29	70	199	11.22	\$4384	\$446
BRTS4P2448L	24 x 192 x 29	70	180	10.73	\$4089	\$401
BRTS4P3084L	30 x 336 x 29	65	345	14.87	\$5410	\$655
BRTS4P3078L	30 x 312 x 29	65	323	14.3	\$5155	\$600
BRTS4P3072L	30 x 288 x 29	70	301	13.73	\$5001	\$586
BRTS4P3066L	30 x 264 x 29	70	279	13.16	\$4854	\$561
BRTS4P3060L	30 x 240 x 29	70	257	12.59	\$4754	\$532
BRTS4P3054L	30 x 216 x 29	70	235	12.02	\$4605	\$446
BRTS4P3048L	30 x 192 x 29	70	213	11.45	\$4404	\$446

Single Line 2 Person workstation consists of two worksurfaces, three leg assemblies, and two supporting structural beams. One leg can be shared by 2 adjoining worksurfaces.

- Anodized Aluminum Leg - Add **\$228.** list upcharge

Single Line 3 Person workstation consists of three worksurfaces, four leg assemblies, and three supporting structural beams. One leg can be shared by 2 adjoining worksurfaces.

- Anodized Aluminum Leg - Add **\$305.** list upcharge

Single Line 4 Person workstation consists of four worksurfaces, five leg assemblies, and four supporting structural beams. One leg can be shared by 2 adjoining worksurfaces.

- Anodized Aluminum Leg - Add **\$382.** list upcharge

Required Specifications

Top finish
Edge finish
Metal finish (legs)
Beam finish

Optional Specifications

Anodized Aluminum Leg
HP laminate

RECTANGULAR LEG PACKAGES

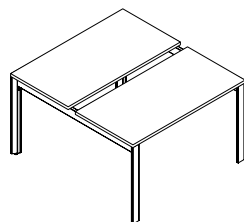

Back-to-Back 2 Person Pod with Levelers

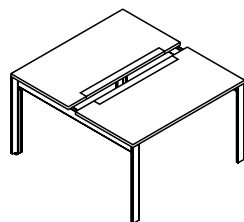

Back-to-Back 2 Person Pod with Access Door and Levelers

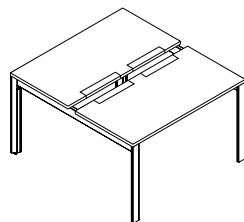

Back-to-Back 2 Person Pod with Access Doors and Levelers

MODEL#	DIMENSIONS D x W x H	FREIGHT CLASS	WT/LBS.	CUBIC FT.	LIST PRICE	HP ADD
BRTBAR2P2484L	50.5 x 84 x 29	70	146	9.4	\$2621	\$306
BRTBAR2P2478L	50.5 x 78 x 29	85	137	9.2	\$2526	\$291
BRTBAR2P2472L	50.5 x 72 x 29	85	128	9.02	\$2442	\$283
BRTBAR2P2466L	50.5 x 66 x 29	85	119	8.76	\$2386	\$267
BRTBAR2P2460L	50.5 x 60 x 29	85	110	8.56	\$2335	\$260
BRTBAR2P3084L	62.5 x 84 x 29	70	174	10.4	\$2699	\$329
BRTBAR2P3078L	62.5 x 78 x 29	70	163	9.8	\$2579	\$291
BRTBAR2P3072L	62.5 x 72 x 29	70	152	9.54	\$2496	\$291
BRTBAR2P3066L	62.5 x 66 x 29	70	141	9.25	\$2420	\$283
BRTBAR2P3060L	62.5 x 60 x 29	85	130	9	\$2368	\$267

Back-to-back 2 Person workstation consists of two worksurfaces, two back-to-back leg assemblies, and two supporting structural beams.

- Anodized Aluminum Leg - Add **\$154**. list upcharge

BRTBAR2PA2484L	50.5 x 84 x 29	70	146	9.4	\$2755	\$547
BRTBAR2PA2478L	50.5 x 78 x 29	85	137	9.2	\$2678	\$489
BRTBAR2PA2472L	50.5 x 72 x 29	85	128	9.02	\$2621	\$469
BRTBAR2PA2466L	50.5 x 66 x 29	85	119	8.76	\$2524	\$411
BRTBAR2PA2460L	50.5 x 60 x 29	85	110	8.56	\$2427	\$372
BRTBAR2PA3084L	62.5 x 84 x 29	70	174	10.4	\$3008	\$664
BRTBAR2PA3078L	62.5 x 78 x 29	70	163	9.8	\$2911	\$625
BRTBAR2PA3072L	62.5 x 72 x 29	70	152	9.54	\$2853	\$568
BRTBAR2PA3066L	62.5 x 66 x 29	70	141	9.25	\$2755	\$508
BRTBAR2PA3060L	62.5 x 60 x 29	85	130	9	\$2621	\$469

Back-to-back 2 Person workstation consists of two worksurfaces, two back-to-back leg assemblies, and two supporting structural beams. Anodized aluminum worksurface door provides access to power/data trough below worksurface. Worksurface with access doors CANNOT be combined with above worksurface power trough.

- Anodized Aluminum Leg - Add **\$154**. list upcharge

BRTBAR2PDA2484L	50.5 x 84 x 29	70	146	9.4	\$2973	\$586
BRTBAR2PDA2478L	50.5 x 78 x 29	85	137	9.2	\$2890	\$525
BRTBAR2PDA2472L	50.5 x 72 x 29	85	128	9.02	\$2827	\$504
BRTBAR2PDA2466L	50.5 x 66 x 29	85	119	8.76	\$2724	\$442
BRTBAR2PDA2460L	50.5 x 60 x 29	85	110	8.56	\$2620	\$399
BRTBAR2PDA3084L	62.5 x 84 x 29	70	174	10.4	\$3244	\$712
BRTBAR2PDA3078L	62.5 x 78 x 29	70	163	9.8	\$3140	\$670
BRTBAR2PDA3072L	62.5 x 72 x 29	70	152	9.54	\$3079	\$607
BRTBAR2PDA3066L	62.5 x 66 x 29	70	141	9.25	\$2973	\$542
BRTBAR2PDA3060L	62.5 x 60 x 29	85	130	9	\$2827	\$504

Back-to-back 2 Person workstation consists of two worksurfaces, two back-to-back leg assemblies, and two supporting structural beams. These tables feature dual access doors providing a central connection point for monitor lifts. Anodized aluminum worksurface door provides access to power/data trough below worksurface. Worksurface with access doors CANNOT be combined with above worksurface power trough.

- Anodized Aluminum Leg - Add **\$154**. list upcharge

Required Specifications

Top finish
Edge finish
Metal finish (legs)
Beam finish

Optional Specifications

Anodized Aluminum Leg
HP laminate

RECTANGULAR LEG PACKAGES

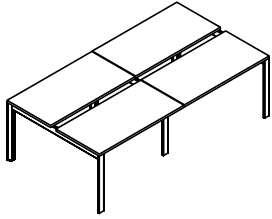

Back-to-Back 4 Person Pod with Levelers

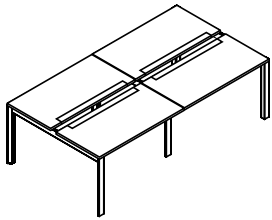

Back-to-Back 4 Person Pod with Access Door and Levelers

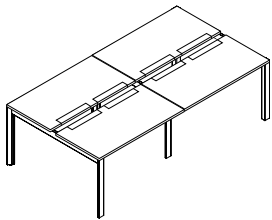

Back-to-Back 4 Person Pod with Access Door and Levelers

MODEL#	DIMENSIONS D x W x H	FREIGHT CLASS	WT/LBS.	CUBIC FT.	LIST PRICE	HP ADD
BRTBAR4P2484L	50.5 x 168 x 29	70	272	15.66	\$4693	\$610
BRTBAR4P2478L	50.5 x 156 x 29	70	256	15.2	\$4507	\$578
BRTBAR4P2472L	50.5 x 144 x 29	70	240	14.74	\$4339	\$561
BRTBAR4P2466L	50.5 x 132 x 29	70	224	14.28	\$4229	\$532
BRTBAR4P2460L	50.5 x 120 x 29	70	208	13.82	\$4120	\$516
BRTBAR4P3084L	62.5 x 168 x 29	70	333	16.86	\$4888	\$655
BRTBAR4P3078L	62.5 x 156 x 29	70	313	16.32	\$4631	\$600
BRTBAR4P3072L	62.5 x 144 x 29	70	293	15.78	\$4476	\$586
BRTBAR4P3066L	62.5 x 132 x 29	70	273	15.24	\$4330	\$561
BRTBAR4P3060L	62.5 x 120 x 29	70	253	14.7	\$4229	\$532

Back-to-back 4 Person workstation consists of four worksurfaces, two back-to-back outer leg assemblies, 1 back-to-back narrow leg assembly, and four supporting structural beams.

- Anodized Aluminum Leg - Add **\$228**. list upcharge

BRTBAR4PA2484L	50.5 x 168 x 29	70	272	15.66	\$4965	\$1091
BRTBAR4PA2478L	50.5 x 156 x 29	70	256	15.2	\$4810	\$972
BRTBAR4PA2472L	50.5 x 144 x 29	70	240	14.74	\$4693	\$933
BRTBAR4PA2466L	50.5 x 132 x 29	70	224	14.28	\$4499	\$819
BRTBAR4PA2460L	50.5 x 120 x 29	70	208	13.82	\$4305	\$742
BRTBAR4PA3084L	62.5 x 168 x 29	70	333	16.86	\$5430	\$1320
BRTBAR4PA3078L	62.5 x 156 x 29	70	313	16.32	\$5236	\$1243
BRTBAR4PA3072L	62.5 x 144 x 29	70	293	15.78	\$5122	\$1129
BRTBAR4PA3066L	62.5 x 132 x 29	70	273	15.24	\$4926	\$1012
BRTBAR4PA3060L	62.5 x 120 x 29	70	253	14.7	\$4656	\$933

Back-to-back 4 Person workstation consists of four worksurfaces, two back-to-back outer leg assemblies, 1 back-to-back narrow leg assembly, and four supporting structural beams. Anodized aluminum worksurface door provides access to power/data trough below worksurface. Worksurface with access doors CANNOT be combined with above worksurface power trough.

- Anodized Aluminum Leg - Add **\$228**. list upcharge

BRTBAR4PDA2484L	50.5 x 168 x 29	70	272	15.66	\$5357	\$1171
BRTBAR4PDA2478L	50.5 x 156 x 29	70	256	15.2	\$5189	\$1044
BRTBAR4PDA2472L	50.5 x 144 x 29	70	240	14.74	\$5063	\$1005
BRTBAR4PDA2466L	50.5 x 132 x 29	70	224	14.28	\$4857	\$875
BRTBAR4PDA2460L	50.5 x 120 x 29	70	208	13.82	\$4644	\$794
BRTBAR4PDA3084L	62.5 x 168 x 29	70	333	16.86	\$5860	\$1418
BRTBAR4PDA3078L	62.5 x 156 x 29	70	313	16.32	\$5649	\$1337
BRTBAR4PDA3072L	62.5 x 144 x 29	70	293	15.78	\$5525	\$1210
BRTBAR4PDA3066L	62.5 x 132 x 29	70	273	15.24	\$5315	\$1087
BRTBAR4PDA3060L	62.5 x 120 x 29	70	253	14.7	\$5024	\$1001

Back-to-back 4 Person workstation consists of four worksurfaces, two back-to-back outer leg assemblies, 1 back-to-back narrow leg assembly, and four supporting structural beams. These tables feature dual access doors providing a central connection point for monitor lifts. Anodized aluminum worksurface door provides access to power/data trough below worksurface. Worksurface with access doors CANNOT be combined with above worksurface power trough.

- Anodized Aluminum Leg - Add **\$228**. list upcharge

Required Specifications

Top finish
Edge finish
Metal finish (legs)
Beam finish

Optional Specifications

Anodized Aluminum Leg
HP laminate

RECTANGULAR LEG PACKAGES

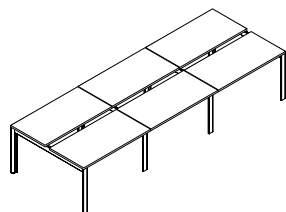

Back-to-Back 6 Person Pod with Levelers

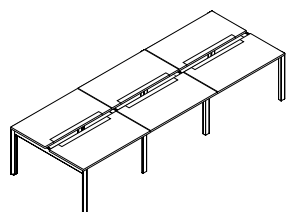

Back-to-Back 6 Person Pod with Access Door and Levelers

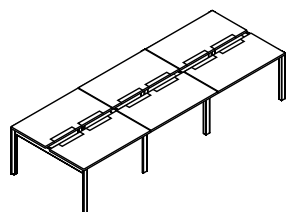

Back-to-Back 6 Person Pod with Access Door and Levelers

MODEL# DIMENSIONS FREIGHT CLASS WT/LBS. CUBIC FT. LIST PRICE HP ADD

	D x W x H						
BRTBAR6P2484L	50.5 x 252 x 29	70	434	22.88	\$6768	\$910	
BRTBAR6P2478L	50.5 x 234 x 29	70	409	22.1	\$6487	\$865	
BRTBAR6P2472L	50.5 x 216 x 29	70	359	21.32	\$6233	\$843	
BRTBAR6P2466L	50.5 x 198 x 29	70	329	20.54	\$6070	\$795	
BRTBAR6P2460L	50.5 x 180 x 29	70	308	19.76	\$5869	\$770	
BRTBAR6P3084L	62.5 x 252 x 29	70	493	24.53	\$7040	\$982	
BRTBAR6P3078L	62.5 x 234 x 29	70	462	23.75	\$6655	\$899	
BRTBAR6P3072L	62.5 x 216 x 29	70	431	22.86	\$6424	\$877	
BRTBAR6P3066L	62.5 x 198 x 29	70	400	21.97	\$6201	\$843	
BRTBAR6P3060L	62.5 x 180 x 29	70	369	21.08	\$6012	\$795	

Back-to-back 6 Person workstation consists of six worksurfaces, two back-to-back outer leg assemblies, two back-to-back narrow leg assemblies, and six supporting structural beams.

- Anodized Aluminum Leg - Add **\$305.** list upcharge

BRTBAR6PA2484L	50.5 x 252 x 29	70	434	22.88	\$7176	\$1633	
BRTBAR6PA2478L	50.5 x 234 x 29	70	409	22.1	\$6944	\$1458	
BRTBAR6PA2472L	50.5 x 216 x 29	70	359	21.32	\$6768	\$1399	
BRTBAR6PA2466L	50.5 x 198 x 29	70	329	20.54	\$6477	\$1225	
BRTBAR6PA2460L	50.5 x 180 x 29	70	308	19.76	\$6148	\$1107	
BRTBAR6PA3084L	62.5 x 252 x 29	70	493	24.53	\$7854	\$1980	
BRTBAR6PA3078L	62.5 x 234 x 29	70	462	23.75	\$7563	\$1865	
BRTBAR6PA3072L	62.5 x 216 x 29	70	431	22.86	\$7388	\$1690	
BRTBAR6PA3066L	62.5 x 198 x 29	70	400	21.97	\$7098	\$1516	
BRTBAR6PA3060L	62.5 x 180 x 29	70	369	21.08	\$6652	\$1399	

Back-to-back 6 Person workstation consists of six worksurfaces, two back-to-back outer leg assemblies, two back-to-back narrow leg assemblies, and six supporting structural beams. Anodized aluminum worksurface door provides access to power/data trough below worksurface. Worksurface with access doors CANNOT be combined with above worksurface power trough.

- Anodized Aluminum Leg - Add **\$305.** list upcharge

BRTBAR6PDA2484L	50.5 x 252 x 29	70	434	22.88	\$7742	\$1748	
BRTBAR6PDA2478L	50.5 x 234 x 29	70	409	22.1	\$7491	\$1566	
BRTBAR6PDA2472L	50.5 x 216 x 29	70	359	21.32	\$7303	\$1505	
BRTBAR6PDA2466L	50.5 x 198 x 29	70	329	20.54	\$6988	\$1256	
BRTBAR6PDA2460L	50.5 x 180 x 29	70	308	19.76	\$6632	\$1191	
BRTBAR6PDA3084L	62.5 x 252 x 29	70	493	24.53	\$8475	\$2128	
BRTBAR6PDA3078L	62.5 x 234 x 29	70	462	23.75	\$8158	\$2001	
BRTBAR6PDA3072L	62.5 x 216 x 29	70	431	22.86	\$7971	\$1813	
BRTBAR6PDA3066L	62.5 x 198 x 29	70	400	21.97	\$7656	\$1625	
BRTBAR6PDA3060L	62.5 x 180 x 29	70	369	21.08	\$7178	\$1502	

Back-to-back 6 Person workstation consists of six worksurfaces, two back-to-back outer leg assemblies, two back-to-back narrow leg assemblies, and six supporting structural beams. These tables feature dual access doors providing a central connection point for monitor lifts. Anodized aluminum worksurface door provides access to power/data trough below worksurface. Worksurface with access doors CANNOT be combined with above worksurface power trough.

- Anodized Aluminum Leg - Add **\$305.** list upcharge

Required Specifications

Top finish
Edge finish
Metal finish (legs)
Beam finish

Optional Specifications

Anodized Aluminum Leg
HP laminate

RECTANGULAR LEG PACKAGES

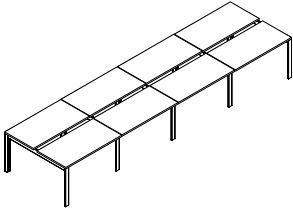

Back-to-Back 8 Person Pod with Levelers

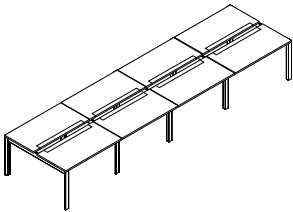

Back-to-Back 8 Person Pod with Access Door and Levelers

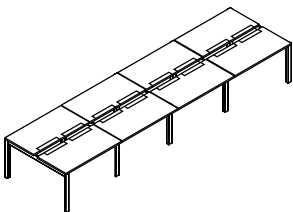

Back-to-Back 8 Person Pod with Access Door and Levelers

MODEL#	DIMENSIONS D x W x H	FREIGHT CLASS	WT./LBS.	CUBIC FT.	LIST PRICE	HP ADD
BRTBAR8P2484L	50.5 x 336 x 29	70	556	28.30	\$8842	\$1215
BRTBAR8P2478L	50.5 x 312 x 29	70	520	27.30	\$8470	\$1151
BRTBAR8P2472L	50.5 x 288 x 29	70	484	26.30	\$8128	\$1120
BRTBAR8P2466L	50.5 x 264 x 29	70	448	25.30	\$7912	\$1058
BRTBAR8P2460L	50.5 x 240 x 29	70	412	24.42	\$7732	\$1027
BRTBAR8P3084L	62.5 x 336 x 29	70	669	30.58	\$9190	\$1308
BRTBAR8P3078L	62.5 x 312 x 29	70	625	29.48	\$8678	\$1197
BRTBAR8P3072L	62.5 x 288 x 29	70	581	28.38	\$8370	\$1166
BRTBAR8P3066L	62.5 x 264 x 29	70	536	27.28	\$8074	\$1120
BRTBAR8P3060L	62.5 x 240 x 29	70	492	26.18	\$7871	\$1058

Back-to-back 8 Person workstation consists of eight worksurfaces, two back-to-back outer leg assemblies, three back-to-back narrow leg assemblies, and eight supporting structural beams.

- Anodized Aluminum Leg - Add **\$382**. list upcharge

BRTBAR8PA2484L	50.5 x 336 x 29	70	556	28.30	\$9383	\$2174
BRTBAR8PA2478L	50.5 x 312 x 29	70	520	27.30	\$9073	\$1941
BRTBAR8PA2472L	50.5 x 288 x 29	70	484	26.30	\$8842	\$1865
BRTBAR8PA2466L	50.5 x 264 x 29	70	448	25.30	\$8453	\$1633
BRTBAR8PA2460L	50.5 x 240 x 29	70	412	24.42	\$8106	\$1476
BRTBAR8PA3084L	62.5 x 336 x 29	70	669	30.58	\$10277	\$2639
BRTBAR8PA3078L	62.5 x 312 x 29	70	625	29.48	\$9886	\$2484
BRTBAR8PA3072L	62.5 x 288 x 29	70	581	28.38	\$9655	\$2252
BRTBAR8PA3066L	62.5 x 264 x 29	70	536	27.28	\$9268	\$2019
BRTBAR8PA3060L	62.5 x 240 x 29	70	492	26.18	\$8725	\$1865

Back-to-back 8 Person workstation consists of eight worksurfaces, two back-to-back outer leg assemblies, three back-to-back narrow leg assemblies, and eight supporting structural beams. Anodized aluminum worksurface door provides access to power/data trough below worksurface. Worksurface with access doors CANNOT be combined with above worksurface power trough.

- Anodized Aluminum Leg - Add **\$382**. list upcharge

BRTBAR8PDA2484L	50.5 x 336 x 29	70	556	28.30	\$10125	\$2336
BRTBAR8PDA2478L	50.5 x 312 x 29	70	520	27.30	\$9787	\$2086
BRTBAR8PDA2472L	50.5 x 288 x 29	70	484	26.30	\$9539	\$2005
BRTBAR8PDA2466L	50.5 x 264 x 29	70	448	25.30	\$9121	\$1754
BRTBAR8PDA2460L	50.5 x 240 x 29	70	412	24.42	\$8744	\$1587
BRTBAR8PDA3084L	62.5 x 336 x 29	70	669	30.58	\$11087	\$2636
BRTBAR8PDA3078L	62.5 x 312 x 29	70	625	29.48	\$10666	\$2671
BRTBAR8PDA3072L	62.5 x 288 x 29	70	581	28.38	\$10415	\$2422
BRTBAR8PDA3066L	62.5 x 264 x 29	70	536	27.28	\$10001	\$2166
BRTBAR8PDA3060L	62.5 x 240 x 29	70	492	26.18	\$9413	\$2005

Back-to-back 8 Person workstation consists of eight worksurfaces, two back-to-back outer leg assemblies, three back-to-back narrow leg assemblies, and eight supporting structural beams. These tables feature dual access doors providing a central connection point for monitor lifts. Anodized aluminum worksurface door provides access to power/data trough below worksurface. Worksurface with access doors CANNOT be combined with above worksurface power trough.

- Anodized Aluminum Leg - Add **\$382**. list upcharge

Required Specifications

Top finish
Edge finish
Metal finish (legs)
Beam finish

Optional Specifications

Anodized Aluminum Leg
HP laminate

RECTANGULAR LEG PACKAGES

MODEL# DIMENSIONS FREIGHT CLASS WT./LBS. CUBIC FT. LIST PRICE HP ADD

D x W x H

BRT36P2484C	24 x 84 x 36	70	120.68	6.42	\$3326	\$184
BRT36P2478C	24 x 78 x 36	70	114.16	6.13	\$3243	\$171
BRT36P2472C	24 x 72 x 36	70	107.64	5.83	\$3160	\$164
BRT36P2466C	24 x 66 x 36	70	101.12	5.62	\$3098	\$160
BRT36P2460C	24 x 60 x 36	70	94.60	5.41	\$3031	\$152
BRT36P2454C	24 x 54 x 36	70	88.08	5.19	\$2936	\$132
BRT36P2448C	24 x 48 x 36	70	81.56	4.98	\$2788	\$120
BRT36P2442C	24 x 42 x 36	70	76.04	4.76	\$2690	\$102
BRT36P2436C	24 x 36 x 36	70	68.52	4.55	\$2607	\$82

BRT36P3084C	30 x 84 x 36	70	148.11	7.32	\$3801	\$197
BRT36P3078C	30 x 78 x 36	70	139.96	6.95	\$3694	\$178
BRT36P3072C	30 x 72 x 36	70	131.81	6.59	\$3602	\$171
BRT36P3066C	30 x 66 x 36	70	123.66	6.32	\$3514	\$171
BRT36P3060C	30 x 60 x 36	70	115.51	6.06	\$3442	\$160
BRT36P3054C	30 x 54 x 36	70	107.36	5.79	\$3351	\$132
BRT36P3048C	30 x 48 x 36	70	99.21	5.53	\$3206	\$132
BRT36P3042C	30 x 42 x 36	70	91.06	5.26	\$3134	\$125
BRT36P3036C	30 x 36 x 36	70	83.91	5	\$3001	\$93

BRT36P3684C	36 x 84 x 36	70	161.97	8.91	\$4256	\$223
BRT36P3678C	36 x 78 x 36	70	152.82	8.50	\$4149	\$211
BRT36P3672C	36 x 72 x 36	70	144.67	8.10	\$4029	\$197
BRT36P3666C	36 x 66 x 36	70	135.52	7.79	\$3919	\$184
BRT36P3660C	36 x 60 x 36	70	126.37	7.48	\$3798	\$164
BRT36P3654C	36 x 54 x 36	70	118.22	7.18	\$3677	\$152
BRT36P3648C	36 x 48 x 36	70	109.07	6.87	\$3512	\$132
BRT36P3642C	36 x 42 x 36	70	99.92	6.56	\$3399	\$120

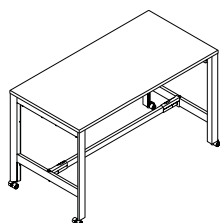

36"H Single Table with Casters

Single table assembly consists of one worksurface, two H leg assemblies, horizontal structural beams, and one bottom table beam. 40mm dia. locking casters with 8mm thread, white body and grey tires.

- 24"D tables include 3 horizontal structural beams. 30"/36"D tables include 4 horizontal structural beams.
- Anodized Aluminum Leg - Add **\$154.** list upcharge

BRT36P2484L	24 x 84 x 36	70	120.20	6.42	\$3216	\$184
BRT36P2478L	24 x 78 x 36	70	113.68	6.13	\$3137	\$171
BRT36P2472L	24 x 72 x 36	70	107.16	5.83	\$3050	\$164
BRT36P2466L	24 x 66 x 36	70	100.64	5.62	\$2991	\$160
BRT36P2460L	24 x 60 x 36	70	94.12	5.41	\$2921	\$152
BRT36P2454L	24 x 54 x 36	70	87.60	5.19	\$2826	\$132
BRT36P2448L	24 x 48 x 36	70	81.08	4.98	\$2678	\$120
BRT36P2442L	24 x 42 x 36	70	75.56	4.76	\$2581	\$102
BRT36P2436L	24 x 36 x 36	85	68.04	4.55	\$2497	\$82

BRT36P3084L	30 x 84 x 36	70	147.63	7.32	\$3691	\$197
BRT36P3078L	30 x 78 x 36	70	139.48	6.96	\$3586	\$178
BRT36P3072L	30 x 72 x 36	70	131.33	6.59	\$3493	\$171
BRT36P3066L	30 x 66 x 36	70	123.18	6.32	\$3407	\$171
BRT36P3060L	30 x 60 x 36	70	115.03	6.06	\$3332	\$160
BRT36P3054L	30 x 54 x 36	70	106.88	5.79	\$3240	\$132
BRT36P3048L	30 x 48 x 36	70	98.73	5.53	\$3098	\$132
BRT36P3042L	30 x 42 x 36	70	90.58	5.26	\$3024	\$125
BRT36P3036L	30 x 36 x 36	70	83.43	5	\$2893	\$93

BRT36P3684L	36 x 84 x 36	70	161.49	8.91	\$4150	\$223
BRT36P3678L	36 x 78 x 36	70	152.34	8.50	\$4039	\$211
BRT36P3672L	36 x 72 x 36	70	144.19	8.10	\$3922	\$197
BRT36P3666L	36 x 66 x 36	70	135.04	7.79	\$3808	\$184
BRT36P3660L	36 x 60 x 36	70	125.89	7.48	\$3690	\$164
BRT36P3654L	36 x 54 x 36	70	117.74	7.18	\$3566	\$152
BRT36P3648L	36 x 48 x 36	70	108.59	6.87	\$3406	\$132
BRT36P3642L	36 x 42 x 36	70	99.44	6.56	\$3291	\$120

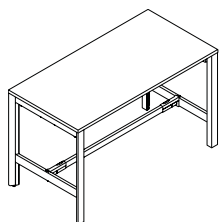

36"H Single Table with Levelers

Single table assembly consists of one worksurface, two H leg assemblies, horizontal structural beams, and one bottom table beam.

- 24"D tables include 3 horizontal structural beams. 30"/36"D tables include 4 horizontal structural beams.
- Anodized Aluminum Leg - Add **\$154.** list upcharge

Required Specifications

Top finish
Edge finish
Metal finish (legs)

Optional Specifications

Anodized Aluminum Leg
HP laminate

RECTANGULAR LEG PACKAGES

MODEL# DIMENSIONS FREIGHT CLASS WT/LBS. CUBIC FT. LIST PRICE HP ADD

D x W x H

BRT36A2484L	24 x 84 x 36	70	106.36	4.74	\$2600	\$184
BRT36A2478L	24 x 78 x 36	70	99.84	4.45	\$2523	\$171
BRT36A2472L	24 x 72 x 36	70	93.32	4.15	\$2437	\$164
BRT36A2466L	24 x 66 x 36	70	86.80	3.94	\$2378	\$160
BRT36A2460L	24 x 60 x 36	70	80.28	3.73	\$2307	\$152
BRT36A2454L	24 x 54 x 36	70	73.76	3.51	\$2211	\$132
BRT36A2448L	24 x 48 x 36	70	67.24	3.30	\$2065	\$120
BRT36A2442L	24 x 42 x 36	70	61.72	3.08	\$1968	\$102
BRT36A2436L	24 x 36 x 36	70	54.20	2.87	\$1884	\$82
BRT36A3084L	30 x 84 x 36	65	131.77	5.56	\$3040	\$197
BRT36A3078L	30 x 78 x 36	65	123.62	5.19	\$2933	\$178
BRT36A3072L	30 x 72 x 36	65	115.47	4.83	\$2841	\$171
BRT36A3066L	30 x 66 x 36	65	107.32	4.56	\$2754	\$171
BRT36A3060L	30 x 60 x 36	65	99.17	4.30	\$2678	\$160
BRT36A3054L	30 x 54 x 36	65	91.02	4.03	\$2588	\$132
BRT36A3048L	30 x 48 x 36	70	82.87	3.77	\$2445	\$132
BRT36A3042L	30 x 42 x 36	70	74.72	3.50	\$2370	\$125
BRT36A3036L	30 x 36 x 36	70	67.57	3.24	\$2240	\$93
BRT36A3684L	36 x 84 x 36	70	143.70	6.65	\$3405	\$223
BRT36A3678L	36 x 78 x 36	70	134.55	6.24	\$3293	\$211
BRT36A3672L	36 x 72 x 36	70	126.40	5.84	\$3175	\$197
BRT36A3666L	36 x 66 x 36	70	117.25	5.53	\$3063	\$184
BRT36A3660L	36 x 60 x 36	70	108.10	5.22	\$2944	\$164
BRT36A3654L	36 x 54 x 36	70	99.95	4.92	\$2821	\$152
BRT36A3648L	36 x 48 x 36	70	90.80	4.61	\$2658	\$132
BRT36A3642L	36 x 42 x 36	70	81.65	4.30	\$2545	\$120

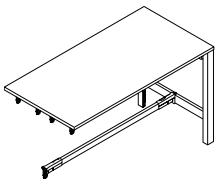

36" H Add-On with Levelers

Single table assembly consists of one worksurface, one H leg assembly, horizontal structural beams, and one bottom table beam.

- 24"D tables include 3 horizontal structural beams. 30"/36" D tables include 4 horizontal structural beams.
- Anodized Aluminum Leg - Add \$77. list upcharge

BRT42P2484C	24 x 84 x 42	70	122.58	6.98	\$3384	\$184
BRT42P2478C	24 x 78 x 42	70	116.06	6.69	\$3306	\$171
BRT42P2472C	24 x 72 x 42	70	109.54	6.39	\$3220	\$164
BRT42P2466C	24 x 66 x 42	70	103.02	6.18	\$3160	\$160
BRT42P2460C	24 x 60 x 42	70	96.50	5.97	\$3090	\$152
BRT42P2454C	24 x 54 x 42	70	89.98	5.75	\$2996	\$132
BRT42P2448C	24 x 48 x 42	70	83.46	5.54	\$2848	\$120
BRT42P2442C	24 x 42 x 42	85	77.94	5.32	\$2752	\$102
BRT42P2436C	24 x 36 x 42	85	70.42	5.11	\$2668	\$82
BRT42P3084C	30 x 84 x 42	70	150.01	7.92	\$3861	\$197
BRT42P3078C	30 x 78 x 42	70	141.86	7.55	\$3755	\$178
BRT42P3072C	30 x 72 x 42	70	133.71	7.19	\$3662	\$171
BRT42P3066C	30 x 66 x 42	70	125.56	6.92	\$3575	\$171
BRT42P3060C	30 x 60 x 42	70	117.41	6.66	\$3503	\$160
BRT42P3054C	30 x 54 x 42	70	109.26	6.39	\$3409	\$132
BRT42P3048C	30 x 48 x 42	70	101.11	6.13	\$3269	\$132
BRT42P3042C	30 x 42 x 42	70	92.96	5.86	\$3194	\$125
BRT42P3036C	30 x 36 x 42	70	85.81	5.60	\$3063	\$93
BRT42P3684C	36 x 84 x 42	70	163.87	9.69	\$4318	\$223
BRT42P3678C	36 x 78 x 42	70	154.72	9.28	\$4208	\$211
BRT42P3672C	36 x 72 x 42	70	146.57	8.88	\$4090	\$197
BRT42P3666C	36 x 66 x 42	70	137.42	8.57	\$3977	\$184
BRT42P3660C	36 x 60 x 42	70	128.27	8.26	\$3859	\$164
BRT42P3654C	36 x 54 x 42	70	120.12	7.96	\$3737	\$152
BRT42P3648C	36 x 48 x 42	85	110.97	7.65	\$3573	\$132
BRT42P3642C	36 x 42 x 42	85	101.82	7.34	\$3459	\$120

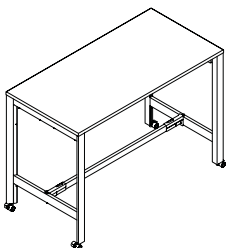

42" H Pod with Casters

Single table assembly consists of one worksurface, two H leg assemblies, horizontal structural beams and one bottom table beam. 40mm dia. locking casters with 8mm thread, white body and grey tires.

- 24"D tables include 3 horizontal structural beams. 30"/36" D tables include 4 horizontal structural beams.
- Anodized Aluminum Leg - Add \$154. list upcharge

Required Specifications

Top finish
Edge finish
Metal finish (legs)

Optional Specifications

Anodized Aluminum Leg
HP laminate

RECTANGULAR LEG PACKAGES

MODEL# DIMENSIONS FREIGHT CLASS WT./LBS. CUBIC FT. LIST PRICE HP ADD

D x W x H

BRT42P2484L	24 x 84 x 42	70	122.10	6.98	\$3277	\$184
BRT42P2478L	24 x 78 x 42	70	115.58	6.69	\$3197	\$171
BRT42P2472L	24 x 72 x 42	70	109.06	6.39	\$3112	\$164
BRT42P2466L	24 x 66 x 42	70	102.54	6.18	\$3050	\$160
BRT42P2460L	24 x 60 x 42	70	96.02	5.97	\$2984	\$152
BRT42P2454L	24 x 54 x 42	70	89.50	5.75	\$2887	\$132
BRT42P2448L	24 x 48 x 42	85	82.98	5.54	\$2739	\$120
BRT42P2442L	24 x 42 x 42	85	77.46	5.32	\$2642	\$102
BRT42P2436L	24 x 36 x 42	85	69.94	5.11	\$2559	\$82

BRT42P3084L	30 x 84 x 42	70	149.53	7.92	\$3756	\$197
BRT42P3078L	30 x 78 x 42	70	141.38	7.55	\$3649	\$178
BRT42P3072L	30 x 72 x 42	70	133.23	7.19	\$3557	\$171
BRT42P3066L	30 x 66 x 42	70	125.08	6.92	\$3470	\$171
BRT42P3060L	30 x 60 x 42	70	116.93	6.66	\$3396	\$160
BRT42P3054L	30 x 54 x 42	70	108.78	6.39	\$3304	\$132
BRT42P3048L	30 x 48 x 42	70	100.63	6.13	\$3163	\$132
BRT42P3042L	30 x 42 x 42	70	92.48	5.86	\$3088	\$125
BRT42P3036L	30 x 36 x 42	70	85.33	5.60	\$2958	\$93

BRT42P3684L	36 x 84 x 42	70	163.39	9.69	\$4211	\$223
BRT42P3678L	36 x 78 x 42	70	154.24	9.28	\$4100	\$211
BRT42P3672L	36 x 72 x 42	70	146.09	8.88	\$3981	\$197
BRT42P3666L	36 x 66 x 42	70	136.94	8.57	\$3871	\$184
BRT42P3660L	36 x 60 x 42	70	127.79	8.26	\$3750	\$164
BRT42P3654L	36 x 54 x 42	70	119.64	7.96	\$3628	\$152
BRT42P3648L	36 x 48 x 42	85	110.49	7.65	\$3464	\$132
BRT42P3642L	36 x 42 x 42	85	101.34	7.34	\$3353	\$120

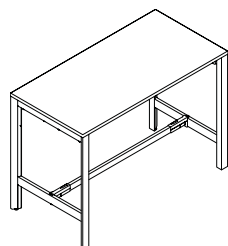

42" H Pod with Levelers

Single table assembly consists of one worksurface, two H leg assemblies, horizontal structural beams and one bottom table beam.

- 24"D tables include 3 horizontal structural beams. 30"/36"D tables include 4 horizontal structural beams.
- Anodized Aluminum Leg - Add **\$154**. list upcharge

BRT42A2484L	24 x 84 x 42	70	107.31	5.02	\$2631	\$184
BRT42A2478L	24 x 78 x 42	70	100.79	4.73	\$2551	\$171
BRT42A2472L	24 x 72 x 42	70	94.27	4.43	\$2470	\$164
BRT42A2466L	24 x 66 x 42	70	87.75	4.22	\$2406	\$160
BRT42A2460L	24 x 60 x 42	70	81.23	4.01	\$2339	\$152
BRT42A2454L	24 x 54 x 42	70	74.71	3.79	\$2243	\$132
BRT42A2448L	24 x 48 x 42	70	68.19	3.58	\$2097	\$120
BRT42A2442L	24 x 42 x 42	70	62.67	3.36	\$1910	\$102
BRT42A2436L	24 x 36 x 42	70	55.15	3.15	\$1832	\$82

BRT42A3084L	30 x 84 x 42	65	132.72	5.86	\$3071	\$197
BRT42A3078L	30 x 78 x 42	65	124.57	5.49	\$2964	\$178
BRT42A3072L	30 x 72 x 42	65	116.42	5.13	\$2870	\$171
BRT42A3066L	30 x 66 x 42	70	108.27	4.86	\$2785	\$171
BRT42A3060L	30 x 60 x 42	70	100.12	4.60	\$2712	\$160
BRT42A3054L	30 x 54 x 42	70	91.97	4.33	\$2620	\$132
BRT42A3048L	30 x 48 x 42	70	83.82	4.07	\$2477	\$132
BRT42A3042L	30 x 42 x 42	70	75.67	3.80	\$2403	\$125
BRT42A3036L	30 x 36 x 42	70	68.52	3.54	\$2271	\$93

BRT42A3684L	36 x 84 x 42	70	114.65	7.04	\$3432	\$223
BRT42A3678L	36 x 78 x 42	70	135.50	6.63	\$3326	\$211
BRT42A3672L	36 x 72 x 42	70	127.35	6.23	\$3205	\$197
BRT42A3666L	36 x 66 x 42	70	118.20	5.92	\$3095	\$184
BRT42A3660L	36 x 60 x 42	70	109.05	5.61	\$2973	\$164
BRT42A3654L	36 x 54 x 42	70	100.90	5.31	\$2852	\$152
BRT42A3648L	36 x 48 x 42	70	91.75	5	\$2689	\$132
BRT42A3642L	36 x 42 x 42	70	82.60	4.69	\$2574	\$120

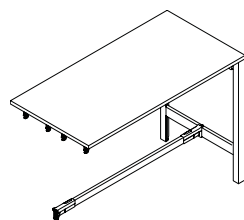

42" H Add-On with Levelers

Single table assembly consists of one worksurface, one H leg assembly, horizontal structural beams, and one bottom table beam.

- 24"D tables include 3 horizontal structural beams. 30"/36"D tables include 4 horizontal structural beams.
- Anodized Aluminum Leg - Add **\$77**. list upcharge

Required Specifications

Top finish
Edge finish
Metal finish (legs)

Optional Specifications

Anodized Aluminum Leg
HP laminate

ROUND LEG PACKAGES

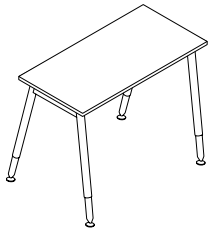

**Single Line 1 Person Pod with Levelers
Round Leg**

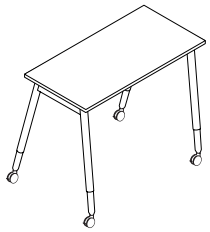

**Single Line 1 Person Pod with Casters
Round Leg**

MODEL#	DIMENSIONS D x W x H	FREIGHT CLASS	WT/LBS.	CUBIC FT.	LIST PRICE	HP ADD
BRTS1P2484LR	24 x 84 x 29	70	75	4.92	\$1632	\$154
BRTS1P2478LR	24 x 78 x 29	85	72	4.82	\$1584	\$148
BRTS1P2472LR	24 x 72 x 29	85	69	4.73	\$1543	\$145
BRTS1P2466LR	24 x 66 x 29	85	66	4.65	\$1514	\$136
BRTS1P2463LR	24 x 62.5 x 29	85	63	4.57	\$1502	\$132
BRTS1P2460LR	24 x 60 x 29	85	60	4.48	\$1487	\$131
BRTS1P2454LR	24 x 54 x 29	85	57	4.40	\$1457	\$94
BRTS1P2451LR	24 x 50.5 x 29	85	54	4.30	\$1399	\$88
BRTS1P2448LR	24 x 48 x 29	85	51	4.20	\$1364	\$104
BRTS1P2442LR	24 x 42 x 29	92.5	48	4.10	\$1307	\$65
BRTS1P2436LR	24 x 36 x 29	92.5	45	4	\$1263	\$46
BRTS1P3084LR	30 x 84 x 29	70	75	4.92	\$1668	\$165
BRTS1P3078LR	30 x 78 x 29	85	72	4.82	\$1606	\$153
BRTS1P3072LR	30 x 72 x 29	85	69	4.73	\$1566	\$129
BRTS1P3066LR	30 x 66 x 29	85	66	4.65	\$1531	\$145
BRTS1P3063LR	30 x 62.5 x 29	85	63	4.57	\$1520	\$140
BRTS1P3060LR	30 x 60 x 29	85	60	4.48	\$1505	\$115
BRTS1P3054LR	30 x 54 x 29	85	57	4.40	\$1468	\$114
BRTS1P3051LR	30 x 50.5 x 29	85	54	4.30	\$1443	\$119
BRTS1P3048LR	30 x 48 x 29	85	51	4.20	\$1397	\$114
BRTS1P3042LR	30 x 42 x 29	92.5	48	4.10	\$1369	\$112
BRTS1P3036LR	30 x 36 x 29	92.5	45	4	\$1225	\$81

Single Line Table Assemblies consist of one worksurface, two leg assemblies, and one supporting structural beam.

BRTS1P2484CR	24 x 84 x 29	70	75	4.92	\$1723	\$154
BRTS1P2478CR	24 x 78 x 29	85	72	4.82	\$1678	\$148
BRTS1P2472CR	24 x 72 x 29	85	69	4.73	\$1635	\$145
BRTS1P2466CR	24 x 66 x 29	85	66	4.65	\$1609	\$136
BRTS1P2463CR	24 x 62.5 x 29	85	63	4.57	\$1597	\$132
BRTS1P2460CR	24 x 60 x 29	85	60	4.48	\$1581	\$131
BRTS1P2454CR	24 x 54 x 29	85	57	4.40	\$1548	\$94
BRTS1P2451CR	24 x 50.5 x 29	85	54	4.30	\$1493	\$88
BRTS1P2448CR	24 x 48 x 29	85	51	4.20	\$1457	\$104
BRTS1P2442CR	24 x 42 x 29	92.5	48	4.10	\$1397	\$65
BRTS1P2436CR	24 x 36 x 29	92.5	45	4	\$1357	\$46
BRTS1P3084CR	30 x 84 x 29	70	75	4.92	\$1762	\$165
BRTS1P3078CR	30 x 78 x 29	85	72	4.82	\$1698	\$153
BRTS1P3072CR	30 x 72 x 29	85	69	4.73	\$1663	\$127
BRTS1P3066CR	30 x 66 x 29	85	66	4.65	\$1622	\$145
BRTS1P3063CR	30 x 62.5 x 29	85	63	4.57	\$1611	\$140
BRTS1P3060CR	30 x 60 x 29	85	60	4.48	\$1597	\$115
BRTS1P3054CR	30 x 54 x 29	85	57	4.40	\$1561	\$114
BRTS1P3051CR	30 x 50.5 x 29	85	54	4.30	\$1534	\$119
BRTS1P3048CR	30 x 48 x 29	85	51	4.20	\$1492	\$114
BRTS1P3042CR	30 x 42 x 29	92.5	48	4.10	\$1461	\$112
BRTS1P3036CR	30 x 36 x 29	92.5	45	4	\$1318	\$81

Single Line Table Assemblies consist of one worksurface, two leg assemblies, and one supporting structural beam. 40mm locking casters with grey tires; steel horizontal beams, aluminum legs.

Required Specifications

Top finish
Edge finish
Metal finish (legs)
Beam finish

Optional Specifications

Anodized Aluminum Leg
HP laminate

ROUND LEG PACKAGES

MODEL#	DIMENSIONS	FREIGHT CLASS	WT./LBS.	CUBIC FT.	LIST PRICE	HP ADD
--------	------------	---------------	----------	-----------	------------	--------

D x W x H

BRTS2P2484LR	24 x 168 x 29	70	149	7.41	\$2862	\$291
BRTS2P2478LR	24 x 156 x 29	70	140	7.27	\$2752	\$291
BRTS2P2472LR	24 x 144 x 29	70	131	7.13	\$2667	\$283
BRTS2P2466LR	24 x 132 x 29	70	122	6.95	\$2621	\$260
BRTS2P2460LR	24 x 120 x 29	70	113	6.71	\$2559	\$260
BRTS2P2454LR	24 x 108 x 29	70	104	6.45	\$2457	\$226
BRTS2P2448LR	24 x 96 x 29	70	95	6.21	\$2309	\$203

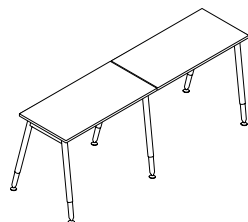

Single Line 2 Person Pod with Levelers
Round Leg

BRTS2P3084LR	30 x 168 x 29	70	173	8.25	\$2922	\$329
BRTS2P3078LR	30 x 156 x 29	70	164	7.97	\$2794	\$303
BRTS2P3072LR	30 x 144 x 29	70	155	7.69	\$2716	\$294
BRTS2P3066LR	30 x 132 x 29	70	140	7.41	\$2643	\$283
BRTS2P3060LR	30 x 120 x 29	70	131	7.13	\$2594	\$267
BRTS2P3054LR	30 x 108 x 29	70	122	6.85	\$2521	\$226
BRTS2P3048LR	30 x 96 x 29	70	113	6.57	\$2420	\$226

Single Line 2 Person workstation consists of two worksurfaces, three leg assemblies, and two supporting structural beams. One leg can be shared by 2 adjoining worksurfaces.

BRTS3P2484LR	24 x 252 x 29	70	219	9.74	\$4061	\$457
BRTS3P2478LR	24 x 234 x 29	70	206	9.53	\$3921	\$434
BRTS3P2472LR	24 x 216 x 29	70	192	9.32	\$3793	\$423
BRTS3P2466LR	24 x 198 x 29	70	179	9.11	\$3712	\$401
BRTS3P2460LR	24 x 180 x 29	70	165	8.89	\$3630	\$388
BRTS3P2454LR	24 x 162 x 29	70	152	8.68	\$3479	\$335
BRTS3P2448LR	24 x 144 x 29	70	138	8.47	\$3259	\$301

BRTS3P3084LR	30 x 263 x 29	65	263	11.59	\$4176	\$492
BRTS3P3078LR	30 x 234 x 29	70	246	11.16	\$3984	\$454
BRTS3P3072LR	30 x 216 x 29	70	229	10.72	\$3869	\$442
BRTS3P3066LR	30 x 198 x 29	70	212	10.30	\$3758	\$423
BRTS3P3060LR	30 x 180 x 29	70	195	9.87	\$3682	\$401
BRTS3P3054LR	30 x 162 x 29	70	178	9.44	\$3572	\$335
BRTS3P3048LR	30 x 144 x 29	70	161	9.01	\$3420	\$335

Single Line 3 Person workstation consists of three worksurfaces, four leg assemblies, and three supporting structural beams. One leg can be shared by 2 adjoining worksurfaces.

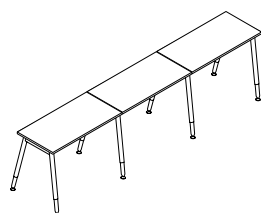

Single Line 3 Person Pod with Levelers
Round Leg

BRTS4P2484LR	24 x 336 x 29	70	291	13.67	\$5276	\$610
BRTS4P2478LR	24 x 312 x 29	70	273	13.18	\$5089	\$578
BRTS4P2472LR	24 x 288 x 29	70	254	12.69	\$4920	\$561
BRTS4P2466LR	24 x 264 x 29	70	236	12.20	\$4810	\$532
BRTS4P2460LR	24 x 240 x 29	70	217	11.71	\$4686	\$532
BRTS4P2454LR	24 x 216 x 29	70	199	11.22	\$4499	\$446
BRTS4P2448LR	24 x 192 x 29	70	180	10.73	\$4158	\$446

BRTS4P3084LR	30 x 336 x 29	65	345	14.87	\$5430	\$655
BRTS4P3078LR	30 x 312 x 29	65	323	14.30	\$5176	\$600
BRTS4P3072LR	30 x 288 x 29	70	301	13.73	\$5020	\$586
BRTS4P3066LR	30 x 264 x 29	70	279	13.16	\$4871	\$561
BRTS4P3060LR	30 x 240 x 29	70	257	12.59	\$4770	\$532
BRTS4P3054LR	30 x 216 x 29	70	235	12.02	\$4624	\$446
BRTS4P3048LR	30 x 192 x 29	70	213	11.45	\$4422	\$446

Single Line 4 Person workstation consists of four worksurfaces, five leg assemblies, and four supporting structural beams. One leg can be shared by 2 adjoining worksurfaces.

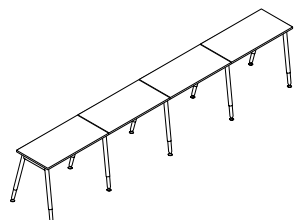

Single Line 4 Person Pod with Levelers
Round Leg

Required Specifications

Top finish
Edge finish
Metal finish (legs)
Beam finish

Optional Specifications

Anodized Aluminum Leg
HP laminate

ROUND LEG PACKAGES

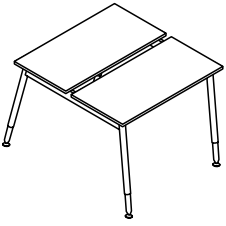

Back-to-Back 2 Person Pod with Levelers Round Leg

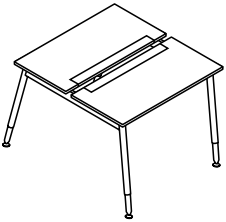

Back-to-Back 2 Person Pod with Access Door and Levelers, Round Leg

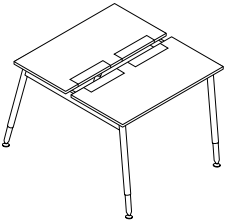

Back-to-Back 2 Person Pod with Access Door and Levelers, Round Leg

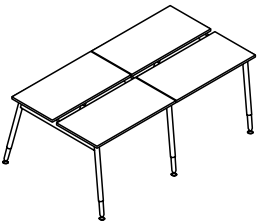

Back-to-Back 4 Person Pod with Levelers Round Leg

MODEL#	DIMENSIONS D x W x H	FREIGHT CLASS	WT./LBS.	CUBIC FT.	LIST PRICE	HP ADD
BRTBAR2P2484LR	50.5 x 84 x 29	70	146	9.40	\$2662	\$306
BRTBAR2P2478LR	50.5 x 78 x 29	85	137	9.20	\$2590	\$291
BRTBAR2P2472LR	50.5 x 72 x 29	85	128	9.02	\$2504	\$283
BRTBAR2P2466LR	50.5 x 66 x 29	85	119	8.76	\$2448	\$267
BRTBAR2P2460LR	50.5 x 60 x 29	85	110	8.56	\$2396	\$260
BRTBAR2P3084LR	62.5 x 84 x 29	70	174	10.40	\$2761	\$329
BRTBAR2P3078LR	62.5 x 78 x 29	70	163	9.80	\$2633	\$303
BRTBAR2P3072LR	62.5 x 72 x 29	70	152	9.54	\$2554	\$283
BRTBAR2P3066LR	62.5 x 66 x 29	70	141	9.25	\$2481	\$283
BRTBAR2P3060LR	62.5 x 60 x 29	85	130	9	\$2228	\$469

Back-to-back 2 Person workstation consists of two worksurfaces, two back-to-back leg assemblies, and two supporting structural beams.

BRTBAR2PA2484LR	50.5 x 84 x 29	70	146	9.40	\$2799	\$547
BRTBAR2PA2478LR	50.5 x 78 x 29	85	137	9.20	\$2739	\$489
BRTBAR2PA2472LR	50.5 x 72 x 29	85	128	9.02	\$2681	\$469
BRTBAR2PA2466LR	50.5 x 66 x 29	85	119	8.76	\$2584	\$411
BRTBAR2PA2460LR	50.5 x 60 x 29	85	110	8.56	\$2488	\$372
BRTBAR2PA3084LR	62.5 x 84 x 29	70	174	10.40	\$3032	\$664
BRTBAR2PA3078LR	62.5 x 78 x 29	70	163	9.80	\$2936	\$625
BRTBAR2PA3072LR	62.5 x 72 x 29	70	152	9.54	\$2874	\$568
BRTBAR2PA3066LR	62.5 x 66 x 29	70	141	9.25	\$2778	\$508
BRTBAR2PA3060LR	62.5 x 60 x 29	85	130	9	\$2643	\$469

Back-to-back 2 Person workstation consists of two worksurfaces, two back-to-back leg assemblies, and two supporting structural beams. Anodized aluminum worksurface door provides access to power/data trough below worksurface. Worksurface with access doors CANNOT be combined with above worksurface power trough.

BRTBAR2PDA2484LR	50.5 x 84 x 29	70	146	9.40	\$3019	\$588
BRTBAR2PDA2478LR	50.5 x 78 x 29	85	137	9.20	\$2958	\$524
BRTBAR2PDA2472LR	50.5 x 72 x 29	85	128	9.02	\$2892	\$504
BRTBAR2PDA2466LR	50.5 x 66 x 29	85	119	8.76	\$2790	\$440
BRTBAR2PDA2460LR	50.5 x 60 x 29	85	110	8.56	\$2687	\$402
BRTBAR2PDA3084LR	62.5 x 84 x 29	70	174	10.40	\$3270	\$712
BRTBAR2PDA3078LR	62.5 x 78 x 29	70	163	9.80	\$3166	\$670
BRTBAR2PDA3072LR	62.5 x 72 x 29	70	152	9.54	\$3100	\$611
BRTBAR2PDA3066LR	62.5 x 66 x 29	70	141	9.25	\$2998	\$546
BRTBAR2PDA3060LR	62.5 x 60 x 29	85	130	9	\$2851	\$505

Back-to-back 2 Person workstation consists of two worksurfaces, two back-to-back leg assemblies, and two supporting structural beams. These tables feature dual access doors providing a central connection point for monitor lifts. Anodized aluminum worksurface door provides access to power/data trough below worksurface. Worksurface with access doors CANNOT be combined with above worksurface power trough.

BRTBAR4P2484LR	50.5 x 168 x 29	70	272	15.66	\$4826	\$610
BRTBAR4P2478LR	50.5 x 156 x 29	70	256	15.20	\$4639	\$578
BRTBAR4P2472LR	50.5 x 144 x 29	70	240	14.74	\$4469	\$561
BRTBAR4P2466LR	50.5 x 132 x 29	70	224	14.28	\$4361	\$532
BRTBAR4P2460LR	50.5 x 120 x 29	70	208	13.82	\$4252	\$516
BRTBAR4P3084LR	62.5 x 168 x 29	70	333	16.86	\$4982	\$655
BRTBAR4P3078LR	62.5 x 156 x 29	70	313	16.32	\$4725	\$600
BRTBAR4P3072LR	62.5 x 144 x 29	70	293	15.78	\$4571	\$586
BRTBAR4P3066LR	62.5 x 132 x 29	70	273	15.24	\$4384	\$561
BRTBAR4P3060LR	62.5 x 120 x 29	70	253	14.70	\$4361	\$532

Back-to-back 4 Person workstation consists of four worksurfaces, three back-to-back outer leg assemblies, and four supporting structural beams.

Required Specifications

Top finish
Edge finish
Metal finish (legs)
Beam finish

Optional Specifications

Anodized Aluminum Leg
HP laminate

ROUND LEG PACKAGES

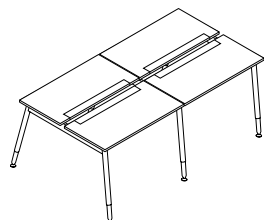

Back-to-Back 4 Person Pod with Access Door and Levelers, Round Leg

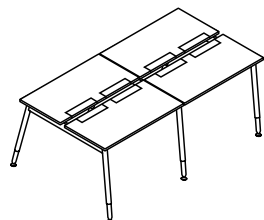

Back-to-Back 4 Person Pod with Access Door and Levelers, Round Leg

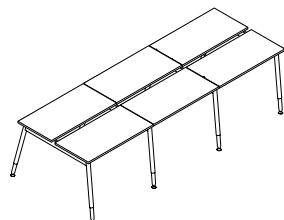

Back-to-Back 6 Person Pod with Levelers Round Leg

MODEL#	DIMENSIONS D x W x H	FREIGHT CLASS	WT/LBS.	CUBIC FT.	LIST PRICE	HP ADD
BRTBAR4PA2484LR	50.5 x 168 x 29	70	272	15.66	\$4965	\$1091
BRTBAR4PA2478LR	50.5 x 156 x 29	70	256	15.20	\$4810	\$972
BRTBAR4PA2472LR	50.5 x 144 x 29	70	240	14.74	\$4693	\$933
BRTBAR4PA2466LR	50.5 x 132 x 29	70	224	14.28	\$4499	\$819
BRTBAR4PA2460LR	50.5 x 120 x 29	70	208	13.82	\$4305	\$742
BRTBAR4PA3084LR	62.5 x 168 x 29	70	333	16.86	\$5430	\$1320
BRTBAR4PA3078LR	62.5 x 156 x 29	70	313	16.32	\$5236	\$1243
BRTBAR4PA3072LR	62.5 x 144 x 29	70	293	15.78	\$5122	\$1129
BRTBAR4PA3066LR	62.5 x 132 x 29	70	273	15.24	\$4926	\$1012
BRTBAR4PA3060LR	62.5 x 120 x 29	70	253	14.70	\$4656	\$933

Back-to-back 4 Person workstation consists of four worksurfaces, three back-to-back outer leg assemblies, and four supporting structural beams. Anodized aluminum worksurface door provides access to power/data trough below worksurface. Worksurface with access doors CANNOT be combined with above worksurface power trough.

BRTBAR4PDA2484LR	50.5 x 168 x 29	70	272	15.66	\$5498	\$1171
BRTBAR4PDA2478LR	50.5 x 156 x 29	70	256	15.20	\$5331	\$1045
BRTBAR4PDA2472LR	50.5 x 144 x 29	70	240	14.74	\$5205	\$1004
BRTBAR4PDA2466LR	50.5 x 132 x 29	70	224	14.28	\$5089	\$879
BRTBAR4PDA2460LR	50.5 x 120 x 29	70	208	13.82	\$4788	\$795
BRTBAR4PDA3084LR	62.5 x 168 x 29	70	333	16.86	\$5958	\$1421
BRTBAR4PDA3078LR	62.5 x 156 x 29	70	313	16.32	\$5749	\$1337
BRTBAR4PDA3072LR	62.5 x 144 x 29	70	293	15.78	\$5623	\$1210
BRTBAR4PDA3066LR	62.5 x 132 x 29	70	273	15.24	\$5498	\$1001
BRTBAR4PDA3060LR	62.5 x 120 x 29	70	253	14.70	\$5164	\$1004

Back-to-back 4 Person workstation consists of four worksurfaces, three back-to-back outer leg assemblies, and four supporting structural beams. These tables feature dual access doors providing a central connection point for monitor lifts. Anodized aluminum worksurface door provides access to power/data trough below worksurface. Worksurface with access doors CANNOT be combined with above worksurface power trough.

BRTBAR6P2484LR	50.5 x 252 x 29	70	434	22.88	\$6969	\$910
BRTBAR6P2478LR	50.5 x 234 x 29	70	409	22.10	\$6690	\$865
BRTBAR6P2472LR	50.5 x 216 x 29	70	359	21.32	\$6435	\$843
BRTBAR6P2466LR	50.5 x 198 x 29	70	329	20.54	\$6270	\$795
BRTBAR6P2460LR	50.5 x 180 x 29	70	308	19.76	\$6110	\$783
BRTBAR6P3084LR	62.5 x 252 x 29	70	493	24.53	\$7215	\$968
BRTBAR6P3078LR	62.5 x 234 x 29	70	462	23.75	\$6818	\$899
BRTBAR6P3072LR	62.5 x 216 x 29	70	431	22.86	\$6585	\$877
BRTBAR6P3066LR	62.5 x 198 x 29	70	400	21.97	\$6363	\$843
BRTBAR6P3060LR	62.5 x 180 x 29	70	369	21.08	\$6213	\$795

Back-to-back 6 Person workstation consists of six worksurfaces, four back-to-back outer leg assemblies, and six supporting structural beams.

Required Specifications

Top finish
Edge finish
Metal finish (legs)
Beam finish

Optional Specifications

Anodized Aluminum Leg
HP laminate

ROUND LEG PACKAGES

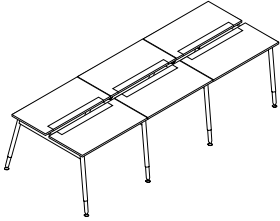

Back-to-Back 6 Person Pod with Access Door and Levelers, Round Leg

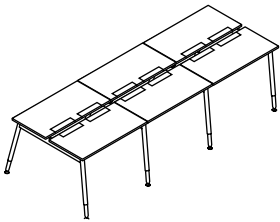

Back-to-Back 6 Person Pod with Access Door and Levelers, Round Leg

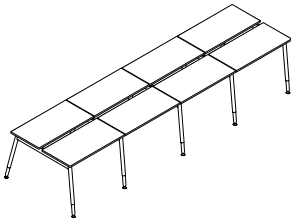

Back-to-Back 8 Person Pod with Levelers Round Leg

MODEL#	DIMENSIONS D x W x H	FREIGHT CLASS	WT/LBS.	CUBIC FT.	LIST PRICE	HP ADD
BRTBAR6PA2484LR	50.5 x 252 x 29	70	434	22.88	\$7376	\$1633
BRTBAR6PA2478LR	50.5 x 234 x 29	70	409	22.10	\$7143	\$1458
BRTBAR6PA2472LR	50.5 x 216 x 29	70	359	21.32	\$6969	\$1399
BRTBAR6PA2466LR	50.5 x 198 x 29	70	329	20.54	\$6677	\$1225
BRTBAR6PA2460LR	50.5 x 180 x 29	70	308	19.76	\$6387	\$1107
BRTBAR6PA3084LR	62.5 x 252 x 29	70	493	24.53	\$8016	\$1980
BRTBAR6PA3078LR	62.5 x 234 x 29	70	462	23.75	\$7726	\$1865
BRTBAR6PA3072LR	62.5 x 216 x 29	70	431	22.86	\$7551	\$1690
BRTBAR6PA3066LR	62.5 x 198 x 29	70	400	21.97	\$7260	\$1516
BRTBAR6PA3060LR	62.5 x 180 x 29	70	369	21.08	\$6853	\$1399

Back-to-back 6 Person workstation consists of six worksurfaces, four back-to-back leg assemblies, and six supporting structural beams. Anodized aluminum worksurface door provides access to power/data trough below worksurface. Worksurface with access doors CANNOT be combined with above worksurface power trough.

BRTBAR6PDA2484LR	50.5 x 252 x 29	70	434	22.88	\$7959	\$1752
BRTBAR6PDA2478LR	50.5 x 234 x 29	70	409	22.10	\$7706	\$1565
BRTBAR6PDA2472LR	50.5 x 216 x 29	70	359	21.32	\$7519	\$1502
BRTBAR6PDA2466LR	50.5 x 198 x 29	70	329	20.54	\$7202	\$1318
BRTBAR6PDA2460LR	50.5 x 180 x 29	70	308	19.76	\$6894	\$1190
BRTBAR6PDA3084LR	62.5 x 252 x 29	70	493	24.53	\$8648	\$2128
BRTBAR6PDA3078LR	62.5 x 234 x 29	70	462	23.75	\$8334	\$1999
BRTBAR6PDA3072LR	62.5 x 216 x 29	70	431	22.86	\$8148	\$1813
BRTBAR6PDA3066LR	62.5 x 198 x 29	70	400	21.97	\$7830	\$1630
BRTBAR6PDA3060LR	62.5 x 180 x 29	70	369	21.08	\$7395	\$1501

Back-to-back 6 Person workstation consists of six worksurfaces, four back-to-back leg assemblies, and six supporting structural beams. These tables feature dual access doors providing a central connection point for monitor lifts. Anodized aluminum worksurface door provides access to power/data trough below worksurface. Worksurface with access doors CANNOT be combined with above worksurface power trough.

BRTBAR8P2484LR	50.5 x 336 x 29	70	556	28.30	\$9127	\$1197
BRTBAR8P2478LR	50.5 x 312 x 29	70	520	27.30	\$8741	\$1151
BRTBAR8P2472LR	50.5 x 288 x 29	70	484	26.30	\$8399	\$1120
BRTBAR8P2466LR	50.5 x 264 x 29	70	448	25.30	\$8181	\$1058
BRTBAR8P2460LR	50.5 x 240 x 29	70	412	24.42	\$7964	\$1027
BRTBAR8P3084LR	62.5 x 336 x 29	70	669	30.58	\$9422	\$1308
BRTBAR8P3078LR	62.5 x 312 x 29	70	625	29.48	\$8910	\$1197
BRTBAR8P3072LR	62.5 x 288 x 29	70	581	28.38	\$8601	\$1166
BRTBAR8P3066LR	62.5 x 264 x 29	70	536	27.28	\$8307	\$1120
BRTBAR8P3060LR	62.5 x 240 x 29	70	492	26.18	\$8106	\$1058

Back-to-back 8 Person workstation consists of eight worksurfaces, five back-to-back leg assemblies, and eight supporting structural beams.

Required Specifications

Top finish
Edge finish
Metal finish (legs)
Beam finish

Optional Specifications

Anodized Aluminum Leg
HP laminate

ROUND LEG PACKAGES

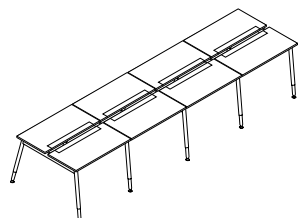

Back-to-Back 8 Person Pod with Access Door and Levelers, Round Leg

MODEL#	DIMENSIONS D x W x H	FREIGHT CLASS	WT/LBS.	CUBIC FT.	LIST PRICE	HP ADD
BRTBAR8PA2484LR	50.5 x 336 x 29	70	556	28.30	\$9655	\$2174
BRTBAR8PA2478LR	50.5 x 312 x 29	70	520	27.30	\$9345	\$1941
BRTBAR8PA2472LR	50.5 x 288 x 29	70	484	26.30	\$9113	\$1865
BRTBAR8PA2466LR	50.5 x 264 x 29	70	448	25.30	\$8725	\$1633
BRTBAR8PA2460LR	50.5 x 240 x 29	70	412	24.42	\$8336	\$1476
BRTBAR8PA3084LR	62.5 x 336 x 29	70	669	30.58	\$10509	\$2639
BRTBAR8PA3078LR	62.5 x 312 x 29	70	625	29.48	\$10119	\$2484
BRTBAR8PA3072LR	62.5 x 288 x 29	70	581	28.38	\$9886	\$2252
BRTBAR8PA3066LR	62.5 x 264 x 29	70	536	27.28	\$9500	\$2019
BRTBAR8PA3060LR	62.5 x 240 x 29	70	492	26.18	\$8957	\$1865

Back-to-back 8 Person workstation consists of eight worksurfaces, five back-to-back leg assemblies, and eight supporting structural beams. Anodized aluminum worksurface door provides access to power/data trough below worksurface. Worksurface with access doors CANNOT be combined with above worksurface power trough.

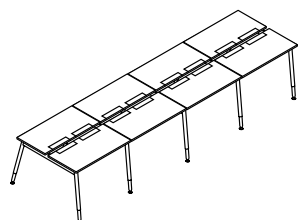

Back-to-Back 8 Person Pod with Access Door and Levelers, Round Leg

BRTBAR8PDA2484LR	50.5 x 336 x 29	70	556	28.30	\$10415	\$2336
BRTBAR8PDA2478LR	50.5 x 312 x 29	70	520	27.30	\$10081	\$2085
BRTBAR8PDA2472LR	50.5 x 288 x 29	70	484	26.30	\$9832	\$1999
BRTBAR8PDA2466LR	50.5 x 264 x 29	70	448	25.30	\$9413	\$1754
BRTBAR8PDA2460LR	50.5 x 240 x 29	70	412	24.42	\$8995	\$1587
BRTBAR8PDA3084LR	62.5 x 336 x 29	70	669	30.58	\$11336	\$2835
BRTBAR8PDA3078LR	62.5 x 312 x 29	70	625	29.48	\$10916	\$2671
BRTBAR8PDA3072LR	62.5 x 288 x 29	70	581	28.38	\$10666	\$2422
BRTBAR8PDA3066LR	62.5 x 264 x 29	70	536	27.28	\$10251	\$2169
BRTBAR8PDA3060LR	62.5 x 240 x 29	70	492	26.18	\$9664	\$2001

Back-to-back 8 Person workstation consists of eight worksurfaces, five back-to-back leg assemblies, and eight supporting structural beams. These tables feature dual access doors providing a central connection point for monitor lifts. Anodized aluminum worksurface door provides access to power/data trough below worksurface. Worksurface with access doors CANNOT be combined with above worksurface power trough.

RETURNS

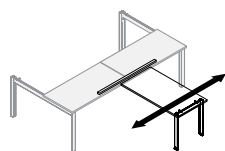

Rail Sliding Table Kit - Rectangular Legs

BRTSLDT72C	72 x 48 x 29	92.5	28.50	2.40	\$779	N/A
------------	--------------	------	-------	------	-------	-----

Includes leg, leg support, sliding bracket hardware, 72" rail and hardware to secure table. **Worksurface not included.** Legs are for 24" d worksurfaces. 40mm dia. locking casters with 8mm thread, white body and grey tires. Maximum length of sliding table surface is 48". **Cannot be used on single line pods with rectangular legs.**

- Anodized Aluminum Leg - Add \$56. list upcharge

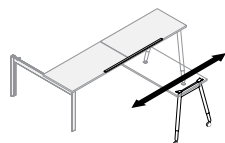

Rail Sliding Table Kit - Round Legs

BRTSLDT72CR	72 x 48 x 29	92.5	28.50	2.40	\$779	N/A
-------------	--------------	------	-------	------	-------	-----

Includes leg, leg support, sliding bracket hardware, 72" rail and hardware to secure table. **Worksurface not included.** Legs are for 24" d worksurfaces. 3" dia. locking casters are standard. Maximum length of sliding table surface is 48".

Required Specifications

Top finish
Edge finish
Metal finish (legs)
Beam finish

Optional Specifications

Anodized Aluminum Leg
HP laminate

MEETING TABLES

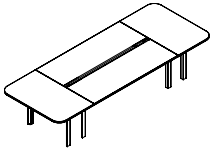

Boardroom Table with Rectangular Leg and Levelers

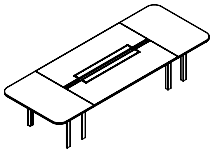

Boardroom Table with Rectangular Leg, Access Door and Levelers

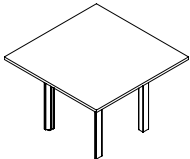

Square Meeting Table with Rectangular Legs

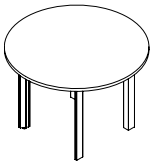

Round Meeting Table with Rectangular Legs

MODEL#	DIMENSIONS D x W x H	FREIGHT CLASS	WT./LBS.	CUBIC FT.	LIST PRICE	HP ADD
BRTBRDP276L	52.5 x 276 x 29	70	474	23.42	\$8481	\$1062
BRTBRDP240L	52.5 x 240 x 29	70	408	22.64	\$8156	\$994
BRTBRDP204L	52.5 x 204 x 29	70	340	20.74	\$6610	\$783
BRTBRDP180L	52.5 x 180 x 29	70	308	19.82	\$6391	\$736
BRTBRDP132L	52.5 x 132 x 29	70	228	15.02	\$4754	\$504
BRTBRDP120L	52.5 x 120 x 29	85	210	14.56	\$4642	\$481

Boardroom Table assemblies consist of 2 or more back-to-back tables with end tables on either side. Inset support legs, levelers. Worksurfaces, supporting structure and connecting hardware included.

- Anodized Aluminum Leg - Add **\$305** list upcharge
- BRTBRDP276L consists of (6) 24" x 72" back-to-back tables and (2) 30" x 50.5" end tables
- BRTBRDP240L consists of (6) 24" x 60" back-to-back tables and (2) 30" x 50.5" end tables
- BRTBRDP204L consists of (4) 24" x 72" back-to-back tables and (2) 30" x 50.5" end tables
- BRTBRDP180L consists of (4) 24" x 60" back-to-back tables and (2) 30" x 50.5" end tables
- BRTBRDP132L consists of (2) 24" x 72" back-to-back tables and (2) 30" x 50.5" end tables
- BRTBRDP120L consists of (2) 24" x 60" back-to-back tables and (2) 30" x 50.5" end tables

BRTBRDPA276L	52.5 x 276 x 29	70	474	23.42	\$9016	\$1621
BRTBRDPA240L	52.5 x 240 x 29	70	408	22.64	\$8706	\$1026
BRTBRDPA204L	52.5 x 204 x 29	70	340	20.74	\$6963	\$845
BRTBRDPA180L	52.5 x 180 x 29	70	308	19.82	\$6577	\$961
BRTBRDPA132L	52.5 x 132 x 29	70	228	15.02	\$4892	\$689
BRTBRDPA120L	52.5 x 120 x 29	85	210	14.56	\$4697	\$591

Boardroom Table assemblies consist of 2 or more back-to-back tables with end tables on either side. Inset support legs, levelers. Worksurfaces, supporting structure and connecting hardware included.

- Anodized Aluminum Leg - Add **\$305** list upcharge
- BRTBRDPA276L consists of (6) 24" x 72" back-to-back tables and (2) 30" x 50.5" end tables
- BRTBRDPA240L consists of (6) 24" x 60" back-to-back tables and (2) 30" x 50.5" end tables
- BRTBRDPA204L consists of (4) 24" x 72" back-to-back tables and (2) 30" x 50.5" end tables
- BRTBRDPA180L consists of (4) 24" x 60" back-to-back tables and (2) 30" x 50.5" end tables
- BRTBRDPA132L consists of (2) 24" x 72" back-to-back tables and (2) 30" x 50.5" end tables
- BRTBRDPA120L consists of (2) 24" x 60" back-to-back tables and (2) 30" x 50.5" end tables

BRTSQ42L	42 x 42 x 29	70	85	4.20	\$1468	\$160
BRTSQ42C	42 x 42 x 29	70	85	4.20	\$1546	\$160

3mm edging. Select BRTSQ42L for levelers or BRTSQ42C for casters.

- Anodized Aluminum Leg - Add **\$154** list upcharge

BRTR42L	42 x 42 x 29	70	65	3.90	\$1468	\$160
BRTR42C	42 x 42 x 29	70	65	3.90	\$1546	\$160

3mm edging. Select BRTR42L for levelers or BRTR42C for casters.

- Anodized Aluminum Leg - Add **\$154** list upcharge

Required Specifications

Top finish
Edge finish
Metal finish (legs)
Beam finish

Optional Specifications

HP laminate
Anodized aluminum leg
Table-edge mounted power module (Meeting Tables)

Below worksurface power trough with power distribution module (Meeting Tables)

LEG ASSEMBLIES

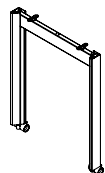

Single Rectangular Leg Assembly with Casters

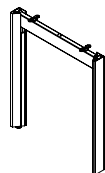

Single Rectangular Leg Assembly with Levelers

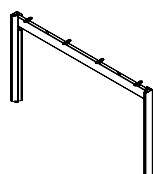

Back-to-Back Rectangular Leg Assembly with Levelers

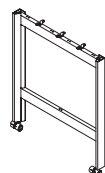

Single H Leg Assembly with Casters

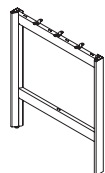

Single H Leg Assembly with Levelers

MODEL#	DIMENSIONS	FREIGHT CLASS	WT./LBS.	CUBIC FT.	LIST PRICE	HP ADD
--------	------------	---------------	----------	-----------	------------	--------

D x W x H

BRTSL24C	24 x 2.5 x 28	150	8	1.34	\$523	N/A
BRTSL30C	30 x 2.5 x 28	150	8	1.41	\$527	N/A
BRTSL36C	36 x 2.5 x 28	150	8	1.81	\$642	N/A

Two single leg assemblies combined with support beams form the structure of the Bridges II series Single Table. One leg can be shared by two adjoining worksurfaces. 40mm white locking casters with grey tires; steel horizontal beams, aluminum legs.

- Anodized Aluminum Leg - Add **\$77** list upcharge

BRTSL24L	24 x 2.5 x 28	150	8	1.34	\$473	N/A
BRTSL30L	30 x 2.5 x 28	150	8	1.34	\$493	N/A
BRTSL36L	36 x 2.5 x 28	125	9	1.50	\$434	N/A

Two single leg assemblies combined with support beams form the structure of the Bridges II series Single Table or Single Line tables. One leg can be shared by two adjoining worksurfaces. Leveling glides; steel horizontal beams, aluminum legs.

- Anodized Aluminum Leg - Add **\$77** list upcharge
- Please specify two beams when using BRTSL36L.

BRTBA34L	34 x 2.5 x 28	150	10	2.47	\$469	N/A
BRTBA51L	50.5 x 2.5 x 28	150	12	2.96	\$508	N/A
BRTBA63L	62.5 x 2.5 x 28	150	13	3.21	\$530	N/A

Two double leg assemblies combined with support beams form the structure of the Bridges II series Back-to-Back Table. One double leg can be shared by four adjoining worksurfaces. Leveling glides; steel horizontal beams, aluminum legs.

- Anodized Aluminum Leg - Add **\$77** list upcharge

BRTHL3624C	24 x 2.5 x 35	100	14	1.68	\$673	N/A
BRTHL3630C	30 x 2.5 x 35	100	16	1.76	\$711	N/A
BRTHL3636C	36 x 2.5 x 35	125	18	2.26	\$805	N/A

BRTHL4224C	24 x 2.5 x 41	125	15	1.96	\$703	N/A
BRTHL4230C	30 x 2.5 x 41	100	17	2.06	\$742	N/A
BRTHL4236C	36 x 2.5 x 41	125	19	2.65	\$833	N/A

Two single leg assemblies combined with support beams form the structure of the Bridges II series Single Line Tables. One leg can be shared by two adjoining worksurfaces. 40mm white locking casters with grey tires; steel horizontal beams, aluminum legs. For proper installation, the following beams are required:

- 24"D legs - 4 beams (3 under the surface and one at the bottom)
- 30"D/36"D legs - 5 beams (4 under the surface and one at the bottom)
- Anodized Aluminum Leg - Add **\$77** list upcharge

BRTHL3624L	24 x 2.5 x 35	100	14	1.68	\$619	N/A
BRTHL3630L	30 x 2.5 x 35	100	16	1.76	\$657	N/A
BRTHL3636L	36 x 2.5 x 35	125	18	2.26	\$751	N/A

BRTHL4224L	24 x 2.5 x 41	125	15	1.96	\$648	N/A
BRTHL4230L	30 x 2.5 x 41	100	17	2.06	\$688	N/A
BRTHL4236L	36 x 2.5 x 41	125	19	2.65	\$780	N/A

Two single leg assemblies combined with support beams form the structure of the Bridges II series Single Line Tables. One leg can be shared by two adjoining worksurfaces. For proper installation, the following beams are required:

- 24"D legs - 4 beams (3 under the surface and one at the bottom)
- 30"D/36"D legs - 5 beams (4 under the surface and one at the bottom)
- Anodized Aluminum Leg - Add **\$77** list upcharge

Required Specifications

Metal finish (legs)

Optional Specifications

Anodized aluminum leg

LEG ASSEMBLIES

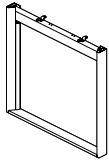

Single Loop Leg

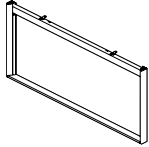

Back-to-Back Loop Leg



120° Rectangular Corner Leg Kit

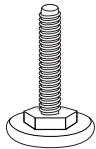

Leveler for Rectangular Leg Table

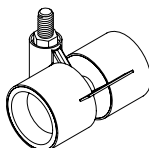

Caster for Rectangular Leg Table

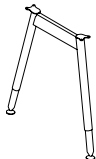

Single Table Round Leg Assembly

MODEL#	DIMENSIONS	FREIGHT CLASS	WT./LBS.	CUBIC FT.	LIST PRICE	HP ADD
--------	------------	---------------	----------	-----------	------------	--------

D x W x H

BRTSLL24L	24 x 2.5 x 28	92.5	11	1.01	\$446	N/A
BRTSLL30L	30 x 2.5 x 28	92.5	13.75	1.26	\$478	N/A
BRTSLL36L	36 x 2.5 x 28	92.5	16.50	1.51	\$512	N/A

Two single leg assemblies combined with support beams form the structure of the Bridges II series Single Line tables. One leg can be shared by two adjoining worksurfaces. Leveling glides; steel horizontal beams, aluminum legs.

- Anodized Aluminum Leg - Add **\$77** list upcharge

BRTBALL51L	50.5 x 2.5 x 28	92.5	23.14	2.12	\$619	N/A
BRTBALL63L	62.5 x 2.5 x 28	92.5	28.64	2.62	\$647	N/A

Two back-to-back leg assemblies form the structure of the Bridges II series Single Line Back-to-Back Table. One double leg can be shared by four adjoining worksurfaces. Leveling glides; steel horizontal beams, aluminum legs.

- Anodized Aluminum Leg - Add **\$77** list upcharge

BRT120L42	34 x 2.5 x 28	250	6.60	2.80	\$896	N/A
-----------	---------------	-----	------	------	--------------	-----

One 120° corner leg kit combined with two single or double leg assemblies and support beams form the structure of the Bridges II 120° Tables. 120° corner leg kit includes one corner leg and adjacent, telescopic beams to support BRTWAC120xxxx or BRTWAC120xxxxA 120° worksurfaces. Telescopic horizontal beams allow single or double leg assemblies to be positioned either under the worksurface (end of a run) or to be shared by adjoining worksurfaces. Levelers, steel horizontal beams, aluminum legs.

- Anodized Aluminum Leg - Add **\$46** list upcharge

BRTLVS	1 x 1 x 2.5	70	.03	.01	\$11	N/A
--------	-------------	----	-----	-----	-------------	-----

5/16" thread with black base. Leveler has 2" adjustment range. Casters and levelers on Rectangular legs cannot be interchanged on site.

BRTLCS	2.6 x 2.7 x 2.5	70	.06	.01	\$35	N/A
--------	-----------------	----	-----	-----	-------------	-----

Locking. 40mm diameter with 8mm thread, white body, light grey tires. Casters and levelers on Rectangular legs cannot be interchanged on site.

BRTSL	24 x 3 x 28	125	8	1.25	\$415	N/A
-------	-------------	-----	---	------	--------------	-----

Two single table leg assemblies combined with a single beam form the supporting structure of the Bridges II series Single Line Table. One leg can be shared by two adjoining worksurfaces. Leveling Glides are standard. Locking casters are available on single tables. Specify BRTLCCR

Required Specifications

Top finish
Edge finish
Metal finish (legs)

Optional Specifications

Anodized Aluminum Leg
HP laminate

LEG ASSEMBLIES

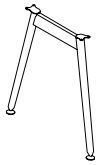

**Single Table Round Leg Assembly,
Fixed Height**

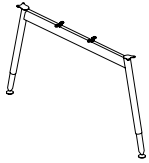

Double Table Round Leg Assembly

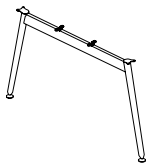

**Double Table Round Leg Assembly,
Fixed Height**

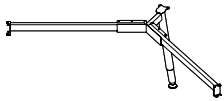

120° Round Corner Leg Assembly

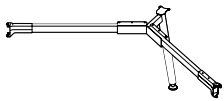

120° Fixed Height Corner Leg Assembly

MODEL#	DIMENSIONS	FREIGHT CLASS	WT/LBS.	CUBIC FT.	LIST PRICE	HP ADD
--------	------------	---------------	---------	-----------	------------	--------

D x W x H

BRTFSL	24 x 2.5 x 28	150	5	.97	\$355	N/A
--------	---------------	-----	---	-----	--------------	-----

Two single table leg assemblies combined with a single beam form the supporting structure of the Bridges II series Single Line Table. One leg can be shared by two adjoining worksurfaces. Leveling glides are standard.

BRTDL	50 x 3 x 28	150	12	2.81	\$538	N/A
-------	-------------	-----	----	------	--------------	-----

Two double table leg assemblies combined with two single beams form the supporting structure of the Bridges II series Back-to-Back Tables. One leg can be shared by two adjoining worksurfaces. Leveling glides are standard.

BRTFDL	50 x 2.5 x 28	250	8	2.03	\$483	N/A
--------	---------------	-----	---	------	--------------	-----

Two double table leg assemblies combined with two single beams form the supporting structure of the Bridges II series Back-to-Back Tables. One leg can be shared by two adjoining worksurfaces. Leveling glides are standard.

BRTCRL42	16 x 18 x 28	92.5	15	1.50	\$829	N/A
----------	--------------	------	----	------	--------------	-----

Provides support for worksurfaces connected at 120°. Single leg and beam assembly for 120° worksurface planning. Works with BRTWAC120xxxx or BRTWAC120xxxxA 120° worksurfaces. For a single application, two BRTSL (single legs) must be added. To join a back-to-back table application, leg assembly will join to existing pod.

- When joining to an existing table, the beam extends to reach the shared leg.

BRTFCRL42	16 x 18 x 28	92.5	13	1.50	\$770	N/A
-----------	--------------	------	----	------	--------------	-----

Provides support for worksurfaces connected at 120°, supported by fixed height legs. Single leg and beam assembly for 120° worksurface planning. Works with BRTWAC120xxxx or BRTWAC120xxxxA 120° worksurfaces. For a single application, two BRTFSL (single legs) must be added. To join a back-to-back table application, leg assembly will join to existing pod.

- When joining to an existing table, the beam extends to reach the shared leg.

Required Specifications

Metal finish (legs)

LEG ASSEMBLIES

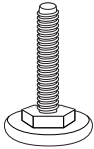

Leveler for Round Leg Table

MODEL#	DIMENSIONS D x W x H	FREIGHT CLASS	WT./LBS.	CUBIC FT.	LIST PRICE	HP ADD
BRTLVR	2.13 x 2.13 x 2	70	.20	.01	\$11	N/A

3/8" thread with black base. Leveler has 1" height adjustment range. Field retrofitable on round leg.



Caster for Round Leg Table

BRTLCR	1.5 x 3 x 3.75	70	.30	.01	\$35	N/A
--------	----------------	----	-----	-----	-------------	-----

Locking. 3" diameter with 3/8" -16 threaded stem. Field retrofitable on round leg.

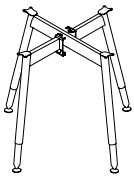

Round Table Leg Assembly

BRTRL	24 x 24 x 28	125	16	2.33	\$853	N/A
-------	--------------	-----	----	------	--------------	-----

Four leg assembly. Leveling Glides are standard. Locking casters are available. Specify (4) BRTLCR. Maximum table diameter is 42". Includes all connecting hardware.

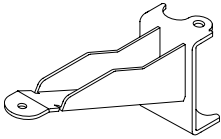

Leg Support Cantilever

BRTLSC	2 x 9 x 5	70	.50	.01	\$148	N/A
--------	-----------	----	-----	-----	--------------	-----

Provides stability for leg supports.

Required Specifications
Metal Finish (legs)

Optional Specifications
Casters (BRTRL)

BEAM APPLICATIONS

D x W x H

Table supporting structures - BEAMS

Legs are connected with supporting beams. There is one beam for a single line of tables while two beams connect back-to-back table structures. Adjustable clamps at either end of the beam can be adjusted to accommodate the following applications in both single table as well as back-to-back table configurations.

STANDARD TABLE BEAM**Single table beam application (1)**

Designed to bridge two legs to form support for a single table, or for two back-to-back worksurfaces. Adjustable clamps at either end of the beam are pushed all the way in to allow both table legs to be tucked under the worksurface.

**End of run table beam application (2)**

Supports one table leg assembly tucked under the worksurface (one adjustable clamp pushed all the way in), while the other table leg assembly can be shared between two adjacent worksurfaces (adjustable clamp pulled out to extend the beam).

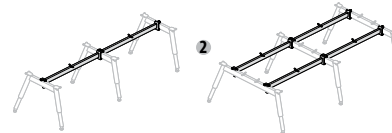
**Interconnecting table beam application (3)**

Supports both table leg assemblies extended to support adjacent worksurfaces on either side. Adjustable clamps at either end of the beam are pushed all the way in to allow both table legs to be tucked under the worksurface. Single table beam application supports single table leg assemblies with legs on both sides tucked under the worksurface.

**TELESCOPIC TABLE BEAM (4)**

Supports a return connected perpendicularly to a 24" or 30" deep primary worksurface. The Telescopic beam is connected to a single or back-to-back leg on one side and to any-worksurface supporting beam on the opposite side. Telescopic beam clamp allows the table leg to be tucked under the worksurface or shared between two adjacent worksurfaces.

**STORAGE TABLE BEAM (5)**

The Storage beam is connected to a single or back-to-back leg on one side and to the worksurface on the opposite side - thus saving one leg assembly. Assembly worksurface is connected to storage units with included storage brackets. Storage table beam's flexibility allows for a single table application (with the table leg tucked in under the worksurface) as well as for a double table installation (two adjacent tables supported by a shared leg in the middle and two storage cabinets at the opposite ends).

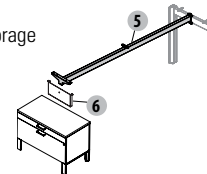
**STORAGE TABLE BEAM ADAPTER (6)**

Connects to a storage table beam. This assembly allows a worksurface to be supported by a leg on one side and a spine (formed by interconnected storage cabinets) on the opposite side.

BEAMS	MODEL#	DIMENSIONS	FREIGHT CLASS	WT./LBS.	CUBIC FT.	LIST PRICE
	BRTSB84C	1 x 79 x 2	60	8.02	.15	\$318
	BRTSB78C	1 x 73 x 2	60	7.38	.12	\$311
	BRTSB72C	1 x 67 x 2	60	6.74	.09	\$302
	BRTSB66C	1 x 61 x 2	60	6.09	.08	\$290
	BRTSB63C	1 x 57.5 x 2	60	5.72	.08	\$286
	BRTSB60C	1 x 55 x 2	60	5.45	.07	\$280
	BRTSB54C	1 x 49 x 2	60	4.86	.06	\$269
	BRTSB51C	1 x 45.5 x 2	60	4.81	.05	\$262
	BRTSB48C	1 x 43 x 2	60	4.60	.05	\$251
	BRTSB42C	1 x 37 x 2	60	3.59	.04	\$241
	BRTSB36C	1 x 31 x 2	60	3.31	.03	\$238
	BRTSB30C	1 x 25 x 2	60	2.70	.02	\$237
	BRTSB24C	1 x 19 x 2	60	2.03	.01	\$230
	BRTSB15C	1 x 10 x 2	70	1.28	.01	\$184

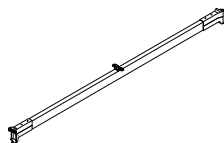
**Standard Table Beam**

Standard Table Beam bridges two legs to form support for a single table, or two back-to-back worksurfaces. Adjustable clamps at either end of the beam accommodate **standard table beam, end of run and interconnecting table beam applications**. Adjustable brackets ship attached to the beam. Specify Standard Table Beam size corresponding nominally to the worksurface length. Includes all hardware necessary to connect to legs. Powder coated steel beam and aluminum cast clamps.

Required Specifications

Metal Finish

BEAMS

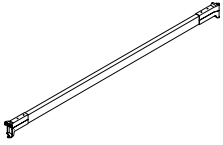

Bottom Table Beam

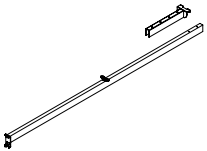

Telescopic Table Beam

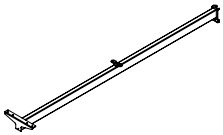

Storage Table Beam

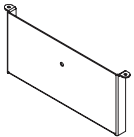

Storage Table Beam Adapter

MODEL#	DIMENSIONS D x W x H	FREIGHT CLASS	WT./LBS.	CUBIC FT.	LIST PRICE
BRTBB84C	1 x 79 x 2	60	10.32	.15	\$358
BRTBB78C	1 x 73 x 2	60	9.68	.12	\$349
BRTBB72C	1 x 67 x 2	60	9.04	.09	\$338
BRTBB66C	1 x 61 x 2	60	8.40	.09	\$326
BRTBB60C	1 x 55 x 2	60	7.75	.08	\$315
BRTBB54C	1 x 49 x 2	60	7.11	.07	\$303
BRTBB48C	1 x 43 x 2	60	6.74	.07	\$281
BRTBB42C	1 x 37 x 2	60	5.83	.06	\$269
BRTBB36C	1 x 31 x 2	60	5.19	.05	\$266

Bottom table beam connects to the lower cross beam on the 36" and 42" high "H" leg to create the footrest. One beam required for each table. Cannot be used as a substitute for the standard table beam. Specify bottom table beam that corresponds to the worksurface length. Includes all hardware necessary to connect to "H" leg. Powder coated steel beam and aluminum cast clamps.

BRTTB84C	1 x 96.5 x 2	60	10.32	.15	\$488
BRTTB78C	1 x 90.5 x 2	60	9.68	.12	\$479
BRTTB72C	1 x 84.5 x 2	60	9.04	.09	\$469
BRTTB66C	1 x 78.5 x 2	60	8.40	.09	\$458
BRTTB60C	1 x 72.5 x 2	60	7.75	.08	\$447
BRTTB54C	1 x 66.5 x 2	60	7.11	.07	\$431
BRTTB48C	1 x 60.5 x 2	60	6.74	.07	\$407
BRTTB42C	1 x 54.5 x 2	60	5.83	.06	\$391
BRTTB36C	1 x 48.5 x 2	60	5.19	.05	\$367

Provides support for a worksurface connected perpendicularly to a run of primary tables. Can be adjusted to accommodate 24" and 30" primary worksurfaces. One end of the beam is attached to a Leg Assembly while the other end is secured, off module to the perpendicular Standard Table Beam, End of Run or Interconnecting Beam. Specify Telescopic Table Beam size corresponding nominally to the return worksurface length.

BRTSTB84C	1 x 80.75 x 2	60	8.64	.09	\$350
BRTSTB78C	1 x 74.75 x 2	60	7.99	.08	\$341
BRTSTB72C	1 x 68.75 x 2	60	7.35	.08	\$329
BRTSTB66C	1 x 62.75 x 2	60	6.74	.07	\$318
BRTSTB60C	1 x 54.75 x 2	60	5.85	.06	\$302
BRTSTB54C	1 x 50.75 x 2	60	5.43	.05	\$280
BRTSTB48C	1 x 44.75 x 2	60	4.78	.05	\$266
BRTSTB42C	1 x 38.75 x 2	60	4.16	.04	\$262
BRTSTB36C	1 x 32.75 x 2	60	3.50	.03	\$251

Allows a worksurface to be supported by a leg on one side and storage tower(s) or spine of 21" and 25" interconnected storage units on the opposite side. Specify Storage Table Beam size corresponding nominally to the worksurface length. Includes all hardware necessary to connect the storage beam to the legs and worksurface.

BRTSA21	1 x 15.2 x 6.5	60	2.15	.05	\$120
BRTSA25	1 x 15.2 x 2.75	60	4.30	.02	\$103

Allows a worksurface to be supported by a leg on one side and storage spine on the opposite side. A typical storage spine is formed by series of Interconnected 21" or 25" storage cabinets of corresponding depth. The 21" or 25" adaptors provide structural support, acting as supports between the top of the storage cabinet spine and the bottom of the perpendicular worksurfaces. The flexible leg/beam/adaptor assembly arrangement allows the leg to be tucked in under the worksurface or to be shared by two adjacent worksurfaces. Specify Storage Beam nominally 18" shorter than worksurfaces for storage spine support application. Specify BRTSA21 or BRTSA25 depending on height of storage units forming the spine. Includes all hardware necessary to connect the adapter to the beam, worksurface and storage spine.

Required Specifications

Metal Finish

WORKSURFACES

MODEL# DIMENSIONS FREIGHT CLASS WT/LBS. CUBIC FT. LIST PRICE HP ADD

D x W x H

BRTWS2484	24 x 84 x 1	60	55	1.80	\$499	\$154
BRTWS2478	24 x 78 x 1	60	51	1.70	\$460	\$148
BRTWS2472	24 x 72 x 1	60	47	1.54	\$431	\$145
BRTWS2466	24 x 66 x 1	60	43	1.41	\$411	\$136
BRTWS2463	24 x 62.5 x 1	65	39	1.41	\$404	\$138
BRTWS2460	24 x 60 x 1	60	39	1.30	\$394	\$131
BRTWS2454	24 x 54 x 1	65	35	1.20	\$355	\$115
BRTWS2451	24 x 50.5 x 1	65	31	1.06	\$359	\$115
BRTWS2448	24 x 48 x 1	65	31	1.06	\$300	\$104
BRTWS2442	24 x 42 x 1	60	28	.90	\$251	\$85
BRTWS2436	24 x 36 x 1	60	23	.71	\$192	\$65
BRTWS3084	30 x 84 x 1	60	69	2.24	\$537	\$165
BRTWS3078	30 x 78 x 1	60	64	2.10	\$483	\$153
BRTWS3072	30 x 72 x 1	65	59	2	\$455	\$151
BRTWS3066	30 x 66 x 1	60	54	1.80	\$427	\$145
BRTWS3063	30 x 62.5 x 1	65	49	1.77	\$417	\$140
BRTWS3060	30 x 60 x 1	65	49	1.77	\$411	\$136
BRTWS3054	30 x 54 x 1	60	44	1.44	\$383	\$115
BRTWS3051	30 x 50.5 x 1	65	39	1.41	\$377	\$120
BRTWS3048	30 x 48 x 1	65	39	1.41	\$355	\$115
BRTWS3042	30 x 42 x 1	60	34	1.12	\$334	\$112
BRTWS3036	30 x 36 x 1	65	30	1.06	\$238	\$81
BRTWS3663	36 x 62.5 x 1	65	53	1.94	\$625	\$162
BRTWS3651	36 x 50.5 x 1	65	43	1.71	\$556	\$93

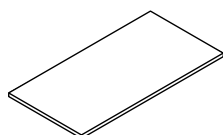

Rectangular Worksurface

Flat 3 mm edge profile on all sides.

BRTWSAA2484	24 x 84 x 1	60	51	1.70	\$594	\$289
BRTWSAA2478	24 x 78 x 1	60	47	1.54	\$563	\$258
BRTWSA2472	24 x 72 x 1	60	47	1.54	\$517	\$238
BRTWSA2466	24 x 66 x 1	60	43	1.41	\$480	\$206
BRTWSA2460	24 x 60 x 1	60	39	1.30	\$442	\$187
BRTWSA2454	24 x 54 x 1	65	35	1.20	\$392	\$179
BRTWSA2448	24 x 48 x 1	65	31	1.06	\$355	\$160
BRTWSA2442	24 x 42 x 1	60	28	.90	\$315	\$140
BRTWSAA3084	30 x 84 x 1	60	64	2.10	\$706	\$349
BRTWSAA3078	30 x 78 x 1	65	59	2	\$665	\$327
BRTWSA3072	30 x 72 x 1	65	59	2	\$615	\$285
BRTWSA3066	30 x 66 x 1	60	54	1.80	\$577	\$256
BRTWSA3060	30 x 60 x 1	65	49	1.77	\$517	\$238
BRTWSA3054	30 x 54 x 1	60	44	1.44	\$469	\$216
BRTWSA3048	30 x 48 x 1	65	39	1.41	\$420	\$187
BRTWSA3042	30 x 42 x 1	60	34	1.12	\$372	\$168

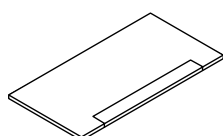

Rectangular Worksurface with Access Door

Flat 3 mm edge profile on all sides. Worksurfaces 42" to 72" w have one access door. 78" w and 84" w worksurfaces have two access doors. Access door is offset 13.5" from either side of worksurface. Anodized aluminum worksurface door provides access to power/data trough below worksurface. Worksurface with access doors CANNOT be combined with above worksurface power trough.

BRTWBE2451R	24 x 50.5 x 1	65	31	1.06	\$355	\$115
BRTWBE2463R	24 x 62.5 x 1	65	39	1.41	\$411	\$136
BRTWBE3051R	30 x 50.5 x 1	65	39	1.41	\$383	\$115
BRTWBE3063R	30 x 62.5 x 1	65	49	1.77	\$427	\$145

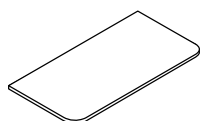

Rectangular Boardroom Table Top Extension, Round Corners

Flat 3 mm edge profile on all sides. Boardroom table extensions convert existing 24" or 30" deep back-to-back Bridges table assembly into a boardroom table. 24" and 30" d rectangular top with round corner can only be supported by 34" double leg and extension beams. *No freestanding and mobile application.*

Required Specifications

Top finish
Edge finish

Optional Specifications

HP laminate

WORKSURFACES

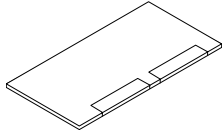

Rectangular Worksurface with 2 Access Doors

MODEL#	DIMENSIONS D x W x H	FREIGHT CLASS	WT./LBS.	CUBIC FT.	LIST PRICE	HP ADD
BRTWSAA2484	24 x 84 x 1	60	51	1.70	\$594	\$289
BRTWSAA2478	24 x 78 x 1	60	47	1.54	\$563	\$258
BRTWSAA2472	24 x 72 x 1	60	43	1.41	\$556	\$257
BRTWSAA2466	24 x 66 x 1	60	39	1.30	\$517	\$226
BRTWSAA2460	24 x 60 x 1	65	35	1.20	\$476	\$203
BRTWSAA3084	30 x 84 x 1	60	64	2.10	\$706	\$349
BRTWSAA3078	30 x 78 x 1	65	59	2	\$665	\$327
BRTWSAA3072	30 x 72 x 1	60	54	1.80	\$659	\$308
BRTWSAA3066	30 x 66 x 1	65	49	1.77	\$622	\$272
BRTWSAA3060	30 x 60 x 1	60	44	1.44	\$556	\$257

Flat 3 mm edge profile on all sides. Access doors are offset 10" (60" worksurfaces) and 13.5" (worksurfaces 66" and wider) from either side of worksurface. Anodized aluminum worksurface doors provide access to power/data trough below worksurface. Worksurfaces with access doors CANNOT be combined with above worksurface power troughs. Dimension between doors is 8" for 60" and 66" surfaces, 20" for 78", and 26" for 84".

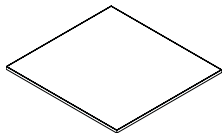

Meeting Table Top

BRTWS2451	24 x 50.5 x 1	65	31	1.06	\$359	\$115
BRTWS3051	30 x 50.5 x 1	65	39	1.41	\$377	\$120
BRTWS3651	36 x 50.5 x 1	65	43	1.71	\$556	\$93
BRTWS4251	42 x 50.5 x 1	65	48	1.93	\$615	\$165
BRTWS4851	48 x 50.5 x 1	65	52	2.07	\$699	\$183
BRTWS5151	50.5 x 50.5 x 1	65	55	2.12	\$748	\$173
BRTWS5451	54 x 50.5 x 1	65	59	2.19	\$808	\$226
BRTWS6051	60 x 50.5 x 1	65	63	2.26	\$919	\$231
BRTWS2463	24 x 62.5 x 1	65	39	1.41	\$404	\$138
BRTWS3063	30 x 62.5 x 1	65	49	1.77	\$417	\$140
BRTWS3663	36 x 62.5 x 1	65	53	1.94	\$625	\$162
BRTWS4263	42 x 62.5 x 1	65	57	2.07	\$748	\$196
BRTWS4863	48 x 62.5 x 1	65	61	2.13	\$898	\$227
BRTWS5463	54 x 62.5 x 1	65	63	2.21	\$1009	\$255
BRTWS6063	60 x 62.5 x 1	65	67	2.34	\$1124	\$279

Can create convenient, flexible extension of the back-to-back Bridges table assembly. Worksurfaces provided with pilot holes for alignment purposes.

- Meeting table top 50.5" long side matches 24" deep back-to-back Bridges table assembly
- Meeting table top 62.5" long side matches 30" deep back-to-back Bridges table assembly

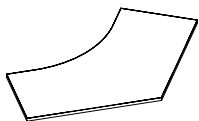

120° Worksurface

BRTWAC120424224	24 x 42 x 1	65	31	1.06	\$886	\$291
BRTWAC120424230	30 x 42 x 1	65	39	1.41	\$965	\$295

5-sided worksurface can be used for a single, freestanding table, can form a pod of two or three tables, or can be combined with rectangular worksurfaces to create a larger workstation.

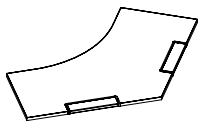

120° Worksurface with Access Door

BRTWAC120A424224	24 x 42 x 1	65	31	1.06	\$943	\$316
BRTWAC120A424230	30 x 42 x 1	65	39	1.41	\$1019	\$395

5-sided worksurface can be used for a single, freestanding table, can form a pod of two or three tables, or can be combined with rectangular worksurfaces to create a larger workstation. Access door is offset 13.5" from either side of worksurface. Anodized aluminum worksurface door provides access to power/data trough below worksurface. Worksurface with access doors CANNOT be combined with above worksurface power trough.

Required Specifications

Top finish
Edge finish

Optional Specifications

HP laminate

WORKSURFACES

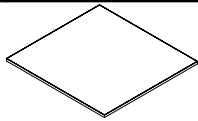

Rectangular Meeting Table Top*

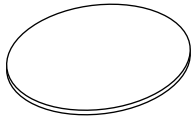

Round Meeting Table Top*

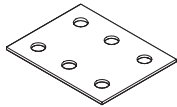

Flat Bracket

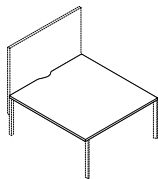

Display Wall Table Top w/Scoop*

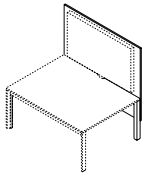

Monitor Facing Double Workstation**

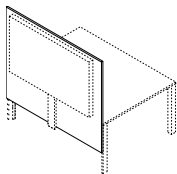

Monitor Facing Back of Double Workstation**

MODEL#	DIMENSIONS	FREIGHT CLASS	WT./LBS.	CUBIC FT.	LIST PRICE	HP ADD
--------	------------	---------------	----------	-----------	------------	--------

D x W x H

BRTMT5151	50.5 x 50.5 x 1	65	55	2.12	\$703	\$392
-----------	-----------------	----	----	------	--------------	--------------

50.5" long side matches 24" d back-to-back table assembly.

BRTMTR42	42 x 42 x 1	65	40	1.76	\$469	\$119
----------	-------------	----	----	------	--------------	--------------

BHBF01	4 x 3	70	.50	.01	\$22	
--------	-------	----	-----	-----	-------------	--

Constructed of cold rolled steel. May be used to ensure alignment of neighboring worksurfaces.

BRTWS6051SCP	60 x 50.5 x 1	60	75	1.75	\$899	\$228
BRTWS5451SCP	54 x 50.5 x 1	60	68	1.58	\$794	\$222
BRTWS4863SCP	48 x 62.5 x 1	60	75	1.74	\$880	\$223

BRTWS6063SCP	60 x 62.5 x 1	60	93	2.17	\$1100	\$272
BRTWS5463SCP	54 x 62.5 x 1	60	84	1.95	\$992	\$249
BRTWS4863SCP	48 x 62.5 x 1	60	75	1.74	\$880	\$223

Display wall mounts to the end of back-to-back table assembly supported by rectangular legs. As opposed to two separate back-to-back worksurfaces, the display wall table top provides one continuous, uninterrupted surface with a scoop cutout next to the display wall (the scoop facilitates cable passage from below the table). Table top 50.5" w side matches 24" d back-to-back table assemblies. Meeting table tops 62.5" w side matches 30" d back-to-back table assemblies.

BRTTVF63	4 x 62.5 x 52	100	74	7.52	\$1757	
BRTTVF51	4 x 50.5 x 52	92.5	62	6.08	\$1663	

Display wall faces the double workstation; facilitates seated presentation area. Includes laminate board, TV/display brackets (black), mounting hardware, vertical cable manager (black). Slim (22mm) bracket capable of supporting displays/TVs up to 50" (resp. 62") wide, up to 80lbs. When installed, top of the 52" x 50.5" (resp. 62.5") wide board reaches 65.5"h. 1" LP laminate board with 3mm edging. Specify **WHB** to add HP white, dry-erase marker board laminate on non-display board surface and standard HP laminate on the opposite side. Display wall mounts to the end of back-to-back table assembly supported by rectangular legs or back-to-back table structure with BRTWSxxxxSCP Display Wall Table Top with Scoop.

- Included vertical cable manager passes through the gap between 2 back-to-back worksurfaces. Should you need one continuous, uninterrupted surface specify BRTWSxxxxSCP Display Wall Table Top with Scoop.
- Add **\$1036** for white, dry erase on 51" w model, and **\$1383** for 63" w

BRTTVBK63	4 x 62.5 x 52	100	74	7.52	\$1757	
BRTTVBK51	4 x 50.5 x 52	92.5	62	6.08	\$1663	

Display wall support board mounts to end of back-to-back table assembly supported by rectangular legs. Display faces back of the double workstation (combine with collaborative seating). Includes laminate board, TV/display brackets (black), mounting hardware, vertical cable manager (black). Slim (22mm) bracket capable of supporting displays/TVs up to 50" (resp. 62") wide, up to 80lbs. When installed, top of the 52" x 50.5" (resp. 62.5") wide board reaches 65.5"h. 1" LP laminate board with 3mm edging. Specify **WHB** to add HP white, dry-erase marker board laminate on non-display board surface and standard HP laminate on the opposite side. Display wall mounts to the end of back-to-back table assembly supported by rectangular legs or back-to-back table structure with BRTWSxxxxSCP Display Wall Table Top with Scoop.

- Add **\$1036** for white, dry erase on 51" w model, and **\$1383** for 63" w

Required Specifications

Top finish
Edge finish

Optional Specifications

HP laminate

POWER DELIVERY / CABLE MANAGEMENT

D x W x H

At the basic level, table and floor based office equipment is serviced by a wall or floor power supply. As the operation grows, there might be a need to organize excessive cable clutter.

Wire Basket (1) connects to the underside of worksurfaces with sprig brackets, and cables are simply dropped and coiled into them. *Wire Basket is not to be used with power troughs.*

Cable Snake (2) Installed in proximity of floor monument to manage vertical cable clutter..

Table clamped, single circuit **Desk Top Power Data Modules (3)** deliver services to desk height, while tapping into wall or floor power supply. Again, the excessive cables can be managed with Cable Trays.

Ceiling pole **BRTCPP (4)** manages power and data cables between ceiling and above or below worksurface power troughs.

Above and Below Worksurface Power/Data Troughs (5) can be installed between back-to-back tables for extended below and above desk height power/data distribution. 8 wire, 4-circuit system. (2 + 2 circuit configuration)

NOTE: Specify **BRTHH58 (8)** to distribute power from double-sided, back-to-back below worksurface power trough to a single-sided, below worksurface power trough at the end of a table run.

Leg shroud (9) attaches to 34" w legs and manages power floor feed, as well as data cables from floor monument.

Single Sided Power/Data Troughs (6) can be installed to the underside of a single table.

Storage power/data box BRTVCM (7) attaches to storage units and provides access to one duplex/data terminal on top storage surface. Integrated single circuit module can be plugged to floor monument under the storage or to a wall outlet

4-2-2 Wiring Schematic

8-Wire Shared Neutral

"2 + 2" - 2 Utility Circuits, 2 Dedicated

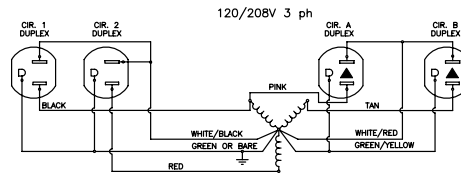
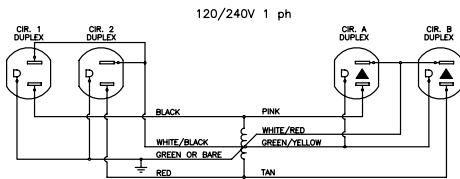

8 Wires

4 Lines (12 ga.)
2 Neutrals (10 ga.)
2 Grounds (12 ga.)

4 Circuits

2 Utility circuits
2 Dedicated Circuits

Receptacles

Duplex - Up to 12 duplex receptacles per circuit
(Up to 48 per infeed)

Specifications

System rated for connection to a grounded 120/240 V single phase, 20A, 60Hz or 120/208 V, 3 phase, 20A, 60Hz branch circuit for U.S. and 15A if product is marked with a C-UL Mark. Outlets rated 15A max.

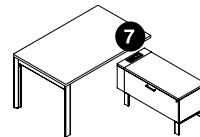
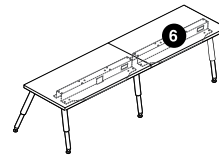
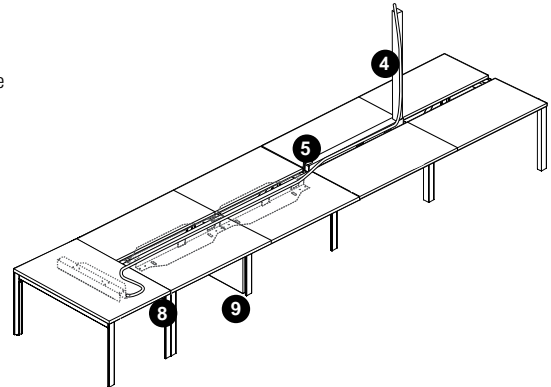
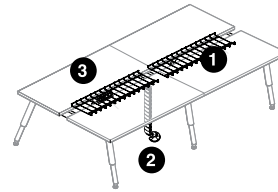

POWER DELIVERY / CABLE MANAGEMENT

MODEL# DIMENSIONS FREIGHT CLASS WT/LBS. CUBIC FT. LIST PRICE

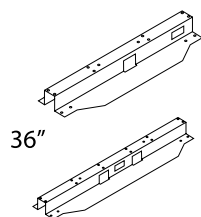

36"

42" - 72"

Below Worksurface Single Power/Data Trough

MODEL#	D x W x H	FREIGHT CLASS	WT/LBS.	CUBIC FT.	LIST PRICE
BRTEETB84SKIT	11.6 x 78.34 x 2.5	100	12	1.31	\$1129
BRTEETB78SKIT	11.6 x 72.34 x 2.5	100	11	1.21	\$1081
BRTEETB72SKIT	11.6 x 66.34 x 2.5	100	9.80	1.11	\$703
BRTEETB66SKIT	11.6 x 60.34 x 2.5	100	8.90	1.01	\$680
BRTEETB60SKIT	11.6 x 54.34 x 2.5	100	8	.91	\$655
BRTEETB54SKIT	11.6 x 48.34 x 2.5	100	7.10	.81	\$642
BRTEETB48SKIT	11.6 x 42.34 x 2.5	100	6.20	.71	\$615
BRTEETB42SKIT	11.6 x 36.34 x 2.5	100	5.30	.61	\$568
BRTEETB36SKIT	11.6 x 30.34 x 2.5	125	4.50	.59	\$517

Formed steel trough is secured below a single table worksurface; outlets are facing the rear worksurface edge. Cannot be used on back-to-back tables. Specify Duplex receptacles separately. *Covers for duplex openings are not supplied.* 36" trough can house one duplex and 42-72" trough can house two duplexes. Specify jumpers between tables separately. Base feed entry at either end and not suitable for ceiling feed. Each trough provides one opening at 1.37" x 2.68" for terminal plate (not supplied). One terminal plate can accommodate up to 4 data/communication terminals (jacks). Data/comm plate spacer BRTPDS available to accommodate larger cable-to-terminal bending radius.

- BRTEETB36SKIT through BRTEETB72SKIT consist of one single sided steel trough, Power Distribution housing, mounting brackets and one charcoal grey extruded Data/Communication cable manager.
- BRTEETB78SKIT and BRTEETB84SKIT consist of two single-sided steel troughs, two Power Distribution Housings, mounting brackets and two charcoal grey extruded Data/Communication cable managers.
- BRTEETB78SKIT includes (1) BRTEETB36SKIT, (1) BRTEETB42SKIT and (1) JUMPER
- BRTEETB84SKIT includes (2) BRTEETB42SKIT and (1) JUMPER
- For 120° table applications, please specify BRTEETB36SKIT single trough kit for tables with BRTWAC120xx and BRTWAC120Axx worksurfaces. BRTEHH28 may be used as usual.
- Specify duplex receptacles separately
- Each trough includes one black BRTPDS Data/Comm spacer, extending the depth behind the Data/Comm opening by 0.6". White (BRTPDSW) and Silver (BRTPDSS). Data/Comm spacers are available as a special order for **\$59** list, see BRTPDS.

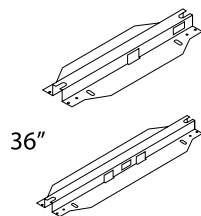

36"

42" - 72"

Below Worksurface Double Power/Data Trough

BRTEETB84DKIT	8.5 x 78.3 x 2.5	92.5	9.80	.96	\$1458
BRTEETB78DKIT	8.5 x 72.3 x 2.5	92.5	9	.88	\$1437
BRTEETB72DKIT	8.5 x 66.3 x 2.5	92.5	8.30	.81	\$847
BRTEETB66DKIT	8.5 x 60.3 x 2.5	92.5	7.50	.74	\$829
BRTEETB60DKIT	8.5 x 54.3 x 2.5	92.5	6.80	.66	\$800
BRTEETB54DKIT	8.5 x 48.3 x 2.5	92.5	6	.59	\$779
BRTEETB48DKIT	8.5 x 42.3 x 2.5	92.5	5.30	.52	\$761
BRTEETB42DKIT	8.5 x 36.3 x 2.5	92.5	4.50	.44	\$730
BRTEETB36DKIT	8.5 x 30.3 x 2.5	92.5	3.80	.37	\$712

Formed steel trough is secured below worksurface; outlets between back-to-back stations supported by double table legs. Cannot be used on single table assemblies. Specify Duplex receptacles separately. *Covers for duplex openings are not supplied.* 36" trough can house one duplex per side and 42-72" trough can house two duplexes per side. Specify jumpers between tables separately. Ceiling feed entry through slots at either end; base feed entry at either end. Each trough provides one opening at 1.37" x 2.68" (one per side) for data/communication terminal plates. A single terminal plate (not supplied) can accommodate up to 4 data/communication plates. Data/comm plate spacer BRTPDS available to accommodate larger cable-to-terminal bending radius.

- BRTEETB36DKIT through BRTEETB72DKIT consist of one double-sided steel trough, Power Distribution housing, mounting brackets and one charcoal grey extruded Data/Communication cable manager.
- BRTEETB78DKIT and BRTEETB84DKIT consist of two double-sided steel troughs, two Power Distribution Housings, mounting brackets and two charcoal grey extruded Data/Communication cable managers.
- BRTEETB78DKIT includes (1) BRTEETB36DKIT, (1) BRTEETB42DKIT and (1) JUMPER
- BRTEETB84DKIT includes (2) BRTEETB42DKIT and (1) JUMPER
- For back-to-back 120° table applications, please specify BRTEETB42DKIT double trough kit for tables with BRTWAC120xx and BRTWAC120Axx worksurfaces. BRTEHH28 may be used as usual.
- Specify duplex receptacles separately
- Each trough includes one black BRTPDS Data/Comm spacer, extending the depth behind the Data/Comm opening by 0.6". White (BRTPDSW) and Silver (BRTPDSS). Data/Comm spacers are available as a special order for **\$59** list, see BRTPDS.

Required Specifications

Metal Finish (Power/Data Troughs)

ELECTRICAL COMPONENTS

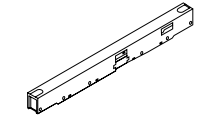

36"

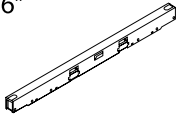

42" - 72"

Above Worksurface Power Trough

MODEL#	DIMENSIONS D x W x H	FREIGHT CLASS	WT/LBS.	CUBIC FT.	LIST PRICE
BRTEETA84KIT	2.5 x 84 x 3.5	65	9.49	.42	\$1265
BRTEETA78KIT	2.5 x 78 x 3.5	65	8.81	.39	\$1217
BRTEETA72KIT	2.5 x 71.9 x 3.5	65	8.12	.36	\$800
BRTEETA66KIT	2.5 x 65.9 x 3.5	65	7.45	.33	\$790
BRTEETA60KIT	2.5 x 59.9 x 3.5	65	6.77	.30	\$730
BRTEETA54KIT	2.5 x 53.9 x 3.5	65	6.09	.27	\$712
BRTEETA48KIT	2.5 x 47.9 x 3.5	65	5.41	.24	\$674
BRTEETA42KIT	2.5 x 41.9 x 3.5	65	4.73	.21	\$634
BRTEETA36KIT	2.5 x 35.9 x 3.5	65	4.06	.18	\$586

Formed steel trough is secured between back-to-back stations. Cannot be used on single table assemblies. Specify Duplex receptacles separately. *Covers for duplex openings are not supplied.* 36" trough side. **Specify jumpers between tables separately.** Ceiling feed entry through can house one duplex per side and 42-72" trough can house two duplexes per slots at either end; base feed entry at either end. Each trough provides two openings at 1.37" x 2.68" (one per side) for data/communication terminal plates. A single terminal plate (not supplied) can accommodate up to 4 data/comm plates. Data/comm plate spacer BRTPDS available to accommodate larger cable-to-terminal bending radius.

- BRTEETA36KIT through BRTEETA72KIT consist of one double-sided steel trough, Power Distribution Housing, mounting brackets and one charcoal grey extruded Data/Communication cable manager.
- BRTEETA78KIT and BRTEETA84KIT consist of two double-sided steel troughs, two Power Distribution Housings, mounting brackets and two charcoal grey extruded Data/Communication cable managers.
- BRTEETA78KIT includes (1) BRTEETA36KIT, (1) BRTEETA42KIT and (1) JUMPER
- BRTEETA84KIT includes (2) BRTEETA42KIT and (1) JUMPER
- Specify above worksurface power trough end cap BRTEETEC to finish open ends of the power trough
- Each trough includes one black BRTPDS Data/Comm spacer, extending the depth behind the Data/Comm opening by 0.6". White (BRTPDSW) and Silver (BRTPDSS). Data/Comm spacers are available as a special order for **\$59** list, see BRTPDS.

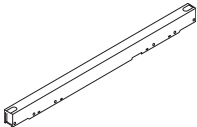

Back-to-Back Storage Tower Gap Filler Kit

BRTEST15KIT	15.5 x 2.5 x 3.5	65	2	.08	\$527
BRTEST24KIT	24 x 2.5 x 3.5	70	2.50	.12	\$572
BRTEST30KIT	31 x 2.5 x 3.5	70	3.50	.16	\$610
BRTEST48KIT	48 x 2.5 x 3.5	70	4	.24	\$673

Consists of a formed sheet metal cover and four brackets which allow the cover to be mounted at either above worksurface power trough level or below worksurface power trough level. Versatile brackets secure the cover trough at corners, to the bottom of back-to-back worksurface supported by either shared 51" or 63" legs or storage beam and storage towers.

- Note: the back-to-back storage tower gap filler is not compatible with single, freestanding tables.
- The BRTEST15kit and BRTEST24kit cover the gap between two back-to-back BRTT5024x or BRTT5030x storage towers
- The BRTEST30kit and BRTEST48kit cover the gap between two pairs of back-to-back BRTT5024x or BRTT5030x storage towers



Above Worksurface Power Trough

BRTEETEC	.5 x 2.25 x 3	70	.10	.01	\$11
----------	---------------	----	-----	-----	-------------

Covers the end of the worksurface power trough. Specify two per linear trough assembly. White finish only.

Required Specifications

Metal Finish (Power/Data Troughs)

ELECTRICAL COMPONENTS

MODEL# DIMENSIONS FREIGHT CLASS WT./LBS. CUBIC FT. LIST PRICE

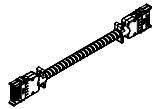

Housing to Housing Harness

	D x W x H				
BRTEHH28	.5 x 28 x 2	70	1	1.17	\$179
BRTEHH40	.5 x 40.5 x 2	70	1.10	1.25	\$191
BRTEHH44	.5 x 44.5 x 2	70	1.5	1.17	\$206
BRTEHH52	.5 x 52.5 x 2	300	2.0	1.17	\$217
BRTEHH58	.5 x 58.5 x 2	300	2.2	1.17	\$226
BRTEHH76	.5 x 76.5 x 2	250	2.8	1.17	\$252

Distributes power between Power Distribution Housings.

- BRTEHH28 distributes power between back-to-back or single sided troughs in a straight run.
- BRTEHH40 distributes power from back-to-back to single sided power troughs
- BRTEHH44 distributes power between back-to-back power troughs separated by (1) pair of storage cabinets without wardrobes. Specify BRTEST15KIT separately.
- BRTEHH52 distributes power from back-to-back power troughs separated by (1) pair of storage cabinets with wardrobes. Specify BRTEST24KIT separately.
- BRTEHH58 distributes power from back-to-back power troughs separated by (2) pairs of storage cabinets without wardrobes. Specify BRTEST30KIT separately.
- BRTEHH58 also distributes power from double-sided, back-to-back below worksurface power troughs to a single sided, below worksurface power trough at the end of a table run.
- BRTEHH76 distributes power from back-to-back power troughs separated by (2) pairs of storage cabinets with wardrobes. Specify BRTEST48KIT separately.

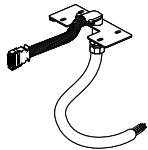

Base Feed

BRTEBF	6 x 4 x 72	250	4	2	\$542
BRTEBF120	6 x 4 x 120	250	6	2	\$755
BRTEBF144	6 x 4 x 144	150	8	2	\$812

Provides single power entry from floor or wall located building power supply. Connects to Power Distribution Housing. Must be hard wired to the building power supply by a licensed electrician.

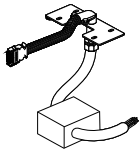

Base Feed - New York Electrical

BRTEBFK	6 x 4 x 100	250	4	2	\$851
---------	-------------	-----	---	---	--------------

Provides single power entry from floor or wall located building power supply. Connects to Power Distribution Housing. Must be hard wired to the building power supply by a licensed electrician.



Ceiling Pole

BRTCPP	1.5 x 4.75 x 99	65	13	.48	\$294
--------	-----------------	----	----	-----	--------------

Brings ceiling feed conduit and data cables from the ceiling down to Power Troughs at desk height. Accommodates 10' ceiling heights. Two part construction allows power/data conduit lay-in. Attaches to a junction between two adjacent Power Troughs in back-to-back applications only. Not for use on single sided Bridges II troughs. Includes mounting hardware and ceiling bezel. Painted Finish.

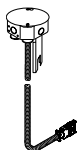

Ceiling Feed

BRTECF120	6 x 6 x 120	250	5	2	\$476
BRTECF144	6 x 6 x 144	250	5	2	\$530

Provides single power entry from ceiling, through ceiling pole into Power Trough, into Power Distribution Module. An 8 wire (4 circuit) metal conduit harness with included metal junction box for hard wiring to the building power supply above ceiling tile. Must be hard wired to the building power supply by a licensed electrician. Ceiling Pole not included.

Required Specifications

Metal Finish (BRTCPP)

ELECTRICAL COMPONENTS

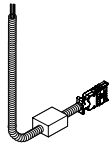

Ceiling Feed - New York Electrical

MODEL#	DIMENSIONS D x W x H	FREIGHT CLASS	WT./LBS.	CUBIC FT.	LIST PRICE
BRTECFK120	6 x 6 x 120	250	5	2	\$712
BRTECFK144	6 x 6 x 144	250	5	2	\$790

Provides single power entry from ceiling, through ceiling pole into Power Trough, into Power Distribution Module. An 8 wire (4 circuit) metal conduit harness with included metal junction box for hard wiring to the building power supply above ceiling tile. Must be hard wired to the building power supply by a licensed electrician. Ceiling Pole not included.

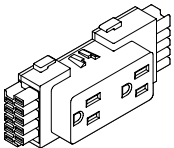

Duplex Receptacles

BRTE8D1	1.25 x 4.63 x 2	70	.10	.01	\$42
BRTE8D2	1.25 x 4.63 x 2	70	.10	.01	\$42
BRTE8DA	1.25 x 4.63 x 2	70	.10	.01	\$42
BRTE8DB	1.25 x 4.63 x 2	70	.10	.01	\$42
BRTE8DXW1	1.25 x 4.63 x 2	70	.10	.01	\$59
BRTE8DXW2	1.25 x 4.63 x 2	70	.10	.01	\$59
BRTE8DXWA	1.25 x 4.63 x 2	70	.10	.01	\$59
BRTE8DXWB	1.25 x 4.63 x 2	70	.10	.01	\$59

Snaps into Power Distribution Housing. Up to 13 duplex receptacles per circuit XW identifies white color plastic, all others standard in black.

- BRTE8D1 / BRTE8DXW1 - Circuit #1 (utility circuit)
- BRTE8D2 / BRTE8DXW2 - Circuit #2 (utility circuit)
- BRTE8DA / BRTE8DXWA - Circuit A (dedicated circuit)
- BRTE8DB / BRTE8DXWB - Circuit B (dedicated circuit)

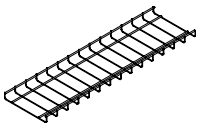

Power/Data Cable Basket

BRTCB76KIT	8 x 34 x 1	70	1.56	.15	\$263
BRTCB70	8 x 70 x 1	100	3.22	.34	\$191
BRTCB64	8 x 64 x 1	92.5	2.94	.29	\$178
BRTCB58	8 x 58 x 1	92.5	2.66	.26	\$172
BRTCB52	8 x 52 x 1	100	2.39	.24	\$162
BRTCB46	8 x 46 x 1	92.5	2.16	.21	\$153
BRTCB40	8 x 40 x 1	70	1.80	.18	\$145
BRTCB34	8 x 34 x 1	70	1.56	.15	\$139
BRTCB28	8 x 28 x 1	70	1.20	.13	\$123
BRTCB22	8 x 22 x 1	70	1.01	.10	\$115
BRTCB16	8 x 16 x 1	70	.73	.07	\$108
BRTCB8	8 x 8 x 1	70	.36	.03	\$97

Shallow, 8" wide basket manages cable excess and serves to manage cords and cables. It can be easily unclipped from spring steel brackets (included) to rearrange cable connections from below worksurface. Spring steel brackets can suspend the Cable Basket below storage cabinet's bottom where it keeps the cords and cables off the floor and manages them under storage cabinets along the horizontal plane - between floor monuments and Storage Vertical Cable Manager, for example. Tall storage cabinet's legs provide easy access to the Cable Basket where it can easily be unclipped from spring steel brackets to rearrange cable connections. Steel wire construction, chrome finish baskets; black spring steel hanging brackets, fasteners.

- Wide Cable Baskets can span under several storage cabinets. Specify Cable Basket a min. 8" shorter than the storage cabinet spine assembly.

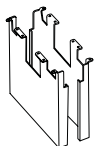

34" Leg Shroud

BRTDLSHS34	5 x 30 x 29	92.5	62	5.25	\$539
------------	-------------	------	----	------	--------------

A two part steel enclosure creates 5" deep and 30" wide cable management cavity between 34" rectangular table legs. Hides floor power feeds as well as data/communication cables rising from floor monuments to the underside of Bridges II tables. Secures to BRTBA34L rectangular leg and to underside of worksurfaces. Specify powder coat finish.

Required Specifications
Metal Finish (BRTDLSHS34)

ELECTRICAL COMPONENTS

**Cable Snake**

MODEL#	DIMENSIONS D x W x H	FREIGHT CLASS	WT./LBS.	CUBIC FT.	LIST PRICE
--------	-------------------------	---------------	----------	-----------	------------

BRTCS	2 x 8 x 30	70	3	.19	\$152
-------	------------	----	---	-----	--------------

Flexible cable management trough. Two pathways within the snake, one for data/communication and one for routing power cables. Translucent White finish only.

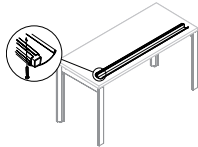
**Wire Manager**

BRTCM43	46 x 5 x 3	92.5	8	.67	\$62
BRTCM55	58 x 5 x 3	92.5	9	.85	\$72

Replacement wire manager can be added. Wire Manager neatly organizes and stores electrical and communication cables. Two lengths: 46" for tops 60" and under; 58" for tops 72". Black Plastic only.

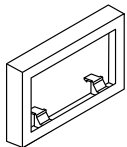
**Data/Comm Spacer**

BRTPDS	.6 x 4.75 x 2.04	70	.10	.01	\$59
BRTPDSW	.6 x 4.75 x 2.04	70	.10	.01	\$59
BRTPDSS	.6 x 4.75 x 2.04	70	.10	.01	\$59

Data/Comm plate spacer extends the depth behind data/comm jacks by 0.6" in order to accommodate larger data/comm cable bending radius. BRTPDS is Black, BRTPDSW is White and BRTPDSS is Silver.

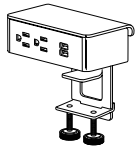
**Duo Module**

BRED50	3.2 x 5.5 x 1.8	70	2.50	.14	\$386
--------	-----------------	----	------	-----	--------------

The duo power module is completely integrated with a mounting clamp to attach to the edge of a worksurface. Provides two outlets and two 2.1 amp USB ports. White face plate, outlets and bracket; 72" long three-prong black cord, silver body.

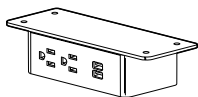
**Duo Under Module**

BREDU51	2.8 x 5.5 x 1.8	70	2.50	.14	\$335
---------	-----------------	----	------	-----	--------------

The duo under power module comes with a thin flush mounting bracket to attach to the underside of a worksurface or above worksurface shelves. Provides two outlets and two 2.1 amp USB ports. White face plate, outlets and brackets; 72" long three-prong black cord, silver body.

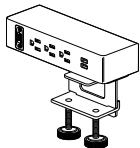
**Trio Plus Module**

BRETP53	3.2 x 8 x 1.8	70	2.50	.14	\$436
---------	---------------	----	------	-----	--------------

The trio plus power module is completely integrated with a mounting clamp to attach to the edge of a worksurface or above worksurface shelves. Provides three outlets and two 2.1 amp USB ports and an adapter kit containing blank cover, HDMI, RJ45 or VGA adapter brackets. Note: HDMI, RJ45 and VGA connectors are not included. White face plate, outlets, adapters and brackets; 72" long three-prong black cord.

ELECTRICAL COMPONENTS

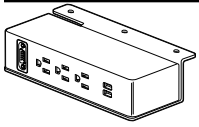

Trio Plus Under Module

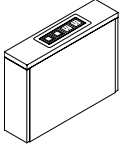

Vertical Cable Manager*

MODEL#	DIMENSIONS D x W x H	FREIGHT CLASS	WT./LBS.	CUBIC FT.	LIST PRICE
BRETPU54	2.8 x 8 x 1.8	70	2.50	.14	\$406

The trio plus under power module comes with a thin flush mounting bracket to attach to the underside of a worksurface. Provides three outlets and two 2.1 amp USB ports and an adapter kit containing blank cover, HDMI, RJ45 or VGA adapter brackets. Note: HDMI, RJ45 and VGA connectors are not included. White face plate, outlets, adapters and brackets; 72" long three-prong black cord.

BRTVCM2118	18 x 6 x 21	92.5	14	1.31	\$1069
BRTVCM2518	18 x 6 x 25	92.5	17	1.56	\$1091
BRTVCM2124	24 x 6 x 21	100	17	1.75	\$1129
BRTVCM2524	24 x 6 x 25	92.5	22	2.08	\$1147

Facilitates power/data transfer from a floor monument under storage cabinets. The units can join other 18" or 24" deep storage units to form a storage spine. Removable top with a Below worksurface Power/Data Module provides easy access. Optional cable basket suspends off storage unit's bottom and manages cables along the horizontal plane. 1" top, unfinished cut-out edges. Universal connecting hardware included. Below Worksurface Power/Data Module included. Provides power - two outlets; 72"L 3-prong power cord. White face plate, outlets and coupler & jack adapters; anodized aluminum bracket supports; thumb screws, black cord. Provides data - two coupler/jack ports; includes Voice/Data Adapter Kit to accept various couplers & jacks (Not Included).

Required Specifications

- Top finish*
- Edge finish*
- Chassis finish*

ACCESSORIES / TABLE DIVIDERS MODEL# DIMENSIONS FREIGHT CLASS WT./LBS. CUBIC FT. LIST PRICE

- 9mm thick panels offered in 9 finishes
- Made from 100% PET (polyester) fiber with a high content (50%) of post-recycled material, free of added chemicals, binders and adhesives
- Lightweight panels are tackable, impact and tear resistant, bacteria resistant, moisture resistant, and installation friendly
- Variation in fiber mix and color are inherent to the character of the product

BRACKET/EXTRUSION FINISH

BLK	Black
CHR	Charcoal
DWT	Designer White
FOG	Fog
NEV	Nevada
SIL	Silver
TPE	Taupe
TUN	Tungsten
ANO	Anodized Aluminum - upcharge applies. Available on select models only. Refer to model for availability and upcharge.

FELT COLORS

BLK	Black	MTS	Mist
BRI	Brick	PWT	Pewter
DEN	Denim	SHR	Shamrock
GPH	Graphite	WHT	White
HVT	Harvest		

FELT DIVIDERS MODEL# DIMENSIONS FREIGHT CLASS WT./LBS. CUBIC FT. LIST PRICE

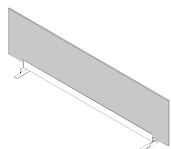

Back-to-Back Parallel Felt Divider

BRTAFDD84	7.5 x 81 x 16.88	125	6.30	1	\$710
BRTAFDD78	7.5 x 75 x 16.88	125	5.90	.92	\$677
BRTAFDD72	7.5 x 69 x 16.88	125	5.40	.85	\$645
BRTAFDD66	7.5 x 63 x 16.88	125	5	.77	\$611
BRTAFDD60	7.5 x 57 x 16.88	125	4.60	.70	\$577
BRTAFDD54	7.5 x 51 x 16.88	125	4.10	.63	\$546
BRTAFDD48	7.5 x 45 x 16.88	125	3.70	.55	\$384
BRTAFDD42	7.5 x 39 x 16.88	125	3.20	.48	\$340
BRTAFDD36	7.5 x 33 x 16.88	125	2.80	.41	\$305

Secures between two back-to-back tables; provides privacy, divides space. 9mm felt material is tackable. Installed divider measures 15.7" from the top of the worksurface. Available in 9 PET felt colors. Please specify. Brackets and extrusion available in all standard Bridges II paint finishes. 36"- 72" wide dividers include 2 support brackets. 78" and 84" wide dividers include 3.

- Anodized Aluminum extrusion - Add **\$164** list upcharge

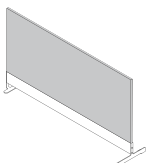

Perpendicular Side to Side Off Module Felt Divider

BRTAFPPD30M	6.5 x 30.24 x 16.85	100	2.60	.27	\$289
BRTAFPPD24M	6.5 x 24.24 x 16.85	100	2.10	.22	\$256

Secures off module to front and back edges of a table; provides privacy, divides space. 9mm felt material is tackable. 24M and 30M kits are designed to be installed on tables with **recessed** legs (round legs, 34" rectangular legs). Cannot be installed at the end of a run. Installed divider measures 15.7" from the top of the worksurface. Available in 9 PET felt colors. Please specify. Brackets and extrusion available in all standard Bridges II paint finishes.

- Anodized Aluminum extrusion - Add **\$164** list upcharge

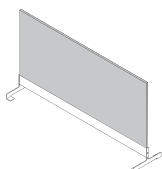

Perpendicular Side to Side Felt Divider

BRTAFPPD63S	6.5 x 62.81 x 16.85	100	4.20	.46	\$600
BRTAFPPD51S	6.5 x 50.81 x 16.85	100	4.20	.46	\$535
BRTAFPPD30S	6.5 x 30.24 x 16.85	92.5	2.70	.27	\$296
BRTAFPPD24S	6.5 x 24.24 x 16.85	92.5	2.30	.22	\$263

Secures to the front edge of both worksurfaces, regardless of type of leg support - supporting brackets can straddle over shared leg; provides privacy, divides space. 9mm felt material is tackable. Cannot be installed at the end of a run. Installed divider measures 15.7" from the top of the worksurface. Available in 9 PET felt colors. Please specify. Brackets and extrusion available in all standard Bridges II paint finishes.

- Anodized Aluminum extrusion - Add **\$164** list upcharge

Required Specifications

- Felt color
- Bracket/extrusion finish

Optional Specifications

- Anodized extrusion

FELT DIVIDERS

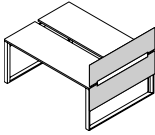
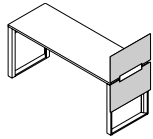

End of Run Felt Divider & Modesty Kit*

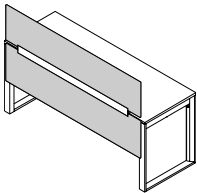

Felt Divider & Modesty Panel Kit*

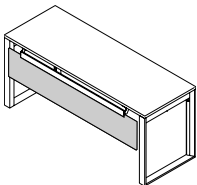

Felt Modesty Panel

MODEL#	DIMENSIONS D x W x H	FREIGHT CLASS	WT/LBS.	CUBIC FT.	LIST PRICE
BRTAFEDN24	4.05 x 25.46 x 30.68	250	3.3	1.12	\$443
BRTAFEDN30	4.05 x 31.46 x 30.68	250	3.98	1.29	\$497
BRTAFEDN51	4.05 x 50.56 x 30.68	150	6.22	1.46	\$912
BRTAFEDN63	4.05 x 62.56 x 30.68	150	7.57	1.63	\$1039

Secures to the side bottom of a single or back-to-back table; provides privacy above and below the worksurface. 9mm felt material is tackable. Installed divider measures 15.7" from the top of the worksurface and 15" below the worksurface. Kit includes two felt dividers, support extrusion and left and right brackets. Available in 9 PET felt colors. Please specify. Brackets and extrusion available in all standard Bridges II paint finishes.

BRTAFDSN84	4.05 x 78 x 30.68	125	9.24	1.2	\$1241
BRTAFDSN78	4.05 x 72 x 30.68	125	8.57	1.11	\$1182
BRTAFDSN72	4.05 x 69 x 30.68	125	7.89	1.02	\$1124
BRTAFDSN66	4.05 x 63 x 30.68	125	7.21	0.93	\$979
BRTAFDSN60	4.05 x 57 x 30.68	125	6.54	0.84	\$935
BRTAFDSN54	4.05 x 51 x 30.68	125	5.87	0.74	\$878
BRTAFDSN48	4.05 x 45 x 30.68	125	5.19	0.65	\$726

Secures to the rear bottom of a single table; provides privacy above and below the worksurface. 9mm felt material is tackable. Installed divider measures 15.7" from the top of the worksurface and 15" below the worksurface. Kit includes two felt dividers, support extrusion and left and right brackets. Available in 9 PET felt colors. Please specify. Brackets and extrusion available in all standard Bridges II paint finishes.

- 66" - 84" dividers require 3 support brackets and cannot be used with worksurfaces that have a single access door.

BRTAFMPSN84	4.17 x 77.75 x 13.82	65	31.12	1.2	\$530
BRTAFMPSN78	4.17 x 71.75 x 13.82	65	28.72	1.11	\$502
BRTAFMPSN72	4.17 x 65.75 x 13.82	65	26.32	1.02	\$476
BRTAFMPSN66	4.17 x 59.75 x 13.82	65	23.92	0.93	\$449
BRTAFMPSN60	4.17 x 53.75 x 13.82	65	21.51	0.84	\$423
BRTAFMPSN54	4.17 x 47.75 x 13.82	65	19.11	0.74	\$405
BRTAFMPSN48	4.17 x 41.75 x 13.82	65	16.71	0.65	\$297

Secures to the rear bottom of a single table; provides privacy below the worksurface. 9mm felt material is tackable. Installed divider measures 15" below the worksurface. Kit includes felt modesty, support extrusion and left and right brackets. Available in 9 PET felt colors. Please specify. Brackets and extrusion available in all standard Bridges II paint finishes.

- 66" - 84" dividers require 3 support brackets and cannot be used with worksurfaces that have a single access door.

Required Specifications

Felt color
Bracket/extrusion finish

TABLE DIVIDERS

MODEL# DIMENSIONS FREIGHT CLASS WT./LBS. CUBIC FT. LIST PRICE

D x W x H

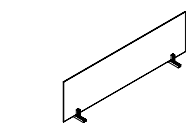

36" - 72"

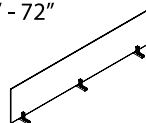

78" - 84"

Table Divider - Glass

BRTAGDD84	.25 x 81 x 16	60	29	.18	\$868
BRTAGDD78	.25 x 75 x 16	60	27	.17	\$819
BRTAGDD72	.25 x 69 x 16	60	25	.16	\$703
BRTAGDD66	.25 x 63 x 16	60	23	.14	\$655
BRTAGDD60	.25 x 57 x 16	60	21	.13	\$604
BRTAGDD54	.25 x 51 x 16	60	18	.11	\$577
BRTAGDD48	.25 x 45 x 16	60	16	.10	\$530
BRTAGDD42	.25 x 39 x 16	60	14	.09	\$489
BRTAGDD36	.25 x 33 x 16	60	12	.07	\$442

Secures between two back-to-back tables; provides privacy, divides space. Installed divider measures 15.7" from the top of the worksurface. 36" - 72" wide dividers include 2 support brackets. 78" and 84" wide dividers include 3. Frosted tempered glass. Satin chrome lower bracket, upper is available in all standard Bridges II paint finishes.

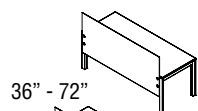

36" - 72"

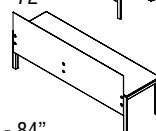

78" - 84"

Parallel Table Divider - Glass

BRTAGDS84	.25 x 81 x 32	60	55	.35	\$1655
BRTAGDS78	.25 x 75 x 32	60	51	.33	\$1573
BRTAGDS72	.25 x 69 x 32	60	47	.30	\$1317
BRTAGDS66	.25 x 63 x 32	60	43	.28	\$1238
BRTAGDS60	.25 x 57 x 32	60	39	.25	\$1158
BRTAGDS54	.25 x 51 x 32	60	35	.23	\$1081
BRTAGDS48	.25 x 45 x 32	60	31	.20	\$1000
BRTAGDS42	.25 x 39 x 32	60	27	.18	\$921
BRTAGDS36	.25 x 33 x 32	60	23	.15	\$844

Secures to the rear edge of a single table; provides privacy, divides space while not obstructing available light. 36" - 72" wide dividers include 2 support brackets. 78" and 84" wide dividers include 3. Frosted tempered glass. Satin chrome lower bracket, upper is available in all standard Bridges II paint finishes.

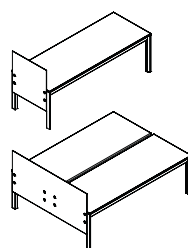

Perpendicular End of Run Divider - Glass

BRTAGED63	.25 x 62.5 x 32	60	35	.23	\$1735
BRTAGED51	.25 x 50.5 x 32	60	31	.20	\$1573
BRTAGED30	.25 x 30 x 32	60	27	.18	\$882
BRTAGED24	.25 x 24 x 32	60	23	.15	\$805

Secures to the rear edge of a single or double back-to-back table; provides privacy, divides space while not obstructing available light. Installed divider reaches 15.7" from the top of the worksurface and 15" below the worksurface. Rounded front top corner of 24" and 30" deep glass dividers. 51" and 63" glass dividers for back-to-back tables have both top corners rounded. 24" and 30" wide dividers include 2 support brackets; 51" and 63" wide dividers include 3. Frosted tempered glass. Satin chrome lower bracket, upper is available in all standard Bridges II paint finishes.

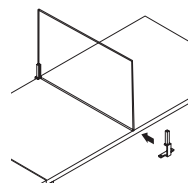

Shared Perpendicular Side to Side Divider, Middle - Glass, Rounded Corners

BRTAGPPD24M	.25 x 24 x 16	60	9	.06	\$505
BRTAGPPD30M	.25 x 30 x 16	60	11.25	.07	\$531

Provides privacy, divides space while not obstructing available light. 24M and 30M kits are designed to be installed on tables with **recessed** legs (round legs, 34" rectangular legs). 24" and 30" kits consist of a wide rear bracket, narrow front bracket (white powder coated steel), tempered glass with **rounded** top corners (acid etched on one side), bracket-fitting gaskets and mounting screws securing the brackets to the underside of the worksurface. Satin chrome lower bracket, upper is available in all standard Bridges II paint finishes.

Required Specifications

Bracket finish

TABLE DIVIDERS

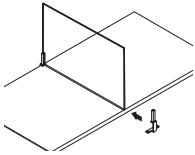

Shared Perpendicular Side to Side Divider, Middle - Glass, Square Corners

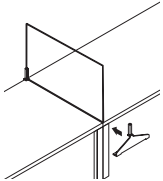

Shared Perpendicular Side to Side Divider, Seam - Glass, Rounded Corners

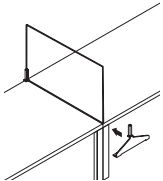

Shared Perpendicular Side to Side Divider, Seam - Glass, Square Corners

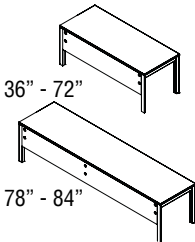

Modesty Panel - Glass

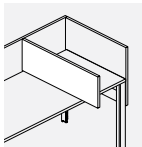

Perpendicular Laminate Side to Side Divider - Extended*

MODEL#	DIMENSIONS D x W x H	FREIGHT CLASS	WT/LBS.	CUBIC FT.	LIST PRICE
BRTAGPPD24MQ	.25 x 24 x 16	60	9	.06	\$505
BRTAGPPD30MQ	.25 x 30 x 16	60	11.25	.07	\$531

Provides privacy, divides space while not obstructing available light. 24M and 30M kits are designed to be installed on tables with **recessed** legs (round legs, 34" rectangular legs). 24" and 30" kits consist of a wide rear bracket, narrow front bracket (white powder coated steel), tempered glass with **square** top corners (acid etched on one side), bracket-fitting gaskets and mounting screws securing the brackets to the underside of the worksurface. Brackets are available in all standard Bridges II paint finishes.

BRTAGPPD24S	.25 x 24 x 16	60	9	.05	\$505
BRTAGPPD30S	.25 x 30 x 16	60	11.25	.07	\$531

Provides privacy, divides space while not obstructing available light. 24S and 30S kits are designed to be installed in the middle or over a seam of two adjacent worksurfaces supported by a shared, full depth **rectangular** leg. 24S and 30S kits consist of two wide rear brackets, wide front bracket, tempered glass with **rounded** top corners (acid etched on one side), bracket-fitting gaskets and mounting screws securing the brackets to the underside of the worksurface. Brackets are available in all standard Bridges II paint finishes.

BRTAGPPD24SQ	.25 x 24 x 16	60	9	.05	\$505
BRTAGPPD30SQ	.25 x 30 x 16	60	11.25	.07	\$531

Provides privacy, divides space while not obstructing available light. 24S and 30S kits are designed to be installed in the middle or over a seam of two adjacent worksurfaces supported by a shared, full depth **rectangular** leg. 24S and 30S kits consist of two wide rear brackets, wide front bracket, tempered glass with **square** top corners (acid etched on one side), bracket-fitting gaskets and mounting screws securing the brackets to the underside of the worksurface. Brackets are available in all standard Bridges II paint finishes.

BRTAGMPS84	.25 x 77.75 x 13.25	60	24	.14	\$1081
BRTAGMPS78	.25 x 71.75 x 13.25	60	22	.13	\$1042
BRTAGMPS72	.25 x 65.75 x 13.25	60	20	.12	\$824
BRTAGMPS66	.25 x 59.75 x 13.25	60	19	.11	\$784
BRTAGMPS60	.25 x 53.75 x 13.25	60	17	.10	\$744
BRTAGMPS54	.25 x 47.75 x 13.25	60	15	.09	\$706
BRTAGMPS48	.25 x 41.75 x 13.25	60	11	.06	\$667
BRTAGMPS42	.25 x 35.75 x 13.25	60	11	.06	\$625
BRTAGMPS36	.25 x 29.75 x 13.25	60	9	.05	\$587

Secures to the rear edge of a single table, between table legs; provides privacy. Installed divider reaches 15" below the worksurface. 36" - 72" wide modesty panels include 2 mounting brackets. 78" and 84" wide modesty panels include 3 mounting brackets. Tempered glass, acid etched on one side (similar to frosted), and satin chrome disc fasteners. Brackets are available in all standard Bridges II paint finishes.

BRTLPE36	.75 x 36 x 16	60	11	.25	\$301
BRTLPE30	.75 x 30 x 16	60	9	.21	\$262

Protrudes by 6" beyond the front worksurface edge for added privacy. Secures off-module or on-module to the front and back edge of worksurface, regardless of type of leg support - supporting brackets can straddle over shared leg. 3/4" LP PVC edge boards. Brackets are available in all standard Bridges II paint finishes.

- Specify BRTLPE30 for 24" d worksurfaces and BRTLPE36 for 30" d worksurfaces

Required Specifications

Chassis/Accent Finish (Laminate Dividers)
Bracket finish
Edge finish*

TABLE DIVIDERS

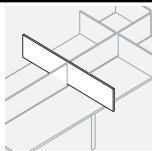

Perpendicular Laminate Side to Side Double Divider - Extended

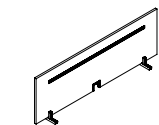

36" - 72"

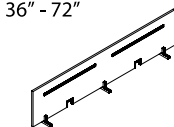

78" - 84"

Table Divider - Laminate

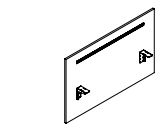

36" - 72"

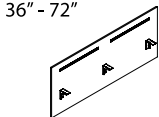

78" - 84"

High Table Divider - Laminate

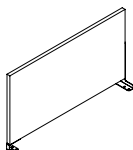

High Perpendicular Side-to-Side Divider - Laminate

MODEL#	DIMENSIONS	FREIGHT CLASS	WT/LBS.	CUBIC FT.	LIST PRICE
--------	------------	---------------	---------	-----------	------------

D x W x H

BRTLDPSE75	.75 x 75 x 16	60	22	.52	\$538
BRTLDPSE63	.75 x 63 x 16	60	18	.44	\$483

Protrudes by 6" beyond the front worksurface edge for added privacy. Installs on-module, between two BRTLPPD dividers. It is secured to the front edge of both worksurfaces, regardless of type of leg support - supporting brackets can straddle over shared leg. Brackets are available in all standard Bridges II paint finishes. 3/4" LP PVC edge boards.

- Can ONLY be installed on-module between two BRTLPPD dividers.
- Specify BRTLDPSE63 for 24"d back-to-back worksurfaces and BRTLDPSE75 for 30"d back-to-back worksurfaces

BRTLPPD84	.75 x 81 x 16	60	24	.56	\$654
BRTLPPD78	.75 x 75 x 16	60	23	.52	\$632
BRTLPPD72	.75 x 69 x 16	60	21	.47	\$504
BRTLPPD66	.75 x 63 x 16	60	19	.43	\$472
BRTLPPD60	.75 x 57 x 16	60	17	.39	\$450
BRTLPPD54	.75 x 51 x 16	60	15	.35	\$431
BRTLPPD48	.75 x 45 x 16	60	14	.31	\$407
BRTLPPD42	.75 x 39 x 16	60	12	.27	\$379
BRTLPPD36	.75 x 33 x 16	60	10	.22	\$344

Secures between two back-to-back tables; provides privacy, divides space. Installed divider measures 15.7" from the top of the worksurface. 36" - 72" wide dividers include 2 support brackets and one pass-through grommet. 78" and 84" wide dividers include 3 support brackets and 2 pass-through grommets. 3/4" PVC edged boards. Integrated anodized aluminum accessory rail, white cut out and rail trims. Brackets are available in all standard Bridges II paint finishes.

- Please refer to the **Compatibility Guide** on page 400 to determine available accessories

BRTLPPDS84	.75 x 81 x 32	60	50	1.16	\$1023
BRTLPPDS78	.75 x 75 x 32	60	47	1.08	\$982
BRTLPPDS72	.75 x 69 x 32	60	43	1	\$803
BRTLPPDS66	.75 x 63 x 32	60	40	.91	\$761
BRTLPPDS60	.75 x 57 x 32	60	36	.83	\$718
BRTLPPDS54	.75 x 51 x 32	60	32	.75	\$664
BRTLPPDS48	.75 x 45 x 32	60	29	.66	\$632
BRTLPPDS42	.75 x 39 x 32	60	25	.56	\$589
BRTLPPDS36	.75 x 33 x 32	60	22	.50	\$482

Installed on one side only. Secures to the back of a single table; provides privacy, divides space. Installed divider measures 15.7" from the top of the worksurface and 15" below the worksurface. 36" - 72" wide dividers include 2 support brackets. 78" and 84" wide dividers include 4 support brackets. 3/4" self edged boards. Integrated anodized aluminum accessory rail, white cut out and rail trims. Brackets are available in all standard Bridges II paint finishes. Integrated modesty panel.

- Please refer to the **Compatibility Guide** on page 400 to determine available accessories

BRTLPPD24	.75 x 24 x 16	60	7	.16	\$239
BRTLPPD30	.75 x 30 x 16	60	9	.20	\$260

Secures off-module to front and back edges of a table; provides privacy, divides space. Can be installed anywhere along worksurface or over the seam of two adjacent worksurfaces. Cannot be installed at the end of a run. Installed divider measures 15.7" from the top of the worksurface. 3/4" self edged boards. Brackets are available in all standard Bridges II paint finishes.

Required Specifications

Chassis/Accent finish
Bracket finish
Edge finish

TABLE DIVIDERS

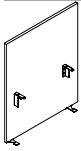

Perpendicular End of Run Divider, Laminate*

MODEL#	DIMENSIONS D x W x H	FREIGHT CLASS	WT/LBS.	CUBIC FT.	LIST PRICE
BRTLPE24	.75 x 24 x 32	60	7	.16	\$380
BRTLPE30	.75 x 30 x 32	60	9	.20	\$407
BRTLPE51	.75 x 50.5 x 32	60	15	.35	\$642
BRTLPE63	.75 x 62.5 x 32	60	19	.43	\$728

Secures to the side edge of a table; provides privacy, divides space. Installed divider measures 15.7" from the top of the worksurface and 15" below the worksurface. Integrated modesty panel. 3/4" self edged boards. Brackets are available in all standard Bridges II paint finishes. For Rectangular leg only.

- BRTLPE51 divider matches 24" deep back-to-back assemblies
- BRTLPE63 divider matches 30" deep back-to-back assemblies

MODESTY PANEL

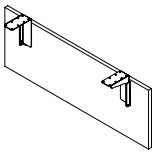

Laminate Modesty Panel*

MODEL#	DIMENSIONS	FREIGHT CLASS	WT/LBS.	CUBIC FT.	LIST PRICE
BRTMPS84	.75 x 78.5 x 14	60	22	.51	\$577
BRTMPS78	.75 x 72.5 x 14	60	20	.47	\$556
BRTMPS72	.75 x 66.5 x 14	60	19	.43	\$537
BRTMPS66	.75 x 60.5 x 14	60	17	.40	\$517
BRTMPS60	.75 x 54.5 x 14	60	16	.36	\$499
BRTMPS54	.75 x 48.5 x 14	60	14	.32	\$480
BRTMPS48	.75 x 42.5 x 14	60	13	.29	\$459
BRTMPS42	.75 x 36.5 x 14	60	11	.25	\$442
BRTMPS36	.75 x 30.5 x 14	60	9	.21	\$420

Secures to the back edge of a table; provides privacy, divides space. Installed divider measures 15" below the worksurface. 3/4" self edged boards. Flips down for easy access to underside of worksurface. Brackets are available in all standard Bridges II paint finishes.

Required Specifications

Chassis/Accent finish
Edge finish
Bracket finish

ACCESSORIES

MODEL# DIMENSIONS FREIGHT CLASS WT./LBS. CUBIC FT. LIST PRICE

D x W x H

MODEL#	D x W x H	FREIGHT CLASS	WT./LBS.	CUBIC FT.	LIST PRICE
BRTPEG24	.75 x 24 x 14	60	6	.14	\$247
BRTPEG24H21	.75 x 24 x 20.5	60	9	.21	\$286
BRTPEG24H27	.75 x 24 x 26.5	60	12	.26	\$334
BRTPEG30	.75 x 30 x 14	60	8	.18	\$266
BRTPEG30H21	.75 x 30 x 20.5	60	12	.26	\$304
BRTPEG30H27	.75 x 30 x 26.5	60	15	.33	\$354
BRTPEG51	.75 x 50.5 x 14	60	13	.30	\$431
BRTPEG51H21	.75 x 50.5 x 20.5	60	20	.43	\$522
BRTPEG51H27	.75 x 50.5 x 26.5	60	26	.56	\$604
BRTPEG63	.75 x 62.5 x 14	60	16	.38	\$469
BRTPEG63H21	.75 x 62.5 x 20.5	60	25	.53	\$558
BRTPEG63H27	.75 x 62.5 x 26.5	60	32	.69	\$642

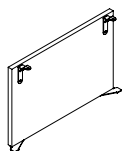

Laminate End of Run Gable*

Perpendicular end of a run gable. Secures to the side edge of a table/tables and legs; provides privacy, divides space. ¾" self edged boards. Brackets are available in all standard Bridges II paint finishes. **For Rectangular leg only.**

- BRTPEG24, 30, 51 and 63 measure 15" below worksurface
- BRTPEGxxH21 lines up with the bottom of storage cabinets
- BRTPEGxxH27 reaches down 1" from the floor (creates full panel look)

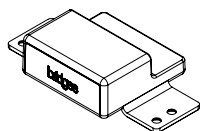
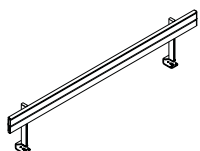

Table End Gap Filler

BRTTEGF	4.5 x 2.5 x 1	70	.03	.01	\$16
---------	---------------	----	-----	-----	-------------

Injection molded block fills the gap finishing the end of back-to-back table assemblies. Secures to the bottom of two back-to-back worksurfaces. Injection molded resin, white.



Single Table Accessory Rail

BRLBST84	2.95 x 81 x 13.5	70	10.24	.61	\$548
BRLBST78	2.95 x 75 x 13.5	70	9.69	.56	\$532
BRLBST72	2.95 x 69 x 13.5	70	9.15	.52	\$516
BRLBST66	2.95 x 63 x 13.5	70	8.61	.48	\$499
BRLBST60	2.95 x 57 x 13.5	70	8.07	.43	\$482
BRLBST54	2.95 x 51 x 13.5	70	7.52	.39	\$472
BRLBST48	2.95 x 45 x 13.5	70	6.98	.35	\$455
BRLBST42	2.95 x 39 x 13.5	70	6.44	.30	\$439
BRLBST36	2.95 x 33 x 13.5	65	5.90	.26	\$417

Table mounted accessory rail. Compatible with standard accessories. Includes end caps and mounting hardware.

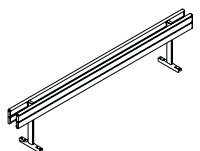

Back-To-Back Accessory Rail

BRLBB2B84	7.50 x 81 x 13.5	65	17.69	.74	\$904
BRLBB2B78	7.50 x 75 x 13.5	65	16.61	.69	\$871
BRLBB2B72	7.50 x 69 x 13.5	65	15.52	.63	\$839
BRLBB2B66	7.50 x 63 x 13.5	65	14.44	.58	\$807
BRLBB2B60	7.50 x 57 x 13.5	65	13.36	.53	\$775
BRLBB2B54	7.50 x 51 x 13.5	65	12.27	.48	\$752
BRLBB2B48	7.50 x 45 x 13.5	65	11.19	.42	\$718
BRLBB2B42	7.50 x 39 x 13.5	65	10.10	.37	\$686
BRLBB2B36	7.50 x 33 x 13.5	65	9.02	.32	\$646

Table mounted accessory rail. Compatible with standard accessories. Includes end caps and mounting hardware.

Required Specifications

Chassis/Accent finish*

Edge finish*

Bracket finish*

FRAMED DIVIDERS

D x W x H

Single Table Or Single Table Row Application; 16" and 30" high dividers

Table Mounted Framed Divider for single table or single table row; recessed 1.5" at both ends, mounted to the table with 0.6" gap at the back.
 BRTMFD/BRTMLD 36" (33" actual) - 66" (63" actual) dividers have 2 mounting brackets.
 BRTMFD/BRTMLD 72" (69" actual) - 84" (81" actual) dividers have 3 mounting brackets.

Perpendicular Single Table End of Run Framed Divider;
 BREFD/BRELD 24" (21" actual for 24" deep worksurfaces),
 BREFD/BRELD 30" (27" actual for 30" deep worksurfaces),
 BREFD/BRELD 36" (33" actual for 36" deep worksurfaces),

Two brackets secure the divider to the side edge of work surface. Flush with rear edge, 3" recessed from front work surface edge.

Perpendicular Shared Framed Divider;
 BRSEFD/BRSLD 24" (21" actual for 24" deep worksurfaces),
 BRSEFD/BRSLD 30" (27" actual for 30" deep worksurfaces),
 BRSEFD/BRSLD 36" (33" actual for 36" deep worksurfaces),

Single bracket secures the divider to the rear edge of worksurface; Can be mounted off-module or over the seam of two adjacent worksurfaces. Flush with the rear edge, 3" recessed from front worksurface edge.

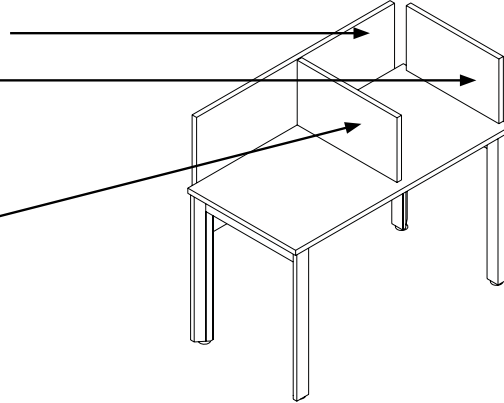

Back-To-Back Table Application; 16" dividers

Perpendicular Back 2 Back Parallel Framed Divider secured between two back-to-back tables; recessed 1.5" at both ends; 0.6" gap between the divider and work surfaces.
 BRPFD/BRPLD 36" (33" actual) - 66" (63" actual) dividers have 2 mounting brackets.
 BRPFD/BRPLD 72" (69" actual) - 84" (81" actual) dividers have 3 mounting brackets.

Perpendicular Shared Frame Back 2 Back Framed Divider;
 BRSEFD/BRSDLD 51" (45" actual for 24" deep back-to-back work surfaces)
 BRSEFD/BRSDLD 63" (57" actual for 30" deep back-to-back work surfaces).
 One bracket secures the divider through the gap between work surfaces; two brackets locate top of the divider between two adjacent Parallel dividers.
 NOTE: cannot be used on its own without the two Parallel dividers.
 3" recessed from front worksurface edges.

Perpendicular Back-To-Back End of Run Framed Divider;
 BREDFD/BREDLD 51" (45" actual for 24" deep back-to-back worksurfaces)
 BREDFD/BREDLD 63" (57" actual for 30" deep back-to-back worksurfaces).
 Three brackets secure the divider to both side edges of worksurfaces.
 3" recessed from front worksurface edges.

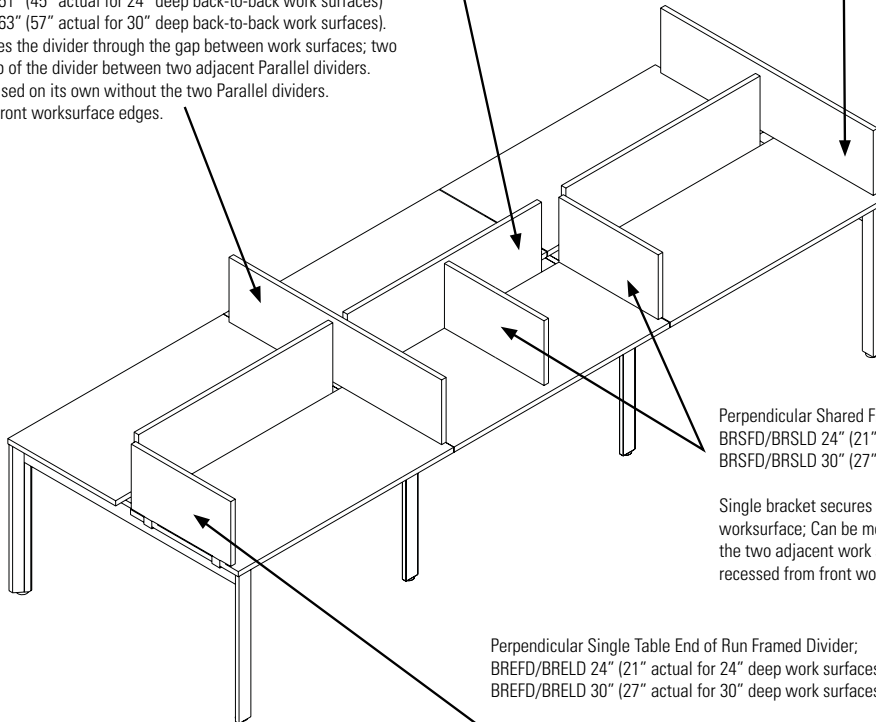

Perpendicular Shared Framed Divider;
 BRSEFD/BRSLD 24" (21" actual for 24" deep work surfaces).
 BRSEFD/BRSLD 30" (27" actual for 30" deep work surfaces).

Single bracket secures the divider to the rear edge of worksurface; Can be mounted off-module or over the seam of the two adjacent work surfaces. Flush with the rear edge, 3" recessed from front work surfaces edge.

Perpendicular Single Table End of Run Framed Divider;
 BREFD/BRELD 24" (21" actual for 24" deep work surfaces).
 BREFD/BRELD 30" (27" actual for 30" deep work surfaces).

Two brackets secure the divider to the side edge of work surface. Flush with the rear edge, 3" recessed from front work surface edge.

Required Specifications

Top finish
 Edge finish
 Metal finish (legs)

Optional Specifications

Anodized Aluminum Leg
 HP laminate

FRAMED DIVIDERS

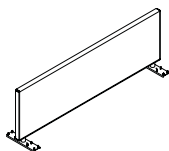

**Back-to-Back Parallel Framed Divider
Fabric**

MODEL#	DIMENSIONS D x W x H	FREIGHT CLASS	WT/LBS.	CUBIC FT.	LIST PRICE
BRPFD84	1.25 x 81 x 16	70	32	1.95	\$907
BRPFD78	1.25 x 75 x 16	70	28	1.81	\$861
BRPFD72	1.25 x 69 x 16	70	24	1.57	\$850
BRPFD66	1.25 x 63 x 16	85	20	1.53	\$817
BRPFD60	1.25 x 57 x 16	92.5	15	1.39	\$770
BRPFD54	1.25 x 51 x 16	92.5	13	1.25	\$649
BRPFD48	1.25 x 45 x 16	85	11	.75	\$615
BRPFD42	1.25 x 39 x 16	100	9	.97	\$534
BRPFD36	1.25 x 33 x 16	100	8	.83	\$522

Secures to the underside of the worksurface. Fabric divider is tackable and always railroaded. Installed divider measures 15.7" from top of worksurface. 36" to 54" dividers include 2 support brackets. 60" to 84" dividers include 3 support brackets. Brackets are available in all standard Bridges II paint finishes.

- 60" - 84" dividers require 3 support brackets and cannot be used with worksurfaces that have a single access door

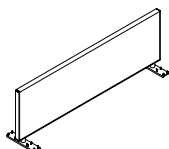

Back-to-Back Parallel Framed Divider

MODEL#	DIMENSIONS D x W x H	FREIGHT CLASS	WT/LBS.	CUBIC FT.	LIST PRICE	HP ADD	DE ADD	DM ADD
BRPLD84	1.25 x 81 x 16	70	32	2.25	\$637	\$321	\$729	\$1848
BRPLD78	1.25 x 75 x 16	70	28	2.08	\$626	\$290	\$730	\$1840
BRPLD72	1.25 x 69 x 16	70	24	1.92	\$619	\$260	\$729	\$1826
BRPLD66	1.25 x 63 x 16	85	20	1.75	\$598	\$270	\$608	\$1660
BRPLD60	1.25 x 57 x 16	92.5	15	1.58	\$577	\$223	\$616	\$1551
BRPLD54	1.25 x 51 x 16	92.5	13	1.42	\$482	\$196	\$644	\$1578
BRPLD48	1.25 x 45 x 16	85	11	1.25	\$414	\$149	\$288	\$756
BRPLD42	1.25 x 39 x 16	100	9	1.08	\$367	\$119	\$245	\$652
BRPLD36	1.25 x 33 x 16	100	8	.92	\$349	\$109	\$219	\$575

Secures to the underside of the worksurface. Divider infill can be specified in low pressure laminate (**LP**), high pressure laminate (**HP**), dry erase whiteboard (**DE**) or dry erase magnetic whiteboard (**DM**). Installed divider measures 15.7" from top of worksurface. 36" to 54" dividers include 2 support brackets. 60" to 84" dividers include 3 support brackets. Brackets are available in all standard Bridges II paint finishes.

- 60" - 84" dividers require 3 support brackets and cannot be used with worksurfaces that have a single access door

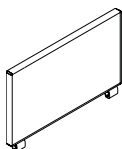

**Perpendicular Single Table End of Run
Framed Divider, Fabric**

MODEL#	DIMENSIONS D x W x H	FREIGHT CLASS	WT/LBS.	CUBIC FT.	LIST PRICE
BREFD36	1.25 x 33 x 16	85	12	.92	\$460
BREFD30	1.25 x 27 x 16	85	11	.75	\$416
BREFD24	1.25 x 21 x 16	70	9	.58	\$404

Connects to the perpendicular end of a single or back-to-back table. Fabric divider is tackable and always railroaded. Installed divider measures 15.7" from top of worksurface. Divider comes with 2 support brackets. Two brackets secure the divider to the side edge of worksurface. Flush with the rear edge, 3" recessed from front worksurface edge. Brackets are available in all standard Bridges II paint finishes.

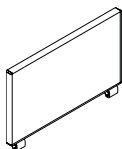

**Perpendicular Single Table End of Run
Framed Divider, Laminate**

MODEL#	DIMENSIONS D x W x H	FREIGHT CLASS	WT/LBS.	CUBIC FT.	LIST PRICE	HP ADD	DE ADD	DM ADD
BRELD36	1.25 x 33 x 16	70	20	.92	\$301	\$110	\$219	\$341
BRELD30	1.25 x 27 x 16	65	17	.75	\$291	\$97	\$167	\$262
BRELD24	1.25 x 21 x 16	65	14	.58	\$261	\$81	\$151	\$229

Connects to the perpendicular end of a single or back-to-back table. Divider infill can be specified in low pressure laminate (**LP**), high pressure laminate (**HP**), dry erase whiteboard (**DE**) or dry erase magnetic whiteboard (**DM**). Installed divider measures 15.7" from top of worksurface. Divider comes with 2 support brackets. Two brackets secure the divider to the side edge of worksurface. Flush with the rear edge, 3" recessed from front worksurface edge. When dry erase magnetic whiteboard (**DM**) is specified it is applied user side **ONLY** and dry erase whiteboard (**DE**) is applied on the opposite side. Brackets are available in all standard Bridges II paint finishes.

Required Specifications

Fabric
Finish
Bracket finish

SHARED FRAMED DIVIDERS

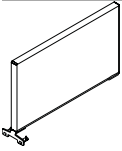

Perpendicular Shared Framed Divider, Fabric

MODEL#	DIMENSIONS D x W x H	FREIGHT CLASS	WT/LBS.	CUBIC FT.	LIST PRICE
BRSFD36	1.25 x 33 x 16	85	12	.92	\$449
BRSFD30	1.25 x 27 x 16	85	11	.75	\$404
BRSFD24	1.25 x 21 x 16	70	9	.58	\$392

Connects anywhere along and between worksurfaces to divide space and create privacy. Divider is fastened under the worksurface flush to the back of the table and recessed 3" from the front edge on the user side. Fabric divider is tackable and always railroaded. Installed divider measures 15.7" from top of worksurface. Divider comes with a support bracket at the back and a spacer plate with double sided adhesive at the front. Brackets are available in all standard Bridges II paint finishes.

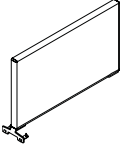

Perpendicular Shared Framed Divider, Laminate

					LIST PRICE	HP ADD	DE ADD	DM ADD
BRSLD36	1.25 x 33 x 16	70	20	.92	\$301	\$110	\$178	\$626
BRSLD30	1.25 x 27 x 16	65	17	.75	\$281	\$97	\$135	\$557
BRSLD24	1.25 x 21 x 16	65	14	.58	\$261	\$72	\$114	\$416

Connects anywhere along and between worksurfaces to divide space and create privacy. Divider is fastened under the worksurface flush to the back of the table and recessed 3" from the front edge on the user side. Divider infill can be specified in low pressure laminate (**LP**), high pressure laminate (**HP**), dry erase whiteboard (**DE**) or dry erase magnetic whiteboard (**DM**). Installed divider measures 15.7" from top of worksurface. Divider comes with a support bracket at the back and a spacer plate with double sided adhesive at the front. Brackets are available in all standard Bridges II paint finishes.

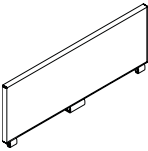

Perpendicular Back-to-Back End of Run Framed Divider, Fabric

					LIST PRICE
BREDFD63	1.25 x 57 x 16	85	21	1.58	\$711
BREDFD51	1.25 x 45 x 16	85	18	1.25	\$627

Connects to the end of run on a back-to-back tables to create privacy. Divider is fastened under the worksurface and recessed 3" from the user edge on either side. Fabric divider is tackable and always railroaded. Installed divider measures 15.7" from top of worksurface. Divider comes with 1 large and 2 small support brackets. Brackets are available in all standard Bridges II paint finishes.

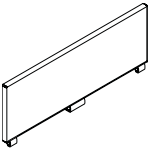

Perpendicular Back-to-Back End of Run Framed Divider, Laminate

					LIST PRICE	HP ADD	DE ADD	DM ADD
BREDLD63	1.25 x 57 x 16	70	32	1.58	\$522	\$223	\$510	\$929
BREDLD51	1.25 x 45 x 16	70	26	1.25	\$424	\$147	\$243	\$444

Connects to the end of run on a back-to-back tables to create privacy. Divider is fastened under the worksurface and recessed 3" from the user edge on either side. Divider infill can be specified in low pressure laminate (**LP**), high pressure laminate (**HP**), dry erase whiteboard (**DE**) or dry erase magnetic whiteboard (**DM**). Installed divider measures 15.7" from top of worksurface. Divider comes with 1 large and 2 small support brackets. When dry erase magnetic whiteboard (DM) is specified it is applied user side ONLY and dry erase whiteboard (DE) is applied on the opposite side. Brackets are available in all standard Bridges II paint finishes.

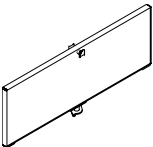

Perpendicular Back-to-Back Shared Framed Divider, Fabric

					LIST PRICE
BRSDFD63	1.25 x 57 x 16	85	20	1.58	\$675
BRSDFD51	1.25 x 45 x 16	85	17	1.25	\$590

Connects between parallel framed dividers for back-to-back tables to divide space and create privacy. Divider is fastened under the worksurface and recessed 3" from the user edge on either side. Fabric divider is tackable and always railroaded. Installed divider measures 15.7" from top of worksurface. Divider comes with 1 center support bracket, 2 spacer plates with adhesive and 2 top spacer clamps. Brackets are available in all standard Bridges II paint finishes.

- Cannot be used on its own without the two parallel dividers

Required Specifications

Fabric
Finish
Bracket finish

SHARED FRAMED DIVIDERS

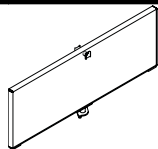

Perpendicular Back-to-Back Shared Framed Divider, Laminate*

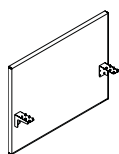

Table Mounted Framed Divider, Fabric*

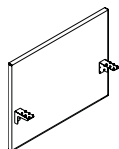

Table Mounted Framed Divider, Laminate*



Ceiling Pole for Wellness Screens

MODEL#	DIMENSIONS D x W x H	FREIGHT CLASS	WT/LBS.	CUBIC FT.	LIST PRICE			
					LIST PRICE	HP ADD	DE ADD	DM ADD
BRSDLD63	1.25 x 57 x 16	70	32	1.58	\$500	\$214	\$502	\$1707
BRSDLD51	1.25 x 45 x 16	70	26	1.25	\$405	\$147	\$233	\$833

Connects between parallel framed dividers for back-to-back tables to divide space and create privacy. Divider is fastened under the worksurface and recessed 3" from the user edge on either side. Divider infill can be specified in low pressure laminate (LP), high pressure laminate (HP), dry erase whiteboard (DE) or dry erase magnetic whiteboard (DM). Installed divider measures 15.7" from top of worksurface. Divider comes with 1 center support bracket, 2 spacer plates with adhesive and 2 top spacer clamps. Brackets are available in all standard Bridges II paint finishes.

- Cannot be used on its own without the two parallel dividers

MODEL#	DIMENSIONS D x W x H	FREIGHT CLASS	WT/LBS.	CUBIC FT.	LIST PRICE
BRTMFD84	1.25 x 81 x 30	70	43	4.22	\$1029
BRTMFD78	1.25 x 75 x 30	70	40	3.91	\$957
BRTMFD72	1.25 x 69 x 30	70	37	3.59	\$921
BRTMFD66	1.25 x 63 x 30	85	33	3.28	\$890
BRTMFD60	1.25 x 57 x 30	92.5	30	2.97	\$783
BRTMFD54	1.25 x 51 x 30	92.5	27	2.66	\$698
BRTMFD48	1.25 x 45 x 30	85	25	2.34	\$627
BRTMFD42	1.25 x 39 x 30	100	22	2.03	\$557
BRTMFD36	1.25 x 33 x 30	100	20	1.90	\$473

Parallel divider for single tables. Fabric divider is tackable and always railroaded. Fastens to the underside of the worksurface. 0.6" gap between worksurface and divider allows for cable pass thru. Installed divider reaches 15.7" up and 15" down from top of worksurface. 36" to 66" dividers include 2 support brackets. 72" to 84" dividers include 3 support brackets. Brackets are available in all standard Bridges II paint finishes.

- 72" - 84" dividers require 3 support brackets and cannot be used with worksurfaces that have a single access door

MODEL#	DIMENSIONS D x W x H	FREIGHT CLASS	WT/LBS.	CUBIC FT.	LIST PRICE	HP ADD	DE ADD	DM ADD
BRTMLD84	1.25 x 81 x 30	70	83	4.22	\$1302	\$427	\$1318	\$2848
BRTMLD78	1.25 x 75 x 30	70	77	3.91	\$1282	\$429	\$1318	\$2848
BRTMLD72	1.25 x 69 x 30	70	71	3.59	\$648	\$288	\$1772	\$3461
BRTMLD66	1.25 x 63 x 30	85	66	3.28	\$619	\$290	\$1779	\$3470
BRTMLD60	1.25 x 57 x 30	92.5	60	2.97	\$598	\$205	\$1787	\$3470
BRTMLD54	1.25 x 51 x 30	92.5	54	2.66	\$568	\$205	\$1685	\$3278
BRTMLD48	1.25 x 45 x 30	85	48	2.34	\$548	\$205	\$695	\$1557
BRTMLD42	1.25 x 39 x 30	100	42	2.03	\$527	\$205	\$704	\$1452
BRTMLD36	1.25 x 33 x 30	100	38	1.90	\$508	\$205	\$385	\$1126

Parallel divider for single tables. Divider infill can be specified in low pressure laminate (LP), high pressure laminate (HP), dry erase whiteboard (DE) or dry erase magnetic whiteboard (DM) user side only. Fastens to the underside of the worksurface. 0.6" gap between worksurface and divider allows for cable pass thru. Installed divider reaches 15.7" up and 15" down from top of worksurface. 36" to 66" dividers include 2 support brackets. 72" to 84" dividers include 3 support brackets. Brackets are available in all standard Bridges II paint finishes.

- 72" - 84" dividers require 3 support brackets and cannot be used with worksurfaces that have a single access door

MODEL#	DIMENSIONS D x W x H	FREIGHT CLASS	WT/LBS.	CUBIC FT.	LIST PRICE
BRTADPCPP	1.5 x 4.75 x 99	65	13	.48	\$624

Brings ceiling feed conduit and data cables from the ceiling down to Power Troughs at desk height. Accommodates 10' ceiling heights. Two part construction allows power/data conduit lay-in. Attaches to a junction between two adjacent Power Troughs in back-to-back applications only. Not for use on single sided Bridges II troughs. Includes mounting hardware and ceiling bezel. Painted Finish.

- Screens must be specified 6" shorter than the nominal worksurface dimension in order to accommodate this ceiling feed.

Required Specifications

Fabric
Finish
Bracket finish*

BACK-TO-BACK WELLNESS SCREENS

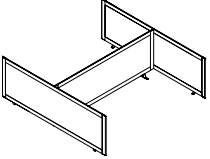

24" H Back-to-Back Wellness Screen

MODEL#	DIMENSIONS D x W x H	FREIGHT CLASS	WT./LBS.	CUBIC FT.	LIST PRICE
BRTADP5136H24	50.50 x 36 x 24.63	150	33	6.31	\$1632
BRTADP5142H24	50.50 x 42 x 24.63	150	34.50	7.36	\$1664
BRTADP5148H24	50.50 x 48 x 24.63	150	36	8.42	\$1699
BRTADP5154H24	50.50 x 54 x 24.63	250	37.50	9.47	\$1733
BRTADP5160H24	50.50 x 60 x 24.63	250	39	10.52	\$1766
BRTADP5166H24	50.50 x 66 x 24.63	250	40.50	11.57	\$1801
BRTADP5172H24	50.50 x 72 x 24.63	250	42	12.63	\$1833
BRTADP5178H24	50.50 x 78 x 24.63	250	43.50	13.68	\$1868
BRTADP5184H24	50.50 x 84 x 24.63	250	45	14.73	\$1902
BRTADP6336H24	62.50 x 36 x 24.63	150	46.50	7.81	\$1764
BRTADP6342H24	62.50 x 42 x 24.63	150	48	9.11	\$1796
BRTADP6348H24	62.50 x 48 x 24.63	150	49.50	10.42	\$1832
BRTADP6354H24	62.50 x 54 x 24.63	150	51	11.72	\$1865
BRTADP6360H24	62.50 x 60 x 24.63	150	52.50	13.02	\$1898
BRTADP6366H24	62.50 x 66 x 24.63	250	54	14.32	\$1933
BRTADP6372H24	62.50 x 72 x 24.63	250	55	15.63	\$1967
BRTADP6378H24	62.50 x 78 x 24.63	250	57.35	16.93	\$2001
BRTADP6384H24	62.50 x 84 x 24.63	250	58.50	18.23	\$2035

Powder coated aluminum frame, translucent ribbed polycarbonate. Includes all hardware to connect. Brackets are painted steel. Side dividers extend 6.25" from the front edge of each surface. Center divider sits over the gap between the worksurface allowing for cable pass-through to trough. Gap for each side is approximately 1". Width and depth are nominal sizes representing the sizes of the Bridges configuration. Allow for .25" overhang at the sides and 6.25" at the front. Frame and hardware available in all Bridges paint finishes. End trim cap is only available in Charcoal (CHR).

- **BRTADP51xxH24 are for configurations with 24" deep surfaces.**
- **BRTADP63xxH24 are for configurations with 30" deep surfaces.**

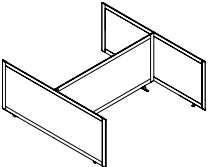

30" H Back-to-Back Wellness Screen

BRTADP5136H30	50.50 x 36 x 30.63	150	35.50	6.31	\$1808
BRTADP5142H30	50.50 x 42 x 30.63	150	37	7.36	\$1848
BRTADP5148H30	50.50 x 48 x 30.63	150	38.50	8.42	\$1885
BRTADP5154H30	50.50 x 54 x 30.63	150	40	9.47	\$1928
BRTADP5160H30	50.50 x 60 x 30.63	250	41.50	10.52	\$1966
BRTADP5166H30	50.50 x 66 x 30.63	250	43	11.57	\$2007
BRTADP5172H30	50.50 x 72 x 30.63	250	44.50	12.63	\$2044
BRTADP5178H30	50.50 x 78 x 30.63	250	46	13.68	\$2083
BRTADP5184H30	50.50 x 84 x 30.63	250	47.50	14.73	\$2123
BRTADP6336H30	62.50 x 36 x 30.63	125	49	7.81	\$2032
BRTADP6342H30	62.50 x 42 x 30.63	150	50.50	9.11	\$2071
BRTADP6348H30	62.50 x 48 x 30.63	150	52	10.42	\$2110
BRTADP6354H30	62.50 x 54 x 30.63	150	53.50	11.72	\$2149
BRTADP6360H30	62.50 x 60 x 30.63	150	55	13.02	\$2188
BRTADP6366H30	62.50 x 66 x 30.63	250	56.50	14.32	\$2228
BRTADP6372H30	62.50 x 72 x 30.63	250	58	15.63	\$2266
BRTADP6378H30	62.50 x 78 x 30.63	250	59.50	16.93	\$2306
BRTADP6384H30	62.50 x 84 x 30.63	250	61	18.23	\$2345

Powder coated aluminum frame, translucent ribbed polycarbonate. Includes all hardware to connect. Brackets are painted steel. Side dividers extend 6.25" from the front edge of each surface. Center divider sits over the gap between the worksurface allowing for cable pass-through to trough. Gap for each side is approximately 1". Width and depth are nominal sizes representing the sizes of the Bridges configuration. Allow for .25" overhang at the sides and 6.25" at the front. Frame and hardware available in all Bridges paint finishes. End trim cap is only available in Charcoal (CHR).

- **BRTADP51xxH30 are for configurations with 24" deep surfaces.**
- **BRTADP63xxH30 are for configurations with 30" deep surfaces.**

Required Specifications
Frame finish

BACK-TO-BACK WELLNESS SCREENS

MODEL# DIMENSIONS FREIGHT CLASS WT/LBS. CUBIC FT. LIST PRICE

D x W x H

BRTADPE5136H24	50.50 x 36 x 24.63	150	26.35	6.31	\$1106
BRTADPE5142H24	50.50 x 42 x 24.63	250	27.85	7.36	\$1139
BRTADPE5148H24	50.50 x 48 x 24.63	250	29.35	8.42	\$1173
BRTADPE5154H24	50.50 x 54 x 24.63	250	30.85	9.47	\$1205
BRTADPE5160H24	50.50 x 60 x 24.63	250	32.35	10.52	\$1241
BRTADPE5166H24	50.50 x 66 x 24.63	250	33.85	11.57	\$1275
BRTADPE5172H24	50.50 x 72 x 24.63	250	35.35	12.63	\$1312
BRTADPE5178H24	50.50 x 78 x 24.63	250	36.85	13.68	\$1344
BRTADPE5184H24	50.50 x 84 x 24.63	250	38.35	14.73	\$1377

BRTADPE6336H24	62.50 x 36 x 24.63	150	39.85	7.81	\$1172
BRTADPE6342H24	62.50 x 42 x 24.63	150	41.35	9.11	\$1204
BRTADPE6348H24	62.50 x 48 x 24.63	150	42.85	10.42	\$1239
BRTADPE6354H24	62.50 x 54 x 24.63	250	44.35	11.72	\$1274
BRTADPE6360H24	62.50 x 60 x 24.63	250	45.85	13.02	\$1308
BRTADPE6366H24	62.50 x 66 x 24.63	250	47.35	14.32	\$1344
BRTADPE6372H24	62.50 x 72 x 24.63	250	48.85	15.63	\$1375
BRTADPE6378H24	62.50 x 78 x 24.63	250	50.35	16.93	\$1410
BRTADPE6384H24	62.50 x 84 x 24.63	250	51.85	18.23	\$1445

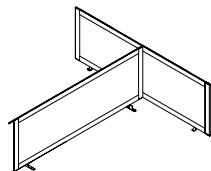

24" H Back-to-Back Wellness Screen Extension Kit

Intended to always connect to Back-to-Back Divider Screen Kit. Powder coated aluminum frame, translucent ribbed polycarbonate. Includes all hardware to connect. Brackets are painted steel. Side dividers extend 6.25" from the front edge of each surface. Center divider sits over the gap between the worksurface allowing for cable pass-through to trough. Gap for each side is approximately 1". Width and depth are nominal sizes representing the sizes of the Bridges configuration. Allow for .25" overhang at the sides and 6.25" at the front. Frame and hardware available in all Bridges paint finishes. End trim cap is only available in Charcoal (CHR).

- **BRTADPE51xxH24 are for configurations with 24" deep surfaces.**
- **BRTADPE63xxH24 are for configurations with 30" deep surfaces.**

BRTADPE5136H30	50.50 x 36 x 30.63	150	28.85	6.31	\$1215
BRTADPE5142H30	50.50 x 42 x 30.63	150	30.35	7.36	\$1254
BRTADPE5148H30	50.50 x 48 x 30.63	250	31.85	8.42	\$1294
BRTADPE5154H30	50.50 x 54 x 30.63	250	33.35	9.47	\$1335
BRTADPE5160H30	50.50 x 60 x 30.63	250	34.85	10.52	\$1372
BRTADPE5166H30	50.50 x 66 x 30.63	250	36.35	11.57	\$1412
BRTADPE5172H30	50.50 x 72 x 30.63	250	37.85	12.63	\$1452
BRTADPE5178H30	50.50 x 78 x 30.63	250	39.35	13.68	\$1489
BRTADPE5184H30	50.50 x 84 x 30.63	250	40.85	14.73	\$1529

BRTADPE6336H30	62.50 x 36 x 30.63	150	42.35	7.81	\$1292
BRTADPE6342H30	62.50 x 42 x 30.63	150	43.85	9.11	\$1333
BRTADPE6348H30	62.50 x 48 x 30.63	150	45.35	10.42	\$1371
BRTADPE6354H30	62.50 x 54 x 30.63	250	46.85	11.72	\$1410
BRTADPE6360H30	62.50 x 60 x 30.63	250	48.35	13.02	\$1449
BRTADPE6366H30	62.50 x 66 x 30.63	250	49.85	14.32	\$1488
BRTADPE6372H30	62.50 x 72 x 30.63	250	51.35	15.63	\$1529
BRTADPE6378H30	62.50 x 78 x 30.63	250	52.85	16.93	\$1566
BRTADPE6384H30	62.50 x 84 x 30.63	250	54.35	18.23	\$1606

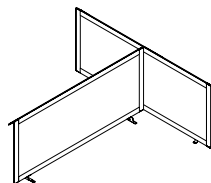

30" H Back-to-Back Wellness Screen Extension Kit

Intended to always connect to Back-to-Back Divider Screen Kit. Powder coated aluminum frame, translucent ribbed polycarbonate. Includes all hardware to connect. Brackets are painted steel. Side dividers extend 6.25" from the front edge of each surface. Center divider sits over the gap between the worksurface allowing for cable pass-through to trough. Gap for each side is approximately 1". Width and depth are nominal sizes representing the sizes of the Bridges configuration. Allow for .25" overhang at the sides and 6.25" at the front. Frame and hardware available in all Bridges paint finishes. End trim cap is only available in Charcoal (CHR).

- **BRTADPE51xxH30 are for configurations with 24" deep surfaces.**
- **BRTADPE63xxH30 are for configurations with 30" deep surfaces.**

Required Specifications

Frame finish

SINGLE TABLE WELLNESS SCREENS

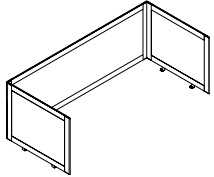

24" H Single Table Wellness Screen

MODEL#	DIMENSIONS D x W x H	FREIGHT CLASS	WT./LBS.	CUBIC FT.	LIST PRICE
BRTADP2436H24	31.75 x 36 x 24.63	125	26.55	3.97	\$1126
BRTADP2442H24	31.75 x 42 x 24.63	125	28.10	4.63	\$1162
BRTADP2448H24	31.75 x 48 x 24.63	150	29.65	5.29	\$1194
BRTADP2454H24	31.75 x 54 x 24.63	150	31.20	5.95	\$1229
BRTADP2460H24	31.75 x 60 x 24.63	150	32.75	6.61	\$1263
BRTADP2466H24	31.75 x 66 x 24.63	150	34.30	7.28	\$1295
BRTADP2472H24	31.75 x 72 x 24.63	150	35.85	7.94	\$1331
BRTADP2478H24	31.75 x 78 x 24.63	150	37.40	8.60	\$1366
BRTADP2484H24	31.75 x 84 x 24.63	150	38.95	9.26	\$1399
BRTADP3036H24	37.75 x 36 x 24.63	100	40.50	4.72	\$1205
BRTADP3042H24	37.75 x 42 x 24.63	125	42.05	5.51	\$1241
BRTADP3048H24	37.75 x 48 x 24.63	125	43.60	6.29	\$1275
BRTADP3054H24	37.75 x 54 x 24.63	150	42.15	7.08	\$1312
BRTADP3060H24	37.75 x 60 x 24.63	150	46.70	7.87	\$1344
BRTADP3066H24	37.75 x 66 x 24.63	150	48.25	8.65	\$1377
BRTADP3072H24	37.75 x 72 x 24.63	150	49.80	9.44	\$1412
BRTADP3078H24	37.75 x 78 x 24.63	150	51.35	10.22	\$1446
BRTADP3084H24	37.75 x 84 x 24.63	150	52.90	11.01	\$1481

Powder coated aluminum frame, translucent ribbed polycarbonate. Includes all hardware to connect. Brackets are painted steel. Side dividers extend 6.25" from the front edge of each surface. Back divider extends over the back edge of the worksurface by 1.5", allowing for cable pass-through to trough. Width and depth are nominal sizes representing the sizes of the Bridges configuration. Allow for .25" overhang at the sides, 1.5" at the back, and 6.25" at the front. Frame and hardware available in all Bridges paint finishes. End trim cap is only available in Charcoal (CHR).

- **BRTADP24xxH24 are for configurations with 24" deep surfaces.**
- **BRTADP30xxH24 are for configurations with 30" deep surfaces.**

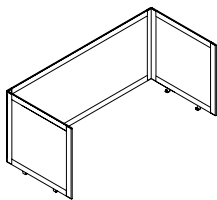

30" H Single Table Wellness Screen

BRTADP2436H30	31.75 x 36 x 30.63	125	28.85	3.97	\$1263
BRTADP2442H30	31.75 x 42 x 30.63	125	30.40	4.63	\$1304
BRTADP2448H30	31.75 x 48 x 30.63	125	31.95	5.29	\$1344
BRTADP2454H30	31.75 x 54 x 30.63	150	33.50	5.95	\$1382
BRTADP2460H30	31.75 x 60 x 30.63	150	35.05	6.61	\$1422
BRTADP2466H30	31.75 x 66 x 30.63	150	36.60	7.28	\$1460
BRTADP2472H30	31.75 x 72 x 30.63	150	38.15	7.94	\$1500
BRTADP2478H30	31.75 x 78 x 30.63	150	39.70	8.60	\$1538
BRTADP2484H30	31.75 x 84 x 30.63	150	41.25	9.26	\$1578
BRTADP3036H30	37.75 x 36 x 30.63	100	42.80	4.72	\$1340
BRTADP3042H30	37.75 x 42 x 30.63	100	44.35	5.51	\$1382
BRTADP3048H30	37.75 x 48 x 30.63	125	45.90	6.29	\$1421
BRTADP3054H30	37.75 x 54 x 30.63	125	47.45	7.08	\$1457
BRTADP3060H30	37.75 x 60 x 30.63	125	49	7.87	\$1496
BRTADP3066H30	37.75 x 66 x 30.63	150	50.55	8.65	\$1537
BRTADP3072H30	37.75 x 72 x 30.63	150	52.10	9.44	\$1573
BRTADP3078H30	37.75 x 78 x 30.63	150	53.65	10.22	\$1615
BRTADP3084H30	37.75 x 84 x 30.63	150	55.20	11.01	\$1655

Powder coated aluminum frame, translucent ribbed polycarbonate. Includes all hardware to connect. Brackets are painted steel. Side dividers extend 6.25" from the front edge of each surface. Back divider extends over the back edge of the worksurface by 1.5", allowing for cable pass-through to trough. Width and depth are nominal sizes representing the sizes of the Bridges configuration. Allow for .25" overhang at the sides, 1.5" at the back, and 6.25" at the front. Frame and hardware available in all Bridges paint finishes. End trim cap is only available in Charcoal (CHR).

- **BRTADP24xxH30 are for configurations with 24" deep surfaces.**
- **BRTADP30xxH30 are for configurations with 30" deep surfaces.**

Required Specifications

Frame finish

SINGLE TABLE WELLNESS SCREENS

MODEL# DIMENSIONS FREIGHT CLASS WT./LBS. CUBIC FT. LIST PRICE

D x W x H

BRTADPE2436H24	31.75 x 36 x 24.63	150	21.05	3.97	\$845
BRTADPE2442H24	31.75 x 42 x 24.63	150	22.60	4.63	\$928
BRTADPE2448H24	31.75 x 48 x 24.63	150	24.15	5.29	\$963
BRTADPE2454H24	31.75 x 54 x 24.63	150	25.70	5.95	\$996
BRTADPE2460H24	31.75 x 60 x 24.63	150	27.25	6.61	\$1029
BRTADPE2466H24	31.75 x 66 x 24.63	250	28.80	7.28	\$1064
BRTADPE2472H24	31.75 x 72 x 24.63	250	30.35	7.94	\$1098
BRTADPE2478H24	31.75 x 78 x 24.63	250	31.90	8.60	\$1132
BRTADPE2484H24	31.75 x 84 x 24.63	250	33.45	9.26	\$1164

BRTADPE3036H24	37.75 x 36 x 24.63	125	35	4.72	\$879
BRTADPE3042H24	37.75 x 42 x 24.63	125	36.55	5.51	\$960
BRTADPE3048H24	37.75 x 48 x 24.63	125	38.10	6.29	\$996
BRTADPE3054H24	37.75 x 54 x 24.63	150	39.65	7.08	\$1029
BRTADPE3060H24	37.75 x 60 x 24.63	150	41.20	7.87	\$1064
BRTADPE3066H24	37.75 x 66 x 24.63	150	42.75	8.65	\$1096
BRTADPE3072H24	37.75 x 72 x 24.63	150	44.30	9.44	\$1129
BRTADPE3078H24	37.75 x 78 x 24.63	150	45.85	10.01	\$1164
BRTADPE3084H24	37.75 x 84 x 24.63	150	47.40	10.01	\$1198

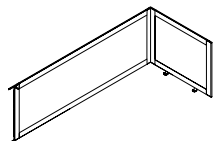

24" H Single Table Wellness Screen Extension Kit

Intended to always connect to Single Table Divider Screen Kit. Powder coated aluminum frame, translucent ribbed polycarbonate. Includes all hardware to connect. Brackets are painted steel. Side dividers extend 6.25" from the front edge of each surface. Back divider extends over the back edge of the worksurface by 1.5", allowing for cable pass-through to trough. Width and depth are nominal sizes representing the sizes of the Bridges configuration. Allow for .25" overhang at the sides, 1.5" at the back, and 6.25" at the front. Frame and hardware available in all Bridges paint finishes. End trim cap is only available in Charcoal (CHR).

- **BRTADPE24xxH24 are for configurations with 24" deep surfaces.**
- **BRTADPE30xxH24 are for configurations with 30" deep surfaces.**

BRTADPE2436H30	31.75 x 36 x 30.63	150	22.85	3.97	\$930
BRTADPE2442H30	31.75 x 42 x 30.63	150	24.40	4.63	\$1018
BRTADPE2448H30	31.75 x 48 x 30.63	150	25.95	5.29	\$1056
BRTADPE2454H30	31.75 x 54 x 30.63	150	27.50	5.95	\$1095
BRTADPE2460H30	31.75 x 60 x 30.63	150	29.05	6.61	\$1136
BRTADPE2466H30	31.75 x 66 x 30.63	150	30.60	7.28	\$1173
BRTADPE2472H30	31.75 x 72 x 30.63	150	32.15	7.94	\$1212
BRTADPE2478H30	31.75 x 78 x 30.63	250	33.70	8.60	\$1251
BRTADPE2484H30	31.75 x 84 x 30.63	250	35.25	9.26	\$1291

BRTADPE3036H30	37.75 x 36 x 30.63	125	36.80	4.72	\$968
BRTADPE3042H30	37.75 x 42 x 30.63	125	38.35	5.51	\$1056
BRTADPE3048H30	37.75 x 48 x 30.63	125	39.90	6.29	\$1095
BRTADPE3054H30	37.75 x 54 x 30.63	150	41.45	7.08	\$1133
BRTADPE3060H30	37.75 x 60 x 30.63	150	43	7.87	\$1173
BRTADPE3066H30	37.75 x 66 x 30.63	150	44.55	8.65	\$1212
BRTADPE3072H30	37.75 x 72 x 30.63	150	46.10	9.44	\$1250
BRTADPE3078H30	37.75 x 78 x 30.63	150	47.65	10.22	\$1291
BRTADPE3084H30	37.75 x 84 x 30.63	150	49.20	11.01	\$1328

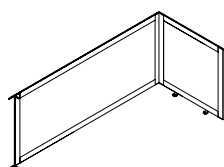

30" H Single Table Wellness Screen Extension Kit

Intended to always connect to Single Table Divider Screen Kit. Powder coated aluminum frame, translucent ribbed polycarbonate. Includes all hardware to connect. Brackets are painted steel. Side dividers extend 6.25" from the front edge of each surface. Back divider extends over the back edge of the worksurface by 1.5", allowing for cable pass-through to trough. Width and depth are nominal sizes representing the sizes of the Bridges configuration. Allow for .25" overhang at the sides, 1.5" at the back, and 6.25" at the front. Frame and hardware available in all Bridges paint finishes. End trim cap is only available in Charcoal (CHR).

- **BRTADPE24xxH30 are for configurations with 24" deep surfaces.**
- **BRTADPE30xxH30 are for configurations with 30" deep surfaces.**

Required Specifications

Frame finish

BACK-TO-BACK FELT DIVIDER SCREENS

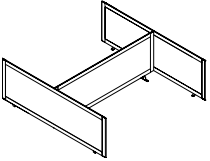

24" H Back-to-Back Felt Divider Screen

MODEL#	DIMENSIONS D x W x H	FREIGHT CLASS	WT/LBS.	CUBIC FT.	LIST PRICE
BRTADF5136H24	50.50 x 36 x 24.60	150	28	6.31	\$1287
BRTADF5142H24	50.50 x 42 x 24.60	150	29.50	7.36	\$1309
BRTADF5148H24	50.50 x 48 x 24.60	150	31	8.42	\$1335
BRTADF5154H24	50.50 x 54 x 24.60	250	32.50	9.47	\$1356
BRTADF5160H24	50.50 x 60 x 24.60	250	34	10.52	\$1385
BRTADF5166H24	50.50 x 66 x 24.60	250	35.50	11.57	\$1410
BRTADF5172H24	50.50 x 72 x 24.60	250	37	12.63	\$1435
BRTADF5178H24	50.50 x 78 x 24.60	250	38.50	13.68	\$1462
BRTADF5184H24	50.50 x 84 x 24.60	250	40	14.73	\$1509
BRTADF6336H24	62.50 x 36 x 24.60	150	41.50	7.81	\$1385
BRTADF6342H24	62.50 x 42 x 24.60	150	43	9.11	\$1410
BRTADF6348H24	62.50 x 48 x 24.60	150	44.50	10.42	\$1435
BRTADF6354H24	62.50 x 54 x 24.60	150	46	11.72	\$1460
BRTADF6360H24	62.50 x 60 x 24.60	150	47.50	13.02	\$1484
BRTADF6366H24	62.50 x 66 x 24.60	250	49	14.32	\$1509
BRTADF6372H24	62.50 x 72 x 24.60	250	50.50	15.63	\$1534
BRTADF6378H24	62.50 x 78 x 24.60	250	52	16.93	\$1559
BRTADF6384H24	62.50 x 84 x 24.60	250	53.50	18.23	\$1608

Provides privacy in an open plan environment. Powder coated aluminum frame with 9mm felt. Includes all hardware to connect. Brackets are painted steel. Side dividers extend 6.25" from the front edge of each surface. Center divider sits over the gap between the worksurface allowing for cable pass-through to trough. Gap for each side is approximately 1". Width and depth are nominal sizes representing the sizes of the Bridges configuration. Allow for .25" overhang at the sides and 6.25" at the front. Frame and hardware available in all Bridges paint finishes. End trim cap is only available in Charcoal (CHR). 9mm PET felt material is tackable and available in 9 colors.

- **BRTAPF51xxH24 are for configurations with 24" deep surfaces.**
- **BRTAPF63xxH24 are for configurations with 30" deep surfaces.**

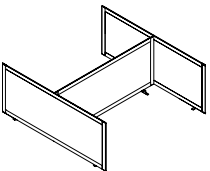

30" H Back-to-Back Felt Divider Screen

BRTADF5136H30	50.50 x 36 x 30.60	150	30.50	6.31	\$1282
BRTADF5142H30	50.50 x 42 x 30.60	150	32	7.36	\$1306
BRTADF5148H30	50.50 x 48 x 30.60	150	33.50	8.42	\$1329
BRTADF5154H30	50.50 x 54 x 30.60	150	35	9.47	\$1352
BRTADF5160H30	50.50 x 60 x 30.60	250	36.50	10.52	\$1375
BRTADF5166H30	50.50 x 66 x 30.60	250	38	11.57	\$1397
BRTADF5172H30	50.50 x 72 x 30.60	250	39.50	12.63	\$1422
BRTADF5178H30	50.50 x 78 x 30.60	250	41	13.68	\$1447
BRTADF5184H30	50.50 x 84 x 30.60	250	42.50	14.73	\$1500
BRTADF6336H30	62.50 x 36 x 30.60	125	44	7.81	\$1440
BRTADF6342H30	62.50 x 42 x 30.60	150	45.50	9.11	\$1462
BRTADF6348H30	62.50 x 48 x 30.60	150	47	10.42	\$1484
BRTADF6354H30	62.50 x 54 x 30.60	150	48.50	11.72	\$1507
BRTADF6360H30	62.50 x 60 x 30.60	150	50	13.02	\$1531
BRTADF6366H30	62.50 x 66 x 30.60	250	51.50	14.32	\$1555
BRTADF6372H30	62.50 x 72 x 30.60	250	53	15.63	\$1578
BRTADF6378H30	62.50 x 78 x 30.60	250	54.50	16.93	\$1601
BRTADF6384H30	62.50 x 84 x 30.60	250	56	18.23	\$1655

Provides privacy in an open plan environment. Powder coated aluminum frame with 9mm felt. Includes all hardware to connect. Brackets are painted steel. Side dividers extend 6.25" from the front edge of each surface. Center divider sits over the gap between the worksurface allowing for cable pass-through to trough. Gap for each side is approximately 1". Width and depth are nominal sizes representing the sizes of the Bridges configuration. Allow for .25" overhang at the sides and 6.25" at the front. Frame and hardware available in all Bridges paint finishes. End trim cap is only available in Charcoal (CHR). 9mm PET felt material is tackable and available in 9 colors.

- **BRTADF51xxH30 are for configurations with 24" deep surfaces.**
- **BRTADF63xxH30 are for configurations with 30" deep surfaces.**

Required Specifications

Frame finish
Felt finish

BACK-TO-BACK FELT DIVIDER SCREENS

MODEL# DIMENSIONS FREIGHT CLASS WT/LBS. CUBIC FT. LIST PRICE

D x W x H

BRTADFE5136H24	50.50 x 36 x 24.60	150	23.35	6.31	\$877
BRTADFE5142H24	50.50 x 42 x 24.60	250	24.85	7.36	\$902
BRTADFE5148H24	50.50 x 48 x 24.60	250	26.35	8.42	\$927
BRTADFE5154H24	50.50 x 54 x 24.60	250	27.85	9.47	\$952
BRTADFE5160H24	50.50 x 60 x 24.60	250	29.35	10.52	\$976
BRTADFE5166H24	50.50 x 66 x 24.60	250	30.85	11.57	\$1001
BRTADFE5172H24	50.50 x 72 x 24.60	250	32.35	12.63	\$1026
BRTADFE5178H24	50.50 x 78 x 24.60	250	33.85	13.68	\$1052
BRTADFE5184H24	50.50 x 84 x 24.60	250	35.35	14.73	\$1102

BRTADFE6336H24	62.50 x 36 x 24.60	150	36.85	7.81	\$924
BRTADFE6342H24	62.50 x 42 x 24.60	150	38.35	9.11	\$949
BRTADFE6348H24	62.50 x 48 x 24.60	150	39.85	10.42	\$975
BRTADFE6354H24	62.50 x 54 x 24.60	250	41.35	11.72	\$999
BRTADFE6360H24	62.50 x 60 x 24.60	250	42.85	13.02	\$1025
BRTADFE6366H24	62.50 x 66 x 24.60	250	44.35	14.32	\$1049
BRTADFE6372H24	62.50 x 72 x 24.60	250	45.85	15.63	\$1075
BRTADFE6378H24	62.50 x 78 x 24.60	250	47.35	16.93	\$1099
BRTADFE6384H24	62.50 x 84 x 24.60	250	48.85	18.23	\$1149

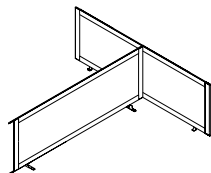

24" H Back-to-Back Felt Divider Screen Extension Kit

Provides an extension to privacy in an open plan environment. Intended to always connect to Back-to-Back Divider Screen Kit. Powder coated aluminum frame with 9mm felt. Includes all hardware to connect. Brackets are painted steel. Side dividers extend 6.25" from the front edge of each surface. Center divider sits over the gap between the worksurface allowing for cable pass-through to trough. Gap for each side is approximately 1". Width and depth are nominal sizes representing the sizes of the Bridges configuration. Allow for .25" overhang at the sides and 6.25" at the front. Frame and hardware available in all Bridges paint finishes. End trim cap is only available in Charcoal (CHR). 9mm PET felt material is tackable and available in 9 colors.

- **BRTADFE51xxH24 are for configurations with 24" deep surfaces.**
- **BRTADFE63xxH24 are for configurations with 30" deep surfaces.**

BRTADFE5136H30	50.50 x 36 x 30.60	150	25.85	6.31	\$875
BRTADFE5142H30	50.50 x 42 x 30.60	150	27.35	7.36	\$898
BRTADFE5148H30	50.50 x 48 x 30.60	250	28.85	8.42	\$922
BRTADFE5154H30	50.50 x 54 x 30.60	250	30.35	9.47	\$945
BRTADFE5160H30	50.50 x 60 x 30.60	250	31.85	10.52	\$968
BRTADFE5166H30	50.50 x 66 x 30.60	250	33.35	11.57	\$992
BRTADFE5172H30	50.50 x 72 x 30.60	250	34.85	12.63	\$1015
BRTADFE5178H30	50.50 x 78 x 30.60	250	36.35	13.68	\$1038
BRTADFE5184H30	50.50 x 84 x 30.60	250	37.85	14.73	\$1092

BRTADFE6336H30	62.50 x 36 x 30.60	150	39.35	7.81	\$921
BRTADFE6342H30	62.50 x 42 x 30.60	150	40.85	9.11	\$944
BRTADFE6348H30	62.50 x 48 x 30.60	150	42.35	10.42	\$967
BRTADFE6354H30	62.50 x 54 x 30.60	250	43.85	11.72	\$990
BRTADFE6360H30	62.50 x 60 x 30.60	250	45.35	13.02	\$1014
BRTADFE6366H30	62.50 x 66 x 30.60	250	46.85	14.32	\$1037
BRTADFE6372H30	62.50 x 72 x 30.60	250	48.35	15.63	\$1060
BRTADFE6378H30	62.50 x 78 x 30.60	250	49.85	16.93	\$1083
BRTADFE6384H30	62.50 x 84 x 30.60	250	51.35	18.23	\$1136

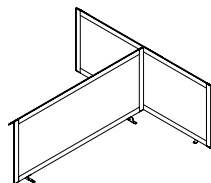

30" H Back-to-Back Felt Divider Screen Extension Kit

Provides an extension to privacy in an open plan environment. Intended to always connect to Back-to-Back Divider Screen Kit. Powder coated aluminum frame with 9mm felt. Includes all hardware to connect. Brackets are painted steel. Side dividers extend 6.25" from the front edge of each surface. Center divider sits over the gap between the worksurface allowing for cable pass-through to trough. Gap for each side is approximately 1". Width and depth are nominal sizes representing the sizes of the Bridges configuration. Allow for .25" overhang at the sides and 6.25" at the front. Frame and hardware available in all Bridges paint finishes. End trim cap is only available in Charcoal (CHR). 9mm PET felt material is tackable and available in 9 colors.

- **BRTADFE51xxH30 are for configurations with 24" deep surfaces.**
- **BRTADFE63xxH30 are for configurations with 30" deep surfaces.**

Required Specifications

Frame finish
Felt finish

SINGLE TABLE FELT DIVIDER SCREENS

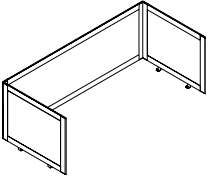

24" H Single Table Felt Divider Screen

MODEL#	DIMENSIONS D x W x H	FREIGHT CLASS	WT./LBS.	CUBIC FT.	LIST PRICE
BRTADF2436H24	31.50 x 36 x 24.60	125	22.55	3.94	\$937
BRTADF2442H24	31.50 x 42 x 24.60	125	24.10	4.59	\$961
BRTADF2448H24	31.50 x 48 x 24.60	150	25.65	5.25	\$986
BRTADF2454H24	31.50 x 54 x 24.60	150	27.20	5.91	\$1010
BRTADF2460H24	31.50 x 60 x 24.60	150	28.75	6.56	\$1037
BRTADF2466H24	31.50 x 66 x 24.60	150	30.30	7.22	\$1061
BRTADF2472H24	31.50 x 72 x 24.60	150	31.85	7.88	\$1086
BRTADF2478H24	31.50 x 78 x 24.60	150	33.40	8.53	\$1111
BRTADF2484H24	31.50 x 84 x 24.60	150	34.95	9.19	\$1160
BRTADF3036H24	37.75 x 36 x 24.60	100	36.50	4.72	\$968
BRTADF3042H24	37.75 x 42 x 24.60	125	38.05	5.51	\$995
BRTADF3048H24	37.75 x 48 x 24.60	125	39.60	6.29	\$1019
BRTADF3054H24	37.75 x 54 x 24.60	150	41.15	7.08	\$1044
BRTADF3060H24	37.75 x 60 x 24.60	150	41.70	7.87	\$1069
BRTADF3066H24	37.75 x 66 x 24.60	150	44.25	8.65	\$1095
BRTADF3072H24	37.75 x 72 x 24.60	150	45.80	9.44	\$1117
BRTADF3078H24	37.75 x 78 x 24.60	150	47.35	10.22	\$1142
BRTADF3084H24	37.75 x 84 x 24.60	150	48.90	11.01	\$1193

Provides privacy in an open plan environment. Powder coated aluminum frame with 9mm felt. Includes all hardware to connect. Brackets are painted steel. Side dividers extend 6.237" from the front edge of each surface. Back divider extends over the back edge of the worksurface by 1.5", allowing for cable pass-through to trough. Width and depth are nominal sizes representing the sizes of the Bridges configuration. Allow for .25" overhang at the sides, 1.5" at the back, and 6.237" at the front. Frame and hardware available in all Bridges paint finishes. End trim cap is only available in Charcoal (CHR). 9mm PET felt material is tackable and available in 9 colors.

- **BRTADF24xxH24 are for configurations with 24" deep surfaces.**
- **BRTADF30xxH24 are for configurations with 30" deep surfaces.**

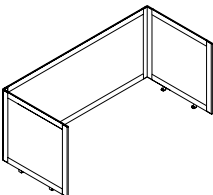

30" H Single Table Felt Divider Screen

BRTADF2436H30	31.50 x 36 x 30.60	125	24.85	3.97	\$930
BRTADF2442H30	31.50 x 42 x 30.60	125	26.40	4.59	\$954
BRTADF2448H30	31.50 x 48 x 30.60	125	27.95	5.25	\$976
BRTADF2454H30	31.50 x 54 x 30.60	150	29.50	5.91	\$999
BRTADF2460H30	31.50 x 60 x 30.60	150	31.05	6.56	\$1022
BRTADF2466H30	31.50 x 66 x 30.60	150	32.60	7.22	\$1045
BRTADF2472H30	31.50 x 72 x 30.60	150	34.14	7.88	\$1069
BRTADF2478H30	31.50 x 78 x 30.60	150	34.70	8.53	\$1092
BRTADF2484H30	31.50 x 84 x 30.60	150	37.25	9.19	\$1147
BRTADF3036H30	37.75 x 36 x 30.60	100	38.80	4.72	\$975
BRTADF3042H30	37.75 x 42 x 30.60	100	40.35	5.51	\$998
BRTADF3048H30	37.75 x 48 x 30.60	125	41.90	6.29	\$1021
BRTADF3054H30	37.75 x 54 x 30.60	125	43.45	7.08	\$1044
BRTADF3060H30	37.75 x 60 x 30.60	125	45	7.87	\$1069
BRTADF3066H30	37.75 x 66 x 30.60	150	46.55	8.65	\$1092
BRTADF3072H30	37.75 x 72 x 30.60	150	48.10	9.44	\$1114
BRTADF3078H30	37.75 x 78 x 30.60	150	49.65	10.22	\$1137
BRTADF3084H30	37.75 x 84 x 30.60	150	51.20	11.01	\$1191

Provides privacy in an open plan environment. Powder coated aluminum frame with 9mm felt. Includes all hardware to connect. Brackets are painted steel. Side dividers extend 6.237" from the front edge of each surface. Back divider extends over the back edge of the worksurface by 1.5", allowing for cable pass-through to trough. Width and depth are nominal sizes representing the sizes of the Bridges configuration. Allow for .25" overhang at the sides, 1.5" at the back, and 6.237" at the front. Frame and hardware available in all Bridges paint finishes. End trim cap is only available in Charcoal (CHR). 9mm PET felt material is tackable and available in 9 colors.

- **BRTADF24xxH30 are for configurations with 24" deep surfaces.**
- **BRTADF30xxH30 are for configurations with 30" deep surfaces.**

Required Specifications

Frame finish
Felt finish

SINGLE TABLE FELT DIVIDER SCREENS

MODEL# DIMENSIONS FREIGHT CLASS WT/LBS. CUBIC FT. LIST PRICE

D x W x H

BRTADFE2436H24	31.50 x 36 x 24.60	150	18.55	3.94	\$709
BRTADFE2442H24	31.50 x 42 x 24.60	150	20.10	4.59	\$776
BRTADFE2448H24	31.50 x 48 x 24.60	150	21.65	5.25	\$802
BRTADFE2454H24	31.50 x 54 x 24.60	150	23.20	5.91	\$827
BRTADFE2460H24	31.50 x 60 x 24.60	150	24.75	6.56	\$852
BRTADFE2466H24	31.50 x 66 x 24.60	250	26.30	7.22	\$877
BRTADFE2472H24	31.50 x 72 x 24.60	250	27.85	7.88	\$902
BRTADFE2478H24	31.50 x 78 x 24.60	250	29.40	8.53	\$927
BRTADFE2484H24	31.50 x 84 x 24.60	250	30.95	9.19	\$976

BRTADFE3036H24	37.75 x 36 x 24.60	125	32.50	4.72	\$735
BRTADFE3042H24	37.75 x 42 x 24.60	125	34.05	5.51	\$803
BRTADFE3048H24	37.75 x 48 x 24.60	125	35.60	6.29	\$829
BRTADFE3054H24	37.75 x 54 x 24.60	150	37.15	7.08	\$853
BRTADFE3060H24	37.75 x 60 x 24.60	150	38.70	7.87	\$879
BRTADFE3066H24	37.75 x 66 x 24.60	150	40.25	8.65	\$904
BRTADFE3072H24	37.75 x 72 x 24.60	150	41.80	9.44	\$929
BRTADFE3078H24	37.75 x 78 x 24.60	150	43.35	10.01	\$954
BRTADFE3084H24	37.75 x 84 x 24.60	150	44.90	10.01	\$1004

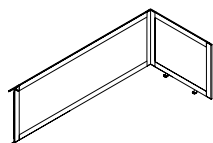
**24" H Single Table Felt Divider Screen Extension Kit**

Provides an extension for privacy in an open plan environment. Intended to always connect to Single Table Divider Screen Kit. Powder coated aluminum frame with 9mm felt. Includes all hardware to connect. Brackets are painted steel. Side dividers extend 6.237" from the front edge of each surface. Back divider extends over the back edge of the worksurface by 1.5", allowing for cable pass-through to trough. Width and depth are nominal sizes representing the sizes of the Bridges configuration. Allow for .25" overhang at the sides, 1.5" at the back, and 6.237" at the front. Frame and hardware available in all Bridges paint finishes. End trim cap is only available in Charcoal (CHR). 9mm PET felt material is tackable and available in 9 colors.

- **BRTADFE24xxH24 are for configurations with 24" deep surfaces.**
- **BRTADFE30xxH24 are for configurations with 30" deep surfaces.**

BRTADFE2436H30	31.50 x 36 x 30.60	150	20.35	3.94	\$743
BRTADFE2442H30	31.50 x 42 x 30.60	150	21.90	4.59	\$811
BRTADFE2448H30	31.50 x 48 x 30.60	150	23.45	5.25	\$833
BRTADFE2454H30	31.50 x 54 x 30.60	150	25	5.91	\$857
BRTADFE2460H30	31.50 x 60 x 30.60	150	26.55	6.56	\$880
BRTADFE2466H30	31.50 x 66 x 30.60	150	28.10	7.22	\$904
BRTADFE2472H30	31.50 x 72 x 30.60	150	29.65	7.88	\$927
BRTADFE2478H30	31.50 x 78 x 30.60	250	31.20	8.53	\$949
BRTADFE2484H30	31.50 x 84 x 30.60	250	32.75	9.19	\$1004

BRTADFE3036H30	37.75 x 36 x 30.60	125	34.30	4.72	\$770
BRTADFE3042H30	37.75 x 42 x 30.60	125	35.85	5.51	\$842
BRTADFE3048H30	37.75 x 48 x 30.60	125	37.40	6.29	\$865
BRTADFE3054H30	37.75 x 54 x 30.60	150	38.95	7.08	\$890
BRTADFE3060H30	37.75 x 60 x 30.60	150	40.50	7.87	\$913
BRTADFE3066H30	37.75 x 66 x 30.60	150	42.05	8.65	\$937
BRTADFE3072H30	37.75 x 72 x 30.60	150	43.60	9.44	\$960
BRTADFE3078H30	37.75 x 78 x 30.60	150	45.15	10.22	\$983
BRTADFE3084H30	37.75 x 84 x 30.60	150	46.70	11.01	\$1037

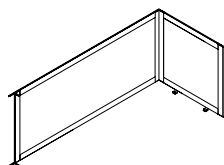
**30" H Single Table Felt Divider Screen Extension Kit**

Provides an extension for privacy in an open plan environment. Intended to always connect to Single Table Divider Screen Kit. Powder coated aluminum frame with 9mm felt. Includes all hardware to connect. Brackets are painted steel. Side dividers extend 6.237" from the front edge of each surface. Back divider extends over the back edge of the worksurface by 1.5", allowing for cable pass-through to trough. Width and depth are nominal sizes representing the sizes of the Bridges configuration. Allow for .25" overhang at the sides, 1.5" at the back, and 6.237" at the front. Frame and hardware available in all Bridges paint finishes. End trim cap is only available in Charcoal (CHR). 9mm PET felt material is tackable and available in 9 colors.

- **BRTADFE24xxH30 are for configurations with 24" deep surfaces.**
- **BRTADFE30xxH30 are for configurations with 30" deep surfaces.**

Required Specifications

Frame finish
Felt finish

BACK-TO-BACK GLASS DIVIDER SCREENS

MODEL# DIMENSIONS FREIGHT CLASS WT/LBS. CUBIC FT. LIST PRICE FRST ADD

D x W x H

BRTADG5136H24	50.50 x 36 x 24.60	150	28	6.31	\$1446	\$442	
BRTADG5142H24	50.50 x 42 x 24.60	150	29.50	7.36	\$2243	\$455	
BRTADG5148H24	50.50 x 48 x 24.60	150	31	8.42	\$2295	\$461	
BRTADG5154H24	50.50 x 54 x 24.60	250	32.50	9.47	\$2347	\$475	
BRTADG5160H24	50.50 x 60 x 24.60	250	34	10.52	\$2398	\$481	
BRTADG5166H24	50.50 x 66 x 24.60	250	35.50	11.57	\$2449	\$494	
BRTADG5172H24	50.50 x 72 x 24.60	250	37	12.63	\$2502	\$508	
BRTADG5178H24	50.50 x 78 x 24.60	250	38.50	13.68	\$2554	\$513	
BRTADG5184H24	50.50 x 84 x 24.60	250	40	14.73	\$2606	\$525	
BRTADG6336H24	62.50 x 36 x 24.60	150	41.50	7.81	\$2398	\$481	
BRTADG6342H24	62.50 x 42 x 24.60	150	43	9.11	\$2444	\$494	
BRTADG6348H24	62.50 x 48 x 24.60	150	44.50	10.42	\$2502	\$508	
BRTADG6354H24	62.50 x 54 x 24.60	150	46	11.72	\$2548	\$513	
BRTADG6360H24	62.50 x 60 x 24.60	150	47.50	13.02	\$2606	\$525	
BRTADG6366H24	62.50 x 66 x 24.60	250	49	14.32	\$2657	\$533	
BRTADG6372H24	62.50 x 72 x 24.60	250	50.50	15.63	\$2703	\$546	
BRTADG6378H24	62.50 x 78 x 24.60	250	52	16.93	\$2761	\$558	
BRTADG6384H24	62.50 x 84 x 24.60	250	53.50	18.23	\$2807	\$566	

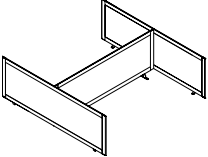

24" H Back-to-Back Glass Divider Screen

Provides privacy in an open plan environment. Easy to clean table mounted partitions. Powder coated aluminum frame with 4mm clear (CLR) glass. Includes all hardware to connect. Brackets are painted steel. Side dividers extend 6.25" from the front edge of each surface. Center divider sits over the gap between the worksurface allowing for cable pass-through to trough. Gap for each side is approximately 1". Width and depth are nominal sizes representing the sizes of the Bridges configuration. Allow for .25" overhang at the sides and 6.25" at the front. Frame and hardware available in all Bridges paint finishes. End trim cap is only available in Charcoal (CHR). **Add 20% upcharge for frosted glass (FRST).**

- **BRTADG51xxH24 are for configurations with 24" deep surfaces.**
- **BRTADG63xxH24 are for configurations with 30" deep surfaces.**

BRTADG5136H30	50.50 x 36 x 30.60	150	30.50	6.31	\$2315	\$467	
BRTADG5142H30	50.50 x 42 x 30.60	150	32	7.36	\$2373	\$481	
BRTADG5148H30	50.50 x 48 x 30.60	150	33.50	8.42	\$2418	\$488	
BRTADG5154H30	50.50 x 54 x 30.60	150	35	9.47	\$2477	\$500	
BRTADG5160H30	50.50 x 60 x 30.60	250	36.50	10.52	\$2528	\$508	
BRTADG5166H30	50.50 x 66 x 30.60	250	38	11.57	\$2580	\$520	
BRTADG5172H30	50.50 x 72 x 30.60	250	39.50	12.63	\$2612	\$525	
BRTADG5178H30	50.50 x 78 x 30.60	250	41	13.68	\$2690	\$539	
BRTADG5184H30	50.50 x 84 x 30.60	250	42.50	14.73	\$2741	\$553	
BRTADG6336H30	62.50 x 36 x 30.60	125	44	7.81	\$2599	\$525	
BRTADG6342H30	62.50 x 42 x 30.60	150	45.50	9.11	\$2651	\$533	
BRTADG6348H30	62.50 x 48 x 30.60	150	47	10.42	\$2703	\$546	
BRTADG6354H30	62.50 x 54 x 30.60	150	48.50	11.72	\$2761	\$558	
BRTADG6360H30	62.50 x 60 x 30.60	150	50	13.02	\$2813	\$566	
BRTADG6366H30	62.50 x 66 x 30.60	250	51.50	14.32	\$2857	\$578	
BRTADG6372H30	62.50 x 72 x 30.60	250	53	15.63	\$2898	\$583	
BRTADG6378H30	62.50 x 78 x 30.60	250	54.50	16.93	\$2968	\$598	
BRTADG6384H30	62.50 x 84 x 30.60	250	56	18.23	\$3027	\$611	

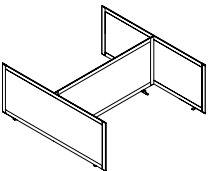

30" H Back-to-Back Glass Divider Screen

Provides privacy in an open plan environment. Easy to clean table mounted partitions. Powder coated aluminum frame with 4mm clear (CLR) glass. Includes all hardware to connect. Brackets are painted steel. Side dividers extend 6.25" from the front edge of each surface. Center divider sits over the gap between the worksurface allowing for cable pass-through to trough. Gap for each side is approximately 1". Width and depth are nominal sizes representing the sizes of the Bridges configuration. Allow for .25" overhang at the sides and 6.25" at the front. Frame and hardware available in all Bridges paint finishes. End trim cap is only available in Charcoal (CHR). **Add 20% upcharge for frosted glass (FRST).**

- **BRTADG51xxH30 are for configurations with 24" deep surfaces.**
- **BRTADG63xxH30 are for configurations with 30" deep surfaces.**

Required specifications
Frame finish

Optional specifications
Frosted glass (FRST)

BACK-TO-BACK GLASS DIVIDER SCREENS

MODEL# DIMENSIONS FREIGHT CLASS WT/LBS. CUBIC FT. LIST PRICE FRST ADD

D x W x H

BRTADGE5136H24	50.50 x 36 x 24.60	150	23.35	6.31	\$1446	\$292
BRTADGE5142H24	50.50 x 42 x 24.60	250	24.85	7.36	\$1499	\$306
BRTADGE5148H24	50.50 x 48 x 24.60	250	26.35	8.42	\$1549	\$313
BRTADGE5154H24	50.50 x 54 x 24.60	250	27.85	9.47	\$1602	\$325
BRTADGE5160H24	50.50 x 60 x 24.60	250	29.35	10.52	\$1654	\$333
BRTADGE5166H24	50.50 x 66 x 24.60	250	30.85	11.57	\$1705	\$345
BRTADGE5172H24	50.50 x 72 x 24.60	250	32.35	12.63	\$1757	\$358
BRTADGE5178H24	50.50 x 78 x 24.60	250	33.85	13.68	\$1808	\$365
BRTADGE5184H24	50.50 x 84 x 24.60	250	35.35	14.73	\$1861	\$378

BRTADGE6336H24	62.50 x 36 x 24.60	150	36.85	7.81	\$1549	\$313
BRTADGE6342H24	62.50 x 42 x 24.60	150	38.35	9.11	\$1602	\$325
BRTADGE6348H24	62.50 x 48 x 24.60	150	39.85	10.42	\$1654	\$333
BRTADGE6354H24	62.50 x 54 x 24.60	250	41.35	11.72	\$1705	\$345
BRTADGE6360H24	62.50 x 60 x 24.60	250	42.85	13.02	\$1749	\$350
BRTADGE6366H24	62.50 x 66 x 24.60	250	44.35	14.32	\$1808	\$365
BRTADGE6372H24	62.50 x 72 x 24.60	250	45.85	15.63	\$1861	\$378
BRTADGE6378H24	62.50 x 78 x 24.60	250	47.35	16.93	\$1907	\$383
BRTADGE6384H24	62.50 x 84 x 24.60	250	48.85	18.23	\$1965	\$396

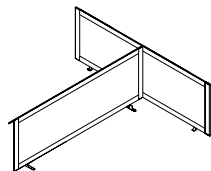

**24" H Back-to-Back Glass Divider
Screen Extension Kit**

Provides an extension to privacy in an open plan environment. Easy to clean table mounted partitions. Intended to always connect to Back-to-Back Divider Screen Kit. Powder coated aluminum frame with 4mm clear (CLR) glass. Includes all hardware to connect. Brackets are painted steel. Side dividers extend 6.25" from the front edge of each surface. Center divider sits over the gap between the worksurface allowing for cable pass-through to trough. Gap for each side is approximately 1". Width and depth are nominal sizes representing the sizes of the Bridges configuration. Allow for .25" overhang at the sides and 6.25" at the front. Frame and hardware available in all Bridges paint finishes. End trim cap is only available in Charcoal (CHR). **Add 20%** upcharge for frosted glass (FRST).

- **BRTADGE51xxH24 are for configurations with 24" deep surfaces.**
- **BRTADGE63xxH24 are for configurations with 30" deep surfaces.**

BRTADGE5136H30	50.50 x 36 x 30.60	150	25.85	6.31	\$1531	\$313
BRTADGE5142H30	50.50 x 42 x 30.60	150	27.35	7.36	\$1575	\$319
BRTADGE5148H30	50.50 x 48 x 30.60	250	28.85	8.42	\$1627	\$333
BRTADGE5154H30	50.50 x 54 x 30.60	250	30.35	9.47	\$1686	\$338
BRTADGE5160H30	50.50 x 60 x 30.60	250	31.85	10.52	\$1737	\$350
BRTADGE5166H30	50.50 x 66 x 30.60	250	33.35	11.57	\$1796	\$365
BRTADGE5172H30	50.50 x 72 x 30.60	250	34.85	12.63	\$1822	\$371
BRTADGE5178H30	50.50 x 78 x 30.60	250	36.35	13.68	\$1894	\$383
BRTADGE5184H30	50.50 x 84 x 30.60	250	37.85	14.73	\$1952	\$396

BRTADGE6336H30	62.50 x 36 x 30.60	150	39.35	7.81	\$1627	\$333
BRTADGE6342H30	62.50 x 42 x 30.60	150	40.85	9.11	\$1686	\$338
BRTADGE6348H30	62.50 x 48 x 30.60	150	42.35	10.42	\$1737	\$350
BRTADGE6354H30	62.50 x 54 x 30.60	250	43.85	11.72	\$1790	\$365
BRTADGE6360H30	62.50 x 60 x 30.60	250	45.35	13.02	\$1841	\$371
BRTADGE6366H30	62.50 x 66 x 30.60	250	46.85	14.32	\$1894	\$383
BRTADGE6372H30	62.50 x 72 x 30.60	250	48.35	15.63	\$1932	\$391
BRTADGE6378H30	62.50 x 78 x 30.60	250	49.85	16.93	\$2004	\$403
BRTADGE6384H30	62.50 x 84 x 30.60	250	51.35	18.23	\$2055	\$416

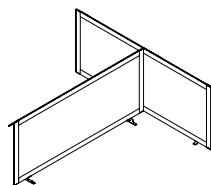

**30" H Back-to-Back Glass Divider
Screen Extension Kit**

Provides an extension to privacy in an open plan environment. Easy to clean table mounted partitions. Intended to always connect to Back-to-Back Divider Screen Kit. Powder coated aluminum frame with 4mm clear (CLR) glass. Includes all hardware to connect. Brackets are painted steel. Side dividers extend 6.25" from the front edge of each surface. Center divider sits over the gap between the worksurface allowing for cable pass-through to trough. Gap for each side is approximately 1". Width and depth are nominal sizes representing the sizes of the Bridges configuration. Allow for .25" overhang at the sides and 6.25" at the front. Frame and hardware available in all Bridges paint finishes. End trim cap is only available in Charcoal (CHR). **Add 20%** upcharge for frosted glass (FRST).

- **BRTADGE51xxH30 are for configurations with 24" deep surfaces.**
- **BRTADGE63xxH30 are for configurations with 30" deep surfaces.**

Required specifications

Frame finish

Optional specifications

Frosted glass (FRST)

SINGLE TABLE GLASS DIVIDER SCREENS

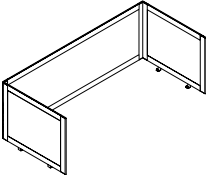

24" H Single Table Glass Divider Screen

MODEL#	DIMENSIONS D x W x H	FREIGHT CLASS	WT./LBS.	CUBIC FT.	LIST PRICE	FRST ADD
BRTADG2436H24	31.50 x 36 x 24.60	125	22.55	3.94	\$1582	\$319
BRTADG2442H24	31.50 x 42 x 24.60	125	24.10	4.59	\$1633	\$333
BRTADG2448H24	31.50 x 48 x 24.60	150	25.65	5.25	\$1686	\$338
BRTADG2454H24	31.50 x 54 x 24.60	150	27.20	5.91	\$1737	\$350
BRTADG2460H24	31.50 x 60 x 24.60	150	28.75	6.56	\$1790	\$365
BRTADG2466H24	31.50 x 66 x 24.60	150	30.30	7.22	\$1841	\$371
BRTADG2472H24	31.50 x 72 x 24.60	150	31.85	7.88	\$1894	\$383
BRTADG2478H24	31.50 x 78 x 24.60	150	33.40	8.53	\$1945	\$391
BRTADG2484H24	31.50 x 84 x 24.60	150	34.95	9.19	\$1997	\$403
BRTADG3036H24	37.75 x 36 x 24.60	100	36.50	4.72	\$1686	\$338
BRTADG3042H24	37.75 x 42 x 24.60	125	38.05	5.51	\$1732	\$350
BRTADG3048H24	37.75 x 48 x 24.60	125	39.60	6.29	\$1790	\$365
BRTADG3054H24	37.75 x 54 x 24.60	125	41.15	7.08	\$1835	\$371
BRTADG3060H24	37.75 x 60 x 24.60	150	41.70	7.87	\$1887	\$383
BRTADG3066H24	37.75 x 66 x 24.60	150	44.25	8.65	\$1939	\$391
BRTADG3072H24	37.75 x 72 x 24.60	150	45.80	9.44	\$1990	\$403
BRTADG3078H24	37.75 x 78 x 24.60	150	47.35	10.22	\$2041	\$409
BRTADG3084H24	37.75 x 84 x 24.60	150	48.90	11.01	\$2094	\$423

Provides privacy in an open plan environment. Easy to clean table mounted partitions. Powder coated aluminum frame with 4mm clear (CLR) glass. Includes all hardware to connect. Brackets are painted steel. Side dividers extend 6.237" from the front edge of each surface. Back divider extends over the back edge of the worksurface by 1.5", allowing for cable pass-through to trough. Width and depth are nominal sizes representing the sizes of the Bridges configuration. Allow for .25" overhang at the sides, 1.5" at the back, and 6.237" at the front. Frame and hardware available in all Bridges paint finishes. End trim cap is only available in Charcoal (CHR). 9mm PET felt material is tackable and available in 9 colors.

- **BRTADG24xxH24 are for configurations with 24" deep surfaces.**
- **BRTADG30xxH24 are for configurations with 30" deep surfaces.**

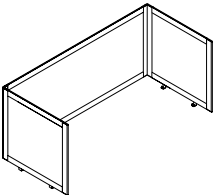

30" H Single Table Glass Divider Screen

BRTADG2436H30	31.50 x 36 x 30.60	125	24.85	3.97	\$1654	\$333
BRTADG2442H30	31.50 x 42 x 30.60	125	26.40	4.59	\$1699	\$345
BRTADG2448H30	31.50 x 48 x 30.60	125	27.95	5.25	\$1749	\$350
BRTADG2454H30	31.50 x 54 x 30.60	150	29.50	5.91	\$1808	\$365
BRTADG2460H30	31.50 x 60 x 30.60	150	31.05	6.56	\$1861	\$378
BRTADG2466H30	31.50 x 66 x 30.60	150	32.60	7.22	\$1919	\$391
BRTADG2472H30	31.50 x 72 x 30.60	150	34.14	7.88	\$1945	\$391
BRTADG2478H30	31.50 x 78 x 30.60	150	34.70	8.53	\$2016	\$409
BRTADG2484H30	31.50 x 84 x 30.60	150	37.25	9.19	\$2074	\$416
BRTADG3036H30	37.75 x 36 x 30.60	100	38.80	4.72	\$1749	\$350
BRTADG3042H30	37.75 x 42 x 30.60	100	40.35	5.51	\$1808	\$365
BRTADG3048H30	37.75 x 48 x 30.60	125	41.90	6.29	\$1861	\$378
BRTADG3054H30	37.75 x 54 x 30.60	125	43.45	7.08	\$1907	\$383
BRTADG3060H30	37.75 x 60 x 30.60	125	45	7.87	\$1965	\$396
BRTADG3066H30	37.75 x 66 x 30.60	150	46.55	8.65	\$2016	\$409
BRTADG3072H30	37.75 x 72 x 30.60	150	48.10	9.44	\$2055	\$416
BRTADG3078H30	37.75 x 78 x 30.60	150	49.65	10.22	\$2127	\$429
BRTADG3084H30	37.75 x 84 x 30.60	150	51.20	11.01	\$2172	\$436

Provides privacy in an open plan environment. Easy to clean table mounted partitions. Powder coated aluminum frame with 4mm clear (CLR) glass. Includes all hardware to connect. Brackets are painted steel. Side dividers extend 6.237" from the front edge of each surface. Back divider extends over the back edge of the worksurface by 1.5", allowing for cable pass-through to trough. Width and depth are nominal sizes representing the sizes of the Bridges configuration. Allow for .25" overhang at the sides, 1.5" at the back, and 6.237" at the front. Frame and hardware available in all Bridges paint finishes. End trim cap is only available in Charcoal (CHR). **Add 20% upcharge for frosted glass (FRST).**

- **BRTADG24xxH30 are for configurations with 24" deep surfaces.**
- **BRTADG30xxH30 are for configurations with 30" deep surfaces.**

Required specifications
Frame finish

Optional specifications
Frosted glass (FRST)

SINGLE TABLE GLASS DIVIDER SCREENS

MODEL# DIMENSIONS FREIGHT CLASS WT/LBS. CUBIC FT. LIST PRICE FRST ADD

D x W x H

BRTADGE2436H24	31.50 x 36 x 24.60	150	18.55	3.94	\$1136	\$228
BRTADGE2442H24	31.50 x 42 x 24.60	150	20.10	4.59	\$1239	\$255
BRTADGE2448H24	31.50 x 48 x 24.60	150	21.65	5.25	\$1283	\$261
BRTADGE2454H24	31.50 x 54 x 24.60	150	23.20	5.91	\$1336	\$274
BRTADGE2460H24	31.50 x 60 x 24.60	150	24.75	6.56	\$1388	\$280
BRTADGE2466H24	31.50 x 66 x 24.60	250	26.30	7.22	\$1440	\$292
BRTADGE2472H24	31.50 x 72 x 24.60	250	27.85	7.88	\$1491	\$300
BRTADGE2478H24	31.50 x 78 x 24.60	250	29.40	8.53	\$1544	\$313
BRTADGE2484H24	31.50 x 84 x 24.60	250	30.95	9.19	\$1595	\$325

BRTADGE3036H24	37.75 x 36 x 24.60	125	32.50	4.72	\$1187	\$241
BRTADGE3042H24	37.75 x 42 x 24.60	125	34.05	5.51	\$1291	\$261
BRTADGE3048H24	37.75 x 48 x 24.60	125	35.60	6.29	\$1341	\$274
BRTADGE3054H24	37.75 x 54 x 24.60	150	37.15	7.08	\$1394	\$280
BRTADGE3060H24	37.75 x 60 x 24.60	150	38.70	7.87	\$1446	\$292
BRTADGE3066H24	37.75 x 66 x 24.60	150	40.25	8.65	\$1499	\$306
BRTADGE3072H24	37.75 x 72 x 24.60	150	41.80	9.44	\$1549	\$313
BRTADGE3078H24	37.75 x 78 x 24.60	150	43.35	10.01	\$1602	\$325
BRTADGE3084H24	37.75 x 84 x 24.60	150	44.90	10.01	\$1654	\$333

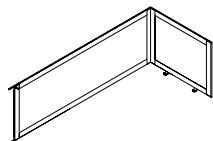

24" H Single Table Glass Divider Screen Extension Kit

Provides an extension for privacy in an open plan environment. Intended to always connect to Single Table Divider Screen Kit. Easy to clean table mounted partitions. Powder coated aluminum frame with 4mm clear (CLR) glass. Includes all hardware to connect. Brackets are painted steel. Side dividers extend 6.237" from the front edge of each surface. Back divider extends over the back edge of the worksurface by 1.5", allowing for cable pass-through to trough. Width and depth are nominal sizes representing the sizes of the Bridges configuration. Allow for .25" overhang at the sides, 1.5" at the back, and 6.237" at the front. Frame and hardware available in all Bridges paint finishes. End trim cap is only available in Charcoal (CHR). **Add 20%** upcharge for frosted glass (FRST).

- **BRTADGE24xxH24 are for configurations with 24" deep surfaces.**
- **BRTADGE30xxH24 are for configurations with 30" deep surfaces.**

BRTADGE2436H30	31.50 x 36 x 30.60	150	20.35	3.94	\$1187	\$241
BRTADGE2442H30	31.50 x 42 x 30.60	150	21.90	4.59	\$1291	\$261
BRTADGE2448H30	31.50 x 48 x 30.60	150	23.45	5.25	\$1341	\$274
BRTADGE2454H30	31.50 x 54 x 30.60	150	25	5.91	\$1400	\$286
BRTADGE2460H30	31.50 x 60 x 30.60	150	26.55	6.56	\$1452	\$292
BRTADGE2466H30	31.50 x 66 x 30.60	150	28.10	7.22	\$1511	\$306
BRTADGE2472H30	31.50 x 72 x 30.60	150	29.65	7.88	\$1537	\$313
BRTADGE2478H30	31.50 x 78 x 30.60	250	31.20	8.53	\$1608	\$325
BRTADGE2484H30	31.50 x 84 x 30.60	250	32.75	9.19	\$1666	\$338

BRTADGE3036H30	37.75 x 36 x 30.60	125	34.30	4.72	\$1246	\$255
BRTADGE3042H30	37.75 x 42 x 30.60	125	35.85	5.51	\$1341	\$274
BRTADGE3048H30	37.75 x 48 x 30.60	125	37.40	6.29	\$1400	\$286
BRTADGE3054H30	37.75 x 54 x 30.60	150	38.95	7.08	\$1452	\$292
BRTADGE3060H30	37.75 x 60 x 30.60	150	40.50	7.87	\$1511	\$306
BRTADGE3066H30	37.75 x 66 x 30.60	150	42.05	8.65	\$1557	\$313
BRTADGE3072H30	37.75 x 72 x 30.60	150	43.60	9.44	\$1589	\$319
BRTADGE3078H30	37.75 x 78 x 30.60	150	45.15	10.22	\$1666	\$338
BRTADGE3084H30	37.75 x 84 x 30.60	150	46.70	11.01	\$1719	\$345

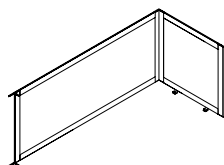

30" H Single Table Glass Divider Screen Extension Kit

Provides an extension for privacy in an open plan environment. Intended to always connect to Single Table Divider Screen Kit. Easy to clean table mounted partitions. Powder coated aluminum frame with 4mm clear (CLR) glass. Includes all hardware to connect. Brackets are painted steel. Side dividers extend 6.237" from the front edge of each surface. Back divider extends over the back edge of the worksurface by 1.5", allowing for cable pass-through to trough. Width and depth are nominal sizes representing the sizes of the Bridges configuration. Allow for .25" overhang at the sides, 1.5" at the back, and 6.237" at the front. Frame and hardware available in all Bridges paint finishes. End trim cap is only available in Charcoal (CHR). **Add 20%** upcharge for frosted glass (FRST).

- **BRTADGE24xxH30 are for configurations with 24" deep surfaces.**
- **BRTADGE30xxH30 are for configurations with 30" deep surfaces.**

Required specifications

Frame finish

Optional specifications

Frosted glass (FRST)

STORAGE

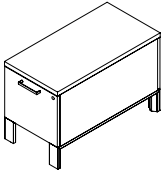

File Pedestal

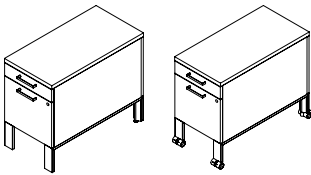

Box/File Pedestal

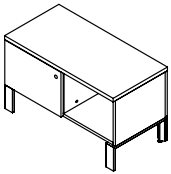

Sliding Door Storage

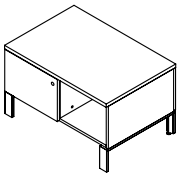

Shared Sliding Door Storage

MODEL#	DIMENSIONS D x W x H	FREIGHT CLASS	WT/LBS.	CUBIC FT.	LIST PRICE	HP ADD
BRT21BF18L	18 x 15.5 x 21	70	58	3.39	\$855	\$63
BRT21BF24L	24 x 15.5 x 21	85	64	4.52	\$994	\$63
BRT21BF30L	30 x 15.5 x 21	85	72	5.65	\$1091	\$82
BRT21BF18C	18 x 15.5 x 21	70	58	3.39	\$855	\$63
BRT21BF24C	24 x 15.5 x 21	85	64	4.52	\$1069	\$63
BRT21BF30C	30 x 15.5 x 21	85	72	5.65	\$1166	\$82

Can join with other 21" h storage units of corresponding depth to form a spine or slide out on casters to serve as an additional worksurface. One file drawer. Fits under table beams even with optional seat cushion. Optional cable basket suspends off storage unit's bottom and manages cables and data cables under storage spine. (Leveler models only.) 1" top; metal handles; powder coated aluminum or anodized aluminum legs. Specify "L" models for levelers or "C" models for 40mm white/grey locking casters.

- Anodized Aluminum Leg - Add **\$85** list upcharge
- 18" deep storage components will not accept legal size paper

BRT25BF18L	18 x 15.5 x 25	70	69	3.89	\$972	\$63
BRT25BF24L	24 x 15.5 x 25	85	74	5.02	\$1129	\$63
BRT25BF30L	30 x 15.5 x 25	85	82	6.15	\$1225	\$82
BRT25BF18C	18 x 15.5 x 25	70	69	3.89	\$1050	\$63
BRT25BF24C	24 x 15.5 x 25	85	74	5.02	\$1204	\$63
BRT25BF30C	30 x 15.5 x 25	85	82	6.15	\$1302	\$82

Can join with other 25" h storage units of corresponding depth to form a spine or slide out on casters to serve as an additional worksurface. One box drawer, one file drawer. Optional cable basket suspends off storage unit's bottom and manages cables and data cables under storage spine. (Leveler models only.) 1" top; metal handles; powder coated aluminum or anodized aluminum legs. Specify "L" models for levelers or "C" models for 40mm white/grey locking casters. Black pencil tray included.

- Anodized Aluminum Leg - Add **\$85** list upcharge
- 18" deep storage components will not accept legal size paper

BRT21LS30L	18 x 30 x 21	100	53	6.56	\$933	\$82
BRT21LS36L	18 x 36 x 21	125	60	7.87	\$1032	\$82
BRT21LS42L	18 x 42 x 21	125	67	9.18	\$1129	\$82

Can join with other 21" h storage units of corresponding depth to form a spine. Optional 15.5" x 18" cushion. Storage compartment internal height: 12.36" Sliding door locks on left side. Optional cable basket suspends off storage unit's bottom and manages cables along the horizontal plane. 1" top; metal handles; powder coated aluminum or anodized aluminum legs.

- Anodized Aluminum Leg - Add **\$85** list upcharge
- 18" deep storage components will not accept legal size paper

BRT21LSS30L	24 x 30 x 21	125	69	8.75	\$1302	\$82
BRT21LSS36L	24 x 36 x 21	125	78	10.50	\$1418	\$103
BRT21LSS42L	24 x 42 x 21	125	87	12.25	\$1534	\$120

Offers two 11" deep storage compartments on either side. For use beside a table assembly, between two adjacent workstations. Can join with other 21" h, 24" d storage units to form a spine. Optional 15.5" x 18" cushion. Storage compartment internal height: 12.36" Sliding door locks on left side. Optional cable basket suspends off storage unit's bottom and manages cables along the horizontal plane. 1" top; metal handles; powder coated aluminum or anodized aluminum legs.

- Anodized Aluminum Leg - Add **\$85** list upcharge

Required Specifications

Metal finish
 Top finish Edge finish
 Chassis finish
 Drawer/door front finish

Optional Specifications

Anodized Aluminum Leg
 HP laminate (tops only)
 Cable Basket

STORAGE

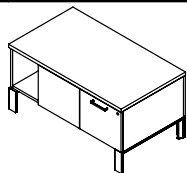

Shared File/Open Storage*

MODEL#	DIMENSIONS	FREIGHT CLASS	WT./LBS.	CUBIC FT.	LIST PRICE	HP ADD
--------	------------	---------------	----------	-----------	------------	--------

D x W x H						
BRT21LSO42L	24 x 42 x 21	100	124	14	\$1747	\$140

Offers storage compartments on either side. For use between two adjacent workstations. Can join with other 21" h, 24" d storage units to form a spine or serve as an additional return worksurface or ad-hoc guest seating with optional 15.5" x 18" cushion. One locking file drawer, One open compartment per side. Storage compartment internal height without shelf: 12.36". Optional cable basket suspends off storage unit's bottom and manages cables along the horizontal plane. 1" top; metal handles; powder coated aluminum or anodized aluminum legs.

- Anodized Aluminum Leg - Add **\$85** list upcharge

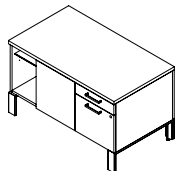

Shared Storage Unit*

BRT25LBF042L	24 x 42 x 25	100	154	16.66	\$2194	\$120
--------------	--------------	-----	-----	-------	--------	-------

Offers storage compartments on either side. For use between two adjacent workstations. Can join with other 25" h, 24" d storage units to form a spine or serve as an additional return worksurface or ad-hoc guest seating with optional 15.5" x 18" cushion. One locking file drawer, One open compartment per side. Storage compartment internal height without shelf: 12.36". Optional cable basket suspends off storage unit's bottom and manages cables along the horizontal plane. 1" top; metal handles; powder coated aluminum or anodized aluminum legs. Black pencil tray included.

- Anodized Aluminum Leg - Add **\$85** list upcharge
- 25" high Bridges storage should not be used under back-to-back Bridges table applications using Below Worksurface Trough. Storage will not fit under the trough.

MODULAR STORAGE

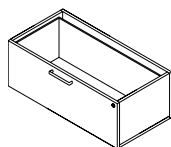

21" H Lateral File Drawer, No Top

MODEL#	DIMENSIONS	FREIGHT CLASS	WT./LBS.	CUBIC FT.	LIST PRICE	HP ADD
--------	------------	---------------	----------	-----------	------------	--------

BRT21F3018U	18 x 30 x 13	92.5	47	4.06	\$1009	n/a
BRT21F3618U	18 x 36 x 13	92.5	51	4.88	\$1115	n/a
BRT21F4218U	18 x 42 x 13	100	56	5.69	\$1294	n/a
BRT21F3024U	24 x 30 x 13	100	51	5.42	\$1033	n/a
BRT21F3624U	24 x 36 x 13	100	55	6.5	\$1151	n/a
BRT21F4224U	24 x 42 x 13	125	60	7.58	\$1353	n/a

Fits below Bridges II tables. Can join with other 21" h storage units of corresponding depth to form a spine. Floor clearance allows for installation of optional cable basket to manage cords and data cables under storage spine. One file drawer. **Top and legs to be ordered separately.** Metal handles.

- 18" deep storage components will not accept legal size paper

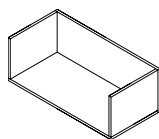

21" H Open Storage, No Top

BRT21LO3018U	18 x 30 x 13	125	25	4.06	\$318	n/a
BRT21LO3618U	18 x 36 x 13	150	29	4.88	\$473	n/a
BRT21LO4218U	18 x 42 x 13	150	32	5.69	\$514	n/a
BRT21LO3024U	24 x 30 x 13	150	29	5.42	\$330	n/a
BRT21LO3624U	24 x 36 x 13	150	33	6.5	\$492	n/a
BRT21LO4224U	24 x 42 x 13	150	36	7.58	\$534	n/a

Open storage unit with no top. Positioned beside a Bridges II table assembly or between two adjacent workstations. Can join with other 21" h storage units to form a spine. Floor clearance allows for installation of optional cable basket to manage cords and data cables under storage spine. One box opening. **Top and legs to be ordered separately.**

Required Specifications

Metal finish*	
Top finish*	Edge finish*
Chassis finish	
Drawer/door front finish	

Optional Specifications

Anodized Aluminum Leg*
HP laminate* (tops only)
Cable Basket
Cushion (BRT21LSO42L)

MODULAR STORAGE

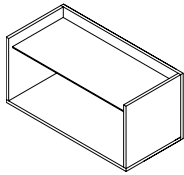

25" H Open Storage, Glass Shelf, No Top

MODEL#	DIMENSIONS D x W x H	FREIGHT CLASS	WT./LBS.	CUBIC FT.	LIST PRICE	HP ADD
BRT25L03018U	18 x 30 x 17	125	40	5.31	\$470	n/a
BRT25L03618U	18 x 36 x 17	125	46	6.38	\$645	n/a
BRT25L04218U	18 x 42 x 17	125	52	7.44	\$666	n/a
BRT25L03024U	24 x 30 x 17	125	44	7.08	\$501	n/a
BRT25L03624U	24 x 36 x 17	150	50	8.5	\$670	n/a
BRT25L04224U	24 x 42 x 17	150	56	9.92	\$699	n/a

Positioned usually beside a table assembly or between two adjacent workstations. Can join with other 25" h storage units to form a storage spine. Floor clearance allows for installation of optional cable basket to manage cords and data cables under storage spine. One box opening with glass shelf. **Top and legs to be ordered separately.**

- 25" high Bridges storage should not be used under back-to-back Bridges table applications using Below Worksurface Trough. Storage will not fit under the trough.

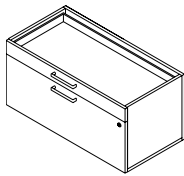

Lateral Box/File Storage, No Top*

BRT25LBF3018U	18 x 30 x 17	92.5	58	5.31	\$1210	n/a
BRT25LBF3618U	18 x 36 x 17	85	78	6.38	\$1405	n/a
BRT25LBF4218U	18 x 42 x 17	100	68	7.44	\$1496	n/a
BRT25LBF3024U	24 x 30 x 17	100	62	7.08	\$1258	n/a
BRT25LBF3624U	24 x 36 x 17	100	82	8.5	\$1461	n/a
BRT25LBF4224U	24 x 42 x 17	125	72	9.92	\$1557	n/a

Positioned usually beside a table assembly or between two adjacent workstations. Can join with other 25" h storage units to form a storage spine. Floor clearance allows for installation of optional cable basket to manage cords and data cables under storage spine. One locking file drawer, one box drawer. **Top and legs to be ordered separately.** Metal handles. Black pencil tray included.

- 18" deep storage components will not accept legal size paper
- 25" high Bridges storage should not be used under back-to-back Bridges table applications using Below Worksurface Trough. Storage will not fit under the trough.

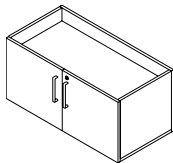

25" H Storage Cabinet, No Top*

BRT25L2D3018U	18 x 30 x 17	125	39	5.31	\$896	n/a
BRT25L2D3618U	18 x 36 x 17	125	45	6.38	\$962	n/a
BRT25L2D4218U	18 x 42 x 17	125	54	7.44	\$1001	n/a
BRT25L2D3024U	24 x 30 x 17	125	43	7.08	\$1042	n/a
BRT25L2D3624U	24 x 36 x 17	150	49	8.5	\$1136	n/a
BRT25L2D4224U	24 x 42 x 17	150	58	9.92	\$1183	n/a

Positioned usually beside a table assembly or between two adjacent workstations. Can join with other 25" h storage units to form a storage spine. Floor clearance allows for installation of optional cable basket to manage cords and data cables under storage spine. Two lockable doors, glass shelf included. **Top and legs to be ordered separately.** Storage compartment internal height is 16.5". Metal handles.

- 25" high Bridges storage should not be used under back-to-back Bridges table applications using Below Worksurface Trough. Storage will not fit under the trough.

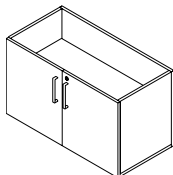

29" H Storage Cabinet, No Top*

BRT29L2D3018U	18 x 30 x 21	125	49	6.56	\$1022	n/a
BRT29L2D3618U	18 x 36 x 21	125	55	7.88	\$1067	n/a
BRT29L2D4218U	18 x 42 x 21	125	64	9.19	\$1114	n/a
BRT29L2D3024U	24 x 30 x 21	125	53	8.75	\$1199	n/a
BRT29L2D3624U	24 x 36 x 21	150	59	10.5	\$1253	n/a
BRT29L2D4224U	24 x 42 x 21	150	68	12.25	\$1281	n/a

Positioned usually beside a table assembly or between two adjacent workstations. Units are level with Bridges tops and can join other 29" h storage units to form a credenza or serve as an additional return worksurface. Floor clearance allows for installation of optional cable basket to manage cords and data cables under storage spine. Two lockable doors, glass shelf included. **Top and legs to be ordered separately.** Storage compartment internal height is 20.5". Metal handles.

- 25" high Bridges storage should not be used under back-to-back Bridges table applications using Below Worksurface Trough. Storage will not fit under the trough.

Required Specifications

Chassis finish
Drawer/door front finish*

Optional Specifications

Cable Basket

MODULAR STORAGE

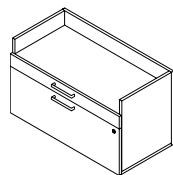

29" H Box/File/Open Storage, No Top

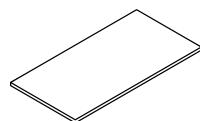

Worksurface for Modular Storage*

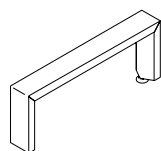

Modular Storage Leg**

MODEL#	DIMENSIONS	FREIGHT CLASS	WT/LBS.	CUBIC FT.	LIST PRICE	HP ADD
--------	------------	---------------	---------	-----------	------------	--------

D x W x H

BRT29LOBF3018U	18 x 30 x 21	92.5	70	6.56	\$1424	n/a
BRT29LOBF3618U	18 x 36 x 21	100	78	7.88	\$1606	n/a
BRT29LOBF4218U	18 x 42 x 21	100	86	9.19	\$1765	n/a
BRT29LOBF3024U	24 x 30 x 21	100	74	8.75	\$1482	n/a
BRT29LOBF3624U	24 x 36 x 21	125	82	10.52	\$1671	n/a
BRT29LOBF4224U	24 x 42 x 21	125	90	12.25	\$1835	n/a

Positioned beside a table assembly or between two adjacent workstations. Units are level with Bridges tops and can join other 29" h storage units to form a credenza or serve as an additional return worksurface. Floor clearance allows for installation of optional cable basket to manage cords and data cables under storage spine. One locking file drawer, one box drawer and one open compartment. **Top and legs to be ordered separately.** Storage compartment internal height: 3.9". Metal handles. Black pencil tray included.

- 18" deep storage components will not accept legal size paper

BRTWU1830	18 x 30 x 1	60	15	0.5	\$179	\$63
BRTWU1836	18 x 36 x 1	60	18	0.59	\$204	\$69
BRTWU1842	18 x 42 x 1	60	21	0.68	\$268	\$91
BRTWU1860	18 x 60 x 1	65	29	0.97	\$423	\$124
BRTWU1866	18 x 66 x 1	65	32	1.1	\$444	\$140
BRTWU1872	18 x 72 x 1	65	35	1.2	\$462	\$152
BRTWU1878	18 x 78 x 1	65	38	1.3	\$489	\$160
BRTWU1884	18 x 84 x 1	65	41	1.4	\$536	\$168
BRTWU1890	18 x 90 x 1	65	44	1.5	\$557	\$173
BRTWU1896	18 x 96 x 1	65	47	1.6	\$580	\$181

BRTWU2430	24 x 30 x 1	60	20	0.65	\$187	\$57
BRTWU2436	24 x 36 x 1	60	24	0.78	\$208	\$71
BRTWU2442	24 x 42 x 1	60	28	0.9	\$274	\$90
BRTWU2460	24 x 60 x 1	60	39	1.3	\$432	\$142
BRTWU2466	24 x 66 x 1	60	43	1.41	\$450	\$147
BRTWU2472	24 x 72 x 1	60	47	1.54	\$470	\$38
BRTWU2478	24 x 78 x 1	60	51	1.7	\$504	\$161
BRTWU2484	24 x 84 x 1	60	55	1.8	\$546	\$170
BRTWU2490	24 x 90 x 1	60	59	1.9	\$568	\$175
BRTWU2496	24 x 96 x 1	60	63	2	\$590	\$184

Flat 3mm profile on all sides. Worksurface provided with pilot holes for alignment purposes. Worksurfaces can be used for each modular unit or can span two to three units.

BRT18LEGL	18 x 2.5 x 8	150	8	1.34	\$68	n/a
BRT24LEGL	24 x 2.5 x 8	150	8	1.34	\$75	n/a

Two single legs form the structure of the Bridges II series modular storage. A single leg can be used at the end of each modular storage unit or can be used to support where two modular units meet. Leveling glides, steel frame, aluminum legs.

- Anodized Aluminum leg - Add **\$36** list upcharge

Required Specifications

Top finish*
Edge finish
Chassis finish
Metal finish**

Optional Specifications

HP laminate* (tops only)
Anodized Aluminum Leg**
Cable Basket (storage unit)

STORAGE

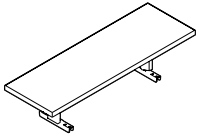

Center Mount Shelf*

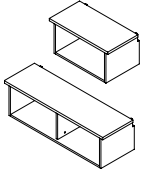
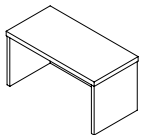
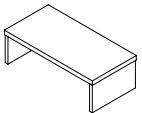

Table Mounted End Shelf*



Single Sided Elevated Table Shelf*

MODEL#	DIMENSIONS	FREIGHT CLASS	WT./LBS.	CUBIC FT.	LIST PRICE	HP ADD
--------	------------	---------------	----------	-----------	------------	--------

	D x W x H					
BRTCMS36	12 x 36 x 6.75	100	15.20	1.69	\$372	n/a
BRTCMS30	12 x 30 x 6.75	100	12.60	1.41	\$262	n/a

Open, shared center mount shelf “floats” 6.75” above the gap formed by two back-to-back worksurfaces. Accepts BRTESSBIN Elevated Shelf Binder Bin - The 30”w shelf accommodates two; 36”w shelf accommodates up to three. Shelves overhang the support structure by 6” on either side. Aluminum/die cast structure attaches to the underside of both worksurfaces.

- Not compatible with BRTEETA Above Worksurface Power Trough and Worksurfaces with Access Doors
- Anodized Aluminum support structure - Add **\$85** list upcharge

BRTTES24	15.5 x 24 x 15	100	29	3.22	\$722	\$63
BRTTES30	15.5 x 30 x 15	100	34	4.03	\$790	\$71
BRTTES51	15.5 x 50.5 x 15	100	57	6.79	\$1302	\$129
BRTTES63	15.5 x 62.5 x 15	100	68	8.40	\$1430	\$167

Single or double open shelf/extended worksurface. Secured to the end of single or back-to-back Bridges table. All mounting hardware included. Storage compartment internal height: 13.25”. 1” top.

BRTSTS0824	12 x 24 x 8	92.5	14	1.33	\$256	\$82
BRTSTS0830	12 x 30 x 8	100	16	1.66	\$294	\$82
BRTSTS0851	12 x 50.5 x 8	100	25	2.80	\$469	\$120
BRTSTS0863	12 x 62.5 x 8	100	28	3.47	\$530	\$179

BRTSTS1324	12 x 24 x 13	100	18	2.16	\$277	\$82
BRTSTS1330	12 x 30 x 13	125	21	2.70	\$315	\$82
BRTSTS1351	12 x 50.5 x 13	125	32	4.55	\$469	\$120
BRTSTS1363	12 x 62.5 x 13	125	38	5.64	\$547	\$160

BRTSTS1624	12 x 24 x 16	125	19	2.66	\$315	\$82
BRTSTS1630	12 x 30 x 16	100	29	3.33	\$372	\$82
BRTSTS1651	12 x 50.5 x 16	150	33	5.61	\$547	\$140
BRTSTS1663	12 x 62.5 x 16	150	39	6.94	\$625	\$179

Secured perpendicularly to the single or back-to-back Bridges table. Integrated anodized aluminum accessory rail. White cut out and accessory rail trims. Optional Elevated Shelf Binder Bin (BRTESSBIN) rests on top surface for enhanced privacy. 8”h provides additional storage space without obstructing view and reaches 16” module height when combined w/8”h Binder shelf. Internal height: 6.6”. 16”h lines up with top of 16” table dividers (15.8”). Specify 12” narrower shared elevated shelf immediately adjacent to the perpendicular elevated shelf. Internal height: 14.6”.

- Please refer to the **Compatibility Guide** on page 400 to determine available accessories

Required Specifications

Top finish
Edge finish
Chassis/Accent Finish

Optional Specifications

HP laminate (tops only)
Elevated Shelf Binder Bin

STORAGE

MODEL# DIMENSIONS FREIGHT CLASS WT./LBS. CUBIC FT. LIST PRICE HP ADD

D x W x H

BRTBTS0836	12 x 36 x 8	100	16	2	\$392	\$82
BRTBTS0842	12 x 42 x 8	100	19	2.33	\$431	\$82
BRTBTS0848	12 x 48 x 8	125	21	2.66	\$469	\$120
BRTBTS0854	12 x 54 x 8	125	23	3	\$489	\$140
BRTBTS0860	12 x 60 x 8	125	26	3.33	\$547	\$160
BRTBTS0866	12 x 66 x 8	125	28	3.66	\$586	\$179
BRTBTS0872	12 x 72 x 8	125	30	4	\$625	\$179
BRTBTS0878	12 x 78 x 8	125	32	4.33	\$664	\$198
BRTBTS0884	12 x 84 x 8	125	35	4.66	\$703	\$216

BRTBTS1336	12 x 36 x 13	125	22	3.25	\$469	\$103
BRTBTS1342	12 x 42 x 13	125	25	3.79	\$530	\$103
BRTBTS1348	12 x 48 x 13	125	28	4.33	\$568	\$140
BRTBTS1354	12 x 54 x 13	125	30	4.87	\$625	\$140
BRTBTS1360	12 x 60 x 13	150	33	5.86	\$664	\$140
BRTBTS1366	12 x 66 x 13	150	36	6.45	\$680	\$238
BRTBTS1372	12 x 72 x 13	125	39	6.50	\$779	\$198
BRTBTS1378	12 x 78 x 13	150	42	7.04	\$838	\$198
BRTBTS1384	12 x 84 x 13	150	44	7.58	\$896	\$216

BRTBTS1636	12 x 36 x 16	125	25	4	\$489	\$82
BRTBTS1642	12 x 42 x 16	125	28	4.66	\$547	\$120
BRTBTS1648	12 x 48 x 16	150	31	5.33	\$604	\$120
BRTBTS1654	12 x 54 x 16	150	34	6	\$642	\$160
BRTBTS1660	12 x 60 x 16	150	38	6.66	\$703	\$160
BRTBTS1666	12 x 66 x 16	150	41	7.33	\$761	\$160
BRTBTS1672	12 x 72 x 16	150	44	8	\$819	\$179
BRTBTS1678	12 x 78 x 16	150	47	8.66	\$855	\$198
BRTBTS1684	12 x 84 x 16	150	50	9.33	\$917	\$216

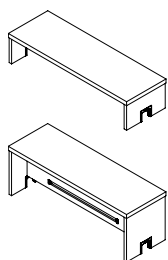

Shared Elevated Table Shelf

Rests on back-to-back Bridges tables. Cut outs in both supporting side gables allow placement over above worksurface power/data troughs. Integrated anodized aluminum accessory rail. White cut out and accessory rail trims. Three heights available. 8" h provides additional storage space without obstructing view; reaches 16" module height when combined w/8" h Binder shelf. Internal height: 6.6". 16" h lines up with top of 16" table dividers (15.8"). Specify 12" narrower shared elevated shelf immediately adjacent to the perpendicular elevated shelf. Internal height: 14.6". Optional Elevated Shelf Binder Bin (BRTESBBIN) rests on top surface for enhanced privacy. 1" top.

- Please refer to the **Compatibility Guide** on page 400 to determine available accessories

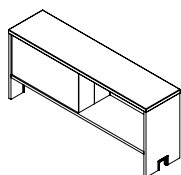

Table Supported Shared Overhead

BRTBASO48	12 x 48 x 21	125	54	7	\$779	\$120
-----------	--------------	-----	----	---	-------	-------

One compartment per side. White magnetic back wall. Lines up with 50" h floor standing storage. Fits over the gap between two parallel back-to-back Bridges tables. Fits over worksurface power/data trough. Storage compartment internal height: 12.8". Optional Elevated Shelf Binder Bin (BRTESBBIN) rests on top surface for enhanced privacy. 1" top.

- Please refer to the **Compatibility Guide** on page 400 to determine available accessories

Required Specifications

Top finish
Edge finish
Chassis/accent finish

Optional Specifications

HP laminate (tops only)
Elevated Shelf Binder Bin

STORAGE

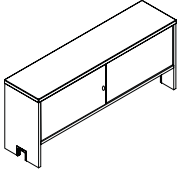

Shared Elevated Overhead*

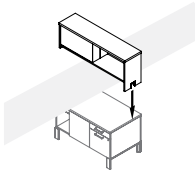

45" High Shared Storage Divider**

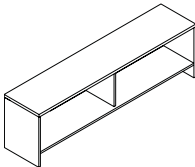

Open Single Sided Storage

MODEL#	DIMENSIONS D x W x H	FREIGHT CLASS	WT./LBS.	CUBIC FT.	LIST PRICE	HP ADD
BRTBASL36	16 x 36 x 21	250	23.50	6.56	\$2250	\$151
BRTBASL42	16 x 42 x 21	250	27.50	7.65	\$2407	\$184
BRTBASL48	16 x 48 x 21	250	31.40	8.75	\$2533	\$217
BRTBASL54	16 x 54 x 21	250	35.30	9.84	\$2725	\$228
BRTBASL60	16 x 60 x 21	250	35.30	9.84	\$2873	\$235
BRTBASL66	16 x 66 x 21	250	43.20	12.03	\$3242	\$275
BRTBASL72	16 x 72 x 21	250	47.10	13.12	\$3413	\$307
BRTBASL78	16 x 78 x 21	250	51	14.21	\$3592	\$330
BRTBASL84	16 x 84 x 21	250	55	15.31	\$3639	\$455

Two compartments facing in opposite direction with locking, sliding laminate doors. Storage compartment internal height: 12.25". Shared elevated overhead fits over the gap between two parallel Bridges back-to-back tables. Integrated anodized aluminum accessory rail below the storage compartments. Fits over Above Worksurface Power/Data Troughs. Elevated Shelf Binder Bins DO NOT work with this overhead. 1" top.

- Note: In order to prevent duplex outlet and worksurface access door interference, please specify Overhead of the same width as the supporting worksurface.
- To prevent interference with Ceiling feed pole, please specify Overhead 6" shorter in width corresponding with the length of the supporting worksurface.
- Please refer to the **Compatibility Guide** on page 400 to determine available accessories

BRTSDS48	12 x 48 x 16	92.5	54	5.33	\$625	\$120
----------	--------------	------	----	------	--------------	--------------

Divides side-to-side workstations. Two shared, open shelves. One compartment per side. White magnetic back wall. Rests on top of shared 25" box/file/open and back-to-back worksurface. Top of unit is 15.7" from the top of the worksurface. Storage compartment internal height: 12.8". Optional Elevated Shelf Binder Bin (BRTEBBIN) rests on top surface for enhanced privacy. 1" top, white powder-coated steel central partition and backs.

BRT21HO3616	16 x 36 x 21	100	81	9	\$1121	\$151
BRT21HO4216	16 x 42 x 21	100	81	9	\$1203	\$173
BRT21HO4816	16 x 48 x 21	250	31.40	8.75	\$1283	\$197
BRT21HO5416	16 x 54 x 21	250	35.30	9.84	\$1363	\$222
BRT21HO6016	16 x 60 x 21	250	35.30	9.84	\$1452	\$247
BRT21HO6616	16 x 66 x 21	250	43.20	12.03	\$1545	\$270
BRT21HO7216	16 x 72 x 21	250	47.10	13.12	\$1602	\$306
BRT21HO7816	16 x 78 x 21	250	51	14.21	\$1723	\$318
BRT21HO8416	16 x 84 x 21	250	55	15.31	\$1792	\$343

Table supported single sided open storage. Storage compartment internal height: 14". 1" top.

- Cannot be used in conjunction with above worksurface power trough.
- To prevent duplex outlet and worksurface access door interference, please specify Overhead of the same width of the supporting worksurface.
- To prevent interference with ceiling feed pole, please specify Overhead 6" shorter in width corresponding with the length of the supporting worksurface.
- Please refer to the **Compatibility Guide** on page 400 to determine available accessories

Required Specifications

Top finish
Edge finish
Chassis finish*
Drawer/door front finish*

Optional Specifications

HP laminate (tops only)
Elevated Shelf Binder Bin**

STORAGE

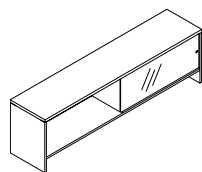

**Open Single Sided Storage,
1 Glass Door**

MODEL#	DIMENSIONS D x W x H	FREIGHT CLASS	WT/LBS.	CUBIC FT.	LIST PRICE	HP ADD
BRT21GS3616	16 x 36 x 21	100	87	9	\$1763	\$149
BRT21GS4216	16 x 42 x 21	100	103	10.50	\$1853	\$172
BRT21GS4816	16 x 48 x 21	100	108	12	\$1932	\$197
BRT21GS5416	16 x 54 x 21	100	133	13.50	\$2304	\$222
BRT21GS6016	16 x 60 x 21	100	144	15	\$2394	\$247
BRT21GS6616	16 x 66 x 21	100	155	16.50	\$2507	\$270
BRT21GS7216	16 x 72 x 21	100	164	18	\$2592	\$294
BRT21GS7816	16 x 78 x 21	100	174	19.50	\$2730	\$317
BRT21GS8416	16 x 84 x 21	100	181	21	\$2810	\$344

Table supported single sided open storage with single sliding glass door with recessed pull. Storage compartment internal height: 14". 1" top.

- Cannot be used in conjunction with above worksurface power trough.
- To prevent duplex outlet and worksurface access door interference, please specify Overhead of the same width of the supporting worksurface.
- To prevent interference with ceiling feed pole, please specify Overhead 6" shorter in width corresponding with the length of the supporting worksurface.
- Please refer to the **Compatibility Guide** on page 400 to determine available accessories

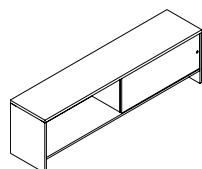

**Open Single Sided Storage,
1 Laminate Door****

BRT21LS3616	16 x 36 x 21	92.5	94	9	\$1712	\$212
BRT21LS4216	16 x 42 x 21	92.5	111	10.50	\$1795	\$244
BRT21LS4816	16 x 48 x 21	100	117	12	\$1874	\$279
BRT21LS5416	16 x 54 x 21	92.5	143	13.50	\$1953	\$315
BRT21LS6016	16 x 60 x 21	92.5	155	15	\$2261	\$345
BRT21LS6616	16 x 66 x 21	92.5	167	16.50	\$2354	\$380
BRT21LS7216	16 x 72 x 21	100	177	18	\$2420	\$416
BRT21LS7816	16 x 78 x 21	100	188	19.50	\$2530	\$450
BRT21LS8416	16 x 84 x 21	100	198	21	\$2599	\$483

Table supported single sided open storage with single sliding laminate door with recessed pull. Storage compartment internal height: 14". 1" top.

- Cannot be used in conjunction with above worksurface power trough.
- To prevent duplex outlet and worksurface access door interference, please specify Overhead of the same width of the supporting worksurface.
- To prevent interference with ceiling feed pole, please specify Overhead 6" shorter in width corresponding with the length of the supporting worksurface.
- Please refer to the **Compatibility Guide** on page 400 to determine available accessories

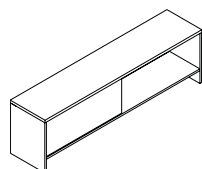

Open Double Sided Storage*

BRT21HDO3616	16 x 36 x 21	100	81	9	\$1162	\$149
BRT21HDO4216	16 x 42 x 21	100	96	10.50	\$1228	\$173
BRT21HDO4816	16 x 48 x 21	100	100	12	\$1286	\$201
BRT21HDO5416	16 x 54 x 21	100	124	13.50	\$1384	\$223
BRT21HDO6016	16 x 60 x 21	100	134	15	\$1457	\$245
BRT21HDO6616	16 x 66 x 21	100	144	16.50	\$1566	\$269
BRT21HDO7216	16 x 72 x 21	100	152	18	\$1616	\$294
BRT21HDO7816	16 x 78 x 21	100	161	19.50	\$1744	\$318
BRT21HDO8416	16 x 84 x 21	100	168	21	\$1793	\$344

Table supported double sided open storage. Fits over the gap between two parallel Bridges II back-to-back tables. Storage compartment internal height: 14". 1" top.

- Cannot be used in conjunction with above worksurface power trough.
- To prevent duplex outlet and worksurface access door interference, please specify Overhead of the same width of the supporting worksurface.
- To prevent interference with ceiling feed pole, please specify Overhead 6" shorter in width corresponding with the length of the supporting worksurface.
- Please refer to the **Compatibility Guide** on page 400 to determine available accessories

Required Specifications

Top finish
Edge finish
Chassis finish*
Drawer/door front finish**

Optional Specifications

HP laminate (tops only)
Elevated Shelf Binder Bin

STORAGE

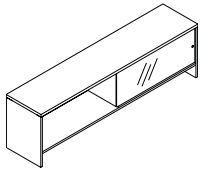

Double Sided Storage, Glass Door

MODEL#	DIMENSIONS D x W x H	FREIGHT CLASS	WT/LBS.	CUBIC FT.	LIST PRICE	HP ADD
BRT21GDS3616	16 x 36 x 21	92.5	94	9	\$2288	\$145
BRT21GDS4216	16 x 42 x 21	92.5	111	10.50	\$2396	\$173
BRT21GDS4816	16 x 48 x 21	100	117	12	\$2448	\$198
BRT21GDS5416	16 x 54 x 21	92.5	143	13.50	\$3167	\$222
BRT21GDS6016	16 x 60 x 21	92.5	155	15	\$3223	\$247
BRT21GDS6616	16 x 66 x 21	92.5	167	16.50	\$3437	\$269
BRT21GDS7216	16 x 72 x 21	100	177	18	\$3513	\$294
BRT21GDS7816	16 x 78 x 21	100	188	19.50	\$3659	\$317
BRT21GDS8416	16 x 84 x 21	100	196	21	\$3894	\$343

Table supported double sided open storage with sliding glass doors and recessed pull. Fits over the gap between two parallel Bridges II back-to-back tables. Storage compartment internal height: 14". 1" top.

- Cannot be used in conjunction with above worksurface power trough.
- To prevent duplex outlet and worksurface access door interference, please specify Overhead of the same width of the supporting worksurface.
- To prevent interference with ceiling feed pole, please specify Overhead 6" shorter in width corresponding with the length of the supporting worksurface.
- Please refer to the **Compatibility Guide** on page 400 to determine available accessories

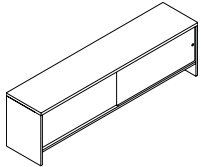

Double Sided Storage, Laminate Door*

BRT21LDS3616	16 x 36 x 21	92.5	106	9	\$2249	\$149
BRT21LDS4216	16 x 42 x 21	85	126	10.50	\$2391	\$173
BRT21LDS4816	16 x 48 x 21	92.5	134	12	\$2441	\$197
BRT21LDS5416	16 x 54 x 21	85	162	13.50	\$3047	\$222
BRT21LDS6016	16 x 60 x 21	92.5	176	15	\$3100	\$247
BRT21LDS6616	16 x 66 x 21	92.5	190	16.50	\$3309	\$270
BRT21LDS7216	16 x 72 x 21	92.5	203	18	\$3359	\$294
BRT21LDS7816	16 x 78 x 21	92.5	216	19.50	\$3484	\$317
BRT21LDS8416	16 x 84 x 21	92.5	227	21	\$3694	\$343

Table supported double sided open storage with sliding laminate doors and recessed pull. Fits over the gap between two parallel Bridges II back-to-back tables. Storage compartment internal height: 14". 1" top.

- Cannot be used in conjunction with above worksurface power trough.
- To prevent duplex outlet and worksurface access door interference, please specify Overhead of the same width of the supporting worksurface.
- To prevent interference with ceiling feed pole, please specify Overhead 6" shorter in width corresponding with the length of the supporting worksurface.
- Please refer to the **Compatibility Guide** on page 400 to determine available accessories

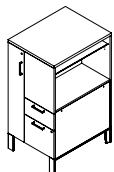

50" H Storage Tower w/Coat Storage*

BRTTW5024L	24 x 24 x 50	100	142	16.66	\$2116	\$140
BRTTW5024R	24 x 24 x 50	100	142	16.66	\$2116	\$140
BRTTW5030L	30 x 24 x 50	125	163	20.83	\$2348	\$140
BRTTW5030R	30 x 24 x 50	125	163	20.83	\$2348	\$140

Provides storage and privacy at the end of a table. Box/File drawers, open compartment with adjustable shelf (50"h); coat storage with hinged door. Specify Left or Right handed. Capable of supporting worksurface on one side. Built-in threaded inserts to secure dedicated worksurface supporting beam. Open side storage compartment internal height: 19.6". Optional cable basket suspends off storage unit's bottom and manages cables along the horizontal plane. 1" top; metal handles; powder-coated aluminum or anodized aluminum legs. Black pencil tray included.

- Anodized Aluminum Leg - Add **\$85** list upcharge

Required Specifications

Top finish
Chassis finish
Drawer/door front finish
Metal finish (legs)

Optional Specifications

Anodized aluminum leg*
HP laminate
E-Lock*

STORAGE

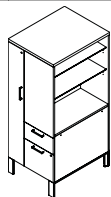
**66" H Storage Tower with Coat Storage**

MODEL#	DIMENSIONS	FREIGHT CLASS	WT/LBS.	CUBIC FT.	LIST PRICE	HP ADD
--------	------------	---------------	---------	-----------	------------	--------

D x W x H

BRTTW6624L	24 x 24 x 66	125	170	22	\$2805	\$181
BRTTW6624R	24 x 24 x 66	125	170	22	\$2805	\$181
BRTTW6630L	30 x 24 x 66	125	195	27.50	\$3112	\$183
BRTTW6630R	30 x 24 x 66	125	195	27.50	\$3112	\$219

Provides storage and privacy at the end of a table. Box/File drawers, open compartment with 2 adjustable shelves (66" h); coat storage with hinged door and 2 shelves. Specify Left or Right handed. Capable of supporting worksurface on one side. Built-in threaded inserts to secure dedicated worksurface supporting beam. Open side storage compartment internal height: 35.6". Optional cable basket suspends off storage unit's bottom and manages cables along the horizontal plane. 1" top; metal handles; powder-coated aluminum or anodized aluminum legs. Black pencil tray included.

- Anodized Aluminum Leg - Add **\$85** list upcharge

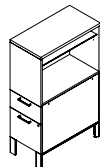
**50" H Storage Tower**

BRTT5024L	24 x 15.5 x 50	100	88	10.76	\$1572	\$103
BRTT5024R	24 x 15.5 x 50	100	88	10.76	\$1572	\$103
BRTT5030L	30 x 15.5 x 50	125	101	13.45	\$1730	\$120
BRTT5030R	30 x 15.5 x 50	125	101	13.45	\$1730	\$120

Provides storage and privacy at the end of a table. Box/File drawers, open compartment with adjustable shelf (50" h). Specify Left or Right handed. Capable of supporting worksurface on one side. Built-in threaded inserts to secure dedicated worksurface supporting beam. Open side storage compartment internal height: 19.6". Optional cable basket suspends off storage unit's bottom and manages cables along the horizontal plane. 1" top; metal handles; powder-coated aluminum or anodized aluminum legs. Black pencil tray included.

- Anodized Aluminum Leg - Add **\$85** list upcharge

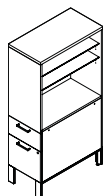
**66" H Storage Tower**

BRTT6624L	24 x 15.5 x 66	100	106	12.91	\$2085	\$131
BRTT6624R	24 x 15.5 x 66	100	106	12.91	\$2085	\$131
BRTT6630L	30 x 15.5 x 66	125	121	16.14	\$2292	\$159
BRTT6630R	30 x 15.5 x 66	125	121	16.14	\$2292	\$159

Provides storage and privacy at the end of a table. Box/File drawers, open compartment with 2 adjustable glass shelves (66" h). Specify Left or Right handed. Capable of supporting worksurface on one side. Built-in threaded inserts to secure dedicated worksurface supporting beam. Open side storage compartment internal height: 35.6". Optional cable basket suspends off storage unit's bottom and manages cables along the horizontal plane. 1" top; metal handles; powder-coated aluminum or anodized aluminum legs. Black pencil tray included.

- Anodized Aluminum Leg - Add **\$85** list upcharge

**Cantilever Storage***

BRTCS45BBFFL	18 x 36 x 45	92.5	256	24	\$2859	\$149
BRTCS45BBFFR	18 x 36 x 45	92.5	256	24	\$2859	\$149

Provides storage and privacy anywhere along the length of the bench. The middle opening of the cabinet allows the upper portion to cantilever above the worksurface. 2 locking file drawers. 2 pencil drawers (not locking). Open compartment with adjustable glass shelf, internal dimension of 15.9". Three fixed open compartments; two above worksurfaces (6.7" interior dimension), one below (3.7" interior dimension). Specify Left or Right handed. Optional cable basket suspends off storage unit's bottom and manages cables along the horizontal plane. 1" top; metal handles; powder-coated aluminum or anodized aluminum legs.

- Anodized Aluminum Leg - Add **\$85** list upcharge

Required Specifications

Top finish
Edge finish
Chassis finish
Drawer/door front finish

Optional Specifications

Anodized aluminum leg
E-Lock*
HP laminate

STORAGE

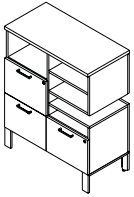

Cantilever Storage*

MODEL#	DIMENSIONS	FREIGHT CLASS	WT/LBS.	CUBIC FT.	LIST PRICE	HP ADD
--------	------------	---------------	---------	-----------	------------	--------

D x W x H

BRTCS45FFFOL	18 x 36 x 45	92.5	256	24	\$2929	\$149
BRTCS45FFFOR	18 x 36 x 45	92.5	256	24	\$2929	\$149

Provides storage and privacy anywhere along the length of the bench. The middle opening of the cabinet allows the upper portion to cantilever above the worksurface. 3 locking file drawers with 2 locks. Open compartment (10.3" interior dimension). Three fixed open compartments; two above worksurfaces (6.7" interior dimension), one below (3.7" interior dimension). Specify Left or Right handed. Optional cable basket suspends off storage unit's bottom and manages cables along the horizontal plane. 1" top; metal handles; powder-coated aluminum or anodized aluminum legs.

- Anodized Aluminum Leg - Add **\$85** list upcharge

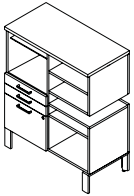

Cantilever Storage*

BRTCS45BBFOL	18 x 36 x 45	92.5	256	24	\$2797	\$149
BRTCS45BBFOR	18 x 36 x 45	92.5	256	24	\$2797	\$149

Provides storage and privacy anywhere along the length of the bench. The middle opening of the cabinet allows the upper portion to cantilever above the worksurface. Locking file drawer. 2 pencil drawers (not locking). Open compartment (10.3" interior dimension) with adjustable glass shelf. 4 fixed open compartments; two above worksurfaces (6.7" interior dimension), two below (lower 12.2" interior dimension; upper 3.3" interior dimension). Specify Left or Right handed. Optional cable basket suspends off storage unit's bottom and manages cables along the horizontal plane. 1" top; metal handles; powder-coated aluminum or anodized aluminum legs.

- Anodized Aluminum Leg - Add **\$85** list upcharge

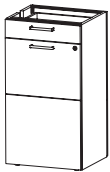

Pier Storage, Box/File

BRTDS2B2F	16 x 18 x 36	125	85	14	\$1752	n/a
-----------	--------------	-----	----	----	---------------	-----

Supports side-by-side divider with Box/File on opposite sides for side-by-side application. Two lockable file drawers, two box drawers. Black pencil tray included.

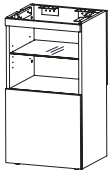

Pier Storage, Open w/Glass Shelves

BRTDSOP	16 x 18 x 36	150	75	14	\$1165	n/a
---------	--------------	-----	----	----	---------------	-----

Supports side-by-side divider with Box/File on opposite sides for side-by-side application. Storage compartment internal height without adjustable shelf: 15"

Required Specifications

Top finish*
Edge finish*
Chassis finish
Drawer/door front finish

Optional Specifications

Anodized aluminum leg*

ACCESSORIES

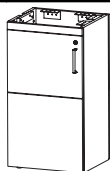
**Pier Storage, Door w/Glass Shelves**

MODEL#	DIMENSIONS	FREIGHT CLASS	WT/LBS.	CUBIC FT.	GRADE	LIST	GRADE	LIST
--------	------------	---------------	---------	-----------	-------	------	-------	------

D x W x H								
BRTDS2D	16 x 18 x 36	150	79	14		\$1565	n/a	

Supports side-by-side divider with hinged, lockable door on opposite sides for side-by-side application. Storage compartment internal height without adjustable shelf: 15"

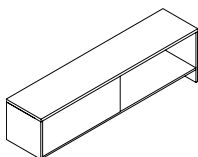
**Side-by-Side Storage, Open***

BRT21PHDO4216	16 x 42 x 21	100	96	10.50		\$1014	\$173	
BRT21PHDO4816	16 x 48 x 21	100	100	12		\$1077	\$201	
BRT21PHDO5416	16 x 54 x 21	100	124	13.50		\$1181	\$222	
BRT21PHDO6016	16 x 60 x 21	100	134	15		\$1248	\$247	
BRT21PHDO6616	16 x 66 x 21	100	144	16.50		\$1353	\$268	
BRT21PHDO7216	16 x 72 x 21	100	152	18		\$1425	\$294	

Pier and table supported side-by-side double-sided open storage. Divides space and provides storage anywhere along bench or table. Storage compartment internal height: 14". 1" top.

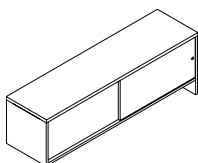
**Side-by-Side Storage, Laminate Doors***

BRT21PLDS4216	16 x 42 x 21	92.5	126	11		\$2347	\$173	
BRT21PLDS4816	16 x 48 x 21	92.5	134	12		\$2397	\$198	
BRT21PLDS5416	16 x 54 x 21	92.5	162	14		\$3007	\$222	
BRT21PLDS6016	16 x 60 x 21	92.5	176	15		\$3060	\$247	
BRT21PLDS6616	16 x 66 x 21	92.5	190	17		\$3267	\$270	
BRT21PLDS7216	16 x 72 x 21	92.5	203	18		\$3317	\$294	

Pier and table supported side-by-side double-sided storage with sliding laminate doors and recessed pull. Divides space and provides storage anywhere along bench or table. Storage compartment internal height: 14". 1" top.

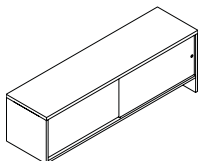
**Side-by-Side Storage, Glass Doors***

BRT21PGDS4216	16 x 42 x 21	92.5	110	10.50		\$2370	\$171	
BRT21PGDS4816	16 x 48 x 21	100	116	12		\$2423	\$197	
BRT21PGDS5416	16 x 54 x 21	92.5	141	13.50		\$3142	\$222	
BRT21PGDS6016	16 x 60 x 21	92.5	153	15		\$3198	\$245	
BRT21PGDS6616	16 x 66 x 21	92.5	165	16.50		\$3412	\$269	
BRT21PGDS7216	16 x 72 x 21	100	175	18		\$3489	\$295	

Pier and table supported side-by-side double-sided storage with sliding glass doors and recessed pull. Divides space and provides storage anywhere along bench or table. Storage compartment internal height: 14". 1" top.

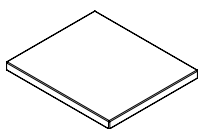
**Cushion****

BRTC	18 x 15.5 x 1.25	150	2	.41	1	\$255	7	\$493
	2				\$291	8	\$533	
	3				\$319	9	\$579	
	4				\$351	10	\$690	
	5				\$400	11	\$782	
	6				\$446	12	\$880	

Optional seat cushion may be added to any storage component. Available in all Global seating fabrics.

• When added to 25"h storage units, unit will NOT fit under any table with a beam

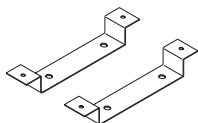
**Glide Tray Adapter**

GAGTA01	2 x 9 x 2.5	70	.50	.03		\$115		
---------	-------------	----	-----	-----	--	--------------	--	--

Accommodates the placement of sliding keyboard mechanisms and CPU holders below the cross beam of Bridges tables. Attaches to Glide Tracks of all Productivity Solutions Keyboard Mechanisms and Sliding CPU holders. Mounting hardware included. Available in black only.

• Cannot be used with GACPU01. See Productivity Solutions for compatible keyboard mechanisms and sliding CPU holder.

Required Specifications

Fabric**
Metal finish (hanging bracket)
Beam finish*

ACCESSORIES

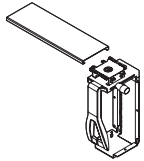

CPU Holder on Glide Track

MODEL#	DIMENSIONS D x W x H	FREIGHT CLASS	WT./LBS.	CUBIC FT.	LIST PRICE
GACPU02	9.2 x 11.7 x 18.5	92.5	12.60	1.15	\$252

Accepts tower CPUs with a width range of 12.5" to 22.5" and width range of 3.5" to 9.3". Soft touch knob for side clamp adjustment and bayonet lance for vertical height adjustment. 12" glide track mounted and 360° swivel for easy access to rear of CPU. Manufactured from steel and engineered resin, providing rugged durability and support. Available in black only.

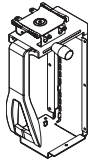

Fixed Mount CPU Holder

GACPU01	9.2 x 11.7 x 18.5	125	9	1.15	\$228
---------	-------------------	-----	---	------	--------------

Fully adjustable clamping mechanism to accept tower CPUs with a height range of 12.5" to 22.5" and width range of 3.5" to 9.3". Soft touch knob for side clamp adjustment and bayonet lance for vertical height adjustment. Mounts directly to underside of desk surface. CPU Holder can also be mounted directly to an upright desk leg surface or wall via side mounting holes. Manufactured from Steel and Engineered Resin, providing rugged durability and support. Available in black only.

- Not compatible with GAGTA01

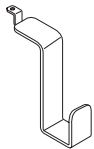

Hanging Bracket

BRTHB	3.3 x 1.5 x 3.5	70	.20	.01	\$32
-------	-----------------	----	-----	-----	-------------

A formed steel bracket hooks over Bridges II table leg. Can be secured either on the inner or outer side of the leg. Specify frame finish.

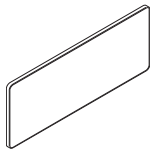

Whiteboard

BRTWB0924	0.5 x 24 x 8.5	70	1	.56	\$255
-----------	----------------	----	---	-----	--------------

White dry-erase marker board surface on white powder coated steel backer. Fits 16" tall Bridges II dividers and single-sided shelves. White dry-erase surface attaches magnetically to the steel backer. When removed, the steel backer can be used as a magnetic board. Please refer to the **Compatibility Guide** (page 400) to determine available accessories.

- Available in Tungsten (TUN) or Designer White (DWT) Only

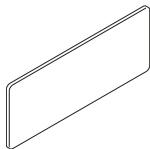

Tackboard*

BRTTB0924	0.5 x 24 x 8.5	70	1	.56	\$255
-----------	----------------	----	---	-----	--------------

Grey tackboard surface on white powder coated steel backer. Fits 16" tall Bridges II dividers and single-sided shelves. Please refer to the **Compatibility Guide** (page 400) to determine available accessories.

- Available in Tungsten (TUN) or Designer White (DWT) Only

Required Specifications

Metal finish
Fabric*

MONITOR ARMS

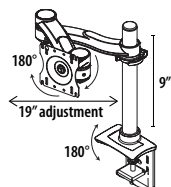
**Single Screen Double Extension Arm**

MODEL#	DIMENSIONS	FREIGHT CLASS	WT/LBS.	CUBIC FT.	LIST PRICE
GAMCSSDE	-- x -- x -- D x W x H	125	7.50	1.09	\$571

Double extension allows 19" of horizontal back and forth movement. Arm folds back to post for more desk space. Displays are able to tilt 180°, swing 180° side-to-side and rotate from landscape to portrait. Minor assembly required.

- To use arm in conjunction with below worksurface power troughs, thru-surface mount must be used. Cannot be clamp mounted when using power troughs.

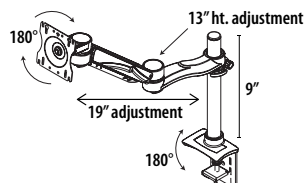
**Single Screen Double Extension Arm with Height Adjustment**

GAMCSSDEH	-- x -- x --	125	8.20	1.09	\$685
-----------	--------------	-----	------	------	--------------

Counterbalanced arm provides an additional 13" of height adjustment. Double extension allows 19" of horizontal back and forth movement. Easy to use Allen wrench allows user to adjust the counterbalance mechanism for easy movement of the monitor. Displays are able to tilt 180°, swing 180° side-to-side and rotate from landscape to portrait. Cable manager comes on extension arm and hides all cables. Minor assembly required.

- To use arm in conjunction with below worksurface power troughs, thru-surface mount must be used. Cannot be clamp mounted when using power troughs.

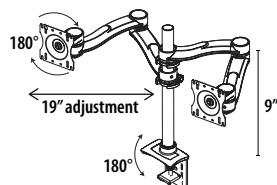
**Dual Screen Double Extension Arm**

GAMCDSDE	-- x -- x --	100	10.70	1.09	\$1006
----------	--------------	-----	-------	------	---------------

For dual monitor applications. Double extension arms allow 19" of horizontal back and forth movement. Easy to use Allen wrench allows user to adjust the counterbalance mechanism for easy movement of the monitor. Displays are able to tilt 180°, swing 180° side-to-side and rotate from landscape to portrait. Minor assembly required.

- To use arm in conjunction with below worksurface power troughs, thru-surface mount must be used. Cannot be clamp mounted when using power troughs.

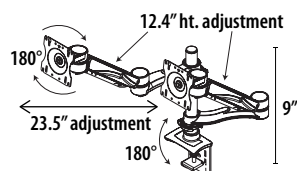
**Dual Screen Double Extension Arm with Height Adjustment**

GAMCDSDEH	-- x -- x --	92.5	12.2	1.09	\$1247
-----------	--------------	------	------	------	---------------

For dual monitor applications. Counterbalanced arms provide an additional 13" of height adjustment. Double extension arms allow 19" of horizontal back and forth movement. Easy to use Allen wrench allows user to adjust the counterbalance mechanism for easy movement of the monitor. Displays are able to tilt 180°, swing 180° side-to-side and rotate from landscape to portrait. Cable manager comes on extension arm and hides all cables. Minor assembly required.

- To use arm in conjunction with below worksurface power troughs, thru-surface mount must be used. Cannot be clamp mounted when using power troughs.

ACCESSORIES

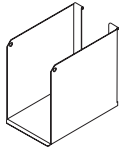

Binder Bin

MODEL#	DIMENSIONS D x W x H	FREIGHT CLASS	WT./LBS.	CUBIC FT.	LIST PRICE
BABB01	10.25 x 4 x 9	100	2	.21	\$70

Load bar/accessory rail mounted metal binder bin.

- Please refer to the **Compatibility Guide** on page 400 to determine compatible storage components

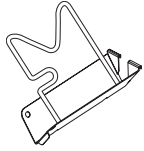

Flip Sorter

BAFS01	9.25 x 2.75 x 9.25	70	.06	.14	\$54
--------	--------------------	----	-----	-----	-------------

Load bar/accessory rail mounted metal flip sorter. Comes with chrome wire.

- Please refer to the **Compatibility Guide** on page 400 to determine compatible storage components

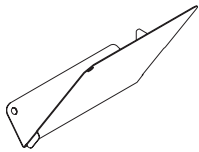

Slant Sorter

BASS01L (Left)	10.25 x 5 x 9.5	70	1	.28	\$44
BASS01R (Right)	10.25 x 5 x 9.5	70	1	.28	\$44

Load bar/accessory rail mounted metal slant sorter.

- Please refer to the **Compatibility Guide** on page 400 to determine compatible storage components

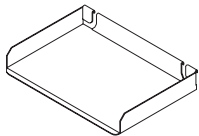

Letter/Legal Tray

BALTO1 (Letter)	9.25 x 13.5 x 2	70	.05	.15	\$58
BALTO1LGL (Legal)	9.25 x 15 x 2	70	.05	.15	\$71

Load bar/accessory rail mounted metal letter or legal tray.

- Please refer to the **Compatibility Guide** on page 400 to determine compatible storage components

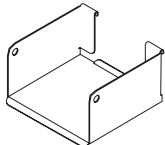

Media Bin

BAMB01	5.25 x 5.75 x 3	70	.08	.05	\$58
--------	-----------------	----	-----	-----	-------------

Load bar/accessory rail mounted metal media bin.

- Please refer to the **Compatibility Guide** on page 400 to determine compatible storage components

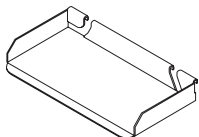

Utility Tray

BAUT01	3.75 x 5.75 x 3	70	.05	.02	\$38
--------	-----------------	----	-----	-----	-------------

Load bar/accessory rail mounted metal utility tray.

- Please refer to the **Compatibility Guide** on page 400 to determine compatible storage components

Required Specifications

Fabric (Cushion)
Metal Finish (hanging bracket, whiteboard, tackboard)

ACCESSORIES

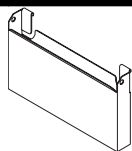
**Mail Box**

MODEL#	DIMENSIONS	FREIGHT CLASS	WT/LBS.	CUBIC FT.	LIST PRICE
--------	------------	---------------	---------	-----------	------------

D x W x H

BAPP01	2.75 x 16 x 9	100	2	.25	\$88
--------	---------------	-----	---	-----	-------------

Load bar/accessory rail mounted metal mail box.

- Please refer to the **Compatibility Guide** on page 400 to determine compatible storage components

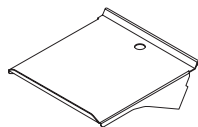
**Telephone Holder**

BATH01	10 x 9 x 2	125	2	.26	\$85
--------	------------	-----	---	-----	-------------

Load bar/accessory rail mounted metal telephone holder.

- Please refer to the **Compatibility Guide** on page 400 to determine compatible storage components

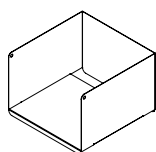
**Elevated Shelf Binder Bin**

BRTESBBIN	12 x 12 x 8	100	6	.66	\$181
-----------	-------------	-----	---	-----	--------------

Load bar/accessory rail mounted elevated shelf binder bin.

- Please refer to the **Compatibility Guide** on page 400 to determine compatible storage components

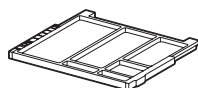
**Pencil Drawer**

PEEPD	15 x 22.5 x 1.5	250	2	0.7	\$164
-------	-----------------	-----	---	-----	--------------

Provides storage for writing instruments and small items at the worksurface. Attaches to underside of worksurface with drawer slides (included). Black ABS plastic only.

ACCESSORIES

D x W x H

ACCESSORIES COMPATIBILITY GUIDE

	DIVIDERS: BRTL PDD BRTL PDS BR2AFD BR2AHD	Elevated Shelves BRTSTS08 BRTBTS08 8" high	Elevated Shelves BRTSTS13 BRTBTS13 13" high	Elevated Shelves BRTSTS16 BRTBTS16 16" high	Shared Overhead BRTBAS048 12" deep	Shared Overhead with slid- ing doors BRTBASS 16" deep
Binder Bin BABB01	yes	no	no	yes	no	no
Flip Sorter BAFS01	yes	no	yes	no	no	no
Slant Sorter BASS01	yes	no	yes	no	no	no
Letter Tray BALT01	yes	yes	yes	yes	yes	yes
Media Bin BAMB01	yes	yes	yes	yes	yes	yes
Utility Tray BAUT01	yes	yes	yes	yes	yes	yes
Mail Box BAPP01	yes	no	no	yes	no	no
Phone Holder BVATH01	yes	yes	yes	yes	yes	yes
Elevated Shelf Binder Bin BRTEBBIN	no	no	no	no	yes	no
Tackboard BRTTB	yes	no	no	yes	no	no
Whiteboard BRTWB	yes	no	no	yes	no	no

COLLABORATIVE SEATING**D x W x H**

Bridges collaborative seating collection consists of seating, privacy screens, tables, tablets and power. It is a versatile modular furniture series which can be configured into many space planning scenarios, including corner, in-line, open concept, traditional reception, as well as secluded seating with high privacy partitions.

Furniture pieces can be used as stand alone items or can be mechanically linked together to form a variety of seating configurations.

Seat and backrest can be integrated with Bridges tables.

Corner tables and in-line 6" table modules double as power delivery centers.

Dedicated seat backrests feature dual USB charging port.

Some inline 6" table modules are furnished with grommets to support tablets.

Legs are available in standard Bridges metal painted finishes and anodized aluminum finish.

Bridges Collaborative Seating upholstery features a single stitch, thick white thread around the edges. The white, wide stitch along with crisp corners are part of its distinctive personality. In order to achieve crisp edges and to minimize "pillow" effect caused by taut fabric, the upholstery material has been applied deliberately loose, which may over time, produce puckering of the upholstery surface material. This can be easily corrected by stretching the fabric by hand or during vacuuming.

In order to efficiently utilize fabric yield, all 60" seats and backs feature a seam in the middle. The double stitch seam is sewn with a thin thread, closely matching the upholstery material in color.

Some complicated fabric patterns prevent pattern matching and will be upholstered without the seam at the discretion of the factory.

Should you require no middle seam by cutting into the roll, please specify "NO SEAM" at time of your order.

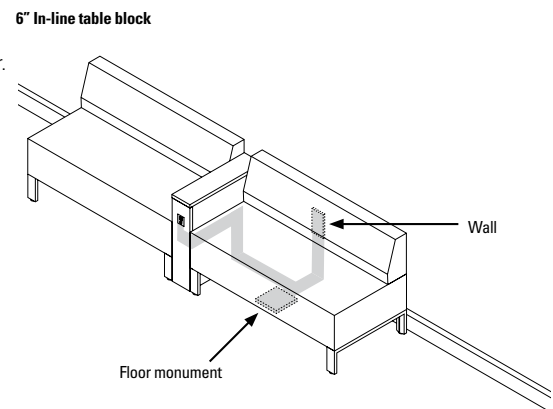
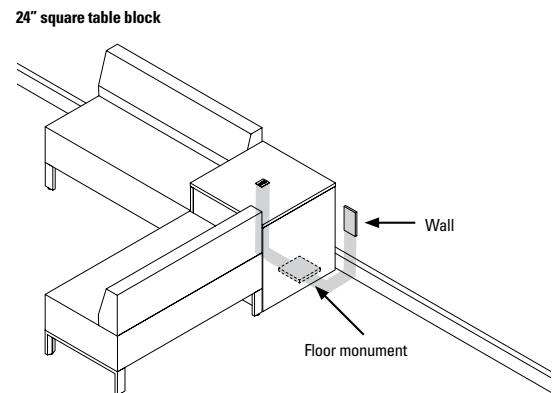
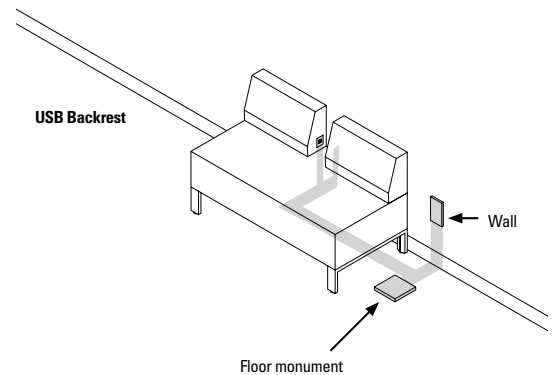

COLLABORATIVE SEATING

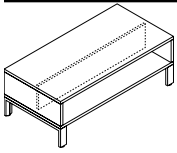

Low Table*

MODEL#	DIMENSIONS D x W x H	FREIGHT CLASS	WT/LBS.	CUBIC FT.	LIST PRICE	HP ADD
BRTST2460F	24 x 60 x 17	150	83.60	14.17	\$880	\$326
BRTST2448F	24 x 48 x 17	125	69	11.33	\$787	\$237
BRTST2424F	24 x 24 x 17	125	40.70	5.67	\$556	\$97

Freestanding 17”h table. Central partition divides space under top surface into two 11” deep compartments. All LP chassis w/ HP or LP top (3mm edging). Bridges storage aluminum leg.

- Anodized Aluminum Leg - Add **\$74.** list upcharge
- To convert to mobile - Add an **M** at the end of the product code. Add **\$35.** list upcharge.

COLLABORATIVE SEATING

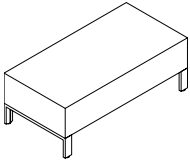

Lounge Seat

					GRADE	LIST	GRADE	LIST
BRTSE60NB	24 x 60 x 17	250	47	14.17	1	\$1659	7	\$2225
					2	\$1743	8	\$2421
					3	\$1807	9	\$2572
					4	\$1901	10	\$2741
					5	\$2039	11	\$3084
					6	\$2101	12	\$3454
BRTSE48NB	24 x 48 x 17	250	36.90	11.33	1	\$1433	7	\$1888
					2	\$1502	8	\$2045
					3	\$1553	9	\$2164
					4	\$1630	10	\$2300
					5	\$1737	11	\$2577
					6	\$1789	12	\$2870
BRTSE24NB	24 x 24 x 17	150	22.70	5.57	1	\$787	7	\$1072
					2	\$831	8	\$1170
					3	\$863	9	\$1246
					4	\$911	10	\$1330
					5	\$979	11	\$1501
					6	\$1010	12	\$1686

Fully upholstered armless lounge seat with metal base. Seats can be freestanding or linked with optional interlocking bracket kit.

- Anodized Aluminum Leg - Add **\$74** list upcharge

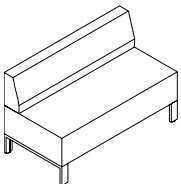

Lounge Seat, Full Backrest

BRTSE6060B	24 x 60 x 29	250	70	24.17	1	\$2649	7	\$3666
					2	\$2797	8	\$4018
					3	\$2912	9	\$4288
					4	\$3084	10	\$4590
					5	\$3327	11	\$5214
					6	\$3443	12	\$5878
BRTSE4848B	24 x 48 x 29	250	55.50	19.33	1	\$2286	7	\$3076
					2	\$2401	8	\$3350
					3	\$2491	9	\$3562
					4	\$2625	10	\$3797
					5	\$2817	11	\$4282
					6	\$2905	12	\$4797
BRTSE2424B	24 x 24 x 29	250	33	9.57	1	\$1239	7	\$1749
					2	\$1315	8	\$1925
					3	\$1373	9	\$2061
					4	\$1458	10	\$2213
					5	\$1580	11	\$2525
					6	\$1638	12	\$2855

Fully upholstered armless lounge seat with full backrest and metal base. Backrests are permanently secured to the seats and cannot be reconfigured on site. Seats can be freestanding or linked with optional interlocking bracket kit.

- Anodized Aluminum Leg - Add **\$74** list upcharge

Required Specifications

Top finish* Edge finish*
 Chassis finish*
 Fabric
 Metal Finish (legs)

Optional Specifications

Anodized Aluminum Leg
 HP laminate*

COLLABORATIVE SEATING

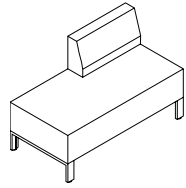

Lounge Seat, 24" Offset Backrest

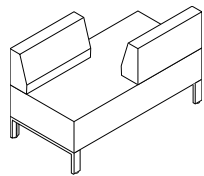

Lounge Seat, Two 24" Offset Backrests

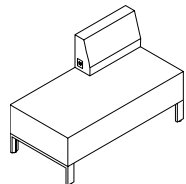

Lounge Seat, 21" USB Backrest

MODEL#	DIMENSIONS	FREIGHT CLASS	WT/LBS.	CUBIC FT.	GRADE	LIST	GRADE	LIST
D x W x H								
BRTSE2448BL	24 x 48 x 29	250	46.10	19.33	1	\$1884	7	\$2563
					2	\$1987	8	\$2800
					3	\$2063	9	\$2980
					4	\$2175	10	\$3179
					5	\$2339	11	\$3596
					6	\$2416	12	\$4038
BRTSE2448BR (shown)	24 x 48 x 29	250	46.10	19.33	1	\$1884	7	\$2563
					2	\$1987	8	\$2800
					3	\$2063	9	\$2980
					4	\$2175	10	\$3179
					5	\$2339	11	\$3596
					6	\$2416	12	\$4038
BRTSE2448BODL (shown)	24 x 48 x 29	250	46.10	19.33	1	\$2336	7	\$3241
					2	\$2468	8	\$3554
					3	\$2570	9	\$3794
					4	\$2724	10	\$4065
					5	\$2940	11	\$4618
					6	\$3043	12	\$5206
BRTSE2448BODR	24 x 48 x 29	250	46.10	19.33	1	\$2336	7	\$3241
					2	\$2468	8	\$3554
					3	\$2570	9	\$3794
					4	\$2724	10	\$4065
					5	\$2940	11	\$4618
					6	\$3043	12	\$5206
BRTSE2148EBL	24 x 48 x 29	250	33	9.67	1	\$2184	7	\$2863
					2	\$2287	8	\$3100
					3	\$2363	9	\$3280
					4	\$2475	10	\$3479
					5	\$2639	11	\$3896
					6	\$2716	12	\$4338
BRTSE2148EBR (shown)	24 x 48 x 29	250	46.10	19.33	1	\$2184	7	\$2863
					2	\$2287	8	\$3100
					3	\$2363	9	\$3280
					4	\$2475	10	\$3479
					5	\$2639	11	\$3896
					6	\$2716	12	\$4338

Fully upholstered armless lounge seat with one backrest and metal base. Specify backrest as either left or right side. Backrests are permanently secured to the bench and cannot be reconfigured on site. Seats can be freestanding or linked with optional interlocking bracket kit.

- Anodized Aluminum Leg - Add **\$74** list upcharge

Fully upholstered armless lounge seat with two offset backrests and metal base. Specify either left or right backrest configuration. Backrests are permanently secured to the bench and cannot be reconfigured on site. Seats can be freestanding or linked with optional interlocking bracket kit.

- Anodized Aluminum Leg - Add **\$74** list upcharge

Fully upholstered armless lounge seat with one backrest and metal base. 21" w backrest comes with embedded dual USB port in its side. Note: The side mounted power/USB outlets always point to the center of the seat. Each USB outlet offers 2 amps. AC/DC transformer plugs into the wall or floor monument (approx. 4' long cable available from the bottom of the seat). Transformer power consumption: 0.68 amps. Specify either left or right backrest configuration. Backrests are permanently secured to the bench and cannot be reconfigured on site. Seats can be freestanding or linked with optional interlocking bracket kit. White USB outlets.

- Anodized Aluminum Leg - Add **\$74** list upcharge

Required Specifications

Fabric
Metal Finish (legs)

Optional Specifications

Anodized Aluminum Leg

COLLABORATIVE SEATING

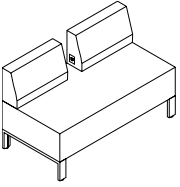

Lounge Seat, Two 21" USB Backrests

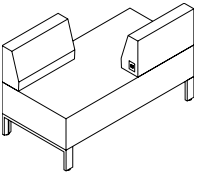

Lounge Seat, Two Offset USB Backrests

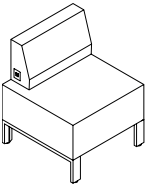

Lounge Seat, 21" USB Backrest

MODEL#	DIMENSIONS D x W x H	FREIGHT CLASS	WT/LBS.	CUBIC FT.	GRADE	LIST	GRADE	LIST
BRTSE2148E2B	24 x 48 x 29	250	57	19.33	1	\$2934	7	\$3838
					2	\$3066	8	\$4151
					3	\$3165	9	\$4392
					4	\$3319	10	\$4660
					5	\$3536	11	\$5213
					6	\$3641	12	\$5803

Fully upholstered armless lounge seat with two backrests and metal base. Both 21" w backrests come with embedded dual USB port in its side. Note: The side mounted power/USB outlets always point to the center of the seat. Each USB outlet offers 2 amps. AC/DC transformer plugs into the wall or floor monument (approx. 52" long cable available from the bottom of the seat). Transformer power consumption: 0.68 amps. Backrests are permanently secured to the bench and cannot be reconfigured on site. Seats can be freestanding or linked with optional interlocking bracket kit. White USB outlets.

- Anodized Aluminum Leg - Add **\$74** list upcharge

BRTSE2148EBODL (shown)	24 x 48 x 29	250	57	19.33	1	\$2934	7	\$3838
					2	\$3066	8	\$4151
					3	\$3165	9	\$4392
					4	\$3319	10	\$4660
					5	\$3536	11	\$5213
					6	\$3641	12	\$5803

BRTSE2148EBODR	24 x 48 x 29	250	57	19.33	1	\$2934	7	\$3838
					2	\$3066	8	\$4151
					3	\$3165	9	\$4392
					4	\$3319	10	\$4660
					5	\$3536	11	\$5213
					6	\$3641	12	\$5803

Fully upholstered armless lounge seat with two offset backrests and metal base. Both 21" w backrests come with embedded dual USB port in its side. Note: The side mounted power/USB outlets always point to the center of the seat. Each USB outlet offers 2 amps. AC/DC transformer plugs into the wall or floor monument (approx. 52" long cable available from the bottom of the seat). Transformer power consumption: 0.68 amps. Specify either left or right backrest configuration. Backrests are permanently secured to the bench and cannot be reconfigured on site. Seats can be freestanding or linked with optional interlocking bracket kit. White USB outlets.

- Anodized Aluminum Leg - Add **\$74** list upcharge

BRTSE2124EBL	24 x 24 x 29	250	46.10	19.33	1	\$1538	7	\$2049
					2	\$1614	8	\$2225
					3	\$1673	9	\$2360
					4	\$1757	10	\$2512
					5	\$1879	11	\$2824
					6	\$1939	12	\$3154

BRTSE2124EBR (shown)	24 x 24 x 29	250	46.10	19.33	1	\$1538	7	\$2049
					2	\$1614	8	\$2225
					3	\$1673	9	\$2360
					4	\$1757	10	\$2512
					5	\$1879	11	\$2824
					6	\$1939	12	\$3154

Fully upholstered armless lounge seat with one backrest and metal base. 21" w backrest comes with embedded dual USB port in its side. Note: Each USB outlet offers 2 amps. AC/DC transformer plugs into the wall or floor monument (approx. 52" long cable available from the bottom of the seat). Transformer power consumption: 0.68 amps. Specify either left or right. Backrests are permanently secured to the bench and cannot be reconfigured on site. Seats can be freestanding or linked with optional interlocking bracket kit. White USB outlets.

- Anodized Aluminum Leg - Add **\$74** list upcharge

Required Specifications

Fabric
Metal Finish (legs)

Optional Specifications

Anodized Aluminum Leg

COLLABORATIVE SEATING

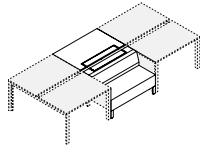

Integrated Lounge Seat, Single-Sided

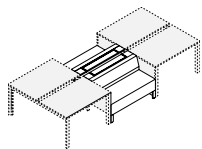

Integrated Lounge Seat, Double-Sided

MODEL#	DIMENSIONS	FREIGHT CLASS	WT/LBS.	CUBIC FT.	GRADE	LIST	GRADE	LIST		
BRTSINT60S	24 x 60 x 29	125	155	24.17						
					D x W x H					
					1	\$5294	7	\$6289		
					2	\$5422	8	\$6641		
					3	\$5535	9	\$6914		
					4	\$5709	10	\$7216		
BRTSINT48S	24 x 48 x 29	100	182	19.33						
					1	\$5065	7	\$5856		
					2	\$5181	8	\$6130		
					3	\$5271	9	\$6343		
					4	\$5406	10	\$6577		
					5	\$5596	11	\$7062		
					6	\$6068	12	\$8501		

Fully upholstered armless lounge seat with full width backrest and metal legs integrated into Bridges 62.5" d back-to-back linear table assembly. The single-sided kit consists of 24" x 48" or 24" x 60" seat, full width back, three-sided below worksurface enclosure, 6" d worksurface module with access door, 30" x 48" or 30" x 60" w worksurface with access door and supporting hardware. The seat module accommodates continuation of power and data distribution services below worksurfaces (specify Below Worksurface Power Trough and power components separately). The 6" d worksurface module with access door provides access to Below Worksurface Power Trough. Backrests are permanently secured to the bench and cannot be reconfigured on site. Tables not included.

• **Only compatible with back-to-back 30" d worksurfaces (62.5" total depth) supported by Bridges rectangular legs.** Not compatible with round legs, 24" d worksurfaces; not compatible with single line table assemblies 24" and 30" d. The kit cannot be used at the end of a table run, nor can it be used as a standalone, freestanding configuration. It must always be supported by back-to-back table assemblies on either side

- Anodized Aluminum Leg - Add **\$74** list upcharge
- High pressure laminate - Add **\$266** list upcharge

BRTSINT60D	24 x 60 x 29	125	155	24.17				
					1	\$6873	7	\$7890
					2	\$7021	8	\$8242
					3	\$7136	9	\$8512
					4	\$7308	10	\$8814
					5	\$7551	11	\$9438
BRTSINT48D	24 x 48 x 29	100	182	19.33				
					1	\$6148	7	\$6938
					2	\$6263	8	\$7212
					3	\$6353	9	\$7424
					4	\$6487	10	\$7659
					5	\$6679	11	\$8144
					6	\$7668	12	\$10103

Fully upholstered armless lounge bench with full backrests and metal legs integrated into Bridges 62.5" d back-to-back linear table assembly. The double-sided kit consists of two 24" x 48" or 24" x 60" seats, full width backs, three-sided below worksurface enclosures, 6" d worksurface modules with access doors and supporting hardware. The seat module accommodates continuation of power and data distribution services below worksurfaces (specify Below Worksurface Power Trough and power components separately). The 6" d worksurface module with access door provides access to Below Worksurface Power Trough. Backrests are permanently secured to the bench and cannot be reconfigured on site. Tables not included.

• **Only compatible with back-to-back 30" d worksurfaces (62.5" total depth) supported by Bridges rectangular legs.** Not compatible with round legs, 24" d worksurfaces; not compatible with single line table assemblies 24" and 30" d. The kit cannot be used at the end of a table run, nor can it be used as a standalone, freestanding configuration. It must always be supported by back-to-back table assemblies on either side.

- Anodized Aluminum Leg - Add **\$74** list upcharge
- High pressure laminate - Add **\$266** list upcharge

Required Specifications

Fabric
Laminate finish (enclosure)
Edge finish (enclosure)
Metal finish (legs)

Optional Specifications

Anodized Aluminum Leg
HP laminate (enclosure)

SEATING PARTITIONS

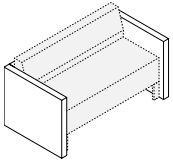

Seat Partitions

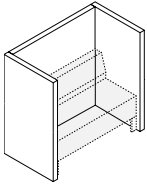

Seat Privacy Partitions

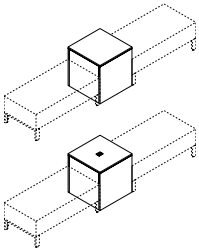

Square Table Block*

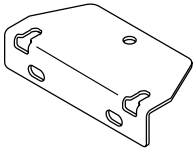

Square Table Block Ganging Bracket Kit

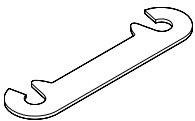

Ganging Bracket Kit

MODEL#	DIMENSIONS D x W x H	FREIGHT CLASS	WT./LBS.	CUBIC FT.	LIST PRICE
BRTPP2448L1	28.7 x 53 x 25	300	41	22.01	\$1941
BRTPP2424L1	28.7 x 29 x 25	250	32	12.04	\$1452

Fully upholstered 2.5" thick, 3-part, low level partition kit wraps around 24" or 48" bridges seat. The seat front is recessed by 2.5". The kit is secured to seats on-site (brackets connecting seat legs to the inner side of the partition are included). Upholstered kits consist of 2" hollow core boards, 1/4" foam, fabric, levelers and connecting hardware. Note: Seats and backrests are not included.

BRTPP2448L2	28.7 x 53 x 50	400	41	44.01	\$2813
BRTPP2424L2	28.7 x 29 x 50	300	32	24.08	\$2199

Fully upholstered 2.5" thick, 3-part, two tier partition kit wraps around 24" or 48" bridges seat. The 50"h assembly provides seated visual privacy. 2.5" thick upholstered partitions improve acoustic privacy for focused time away from the team or for a quiet phone call. Recessed seat extends the partition at the front by 2.5" for enhanced sense of privacy. The kit is secured to seats on-site (brackets connecting seat legs to the inner side of the partition are included). Upholstered kits consist of 2" hollow core boards, 1/4" foam, fabric, levelers and connecting hardware. Note: Seats and backrests are not included.

BRTS2424B	24 x 24 x 25	250	32	12.04	\$619	\$90
BRTS2424BP	24 x 24 x 25	125	59.30	8.33	\$1231	\$90

Freestanding 24" square table block serves as a visual anchor whenever a bridges seat needs to turn a corner or split into 2, 3 or 4 directions. BRTS2424BP can be positioned directly over a floor monument, which will supply power to the top-mounted power module. This option includes 24"x 24" block chassis and flush-mounted Duo power module (two outlets and two 2.1 amp USB ports, white face plate, outlets and bezel, 72" long three prong black cord). The square table block can function as a self-supporting, freestanding unit or it can be secured permanently to adjacent bridges seats with optional interconnecting brackets listed below. 2 Square Table Ganging Bracket Kits included.

BRTSTBG	2.4 x 5 x 1.1	70	.05	.01	\$47	n/a
---------	---------------	----	-----	-----	-------------	-----

Two square table block ganging brackets connect seat legs permanently to the side of the 24" square table block on site. The kit employs machine screws connecting legs to seats, and ships with wood screws which provide permanent connection to the square table block. Includes 2 brackets and screws. Black powdercoat finish.

BRTSTSB	1.3 x 6 x .1	70	.03	.01	\$21	n/a
---------	--------------	----	-----	-----	-------------	-----

Two ganging brackets connect seat temporarily to adjacent in-line seat or 24"d bridges storage. Black powdercoat finish.

Required Specifications

Fabric

COLLABORATIVE SEATING

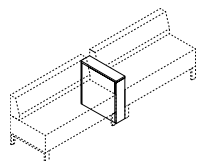

Inline 6" Block

BRTS2406B

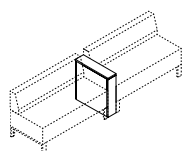

Inline table - no power module or swivel arm

MODEL#	DIMENSIONS D x W x H	FREIGHT CLASS	WT/LBS.	CUBIC FT.	LIST PRICE	HP ADD
BRTS2406B	24 x 6 x 25	92.5	21	2.08	\$531	\$47
BRTS2406BP	24 x 6 x 25	92.5	23.30	2.08	\$1144	\$47
BRTS2406B2P	24 x 6 x 25	92.5	24.30	2.08	\$1758	\$47
BRTS2406BT	24 x 6 x 25	85	25.60	2.08	\$1014	\$47
BRTS2406BPT	24 x 6 x 25	92.5	24.30	2.08	\$1627	\$47

Multifunctional inline 6" table block divides seating areas, serves as a utility surface, can support tablet arms, lamps, and double as a power delivery center. It is permanently secured between two bridge seats and cannot be placed at the end of a run. Two Square Table Block Ganging Brackets (BRTSTBG) connect seat legs permanently to the side of the in-line table block on site. The included kit employs machine screws connecting legs to seats and ships with wood screws, which provide permanent connection to the in-line 6" block. Black powdercoat finish. The chassis is available without power module, with one power module or with two vertically embedded power modules. Vertical panel flush-mounted Duo module provides two outlets and two 2.1 amp USB ports; 72" cord exits through the bottom and plugs into a floor monument under seats, white face plate and bezel. 2 Square Table Ganging Bracket Kits included.

- BRTS2406BT and BRTS2406BPT include 9.5" x 14.5" swivel tablet. If top is specified in high pressure laminate, tablet will also be manufactured in high pressure laminate.

BRTS2406BP

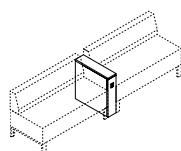

Inline table w/front power module

BRTS2406B2P

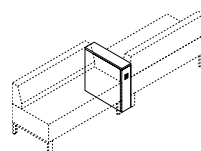

Inline table w/front and rear power module

BRTS2406BT

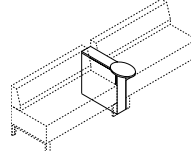

Inline table w/swivel tablet arm

BRTS2406BPT

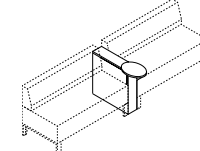

Inline table w/front power module and swivel tablet arm

Required Specifications

Top finish*
Edge finish*
Chassis/Accent finish*

Optional Specifications

HP laminate* (top only)



Divide is a modular desk-mounted panel system that can be retro installed on many Global Desks. The panels can be vertically stacked to provide varying degrees of privacy. The panels are available in laminate or fabric tackboards as well as glazed panels that allow light to pass through. Divide's off-desk accessories help to organize paperwork and free up the workspace. Divide is offered in many laminate and fabric color options to complement any office environment.

Features and Benefits

- Available as fabric, glazed or laminate partitioning panels in an array of heights and widths
- Easy to specify: choose the desired panel height and width and its corresponding height divide post(s)
- A built-in paper management rail (on fabric and glazed panels) is designed to accommodate off-desk accessories for workspace organization.
- Laminate panels offer an optional wire access cutout at the bottom of each panel (order as SCP2)
- Laminate transaction tops are offered in various shapes and sizes, and are standard as either 1" thick or 1.5" thick to match
- All Adaptabilities, Genoa, and Zira laminate colors are offered as well as a wide variety of fabrics



GENERAL INFORMATION

- Divide is a desk mounted panel system that can be field installed at any time on many Global desks
- Vertical stacking of varying heights provides semi-private to private work areas
- Designed for use on the Adaptabilities, Genoa, and Zira laminate desk series', and may be retrofitted onto non-Global square edged product if necessary.
- Panels are available in 12", 18", 24" and 36" heights and can be stacked to produce heights of 24", 30", 36" and 42" for a virtually limitless variety of configurations
- Progressive, desk mounted partition system consisting of three major categories:
 - Divide posts - to support the partitions
 - Partitioning screens - a variety of widths and heights to create personalized privacy; offered in laminate, glaze or select fabrics
 - Transaction tops - laminate tops ideal for creating reception stations
- For environmental certifications, please visit globalfurnituregroup.com
- Model numbers reflect total width of panel and posts

DIVIDE POSTS

- Available in 6 standard heights:
 - 12" high - to create **semi-private** spaces and to support Transaction Tops
 - 18" high - to create **semi-private** spaces and to support Transaction Tops
 - 24" high - to create **semi-private** spaces
 - 30" high - to create **semi-private** spaces
 - 36" high - to create **private** spaces and to match the height of 36" high hutches and/or 65" high Adaptabilities, Genoa and Zira cabinets
 - 42" high - to create **private** spaces and to match the height of 42" high hutches and/or 72" high Zira cabinets
- Posts are field installed. Each plate divider includes: 1 post mounting plate, 1 threaded rod, 3 cover strips and 1 top cap plus mounting hardware (contains 8 screws, 1 washer, 1 locking nut). 2 divide posts are required per partitioning panel.
- Available in Black (**BLK**) or Tungsten (**TUN**) finish, please specify.

PARTITIONING SCREENS

- Available in 4 standard heights: 12", 18", 24" and 36" and can be used in combinations to create systems consisting of 12", 18", 24", 30", 36" and 42" heights.
- Available in 3 materials:
 - **Laminate** - available in all laminate colors used on Adaptabilities, Genoa, Halton and Zira (see right). Accent edging at top and bottom is Black (**BLK**) only. Optional wire access scoop cut-out is offered, centered at the bottom of the panel - order as **SCP2** after model #. Woodgrain direction is horizontal for all sizes.
 - **Glazed** - choice of **clear**, **ribbed** or **frosted** glazing. Top and bottom rail optional in Black (**BLK**) or Tungsten (**TUN**) finish, please specify. Top rail is designed to accommodate off-desk accessories. Glazed panels with document pass-through feature a 4" gap at the bottom.
 - **Fabric** - available in all Grade 1, 2, 3 and 4 panel fabrics and select seating fabrics only (see right). Top and bottom rail optional in Black (**BLK**) or Tungsten (**TUN**), finish please specify. Top rail is designed to accommodate off-desk accessories.
- Filler panels are included with each Divide panel. To be used between two posts in a straight run from worksurface to worksurface.
- Special width panels are available in laminate or glazed material options only. For pricing, contact Specials.

TRANSACTION TOPS

- Tops are available in 1" or 1.5" thick thermally fused laminate
- Tops are sealed with Global's preferred edging in matching color
- Woodgrain surfaces feature edging in matching printed woodgrain
- Transaction tops are available with optional edges at no upcharge. Please specify (see right column).

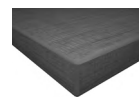

A3 1" top, standard

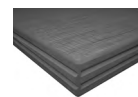

AR 1" top, bicut edge

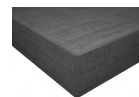

C3 1.5" top, standard

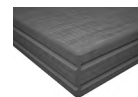

CR 1.5" top, bicut edge



CF 1.5" top, fluted edge

- Includes all necessary flat mounting plates and joining plates.
- Features pre-drilled locating holes to allow for quick alignment with the divide post
- Available with a radius cut on one or both ends (each radius adds a 6" overhang).
- Woodgrain surfaces feature edging with matching printed woodgrain
- Products specified with the high pressure laminate option are finished on the underside of the surface with a kraft paper backing.

LAMINATE AND EDGE FINISHES (laminate panels and transaction tops)

ACJ	Absolute Acajou	FCL	First Class
ASN	Asian Night	NBL	Noce Biondo
AWC	Avant Cherry	NGL	Noce Grigio
AWH	Avant Honey	NEL	Noce Leggero
BLK	Black	NML	Noce Medio
BZD	Blizzard	QTM	Quartered Mahogany
BRC	Brushed Cobalt	SBY	Sheer Beauty
CMB	Clear Maple	SOG	Storm Grey
CGY	Custom Grey	SDT	Stonedust
DES	Dark Espresso	WHE	Walnut Heights
DWT	Designer White	WHC	White Chocolate
FAS	Fashionista	WCR	Winter Cherry

FABRICS (fabric screens)

- Fabric screens can be upholstered in the following fabrics only:
- Anchorage
 - Imprint
 - Lola
 - Merge

D DIVIDE™ - NOTES

PLEASE NOTE:

- Divide screens cannot be centered between two back to back worksurfaces.
- Screens must be installed on one worksurface or the other.
- Divide cannot be used with Adaptabilities reception units.
- When panels are mounted on a 30" deep worksurface from Adaptabilities, Genoa or Zira, please specify 29" wide panel

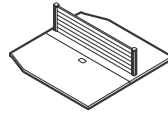

Correct Installation

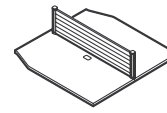

Incorrect Installation

HOW TO ORDER DIVIDE SCREENS

example: DTB 1236 GN31

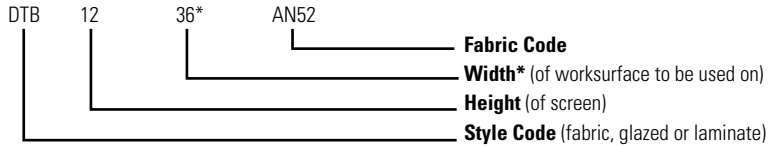

*NOTE: Number denotes width of worksurface to use - please see dimensions in price book for actual dimensions of the screen.

PARTS AND COMPONENTS

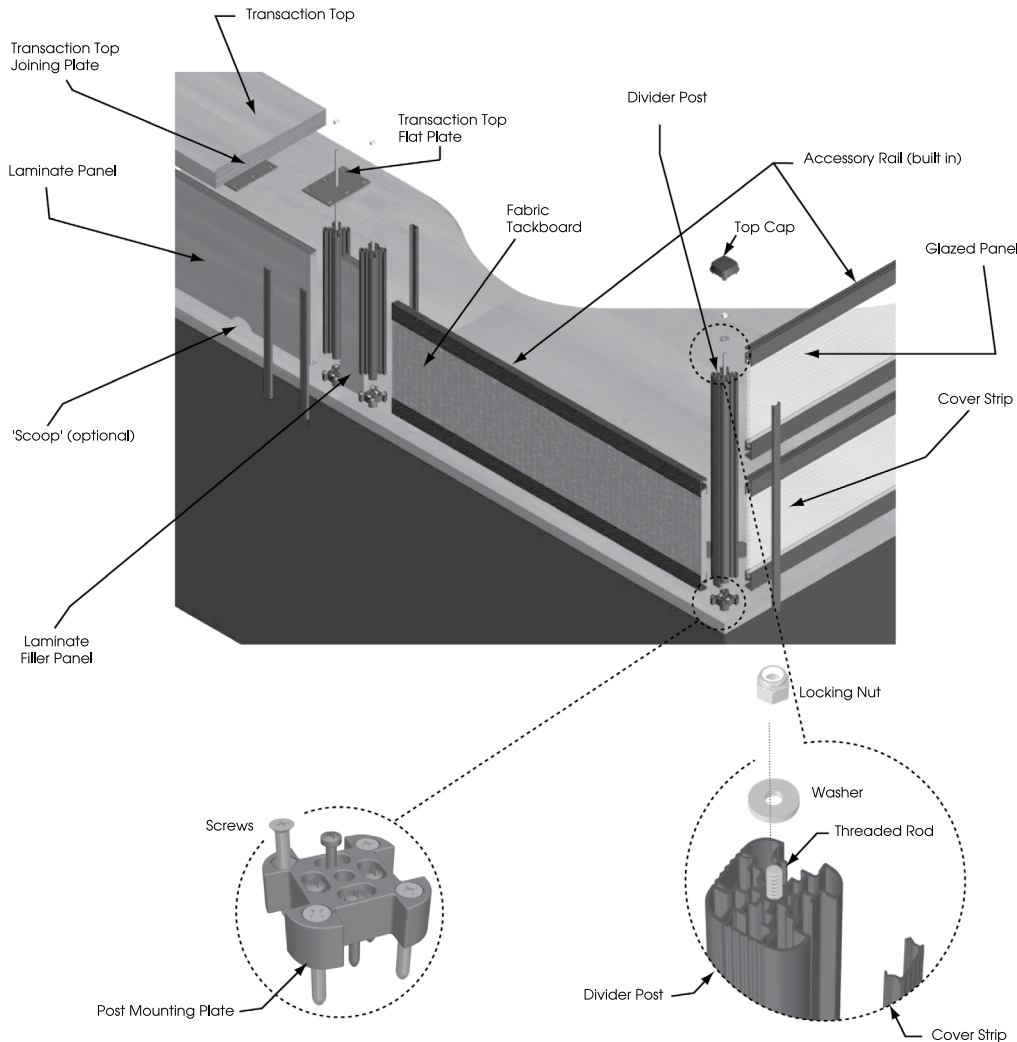

INSTALLATION IS AS SIMPLE AS 1...2...3

- 1) Attach the threaded **Post Mounting Plate** with enclosed screws to the top side of the worksurface.
- 2) **Divider Post** is bolted to the Mounting Plate.
- 3) **Top Cap** is attached to the top of the Divide Post.

12”H System

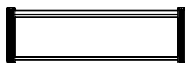

12” panel



12” raised panel

18”H System



18” panel

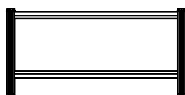

18” raised panel

24”H System



24” panel

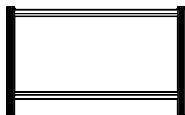

24” raised panel

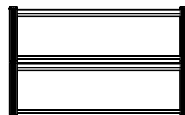

(2) 12” panels

30”H System

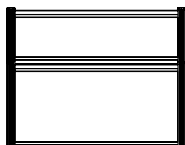

12” panel + 18” panel

36”H System

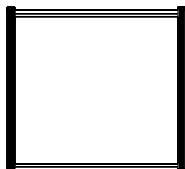

36” panel

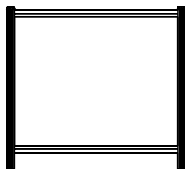

36” raised panel

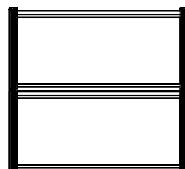

(2) 18” panels

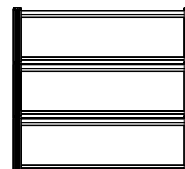

(3) 12” panels

42”H System

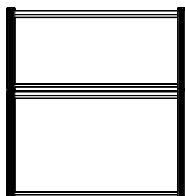

18” panel + 24” panel

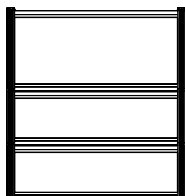

(1) 18” panel
(2) 12” panels

FABRIC PANELS

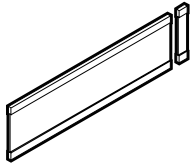

Fabric Panel - 12" High

MODEL#	DIMENSIONS D x W x H	FREIGHT CLASS	WT/LBS.	CUBIC FT.	GR.1	GR.2	GR.3	GR.4	GR.5
DTB1220	.68 x 14.8 x 12	92.5	3	.30	\$270	\$303	\$330	\$370	\$421
DTB1224	.68 x 18.9 x 12	85	4	.30	\$282	\$315	\$340	\$374	\$430
DTB1229	.68 x 24.5 x 12	92.5	4	.40	\$299	\$335	\$359	\$399	\$449
DTB1230	.68 x 24.8 x 12	85	5	.40	\$299	\$335	\$359	\$399	\$449
DTB1236	.68 x 30.8 x 12	85	5	.40	\$332	\$366	\$390	\$426	\$478
DTB1242	.68 x 36.8 x 12	85	6	.50	\$386	\$420	\$444	\$478	\$534
DTB1248	.68 x 42.8 x 12	92.5	7	.60	\$418	\$450	\$476	\$509	\$564
DTB1260	.68 x 54.8 x 12	85	9	.70	\$447	\$481	\$507	\$543	\$597
DTB1266	.68 x 60.8 x 12	85	10	.80	\$472	\$505	\$532	\$566	\$620
DTB1272	.68 x 66.8 x 12	85	11	.80	\$502	\$536	\$562	\$596	\$650

Features built-in accessory rail. Includes matching filler panel. Ships 1 set per carton. **Specify DTB1229 for panels placed along the depth side of a 30" deep worksurface.**

- Top and bottom rail optional in Black (**BLK**) or Tungsten (**TUN**) finish, please specify.
- *Model # depicts size of worksurface to be used on - see NOTES on page 410 for additional ordering information.*
- When specifying a Grade 1, 2, 3, 4 or 5 seating fabric, please note fabric pattern will run horizontally
- Divide Post **MUST** be ordered separately. Two posts are required per panel.

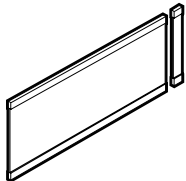

Fabric Panel - 18" High

DTB1820	.68 x 14.8 x 18	85	4	.30	\$299	\$335	\$359	\$399	\$449
DTB1824	.68 x 18.9 x 18	85	5	.40	\$314	\$346	\$372	\$405	\$460
DTB1829	.68 x 24.5 x 18	85	6	.50	\$332	\$366	\$390	\$426	\$478
DTB1830	.68 x 24.8 x 18	85	6	.50	\$332	\$366	\$390	\$426	\$478
DTB1836	.68 x 30.8 x 18	92.5	7	.60	\$386	\$420	\$444	\$478	\$534
DTB1842	.68 x 36.8 x 18	92.5	8	.70	\$422	\$455	\$479	\$513	\$566
DTB1848	.68 x 42.8 x 18	85	10	.80	\$447	\$481	\$507	\$543	\$597
DTB1860	.68 x 54.8 x 18	85	12	.90	\$472	\$505	\$532	\$566	\$620
DTB1866	.68 x 60.8 x 18	85	14	1	\$502	\$536	\$562	\$596	\$650
DTB1872	.68 x 66.8 x 18	85	14	1.10	\$562	\$596	\$622	\$658	\$712

Features built-in accessory rail. Includes matching filler panel. Ships 1 set per carton. **Specify DTB1829 for panels placed along the depth side of a 30" deep worksurface.**

- Top and bottom rail optional in Black (**BLK**) or Tungsten (**TUN**) finish, please specify.
- *Model # depicts size of worksurface to be used on - see NOTES on page 410 for additional ordering information.*
- When specifying a Grade 1, 2, 3, 4 or 5 seating fabric, please note fabric pattern will run horizontally
- Divide Post **MUST** be ordered separately. Two posts are required per panel.

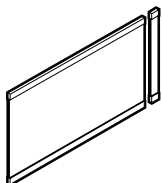

Fabric Panel - 24" High

DTB2420	.68 x 14.8 x 24	92.5	4	.40	\$332	\$366	\$390	\$426	\$478
DTB2424	.68 x 18.9 x 24	100	4	.50	\$332	\$366	\$390	\$426	\$478
DTB2429	.68 x 24.5 x 24	92.5	6	.60	\$386	\$420	\$444	\$478	\$534
DTB2430	.68 x 24.8 x 24	92.5	6	.60	\$386	\$420	\$444	\$478	\$534
DTB2436	.68 x 30.8 x 24	92.5	7	.70	\$418	\$450	\$476	\$509	\$564
DTB2442	.68 x 36.8 x 24	92.5	8	.80	\$447	\$481	\$507	\$543	\$597
DTB2448	.68 x 42.8 x 24	92.5	9	.90	\$472	\$505	\$532	\$566	\$620
DTB2460	.68 x 54.8 x 24	92.5	11	1.10	\$502	\$536	\$562	\$596	\$650
DTB2466	.68 x 60.8 x 24	92.5	12	1.20	\$562	\$596	\$622	\$658	\$712
DTB2472	.68 x 66.8 x 24	92.5	14	1.40	\$611	\$645	\$672	\$705	\$761

Features built-in accessory rail. Includes matching filler panel. Ships 1 set per carton. **Specify DTB2429 for panels placed along the depth side of a 30" deep worksurface.**

- Top and bottom rail optional in Black (**BLK**) or Tungsten (**TUN**) finish, please specify.
- *Model # depicts size of worksurface to be used on - see NOTES on page 410 for additional ordering information.*
- When specifying a Grade 1, 2, 3, 4 or 5 seating fabric, please note fabric pattern will run horizontally
- Divide Post **MUST** be ordered separately. Two posts are required per panel.

Required Specifications

Fabric
Rail Finish

FABRIC PANELS

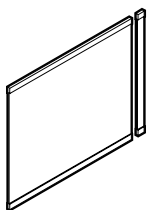

Fabric Panel - 36" High*

MODEL#	DIMENSIONS	FREIGHT CLASS	WT/LBS.	CUBIC FT.	GR. 1	GR. 2	GR. 3	GR. 4	GR. 5
D x W x H									
DTB3620	.68 x 14.8 x 36	92.5	6	.60	\$409	\$435	\$455	\$485	\$528
DTB3624	.68 x 18.9 x 36	92.5	7	.70	\$409	\$435	\$455	\$485	\$528
DTB3629	.68 x 24.5 x 36	92.5	9	.90	\$552	\$578	\$598	\$628	\$671
DTB3630	.68 x 24.8 x 36	92.5	9	.90	\$552	\$578	\$598	\$628	\$671
DTB3636	.68 x 30.8 x 36	92.5	10	1	\$623	\$650	\$670	\$700	\$743
DTB3642	.68 x 36.8 x 36	92.5	12	1.20	\$668	\$694	\$714	\$744	\$787
DTB3648	.68 x 42.8 x 36	92.5	14	1.30	\$779	\$805	\$825	\$855	\$898
DTB3660	.68 x 54.8 x 36	92.5	17	1.60	\$908	\$934	\$954	\$984	\$1027
DTB3666	.68 x 60.8 x 36	92.5	19	1.80	\$1012	\$1039	\$1059	\$1089	\$1132
DTB3672	.68 x 66.8 x 36	92.5	21	1.90	\$1070	\$1096	\$1116	\$1146	\$1189

Features built-in accessory rail. Includes matching filler panel. Ships 1 set per carton. **Specify DTB3629 for panels placed along the depth side of a 30" deep worksurface.**

- Top and bottom rail optional in Black (BLK) or Tungsten (TUN) finish, please specify.
- Model # depicts size of worksurface to be used on - see NOTES on page 410 for additional ordering information.
- When specifying a Grade 1, 2, 3, 4 or 5 seating fabric, please note fabric pattern will run horizontally
- Divide Post **MUST** be ordered separately. Two posts are required per panel.

GLAZED PANELS

LIST PRICE

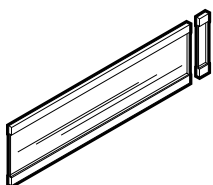

Glazed Panel - 12" High**

DGP1220	.68 x 14.8 x 12	125	2	.30	\$265
DGP1224	.68 x 18.9 x 12	92.5	3	.30	\$282
DGP1229	.68 x 24.5 x 12	125	3	.40	\$335
DGP1230	.68 x 24.8 x 12	92.5	4	.40	\$335
DGP1236	.68 x 30.8 x 12	92.5	4	.40	\$389
DGP1242	.68 x 36.8 x 12	92.5	5	.50	\$442
DGP1248	.68 x 42.8 x 12	100	5	.60	\$522
DGP1260	.68 x 54.8 x 12	92.5	7	.70	\$611
DGP1266	.68 x 60.8 x 12	100	7	.80	\$668
DGP1272	.68 x 66.8 x 12	92.5	8	.80	\$723

Features built-in accessory rail. Includes matching filler panel. Ships 1 set per carton. **Specify DGP1229 for panels placed along the depth side of a 30" deep worksurface.**

- Top and bottom rail optional in Black (BLK) or Tungsten (TUN) finish, please specify.
- Model # depicts size of worksurface to be used on - see NOTES on page 410 for additional ordering information.
- Divide Post **MUST** be ordered separately. Two posts are required per panel.
- Glazing is available in Frosted (GF), Clear (GC) or Ribbed (RG).

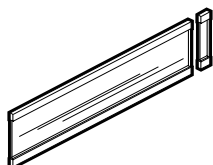

Glazed Panel - 12" High, Raised**

DRGP1220	.68 x 14.8 x 12	60	2	.02	\$236
DRGP1224	.68 x 18.9 x 12	60	3	.03	\$274
DRGP1229	.68 x 24.5 x 12	60	3	.03	\$322
DRGP1230	.68 x 24.8 x 12	60	4	.03	\$322
DRGP1236	.68 x 30.8 x 12	60	4	.04	\$377
DRGP1242	.68 x 36.8 x 12	60	5	.05	\$427
DRGP1248	.68 x 42.8 x 12	60	5	.05	\$507
DRGP1260	.68 x 54.8 x 12	60	7	.07	\$600
DRGP1266	.68 x 60.8 x 12	60	7	.07	\$655
DRGP1272	.68 x 66.8 x 12	60	8	.08	\$711

4" gap at bottom. Features built-in accessory rail. Includes matching filler panel. Ships 1 set per carton. Raised glazed panels to be offered on the lower level only. **Specify DRGP1229 for panels placed along the depth side of a 30" deep worksurface.**

- Top and bottom rail optional in Black (BLK) or Tungsten (TUN) finish, please specify.
- Model # depicts size of worksurface to be used on - see NOTES on page 410 for additional ordering information.
- Divide Post **MUST** be ordered separately. Two posts are required per panel.
- Glazing is available in Frosted (GF), Clear (GC) or Ribbed (RG).

Required Specifications

Fabric*
Glaze**
Rail Finish

GLAZED PANELS

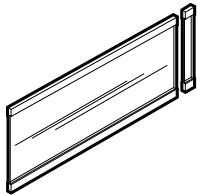

Glazed Panel - 18" High

MODEL#	DIMENSIONS D x W x H	FREIGHT CLASS	WT./LBS.	CUBIC FT.	LIST PRICE
DGP1820	.68 x 14.8 x 18	92.5	3	.30	\$296
DGP1824	.68 x 18.9 x 18	125	3	.40	\$320
DGP1829	.68 x 24.5 x 18	100	4	.50	\$374
DGP1830	.68 x 24.8 x 18	100	4	.50	\$374
DGP1836	.68 x 30.8 x 18	100	5	.60	\$432
DGP1842	.68 x 36.8 x 18	125	5	.70	\$482
DGP1848	.68 x 42.8 x 18	125	6	.80	\$578
DGP1860	.68 x 54.8 x 18	100	8	.90	\$691
DGP1866	.68 x 60.8 x 18	100	8	1	\$747
DGP1872	.68 x 66.8 x 18	100	9	1.10	\$807

Features built-in accessory rail. Includes matching filler panel. Ships 1 set per carton. **Specify DGP1829 for panels placed along the depth side of a 30" deep worksurface.**

- Top and bottom rail optional in Black (**BLK**) or Tungsten (**TUN**) finish, please specify.
- *Model # depicts size of worksurface to be used on - see NOTES on page 410 for additional ordering information.*
- Divide Post **MUST** be ordered separately. Two posts are required per panel.
- Glazing is available in Frosted (**GF**), Clear (**GC**) or Ribbed (**RG**).

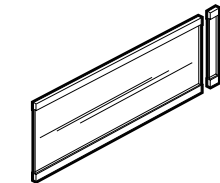

Glazed Panel - 18" High, Raised

DRGP1820	.68 x 14.8 x 18	60	3	.03	\$274
DRGP1824	.68 x 18.9 x 18	60	3	.04	\$310
DRGP1829	.68 x 24.5 x 18	60	4	.05	\$359
DRGP1830	.68 x 24.8 x 18	60	4	.05	\$359
DRGP1836	.68 x 30.8 x 18	60	5	.06	\$422
DRGP1842	.68 x 36.8 x 18	60	5	.06	\$470
DRGP1848	.68 x 42.8 x 18	60	6	.07	\$563
DRGP1860	.68 x 54.8 x 18	60	8	.09	\$673
DRGP1866	.68 x 60.8 x 18	100	8	1	\$729
DRGP1872	.68 x 66.8 x 18	100	9	1.10	\$790

4" gap at bottom. Features built-in accessory rail. Includes matching filler panel. Ships 1 set per carton. Raised glazed panels to be offered on the lower level only. **Specify DRGP1829 for panels placed along the depth side of a 30" deep worksurface.**

- Top and bottom rail optional in Black (**BLK**) or Tungsten (**TUN**) finish, please specify.
- *Model # depicts size of worksurface to be used on - see NOTES on page 410 for additional ordering information.*
- Divide Post **MUST** be ordered separately. Two posts are required per panel.
- Glazing is available in Frosted (**GF**), Clear (**GC**) or Ribbed (**RG**).

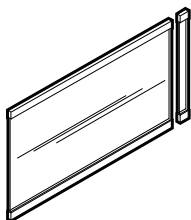

Glazed Panel - 24" High

DGP2420	.68 x 14.8 x 24	125	3	.40	\$320
DGP2424	.68 x 18.9 x 24	100	4	.50	\$358
DGP2429	.68 x 24.5 x 24	125	4	.60	\$429
DGP2430	.68 x 24.8 x 24	100	5	.60	\$429
DGP2436	.68 x 30.8 x 24	125	5	.70	\$495
DGP2442	.68 x 36.8 x 24	125	6	.80	\$562
DGP2448	.68 x 42.8 x 24	125	7	.90	\$660
DGP2460	.68 x 54.8 x 24	100	9	1.10	\$801
DGP2466	.68 x 60.8 x 24	100	10	1.20	\$874
DGP2472	.68 x 66.8 x 24	125	10	1.40	\$940

Features built-in accessory rail. Includes matching filler panel. Ships 1 set per carton. **Specify DGP2429 for panels placed along the depth side of a 30" deep worksurface.**

- Top and bottom rail optional in Black (**BLK**) or Tungsten (**TUN**) finish, please specify.
- *Model # depicts size of worksurface to be used on - see NOTES on page 410 for additional ordering information.*
- Divide Post **MUST** be ordered separately. Two posts are required per panel.
- Glazing is available in Frosted (**GF**), Clear (**GC**) or Ribbed (**RG**).

Required Specifications

- Glaze
- Rail finish

GLAZED PANELS

MODEL# DIMENSIONS FREIGHT CLASS WT/LBS. CUBIC FT. LIST PRICE

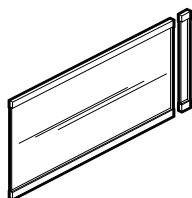

Glazed Panel - 24" High, Raised

	D x W x H				
DRGP2420	.68 x 14.8 x 24	60	3	.04	\$310
DRGP2424	.68 x 18.9 x 24	60	4	.05	\$348
DRGP2429	.68 x 24.5 x 24	60	4	.06	\$415
DRGP2430	.68 x 24.8 x 24	60	5	.06	\$415
DRGP2436	.68 x 30.8 x 24	60	5	.07	\$483
DRGP2442	.68 x 36.8 x 24	60	6	.08	\$550
DRGP2448	.68 x 42.8 x 24	60	7	.09	\$642
DRGP2460	.68 x 54.8 x 24	100	9	1.10	\$785
DRGP2466	.68 x 60.8 x 24	100	10	1.20	\$857
DRGP2472	.68 x 66.8 x 24	125	10	1.30	\$926

4" gap at bottom. Features built-in accessory rail. Includes matching filler panel. Ships 1 set per carton. Raised glazed panels to be offered on the lower level only. **Specify DRGP2429 for panels placed along the depth side of a 30" deep work surface.**

- Top and bottom rail optional in Black (BLK) or Tungsten (TUN) finish, please specify.
- Model # depicts size of work surface to be used on - see NOTES on page 410 for additional ordering information.
- Divide Post **MUST** be ordered separately. Two posts are required per panel.
- Glazing is available in Frosted (GF), Clear (GC) or Ribbed (RG).

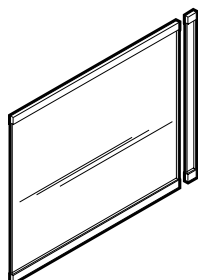

Glazed Panel - 36" High

DGP3620	.68 x 14.8 x 36	125	4	.60	\$389
DGP3624	.68 x 18.9 x 36	150	4	.70	\$429
DGP3629	.68 x 24.5 x 36	150	5	.90	\$512
DGP3630	.68 x 24.8 x 36	125	6	.90	\$512
DGP3636	.68 x 30.8 x 36	125	7	1	\$604
DGP3642	.68 x 36.8 x 36	125	8	1.20	\$691
DGP3648	.68 x 42.8 x 36	125	9	1.30	\$807
DGP3660	.68 x 54.8 x 36	125	11	1.60	\$974
DGP3666	.68 x 60.8 x 36	125	12	1.80	\$1061
DGP3672	.68 x 66.8 x 36	125	13	1.90	\$1145

Features built-in accessory rail. Includes matching filler panel. Ships 1 set per carton. **Specify DGP3629 for panels placed along the depth side of a 30" deep work surface.**

- Top and bottom rail optional in Black (BLK) or Tungsten (TUN) finish, please specify.
- Model # depicts size of work surface to be used on - see NOTES on page 410 for additional ordering information.
- Divide Post **MUST** be ordered separately. Two posts are required per panel.
- Glazing is available in Frosted (GF), Clear (GC) or Ribbed (RG).

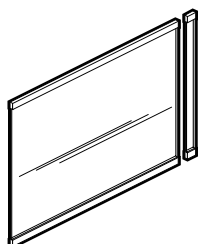

Glazed Panel - 36" High, Raised

DRGP3620	.68 x 14.8 x 36	60	4	.06	\$377
DRGP3624	.68 x 18.9 x 36	60	4	.07	\$415
DRGP3629	.68 x 24.5 x 36	60	5	.08	\$501
DRGP3630	.68 x 24.8 x 36	60	6	.08	\$501
DRGP3636	.68 x 30.8 x 36	125	7	1	\$593
DRGP3642	.68 x 36.8 x 36	125	8	1.10	\$673
DRGP3648	.68 x 42.8 x 36	125	9	1.30	\$790
DRGP3660	.68 x 54.8 x 36	125	11	1.60	\$950
DRGP3666	.68 x 60.8 x 36	125	12	1.70	\$1036
DRGP3672	.68 x 66.8 x 36	125	13	1.90	\$1122

4" gap at bottom. Features built-in accessory rail. Includes matching filler panel. Ships 1 set per carton. Raised glazed panels to be offered on the lower level only. **Specify DRGP3629 for panels placed along the depth side of a 30" deep work surface.**

- Top and bottom rail optional in Black (BLK) or Tungsten (TUN) finish, please specify.
- Model # depicts size of work surface to be used on - see NOTES on page 410 for additional ordering information.
- Divide Post **MUST** be ordered separately. Two posts are required per panel.
- Glazing is available in Frosted (GF), Clear (GC) or Ribbed (RG).

Required Specifications

Glaze
Rail finish

LAMINATE PANELS

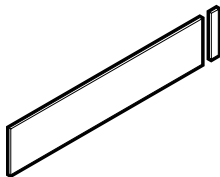

Laminate Panel - 12" High

MODEL#	DIMENSIONS D x W x H	FREIGHT CLASS	WT/LBS.	CUBIC FT.	LIST PRICE
DLP1220	.68 x 14.8 x 12	70	5	.30	\$88
DLP1224	.68 x 18.9 x 12	70	5	.30	\$104
DLP1229	.68 x 24.5 x 12	70	7	.40	\$131
DLP1230	.68 x 24.8 x 12	70	7	.40	\$131
DLP1236	.68 x 30.8 x 12	70	8	.40	\$144
DLP1242	.68 x 36.8 x 12	70	10	.50	\$164
DLP1248	.68 x 42.8 x 12	70	11	.60	\$184
DLP1260	.68 x 54.8 x 12	70	14	.70	\$199
DLP1266	.68 x 60.8 x 12	70	16	.80	\$219
DLP1272	.68 x 66.8 x 12	70	17	.80	\$247

Includes matching filler panel. Scoop option (**SCP2**) available, **Add \$42**. Ships 1 set per carton. **Specify DLP1229 for panels placed along the depth side of a 30" deep worksurface.**

- Model # depicts size of worksurface to be used on - see *NOTES* on page 410 for additional ordering information.
- Divide Post **MUST** be ordered separately. Two posts are required per panel.
- Accent edging at top and bottom Black (**BLK**) only.

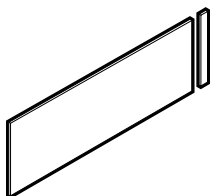

Laminate Panel - 18" High

DLP1820	.68 x 14.8 x 18	65	7	.30	\$106
DLP1824	.68 x 18.9 x 18	70	8	.40	\$120
DLP1829	.68 x 24.5 x 18	70	10	.50	\$142
DLP1830	.68 x 24.8 x 18	70	10	.50	\$142
DLP1836	.68 x 30.8 x 18	70	12	.60	\$161
DLP1842	.68 x 36.8 x 18	70	15	.70	\$184
DLP1848	.68 x 42.8 x 18	70	17	.80	\$213
DLP1860	.68 x 54.8 x 18	65	21	.90	\$233
DLP1866	.68 x 60.8 x 18	65	23	1	\$256
DLP1872	.68 x 66.8 x 18	65	25	1.10	\$282

Includes matching filler panel. Scoop option (**SCP2**) available, **Add \$42**. Ships 1 set per carton. **Specify DLP1829 for panels placed along the depth side of a 30" deep worksurface.**

- Model # depicts size of worksurface to be used on - see *NOTES* on page 410 for additional ordering information.
- Divide Post **MUST** be ordered separately. Two posts are required per panel.
- Accent edging at top and bottom Black (**BLK**) only.

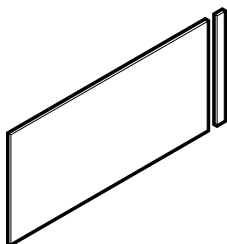

Laminate Panel - 24" High

DLP2420	.68 x 14.8 x 24	65	9	.40	\$120
DLP2424	.68 x 18.9 x 24	70	11	.50	\$130
DLP2429	.68 x 24.5 x 24	70	13	.60	\$161
DLP2430	.68 x 24.8 x 24	70	13	.60	\$161
DLP2436	.68 x 30.8 x 24	65	16	.70	\$178
DLP2442	.68 x 36.8 x 24	65	19	.80	\$207
DLP2448	.68 x 42.8 x 24	65	22	.90	\$236
DLP2460	.68 x 54.8 x 24	65	28	1.10	\$265
DLP2466	.68 x 60.8 x 24	65	30	1.20	\$295
DLP2472	.68 x 66.8 x 24	65	33	1.40	\$323

Includes matching filler panel. Scoop option (**SCP2**) available, **Add \$42**. Ships 1 set per carton. **Specify DLP2429 for panels placed along the depth side of a 30" deep worksurface.**

- Model # depicts size of worksurface to be used on - see *NOTES* on page 410 for additional ordering information.
- Divide Post **MUST** be ordered separately. Two posts are required per panel.
- Accent edging at top and bottom Black (**BLK**) only.

Required Specifications

Laminate finish. Note: woodgrain finishes are horizontal on all sizes.

LAMINATE PANELS

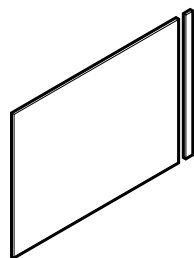

Laminate Panel - 36" High*

MODEL#	DIMENSIONS	FREIGHT CLASS	WT/LBS.	CUBIC FT.	LIST PRICE
--------	------------	---------------	---------	-----------	------------

D x W x H					
DLP3620	.68 x 14.8 x 36	70	13	.60	\$146
DLP3624	.68 x 18.9 x 36	65	16	.70	\$161
DLP3629	.68 x 24.5 x 36	70	20	.90	\$197
DLP3630	.68 x 24.8 x 36	70	20	.90	\$197
DLP3636	.68 x 30.8 x 36	65	24	1	\$227
DLP3642	.68 x 36.8 x 36	65	28	1.20	\$262
DLP3648	.68 x 42.8 x 36	65	33	1.30	\$295
DLP3660	.68 x 54.8 x 36	65	41	1.60	\$339
DLP3666	.68 x 60.8 x 36	65	45	1.80	\$374
DLP3672	.68 x 66.8 x 36	65	50	1.90	\$411

Includes matching filler panel. Scoop option (**SCP2**) available, **Add \$42**. Ships 1 set per carton. **Specify DLP3629 for panels placed along the depth side of a 30" deep worksurface.**

- Model # depicts size of worksurface to be used on - see *NOTES* on page 410 for additional ordering information.
- Divide Post **MUST** be ordered separately. Two posts are required per panel.
- Accent edging at top and bottom Black (**BLK**) only.

DIVIDE POSTS



Divide Post

MODEL#	DIMENSIONS	FREIGHT CLASS	WT/LBS.	CUBIC FT.	LIST PRICE
--------	------------	---------------	---------	-----------	------------

DPOST12	1.68 x 1.68 x 12	70	2	.10	\$121
DPOST18	1.68 x 1.68 x 18	70	2	.10	\$164
DPOST24	1.68 x 1.68 x 24	60	3	.10	\$214
DPOST30	1.68 x 1.68 x 30	60	4	.10	\$296
DPOST36	1.68 x 1.68 x 36	70	4	.20	\$339
DPOST42	1.68 x 1.68 x 42	65	5	.20	\$377

For supporting panels. Includes one post mounting plate, one top cap, three cover strips, threaded rod and all mounting hardware. Installation templates are supplied with each project. Available in Black (**BLK**) or Tungsten (**TUN**), please specify.

- Requires 2 divide posts per panel
- Divide post is mounted 1.063" from worksurface edge.



Post-to-Wall Filler Strip

DFS12	1.43 x .75 x 12	150	2	.50	\$67
DFS18	1.43 x .75 x 18	150	2	.50	\$67
DFS24	1.43 x .75 x 24	150	2	.50	\$67
DFS30	1.43 x .75 x 30	150	2	.50	\$71
DFS36	1.43 x .75 x 36	150	2	.50	\$71
DFS42	1.43 x .75 x 42	150	3	.60	\$71

Used to fill gap between divide post and an adjacent wall, wardrobe unit, or hutch. Ships 1 per carton. Black only.

Required Specifications

Laminate finish*. Note: woodgrain finishes are horizontal on all sizes.

TRANSACTION TOPS

D x W x H

- To order a radius end on one side of a transaction top, add the suffix "D" to the model number (ex. DATT30D). Add a **15% upcharge**.
- To order a radius end on both sides of a transaction top, add the suffix "DD" to the model number (ex. DATT30DD). Add a **20% upcharge**.
- Each radius end adds a 6" overhang per side (see illustrations below).

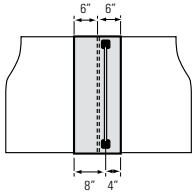

Transaction top is offset 6" from edge of worksurface in both directions.

Transaction top is offset 4" from the center of divider post towards the inside and 8" towards the outside.

Transaction Top Offset

- 4" from the center of the Divider Post to the inside of worksurface
- 8" from the center of the Divider Post to the outside of worksurface

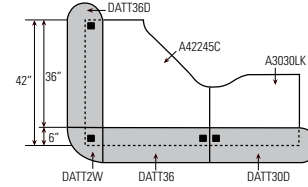

Two Way Connector Transaction Top (DATT2W/DCTT2W)

Use with a corner worksurface to link transaction tops together.

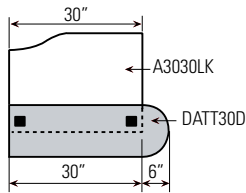

Radius End Transaction Top - one side

Add suffix "D" to model number for radius end on one side.

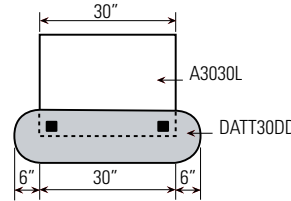

Radius End Transaction Top - two sides

Add suffix "DD" to model number for radius end on both sides.

STRAIGHT TRANSACTION TOPS

MODEL# DIMENSIONS FREIGHT CLASS WT./LBS. CUBIC FT. LIST PRICE

DATT14	12 x 14 x 1	65	7	.30	\$264
DATT18	12 x 18 x 1	70	8	.40	\$264
DATT20	12 x 20 x 1	70	9	.50	\$264
DATT23	12 x 23 x 1	70	10	.50	\$300
DATT24	12 x 24 x 1	70	10	.50	\$300
DATT29	12 x 29 x 1	70	12	.60	\$321
DATT30	12 x 30 x 1	70	12	.60	\$321
DATT36	12 x 36 x 1	70	14	.70	\$339
DATT42	12 x 42 x 1	70	16	.80	\$358
DATT48	12 x 48 x 1	70	18	.90	\$358
DATT54	12 x 54 x 1	70	21	1	\$404
DATT60	12 x 60 x 1	70	23	1.10	\$404
DATT66	12 x 66 x 1	70	25	1.20	\$451
DATT72	12 x 72 x 1	70	27	1.30	\$451



Straight Transaction Top - 1" thick

12" deep x 1" thick top. Includes all necessary Flat Plates, Joining Plates and screws. Thickness matches Adaptabilities, Genoa, Halton and Zira Series worksurfaces. Ships 1 set per carton.

- Add "D" to model number for radius end on one side, ADD **15% upcharge**.
- Add "DD" to model number for radius end on both sides, ADD **20% upcharge**.
- Each radius adds 6" overhang per side.

Required Specifications

Laminate Finish
Edge Detail

Optional Specifications

Radius End

TRANSACTION TOPS

MODEL# DIMENSIONS FREIGHT CLASS WT/LBS. CUBIC FT. LIST PRICE

D x W x H

DCTT14	12 x 14 x 1.5	60	9	.30	\$367
DCTT18	12 x 18 x 1.5	65	11	.40	\$367
DCTT20	12 x 14.8 x 1.5	65	12	.50	\$367
DCTT23	12 x 23 x 1.5	65	14	.50	\$426
DCTT24	12 x 18.9 x 1.5	65	14	.50	\$426
DCTT29	12 x 24.5 x 1.5	65	17	.60	\$453
DCTT30	12 x 30 x 1.5	65	17	.60	\$453
DCTT36	12 x 36 x 1.5	65	20	.70	\$475
DCTT42	12 x 42 x 1.5	65	23	.80	\$475
DCTT48	12 x 48 x 1.5	65	26	.90	\$475
DCTT54	12 x 54 x 1.5	65	29	1	\$540
DCTT60	12 x 60 x 1.5	65	32	1.10	\$540
DCTT66	12 x 66 x 1.5	65	35	1.20	\$591
DCTT72	12 x 72 x 1.5	65	38	1.30	\$591



Straight Transaction Top - 1½" thick

12" deep x 1½" thick top. Includes all necessary Flat Plates, Joining Plates and screws. Thickness matches Zira worksurfaces. Ships 1 set per carton.

- Add "D" to model number for radius end on one side, ADD **15% upcharge**.
- Add "DD" to model number for radius end on both sides, ADD **20% upcharge**.
- Each radius adds 6" overhang per side.

GALLERY CORNER TRANSACTION TOPS

MODEL# DIMENSIONS FREIGHT CLASS WT/LBS. CUBIC FT. LIST PRICE

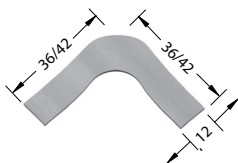

Gallery Corner Transaction Top - 1" thick

DA1GC36	36 x 36 x 1	125	32	5	\$806
DA1GC42	42 x 42 x 1	150	38	6.50	\$806

One piece corner top to be used on 36" and 42" 5-sided corners. Cut-out maximizes use of worksurface space allowing for computer screen. Includes all necessary Flat Plates, Joining Plates and screws. Thickness matches Adaptabilities, Genoa, Halton and Zira Series worksurfaces. Ships 1 set per carton.

- Woodgrain runs in one direction.



Gallery Corner Transaction Top - 1½" thick

DC1GC36	36 x 36 x 1.5	100	43	5	\$1003
DC1GC42	42 x 42 x 1.5	125	50	6.50	\$1003

One piece corner top to be used on 36" and 42" 5-sided corners. Cut-out maximizes use of worksurface space allowing for computer screen. Includes all necessary Flat Plates, Joining Plates and screws. Thickness matches Zira worksurfaces. Ships 1 set per carton.

- Woodgrain runs in one direction.

2 PIECE GALLERY CORNER TRANSACTION TOPS

MODEL# DIMENSIONS FREIGHT CLASS WT/LBS. CUBIC FT. LIST PRICE



2 Piece Gallery Corner Transaction Top - 1" thick

DA2GC36	36 x 36 x 1	70	29	1.90	\$572
DA2GC42	42 x 42 x 1	70	33	1.90	\$572

Two piece corner top to be used on 36" and 42" 5-sided corners. Cut-out maximizes use of worksurface space allowing for computer screen. Includes all necessary Flat Plates, Joining Plates and screws. Thickness matches Adaptabilities, Genoa, Halton and Zira Series worksurfaces. Ships 1 set per carton.

- Woodgrain runs in two directions.

Required Specifications

Laminate Finish
Edge Detail

Optional Specifications

Radius End (DCTT models)

2 PIECE GALLERY CORNER TRANSACTION TOPS

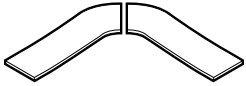

2 Piece Gallery Corner Transaction Top - 1½" thick

MODEL#	DIMENSIONS	FREIGHT CLASS	WT/LBS.	CUBIC FT.	LIST PRICE
D x W x H					
DC2GC36	36 x 36 x 1.5	70	39	1.90	\$768
DC2GC42	42 x 42 x 1.5	65	45	1.90	\$768

Two piece corner top to be used on 36" and 42" 5-sided corners. Cut-out maximizes use of worksurface space allowing for computer screen. Includes all necessary Flat Plates, Joining Plates and screws. Thickness matches Zira worksurfaces. Ships 1 set per carton.

- Woodgrain runs in two directions.

2-WAY CONNECTOR TRANSACTION TOPS

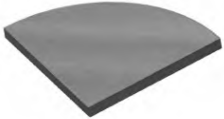

2-Way Connector Transaction Top - 1" thick

MODEL#	DIMENSIONS	FREIGHT CLASS	WT/LBS.	CUBIC FT.	LIST PRICE
DATT2W	12 x 12 x 1	70	6	.30	\$361

Used as a corner piece to link two transaction tops. Deduct 6" from each side adjoining the corner piece. Includes all necessary Flat Plates, Joining Plates and screws. Thickness matches Adaptabilities, Genoa, Halton and Zira Series worksurfaces. Ships 1 set per carton.

- Woodgrain runs diagonally.

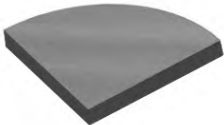

2-Way Connector Transaction Top - 1½" thick

DCTT2W	12 x 12 x 1.5	65	7	.30	\$422
--------	---------------	----	---	-----	--------------

Used as a corner piece to link two transaction tops. Deduct 6" from each side adjoining the corner piece. Includes all necessary Flat Plates, Joining Plates and screws. Thickness matches Zira worksurfaces. Ships 1 set per carton.

- Woodgrain runs diagonally.

4-WAY CONNECTOR TRANSACTION TOPS

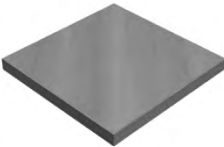

4-Way Connector Transaction Top - 1" thick

DATT4W	12 x 12 x 1	65	8	.30	\$385
--------	-------------	----	---	-----	--------------

Used as a corner piece to link four transaction tops. Deduct 6" from each side adjoining the corner piece. Includes all necessary Flat Plates, Joining Plates and screws. Thickness matches Adaptabilities, Genoa, Halton and Zira Series worksurfaces. Ships 1 set per carton.

- Woodgrain runs diagonally.

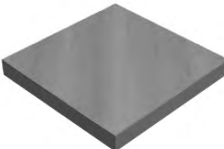

4-Way Connector Transaction Top - 1½" thick

DCTT4W	12 x 12 x 1.5	60	10	.30	\$494
--------	---------------	----	----	-----	--------------

Used as a corner piece to link four transaction tops. Deduct 6" from each side adjoining the corner piece. Includes all necessary Flat Plates, Joining Plates and screws. Thickness matches Zira worksurfaces. Ships 1 set per carton.

- Woodgrain runs diagonally.

Required Specifications

- Laminate Finish
- Edge Detail

personal storage



Sidebar Storage

456

S SIDEBAR STORAGE - NOTES



Sidebar storage is well suited to the modern workplace. Fun, unique and functional storage items provide personal touches to the workspace all while maintaining a practical appeal.

Features and Benefits

- All surfaces are 1" thick, constructed of 45 lb. density particle board covered on both sides with high performance thermally fused laminate.
- Surfaces available in four detail options.
- Tapered feet feature adjustable glides and can be painted in Black (BLK) or Tungsten (TTU).
- Tiered storage enhances the visuals of any office setting



Foot options



Stack-on storage



Low credenza storage with cushion

GENERAL INFORMATION

- SideBar is a great complement to Bungee & Bungee SL training tables as well as Zira Desking.
- High pressure tops are available on all SideBar laminates at an extended lead time – please refer to model # for availability and pricing.
- For environmental certifications, please visit globalfurnituregroup.com

CONSTRUCTION

- Tops are 1" thick, available in a variety of edge details
- All finishes feature edging in matching color (i.e. wood grain surfaces feature edging with matching printed wood grain)
- High pressure tops are available in all SideBar laminate finishes at an extended lead time. Please see model # for availability and pricing
- Products specified with the high pressure laminate option are finished on the underside of the surface with a kraft paper backing.

STORAGE

- Tops of all storage units are 1" thick, available in a variety of edge details
- Drawer and open cavity heights are built on a common module of 13.5". In open cavities, this height accommodates standard size binders.
- All lateral files feature a foolproof interlock device
- 75 lb. box – 150 lb. file drawer weight capacity with full height sides. Pencil tray included in box drawer.
- All storage is standard with handles unless otherwise noted
- All drawers are locking unless otherwise noted
- All shelves are fixed

CONSTRUCTION

- Constructed of 45 lb. density particleboard covered on both sides with high performance thermally fused laminate
- Levelling glides are standard on all floor units
- Premium full extension progressive ball bearing slides on file drawers and box drawers
- All drawer fronts are edge banded on all four sides

FEET

- Levelers adjust up to 1".
- Storage unit feet will coordinate with handle finish (brass handles will default to Black [BLK] feet).
- If no handle selection is available, legs and feet are available in Tungsten (**TTU**) or Black (**TBL**)

LOCKS

- Locks are standard on all storage modules unless otherwise noted. Lock finish will coordinate with handle finish (brass handles will default to Black [BK] locks).

SHIPPING

- Most items are shipped assembled, 1 per carton, unless otherwise noted. Items are easy to assemble

S SIDEBAR STORAGE - NOTES

1. SPECIFY MODEL NUMBER

2. SPECIFY FINISH

Top/Base/Door, Drawer and Cabinet Finishes:

ACJ	Absolute Acajou	NBL	Noce Biondo
ASN	Asian Night	NGL	Noce Grigio
AWC	Avant Cherry	NEL	Noce Leggero
AWH	Avant Honey	NML	Noce Medio
BLK	Black	QTM	Quartered Mahogany
BRC	Brushed Cobalt	SBY	Sheer Beauty
CMB	Clear Maple	SOG	Storm Grey
DES	Dark Espresso	WHE	Walnut Heights
DWT	Designer White	WHC	White Chocolate
FAS	Fashionista	WCR	Winter Cherry
FCL	First Class		

Edge:

AB	Split color edge with Black Trim
AS	Split color edge with Silver Trim
A3	Standard edge
AR	Bicut edge

Feet:

Storage Feet are available in Tungsten (**TTU**) or Black (**TBL**).

3. SPECIFY OPTIONS

EDGE OPTIONS

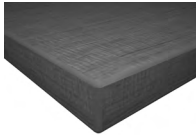

A3 - square corner, standard edge

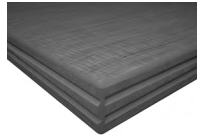

AR - square corner, bicut edge



AS - square corner, Silver



AB - square corner, Black

HANDLES

- Handles are standard on most drawers/storage modules. All other drawers, including mobile and hanging pedestals, can be ordered with a choice of nine handle options to be **factory installed**. Each handle is identified by the letters "**HU**", "**HV**", "**HW**", "**HX**", "**HS**", "**HZ**", "**HO**", "**HQ**", and "**HR**". To specify a handle, please specify the code after the model number. To order a handle as an option, please specify the code when ordering. List Price is **\$47**.



HS Flared Silver



HV Square Edge Silver



HO Crescent Black



HW Flared Brass



HU Square Edge Black



HZ Dimpled Nickel



HX Flared Black



HQ Bar Silver



HR Bar Black

MOBILE PEDESTAL

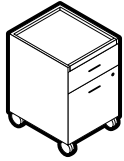

Mobile Pedestal*

MODEL#	DIMENSIONS D x W x H	FREIGHT CLASS	WT/LBS.	CUBIC FT.	LIST PRICE	HP ADD
S1619MP	19 x 16 x 25	85	76	6	\$989	n/a
S1623MP	23 x 16 x 25	92.5	82	7	\$1028	n/a

Box/File drawers on fully progressive ball bearing slides, accommodate letter and legal size hanging files. Pedestal top is inset within side panels. Includes counterweight to prevent tipping. Drawers are locking. Handles are standard. Only front casters are locking.

- File drawer construction is for accommodating hanging files and NOT for stacking material on the drawer bottom.

MOBILE PEDESTAL

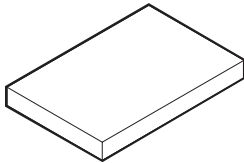

Cushion for Mobile Pedestals**

MODEL#	DIMENSIONS	FREIGHT CLASS	WT/LBS.	CUBIC FT.	GRADE	LIST	GRADE	LIST
CU1517	17 x 15 x 1.5	125	6	.90	1	\$145	7	\$414
					2	\$188	8	\$507
					3	\$217	9	\$579
					4	\$263	10	\$657
					5	\$325	11	\$820
					6	\$357	12	\$998
CU1520	20 x 15 x 1.5	70	1	1	1	\$156	7	\$423
					2	\$196	8	\$517
					3	\$226	9	\$588
					4	\$273	10	\$667
					5	\$336	11	\$831
					6	\$365	12	\$1008

Cushion attaches with Velcro strips.

- CU1517 for use on S1619MP. CU1520 for use on S1623MP.

Required Specifications

- Top finish*
- Drawer front finish*
- Handles*
- Fabric**

S SIDEBAR STORAGE

STORAGE

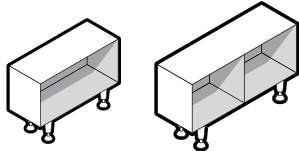

30" w

36" w

Low Bookcase

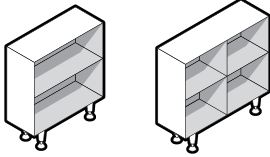

30" w

36" w

2 High Bookcase

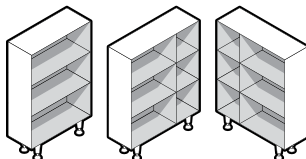

30" w

36" w - left

36" w - right

3 High Bookcase

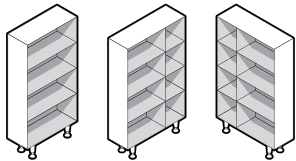

30" w

36" w - left

36" w - right

4 High Bookcase

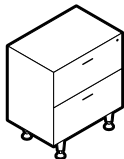

2 High Lateral File

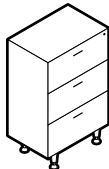

3 High Lateral File

MODEL#	DIMENSIONS	FREIGHT CLASS	WT/LBS.	CUBIC FT.	LIST PRICE	HP ADD
--------	------------	---------------	---------	-----------	------------	--------

D x W x H

S3012A0	12 x 30 x 22.85	125	49	7	\$618	n/a
S3612A0	12 x 36 x 22.85	125	61	8.25	\$715	n/a

Open bookcases accommodate binders in every cavity. One fixed shelf. 36" w units feature a fixed vertical divider.

S3012D0	12 x 30 x 36.35	125	77	10.50	\$853	n/a
S3612D0	12 x 36 x 36.35	125	94	12.50	\$989	n/a

Open bookcases accommodate binders in every cavity. Two fixed shelves. 36" w units feature a fixed vertical divider. Matches Tier 2.

S3012F0	12 x 30 x 49.85	125	102	14	\$1028	n/a
S3612FOL	12 x 36 x 49.85	125	127	16.50	\$1218	n/a
S3612FOR	12 x 36 x 49.85	125	127	16.50	\$1218	n/a

Open bookcases accommodate binders in every cavity. Three fixed shelves. 36" w units feature a fixed vertical divider. Matches Tier 3.

S3012H0	12 x 30 x 63.35	125	129	17.50	\$1218	n/a
S3612HOL	12 x 36 x 63.35	125	161	20.75	\$1467	n/a
S3612HOR	12 x 36 x 63.35	125	161	20.75	\$1467	n/a

Open bookcases accommodate binders in every cavity. Four fixed shelves. 36" w units feature a fixed vertical divider. Matches Tier 4.

S3020DZ	20 x 30 x 36.35	100	142	16.50	\$1668	n/a
S3024DZ	24 x 30 x 36.35	125	149	19.50	\$1760	n/a
S3620DZ	20 x 36 x 36.35	125	153	19.50	\$1805	n/a
S3624DZ	24 x 36 x 36.35	125	168	23.35	\$1902	n/a

Two file drawers. Handles are standard. Lock secures all drawers. Front-to-back and side-to-side letter/legal filing capability. Matches Tier 2.

- Lateral file drawer construction is for accommodating hanging files and NOT for stacking material on the drawer bottom.

S3020FZ	20 x 30 x 49.85	100	191	22	\$2051	n/a
S3024FZ	24 x 30 x 49.85	125	198	26	\$2158	n/a
S3620FZ	20 x 36 x 49.85	125	203	26	\$2223	n/a
S3624FZ	24 x 36 x 49.85	125	221	31	\$2340	n/a

Three file drawers. Handles are standard. Lock secures all drawers. Front-to-back and side-to-side letter/legal filing capability. Matches Tier 3.

- Lateral file drawer construction is for accommodating hanging files and NOT for stacking material on the drawer bottom.

Required Specifications

Top finish
Top/edge detail
Base finish
Drawer Front Finish (Units w/doors)

Handles
Leg Finish (Bookcases only)
Shelf Finish (Open Units)

STORAGE

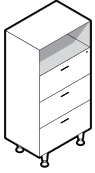

3 High Lateral File - Open

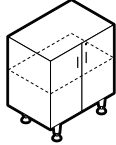

2 High Storage Cabinet

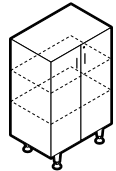

3 High Storage Cabinet

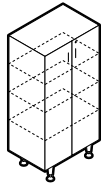

4 High Storage Cabinet

MODEL# DIMENSIONS FREIGHT CLASS WT/LBS. CUBIC FT. LIST PRICE HP ADD

D x W x H

S3020HZ	20 x 30 x 63.35	100	239	27.50	\$2524	n/a
S3024HZ	24 x 30 x 63.35	125	246	32.50	\$2645	n/a
S3620HZ	20 x 36 x 63.35	125	253	32.75	\$2733	n/a
S3624HZ	24 x 36 x 63.35	125	275	38.75	\$2868	n/a

Three file drawers. Handles are standard. Lock secures all drawers. Front-to-back and side-to-side letter/legal filing capability. Matches Tier 4.

- Lateral file drawer construction is for accommodating hanging files and NOT for stacking material on the drawer bottom.

S3020DX	20 x 30 x 36.35	125	122	16.50	\$1295	n/a
S3024DX	24 x 30 x 36.35	125	139	19.50	\$1395	n/a
S3620DX	20 x 36 x 36.35	125	151	19.50	\$1519	n/a
S3624DX	24 x 36 x 36.35	125	173	23	\$1656	n/a

Laminate doors are standard. Handles are standard. Two fixed shelves. Standard with lock. Matches Tier 2.

S3020FX	20 x 30 x 49.85	125	167	22	\$1605	n/a
S3024FX	24 x 30 x 49.85	125	190	26	\$1732	n/a
S3620FX	20 x 36 x 49.85	100	209	23.75	\$1902	n/a
S3624FX	24 x 36 x 49.85	125	238	30.75	\$2082	n/a

Laminate doors are standard. Handles are standard. Three fixed shelves. Standard with lock. Matches Tier 3.

S3020HX	20 x 30 x 63.35	125	212	27.50	\$1923	n/a
S3024HX	24 x 30 x 63.35	125	241	32.50	\$2086	n/a
S3620HX	20 x 36 x 63.35	100	266	32.50	\$2340	n/a
S3624HX	24 x 36 x 63.35	125	303	38.50	\$2549	n/a

Laminate doors are standard. Handles are standard. Includes four fixed shelves. Standard with lock. Matches Tier 4.

Required Specifications

Top finish
 Top/edge detail
 Base finish
 Door / Drawer Front Finish

Handles

S SIDEBAR STORAGE

LOW CREDENZAS

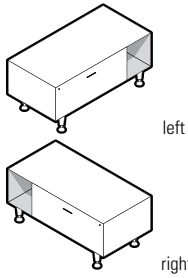

Low Credenza - Lateral Drawer

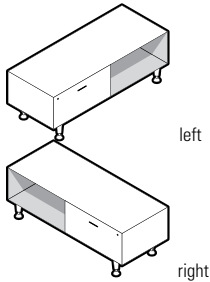

Low Credenza - Lateral Drawer

MODEL#	DIMENSIONS D x W x H	FREIGHT CLASS	WT./LBS.	CUBIC FT.	LIST PRICE	HP ADD
S4220ASL	20 x 42 x 22.85	125	110	15	\$1245	\$200
S4224ASL	24 x 42 x 22.85	125	123	17.50	\$1335	\$234
S4820ASL	20 x 48 x 22.85	125	121	17	\$1347	\$234
S4824ASL	24 x 48 x 22.85	125	136	20	\$1440	\$264
S4220ASR	20 x 42 x 22.85	125	110	15	\$1245	\$200
S4224ASR	24 x 42 x 22.85	125	123	17.50	\$1335	\$234
S4820ASR	20 x 48 x 22.85	125	121	17	\$1347	\$234
S4824ASR	24 x 48 x 22.85	125	136	20	\$1440	\$264

Lateral file drawer is standard on one side, open cavity on the other. Handles are standard. Specify left or right handed. Standard with lock. Front-to-back and side-to-side letter/legal filing capability.

- 42" w cabinet has a 30" w lateral drawer.
- 48" w cabinet has a 36" w lateral drawer.
- Lateral file drawer construction is for accommodating hanging files and NOT for stacking material on the drawer bottom.

S6020ASL	20 x 60 x 22.85	125	138	21	\$1484	\$299
S6024ASL	24 x 60 x 22.85	125	156	24.75	\$1588	\$331
S7220ASL	20 x 72 x 22.85	125	159	20.75	\$1656	\$331
S7224ASL	24 x 72 x 22.85	125	179	25	\$1764	\$396
S6020ASR	20 x 60 x 22.85	125	138	21	\$1484	\$299
S6024ASR	24 x 60 x 22.85	125	156	24.75	\$1588	\$331
S7220ASR	20 x 72 x 22.85	125	159	20.75	\$1656	\$331
S7224ASR	24 x 72 x 22.85	125	179	25	\$1764	\$396

Lateral file drawer is standard on one side, open cavity on the other. Specify left or right handed. Standard with lock. Front-to-back and side-to-side letter/legal filing capability.

- 60" w cabinet has a 30" w lateral drawer.
- 72" w cabinet has a 36" w lateral drawer.
- Lateral file drawer construction is for accommodating hanging files and NOT for stacking material on the drawer bottom.

MEDIUM CREDENZAS

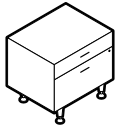

Medium Credenza - Box/File

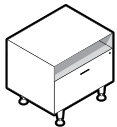

Medium Credenza w/Lateral File

MODEL#	DIMENSIONS	FREIGHT CLASS	WT./LBS.	CUBIC FT.	LIST PRICE	HP ADD
S3020BZ	20 x 30 x 29.6	100	113	13.75	\$1322	\$167
S3024BZ	24 x 30 x 29.6	125	126	16.25	\$1407	\$167
S3620BZ	20 x 36 x 29.6	125	128	16.25	\$1446	\$167
S3624BZ	24 x 36 x 29.6	100	142	16.75	\$1532	\$200
S3020BY	20 x 30 x 29.6	100	116	13.75	\$1255	\$167
S3024BY	24 x 30 x 29.6	100	131	16.25	\$1354	\$167
S3620BY	20 x 36 x 29.6	100	132	16.25	\$1382	\$167
S3624BY	24 x 36 x 29.6	100	149	16.75	\$1484	\$200

Wide box and lateral file. Handles are standard. Lock secures both drawers.

- Lateral file drawer construction is for accommodating hanging files and NOT for stacking material on the drawer bottom.

Open cavity and lateral file. Handles are standard. Standard with lock.

- Lateral file drawer construction is for accommodating hanging files and NOT for stacking material on the drawer bottom.

Required Specifications

Top finish
Top/edge detail
Base finish
Door/drawer front finish

Handles

Optional Specifications

HP laminate

MEDIUM CREDENZAS

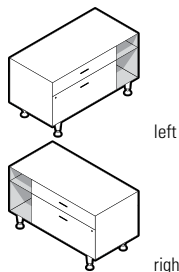

Medium Credenza - Box/Lateral File

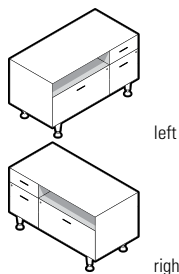

Medium Credenza - Mixed Drawers

MODEL#	DIMENSIONS D x W x H	FREIGHT CLASS	WT/LBS.	CUBIC FT.	LIST PRICE	HP ADD
S4220BSL	20 x 42 x 29.6	125	142	18.75	\$1564	\$200
S4224BSL	24 x 42 x 29.6	125	160	22	\$1668	\$234
S4820BSL	20 x 48 x 29.6	125	155	21.25	\$1695	\$234
S4824BSL	24 x 48 x 29.6	125	173	25	\$1805	\$264
S4220BSR	20 x 42 x 29.6	125	142	18.75	\$1564	\$200
S4224BSR	24 x 42 x 29.6	125	160	22	\$1668	\$234
S4820BSR	20 x 48 x 29.6	125	155	21.25	\$1695	\$234
S4824BSR	24 x 48 x 29.6	125	173	25	\$1805	\$264

Wide box and lateral file is standard on one side, open cavity with fixed shelf on the other. Handles are standard. Specify left or right handed. Standard with lock. Front-to-back and side-to-side letter/legal filing capability.

- 42" w credenza has a 30" w box/lateral file
- 48" w credenza has a 36" w box/lateral file
- Lateral file drawer construction is for accommodating hanging files and NOT for stacking material on the drawer bottom.

S4220BQL	20 x 42 x 29.6	100	165	18.75	\$1989	\$200
S4224BQL	24 x 42 x 29.6	100	184	22	\$2112	\$234
S4820BQL	20 x 48 x 29.6	100	179	21.25	\$2116	\$234
S4824BQL	24 x 48 x 29.6	100	184	22	\$2112	\$264
S4220BQR	20 x 42 x 29.6	100	165	18.75	\$1989	\$200
S4224BQR	24 x 42 x 29.6	100	184	22	\$2112	\$234
S4820BQR	20 x 48 x 29.6	100	179	21.25	\$2116	\$234
S4824BQR	24 x 48 x 29.6	100	184	22	\$2112	\$264

Box/file is standard on one side, open cavity and lateral file on the other side. Specify left or right handed. Handles are standard. Standard with locks. Front-to-back and side-to-side letter/legal filing capability.

- 42" w credenza has a 30" w lateral drawer
- 48" w credenza has a 36" w lateral drawer
- Lateral file drawer construction is for accommodating hanging files and NOT for stacking material on the drawer bottom.

Required Specifications

Top finish
Top/edge detail
Base finish
Door/drawer front finish

Handles

Optional Specifications

HP laminate

S SIDEBAR STORAGE

STACK-ON STORAGE

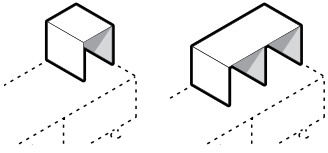

Stack-On Bookcases

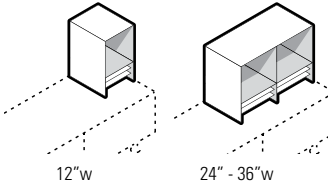

Stack-On Bookcase w/Collators**

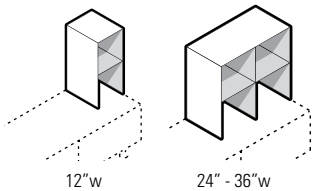

Stack-On Bookcases

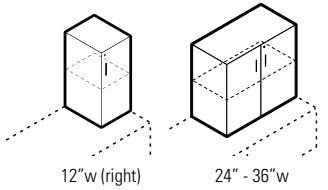

Stack-On Storage Cabinet*

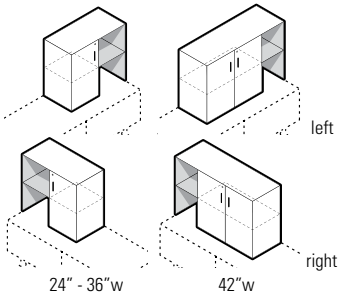

Stack-On Mixed Storage Cabinet*

MODEL#	DIMENSIONS D x W x H	FREIGHT CLASS	WT/LBS.	CUBIC FT.	LIST PRICE	HP ADD
S1214A0	14.3 x 12 x 13.5	92.5	23	2.20	\$247	n/a
S2414A0	14.3 x 24 x 13.5	100	37	4	\$375	n/a
S3014A0	14.3 x 30 x 13.5	100	41	5	\$415	n/a
S3614A0	14.3 x 36 x 13.5	125	46	5.90	\$453	n/a

Designed to be placed on top of credenzas. Open cavity. Unit rests directly on credenza top.
 • Sxx14A0 Stack-On bookcases add 1 tier when placed on any storage unit.

S1214B0	14.3 x 12 x 20.25	92.5	35	3.10	\$356	n/a
S2414B0	14.3 x 24 x 20.25	92.5	59	5.75	\$586	n/a
S3014B0	14.3 x 30 x 20.25	100	68	7	\$656	n/a
S3614B0	14.3 x 36 x 20.25	100	77	8.50	\$754	n/a

Designed to be placed on top credenzas. Open cavity with collator below. Unit rests directly on credenza top.
 • Sxx14B0 Stack-On bookcases add 1.5 tiers when placed on any storage unit.

S1214D0	14.3 x 12 x 27	92.5	41	4	\$401	n/a
S2414D0	14.3 x 24 x 27	100	68	7.50	\$630	n/a
S3014D0	14.3 x 30 x 27	100	76	9.25	\$691	n/a
S3614D0	14.3 x 36 x 27	125	85	11	\$767	n/a

Designed to be placed on top of credenzas. Open cavities with fixed shelf. Unit rests directly on credenza top.
 • Sxx14D0 Stack-On bookcases add 2 tiers when placed on any storage unit.

S1215DTL	15 x 12 x 27	92.5	47	4.20	\$526	n/a
S1215DTR	15 x 12 x 27	92.5	47	4.20	\$526	n/a
S2415DT	15 x 24 x 27	92.5	79	7.75	\$880	n/a
S3015DT	15 x 30 x 27	100	91	9.50	\$964	n/a
S3615DT	15 x 36 x 27	100	103	11.25	\$1075	n/a

Designed to be placed on top of credenzas. Laminate doors are standard. Includes fixed shelf. For 12" w units specify left or right handed. Handles are standard. Standard with locks. Unit rests directly on credenza top.
 • Sxx15DT/DTL/DTR Stack-On storage cabinets add 2 tiers when placed on any storage unit.

S2415DNL	15 x 24 x 27	100	73	7.75	\$754	n/a
S3015DNL	15 x 30 x 27	100	83	9.50	\$828	n/a
S3615DNL	15 x 36 x 27	100	94	11.25	\$925	n/a
S4215DNL	15 x 42 x 27	100	117	13	\$1183	n/a
S2415DNR	15 x 24 x 27	100	73	7.75	\$754	n/a
S3015DNR	15 x 30 x 27	100	83	9.50	\$828	n/a
S3615DNR	15 x 36 x 27	100	94	11.25	\$925	n/a
S4215DNR	15 x 42 x 27	100	117	13	\$1183	n/a

Designed to be placed on top of credenzas. Laminate doors are standard on one side with one fixed shelf. Open cavity with one fixed shelf on the other side. Specify left or right handed. Handles are standard. Standard with locks. Unit rests directly on credenza top.
 • Sxx15DNL/DNR Stack-On mixed storage cabinets add 2 tiers when placed on any storage unit.

Required Specifications

Top finish
 Top/edge detail
 Base finish
 Door/drawer front finish*

Handles*
 Collator finish**

STACK-ON STORAGE

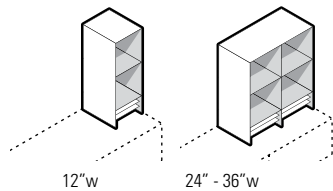

Stack-On Bookcase w/Collators

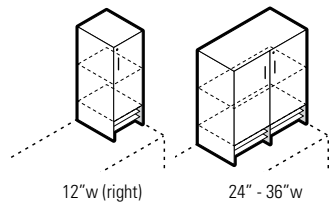

Stack-On Closed Storage* Cabinet w/Collators

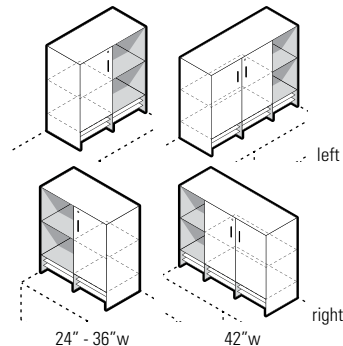

Stack-On Mixed Storage* Cabinet w/Collators

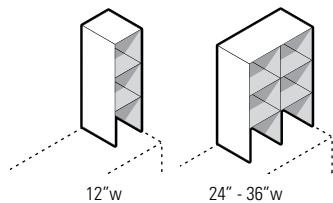

Stack-On Bookcases

MODEL#	DIMENSIONS	FREIGHT CLASS	WT/LBS.	CUBIC FT.	LIST PRICE	HP ADD
--------	------------	---------------	---------	-----------	------------	--------

D x W x H						
S1214EO	14.3 x 12 x 33.75	92.5	53	5	\$520	n/a
S2414EO	14.3 x 24 x 33.75	100	90	9.25	\$859	n/a
S3014EO	14.3 x 30 x 33.75	100	102	11.25	\$951	n/a
S3614EO	14.3 x 36 x 33.75	100	115	13.25	\$1079	n/a

Designed to be placed on top of credenzas. Open cavities with one fixed shelf and collator below. Unit rests directly on credenza top.

- Sxx14EO Stack-On bookcases add 2.5 tiers when placed on any storage unit.

S1215ETL	15 x 12 x 33.75	92.5	59	5.25	\$643	n/a
S1215ETR	15 x 12 x 33.75	92.5	59	5.25	\$643	n/a
S2415ET	15 x 24 x 33.75	92.5	102	9.50	\$1101	n/a
S3015ET	15 x 30 x 33.75	100	117	11.75	\$1218	n/a
S3615ET	15 x 36 x 33.75	100	133	14	\$1382	n/a

Designed to be placed on top of credenzas. Laminate doors are standard with one fixed shelf and collator below. For 12" w units specify left or right handed. Handles are standard. Standard with locks. Unit rests directly on credenza top.

- Sxx15ET/ETL/ETR Stack-On storage cabinets add 2.5 tiers when placed on any storage unit.

S2415ENL	15 x 24 x 33.75	92.5	96	9.50	\$977	n/a
S3015ENL	15 x 30 x 33.75	100	110	11.75	\$1087	n/a
S3615ENL	15 x 36 x 33.75	100	124	14	\$1231	n/a
S4215ENL	15 x 42 x 33.75	100	154	16	\$1536	n/a

S2415ENR	15 x 24 x 33.75	92.5	96	9.50	\$977	n/a
S3015ENR	15 x 30 x 33.75	100	110	11.75	\$1087	n/a
S3615ENR	15 x 36 x 33.75	100	124	14	\$1231	n/a
S4215ENR	15 x 42 x 33.75	100	154	16	\$1536	n/a

Designed to be placed on top of credenzas. Laminate doors are standard on one side with one fixed shelf. Open cavities on the other side, with one fixed shelf and collator below. Specify left or right handed. Handles are standard. Standard with locks. Unit rests directly on credenza top.

- Sxx15ENL/ENR Stack-On mixed storage cabinets add 2.5 tiers when placed on any storage unit.

S1214FO	14.3 x 12 x 40.5	100	59	6	\$560	n/a
S2414FO	14.3 x 24 x 40.5	100	98	10.75	\$873	n/a
S3014FO	14.3 x 30 x 40.5	100	110	13.25	\$956	n/a
S3614FO	14.3 x 36 x 40.5	125	123	15.75	\$1061	n/a

Designed to be placed on top of credenzas. Open cavities with two fixed shelves. Unit rests directly on credenza top.

- Sxx14FO Stack-On bookcases add 3 tiers when placed on any storage unit.

Required Specifications

Top finish
Top/edge detail
Base finish
Door/drawer front finish*

Handles*
Collator finish

S SIDEBAR STORAGE

STACK-ON STORAGE

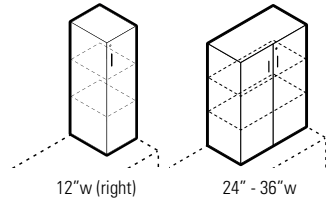

Stack-On Storage Cabinet

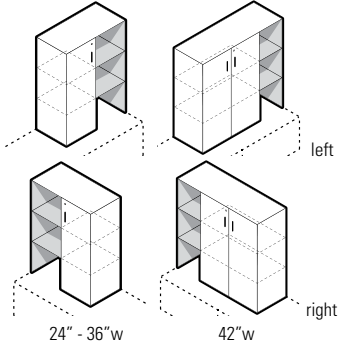

Stack-On Mixed Storage Cabinet

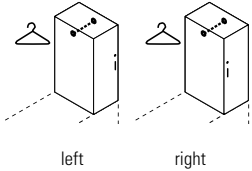

Stack-On Wardrobe Cabinet

MODEL#	DIMENSIONS D x W x H	FREIGHT CLASS	WT/LBS.	CUBIC FT.	LIST PRICE	HP ADD
S1215FTL	15 x 12 x 40.5	92.5	68	6.25	\$715	n/a
S1215FTR	15 x 12 x 40.5	92.5	68	6.25	\$715	n/a
S2415FT	15 x 24 x 40.5	92.5	116	11.25	\$1193	n/a
S3015FT	15 x 30 x 40.5	100	132	14	\$1308	n/a
S3615FT	15 x 36 x 40.5	100	150	16.50	\$1458	n/a

Designed to be placed on top of credenzas. Laminate doors are standard, with two fixed shelves. Handles are standard. Standard with locks. Unit rests directly on credenza top.

- Sxx15FT/FTL/FTR Stack-On storage cabinets add 3 tiers when placed on any storage unit.

S2415FNL	15 x 24 x 40.5	100	107	11.25	\$1034	n/a
S3015FNL	15 x 30 x 40.5	100	121	14	\$1132	n/a
S3615FNL	15 x 36 x 40.5	100	137	16.50	\$1264	n/a
S4215FNL	15 x 42 x 40.5	100	171	19	\$1616	n/a

S2415FNR	15 x 24 x 40.5	100	107	11.25	\$1034	n/a
S3015FNR	15 x 30 x 40.5	100	121	14	\$1132	n/a
S3615FNR	15 x 36 x 40.5	100	137	16.50	\$1264	n/a
S4215FNR	15 x 42 x 40.5	100	171	19	\$1616	n/a

Designed to be placed on top of credenzas. Laminate doors are standard on one side, with two fixed shelves. Open cavities on the other side, with two fixed shelves. Specify left or right handed. Handles are standard. Standard with locks. Unit rests directly on credenza top.

- Sxx15FNL/FNR Stack-On mixed storage cabinets add 3 tiers when placed on any storage unit.

S1224FTL	24 x 12 x 40.5	100	83	9.50	\$845	n/a
S1224FTR	24 x 12 x 40.5	100	83	9.50	\$845	n/a

Designed to be placed on top of credenzas. Laminate doors are standard. Includes hanging rod. Specify left or right handed. Handles are standard. Standard with locks. Unit rests directly on credenza top.

- S1224FTL/FTR Stack-On wardrobe cabinets add 3 tiers when placed on any storage unit.

Required Specifications

Top finish
Top/edge detail
Base finish
Door/drawer front finish

Handles