



bridges II connect
share
achieve

Our desire was to develop an environment for collaborative teamwork which would facilitate connection, or bridging of people and ideas. A set of components which would even serve as a catalyst, inviting team members out of their cocooned comfort zones and encouraging them to engage, co-create. With Bridges II you can develop an environment of collaborative teamwork through workspace configuration that enhances line communication and bridges people with a spectrum of ideas and interfaces. Bridges II features a set of components that facilitate communication and streamline interaction through product that efficiently adapts and creatively configures. The product focuses on advancing engagement and collaborative creation through quick adaptations necessary to meet the needs of a fast paced and ever changing work environment. With flexible building components, Bridges II fits numerous applications, from boardrooms to multi-person workstations. It is easy to customize and reconfigure to fit specific requirements.

Features and Benefits

- High performance thermally fused laminate tops are 1" thick
- High pressure laminate tops are 1-1/16" thick
- Flat 3mm edge profile on all sides
- Worksurfaces provided with pilot holes for alignment
- Numerous Power/Data accessories
- Interconnected storage units can form a spine to create space division, storage, cable management and worksurface support
- Leg Options:
Height adjustable round legs
Fixed height rectangular legs



Rectangular Leg



Power Trough



Round Leg

GENERAL INFORMATION**Flexible Building components**

- Single leg tables (freestanding or mobile)
- Training Rooms
- Boardrooms
- Libraries
- 1 person general and private office
- 2 person workstation
- 3 person workstation
- 6+ person workstation
- Storage spine-based workstation

Easy to customize and reconfigure to fit specific requirements. From the facility manager's perspective, all workstations can be standardized to form a linear worksurface and power/data services, and their respective function or purpose can be governed by the type, quantity and placement of adjacent components like dividers, storage cabinets, shelves and accessories. These adjacent components can be easily reconfigured with minimal down time - without having to invite electrical and IT crews.

Compatible with various environments

- Clean, simple, elegant design language, with finishes suggesting comfortable, even domestic flavor. Understated to designer combinations, like anodized aluminum and white, give a hint of subtle sophistication.

Choice of **two functionally and visually different leg** supports

- Casters or levelers
- Height adjustable round legs
- Fixed height rectangular legs
- Optional anodized aluminum finish (Rectangular legs only). Refer to individual models for upcharge.

Various **power/data delivery** levels to choose from

- Wire basket to organize cable access under worksurfaces and storage units
- Vertical cable manager integrated into rectangular leg
- Worksurface edge-mounted power/data units (easy to reconfigure, plug into wall/floor outlets), or power troughs
- Single-sided and double-sided below worksurface power/data trough (desktop/floor standing computers and office equipment)
- Worksurface access door (access to below worksurface power outlets and data terminals)
- Above worksurface power/data trough provides immediate access for laptops, tablets and phones
- Storage integrated power/data unit
- Horizontal cable management under storage units with optional wire basket

Interconnected storage units can form a spine to create space division, storage, cable management and worksurface support. Storage leg can be configured to act as a ganging bracket.

- For environmental certifications, please visit globalfurnituregroup.com.

B BRIDGES II™ - NOTES

WORKSURFACES

- Standard in high performance thermally fused laminate. Optional high pressure (HP) laminate available.
- High performance thermally fused laminate tops are 1" thick particle board and have a flat 3mm edge profile on all sides
- High pressure (HP) laminate tops are 1-1/16" thick laminate particle board and have a flat 3mm edge profile on all sides
- Laminate surfaces offer a selection of matching + coordinating edgeband. Specify separately from the surface finish.



- Products specified with the high pressure laminate option are finished on the underside of the surface with a kraft paper backing.
- Doors and Drawer Fronts feature a matching 3mm edge. All other surfaces feature a matching self edge.

TABLES

- All multiple linear workstations are standard with levelers
- Tops square for flush surface-to-surface abutment and to accept desk mounted accessories
- Worksurfaces provided with pilot holes for alignment purposes

CODES

- This price list uses a numbering system with meaningful alphanumeric characters to create a simple-to-understand product number. This makes specifying the product much easier and more accurate.

Example of a worksurface:

Product code: BRTWS2472AWC + HP

BRT = Bridges II

WS = Type of Worksurface

2472 = Size: Depth x Width

AWC = High Pressure Laminate

HP = Finish

RECTANGULAR LEG

- For single and shared worksurface support
- Bridges II Rectangular legs are available with: Locking Casters (**BRTLCS**) or Levelers (**BRTLVS**)

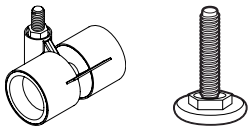

- Casters and Levelers **CANNOT** be retrofitted
- Levelers have a 2" height range, with 5/16" thread
- Levelers are available in Black only
- Casters are 45mm high with 8mm thread, available in White body / Grey tire combination only
- Leg frame is offered in 8 standard paint finishes and anodized aluminum finish
- Paint finish is a durable, environmentally friendly epoxy powder coating
- When anodized finish is selected, crossbeam is always White

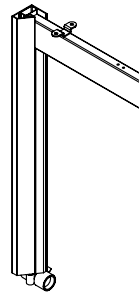

ROUND LEG

- For single and shared worksurface support
- Tubular steel legs are adjustable in 1" increments
- Height adjustment allows the user to easily set the height of a table
- Legs have a height adjustment of 24" - 32" in 1" increments with levelers and 27" - 35" with casters
- Bridges II Round legs are available with: Locking Casters (**BRTLCS**) or Levelers (**BRTLVR**)

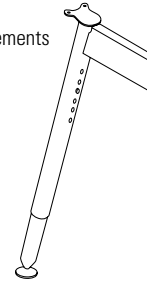
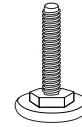

- Casters and Levelers CAN be retrofitted
- Levelers have a 1" height range, with 3/8-16" thread
- Levelers are available in Chrome only
- Casters available in Tungsten/Black combination only
- Casters are 3" diameter with an overall height of 3 3/4" with 3/8-16" thread
- Inner legs are available in Chrome only
- Leg frame is offered in 8 standard paint finishes
- Paint finish is a durable, environmentally friendly epoxy powder coating

FINISHES

Metal Frame Finishes:

BLK	Black
BZD	Blizzard**
CHR	Charcoal
DWT	Designer White
FOG	Fog
NEV	Nevada
SIL	Silver
SDT	Stonedust**
TPE	Taupe
TUN	Tungsten
ANO*	Anodized Aluminum - Upcharge applies. Refer to models for upcharge.

*ANO is a process, not a paint finish.
**Textured finish

Laminate Top Finishes:

ACJ	Absolute Acajou
ASN	Asian Night
AWC	Avant Cherry
AWH	Avant Honey
BLK	Black - Coordinates with BLK Metal Frame Finish
BZD	Blizzard
BRC	Brushed Cobalt - Coordinates with TUN Metal Frame Finish
CMB	Clear Maple
CGY	Custom Grey - Coordinates with SIL Metal Frame Finish
DES	Dark Espresso
DWT	Designer White - Coordinates with DWT Metal Frame Finish
FAS	Fashionista
FCL	First Class
NBL	Noce Biondo
NGL	Noce Grigio
NEL	Noce Leggero
NML	Noce Medio
QTM	Quartered Mahogany
SBY	Sheer Beauty
SDT	Stonedust
SOG	Storm Grey - Coordinates with CHR Metal Frame Finish
WHE	Walnut Heights
WHC	White Chocolate
WCR	Winter Cherry

Edgeband Finishes:

AAE	Absolute Acajou
ASE	Asian Night
ACE	Avant Cherry
AHE	Avant Honey
BLK	Black
BRC	Brushed Cobalt
BZD	Blizzard
CHR	Charcoal (<i>use w/SOG</i>)
CME	Clear Maple
DEE	Dark Espresso
DWE	Designer White
FAS	Fashionista
FCL	First Class
NEV	Nevada
QTM	Quartered Mahogany
SBY	Sheer Beauty
SIL	Silver (<i>use w/CGY</i>)
SDT	Stonedust
TPE	Taupe
WHE	Walnut Heights
CBE	White Chocolate
WCE	Winter Cherry

Chassis/Accent Finishes:

ACJ	Absolute Acajou
ASN	Asian Night
AWC	Avant Cherry
AWH	Avant Honey
BLK	Black - Coordinates with BLK Metal Frame Finish
BRC	Brushed Cobalt - Coordinates with TUN Metal Frame Finish
BZD	Blizzard
CGY	Custom Grey - Coordinates with SIL Metal Frame Finish
CMB	Clear Maple
DES	Dark Espresso
DWT	Designer White - Coordinates with DWT Metal Frame Finish
FAS	Fashionista
FCL	First Class
NBL	Noce Biondo
NGL	Noce Grigio
NEL	Noce Leggero
NML	Noce Medio
QTM	Quartered Mahogany
SBY	Sheer Beauty
SOG	Storm Grey - Coordinates with CHR Metal Frame Finish
SDT	Stonedust
STG	String - Coordinates with NEV Metal Frame Finish
WHC	White Chocolate
WHE	Walnut Heights
WCR	Winter Cherry

Metal Beam + Access Door Finishes:

BLK	Black
BZD	Blizzard*
CHR	Charcoal
DWT	Designer White
FOG	Fog
NEV	Nevada
SIL	Silver
SDT	Stonedust*
TPE	Taupe
TUN	Tungsten

*Textured finish

FABRIC TABLE DIVIDERS / SEAT PRIVACY PARTITIONSBridges II Fabric Table Dividers are available in: **Anchorage, Lola, Merge****COLLABORATIVE SEATING**

- All standard seating fabrics and grades apply.

30"W UNITS STORAGE CAPACITY CHART

Side to Side

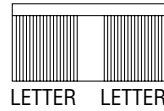

Side to Side Letter/Front to Back Legal

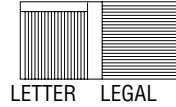
**36"W UNITS STORAGE CAPACITY CHART**

Side to Side Letter

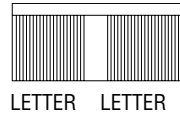

Side to Side Legal

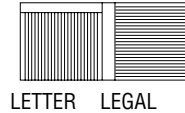

Side to Side Letter/Front to Back Legal

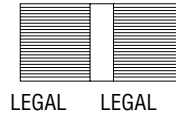

RECTANGULAR LEG PACKAGES

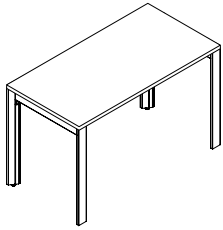

Single Line 1 Person Pod with Levelers

MODEL#	DIMENSIONS	FREIGHT CLASS	WT./LBS.	CUBIC FT.	LIST PRICE	HP ADD
D x W x H						
BRTS1P2484L	24 x 84 x 29	70	75	4.92	\$1687	\$165
BRTS1P2478L	24 x 78 x 29	85	72	4.82	\$1638	\$158
BRTS1P2472L	24 x 72 x 29	85	69	4.73	\$1581	\$163
BRTS1P2466L	24 x 66 x 29	85	66	4.65	\$1564	\$145
BRTS1P2463L	24 x 62.5 x 29	85	63	4.57	\$1552	\$141
BRTS1P2460L	24 x 60 x 29	85	60	4.48	\$1535	\$140
BRTS1P2454L	24 x 54 x 29	85	57	4.4	\$1482	\$122
BRTS1P2451L	24 x 50.5 x 29	85	54	4.3	\$1441	\$117
BRTS1P2448L	24 x 48 x 29	85	51	4.2	\$1403	\$111
BRTS1P2442L	24 x 42 x 29	92.5	48	4.1	\$1342	\$91
BRTS1P2436L	24 x 36 x 29	92.5	45	4	\$1258	\$78
BRTS1P3084L	30 x 84 x 29	70	84	5.2	\$1769	\$176
BRTS1P3078L	30 x 78 x 29	70	81	5.1	\$1701	\$163
BRTS1P3072L	30 x 72 x 29	70	78	5.01	\$1661	\$161
BRTS1P3066L	30 x 66 x 29	70	75	4.9	\$1621	\$155
BRTS1P3063L	30 x 62.5 x 29	70	72	4.8	\$1609	\$150
BRTS1P3060L	30 x 60 x 29	85	69	4.73	\$1593	\$145
BRTS1P3054L	30 x 54 x 29	85	66	4.6	\$1556	\$121
BRTS1P3051L	30 x 50.5 x 29	85	63	4.5	\$1528	\$127
BRTS1P3048L	30 x 48 x 29	85	60	4.41	\$1502	\$122
BRTS1P3042L	30 x 42 x 29	85	57	4.3	\$1469	\$120
BRTS1P3036L	30 x 36 x 29	85	54	4.2	\$1357	\$83

Single Line Table Assemblies consist of one worksurface, two leg assemblies, and one supporting structural beam.

- Anodized Aluminum Leg - Add **\$165.** list upcharge

Required Specifications

Top finish
Metal finish (legs)

Edge finish
Beam finish

Optional Specifications

Anodized Aluminum Leg
HP laminate

RECTANGULAR LEG PACKAGES

MODEL#	DIMENSIONS	FREIGHT CLASS	WT./LBS.	CUBIC FT.	LIST PRICE	HP ADD
--------	------------	---------------	----------	-----------	------------	--------

D x W x H

BRTS1P2484C	24 x 84 x 29	70	75	4.92	\$1769	\$165
BRTS1P2478C	24 x 78 x 29	85	72	4.82	\$1720	\$158
BRTS1P2472C	24 x 72 x 29	85	69	4.73	\$1674	\$155
BRTS1P2466C	24 x 66 x 29	85	66	4.65	\$1647	\$145
BRTS1P2463C	24 x 62.5 x 29	85	63	4.57	\$1633	\$141
BRTS1P2460C	24 x 60 x 29	85	60	4.48	\$1619	\$140
BRTS1P2454C	24 x 54 x 29	85	57	4.4	\$1564	\$122
BRTS1P2451C	24 x 50.5 x 29	85	54	4.3	\$1526	\$117
BRTS1P2448C	24 x 48 x 29	85	51	4.2	\$1485	\$111
BRTS1P2442C	24 x 42 x 29	92.5	48	4.1	\$1422	\$91
BRTS1P2436C	24 x 36 x 29	92.5	45	4	\$1343	\$78

BRTS1P3084C	30 x 84 x 29	70	84	5.2	\$1867	\$163
BRTS1P3078C	30 x 78 x 29	70	81	5.1	\$1783	\$163
BRTS1P3072C	30 x 72 x 29	70	78	5.01	\$1743	\$138
BRTS1P3066C	30 x 66 x 29	70	75	4.9	\$1704	\$155
BRTS1P3063C	30 x 62.5 x 29	70	72	4.8	\$1692	\$150
BRTS1P3060C	30 x 60 x 29	85	69	4.73	\$1675	\$145
BRTS1P3054C	30 x 54 x 29	85	66	4.6	\$1640	\$121
BRTS1P3051C	30 x 50.5 x 29	85	63	4.5	\$1611	\$127
BRTS1P3048C	30 x 48 x 29	85	60	4.41	\$1584	\$122
BRTS1P3042C	30 x 42 x 29	85	57	4.3	\$1553	\$120
BRTS1P3036C	30 x 36 x 29	85	54	4.2	\$1440	\$83

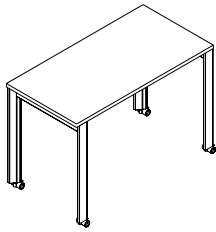

Single Line 1 Person Pod with Casters

Single Line Table Assemblies consist of one worksurface, two leg assemblies, and one supporting structural beam. 40mm white locking casters with grey tires; steel horizontal beams, aluminum legs.

- Anodized Aluminum Leg - Add **\$165**. list upcharge

Required Specifications

Top finish
Metal finish (legs)

Edge finish
Beam finish

Optional Specifications

Anodized Aluminum Leg
HP laminate

RECTANGULAR LEG PACKAGES

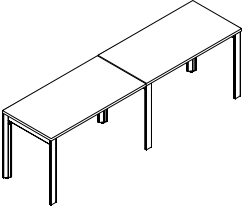

Single Line 2 Person Pod with Levelers

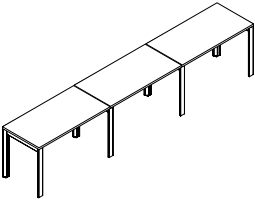

Single Line 3 Person Pod with Levelers

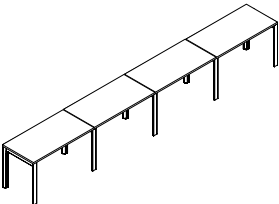

Single Line 4 Person Pod with Levelers

MODEL#	DIMENSIONS D x W x H	FREIGHT CLASS	WT/LBS.	CUBIC FT.	LIST PRICE	HP ADD
BRTS2P2484L	24 x 168 x 29	70	149	7.41	\$2956	\$326
BRTS2P2478L	24 x 156 x 29	70	140	7.27	\$2856	\$310
BRTS2P2472L	24 x 144 x 29	70	131	7.13	\$2767	\$302
BRTS2P2466L	24 x 132 x 29	70	122	6.95	\$2709	\$285
BRTS2P2460L	24 x 120 x 29	70	113	6.71	\$2650	\$277
BRTS2P2454L	24 x 108 x 29	70	104	6.45	\$2542	\$241
BRTS2P2448L	24 x 96 x 29	70	95	6.21	\$2386	\$217
BRTS2P3084L	30 x 168 x 29	70	173	8.25	\$3101	\$351
BRTS2P3078L	30 x 156 x 29	70	164	7.97	\$2964	\$323
BRTS2P3072L	30 x 144 x 29	70	155	7.69	\$2903	\$314
BRTS2P3066L	30 x 132 x 29	70	140	7.41	\$2805	\$302
BRTS2P3060L	30 x 120 x 29	70	131	7.13	\$2749	\$285
BRTS2P3054L	30 x 108 x 29	70	122	6.85	\$2670	\$241
BRTS2P3048L	30 x 96 x 29	70	113	6.57	\$2563	\$241
BRTS3P2484L	24 x 252 x 29	70	219	9.74	\$4227	\$487
BRTS3P2478L	24 x 234 x 29	70	206	9.53	\$4077	\$463
BRTS3P2472L	24 x 216 x 29	70	192	9.32	\$3942	\$451
BRTS3P2466L	24 x 198 x 29	70	179	9.11	\$3853	\$428
BRTS3P2460L	24 x 180 x 29	70	165	8.89	\$3770	\$392
BRTS3P2454L	24 x 162 x 29	70	152	8.68	\$3607	\$357
BRTS3P2448L	24 x 144 x 29	70	138	8.47	\$3371	\$321
BRTS3P3084L	30 x 252 x 29	65	263	11.59	\$4434	\$524
BRTS3P3078L	30 x 234 x 29	70	246	11.16	\$4229	\$484
BRTS3P3072L	30 x 216 x 29	70	229	10.72	\$4105	\$471
BRTS3P3066L	30 x 198 x 29	70	212	10.3	\$3987	\$451
BRTS3P3060L	30 x 180 x 29	70	195	9.87	\$3905	\$428
BRTS3P3054L	30 x 162 x 29	70	178	9.44	\$3789	\$357
BRTS3P3048L	30 x 144 x 29	70	161	9.01	\$3628	\$357
BRTS4P2484L	24 x 336 x 29	70	291	13.67	\$5493	\$650
BRTS4P2478L	24 x 312 x 29	70	273	13.18	\$5296	\$616
BRTS4P2472L	24 x 288 x 29	70	254	12.69	\$5147	\$609
BRTS4P2466L	24 x 264 x 29	70	236	12.2	\$4999	\$567
BRTS4P2460L	24 x 240 x 29	70	217	11.71	\$4884	\$550
BRTS4P2454L	24 x 216 x 29	70	199	11.22	\$4669	\$475
BRTS4P2448L	24 x 192 x 29	70	180	10.73	\$4355	\$428
BRTS4P3084L	30 x 336 x 29	65	345	14.87	\$5762	\$698
BRTS4P3078L	30 x 312 x 29	65	323	14.3	\$5491	\$639
BRTS4P3072L	30 x 288 x 29	70	301	13.73	\$5327	\$625
BRTS4P3066L	30 x 264 x 29	70	279	13.16	\$5170	\$598
BRTS4P3060L	30 x 240 x 29	70	257	12.59	\$5064	\$567
BRTS4P3054L	30 x 216 x 29	70	235	12.02	\$4905	\$475
BRTS4P3048L	30 x 192 x 29	70	213	11.45	\$4691	\$475

Single Line 2 Person workstation consists of two worksurfaces, three leg assemblies, and two supporting structural beams. One leg can be shared by 2 adjoining worksurfaces.

- Anodized Aluminum Leg - Add **\$243.** list upcharge

Single Line 3 Person workstation consists of three worksurfaces, four leg assemblies, and three supporting structural beams. One leg can be shared by 2 adjoining worksurfaces.

- Anodized Aluminum Leg - Add **\$325.** list upcharge

Single Line 4 Person workstation consists of four worksurfaces, five leg assemblies, and four supporting structural beams. One leg can be shared by 2 adjoining worksurfaces.

- Anodized Aluminum Leg - Add **\$407.** list upcharge

Required Specifications

Top finish
Metal finish (legs)

Edge finish
Beam finish

Optional Specifications

Anodized Aluminum Leg
HP laminate

RECTANGULAR LEG PACKAGES

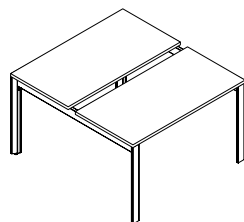

Back-to-Back 2 Person Pod with Levelers

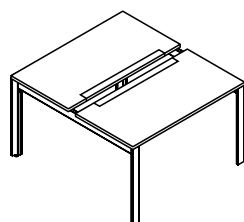

Back-to-Back 2 Person Pod with Access Door and Levelers*

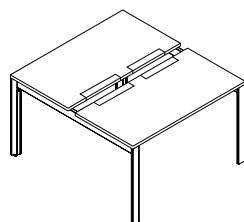

Back-to-Back 2 Person Pod with Access Doors and Levelers*

MODEL# DIMENSIONS FREIGHT CLASS WT/LBS. CUBIC FT. LIST PRICE HP ADD

	D x W x H					
BRTBAR2P2484L	50.5 x 84 x 29	70	146	9.4	\$2792	\$326
BRTBAR2P2478L	50.5 x 78 x 29	85	137	9.2	\$2691	\$310
BRTBAR2P2472L	50.5 x 72 x 29	85	128	9.02	\$2601	\$302
BRTBAR2P2466L	50.5 x 66 x 29	85	119	8.76	\$2542	\$285
BRTBAR2P2460L	50.5 x 60 x 29	85	110	8.56	\$2487	\$277
BRTBAR2P3084L	62.5 x 84 x 29	70	174	10.4	\$2875	\$351
BRTBAR2P3078L	62.5 x 78 x 29	70	163	9.8	\$2747	\$310
BRTBAR2P3072L	62.5 x 72 x 29	70	152	9.54	\$2659	\$310
BRTBAR2P3066L	62.5 x 66 x 29	70	141	9.25	\$2578	\$302
BRTBAR2P3060L	62.5 x 60 x 29	85	130	9	\$2522	\$285

Back-to-back 2 Person workstation consists of two worksurfaces, two back-to-back leg assemblies, and two supporting structural beams.

- Anodized Aluminum Leg - Add **\$165**. list upcharge

BRTBAR2PA2484L	50.5 x 84 x 29	70	146	9.4	\$2935	\$583
BRTBAR2PA2478L	50.5 x 78 x 29	85	137	9.2	\$2853	\$521
BRTBAR2PA2472L	50.5 x 72 x 29	85	128	9.02	\$2792	\$500
BRTBAR2PA2466L	50.5 x 66 x 29	85	119	8.76	\$2689	\$438
BRTBAR2PA2460L	50.5 x 60 x 29	85	110	8.56	\$2585	\$397
BRTBAR2PA3084L	62.5 x 84 x 29	70	174	10.4	\$3204	\$708
BRTBAR2PA3078L	62.5 x 78 x 29	70	163	9.8	\$3101	\$666
BRTBAR2PA3072L	62.5 x 72 x 29	70	152	9.54	\$3039	\$605
BRTBAR2PA3066L	62.5 x 66 x 29	70	141	9.25	\$2935	\$542
BRTBAR2PA3060L	62.5 x 60 x 29	85	130	9	\$2792	\$500

Back-to-back 2 Person workstation consists of two worksurfaces, two back-to-back leg assemblies, and two supporting structural beams. Painted aluminum workstation door provides access to power/data trough below worksurface. Worksurface with access doors CANNOT be combined with above worksurface power trough.

- Anodized Aluminum Leg - Add **\$165**. list upcharge

BRTBAR2PDA2484L	50.5 x 84 x 29	70	146	9.4	\$3167	\$625
BRTBAR2PDA2478L	50.5 x 78 x 29	85	137	9.2	\$3078	\$560
BRTBAR2PDA2472L	50.5 x 72 x 29	85	128	9.02	\$3011	\$537
BRTBAR2PDA2466L	50.5 x 66 x 29	85	119	8.76	\$2902	\$471
BRTBAR2PDA2460L	50.5 x 60 x 29	85	110	8.56	\$2791	\$425
BRTBAR2PDA3084L	62.5 x 84 x 29	70	174	10.4	\$3455	\$759
BRTBAR2PDA3078L	62.5 x 78 x 29	70	163	9.8	\$3345	\$714
BRTBAR2PDA3072L	62.5 x 72 x 29	70	152	9.54	\$3280	\$647
BRTBAR2PDA3066L	62.5 x 66 x 29	70	141	9.25	\$3167	\$578
BRTBAR2PDA3060L	62.5 x 60 x 29	85	130	9	\$3011	\$537

Back-to-back 2 Person workstation consists of two worksurfaces, two back-to-back leg assemblies, and two supporting structural beams. These tables feature dual access doors providing a central connection point for monitor lifts. Painted aluminum workstation door provides access to power/data trough below worksurface. Worksurface with access doors CANNOT be combined with above worksurface power trough.

- Anodized Aluminum Leg - Add **\$165**. list upcharge

Required Specifications

Top finish	Edge finish
Metal finish (legs)	Beam finish
Access door finish*	

Optional Specifications

Anodized Aluminum Leg
HP laminate

RECTANGULAR LEG PACKAGES

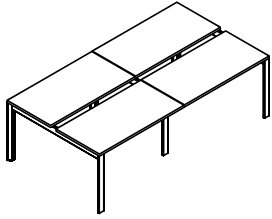

Back-to-Back 4 Person Pod with Levelers

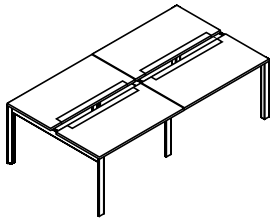

Back-to-Back 4 Person Pod with Access Door and Levelers*

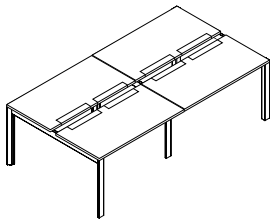

Back-to-Back 4 Person Pod with Access Door and Levelers*

MODEL#	DIMENSIONS D x W x H	FREIGHT CLASS	WT/LBS.	CUBIC FT.	LIST PRICE	HP ADD
BRTBAR4P2484L	50.5 x 168 x 29	70	272	15.66	\$4999	\$650
BRTBAR4P2478L	50.5 x 156 x 29	70	256	15.2	\$4800	\$616
BRTBAR4P2472L	50.5 x 144 x 29	70	240	14.74	\$4622	\$598
BRTBAR4P2466L	50.5 x 132 x 29	70	224	14.28	\$4504	\$567
BRTBAR4P2460L	50.5 x 120 x 29	70	208	13.82	\$4388	\$550
BRTBAR4P3084L	62.5 x 168 x 29	70	333	16.86	\$5206	\$698
BRTBAR4P3078L	62.5 x 156 x 29	70	313	16.32	\$4933	\$639
BRTBAR4P3072L	62.5 x 144 x 29	70	293	15.78	\$4767	\$625
BRTBAR4P3066L	62.5 x 132 x 29	70	273	15.24	\$4612	\$598
BRTBAR4P3060L	62.5 x 120 x 29	70	253	14.7	\$4504	\$567

Back-to-back 4 Person workstation consists of four worksurfaces, two back-to-back outer leg assemblies, 1 back-to-back narrow leg assembly, and four supporting structural beams.

- Anodized Aluminum Leg - Add **\$243** list upcharge

BRTBAR4PA2484L	50.5 x 168 x 29	70	272	15.66	\$5288	\$1162
BRTBAR4PA2478L	50.5 x 156 x 29	70	256	15.2	\$5123	\$1036
BRTBAR4PA2472L	50.5 x 144 x 29	70	240	14.74	\$4999	\$994
BRTBAR4PA2466L	50.5 x 132 x 29	70	224	14.28	\$4792	\$873
BRTBAR4PA2460L	50.5 x 120 x 29	70	208	13.82	\$4585	\$791
BRTBAR4PA3084L	62.5 x 168 x 29	70	333	16.86	\$5783	\$1406
BRTBAR4PA3078L	62.5 x 156 x 29	70	313	16.32	\$5577	\$1324
BRTBAR4PA3072L	62.5 x 144 x 29	70	293	15.78	\$5455	\$1203
BRTBAR4PA3066L	62.5 x 132 x 29	70	273	15.24	\$5247	\$1078
BRTBAR4PA3060L	62.5 x 120 x 29	70	253	14.7	\$4959	\$994

Back-to-back 4 Person workstation consists of four worksurfaces, two back-to-back outer leg assemblies, 1 back-to-back narrow leg assembly, and four supporting structural beams. Painted aluminum worksurface door provides access to power/data trough below worksurface. Worksurface with access doors CANNOT be combined with above worksurface power trough.

- Anodized Aluminum Leg - Add **\$243** list upcharge

BRTBAR4PDA2484L	50.5 x 168 x 29	70	272	15.66	\$5706	\$1248
BRTBAR4PDA2478L	50.5 x 156 x 29	70	256	15.2	\$5527	\$1112
BRTBAR4PDA2472L	50.5 x 144 x 29	70	240	14.74	\$5393	\$1071
BRTBAR4PDA2466L	50.5 x 132 x 29	70	224	14.28	\$5173	\$932
BRTBAR4PDA2460L	50.5 x 120 x 29	70	208	13.82	\$4946	\$846
BRTBAR4PDA3084L	62.5 x 168 x 29	70	333	16.86	\$6241	\$1511
BRTBAR4PDA3078L	62.5 x 156 x 29	70	313	16.32	\$6017	\$1424
BRTBAR4PDA3072L	62.5 x 144 x 29	70	293	15.78	\$5885	\$1289
BRTBAR4PDA3066L	62.5 x 132 x 29	70	273	15.24	\$5661	\$1158
BRTBAR4PDA3060L	62.5 x 120 x 29	70	253	14.7	\$5351	\$1067

Back-to-back 4 Person workstation consists of four worksurfaces, two back-to-back outer leg assemblies, 1 back-to-back narrow leg assembly, and four supporting structural beams. These tables feature dual access doors providing a central connection point for monitor lifts. Painted aluminum worksurface door provides access to power/data trough below worksurface. Worksurface with access doors CANNOT be combined with above worksurface power trough.

- Anodized Aluminum Leg - Add **\$243** list upcharge

Required Specifications

Top finish
Metal finish (legs)
Access door finish*

Edge finish
Beam finish

Optional Specifications

Anodized Aluminum Leg
HP laminate

RECTANGULAR LEG PACKAGES

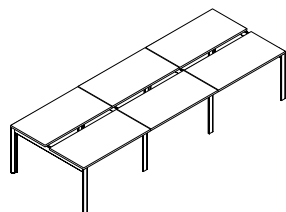

Back-to-Back 6 Person Pod with Levelers

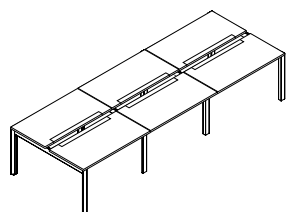

Back-to-Back 6 Person Pod with Access Door and Levelers*

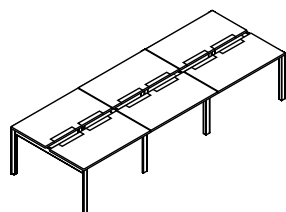

Back-to-Back 6 Person Pod with Access Door and Levelers*

MODEL# DIMENSIONS FREIGHT CLASS WT/LBS. CUBIC FT. LIST PRICE HP ADD

	D x W x H						
BRTBAR6P2484L	50.5 x 252 x 29	70	434	22.88	\$7208	\$970	
BRTBAR6P2478L	50.5 x 234 x 29	70	409	22.1	\$6909	\$922	
BRTBAR6P2472L	50.5 x 216 x 29	70	359	21.32	\$6639	\$898	
BRTBAR6P2466L	50.5 x 198 x 29	70	329	20.54	\$6465	\$847	
BRTBAR6P2460L	50.5 x 180 x 29	70	308	19.76	\$6251	\$821	
BRTBAR6P3084L	62.5 x 252 x 29	70	493	24.53	\$7498	\$1046	
BRTBAR6P3078L	62.5 x 234 x 29	70	462	23.75	\$7088	\$958	
BRTBAR6P3072L	62.5 x 216 x 29	70	431	22.86	\$6842	\$935	
BRTBAR6P3066L	62.5 x 198 x 29	70	400	21.97	\$6605	\$898	
BRTBAR6P3060L	62.5 x 180 x 29	70	369	21.08	\$6403	\$847	

Back-to-back 6 Person workstation consists of six worksurfaces, two back-to-back outer leg assemblies, two back-to-back narrow leg assemblies, and six supporting structural beams.

- Anodized Aluminum Leg - Add **\$325** list upcharge

BRTBAR6PA2484L	50.5 x 252 x 29	70	434	22.88	\$7643	\$1740	
BRTBAR6PA2478L	50.5 x 234 x 29	70	409	22.1	\$7396	\$1553	
BRTBAR6PA2472L	50.5 x 216 x 29	70	359	21.32	\$7208	\$1490	
BRTBAR6PA2466L	50.5 x 198 x 29	70	329	20.54	\$6899	\$1305	
BRTBAR6PA2460L	50.5 x 180 x 29	70	308	19.76	\$6548	\$1179	
BRTBAR6PA3084L	62.5 x 252 x 29	70	493	24.53	\$8365	\$2109	
BRTBAR6PA3078L	62.5 x 234 x 29	70	462	23.75	\$8055	\$1987	
BRTBAR6PA3072L	62.5 x 216 x 29	70	431	22.86	\$7869	\$1800	
BRTBAR6PA3066L	62.5 x 198 x 29	70	400	21.97	\$7560	\$1615	
BRTBAR6PA3060L	62.5 x 180 x 29	70	369	21.08	\$7085	\$1490	

Back-to-back 6 Person workstation consists of six worksurfaces, two back-to-back outer leg assemblies, two back-to-back narrow leg assemblies, and six supporting structural beams. Painted aluminum worksurface door provides access to power/data trough below worksurface. Worksurface with access doors CANNOT be combined with above worksurface power trough.

- Anodized Aluminum Leg - Add **\$325** list upcharge

BRTBAR6PDA2484L	50.5 x 252 x 29	70	434	22.88	\$8246	\$1862	
BRTBAR6PDA2478L	50.5 x 234 x 29	70	409	22.1	\$7978	\$1668	
BRTBAR6PDA2472L	50.5 x 216 x 29	70	359	21.32	\$7778	\$1603	
BRTBAR6PDA2466L	50.5 x 198 x 29	70	329	20.54	\$7443	\$1338	
BRTBAR6PDA2460L	50.5 x 180 x 29	70	308	19.76	\$7064	\$1269	
BRTBAR6PDA3084L	62.5 x 252 x 29	70	493	24.53	\$9026	\$2267	
BRTBAR6PDA3078L	62.5 x 234 x 29	70	462	23.75	\$8689	\$2132	
BRTBAR6PDA3072L	62.5 x 216 x 29	70	431	22.86	\$8490	\$1931	
BRTBAR6PDA3066L	62.5 x 198 x 29	70	400	21.97	\$8154	\$1731	
BRTBAR6PDA3060L	62.5 x 180 x 29	70	369	21.08	\$7645	\$1600	

Back-to-back 6 Person workstation consists of six worksurfaces, two back-to-back outer leg assemblies, two back-to-back narrow leg assemblies, and six supporting structural beams. These tables feature dual access doors providing a central connection point for monitor lifts. Painted aluminum worksurface door provides access to power/data trough below worksurface. Worksurface with access doors CANNOT be combined with above worksurface power trough.

- Anodized Aluminum Leg - Add **\$325** list upcharge

Required Specifications

Top finish	Edge finish
Metal finish (legs)	Beam finish
Access door finish*	

Optional Specifications

Anodized Aluminum Leg
HP laminate

RECTANGULAR LEG PACKAGES

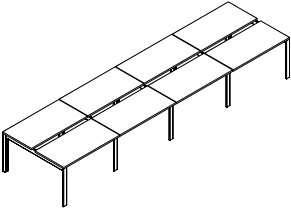

Back-to-Back 8 Person Pod with Levelers

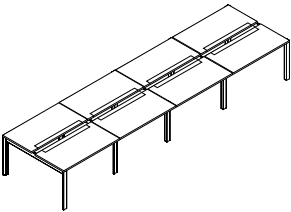

Back-to-Back 8 Person Pod with Access Door and Levelers*

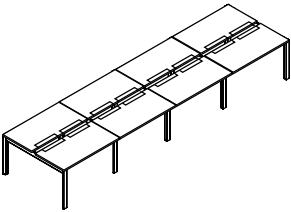

Back-to-Back 8 Person Pod with Access Door and Levelers*

MODEL#	DIMENSIONS D x W x H	FREIGHT CLASS	WT/LBS.	CUBIC FT.	LIST PRICE	HP ADD
BRTBAR8P2484L	50.5 x 336 x 29	70	556	28.30	\$9417	\$1294
BRTBAR8P2478L	50.5 x 312 x 29	70	520	27.30	\$9021	\$1226
BRTBAR8P2472L	50.5 x 288 x 29	70	484	26.30	\$8657	\$1193
BRTBAR8P2466L	50.5 x 264 x 29	70	448	25.30	\$8427	\$1127
BRTBAR8P2460L	50.5 x 240 x 29	70	412	24.42	\$8235	\$1094
BRTBAR8P3084L	62.5 x 336 x 29	70	669	30.58	\$9788	\$1394
BRTBAR8P3078L	62.5 x 312 x 29	70	625	29.48	\$9243	\$1275
BRTBAR8P3072L	62.5 x 288 x 29	70	581	28.38	\$8915	\$1242
BRTBAR8P3066L	62.5 x 264 x 29	70	536	27.28	\$8599	\$1193
BRTBAR8P3060L	62.5 x 240 x 29	70	492	26.18	\$8383	\$1127

Back-to-back 8 Person workstation consists of eight worksurfaces, two back-to-back outer leg assemblies, three back-to-back narrow leg assemblies, and eight supporting structural beams.

- Anodized Aluminum Leg - Add **\$407.** list upcharge

BRTBAR8PA2484L	50.5 x 336 x 29	70	556	28.30	\$9993	\$2316
BRTBAR8PA2478L	50.5 x 312 x 29	70	520	27.30	\$9663	\$2068
BRTBAR8PA2472L	50.5 x 288 x 29	70	484	26.30	\$9417	\$1987
BRTBAR8PA2466L	50.5 x 264 x 29	70	448	25.30	\$9003	\$1740
BRTBAR8PA2460L	50.5 x 240 x 29	70	412	24.42	\$8633	\$1572
BRTBAR8PA3084L	62.5 x 336 x 29	70	669	30.58	\$10946	\$2811
BRTBAR8PA3078L	62.5 x 312 x 29	70	625	29.48	\$10529	\$2646
BRTBAR8PA3072L	62.5 x 288 x 29	70	581	28.38	\$10283	\$2399
BRTBAR8PA3066L	62.5 x 264 x 29	70	536	27.28	\$9871	\$2151
BRTBAR8PA3060L	62.5 x 240 x 29	70	492	26.18	\$9293	\$1987

Back-to-back 8 Person workstation consists of eight worksurfaces, two back-to-back outer leg assemblies, three back-to-back narrow leg assemblies, and eight supporting structural beams. Painted aluminum worksurface door provides access to power/data trough below worksurface. Worksurface with access doors CANNOT be combined with above worksurface power trough.

- Anodized Aluminum Leg - Add **\$407.** list upcharge

BRTBAR8PDA2484L	50.5 x 336 x 29	70	556	28.30	\$10784	\$2488
BRTBAR8PDA2478L	50.5 x 312 x 29	70	520	27.30	\$10424	\$2222
BRTBAR8PDA2472L	50.5 x 288 x 29	70	484	26.30	\$10160	\$2136
BRTBAR8PDA2466L	50.5 x 264 x 29	70	448	25.30	\$9714	\$1869
BRTBAR8PDA2460L	50.5 x 240 x 29	70	412	24.42	\$9313	\$1691
BRTBAR8PDA3084L	62.5 x 336 x 29	70	669	30.58	\$11808	\$2808
BRTBAR8PDA3078L	62.5 x 312 x 29	70	625	29.48	\$11360	\$2845
BRTBAR8PDA3072L	62.5 x 288 x 29	70	581	28.38	\$11092	\$2580
BRTBAR8PDA3066L	62.5 x 264 x 29	70	536	27.28	\$10652	\$2307
BRTBAR8PDA3060L	62.5 x 240 x 29	70	492	26.18	\$10025	\$2136

Back-to-back 8 Person workstation consists of eight worksurfaces, two back-to-back outer leg assemblies, three back-to-back narrow leg assemblies, and eight supporting structural beams. These tables feature dual access doors providing a central connection point for monitor lifts. Painted aluminum worksurface door provides access to power/data trough below worksurface. Worksurface with access doors CANNOT be combined with above worksurface power trough.

- Anodized Aluminum Leg - Add **\$407.** list upcharge

Required Specifications

Top finish
Metal finish (legs)
Access door finish*

Edge finish
Beam finish

Optional Specifications

Anodized Aluminum Leg
HP laminate

RECTANGULAR LEG PACKAGES

MODEL# DIMENSIONS FREIGHT CLASS WT./LBS. CUBIC FT. LIST PRICE HP ADD

D x W x H

BRT36P2484C	24 x 84 x 36	70	120.68	6.42	\$3543	\$196
BRT36P2478C	24 x 78 x 36	70	114.16	6.13	\$3454	\$183
BRT36P2472C	24 x 72 x 36	70	107.64	5.83	\$3366	\$175
BRT36P2466C	24 x 66 x 36	70	101.12	5.62	\$3300	\$171
BRT36P2460C	24 x 60 x 36	70	94.60	5.41	\$3229	\$162
BRT36P2454C	24 x 54 x 36	70	88.08	5.19	\$3127	\$141
BRT36P2448C	24 x 48 x 36	70	81.56	4.98	\$2970	\$128
BRT36P2442C	24 x 42 x 36	70	76.04	4.76	\$2865	\$109
BRT36P2436C	24 x 36 x 36	70	68.52	4.55	\$2777	\$88

BRT36P3084C	30 x 84 x 36	70	148.11	7.32	\$4049	\$210
BRT36P3078C	30 x 78 x 36	70	139.96	6.95	\$3935	\$190
BRT36P3072C	30 x 72 x 36	70	131.81	6.59	\$3837	\$183
BRT36P3066C	30 x 66 x 36	70	123.66	6.32	\$3743	\$183
BRT36P3060C	30 x 60 x 36	70	115.51	6.06	\$3666	\$171
BRT36P3054C	30 x 54 x 36	70	107.36	5.79	\$3569	\$141
BRT36P3048C	30 x 48 x 36	70	99.21	5.53	\$3415	\$141
BRT36P3042C	30 x 42 x 36	70	91.06	5.26	\$3338	\$134
BRT36P3036C	30 x 36 x 36	70	83.91	5	\$3197	\$100

BRT36P3684C	36 x 84 x 36	70	161.97	8.91	\$4533	\$238
BRT36P3678C	36 x 78 x 36	70	152.82	8.50	\$4419	\$225
BRT36P3672C	36 x 72 x 36	70	144.67	8.10	\$4291	\$210
BRT36P3666C	36 x 66 x 36	70	135.52	7.79	\$4174	\$196
BRT36P3660C	36 x 60 x 36	70	126.37	7.48	\$4045	\$175
BRT36P3654C	36 x 54 x 36	70	118.22	7.18	\$3917	\$162
BRT36P3648C	36 x 48 x 36	70	109.07	6.87	\$3741	\$141
BRT36P3642C	36 x 42 x 36	70	99.92	6.56	\$3620	\$128

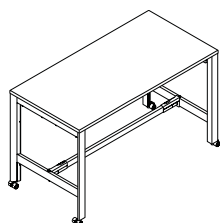

36"H Single Table with Casters

Single table assembly consists of one worksurface, two H leg assemblies, horizontal structural beams, and one bottom table beam. 40mm dia. locking casters with 8mm thread, white body and grey tires.

- 24"D tables include 3 horizontal structural beams. 30"/36"D tables include 4 horizontal structural beams.
- Anodized Aluminum Leg - Add **\$165**. list upcharge

BRT36P2484L	24 x 84 x 36	70	120.20	6.42	\$3426	\$196
BRT36P2478L	24 x 78 x 36	70	113.68	6.13	\$3341	\$183
BRT36P2472L	24 x 72 x 36	70	107.16	5.83	\$3249	\$175
BRT36P2466L	24 x 66 x 36	70	100.64	5.62	\$3186	\$171
BRT36P2460L	24 x 60 x 36	70	94.12	5.41	\$3111	\$162
BRT36P2454L	24 x 54 x 36	70	87.60	5.19	\$3010	\$141
BRT36P2448L	24 x 48 x 36	70	81.08	4.98	\$2853	\$128
BRT36P2442L	24 x 42 x 36	70	75.56	4.76	\$2749	\$109
BRT36P2436L	24 x 36 x 36	85	68.04	4.55	\$2660	\$88

BRT36P3084L	30 x 84 x 36	70	147.63	7.32	\$3931	\$210
BRT36P3078L	30 x 78 x 36	70	139.48	6.96	\$3820	\$190
BRT36P3072L	30 x 72 x 36	70	131.33	6.59	\$3721	\$183
BRT36P3066L	30 x 66 x 36	70	123.18	6.32	\$3629	\$183
BRT36P3060L	30 x 60 x 36	70	115.03	6.06	\$3549	\$171
BRT36P3054L	30 x 54 x 36	70	106.88	5.79	\$3451	\$141
BRT36P3048L	30 x 48 x 36	70	98.73	5.53	\$3300	\$141
BRT36P3042L	30 x 42 x 36	70	90.58	5.26	\$3221	\$134
BRT36P3036L	30 x 36 x 36	70	83.43	5	\$3082	\$100

BRT36P3684L	36 x 84 x 36	70	161.49	8.91	\$4420	\$238
BRT36P3678L	36 x 78 x 36	70	152.34	8.50	\$4302	\$225
BRT36P3672L	36 x 72 x 36	70	144.19	8.10	\$4177	\$210
BRT36P3666L	36 x 66 x 36	70	135.04	7.79	\$4056	\$196
BRT36P3660L	36 x 60 x 36	70	125.89	7.48	\$3930	\$175
BRT36P3654L	36 x 54 x 36	70	117.74	7.18	\$3798	\$162
BRT36P3648L	36 x 48 x 36	70	108.59	6.87	\$3628	\$141
BRT36P3642L	36 x 42 x 36	70	99.44	6.56	\$3505	\$128

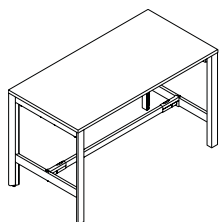

36"H Single Table with Levelers

Single table assembly consists of one worksurface, two H leg assemblies, horizontal structural beams, and one bottom table beam.

- 24"D tables include 3 horizontal structural beams. 30"/36"D tables include 4 horizontal structural beams.
- Anodized Aluminum Leg - Add **\$165**. list upcharge

Required Specifications

Top finish
Edge finish
Metal finish (legs)

Optional Specifications

Anodized Aluminum Leg
HP laminate

RECTANGULAR LEG PACKAGES

MODEL#	DIMENSIONS	FREIGHT CLASS	WT/LBS.	CUBIC FT.	LIST PRICE	HP ADD
--------	------------	---------------	---------	-----------	------------	--------

D x W x H

BRT36A2484L	24 x 84 x 36	70	106.36	4.74	\$2769	\$196
BRT36A2478L	24 x 78 x 36	70	99.84	4.45	\$2687	\$183
BRT36A2472L	24 x 72 x 36	70	93.32	4.15	\$2596	\$175
BRT36A2466L	24 x 66 x 36	70	86.80	3.94	\$2533	\$171
BRT36A2460L	24 x 60 x 36	70	80.28	3.73	\$2457	\$162
BRT36A2454L	24 x 54 x 36	70	73.76	3.51	\$2355	\$141
BRT36A2448L	24 x 48 x 36	70	67.24	3.30	\$2200	\$128
BRT36A2442L	24 x 42 x 36	70	61.72	3.08	\$2096	\$109
BRT36A2436L	24 x 36 x 36	70	54.20	2.87	\$2007	\$88
BRT36A3084L	30 x 84 x 36	65	131.77	5.56	\$3238	\$210
BRT36A3078L	30 x 78 x 36	65	123.62	5.19	\$3124	\$190
BRT36A3072L	30 x 72 x 36	65	115.47	4.83	\$3026	\$183
BRT36A3066L	30 x 66 x 36	65	107.32	4.56	\$2934	\$183
BRT36A3060L	30 x 60 x 36	65	99.17	4.30	\$2853	\$171
BRT36A3054L	30 x 54 x 36	65	91.02	4.03	\$2757	\$141
BRT36A3048L	30 x 48 x 36	70	82.87	3.77	\$2604	\$141
BRT36A3042L	30 x 42 x 36	70	74.72	3.50	\$2525	\$134
BRT36A3036L	30 x 36 x 36	70	67.57	3.24	\$2386	\$100
BRT36A3684L	36 x 84 x 36	70	143.70	6.65	\$3627	\$238
BRT36A3678L	36 x 78 x 36	70	134.55	6.24	\$3508	\$225
BRT36A3672L	36 x 72 x 36	70	126.40	5.84	\$3382	\$210
BRT36A3666L	36 x 66 x 36	70	117.25	5.53	\$3263	\$196
BRT36A3660L	36 x 60 x 36	70	108.10	5.22	\$3136	\$175
BRT36A3654L	36 x 54 x 36	70	99.95	4.92	\$3005	\$162
BRT36A3648L	36 x 48 x 36	70	90.80	4.61	\$2831	\$141
BRT36A3642L	36 x 42 x 36	70	81.65	4.30	\$2711	\$128

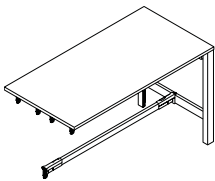

36" H Add-On with Levelers

Single table assembly consists of one worksurface, one H leg assembly, horizontal structural beams, and one bottom table beam.

- 24"D tables include 3 horizontal structural beams. 30"/36" D tables include 4 horizontal structural beams.
- Anodized Aluminum Leg - Add **\$83**. list upcharge

BRT42P2484C	24 x 84 x 42	70	122.58	6.98	\$3604	\$196
BRT42P2478C	24 x 78 x 42	70	116.06	6.69	\$3521	\$183
BRT42P2472C	24 x 72 x 42	70	109.54	6.39	\$3430	\$175
BRT42P2466C	24 x 66 x 42	70	103.02	6.18	\$3366	\$171
BRT42P2460C	24 x 60 x 42	70	96.50	5.97	\$3291	\$162
BRT42P2454C	24 x 54 x 42	70	89.98	5.75	\$3191	\$141
BRT42P2448C	24 x 48 x 42	70	83.46	5.54	\$3034	\$128
BRT42P2442C	24 x 42 x 42	85	77.94	5.32	\$2931	\$109
BRT42P2436C	24 x 36 x 42	85	70.42	5.11	\$2842	\$88
BRT42P3084C	30 x 84 x 42	70	150.01	7.92	\$4112	\$210
BRT42P3078C	30 x 78 x 42	70	141.86	7.55	\$4000	\$190
BRT42P3072C	30 x 72 x 42	70	133.71	7.19	\$3901	\$183
BRT42P3066C	30 x 66 x 42	70	125.56	6.92	\$3808	\$183
BRT42P3060C	30 x 60 x 42	70	117.41	6.66	\$3731	\$171
BRT42P3054C	30 x 54 x 42	70	109.26	6.39	\$3631	\$141
BRT42P3048C	30 x 48 x 42	70	101.11	6.13	\$3482	\$141
BRT42P3042C	30 x 42 x 42	70	92.96	5.86	\$3402	\$134
BRT42P3036C	30 x 36 x 42	70	85.81	5.60	\$3263	\$100
BRT42P3684C	36 x 84 x 42	70	163.87	9.69	\$4599	\$238
BRT42P3678C	36 x 78 x 42	70	154.72	9.28	\$4482	\$225
BRT42P3672C	36 x 72 x 42	70	146.57	8.88	\$4356	\$210
BRT42P3666C	36 x 66 x 42	70	137.42	8.57	\$4236	\$196
BRT42P3660C	36 x 60 x 42	70	128.27	8.26	\$4110	\$175
BRT42P3654C	36 x 54 x 42	70	120.12	7.96	\$3980	\$162
BRT42P3648C	36 x 48 x 42	85	110.97	7.65	\$3806	\$141
BRT42P3642C	36 x 42 x 42	85	101.82	7.34	\$3684	\$128

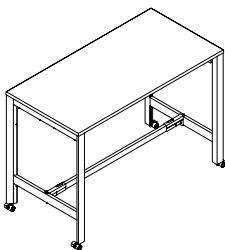

42" H Pod with Casters

Single table assembly consists of one worksurface, two H leg assemblies, horizontal structural beams and one bottom table beam. 40mm dia. locking casters with 8mm thread, white body and grey tires.

- 24"D tables include 3 horizontal structural beams. 30"/36" D tables include 4 horizontal structural beams.
- Anodized Aluminum Leg - Add **\$165**. list upcharge

Required Specifications

- Top finish
- Edge finish
- Metal finish (legs)

Optional Specifications

- Anodized Aluminum Leg
- HP laminate

RECTANGULAR LEG PACKAGES

MODEL# DIMENSIONS FREIGHT CLASS WT./LBS. CUBIC FT. LIST PRICE HP ADD

D x W x H

BRT42P2484L	24 x 84 x 42	70	122.10	6.98	\$3491	\$196
BRT42P2478L	24 x 78 x 42	70	115.58	6.69	\$3405	\$183
BRT42P2472L	24 x 72 x 42	70	109.06	6.39	\$3315	\$175
BRT42P2466L	24 x 66 x 42	70	102.54	6.18	\$3249	\$171
BRT42P2460L	24 x 60 x 42	70	96.02	5.97	\$3178	\$162
BRT42P2454L	24 x 54 x 42	70	89.50	5.75	\$3075	\$141
BRT42P2448L	24 x 48 x 42	85	82.98	5.54	\$2918	\$128
BRT42P2442L	24 x 42 x 42	85	77.46	5.32	\$2814	\$109
BRT42P2436L	24 x 36 x 42	85	69.94	5.11	\$2726	\$88

BRT42P3084L	30 x 84 x 42	70	149.53	7.92	\$4001	\$210
BRT42P3078L	30 x 78 x 42	70	141.38	7.55	\$3887	\$190
BRT42P3072L	30 x 72 x 42	70	133.23	7.19	\$3789	\$183
BRT42P3066L	30 x 66 x 42	70	125.08	6.92	\$3696	\$183
BRT42P3060L	30 x 60 x 42	70	116.93	6.66	\$3617	\$171
BRT42P3054L	30 x 54 x 42	70	108.78	6.39	\$3519	\$141
BRT42P3048L	30 x 48 x 42	70	100.63	6.13	\$3369	\$141
BRT42P3042L	30 x 42 x 42	70	92.48	5.86	\$3289	\$134
BRT42P3036L	30 x 36 x 42	70	85.33	5.60	\$3151	\$100

BRT42P3684L	36 x 84 x 42	70	163.39	9.69	\$4485	\$238
BRT42P3678L	36 x 78 x 42	70	154.24	9.28	\$4367	\$225
BRT42P3672L	36 x 72 x 42	70	146.09	8.88	\$4240	\$210
BRT42P3666L	36 x 66 x 42	70	136.94	8.57	\$4123	\$196
BRT42P3660L	36 x 60 x 42	70	127.79	8.26	\$3994	\$175
BRT42P3654L	36 x 54 x 42	70	119.64	7.96	\$3864	\$162
BRT42P3648L	36 x 48 x 42	85	110.49	7.65	\$3690	\$141
BRT42P3642L	36 x 42 x 42	85	101.34	7.34	\$3571	\$128

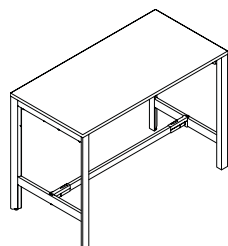

42" H Pod with Levelers

Single table assembly consists of one worksurface, two H leg assemblies, horizontal structural beams and one bottom table beam.

- 24"D tables include 3 horizontal structural beams. 30"/36"D tables include 4 horizontal structural beams.
- Anodized Aluminum Leg - Add **\$165**. list upcharge

BRT42A2484L	24 x 84 x 42	70	107.31	5.02	\$2803	\$196
BRT42A2478L	24 x 78 x 42	70	100.79	4.73	\$2717	\$183
BRT42A2472L	24 x 72 x 42	70	94.27	4.43	\$2631	\$175
BRT42A2466L	24 x 66 x 42	70	87.75	4.22	\$2563	\$171
BRT42A2460L	24 x 60 x 42	70	81.23	4.01	\$2492	\$162
BRT42A2454L	24 x 54 x 42	70	74.71	3.79	\$2389	\$141
BRT42A2448L	24 x 48 x 42	70	68.19	3.58	\$2234	\$128
BRT42A2442L	24 x 42 x 42	70	62.67	3.36	\$2035	\$109
BRT42A2436L	24 x 36 x 42	70	55.15	3.15	\$1952	\$88

BRT42A3084L	30 x 84 x 42	65	132.72	5.86	\$3271	\$210
BRT42A3078L	30 x 78 x 42	65	124.57	5.49	\$3157	\$190
BRT42A3072L	30 x 72 x 42	65	116.42	5.13	\$3057	\$183
BRT42A3066L	30 x 66 x 42	70	108.27	4.86	\$2967	\$183
BRT42A3060L	30 x 60 x 42	70	100.12	4.60	\$2889	\$171
BRT42A3054L	30 x 54 x 42	70	91.97	4.33	\$2791	\$141
BRT42A3048L	30 x 48 x 42	70	83.82	4.07	\$2639	\$141
BRT42A3042L	30 x 42 x 42	70	75.67	3.80	\$2560	\$134
BRT42A3036L	30 x 36 x 42	70	68.52	3.54	\$2419	\$100

BRT42A3684L	36 x 84 x 42	70	114.65	7.04	\$3656	\$238
BRT42A3678L	36 x 78 x 42	70	135.50	6.63	\$3543	\$225
BRT42A3672L	36 x 72 x 42	70	127.35	6.23	\$3414	\$210
BRT42A3666L	36 x 66 x 42	70	118.20	5.92	\$3297	\$196
BRT42A3660L	36 x 60 x 42	70	109.05	5.61	\$3167	\$175
BRT42A3654L	36 x 54 x 42	70	100.90	5.31	\$3038	\$162
BRT42A3648L	36 x 48 x 42	70	91.75	5	\$2864	\$141
BRT42A3642L	36 x 42 x 42	70	82.60	4.69	\$2742	\$128

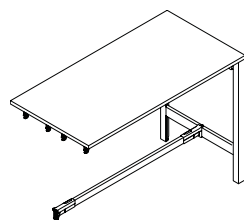

42" H Add-On with Levelers

Single table assembly consists of one worksurface, one H leg assembly, horizontal structural beams, and one bottom table beam.

- 24"D tables include 3 horizontal structural beams. 30"/36"D tables include 4 horizontal structural beams.
- Anodized Aluminum Leg - Add **\$83**. list upcharge

Required Specifications

Top finish
Edge finish
Metal finish (legs)

Optional Specifications

Anodized Aluminum Leg
HP laminate

ROUND LEG PACKAGES

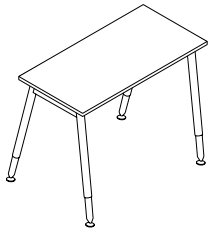

**Single Line 1 Person Pod with Levelers
Round Leg**

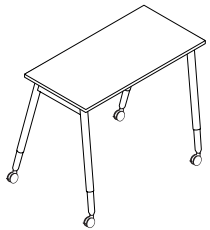

**Single Line 1 Person Pod with Casters
Round Leg**

MODEL#	DIMENSIONS D x W x H	FREIGHT CLASS	WT/LBS.	CUBIC FT.	LIST PRICE	HP ADD
BRTS1P2484LR	24 x 84 x 29	70	75	4.92	\$1739	\$165
BRTS1P2478LR	24 x 78 x 29	85	72	4.82	\$1687	\$158
BRTS1P2472LR	24 x 72 x 29	85	69	4.73	\$1644	\$155
BRTS1P2466LR	24 x 66 x 29	85	66	4.65	\$1613	\$145
BRTS1P2463LR	24 x 62.5 x 29	85	63	4.57	\$1600	\$141
BRTS1P2460LR	24 x 60 x 29	85	60	4.48	\$1584	\$140
BRTS1P2454LR	24 x 54 x 29	85	57	4.40	\$1552	\$101
BRTS1P2451LR	24 x 50.5 x 29	85	54	4.30	\$1490	\$94
BRTS1P2448LR	24 x 48 x 29	85	51	4.20	\$1453	\$111
BRTS1P2442LR	24 x 42 x 29	92.5	48	4.10	\$1392	\$70
BRTS1P2436LR	24 x 36 x 29	92.5	45	4	\$1346	\$49

BRTS1P3084LR	30 x 84 x 29	70	75	4.92	\$1777	\$176
BRTS1P3078LR	30 x 78 x 29	85	72	4.82	\$1711	\$163
BRTS1P3072LR	30 x 72 x 29	85	69	4.73	\$1668	\$138
BRTS1P3066LR	30 x 66 x 29	85	66	4.65	\$1631	\$155
BRTS1P3063LR	30 x 62.5 x 29	85	63	4.57	\$1619	\$150
BRTS1P3060LR	30 x 60 x 29	85	60	4.48	\$1603	\$123
BRTS1P3054LR	30 x 54 x 29	85	57	4.40	\$1564	\$122
BRTS1P3051LR	30 x 50.5 x 29	85	54	4.30	\$1537	\$127
BRTS1P3048LR	30 x 48 x 29	85	51	4.20	\$1488	\$122
BRTS1P3042LR	30 x 42 x 29	92.5	48	4.10	\$1458	\$120
BRTS1P3036LR	30 x 36 x 29	92.5	45	4	\$1305	\$87

Single Line Table Assemblies consist of one worksurface, two leg assemblies, and one supporting structural beam.

BRTS1P2484CR	24 x 84 x 29	70	75	4.92	\$1835	\$165
BRTS1P2478CR	24 x 78 x 29	85	72	4.82	\$1788	\$158
BRTS1P2472CR	24 x 72 x 29	85	69	4.73	\$1742	\$155
BRTS1P2466CR	24 x 66 x 29	85	66	4.65	\$1714	\$145
BRTS1P2463CR	24 x 62.5 x 29	85	63	4.57	\$1701	\$141
BRTS1P2460CR	24 x 60 x 29	85	60	4.48	\$1684	\$140
BRTS1P2454CR	24 x 54 x 29	85	57	4.40	\$1649	\$101
BRTS1P2451CR	24 x 50.5 x 29	85	54	4.30	\$1591	\$94
BRTS1P2448CR	24 x 48 x 29	85	51	4.20	\$1552	\$111
BRTS1P2442CR	24 x 42 x 29	92.5	48	4.10	\$1488	\$70
BRTS1P2436CR	24 x 36 x 29	92.5	45	4	\$1446	\$49

BRTS1P3084CR	30 x 84 x 29	70	75	4.92	\$1877	\$176
BRTS1P3078CR	30 x 78 x 29	85	72	4.82	\$1809	\$163
BRTS1P3072CR	30 x 72 x 29	85	69	4.73	\$1772	\$136
BRTS1P3066CR	30 x 66 x 29	85	66	4.65	\$1728	\$155
BRTS1P3063CR	30 x 62.5 x 29	85	63	4.57	\$1716	\$150
BRTS1P3060CR	30 x 60 x 29	85	60	4.48	\$1701	\$123
BRTS1P3054CR	30 x 54 x 29	85	57	4.40	\$1663	\$122
BRTS1P3051CR	30 x 50.5 x 29	85	54	4.30	\$1634	\$127
BRTS1P3048CR	30 x 48 x 29	85	51	4.20	\$1589	\$122
BRTS1P3042CR	30 x 42 x 29	92.5	48	4.10	\$1556	\$120
BRTS1P3036CR	30 x 36 x 29	92.5	45	4	\$1404	\$87

Single Line Table Assemblies consist of one worksurface, two leg assemblies, and one supporting structural beam. 40mm locking casters with grey tires; steel horizontal beams, aluminum legs.

Required Specifications

Top finish
Edge finish
Metal finish (legs)
Beam finish

Optional Specifications

Anodized Aluminum Leg
HP laminate

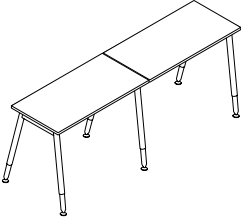
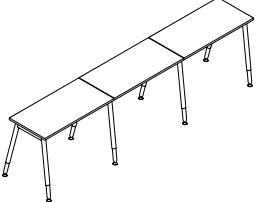
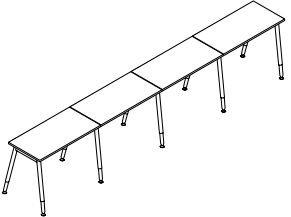
ROUND LEG PACKAGES	MODEL#	DIMENSIONS	FREIGHT CLASS	WT./LBS.	CUBIC FT.	LIST PRICE	HP ADD	
 <p>Single Line 2 Person Pod with Levelers Round Leg</p>		D x W x H						
	BRTS2P2484LR	24 x 168 x 29	70	149	7.41	\$3049	\$310	
	BRTS2P2478LR	24 x 156 x 29	70	140	7.27	\$2931	\$310	
	BRTS2P2472LR	24 x 144 x 29	70	131	7.13	\$2841	\$302	
	BRTS2P2466LR	24 x 132 x 29	70	122	6.95	\$2792	\$277	
	BRTS2P2460LR	24 x 120 x 29	70	113	6.71	\$2726	\$277	
	BRTS2P2454LR	24 x 108 x 29	70	104	6.45	\$2617	\$241	
	BRTS2P2448LR	24 x 96 x 29	70	95	6.21	\$2460	\$217	
	BRTS2P3084LR	30 x 168 x 29	70	173	8.25	\$3112	\$351	
	BRTS2P3078LR	30 x 156 x 29	70	164	7.97	\$2976	\$323	
	BRTS2P3072LR	30 x 144 x 29	70	155	7.69	\$2893	\$314	
	BRTS2P3066LR	30 x 132 x 29	70	140	7.41	\$2815	\$302	
	BRTS2P3060LR	30 x 120 x 29	70	131	7.13	\$2763	\$285	
	BRTS2P3054LR	30 x 108 x 29	70	122	6.85	\$2685	\$241	
	BRTS2P3048LR	30 x 96 x 29	70	113	6.57	\$2578	\$241	
	Single Line 2 Person workstation consists of two worksurfaces, three leg assemblies, and two supporting structural beams. One leg can be shared by 2 adjoining worksurfaces.							
	 <p>Single Line 3 Person Pod with Levelers Round Leg</p>	BRTS3P2484LR	24 x 252 x 29	70	219	9.74	\$4325	\$487
		BRTS3P2478LR	24 x 234 x 29	70	206	9.53	\$4176	\$463
BRTS3P2472LR		24 x 216 x 29	70	192	9.32	\$4040	\$451	
BRTS3P2466LR		24 x 198 x 29	70	179	9.11	\$3954	\$428	
BRTS3P2460LR		24 x 180 x 29	70	165	8.89	\$3866	\$414	
BRTS3P2454LR		24 x 162 x 29	70	152	8.68	\$3706	\$357	
BRTS3P2448LR		24 x 144 x 29	70	138	8.47	\$3471	\$321	
BRTS3P3084LR		30 x 263 x 29	65	263	11.59	\$4448	\$524	
BRTS3P3078LR		30 x 234 x 29	70	246	11.16	\$4243	\$484	
BRTS3P3072LR		30 x 216 x 29	70	229	10.72	\$4121	\$471	
BRTS3P3066LR		30 x 198 x 29	70	212	10.30	\$4003	\$451	
BRTS3P3060LR		30 x 180 x 29	70	195	9.87	\$3922	\$428	
BRTS3P3054LR		30 x 162 x 29	70	178	9.44	\$3805	\$357	
BRTS3P3048LR		30 x 144 x 29	70	161	9.01	\$3643	\$357	
Single Line 3 Person workstation consists of three worksurfaces, four leg assemblies, and three supporting structural beams. One leg can be shared by 2 adjoining worksurfaces.								
 <p>Single Line 4 Person Pod with Levelers Round Leg</p>		BRTS4P2484LR	24 x 336 x 29	70	291	13.67	\$5619	\$650
		BRTS4P2478LR	24 x 312 x 29	70	273	13.18	\$5420	\$616
		BRTS4P2472LR	24 x 288 x 29	70	254	12.69	\$5240	\$598
	BRTS4P2466LR	24 x 264 x 29	70	236	12.20	\$5123	\$567	
	BRTS4P2460LR	24 x 240 x 29	70	217	11.71	\$4991	\$567	
	BRTS4P2454LR	24 x 216 x 29	70	199	11.22	\$4792	\$475	
	BRTS4P2448LR	24 x 192 x 29	70	180	10.73	\$4429	\$475	
	BRTS4P3084LR	30 x 336 x 29	65	345	14.87	\$5783	\$698	
	BRTS4P3078LR	30 x 312 x 29	65	323	14.30	\$5513	\$639	
	BRTS4P3072LR	30 x 288 x 29	70	301	13.73	\$5347	\$625	
	BRTS4P3066LR	30 x 264 x 29	70	279	13.16	\$5188	\$598	
	BRTS4P3060LR	30 x 240 x 29	70	257	12.59	\$5081	\$567	
	BRTS4P3054LR	30 x 216 x 29	70	235	12.02	\$4925	\$475	
	BRTS4P3048LR	30 x 192 x 29	70	213	11.45	\$4710	\$475	
	Single Line 4 Person workstation consists of four worksurfaces, five leg assemblies, and four supporting structural beams. One leg can be shared by 2 adjoining worksurfaces.							

Required Specifications

Top finish
Edge finish
Metal finish (legs)
Beam finish

Optional Specifications

Anodized Aluminum Leg
HP laminate

ROUND LEG PACKAGES

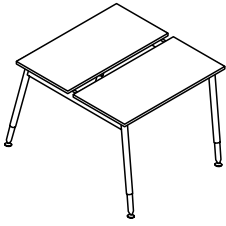

Back-to-Back 2 Person Pod with Levelers Round Leg

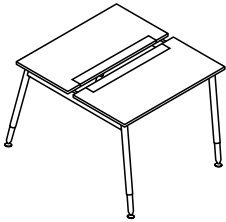

Back-to-Back 2 Person Pod with Access Door and Levelers, Round Leg*

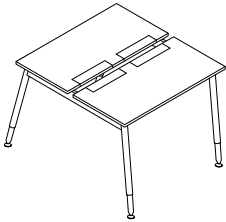

Back-to-Back 2 Person Pod with Access Door and Levelers, Round Leg*

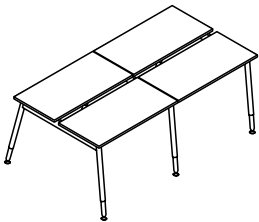

Back-to-Back 4 Person Pod with Levelers Round Leg

MODEL#	DIMENSIONS D x W x H	FREIGHT CLASS	WT./LBS.	CUBIC FT.	LIST PRICE	HP ADD
BRTBAR2P2484LR	50.5 x 84 x 29	70	146	9.40	\$2836	\$326
BRTBAR2P2478LR	50.5 x 78 x 29	85	137	9.20	\$2759	\$310
BRTBAR2P2472LR	50.5 x 72 x 29	85	128	9.02	\$2667	\$302
BRTBAR2P2466LR	50.5 x 66 x 29	85	119	8.76	\$2608	\$285
BRTBAR2P2460LR	50.5 x 60 x 29	85	110	8.56	\$2552	\$277
BRTBAR2P3084LR	62.5 x 84 x 29	70	174	10.40	\$2941	\$351
BRTBAR2P3078LR	62.5 x 78 x 29	70	163	9.80	\$2805	\$323
BRTBAR2P3072LR	62.5 x 72 x 29	70	152	9.54	\$2721	\$302
BRTBAR2P3066LR	62.5 x 66 x 29	70	141	9.25	\$2643	\$302
BRTBAR2P3060LR	62.5 x 60 x 29	85	130	9	\$2373	\$500

Back-to-back 2 Person workstation consists of two worksurfaces, two back-to-back leg assemblies, and two supporting structural beams.

BRTBAR2PA2484LR	50.5 x 84 x 29	70	146	9.40	\$2981	\$583
BRTBAR2PA2478LR	50.5 x 78 x 29	85	137	9.20	\$2918	\$521
BRTBAR2PA2472LR	50.5 x 72 x 29	85	128	9.02	\$2856	\$500
BRTBAR2PA2466LR	50.5 x 66 x 29	85	119	8.76	\$2752	\$438
BRTBAR2PA2460LR	50.5 x 60 x 29	85	110	8.56	\$2650	\$397
BRTBAR2PA3084LR	62.5 x 84 x 29	70	174	10.40	\$3230	\$708
BRTBAR2PA3078LR	62.5 x 78 x 29	70	163	9.80	\$3127	\$666
BRTBAR2PA3072LR	62.5 x 72 x 29	70	152	9.54	\$3061	\$605
BRTBAR2PA3066LR	62.5 x 66 x 29	70	141	9.25	\$2959	\$542
BRTBAR2PA3060LR	62.5 x 60 x 29	85	130	9	\$2815	\$500

Back-to-back 2 Person workstation consists of two worksurfaces, two back-to-back leg assemblies, and two supporting structural beams. Painted aluminum worksurface door provides access to power/data trough below worksurface. Worksurface with access doors CANNOT be combined with above worksurface power trough.

BRTBAR2PDA2484LR	50.5 x 84 x 29	70	146	9.40	\$3216	\$627
BRTBAR2PDA2478LR	50.5 x 78 x 29	85	137	9.20	\$3151	\$559
BRTBAR2PDA2472LR	50.5 x 72 x 29	85	128	9.02	\$3080	\$537
BRTBAR2PDA2466LR	50.5 x 66 x 29	85	119	8.76	\$2972	\$469
BRTBAR2PDA2460LR	50.5 x 60 x 29	85	110	8.56	\$2862	\$429
BRTBAR2PDA3084LR	62.5 x 84 x 29	70	174	10.40	\$3483	\$759
BRTBAR2PDA3078LR	62.5 x 78 x 29	70	163	9.80	\$3372	\$714
BRTBAR2PDA3072LR	62.5 x 72 x 29	70	152	9.54	\$3302	\$651
BRTBAR2PDA3066LR	62.5 x 66 x 29	70	141	9.25	\$3193	\$582
BRTBAR2PDA3060LR	62.5 x 60 x 29	85	130	9	\$3037	\$538

Back-to-back 2 Person workstation consists of two worksurfaces, two back-to-back leg assemblies, and two supporting structural beams. These tables feature dual access doors providing a central connection point for monitor lifts. Painted aluminum worksurface door provides access to power/data trough below worksurface. Worksurface with access doors CANNOT be combined with above worksurface power trough.

BRTBAR4P2484LR	50.5 x 168 x 29	70	272	15.66	\$5140	\$650
BRTBAR4P2478LR	50.5 x 156 x 29	70	256	15.20	\$4941	\$616
BRTBAR4P2472LR	50.5 x 144 x 29	70	240	14.74	\$4760	\$598
BRTBAR4P2466LR	50.5 x 132 x 29	70	224	14.28	\$4645	\$567
BRTBAR4P2460LR	50.5 x 120 x 29	70	208	13.82	\$4529	\$550
BRTBAR4P3084LR	62.5 x 168 x 29	70	333	16.86	\$5306	\$698
BRTBAR4P3078LR	62.5 x 156 x 29	70	313	16.32	\$5033	\$639
BRTBAR4P3072LR	62.5 x 144 x 29	70	293	15.78	\$4869	\$625
BRTBAR4P3066LR	62.5 x 132 x 29	70	273	15.24	\$4669	\$598
BRTBAR4P3060LR	62.5 x 120 x 29	70	253	14.70	\$4645	\$567

Back-to-back 4 Person workstation consists of four worksurfaces, three back-to-back outer leg assemblies, and four supporting structural beams.

Required Specifications

Top finish	Edge finish
Metal finish (legs)	Beam finish
Access door finish*	

Optional Specifications

Anodized Aluminum Leg
HP laminate

ROUND LEG PACKAGES

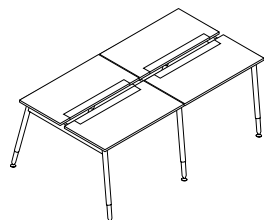

Back-to-Back 4 Person Pod with Access Door and Levelers, Round Leg*

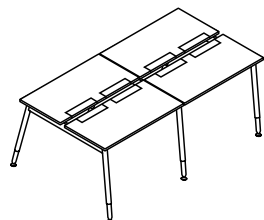

Back-to-Back 4 Person Pod with Access Door and Levelers, Round Leg*

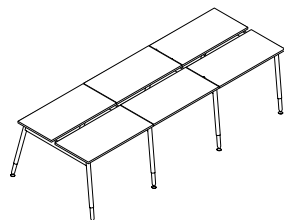

Back-to-Back 6 Person Pod with Levelers Round Leg

MODEL#	DIMENSIONS D x W x H	FREIGHT CLASS	WT/LBS.	CUBIC FT.	LIST PRICE	HP ADD
BRTBAR4PA2484LR	50.5 x 168 x 29	70	272	15.66	\$5288	\$1162
BRTBAR4PA2478LR	50.5 x 156 x 29	70	256	15.20	\$5123	\$1036
BRTBAR4PA2472LR	50.5 x 144 x 29	70	240	14.74	\$4999	\$994
BRTBAR4PA2466LR	50.5 x 132 x 29	70	224	14.28	\$4792	\$873
BRTBAR4PA2460LR	50.5 x 120 x 29	70	208	13.82	\$4585	\$791
BRTBAR4PA3084LR	62.5 x 168 x 29	70	333	16.86	\$5783	\$1406
BRTBAR4PA3078LR	62.5 x 156 x 29	70	313	16.32	\$5577	\$1324
BRTBAR4PA3072LR	62.5 x 144 x 29	70	293	15.78	\$5455	\$1203
BRTBAR4PA3066LR	62.5 x 132 x 29	70	273	15.24	\$5247	\$1078
BRTBAR4PA3060LR	62.5 x 120 x 29	70	253	14.70	\$4959	\$994

Back-to-back 4 Person workstation consists of four worksurfaces, three back-to-back outer leg assemblies, and four supporting structural beams. Painted aluminum worksurface door provides access to power/data trough below worksurface. Worksurface with access doors CANNOT be combined with above worksurface power trough.

BRTBAR4PDA2484LR	50.5 x 168 x 29	70	272	15.66	\$5856	\$1248
BRTBAR4PDA2478LR	50.5 x 156 x 29	70	256	15.20	\$5678	\$1113
BRTBAR4PDA2472LR	50.5 x 144 x 29	70	240	14.74	\$5544	\$1070
BRTBAR4PDA2466LR	50.5 x 132 x 29	70	224	14.28	\$5420	\$937
BRTBAR4PDA2460LR	50.5 x 120 x 29	70	208	13.82	\$5100	\$847
BRTBAR4PDA3084LR	62.5 x 168 x 29	70	333	16.86	\$6346	\$1514
BRTBAR4PDA3078LR	62.5 x 156 x 29	70	313	16.32	\$6123	\$1424
BRTBAR4PDA3072LR	62.5 x 144 x 29	70	293	15.78	\$5989	\$1289
BRTBAR4PDA3066LR	62.5 x 132 x 29	70	273	15.24	\$5856	\$1067
BRTBAR4PDA3060LR	62.5 x 120 x 29	70	253	14.70	\$5500	\$1070

Back-to-back 4 Person workstation consists of four worksurfaces, three back-to-back outer leg assemblies, and four supporting structural beams. These tables feature dual access doors providing a central connection point for monitor lifts. Painted aluminum worksurface door provides access to power/data trough below worksurface. Worksurface with access doors CANNOT be combined with above worksurface power trough.

BRTBAR6P2484LR	50.5 x 252 x 29	70	434	22.88	\$7422	\$970
BRTBAR6P2478LR	50.5 x 234 x 29	70	409	22.10	\$7125	\$922
BRTBAR6P2472LR	50.5 x 216 x 29	70	359	21.32	\$6854	\$898
BRTBAR6P2466LR	50.5 x 198 x 29	70	329	20.54	\$6678	\$847
BRTBAR6P2460LR	50.5 x 180 x 29	70	308	19.76	\$6508	\$834
BRTBAR6P3084LR	62.5 x 252 x 29	70	493	24.53	\$7684	\$1031
BRTBAR6P3078LR	62.5 x 234 x 29	70	462	23.75	\$7262	\$958
BRTBAR6P3072LR	62.5 x 216 x 29	70	431	22.86	\$7014	\$935
BRTBAR6P3066LR	62.5 x 198 x 29	70	400	21.97	\$6777	\$898
BRTBAR6P3060LR	62.5 x 180 x 29	70	369	21.08	\$6617	\$847

Back-to-back 6 Person workstation consists of six worksurfaces, four back-to-back outer leg assemblies, and six supporting structural beams.

Required Specifications

Top finish	Edge finish
Metal finish (legs)	Beam finish
Access door finish*	

Optional Specifications

Anodized Aluminum Leg
HP laminate

ROUND LEG PACKAGES

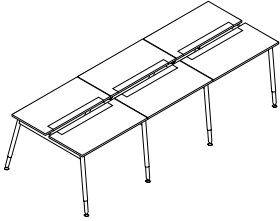

Back-to-Back 6 Person Pod with Access Door and Levelers, Round Leg*

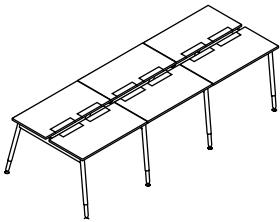

Back-to-Back 6 Person Pod with Access Door and Levelers, Round Leg*

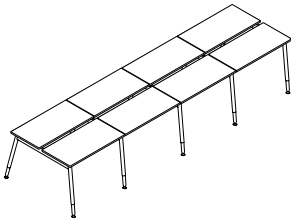

Back-to-Back 8 Person Pod with Levelers Round Leg

MODEL#	DIMENSIONS D x W x H	FREIGHT CLASS	WT/LBS.	CUBIC FT.	LIST PRICE	HP ADD
BRTBAR6PA2484LR	50.5 x 252 x 29	70	434	22.88	\$7856	\$1740
BRTBAR6PA2478LR	50.5 x 234 x 29	70	409	22.10	\$7608	\$1553
BRTBAR6PA2472LR	50.5 x 216 x 29	70	359	21.32	\$7422	\$1490
BRTBAR6PA2466LR	50.5 x 198 x 29	70	329	20.54	\$7112	\$1305
BRTBAR6PA2460LR	50.5 x 180 x 29	70	308	19.76	\$6803	\$1179
BRTBAR6PA3084LR	62.5 x 252 x 29	70	493	24.53	\$8538	\$2109
BRTBAR6PA3078LR	62.5 x 234 x 29	70	462	23.75	\$8229	\$1987
BRTBAR6PA3072LR	62.5 x 216 x 29	70	431	22.86	\$8042	\$1800
BRTBAR6PA3066LR	62.5 x 198 x 29	70	400	21.97	\$7732	\$1615
BRTBAR6PA3060LR	62.5 x 180 x 29	70	369	21.08	\$7299	\$1490

Back-to-back 6 Person workstation consists of six worksurfaces, four back-to-back leg assemblies, and six supporting structural beams. Painted aluminum worksurface door provides access to power/data trough below worksurface. Worksurface with access doors CANNOT be combined with above worksurface power trough.

BRTBAR6PDA2484LR	50.5 x 252 x 29	70	434	22.88	\$8477	\$1866
BRTBAR6PDA2478LR	50.5 x 234 x 29	70	409	22.10	\$8207	\$1667
BRTBAR6PDA2472LR	50.5 x 216 x 29	70	359	21.32	\$8008	\$1600
BRTBAR6PDA2466LR	50.5 x 198 x 29	70	329	20.54	\$7671	\$1404
BRTBAR6PDA2460LR	50.5 x 180 x 29	70	308	19.76	\$7343	\$1268
BRTBAR6PDA3084LR	62.5 x 252 x 29	70	493	24.53	\$9211	\$2267
BRTBAR6PDA3078LR	62.5 x 234 x 29	70	462	23.75	\$8876	\$2129
BRTBAR6PDA3072LR	62.5 x 216 x 29	70	431	22.86	\$8678	\$1931
BRTBAR6PDA3066LR	62.5 x 198 x 29	70	400	21.97	\$8339	\$1736
BRTBAR6PDA3060LR	62.5 x 180 x 29	70	369	21.08	\$7876	\$1599

Back-to-back 6 Person workstation consists of six worksurfaces, four back-to-back leg assemblies, and six supporting structural beams. These tables feature dual access doors providing a central connection point for monitor lifts. Painted aluminum worksurface door provides access to power/data trough below worksurface. Worksurface with access doors CANNOT be combined with above worksurface power trough.

BRTBAR8P2484LR	50.5 x 336 x 29	70	556	28.30	\$9721	\$1275
BRTBAR8P2478LR	50.5 x 312 x 29	70	520	27.30	\$9310	\$1226
BRTBAR8P2472LR	50.5 x 288 x 29	70	484	26.30	\$8945	\$1193
BRTBAR8P2466LR	50.5 x 264 x 29	70	448	25.30	\$8713	\$1127
BRTBAR8P2460LR	50.5 x 240 x 29	70	412	24.42	\$8482	\$1094
BRTBAR8P3084LR	62.5 x 336 x 29	70	669	30.58	\$10035	\$1394
BRTBAR8P3078LR	62.5 x 312 x 29	70	625	29.48	\$9490	\$1275
BRTBAR8P3072LR	62.5 x 288 x 29	70	581	28.38	\$9161	\$1242
BRTBAR8P3066LR	62.5 x 264 x 29	70	536	27.28	\$8847	\$1193
BRTBAR8P3060LR	62.5 x 240 x 29	70	492	26.18	\$8633	\$1127

Back-to-back 8 Person workstation consists of eight worksurfaces, five back-to-back leg assemblies, and eight supporting structural beams.

Required Specifications

Top finish
Metal finish (legs)
Access door finish*

Edge finish
Beam finish

Optional Specifications

Anodized Aluminum Leg
HP laminate

ROUND LEG PACKAGES

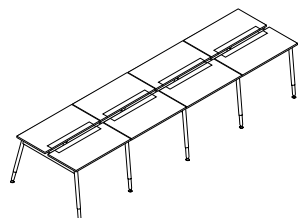

Back-to-Back 8 Person Pod with Access Door and Levelers, Round Leg*

MODEL#	DIMENSIONS D x W x H	FREIGHT CLASS	WT/LBS.	CUBIC FT.	LIST PRICE	HP ADD
BRTBAR8PA2484LR	50.5 x 336 x 29	70	556	28.30	\$10283	\$2316
BRTBAR8PA2478LR	50.5 x 312 x 29	70	520	27.30	\$9953	\$2068
BRTBAR8PA2472LR	50.5 x 288 x 29	70	484	26.30	\$9706	\$1987
BRTBAR8PA2466LR	50.5 x 264 x 29	70	448	25.30	\$9293	\$1740
BRTBAR8PA2460LR	50.5 x 240 x 29	70	412	24.42	\$8878	\$1572
BRTBAR8PA3084LR	62.5 x 336 x 29	70	669	30.58	\$11193	\$2811
BRTBAR8PA3078LR	62.5 x 312 x 29	70	625	29.48	\$10777	\$2646
BRTBAR8PA3072LR	62.5 x 288 x 29	70	581	28.38	\$10529	\$2399
BRTBAR8PA3066LR	62.5 x 264 x 29	70	536	27.28	\$10118	\$2151
BRTBAR8PA3060LR	62.5 x 240 x 29	70	492	26.18	\$9540	\$1987

Back-to-back 8 Person workstation consists of eight worksurfaces, five back-to-back leg assemblies, and eight supporting structural beams. Painted aluminum worksurface door provides access to power/data trough below worksurface. Worksurface with access doors CANNOT be combined with above worksurface power trough.

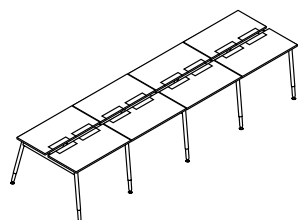

Back-to-Back 8 Person Pod with Access Door and Levelers, Round Leg*

BRTBAR8PDA2484LR	50.5 x 336 x 29	70	556	28.30	\$11092	\$2488
BRTBAR8PDA2478LR	50.5 x 312 x 29	70	520	27.30	\$10737	\$2221
BRTBAR8PDA2472LR	50.5 x 288 x 29	70	484	26.30	\$10472	\$2129
BRTBAR8PDA2466LR	50.5 x 264 x 29	70	448	25.30	\$10025	\$1869
BRTBAR8PDA2460LR	50.5 x 240 x 29	70	412	24.42	\$9580	\$1691
BRTBAR8PDA3084LR	62.5 x 336 x 29	70	669	30.58	\$12073	\$3020
BRTBAR8PDA3078LR	62.5 x 312 x 29	70	625	29.48	\$11626	\$2845
BRTBAR8PDA3072LR	62.5 x 288 x 29	70	581	28.38	\$11360	\$2580
BRTBAR8PDA3066LR	62.5 x 264 x 29	70	536	27.28	\$10918	\$2310
BRTBAR8PDA3060LR	62.5 x 240 x 29	70	492	26.18	\$10293	\$2132

Back-to-back 8 Person workstation consists of eight worksurfaces, five back-to-back leg assemblies, and eight supporting structural beams. These tables feature dual access doors providing a central connection point for monitor lifts. Painted aluminum worksurface door provides access to power/data trough below worksurface. Worksurface with access doors CANNOT be combined with above worksurface power trough.

RETURNS

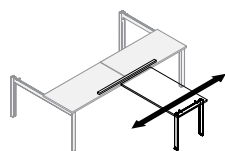

Rail Sliding Table Kit - Rectangular Legs

BRTSLDT72C	72 x 48 x 29	92.5	28.50	2.40	\$830	N/A
------------	--------------	------	-------	------	-------	-----

Includes leg, leg support, sliding bracket hardware, 72" rail and hardware to secure table. **Worksurface not included.** Legs are for 24"d worksurfaces. 40mm dia. locking casters with 8mm thread, white body and grey tires. Maximum length of sliding table surface is 48". **Cannot be used on single line pods with rectangular legs.**

- Anodized Aluminum Leg - Add \$56. list upcharge



Rail Sliding Table Kit - Round Legs

BRTSLDT72CR	72 x 48 x 29	92.5	28.50	2.40	\$830	N/A
-------------	--------------	------	-------	------	-------	-----

Includes leg, leg support, sliding bracket hardware, 72" rail and hardware to secure table. **Worksurface not included.** Legs are for 24"d worksurfaces. 3" dia. locking casters are standard. Maximum length of sliding table surface is 48".

Required Specifications

Top finish	Edge finish
Metal finish (legs)	Beam finish
Access door finish*	

Optional Specifications

Anodized Aluminum Leg
HP laminate

MEETING TABLES

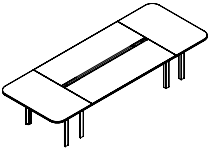

Boardroom Table with Rectangular Leg and Levelers

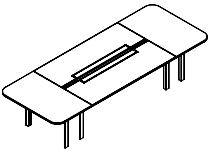

Boardroom Table with Rectangular Leg, Access Door and Levelers*

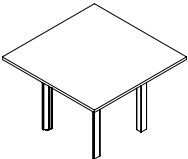

Square Meeting Table with Rectangular Legs

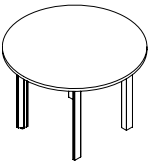

Round Meeting Table with Rectangular Legs

MODEL#	DIMENSIONS D x W x H	FREIGHT CLASS	WT/LBS.	CUBIC FT.	LIST PRICE	HP ADD
BRTBRDP276L	52.5 x 276 x 29	70	474	23.42	\$9033	\$1132
BRTBRDP240L	52.5 x 240 x 29	70	408	22.64	\$8687	\$1059
BRTBRDP204L	52.5 x 204 x 29	70	340	20.74	\$7040	\$834
BRTBRDP180L	52.5 x 180 x 29	70	308	19.82	\$6807	\$784
BRTBRDP132L	52.5 x 132 x 29	70	228	15.02	\$5064	\$537
BRTBRDP120L	52.5 x 120 x 29	85	210	14.56	\$4944	\$513

Boardroom Table assemblies consist of 2 or more back-to-back tables with end tables on either side. Inset support legs, levelers. Worksurfaces, supporting structure and connecting hardware included.

- Anodized Aluminum Leg - Add **\$325** list upcharge
- BRTBRDP276L consists of (6) 24" x 72" back-to-back tables and (2) 30" x 50.5" end tables
- BRTBRDP240L consists of (6) 24" x 60" back-to-back tables and (2) 30" x 50.5" end tables
- BRTBRDP204L consists of (4) 24" x 72" back-to-back tables and (2) 30" x 50.5" end tables
- BRTBRDP180L consists of (4) 24" x 60" back-to-back tables and (2) 30" x 50.5" end tables
- BRTBRDP132L consists of (2) 24" x 72" back-to-back tables and (2) 30" x 50.5" end tables
- BRTBRDP120L consists of (2) 24" x 60" back-to-back tables and (2) 30" x 50.5" end tables

BRTBRDPA276L	52.5 x 276 x 29	70	474	23.42	\$9603	\$1727
BRTBRDPA240L	52.5 x 240 x 29	70	408	22.64	\$9272	\$1093
BRTBRDPA204L	52.5 x 204 x 29	70	340	20.74	\$7416	\$900
BRTBRDPA180L	52.5 x 180 x 29	70	308	19.82	\$7005	\$1024
BRTBRDPA132L	52.5 x 132 x 29	70	228	15.02	\$5210	\$734
BRTBRDPA120L	52.5 x 120 x 29	85	210	14.56	\$5003	\$630

Boardroom Table assemblies consist of 2 or more back-to-back tables with end tables on either side. Inset support legs, levelers. Worksurfaces, supporting structure and connecting hardware included.

- Anodized Aluminum Leg - Add **\$325** list upcharge
- BRTBRDPA276L consists of (6) 24" x 72" back-to-back tables and (2) 30" x 50.5" end tables
- BRTBRDPA240L consists of (6) 24" x 60" back-to-back tables and (2) 30" x 50.5" end tables
- BRTBRDPA204L consists of (4) 24" x 72" back-to-back tables and (2) 30" x 50.5" end tables
- BRTBRDPA180L consists of (4) 24" x 60" back-to-back tables and (2) 30" x 50.5" end tables
- BRTBRDPA132L consists of (2) 24" x 72" back-to-back tables and (2) 30" x 50.5" end tables
- BRTBRDPA120L consists of (2) 24" x 60" back-to-back tables and (2) 30" x 50.5" end tables

BRTSQ42L	42 x 42 x 29	70	85	4.20	\$1564	\$171
BRTSQ42C	42 x 42 x 29	70	85	4.20	\$1647	\$171

3mm edging. Select BRTSQ42L for levelers or BRTSQ42C for casters.

- Anodized Aluminum Leg - Add **\$165** list upcharge

BRTR42L	42 x 42 x 29	70	65	3.90	\$1564	\$171
BRTR42C	42 x 42 x 29	70	65	3.90	\$1647	\$171

3mm edging. Select BRTR42L for levelers or BRTR42C for casters.

- Anodized Aluminum Leg - Add **\$165** list upcharge

Required Specifications

Top finish
Metal finish (legs)
Beam finish
Access door finish*

Edge finish

Optional Specifications

HP laminate
Anodized aluminum leg
Table-edge mounted power module (Meeting Tables)

Below worksurface power trough with power distribution module (Meeting Tables)

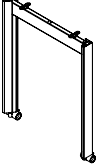
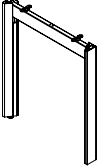
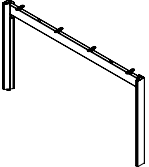
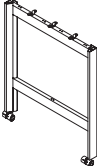
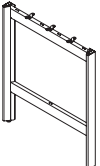
LEG ASSEMBLIES	MODEL#	DIMENSIONS	FREIGHT CLASS	WT./LBS.	CUBIC FT.	LIST PRICE	HP ADD
 <p>Single Rectangular Leg Assembly with Casters</p>		D x W x H					
	BRTSL24C	24 x 2.5 x 28	150	8	1.34	\$557	N/A
	BRTSL30C	30 x 2.5 x 28	150	8	1.41	\$562	N/A
	BRTSL36C	36 x 2.5 x 28	150	8	1.81	\$684	N/A
<p>Two single leg assemblies combined with support beams form the structure of the Bridges II series Single Table. One leg can be shared by two adjoining worksurfaces. 40mm white locking casters with grey tires; steel horizontal beams, aluminum legs.</p> <ul style="list-style-type: none"> • Anodized Aluminum Leg - Add \$83 list upcharge 							
 <p>Single Rectangular Leg Assembly with Levelers</p>							
	BRTSL24L	24 x 2.5 x 28	150	8	1.34	\$504	N/A
	BRTSL30L	30 x 2.5 x 28	150	8	1.34	\$526	N/A
	BRTSL36L	36 x 2.5 x 28	125	9	1.50	\$463	N/A
<p>Two single leg assemblies combined with support beams form the structure of the Bridges II series Single Table or Single Line tables. One leg can be shared by two adjoining worksurfaces. Leveling glides; steel horizontal beams, aluminum legs.</p> <ul style="list-style-type: none"> • Anodized Aluminum Leg - Add \$83 list upcharge • Please specify two beams when using BRTSL36L. 							
 <p>Back-to-Back Rectangular Leg Assembly with Levelers</p>							
	BRTBA34L	34 x 2.5 x 28	150	10	2.47	\$500	N/A
	BRTBA51L	50.5 x 2.5 x 28	150	12	2.96	\$542	N/A
	BRTBA63L	62.5 x 2.5 x 28	150	13	3.21	\$565	N/A
<p>Two double leg assemblies combined with support beams form the structure of the Bridges II series Back-to-Back Table. One double leg can be shared by four adjoining worksurfaces. Leveling glides; steel horizontal beams, aluminum legs.</p> <ul style="list-style-type: none"> • Anodized Aluminum Leg - Add \$83 list upcharge 							
 <p>Single H Leg Assembly with Casters</p>							
	BRTHL3624C	24 x 2.5 x 35	100	14	1.68	\$717	N/A
	BRTHL3630C	30 x 2.5 x 35	100	16	1.76	\$758	N/A
	BRTHL3636C	36 x 2.5 x 35	125	18	2.26	\$858	N/A
	BRTHL4224C	24 x 2.5 x 41	125	15	1.96	\$749	N/A
	BRTHL4230C	30 x 2.5 x 41	100	17	2.06	\$791	N/A
	BRTHL4236C	36 x 2.5 x 41	125	19	2.65	\$888	N/A
<p>Two single leg assemblies combined with support beams form the structure of the Bridges II series Single Line Tables. One leg can be shared by two adjoining worksurfaces. 40mm white locking casters with grey tires; steel horizontal beams, aluminum legs. For proper installation, the following beams are required:</p> <ul style="list-style-type: none"> • 24"D legs - 4 beams (3 under the surface and one at the bottom) • 30"D/36"D legs - 5 beams (4 under the surface and one at the bottom) • Anodized Aluminum Leg - Add \$83 list upcharge 							
 <p>Single H Leg Assembly with Levelers</p>							
	BRTHL3624L	24 x 2.5 x 35	100	14	1.68	\$660	N/A
	BRTHL3630L	30 x 2.5 x 35	100	16	1.76	\$700	N/A
	BRTHL3636L	36 x 2.5 x 35	125	18	2.26	\$800	N/A
	BRTHL4224L	24 x 2.5 x 41	125	15	1.96	\$691	N/A
	BRTHL4230L	30 x 2.5 x 41	100	17	2.06	\$733	N/A
	BRTHL4236L	36 x 2.5 x 41	125	19	2.65	\$831	N/A
<p>Two single leg assemblies combined with support beams form the structure of the Bridges II series Single Line Tables. One leg can be shared by two adjoining worksurfaces. For proper installation, the following beams are required:</p> <ul style="list-style-type: none"> • 24"D legs - 4 beams (3 under the surface and one at the bottom) • 30"D/36"D legs - 5 beams (4 under the surface and one at the bottom) • Anodized Aluminum Leg - Add \$83 list upcharge 							

Required Specifications

Metal finish (legs)

Optional Specifications

Anodized aluminum leg

LEG ASSEMBLIES

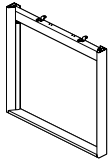

Single Loop Leg

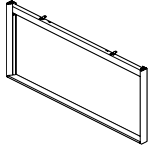

Back-to-Back Loop Leg



120° Rectangular Corner Leg Kit

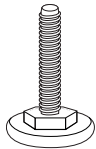

Leveler for Rectangular Leg Table

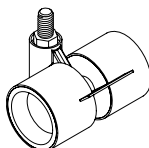

Caster for Rectangular Leg Table

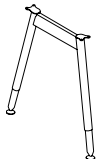

Single Table Round Leg Assembly

MODEL#	DIMENSIONS	FREIGHT CLASS	WT./LBS.	CUBIC FT.	LIST PRICE	HP ADD
--------	------------	---------------	----------	-----------	------------	--------

D x W x H

BRTSLL24L	24 x 2.5 x 28	92.5	11	1.01	\$475	N/A
BRTSLL30L	30 x 2.5 x 28	92.5	13.75	1.26	\$510	N/A
BRTSLL36L	36 x 2.5 x 28	92.5	16.50	1.51	\$546	N/A

Two single leg assemblies combined with support beams form the structure of the Bridges II series Single Line tables. One leg can be shared by two adjoining worksurfaces. Leveling glides; steel horizontal beams, aluminum legs.

- Anodized Aluminum Leg - Add **\$83** list upcharge

BRTBALL51L	50.5 x 2.5 x 28	92.5	23.14	2.12	\$660	N/A
BRTBALL63L	62.5 x 2.5 x 28	92.5	28.64	2.62	\$690	N/A

Two back-to-back leg assemblies form the structure of the Bridges II series Single Line Back-to-Back Table. One double leg can be shared by four adjoining worksurfaces. Leveling glides; steel horizontal beams, aluminum legs.

- Anodized Aluminum Leg - Add **\$83** list upcharge

BRT120L42	34 x 2.5 x 28	250	6.60	2.80	\$955	N/A
-----------	---------------	-----	------	------	--------------	-----

One 120° corner leg kit combined with two single or double leg assemblies and support beams form the structure of the Bridges II 120° Tables. 120° corner leg kit includes one corner leg and adjacent, telescopic beams to support BRTWAC120xxx or BRTWAC120xxxxA 120° worksurfaces. Telescopic horizontal beams allow single or double leg assemblies to be positioned either under the worksurface (end of a run) or to be shared by adjoining worksurfaces. Levelers, steel horizontal beams, aluminum legs.

- Anodized Aluminum Leg - Add **\$49** list upcharge

BRTLVS	1 x 1 x 2.5	70	.03	.01	\$12	N/A
--------	-------------	----	-----	-----	-------------	-----

5/16" thread with black base. Leveler has 2" adjustment range. Casters and levelers on Rectangular legs cannot be interchanged on site.

BRTLCS	2.6 x 2.7 x 2.5	70	.06	.01	\$38	N/A
--------	-----------------	----	-----	-----	-------------	-----

Locking. 40mm diameter with 8mm thread, white body, light grey tires. Casters and levelers on Rectangular legs cannot be interchanged on site.

BRTSL	24 x 3 x 28	125	8	1.25	\$442	N/A
-------	-------------	-----	---	------	--------------	-----

Two single table leg assemblies combined with a single beam form the supporting structure of the Bridges II series Single Line Table. One leg can be shared by two adjoining worksurfaces. Leveling glides are standard. Locking casters are available on single tables. Specify **BRTLCR**.

Required Specifications

Top finish
Edge finish
Metal finish (legs)

Optional Specifications

Anodized Aluminum Leg
HP laminate

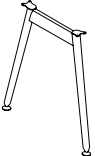
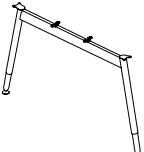
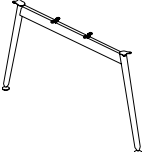
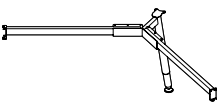
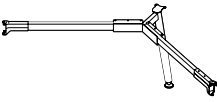
LEG ASSEMBLIES	MODEL#	DIMENSIONS	FREIGHT CLASS	WT/LBS.	CUBIC FT.	LIST PRICE	HP ADD	
 <p>Single Table Round Leg Assembly, Fixed Height</p>  <p>Double Table Round Leg Assembly</p>  <p>Double Table Round Leg Assembly, Fixed Height</p>  <p>120° Round Corner Leg Assembly</p>  <p>120° Fixed Height Corner Leg Assembly</p>		D x W x H						
	BRTFSL	24 x 2.5 x 28	150	5	.97	\$379	N/A	
	BRTDL	50 x 3 x 28	150	12	2.81	\$573	N/A	
	BRTFDL	50 x 2.5 x 28	250	8	2.03	\$515	N/A	
	BRTCRL42	16 x 18 x 28	92.5	15	1.50	\$883	N/A	
	BRTFCRL42	16 x 18 x 28	92.5	13	1.50	\$821	N/A	

Required Specifications

Metal finish (legs)

B BRIDGES II™

LEG ASSEMBLIES

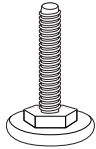

Leveler for Round Leg Table

MODEL#	DIMENSIONS D x W x H	FREIGHT CLASS	WT./LBS.	CUBIC FT.	LIST PRICE	HP ADD
BRTLVR	2.13 x 2.13 x 2	70	.20	.01	\$12	N/A

3/8" thread with black base. Leveler has 1" height adjustment range. Field retrofitable on round leg.



Caster for Round Leg Table

BRTLCR	1.5 x 3 x 3.75	70	.30	.01	\$38	N/A
--------	----------------	----	-----	-----	-------------	-----

Locking. 3" diameter with 3/8" -16 threaded stem. Field retrofitable on round leg.

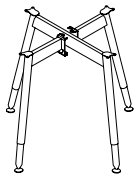

Round Table Leg Assembly

BRTRL	24 x 24 x 28	125	16	2.33	\$909	N/A
-------	--------------	-----	----	------	--------------	-----

Four leg assembly. Leveling Glides are standard. Locking casters are available. Specify (4) BRTLCR. Maximum table diameter is 42". Includes all connecting hardware.

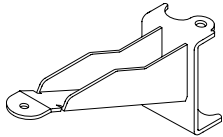

Leg Support Cantilever

BRTLSC	2 x 9 x 5	70	.50	.01	\$158	N/A
--------	-----------	----	-----	-----	--------------	-----

Provides stability for leg supports.

Required Specifications
Metal Finish (legs)

Optional Specifications
Casters (BRTRL)

BEAM APPLICATIONS

D x W x H

Table supporting structures - BEAMS

Legs are connected with supporting beams. There is one beam for a single line of tables while two beams connect back-to-back table structures. Adjustable clamps at either end of the beam can be adjusted to accommodate the following applications in both single table as well as back-to-back table configurations.

STANDARD TABLE BEAM**Single table beam application (1)**

Designed to bridge two legs to form support for a single table, or for two back-to-back worksurfaces. Adjustable clamps at either end of the beam are pushed all the way in to allow both table legs to be tucked under the worksurface.

**End of run table beam application (2)**

Supports one table leg assembly tucked under the worksurface (one adjustable clamp pushed all the way in), while the other table leg assembly can be shared between two adjacent worksurfaces (adjustable clamp pulled out to extend the beam).

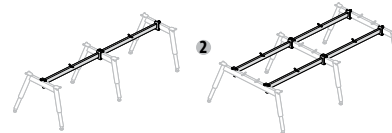
**Interconnecting table beam application (3)**

Supports both table leg assemblies extended to support adjacent worksurfaces on either side. Adjustable clamps at either end of the beam are pushed all the way in to allow both table legs to be tucked under the worksurface. Single table beam application supports single table leg assemblies with legs on both sides tucked under the worksurface.

**TELESCOPIC TABLE BEAM (4)**

Supports a return connected perpendicularly to a 24" or 30" deep primary worksurface. The Telescopic beam is connected to a single or back-to-back leg on one side and to any-worksurface supporting beam on the opposite side. Telescopic beam clamp allows the table leg to be tucked under the worksurface or shared between two adjacent worksurfaces.

**STORAGE TABLE BEAM (5)**

The Storage beam is connected to a single or back-to-back leg on one side and to the worksurface on the opposite side - thus saving one leg assembly. Assembly worksurface is connected to storage units with included storage brackets. Storage table beam's flexibility allows for a single table application (with the table leg tucked in under the worksurface) as well as for a double table installation (two adjacent tables supported by a shared leg in the middle and two storage cabinets at the opposite ends).

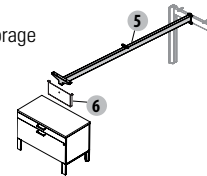
**STORAGE TABLE BEAM ADAPTER (6)**

Connects to a storage table beam. This assembly allows a worksurface to be supported by a leg on one side and a spine (formed by interconnected storage cabinets) on the opposite side.

BEAMS	MODEL#	DIMENSIONS	FREIGHT CLASS	WT./LBS.	CUBIC FT.	LIST PRICE
	BRTSB84C	1 x 79 x 2	60	8.02	.15	\$339
	BRTSB78C	1 x 73 x 2	60	7.38	.12	\$332
	BRTSB72C	1 x 67 x 2	60	6.74	.09	\$322
	BRTSB66C	1 x 61 x 2	60	6.09	.08	\$309
	BRTSB63C	1 x 57.5 x 2	60	5.72	.08	\$305
	BRTSB60C	1 x 55 x 2	60	5.45	.07	\$299
	BRTSB54C	1 x 49 x 2	60	4.86	.06	\$287
	BRTSB51C	1 x 45.5 x 2	60	4.81	.05	\$280
	BRTSB48C	1 x 43 x 2	60	4.60	.05	\$268
	BRTSB42C	1 x 37 x 2	60	3.59	.04	\$257
	BRTSB36C	1 x 31 x 2	60	3.31	.03	\$254
	BRTSB30C	1 x 25 x 2	60	2.70	.02	\$253
	BRTSB24C	1 x 19 x 2	60	2.03	.01	\$245
	BRTSB15C	1 x 10 x 2	70	1.28	.01	\$196

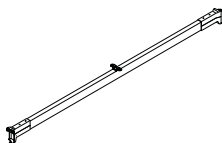
**Standard Table Beam**

Standard Table Beam bridges two legs to form support for a single table, or two back-to-back worksurfaces. Adjustable clamps at either end of the beam accommodate **standard table beam, end of run and interconnecting table beam applications**. Adjustable brackets ship attached to the beam. Specify Standard Table Beam size corresponding nominally to the worksurface length. Includes all hardware necessary to connect to legs. Powder coated steel beam and aluminum cast clamps.

Required Specifications

Metal Finish

BEAMS	MODEL#	DIMENSIONS	FREIGHT CLASS	WT./LBS.	CUBIC FT.	LIST PRICE
		D x W x H				
	BRTBB84C	1 x 79 x 2	60	10.32	.15	\$382
	BRTBB78C	1 x 73 x 2	60	9.68	.12	\$372
	BRTBB72C	1 x 67 x 2	60	9.04	.09	\$360
	BRTBB66C	1 x 61 x 2	60	8.40	.09	\$348
	BRTBB60C	1 x 55 x 2	60	7.75	.08	\$336
	BRTBB54C	1 x 49 x 2	60	7.11	.07	\$323
	BRTBB48C	1 x 43 x 2	60	6.74	.07	\$300
	BRTBB42C	1 x 37 x 2	60	5.83	.06	\$287
	BRTBB36C	1 x 31 x 2	60	5.19	.05	\$284

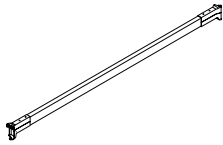

Bottom Table Beam

Bottom table beam connects to the lower cross beam on the 36" and 42" high "H" leg to create the footrest. One beam required for each table. Cannot be used as a substitute for the standard table beam. Specify bottom table beam that corresponds to the worksurface length. Includes all hardware necessary to connect to "H" leg. Powder coated steel beam and aluminum cast clamps.

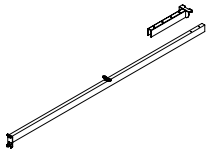

Telescopic Table Beam

BRTTB84C	1 x 96.5 x 2	60	10.32	.15	\$520
BRTTB78C	1 x 90.5 x 2	60	9.68	.12	\$511
BRTTB72C	1 x 84.5 x 2	60	9.04	.09	\$500
BRTTB66C	1 x 78.5 x 2	60	8.40	.09	\$488
BRTTB60C	1 x 72.5 x 2	60	7.75	.08	\$477
BRTTB54C	1 x 66.5 x 2	60	7.11	.07	\$460
BRTTB48C	1 x 60.5 x 2	60	6.74	.07	\$434
BRTTB42C	1 x 54.5 x 2	60	5.83	.06	\$417
BRTTB36C	1 x 48.5 x 2	60	5.19	.05	\$391

Provides support for a worksurface connected perpendicularly to a run of primary tables. Can be adjusted to accommodate 24" and 30" primary worksurfaces. One end of the beam is attached to a Leg Assembly while the other end is secured, off module to the perpendicular Standard Table Beam, End of Run or Interconnecting Beam. Specify Telescopic Table Beam size corresponding nominally to the return worksurface length.

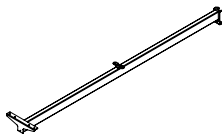

Storage Table Beam

BRTSTB84C	1 x 80.75 x 2	60	8.64	.09	\$373
BRTSTB78C	1 x 74.75 x 2	60	7.99	.08	\$364
BRTSTB72C	1 x 68.75 x 2	60	7.35	.08	\$351
BRTSTB66C	1 x 62.75 x 2	60	6.74	.07	\$339
BRTSTB60C	1 x 54.75 x 2	60	5.85	.06	\$322
BRTSTB54C	1 x 50.75 x 2	60	5.43	.05	\$299
BRTSTB48C	1 x 44.75 x 2	60	4.78	.05	\$284
BRTSTB42C	1 x 38.75 x 2	60	4.16	.04	\$280
BRTSTB36C	1 x 32.75 x 2	60	3.50	.03	\$268

Allows a worksurface to be supported by a leg on one side and storage tower(s) or spine of 21" and 25" interconnected storage units on the opposite side. Specify Storage Table Beam size corresponding nominally to the worksurface length. Includes all hardware necessary to connect the storage beam to the legs and worksurface.

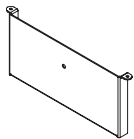

Storage Table Beam Adapter

BRTSA21	1 x 15.2 x 6.5	60	2.15	.05	\$128
BRTSA25	1 x 15.2 x 2.75	60	4.30	.02	\$110

Allows a worksurface to be supported by a leg on one side and storage spine on the opposite side. A typical storage spine is formed by series of Interconnected 21" or 25" storage cabinets of corresponding depth. The 21" or 25" adaptors provide structural support, acting as supports between the top of the storage cabinet spine and the bottom of the perpendicular worksurfaces. The flexible leg/beam/adaptor assembly arrangement allows the leg to be tucked in under the worksurface or to be shared by two adjacent worksurfaces. Specify Storage Beam nominally 18" shorter than worksurfaces for storage spine support application. Specify **BRTSA21** or **BRTSA25** depending on height of storage units forming the spine. Includes all hardware necessary to connect the adapter to the beam, worksurface and storage spine.

Required Specifications
Metal Finish

WORKSURFACES	MODEL#	DIMENSIONS	FREIGHT CLASS	WT./LBS.	CUBIC FT.	LIST PRICE	HP ADD
		D x W x H					
	BRTWS2484	24 x 84 x 1	60	55	1.80	\$532	\$165
	BRTWS2478	24 x 78 x 1	60	51	1.70	\$490	\$158
	BRTWS2472	24 x 72 x 1	60	47	1.54	\$460	\$155
	BRTWS2466	24 x 66 x 1	60	43	1.41	\$438	\$145
	BRTWS2463	24 x 62.5 x 1	65	39	1.41	\$431	\$147
	BRTWS2460	24 x 60 x 1	60	39	1.30	\$420	\$140
	BRTWS2454	24 x 54 x 1	65	35	1.20	\$379	\$123
	BRTWS2451	24 x 50.5 x 1	65	31	1.06	\$383	\$123
	BRTWS2448	24 x 48 x 1	65	31	1.06	\$320	\$111
	BRTWS2442	24 x 42 x 1	60	28	.90	\$268	\$91
	BRTWS2436	24 x 36 x 1	60	23	.71	\$205	\$70

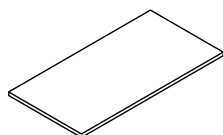

Rectangular Worksurface

BRTWS3084	30 x 84 x 1	60	69	2.24	\$572	\$176
BRTWS3078	30 x 78 x 1	60	64	2.10	\$515	\$163
BRTWS3072	30 x 72 x 1	65	59	2	\$485	\$161
BRTWS3066	30 x 66 x 1	60	54	1.8	\$455	\$155
BRTWS3063	30 x 62.5 x 1	65	49	1.77	\$445	\$150
BRTWS3060	30 x 60 x 1	65	49	1.77	\$438	\$145
BRTWS3054	30 x 54 x 1	60	44	1.44	\$408	\$123
BRTWS3051	30 x 50.5 x 1	65	39	1.41	\$402	\$128
BRTWS3048	30 x 48 x 1	65	39	1.41	\$379	\$123
BRTWS3042	30 x 42 x 1	60	34	1.12	\$356	\$120
BRTWS3036	30 x 36 x 1	65	30	1.06	\$254	\$87
BRTWS3684	36 x 84 x 1	70	79	5.25	\$941	\$238
BRTWS3678	36 x 78 x 1	85	73	4.88	\$875	\$223
BRTWS3672	36 x 72 x 1	70	68	4.5	\$813	\$205
BRTWS3666	36 x 66 x 1	70	62	4.13	\$750	\$191
BRTWS3660	36 x 60 x 1	85	56	3.75	\$687	\$174
BRTWS3654	36 x 54 x 1	70	51	3.38	\$619	\$159
BRTWS3648	36 x 48 x 1	70	45	3	\$557	\$141
BRTWS3642	36 x 42 x 1	85	39	2.63	\$491	\$127

Flat 3 mm edge profile on all sides.

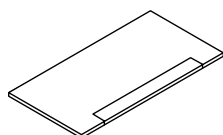

Rectangular Worksurface with Access Door*

BRTWSAA2484	24 x 84 x 1	60	51	1.7	\$633	\$308
BRTWSAA2478	24 x 78 x 1	60	47	1.54	\$600	\$275
BRTWSA2472	24 x 72 x 1	60	47	1.54	\$551	\$254
BRTWSA2466	24 x 66 x 1	60	43	1.41	\$512	\$220
BRTWSA2460	24 x 60 x 1	60	39	1.3	\$471	\$200
BRTWSA2454	24 x 54 x 1	65	35	1.2	\$418	\$191
BRTWSA2448	24 x 48 x 1	65	31	1.06	\$379	\$171
BRTWSA2442	24 x 42 x 1	60	28	0.9	\$336	\$150
BRTWSAA3084	30 x 84 x 1	60	64	2.1	\$752	\$372
BRTWSAA3078	30 x 78 x 1	65	59	2	\$709	\$349
BRTWSA3072	30 x 72 x 1	65	59	2	\$655	\$304
BRTWSA3066	30 x 66 x 1	60	54	1.8	\$615	\$273
BRTWSA3060	30 x 60 x 1	65	49	1.77	\$551	\$254
BRTWSA3054	30 x 54 x 1	60	44	1.44	\$500	\$231
BRTWSA3048	30 x 48 x 1	65	39	1.41	\$448	\$200
BRTWSA3042	30 x 42 x 1	60	34	1.12	\$397	\$179

Flat 3 mm edge profile on all sides. Worksurfaces 42" to 72" w have one access door. 78" w and 84" w worksurfaces have two access doors. Access door is offset 13.5" from either side of worksurface. Painted aluminum worksurface door provides access to power/data trough below worksurface. Worksurface with access doors CANNOT be combined with above worksurface power trough.

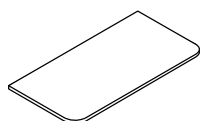

Rectangular Boardroom Table Top Extension, Round Corners

BRTWBE2451R	24 x 50.5 x 1	65	31	1.06	\$355	\$123
BRTWBE2463R	24 x 62.5 x 1	65	39	1.41	\$411	\$145
BRTWBE3051R	30 x 50.5 x 1	65	39	1.41	\$383	\$123
BRTWBE3063R	30 x 62.5 x 1	65	49	1.77	\$427	\$155

Flat 3 mm edge profile on all sides. Boardroom table extensions convert existing 24" or 30" deep back-to-back Bridges table assembly into a boardroom table. 24" and 30" d rectangular top with round corner can only be supported by 34" double leg and extension beams. *No freestanding and mobile application.*

Required Specifications

Top finish
Edge finish
Access door finish*

Optional Specifications

HP laminate

WORKSURFACES

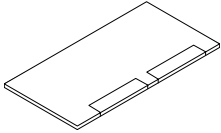

Rectangular Worksurface with 2 Access Doors*

MODEL#	DIMENSIONS D x W x H	FREIGHT CLASS	WT/LBS.	CUBIC FT.	LIST PRICE	HP ADD
BRTWSAA2484	24 x 84 x 1	60	51	1.70	\$633	\$308
BRTWSAA2478	24 x 78 x 1	60	47	1.54	\$600	\$275
BRTWSAA2472	24 x 72 x 1	60	43	1.41	\$593	\$274
BRTWSAA2466	24 x 66 x 1	60	39	1.30	\$551	\$241
BRTWSAA2460	24 x 60 x 1	65	35	1.20	\$507	\$217
BRTWSAA3084	30 x 84 x 1	60	64	2.10	\$752	\$372
BRTWSAA3078	30 x 78 x 1	65	59	2	\$709	\$349
BRTWSAA3072	30 x 72 x 1	60	54	1.80	\$702	\$329
BRTWSAA3066	30 x 66 x 1	65	49	1.77	\$663	\$290
BRTWSAA3060	30 x 60 x 1	60	44	1.44	\$593	\$274

Flat 3 mm edge profile on all sides. Access doors are offset 10" (60" worksurfaces) and 13.5" (worksurfaces 66" and wider) from either side of work surface. Painted aluminum work surface doors provide access to power/data trough below work surface. Worksurfaces with access doors CANNOT be combined with above work surface power troughs. Dimension between doors is 8" for 60" and 66" surfaces, 20" for 78", and 26" for 84".

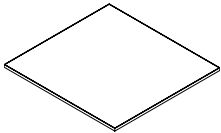

Meeting Table Top

BRTWS2451	24 x 50.5 x 1	65	31	1.06	\$383	\$123
BRTWS3051	30 x 50.5 x 1	65	39	1.41	\$402	\$128
BRTWS3651	36 x 50.5 x 1	65	43	1.71	\$593	\$100
BRTWS4251	42 x 50.5 x 1	65	48	1.93	\$655	\$176
BRTWS4851	48 x 50.5 x 1	65	52	2.07	\$745	\$195
BRTWS5151	50.5 x 50.5 x 1	65	55	2.12	\$797	\$185
BRTWS5451	54 x 50.5 x 1	65	59	2.19	\$861	\$241
BRTWS6051	60 x 50.5 x 1	65	63	2.26	\$979	\$247
BRTWS2463	24 x 62.5 x 1	65	39	1.41	\$431	\$147
BRTWS3063	30 x 62.5 x 1	65	49	1.77	\$445	\$150
BRTWS3663	36 x 62.5 x 1	65	53	1.94	\$666	\$173
BRTWS4263	42 x 62.5 x 1	65	57	2.07	\$797	\$209
BRTWS4863	48 x 62.5 x 1	65	61	2.13	\$957	\$242
BRTWS5463	54 x 62.5 x 1	65	63	2.21	\$1075	\$272
BRTWS6063	60 x 62.5 x 1	65	67	2.34	\$1198	\$298

Can create convenient, flexible extension of the back-to-back Bridges table assembly. Worksurfaces provided with pilot holes for alignment purposes.

- Meeting table top 50.5" long side matches 24" deep back-to-back Bridges table assembly
- Meeting table top 62.5" long side matches 30" deep back-to-back Bridges table assembly

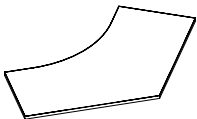

120° Worksurface

BRTWAC120424224	24 x 42 x 1	65	31	1.06	\$944	\$310
BRTWAC120424230	30 x 42 x 1	65	39	1.41	\$1028	\$315

5-sided work surface can be used for a single, freestanding table, can form a pod of two or three tables, or can be combined with rectangular work surfaces to create a larger workstation.

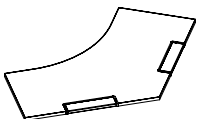

120° Worksurface with Access Door*

BRTWAC120A424224	24 x 42 x 1	65	31	1.06	\$1005	\$337
BRTWAC120A424230	30 x 42 x 1	65	39	1.41	\$1086	\$421

5-sided work surface can be used for a single, freestanding table, can form a pod of two or three tables, or can be combined with rectangular work surfaces to create a larger workstation. Access door is offset 13.5" from either side of work surface. Painted aluminum work surface door provides access to power/data trough below work surface. Work surface with access doors CANNOT be combined with above work surface power trough.

Required Specifications

Top finish
Edge finish
Access door finish*

Optional Specifications

HP laminate

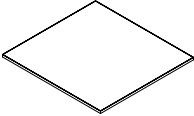
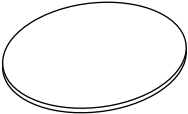
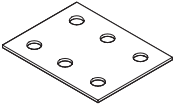
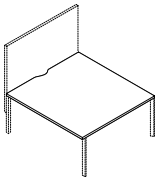
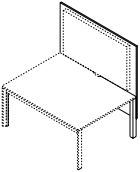
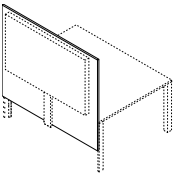
WORKSURFACES	MODEL#	DIMENSIONS	FREIGHT CLASS	WT./LBS.	CUBIC FT.	LIST PRICE	HP ADD
 <p>Rectangular Meeting Table Top*</p>		D x W x H					
	BRTMT5151	50.5 x 50.5 x 1	65	55	2.12	\$749	\$418
		50.5" long side matches 24" d back-to-back table assembly.					
 <p>Round Meeting Table Top*</p>	BRTMTR42	42 x 42 x 1	65	40	1.76	\$500	\$127
 <p>Flat Bracket</p>	BHBF01	4 x 3	70	.50	.01	\$24	
		Constructed of cold rolled steel. May be used to ensure alignment of neighboring worksurfaces.					
 <p>Display Wall Table Top w/Scoop*</p>	BRTWS6051SCP	60 x 50.5 x 1	60	75	1.75	\$958	\$243
	BRTWS5451SCP	54 x 50.5 x 1	60	68	1.58	\$846	\$237
	BRTWS4863SCP	48 x 62.5 x 1	60	75	1.74	\$938	\$238
	BRTWS6063SCP	60 x 62.5 x 1	60	93	2.17	\$1172	\$290
	BRTWS5463SCP	54 x 62.5 x 1	60	84	1.95	\$1057	\$266
	BRTWS4863SCP	48 x 62.5 x 1	60	75	1.74	\$938	\$238
	Display wall mounts to the end of back-to-back table assembly supported by rectangular legs. As opposed to two separate back-to-back worksurfaces, the display wall table top provides one continuous, uninterrupted surface with a scoop cutout next to the display wall (the scoop facilitates cable passage from below the table). Table top 50.5" w side matches 24" d back-to-back table assemblies. Meeting table tops 62.5" w side matches 30" d back-to-back table assemblies.						
 <p>Monitor Facing Double Workstation**</p>	BRTTVF63	4 x 62.5 x 52	100	74	7.52	\$1872	
	BRTTVF51	4 x 50.5 x 52	92.5	62	6.08	\$1772	
	Display wall faces the double workstation; facilitates seated presentation area. Includes laminate board, TV/display brackets (black), mounting hardware, vertical cable manager (black). Slim (22mm) bracket capable of supporting displays/TVs up to 50" (resp. 62") wide, up to 80lbs. When installed, top of the 52" x 50.5" (resp. 62.5") wide board reaches 65.5"h. 1" LP laminate board with 3mm edging. Specify WHB to add HP white, dry-erase marker board laminate on non-display board surface and standard HP laminate on the opposite side. Display wall mounts to the end of back-to-back table assembly supported by rectangular legs or back-to-back table structure with BRTWSxxxxSCP Display Wall Table Top with Scoop.						
	<ul style="list-style-type: none"> • Included vertical cable manager passes through the gap between 2 back-to-back worksurfaces. Should you need one continuous, uninterrupted surface specify Display Wall Table Top with Scoop (BRTWSxxxxSCP). • Add \$1215 for white, dry erase on 51" w model, and \$1621 for 63" w 						
 <p>Monitor Facing Back of Double Workstation**</p>	BRTTVBK63	4 x 62.5 x 52	100	74	7.52	\$1872	
	BRTTVBK51	4 x 50.5 x 52	92.5	62	6.08	\$1772	
	Display wall support board mounts to end of back-to-back table assembly supported by rectangular legs. Display faces back of the double workstation (combine with collaborative seating). Includes laminate board, TV/display brackets (black), mounting hardware, vertical cable manager (black). Slim (22mm) bracket capable of supporting displays/TVs up to 50" (resp. 62") wide, up to 80lbs. When installed, top of the 52" x 50.5" (resp. 62.5") wide board reaches 65.5"h. 1" LP laminate board with 3mm edging. Specify WHB to add HP white, dry-erase marker board laminate on non-display board surface and standard HP laminate on the opposite side. Display wall mounts to the end of back-to-back table assembly supported by rectangular legs or back-to-back table structure with Display Wall Table Top with Scoop (BRTWSxxxxSCP).						
	<ul style="list-style-type: none"> • Add \$1215 for white, dry erase on 51" w model, and \$1621 for 63" w 						

Required Specifications

Top finish
Edge finish

Optional Specifications

HP laminate

POWER DELIVERY / CABLE MANAGEMENT

D x W x H

At the basic level, table and floor based office equipment is serviced by a wall or floor power supply. As the operation grows, there might be a need to organize excessive cable clutter.

Wire Basket (1) connects to the underside of worksurfaces with sprig brackets, and cables are simply dropped and coiled into them. *Wire Basket is not to be used with power troughs.*

Cable Snake (2) Installed in proximity of floor monument to manage vertical cable clutter..

Table clamped, single circuit **Desk Top Power Data Modules (3)** deliver services to desk height, while tapping into wall or floor power supply. Again, the excessive cables can be managed with Cable Trays.

Ceiling pole **BRTCPP (4)** manages power and data cables between ceiling and above or below worksurface power troughs.

Above and Below Worksurface Power/Data Troughs (5) can be installed between back-to-back tables for extended below and above desk height power/data distribution. 8 wire, 4-circuit system. (2 + 2 circuit configuration)

NOTE: Specify **BRTHH58 (8)** to distribute power from double-sided, back-to-back below worksurface power trough to a single-sided, below worksurface power trough at the end of a table run.

Leg shroud (9) attaches to 34" w legs and manages power floor feed, as well as data cables from floor monument.

Single Sided Power/Data Troughs (6) can be installed to the underside of a single table.

Storage power/data box BRTVCM (7) attaches to storage units and provides access to one duplex/data terminal on top storage surface. Integrated single circuit module can be plugged to floor monument under the storage or to a wall outlet

4-2-2 Wiring Schematic

8-Wire Shared Neutral

"2 + 2" - 2 Utility Circuits, 2 Dedicated

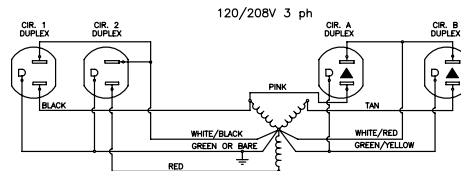
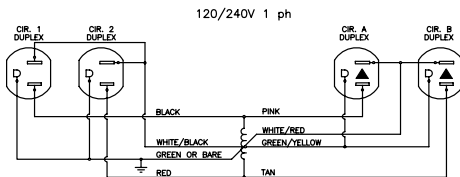

8 Wires

4 Lines (12 ga.)
2 Neutrals (10 ga.)
2 Grounds (12 ga.)

4 Circuits

2 Utility circuits
2 Dedicated Circuits

Receptacles

Duplex - Up to 12 duplex receptacles per circuit
(Up to 48 per infeed)

Specifications

System rated for connection to a grounded 120/240 V single phase, 20A, 60Hz or 120/208 V, 3 phase, 20A, 60Hz branch circuit for U.S. and 15A if product is marked with a C-UL Mark. Outlets rated 15A max.

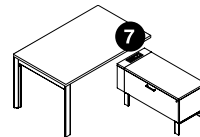
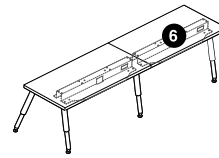
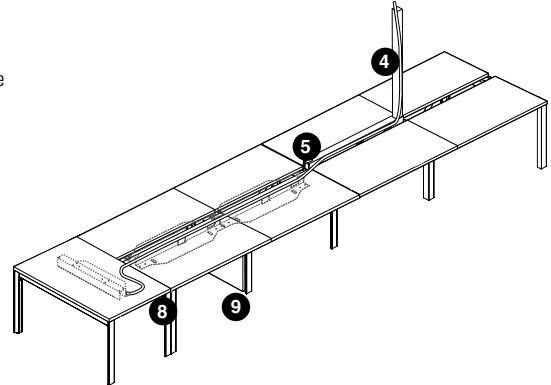
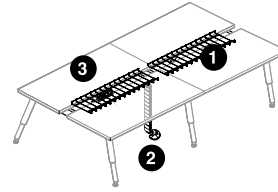

POWER DELIVERY / CABLE MANAGEMENT

MODEL# DIMENSIONS FREIGHT CLASS WT/LBS. CUBIC FT. LIST PRICE

D x W x H

MODEL#	DIMENSIONS	FREIGHT CLASS	WT/LBS.	CUBIC FT.	LIST PRICE
BRTEETB84SKIT	11.6 x 78.34 x 2.5	100	12	1.31	\$1203
BRTEETB78SKIT	11.6 x 72.34 x 2.5	100	11	1.21	\$1152
BRTEETB72SKIT	11.6 x 66.34 x 2.5	100	9.80	1.11	\$749
BRTEETB66SKIT	11.6 x 60.34 x 2.5	100	8.90	1.01	\$725
BRTEETB60SKIT	11.6 x 54.34 x 2.5	100	8	.91	\$698
BRTEETB54SKIT	11.6 x 48.34 x 2.5	100	7.10	.81	\$684
BRTEETB48SKIT	11.6 x 42.34 x 2.5	100	6.20	.71	\$655
BRTEETB42SKIT	11.6 x 36.34 x 2.5	100	5.30	.61	\$605
BRTEETB36SKIT	11.6 x 30.34 x 2.5	125	4.50	.59	\$551

36"

42" - 72"

Below Worksurface Single Power/Data Trough

Formed steel trough is secured below a single table worksurface; outlets are facing the rear worksurface edge. Cannot be used on back-to-back tables. Specify Duplex receptacles separately. *Covers for duplex openings are not supplied.* 36" trough can house one duplex and 42-72" trough can house two duplexes. Specify jumpers between tables separately. Base feed entry at either end and not suitable for ceiling feed. Each trough provides one opening at 1.37" x 2.68" for terminal plate (not supplied). One terminal plate can accommodate up to 4 data/communication terminals (jacks). Data/comm plate spacer BRTPDS available to accommodate larger cable-to-terminal bending radius.

- BRTEETB36SKIT through BRTEETB72SKIT consist of one single sided steel trough, Power Distribution housing, mounting brackets and one charcoal grey extruded Data/Communication cable manager.
- BRTEETB78SKIT and BRTEETB84SKIT consist of two single-sided steel troughs, two Power Distribution Housings, mounting brackets and two charcoal grey extruded Data/Communication cable managers.
- BRTEETB78SKIT includes (1) BRTEETB36SKIT, (1) BRTEETB42SKIT and (1) JUMPER
- BRTEETB84SKIT includes (2) BRTEETB42SKIT and (1) JUMPER
- For 120° table applications, please specify BRTEETB36SKIT single trough kit for tables with BRTWAC120xx and BRTWAC120Axx worksurfaces. BRTEHH28 may be used as usual.
- Specify duplex receptacles separately
- Each trough includes one black **BRTPDS** Data/Comm spacer, extending the depth behind the Data/Comm opening by 0.6". White (BRTPDSW) and Silver (BRTPDSS). Data/Comm spacers are available as a special order for **\$63** list, see **BRTPDS**.

36"

42" - 72"

Below Worksurface Double Power/Data Trough

BRTEETB84DKIT	8.5 x 78.3 x 2.5	92.5	9.80	.96	\$1553
BRTEETB78DKIT	8.5 x 72.3 x 2.5	92.5	9	.88	\$1531
BRTEETB72DKIT	8.5 x 66.3 x 2.5	92.5	8.30	.81	\$903
BRTEETB66DKIT	8.5 x 60.3 x 2.5	92.5	7.50	.74	\$883
BRTEETB60DKIT	8.5 x 54.3 x 2.5	92.5	6.80	.66	\$852
BRTEETB54DKIT	8.5 x 48.3 x 2.5	92.5	6	.59	\$830
BRTEETB48DKIT	8.5 x 42.3 x 2.5	92.5	5.30	.52	\$811
BRTEETB42DKIT	8.5 x 36.3 x 2.5	92.5	4.50	.44	\$778
BRTEETB36DKIT	8.5 x 30.3 x 2.5	92.5	3.80	.37	\$759

Formed steel trough is secured below worksurface; outlets between back-to-back stations supported by double table legs. Cannot be used on single table assemblies. Specify Duplex receptacles separately. *Covers for duplex openings are not supplied.* 36" trough can house one duplex per side and 42-72" trough can house two duplexes per side. Specify jumpers between tables separately. Ceiling feed entry through slots at either end; base feed entry at either end. Each trough provides one opening at 1.37" x 2.68" (one per side) for data/communication terminal plates. A single terminal plate (not supplied) can accommodate up to 4 data/communication plates. Data/comm plate spacer BRTPDS available to accommodate larger cable-to-terminal bending radius.

- BRTEETB36DKIT through BRTEETB72DKIT consist of one double-sided steel trough, Power Distribution housing, mounting brackets and one charcoal grey extruded Data/Communication cable manager.
- BRTEETB78DKIT and BRTEETB84DKIT consist of two double-sided steel troughs, two Power Distribution Housings, mounting brackets and two charcoal grey extruded Data/Communication cable managers.
- BRTEETB78DKIT includes (1) BRTEETB36DKIT, (1) BRTEETB42DKIT and (1) JUMPER
- BRTEETB84DKIT includes (2) BRTEETB42DKIT and (1) JUMPER
- For back-to-back 120° table applications, please specify BRTEETB42DKIT double trough kit for tables with BRTWAC120xx and BRTWAC120Axx worksurfaces. BRTEHH28 may be used as usual.
- Specify duplex receptacles separately
- Each trough includes one black BRTPDS Data/Comm spacer, extending the depth behind the Data/Comm opening by 0.6". White (BRTPDSW) and Silver (BRTPDSS). Data/Comm spacers are available as a special order for **\$63** list, see **BRTPDS**.

Required Specifications

Metal Finish (Power/Data Troughs)

ELECTRICAL COMPONENTS

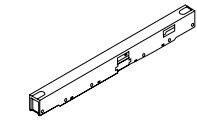

36"

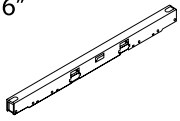

42" - 72"

Above Worksurface Power Trough

MODEL#	DIMENSIONS D x W x H	FREIGHT CLASS	WT/LBS.	CUBIC FT.	LIST PRICE
BRTEETA84KIT	2.5 x 84 x 3.5	65	9.49	.42	\$1348
BRTEETA78KIT	2.5 x 78 x 3.5	65	8.81	.39	\$1297
BRTEETA72KIT	2.5 x 71.9 x 3.5	65	8.12	.36	\$852
BRTEETA66KIT	2.5 x 65.9 x 3.5	65	7.45	.33	\$842
BRTEETA60KIT	2.5 x 59.9 x 3.5	65	6.77	.30	\$778
BRTEETA54KIT	2.5 x 53.9 x 3.5	65	6.09	.27	\$759
BRTEETA48KIT	2.5 x 47.9 x 3.5	65	5.41	.24	\$718
BRTEETA42KIT	2.5 x 41.9 x 3.5	65	4.73	.21	\$676
BRTEETA36KIT	2.5 x 35.9 x 3.5	65	4.06	.18	\$625

Formed steel trough is secured between back-to-back stations. Cannot be used on single table assemblies. Specify Duplex receptacles separately. *Covers for duplex openings are not supplied.* 36" trough side. **Specify jumpers between tables separately.** Ceiling feed entry through can house one duplex per side and 42-72" trough can house two duplexes per slots at either end; base feed entry at either end. Each trough provides two openings at 1.37" x 2.68" (one per side) for data/communication terminal plates. A single terminal plate (not supplied) can accommodate up to 4 data/comm plates. Data/comm plate spacer BRTPDS available to accommodate larger cable-to-terminal bending radius.

- BRTEETA36KIT through BRTEETA72KIT consist of one double-sided steel trough, Power Distribution Housing, mounting brackets and one charcoal grey extruded Data/Communication cable manager.
- BRTEETA78KIT and BRTEETA84KIT consist of two double-sided steel troughs, two Power Distribution Housings, mounting brackets and two charcoal grey extruded Data/Communication cable managers.
- BRTEETA78KIT includes (1) BRTEETA36KIT, (1) BRTEETA42KIT and (1) JUMPER
- BRTEETA84KIT includes (2) BRTEETA42KIT and (1) JUMPER
- Specify above worksurface power trough end cap BRTEETEC to finish open ends of the power trough
- Each trough includes one black BRTPDS Data/Comm spacer, extending the depth behind the Data/Comm opening by 0.6". White (BRTPDSW) and Silver (BRTPDSS). Data/Comm spacers are available as a special order for **\$63** list, see **BRTPDS**.

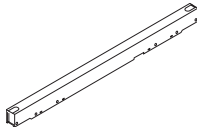

Back-to-Back Storage Tower Gap Filler Kit

BRTEST15KIT	15.5 x 2.5 x 3.5	65	2	.08	\$562
BRTEST24KIT	24 x 2.5 x 3.5	70	2.50	.12	\$610
BRTEST30KIT	31 x 2.5 x 3.5	70	3.50	.16	\$650
BRTEST48KIT	48 x 2.5 x 3.5	70	4	.24	\$717

Consists of a formed sheet metal cover and four brackets which allow the cover to be mounted at either above worksurface power trough level or below worksurface power trough level. Versatile brackets secure the cover trough at corners, to the bottom of back-to-back worksurface supported by either shared 51" or 63" legs or storage beam and storage towers.

- Note: the back-to-back storage tower gap filler is not compatible with single, freestanding tables.
- The BRTEST15kit and BRTEST24kit cover the gap between two back-to-back BRTT5024x or BRTT5030x storage towers
- The BRTEST30kit and BRTEST48kit cover the gap between two pairs of back-to-back BRTT5024x or BRTT5030x storage towers

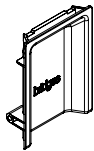

Above Worksurface Power Trough

BRTEETEC	.5 x 2.25 x 3	70	.10	.01	\$12
----------	---------------	----	-----	-----	-------------

Covers the end of the worksurface power trough. Specify two per linear trough assembly. White finish only.

Required Specifications

Metal Finish (Power/Data Troughs)

ELECTRICAL COMPONENTS

MODEL# DIMENSIONS FREIGHT CLASS WT./LBS. CUBIC FT. LIST PRICE

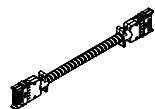

Housing to Housing Harness

	D x W x H					
BRTEHH28	.5 x 28 x 2	70	1	1.17		\$179
BRTEHH40	.5 x 40.5 x 2	70	1.10	1.25		\$191
BRTEHH44	.5 x 44.5 x 2	70	1.5	1.17		\$206
BRTEHH52	.5 x 52.5 x 2	300	2.0	1.17		\$217
BRTEHH58	.5 x 58.5 x 2	300	2.2	1.17		\$226
BRTEHH76	.5 x 76.5 x 2	250	2.8	1.17		\$252

Distributes power between Power Distribution Housings.

- BRTEHH28 distributes power between back-to-back or single sided troughs in a straight run.
- BRTEHH40 distributes power from back-to-back to single sided power troughs
- BRTEHH44 distributes power between back-to-back power troughs separated by (1) pair of storage cabinets without wardrobes. Specify BRTEST15KIT separately.
- BRTEHH52 distributes power from back-to-back power troughs separated by (1) pair of storage cabinets with wardrobes. Specify BRTEST24KIT separately.
- BRTEHH58 distributes power from back-to-back power troughs separated by (2) pairs of storage cabinets without wardrobes. Specify BRTEST30KIT separately.
- BRTEHH58 also distributes power from double-sided, back-to-back below worksurface power troughs to a single sided, below worksurface power trough at the end of a table run.
- BRTEHH76 distributes power from back-to-back power troughs separated by (2) pairs of storage cabinets with wardrobes. Specify BRTEST48KIT separately.

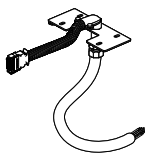

Base Feed

BRTEBF	6 x 4 x 72	250	4	2		\$578
BRTEBF120	6 x 4 x 120	250	6	2		\$805
BRTEBF144	6 x 4 x 144	150	8	2		\$865

Provides single power entry from floor or wall located building power supply. Connects to Power Distribution Housing. Must be hard wired to the building power supply by a licensed electrician.

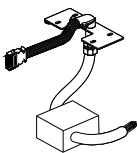

Base Feed - New York Electrical

BRTEBFK	6 x 4 x 100	250	4	2		\$907
---------	-------------	-----	---	---	--	--------------

Provides single power entry from floor or wall located building power supply. Connects to Power Distribution Housing. Must be hard wired to the building power supply by a licensed electrician.



Ceiling Pole

BRTCPP	1.5 x 4.75 x 99	65	13	.48		\$314
--------	-----------------	----	----	-----	--	--------------

Brings ceiling feed conduit and data cables from the ceiling down to Power Troughs at desk height. Accommodates 10' ceiling heights. Two part construction allows power/data conduit lay-in. Attaches to a junction between two adjacent Power Troughs in back-to-back applications only. Not for use on single sided Bridges II troughs. Includes mounting hardware and ceiling bezel. Painted Finish.

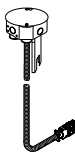

Ceiling Feed

BRTECF120	6 x 6 x 120	250	5	2		\$476
BRTECF144	6 x 6 x 144	250	5	2		\$530

Provides single power entry from ceiling, through ceiling pole into Power Trough, into Power Distribution Module. An 8 wire (4 circuit) metal conduit harness with included metal junction box for hard wiring to the building power supply above ceiling tile. Must be hard wired to the building power supply by a licensed electrician. Ceiling Pole not included.

Required Specifications

Metal Finish (BRTCPP)

ELECTRICAL COMPONENTS

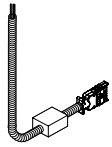

Ceiling Feed - New York Electrical

MODEL#	DIMENSIONS D x W x H	FREIGHT CLASS	WT./LBS.	CUBIC FT.	LIST PRICE
BRTECFK120	6 x 6 x 120	250	5	2	\$712
BRTECFK144	6 x 6 x 144	250	5	2	\$790

Provides single power entry from ceiling, through ceiling pole into Power Trough, into Power Distribution Module. An 8 wire (4 circuit) metal conduit harness with included metal junction box for hard wiring to the building power supply above ceiling tile. Must be hard wired to the building power supply by a licensed electrician. Ceiling Pole not included.

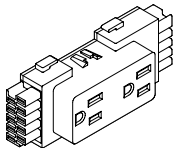

Duplex Receptacles

BRTE8D1	1.25 x 4.63 x 2	70	.10	.01	\$45
BRTE8D2	1.25 x 4.63 x 2	70	.10	.01	\$45
BRTE8DA	1.25 x 4.63 x 2	70	.10	.01	\$45
BRTE8DB	1.25 x 4.63 x 2	70	.10	.01	\$45
BRTE8DXW1	1.25 x 4.63 x 2	70	.10	.01	\$63
BRTE8DXW2	1.25 x 4.63 x 2	70	.10	.01	\$63
BRTE8DXWA	1.25 x 4.63 x 2	70	.10	.01	\$63
BRTE8DXWB	1.25 x 4.63 x 2	70	.10	.01	\$63

Snaps into Power Distribution Housing. Up to 13 duplex receptacles per circuit XW identifies white color plastic, all others standard in black.

- BRTE8D1 / BRTE8DXW1 - Circuit #1 (utility circuit)
- BRTE8D2 / BRTE8DXW2 - Circuit #2 (utility circuit)
- BRTE8DA / BRTE8DXWA - Circuit A (dedicated circuit)
- BRTE8DB / BRTE8DXWB - Circuit B (dedicated circuit)

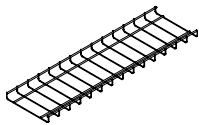

Power/Data Cable Basket

BRTCB76KIT	8 x 34 x 1	70	1.56	.15	\$281
BRTCB70	8 x 70 x 1	100	3.22	.34	\$204
BRTCB64	8 x 64 x 1	92.5	2.94	.29	\$190
BRTCB58	8 x 58 x 1	92.5	2.66	.26	\$184
BRTCB52	8 x 52 x 1	100	2.39	.24	\$173
BRTCB46	8 x 46 x 1	92.5	2.16	.21	\$163
BRTCB40	8 x 40 x 1	70	1.80	.18	\$155
BRTCB34	8 x 34 x 1	70	1.56	.15	\$149
BRTCB28	8 x 28 x 1	70	1.20	.13	\$131
BRTCB22	8 x 22 x 1	70	1.01	.10	\$123
BRTCB16	8 x 16 x 1	70	.73	.07	\$116
BRTCB8	8 x 8 x 1	70	.36	.03	\$104

Shallow, 8" wide basket manages cable excess and serves to manage cords and cables. It can be easily unclipped from spring steel brackets (included) to rearrange cable connections from below worksurface. Spring steel brackets can suspend the Cable Basket below storage cabinet's bottom where it keeps the cords and cables off the floor and manages them under storage cabinets along the horizontal plane - between floor monuments and Storage Vertical Cable Manager, for example. Tall storage cabinet's legs provide easy access to the Cable Basket where it can easily be unclipped from spring steel brackets to rearrange cable connections. Steel wire construction, chrome finish baskets; black spring steel hanging brackets, fasteners.

- Wide Cable Baskets can span under several storage cabinets. Specify Cable Basket a min. 8" shorter than the storage cabinet spine assembly.

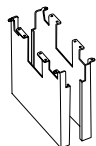

34" Leg Shroud

BRTDLSHS34	5 x 30 x 29	92.5	62	5.25	\$575
------------	-------------	------	----	------	--------------

A two part steel enclosure creates 5" deep and 30" wide cable management cavity between 34" rectangular table legs. Hides floor power feeds as well as data/communication cables rising from floor monuments to the underside of Bridges II tables. Secures to BRTBA34L rectangular leg and to underside of worksurfaces. Specify powder coat finish.

Required Specifications
Metal Finish (BRTDLSHS34)

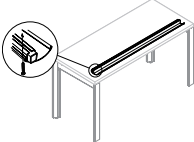
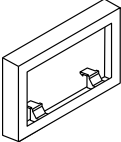
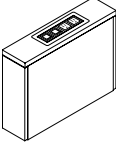
ELECTRICAL COMPONENTS	MODEL#	DIMENSIONS	FREIGHT CLASS	WT/LBS.	CUBIC FT.	LIST PRICE
 <p>Cable Snake</p>		D x W x H				
	BRTCS	2 x 8 x 30	70	3	.19	\$162
Flexible cable management trough. Two pathways within the snake, one for data/communication and one for routing power cables. Translucent White finish only.						
 <p>Wire Manager</p>	BRTCM43	46 x 5 x 3	92.5	8	.67	\$67
	BRTCM55	58 x 5 x 3	92.5	9	.85	\$77
Replacement wire manager can be added. Wire Manager neatly organizes and stores electrical and communication cables. Two lengths: 46" for tops 60" and under; 58" for tops 72". Black Plastic only.						
 <p>Data/Comm Spacer</p>	BRTPDS	.6 x 4.75 x 2.04	70	.10	.01	\$63
	BRTPDSW	.6 x 4.75 x 2.04	70	.10	.01	\$63
	BRTPDSS	.6 x 4.75 x 2.04	70	.10	.01	\$63
Data/Comm plate spacer extends the depth behind data/comm jacks by 0.6" in order to accommodate larger data/comm cable bending radius. BRTPDS is Black, BRTPDSW is White and BRTPDSS is Silver.						
 <p>Vertical Cable Manager*</p>	BRTVCM2118	18 x 6 x 21	92.5	14	1.31	\$1139
	BRTVCM2518	18 x 6 x 25	92.5	17	1.56	\$1162
	BRTVCM2124	24 x 6 x 21	100	17	1.75	\$1203
	BRTVCM2524	24 x 6 x 25	92.5	22	2.08	\$1222
Facilitates power/data transfer from a floor monument under storage cabinets. The units can join other 18" or 24" deep storage units to form a storage spine. Removable top with a Below worksurface Power/Data Module provides easy access. Optional cable basket suspends off storage unit's bottom and manages cables along the horizontal plane. 1" top, unfinished cut-out edges. Universal connecting hardware included. Below Worksurface Power/Data Module included. Provides power - two outlets; 72"L 3-prong power cord. White face plate, outlets and coupler & jack adapters; anodized aluminum bracket supports; thumb screws, black cord. Provides data - two coupler/jack ports; includes Voice/Data Adapter Kit to accept various couplers & jacks (Not Included).						

ACCESSORIES / TABLE DIVIDERS	MODEL#	DIMENSIONS	FREIGHT CLASS	WT./LBS.	CUBIC FT.	LIST PRICE
------------------------------	--------	------------	---------------	----------	-----------	------------

- 9mm thick panels offered in 18 finishes
- Made from 100% PET (polyester) fiber with a high content (50%) of post-recycled material, free of added chemicals, binders and adhesives
- Lightweight panels are tackable, impact and tear resistant, bacteria resistant, moisture resistant, and installation friendly
- Variation in fiber mix and color are inherent to the character of the product

BRACKET/EXTRUSION FINISH

BRACKET/EXTRUSION FINISH	BRACKET/EXTRUSION FINISH	BRACKET/EXTRUSION FINISH	BRACKET/EXTRUSION FINISH
BLK	Black	CHR	Charcoal
DWT	Designer White	FOG	Fog
NEV	Nevada	SIL	Silver
TPE	Taupe	TUN	Tungsten
ANO	Anodized Aluminum - upcharge applies. <i>Available on select models only. Refer to model for availability and upcharge.</i>		

FELT COLORS

(AMT) Amethyst	(APR) Apricot
(BLK) Black	(BSK) Blue Smoke
(BRI) Brick	(CNN) Carnation
(DEN) Denim	(EMD) Emerald
(GPH) Graphite	(HVT) Harvest
(LAP) Lapis	(MTS) Mist
(NVY) Navy	(PWT) Pewter
(RBY) Ruby	(SHR) Shamrock
(SFR) Sunflower	(WHT) White

FELT DIVIDERS	MODEL#	DIMENSIONS	FREIGHT CLASS	WT./LBS.	CUBIC FT.	LIST PRICE
---------------	--------	------------	---------------	----------	-----------	------------

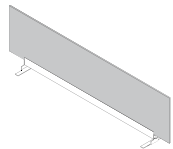

Back-to-Back Parallel Felt Divider

BRTAFDD84	7.5 x 81 x 16.88	125	6.30	1	\$757
BRTAFDD78	7.5 x 75 x 16.88	125	5.90	.92	\$722
BRTAFDD72	7.5 x 69 x 16.88	125	5.40	.85	\$687
BRTAFDD66	7.5 x 63 x 16.88	125	5	.77	\$651
BRTAFDD60	7.5 x 57 x 16.88	125	4.60	.70	\$615
BRTAFDD54	7.5 x 51 x 16.88	125	4.10	.63	\$582
BRTAFDD48	7.5 x 45 x 16.88	125	3.70	.55	\$409
BRTAFDD42	7.5 x 39 x 16.88	125	3.20	.48	\$363
BRTAFDD36	7.5 x 33 x 16.88	125	2.80	.41	\$325

Secures between two back-to-back tables; provides privacy, divides space. 9mm felt material is tackable. Installed divider measures 15.7" from the top of the worksurface. Available in 9 PET felt colors. Please specify. Brackets and extrusion available in all standard Bridges II paint finishes. 36" - 72" wide dividers include 2 support brackets. 78" and 84" wide dividers include 3.

- Anodized Aluminum extrusion - Add **\$175** list upcharge

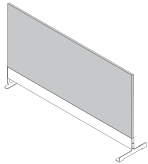

Perpendicular Side to Side Off Module Felt Divider

BRTAFPPD30M	6.5 x 30.24 x 16.85	100	2.60	.27	\$308
BRTAFPPD24M	6.5 x 24.24 x 16.85	100	2.10	.22	\$273

Secures off module to front and back edges of a table; provides privacy, divides space. 9mm felt material is tackable. 24M and 30M kits are designed to be installed on tables with **recessed** legs (round legs, 34" rectangular legs). Cannot be installed at the end of a run. Installed divider measures 15.7" from the top of the worksurface. Available in 9 PET felt colors. Please specify. Brackets and extrusion available in all standard Bridges II paint finishes.

- Anodized Aluminum extrusion - Add **\$175** list upcharge

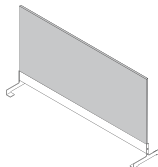

Perpendicular Side to Side Felt Divider

BRTAFPPD63S	6.5 x 62.81 x 16.85	100	4.20	.46	\$639
BRTAFPPD51S	6.5 x 50.81 x 16.85	100	4.20	.46	\$570
BRTAFPPD30S	6.5 x 30.24 x 16.85	92.5	2.70	.27	\$316
BRTAFPPD24S	6.5 x 24.24 x 16.85	92.5	2.30	.22	\$281

Secures to the front edge of both worksurfaces, regardless of type of leg support - supporting brackets can straddle over shared leg; provides privacy, divides space. 9mm felt material is tackable. Cannot be installed at the end of a run. Installed divider measures 15.7" from the top of the worksurface. Available in 9 PET felt colors. Please specify. Brackets and extrusion available in all standard Bridges II paint finishes.

- Anodized Aluminum extrusion - Add **\$175** list upcharge

Required Specifications

- Top finish*
- Edge finish*
- Chassis finish*

FELT DIVIDERS

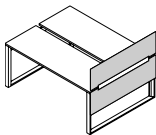
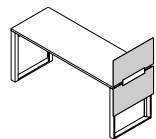
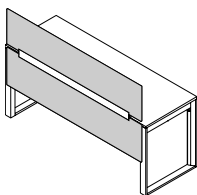
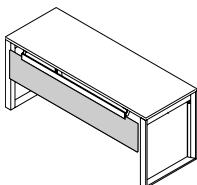
**End of Run Felt Divider & Modesty Kit*****Felt Divider & Modesty Panel Kit*****Felt Modesty Panel**

MODEL#	DIMENSIONS	FREIGHT CLASS	WT/LBS.	CUBIC FT.	LIST PRICE
--------	------------	---------------	---------	-----------	------------

D x W x H

BRTAFEDN24	4.05 x 25.46 x 30.68	250	3.3	1.12	\$472
BRTAFEDN30	4.05 x 31.46 x 30.68	250	3.98	1.29	\$530
BRTAFEDN51	4.05 x 50.56 x 30.68	150	6.22	1.46	\$972
BRTAFEDN63	4.05 x 62.56 x 30.68	150	7.57	1.63	\$1107

Secures to the side bottom of a single or back-to-back table; provides privacy above and below the worksurface. 9mm felt material is tackable. Installed divider measures 15.7" from the top of the worksurface and 15" below the worksurface. Kit includes two felt dividers, support extrusion and left and right brackets. Available in 9 PET felt colors. Please specify. Brackets and extrusion available in all standard Bridges II paint finishes.

BRTAFDSN84	4.05 x 78 x 30.68	125	9.24	1.2	\$1322
BRTAFDSN78	4.05 x 72 x 30.68	125	8.57	1.11	\$1259
BRTAFDSN72	4.05 x 69 x 30.68	125	7.89	1.02	\$1198
BRTAFDSN66	4.05 x 63 x 30.68	125	7.21	0.93	\$1043
BRTAFDSN60	4.05 x 57 x 30.68	125	6.54	0.84	\$996
BRTAFDSN54	4.05 x 51 x 30.68	125	5.87	0.74	\$936
BRTAFDSN48	4.05 x 45 x 30.68	125	5.19	0.65	\$774

Secures to the rear bottom of a single table; provides privacy above and below the worksurface. 9mm felt material is tackable. Installed divider measures 15.7" from the top of the worksurface and 15" below the worksurface. Kit includes two felt dividers, support extrusion and left and right brackets. Available in 9 PET felt colors. Please specify. Brackets and extrusion available in all standard Bridges II paint finishes.

- 66" - 84" dividers require 3 support brackets and cannot be used with worksurfaces that have a single access door.

BRTAFMPSN84	4.17 x 77.75 x 13.82	65	31.12	1.2	\$565
BRTAFMPSN78	4.17 x 71.75 x 13.82	65	28.72	1.11	\$535
BRTAFMPSN72	4.17 x 65.75 x 13.82	65	26.32	1.02	\$507
BRTAFMPSN66	4.17 x 59.75 x 13.82	65	23.92	0.93	\$479
BRTAFMPSN60	4.17 x 53.75 x 13.82	65	21.51	0.84	\$451
BRTAFMPSN54	4.17 x 47.75 x 13.82	65	19.11	0.74	\$432
BRTAFMPSN48	4.17 x 41.75 x 13.82	65	16.71	0.65	\$317

Secures to the rear bottom of a single table; provides privacy below the worksurface. 9mm felt material is tackable. Installed divider measures 15" below the worksurface. Kit includes felt modesty, support extrusion and left and right brackets. Available in 9 PET felt colors. Please specify. Brackets and extrusion available in all standard Bridges II paint finishes.

- 66" - 84" dividers require 3 support brackets and cannot be used with worksurfaces that have a single access door.

Required Specifications

Felt color
Bracket/extrusion finish

Optional Specifications

Anodized extrusion

TABLE DIVIDERS

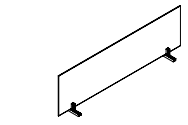

36" - 72"

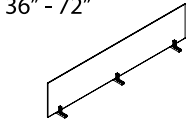

78" - 84"

Table Divider - Glass

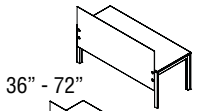

36" - 72"

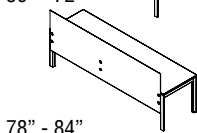

78" - 84"

Parallel Table Divider - Glass

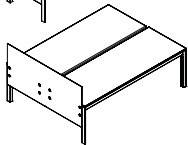
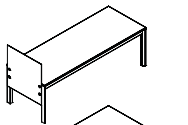

Perpendicular End of Run Divider - Glass

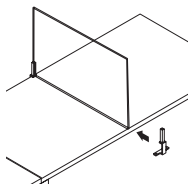

Shared Perpendicular Side to Side Divider, Middle - Glass, Rounded Corners

MODEL#	DIMENSIONS D x W x H	FREIGHT CLASS	WT/LBS.	CUBIC FT.	LIST PRICE
BRTAGDD84	.25 x 81 x 16	60	29	.18	\$925
BRTAGDD78	.25 x 75 x 16	60	27	.17	\$873
BRTAGDD72	.25 x 69 x 16	60	25	.16	\$749
BRTAGDD66	.25 x 63 x 16	60	23	.14	\$698
BRTAGDD60	.25 x 57 x 16	60	21	.13	\$644
BRTAGDD54	.25 x 51 x 16	60	18	.11	\$615
BRTAGDD48	.25 x 45 x 16	60	16	.10	\$565
BRTAGDD42	.25 x 39 x 16	60	14	.09	\$521
BRTAGDD36	.25 x 33 x 16	60	12	.07	\$471

Secures between two back-to-back tables; provides privacy, divides space. Installed divider measures 15.7" from the top of the worksurface. 36" - 72" wide dividers include 2 support brackets. 78" and 84" wide dividers include 3. Frosted tempered glass. Satin chrome lower bracket, upper is available in all standard Bridges II paint finishes.

BRTAGDS84	.25 x 81 x 32	60	55	.35	\$1763
BRTAGDS78	.25 x 75 x 32	60	51	.33	\$1676
BRTAGDS72	.25 x 69 x 32	60	47	.30	\$1403
BRTAGDS66	.25 x 63 x 32	60	43	.28	\$1319
BRTAGDS60	.25 x 57 x 32	60	39	.25	\$1234
BRTAGDS54	.25 x 51 x 32	60	35	.23	\$1152
BRTAGDS48	.25 x 45 x 32	60	31	.20	\$1065
BRTAGDS42	.25 x 39 x 32	60	27	.18	\$981
BRTAGDS36	.25 x 33 x 32	60	23	.15	\$899

Secures to the rear edge of a single table; provides privacy, divides space while not obstructing available light. 36" - 72" wide dividers include 2 support brackets. 78" and 84" wide dividers include 3. Frosted tempered glass. Satin chrome lower bracket, upper is available in all standard Bridges II paint finishes.

BRTAGED63	.25 x 62.5 x 32	60	35	.23	\$1848
BRTAGED51	.25 x 50.5 x 32	60	31	.20	\$1676
BRTAGED30	.25 x 30 x 32	60	27	.18	\$940
BRTAGED24	.25 x 24 x 32	60	23	.15	\$858

Secures to the rear edge of a single or double back-to-back table; provides privacy, divides space while not obstructing available light. Installed divider reaches 15.7" from the top of the worksurface and 15" below the worksurface. Rounded front top corner of 24" and 30" deep glass dividers. 51" and 63" glass dividers for back-to-back tables have both top corners rounded. 24" and 30" wide dividers include 2 support brackets; 51" and 63" wide dividers include 3. Frosted tempered glass. Satin chrome lower bracket, upper is available in all standard Bridges II paint finishes.

BRTAGPPD24M	.25 x 24 x 16	60	9	.06	\$538
BRTAGPPD30M	.25 x 30 x 16	60	11.25	.07	\$566

Provides privacy, divides space while not obstructing available light. 24M and 30M kits are designed to be installed on tables with **recessed** legs (round legs, 34" rectangular legs). 24" and 30" kits consist of a wide rear bracket, narrow front bracket (white powder coated steel), tempered glass with **rounded** top corners (acid etched on one side), bracket-fitting gaskets and mounting screws securing the brackets to the underside of the worksurface. Satin chrome lower bracket, upper is available in all standard Bridges II paint finishes.

Required Specifications

Bracket finish

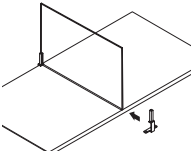
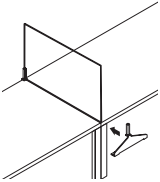
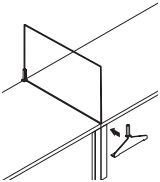
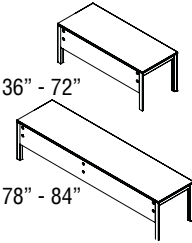
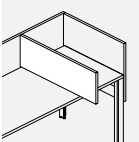
TABLE DIVIDERS	MODEL#	DIMENSIONS	FREIGHT CLASS	WT./LBS.	CUBIC FT.	LIST PRICE
 <p>Shared Perpendicular Side to Side Divider, Middle - Glass, Square Corners</p>		D x W x H				
	BRTAGPPD24MQ	.25 x 24 x 16	60	9	.06	\$538
	BRTAGPPD30MQ	.25 x 30 x 16	60	11.25	.07	\$566
 <p>Shared Perpendicular Side to Side Divider, Seam - Glass, Rounded Corners</p>						
	BRTAGPPD24S	.25 x 24 x 16	60	9	.05	\$538
	BRTAGPPD30S	.25 x 30 x 16	60	11.25	.07	\$566
 <p>Shared Perpendicular Side to Side Divider, Seam - Glass, Square Corners</p>						
	BRTAGPPD24SQ	.25 x 24 x 16	60	9	.05	\$538
	BRTAGPPD30SQ	.25 x 30 x 16	60	11.25	.07	\$566
 <p>Modesty Panel - Glass</p> <p>36" - 72" 78" - 84"</p>	BRTAGMPS84	.25 x 77.75 x 13.25	60	24	.14	\$1152
	BRTAGMPS78	.25 x 71.75 x 13.25	60	22	.13	\$1110
	BRTAGMPS72	.25 x 65.75 x 13.25	60	20	.12	\$878
	BRTAGMPS66	.25 x 59.75 x 13.25	60	19	.11	\$835
	BRTAGMPS60	.25 x 53.75 x 13.25	60	17	.10	\$793
	BRTAGMPS54	.25 x 47.75 x 13.25	60	15	.09	\$752
	BRTAGMPS48	.25 x 41.75 x 13.25	60	11	.06	\$711
	BRTAGMPS42	.25 x 35.75 x 13.25	60	11	.06	\$666
	BRTAGMPS36	.25 x 29.75 x 13.25	60	9	.05	\$626
	 <p>Perpendicular Laminate Side to Side Divider - Extended*</p>					
BRTLPE36		.75 x 36 x 16	60	11	.25	\$321
	BRTLPE30	.75 x 30 x 16	60	9	.21	\$280

Provides privacy, divides space while not obstructing available light. 24M and 30M kits are designed to be installed on tables with **recessed** legs (round legs, 34" rectangular legs). 24" and 30" kits consist of a wide rear bracket, narrow front bracket (white powder coated steel), tempered glass with **square** top corners (acid etched on one side), bracket-fitting gaskets and mounting screws securing the brackets to the underside of the worksurface. Brackets are available in all standard Bridges II paint finishes.

Provides privacy, divides space while not obstructing available light. 24S and 30S kits are designed to be installed in the middle or over a seam of two adjacent worksurfaces supported by a shared, full depth **rectangular** leg. 24S and 30S kits consist of two wide rear brackets, wide front bracket, tempered glass with **rounded** top corners (acid etched on one side), bracket-fitting gaskets and mounting screws securing the brackets to the underside of the worksurface. Brackets are available in all standard Bridges II paint finishes.

Provides privacy, divides space while not obstructing available light. 24S and 30S kits are designed to be installed in the middle or over a seam of two adjacent worksurfaces supported by a shared, full depth **rectangular** leg. 24S and 30S kits consist of two wide rear brackets, wide front bracket, tempered glass with **square** top corners (acid etched on one side), bracket-fitting gaskets and mounting screws securing the brackets to the underside of the worksurface. Brackets are available in all standard Bridges II paint finishes.

Secures to the rear edge of a single table, between table legs; provides privacy. Installed divider reaches 15" below the worksurface. 36" - 72" wide modesty panels include 2 mounting brackets. 78" and 84" wide modesty panels include 3 mounting brackets. Tempered glass, acid etched on one side (similar to frosted), and satin chrome disc fasteners. Brackets are available in all standard Bridges II paint finishes.

Protrudes by 6" beyond the front worksurface edge for added privacy. Secures off-module or on-module to the front and back edge of worksurface, regardless of type of leg support - supporting brackets can straddle over shared leg. 3/4" LP PVC edge boards. Brackets are available in all standard Bridges II paint finishes.

- Specify BRTLPE30 for 24"d worksurfaces and BRTLPE36 for 30"d worksurfaces

Required Specifications

Chassis/Accent Finish*

Bracket finish

Edge finish*

TABLE DIVIDERS

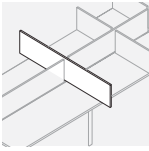

Perpendicular Laminate Side to Side Double Divider - Extended

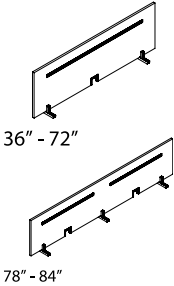
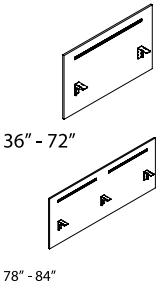
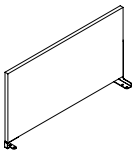

Table Divider - Laminate



High Table Divider - Laminate



High Perpendicular Side-to-Side Divider - Laminate

MODEL#	DIMENSIONS D x W x H	FREIGHT CLASS	WT/LBS.	CUBIC FT.	LIST PRICE
BRTLDPSE75	.75 x 75 x 16	60	22	.52	\$573
BRTLDPSE63	.75 x 63 x 16	60	18	.44	\$515

Protrudes by 6" beyond the front worksurface edge for added privacy. Installs on-module, between two BRTLPPD dividers. It is secured to the front edge of both worksurfaces, regardless of type of leg support - supporting brackets can straddle over shared leg. Brackets are available in all standard Bridges II paint finishes. 3/4" LP PVC edge boards.

- Can ONLY be installed on-module between two BRTLPPD dividers.
- Specify BRTLDPSE63 for 24"d back-to-back worksurfaces and BRTLDPSE75 for 30"d back-to-back worksurfaces

BRTLPPD84	.75 x 81 x 16	60	24	.56	\$697
BRTLPPD78	.75 x 75 x 16	60	23	.52	\$674
BRTLPPD72	.75 x 69 x 16	60	21	.47	\$537
BRTLPPD66	.75 x 63 x 16	60	19	.43	\$503
BRTLPPD60	.75 x 57 x 16	60	17	.39	\$480
BRTLPPD54	.75 x 51 x 16	60	15	.35	\$460
BRTLPPD48	.75 x 45 x 16	60	14	.31	\$434
BRTLPPD42	.75 x 39 x 16	60	12	.27	\$404
BRTLPPD36	.75 x 33 x 16	60	10	.22	\$367

Secures between two back-to-back tables; provides privacy, divides space. Installed divider measures 15.7" from the top of the worksurface. 36" - 72" wide dividers include 2 support brackets and one pass-through grommet. 78" and 84" wide dividers include 3 support brackets and 2 pass-through grommets. 3/4" PVC edged boards. Integrated anodized aluminum accessory rail, white cut out and rail trims. Brackets are available in all standard Bridges II paint finishes.

- Please refer to the **Compatibility Guide** on page 490 to determine available accessories

BRTLPPDS84	.75 x 81 x 32	60	50	1.16	\$1090
BRTLPPDS78	.75 x 75 x 32	60	47	1.08	\$1046
BRTLPPDS72	.75 x 69 x 32	60	43	1	\$856
BRTLPPDS66	.75 x 63 x 32	60	40	.91	\$811
BRTLPPDS60	.75 x 57 x 32	60	36	.83	\$765
BRTLPPDS54	.75 x 51 x 32	60	32	.75	\$708
BRTLPPDS48	.75 x 45 x 32	60	29	.66	\$674
BRTLPPDS42	.75 x 39 x 32	60	25	.56	\$628
BRTLPPDS36	.75 x 33 x 32	60	22	.50	\$514

Installed on one side only. Secures to the back of a single table; provides privacy, divides space. Installed divider measures 15.7" from the top of the worksurface and 15" below the worksurface. 36" - 72" wide dividers include 2 support brackets. 78" and 84" wide dividers include 4 support brackets. 3/4" self edged boards. Integrated anodized aluminum accessory rail, white cut out and rail trims. Brackets are available in all standard Bridges II paint finishes. Integrated modesty panel.

- Please refer to the **Compatibility Guide** on page 490 to determine available accessories

BRTLPPD24	.75 x 24 x 16	60	7	.16	\$255
BRTLPPD30	.75 x 30 x 16	60	9	.20	\$277

Secures off-module to front and back edges of a table; provides privacy, divides space. Can be installed anywhere along worksurface or over the seam of two adjacent worksurfaces. Cannot be installed at the end of a run. Installed divider measures 15.7" from the top of the worksurface. 3/4" self edged boards. Brackets are available in all standard Bridges II paint finishes.

Required Specifications

Chassis/Accent finish
Bracket finish
Edge finish

TABLE DIVIDERS

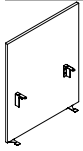

**Perpendicular End of Run Divider,
Laminate***

MODEL#	DIMENSIONS	FREIGHT CLASS	WT/LBS.	CUBIC FT.	LIST PRICE
--------	------------	---------------	---------	-----------	------------

D x W x H

BRTLPE24	.75 x 24 x 32	60	7	.16	\$405
BRTLPE30	.75 x 30 x 32	60	9	.20	\$434
BRTLPE51	.75 x 50.5 x 32	60	15	.35	\$684
BRTLPE63	.75 x 62.5 x 32	60	19	.43	\$776

Secures to the side edge of a table; provides privacy, divides space. Installed divider measures 15.7" from the top of the worksurface and 15" below the worksurface. Integrated modesty panel. 3/4" self edged boards. Brackets are available in all standard Bridges II paint finishes. For Rectangular leg only.

- BRTLPE51 divider matches 24" deep back-to-back assemblies
- BRTLPE63 divider matches 30" deep back-to-back assemblies

MODESTY PANEL

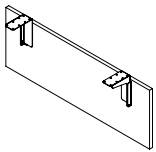

Laminate Modesty Panel*

MODEL#	DIMENSIONS	FREIGHT CLASS	WT/LBS.	CUBIC FT.	LIST PRICE
--------	------------	---------------	---------	-----------	------------

BRTMPS84	.75 x 78.5 x 14	60	22	.51	\$615
BRTMPS78	.75 x 72.5 x 14	60	20	.47	\$593
BRTMPS72	.75 x 66.5 x 14	60	19	.43	\$572
BRTMPS66	.75 x 60.5 x 14	60	17	.40	\$551
BRTMPS60	.75 x 54.5 x 14	60	16	.36	\$532
BRTMPS54	.75 x 48.5 x 14	60	14	.32	\$512
BRTMPS48	.75 x 42.5 x 14	60	13	.29	\$489
BRTMPS42	.75 x 36.5 x 14	60	11	.25	\$471
BRTMPS36	.75 x 30.5 x 14	60	9	.21	\$448

Secures to the back edge of a table; provides privacy, divides space. Installed divider measures 15" below the worksurface. 3/4" self edged boards. Flips down for easy access to underside of worksurface. Brackets are available in all standard Bridges II paint finishes.

Required Specifications

Chassis/Accent finish
Bracket finish
Edge finish

ACCESSORIES

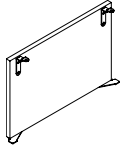

Laminate End of Run Gable*

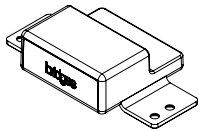
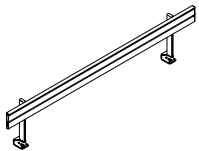
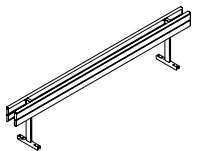

Table End Gap Filler



Single Table Accessory Rail



Back-To-Back Accessory Rail

MODEL#	DIMENSIONS D x W x H	FREIGHT CLASS	WT./LBS.	CUBIC FT.	LIST PRICE
BRTPEG24	.75 x 24 x 14	60	6	.14	\$264
BRTPEG24H21	.75 x 24 x 20.5	60	9	.21	\$305
BRTPEG24H27	.75 x 24 x 26.5	60	12	.26	\$356
BRTPEG30	.75 x 30 x 14	60	8	.18	\$284
BRTPEG30H21	.75 x 30 x 20.5	60	12	.26	\$324
BRTPEG30H27	.75 x 30 x 26.5	60	15	.33	\$378
BRTPEG51	.75 x 50.5 x 14	60	13	.30	\$460
BRTPEG51H21	.75 x 50.5 x 20.5	60	20	.43	\$556
BRTPEG51H27	.75 x 50.5 x 26.5	60	26	.56	\$644
BRTPEG63	.75 x 62.5 x 14	60	16	.38	\$500
BRTPEG63H21	.75 x 62.5 x 20.5	60	25	.53	\$595
BRTPEG63H27	.75 x 62.5 x 26.5	60	32	.69	\$684

Perpendicular end of a run gable. Secures to the side edge of a table/tables and legs; provides privacy, divides space. ¾" self edged boards. Brackets are available in all standard Bridges II paint finishes. **For Rectangular leg only.**

- BRTPEG24, 30, 51 and 63 measure 15" below worksurface
- BRTPEGxxH21 lines up with the bottom of storage cabinets
- BRTPEGxxH27 reaches down 1" from the floor (creates full panel look)

BRTTEGF	4.5 x 2.5 x 1	70	.03	.01	\$18
---------	---------------	----	-----	-----	-------------

Injection molded block fills the gap finishing the end of back-to-back table assemblies. Secures to the bottom of two back-to-back worksurfaces. Injection molded resin, white.

BRLBST84	2.95 x 81 x 13.5	70	10.24	.61	\$584
BRLBST78	2.95 x 75 x 13.5	70	9.69	.56	\$567
BRLBST72	2.95 x 69 x 13.5	70	9.15	.52	\$550
BRLBST66	2.95 x 63 x 13.5	70	8.61	.48	\$532
BRLBST60	2.95 x 57 x 13.5	70	8.07	.43	\$514
BRLBST54	2.95 x 51 x 13.5	70	7.52	.39	\$503
BRLBST48	2.95 x 45 x 13.5	70	6.98	.35	\$485
BRLBST42	2.95 x 39 x 13.5	70	6.44	.30	\$468
BRLBST36	2.95 x 33 x 13.5	65	5.90	.26	\$445

Table mounted accessory rail. Compatible with standard accessories. Includes end caps and mounting hardware.

BRLBB2B84	7.50 x 81 x 13.5	65	17.69	.74	\$963
BRLBB2B78	7.50 x 75 x 13.5	65	16.61	.69	\$928
BRLBB2B72	7.50 x 69 x 13.5	65	15.52	.63	\$894
BRLBB2B66	7.50 x 63 x 13.5	65	14.44	.58	\$860
BRLBB2B60	7.50 x 57 x 13.5	65	13.36	.53	\$826
BRLBB2B54	7.50 x 51 x 13.5	65	12.27	.48	\$801
BRLBB2B48	7.50 x 45 x 13.5	65	11.19	.42	\$765
BRLBB2B42	7.50 x 39 x 13.5	65	10.10	.37	\$731
BRLBB2B36	7.50 x 33 x 13.5	65	9.02	.32	\$688

Table mounted accessory rail. Compatible with standard accessories. Includes end caps and mounting hardware.

Required Specifications

- Chassis/Accent finish*
- Edge finish*
- Bracket finish*

FRAMED DIVIDERS

D x W x H

Single Table Or Single Table Row Application; 16" and 30" high dividers

Table Mounted Framed Divider for single table or single table row; recessed 1.5" at both ends, mounted to the table with 0.6" gap at the back.
 BRTMFD/BRTMLD 36" (33" actual) - 66" (63" actual) dividers have 2 mounting brackets.
 BRTMFD/BRTMLD 72" (69" actual) - 84" (81" actual) dividers have 3 mounting brackets.

Perpendicular Single Table End of Run Framed Divider;
 BREFD/BRELD 24" (21" actual for 24" deep work surfaces),
 BREFD/BRELD 30" (27" actual for 30" deep work surfaces),
 BREFD/BRELD 36" (33" actual for 36" deep work surfaces),

Two brackets secure the divider to the side edge of work surface. Flush with rear edge, 3" recessed from front work surface edge.

Perpendicular Shared Framed Divider;
 BRSEFD/BRSLD 24" (21" actual for 24" deep work surfaces),
 BRSEFD/BRSLD 30" (27" actual for 30" deep work surfaces),
 BRSEFD/BRSLD 36" (33" actual for 36" deep work surfaces),

Single bracket secures the divider to the rear edge of worksurface; Can be mounted off-module or over the seam of two adjacent work surfaces. Flush with the rear edge, 3" recessed from front worksurface edge.

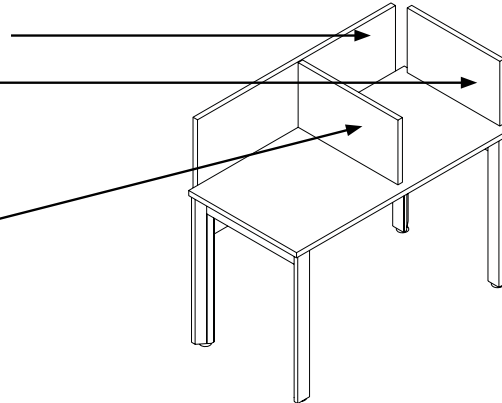

Back-To-Back Table Application; 16" dividers

Perpendicular Back 2 Back Parallel Framed Divider secured between two back-to-back tables; recessed 1.5" at both ends; 0.6" gap between the divider and work surfaces.
 BRPFDF/BRPLD 36" (33" actual) - 66" (63" actual) dividers have 2 mounting brackets.
 BRPFDF/BRPLD 72" (69" actual) - 84" (81" actual) dividers have 3 mounting brackets.

Perpendicular Shared Frame Back 2 Back Framed Divider;
 BRSEFD/BRSDLD 51" (45" actual for 24" deep back-to-back work surfaces)
 BRSEFD/BRSDLD 63" (57" actual for 30" deep back-to-back work surfaces).
 One bracket secures the divider through the gap between work surfaces; two brackets locate top of the divider between two adjacent Parallel dividers.
 NOTE: cannot be used on its own without the two Parallel dividers.
 3" recessed from front worksurface edges.

Perpendicular Back-To-Back End of Run Framed Divider;
 BREDFD/BREDLD 51" (45" actual for 24" deep back-to-back work surfaces)
 BREDFD/BREDLD 63" (57" actual for 30" deep back-to-back work surfaces).
 Three brackets secure the divider to both side edges of work surfaces.
 3" recessed from front worksurface edges.

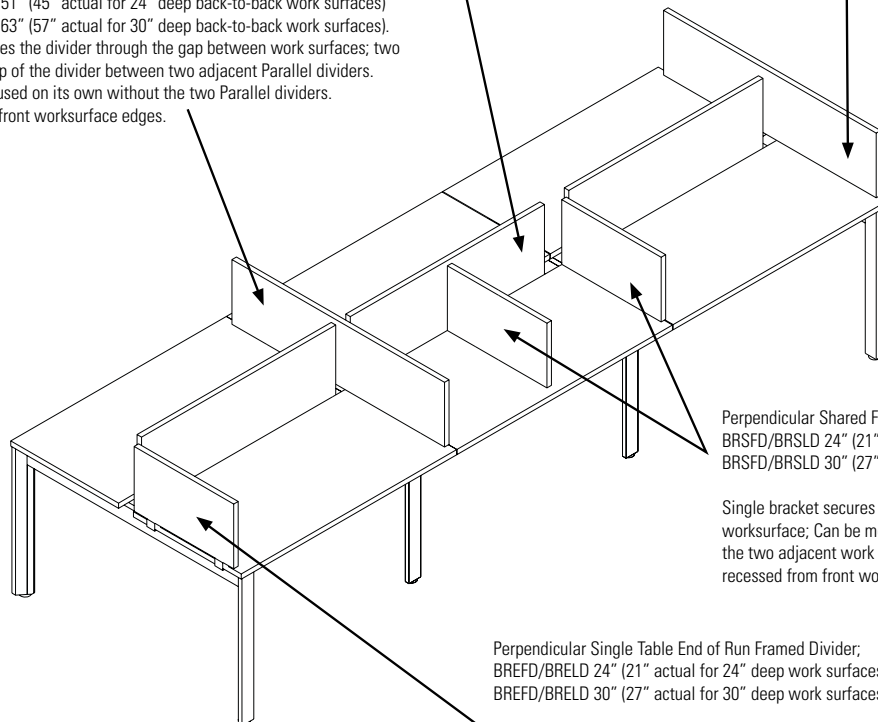

Perpendicular Shared Framed Divider;
 BRSEFD/BRSLD 24" (21" actual for 24" deep work surfaces).
 BRSEFD/BRSLD 30" (27" actual for 30" deep work surfaces).

Single bracket secures the divider to the rear edge of worksurface; Can be mounted off-module or over the seam of the two adjacent work surfaces. Flush with the rear edge, 3" recessed from front work surfaces edge.

Perpendicular Single Table End of Run Framed Divider;
 BREFD/BRELD 24" (21" actual for 24" deep work surfaces).
 BREFD/BRELD 30" (27" actual for 30" deep work surfaces).

Two brackets secure the divider to the side edge of work surface. Flush with the rear edge, 3" recessed from front work surface edge.

FRAMED DIVIDERS

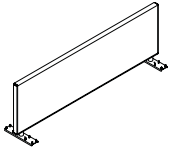

Back-to-Back Parallel Framed Divider Fabric

MODEL#	DIMENSIONS D x W x H	FREIGHT CLASS	WT/LBS.	CUBIC FT.	LIST PRICE
BRPFD84	1.25 x 81 x 16	70	32	1.95	\$966
BRPFD78	1.25 x 75 x 16	70	28	1.81	\$917
BRPFD72	1.25 x 69 x 16	70	24	1.57	\$906
BRPFD66	1.25 x 63 x 16	85	20	1.53	\$871
BRPFD60	1.25 x 57 x 16	92.5	15	1.39	\$821
BRPFD54	1.25 x 51 x 16	92.5	13	1.25	\$692
BRPFD48	1.25 x 45 x 16	85	11	.75	\$655
BRPFD42	1.25 x 39 x 16	100	9	.97	\$569
BRPFD36	1.25 x 33 x 16	100	8	.83	\$556

Secures to the underside of the worksurface. Fabric divider is tackable and always railroaded. Installed divider measures 15.7" from top of worksurface. 36" to 54" dividers include 2 support brackets. 60" to 84" dividers include 3 support brackets. Brackets are available in all standard Bridges II paint finishes.

- 60" - 84" dividers require 3 support brackets and cannot be used with worksurfaces that have a single access door

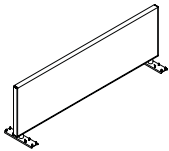

Back-to-Back Parallel Framed Divider*

					LIST PRICE	HP ADD	DE ADD	DM ADD
BRPLD84	1.25 x 81 x 16	70	32	2.25	\$679	\$342	\$777	\$1969
BRPLD78	1.25 x 75 x 16	70	28	2.08	\$667	\$309	\$778	\$1960
BRPLD72	1.25 x 69 x 16	70	24	1.92	\$660	\$277	\$777	\$1945
BRPLD66	1.25 x 63 x 16	85	20	1.75	\$637	\$288	\$648	\$1768
BRPLD60	1.25 x 57 x 16	92.5	15	1.58	\$615	\$238	\$657	\$1652
BRPLD54	1.25 x 51 x 16	92.5	13	1.42	\$514	\$209	\$686	\$1681
BRPLD48	1.25 x 45 x 16	85	11	1.25	\$441	\$159	\$307	\$806
BRPLD42	1.25 x 39 x 16	100	9	1.08	\$391	\$127	\$261	\$695
BRPLD36	1.25 x 33 x 16	100	8	.92	\$372	\$117	\$234	\$613

Secures to the underside of the worksurface. Divider infill can be specified in low pressure laminate (LP), high pressure laminate (HP), dry erase whiteboard (DE) or dry erase magnetic whiteboard (DM). Installed divider measures 15.7" from top of worksurface. 36" to 54" dividers include 2 support brackets. 60" to 84" dividers include 3 support brackets. Brackets are available in all standard Bridges II paint finishes.

- 60" - 84" dividers require 3 support brackets and cannot be used with worksurfaces that have a single access door

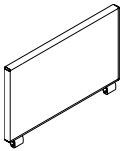

Perpendicular Single Table End of Run Framed Divider, Fabric

					LIST PRICE
BREFD36	1.25 x 33 x 16	85	12	.92	\$490
BREFD30	1.25 x 27 x 16	85	11	.75	\$444
BREFD24	1.25 x 21 x 16	70	9	.58	\$431

Connects to the perpendicular end of a single or back-to-back table. Fabric divider is tackable and always railroaded. Installed divider measures 15.7" from top of worksurface. Divider comes with 2 support brackets. Two brackets secure the divider to the side edge of worksurface. Flush with the rear edge, 3" recessed from front worksurface edge. Brackets are available in all standard Bridges II paint finishes.

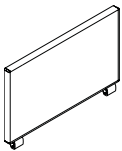

Perpendicular Single Table End of Run Framed Divider, Laminate*

					LIST PRICE	HP ADD	DE ADD	DM ADD
BRELD36	1.25 x 33 x 16	70	20	.92	\$321	\$118	\$234	\$364
BRELD30	1.25 x 27 x 16	65	17	.75	\$310	\$104	\$178	\$280
BRELD24	1.25 x 21 x 16	65	14	.58	\$278	\$87	\$161	\$244

Connects to the perpendicular end of a single or back-to-back table. Divider infill can be specified in low pressure laminate (LP), high pressure laminate (HP), dry erase whiteboard (DE) or dry erase magnetic whiteboard (DM). Installed divider measures 15.7" from top of worksurface. Divider comes with 2 support brackets. Two brackets secure the divider to the side edge of worksurface. Flush with the rear edge, 3" recessed from front worksurface edge. When dry erase magnetic whiteboard (DM) is specified it is applied user side ONLY and dry erase whiteboard (DE) is applied on the opposite side. Brackets are available in all standard Bridges II paint finishes.

Required Specifications

Fabric
Finish
Bracket finish

Optional Specifications

HP laminate*
Dry erase/dry erase magnetic whiteboard*

SHARED FRAMED DIVIDERS

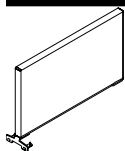

Perpendicular Shared Framed Divider, Fabric

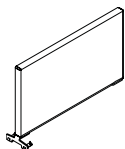

Perpendicular Shared Framed Divider, Laminate*

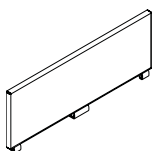

Perpendicular Back-to-Back End of Run Framed Divider, Fabric

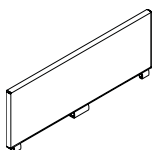

Perpendicular Back-to-Back End of Run Framed Divider, Laminate*

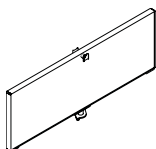

Perpendicular Back-to-Back Shared Framed Divider, Fabric

MODEL#	DIMENSIONS	FREIGHT CLASS	WT./LBS.	CUBIC FT.	LIST PRICE
--------	------------	---------------	----------	-----------	------------

D x W x H

BRSFD36	1.25 x 33 x 16	85	12	.92	\$479
BRSFD30	1.25 x 27 x 16	85	11	.75	\$431
BRSFD24	1.25 x 21 x 16	70	9	.58	\$418

Connects anywhere along and between worksurfaces to divide space and create privacy. Divider is fastened under the worksurface flush to the back of the table and recessed 3" from the front edge on the user side. Fabric divider is tackable and always railroaded. Installed divider measures 15.7" from top of worksurface. Divider comes with a support bracket at the back and a spacer plate with double sided adhesive at the front. Brackets are available in all standard Bridges II paint finishes.

LIST PRICE HP ADD DE ADD DM ADD

BRSFD36	1.25 x 33 x 16	70	20	.92	\$321	\$118	\$178	\$667
BRSFD30	1.25 x 27 x 16	65	17	.75	\$300	\$104	\$135	\$594
BRSFD24	1.25 x 21 x 16	65	14	.58	\$278	\$77	\$114	\$444

Connects anywhere along and between worksurfaces to divide space and create privacy. Divider is fastened under the worksurface flush to the back of the table and recessed 3" from the front edge on the user side. Divider infill can be specified in low pressure laminate (LP), high pressure laminate (HP), dry erase whiteboard (DE) or dry erase magnetic whiteboard (DM). Installed divider measures 15.7" from top of worksurface. Divider comes with a support bracket at the back and a spacer plate with double sided adhesive at the front. Brackets are available in all standard Bridges II paint finishes.

LIST PRICE

BREDFD63	1.25 x 57 x 16	85	21	1.58	\$758
BREDFD51	1.25 x 45 x 16	85	18	1.25	\$668

Connects to the end of run on a back-to-back tables to create privacy. Divider is fastened under the worksurface and recessed 3" from the user edge on either side. Fabric divider is tackable and always railroaded. Installed divider measures 15.7" from top of worksurface. Divider comes with 1 large and 2 small support brackets. Brackets are available in all standard Bridges II paint finishes.

LIST PRICE HP ADD DE ADD DM ADD

BRELD63	1.25 x 57 x 16	70	32	1.58	\$556	\$238	\$510	\$990
BRELD51	1.25 x 45 x 16	70	26	1.25	\$452	\$157	\$243	\$473

Connects to the end of run on a back-to-back tables to create privacy. Divider is fastened under the worksurface and recessed 3" from the user edge on either side. Divider infill can be specified in low pressure laminate (LP), high pressure laminate (HP), dry erase whiteboard (DE) or dry erase magnetic whiteboard (DM). Installed divider measures 15.7" from top of worksurface. Divider comes with 1 large and 2 small support brackets. When dry erase magnetic whiteboard (DM) is specified it is applied user side ONLY and dry erase whiteboard (DE) is applied on the opposite side. Brackets are available in all standard Bridges II paint finishes.

LIST PRICE

BRSDFD63	1.25 x 57 x 16	85	20	1.58	\$719
BRSDFD51	1.25 x 45 x 16	85	17	1.25	\$629

Connects between parallel framed dividers for back-to-back tables to divide space and create privacy. Divider is fastened under the worksurface and recessed 3" from the user edge on either side. Fabric divider is tackable and always railroaded. Installed divider measures 15.7" from top of worksurface. Divider comes with 1 center support bracket, 2 spacer plates with adhesive and 2 top spacer clamps. Brackets are available in all standard Bridges II paint finishes.

- Cannot be used on its own without the two parallel dividers

Required Specifications

Fabric
Finish
Bracket finish

Optional Specifications

HP laminate*
Dry erase/dry erase magnetic whiteboard*

SHARED FRAMED DIVIDERS

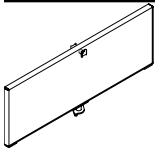

Perpendicular Back-to-Back Shared Framed Divider, Laminate*

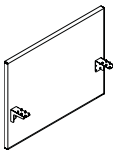

Table Mounted Framed Divider, Fabric*

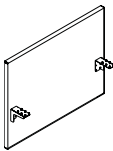

Table Mounted Framed Divider, Laminate*



Ceiling Pole for Wellness Screens

MODEL#	DIMENSIONS D x W x H	FREIGHT CLASS	WT/LBS.	CUBIC FT.	LIST PRICE			
					LIST PRICE	HP ADD	DE ADD	DM ADD
BRSDLD63	1.25 x 57 x 16	70	32	1.58	\$533	\$228	\$502	\$1818
BRSDLD51	1.25 x 45 x 16	70	26	1.25	\$432	\$157	\$233	\$888

Connects between parallel framed dividers for back-to-back tables to divide space and create privacy. Divider is fastened under the worksurface and recessed 3" from the user edge on either side. Divider infill can be specified in low pressure laminate (LP), high pressure laminate (HP), dry erase whiteboard (DE) or dry erase magnetic whiteboard (DM). Installed divider measures 15.7" from top of worksurface. Divider comes with 1 center support bracket, 2 spacer plates with adhesive and 2 top spacer clamps. Brackets are available in all standard Bridges II paint finishes.

- Cannot be used on its own without the two parallel dividers

MODEL#	DIMENSIONS D x W x H	FREIGHT CLASS	WT/LBS.	CUBIC FT.	LIST PRICE
BRTMFD84	1.25 x 81 x 30	70	43	4.22	\$1096
BRTMFD78	1.25 x 75 x 30	70	40	3.91	\$1020
BRTMFD72	1.25 x 69 x 30	70	37	3.59	\$981
BRTMFD66	1.25 x 63 x 30	85	33	3.28	\$948
BRTMFD60	1.25 x 57 x 30	92.5	30	2.97	\$834
BRTMFD54	1.25 x 51 x 30	92.5	27	2.66	\$744
BRTMFD48	1.25 x 45 x 30	85	25	2.34	\$668
BRTMFD42	1.25 x 39 x 30	100	22	2.03	\$594
BRTMFD36	1.25 x 33 x 30	100	20	1.90	\$504

Parallel divider for single tables. Fabric divider is tackable and always railroded. Fastens to the underside of the worksurface. 0.6" gap between worksurface and divider allows for cable pass thru. Installed divider reaches 15.7" up and 15" down from top of worksurface. 36" to 66" dividers include 2 support brackets. 72" to 84" dividers include 3 support brackets. Brackets are available in all standard Bridges II paint finishes.

- 72" - 84" dividers require 3 support brackets and cannot be used with worksurfaces that have a single access door

MODEL#	DIMENSIONS D x W x H	FREIGHT CLASS	WT/LBS.	CUBIC FT.	LIST PRICE	HP ADD	DE ADD	DM ADD
BRTMLD84	1.25 x 81 x 30	70	83	4.22	\$1387	\$455	\$1318	\$3034
BRTMLD78	1.25 x 75 x 30	70	77	3.91	\$1366	\$457	\$1318	\$3034
BRTMLD72	1.25 x 69 x 30	70	71	3.59	\$691	\$307	\$1772	\$3686
BRTMLD66	1.25 x 63 x 30	85	66	3.28	\$660	\$309	\$1779	\$3696
BRTMLD60	1.25 x 57 x 30	92.5	60	2.97	\$637	\$219	\$1787	\$3696
BRTMLD54	1.25 x 51 x 30	92.5	54	2.66	\$605	\$219	\$1685	\$3492
BRTMLD48	1.25 x 45 x 30	85	48	2.34	\$584	\$219	\$695	\$1659
BRTMLD42	1.25 x 39 x 30	100	42	2.03	\$562	\$219	\$704	\$1547
BRTMLD36	1.25 x 33 x 30	100	38	1.90	\$542	\$219	\$385	\$1200

Parallel divider for single tables. Divider infill can be specified in low pressure laminate (LP), high pressure laminate (HP), dry erase whiteboard (DE) or dry erase magnetic whiteboard (DM) user side only. Fastens to the underside of the worksurface. 0.6" gap between worksurface and divider allows for cable pass thru. Installed divider reaches 15.7" up and 15" down from top of worksurface. 36" to 66" dividers include 2 support brackets. 72" to 84" dividers include 3 support brackets. Brackets are available in all standard Bridges II paint finishes.

- 72" - 84" dividers require 3 support brackets and cannot be used with worksurfaces that have a single access door

BRTADPCPP	1.5 x 4.75 x 99	65	13	.48	\$665
-----------	-----------------	----	----	-----	-------

Brings ceiling feed conduit and data cables from the ceiling down to Power Troughs at desk height. Accommodates 10' ceiling heights. Two part construction allows power/data conduit lay-in. Attaches to a junction between two adjacent Power Troughs in back-to-back applications only. Not for use on single sided Bridges II troughs. Includes mounting hardware and ceiling bezel. Painted Finish.

- Screens must be specified 6" shorter than the nominal worksurface dimension in order to accommodate this ceiling feed.

Required Specifications

Fabric
Finish
Bracket finish*

BACK-TO-BACK WELLNESS SCREENS

MODEL# DIMENSIONS FREIGHT CLASS WT./LBS. CUBIC FT. LIST PRICE

D x W x H

BRTADP5136H24	50.50 x 36 x 24.63	150	33	6.31	\$1739
BRTADP5142H24	50.50 x 42 x 24.63	150	34.50	7.36	\$1773
BRTADP5148H24	50.50 x 48 x 24.63	150	36	8.42	\$1810
BRTADP5154H24	50.50 x 54 x 24.63	250	37.50	9.47	\$1846
BRTADP5160H24	50.50 x 60 x 24.63	250	39	10.52	\$1881
BRTADP5166H24	50.50 x 66 x 24.63	250	40.50	11.57	\$1919
BRTADP5172H24	50.50 x 72 x 24.63	250	42	12.63	\$1953
BRTADP5178H24	50.50 x 78 x 24.63	250	43.50	13.68	\$1990
BRTADP5184H24	50.50 x 84 x 24.63	250	45	14.73	\$2026

BRTADP6336H24	62.50 x 36 x 24.63	150	46.50	7.81	\$1879
BRTADP6342H24	62.50 x 42 x 24.63	150	48	9.11	\$1913
BRTADP6348H24	62.50 x 48 x 24.63	150	49.50	10.42	\$1952
BRTADP6354H24	62.50 x 54 x 24.63	150	51	11.72	\$1987
BRTADP6360H24	62.50 x 60 x 24.63	150	52.50	13.02	\$2022
BRTADP6366H24	62.50 x 66 x 24.63	250	54	14.32	\$2059
BRTADP6372H24	62.50 x 72 x 24.63	250	55	15.63	\$2095
BRTADP6378H24	62.50 x 78 x 24.63	250	57.35	16.93	\$2132
BRTADP6384H24	62.50 x 84 x 24.63	250	58.50	18.23	\$2168

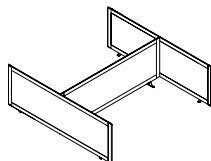

24" H Back-to-Back Wellness Screen

Powder coated aluminum frame, translucent ribbed polycarbonate. Includes all hardware to connect. Brackets are painted steel. Side dividers extend 6.25" from the front edge of each surface. Center divider sits over the gap between the worksurface allowing for cable pass-through to trough. Gap for each side is approximately 1". Width and depth are nominal sizes representing the sizes of the Bridges configuration. Allow for .25" overhang at the sides and 6.25" at the front. Frame and hardware available in all Bridges paint finishes. End trim cap is only available in Charcoal (CHR).

- **BRTADP51xxH24 are for configurations with 24" deep surfaces.**
- **BRTADP63xxH24 are for configurations with 30" deep surfaces.**

BRTADP5136H30	50.50 x 36 x 30.63	150	35.50	6.31	\$1926
BRTADP5142H30	50.50 x 42 x 30.63	150	37	7.36	\$1969
BRTADP5148H30	50.50 x 48 x 30.63	150	38.50	8.42	\$2008
BRTADP5154H30	50.50 x 54 x 30.63	150	40	9.47	\$2054
BRTADP5160H30	50.50 x 60 x 30.63	250	41.50	10.52	\$2094
BRTADP5166H30	50.50 x 66 x 30.63	250	43	11.57	\$2138
BRTADP5172H30	50.50 x 72 x 30.63	250	44.50	12.63	\$2177
BRTADP5178H30	50.50 x 78 x 30.63	250	46	13.68	\$2219
BRTADP5184H30	50.50 x 84 x 30.63	250	47.50	14.73	\$2261

BRTADP6336H30	62.50 x 36 x 30.63	125	49	7.81	\$2165
BRTADP6342H30	62.50 x 42 x 30.63	150	50.50	9.11	\$2206
BRTADP6348H30	62.50 x 48 x 30.63	150	52	10.42	\$2248
BRTADP6354H30	62.50 x 54 x 30.63	150	53.50	11.72	\$2289
BRTADP6360H30	62.50 x 60 x 30.63	150	55	13.02	\$2331
BRTADP6366H30	62.50 x 66 x 30.63	250	56.50	14.32	\$2373
BRTADP6372H30	62.50 x 72 x 30.63	250	58	15.63	\$2414
BRTADP6378H30	62.50 x 78 x 30.63	250	59.50	16.93	\$2456
BRTADP6384H30	62.50 x 84 x 30.63	250	61	18.23	\$2498

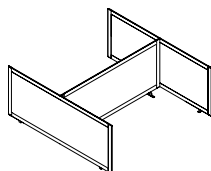

30" H Back-to-Back Wellness Screen

Powder coated aluminum frame, translucent ribbed polycarbonate. Includes all hardware to connect. Brackets are painted steel. Side dividers extend 6.25" from the front edge of each surface. Center divider sits over the gap between the worksurface allowing for cable pass-through to trough. Gap for each side is approximately 1". Width and depth are nominal sizes representing the sizes of the Bridges configuration. Allow for .25" overhang at the sides and 6.25" at the front. Frame and hardware available in all Bridges paint finishes. End trim cap is only available in Charcoal (CHR).

- **BRTADP51xxH30 are for configurations with 24" deep surfaces.**
- **BRTADP63xxH30 are for configurations with 30" deep surfaces.**

Required Specifications

Frame finish

BACK-TO-BACK WELLNESS SCREENS

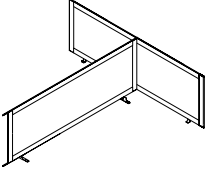

24" H Back-to-Back Wellness Screen Extension Kit

MODEL#	DIMENSIONS D x W x H	FREIGHT CLASS	WT./LBS.	CUBIC FT.	LIST PRICE
BRTADPE5136H24	50.50 x 36 x 24.63	150	26.35	6.31	\$1178
BRTADPE5142H24	50.50 x 42 x 24.63	250	27.85	7.36	\$1214
BRTADPE5148H24	50.50 x 48 x 24.63	250	29.35	8.42	\$1250
BRTADPE5154H24	50.50 x 54 x 24.63	250	30.85	9.47	\$1284
BRTADPE5160H24	50.50 x 60 x 24.63	250	32.35	10.52	\$1322
BRTADPE5166H24	50.50 x 66 x 24.63	250	33.85	11.57	\$1358
BRTADPE5172H24	50.50 x 72 x 24.63	250	35.35	12.63	\$1398
BRTADPE5178H24	50.50 x 78 x 24.63	250	36.85	13.68	\$1432
BRTADPE5184H24	50.50 x 84 x 24.63	250	38.35	14.73	\$1467
BRTADPE6336H24	62.50 x 36 x 24.63	150	39.85	7.81	\$1249
BRTADPE6342H24	62.50 x 42 x 24.63	150	41.35	9.11	\$1283
BRTADPE6348H24	62.50 x 48 x 24.63	150	42.85	10.42	\$1320
BRTADPE6354H24	62.50 x 54 x 24.63	250	44.35	11.72	\$1357
BRTADPE6360H24	62.50 x 60 x 24.63	250	45.85	13.02	\$1394
BRTADPE6366H24	62.50 x 66 x 24.63	250	47.35	14.32	\$1432
BRTADPE6372H24	62.50 x 72 x 24.63	250	48.85	15.63	\$1465
BRTADPE6378H24	62.50 x 78 x 24.63	250	50.35	16.93	\$1502
BRTADPE6384H24	62.50 x 84 x 24.63	250	51.85	18.23	\$1539

Intended to always connect to Back-to-Back Divider Screen Kit. Powder coated aluminum frame, translucent ribbed polycarbonate. Includes all hardware to connect. Brackets are painted steel. Side dividers extend 6.25" from the front edge of each surface. Center divider sits over the gap between the worksurface allowing for cable pass-through to trough. Gap for each side is approximately 1". Width and depth are nominal sizes representing the sizes of the Bridges configuration. Allow for .25" overhang at the sides and 6.25" at the front. Frame and hardware available in all Bridges paint finishes. End trim cap is only available in Charcoal (CHR).

- **BRTADPE51xxH24 are for configurations with 24" deep surfaces.**
- **BRTADPE63xxH24 are for configurations with 30" deep surfaces.**

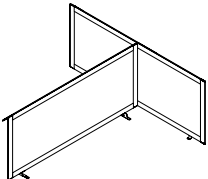

30" H Back-to-Back Wellness Screen Extension Kit

BRTADPE5136H30	50.50 x 36 x 30.63	150	28.85	6.31	\$1294
BRTADPE5142H30	50.50 x 42 x 30.63	150	30.35	7.36	\$1336
BRTADPE5148H30	50.50 x 48 x 30.63	250	31.85	8.42	\$1379
BRTADPE5154H30	50.50 x 54 x 30.63	250	33.35	9.47	\$1422
BRTADPE5160H30	50.50 x 60 x 30.63	250	34.85	10.52	\$1462
BRTADPE5166H30	50.50 x 66 x 30.63	250	36.35	11.57	\$1504
BRTADPE5172H30	50.50 x 72 x 30.63	250	37.85	12.63	\$1547
BRTADPE5178H30	50.50 x 78 x 30.63	250	39.35	13.68	\$1586
BRTADPE5184H30	50.50 x 84 x 30.63	250	40.85	14.73	\$1629
BRTADPE6336H30	62.50 x 36 x 30.63	150	42.35	7.81	\$1376
BRTADPE6342H30	62.50 x 42 x 30.63	150	43.85	9.11	\$1420
BRTADPE6348H30	62.50 x 48 x 30.63	150	45.35	10.42	\$1461
BRTADPE6354H30	62.50 x 54 x 30.63	250	46.85	11.72	\$1502
BRTADPE6360H30	62.50 x 60 x 30.63	250	48.35	13.02	\$1544
BRTADPE6366H30	62.50 x 66 x 30.63	250	49.85	14.32	\$1585
BRTADPE6372H30	62.50 x 72 x 30.63	250	51.35	15.63	\$1629
BRTADPE6378H30	62.50 x 78 x 30.63	250	52.85	16.93	\$1668
BRTADPE6384H30	62.50 x 84 x 30.63	250	54.35	18.23	\$1711

Intended to always connect to Back-to-Back Divider Screen Kit. Powder coated aluminum frame, translucent ribbed polycarbonate. Includes all hardware to connect. Brackets are painted steel. Side dividers extend 6.25" from the front edge of each surface. Center divider sits over the gap between the worksurface allowing for cable pass-through to trough. Gap for each side is approximately 1". Width and depth are nominal sizes representing the sizes of the Bridges configuration. Allow for .25" overhang at the sides and 6.25" at the front. Frame and hardware available in all Bridges paint finishes. End trim cap is only available in Charcoal (CHR).

- **BRTADPE51xxH30 are for configurations with 24" deep surfaces.**
- **BRTADPE63xxH30 are for configurations with 30" deep surfaces.**

Required Specifications
Frame finish

SINGLE TABLE WELLNESS SCREENS

MODEL# DIMENSIONS FREIGHT CLASS WT/LBS. CUBIC FT. LIST PRICE

D x W x H

BRTADP2436H24	31.75 x 36 x 24.63	125	26.55	3.97	\$1200
BRTADP2442H24	31.75 x 42 x 24.63	125	28.10	4.63	\$1238
BRTADP2448H24	31.75 x 48 x 24.63	150	29.65	5.29	\$1272
BRTADP2454H24	31.75 x 54 x 24.63	150	31.20	5.95	\$1309
BRTADP2460H24	31.75 x 60 x 24.63	150	32.75	6.61	\$1346
BRTADP2466H24	31.75 x 66 x 24.63	150	34.30	7.28	\$1380
BRTADP2472H24	31.75 x 72 x 24.63	150	35.85	7.94	\$1418
BRTADP2478H24	31.75 x 78 x 24.63	150	37.40	8.60	\$1455
BRTADP2484H24	31.75 x 84 x 24.63	150	38.95	9.26	\$1490

BRTADP3036H24	37.75 x 36 x 24.63	100	40.50	4.72	\$1284
BRTADP3042H24	37.75 x 42 x 24.63	125	42.05	5.51	\$1322
BRTADP3048H24	37.75 x 48 x 24.63	125	43.60	6.29	\$1358
BRTADP3054H24	37.75 x 54 x 24.63	150	42.15	7.08	\$1398
BRTADP3060H24	37.75 x 60 x 24.63	150	46.70	7.87	\$1432
BRTADP3066H24	37.75 x 66 x 24.63	150	48.25	8.65	\$1467
BRTADP3072H24	37.75 x 72 x 24.63	150	49.80	9.44	\$1504
BRTADP3078H24	37.75 x 78 x 24.63	150	51.35	10.22	\$1540
BRTADP3084H24	37.75 x 84 x 24.63	150	52.90	11.01	\$1578

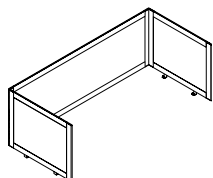

24" H Single Table Wellness Screen

Powder coated aluminum frame, translucent ribbed polycarbonate. Includes all hardware to connect. Brackets are painted steel. Side dividers extend 6.25" from the front edge of each surface. Back divider extends over the back edge of the worksurface by 1.5", allowing for cable pass-through to trough. Width and depth are nominal sizes representing the sizes of the Bridges configuration. Allow for .25" overhang at the sides, 1.5" at the back, and 6.25" at the front. Frame and hardware available in all Bridges paint finishes. End trim cap is only available in Charcoal (CHR).

- **BRTADP24xxH24 are for configurations with 24" deep surfaces.**
- **BRTADP30xxH24 are for configurations with 30" deep surfaces.**

BRTADP2436H30	31.75 x 36 x 30.63	125	28.85	3.97	\$1346
BRTADP2442H30	31.75 x 42 x 30.63	125	30.40	4.63	\$1389
BRTADP2448H30	31.75 x 48 x 30.63	125	31.95	5.29	\$1432
BRTADP2454H30	31.75 x 54 x 30.63	150	33.50	5.95	\$1472
BRTADP2460H30	31.75 x 60 x 30.63	150	35.05	6.61	\$1515
BRTADP2466H30	31.75 x 66 x 30.63	150	36.60	7.28	\$1555
BRTADP2472H30	31.75 x 72 x 30.63	150	38.15	7.94	\$1598
BRTADP2478H30	31.75 x 78 x 30.63	150	39.70	8.60	\$1638
BRTADP2484H30	31.75 x 84 x 30.63	150	41.25	9.26	\$1681

BRTADP3036H30	37.75 x 36 x 30.63	100	42.80	4.72	\$1428
BRTADP3042H30	37.75 x 42 x 30.63	100	44.35	5.51	\$1472
BRTADP3048H30	37.75 x 48 x 30.63	125	45.90	6.29	\$1514
BRTADP3054H30	37.75 x 54 x 30.63	125	47.45	7.08	\$1552
BRTADP3060H30	37.75 x 60 x 30.63	125	49	7.87	\$1594
BRTADP3066H30	37.75 x 66 x 30.63	150	50.55	8.65	\$1637
BRTADP3072H30	37.75 x 72 x 30.63	150	52.10	9.44	\$1676
BRTADP3078H30	37.75 x 78 x 30.63	150	53.65	10.22	\$1720
BRTADP3084H30	37.75 x 84 x 30.63	150	55.20	11.01	\$1763

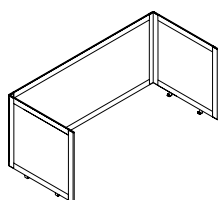

30" H Single Table Wellness Screen

Powder coated aluminum frame, translucent ribbed polycarbonate. Includes all hardware to connect. Brackets are painted steel. Side dividers extend 6.25" from the front edge of each surface. Back divider extends over the back edge of the worksurface by 1.5", allowing for cable pass-through to trough. Width and depth are nominal sizes representing the sizes of the Bridges configuration. Allow for .25" overhang at the sides, 1.5" at the back, and 6.25" at the front. Frame and hardware available in all Bridges paint finishes. End trim cap is only available in Charcoal (CHR).

- **BRTADP24xxH30 are for configurations with 24" deep surfaces.**
- **BRTADP30xxH30 are for configurations with 30" deep surfaces.**

Required Specifications

Frame finish

SINGLE TABLE WELLNESS SCREENS

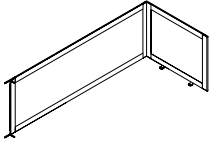

24" H Single Table Wellness Screen Extension Kit

MODEL#	DIMENSIONS D x W x H	FREIGHT CLASS	WT/LBS.	CUBIC FT.	LIST PRICE
BRTADPE2436H24	31.75 x 36 x 24.63	150	21.05	3.97	\$900
BRTADPE2442H24	31.75 x 42 x 24.63	150	22.60	4.63	\$989
BRTADPE2448H24	31.75 x 48 x 24.63	150	24.15	5.29	\$1026
BRTADPE2454H24	31.75 x 54 x 24.63	150	25.70	5.95	\$1061
BRTADPE2460H24	31.75 x 60 x 24.63	150	27.25	6.61	\$1096
BRTADPE2466H24	31.75 x 66 x 24.63	250	28.80	7.28	\$1134
BRTADPE2472H24	31.75 x 72 x 24.63	250	30.35	7.94	\$1170
BRTADPE2478H24	31.75 x 78 x 24.63	250	31.90	8.60	\$1206
BRTADPE2484H24	31.75 x 84 x 24.63	250	33.45	9.26	\$1240
BRTADPE3036H24	37.75 x 36 x 24.63	125	35	4.72	\$937
BRTADPE3042H24	37.75 x 42 x 24.63	125	36.55	5.51	\$1023
BRTADPE3048H24	37.75 x 48 x 24.63	125	38.10	6.29	\$1061
BRTADPE3054H24	37.75 x 54 x 24.63	150	39.65	7.08	\$1096
BRTADPE3060H24	37.75 x 60 x 24.63	150	41.20	7.87	\$1134
BRTADPE3066H24	37.75 x 66 x 24.63	150	42.75	8.65	\$1168
BRTADPE3072H24	37.75 x 72 x 24.63	150	44.30	9.44	\$1203
BRTADPE3078H24	37.75 x 78 x 24.63	150	45.85	10.01	\$1240
BRTADPE3084H24	37.75 x 84 x 24.63	150	47.40	10.01	\$1276

Intended to always connect to Single Table Divider Screen Kit. Powder coated aluminum frame, translucent ribbed polycarbonate. Includes all hardware to connect. Brackets are painted steel. Side dividers extend 6.25" from the front edge of each surface. Back divider extends over the back edge of the worksurface by 1.5", allowing for cable pass-through to trough. Width and depth are nominal sizes representing the sizes of the Bridges configuration. Allow for .25" overhang at the sides, 1.5" at the back, and 6.25" at the front. Frame and hardware available in all Bridges paint finishes. End trim cap is only available in Charcoal (CHR).

- **BRTADPE24xxH24 are for configurations with 24" deep surfaces.**
- **BRTADPE30xxH24 are for configurations with 30" deep surfaces.**

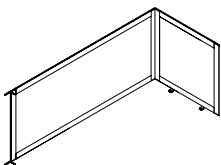

30" H Single Table Wellness Screen Extension Kit

BRTADPE2436H30	31.75 x 36 x 30.63	150	22.85	3.97	\$991
BRTADPE2442H30	31.75 x 42 x 30.63	150	24.40	4.63	\$1085
BRTADPE2448H30	31.75 x 48 x 30.63	150	25.95	5.29	\$1125
BRTADPE2454H30	31.75 x 54 x 30.63	150	27.50	5.95	\$1167
BRTADPE2460H30	31.75 x 60 x 30.63	150	29.05	6.61	\$1210
BRTADPE2466H30	31.75 x 66 x 30.63	150	30.60	7.28	\$1250
BRTADPE2472H30	31.75 x 72 x 30.63	150	32.15	7.94	\$1291
BRTADPE2478H30	31.75 x 78 x 30.63	250	33.70	8.60	\$1333
BRTADPE2484H30	31.75 x 84 x 30.63	250	35.25	9.26	\$1375
BRTADPE3036H30	37.75 x 36 x 30.63	125	36.80	4.72	\$1031
BRTADPE3042H30	37.75 x 42 x 30.63	125	38.35	5.51	\$1125
BRTADPE3048H30	37.75 x 48 x 30.63	125	39.90	6.29	\$1167
BRTADPE3054H30	37.75 x 54 x 30.63	150	41.45	7.08	\$1207
BRTADPE3060H30	37.75 x 60 x 30.63	150	43	7.87	\$1250
BRTADPE3066H30	37.75 x 66 x 30.63	150	44.55	8.65	\$1291
BRTADPE3072H30	37.75 x 72 x 30.63	150	46.10	9.44	\$1332
BRTADPE3078H30	37.75 x 78 x 30.63	150	47.65	10.22	\$1375
BRTADPE3084H30	37.75 x 84 x 30.63	150	49.20	11.01	\$1415

Intended to always connect to Single Table Divider Screen Kit. Powder coated aluminum frame, translucent ribbed polycarbonate. Includes all hardware to connect. Brackets are painted steel. Side dividers extend 6.25" from the front edge of each surface. Back divider extends over the back edge of the worksurface by 1.5", allowing for cable pass-through to trough. Width and depth are nominal sizes representing the sizes of the Bridges configuration. Allow for .25" overhang at the sides, 1.5" at the back, and 6.25" at the front. Frame and hardware available in all Bridges paint finishes. End trim cap is only available in Charcoal (CHR).

- **BRTADPE24xxH30 are for configurations with 24" deep surfaces.**
- **BRTADPE30xxH30 are for configurations with 30" deep surfaces.**

Required Specifications
Frame finish

BACK-TO-BACK FELT DIVIDER SCREENS

MODEL# DIMENSIONS FREIGHT CLASS WT/LBS. CUBIC FT. LIST PRICE

D x W x H

BRTADF5136H24	50.50 x 36 x 24.60	150	28	6.31	\$1371
BRTADF5142H24	50.50 x 42 x 24.60	150	29.50	7.36	\$1395
BRTADF5148H24	50.50 x 48 x 24.60	150	31	8.42	\$1422
BRTADF5154H24	50.50 x 54 x 24.60	250	32.50	9.47	\$1445
BRTADF5160H24	50.50 x 60 x 24.60	250	34	10.52	\$1476
BRTADF5166H24	50.50 x 66 x 24.60	250	35.50	11.57	\$1502
BRTADF5172H24	50.50 x 72 x 24.60	250	37	12.63	\$1529
BRTADF5178H24	50.50 x 78 x 24.60	250	38.50	13.68	\$1558
BRTADF5184H24	50.50 x 84 x 24.60	250	40	14.73	\$1608

BRTADF6336H24	62.50 x 36 x 24.60	150	41.50	7.81	\$1476
BRTADF6342H24	62.50 x 42 x 24.60	150	43	9.11	\$1502
BRTADF6348H24	62.50 x 48 x 24.60	150	44.50	10.42	\$1529
BRTADF6354H24	62.50 x 54 x 24.60	150	46	11.72	\$1555
BRTADF6360H24	62.50 x 60 x 24.60	150	47.50	13.02	\$1581
BRTADF6366H24	62.50 x 66 x 24.60	250	49	14.32	\$1608
BRTADF6372H24	62.50 x 72 x 24.60	250	50.50	15.63	\$1634
BRTADF6378H24	62.50 x 78 x 24.60	250	52	16.93	\$1661
BRTADF6384H24	62.50 x 84 x 24.60	250	53.50	18.23	\$1713

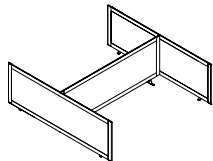

24" H Back-to-Back Felt Divider Screen

Provides privacy in an open plan environment. Powder coated aluminum frame with 9mm felt. Includes all hardware to connect. Brackets are painted steel. Side dividers extend 6.25" from the front edge of each surface. Center divider sits over the gap between the worksurface allowing for cable pass-through to trough. Gap for each side is approximately 1". Width and depth are nominal sizes representing the sizes of the Bridges configuration. Allow for .25" overhang at the sides and 6.25" at the front. Frame and hardware available in all Bridges paint finishes. End trim cap is only available in Charcoal (CHR). 9mm PET felt material is tackable and available in 9 colors.

- **BRTAPF51xxH24 are for configurations with 24" deep surfaces.**
- **BRTAPF63xxH24 are for configurations with 30" deep surfaces.**

BRTADF5136H30	50.50 x 36 x 30.60	150	30.50	6.31	\$1366
BRTADF5142H30	50.50 x 42 x 30.60	150	32	7.36	\$1391
BRTADF5148H30	50.50 x 48 x 30.60	150	33.50	8.42	\$1416
BRTADF5154H30	50.50 x 54 x 30.60	150	35	9.47	\$1440
BRTADF5160H30	50.50 x 60 x 30.60	250	36.50	10.52	\$1465
BRTADF5166H30	50.50 x 66 x 30.60	250	38	11.57	\$1488
BRTADF5172H30	50.50 x 72 x 30.60	250	39.50	12.63	\$1515
BRTADF5178H30	50.50 x 78 x 30.60	250	41	13.68	\$1542
BRTADF5184H30	50.50 x 84 x 30.60	250	42.50	14.73	\$1598

BRTADF6336H30	62.50 x 36 x 30.60	125	44	7.81	\$1534
BRTADF6342H30	62.50 x 42 x 30.60	150	45.50	9.11	\$1558
BRTADF6348H30	62.50 x 48 x 30.60	150	47	10.42	\$1581
BRTADF6354H30	62.50 x 54 x 30.60	150	48.50	11.72	\$1605
BRTADF6360H30	62.50 x 60 x 30.60	150	50	13.02	\$1631
BRTADF6366H30	62.50 x 66 x 30.60	250	51.50	14.32	\$1657
BRTADF6372H30	62.50 x 72 x 30.60	250	53	15.63	\$1681
BRTADF6378H30	62.50 x 78 x 30.60	250	54.50	16.93	\$1706
BRTADF6384H30	62.50 x 84 x 30.60	250	56	18.23	\$1763

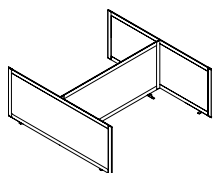

30" H Back-to-Back Felt Divider Screen

Provides privacy in an open plan environment. Powder coated aluminum frame with 9mm felt. Includes all hardware to connect. Brackets are painted steel. Side dividers extend 6.25" from the front edge of each surface. Center divider sits over the gap between the worksurface allowing for cable pass-through to trough. Gap for each side is approximately 1". Width and depth are nominal sizes representing the sizes of the Bridges configuration. Allow for .25" overhang at the sides and 6.25" at the front. Frame and hardware available in all Bridges paint finishes. End trim cap is only available in Charcoal (CHR). 9mm PET felt material is tackable and available in 9 colors.

- **BRTADF51xxH30 are for configurations with 24" deep surfaces.**
- **BRTADF63xxH30 are for configurations with 30" deep surfaces.**

Required Specifications

Frame finish

BACK-TO-BACK FELT DIVIDER SCREENS

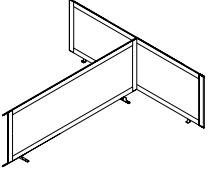

24" H Back-to-Back Felt Divider Screen Extension Kit

MODEL#	DIMENSIONS D x W x H	FREIGHT CLASS	WT./LBS.	CUBIC FT.	LIST PRICE
BRTADFE5136H24	50.50 x 36 x 24.60	150	23.35	6.31	\$935
BRTADFE5142H24	50.50 x 42 x 24.60	250	24.85	7.36	\$961
BRTADFE5148H24	50.50 x 48 x 24.60	250	26.35	8.42	\$988
BRTADFE5154H24	50.50 x 54 x 24.60	250	27.85	9.47	\$1014
BRTADFE5160H24	50.50 x 60 x 24.60	250	29.35	10.52	\$1040
BRTADFE5166H24	50.50 x 66 x 24.60	250	30.85	11.57	\$1067
BRTADFE5172H24	50.50 x 72 x 24.60	250	32.35	12.63	\$1093
BRTADFE5178H24	50.50 x 78 x 24.60	250	33.85	13.68	\$1121
BRTADFE5184H24	50.50 x 84 x 24.60	250	35.35	14.73	\$1174
BRTADFE6336H24	62.50 x 36 x 24.60	150	36.85	7.81	\$985
BRTADFE6342H24	62.50 x 42 x 24.60	150	38.35	9.11	\$1011
BRTADFE6348H24	62.50 x 48 x 24.60	150	39.85	10.42	\$1039
BRTADFE6354H24	62.50 x 54 x 24.60	250	41.35	11.72	\$1064
BRTADFE6360H24	62.50 x 60 x 24.60	250	42.85	13.02	\$1092
BRTADFE6366H24	62.50 x 66 x 24.60	250	44.35	14.32	\$1118
BRTADFE6372H24	62.50 x 72 x 24.60	250	45.85	15.63	\$1145
BRTADFE6378H24	62.50 x 78 x 24.60	250	47.35	16.93	\$1171
BRTADFE6384H24	62.50 x 84 x 24.60	250	48.85	18.23	\$1224

Provides an extension to privacy in an open plan environment. Intended to always connect to Back-to-Back Divider Screen Kit. Powder coated aluminum frame with 9mm felt. Includes all hardware to connect. Brackets are painted steel. Side dividers extend 6.25" from the front edge of each surface. Center divider sits over the gap between the worksurface allowing for cable pass-through to trough. Gap for each side is approximately 1". Width and depth are nominal sizes representing the sizes of the Bridges configuration. Allow for .25" overhang at the sides and 6.25" at the front. Frame and hardware available in all Bridges paint finishes. End trim cap is only available in Charcoal (CHR). 9mm PET felt material is tackable and available in 9 colors.

- **BRTADFE51xxH24 are for configurations with 24" deep surfaces.**
- **BRTADFE63xxH24 are for configurations with 30" deep surfaces.**

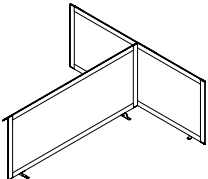

30" H Back-to-Back Felt Divider Screen Extension Kit

BRTADFE5136H30	50.50 x 36 x 30.60	150	25.85	6.31	\$932
BRTADFE5142H30	50.50 x 42 x 30.60	150	27.35	7.36	\$957
BRTADFE5148H30	50.50 x 48 x 30.60	250	28.85	8.42	\$982
BRTADFE5154H30	50.50 x 54 x 30.60	250	30.35	9.47	\$1007
BRTADFE5160H30	50.50 x 60 x 30.60	250	31.85	10.52	\$1031
BRTADFE5166H30	50.50 x 66 x 30.60	250	33.35	11.57	\$1057
BRTADFE5172H30	50.50 x 72 x 30.60	250	34.85	12.63	\$1081
BRTADFE5178H30	50.50 x 78 x 30.60	250	36.35	13.68	\$1106
BRTADFE5184H30	50.50 x 84 x 30.60	250	37.85	14.73	\$1163
BRTADFE6336H30	62.50 x 36 x 30.60	150	39.35	7.81	\$981
BRTADFE6342H30	62.50 x 42 x 30.60	150	40.85	9.11	\$1006
BRTADFE6348H30	62.50 x 48 x 30.60	150	42.35	10.42	\$1030
BRTADFE6354H30	62.50 x 54 x 30.60	250	43.85	11.72	\$1055
BRTADFE6360H30	62.50 x 60 x 30.60	250	45.35	13.02	\$1080
BRTADFE6366H30	62.50 x 66 x 30.60	250	46.85	14.32	\$1105
BRTADFE6372H30	62.50 x 72 x 30.60	250	48.35	15.63	\$1129
BRTADFE6378H30	62.50 x 78 x 30.60	250	49.85	16.93	\$1154
BRTADFE6384H30	62.50 x 84 x 30.60	250	51.35	18.23	\$1210

Provides an extension to privacy in an open plan environment. Intended to always connect to Back-to-Back Divider Screen Kit. Powder coated aluminum frame with 9mm felt. Includes all hardware to connect. Brackets are painted steel. Side dividers extend 6.25" from the front edge of each surface. Center divider sits over the gap between the worksurface allowing for cable pass-through to trough. Gap for each side is approximately 1". Width and depth are nominal sizes representing the sizes of the Bridges configuration. Allow for .25" overhang at the sides and 6.25" at the front. Frame and hardware available in all Bridges paint finishes. End trim cap is only available in Charcoal (CHR). 9mm PET felt material is tackable and available in 9 colors.

- **BRTADFE51xxH30 are for configurations with 24" deep surfaces.**
- **BRTADFE63xxH30 are for configurations with 30" deep surfaces.**

Required Specifications

Frame finish
Felt finish

SINGLE FELT DIVIDER SCREENS

MODEL# DIMENSIONS FREIGHT CLASS WT/LBS. CUBIC FT. LIST PRICE

D x W x H

BRTADF2436H24	31.50 x 36 x 24.60	125	22.55	3.94	\$998
BRTADF2442H24	31.50 x 42 x 24.60	125	24.10	4.59	\$1024
BRTADF2448H24	31.50 x 48 x 24.60	150	25.65	5.25	\$1051
BRTADF2454H24	31.50 x 54 x 24.60	150	27.20	5.91	\$1076
BRTADF2460H24	31.50 x 60 x 24.60	150	28.75	6.56	\$1105
BRTADF2466H24	31.50 x 66 x 24.60	150	30.30	7.22	\$1130
BRTADF2472H24	31.50 x 72 x 24.60	150	31.85	7.88	\$1157
BRTADF2478H24	31.50 x 78 x 24.60	150	33.40	8.53	\$1184
BRTADF2484H24	31.50 x 84 x 24.60	150	34.95	9.19	\$1236

BRTADF3036H24	37.75 x 36 x 24.60	100	36.50	4.72	\$1031
BRTADF3042H24	37.75 x 42 x 24.60	125	38.05	5.51	\$1060
BRTADF3048H24	37.75 x 48 x 24.60	125	39.60	6.29	\$1086
BRTADF3054H24	37.75 x 54 x 24.60	150	41.15	7.08	\$1112
BRTADF3060H24	37.75 x 60 x 24.60	150	41.70	7.87	\$1139
BRTADF3066H24	37.75 x 66 x 24.60	150	44.25	8.65	\$1167
BRTADF3072H24	37.75 x 72 x 24.60	150	45.80	9.44	\$1190
BRTADF3078H24	37.75 x 78 x 24.60	150	47.35	10.22	\$1217
BRTADF3084H24	37.75 x 84 x 24.60	150	48.90	11.01	\$1271

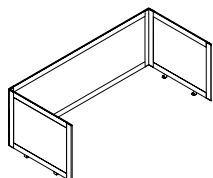

24" H Single Table Felt Divider Screen

Provides privacy in an open plan environment. Powder coated aluminum frame with 9mm felt. Includes all hardware to connect. Brackets are painted steel. Side dividers extend 6.237" from the front edge of each surface. Back divider extends over the back edge of the worksurface by 1.5", allowing for cable pass-through to trough. Width and depth are nominal sizes representing the sizes of the Bridges configuration. Allow for .25" overhang at the sides, 1.5" at the back, and 6.237" at the front. Frame and hardware available in all Bridges paint finishes. End trim cap is only available in Charcoal (CHR). 9mm PET felt material is tackable and available in 9 colors.

- **BRTADF24xxH24 are for configurations with 24" deep surfaces.**
- **BRTADF30xxH24 are for configurations with 30" deep surfaces.**

BRTADF2436H30	31.50 x 36 x 30.60	125	24.85	3.97	\$991
BRTADF2442H30	31.50 x 42 x 30.60	125	26.40	4.59	\$1017
BRTADF2448H30	31.50 x 48 x 30.60	125	27.95	5.25	\$1040
BRTADF2454H30	31.50 x 54 x 30.60	150	29.50	5.91	\$1064
BRTADF2460H30	31.50 x 60 x 30.60	150	31.05	6.56	\$1089
BRTADF2466H30	31.50 x 66 x 30.60	150	32.60	7.22	\$1113
BRTADF2472H30	31.50 x 72 x 30.60	150	34.14	7.88	\$1139
BRTADF2478H30	31.50 x 78 x 30.60	150	34.70	8.53	\$1163
BRTADF2484H30	31.50 x 84 x 30.60	150	37.25	9.19	\$1222

BRTADF3036H30	37.75 x 36 x 30.60	100	38.80	4.72	\$1039
BRTADF3042H30	37.75 x 42 x 30.60	100	40.35	5.51	\$1063
BRTADF3048H30	37.75 x 48 x 30.60	125	41.90	6.29	\$1088
BRTADF3054H30	37.75 x 54 x 30.60	125	43.45	7.08	\$1112
BRTADF3060H30	37.75 x 60 x 30.60	125	45	7.87	\$1139
BRTADF3066H30	37.75 x 66 x 30.60	150	46.55	8.65	\$1163
BRTADF3072H30	37.75 x 72 x 30.60	150	48.10	9.44	\$1187
BRTADF3078H30	37.75 x 78 x 30.60	150	49.65	10.22	\$1211
BRTADF3084H30	37.75 x 84 x 30.60	150	51.20	11.01	\$1269

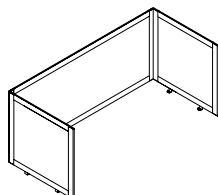

30" H Single Table Felt Divider Screen

Provides privacy in an open plan environment. Powder coated aluminum frame with 9mm felt. Includes all hardware to connect. Brackets are painted steel. Side dividers extend 6.237" from the front edge of each surface. Back divider extends over the back edge of the worksurface by 1.5", allowing for cable pass-through to trough. Width and depth are nominal sizes representing the sizes of the Bridges configuration. Allow for .25" overhang at the sides, 1.5" at the back, and 6.237" at the front. Frame and hardware available in all Bridges paint finishes. End trim cap is only available in Charcoal (CHR). 9mm PET felt material is tackable and available in 9 colors.

- **BRTADF24xxH30 are for configurations with 24" deep surfaces.**
- **BRTADF30xxH30 are for configurations with 30" deep surfaces.**

Required Specifications

Frame finish
Felt finish

SINGLE TABLE FELT DIVIDER SCREENS

MODEL# DIMENSIONS FREIGHT CLASS WT/LBS. CUBIC FT. LIST PRICE

D x W x H

BRTADFE2436H24	31.50 x 36 x 24.60	150	18.55	3.94	\$756
BRTADFE2442H24	31.50 x 42 x 24.60	150	20.10	4.59	\$827
BRTADFE2448H24	31.50 x 48 x 24.60	150	21.65	5.25	\$855
BRTADFE2454H24	31.50 x 54 x 24.60	150	23.20	5.91	\$881
BRTADFE2460H24	31.50 x 60 x 24.60	150	24.75	6.56	\$908
BRTADFE2466H24	31.50 x 66 x 24.60	250	26.30	7.22	\$935
BRTADFE2472H24	31.50 x 72 x 24.60	250	27.85	7.88	\$961
BRTADFE2478H24	31.50 x 78 x 24.60	250	29.40	8.53	\$988
BRTADFE2484H24	31.50 x 84 x 24.60	250	30.95	9.19	\$1040

BRTADFE3036H24	37.75 x 36 x 24.60	125	32.50	4.72	\$783
BRTADFE3042H24	37.75 x 42 x 24.60	125	34.05	5.51	\$856
BRTADFE3048H24	37.75 x 48 x 24.60	125	35.60	6.29	\$883
BRTADFE3054H24	37.75 x 54 x 24.60	150	37.15	7.08	\$909
BRTADFE3060H24	37.75 x 60 x 24.60	150	38.70	7.87	\$937
BRTADFE3066H24	37.75 x 66 x 24.60	150	40.25	8.65	\$963
BRTADFE3072H24	37.75 x 72 x 24.60	150	41.80	9.44	\$990
BRTADFE3078H24	37.75 x 78 x 24.60	150	43.35	10.01	\$1017
BRTADFE3084H24	37.75 x 84 x 24.60	150	44.90	10.01	\$1070

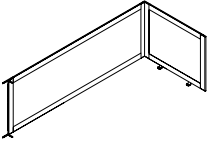

24" H Single Table Felt Divider Screen Extension Kit

Provides an extension for privacy in an open plan environment. Intended to always connect to Single Table Divider Screen Kit. Powder coated aluminum frame with 9mm felt. Includes all hardware to connect. Brackets are painted steel. Side dividers extend 6.237" from the front edge of each surface. Back divider extends over the back edge of the worksurface by 1.5", allowing for cable pass-through to trough. Width and depth are nominal sizes representing the sizes of the Bridges configuration. Allow for .25" overhang at the sides, 1.5" at the back, and 6.237" at the front. Frame and hardware available in all Bridges paint finishes. End trim cap is only available in Charcoal (CHR). 9mm PET felt material is tackable and available in 9 colors.

- **BRTADFE24xxH24 are for configurations with 24" deep surfaces.**
- **BRTADFE30xxH24 are for configurations with 30" deep surfaces.**

BRTADFE2436H30	31.50 x 36 x 30.60	150	20.35	3.94	\$792
BRTADFE2442H30	31.50 x 42 x 30.60	150	21.90	4.59	\$864
BRTADFE2448H30	31.50 x 48 x 30.60	150	23.45	5.25	\$888
BRTADFE2454H30	31.50 x 54 x 30.60	150	25	5.91	\$913
BRTADFE2460H30	31.50 x 60 x 30.60	150	26.55	6.56	\$938
BRTADFE2466H30	31.50 x 66 x 30.60	150	28.10	7.22	\$963
BRTADFE2472H30	31.50 x 72 x 30.60	150	29.65	7.88	\$988
BRTADFE2478H30	31.50 x 78 x 30.60	250	31.20	8.53	\$1011
BRTADFE2484H30	31.50 x 84 x 30.60	250	32.75	9.19	\$1070

BRTADFE3036H30	37.75 x 36 x 30.60	125	34.30	4.72	\$821
BRTADFE3042H30	37.75 x 42 x 30.60	125	35.85	5.51	\$897
BRTADFE3048H30	37.75 x 48 x 30.60	125	37.40	6.29	\$922
BRTADFE3054H30	37.75 x 54 x 30.60	150	38.95	7.08	\$948
BRTADFE3060H30	37.75 x 60 x 30.60	150	40.50	7.87	\$973
BRTADFE3066H30	37.75 x 66 x 30.60	150	42.05	8.65	\$998
BRTADFE3072H30	37.75 x 72 x 30.60	150	43.60	9.44	\$1023
BRTADFE3078H30	37.75 x 78 x 30.60	150	45.15	10.22	\$1047
BRTADFE3084H30	37.75 x 84 x 30.60	150	46.70	11.01	\$1105

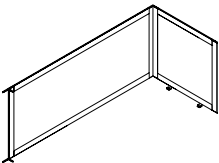

30" H Single Table Felt Divider Screen Extension Kit

Provides an extension for privacy in an open plan environment. Intended to always connect to Single Table Divider Screen Kit. Powder coated aluminum frame with 9mm felt. Includes all hardware to connect. Brackets are painted steel. Side dividers extend 6.237" from the front edge of each surface. Back divider extends over the back edge of the worksurface by 1.5", allowing for cable pass-through to trough. Width and depth are nominal sizes representing the sizes of the Bridges configuration. Allow for .25" overhang at the sides, 1.5" at the back, and 6.237" at the front. Frame and hardware available in all Bridges paint finishes. End trim cap is only available in Charcoal (CHR). 9mm PET felt material is tackable and available in 9 colors.

- **BRTADFE24xxH30 are for configurations with 24" deep surfaces.**
- **BRTADFE30xxH30 are for configurations with 30" deep surfaces.**

Required Specifications

Frame finish
Felt finish

BACK-TO-BACK GLASS DIVIDER SCREENS

MODEL# DIMENSIONS FREIGHT CLASS WT/LBS. CUBIC FT. LIST PRICE FRST ADD

D x W x H

BRTADG5136H24	50.50 x 36 x 24.60	150	28	6.31	\$1540	\$471
BRTADG5142H24	50.50 x 42 x 24.60	150	29.50	7.36	\$2389	\$485
BRTADG5148H24	50.50 x 48 x 24.60	150	31	8.42	\$2445	\$491
BRTADG5154H24	50.50 x 54 x 24.60	250	32.50	9.47	\$2500	\$506
BRTADG5160H24	50.50 x 60 x 24.60	250	34	10.52	\$2554	\$513
BRTADG5166H24	50.50 x 66 x 24.60	250	35.50	11.57	\$2609	\$527
BRTADG5172H24	50.50 x 72 x 24.60	250	37	12.63	\$2665	\$542
BRTADG5178H24	50.50 x 78 x 24.60	250	38.50	13.68	\$2721	\$547
BRTADG5184H24	50.50 x 84 x 24.60	250	40	14.73	\$2776	\$560

BRTADG6336H24	62.50 x 36 x 24.60	150	41.50	7.81	\$2554	\$513
BRTADG6342H24	62.50 x 42 x 24.60	150	43	9.11	\$2603	\$527
BRTADG6348H24	62.50 x 48 x 24.60	150	44.50	10.42	\$2665	\$542
BRTADG6354H24	62.50 x 54 x 24.60	150	46	11.72	\$2714	\$547
BRTADG6360H24	62.50 x 60 x 24.60	150	47.50	13.02	\$2776	\$560
BRTADG6366H24	62.50 x 66 x 24.60	250	49	14.32	\$2830	\$568
BRTADG6372H24	62.50 x 72 x 24.60	250	50.50	15.63	\$2879	\$582
BRTADG6378H24	62.50 x 78 x 24.60	250	52	16.93	\$2941	\$595
BRTADG6384H24	62.50 x 84 x 24.60	250	53.50	18.23	\$2990	\$603

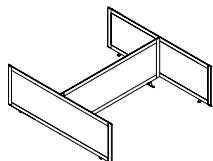

24"H Back-to-Back Glass Divider Screen

Provides privacy in an open plan environment. Easy to clean table mounted partitions. Powder coated aluminum frame with 4mm clear (CLR) glass. Includes all hardware to connect. Brackets are painted steel. Side dividers extend 6.25" from the front edge of each surface. Center divider sits over the gap between the worksurface allowing for cable pass-through to trough. Gap for each side is approximately 1". Width and depth are nominal sizes representing the sizes of the Bridges configuration. Allow for .25" overhang at the sides and 6.25" at the front. Frame and hardware available in all Bridges paint finishes. End trim cap is only available in Charcoal (CHR). Add 20% upcharge for frosted glass (FRST).

- BRTADG51xxH24 are for configurations with 24" deep surfaces.
- BRTADG63xxH24 are for configurations with 30" deep surfaces.

BRTADG5136H30	50.50 x 36 x 30.60	150	30.50	6.31	\$2466	\$498
BRTADG5142H30	50.50 x 42 x 30.60	150	32	7.36	\$2528	\$513
BRTADG5148H30	50.50 x 48 x 30.60	150	33.50	8.42	\$2576	\$520
BRTADG5154H30	50.50 x 54 x 30.60	150	35	9.47	\$2639	\$533
BRTADG5160H30	50.50 x 60 x 30.60	250	36.50	10.52	\$2693	\$542
BRTADG5166H30	50.50 x 66 x 30.60	250	38	11.57	\$2748	\$554
BRTADG5172H30	50.50 x 72 x 30.60	250	39.50	12.63	\$2782	\$560
BRTADG5178H30	50.50 x 78 x 30.60	250	41	13.68	\$2865	\$575
BRTADG5184H30	50.50 x 84 x 30.60	250	42.50	14.73	\$2920	\$589

BRTADG6336H30	62.50 x 36 x 30.60	125	44	7.81	\$2768	\$560
BRTADG6342H30	62.50 x 42 x 30.60	150	45.50	9.11	\$2824	\$568
BRTADG6348H30	62.50 x 48 x 30.60	150	47	10.42	\$2879	\$582
BRTADG6354H30	62.50 x 54 x 30.60	150	48.50	11.72	\$2941	\$595
BRTADG6360H30	62.50 x 60 x 30.60	150	50	13.02	\$2996	\$603
BRTADG6366H30	62.50 x 66 x 30.60	250	51.50	14.32	\$3043	\$616
BRTADG6372H30	62.50 x 72 x 30.60	250	53	15.63	\$3087	\$621
BRTADG6378H30	62.50 x 78 x 30.60	250	54.50	16.93	\$3161	\$637
BRTADG6384H30	62.50 x 84 x 30.60	250	56	18.23	\$3224	\$651

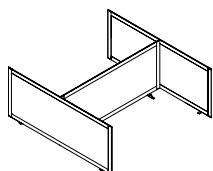

30"H Back-to-Back Glass Divider Screen

Provides privacy in an open plan environment. Easy to clean table mounted partitions. Powder coated aluminum frame with 4mm clear (CLR) glass. Includes all hardware to connect. Brackets are painted steel. Side dividers extend 6.25" from the front edge of each surface. Center divider sits over the gap between the worksurface allowing for cable pass-through to trough. Gap for each side is approximately 1". Width and depth are nominal sizes representing the sizes of the Bridges configuration. Allow for .25" overhang at the sides and 6.25" at the front. Frame and hardware available in all Bridges paint finishes. End trim cap is only available in Charcoal (CHR). Add 20% upcharge for frosted glass (FRST).

- BRTADG51xxH30 are for configurations with 24" deep surfaces.
- BRTADG63xxH30 are for configurations with 30" deep surfaces.

Required specifications

Frame finish

Optional specifications

Frosted glass (FRST)

BACK-TO-BACK GLASS DIVIDER SCREENS

MODEL# DIMENSIONS FREIGHT CLASS WT/LBS. CUBIC FT. LIST PRICE FRST ADD

D x W x H

BRTADGE5136H24	50.50 x 36 x 24.60	150	23.35	6.31	\$1540	\$311
BRTADGE5142H24	50.50 x 42 x 24.60	250	24.85	7.36	\$1597	\$326
BRTADGE5148H24	50.50 x 48 x 24.60	250	26.35	8.42	\$1650	\$334
BRTADGE5154H24	50.50 x 54 x 24.60	250	27.85	9.47	\$1707	\$347
BRTADGE5160H24	50.50 x 60 x 24.60	250	29.35	10.52	\$1762	\$355
BRTADGE5166H24	50.50 x 66 x 24.60	250	30.85	11.57	\$1816	\$368
BRTADGE5172H24	50.50 x 72 x 24.60	250	32.35	12.63	\$1872	\$382
BRTADGE5178H24	50.50 x 78 x 24.60	250	33.85	13.68	\$1926	\$389
BRTADGE5184H24	50.50 x 84 x 24.60	250	35.35	14.73	\$1982	\$403
BRTADGE6336H24	62.50 x 36 x 24.60	150	36.85	7.81	\$1650	\$334
BRTADGE6342H24	62.50 x 42 x 24.60	150	38.35	9.11	\$1707	\$347
BRTADGE6348H24	62.50 x 48 x 24.60	150	39.85	10.42	\$1762	\$355
BRTADGE6354H24	62.50 x 54 x 24.60	250	41.35	11.72	\$1816	\$368
BRTADGE6360H24	62.50 x 60 x 24.60	250	42.85	13.02	\$1863	\$373
BRTADGE6366H24	62.50 x 66 x 24.60	250	44.35	14.32	\$1926	\$389
BRTADGE6372H24	62.50 x 72 x 24.60	250	45.85	15.63	\$1982	\$403
BRTADGE6378H24	62.50 x 78 x 24.60	250	47.35	16.93	\$2031	\$408
BRTADGE6384H24	62.50 x 84 x 24.60	250	48.85	18.23	\$2093	\$422

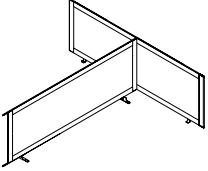

24" H Back-to-Back Glass Divider Screen Extension Kit

Provides an extension to privacy in an open plan environment. Easy to clean table mounted partitions. Intended to always connect to Back-to-Back Divider Screen Kit. Powder coated aluminum frame with 4mm clear (CLR) glass. Includes all hardware to connect. Brackets are painted steel. Side dividers extend 6.25" from the front edge of each surface. Center divider sits over the gap between the worksurface allowing for cable pass-through to trough. Gap for each side is approximately 1". Width and depth are nominal sizes representing the sizes of the Bridges configuration. Allow for .25" overhang at the sides and 6.25" at the front. Frame and hardware available in all Bridges paint finishes. End trim cap is only available in Charcoal (CHR). **Add 20%** upcharge for frosted glass (FRST).

- **BRTADGE51xxH24 are for configurations with 24" deep surfaces.**
- **BRTADGE63xxH24 are for configurations with 30" deep surfaces.**

BRTADGE5136H30	50.50 x 36 x 30.60	150	25.85	6.31	\$1631	\$334
BRTADGE5142H30	50.50 x 42 x 30.60	150	27.35	7.36	\$1678	\$340
BRTADGE5148H30	50.50 x 48 x 30.60	250	28.85	8.42	\$1733	\$355
BRTADGE5154H30	50.50 x 54 x 30.60	250	30.35	9.47	\$1796	\$360
BRTADGE5160H30	50.50 x 60 x 30.60	250	31.85	10.52	\$1850	\$373
BRTADGE5166H30	50.50 x 66 x 30.60	250	33.35	11.57	\$1913	\$389
BRTADGE5172H30	50.50 x 72 x 30.60	250	34.85	12.63	\$1941	\$396
BRTADGE5178H30	50.50 x 78 x 30.60	250	36.35	13.68	\$2018	\$408
BRTADGE5184H30	50.50 x 84 x 30.60	250	37.85	14.73	\$2079	\$422

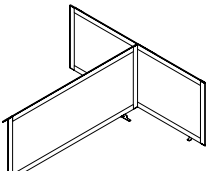

30" H Back-to-Back Glass Divider Screen Extension Kit

Provides an extension to privacy in an open plan environment. Easy to clean table mounted partitions. Intended to always connect to Back-to-Back Divider Screen Kit. Powder coated aluminum frame with 4mm clear (CLR) glass. Includes all hardware to connect. Brackets are painted steel. Side dividers extend 6.25" from the front edge of each surface. Center divider sits over the gap between the worksurface allowing for cable pass-through to trough. Gap for each side is approximately 1". Width and depth are nominal sizes representing the sizes of the Bridges configuration. Allow for .25" overhang at the sides and 6.25" at the front. Frame and hardware available in all Bridges paint finishes. End trim cap is only available in Charcoal (CHR). **Add 20%** upcharge for frosted glass (FRST).

- **BRTADGE51xxH30 are for configurations with 24" deep surfaces.**
- **BRTADGE63xxH30 are for configurations with 30" deep surfaces.**

Required specifications
Frame finish

Optional specifications
Frosted glass (FRST)

SINGLE TABLE GLASS DIVIDER SCREENS	MODEL#	DIMENSIONS	FREIGHT CLASS	WT/LBS.	CUBIC FT.	LIST PRICE	FRST ADD
		D x W x H					
	BRTADG2436H24	31.50 x 36 x 24.60	125	22.55	3.94	\$1685	\$340
	BRTADG2442H24	31.50 x 42 x 24.60	125	24.10	4.59	\$1740	\$355
	BRTADG2448H24	31.50 x 48 x 24.60	150	25.65	5.25	\$1796	\$360
	BRTADG2454H24	31.50 x 54 x 24.60	150	27.20	5.91	\$1850	\$373
	BRTADG2460H24	31.50 x 60 x 24.60	150	28.75	6.56	\$1907	\$389
	BRTADG2466H24	31.50 x 66 x 24.60	150	30.30	7.22	\$1961	\$396
	BRTADG2472H24	31.50 x 72 x 24.60	150	31.85	7.88	\$2018	\$408
	BRTADG2478H24	31.50 x 78 x 24.60	150	33.40	8.53	\$2072	\$417
	BRTADG2484H24	31.50 x 84 x 24.60	150	34.95	9.19	\$2127	\$430
	BRTADG3036H24	37.75 x 36 x 24.60	100	36.50	4.72	\$1796	\$360
	BRTADG3042H24	37.75 x 42 x 24.60	125	38.05	5.51	\$1845	\$373
	BRTADG3048H24	37.75 x 48 x 24.60	125	39.60	6.29	\$1907	\$389
	BRTADG3054H24	37.75 x 54 x 24.60	125	41.15	7.08	\$1955	\$396
	BRTADG3060H24	37.75 x 60 x 24.60	150	41.70	7.87	\$2010	\$408
	BRTADG3066H24	37.75 x 66 x 24.60	150	44.25	8.65	\$2066	\$417
	BRTADG3072H24	37.75 x 72 x 24.60	150	45.80	9.44	\$2120	\$430
	BRTADG3078H24	37.75 x 78 x 24.60	150	47.35	10.22	\$2174	\$436
	BRTADG3084H24	37.75 x 84 x 24.60	150	48.90	11.01	\$2231	\$451

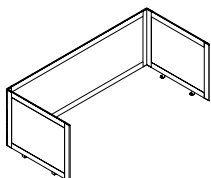

24" H Single Table Glass Divider Screen

Provides privacy in an open plan environment. Easy to clean table mounted partitions. Powder coated aluminum frame with 4mm clear (CLR) glass. Includes all hardware to connect. Brackets are painted steel. Side dividers extend 6.237" from the front edge of each surface. Back divider extends over the back edge of the worksurface by 1.5", allowing for cable pass-through to trough. Width and depth are nominal sizes representing the sizes of the Bridges configuration. Allow for .25" overhang at the sides, 1.5" at the back, and 6.237" at the front. Frame and hardware available in all Bridges paint finishes. End trim cap is only available in Charcoal (CHR). 9mm PET felt material is tackable and available in 9 colors.

- **BRTADG24xxH24 are for configurations with 24" deep surfaces.**
- **BRTADG30xxH24 are for configurations with 30" deep surfaces.**

BRTADG2436H30	31.50 x 36 x 30.60	125	24.85	3.97	\$1762	\$355
BRTADG2442H30	31.50 x 42 x 30.60	125	26.40	4.59	\$1810	\$368
BRTADG2448H30	31.50 x 48 x 30.60	125	27.95	5.25	\$1863	\$373
BRTADG2454H30	31.50 x 54 x 30.60	150	29.50	5.91	\$1926	\$389
BRTADG2460H30	31.50 x 60 x 30.60	150	31.05	6.56	\$1982	\$403
BRTADG2466H30	31.50 x 66 x 30.60	150	32.60	7.22	\$2044	\$417
BRTADG2472H30	31.50 x 72 x 30.60	150	34.14	7.88	\$2072	\$417
BRTADG2478H30	31.50 x 78 x 30.60	150	34.70	8.53	\$2148	\$436
BRTADG2484H30	31.50 x 84 x 30.60	150	37.25	9.19	\$2209	\$444

BRTADG3036H30	37.75 x 36 x 30.60	100	38.80	4.72	\$1863	\$373
BRTADG3042H30	37.75 x 42 x 30.60	100	40.35	5.51	\$1926	\$389
BRTADG3048H30	37.75 x 48 x 30.60	125	41.90	6.29	\$1982	\$403
BRTADG3054H30	37.75 x 54 x 30.60	125	43.45	7.08	\$2031	\$408
BRTADG3060H30	37.75 x 60 x 30.60	125	45	7.87	\$2093	\$422
BRTADG3066H30	37.75 x 66 x 30.60	150	46.55	8.65	\$2148	\$436
BRTADG3072H30	37.75 x 72 x 30.60	150	48.10	9.44	\$2189	\$444
BRTADG3078H30	37.75 x 78 x 30.60	150	49.65	10.22	\$2266	\$457
BRTADG3084H30	37.75 x 84 x 30.60	150	51.20	11.01	\$2314	\$465

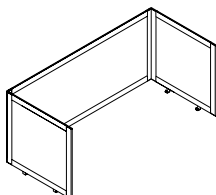

30" H Single Table Glass Divider Screen

Provides privacy in an open plan environment. Easy to clean table mounted partitions. Powder coated aluminum frame with 4mm clear (CLR) glass. Includes all hardware to connect. Brackets are painted steel. Side dividers extend 6.237" from the front edge of each surface. Back divider extends over the back edge of the worksurface by 1.5", allowing for cable pass-through to trough. Width and depth are nominal sizes representing the sizes of the Bridges configuration. Allow for .25" overhang at the sides, 1.5" at the back, and 6.237" at the front. Frame and hardware available in all Bridges paint finishes. End trim cap is only available in Charcoal (CHR). **Add 20% upcharge for frosted glass (FRST).**

- **BRTADG24xxH30 are for configurations with 24" deep surfaces.**
- **BRTADG30xxH30 are for configurations with 30" deep surfaces.**

Required specifications

Frame finish

Optional specifications

Frosted glass (FRST)

SINGLE TABLE GLASS DIVIDER SCREENS

MODEL#	DIMENSIONS	FREIGHT CLASS	WT/LBS.	CUBIC FT.	LIST PRICE	FRST ADD
D x W x H						
BRTADGE2436H24	31.50 x 36 x 24.60	150	18.55	3.94	\$1210	\$243
BRTADGE2442H24	31.50 x 42 x 24.60	150	20.10	4.59	\$1320	\$272
BRTADGE2448H24	31.50 x 48 x 24.60	150	21.65	5.25	\$1367	\$278
BRTADGE2454H24	31.50 x 54 x 24.60	150	23.20	5.91	\$1423	\$292
BRTADGE2460H24	31.50 x 60 x 24.60	150	24.75	6.56	\$1479	\$299
BRTADGE2466H24	31.50 x 66 x 24.60	250	26.30	7.22	\$1534	\$311
BRTADGE2472H24	31.50 x 72 x 24.60	250	27.85	7.88	\$1588	\$320
BRTADGE2478H24	31.50 x 78 x 24.60	250	29.40	8.53	\$1645	\$334
BRTADGE2484H24	31.50 x 84 x 24.60	250	30.95	9.19	\$1699	\$347
BRTADGE3036H24	37.75 x 36 x 24.60	125	32.50	4.72	\$1265	\$257
BRTADGE3042H24	37.75 x 42 x 24.60	125	34.05	5.51	\$1375	\$278
BRTADGE3048H24	37.75 x 48 x 24.60	125	35.60	6.29	\$1429	\$292
BRTADGE3054H24	37.75 x 54 x 24.60	150	37.15	7.08	\$1485	\$299
BRTADGE3060H24	37.75 x 60 x 24.60	150	38.70	7.87	\$1540	\$311
BRTADGE3066H24	37.75 x 66 x 24.60	150	40.25	8.65	\$1597	\$326
BRTADGE3072H24	37.75 x 72 x 24.60	150	41.80	9.44	\$1650	\$334
BRTADGE3078H24	37.75 x 78 x 24.60	150	43.35	10.01	\$1707	\$347
BRTADGE3084H24	37.75 x 84 x 24.60	150	44.90	10.01	\$1762	\$355

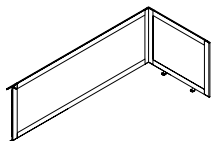

24" H Single Table Glass Divider Screen Extension Kit

Provides an extension for privacy in an open plan environment. Intended to always connect to Single Table Divider Screen Kit. Easy to clean table mounted partitions. Powder coated aluminum frame with 4mm clear (CLR) glass. Includes all hardware to connect. Brackets are painted steel. Side dividers extend 6.237" from the front edge of each surface. Back divider extends over the back edge of the worksurface by 1.5", allowing for cable pass-through to trough. Width and depth are nominal sizes representing the sizes of the Bridges configuration. Allow for .25" overhang at the sides, 1.5" at the back, and 6.237" at the front. Frame and hardware available in all Bridges paint finishes. End trim cap is only available in Charcoal (CHR). **Add 20%** upcharge for frosted glass (**FRST**).

- **BRTADGE24xxH24 are for configurations with 24" deep surfaces.**
- **BRTADGE30xxH24 are for configurations with 30" deep surfaces.**

Required specifications
Frame finish

Optional specifications
Frosted glass (FRST)

SINGLE TABLE GLASS DIVIDER SCREENS	MODEL#	DIMENSIONS	FREIGHT CLASS	WT/LBS.	CUBIC FT.	LIST PRICE	FRST ADD
		D x W x H					
	BRTADGE2436H30	31.50 x 36 x 30.60	150	20.35	3.94	\$1265	\$1522
	BRTADGE2442H30	31.50 x 42 x 30.60	150	21.90	4.59	\$1375	\$278
	BRTADGE2448H30	31.50 x 48 x 30.60	150	23.45	5.25	\$1429	\$292
	BRTADGE2454H30	31.50 x 54 x 30.60	150	25	5.91	\$1491	\$305
	BRTADGE2460H30	31.50 x 60 x 30.60	150	26.55	6.56	\$1547	\$311
	BRTADGE2466H30	31.50 x 66 x 30.60	150	28.10	7.22	\$1610	\$326
	BRTADGE2472H30	31.50 x 72 x 30.60	150	29.65	7.88	\$1637	\$334
	BRTADGE2478H30	31.50 x 78 x 30.60	250	31.20	8.53	\$1713	\$347
	BRTADGE2484H30	31.50 x 84 x 30.60	250	32.75	9.19	\$1775	\$360
	BRTADGE3036H30	37.75 x 36 x 30.60	125	34.30	4.72	\$1327	\$272
	BRTADGE3042H30	37.75 x 42 x 30.60	125	35.85	5.51	\$1429	\$292
	BRTADGE3048H30	37.75 x 48 x 30.60	125	37.40	6.29	\$1491	\$305
	BRTADGE3054H30	37.75 x 54 x 30.60	150	38.95	7.08	\$1547	\$311
	BRTADGE3060H30	37.75 x 60 x 30.60	150	40.50	7.87	\$1610	\$326
	BRTADGE3066H30	37.75 x 66 x 30.60	150	42.05	8.65	\$1659	\$334
	BRTADGE3072H30	37.75 x 72 x 30.60	150	43.60	9.44	\$1693	\$340
	BRTADGE3078H30	37.75 x 78 x 30.60	150	45.15	10.22	\$1775	\$360
	BRTADGE3084H30	37.75 x 84 x 30.60	150	46.70	11.01	\$1831	\$368

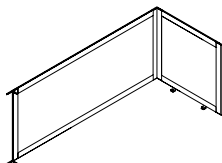

30" H Single Table Glass Divider Screen Extension Kit

Provides an extension for privacy in an open plan environment. Intended to always connect to Single Table Divider Screen Kit. Easy to clean table mounted partitions. Powder coated aluminum frame with 4mm clear (CLR) glass. Includes all hardware to connect. Brackets are painted steel. Side dividers extend 6.237" from the front edge of each surface. Back divider extends over the back edge of the worksurface by 1.5", allowing for cable pass-through to trough. Width and depth are nominal sizes representing the sizes of the Bridges configuration. Allow for .25" overhang at the sides, 1.5" at the back, and 6.237" at the front. Frame and hardware available in all Bridges paint finishes. End trim cap is only available in Charcoal (CHR). **Add 20%** upcharge for frosted glass (FRST).

- **BRTADGE24xxH30 are for configurations with 24" deep surfaces.**
- **BRTADGE30xxH30 are for configurations with 30" deep surfaces.**

Required specifications

Frame finish

Optional specifications

Frosted glass (FRST)

STARTER BEAM

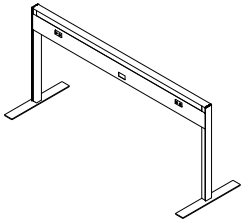

Starter Beam

MODEL#	DIMENSIONS	FREIGHT CLASS	WT/LBS.	CUBIC FT.	LIST PRICE
D x W x H					
BRPBS1824	24 x 24 x 18	250	20.23	6	\$492
BRPBS1830	24 x 30 x 18	250	21.83	7.5	\$522
BRPBS1836	24 x 36 x 18	250	23.14	9	\$546
BRPBS1842	24 x 42 x 18	250	24.46	10.5	\$570
BRPBS1848	24 x 48 x 18	250	25.77	12	\$601
BRPBS1854	24 x 54 x 18	250	27.08	13.5	\$627
BRPBS1860	24 x 60 x 18	300	28.39	15	\$651
BRPBS1866	24 x 66 x 18	300	29.7	16.5	\$681
BRPBS1872	24 x 72 x 18	300	31.01	18	\$721
BRPBS2624	24 x 24 x 26	250	21.24	8.7	\$524
BRPBS2630	24 x 30 x 26	250	22.84	10.8	\$554
BRPBS2636	24 x 36 x 26	300	24.15	13	\$577
BRPBS2642	24 x 42 x 26	300	25.47	15.2	\$602
BRPBS2648	24 x 48 x 26	300	26.77	17.3	\$633
BRPBS2654	24 x 54 x 26	300	28.09	19.5	\$659
BRPBS2660	24 x 60 x 26	300	29.4	21.7	\$683
BRPBS2666	24 x 66 x 26	300	30.7	28.8	\$713
BRPBS2672	24 x 72 x 26	300	32.02	26	\$753
BRPBS3424	24 x 24 x 34	300	22.25	11.3	\$552
BRPBS3430	24 x 30 x 34	300	23.85	14.2	\$592
BRPBS3436	24 x 36 x 34	300	25.16	17	\$616
BRPBS3442	24 x 42 x 34	300	26.47	19.8	\$641
BRPBS3448	24 x 48 x 34	300	27.78	22.7	\$672
BRPBS3454	24 x 54 x 34	300	29.09	25.5	\$697
BRPBS3460	24 x 60 x 34	300	30.4	28.3	\$722
BRPBS3466	24 x 66 x 34	300	31.71	31.2	\$747
BRPBS3472	24 x 72 x 34	400	33.02	34	\$795

Starter beam can serve as a single, standalone unit or the beginning of a longer run of interconnected beams. 30" to 72" wide beams feature knockouts for two electrical duplex and one communication face place on each side while 24" wide beams accommodate one electrical duplex and one communication face place on each side. The leg expands by approximately 4" in height to compensate for uneven floors and allow for accurate leveling. Feet depth is 24". Starter Beam consists of horizontal channel, raceway covers, two legs, two 24" deep feet, two vertical end trims and corresponding end trim capture strips. Specify standard Flat Top Trim (**BRPBTC**), Glass and top trim kit (**BRPBEG**), or PET felt and top trim kit (**BRPBEF**) separately. Specify electrical components separately.

Required Specifications
Paint finish

ADD-ON BEAM / TRIM KIT **MODEL#** **DIMENSIONS** **FREIGHT CLASS** **WT./LBS.** **CUBIC FT.** **LIST PRICE**

D x W x H

BRPBA1824	24 x 24 x 18	250	14.46	6	\$362	
BRPBA1830	24 x 30 x 18	250	16.06	7.5	\$392	
BRPBA1836	24 x 36 x 18	300	17.37	9	\$415	
BRPBA1842	24 x 42 x 18	300	18.68	10.5	\$440	
BRPBA1848	24 x 48 x 18	300	19.99	12	\$471	
BRPBA1854	24 x 54 x 18	300	21.31	13.5	\$497	
BRPBA1860	24 x 60 x 18	300	22.62	15	\$521	
BRPBA1866	24 x 66 x 18	300	23.92	16.5	\$547	
BRPBA1872	24 x 72 x 18	300	25.24	18	\$590	
BRPBA2624	24 x 24 x 26	300	15.5	8.7	\$394	
BRPBA2630	24 x 30 x 26	300	17.11	10.8	\$424	
BRPBA2636	24 x 36 x 26	300	18.42	13	\$447	
BRPBA2642	24 x 42 x 26	300	19.73	15.2	\$472	
BRPBA2648	24 x 48 x 26	300	21.04	17.3	\$503	
BRPBA2654	24 x 54 x 26	300	22.35	19.5	\$529	
BRPBA2660	24 x 60 x 26	300	23.66	21.7	\$553	
BRPBA2666	24 x 66 x 26	300	24.97	23.8	\$579	
BRPBA2672	24 x 72 x 26	300	26.28	26	\$622	
BRPBA3424	24 x 24 x 34	300	16.55	11.3	\$432	
BRPBA3430	24 x 30 x 34	300	18.15	14.2	\$462	
BRPBA3436	24 x 36 x 34	300	19.46	17	\$485	
BRPBA3442	24 x 42 x 34	300	20.77	19.8	\$510	
BRPBA3448	24 x 48 x 34	400	22.08	22.7	\$541	
BRPBA3454	24 x 54 x 34	400	23.4	25.5	\$567	
BRPBA3460	24 x 60 x 34	400	24.71	28.3	\$591	
BRPBA3466	24 x 66 x 34	400	26.01	31.2	\$617	
BRPBA3472	24 x 72 x 34	400	27.33	34	\$661	

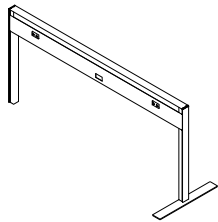

Add-On Beam

Add-on beam connects to the Starter Beam and serves to extend the run of powerbeams as desired. 30" to 72" wide beams feature knockouts for two electrical duplex and one communication face place on each side while 24" wide beams accommodate one electrical duplex and one communication face place on each side. Add-on beam consists of horizontal channel, raceway covers, two legs, one foot and a pair of beam-to-beam connecting capture strips. The leg expands by approximately 4" in height to compensate for uneven floors and allow for accurate leveling. The foot has a depth of 24". Specify standard Flat Top Trim (**BRPBTC**), Glass and top trim kit (**BRPBEG**), or PET felt and top trim kit (**BRPBEF**) separately. Specify electrical components separately.

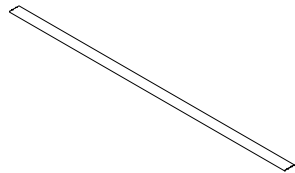

Flat Top Trim Kit

BRPBTC24	2.61 x 24 x 0.2	70	0.24	0.01	\$13
BRPBTC30	2.61 x 30 x 0.2	70	0.61	0.01	\$16
BRPBTC36	2.61 x 36 x 0.2	70	0.73	0.01	\$19
BRPBTC42	2.61 x 42 x 0.2	70	0.85	0.01	\$21
BRPBTC48	2.61 x 48 x 0.2	70	0.97	0.01	\$25
BRPBTC54	2.61 x 54 x 0.2	70	1.1	0.02	\$28
BRPBTC60	2.61 x 60 x 0.2	70	1.22	0.02	\$28
BRPBTC66	2.61 x 66 x 0.2	70	1.34	0.02	\$32
BRPBTC72	2.61 x 72 x 0.2	70	1.47	0.02	\$37

Attaches on top of beams to add privacy or divide space. Flat top trim is made of aluminum extrusion. Specify finish.

Required Specifications

Paint finish

TOP TRIM KITS **MODEL#** **DIMENSIONS** **FREIGHT CLASS** **WT./LBS.** **CUBIC FT.** **LIST PRICE** **FRST ADD**

D x W x H

BRPBEG0824	2.61 x 24 x 8	60	9.42	0.3	\$152	\$99
BRPBEG0830	2.61 x 30 x 8	60	11.79	0.4	\$161	\$99
BRPBEG0836	2.61 x 36 x 8	60	14.15	0.4	\$170	\$99
BRPBEG0842	2.61 x 42 x 8	60	16.52	0.5	\$180	\$99
BRPBEG0848	2.61 x 48 x 8	60	18.88	0.6	\$198	\$110
BRPBEG0854	2.61 x 54 x 8	60	19.52	0.7	\$219	\$124
BRPBEG0860	2.61 x 60 x 8	65	20.58	0.7	\$240	\$138
BRPBEG0866	2.61 x 66 x 8	65	21.55	0.8	\$261	\$151
BRPBEG0872	2.61 x 72 x 8	65	23.62	0.9	\$289	\$164

BRPBEG1624	2.61 x 24 x 16	70	9.81	0.6	\$158	\$99
BRPBEG1630	2.61 x 30 x 16	70	12.37	0.7	\$194	\$117
BRPBEG1636	2.61 x 36 x 16	70	14.85	0.9	\$218	\$148
BRPBEG1642	2.61 x 42 x 16	70	17.34	1	\$247	\$173
BRPBEG1648	2.61 x 48 x 16	70	19.82	1.2	\$277	\$198
BRPBEG1654	2.61 x 54 x 16	70	21.25	1.3	\$307	\$194
BRPBEG1660	2.61 x 60 x 16	70	23.62	1.5	\$337	\$247
BRPBEG1666	2.61 x 66 x 16	70	25.98	1.6	\$367	\$272
BRPBEG1672	2.61 x 72 x 16	70	28.35	1.7	\$404	\$296

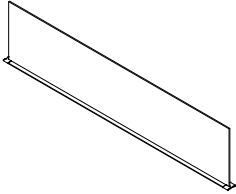

Embedded Glass and Top Trim Kit*

Attaches on top of beams to add privacy or divide space. Trim kit consists of extruded aluminum channel, die-cast channel end covers, glass partition, gasket and hardware required to secure the trim to the beam's horizontal channel. Standard with clear tempered glass.

BRPBEF0824	2.61 x 24 x 8	70	1.32	0.3	\$74	
BRPBEF0830	2.61 x 30 x 8	70	1.65	0.4	\$79	
BRPBEF0836	2.61 x 36 x 8	70	1.99	0.4	\$103	
BRPBEF0842	2.61 x 42 x 8	150	2.32	0.5	\$108	
BRPBEF0848	2.61 x 48 x 8	150	2.65	0.6	\$194	
BRPBEF0854	2.61 x 54 x 8	150	2.98	0.7	\$199	
BRPBEF0860	2.61 x 60 x 8	150	3.32	0.7	\$203	
BRPBEF0866	2.61 x 66 x 8	150	3.65	0.8	\$208	
BRPBEF0872	2.61 x 72 x 8	150	3.98	0.9	\$218	

BRPBEF1624	2.61 x 24 x 16	70	1.83	0.6	\$74	
BRPBEF1630	2.61 x 30 x 16	250	2.3	0.7	\$79	
BRPBEF1636	2.61 x 36 x 16	250	2.76	0.9	\$103	
BRPBEF1642	2.61 x 42 x 16	250	3.22	1	\$108	
BRPBEF1648	2.61 x 48 x 16	250	3.68	1.16	\$194	
BRPBEF1654	2.61 x 54 x 16	250	4.14	1.3	\$199	
BRPBEF1660	2.61 x 60 x 16	250	4.61	1.5	\$203	
BRPBEF1666	2.61 x 66 x 16	250	5.07	1.6	\$208	
BRPBEF1672	2.61 x 72 x 16	250	5.53	1.7	\$218	

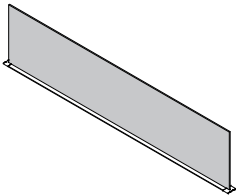

Embedded PET Felt and Top Trim Kit**

Attaches on top of beams to add privacy or divide space. Trim kit consists of extruded aluminum channel, die-cast channel end covers, PET felt partition and hardware required to secure the trim to the beam's horizontal channel. 9mm PET felt material is tackable and available in 9 colors.

Required Specifications

Paint finish
Felt finish**

Optional Specifications

Frosted glass (FRST)*

MODEL#	DIMENSIONS	FREIGHT CLASS	WT/LBS.	CUBIC FT.	LIST PRICE
D x W x H					
BRPBEP0824	2.61 x 24 x 8	70	1.32	0.3	\$148
BRPBEP0830	2.61 x 30 x 8	70	1.65	0.4	\$157
BRPBEP0836	2.61 x 36 x 8	70	1.99	0.4	\$206
BRPBEP0842	2.61 x 42 x 8	150	2.32	0.5	\$215
BRPBEP0848	2.61 x 48 x 8	150	2.65	0.6	\$388
BRPBEP0854	2.61 x 54 x 8	150	2.98	0.7	\$397
BRPBEP0860	2.61 x 60 x 8	150	3.32	0.7	\$406
BRPBEP0866	2.61 x 66 x 8	150	3.65	0.8	\$415
BRPBEP0872	2.61 x 72 x 8	150	3.98	0.9	\$436
BRPBEP1624	2.61 x 24 x 16	70	1.83	0.6	\$148
BRPBEP1630	2.61 x 30 x 16	250	2.3	0.7	\$157
BRPBEP1636	2.61 x 36 x 16	250	2.76	0.9	\$206
BRPBEP1642	2.61 x 42 x 16	250	3.22	1	\$215
BRPBEP1648	2.61 x 48 x 16	250	3.68	1.2	\$388
BRPBEP1654	2.61 x 54 x 16	250	4.14	1.3	\$397
BRPBEP1660	2.61 x 60 x 16	250	4.61	1.5	\$406
BRPBEP1666	2.61 x 66 x 16	250	5.07	1.6	\$415
BRPBEP1672	2.61 x 72 x 16	250	5.53	1.7	\$436

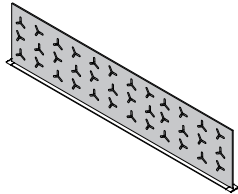

Embedded Perforated PET Felt and Top Trim Kit

Attaches on top of beams to add privacy or divide space. Trim kit consists of extruded aluminum channel, die-cast channel end covers, perforated PET felt partition and hardware required to secure the trim to the beam's horizontal channel. 9mm PET felt material is tackable and available in 9 colors.

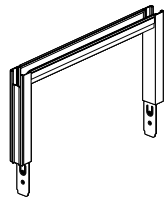

Overpanel Frame

BPX30P0824	2.61 x 24 x 8	100	4	0.44	\$134
BPX30P0830	2.61 x 30 x 8	125	4	0.66	\$147
BPX30P0836	2.61 x 36 x 8	150	4	0.71	\$159
BPX30P0842	2.61 x 42 x 8	150	5	0.88	\$174
BPX30P0848	2.61 x 48 x 8	150	5	0.93	\$185
BPX30P0854	2.61 x 54 x 8	150	6	1.04	\$196
BPX30P0860	2.61 x 60 x 8	150	6	1.2	\$207
BPX30P0866	2.61 x 66 x 8	150	7	1.31	\$301
BPX30P0872	2.61 x 72 x 8	150	8	1.42	\$392
BPX30P1624	2.61 x 24 x 16	125	5	0.73	\$134
BPX30P1630	2.61 x 30 x 16	150	5	1.09	\$147
BPX30P1636	2.61 x 36 x 16	150	5	1.19	\$159
BPX30P1642	2.61 x 42 x 16	150	6	1.46	\$174
BPX30P1648	2.61 x 48 x 16	250	6	1.55	\$185
BPX30P1654	2.61 x 54 x 16	150	7	1.73	\$196
BPX30P1660	2.61 x 60 x 16	250	7	2.01	\$207
BPX30P1666	2.61 x 66 x 16	150	9	2.17	\$301
BPX30P1672	2.61 x 72 x 16	150	10	2.37	\$392

Attaches on top of beams to add privacy or divide space. Consists of extruded aluminum frame and bayonets connecting the frame to the top of the beam vertical leg. Any tile can be attached to either side to enclose the frame. Specify standard Flat Top Trim (**BRPBTC**), Glass and top trim kit (**BRPBEG**) or PET felt and top trim kit (**BRPBEP**) separately.

- Maximum height of beam with overpanel is 42".

Required Specifications

Paint finish

REMOVABLE FACE TILES	MODEL#	DIMENSIONS D x W x H	FREIGHT CLASS	WT/LBS.	CUBIC FT.	LIST PRICE		
						GR 1	GR 2	LAMINATE
	BP3FT0824	2.61 x 24 x 8	125	1	0.3	\$156	\$156	\$170
	BP3FT0830	2.61 x 30 x 8	125	2	0.4	\$178	\$178	\$197
	BP3FT0836	2.61 x 36 x 8	125	2	0.4	\$211	\$211	\$237
	BP3FT0842	2.61 x 42 x 8	150	2	0.6	\$227	\$227	\$249
	BP3FT0848	2.61 x 48 x 8	150	3	0.7	\$237	\$237	\$257
	BP3FT0854	2.61 x 54 x 8	60	3	0.1	\$246	\$246	\$267
	BP3FT0860	2.61 x 60 x 8	125	4	0.8	\$254	\$254	\$274
	BP3FT0866	2.61 x 66 x 8	150	4	0.9	\$443	\$443	\$533
	BP3FT0872	2.61 x 72 x 8	150	4	1	\$569	\$569	\$711
	BP3FT1624	2.61 x 24 x 16	125	2	0.3	\$156	\$156	\$170
	BP3FT1630	2.61 x 30 x 16	125	3	0.4	\$178	\$178	\$197
	BP3FT1636	2.61 x 36 x 16	125	3	0.4	\$211	\$211	\$237
	BP3FT1642	2.61 x 42 x 16	150	3	0.6	\$227	\$227	\$249
	BP3FT1648	2.61 x 48 x 16	150	4	0.7	\$237	\$237	\$257
	BP3FT1654	2.61 x 54 x 16	60	4	0.1	\$246	\$246	\$267
	BP3FT1660	2.61 x 60 x 16	125	5	0.8	\$254	\$254	\$274
	BP3FT1666	2.61 x 66 x 16	150	5	0.9	\$443	\$443	\$533
	BP3FT1672	2.61 x 72 x 16	125	6	1	\$569	\$569	\$711

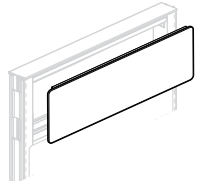

Removable Face Tile, Fabric or Laminate*

Removable fabric tile attaches to the overpanel frame to add privacy or divide space. Includes tile clips. Easily interchangeable on site. Specify two tiles per opening of corresponding width. Tiles can be combined. For example, fabric tile on one side and accessory tile on the other.

	BP3AT0824	2.61 x 24 x 8	85	2.3	0.17	\$185		
	BP3AT0830	2.61 x 30 x 8	85	2.9	0.21	\$197		
	BP3AT0836	2.61 x 36 x 8	85	3.5	0.25	\$238		
	BP3AT0842	2.61 x 42 x 8	85	4.1	0.29	\$281		
	BP3AT0848	2.61 x 48 x 8	85	4.7	0.33	\$326		
	BP3AT0854	2.61 x 54 x 8	85	5.3	0.38	\$356		
	BP3AT0860	2.61 x 60 x 8	85	5.9	0.42	\$402		
	BP3AT0866	2.61 x 66 x 8	85	6.5	0.46	\$577		
	BP3AT0872	2.61 x 72 x 8	85	7	0.5	\$750		
	BP3AT1624	2.61 x 24 x 16	85	4.7	0.33	\$185		
	BP3AT1630	2.61 x 30 x 16	85	5.7	0.42	\$197		
	BP3AT1636	2.61 x 36 x 16	85	7	0.5	\$238		
	BP3AT1642	2.61 x 42 x 16	85	8.2	0.58	\$281		
	BP3AT1648	2.61 x 48 x 16	85	9.4	0.67	\$326		
	BP3AT1654	2.61 x 54 x 16	85	10.6	0.75	\$356		
	BP3AT1660	2.61 x 60 x 16	85	11.9	0.83	\$402		
	BP3AT1666	2.61 x 66 x 16	85	13	0.91	\$577		
	BP3AT1672	2.61 x 72 x 16	85	14	1	\$750		

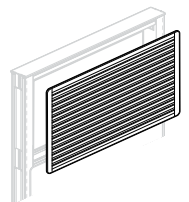

Removable Face Tile, Accessory

Attaches to the overpanel frame to add privacy or divide space. Provides support for accessories. Includes tile clips. Easily interchangeable on site. Specify two tiles per opening of corresponding width. Tiles can be combined. For example, fabric tile on one side and accessory tile on the other.

Required Specifications
 Fabric or Finish*
 Paint finish

REMOVABLE FACE TILES	MODEL#	DIMENSIONS	FREIGHT CLASS	WT/LBS.	CUBIC FT.	LIST PRICE	FRST ADD
		D x W x H					
	BP3GT0824	2.61 x 24 x 8	70	3.1	0.2	\$152	\$42
	BP3GT0830	2.61 x 30 x 8	70	3.9	0.2	\$193	\$42
	BP3GT0836	2.61 x 36 x 8	70	4.7	0.3	\$235	\$39
	BP3GT0842	2.61 x 42 x 8	70	5.5	0.3	\$271	\$44
	BP3GT0848	2.61 x 48 x 8	70	6.3	0.3	\$315	\$40
	BP3GT0854	2.61 x 54 x 8	70	7.1	0.4	\$350	\$44
	BP3GT0860	2.61 x 60 x 8	70	7.8	0.4	\$394	\$41
	BP3GT0866	2.61 x 66 x 8	70	8.6	0.5	\$561	\$42
	BP3GT0872	2.61 x 72 x 8	70	9.4	0.5	\$731	\$41
	BP3GT1624	2.61 x 24 x 16	70	5.8	0.3	\$152	\$42
	BP3GT1630	2.61 x 30 x 16	70	7.2	0.4	\$193	\$42
	BP3GT1636	2.61 x 36 x 16	70	8.7	0.5	\$235	\$44
	BP3GT1642	2.61 x 42 x 16	70	10.2	0.6	\$271	\$44
	BP3GT1648	2.61 x 48 x 16	70	11.6	0.7	\$315	\$40
	BP3GT1654	2.61 x 54 x 16	70	13.1	0.8	\$350	\$44
	BP3GT1660	2.61 x 60 x 16	70	14.6	0.8	\$394	\$41
	BP3GT1666	2.61 x 66 x 16	70	16	0.9	\$561	\$42
	BP3GT1672	2.61 x 72 x 16	70	17.5	1	\$731	\$41

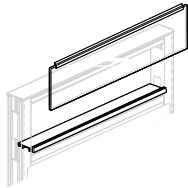

Removable Face Tile, Glass*

Removable glass tile attaches to the overpanel frame to add visual accessibility and light transfer. Includes tile clips. Easily interchangeable on site. Specify one glazed tile per opening of corresponding width. Clear tempered glass is standard.

Add 20% upcharge for frosted glass (FRST).



90 Degree Post

BRP3PS018	2.61 x 2.61 x 18	65	3	0.1	\$59
BRP3PS026	2.61 x 2.61 x 26	65	3.6	0.1	\$84
BRP3PS034	2.61 x 2.61 x 34	65	4	0.1	\$109

Post facilitates splitting a beam run up to 4 directions at a 90° angle. Post kit consists of extruded aluminum post and four pairs of capture strip connectors. Post vertical trim must be specified according to your post: 2-way, 3-way, or 4-way.



60 Degree Post

BRP3PS60018	2.61 x 2.61 x 18	65	3	0.1	\$59
BRP3PS60026	2.61 x 2.61 x 26	65	3.6	0.1	\$84
BRP3PS60034	2.61 x 2.61 x 34	65	4	0.1	\$109

Post facilitates splitting a beam run up to 3 directions at a 120° angle. Post kit consists of extruded aluminum post and three pairs of capture strip connectors. Post vertical trim must be specified according to your post: 2-way or 3-way.







45 Degree Post

BRP3PS45018	2.61 x 2.61 x 18	65	3	0.1	\$59
BRP3PS45026	2.61 x 2.61 x 26	65	3.6	0.1	\$84
BRP3PS45034	2.61 x 2.61 x 34	65	4	0.1	\$109

Post facilitates two beams at a 45° angle. Post kit consists of extruded aluminum post and four pairs of capture strip connectors. Post vertical trim must be specified according to your post: 2-way, 3-way, or 4-way.

Required Specifications
Paint finish

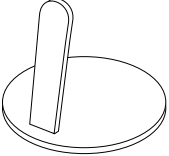
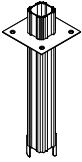
Optional Specifications
Frosted glass (FRST)*

	MODEL#	DIMENSIONS	FREIGHT CLASS	WT./LBS.	CUBIC FT.	LIST PRICE
 <p>Post Trim</p>	D x W x H					
	BRPVTRF18	2.61 x 2.61 x 18	70	0.5	0.01	\$46
	BRPVTRF26	2.61 x 2.61 x 26	70	0.72	0.02	\$67
	BRPVTRF34	2.61 x 2.61 x 34	70	0.94	0.03	\$89
	BRPVTRF42	2.61 x 2.61 x 42	70	1.16	0.04	\$130
<p>Attaches to post. Consists of extruded aluminum post and one pair of capture strip connectors. Post vertical trim must be specified according to your post: 2-way, 3-way, or 4-way.</p>						
 <p>Overpanel End Trim</p>	BA3VTEF8	0.13 x 2.61 x 8	70	0.2	0.01	\$26
	BA3VTEF16	0.13 x 2.61 x 16	70	0.5	0.01	\$55
	BA3VTEF32	0.13 x 2.61 x 32	xx	1.1	0.06	\$82
<p>Attaches to sides of overpanel extension frame. Consists of extruded aluminum post, die-cast corner and one pair of capture strip connectors. When specified as an add-on, use with overpanel frame. Alternatively, we recommend using the BRPVTRFxx of the appropriate size for a clean, seamless trim.</p>						
 <p>Round Disc Base for Post</p>	BRPRB	7.5 x 7.5 x 6.5	60	3.67	0.01	\$285
<p>Attaches to the bottom of a BRP3PS post to provide stability at an intersection. Round metal plate is 1/4" thick.</p>						
 <p>Post Extension</p>	BEPE81	2.61 x 2.61 x 81	65	9	0.4	\$227
<p>Lightweight aluminum pole used to bring power and/or data/communication cables from ceiling to a panel through a post. Attaches to ceiling and post, includes connectors, ceiling trim plate and screws. Ceiling bezel is white only. Post extension will accept: - (75) 5.6mm dia. data cables - (60) 5.6mm (0.22") dia. data cables with 1 power feed - (45) cables 5.6mm (0.22") dia. data cables with 2 power feeds</p>						
 <p>Post Extension for Over Panels</p>	BH3PE008	2.61 x 2.61 x 8	70	1	0.03	\$51
	BH3PE016	2.61 x 2.61 x 16	65	2	0.07	\$62
	BH3PE032	2.61 x 2.61 x 32	65	4	0.14	\$109
	BH3PE45016	2.61 x 2.61 x 16	65	2	0.07	\$62
	BH3PE45032	2.61 x 2.61 x 32	65	4	0.14	\$109
	BH3PE60016	2.61 x 2.61 x 16	65	2	0.07	\$62
	BH3PE60032	2.61 x 2.61 x 32	65	4	0.14	\$109
<p>Provides route for ceiling data or electrical cables through the post to the panel. Includes 2 capture strip panel connectors.</p>						

Required Specifications
 Paint finish

END OF RUN GALLERY PANELS **MODEL#** **DIMENSIONS** **FREIGHT CLASS** **WT./LBS.** **CUBIC FT.** **LIST PRICE**

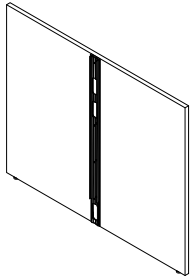

End of Run Gallery Panel, T-config

	D x W x H					
B3LEP4227NC	1 x 26.5 x 42	60	29.49	0.64	\$1020	
B3LEP4251NC	1 x 51 x 42	60	55.17	1.24	\$1497	
B3LEP4263NC	1 x 63 x 42	60	68.01	1.53	\$1677	
B3LEP4275NC	1 x 75 x 42	60	80.86	1.82	\$1866	
B3LEP5027NC	1 x 26.5 x 50	60	35.25	0.77	\$1190	
B3LEP5051NC	1 x 51 x 50	60	65.92	1.48	\$1738	
B3LEP5063NC	1 x 63 x 50	60	81.27	1.82	\$1959	
B3LEP5075NC	1 x 75 x 50	60	96.62	2.17	\$2210	

No connectors for additional gallery panels. Provides floor standing support while enclosing the end of a panel run on two sides. Attaches to the end of a Bridges Power Beam with capture strips to form a T-configuration. Connection is on the interior face center. Includes all attachment hardware and glides. Total height is inclusive of panel glides extended to their full height. 51" w gallery panel accommodates two 24" deep surfaces; 63" w accommodates two 30" deep surfaces; 75" w accommodates two 36" deep surfaces. Edged in PVC on three exposed edges and self edge on bottom. If woodgrain laminate is selected, woodgrain runs horizontally.

- Power beam and overpanel must add up to height of gallery panels.

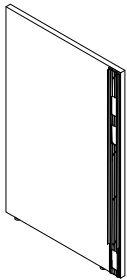

Left End of Run Gallery Panel, L-config

B3LSEPL4215NC	1 x 14.25 x 42	60	16.64	0.35	\$839	
B3LSEPL4227NC	1 x 27 x 42	60	29.47	0.66	\$1142	
B3LSEPL4233NC	1 x 33 x 42	60	35.89	0.8	\$1231	
B3LSEPL4239NC	1 x 39 x 42	60	42.32	0.95	\$1294	
B3LSEPL5015NC	1 x 14.25 x 50	60	19.9	0.41	\$956	
B3LSEPL5027NC	1 x 27 x 50	60	35.23	0.78	\$1298	
B3LSEPL5033NC	1 x 33 x 50	60	42.9	0.95	\$1406	
B3LSEPL5039NC	1 x 39 x 50	60	50.57	1.13	\$1505	

No connectors for additional gallery panels. Provides floor standing support while enclosing the end of a Bridges Power Beam run on one side. Attaches to the end of a panel with capture strips to form an L-configuration. Connection is on the interior face, right side. Includes all attachment hardware and glides. Total height is inclusive of panel glides extended to their full height. 27" w gallery panel accommodates a 24" deep surface; 33" w accommodates a 30" deep surface; 39" w accommodates a 36" deep surface. Edged in PVC on three exposed edges and self edge on bottom. If woodgrain laminate is selected, woodgrain runs horizontally.

- Power beam and overpanel must add up to height of gallery panels.



Right End of Run Gallery Panel, L-config

B3LSEPR4215NC	1 x 14.25 x 42	60	16.64	0.35	\$839	
B3LSEPR4227NC	1 x 27 x 42	60	29.47	0.66	\$1142	
B3LSEPR4233NC	1 x 33 x 42	60	35.89	0.8	\$1231	
B3LSEPR4239NC	1 x 39 x 42	60	42.32	0.95	\$1294	
B3LSEPR5015NC	1 x 14.25 x 50	60	19.9	0.41	\$956	
B3LSEPR5027NC	1 x 27 x 50	60	35.23	0.78	\$1298	
B3LSEPR5033NC	1 x 33 x 50	60	42.9	0.95	\$1406	
B3LSEPR5039NC	1 x 39 x 50	60	50.57	1.13	\$1505	

No connectors for additional gallery panels. Provides floor standing support while enclosing the end of a Bridges Power Beam run on one side. Attaches to the end of a panel with capture strips to form an L-configuration. Connection is on the interior face, left side. Includes all attachment hardware and glides. The total height includes the panel glides extended to their maximum height. 27" w gallery panel accommodates a 24" deep surface; 33" w accommodates a 30" deep surface; 39" w accommodates a 36" deep surface. Edged in PVC on three exposed edges and self edge on bottom. If woodgrain laminate is selected, woodgrain runs horizontally.

- Power beam and overpanel must add up to height of gallery panels.

Required Specifications

- Laminate finish
- Edge finish
- Paint finish

END OF RUN GALLERY PANELS

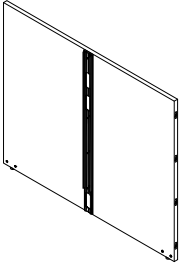

End of Run Gallery Panel, T-config



Left End of Run Gallery Panel, L-config



Right End of Run Gallery Panel, L-config

MODEL#	DIMENSIONS D x W x H	FREIGHT CLASS	WT/LBS.	CUBIC FT.	LIST PRICE
B3LEP4251	1 x 51 x 42	60	55.25	1.24	\$1530
B3LEP4263	1 x 63 x 42	60	68.1	1.53	\$1708
B3LEP4275	1 x 75 x 42	60	80.95	1.82	\$1899
B3LEP5051	1 x 51 x 50	60	66.01	1.48	\$1771
B3LEP5063	1 x 63 x 50	60	81.36	1.82	\$1992
B3LEP5075	1 x 75 x 50	60	96.71	2.17	\$2244

With connectors for additional gallery panels. Provides floor standing support while enclosing the end of a Bridges Power Beam run. Attaches to the end of a panel with capture strips to form a T-configuration. Connections at both ends as well as on the middle of interior face. Includes all attachment hardware and glides. The total height includes the panel glides extended to their maximum height. 51" w gallery panel accommodates two 24" deep surfaces; 63" w accommodates two 30" deep surfaces; 75" w accommodates two 36" deep surfaces. Edged in PVC on three exposed edges and self edge on bottom. If woodgrain laminate is selected, woodgrain runs horizontally (woodgrain will not align at panel seams). End connections are for connecting other gallery panels:

- Right side is compatible with right hand Gallery Panels (**B3LXPRxxxx** and **B3LXPRxxxxNC**, **B3L2PRxxxx** and **B3L3PRxxxx**) only.
- Left side is compatible with left hand Gallery Panels (**B3LXPLxxxx** and **B3LXPLxxxxNC**, **B3L2PLxxxx** and **B3L3PLxxxx**) only.
- Power beam and overpanel must add up to height of gallery panels.

B3LSEPL4227	1 x 27 x 42	60	29.51	0.66	\$1157
B3LSEPL4233	1 x 33 x 42	60	35.94	0.8	\$1247
B3LSEPL4239	1 x 39 x 42	60	42.36	0.95	\$1309
B3LSEPL5027	1 x 27 x 50	60	35.27	0.78	\$1313
B3LSEPL5033	1 x 33 x 50	60	42.94	0.95	\$1425
B3LSEPL5039	1 x 39 x 50	60	50.62	1.13	\$1524

With connectors for additional gallery panels. Provides floor standing support while enclosing the end of a Bridges Power Beam run. Attaches to the end of a panel with capture strips to form a L-configuration. Connection is on the interior face, right side. Connections for a gallery panel are on the *left* edge. Includes all attachment hardware and glides. The total height includes the panel glides extended to their maximum height. 27" w gallery panel accommodates a 24" deep surface; 33" w accommodates a 30" deep surface; 39" w accommodates a 36" deep surfaces. Edged in PVC on two exposed edges, self edge on connecting edge and the bottom. If woodgrain laminate is selected, woodgrain runs horizontally (woodgrain will not align at panel seams).

- Power beam and overpanel must add up to height of gallery panels.
- Compatible with left hand Gallery Panels (**B3LXPLxxxx** and **B3LXPLxxxxNC**, **B3L2PLxxxx** and **B3L3PLxxxx**) only.

B3LSEPR4227	1 x 27 x 42	60	29.51	0.66	\$1157
B3LSEPR4233	1 x 33 x 42	60	35.94	0.8	\$1247
B3LSEPR4239	1 x 39 x 42	60	42.36	0.95	\$1309
B3LSEPR5027	1 x 27 x 50	60	35.27	0.78	\$1313
B3LSEPR5033	1 x 33 x 50	60	42.94	0.95	\$1425
B3LSEPR5039	1 x 39 x 50	60	50.62	1.13	\$1524

With connectors for additional gallery panels. Provides floor standing support while enclosing the end of a Bridges Power Beam run. Attaches to the end of a panel with capture strips to form a L-configuration. Connection is on the interior face, left side. Connections for a gallery panel are on the *right* edge. Includes all attachment hardware and glides. The total height includes the panel glides extended to their maximum height. 27" w gallery panel accommodates a 24" deep surface; 33" w accommodates a 30" deep surface; 39" w accommodates a 36" deep surfaces. Edged in PVC on two exposed edges, self edge on connecting edge and the bottom. If woodgrain laminate is selected, woodgrain runs horizontally (woodgrain will not align at panel seams).

- Power beam and overpanel must add up to height of gallery panels.
- Compatible with right hand Gallery Panels (**B3LXPRxxxx** and **B3LXPRxxxxNC**, **B3L2PRxxxx** and **B3L3PRxxxx**) only.

Required Specifications

- Laminate finish
- Edge finish
- Paint finish

GALLERY PANEL EXTENSIONS **MODEL#** **DIMENSIONS** **FREIGHT CLASS** **WT./LBS.** **CUBIC FT.** **LIST PRICE**

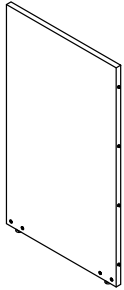

Left Gallery Panel Extension

	D x W x H					
B3LXPL4224	1 x 24 x 42	60	25.83	0.58	\$595	
B3LXPL4230	1 x 30 x 42	60	32.27	0.58	\$685	
B3LXPL4236	1 x 36 x 42	60	38.68	0.88	\$775	
B3LXPL4242	1 x 42 x 42	60	45.11	1.02	\$863	
B3LXPL4248	1 x 48 x 42	60	51.53	1.17	\$953	
B3LXPL5024	1 x 24 x 50	60	30.83	0.69	\$709	
B3LXPL5030	1 x 30 x 50	60	38.51	0.87	\$821	
B3LXPL5036	1 x 36 x 50	60	46.18	1.04	\$931	
B3LXPL5042	1 x 42 x 50	60	53.86	1.22	\$1039	
B3LXPL5048	1 x 48 x 50	60	61.53	1.39	\$1151	

With connectors for additional gallery panels. Provides floor standing support while extending a run of gallery panels. Attaches to the left edge of a gallery panel by the pin connectors to allow for additional gallery panels to be added on the left side. Pin connectors on the right edge and modular connectors on the left edge of the interior face. Includes all attachment hardware and glides. The total height includes the panel glides extended to their maximum height. Edged in PVC on exposed top edge only; self edge on other three sides. If woodgrain laminate is selected, woodgrain runs horizontally (woodgrain will not align at panel seams).

- Power beam and overpanel must add up to height of gallery panels.
- Right side is compatible with models: **B3LEPxxx**, **B3LSEPL**, **B3LMPxxx**, **B3LSMP** and **B3LXPLxxx** only.
- Left side is compatible with **B3LXPLxxxx** and **B3LXPLxxxxNC**, **B3L2PLxxxx** and **B3L3PLxxxx** only.

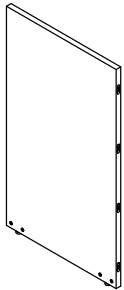

Right Gallery Panel Extension

B3LXPR4224	1 x 24 x 42	60	25.83	0.58	\$595
B3LXPR4230	1 x 30 x 42	60	25.83	0.58	\$685
B3LXPR4236	1 x 36 x 42	60	38.68	0.88	\$775
B3LXPR4242	1 x 42 x 42	60	45.11	1.02	\$863
B3LXPR4248	1 x 48 x 42	60	51.53	1.17	\$953
B3LXPR5024	1 x 24 x 50	60	30.83	0.69	\$709
B3LXPR5030	1 x 30 x 50	60	38.51	0.87	\$821
B3LXPR5036	1 x 36 x 50	60	46.18	1.04	\$931
B3LXPR5042	1 x 42 x 50	60	53.86	1.22	\$1039
B3LXPR5048	1 x 48 x 50	60	61.53	1.39	\$1151

With connectors for additional gallery panels. Provides floor standing support while extending a run of gallery panels. Attaches to the right edge of a gallery panel by the pin connectors to allow for additional gallery panels to be added on the right side. Pin connectors on the left edge and modular connectors on the right edge of the interior face. Includes all attachment hardware and glides. The total height includes the panel glides extended to their maximum height. Edged in PVC on exposed top edge only; self edge on other three sides. If woodgrain laminate is selected, woodgrain runs horizontally (woodgrain will not align at panel seams).

- Power beam and overpanel must add up to height of gallery panels.
- Right side is compatible with **B3LXPRxxxx** and **B3LXPRxxxxNC**, **B3L2PRxxxx** and **B3L3PRxxxx** only.
- Left side is compatible with left hand panels **B3LXPLxxxx** and **B3LXPLxxxxNC**, **B3L2PLxxxx** and **B3L3PLxxxx** only.

Required Specifications

- Laminate finish
- Edge finish
- Paint finish

GALLERY PANEL EXTENSIONS

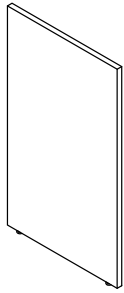

Left Gallery Panel Extension

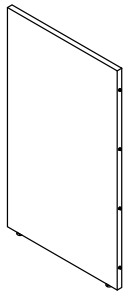

Right Gallery Panel Extension

MODEL#	DIMENSIONS D x W x H	FREIGHT CLASS	WT./LBS.	CUBIC FT.	LIST PRICE
B3LXPL4212NC	1 x 12 x 42	60	12.95	0.29	\$348
B3LXPL4224NC	1 x 24 x 42	60	25.83	0.58	\$580
B3LXPL4230NC	1 x 30 x 42	60	32.22	0.73	\$669
B3LXPL4236NC	1 x 36 x 42	60	38.65	0.88	\$756
B3LXPL4242NC	1 x 42 x 42	60	45.07	1.02	\$849
B3LXPL4248NC	1 x 48 x 42	60	51.5	1.17	\$935
B3LXPL5012NC	1 x 12 x 50	60	15.45	0.35	\$435
B3LXPL5024NC	1 x 24 x 50	60	30.8	0.69	\$695
B3LXPL5030NC	1 x 30 x 50	60	38.47	0.87	\$803
B3LXPL5036NC	1 x 36 x 50	60	46.15	1.04	\$912
B3LXPL5042NC	1 x 42 x 50	60	53.82	1.22	\$1028
B3LXPL5048NC	1 x 48 x 50	60	61.5	1.39	\$1137

No connectors for additional gallery panels. Provides floor standing support while enclosing the end of a run of left gallery panels. Attaches to the left edge of a gallery panel by the pin connectors to finish the run. Pin connectors are on the right edge of the interior face. Includes all attachment hardware and glides. The total height includes the panel glides extended to their maximum height. Edged in PVC on two exposed edges; self edge on connecting side and bottom. If woodgrain laminate is selected, woodgrain runs horizontally (woodgrain will not align at panel seams).

- Power beam and overpanel must add up to height of gallery panels.
- Compatible with models: **B3LEP**xxxx, **B3LSEPL**xxxx, **B3LMP**xxxx, **B3LSMP**xxxx and **B3LXPL**xxxx only.

B3LXPR4212NC	1 x 12 x 42	60	12.95	0.29	\$348
B3LXPR4224NC	1 x 24 x 42	60	25.83	0.58	\$580
B3LXPR4230NC	1 x 30 x 42	60	32.22	0.73	\$669
B3LXPR4236NC	1 x 36 x 42	60	38.65	0.88	\$756
B3LXPR4242NC	1 x 42 x 42	60	45.07	1.02	\$849
B3LXPR4248NC	1 x 48 x 42	60	51.5	1.17	\$935
B3LXPR5012NC	1 x 12 x 50	60	15.45	0.35	\$435
B3LXPR5024NC	1 x 24 x 50	60	30.8	0.69	\$695
B3LXPR5030NC	1 x 30 x 50	60	38.47	0.87	\$803
B3LXPR5036NC	1 x 36 x 50	60	46.15	1.04	\$912
B3LXPR5042NC	1 x 42 x 50	60	53.82	1.22	\$1028
B3LXPR5048NC	1 x 48 x 50	60	61.5	1.39	\$1137

No connectors for additional gallery panels. Provides floor standing support while enclosing the end of a run of left gallery panels. Attaches to the left edge of a gallery panel by the pin connectors to finish the run. Pin connectors are on the right edge of the interior face. Includes all attachment hardware and glides. The total height includes the panel glides extended to their maximum height. Edged in PVC on two exposed edges; self edge on connecting side and bottom. If woodgrain laminate is selected, woodgrain runs horizontally (woodgrain will not align at panel seams).

- Power beam and overpanel must add up to height of gallery panels.
- Compatible with models: **B3LEP**xxxx, **B3LSEPL**xxxx, **B3LMP**xxxx, **B3LSMP**xxxx and **B3LXPL**xxxx only.

Required Specifications

- Laminate finish
- Edge finish
- Paint finish

END OF RUN RETURNS **MODEL#** **DIMENSIONS** **FREIGHT CLASS** **WT./LBS.** **CUBIC FT.** **LIST PRICE**

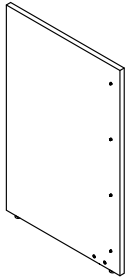

Left Gallery Panel End of Run Return

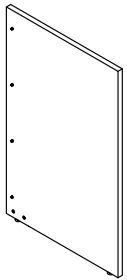

Right Gallery Panel End of Run Return

D x W x H

B3L2PL4213	1 x 13 x 42	60	14.02	0.32	\$378
B3L2PL4225	1 x 25 x 42	60	26.87	0.61	\$669
B3L2PL4231	1 x 31 x 42	60	33.29	0.75	\$756
B3L2PL4237	1 x 37 x 42	60	39.72	0.9	\$821
B3L2PL5013	1 x 13 x 50	60	16.73	0.38	\$471
B3L2PL5025	1 x 25 x 50	60	32.08	0.72	\$803
B3L2PL5031	1 x 31 x 50	60	39.75	0.9	\$912
B3L2PL5037	1 x 37 x 50	60	47.43	1.07	\$1011

Provides floor standing support while enclosing the end of a gallery panel run. Attaches at the left edge with connectors to form an L-configuration. Connection is on the interior face, right side. Includes all attachment hardware and glides. The total height includes the panel glides extended to their maximum height. 25" w gallery panel accommodates a 24" deep surface; 31" w accommodates a 30" deep surface; 37" w accommodates a 36" deep surface. Edged in PVC on three exposed edges; self edge on bottom. If woodgrain laminate is selected, woodgrain runs horizontally (woodgrain will not align at panel seams).

- Power beam and overpanel must add up to height of gallery panels.
- Compatible with models: **B3LEP**xxxx, **B3LSEPL**xxxx, **B3LMP**xxxx, **B3LSMP**xxxx and **B3LXPL**xxxx only.

B3L2PR4213	1 x 13 x 42	60	14.02	0.32	\$378
B3L2PR4225	1 x 25 x 42	60	26.87	0.61	\$669
B3L2PR4231	1 x 31 x 42	60	33.29	0.75	\$756
B3L2PR4237	1 x 37 x 42	60	39.72	0.9	\$821
B3L2PR5013	1 x 13 x 50	60	16.73	0.38	\$471
B3L2PR5025	1 x 25 x 50	60	32.08	0.72	\$803
B3L2PR5031	1 x 31 x 50	60	39.75	0.9	\$912
B3L2PR5037	1 x 37 x 50	60	47.43	1.07	\$1011

Provides floor standing support while enclosing the end of a gallery panel run. Attaches at the right edge with connectors to form an L-configuration. Connection is on the interior face, left side. Includes all attachment hardware and glides. ToThe total height includes the panel glides extended to their maximum height. 25" w gallery panel accommodates a 24" deep surface; 31" w accommodates a 30" deep surface; 37" w accommodates a 36" deep surface. Edged in PVC on three exposed edges; self edge on bottom. If woodgrain laminate is selected, woodgrain runs horizontally (woodgrain will not align at panel seams).

- Power beam and overpanel must add up to height of gallery panels.
- Compatible with models: **B3LEP**xxxx, **B3LSEPR**xxxx, **B3LMP**xxxx and **B3LXPR**xxxx only.

Required Specifications

- Laminate finish
- Edge finish
- Paint finish

GALLERY PANEL - 3WAY RETURNS

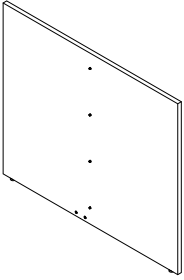

Left End of Run 3-Way Return*

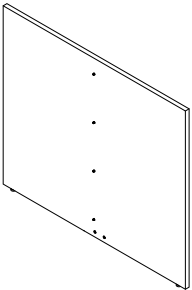

Right End of Run 3-Way Return*

MODEL#	DIMENSIONS	FREIGHT CLASS	WT/LBS.	CUBIC FT.	LIST PRICE
D x W x H					
B3L3PL4225	1 x 25 x 42	60	26.87	0.61	\$561
B3L3PL4249	1 x 49 x 42	60	52.57	1.19	\$907
B3L3PL4261	1 x 61 x 42	60	65.41	1.48	\$1203
B3L3PL4273	1 x 73 x 42	60	78.26	1.77	\$1397
B3L3PL5025	1 x 25 x 50	60	32.08	0.72	\$703
B3L3PL5049	1 x 49 x 50	60	62.77	1.42	\$1246
B3L3PL5061	1 x 61 x 50	60	78.12	1.77	\$1464
B3L3PL5073	1 x 73 x 50	60	93.47	2.11	\$1718

Provides floor standing support while enclosing the end of a gallery panel run. Attaches at the left edge with connectors to form a T-configuration. Connections are on the interior face in the middle. Includes all attachment hardware and glides. The total height includes the panel glides extended to their maximum height. 49" w gallery panel accommodates two 24" deep surfaces; 61" w accommodates two 30" deep surfaces; 73" w accommodates two 36" deep surfaces. Edged in PVC on three exposed edges; self edge on bottom. If woodgrain laminate is selected, grain direction runs horizontally.

- Power beam and overpanel must add up to height of gallery panels.
- Compatible with models: **B3LEP**xxxx, **B3LSEPL**xxxx, **B3LMP**xxxx, **B3LSMP**xxxx and **B3LXPL**xxxx only.

B3L3PR4225	1 x 25 x 42	60	26.87	0.61	\$561
B3L3PR4249	1 x 49 x 42	60	52.57	1.19	\$907
B3L3PR4261	1 x 61 x 42	60	65.41	1.48	\$1203
B3L3PR4273	1 x 73 x 42	60	78.26	1.77	\$1397
B3L3PR5025	1 x 25 x 50	60	32.08	0.72	\$703
B3L3PR5049	1 x 49 x 50	60	62.77	1.42	\$1246
B3L3PR5061	1 x 61 x 50	60	78.12	1.77	\$1464
B3L3PR5073	1 x 73 x 50	60	93.47	2.11	\$1718

Provides floor standing support while enclosing the end of a gallery panel run. Attaches at the right edge with connectors to form a T-configuration. Connections are on the interior face in the middle. Includes all attachment hardware and glides. The total height includes the panel glides extended to their maximum height. 49" w gallery panel accommodates two 24" deep surfaces; 61" w accommodates two 30" deep surfaces; 73" w accommodates two 36" deep surfaces. Edged in PVC on three exposed edges; self edge on bottom. If woodgrain laminate is selected, woodgrain runs horizontally.

- Power beam and overpanel must add up to height of gallery panels.
- Compatible with models: **B3LEP**xxxx, **B3LSEPR**xxxx, **B3LMP**xxxx and **B3LXPR**xxxx only.

GALLERY PANEL ACCESSORIES

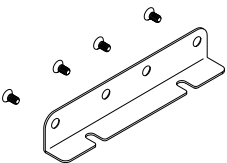

Gallery Panel Bottom Inline Bracket

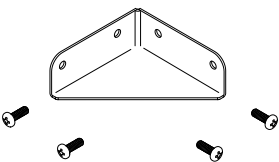

Gallery Panel Corner Bracket

MODEL#	DIMENSIONS	FREIGHT CLASS	WT/LBS.	CUBIC FT.	LIST PRICE
B3HLPBB01	8 x 1.5 x 7	70	1	0.5	\$81

Connects two gallery panels at the bottom with screws. Available in all Bridges II paint colors. Specify finish.

B3HLPCB01	4 x 1.5 x 7	100	4	0.5	\$79
-----------	-------------	-----	---	-----	-------------

Connects two gallery panels at 90 degrees with screws. Available in all Bridges II paint colors. Specify finish.

Required Specifications

- Laminate finish*
- Edge finish*
- Paint finish

PRIVACY GLASS	MODEL#	DIMENSIONS	FREIGHT CLASS	WT/LBS.	CUBIC FT.	LIST PRICE	FRST ADD
---------------	--------	------------	---------------	---------	-----------	------------	----------

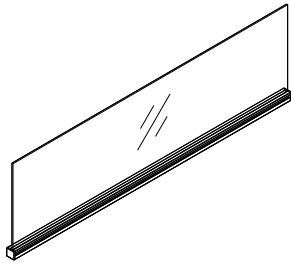

Privacy Glass for 1" Laminate Panels*

	D x W x H						
B3PMP24G18W	1 x 24 x 8	60	4.84	0.11	\$457	\$91	
B3PMP30G18W	1 x 30 x 8	60	6.06	0.14	\$496	\$99	
B3PMP36G18W	1 x 36 x 8	60	7.28	0.17	\$528	\$105	
B3PMP42G18W	1 x 42 x 8	60	8.5	0.19	\$551	\$111	
B3PMP48G18W	1 x 48 x 8	60	9.72	0.22	\$581	\$116	
B3PMP24G16W	1 x 24 x 16	60	8.92	0.22	\$457	\$91	
B3PMP30G16W	1 x 30 x 16	60	11.17	0.28	\$496	\$99	
B3PMP36G16W	1 x 36 x 16	60	13.43	0.33	\$528	\$105	
B3PMP42G16W	1 x 42 x 16	60	15.68	0.39	\$551	\$111	
B3PMP48G16W	1 x 48 x 16	60	17.92	0.44	\$581	\$116	

Privacy glass integrated with aluminum top trim. Attaches on top of gallery panels to add privacy or divide space. Includes aluminum trim with channel, end caps and glass tile. Top rail may also be used to hang accessories. Glass and attachment hardware ship separately. Specify paint finish for channel. Standard in Clear (CLR). **Add 20%** upcharge for frosted glass (FRST).

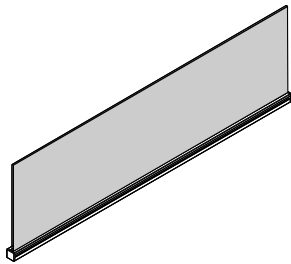

Felt Divider for 1" Laminate Panels**

B3PFD0824W	1 x 24 x 8	70	1.32	0.11	\$183		
B3PFD0830W	1 x 30 x 8	70	1.65	0.14	\$213		
B3PFD0836W	1 x 36 x 8	70	1.99	0.17	\$252		
B3PFD0842W	1 x 42 x 8	85	2.32	0.19	\$284		
B3PFD0848W	1 x 48 x 8	85	2.65	0.22	\$416		
B3PFD0854W	1 x 54 x 8	92.5	2.98	0.25	\$455		
B3PFD0860W	1 x 60 x 8	92.5	3.32	0.28	\$488		
B3PFD0866W	1 x 66 x 8	92.5	3.65	0.31	\$515		
B3PFD0872W	1 x 72 x 8	85	3.98	0.33	\$581		
B3PFD1624W	1 x 24 x 16	70	1.83	0.22	\$208		
B3PFD1630W	1 x 30 x 16	100	2.3	0.28	\$240		
B3PFD1636W	1 x 36 x 16	100	2.76	0.33	\$268		
B3PFD1642W	1 x 42 x 16	100	3.22	0.39	\$307		
B3PFD1648W	1 x 48 x 16	100	3.68	0.44	\$457		
B3PFD1654W	1 x 54 x 16	100	4.14	0.5	\$498		
B3PFD1660W	1 x 60 x 16	100	4.61	0.56	\$533		
B3PFD1666W	1 x 66 x 16	100	5.07	0.61	\$561		
B3PFD1672W	1 x 72 x 16	100	5.53	0.67	\$638		

Privacy felt integrated with aluminum top trim. Attaches on top of gallery panels to add privacy or divide space. Includes aluminum trim with channel, end caps and felt tile. Top rail may also be used to hang accessories. Felt and attachment hardware ship separately. Specify paint finish for channel.

Required Specifications

Paint finish
Felt finish**

Optional Specifications

Frosted glass (FRST)*

ELECTRICAL - POWER BEAM

MODEL# DIMENSIONS FREIGHT CLASS WT/LBS. CUBIC FT. LIST PRICE

D x W x H

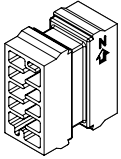

I Connector

BRTECI	4.63 x 1.5 x 1.5	70	0.06	0.01	\$119
--------	------------------	----	------	------	--------------

Inline coupler used to connect two **BRTEHHxx** pass-thru cables (sold separately; see page 471).

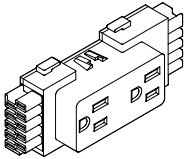

Duplex Receptacles

BRTE8D1	1.25 x 4.63 x 2	70	.10	.01	\$45
BRTE8D2	1.25 x 4.63 x 2	70	.10	.01	\$45
BRTE8DA	1.25 x 4.63 x 2	70	.10	.01	\$45
BRTE8DB	1.25 x 4.63 x 2	70	.10	.01	\$45

Snaps into Power Distribution Housing. Up to 6 duplex receptacles per circuit.

- BRTE8D1 - Circuit #1 (utility circuit)
- BRTE8D2 - Circuit #2 (utility circuit)
- BRTE8DA - Circuit A (dedicated circuit)
- BRTE8DB - Circuit B (utility circuit)

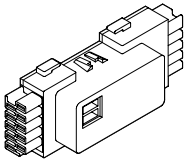

USB Receptacles

BRTEDU1B	1.25 x 4.63 x 2	300	3.82	2	\$424
BRTEDU1W	1.25 x 4.63 x 2	300	6.98	2	\$424

Snaps into Power Distribution Housing. USB charging module provides convenient charging power access though dual ports on face of receptacles.

- Two USB ports.
- 2 amp output, considered as circuit #1.

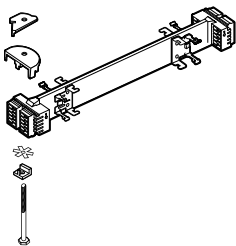

Power Distribution Housing Kit

BRTE3D24	2.6 x 9.25 x 2	70	0.83	1.2	\$262
BRTE3D30	2.6 x 15.25 x 2	70	1.28	1.2	\$301
BRTE3D36	2.6 x 21.25 x 2	70	1.62	1.7	\$317
BRTE3D42	2.6 x 27.25 x 2	300	2	2	\$334
BRTE3D48	2.6 x 33.25 x 2	400	2.32	2.5	\$348
BRTE3D54	2.6 x 39.25 x 2	400	2.66	3.2	\$359
BRTE3D60	2.6 x 45.25 x 2	400	3.04	3.2	\$374
BRTE3D66	2.6 x 51.25 x 2	300	3.76	3.3	\$580
BRTE3D72	2.6 x 57.25 x 2	300	3.76	3.3	\$580

Provides two duplex receptacles per beam side for all beam widths above 24" wide. Power Distribution Housing is specified per beam size. eg. **BRTE3D36** is for use with a 36" beam.

- 24" wide beam allows for only one (1) duplex receptacle per beam side.

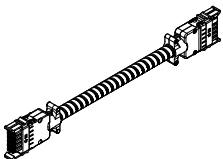

Jumper Cable

BRTEJC16	0.5 x 16.75 x 2	70	0.66	1.2	\$205
BRTEJC20	0.5 x 20.75 x 2	70	0.78	1.2	\$215

Electrically connects two Power Distribution Housings.

- BE8JC16 electrically connects two Power Beams positioned side by side.
- BE8JC20 electrically connects two Power Beams separated by a post.
- Wires are concealed in a flexible metal conduit.
- **Cannot go through a post in a corner application.** Please use the Jumper Cable Mesh for this application.

Required Specifications

ELECTRICAL - POWER BEAM

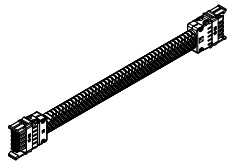

Jumper Cable Mesh

MODEL#	DIMENSIONS D x W x H	FREIGHT CLASS	WT./LBS.	CUBIC FT.	LIST PRICE
BRTEJM19	0.05 x 19 x 2	70	0.75	1.2	\$170
BRTEJMS20	0.05 x 19 x 2	70	0.75	1.2	\$221

Electrically connects two Power Distribution Housings in two Power Beams separated by a post in a corner application.

- BRTEJM19 - Wires are covered with a durable nylon mesh.
- BRTEJMS20 - Wires are concealed in a flexible metal shroud and covered with a durable nylon mesh.

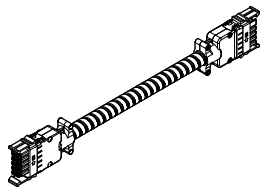

Housing to Housing Pass-Thru Cable

BRTEHH40	.5 x 40.5 x 2	70	1.44	1.25	\$191
BRTEHH46	.5 x 46.5 x 2	70	1.71	1.2	\$270
BRTEHH52	.5 x 52.5 x 2	300	1.95	1.17	\$217
BRTEHH58	.5 x 58.5 x 2	300	2.21	1.17	\$226
BRTEHH64	.5 x 64.5 x 2	300	2.37	1.2	\$306
BRTEHH70	.5 x 70.5 x 2	250	2.6	1.2	\$317
BRTEHH76	.5 x 76.5 x 2	250	2.81	1.17	\$252
BRTEHH82	.5 x 82.5 x 2	250	3.03	1.2	\$339
BRTEHH88	.5 x 88.5 x 2	250	3.05	1.2	\$350
BRTEHH94	.5 x 94.5 x 2	250	3.3	1.2	\$363
BRTEHH100	.5 x 100.5 x 2	250	3.47	1.2	\$374
BRTEHH106	.5 x 106.5 x 2	250	3.87	1.2	\$389
BRTEHH118	.5 x 118.5 x 2	250	4.08	1.2	\$410
BRTEHH130	.5 x 130.5 x 2	250	4.73	1.2	\$433
BRTEHH142	.5 x 142.5 x 2	150	4.99	1.2	\$457

Distributes power between Power Distribution Housings in Power Beams separated by one or more Power Beams that may not have power. Wires are concealed in a flexible metal conduit.

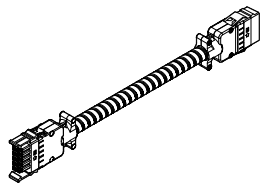

Housing to Jumper Pass-Thru Cable

BRTEHJ24	.5 x 24 x 2	70	0.9	1.2	\$197
BRTEHJ30	.5 x 30 x 2	70	1.3	1.2	\$211
BRTEHJ36	.5 x 36 x 2	70	1.44	1.2	\$221
BRTEHJ42	.5 x 42 x 2	70	1.71	1.2	\$230
BRTEHJ48	.5 x 48 x 2	70	1.95	1.2	\$241
BRTEHJ54	.5 x 54 x 2	300	2.21	1.2	\$249
BRTEHJ60	.5 x 60 x 2	300	2.37	1.2	\$257
BRTEHJ72	.5 x 72 x 2	250	2.81	1.2	\$274
BRTEHJ84	.5 x 84 x 2	250	3.05	1.2	\$300
BRTEHJ96	.5 x 96 x 2	250	3.3	1.2	\$320
BRTEHJ108	.5 x 108 x 2	250	3.87	1.2	\$339
BRTEHJ120	.5 x 120 x 2	250	4.08	1.2	\$359
BRTEHJ144	.5 x 144 x 2	250	4.59	1.2	\$381

Connects a Power Distribution Housing to a housing connection of a harness. Wires are concealed in a flexible metal conduit.

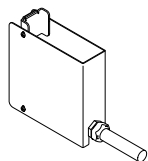

Base Feed & Housing for Power Beam*

BRTBPEFH18	2.5 x 6 x 18	85	2.7	0.2	\$699
BRTBPEFH26	2.5 x 6 x 26	65	5.41	0.2	\$745
BRTBPEFH34	2.5 x 6 x 34	65	7.03	0.3	\$780

Attaches to inner side of the Power Beam leg. Base feed kit consists of two mounting brackets, steel shroud and base feed harness with 72" long liquid-tight conduit hardwired to building power supply. Must be hard wired to building power supply by a licensed electrician.

- Specify **BRTBPEFH18** for 18"H power beams; **BRTBPEFH26** for 26"H power beams; **BRTBPEFH34** for 34"H power beams.
- Post vertical trim must be specified in accordance to your post 2-way, 3-way or 4-way configuration.
- Note: On-site drilling required to secure mounting brackets to the inside of the beam vertical leg.

Required Specifications

Paint finish*

ELECTRICAL - POWER BEAM MODEL# DIMENSIONS FREIGHT CLASS WT/LBS. CUBIC FT. LIST PRICE

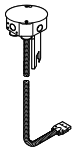

Ceiling Feed - Single

	D x W x H				
BRTECF120	6 x 6 x 120	250	5.25	2	\$476
BRTECF144	6 x 6 x 144	250	6	2	\$530

Provides single power entry from ceiling, through post and into Power Beam raceway channel. Power entry cable penetrates 8" into a power beam and plugs into either a Power Distribution Housing or **BRTEHJxx** Pass-Thru Harness. Must be hard wired to power source by a licensed electrician. Specify Post Extension separately.

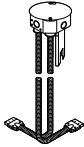

Ceiling Feed - Double

BRTECF1202	3 x 6 x 120	250	5.24	2	\$995
BRTECF1442	3 x 6 x 144	250	5.96	2	\$1121

Provides dual power entry from ceiling, through post and into Power Beam raceway channel. Power entry cable penetrates 8" into a power beam and plugs into either a Power Distribution Housing or **BRTEHJxx** Pass-Thru Harness. Must be hard wired to power source by a licensed electrician. Specify Post Extension separately.

- For use in the middle of a run to distribute power in two directions **OR** at the beginning of a run where second Ceiling Feed harness is connected to **BRTEHJxx** and distributes power underneath Power Distribution Housing to pick up a second circuit grouping in a long panel run.

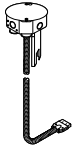

Ceiling Feed - New York Electrical

BRTECFK120	6 x 6 x 120	250	5.25	2	\$712
BRTECFK144	6 x 6 x 144	250	6	2	\$790

Provides single power entry from ceiling, through post and into Power Beam raceway channel. Power entry cable penetrates 8" into a power beam and plugs into either a Power Distribution Housing or **BRTEHJxx** Pass-Thru Harness. Must be hard wired to power source by a licensed electrician. Specify Post Extension separately.

BRTECHJB	x	70	5.25	0.01	\$342
----------	---	----	------	------	--------------

Hardwire Junction Box - Chicago

Provides single power entry from ceiling, through post and into Power Beam raceway channel. Power entry cable penetrates 8" into a power beam and plugs into either a Power Distribution Housing or **BRTEHJxx** Pass-Thru Harness. Must be hard wired to power source by a licensed electrician. Specify Post Extension separately.

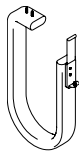

Wire Manager Kit*

BRTWMS	5.25 x 42 x 1.25	70	1.87	.40	\$157
--------	------------------	----	------	-----	--------------

Provides wire management from under the Freefit worksurface to the Power Beam. The bracket can be aligned anywhere on the Power Beam. Kit includes a neoprene sock, bracket and screws. Specify bracket paint finish.

Required Specifications

Paint finish*

STORAGE	MODEL#	DIMENSIONS	FREIGHT CLASS	WT./LBS.	CUBIC FT.	LIST PRICE	HP ADD
		D x W x H					
	BRT21BF18L	18 x 15.5 x 21	70	58	3.39	\$911	\$68
	BRT21BF24L	24 x 15.5 x 21	85	64	4.52	\$1059	\$68
	BRT21BF30L	30 x 15.5 x 21	85	72	5.65	\$1162	\$88
	BRT21BF18C	18 x 15.5 x 21	70	58	3.39	\$911	\$68
	BRT21BF24C	24 x 15.5 x 21	85	64	4.52	\$1139	\$68
	BRT21BF30C	30 x 15.5 x 21	85	72	5.65	\$1242	\$88

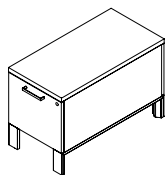

File Pedestal

Can join with other 21" h storage units of corresponding depth to form a spine or slide out on casters to serve as an additional worksurface. One file drawer. Fits under table beams even with optional seat cushion. Optional cable basket suspends off storage unit's bottom and manages cables and data cables under storage spine. (Leveler models only.) 1" top; metal handles; powder coated aluminum or anodized aluminum legs. Specify "L" models for levelers or "C" models for 40mm white/grey locking casters.

- Anodized Aluminum Leg - Add **\$91** list upcharge
- 18" deep storage components will not accept legal size paper

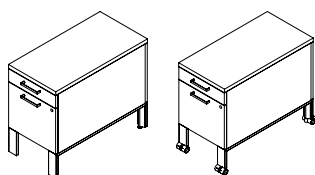

Box/File Pedestal

BRT25BF18L	18 x 15.5 x 25	70	69	3.89	\$1036	\$68
BRT25BF24L	24 x 15.5 x 25	85	74	5.02	\$1203	\$68
BRT25BF30L	30 x 15.5 x 25	85	82	6.15	\$1305	\$88
BRT25BF18C	18 x 15.5 x 25	70	69	3.89	\$1119	\$68
BRT25BF24C	24 x 15.5 x 25	85	74	5.02	\$1283	\$68
BRT25BF30C	30 x 15.5 x 25	85	82	6.15	\$1387	\$88

Can join with other 25" h storage units of corresponding depth to form a spine or slide out on casters to serve as an additional worksurface. One box drawer, one file drawer. Optional cable basket suspends off storage unit's bottom and manages cables and data cables under storage spine. (Leveler models only.) 1" top; metal handles; powder coated aluminum or anodized aluminum legs. Specify "L" models for levelers or "C" models for 40mm white/grey locking casters. Black pencil tray included.

- Anodized Aluminum Leg - Add **\$91** list upcharge
- 18" deep storage components will not accept legal size paper

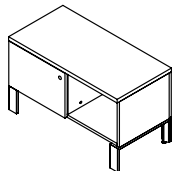

Sliding Door Storage

BRT21LS30L	18 x 30 x 21	100	53	6.56	\$994	\$88
BRT21LS36L	18 x 36 x 21	125	60	7.87	\$1100	\$88
BRT21LS42L	18 x 42 x 21	125	67	9.18	\$1203	\$88

Can join with other 21" h storage units of corresponding depth to form a spine. Optional 15.5" x 18" cushion. Storage compartment internal height: 12.36". Sliding door locks on left side. Optional cable basket suspends off storage unit's bottom and manages cables along the horizontal plane. 1" top; metal handles; powder coated aluminum or anodized aluminum legs.

- Anodized Aluminum Leg - Add **\$91** list upcharge
- 18" deep storage components will not accept legal size paper

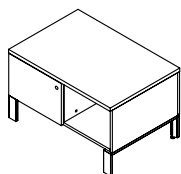

Shared Sliding Door Storage

BRT21LSS30L	24 x 30 x 21	125	69	8.75	\$1387	\$88
BRT21LSS36L	24 x 36 x 21	125	78	10.50	\$1511	\$110
BRT21LSS42L	24 x 42 x 21	125	87	12.25	\$1634	\$128

Offers two 11" deep storage compartments on either side. For use beside a table assembly, between two adjacent workstations. Can join with other 21" h, 24" d storage units to form a spine. Optional 15.5" x 18" cushion. Storage compartment internal height: 12.36". Sliding door locks on left side. Optional cable basket suspends off storage unit's bottom and manages cables along the horizontal plane. 1" top; metal handles; powder coated aluminum or anodized aluminum legs.

- Anodized Aluminum Leg - Add **\$91** list upcharge

Required Specifications

Metal finish
Top finish
Chassis finish
Drawer/door front finish

Edge finish

Optional Specifications

Anodized Aluminum Leg
HP laminate (tops only)
Cable Basket

STORAGE

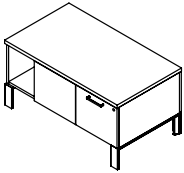

Shared File/Open Storage*

MODEL#	DIMENSIONS D x W x H	FREIGHT CLASS	WT/LBS.	CUBIC FT.	LIST PRICE	HP ADD
BRT21LSO42L	24 x 42 x 21	100	124	14	\$1861	\$150

Offers storage compartments on either side. For use between two adjacent workstations. Can join with other 21”h, 24”d storage units to form a spine or serve as an additional return worksurface or ad-hoc guest seating with optional 15.5” x 18”cushion. One locking file drawer, One open compartment per side. Storage compartment internal height without shelf: 12.36”. Optional cable basket suspends off storage unit’s bottom and manages cables along the horizontal plane. 1” top; metal handles; powder coated aluminum or anodized aluminum legs.

- Anodized Aluminum Leg - Add **\$91** list upcharge

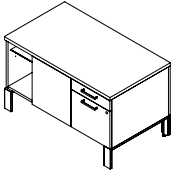

Shared Storage Unit*

BRT25LBF042L	24 x 42 x 25	100	154	16.66	\$2337	\$128
--------------	--------------	-----	-----	-------	---------------	--------------

Offers storage compartments on either side. For use between two adjacent workstations. Can join with other 25”h, 24”d storage units to form a spine or serve as an additional return worksurface or ad-hoc guest seating with optional 15.5” x 18”cushion. One locking file drawer, One open compartment per side. Storage compartment internal height without shelf: 12.36”. Optional cable basket suspends off storage unit’s bottom and manages cables along the horizontal plane. 1” top; metal handles; powder coated aluminum or anodized aluminum legs. Black pencil tray included.

- Anodized Aluminum Leg - Add **\$91** list upcharge
- 25” high Bridges storage should not be used under back-to-back Bridges table applications using Below Worksurface Trough. Storage will not fit under the trough.

MODULAR STORAGE

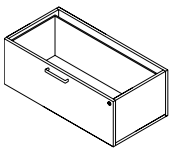

21”H Lateral File Drawer, No Top

MODEL#	DIMENSIONS	FREIGHT CLASS	WT/LBS.	CUBIC FT.	LIST PRICE	HP ADD
BRT21F3018U	18 x 30 x 13	92.5	47	4.06	\$1075	n/a
BRT21F3618U	18 x 36 x 13	92.5	51	4.88	\$1188	n/a
BRT21F4218U	18 x 42 x 13	100	56	5.69	\$1379	n/a
BRT21F3024U	24 x 30 x 13	100	51	5.42	\$1101	n/a
BRT21F3624U	24 x 36 x 13	100	55	6.5	\$1226	n/a
BRT21F4224U	24 x 42 x 13	125	60	7.58	\$1441	n/a

Fits below Bridges II tables. Can join with other 21”h storage units of corresponding depth to form a spine. Floor clearance allows for installation of optional cable basket to manage cords and data cables under storage spine. One file drawer. **Top and legs to be ordered separately.** Metal handles.

- 18” deep storage components will not accept legal size paper

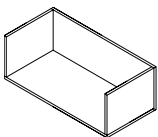

21”H Open Storage, No Top

BRT21LO3018U	18 x 30 x 13	125	25	4.06	\$339	n/a
BRT21LO3618U	18 x 36 x 13	150	29	4.88	\$504	n/a
BRT21LO4218U	18 x 42 x 13	150	32	5.69	\$548	n/a
BRT21LO3024U	24 x 30 x 13	150	29	5.42	\$352	n/a
BRT21LO3624U	24 x 36 x 13	150	33	6.5	\$524	n/a
BRT21LO4224U	24 x 42 x 13	150	36	7.58	\$569	n/a

Open storage unit with no top. Positioned beside a Bridges II table assembly or between two adjacent workstations. Can join with other 21”h storage units to form a spine. Floor clearance allows for installation of optional cable basket to manage cords and data cables under storage spine. One box opening. **Top and legs to be ordered separately.**

Required Specifications

Metal finish*	
Top finish*	Edge finish*
Chassis finish	
Drawer/door front finish	

Optional Specifications

Anodized Aluminum Leg*
HP laminate* (tops only)
Cable Basket
Cushion (BRT21LSO42L)

MODULAR STORAGE

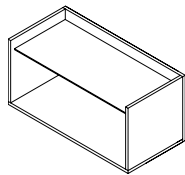

25" H Open Storage, Glass Shelf, No Top

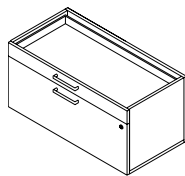

Lateral Box/File Storage, No Top*

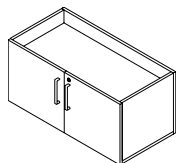

25" H Storage Cabinet, No Top*

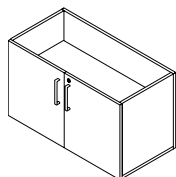

29" H Storage Cabinet, No Top*

MODEL#	DIMENSIONS	FREIGHT CLASS	WT./LBS.	CUBIC FT.	LIST PRICE	HP ADD
--------	------------	---------------	----------	-----------	------------	--------

D x W x H

BRT25L03018U	18 x 30 x 17	125	40	5.31	\$501	n/a
BRT25L03618U	18 x 36 x 17	125	46	6.38	\$687	n/a
BRT25L04218U	18 x 42 x 17	125	52	7.44	\$710	n/a
BRT25L03024U	24 x 30 x 17	125	44	7.08	\$534	n/a
BRT25L03624U	24 x 36 x 17	150	50	8.5	\$714	n/a
BRT25L04224U	24 x 42 x 17	150	56	9.92	\$745	n/a

Positioned usually beside a table assembly or between two adjacent workstations. Can join with other 25" h storage units to form a storage spine. Floor clearance allows for installation of optional cable basket to manage cords and data cables under storage spine. One box opening with glass shelf. **Top and legs to be ordered separately.**

- 25" high Bridges storage should not be used under back-to-back Bridges table applications using Below Worksurface Trough. Storage will not fit under the trough.

BRT25LBF3018U	18 x 30 x 17	92.5	58	5.31	\$1289	n/a
BRT25LBF3618U	18 x 36 x 17	85	78	6.38	\$1497	n/a
BRT25LBF4218U	18 x 42 x 17	100	68	7.44	\$1594	n/a
BRT25LBF3024U	24 x 30 x 17	100	62	7.08	\$1340	n/a
BRT25LBF3624U	24 x 36 x 17	100	82	8.5	\$1556	n/a
BRT25LBF4224U	24 x 42 x 17	125	72	9.92	\$1659	n/a

Positioned usually beside a table assembly or between two adjacent workstations. Can join with other 25" h storage units to form a storage spine. Floor clearance allows for installation of optional cable basket to manage cords and data cables under storage spine. One locking file drawer, one box drawer. **Top and legs to be ordered separately.** Metal handles. Black pencil tray included.

- 18" deep storage components will not accept legal size paper
- 25" high Bridges storage should not be used under back-to-back Bridges table applications using Below Worksurface Trough. Storage will not fit under the trough.

BRT25L2D3018U	18 x 30 x 17	125	39	5.31	\$955	n/a
BRT25L2D3618U	18 x 36 x 17	125	45	6.38	\$1025	n/a
BRT25L2D4218U	18 x 42 x 17	125	54	7.44	\$1067	n/a
BRT25L2D3024U	24 x 30 x 17	125	43	7.08	\$1110	n/a
BRT25L2D3624U	24 x 36 x 17	150	49	8.5	\$1210	n/a
BRT25L2D4224U	24 x 42 x 17	150	58	9.92	\$1260	n/a

Positioned usually beside a table assembly or between two adjacent workstations. Can join with other 25" h storage units to form a storage spine. Floor clearance allows for installation of optional cable basket to manage cords and data cables under storage spine. Two lockable doors, glass shelf included. **Top and legs to be ordered separately.** Storage compartment internal height is 16.5". Metal handles.

- 25" high Bridges storage should not be used under back-to-back Bridges table applications using Below Worksurface Trough. Storage will not fit under the trough.

BRT29L2D3018U	18 x 30 x 21	125	49	6.56	\$1089	n/a
BRT29L2D3618U	18 x 36 x 21	125	55	7.88	\$1137	n/a
BRT29L2D4218U	18 x 42 x 21	125	64	9.19	\$1187	n/a
BRT29L2D3024U	24 x 30 x 21	125	53	8.75	\$1277	n/a
BRT29L2D3624U	24 x 36 x 21	150	59	10.5	\$1335	n/a
BRT29L2D4224U	24 x 42 x 21	150	68	12.25	\$1365	n/a

Positioned usually beside a table assembly or between two adjacent workstations. Units are level with Bridges tops and can join other 29" h storage units to form a credenza or serve as an additional return worksurface. Floor clearance allows for installation of optional cable basket to manage cords and data cables under storage spine. Two lockable doors, glass shelf included. **Top and legs to be ordered separately.** Storage compartment internal height is 20.5". Metal handles.

- 25" high Bridges storage should not be used under back-to-back Bridges table applications using Below Worksurface Trough. Storage will not fit under the trough.

Required Specifications

Chassis finish
Drawer/door front finish*

Optional Specifications

Cable Basket

STORAGE

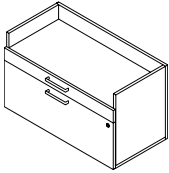

29" H Box/File/Open Storage, No Top

MODEL#	DIMENSIONS D x W x H	FREIGHT CLASS	WT./LBS.	CUBIC FT.	LIST PRICE	HP ADD
BRT29LOBF3018U	18 x 30 x 21	92.5	70	6.56	\$1517	n/a
BRT29LOBF3618U	18 x 36 x 21	100	78	7.88	\$1711	n/a
BRT29LOBF4218U	18 x 42 x 21	100	86	9.19	\$1880	n/a
BRT29LOBF3024U	24 x 30 x 21	100	74	8.75	\$1579	n/a
BRT29LOBF3624U	24 x 36 x 21	125	82	10.52	\$1780	n/a
BRT29LOBF4224U	24 x 42 x 21	125	90	12.25	\$1955	n/a

Positioned beside a table assembly or between two adjacent workstations. Units are level with Bridges tops and can join other 29" h storage units to form a credenza or serve as an additional return worksurface. Floor clearance allows for installation of optional cable basket to manage cords and data cables under storage spine. One locking file drawer, one box drawer and one open compartment. **Top and legs to be ordered separately.** Storage compartment internal height: 3.9". Metal handles. Black pencil tray included.

- 18" deep storage components will not accept legal size paper

BRTWU1830	18 x 30 x 1	60	15	0.5	\$191	\$68
BRTWU1836	18 x 36 x 1	60	18	0.59	\$218	\$74
BRTWU1842	18 x 42 x 1	60	21	0.68	\$286	\$97
BRTWU1860	18 x 60 x 1	65	29	0.97	\$451	\$133
BRTWU1866	18 x 66 x 1	65	32	1.1	\$473	\$150
BRTWU1872	18 x 72 x 1	65	35	1.2	\$493	\$162
BRTWU1878	18 x 78 x 1	65	38	1.3	\$521	\$171
BRTWU1884	18 x 84 x 1	65	41	1.4	\$571	\$179
BRTWU1890	18 x 90 x 1	65	44	1.5	\$594	\$185
BRTWU1896	18 x 96 x 1	65	47	1.6	\$618	\$193

BRTWU2430	24 x 30 x 1	60	20	0.65	\$200	\$61
BRTWU2436	24 x 36 x 1	60	24	0.78	\$222	\$76
BRTWU2442	24 x 42 x 1	60	28	0.9	\$292	\$96
BRTWU2460	24 x 60 x 1	60	39	1.3	\$461	\$152
BRTWU2466	24 x 66 x 1	60	43	1.41	\$480	\$157
BRTWU2472	24 x 72 x 1	60	47	1.54	\$501	\$41
BRTWU2478	24 x 78 x 1	60	51	1.7	\$537	\$172
BRTWU2484	24 x 84 x 1	60	55	1.8	\$582	\$182
BRTWU2490	24 x 90 x 1	60	59	1.9	\$605	\$187
BRTWU2496	24 x 96 x 1	60	63	2	\$629	\$196

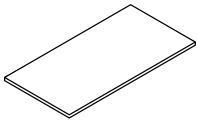

Worksurface for Modular Storage*

Flat 3mm profile on all sides. Worksurface provided with pilot holes for alignment purposes. Worksurfaces can be used for each modular unit or can span two to three units.

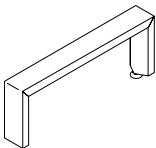

Modular Storage Leg**

BRT18LEGL	18 x 2.5 x 8	150	8	1.34	\$73	n/a
BRT24LEGL	24 x 2.5 x 8	150	8	1.34	\$80	n/a

Two single legs form the structure of the Bridges II series modular storage. A single leg can be used at the end of each modular storage unit or can be used to support where two modular units meet. Leveling glides, steel frame, aluminum legs.

- Anodized Aluminum leg - Add **\$39** list upcharge

Required Specifications

Top finish*
Edge finish
Chassis finish
Metal finish**

Optional Specifications

HP laminate* (tops only)
Anodized Aluminum Leg**
Cable Basket (storage unit)

STORAGE

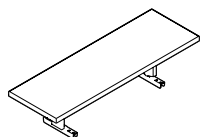

Center Mount Shelf**

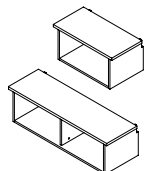
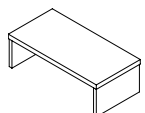

Table Mounted End Shelf*



Single Sided Elevated Table Shelf*

MODEL#	DIMENSIONS	FREIGHT CLASS	WT./LBS.	CUBIC FT.	LIST PRICE	HP ADD
--------	------------	---------------	----------	-----------	------------	--------

D x W x H

BRTCMS36	12 x 36 x 6.75	100	15.20	1.69	\$397	n/a
BRTCMS30	12 x 30 x 6.75	100	12.60	1.41	\$280	n/a

Open, shared center mount shelf "floats" 6.75" above the gap formed by two back-to-back worksurfaces. Accepts **BRTESBBIN** Elevated Shelf Binder Bin - The 30" w shelf accommodates two; 36" w shelf accommodates up to three. Shelves overhang the support structure by 6" on either side. Aluminum/die cast structure attaches to the underside of both worksurfaces.

- Not compatible with BRTEETA Above Worksurface Power Trough and Worksurfaces with Access Doors
- Anodized Aluminum support structure - Add **\$91** list upcharge

BRTTES24	15.5 x 24 x 15	100	29	3.22	\$769	\$68
BRTTES30	15.5 x 30 x 15	100	34	4.03	\$842	\$76
BRTTES51	15.5 x 50.5 x 15	100	57	6.79	\$1387	\$138
BRTTES63	15.5 x 62.5 x 15	100	68	8.40	\$1523	\$178

Single or double open shelf/extended worksurface. Secured to the end of single or back-to-back Bridges table. All mounting hardware included. Storage compartment internal height: 13.25". 1" top.

BRTSTS0824	12 x 24 x 8	92.5	14	1.33	\$273	\$88
BRTSTS0830	12 x 30 x 8	100	16	1.66	\$314	\$88
BRTSTS0851	12 x 50.5 x 8	100	25	2.80	\$500	\$128
BRTSTS0863	12 x 62.5 x 8	100	28	3.47	\$565	\$191

BRTSTS1324	12 x 24 x 13	100	18	2.16	\$296	\$88
BRTSTS1330	12 x 30 x 13	125	21	2.70	\$336	\$88
BRTSTS1351	12 x 50.5 x 13	125	32	4.55	\$500	\$128
BRTSTS1363	12 x 62.5 x 13	125	38	5.64	\$583	\$171

BRTSTS1624	12 x 24 x 16	125	19	2.66	\$336	\$88
BRTSTS1630	12 x 30 x 16	100	29	3.33	\$397	\$88
BRTSTS1651	12 x 50.5 x 16	150	33	5.61	\$583	\$150
BRTSTS1663	12 x 62.5 x 16	150	39	6.94	\$666	\$191

Secured perpendicularly to the single or back-to-back Bridges table. Integrated anodized aluminum accessory rail. White cut out and accessory rail trims. Optional Elevated Shelf Binder Bin (**BRTESBBIN**) rests on top surface for enhanced privacy. 8" h provides additional storage space without obstructing view and reaches 16" module height when combined w/8" h Binder shelf. Internal height: 6.6". 16" h lines up with top of 16" table dividers (15.8"). Specify 12" narrower shared elevated shelf immediately adjacent to the perpendicular elevated shelf. Internal height: 14.6".

- Please refer to the **Compatibility Guide** on page 490 to determine available accessories

Required Specifications

Top finish
Edge finish
Metal finish**
Chassis/Accent finish*

Optional Specifications

HP laminate (tops only)
Elevated Shelf Binder Bin
Anodized Aluminum**

MODULAR STORAGE

MODEL#	DIMENSIONS	FREIGHT CLASS	WT/LBS.	CUBIC FT.	LIST PRICE	HP ADD
--------	------------	---------------	---------	-----------	------------	--------

D x W x H

BRTBTS0836	12 x 36 x 8	100	16	2	\$418	\$88
BRTBTS0842	12 x 42 x 8	100	19	2.33	\$460	\$88
BRTBTS0848	12 x 48 x 8	125	21	2.66	\$500	\$128
BRTBTS0854	12 x 54 x 8	125	23	3	\$521	\$150
BRTBTS0860	12 x 60 x 8	125	26	3.33	\$583	\$171
BRTBTS0866	12 x 66 x 8	125	28	3.66	\$625	\$191
BRTBTS0872	12 x 72 x 8	125	30	4	\$666	\$191
BRTBTS0878	12 x 78 x 8	125	32	4.33	\$708	\$211
BRTBTS0884	12 x 84 x 8	125	35	4.66	\$749	\$231
BRTBTS1336	12 x 36 x 13	125	22	3.25	\$500	\$110
BRTBTS1342	12 x 42 x 13	125	25	3.79	\$565	\$110
BRTBTS1348	12 x 48 x 13	125	28	4.33	\$605	\$150
BRTBTS1354	12 x 54 x 13	125	30	4.87	\$666	\$150
BRTBTS1360	12 x 60 x 13	150	33	5.86	\$708	\$150
BRTBTS1366	12 x 66 x 13	150	36	6.45	\$725	\$254
BRTBTS1372	12 x 72 x 13	125	39	6.50	\$830	\$211
BRTBTS1378	12 x 78 x 13	150	42	7.04	\$893	\$211
BRTBTS1384	12 x 84 x 13	150	44	7.58	\$955	\$231
BRTBTS1636	12 x 36 x 16	125	25	4	\$521	\$88
BRTBTS1642	12 x 42 x 16	125	28	4.66	\$583	\$128
BRTBTS1648	12 x 48 x 16	150	31	5.33	\$644	\$128
BRTBTS1654	12 x 54 x 16	150	34	6	\$684	\$171
BRTBTS1660	12 x 60 x 16	150	38	6.66	\$749	\$171
BRTBTS1666	12 x 66 x 16	150	41	7.33	\$811	\$171
BRTBTS1672	12 x 72 x 16	150	44	8	\$873	\$191
BRTBTS1678	12 x 78 x 16	150	47	8.66	\$911	\$211
BRTBTS1684	12 x 84 x 16	150	50	9.33	\$977	\$231

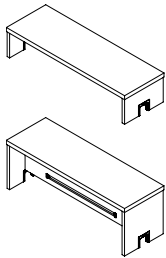

Shared Elevated Table Shelf

Rests on back-to-back Bridges tables. Cut outs in both supporting side gables allow placement over above worksurface power/data troughs. Integrated anodized aluminum accessory rail. White cut out and accessory rail trims. Three heights available. 8" h provides additional storage space without obstructing view; reaches 16" module height when combined w/8" h Binder shelf. Internal height: 6.6". 16" h lines up with top of 16" table dividers (15.8"). Specify 12" narrower shared elevated shelf immediately adjacent to the perpendicular elevated shelf. Internal height: 14.6". Optional Elevated Shelf Binder Bin (**BRTESBBIN**) rests on top surface for enhanced privacy. 1" top.

- Please refer to the **Compatibility Guide** on page 490 to determine available accessories

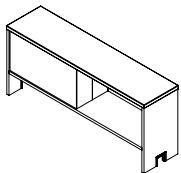

Table Supported Shared Overhead

BRTBAS048	12 x 48 x 21	125	54	7	\$830	\$128
-----------	--------------	-----	----	---	-------	-------

One compartment per side. White magnetic back wall. Lines up with 50" h floor standing storage. Fits over the gap between two parallel back-to-back Bridges tables. Fits over worksurface power/data trough. Storage compartment internal height: 12.8". Optional Elevated Shelf Binder Bin (**BRTESBBIN**) rests on top surface for enhanced privacy. 1" top.

- Please refer to the **Compatibility Guide** on page 490 to determine available accessories

Required Specifications

Top finish
Edge finish
Chassis/accent finish

Optional Specifications

HP laminate (tops only)
Elevated Shelf Binder Bin

MODULAR STORAGE

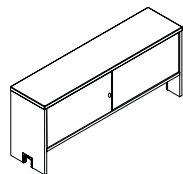

Shared Elevated Overhead*

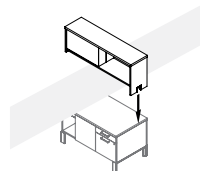

45" High Shared Storage Divider**

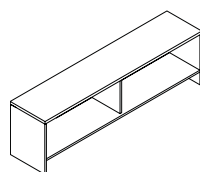

Open Single Sided Storage

MODEL#	DIMENSIONS	FREIGHT CLASS	WT./LBS.	CUBIC FT.	LIST PRICE	HP ADD
--------	------------	---------------	----------	-----------	------------	--------

	D x W x H					
BRTBASL36	16 x 36 x 21	250	23.50	6.56	\$2397	\$161
BRTBASL42	16 x 42 x 21	250	27.50	7.65	\$2564	\$196
BRTBASL48	16 x 48 x 21	250	31.40	8.75	\$2698	\$232
BRTBASL54	16 x 54 x 21	250	35.30	9.84	\$2903	\$243
BRTBASL60	16 x 60 x 21	250	35.30	9.84	\$3060	\$251
BRTBASL66	16 x 66 x 21	250	43.20	12.03	\$3453	\$293
BRTBASL72	16 x 72 x 21	250	47.10	13.12	\$3635	\$327
BRTBASL78	16 x 78 x 21	250	51	14.21	\$3826	\$352
BRTBASL84	16 x 84 x 21	250	55	15.31	\$3876	\$485

Two compartments facing in opposite direction with locking, sliding laminate doors. Storage compartment internal height: 12.25". Shared elevated overhead fits over the gap between two parallel Bridges back-to-back tables. Integrated anodized aluminum accessory rail below the storage compartments. Fits over Above Worksurface Power/Data Troughs. Elevated Shelf Binder Bins DO NOT work with this overhead. 1" top.

- Note: In order to prevent duplex outlet and worksurface access door interference, please specify Overhead of the same width as the supporting worksurface.
- To prevent interference with Ceiling feed pole, please specify Overhead 6" shorter in width corresponding with the length of the supporting worksurface.
- Please refer to the **Compatibility Guide** on page 490 to determine available accessories

BRTSDS48	12 x 48 x 16	92.5	54	5.33	\$666	\$128
----------	--------------	------	----	------	--------------	--------------

Divides side-to-side workstations. Two shared, open shelves. One compartment per side. White magnetic back wall. Rests on top of shared 25" box/file/open and back-to-back worksurface. Top of unit is 15.7" from the top of the worksurface. Storage compartment internal height: 12.8". Optional Elevated Shelf Binder Bin (BRTEBBIN) rests on top surface for enhanced privacy. 1" top, white powder-coated steel central partition and backs.

BRT21HO3616	16 x 36 x 21	100	81	9	\$1194	\$161
BRT21HO4216	16 x 42 x 21	100	81	9	\$1282	\$185
BRT21HO4816	16 x 48 x 21	250	31.40	8.75	\$1367	\$210
BRT21HO5416	16 x 54 x 21	250	35.30	9.84	\$1452	\$237
BRT21HO6016	16 x 60 x 21	250	35.30	9.84	\$1547	\$264
BRT21HO6616	16 x 66 x 21	250	43.20	12.03	\$1646	\$288
BRT21HO7216	16 x 72 x 21	250	47.10	13.12	\$1707	\$326
BRT21HO7816	16 x 78 x 21	250	51	14.21	\$1835	\$339
BRT21HO8416	16 x 84 x 21	250	55	15.31	\$1909	\$366

Table supported single sided open storage. Storage compartment internal height: 14". 1" top.

- Cannot be used in conjunction with above worksurface power trough.
- To prevent duplex outlet and worksurface access door interference, please specify Overhead of the same width of the supporting worksurface.
- To prevent interference with ceiling feed pole, please specify Overhead 6" shorter in width corresponding with the length of the supporting worksurface.
- Please refer to the **Compatibility Guide** on page 490 to determine available accessories

Required Specifications

Top finish
Edge finish
Chassis finish*
Drawer/door front finish*

Optional Specifications

HP laminate (tops only)
Elevated Shelf Binder Bin**

STORAGE

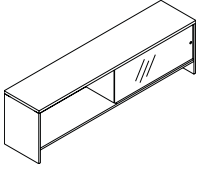

**Open Single Sided Storage,
1 Glass Door**

MODEL#	DIMENSIONS D x W x H	FREIGHT CLASS	WT/LBS.	CUBIC FT.	LIST PRICE	HP ADD
BRT21GS3616	16 x 36 x 21	100	87	9	\$1878	\$159
BRT21GS4216	16 x 42 x 21	100	103	10.50	\$1974	\$184
BRT21GS4816	16 x 48 x 21	100	108	12	\$2058	\$210
BRT21GS5416	16 x 54 x 21	100	133	13.50	\$2454	\$237
BRT21GS6016	16 x 60 x 21	100	144	15	\$2550	\$264
BRT21GS6616	16 x 66 x 21	100	155	16.50	\$2670	\$288
BRT21GS7216	16 x 72 x 21	100	164	18	\$2761	\$314
BRT21GS7816	16 x 78 x 21	100	174	19.50	\$2908	\$338
BRT21GS8416	16 x 84 x 21	100	181	21	\$2993	\$367

Table supported single sided open storage with single sliding glass door with recessed pull. Storage compartment internal height: 14". 1" top.

- Cannot be used in conjunction with above worksurface power trough.
- To prevent duplex outlet and worksurface access door interference, please specify Overhead of the same width of the supporting worksurface.
- To prevent interference with ceiling feed pole, please specify Overhead 6" shorter in width corresponding with the length of the supporting worksurface.
- Please refer to the **Compatibility Guide** on page 490 to determine available accessories

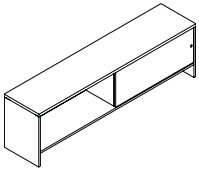

**Open Single Sided Storage,
1 Laminate Door****

BRT21LS3616	16 x 36 x 21	92.5	94	9	\$1824	\$226
BRT21LS4216	16 x 42 x 21	92.5	111	10.50	\$1912	\$260
BRT21LS4816	16 x 48 x 21	100	117	12	\$1996	\$298
BRT21LS5416	16 x 54 x 21	92.5	143	13.50	\$2080	\$336
BRT21LS6016	16 x 60 x 21	92.5	155	15	\$2408	\$368
BRT21LS6616	16 x 66 x 21	92.5	167	16.50	\$2508	\$405
BRT21LS7216	16 x 72 x 21	100	177	18	\$2578	\$444
BRT21LS7816	16 x 78 x 21	100	188	19.50	\$2695	\$480
BRT21LS8416	16 x 84 x 21	100	198	21	\$2768	\$515

Table supported single sided open storage with single sliding laminate door with recessed pull. Storage compartment internal height: 14". 1" top.

- Cannot be used in conjunction with above worksurface power trough.
- To prevent duplex outlet and worksurface access door interference, please specify Overhead of the same width of the supporting worksurface.
- To prevent interference with ceiling feed pole, please specify Overhead 6" shorter in width corresponding with the length of the supporting worksurface.
- Please refer to the **Compatibility Guide** on page 490 to determine available accessories

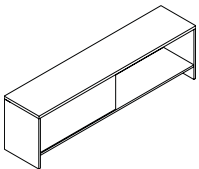

Open Double Sided Storage*

BRT21HDO3616	16 x 36 x 21	100	81	9	\$1238	\$159
BRT21HDO4216	16 x 42 x 21	100	96	10.50	\$1308	\$185
BRT21HDO4816	16 x 48 x 21	100	100	12	\$1370	\$215
BRT21HDO5416	16 x 54 x 21	100	124	13.50	\$1474	\$238
BRT21HDO6016	16 x 60 x 21	100	134	15	\$1552	\$261
BRT21HDO6616	16 x 66 x 21	100	144	16.50	\$1668	\$287
BRT21HDO7216	16 x 72 x 21	100	152	18	\$1722	\$314
BRT21HDO7816	16 x 78 x 21	100	161	19.50	\$1858	\$339
BRT21HDO8416	16 x 84 x 21	100	168	21	\$1910	\$367

Table supported double sided open storage. Fits over the gap between two parallel Bridges II back-to-back tables. Storage compartment internal height: 14". 1" top.

- Cannot be used in conjunction with above worksurface power trough.
- To prevent duplex outlet and worksurface access door interference, please specify Overhead of the same width of the supporting worksurface.
- To prevent interference with ceiling feed pole, please specify Overhead 6" shorter in width corresponding with the length of the supporting worksurface.
- Please refer to the **Compatibility Guide** on page 490 to determine available accessories

Required Specifications

Top finish
Edge finish
Chassis finish*
Drawer/door front finish**

Optional Specifications

HP laminate (tops only)
Elevated Shelf Binder Bin

STORAGE	MODEL#	DIMENSIONS	FREIGHT CLASS	WT/LBS.	CUBIC FT.	LIST PRICE	HP ADD
		D x W x H					
	BRT21GDS3616	16 x 36 x 21	92.5	94	9	\$2437	\$155
	BRT21GDS4216	16 x 42 x 21	92.5	111	10.50	\$2552	\$185
	BRT21GDS4816	16 x 48 x 21	100	117	12	\$2608	\$211
	BRT21GDS5416	16 x 54 x 21	92.5	143	13.50	\$3373	\$237
	BRT21GDS6016	16 x 60 x 21	92.5	155	15	\$3433	\$264
	BRT21GDS6616	16 x 66 x 21	92.5	167	16.50	\$3661	\$287
	BRT21GDS7216	16 x 72 x 21	100	177	18	\$3742	\$314
	BRT21GDS7816	16 x 78 x 21	100	188	19.50	\$3897	\$338
	BRT21GDS8416	16 x 84 x 21	100	196	21	\$4148	\$366

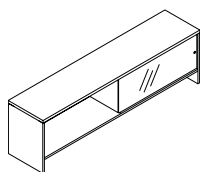

Double Sided Storage, Glass Door

Table supported double sided open storage with sliding glass doors and recessed pull. Fits over the gap between two parallel Bridges II back-to-back tables. Storage compartment internal height: 14". 1" top.

- Cannot be used in conjunction with above worksurface power trough.
- To prevent duplex outlet and worksurface access door interference, please specify Overhead of the same width of the supporting worksurface.
- To prevent interference with ceiling feed pole, please specify Overhead 6" shorter in width corresponding with the length of the supporting worksurface.
- Please refer to the **Compatibility Guide** on page 490 to determine available accessories

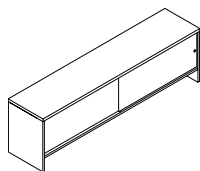

Double Sided Storage, Laminate Door*

BRT21LDS3616	16 x 36 x 21	92.5	106	9	\$2396	\$159
BRT21LDS4216	16 x 42 x 21	85	126	10.50	\$2547	\$185
BRT21LDS4816	16 x 48 x 21	92.5	134	12	\$2600	\$210
BRT21LDS5416	16 x 54 x 21	85	162	13.50	\$3246	\$237
BRT21LDS6016	16 x 60 x 21	92.5	176	15	\$3302	\$264
BRT21LDS6616	16 x 66 x 21	92.5	190	16.50	\$3525	\$288
BRT21LDS7216	16 x 72 x 21	92.5	203	18	\$3578	\$314
BRT21LDS7816	16 x 78 x 21	92.5	216	19.50	\$3711	\$338
BRT21LDS8416	16 x 84 x 21	92.5	227	21	\$3935	\$366

Table supported double sided open storage with sliding laminate doors and recessed pull. Fits over the gap between two parallel Bridges II back-to-back tables. Storage compartment internal height: 14". 1" top.

- Cannot be used in conjunction with above worksurface power trough.
- To prevent duplex outlet and worksurface access door interference, please specify Overhead of the same width of the supporting worksurface.
- To prevent interference with ceiling feed pole, please specify Overhead 6" shorter in width corresponding with the length of the supporting worksurface.
- Please refer to the **Compatibility Guide** on page 490 to determine available accessories

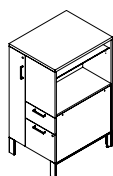

50" H Storage Tower w/Coat Storage*

BRTTW5024L	24 x 24 x 50	100	142	16.66	\$2254	\$150
BRTTW5024R	24 x 24 x 50	100	142	16.66	\$2254	\$150
BRTTW5030L	30 x 24 x 50	125	163	20.83	\$2501	\$150
BRTTW5030R	30 x 24 x 50	125	163	20.83	\$2501	\$150

Provides storage and privacy at the end of a table. Box/File drawers, open compartment with adjustable glass shelf (50"h); coat storage with hinged door. Specify Left or Right handed. Capable of supporting worksurface on one side. Built-in threaded inserts to secure dedicated worksurface supporting beam. Open side storage compartment internal height: 19.6". Optional cable basket suspends off storage unit's bottom and manages cables along the horizontal plane. 1" top; metal handles; powder-coated aluminum or anodized aluminum legs. Black pencil tray included.

- Anodized Aluminum Leg - Add **\$91** list upcharge

Required Specifications

Top finish
Chassis finish
Drawer/door front finish
Metal finish (legs)

Edge finish

Optional Specifications

Anodized aluminum leg*
HP laminate
E-Lock*

STORAGE

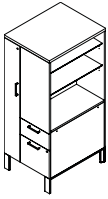

66" H Storage Tower with Coat Storage

MODEL#	DIMENSIONS D x W x H	FREIGHT CLASS	WT/LBS.	CUBIC FT.	LIST PRICE	HP ADD
BRTTW6624L	24 x 24 x 66	125	170	22	\$2988	\$193
BRTTW6624R	24 x 24 x 66	125	170	22	\$2988	\$193
BRTTW6630L	30 x 24 x 66	125	195	27.50	\$3315	\$195
BRTTW6630R	30 x 24 x 66	125	195	27.50	\$3315	\$234

Provides storage and privacy at the end of a table. Box/File drawers, open compartment with 2 adjustable glass shelves (66"h); coat storage with hinged door and 2 shelves. Specify Left or Right handed. Capable of supporting worksurface on one side. Built-in threaded inserts to secure dedicated worksurface supporting beam. Open side storage compartment internal height: 35.6". Optional cable basket suspends off storage unit's bottom and manages cables along the horizontal plane. 1" top; metal handles; powder-coated aluminum or anodized aluminum legs. Black pencil tray included.

- Anodized Aluminum Leg - Add **\$91** list upcharge

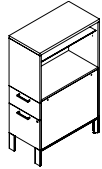

50" H Storage Tower

BRTT5024L	24 x 15.5 x 50	100	88	10.76	\$1675	\$110
BRTT5024R	24 x 15.5 x 50	100	88	10.76	\$1675	\$110
BRTT5030L	30 x 15.5 x 50	125	101	13.45	\$1843	\$128
BRTT5030R	30 x 15.5 x 50	125	101	13.45	\$1843	\$128

Provides storage and privacy at the end of a table. Box/File drawers, open compartment with adjustable glass shelf (50"h). Specify Left or Right handed. Capable of supporting worksurface on one side. Built-in threaded inserts to secure dedicated worksurface supporting beam. Open side storage compartment internal height: 19.6". Optional cable basket suspends off storage unit's bottom and manages cables along the horizontal plane. 1" top; metal handles; powder-coated aluminum or anodized aluminum legs. Black pencil tray included.

- Anodized Aluminum Leg - Add **\$91** list upcharge

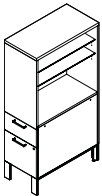

66" H Storage Tower

BRTT6624L	24 x 15.5 x 66	100	106	12.91	\$2221	\$140
BRTT6624R	24 x 15.5 x 66	100	106	12.91	\$2221	\$140
BRTT6630L	30 x 15.5 x 66	125	121	16.14	\$2441	\$170
BRTT6630R	30 x 15.5 x 66	125	121	16.14	\$2441	\$170

Provides storage and privacy at the end of a table. Box/File drawers, open compartment with 2 adjustable glass shelves (66"h). Specify Left or Right handed. Capable of supporting worksurface on one side. Built-in threaded inserts to secure dedicated worksurface supporting beam. Open side storage compartment internal height: 35.6". Optional cable basket suspends off storage unit's bottom and manages cables along the horizontal plane. 1" top; metal handles; powder-coated aluminum or anodized aluminum legs. Black pencil tray included.

- Anodized Aluminum Leg - Add **\$91** list upcharge

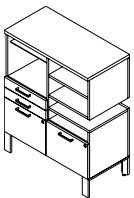

Cantilever Storage*

BRTCS45BBFFL	18 x 36 x 45	92.5	256	24	\$3045	\$159
BRTCS45BBFFR	18 x 36 x 45	92.5	256	24	\$3045	\$159

Provides storage and privacy anywhere along the length of the bench. The middle opening of the cabinet allows the upper portion to cantilever above the worksurface. 2 locking file drawers. 2 pencil drawers (not locking). Open compartment with adjustable glass shelf, internal dimension of 15.9". Three fixed open compartments; two above worksurfaces (6.7" interior dimension), one below (3.7" interior dimension). Specify Left or Right handed. Optional cable basket suspends off storage unit's bottom and manages cables along the horizontal plane. 1" top; metal handles; powder-coated aluminum or anodized aluminum legs.

- Anodized Aluminum Leg - Add **\$91** list upcharge

Required Specifications

Top finish
Chassis finish
Drawer/door front finish
Metal finish (legs)

Optional Specifications

Anodized aluminum leg
HP laminate
E-Lock*

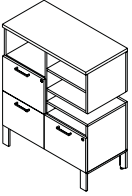
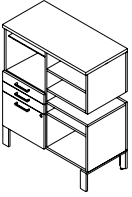
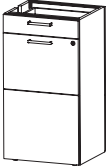
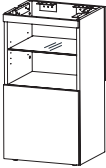
STORAGE	MODEL#	DIMENSIONS	FREIGHT CLASS	WT/LBS.	CUBIC FT.	LIST PRICE	HP ADD
		D x W x H					
	BRTCS45FFFOL	18 x 36 x 45	92.5	256	24	\$3120	\$159
	BRTCS45FFFOR	18 x 36 x 45	92.5	256	24	\$3120	\$159
Cantilever Storage*	<p>Provides storage and privacy anywhere along the length of the bench. The middle opening of the cabinet allows the upper portion to cantilever above the worksurface. 3 locking file drawers with 2 locks. Open compartment (10.3" interior dimension). Three fixed open compartments; two above worksurfaces (6.7" interior dimension), one below (3.7" interior dimension). Specify Left or Right handed. Optional cable basket suspends off storage unit's bottom and manages cables along the horizontal plane. 1" top; metal handles; powder-coated aluminum or anodized aluminum legs.</p> <ul style="list-style-type: none"> Anodized Aluminum Leg - Add \$91 list upcharge 						
							
	BRTCS45BBFOOL	18 x 36 x 45	92.5	256	24	\$2979	\$159
	BRTCS45BBFOR	18 x 36 x 45	92.5	256	24	\$2979	\$159
Cantilever Storage*	<p>Provides storage and privacy anywhere along the length of the bench. The middle opening of the cabinet allows the upper portion to cantilever above the worksurface. Locking file drawer. 2 pencil drawers (not locking). Open compartment (10.3" interior dimension) with adjustable glass shelf. 4 fixed open compartments; two above worksurfaces (6.7" interior dimension), two below (lower 12.2" interior dimension; upper 3.3" interior dimension). Specify Left or Right handed. Optional cable basket suspends off storage unit's bottom and manages cables along the horizontal plane. 1" top; metal handles; powder-coated aluminum or anodized aluminum legs.</p> <ul style="list-style-type: none"> Anodized Aluminum Leg - Add \$91 list upcharge 						
							
	BRTDS2B2F	16 x 18 x 36	125	85	14	\$1866	n/a
Pier Storage, Box/File	<p>Supports side-by-side divider with Box/File on opposite sides for side-by-side application. Two lockable file drawers, two box drawers. Black pencil tray included.</p>						
							
	BRTDSOP	16 x 18 x 36	150	75	14	\$1241	n/a
Pier Storage, Open w/Glass Shelves	<p>Supports side-by-side divider with Box/File on opposite sides for side-by-side application. Storage compartment internal height without adjustable shelf: 15"</p>						

Required Specifications

Top finish*
 Edge finish*
 Chassis finish
 Drawer/door front finish

Optional Specifications

Anodized aluminum leg
 HP laminate (tops only)

STORAGE

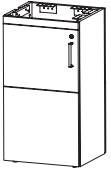

Pier Storage, Door w/Glass Shelves

MODEL#	DIMENSIONS	FREIGHT CLASS	WT./LBS.	CUBIC FT.	LIST PRICE	HP ADD
--------	------------	---------------	----------	-----------	------------	--------

D x W x H

BRTDS2D	16 x 18 x 36	150	79	14	\$1667	n/a
---------	--------------	-----	----	----	---------------	-----

Supports side-by-side divider with hinged, lockable door on opposite sides for side-by-side application. Storage compartment internal height without adjustable shelf: 15"

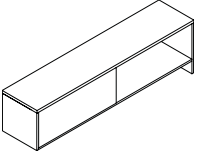

Side-by-Side Storage, Open*

BRT21PHDO4216	16 x 42 x 21	100	96	10.50	\$1080	\$185
BRT21PHDO4816	16 x 48 x 21	100	100	12	\$1148	\$215
BRT21PHDO5416	16 x 54 x 21	100	124	13.50	\$1258	\$237
BRT21PHDO6016	16 x 60 x 21	100	134	15	\$1330	\$264
BRT21PHDO6616	16 x 66 x 21	100	144	16.50	\$1441	\$286
BRT21PHDO7216	16 x 72 x 21	100	152	18	\$1518	\$314

Pier and table supported side-by-side double-sided open storage. Divides space and provides storage anywhere along bench or table. Storage compartment internal height: 14". 1" top.

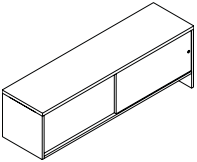

Side-by-Side Storage, Laminate Doors*

BRT21PLDS4216	16 x 42 x 21	92.5	126	11	\$2500	\$185
BRT21PLDS4816	16 x 48 x 21	92.5	134	12	\$2553	\$211
BRT21PLDS5416	16 x 54 x 21	92.5	162	14	\$3203	\$237
BRT21PLDS6016	16 x 60 x 21	92.5	176	15	\$3259	\$264
BRT21PLDS6616	16 x 66 x 21	92.5	190	17	\$3480	\$288
BRT21PLDS7216	16 x 72 x 21	92.5	203	18	\$3533	\$314

Pier and table supported side-by-side double-sided storage with sliding laminate doors and recessed pull. Divides space and provides storage anywhere along bench or table. Storage compartment internal height: 14". 1" top.

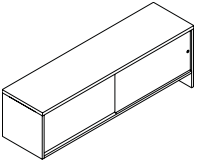

Side-by-Side Storage, Glass Doors*

BRT21PGDS4216	16 x 42 x 21	92.5	110	10.50	\$2525	\$183
BRT21PGDS4816	16 x 48 x 21	100	116	12	\$2581	\$210
BRT21PGDS5416	16 x 54 x 21	92.5	141	13.50	\$3347	\$237
BRT21PGDS6016	16 x 60 x 21	92.5	153	15	\$3406	\$261
BRT21PGDS6616	16 x 66 x 21	92.5	165	16.50	\$3634	\$287
BRT21PGDS7216	16 x 72 x 21	100	175	18	\$3716	\$315

Pier and table supported side-by-side double-sided storage with sliding glass doors and recessed pull. Divides space and provides storage anywhere along bench or table. Storage compartment internal height: 14". 1" top.

Required Specifications

Top finish*
Edge finish*
Chassis finish
Drawer/door front finish (excl. glass)

Optional Specifications

HP laminate*

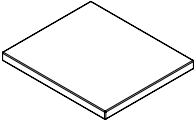
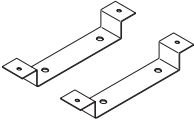
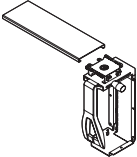
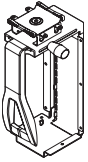
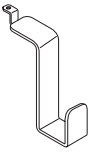
ACCESSORIES	MODEL #	DIMENSIONS	FREIGHT CLASS	WT/LBS.	CUBIC FT.	GRADE	LIST	GRADE	LIST	
 <p>Cushion*</p>	D x W x H									
	BRTC	18 x 15.5 x 1.25	150	2	.41	1	\$272	7	\$526	
						2	\$311	8	\$569	
						3	\$341	9	\$618	
						4	\$375	10	\$736	
						5	\$427	11	\$834	
						6	\$476	12	\$938	
<p>Optional seat cushion may be added to any storage component. Available in all Global seating fabrics.</p> <ul style="list-style-type: none"> • When added to 25" h storage units, unit will NOT fit under any table with a beam 										
 <p>Glide Tray Adapter</p>	GAGTA01	2 x 9 x 2.5	70	.50	.03		\$123			
	<p>Accommodates the placement of sliding keyboard mechanisms and CPU holders below the cross beam of Bridges tables. Attaches to Glide Tracks of all Productivity Solutions Keyboard Mechanisms and Sliding CPU holders. Mounting hardware included. Available in Black only.</p> <ul style="list-style-type: none"> • Cannot be used with GACPU01. See Productivity Solutions for compatible keyboard mechanisms and sliding CPU holder. 									
 <p>CPU Holder on Glide Track</p>	GACPU02	9.2 x 11.7 x 18.5	92.5	12.60	1.15		\$269			
	<p>Accepts tower CPUs with a width range of 12.5" to 22.5" and width range of 3.5" to 9.3". Soft touch knob for side clamp adjustment and bayonet lance for vertical height adjustment. 12" glide track mounted and 360° swivel for easy access to rear of CPU. Manufactured from steel and engineered resin, providing rugged durability and support. Available in Black only.</p>									
 <p>Fixed Mount CPU Holder</p>	GACPU01	9.2 x 11.7 x 18.5	125	9	1.15		\$243			
	<p>Fully adjustable clamping mechanism to accept tower CPUs with a height range of 12.5" to 22.5" and width range of 3.5" to 9.3". Soft touch knob for side clamp adjustment and bayonet lance for vertical height adjustment. Mounts directly to underside of desk surface. CPU Holder can also be mounted directly to an upright desk leg surface or wall via side mounting holes. Manufactured from Steel and Engineered Resin, providing rugged durability and support. Available in black only.</p> <ul style="list-style-type: none"> • Not compatible with GAGTA01 									
 <p>Hanging Bracket**</p>	BRTHB	3.3 x 1.5 x 3.5	70	.20	.01		\$35			
	<p>A formed steel bracket hooks over Bridges II table leg. Can be secured either on the inner or outer side of the leg. Specify metal paint finish.</p>									

Required Specifications

Fabric*

Paint finish**

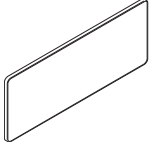
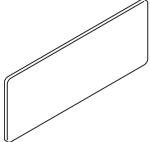
ACCESSORIES	MODEL#	DIMENSIONS	FREIGHT CLASS	WT/LBS.	CUBIC FT.	LIST PRICE
 <p data-bbox="92 322 194 352">Whiteboard</p>	BRTWB0924	D x W x H 0.5 x 24 x 8.5	70	1	.56	\$272
<p>White dry-erase marker board surface on white powder coated steel backer. Fits 16" tall Bridges II dividers and single-sided shelves. White dry-erase surface attaches magnetically to the steel backer. When removed, the steel backer can be used as a magnetic board. <i>Please refer to the Compatibility Guide (page 490) to determine available accessories.</i></p> <ul style="list-style-type: none"> • Available in Tungsten (TUN) or Designer White (DWT) Only 						
 <p data-bbox="92 655 194 685">Tackboard*</p>	BRTTB0924	0.5 x 24 x 8.5	70	1	.56	\$272
<p>Grey tackboard surface on white powder coated steel backer. Fits 16" tall Bridges II dividers and single-sided shelves. <i>Please refer to the Compatibility Guide (page 490) to determine available accessories.</i></p> <ul style="list-style-type: none"> • Available in Tungsten (TUN) or Designer White (DWT) Only 						

Required Specifications

Metal finish
Fabric*

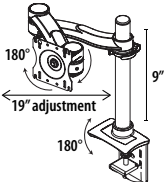
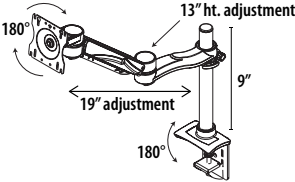
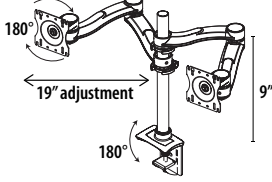
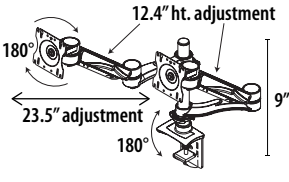
MONITOR ARMS	MODEL#	DIMENSIONS	FREIGHT CLASS	WT/LBS.	CUBIC FT.	LIST PRICE
 <p>Single Screen Double Extension Arm</p>	GAMCSSDE	D x W x H -- x -- x --	125	7.50	1.09	\$609
<p>Double extension allows 19" of horizontal back and forth movement. Arm folds back to post for more desk space. Displays are able to tilt 180°, swing 180° side-to-side and rotate from landscape to portrait. Minor assembly required.</p> <ul style="list-style-type: none"> To use arm in conjunction with below worksurface power troughs, thru-surface mount must be used. Cannot be clamp mounted when using power troughs. 						
 <p>Single Screen Double Extension Arm with Height Adjustment</p>	GAMCSSDEH	-- x -- x --	125	8.20	1.09	\$730
<p>Counterbalanced arm provides an additional 13" of height adjustment. Double extension allows 19" of horizontal back and forth movement. Easy to use Allen wrench allows user to adjust the counterbalance mechanism for easy movement of the monitor. Displays are able to tilt 180°, swing 180° side-to-side and rotate from landscape to portrait. Cable manager comes on extension arm and hides all cables. Minor assembly required.</p> <ul style="list-style-type: none"> To use arm in conjunction with below worksurface power troughs, thru-surface mount must be used. Cannot be clamp mounted when using power troughs. 						
 <p>Dual Screen Double Extension Arm</p>	GAMCDSDE	-- x -- x --	100	10.70	1.09	\$1072
<p>For dual monitor applications. Double extension arms allow 19" of horizontal back and forth movement. Easy to use Allen wrench allows user to adjust the counterbalance mechanism for easy movement of the monitor. Displays are able to tilt 180°, swing 180° side-to-side and rotate from landscape to portrait. Minor assembly required.</p> <ul style="list-style-type: none"> To use arm in conjunction with below worksurface power troughs, thru-surface mount must be used. Cannot be clamp mounted when using power troughs. 						
 <p>Dual Screen Double Extension Arm with Height Adjustment</p>	GAMCDSDEH	-- x -- x --	92.5	12.2	1.09	\$1316
<p>For dual monitor applications. Counterbalanced arms provide an additional 13" of height adjustment. Double extension arms allow 19" of horizontal back and forth movement. Easy to use Allen wrench allows user to adjust the counterbalance mechanism for easy movement of the monitor. Displays are able to tilt 180°, swing 180° side-to-side and rotate from landscape to portrait. Cable manager comes on extension arm and hides all cables. Minor assembly required.</p> <ul style="list-style-type: none"> To use arm in conjunction with below worksurface power troughs, thru-surface mount must be used. Cannot be clamp mounted when using power troughs. 						

ACCESSORIES

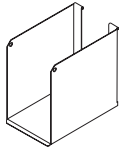

Binder Bin

MODEL#	DIMENSIONS D x W x H	FREIGHT CLASS	WT./LBS.	CUBIC FT.	LIST PRICE
BABB01	10.25 x 4 x 9	100	2	.21	\$75

Load bar/accessory rail mounted metal binder bin.

- Please refer to the **Compatibility Guide** on page 490 to determine compatible storage components

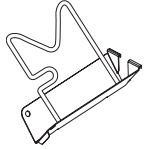

Flip Sorter

BAFS01	9.25 x 2.75 x 9.25	70	.06	.14	\$58
--------	--------------------	----	-----	-----	-------------

Load bar/accessory rail mounted metal flip sorter. Comes with chrome wire.

- Please refer to the **Compatibility Guide** on page 490 to determine compatible storage components

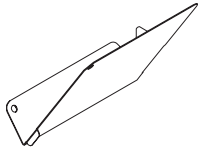

Slant Sorter

BASS01L (Left)	10.25 x 5 x 9.5	70	1	.28	\$47
BASS01R (Right)	10.25 x 5 x 9.5	70	1	.28	\$47

Load bar/accessory rail mounted metal slant sorter.

- Please refer to the **Compatibility Guide** on page 490 to determine compatible storage components

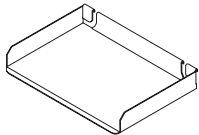

Letter/Legal Tray

BALTO1 (Letter)	9.25 x 13.5 x 2	70	.05	.15	\$62
BALTO1LGL (Legal)	9.25 x 15 x 2	70	.05	.15	\$76

Load bar/accessory rail mounted metal letter or legal tray.

- Please refer to the **Compatibility Guide** on page 490 to determine compatible storage components

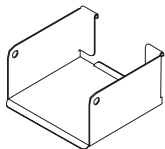

Media Bin

BAMB01	5.25 x 5.75 x 3	70	.08	.05	\$62
--------	-----------------	----	-----	-----	-------------

Load bar/accessory rail mounted metal media bin.

- Please refer to the **Compatibility Guide** on page 490 to determine compatible storage components

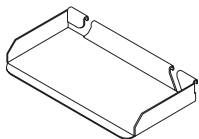

Utility Tray

BAUT01	3.75 x 5.75 x 3	70	.05	.02	\$41
--------	-----------------	----	-----	-----	-------------

Load bar/accessory rail mounted metal utility tray.

- Please refer to the **Compatibility Guide** on page 490 to determine compatible storage components

Required Specifications

Paint finish

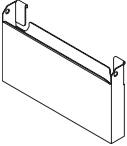
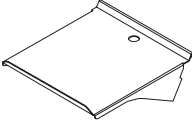
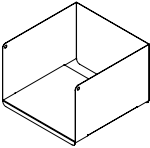
ACCESSORIES	MODEL#	DIMENSIONS	FREIGHT CLASS	WT./LBS.	CUBIC FT.	LIST PRICE
 <p>Mail Box*</p>		D x W x H				
	BAPP01	2.75 x 16 x 9	100	2	.25	\$94
<p>Load bar/accessory rail mounted metal mail box.</p> <ul style="list-style-type: none"> • Please refer to the Compatibility Guide on page 490 to determine compatible storage components 						
 <p>Telephone Holder*</p>						
	BATH01	10 x 9 x 2	125	2	.26	\$91
<p>Load bar/accessory rail mounted metal telephone holder.</p> <ul style="list-style-type: none"> • Please refer to the Compatibility Guide on page 490 to determine compatible storage components 						
 <p>Elevated Shelf Binder Bin*</p>						
	BRTESBBIN	12 x 12 x 8	100	6	.66	\$193
<p>Load bar/accessory rail mounted elevated shelf binder bin.</p> <ul style="list-style-type: none"> • Please refer to the Compatibility Guide on page 490 to determine compatible storage components 						

Required Specifications

Paint finish*

ACCESSORIES

D x W x H

ACCESSORIES COMPATIBILITY GUIDE

	DIVIDERS: BRTL PDD BRTL PDS BR2AFD BR2AHD	Elevated Shelves BRTSTS08 BRTBTS08 8" high	Elevated Shelves BRTSTS13 BRTBTS13 13" high	Elevated Shelves BRTSTS16 BRTBTS16 16" high	Shared Overhead BRTBAS048 12" deep	Shared Overhead with slid- ing doors BRTBASS 16" deep
Binder Bin BABB01	yes	no	no	yes	no	no
Flip Sorter BAFS01	yes	no	yes	no	no	no
Slant Sorter BASS01	yes	no	yes	no	no	no
Letter Tray BALT01	yes	yes	yes	yes	yes	yes
Media Bin BAMB01	yes	yes	yes	yes	yes	yes
Utility Tray BAUT01	yes	yes	yes	yes	yes	yes
Mail Box BAPP01	yes	no	no	yes	no	no
Phone Holder BVATH01	yes	yes	yes	yes	yes	yes
Elevated Shelf Binder Bin BRTEBBIN	no	no	no	no	yes	no
Tackboard BRTTB	yes	no	no	yes	no	no
Whiteboard BRTWB	yes	no	no	yes	no	no

COLLABORATIVE SEATING**D x W x H**

Bridges collaborative seating collection consists of seating, privacy screens, tables, tablets and power. It is a versatile modular furniture series which can be configured into many space planning scenarios, including corner, in-line, open concept, traditional reception, as well as secluded seating with high privacy partitions.

Furniture pieces can be used as stand alone items or can be mechanically linked together to form a variety of seating configurations.

Seat and backrest can be integrated with Bridges tables.

Corner tables and in-line 6" table modules double as power delivery centers.

Dedicated seat backrests feature dual USB charging port.

Some inline 6" table modules are furnished with grommets to support tablets.

Legs are available in standard Bridges metal painted finishes and anodized aluminum finish.

Bridges Collaborative Seating upholstery features a single stitch, thick white thread around the edges. The white, wide stitch along with crisp corners are part of its distinctive personality. In order to achieve crisp edges and to minimize "pillow" effect caused by taut fabric, the upholstery material has been applied deliberately loose, which may over time, produce puckering of the upholstery surface material. This can be easily corrected by stretching the fabric by hand or during vacuuming.

In order to efficiently utilize fabric yield, all 60" seats and backs feature a seam in the middle. The double stitch seam is sewn with a thin thread, closely matching the upholstery material in color.

Some complicated fabric patterns prevent pattern matching and will be upholstered without the seam at the discretion of the factory.

Should you require no middle seam by cutting into the roll, please specify "NO SEAM" at time of your order.

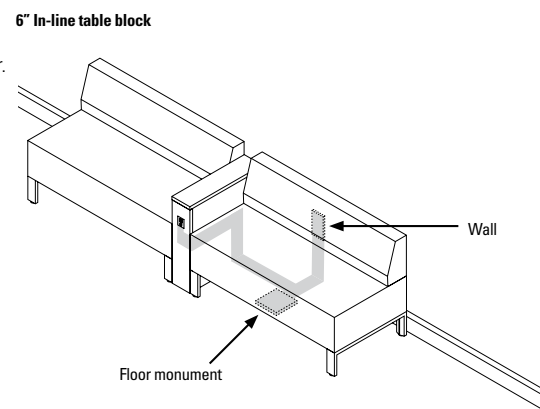
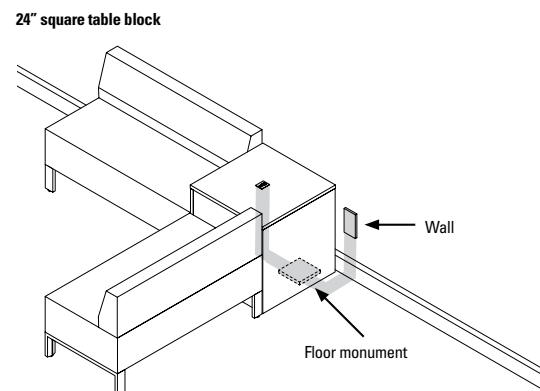
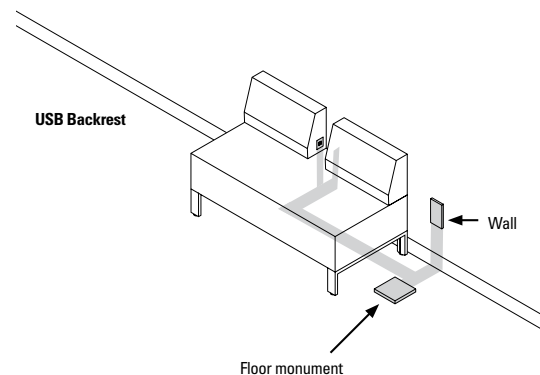

COLLABORATIVE SEATING

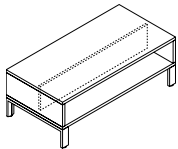

Low Table*

MODEL#	DIMENSIONS D x W x H	FREIGHT CLASS	WT/LBS.	CUBIC FT.	LIST PRICE	HP ADD
BRTST2460F	24 x 60 x 17	150	83.60	14.17	\$938	\$348
BRTST2448F	24 x 48 x 17	125	69	11.33	\$839	\$253
BRTST2424F	24 x 24 x 17	125	40.70	5.67	\$593	\$104

Freestanding 17”h table. Central partition divides space under top surface into two 11” deep compartments. All LP chassis w/ HP or LP top (3mm edging). Bridges storage aluminum leg.

- Anodized Aluminum Leg - Add **\$79** list upcharge

COLLABORATIVE SEATING

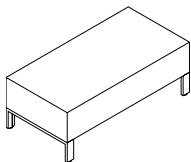

Lounge Seat

MODEL#	DIMENSIONS	FREIGHT CLASS	WT/LBS.	CUBIC FT.	GRADE	LIST	GRADE	LIST
BRTSE60NB	24 x 60 x 17	250	47	14.17	1	\$1767	7	\$2370
					2	\$1857	8	\$2579
					3	\$1925	9	\$2740
					4	\$2025	10	\$2920
					5	\$2172	11	\$3285
					6	\$2238	12	\$3679
BRTSE48NB	24 x 48 x 17	250	36.90	11.33	1	\$1527	7	\$2012
					2	\$1601	8	\$2179
					3	\$1655	9	\$2306
					4	\$1737	10	\$2451
					5	\$1851	11	\$2746
					6	\$1907	12	\$3058
BRTSE24NB	24 x 24 x 17	150	22.70	5.57	1	\$839	7	\$1143
					2	\$886	8	\$1247
					3	\$920	9	\$1328
					4	\$972	10	\$1418
					5	\$1044	11	\$1600
					6	\$1077	12	\$1797

Fully upholstered armless lounge seat with metal base. Seats can be freestanding or linked with optional interlocking bracket kit.

- Anodized Aluminum Leg - Add **\$79** list upcharge

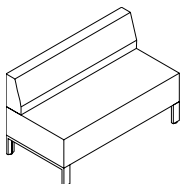

Lounge Seat, Full Backrest

BRTSE6060B	24 x 60 x 29	250	70	24.17	1	\$2822	7	\$3906
					2	\$2980	8	\$4280
					3	\$3103	9	\$4568
					4	\$3286	10	\$4890
					5	\$3545	11	\$5554
					6	\$3668	12	\$6261
BRTSE4848B	24 x 48 x 29	250	55.50	19.33	1	\$2435	7	\$3277
					2	\$2558	8	\$3569
					3	\$2654	9	\$3794
					4	\$2797	10	\$4045
					5	\$3001	11	\$4561
					6	\$3095	12	\$5110
BRTSE2424B	24 x 24 x 29	250	33	9.57	1	\$1320	7	\$1864
					2	\$1401	8	\$2051
					3	\$1463	9	\$2196
					4	\$1554	10	\$2358
					5	\$1684	11	\$2690
					6	\$1745	12	\$3042

Fully upholstered armless lounge seat with full backrest and metal base. Backrests are permanently secured to the seats and cannot be reconfigured on site. Seats can be freestanding or linked with optional interlocking bracket kit.

- Anodized Aluminum Leg - Add **\$79** list upcharge

Required Specifications

Top finish* Edge finish*
 Chassis finish*
 Fabric
 Paint finish (legs)

Optional Specifications

Anodized Aluminum Leg
 HP laminate*

COLLABORATIVE SEATING

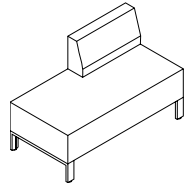

Lounge Seat, 24" Offset Backrest

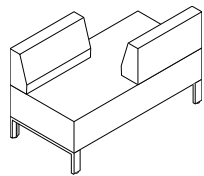

Lounge Seat, Two 24" Offset Backrests

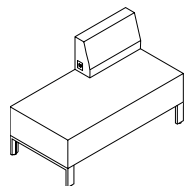

Lounge Seat, 21" USB Backrest

MODEL#	DIMENSIONS	FREIGHT CLASS	WT/LBS.	CUBIC FT.	GRADE	LIST	GRADE	LIST
D x W x H								
BRTSE2448BL	24 x 48 x 29	250	46.10	19.33	1	\$2007	7	\$2731
					2	\$2117	8	\$2983
					3	\$2198	9	\$3175
					4	\$2317	10	\$3387
					5	\$2492	11	\$3831
					6	\$2574	12	\$4302
BRTSE2448BR (shown)	24 x 48 x 29	250	46.10	19.33	1	\$2007	7	\$2731
					2	\$2117	8	\$2983
					3	\$2198	9	\$3175
					4	\$2317	10	\$3387
					5	\$2492	11	\$3831
					6	\$2574	12	\$4302
Fully upholstered armless lounge seat with one backrest and metal base. Specify backrest as either left or right side. Backrests are permanently secured to the bench and cannot be reconfigured on site. Seats can be freestanding or linked with optional interlocking bracket kit.								
• Anodized Aluminum Leg - Add \$79 list upcharge								
BRTSE2448BODL (shown)	24 x 48 x 29	250	46.10	19.33	1	\$2488	7	\$3452
					2	\$2629	8	\$3786
					3	\$2738	9	\$4041
					4	\$2902	10	\$4330
					5	\$3132	11	\$4919
					6	\$3241	12	\$5545
BRTSE2448BODR	24 x 48 x 29	250	46.10	19.33	1	\$2488	7	\$3452
					2	\$2629	8	\$3786
					3	\$2738	9	\$4041
					4	\$2902	10	\$4330
					5	\$3132	11	\$4919
					6	\$3241	12	\$5545
Fully upholstered armless lounge seat with two offset backrests and metal base. Specify either left or right backrest configuration. Backrests are permanently secured to the bench and cannot be reconfigured on site. Seats can be freestanding or linked with optional interlocking bracket kit.								
• Anodized Aluminum Leg - Add \$79 list upcharge								
BRTSE2148EBL	24 x 48 x 29	250	33	9.67	1	\$2326	7	\$3050
					2	\$2436	8	\$3302
					3	\$2517	9	\$3494
					4	\$2636	10	\$3706
					5	\$2811	11	\$4150
					6	\$2893	12	\$4621
BRTSE2148EBR (shown)	24 x 48 x 29	250	46.10	19.33	1	\$2326	7	\$3050
					2	\$2436	8	\$3302
					3	\$2517	9	\$3494
					4	\$2636	10	\$3706
					5	\$2811	11	\$4150
					6	\$2893	12	\$4621
Fully upholstered armless lounge seat with one backrest and metal base. 21" w backrest comes with embedded dual USB port in its side. Note: The side mounted power/USB outlets always point to the center of the seat. Each USB outlet offers 2 amps. AC/DC transformer plugs into the wall or floor monument (approx. 4' long cable available from the bottom of the seat). Transformer power consumption: 0.68 amps. Specify either left or right backrest configuration. Backrests are permanently secured to the bench and cannot be reconfigured on site. Seats can be freestanding or linked with optional interlocking bracket kit. White USB outlets.								
• Anodized Aluminum Leg - Add \$79 list upcharge								

Required SpecificationsFabric
Paint finish (legs)**Optional Specifications**

Anodized Aluminum Leg

COLLABORATIVE SEATING

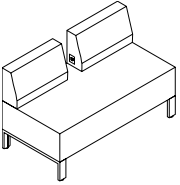

Lounge Seat, Two 21" USB Backrests

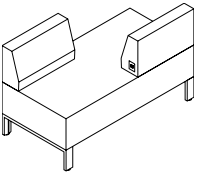

Lounge Seat, Two Offset USB Backrests

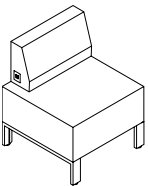

Lounge Seat, 21" USB Backrest

MODEL#	DIMENSIONS D x W x H	FREIGHT CLASS	WT/LBS.	CUBIC FT.	GRADE	LIST	GRADE	LIST
BRTSE2148E2B	24 x 48 x 29	250	57	19.33	1	\$3125	7	\$4088
					2	\$3266	8	\$4422
					3	\$3372	9	\$4678
					4	\$3536	10	\$4964
					5	\$3767	11	\$5553
					6	\$3878	12	\$6181

Fully upholstered armless lounge seat with two backrests and metal base. Both 21" w backrests come with embedded dual USB port in its side. Note: The side mounted power/USB outlets always point to the center of the seat. Each USB outlet offers 2 amps. AC/DC transformer plugs into the wall or floor monument (approx. 52" long cable available from the bottom of the seat). Transformer power consumption: 0.68 amps. Backrests are permanently secured to the bench and cannot be reconfigured on site. Seats can be freestanding or linked with optional interlocking bracket kit. White USB outlets.

- Anodized Aluminum Leg - Add \$79 list upcharge

BRTSE2148EBODL (shown)	24 x 48 x 29	250	57	19.33	1	\$3125	7	\$4088
					2	\$3266	8	\$4422
					3	\$3372	9	\$4678
					4	\$3536	10	\$4964
					5	\$3767	11	\$5553
					6	\$3878	12	\$6181

BRTSE2148EBODR	24 x 48 x 29	250	57	19.33	1	\$3125	7	\$4088
					2	\$3266	8	\$4422
					3	\$3372	9	\$4678
					4	\$3536	10	\$4964
					5	\$3767	11	\$5553
					6	\$3878	12	\$6181

Fully upholstered armless lounge seat with two offset backrests and metal base. Both 21" w backrests come with embedded dual USB port in its side. Note: The side mounted power/USB outlets always point to the center of the seat. Each USB outlet offers 2 amps. AC/DC transformer plugs into the wall or floor monument (approx. 52" long cable available from the bottom of the seat). Transformer power consumption: 0.68 amps. Specify either left or right backrest configuration. Backrests are permanently secured to the bench and cannot be reconfigured on site. Seats can be freestanding or linked with optional interlocking bracket kit. White USB outlets.

- Anodized Aluminum Leg - Add \$79 list upcharge

BRTSE2124EBL	24 x 24 x 29	250	46.10	19.33	1	\$1638	7	\$2183
					2	\$1719	8	\$2370
					3	\$1782	9	\$2514
					4	\$1872	10	\$2676
					5	\$2002	11	\$3008
					6	\$2066	12	\$3360

BRTSE2124EBR (shown)	24 x 24 x 29	250	46.10	19.33	1	\$1638	7	\$2183
					2	\$1719	8	\$2370
					3	\$1782	9	\$2514
					4	\$1872	10	\$2676
					5	\$2002	11	\$3008
					6	\$2066	12	\$3360

Fully upholstered armless lounge seat with one backrest and metal base. 21" w backrest comes with embedded dual USB port in its side. Note: Each USB outlet offers 2 amps. AC/DC transformer plugs into the wall or floor monument (approx. 52" long cable available from the bottom of the seat). Transformer power consumption: 0.68 amps. Specify either left or right. Backrests are permanently secured to the bench and cannot be reconfigured on site. Seats can be freestanding or linked with optional interlocking bracket kit. White USB outlets.

- Anodized Aluminum Leg - Add \$79 list upcharge

Required Specifications

Fabric
Metal Finish (legs)

Optional Specifications

Anodized Aluminum Leg

COLLABORATIVE SEATING

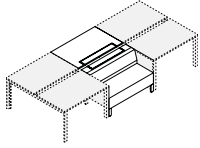

Integrated Lounge Seat, Single-Sided

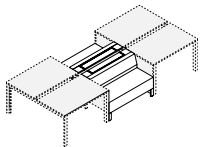

Integrated Lounge Seat, Double-Sided

MODEL#	DIMENSIONS	FREIGHT CLASS	WT./LBS.	CUBIC FT.	GRADE	LIST	GRADE	LIST		
BRTSINT60S	24 x 60 x 29	125	155	24.17						
					D x W x H					
					1	\$5639	7	\$6699		
					2	\$5776	8	\$7074		
					3	\$5896	9	\$7365		
					4	\$6081	10	\$7686		
BRTSINT48S	24 x 48 x 29	100	182	19.33						
					1	\$5395	7	\$6238		
					2	\$5519	8	\$6530		
					3	\$5615	9	\$6757		
					4	\$5759	10	\$7006		
					5	\$5961	11	\$7522		
					6	\$6464	12	\$9055		

Fully upholstered armless lounge seat with full width backrest and metal legs integrated into Bridges 62.5" d back-to-back linear table assembly. The single-sided kit consists of 24" x 48" or 24" x 60" seat, full width back, three-sided below worksurface enclosure, 6" d worksurface module with access door, 30" x 48" or 30" x 60" w worksurface with access door and supporting hardware. The seat module accommodates continuation of power and data distribution services below worksurfaces (specify Below Worksurface Power Trough and power components separately). The 6" d worksurface module with access door provides access to Below Worksurface Power Trough. Backrests are permanently secured to the bench and cannot be reconfigured on site. Tables not included.

• **Only compatible with back-to-back 30" d worksurfaces (62.5" total depth) supported by Bridges rectangular legs.** Not compatible with round legs, 24" d worksurfaces; not compatible with single line table assemblies 24" and 30" d. The kit cannot be used at the end of a table run, nor can it be used as a standalone, freestanding configuration. It must always be supported by back-to-back table assemblies on either side

- Anodized Aluminum Leg - Add **\$79!** list upcharge
- High pressure laminate - Add **\$284** list upcharge

BRTSINT60D	24 x 60 x 29	125	155	24.17				
					1	\$7320	7	\$8404
					2	\$7478	8	\$8778
					3	\$7601	9	\$9066
					4	\$7784	10	\$9388
					5	\$8043	11	\$10052
BRTSINT48D	24 x 48 x 29	100	182	19.33				
					1	\$6548	7	\$7390
					2	\$6671	8	\$7682
					3	\$6767	9	\$7907
					4	\$6910	10	\$8158
					5	\$7114	11	\$8674
					6	\$7209	12	\$9223

Fully upholstered armless lounge bench with full backrests and metal legs integrated into Bridges 62.5" d back-to-back linear table assembly. The double-sided kit consists of two 24" x 48" or 24" x 60" seats, full width backs, three-sided below worksurface enclosures, 6" d worksurface modules with access doors and supporting hardware. The seat module accommodates continuation of power and data distribution services below worksurfaces (specify Below Worksurface Power Trough and power components separately). The 6" d worksurface module with access door provides access to Below Worksurface Power Trough. Backrests are permanently secured to the bench and cannot be reconfigured on site. Tables not included.

• **Only compatible with back-to-back 30" d worksurfaces (62.5" total depth) supported by Bridges rectangular legs.** Not compatible with round legs, 24" d worksurfaces; not compatible with single line table assemblies 24" and 30" d. The kit cannot be used at the end of a table run, nor can it be used as a standalone, freestanding configuration. It must always be supported by back-to-back table assemblies on either side.

- Anodized Aluminum Leg - Add **\$79** list upcharge
- High pressure laminate - Add **\$284** list upcharge

Required Specifications

Fabric
Laminate finish (enclosure)
Edge finish (enclosure)
Metal finish (legs)

Optional Specifications

Anodized Aluminum Leg
HP laminate (enclosure)

SEATING PARTITIONS

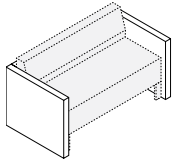

Seat Partitions

MODEL#	DIMENSIONS D x W x H	FREIGHT CLASS	WT./LBS.	CUBIC FT.	LIST PRICE
BRTPP2448L1	28.7 x 53 x 25	300	41	22.01	\$2068
BRTPP2424L1	28.7 x 29 x 25	250	32	12.04	\$1547

Fully upholstered 2.5" thick, 3-part, low level partition kit wraps around 24" or 48" bridges seat. The seat front is recessed by 2.5". The kit is secured to seats on-site (brackets connecting seat legs to the inner side of the partition are included). Upholstered kits consist of 2" hollow core boards, 1/4" foam, fabric, levelers and connecting hardware. Note: Seats and backrests are not included.

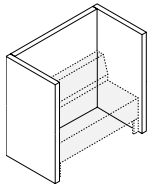

Seat Privacy Partitions

BRTPP2448L2	28.7 x 53 x 50	400	41	44.01	\$2996
BRTPP2424L2	28.7 x 29 x 50	300	32	24.08	\$2342

Fully upholstered 2.5" thick, 3-part, two tier partition kit wraps around 24" or 48" bridges seat. The 50"h assembly provides seated visual privacy. 2.5" thick upholstered partitions improve acoustic privacy for focused time away from the team or for a quiet phone call. Recessed seat extends the partition at the front by 2.5" for enhanced sense of privacy. The kit is secured to seats on-site (brackets connecting seat legs to the inner side of the partition are included). Upholstered kits consist of 2" hollow core boards, 1/4" foam, fabric, levelers and connecting hardware. Note: Seats and backrests are not included.

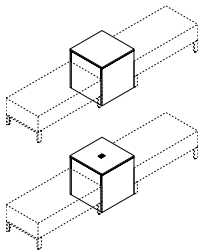

Square Table Block*

BRTS2424B	24 x 24 x 25	250	32	12.04	\$660	\$96
BRTS2424BP	24 x 24 x 25	125	59.30	8.33	\$1312	\$96

Freestanding 24" square table block serves as a visual anchor whenever a bridges seat needs to turn a corner or split into 2, 3 or 4 directions. BRTS2424BP can be positioned directly over a floor monument, which will supply power to the top-mounted power module. This option includes 24"x 24" block chassis and flush-mounted Duo power module (two outlets and two 2.1 amp USB ports, white face plate, outlets and bezel, 72" long three prong black cord). The square table block can function as a self-supporting, freestanding unit or it can be secured permanently to adjacent bridges seats with optional interconnecting brackets listed below. 2 Square Table Ganging Bracket Kits included.

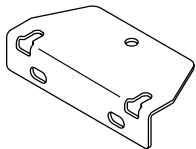

Square Table Block Ganging Bracket Kit

BRTSTBG	2.4 x 5 x 1.1	70	.05	.01	\$51	n/a
---------	---------------	----	-----	-----	-------------	-----

Two square table block ganging brackets connect seat legs permanently to the side of the 24" square table block on site. The kit employs machine screws connecting legs to seats, and ships with wood screws which provide permanent connection to the square table block. Includes 2 brackets and screws. Black powdercoat finish.

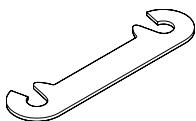

Ganging Bracket Kit

BRTSTSB	1.3 x 6 x .1	70	.03	.01	\$23	n/a
---------	--------------	----	-----	-----	-------------	-----

Two ganging brackets connect seat temporarily to adjacent in-line seat or 24"d bridges storage. Black powdercoat finish.

Required Specifications

Fabric
Laminate finish (enclosure)
Edge finish (enclosure)
Metal finish (legs)

Optional Specifications

Anodized Aluminum Leg
HP laminate (enclosure)

COLLABORATIVE SEATING

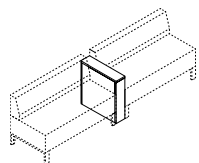
**Inline 6" Block**

BRTS2406B

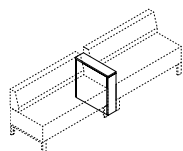

Inline table - no power module or swivel arm

MODEL#	DIMENSIONS D x W x H	FREIGHT CLASS	WT/LBS.	CUBIC FT.	LIST PRICE	HP ADD
BRTS2406B	24 x 6 x 25	92.5	21	2.08	\$566	\$51
BRTS2406BP	24 x 6 x 25	92.5	23.30	2.08	\$1219	\$51
BRTS2406B2P	24 x 6 x 25	92.5	24.30	2.08	\$1873	\$51
BRTS2406BT	24 x 6 x 25	85	25.60	2.08	\$1080	\$51
BRTS2406BPT	24 x 6 x 25	92.5	24.30	2.08	\$1733	\$51

Multifunctional inline 6" table block divides seating areas, serves as a utility surface, can support tablet arms, lamps, and double as a power delivery center. It is permanently secured between two Bridges seats and cannot be placed at the end of a run. Two Square Table Block Ganging Brackets (BRTSTBG) connect seat legs permanently to the side for the in-line table block on site. The included kit employs machine screws connecting legs to seats and ships with wood screws, which provide permanent connection to the in-line 6" block. Black powdercoat finish. The chassis is available without power module, with one power module or with two vertically embedded power modules. Vertical panel flush-mounted Duo module provides two outlets and two 2.1 amp USB ports; 72" cord exits through the bottom and plugs into a floor monument under seats, white face plate and bezel. 2 Square Table Ganging Bracket Kits included.

- BRTS2406BT and BRTS2406BPT include 9.5" x 14.5" swivel tablet. If top is specified in high pressure laminate, tablet will also be manufactured in high pressure laminate.

BRTS2406BP

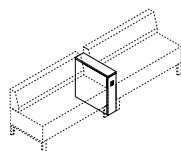

Inline table w/front power module

BRTS2406B2P

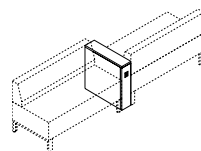

Inline table w/front and rear power module

BRTS2406BT

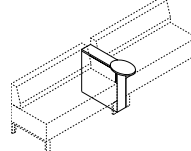

Inline table w/swivel tablet arm

BRTS2406BPT

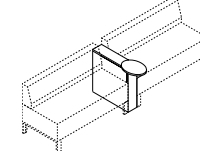

Inline table w/front power module and swivel tablet arm

Required Specifications

Top finish
Edge finish
Chassis/Accent finish
Fabric

Optional Specifications

HP laminate (top only)



Divide is a modular desk-mounted panel system that can be retro installed on many Global Desks. The panels can be vertically stacked to provide varying degrees of privacy. The panels are available in laminate or fabric tackboards as well as glazed panels that allow light to pass through. Divide is offered in many laminate and fabric color options to complement any office environment.

Features and Benefits

- Available as fabric, glazed or laminate partitioning panels in an array of heights and widths
- Easy to specify: choose the desired panel height and width and its corresponding height divide post(s)
- Laminate panels offer an optional wire access cutout at the bottom of each panel (order as SCP2)
- Laminate transaction tops are offered in various shapes and sizes, and are standard as either 1" thick or 1.5" thick to match
- All Adaptabilities, Genoa, and Zira laminate colors are offered as well as a wide variety of fabrics



GENERAL INFORMATION

- Divide is a desk mounted panel system that can be field installed at any time on many Global desks
- Vertical stacking of varying heights provides semi-private to private work areas
- Designed for use on the Adaptabilities, Genoa, and Zira laminate desk series', and may be retrofitted onto non-Global square edged product if necessary.
- Panels are available in 12", 18", 24" and 36" heights and can be stacked to produce heights of 24", 30", 36" and 42" for a virtually limitless variety of configurations
- Progressive, desk mounted partition system consisting of three major categories:
 - Divide posts - to support the partitions
 - Partitioning screens - a variety of widths and heights to create personalized privacy; offered in laminate, glaze or select fabrics
 - Transaction tops - laminate tops ideal for creating reception stations
- For environmental certifications, please visit globalfurnituregroup.com
- Model numbers reflect total width of panel and posts

DIVIDE POSTS

- Available in 6 standard heights:
 - 12" high - to create **semi-private** spaces and to support Transaction Tops
 - 18" high - to create **semi-private** spaces and to support Transaction Tops
 - 24" high - to create **semi-private** spaces
 - 30" high - to create **semi-private** spaces
 - 36" high - to create **private** spaces and to match the height of 36" high hutches and/or 65" high Adaptabilities, Genoa and Zira cabinets
 - 42" high - to create **private** spaces and to match the height of 42" high hutches and/or 72" high Zira cabinets
- Posts are field installed. Each plate divider includes: 1 post mounting plate, 1 threaded rod, 3 cover strips and 1 top cap plus mounting hardware (contains 8 screws, 1 washer, 1 locking nut). 2 divide posts are required per partitioning panel.
- Available in Black (**BLK**) or Tungsten (**TUN**) finish, please specify.

PARTITIONING SCREENS

- Available in 4 standard heights: 12", 18", 24" and 36" and can be used in combinations to create systems consisting of 12", 18", 24", 30", 36" and 42" heights.
- Available in 3 materials:
 - **Laminate:** available in all laminate colors used on Adaptabilities, Genoa and Zira (see right). Accent edging at top and bottom is Black (**BLK**) only. Optional wire access scoop cut-out is offered, centered at the bottom of the panel - order as **SCP2** after model #. Woodgrain direction is horizontal for all sizes.
 - **Glazed:** choice of **ribbed** or **frosted** glazing. Frosted material is 3mm thick Acrylic P95; Ribbed material is 10mm thick multiwall UV protected polycarbonate. Top and bottom rail are optional in Black (**BLK**) or Tungsten (**TUN**) finish, please specify. Top rail is designed to accommodate off-desk accessories. Glazed panels are also available with 4" raised bottom for pass-through option.
 - **Fabric:** available in all Grade 1, 2, 3 and 4 panel fabrics and select seating fabrics only (see right). Top and bottom rail optional in Black (**BLK**) or Tungsten (**TUN**), finish please specify. Top rail is designed to accommodate off-desk accessories.
- Filler panels are included with each Divide panel. To be used between two posts in a straight run from worksurface to worksurface.
- Special width panels are available in laminate or glazed material options only. For pricing, contact Specials.

TRANSACTION TOPS

- Tops are available in 1" or 1.5" thick thermally fused laminate
- Tops are sealed with Global's preferred edging in matching color
- Woodgrain surfaces feature edging in matching printed woodgrain
- Transaction tops are available with optional edges at no upcharge. Please specify (see right column).



A3 1" top, standard



AR 1" top, bicut edge



C3 1.5" top, standard



CR 1.5" top, bicut edge



CF 1.5" top, fluted edge

- Includes all necessary flat mounting plates and joining plates.
- Features pre-drilled locating holes to allow for quick alignment with the divide post
- Available with a radius cut on one or both ends (each radius adds a 6" overhang).
- Woodgrain surfaces feature edging with matching printed woodgrain
- Products specified with the high pressure laminate option are finished on the underside of the surface with a kraft paper backing.

LAMINATE AND EDGE FINISHES (laminate panels and transaction tops)

ACJ	Absolute Acajou	FCL	First Class
ASN	Asian Night	NBL	Noce Biondo
AWC	Avant Cherry	NGL	Noce Grigio
AWH	Avant Honey	NEL	Noce Leggero
BLK	Black	NML	Noce Medio
BZD	Blizzard	QTM	Quartered Mahogany
BRC	Brushed Cobalt	SBY	Sheer Beauty
CMB	Clear Maple	SOG	Storm Grey
CGY	Custom Grey	SDT	Stonedust
DES	Dark Espresso	WHE	Walnut Heights
DWT	Designer White	WHC	White Chocolate
FAS	Fashionista	WCR	Winter Cherry

FABRICS (fabric screens)

Fabric screens can be upholstered in the following fabrics only:

- Anchorage
- Imprint
- Lola
- Merge

D DIVIDE™ - NOTES

PLEASE NOTE:

- Divide screens cannot be centered between two back to back worksurfaces.
- Screens must be installed on one worksurface or the other.
- Divide cannot be used with Adaptabilities reception units.
- When panels are mounted on a 30" deep worksurface from Adaptabilities, Genoa or Zira, please specify 29" wide panel

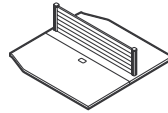

Correct Installation

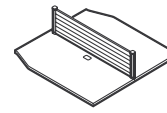

Incorrect Installation

HOW TO ORDER DIVIDE SCREENS

example: DTB 1236 GN31

DTB 12 36* AN52

Fabric Code
Width* (of worksurface to be used on)
Height (of screen)
Style Code (fabric, glazed or laminate)

*NOTE: Number denotes width of worksurface to use - please see dimensions in price book for actual dimensions of the screen.

PARTS AND COMPONENTS

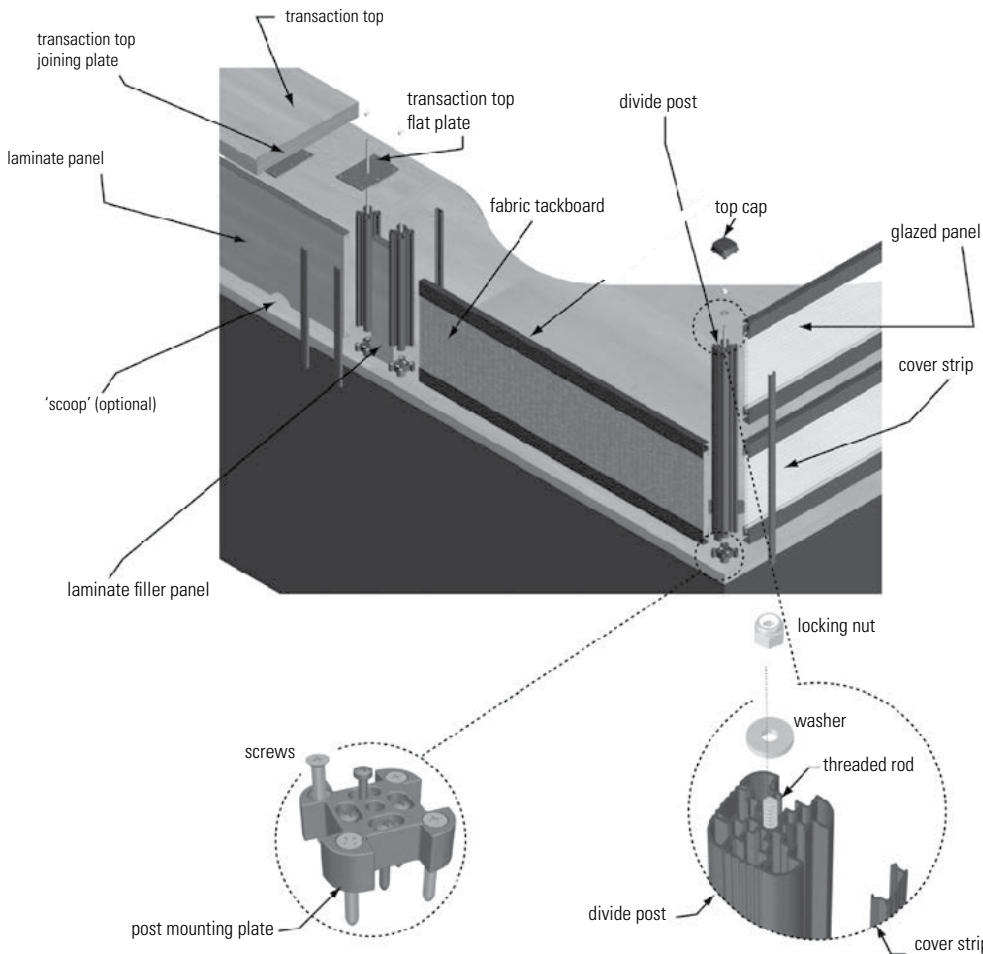

INSTALLATION IS AS SIMPLE AS 1...2...3

- 1) Attach the threaded **Post Mounting Plate** with enclosed screws to the top side of the worksurface.
- 2) **Divider Post** is bolted to the Mounting Plate.
- 3) **Top Cap** is attached to the top of the Divide Post.

12”H System

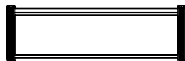

12” panel



12” raised panel

18”H System



18” panel

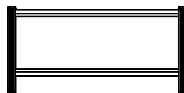

18” raised panel

24”H System

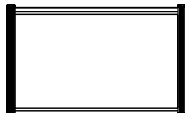

24” panel



24” raised panel

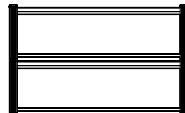

(2) 12” panels

30”H System

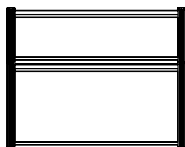

12” panel + 18” panel

36”H System

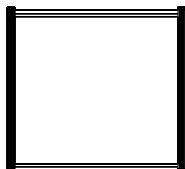

36” panel

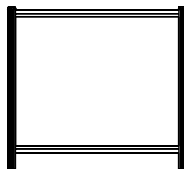

36” raised panel

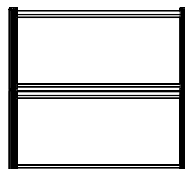

(2) 18” panels

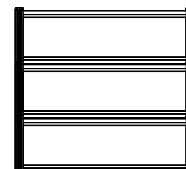

(3) 12” panels

42”H System

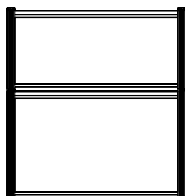

18” panel + 24” panel

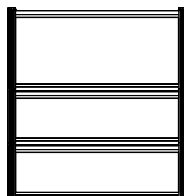

(1) 18” panel
(2) 12” panels

FABRIC PANELS

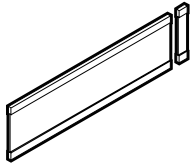

Fabric Panel - 12" High

MODEL#	DIMENSIONS	FREIGHT CLASS	WT/LBS.	CUBIC FT.	GR. 1	GR. 2	GR. 3	GR. 4	GR. 5
	D x W x H								
DTB1220	.68 x 14.8 x 12	92.5	3	.30	\$288	\$324	\$352	\$395	\$449
DTB1224	.68 x 18.9 x 12	85	4	.30	\$301	\$337	\$363	\$399	\$459
DTB1229	.68 x 24.5 x 12	92.5	4	.40	\$319	\$358	\$383	\$426	\$479
DTB1230	.68 x 24.8 x 12	85	5	.40	\$319	\$358	\$383	\$426	\$479
DTB1236	.68 x 30.8 x 12	85	5	.40	\$354	\$391	\$416	\$455	\$510
DTB1242	.68 x 36.8 x 12	85	6	.50	\$412	\$449	\$474	\$510	\$570
DTB1248	.68 x 42.8 x 12	92.5	7	.60	\$446	\$481	\$508	\$543	\$602
DTB1260	.68 x 54.8 x 12	85	9	.70	\$477	\$514	\$541	\$580	\$637
DTB1266	.68 x 60.8 x 12	85	10	.80	\$503	\$539	\$567	\$604	\$661
DTB1272	.68 x 66.8 x 12	85	11	.80	\$535	\$572	\$599	\$636	\$693

Includes matching filler panel. Ships 1 set per carton. **Specify DTB1229 for panels placed along the depth side of a 30" deep worksurface.**

- Top and bottom rail optional in Black (**BLK**) or Tungsten (**TUN**) finish, please specify.
- *Model # depicts size of worksurface to be used on - see NOTES on page 500 for additional ordering information.*
- When specifying a Grade 1, 2, 3, 4 or 5 seating fabric, please note fabric pattern will run horizontally
- Divide Post **MUST** be ordered separately. Two posts are required per panel.

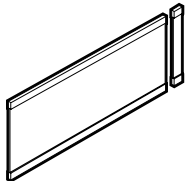

Fabric Panel - 18" High

DTB1820	.68 x 14.8 x 18	85	4	.30	\$319	\$358	\$383	\$426	\$479
DTB1824	.68 x 18.9 x 18	85	5	.40	\$335	\$370	\$397	\$432	\$491
DTB1829	.68 x 24.5 x 18	85	6	.50	\$354	\$391	\$416	\$455	\$510
DTB1830	.68 x 24.8 x 18	85	6	.50	\$354	\$391	\$416	\$455	\$510
DTB1836	.68 x 30.8 x 18	92.5	7	.60	\$412	\$449	\$474	\$510	\$570
DTB1842	.68 x 36.8 x 18	92.5	8	.70	\$450	\$486	\$511	\$547	\$604
DTB1848	.68 x 42.8 x 18	85	10	.80	\$477	\$514	\$541	\$580	\$637
DTB1860	.68 x 54.8 x 18	85	12	.90	\$503	\$539	\$567	\$604	\$661
DTB1866	.68 x 60.8 x 18	85	14	1	\$535	\$572	\$599	\$636	\$693
DTB1872	.68 x 66.8 x 18	85	14	1.10	\$599	\$636	\$663	\$702	\$759

Includes matching filler panel. Ships 1 set per carton. **Specify DTB1829 for panels placed along the depth side of a 30" deep worksurface.**

- Top and bottom rail optional in Black (**BLK**) or Tungsten (**TUN**) finish, please specify.
- *Model # depicts size of worksurface to be used on - see NOTES on page 500 for additional ordering information.*
- When specifying a Grade 1, 2, 3, 4 or 5 seating fabric, please note fabric pattern will run horizontally
- Divide Post **MUST** be ordered separately. Two posts are required per panel.

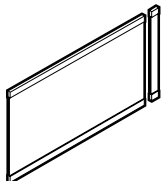

Fabric Panel - 24" High

DTB2420	.68 x 14.8 x 24	92.5	4	.40	\$354	\$391	\$416	\$455	\$510
DTB2424	.68 x 18.9 x 24	100	4	.50	\$354	\$391	\$416	\$455	\$510
DTB2429	.68 x 24.5 x 24	92.5	6	.60	\$412	\$449	\$474	\$510	\$570
DTB2430	.68 x 24.8 x 24	92.5	6	.60	\$412	\$449	\$474	\$510	\$570
DTB2436	.68 x 30.8 x 24	92.5	7	.70	\$446	\$481	\$508	\$543	\$602
DTB2442	.68 x 36.8 x 24	92.5	8	.80	\$477	\$514	\$541	\$580	\$637
DTB2448	.68 x 42.8 x 24	92.5	9	.90	\$503	\$539	\$567	\$604	\$661
DTB2460	.68 x 54.8 x 24	92.5	11	1.10	\$535	\$572	\$599	\$636	\$693
DTB2466	.68 x 60.8 x 24	92.5	12	1.20	\$599	\$636	\$663	\$702	\$759
DTB2472	.68 x 66.8 x 24	92.5	14	1.40	\$651	\$688	\$716	\$752	\$811

Includes matching filler panel. Ships 1 set per carton. **Specify DTB2429 for panels placed along the depth side of a 30" deep worksurface.**

- Top and bottom rail optional in Black (**BLK**) or Tungsten (**TUN**) finish, please specify.
- *Model # depicts size of worksurface to be used on - see NOTES on page 500 for additional ordering information.*
- When specifying a Grade 1, 2, 3, 4 or 5 seating fabric, please note fabric pattern will run horizontally
- Divide Post **MUST** be ordered separately. Two posts are required per panel.

Required Specifications

- Fabric
- Rail Finish

FABRIC PANELS

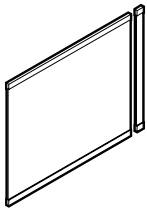

Fabric Panel - 36" High*

MODEL#	DIMENSIONS	FREIGHT CLASS	WT/LBS.	CUBIC FT.	GR.1	GR.2	GR.3	GR.4	GR.5	
D x W x H										
DTB3620	.68 x 14.8 x 36	92.5	6	.60	\$436	\$464	\$485	\$517	\$563	
DTB3624	.68 x 18.9 x 36	92.5	7	.70	\$436	\$464	\$485	\$517	\$563	
DTB3629	.68 x 24.5 x 36	92.5	9	.90	\$588	\$616	\$637	\$669	\$715	
DTB3630	.68 x 24.8 x 36	92.5	9	.90	\$588	\$616	\$637	\$669	\$715	
DTB3636	.68 x 30.8 x 36	92.5	10	1	\$664	\$693	\$715	\$747	\$792	
DTB3642	.68 x 36.8 x 36	92.5	12	1.20	\$712	\$740	\$761	\$793	\$839	
DTB3648	.68 x 42.8 x 36	92.5	14	1.30	\$830	\$858	\$879	\$911	\$957	
DTB3660	.68 x 54.8 x 36	92.5	17	1.60	\$968	\$996	\$1017	\$1049	\$1095	
DTB3666	.68 x 60.8 x 36	92.5	19	1.80	\$1078	\$1107	\$1129	\$1161	\$1206	
DTB3672	.68 x 66.8 x 36	92.5	21	1.90	\$1140	\$1168	\$1189	\$1221	\$1267	

Includes matching filler panel. Ships 1 set per carton. **Specify DTB3629 for panels placed along the depth side of a 30" deep worksurface.**

- Top and bottom rail optional in Black (BLK) or Tungsten (TUN) finish, please specify.
- Model # depicts size of worksurface to be used on - see NOTES on page 500 for additional ordering information.
- When specifying a Grade 1, 2, 3, 4 or 5 seating fabric, please note fabric pattern will run horizontally
- Divide Post **MUST** be ordered separately. Two posts are required per panel.

GLAZED PANELS

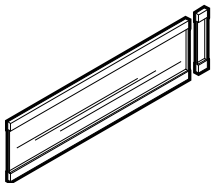

Glazed Panel - 12" High**

MODEL#	DIMENSIONS	FREIGHT CLASS	WT/LBS.	CUBIC FT.	LIST PRICE
DGP1220	.68 x 14.8 x 12	125	2	.30	\$283
DGP1224	.68 x 18.9 x 12	92.5	3	.30	\$301
DGP1229	.68 x 24.5 x 12	125	3	.40	\$357
DGP1230	.68 x 24.8 x 12	92.5	4	.40	\$357
DGP1236	.68 x 30.8 x 12	92.5	4	.40	\$415
DGP1242	.68 x 36.8 x 12	92.5	5	.50	\$471
DGP1248	.68 x 42.8 x 12	100	5	.60	\$556
DGP1260	.68 x 54.8 x 12	92.5	7	.70	\$651
DGP1266	.68 x 60.8 x 12	100	7	.80	\$712
DGP1272	.68 x 66.8 x 12	92.5	8	.80	\$770

Includes matching filler panel. Ships 1 set per carton. **Specify DGP1229 for panels placed along the depth side of a 30" deep worksurface.**

- Top and bottom rail optional in Black (BLK) or Tungsten (TUN) finish, please specify.
- Model # depicts size of worksurface to be used on - see NOTES on page 500 for additional ordering information.
- Divide Post **MUST** be ordered separately. Two posts are required per panel.
- Glazing is available in Frosted (GF) or Ribbed (RG).

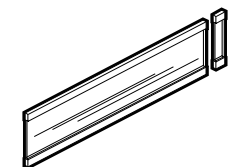

Glazed Panel - 12" High, Raised**

DRGP1220	.68 x 14.8 x 12	60	2	.02	\$252
DRGP1224	.68 x 18.9 x 12	60	3	.03	\$292
DRGP1229	.68 x 24.5 x 12	60	3	.03	\$343
DRGP1230	.68 x 24.8 x 12	60	4	.03	\$343
DRGP1236	.68 x 30.8 x 12	60	4	.04	\$402
DRGP1242	.68 x 36.8 x 12	60	5	.05	\$455
DRGP1248	.68 x 42.8 x 12	60	5	.05	\$540
DRGP1260	.68 x 54.8 x 12	60	7	.07	\$639
DRGP1266	.68 x 60.8 x 12	60	7	.07	\$698
DRGP1272	.68 x 66.8 x 12	60	8	.08	\$758

4" gap at bottom. Includes matching filler panel. Ships 1 set per carton. Raised glazed panels to be offered on the lower level only. **Specify DRGP1229 for panels placed along the depth side of a 30" deep worksurface.**

- Top and bottom rail optional in Black (BLK) or Tungsten (TUN) finish, please specify.
- Model # depicts size of worksurface to be used on - see NOTES on page 500 for additional ordering information.
- Divide Post **MUST** be ordered separately. Two posts are required per panel.
- Glazing is available in Frosted (GF) or Ribbed (RG).

Required Specifications

- Fabric*
- Glaze**
- Rail Finish

GLAZED PANELS

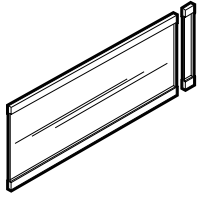

Glazed Panel - 18" High

MODEL#	DIMENSIONS D x W x H	FREIGHT CLASS	WT/LBS.	CUBIC FT.	LIST PRICE
DGP1820	.68 x 14.8 x 18	92.5	3	.30	\$316
DGP1824	.68 x 18.9 x 18	125	3	.40	\$341
DGP1829	.68 x 24.5 x 18	100	4	.50	\$399
DGP1830	.68 x 24.8 x 18	100	4	.50	\$399
DGP1836	.68 x 30.8 x 18	100	5	.60	\$461
DGP1842	.68 x 36.8 x 18	125	5	.70	\$514
DGP1848	.68 x 42.8 x 18	125	6	.80	\$616
DGP1860	.68 x 54.8 x 18	100	8	.90	\$736
DGP1866	.68 x 60.8 x 18	100	8	1	\$796
DGP1872	.68 x 66.8 x 18	100	9	1.10	\$860

Includes matching filler panel. Ships 1 set per carton. **Specify DGP1829 for panels placed along the depth side of a 30" deep worksurface.**

- Top and bottom rail optional in Black (**BLK**) or Tungsten (**TUN**) finish, please specify.
- *Model # depicts size of worksurface to be used on - see NOTES on page 500 for additional ordering information.*
- Divide Post **MUST** be ordered separately. Two posts are required per panel.
- Glazing is available in Frosted (**GF**) or Ribbed (**RG**).

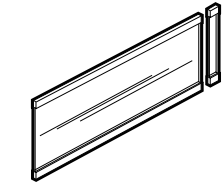

Glazed Panel - 18" High, Raised

DRGP1820	.68 x 14.8 x 18	60	3	.03	\$292
DRGP1824	.68 x 18.9 x 18	60	3	.04	\$331
DRGP1829	.68 x 24.5 x 18	60	4	.05	\$383
DRGP1830	.68 x 24.8 x 18	60	4	.05	\$383
DRGP1836	.68 x 30.8 x 18	60	5	.06	\$450
DRGP1842	.68 x 36.8 x 18	60	5	.06	\$501
DRGP1848	.68 x 42.8 x 18	60	6	.07	\$600
DRGP1860	.68 x 54.8 x 18	60	8	.09	\$717
DRGP1866	.68 x 60.8 x 18	100	8	1	\$777
DRGP1872	.68 x 66.8 x 18	100	9	1.10	\$842

4" gap at bottom. Includes matching filler panel. Ships 1 set per carton. Raised glazed panels to be offered on the lower level only. **Specify DRGP1829 for panels placed along the depth side of a 30" deep worksurface.**

- Top and bottom rail optional in Black (**BLK**) or Tungsten (**TUN**) finish, please specify.
- *Model # depicts size of worksurface to be used on - see NOTES on page 500 for additional ordering information.*
- Divide Post **MUST** be ordered separately. Two posts are required per panel.
- Glazing is available in Frosted (**GF**) or Ribbed (**RG**).

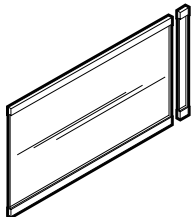

Glazed Panel - 24" High

DGP2420	.68 x 14.8 x 24	125	3	.40	\$341
DGP2424	.68 x 18.9 x 24	100	4	.50	\$382
DGP2429	.68 x 24.5 x 24	125	4	.60	\$457
DGP2430	.68 x 24.8 x 24	100	5	.60	\$457
DGP2436	.68 x 30.8 x 24	125	5	.70	\$528
DGP2442	.68 x 36.8 x 24	125	6	.80	\$599
DGP2448	.68 x 42.8 x 24	125	7	.90	\$703
DGP2460	.68 x 54.8 x 24	100	9	1.10	\$854
DGP2466	.68 x 60.8 x 24	100	10	1.20	\$931
DGP2472	.68 x 66.8 x 24	125	10	1.40	\$1002

Includes matching filler panel. Ships 1 set per carton. **Specify DGP2429 for panels placed along the depth side of a 30" deep worksurface.**

- Top and bottom rail optional in Black (**BLK**) or Tungsten (**TUN**) finish, please specify.
- *Model # depicts size of worksurface to be used on - see NOTES on page 500 for additional ordering information.*
- Divide Post **MUST** be ordered separately. Two posts are required per panel.
- Glazing is available in Frosted (**GF**) or Ribbed (**RG**).

Required Specifications

Glaze
Rail finish

GLAZED PANELS

MODEL# DIMENSIONS FREIGHT CLASS WT/LBS. CUBIC FT. LIST PRICE

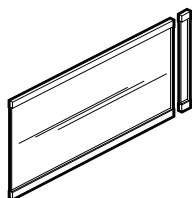

Glazed Panel - 24" High, Raised

	D x W x H				
DRGP2420	.68 x 14.8 x 24	60	3	.04	\$331
DRGP2424	.68 x 18.9 x 24	60	4	.05	\$371
DRGP2429	.68 x 24.5 x 24	60	4	.06	\$442
DRGP2430	.68 x 24.8 x 24	60	5	.06	\$442
DRGP2436	.68 x 30.8 x 24	60	5	.07	\$515
DRGP2442	.68 x 36.8 x 24	60	6	.08	\$586
DRGP2448	.68 x 42.8 x 24	60	7	.09	\$684
DRGP2460	.68 x 54.8 x 24	100	9	1.10	\$837
DRGP2466	.68 x 60.8 x 24	100	10	1.20	\$913
DRGP2472	.68 x 66.8 x 24	125	10	1.30	\$987

4" gap at bottom. Includes matching filler panel. Ships 1 set per carton. Raised glazed panels to be offered on the lower level only. **Specify DRGP2429 for panels placed along the depth side of a 30" deep worksurface.**

- Top and bottom rail optional in Black (BLK) or Tungsten (TUN) finish, please specify.
- Model # depicts size of worksurface to be used on - see NOTES on page 500 for additional ordering information.
- Divide Post **MUST** be ordered separately. Two posts are required per panel.
- Glazing is available in Frosted (GF) or Ribbed (RG).

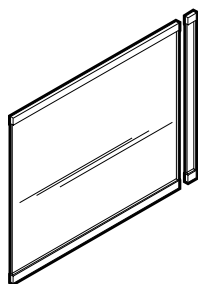

Glazed Panel - 36" High

DGP3620	.68 x 14.8 x 36	125	4	.60	\$415
DGP3624	.68 x 18.9 x 36	150	4	.70	\$457
DGP3629	.68 x 24.5 x 36	150	5	.90	\$546
DGP3630	.68 x 24.8 x 36	125	6	.90	\$546
DGP3636	.68 x 30.8 x 36	125	7	1	\$644
DGP3642	.68 x 36.8 x 36	125	8	1.20	\$736
DGP3648	.68 x 42.8 x 36	125	9	1.30	\$860
DGP3660	.68 x 54.8 x 36	125	11	1.60	\$1038
DGP3666	.68 x 60.8 x 36	125	12	1.80	\$1130
DGP3672	.68 x 66.8 x 36	125	13	1.90	\$1220

Includes matching filler panel. Ships 1 set per carton. **Specify DGP3629 for panels placed along the depth side of a 30" deep worksurface.**

- Top and bottom rail optional in Black (BLK) or Tungsten (TUN) finish, please specify.
- Model # depicts size of worksurface to be used on - see NOTES on page 500 for additional ordering information.
- Divide Post **MUST** be ordered separately. Two posts are required per panel.
- Glazing is available in Frosted (GF) or Ribbed (RG).

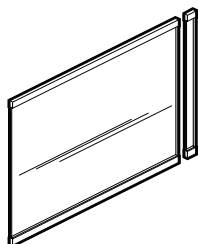

Glazed Panel - 36" High, Raised

DRGP3620	.68 x 14.8 x 36	60	4	.06	\$402
DRGP3624	.68 x 18.9 x 36	60	4	.07	\$442
DRGP3629	.68 x 24.5 x 36	60	5	.08	\$534
DRGP3630	.68 x 24.8 x 36	60	6	.08	\$534
DRGP3636	.68 x 30.8 x 36	125	7	1	\$632
DRGP3642	.68 x 36.8 x 36	125	8	1.10	\$717
DRGP3648	.68 x 42.8 x 36	125	9	1.30	\$842
DRGP3660	.68 x 54.8 x 36	125	11	1.60	\$1012
DRGP3666	.68 x 60.8 x 36	125	12	1.70	\$1104
DRGP3672	.68 x 66.8 x 36	125	13	1.90	\$1195

4" gap at bottom. Includes matching filler panel. Ships 1 set per carton. Raised glazed panels to be offered on the lower level only. **Specify DRGP3629 for panels placed along the depth side of a 30" deep worksurface.**

- Top and bottom rail optional in Black (BLK) or Tungsten (TUN) finish, please specify.
- Model # depicts size of worksurface to be used on - see NOTES on page 500 for additional ordering information.
- Divide Post **MUST** be ordered separately. Two posts are required per panel.
- Glazing is available in Frosted (GF) or Ribbed (RG).

Required Specifications

Glaze
Rail finish

LAMINATE PANELS

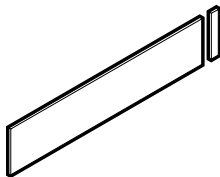

Laminate Panel - 12" High

MODEL#	DIMENSIONS D x W x H	FREIGHT CLASS	WT/LBS.	CUBIC FT.	LIST PRICE
DLP1220	.68 x 14.8 x 12	70	5	.30	\$94
DLP1224	.68 x 18.9 x 12	70	5	.30	\$111
DLP1229	.68 x 24.5 x 12	70	7	.40	\$140
DLP1230	.68 x 24.8 x 12	70	7	.40	\$140
DLP1236	.68 x 30.8 x 12	70	8	.40	\$154
DLP1242	.68 x 36.8 x 12	70	10	.50	\$175
DLP1248	.68 x 42.8 x 12	70	11	.60	\$196
DLP1260	.68 x 54.8 x 12	70	14	.70	\$212
DLP1266	.68 x 60.8 x 12	70	16	.80	\$234
DLP1272	.68 x 66.8 x 12	70	17	.80	\$264

Includes matching filler panel. Scoop option (SCP2) available, Add \$42. Ships 1 set per carton. **Specify DLP1229 for panels placed along the depth side of a 30" deep worksurface.**

- Model # depicts size of worksurface to be used on - see NOTES on page 500 for additional ordering information.
- Divide Post **MUST** be ordered separately. Two posts are required per panel.
- Accent edging at top and bottom Black (BLK) only.

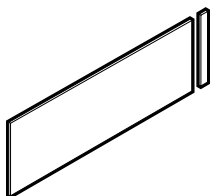

Laminate Panel - 18" High

DLP1820	.68 x 14.8 x 18	65	7	.30	\$113
DLP1824	.68 x 18.9 x 18	70	8	.40	\$128
DLP1829	.68 x 24.5 x 18	70	10	.50	\$152
DLP1830	.68 x 24.8 x 18	70	10	.50	\$152
DLP1836	.68 x 30.8 x 18	70	12	.60	\$172
DLP1842	.68 x 36.8 x 18	70	15	.70	\$196
DLP1848	.68 x 42.8 x 18	70	17	.80	\$227
DLP1860	.68 x 54.8 x 18	65	21	.90	\$249
DLP1866	.68 x 60.8 x 18	65	23	1	\$273
DLP1872	.68 x 66.8 x 18	65	25	1.10	\$301

Includes matching filler panel. Scoop option (SCP2) available, Add \$42. Ships 1 set per carton. **Specify DLP1829 for panels placed along the depth side of a 30" deep worksurface.**

- Model # depicts size of worksurface to be used on - see NOTES on page 500 for additional ordering information.
- Divide Post **MUST** be ordered separately. Two posts are required per panel.
- Accent edging at top and bottom Black (BLK) only.

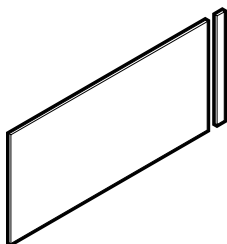

Laminate Panel - 24" High

DLP2420	.68 x 14.8 x 24	65	9	.40	\$128
DLP2424	.68 x 18.9 x 24	70	11	.50	\$139
DLP2429	.68 x 24.5 x 24	70	13	.60	\$172
DLP2430	.68 x 24.8 x 24	70	13	.60	\$172
DLP2436	.68 x 30.8 x 24	65	16	.70	\$190
DLP2442	.68 x 36.8 x 24	65	19	.80	\$221
DLP2448	.68 x 42.8 x 24	65	22	.90	\$252
DLP2460	.68 x 54.8 x 24	65	28	1.10	\$283
DLP2466	.68 x 60.8 x 24	65	30	1.20	\$315
DLP2472	.68 x 66.8 x 24	65	33	1.40	\$344

Includes matching filler panel. Scoop option (SCP2) available, Add \$42. Ships 1 set per carton. **Specify DLP2429 for panels placed along the depth side of a 30" deep worksurface.**

- Model # depicts size of worksurface to be used on - see NOTES on page 500 for additional ordering information.
- Divide Post **MUST** be ordered separately. Two posts are required per panel.
- Accent edging at top and bottom Black (BLK) only.

Required Specifications

Laminate finish. Note: woodgrain finishes are horizontal on all sizes.

LAMINATE PANELS

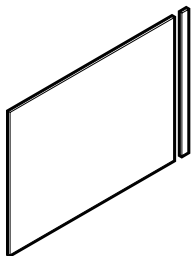

Laminate Panel - 36" High*

MODEL#	DIMENSIONS	FREIGHT CLASS	WT/LBS.	CUBIC FT.	LIST PRICE
--------	------------	---------------	---------	-----------	------------

D x W x H					
DLP3620	.68 x 14.8 x 36	70	13	.60	\$156
DLP3624	.68 x 18.9 x 36	65	16	.70	\$172
DLP3629	.68 x 24.5 x 36	70	20	.90	\$210
DLP3630	.68 x 24.8 x 36	70	20	.90	\$210
DLP3636	.68 x 30.8 x 36	65	24	1	\$242
DLP3642	.68 x 36.8 x 36	65	28	1.20	\$280
DLP3648	.68 x 42.8 x 36	65	33	1.30	\$315
DLP3660	.68 x 54.8 x 36	65	41	1.60	\$362
DLP3666	.68 x 60.8 x 36	65	45	1.80	\$399
DLP3672	.68 x 66.8 x 36	65	50	1.90	\$438

Includes matching filler panel. Scoop option (**SCP2**) available, **Add \$42**. Ships 1 set per carton. **Specify DLP3629 for panels placed along the depth side of a 30" deep worksurface.**

- Model # depicts size of worksurface to be used on - see *NOTES* on page 500 for additional ordering information.
- Divide Post **MUST** be ordered separately. Two posts are required per panel.
- Accent edging at top and bottom Black (**BLK**) only.

DIVIDE POSTS



Divide Post

MODEL#	DIMENSIONS	FREIGHT CLASS	WT/LBS.	CUBIC FT.	LIST PRICE
--------	------------	---------------	---------	-----------	------------

DPOST12	1.68 x 1.68 x 12	70	2	.10	\$129
DPOST18	1.68 x 1.68 x 18	70	2	.10	\$175
DPOST24	1.68 x 1.68 x 24	60	3	.10	\$228
DPOST30	1.68 x 1.68 x 30	60	4	.10	\$316
DPOST36	1.68 x 1.68 x 36	70	4	.20	\$362
DPOST42	1.68 x 1.68 x 42	65	5	.20	\$402

For supporting panels. Includes one post mounting plate, one top cap, three cover strips, threaded rod and all mounting hardware. Installation templates are supplied with each project. Available in Black (**BLK**) or Tungsten (**TUN**), please specify.

- Requires 2 divide posts per panel
- Divide post is mounted 1.063" from worksurface edge.



Post-to-Wall Filler Strip

DFS12	1.43 x .75 x 12	150	2	.50	\$72
DFS18	1.43 x .75 x 18	150	2	.50	\$72
DFS24	1.43 x .75 x 24	150	2	.50	\$72
DFS30	1.43 x .75 x 30	150	2	.50	\$76
DFS36	1.43 x .75 x 36	150	2	.50	\$76
DFS42	1.43 x .75 x 42	150	3	.60	\$76

Used to fill gap between divide post and an adjacent wall, wardrobe unit, or hutch. Ships 1 per carton. Black only.

Required Specifications

Laminate finish*. Note: woodgrain finishes are horizontal on all sizes.

TRANSACTION TOPS

D x W x H

- To order a radius end on one side of a transaction top, add the suffix "D" to the model number (ex. DATT30D). Add a **15% upcharge**.
- To order a radius end on both sides of a transaction top, add the suffix "DD" to the model number (ex. DATT30DD). Add a **20% upcharge**.
- Each radius end adds a 6" overhang per side (see illustrations below).

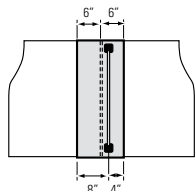

Transaction top is offset 6" from edge of worksurface in both directions.

Transaction top is offset 4" from the center of divider post towards the inside and 8" towards the outside.

Transaction Top Offset

- 4" from the center of the Divider Post to the inside of worksurface
- 8" from the center of the Divider Post to the outside of worksurface

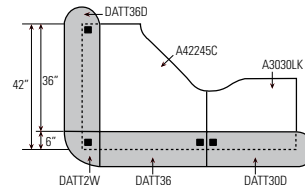

Two Way Connector Transaction Top (DATT2W/DCTT2W)

Use with a corner worksurface to link transaction tops together.

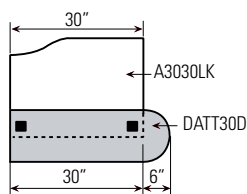

Radius End Transaction Top - one side

Add suffix "D" to model number for radius end on one side.

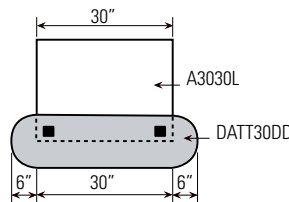

Radius End Transaction Top - two sides

Add suffix "DD" to model number for radius end on both sides.

STRAIGHT TRANSACTION TOPS

MODEL# DIMENSIONS FREIGHT CLASS WT./LBS. CUBIC FT. LIST PRICE

DATT14	12 x 14 x 1	65	7	.30	\$282
DATT18	12 x 18 x 1	70	8	.40	\$282
DATT20	12 x 20 x 1	70	9	.50	\$282
DATT23	12 x 23 x 1	70	10	.50	\$320
DATT24	12 x 24 x 1	70	10	.50	\$320
DATT29	12 x 29 x 1	70	12	.60	\$342
DATT30	12 x 30 x 1	70	12	.60	\$342
DATT36	12 x 36 x 1	70	14	.70	\$362
DATT42	12 x 42 x 1	70	16	.80	\$382
DATT48	12 x 48 x 1	70	18	.90	\$382
DATT54	12 x 54 x 1	70	21	1	\$431
DATT60	12 x 60 x 1	70	23	1.10	\$431
DATT66	12 x 66 x 1	70	25	1.20	\$481
DATT72	12 x 72 x 1	70	27	1.30	\$481



Straight Transaction Top - 1" thick

12" deep x 1" thick top. Includes all necessary Flat Plates, Joining Plates and screws. Thickness matches Adaptabilities, Genoa, Halton and Zira Series worksurfaces. Ships 1 set per carton.

- Add "D" to model number for radius end on one side, ADD **15% upcharge**.
- Add "DD" to model number for radius end on both sides, ADD **20% upcharge**.
- Each radius adds 6" overhang per side.

Required Specifications

Laminate Finish
Edge Detail

Optional Specifications

Radius End

TRANSACTION TOPS

MODEL# DIMENSIONS FREIGHT CLASS WT/LBS. CUBIC FT. LIST PRICE

D x W x H

DCTT14	12 x 14 x 1.5	60	9	.30	\$391
DCTT18	12 x 18 x 1.5	65	11	.40	\$391
DCTT20	12 x 14.8 x 1.5	65	12	.50	\$391
DCTT23	12 x 23 x 1.5	65	14	.50	\$454
DCTT24	12 x 18.9 x 1.5	65	14	.50	\$454
DCTT29	12 x 24.5 x 1.5	65	17	.60	\$483
DCTT30	12 x 30 x 1.5	65	17	.60	\$483
DCTT36	12 x 36 x 1.5	65	20	.70	\$506
DCTT42	12 x 42 x 1.5	65	23	.80	\$506
DCTT48	12 x 48 x 1.5	65	26	.90	\$506
DCTT54	12 x 54 x 1.5	65	29	1	\$576
DCTT60	12 x 60 x 1.5	65	32	1.10	\$576
DCTT66	12 x 66 x 1.5	65	35	1.20	\$630
DCTT72	12 x 72 x 1.5	65	38	1.30	\$630

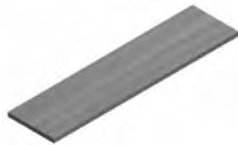

Straight Transaction Top - 1½" thick

12" deep x 1½" thick top. Includes all necessary Flat Plates, Joining Plates and screws. Thickness matches Zira worksurfaces. Ships 1 set per carton.

- Add "D" to model number for radius end on one side, ADD **15% upcharge**.
- Add "DD" to model number for radius end on both sides, ADD **20% upcharge**.
- Each radius adds 6" overhang per side.

GALLERY CORNER TRANSACTION TOPS

MODEL# DIMENSIONS FREIGHT CLASS WT/LBS. CUBIC FT. LIST PRICE

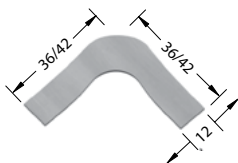

Gallery Corner Transaction Top - 1" thick

DA1GC36	36 x 36 x 1	125	32	5	\$859
DA1GC42	42 x 42 x 1	150	38	6.50	\$859

One piece corner top to be used on 36" and 42" 5-sided corners. Cut-out maximizes use of worksurface space allowing for computer screen. Includes all necessary Flat Plates, Joining Plates and screws. Thickness matches Adaptabilities, Genoa, Halton and Zira Series worksurfaces. Ships 1 set per carton.

- Woodgrain runs in one direction.

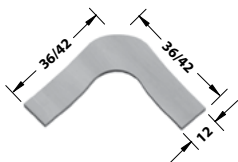

Gallery Corner Transaction Top - 1½" thick

DC1GC36	36 x 36 x 1.5	100	43	5	\$1069
DC1GC42	42 x 42 x 1.5	125	50	6.50	\$1069

One piece corner top to be used on 36" and 42" 5-sided corners. Cut-out maximizes use of worksurface space allowing for computer screen. Includes all necessary Flat Plates, Joining Plates and screws. Thickness matches Zira worksurfaces. Ships 1 set per carton.

- Woodgrain runs in one direction.

2 PIECE GALLERY CORNER TRANSACTION TOPS

MODEL# DIMENSIONS FREIGHT CLASS WT/LBS. CUBIC FT. LIST PRICE



2 Piece Gallery Corner Transaction Top - 1" thick

DA2GC36	36 x 36 x 1	70	29	1.90	\$610
DA2GC42	42 x 42 x 1	70	33	1.90	\$610

Two piece corner top to be used on 36" and 42" 5-sided corners. Cut-out maximizes use of worksurface space allowing for computer screen. Includes all necessary Flat Plates, Joining Plates and screws. Thickness matches Adaptabilities, Genoa, Halton and Zira Series worksurfaces. Ships 1 set per carton.

- Woodgrain runs in two directions.

Required Specifications

Laminate Finish
Edge Detail

Optional Specifications

Radius End (DCTT models)

2 PIECE GALLERY CORNER TRANSACTION TOPS



**2 Piece Gallery Corner
Transaction Top - 1½" thick**

MODEL#	DIMENSIONS	FREIGHT CLASS	WT/LBS.	CUBIC FT.	LIST PRICE
	D x W x H				
DC2GC36	36 x 36 x 1.5	70	39	1.90	\$818
DC2GC42	42 x 42 x 1.5	65	45	1.90	\$818

Two piece corner top to be used on 36" and 42" 5-sided corners. Cut-out maximizes use of worksurface space allowing for computer screen. Includes all necessary Flat Plates, Joining Plates and screws. Thickness matches Zira worksurfaces. Ships 1 set per carton.

- Woodgrain runs in two directions.

2-WAY CONNECTOR TRANSACTION TOPS



**2-Way Connector
Transaction Top - 1" thick**

MODEL#	DIMENSIONS	FREIGHT CLASS	WT/LBS.	CUBIC FT.	LIST PRICE
DATT2W	12 x 12 x 1	70	6	.30	\$385

Used as a corner piece to link two transaction tops. Deduct 6" from each side adjoining the corner piece. Includes all necessary Flat Plates, Joining Plates and screws. Thickness matches Adaptabilities, Genoa, Halton and Zira Series worksurfaces. Ships 1 set per carton.

- Woodgrain runs diagonally.

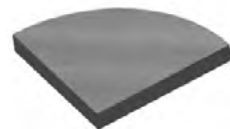

**2-Way Connector
Transaction Top - 1½" thick**

DCTT2W	12 x 12 x 1.5	65	7	.30	\$450
--------	---------------	----	---	-----	--------------

Used as a corner piece to link two transaction tops. Deduct 6" from each side adjoining the corner piece. Includes all necessary Flat Plates, Joining Plates and screws. Thickness matches Zira worksurfaces. Ships 1 set per carton.

- Woodgrain runs diagonally.

4-WAY CONNECTOR TRANSACTION TOPS

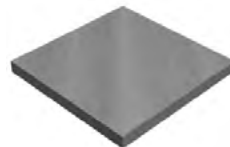

**4-Way Connector
Transaction Top - 1" thick**

DATT4W	12 x 12 x 1	65	8	.30	\$411
--------	-------------	----	---	-----	--------------

Used as a corner piece to link four transaction tops. Deduct 6" from each side adjoining the corner piece. Includes all necessary Flat Plates, Joining Plates and screws. Thickness matches Adaptabilities, Genoa, Halton and Zira Series worksurfaces. Ships 1 set per carton.

- Woodgrain runs diagonally.

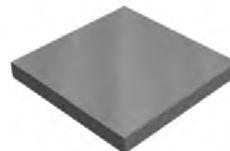

**4-Way Connector
Transaction Top - 1½" thick**

DCTT4W	12 x 12 x 1.5	60	10	.30	\$527
--------	---------------	----	----	-----	--------------

Used as a corner piece to link four transaction tops. Deduct 6" from each side adjoining the corner piece. Includes all necessary Flat Plates, Joining Plates and screws. Thickness matches Zira worksurfaces. Ships 1 set per carton.

- Woodgrain runs diagonally.

Required Specifications

- Laminate Finish
- Edge Detail

personal storage



Sidebar Storage

510

S SIDEBAR STORAGE - NOTES



Sidebar storage is well suited to the modern workplace. Fun, unique and functional storage items provide personal touches to the workspace all while maintaining a practical appeal.

Features and Benefits

- All surfaces are 1" thick, constructed of 45 lb. density particle board covered on both sides with high performance thermally fused laminate.
- Surfaces available in four detail options.
- Tapered feet feature adjustable glides and can be painted in Black (BLK) or Tungsten (TTU).
- Tiered storage enhances the visuals of any office setting



Foot options



Stack-on storage



Low credenza storage with cushion

GENERAL INFORMATION

- SideBar is a great complement to Bungee & Bungee SL training tables as well as Zira Desking.
- High pressure tops are available on all SideBar laminates at an extended lead time – please refer to model # for availability and pricing.
- For environmental certifications, please visit globalfurnituregroup.com

CONSTRUCTION

- Tops are 1" thick thermally fused laminate (**TFL**) or optional 1-1/16" thick high pressure laminate (**HPL**) available in a variety of edge details
- All finishes feature edging in matching color (i.e. woodgrain surfaces feature edging with matching printed woodgrain)
- Constructed of 45 lb. density particleboard covered on both sides with high performance thermally fused laminate (**TFL**) or high pressure laminate surfaces (**HPL**)
- Leveling glides are standard on all floor units
- Premium full extension progressive ball bearing slides on file drawers and box drawers
- All drawer fronts are edge banded on all four sides
- Products specified with the high pressure laminate option (**HPL**) are finished on the underside of the surface with a kraft paper backing.

STORAGE

- Tops of all storage units are 1" thick, available in a variety of edge details
- Drawer and open cavity heights are built on a common module of 13.5". In open cavities, this height accommodates standard size binders.
- All lateral files feature a foolproof interlock device
- 75 lb. box – 150 lb. file drawer weight capacity with full height sides. Pencil tray included in box drawer.
- All storage is standard with handles unless otherwise noted
- All drawers are locking unless otherwise noted
- All shelves are fixed

FEET

- Levelers adjust up to 1".
- Storage unit feet will coordinate with handle finish (brass handles will default to Black [BLK] feet).
- If no handle selection is available, legs and feet are available in Tungsten (**TTU**) or Black (**TBL**)

LOCKS

- Locks are standard on all storage modules unless otherwise noted. Lock finish will coordinate with handle finish (brass handles will default to Black [BK] locks).

SHIPPING

- Most items are shipped assembled, 1 per carton, unless otherwise noted. Items are easy to assemble

S SIDEBAR STORAGE - NOTES

1. SPECIFY MODEL NUMBER

2. SPECIFY MATERIAL TYPE

- **TFL** for product with thermally fused laminate tops
- **HPL** for product with high pressure laminate tops (upcharge applies)

3. SPECIFY FINISH

Top/Base/Door, Drawer and Cabinet Finishes:

ACJ	Absolute Acajou	FCL	First Class
ASN	Asian Night	NBL	Noce Biondo
AWC	Avant Cherry	NGL	Noce Grigio
AWH	Avant Honey	NEL	Noce Leggero
BLK	Black	NML	Noce Medio
BZD	Blizzard	QTM	Quartered Mahogany
BRC	Brushed Cobalt	SBY	Sheer Beauty
CMB	Clear Maple	SDT	Stonedust
CGY	Custom Grey	SOG	Storm Grey
DES	Dark Espresso	WHE	Walnut Heights
DWT	Designer White	WHC	White Chocolate
FAS	Fashionista	WCR	Winter Cherry

Edge:

AB	Split color edge with Black Trim
AS	Split color edge with Silver Trim
A3	Standard edge
AR	Bicut edge

Feet:

Storage Feet are available in Tungsten (**TTU**) or Black (**TBL**).

4. SPECIFY OPTIONS

EDGE OPTIONS

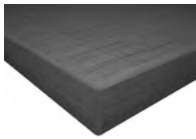

A3 - square corner, standard edge



AR - square corner, bicut edge



AS - square corner, Silver



AB - square corner, Black

HANDLES

- Handles are standard on most drawers/storage modules. All other drawers, including mobile and hanging pedestals, can be ordered with a choice of nine handle options to be **factory installed**. Each handle is identified by the letters "**HU**", "**HV**", "**HW**", "**HX**", "**HS**", "**HZ**", "**HO**", "**HQ**", and "**HR**". To specify a handle, please specify the code after the model number. To order a handle as an option, please specify the code when ordering. List Price is **\$58**.



HS Flared Silver



HV Square Edge Silver



HO Crescent Black



HW Flared Brass



HU Square Edge Black



HZ Dimpled Nickel



HX Flared Black



HQ Bar Silver



HR Bar Black

MOBILE PEDESTAL

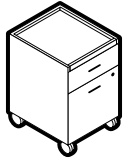

Mobile Pedestal*

MODEL#	DIMENSIONS D x W x H	FREIGHT CLASS	WT/LBS.	CUBIC FT.	LIST PRICE	HP ADD
S1619MP	19 x 16 x 25	85	76	6	\$1054	n/a
S1623MP	23 x 16 x 25	92.5	82	7	\$1095	n/a

Box/File drawers on fully progressive ball bearing slides, accommodate letter and legal size hanging files. Pedestal top is inset within side panels. Includes counterweight to prevent tipping. Drawers are locking. Handles are standard. Only front casters are locking.

- File drawer construction is for accommodating hanging files and NOT for stacking material on the drawer bottom.

MOBILE PEDESTAL

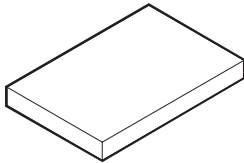

Cushion for Mobile Pedestals**

MODEL#	DIMENSIONS	FREIGHT CLASS	WT/LBS.	CUBIC FT.	GRADE	LIST	GRADE	LIST
CU1517	17 x 15 x 1.5	125	6	.90	1	\$155	7	\$442
					2	\$201	8	\$541
					3	\$232	9	\$618
					4	\$281	10	\$701
					5	\$347	11	\$874
					6	\$381	12	\$1064
CU1520	20 x 15 x 1.5	70	1	1	1	\$167	7	\$452
					2	\$210	8	\$552
					3	\$242	9	\$628
					4	\$292	10	\$712
					5	\$359	11	\$886
					6	\$390	12	\$1075

Cushion attaches with Velcro strips.

- CU1517 for use on S1619MP. CU1520 for use on S1623MP.

Required Specifications

- Top finish*
- Drawer front finish*
- Handles*
- Fabric**

S SIDEBAR STORAGE

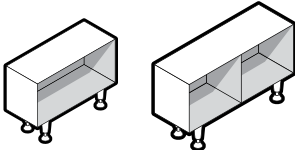
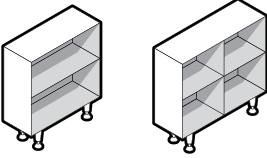
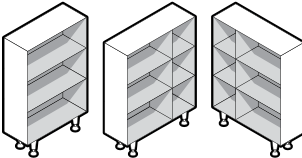
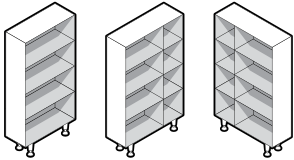
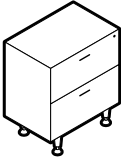
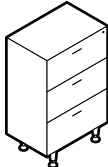
STORAGE	MODEL#	DIMENSIONS D x W x H	FREIGHT CLASS	WT/LBS.	CUBIC FT.	LIST PRICE	HP ADD
 <p>30"w 36"w</p> <p>Low Bookcase</p>	S3012A0	12 x 30 x 22.85	125	49	7	\$659	n/a
	S3612A0	12 x 36 x 22.85	125	61	8.25	\$762	n/a
Open bookcases accommodate binders in every cavity. One fixed shelf. 36"w units feature a fixed vertical divider.							
 <p>30"w 36"w</p> <p>2 High Bookcase</p>	S3012D0	12 x 30 x 36.35	125	77	10.50	\$909	n/a
	S3612D0	12 x 36 x 36.35	125	94	12.50	\$1054	n/a
Open bookcases accommodate binders in every cavity. Two fixed shelves. 36"w units feature a fixed vertical divider. Matches Tier 2.							
 <p>30"w 36"w - left 36"w - right</p> <p>3 High Bookcase</p>	S3012F0	12 x 30 x 49.85	125	102	14	\$1095	n/a
	S3612FOL	12 x 36 x 49.85	125	127	16.50	\$1298	n/a
	S3612FOR	12 x 36 x 49.85	125	127	16.50	\$1298	n/a
Open bookcases accommodate binders in every cavity. Three fixed shelves. 36"w units feature a fixed vertical divider. Matches Tier 3.							
 <p>30"w 36"w - left 36"w - right</p> <p>4 High Bookcase</p>	S3012H0	12 x 30 x 63.35	125	129	17.50	\$1298	n/a
	S3612HOL	12 x 36 x 63.35	125	161	20.75	\$1563	n/a
	S3612HOR	12 x 36 x 63.35	125	161	20.75	\$1563	n/a
Open bookcases accommodate binders in every cavity. Four fixed shelves. 36"w units feature a fixed vertical divider. Matches Tier 4.							
 <p>2 High Lateral File</p>	S3020DZ	20 x 30 x 36.35	100	142	16.50	\$1777	n/a
	S3024DZ	24 x 30 x 36.35	125	149	19.50	\$1875	n/a
	S3620DZ	20 x 36 x 36.35	125	153	19.50	\$1923	n/a
	S3624DZ	24 x 36 x 36.35	125	168	23.35	\$2026	n/a
Two file drawers. Handles are standard. Lock secures all drawers. Front-to-back and side-to-side letter/legal filing capability. Matches Tier 2.							
<ul style="list-style-type: none"> Lateral file drawer construction is for accommodating hanging files and NOT for stacking material on the drawer bottom. 							
 <p>3 High Lateral File</p>	S3020FZ	20 x 30 x 49.85	100	191	22	\$2185	n/a
	S3024FZ	24 x 30 x 49.85	125	198	26	\$2299	n/a
	S3620FZ	20 x 36 x 49.85	125	203	26	\$2368	n/a
	S3624FZ	24 x 36 x 49.85	125	221	31	\$2493	n/a
Three file drawers. Handles are standard. Lock secures all drawers. Front-to-back and side-to-side letter/legal filing capability. Matches Tier 3.							
<ul style="list-style-type: none"> Lateral file drawer construction is for accommodating hanging files and NOT for stacking material on the drawer bottom. 							

Required Specifications

Top finish
 Top/edge detail
 Base finish
 Drawer Front Finish (Units w/doors)

Handles
 Leg Finish (Bookcases only)
 Shelf Finish (Open Units)

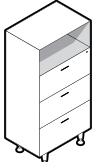
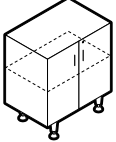
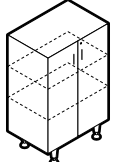
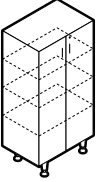
STORAGE	MODEL#	DIMENSIONS	FREIGHT CLASS	WT/LBS.	CUBIC FT.	LIST PRICE	HP ADD
 <p>3 High Lateral File - Open</p>	D x W x H						
	S3020HZ	20 x 30 x 63.35	100	239	27.50	\$2689	n/a
	S3024HZ	24 x 30 x 63.35	125	246	32.50	\$2817	n/a
	S3620HZ	20 x 36 x 63.35	125	253	32.75	\$2911	n/a
	S3624HZ	24 x 36 x 63.35	125	275	38.75	\$3055	n/a
<p>Three file drawers. Handles are standard. Lock secures all drawers. Front-to-back and side-to-side letter/legal filing capability. Matches Tier 4.</p> <ul style="list-style-type: none"> Lateral file drawer construction is for accommodating hanging files and NOT for stacking material on the drawer bottom. 							
 <p>2 High Storage Cabinet</p>	S3020DX	20 x 30 x 36.35	125	122	16.50	\$1380	n/a
	S3024DX	24 x 30 x 36.35	125	139	19.50	\$1486	n/a
	S3620DX	20 x 36 x 36.35	125	151	19.50	\$1618	n/a
	S3624DX	24 x 36 x 36.35	125	173	23	\$1764	n/a
<p>Laminate doors are standard. Handles are standard. Two fixed shelves. Standard with lock. Matches Tier 2.</p>							
 <p>3 High Storage Cabinet</p>	S3020FX	20 x 30 x 49.85	125	167	22	\$1710	n/a
	S3024FX	24 x 30 x 49.85	125	190	26	\$1845	n/a
	S3620FX	20 x 36 x 49.85	100	209	23.75	\$2026	n/a
	S3624FX	24 x 36 x 49.85	125	238	30.75	\$2218	n/a
<p>Laminate doors are standard. Handles are standard. Three fixed shelves. Standard with lock. Matches Tier 3.</p>							
 <p>4 High Storage Cabinet</p>	S3020HX	20 x 30 x 63.35	125	212	27.50	\$2048	n/a
	S3024HX	24 x 30 x 63.35	125	241	32.50	\$2222	n/a
<p>Laminate doors are standard. Handles are standard. Includes four fixed shelves. Standard with lock. Matches Tier 4.</p>							

Required Specifications

Top finish
 Top/edge detail
 Base finish
 Door / Drawer Front Finish

Handles

S SIDEBAR STORAGE

LOW CREDENZAS

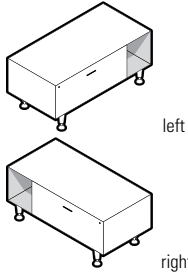

Low Credenza - Lateral Drawer

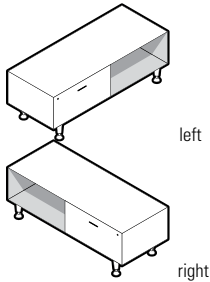

Low Credenza - Lateral Drawer

MODEL#	DIMENSIONS D x W x H	FREIGHT CLASS	WT/LBS.	CUBIC FT.	LIST PRICE	HP ADD
S4220ASL	20 x 42 x 22.85	125	110	15	\$1326	\$213
S4224ASL	24 x 42 x 22.85	125	123	17.50	\$1422	\$250
S4820ASL	20 x 48 x 22.85	125	121	17	\$1435	\$250
S4824ASL	24 x 48 x 22.85	125	136	20	\$1534	\$282
S4220ASR	20 x 42 x 22.85	125	110	15	\$1326	\$213
S4224ASR	24 x 42 x 22.85	125	123	17.50	\$1422	\$250
S4820ASR	20 x 48 x 22.85	125	121	17	\$1435	\$250
S4824ASR	24 x 48 x 22.85	125	136	20	\$1534	\$282

Lateral file drawer is standard on one side, open cavity on the other. Handles are standard. Specify left or right handed. Standard with lock. Front-to-back and side-to-side letter/legal filing capability.

- 42" w cabinet has a 30" w lateral drawer.
- 48" w cabinet has a 36" w lateral drawer.
- Lateral file drawer construction is for accommodating hanging files and NOT for stacking material on the drawer bottom.

S6020ASL	20 x 60 x 22.85	125	138	21	\$1581	\$319
S6024ASL	24 x 60 x 22.85	125	156	24.75	\$1692	\$353
S7220ASL	20 x 72 x 22.85	125	159	20.75	\$1764	\$353
S7224ASL	24 x 72 x 22.85	125	179	25	\$1879	\$422
S6020ASR	20 x 60 x 22.85	125	138	21	\$1581	\$319
S6024ASR	24 x 60 x 22.85	125	156	24.75	\$1692	\$353
S7220ASR	20 x 72 x 22.85	125	159	20.75	\$1764	\$353
S7224ASR	24 x 72 x 22.85	125	179	25	\$1879	\$422

Lateral file drawer is standard on one side, open cavity on the other. Specify left or right handed. Standard with lock. Front-to-back and side-to-side letter/legal filing capability.

- 60" w cabinet has a 30" w lateral drawer.
- 72" w cabinet has a 36" w lateral drawer.
- Lateral file drawer construction is for accommodating hanging files and NOT for stacking material on the drawer bottom.

MEDIUM CREDENZAS

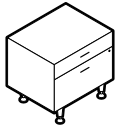

Medium Credenza - Box/File

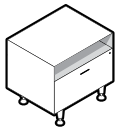

Medium Credenza w/Lateral File

MODEL#	DIMENSIONS	FREIGHT CLASS	WT/LBS.	CUBIC FT.	LIST PRICE	HP ADD
S3020BZ	20 x 30 x 29.6	100	113	13.75	\$1408	\$178
S3024BZ	24 x 30 x 29.6	125	126	16.25	\$1499	\$178
S3620BZ	20 x 36 x 29.6	125	128	16.25	\$1540	\$178
S3624BZ	24 x 36 x 29.6	100	142	16.75	\$1632	\$213

Wide box and lateral file. Handles are standard. Lock secures both drawers.

- Lateral file drawer construction is for accommodating hanging files and NOT for stacking material on the drawer bottom.

S3020BY	20 x 30 x 29.6	100	116	13.75	\$1337	\$178
S3024BY	24 x 30 x 29.6	100	131	16.25	\$1443	\$178
S3620BY	20 x 36 x 29.6	100	132	16.25	\$1472	\$178
S3624BY	24 x 36 x 29.6	100	149	16.75	\$1581	\$213

Open cavity and lateral file. Handles are standard. Standard with lock.

- Lateral file drawer construction is for accommodating hanging files and NOT for stacking material on the drawer bottom.

Required Specifications

Top finish
Top/edge detail
Base finish
Door/drawer front finish

Handles

Optional Specifications

HP laminate

MEDIUM CRENZAS

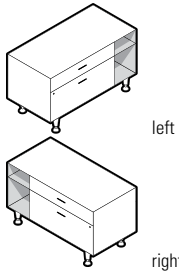

Medium Credenza - Box/Lateral File

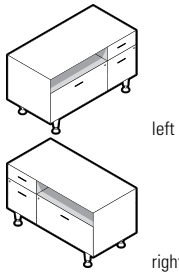

Medium Credenza - Mixed Drawers

MODEL#	DIMENSIONS D x W x H	FREIGHT CLASS	WT/LBS.	CUBIC FT.	LIST PRICE	HP ADD
S4220BSL	20 x 42 x 29.6	125	142	18.75	\$1666	\$213
S4224BSL	24 x 42 x 29.6	125	160	22	\$1777	\$250
S4820BSL	20 x 48 x 29.6	125	155	21.25	\$1806	\$250
S4824BSL	24 x 48 x 29.6	125	173	25	\$1923	\$282
S4220BSR	20 x 42 x 29.6	125	142	18.75	\$1666	\$213
S4224BSR	24 x 42 x 29.6	125	160	22	\$1777	\$250
S4820BSR	20 x 48 x 29.6	125	155	21.25	\$1806	\$250
S4824BSR	24 x 48 x 29.6	125	173	25	\$1923	\$282

Wide box and lateral file is standard on one side, open cavity with fixed shelf on the other. Handles are standard. Specify left or right handed. Standard with lock. Front-to-back and side-to-side letter/legal filing capability.

- 42" w credenza has a 30" w box/lateral file
- 48" w credenza has a 36" w box/lateral file
- Lateral file drawer construction is for accommodating hanging files and NOT for stacking material on the drawer bottom.

S4220BQL	20 x 42 x 29.6	100	165	18.75	\$2119	\$213
S4224BQL	24 x 42 x 29.6	100	184	22	\$2250	\$250
S4820BQL	20 x 48 x 29.6	100	179	21.25	\$2254	\$250
S4824BQL	24 x 48 x 29.6	100	184	22	\$2250	\$282
S4220BQR	20 x 42 x 29.6	100	165	18.75	\$2119	\$213
S4224BQR	24 x 42 x 29.6	100	184	22	\$2250	\$250
S4820BQR	20 x 48 x 29.6	100	179	21.25	\$2254	\$250
S4824BQR	24 x 48 x 29.6	100	184	22	\$2250	\$282

Box/file is standard on one side, open cavity and lateral file on the other side. Specify left or right handed. Handles are standard. Standard with locks. Front-to-back and side-to-side letter/legal filing capability.

- 42" w credenza has a 30" w lateral drawer
- 48" w credenza has a 36" w lateral drawer
- Lateral file drawer construction is for accommodating hanging files and NOT for stacking material on the drawer bottom.

Required Specifications

Top finish
Top/edge detail
Base finish
Door/drawer front finish

Handles

Optional Specifications

HP laminate

S SIDEBAR STORAGE

STACK-ON STORAGE

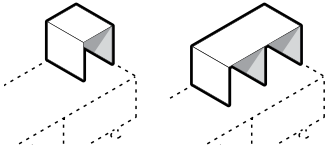

Stack-On Bookcases

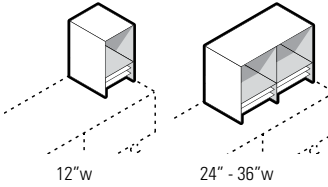

Stack-On Bookcase w/Collators**

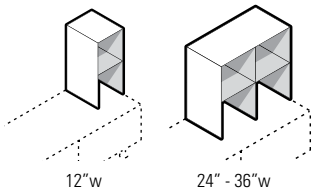

Stack-On Bookcases

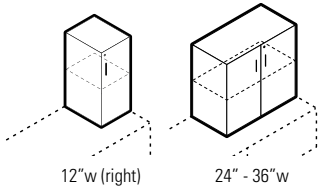

Stack-On Storage Cabinet*

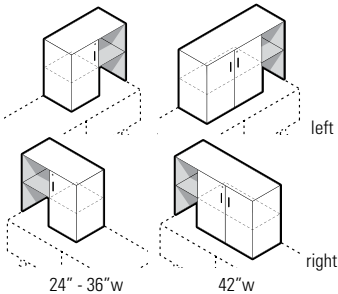

Stack-On Mixed Storage Cabinet*

MODEL#	DIMENSIONS D x W x H	FREIGHT CLASS	WT/LBS.	CUBIC FT.	LIST PRICE	HP ADD
S1214A0	14.3 x 12 x 13.5	92.5	23	2.20	\$264	n/a
S2414A0	14.3 x 24 x 13.5	100	37	4	\$400	n/a
S3014A0	14.3 x 30 x 13.5	100	41	5	\$442	n/a
S3614A0	14.3 x 36 x 13.5	125	46	5.90	\$483	n/a

Designed to be placed on top of credenzas. Open cavity. Unit rests directly on credenza top.
 • Sxx14A0 Stack-On bookcases add 1 tier when placed on any storage unit.

S1214B0	14.3 x 12 x 20.25	92.5	35	3.10	\$380	n/a
S2414B0	14.3 x 24 x 20.25	92.5	59	5.75	\$625	n/a
S3014B0	14.3 x 30 x 20.25	100	68	7	\$699	n/a
S3614B0	14.3 x 36 x 20.25	100	77	8.50	\$804	n/a

Designed to be placed on top credenzas. Open cavity with collator below. Unit rests directly on credenza top.
 • Sxx14B0 Stack-On bookcases add 1.5 tiers when placed on any storage unit.

S1214D0	14.3 x 12 x 27	92.5	41	4	\$428	n/a
S2414D0	14.3 x 24 x 27	100	68	7.50	\$671	n/a
S3014D0	14.3 x 30 x 27	100	76	9.25	\$736	n/a
S3614D0	14.3 x 36 x 27	125	85	11	\$817	n/a

Designed to be placed on top of credenzas. Open cavities with fixed shelf. Unit rests directly on credenza top.
 • Sxx14D0 Stack-On bookcases add 2 tiers when placed on any storage unit.

S1215DTL	15 x 12 x 27	92.5	47	4.20	\$561	n/a
S1215DTR	15 x 12 x 27	92.5	47	4.20	\$561	n/a
S2415DT	15 x 24 x 27	92.5	79	7.75	\$938	n/a
S3015DT	15 x 30 x 27	100	91	9.50	\$1027	n/a
S3615DT	15 x 36 x 27	100	103	11.25	\$1145	n/a

Designed to be placed on top of credenzas. Laminate doors are standard. Includes fixed shelf. For 12" w units specify left or right handed. Handles are standard. Standard with locks. Unit rests directly on credenza top.
 • Sxx15DT/DTL/DTR Stack-On storage cabinets add 2 tiers when placed on any storage unit.

S2415DNL	15 x 24 x 27	100	73	7.75	\$804	n/a
S3015DNL	15 x 30 x 27	100	83	9.50	\$882	n/a
S3615DNL	15 x 36 x 27	100	94	11.25	\$986	n/a
S4215DNL	15 x 42 x 27	100	117	13	\$1260	n/a
S2415DNR	15 x 24 x 27	100	73	7.75	\$804	n/a
S3015DNR	15 x 30 x 27	100	83	9.50	\$882	n/a
S3615DNR	15 x 36 x 27	100	94	11.25	\$986	n/a
S4215DNR	15 x 42 x 27	100	117	13	\$1260	n/a

Designed to be placed on top of credenzas. Laminate doors are standard on one side with one fixed shelf. Open cavity with one fixed shelf on the other side. Specify left or right handed. Handles are standard. Standard with locks. Unit rests directly on credenza top.
 • Sxx15DNL/DNR Stack-On mixed storage cabinets add 2 tiers when placed on any storage unit.

Required Specifications

Top finish
 Top/edge detail
 Base finish
 Door/drawer front finish*

Handles*
 Collator finish**

STACK-ON STORAGE

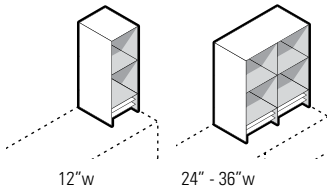

Stack-On Bookcase w/Collators

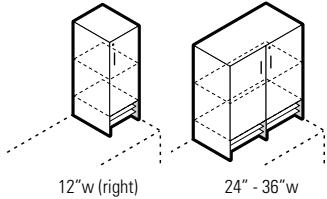

Stack-On Closed Storage* Cabinet w/Collators

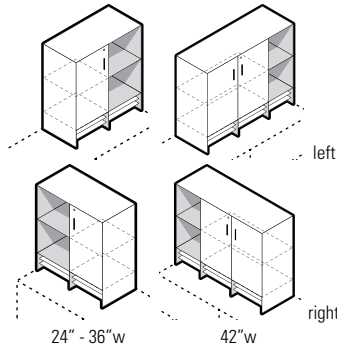

Stack-On Mixed Storage* Cabinet w/Collators

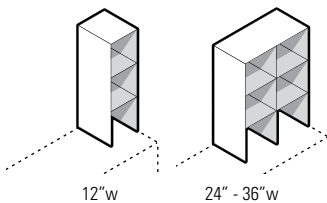

Stack-On Bookcases

MODEL#	DIMENSIONS	FREIGHT CLASS	WT/LBS.	CUBIC FT.	LIST PRICE	HP ADD
--------	------------	---------------	---------	-----------	------------	--------

D x W x H						
S1214EO	14.3 x 12 x 33.75	92.5	53	5	\$554	n/a
S2414EO	14.3 x 24 x 33.75	100	90	9.25	\$915	n/a
S3014EO	14.3 x 30 x 33.75	100	102	11.25	\$1013	n/a
S3614EO	14.3 x 36 x 33.75	100	115	13.25	\$1150	n/a

Designed to be placed on top of credenzas. Open cavities with one fixed shelf and collator below. Unit rests directly on credenza top.

- Sxx14EO Stack-On bookcases add 2.5 tiers when placed on any storage unit.

S1215ETL	15 x 12 x 33.75	92.5	59	5.25	\$685	n/a
S1215ETR	15 x 12 x 33.75	92.5	59	5.25	\$685	n/a
S2415ET	15 x 24 x 33.75	92.5	102	9.50	\$1173	n/a
S3015ET	15 x 30 x 33.75	100	117	11.75	\$1298	n/a
S3615ET	15 x 36 x 33.75	100	133	14	\$1472	n/a

Designed to be placed on top of credenzas. Laminate doors are standard with one fixed shelf and collator below. For 12" w units specify left or right handed. Handles are standard. Standard with locks. Unit rests directly on credenza top.

- Sxx15ET/ETL/ETR Stack-On storage cabinets add 2.5 tiers when placed on any storage unit.

S2415ENL	15 x 24 x 33.75	92.5	96	9.50	\$1041	n/a
S3015ENL	15 x 30 x 33.75	100	110	11.75	\$1158	n/a
S3615ENL	15 x 36 x 33.75	100	124	14	\$1312	n/a
S4215ENL	15 x 42 x 33.75	100	154	16	\$1636	n/a

S2415ENR	15 x 24 x 33.75	92.5	96	9.50	\$1041	n/a
S3015ENR	15 x 30 x 33.75	100	110	11.75	\$1158	n/a
S3615ENR	15 x 36 x 33.75	100	124	14	\$1312	n/a
S4215ENR	15 x 42 x 33.75	100	154	16	\$1636	n/a

Designed to be placed on top of credenzas. Laminate doors are standard on one side with one fixed shelf. Open cavities on the other side, with one fixed shelf and collator below. Specify left or right handed. Handles are standard. Standard with locks. Unit rests directly on credenza top.

- Sxx15ENL/ENR Stack-On mixed storage cabinets add 2.5 tiers when placed on any storage unit.

S1214FO	14.3 x 12 x 40.5	100	59	6	\$597	n/a
S2414FO	14.3 x 24 x 40.5	100	98	10.75	\$930	n/a
S3014FO	14.3 x 30 x 40.5	100	110	13.25	\$1019	n/a
S3614FO	14.3 x 36 x 40.5	125	123	15.75	\$1130	n/a

Designed to be placed on top of credenzas. Open cavities with two fixed shelves. Unit rests directly on credenza top.

- Sxx14FO Stack-On bookcases add 3 tiers when placed on any storage unit.

Required Specifications

Top finish
Top/edge detail
Base finish
Door/drawer front finish*

Handles*
Collator finish

S SIDEBAR STORAGE

STACK-ON STORAGE

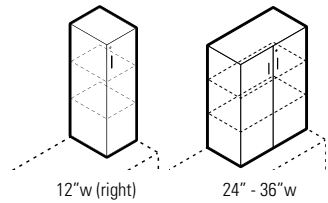

Stack-On Storage Cabinet

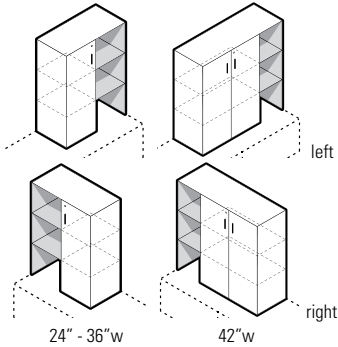

Stack-On Mixed Storage Cabinet

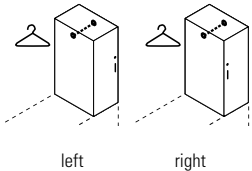

Stack-On Wardrobe Cabinet

MODEL#	DIMENSIONS	FREIGHT CLASS	WT/LBS.	CUBIC FT.	LIST PRICE	HP ADD
--------	------------	---------------	---------	-----------	------------	--------

	D x W x H					
S1215FTL	15 x 12 x 40.5	92.5	68	6.25	\$762	n/a
S1215FTR	15 x 12 x 40.5	92.5	68	6.25	\$762	n/a
S2415FT	15 x 24 x 40.5	92.5	116	11.25	\$1271	n/a
S3015FT	15 x 30 x 40.5	100	132	14	\$1394	n/a
S3615FT	15 x 36 x 40.5	100	150	16.50	\$1553	n/a

Designed to be placed on top of credenzas. Laminate doors are standard, with two fixed shelves. Handles are standard. Standard with locks. Unit rests directly on credenza top.

- Sxx15FT/FTL/FTR Stack-On storage cabinets add 3 tiers when placed on any storage unit.

S2415FNL	15 x 24 x 40.5	100	107	11.25	\$1102	n/a
S3015FNL	15 x 30 x 40.5	100	121	14	\$1206	n/a
S3615FNL	15 x 36 x 40.5	100	137	16.50	\$1347	n/a
S4215FNL	15 x 42 x 40.5	100	171	19	\$1722	n/a

S2415FNR	15 x 24 x 40.5	100	107	11.25	\$1102	n/a
S3015FNR	15 x 30 x 40.5	100	121	14	\$1206	n/a
S3615FNR	15 x 36 x 40.5	100	137	16.50	\$1347	n/a
S4215FNR	15 x 42 x 40.5	100	171	19	\$1722	n/a

Designed to be placed on top of credenzas. Laminate doors are standard on one side, with two fixed shelves. Open cavities on the other side, with two fixed shelves. Specify left or right handed. Handles are standard. Standard with locks. Unit rests directly on credenza top.

- Sxx15FNL/FNR Stack-On mixed storage cabinets add 3 tiers when placed on any storage unit.

S1224FTL	24 x 12 x 40.5	100	83	9.50	\$900	n/a
S1224FTR	24 x 12 x 40.5	100	83	9.50	\$900	n/a

Designed to be placed on top of credenzas. Laminate doors are standard. Includes hanging rod. Specify left or right handed. Handles are standard. Standard with locks. Unit rests directly on credenza top.

- S1224FTL/FTR Stack-On wardrobe cabinets add 3 tiers when placed on any storage unit.

Required Specifications

Top finish
Top/edge detail
Base finish
Door/drawer front finish

Handles

wellness solutions



Wellness Solutions

522

WELLNESS SCREENS MODEL# DIMENSIONS FREIGHT CLASS WT./LBS. CUBIC FT. LIST PRICE

D x W x H

- Surface mounted wellness guard provides a physical divider
- Acrylic glazing is clear and support rails are painted Designer White (DWT).
- Aluminum extruded posts

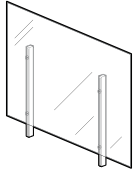

Wellness Screen - Under Mount

GCAMSG3636LP	2 x 36 x 36	300	20.20	2.92	\$530
GCAMSG3648LP	2 x 48 x 36	300	22.80	3.98	\$688

No mounting hardware included; drilling required. For use with existing worksurface or transaction top.

FREESTANDING DIVIDERS - FELT	MODEL#	DIMENSIONS D x W x H	FREIGHT CLASS	WT./LBS.	CUBIC FT.	LIST PRICE
<ul style="list-style-type: none"> • Divide space with flexibility. • Lightweight and easy to clean partitions • Minimal footprint for storage • Screens are surrounded by a 0.5" x 2.5" powder coated aluminum frame in Designer White (DWT) or Tungsten (TUN) • Charcoal soft touch radius end trim • 7" panel opening at panel bottom for easy cleaning and cable pass-through • Includes all connecting hardware and 1" leveling glide • Stations are 60" wide by 42" deep by 66" high. 			FELT COLORS			
			(AMT) Amethyst	(HVT) Harvest		
			(APR) Apricot	(LAP) Lapis		
			(BLK) Black	(MTS) Mist		
			(BSK) Blue Smoke	(NVY) Navy		
			(BRI) Brick	(PWT) Pewter		
			(CNN) Carnation	(RBY) Ruby		
			(DEN) Denim	(SHR) Shamrock		
			(EMD) Emerald	(SFR) Sunflower		
			(GPH) Graphite	(WHT) White		

MODEL#	DIMENSIONS	FREIGHT CLASS	WT./LBS.	CUBIC FT.	LIST PRICE
GCUPFSF5442	20 x 42 x 51.75	400	21.8	25.16	\$839
GCUPFSF5448	20 x 48 x 51.75	400	22.54	28.75	\$852
GCUPFSF5460	20 x 60 x 51.75	400	24.03	35.94	\$1045
GCUPFSF6042	20 x 42 x 57.75	400	22.57	28.07	\$859
GCUPFSF6048	20 x 48 x 57.75	400	23.3	32.08	\$865
GCUPFSF6060	20 x 60 x 57.75	400	24.87	40.1	\$1059
GCUPFSF7242	20 x 42 x 69.75	400	24.06	33.91	\$1051
GCUPFSF7248	20 x 48 x 69.75	400	24.88	38.75	\$1064
GCUPFSF7260	20 x 60 x 69.75	400	29.79	48.44	\$1334

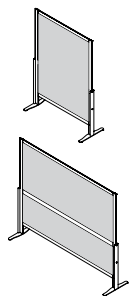

Felt Screen - Flat Feet

Provides privacy and room separation. PET felt screen with steel flat feet. 60" wide divider has a crossbar in the middle.

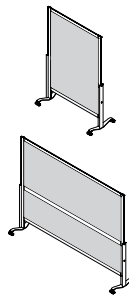

Felt Screen - Casters

GCUPMSF5442	20 x 42 x 52.05	400	22.98	25.3	\$1134
GCUPMSF5448	20 x 48 x 52.05	400	23.72	28.92	\$1148
GCUPMSF5460	20 x 60 x 52.05	400	25.21	36.15	\$1327
GCUPMSF6042	20 x 42 x 58.05	400	23.75	28.22	\$1155
GCUPMSF6048	20 x 48 x 58.05	400	24.51	32.25	\$1169
GCUPMSF6060	20 x 60 x 58.05	400	26.05	40.31	\$1348
GCUPMSF7242	20 x 42 x 70.05	400	25.24	34.05	\$1340
GCUPMSF7248	20 x 48 x 70.05	400	26.06	38.92	\$1348
GCUPMSF7260	20 x 60 x 70.05	400	30.97	48.65	\$1597

Provides privacy and room separation. PET felt screen with steel feet with casters. 60" wide divider has a crossbar in the middle.

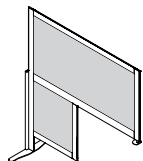

Shared Divider Felt Screen

GCUPSHF5448	20 x 48 x 53.57	400	18.06	29.76	\$700
GCUPSHF5454	20 x 54 x 53.57	400	18.8	33.48	\$796
GCUPSHF6048	20 x 48 x 59.57	400	18.84	33.09	\$748
GCUPSHF6054	20 x 54 x 59.57	400	19.6	37.23	\$982

Provides privacy and divides space for workstations. Divider stands on the floor and sits on the worksurface. Has no mechanical connection to any surface. Lightweight and easy to clean and move. PET felt screen with steel flat foot. 60" wide divider has a crossbar in the middle. Extends 24" from the worksurface. Sits 24" or 30" above worksurface.

Required Specifications

Frame/ foot finish
PET felt

FREESTANDING DIVIDERS - GLASS

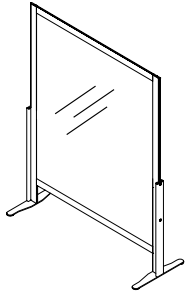

Glass Screen - Flat Feet

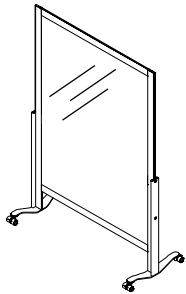

Glass Screen - Casters

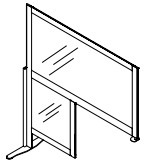

Shared Divider Glass Screen

MODEL#	DIMENSIONS D x W x H	FREIGHT CLASS	WT/LBS.	CUBIC FT.	LIST PRICE
GCUPFSG5424	20 x 24 x 51.75	250	30.83	14.38	\$955
GCUPFSG5430	20 x 30 x 51.75	300	34.95	17.97	\$1038
GCUPFSG5436	20 x 36 x 51.75	300	39.07	21.56	\$1119
GCUPFSG5442	20 x 42 x 51.75	300	43.19	25.16	\$1202
GCUPFSG5448	20 x 48 x 51.75	300	47.31	28.75	\$1285
GCUPFSG5460	20 x 60 x 51.75	300	55.56	35.94	\$1449
GCUPFSG6024	20 x 24 x 57.75	250	33.11	16.04	\$1012
GCUPFSG6030	20 x 30 x 57.75	300	37.74	20.05	\$1102
GCUPFSG6036	20 x 36 x 57.75	300	42.36	24.06	\$1192
GCUPFSG6042	20 x 42 x 57.75	300	46.99	28.07	\$1283
GCUPFSG6048	20 x 48 x 57.75	300	51.61	32.08	\$1374
GCUPFSG6060	20 x 60 x 57.75	300	60.86	40.1	\$1554

Provides privacy and room separation. Lightweight and easy to clean and move. Aluminum frame, clear glass screen with steel flat feet.

- For frosted glass (**FRST**), add 20%.

GCUPMSG5424	20 x 24 x 52.05	250	31.99	14.46	\$1368
GCUPMSG5430	20 x 30 x 52.05	300	36.11	18.07	\$1450
GCUPMSG5436	20 x 36 x 52.05	300	40.24	21.69	\$1532
GCUPMSG5442	20 x 42 x 52.05	300	44.36	25.3	\$1614
GCUPMSG5448	20 x 48 x 52.05	300	48.48	28.92	\$1696
GCUPMSG5460	20 x 60 x 52.05	300	56.72	36.15	\$1861
GCUPMSG6024	20 x 24 x 58.05	250	34.28	16.13	\$1424
GCUPMSG6030	20 x 30 x 58.05	300	38.9	20.16	\$1515
GCUPMSG6036	20 x 36 x 58.05	300	43.53	24.19	\$1604
GCUPMSG6042	20 x 42 x 58.05	300	48.15	28.22	\$1695
GCUPMSG6048	20 x 48 x 58.05	300	52.78	32.25	\$1785
GCUPMSG6060	20 x 60 x 58.05	300	62.03	40.31	\$1966

Provides privacy and room separation. Lightweight and easy to clean and move. Aluminum frame, clear glass screen with steel flat feet.

- For frosted glass (**FRST**), add 20%.

GCUPSHG5448	20 x 48 x 53.57	300	36.17	29.76	\$1054
GCUPSHG5454	20 x 54 x 53.57	300	38.51	33.48	\$1102
GCUPSHG6048	20 x 48 x 59.57	300	40.52	33.09	\$1140
GCUPSHG6054	20 x 54 x 59.57	300	43.36	37.23	\$1195

Provides privacy and divides space for workstations. Divider stands on the floor and sits on the worksurface. Has no mechanical connection to any surface. Lightweight and easy to clean and move. Aluminum frame, clear glass screen with steel flat foot. Extends 24" from the worksurface. Sits 24" or 30" above worksurface.

- For frosted glass (**FRST**), add 20%.

Required Specifications

Frame/foot finish

Optional Specifications

Frosted glass (FRST)

LINKING PANELS	MODEL#	DIMENSIONS	FREIGHT CLASS	WT./LBS.	CUBIC FT.	LIST PRICE
----------------	--------	------------	---------------	----------	-----------	------------

D x W x H

- Segmented panels offer a thermally fused laminate lower and high pressure upper pressed on a lightweight core
- Minimal footprint for storage
- Easy to connect
- Easy to reconfigure
- Easy to clean
- Panels available in Designer White (**DWT**) or Absolute Acajou (**ACJ**) laminates
- Frames available in Designer White (**DWT**) or Tungsten (**TUN**)
- Width options: 36", 42", 48", 60" wide
- 66" high
- 1.3" thick.

LINKING PANELS - SEGMENTED	MODEL#	DIMENSIONS	FREIGHT CLASS	WT./LBS.	CUBIC FT.	LIST PRICE
----------------------------	--------	------------	---------------	----------	-----------	------------

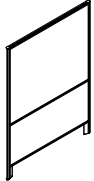

Segmented Linking Panel*

DLSP6636	1.3 x 36 x 66	92.5	35	3	\$900
DLSP6642	1.3 x 42 x 66	92.5	41	3.46	\$926
DLSP6648	1.3 x 48 x 66	92.5	47	3.93	\$944
DLSP6660	1.3 x 60 x 66	85	59	4.90	\$1449

Segmented panels offer a thermally fused laminate lower and high pressure upper pressed on a lightweight core. Minimal footprint for storage. Laminate core available in Designer White (**DWT**) or Absolute Acajou (**ACJ**). Aluminum extrusion comes in powder coated paint finish in Designer White (**DWT**) or Absolute Acajou (**ACJ**). Comes complete with hinge kits and levelers on both legs.

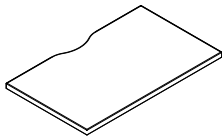

Worksurface, for Segmented Panel**

DLSPWS1830SCPLP	18 x 30 x 1	60	15	.50	\$210
-----------------	-------------	----	----	-----	--------------

Straight rectangular laminate worksurface, non handed, can be interchanged on site, and features a scoop for cable pass-through. Available in Designer White (**DWT**) or Absolute Acajou (**ACJ**). Edging available in Designer White (**DWE**) or Absolute Acajou (**ACJ**).

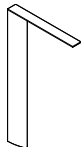

Worksurface Off-Module Cantilever*

DLSPHOMC	12 x 3 x 21	100	4	.42	\$165
----------	-------------	-----	---	-----	--------------

Installs on horizontal rails of panels to provide worksurface support. Frees up space under the worksurface. Powder coated paint finish in Designer White (**DWT**) or Tungsten (**TUN**).

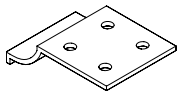

Worksurface Bracket*

DLSPHBRKT	3 x 2.25 x 0.75	70	.10	.05	\$15
-----------	-----------------	----	-----	-----	-------------

Extruded aluminum bracket that is bolted to the underside of the worksurface. Bracket supports worksurface at any location along the middle rail of the panel. Includes mounting hardware. Powder coated paint finish in Designer White (**DWT**) or Tungsten (**TUN**).

Required Specifications

- Frame finish*
- Laminate finish**

LAMINATE LINKING PANELS	MODEL#	DIMENSIONS	FREIGHT CLASS	WT./LBS.	CUBIC FT.	LIST PRICE
-------------------------	--------	------------	---------------	----------	-----------	------------

D x W x H

- Laminate linking panels provide privacy.
- Standard height of 54" or 66", width in 6" increments from 24" to 60".
- Aluminum extrusion comes in powder coated paint finish: Designer White (**DWT**) or Tungsten (**TUN**).
- Laminate core offered in Designer White (**DWT**) or Absolute Acajou (**ACJ**).
- Edge banded to match laminate finish.
- Panels come complete with hinge kits

Planning Diagrams

- When supported on one side (by 90° turn, supporting "T" legs or wall mounting), panels can run two long OR a maximum of 8'.
- When supported on both sides (by 90° turn, supporting "T" legs or wall mounting), panels can run three long OR a maximum of 13'.

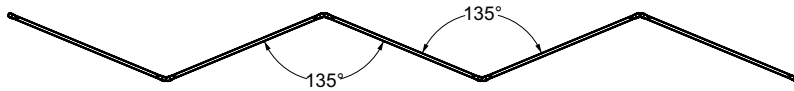
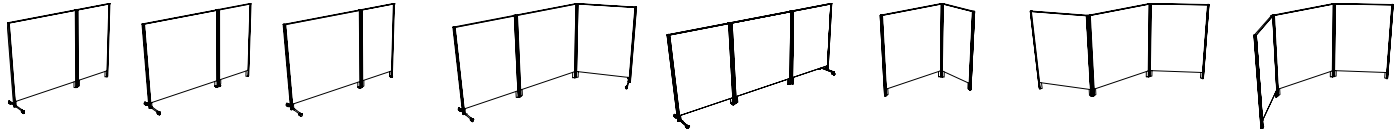

For longer, unsupported runs, panels must maintain a 135° angle (or less) to remain stable.

LAMINATE LINKING PANELS	MODEL#	DIMENSIONS	FREIGHT CLASS	WT./LBS.	CUBIC FT.	LIST PRICE
-------------------------	--------	------------	---------------	----------	-----------	------------

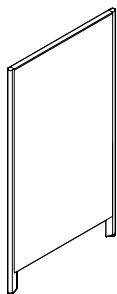

Laminate Panel - Leveler/Leveler

DPL5424	1.3 x 24 x 54	92.5	18	1.62	\$684	
DPL5430	1.3 x 30 x 54	92.5	23	2.08	\$759	
DPL5436	1.3 x 36 x 54	92.5	27	2.47	\$834	
DPL5442	1.3 x 42 x 54	92.5	32	2.85	\$909	
DPL5448	1.3 x 48 x 54	92.5	37	3.25	\$983	
DPL5454	1.3 x 54 x 54	92.5	42	3.63	\$1060	
DPL5460	1.3 x 60 x 54	92.5	47	4.02	\$1135	
DPL6624	1.3 x 24 x 66	92.5	23	2.04	\$777	
DPL6630	1.3 x 30 x 66	92.5	29	2.52	\$859	
DPL6636	1.3 x 36 x 66	92.5	35	3	\$941	
DPL6642	1.3 x 42 x 66	92.5	41	3.46	\$1023	
DPL6648	1.3 x 48 x 66	92.5	47	3.93	\$1107	
DPL6654	1.3 x 54 x 66	92.5	53	4.40	\$1190	
DPL6660	1.3 x 60 x 66	92.5	59	4.90	\$1271	

Levelers on both legs.

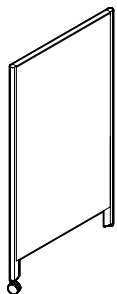

Laminate Panel - Caster/Leveler

DPLSCH5424	1.3 x 24 x 54	92.5	18	1.62	\$819	
DPLSCH5430	1.3 x 30 x 54	92.5	23	2.08	\$899	
DPLSCH5436	1.3 x 36 x 54	92.5	27	2.47	\$978	
DPLSCH5442	1.3 x 42 x 54	92.5	32	2.85	\$1057	
DPLSCH5448	1.3 x 48 x 54	92.5	37	3.25	\$1135	
DPLSCH5454	1.3 x 54 x 54	92.5	42	3.63	\$1214	
DPLSCH5460	1.3 x 60 x 54	92.5	47	4.02	\$1292	
DPLSCH6624	1.3 x 24 x 66	92.5	23	2.04	\$911	
DPLSCH6630	1.3 x 30 x 66	92.5	29	2.52	\$999	
DPLSCH6636	1.3 x 36 x 66	92.5	35	3	\$1087	
DPLSCH6642	1.3 x 42 x 66	92.5	41	3.46	\$1172	
DPLSCH6648	1.3 x 48 x 66	92.5	47	3.93	\$1257	
DPLSCH6654	1.3 x 54 x 66	92.5	53	4.40	\$1376	
DPLSCH6660	1.3 x 60 x 66	92.5	59	4.90	\$1432	

Single locking caster on one leg, leveler on the other.

Required Specifications

- Frame finish
- Laminate finish

LAMINATE LINKING PANELS **MODEL#** **DIMENSIONS** **FREIGHT CLASS** **WT./LBS.** **CUBIC FT.** **LIST PRICE**

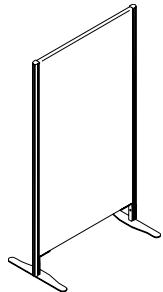

Laminate Panel - Flat Feet

		D x W x H					
DPLDF5424	1.3 x 24 x 54	65	40.2	1.62	\$807		
DPLDF5430	1.3 x 30 x 54	65	47.6	2.08	\$864		
DPLDF5436	1.3 x 36 x 54	70	54.9	2.47	\$920		
DPLDF5442	1.3 x 42 x 54	70	62.3	2.85	\$977		
DPLDF5448	1.3 x 48 x 54	70	69.6	3.25	\$1031		
DPLDF5454	1.3 x 54 x 54	70	77	3.63	\$1089		
DPLDF5460	1.3 x 60 x 54	70	84.3	4.02	\$1145		
DPLDF6624	1.3 x 24 x 66	65	48.6	2.04	\$875		
DPLDF6630	1.3 x 30 x 66	65	57.9	2.52	\$936		
DPLDF6636	1.3 x 36 x 66	70	67.3	3	\$998		
DPLDF6642	1.3 x 42 x 66	70	76.6	3.46	\$1059		
DPLDF6648	1.3 x 48 x 66	70	85.9	3.93	\$1121		
DPLDF6654	1.3 x 54 x 66	70	95.2	4.40	\$1183		
DPLDF6660	1.3 x 60 x 66	70	104.5	4.90	\$1245		

Flat foot on both legs. Freestanding.

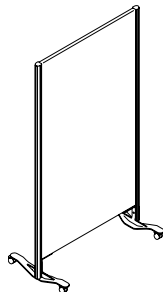

Laminate Panel - Double Casters

DPLMN5424	1.3 x 24 x 54	65	18	1.62	\$856		
DPLMN5430	1.3 x 30 x 54	65	23	2.08	\$930		
DPLMN5436	1.3 x 36 x 54	65	27	2.47	\$1006		
DPLMN5442	1.3 x 42 x 54	70	32	2.85	\$1078		
DPLMN5448	1.3 x 48 x 54	70	37	3.25	\$1154		
DPLMN5454	1.3 x 54 x 54	70	42	3.63	\$1228		
DPLMN5460	1.3 x 60 x 54	70	47	4.02	\$1301		
DPLMN6624	1.3 x 24 x 66	65	23	2.04	\$948		
DPLMN6630	1.3 x 30 x 66	65	29	2.52	\$1028		
DPLMN6636	1.3 x 36 x 66	65	35	3	\$1111		
DPLMN6642	1.3 x 42 x 66	70	41	3.46	\$1194		
DPLMN6648	1.3 x 48 x 66	70	47	3.93	\$1275		
DPLMN6654	1.3 x 54 x 66	70	53	4.40	\$1356		
DPLMN6660	1.3 x 60 x 66	70	59	4.90	\$1439		

Double locking caster base on both legs. Freestanding.

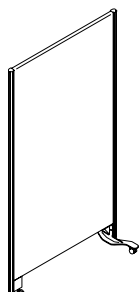

Laminate Panel - Single Caster/Double Casters

DPLDCMN5424	1.3 x 24 x 54	65	18	1.62	\$805		
DPLDCMN5430	1.3 x 30 x 54	70	23	2.08	\$879		
DPLDCMN5436	1.3 x 36 x 54	70	27	2.47	\$947		
DPLDCMN5442	1.3 x 42 x 54	70	32	2.85	\$1020		
DPLDCMN5448	1.3 x 48 x 54	70	37	3.25	\$1090		
DPLDCMN5454	1.3 x 54 x 54	70	42	3.63	\$1158		
DPLDCMN5460	1.3 x 60 x 54	70	47	4.02	\$1234		
DPLDCMN6624	1.3 x 24 x 66	65	23	2.04	\$889		
DPLDCMN6630	1.3 x 30 x 66	70	29	2.52	\$969		
DPLDCMN6636	1.3 x 36 x 66	70	35	3	\$1046		
DPLDCMN6642	1.3 x 42 x 66	70	41	3.46	\$1124		
DPLDCMN6648	1.3 x 48 x 66	70	47	3.93	\$1201		
DPLDCMN6654	1.3 x 54 x 66	70	53	4.40	\$1280		
DPLDCMN6660	1.3 x 60 x 66	70	59	4.90	\$1338		

Single locking caster on one leg and double locking caster base on the other. Freestanding.

Required Specifications

- Frame finish
- Laminate finish

LAMINATE PANELS

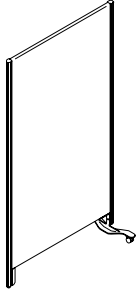

**Laminate Panel -
Leveler/Double Caster**

MODEL#	DIMENSIONS	FREIGHT CLASS	WT./LBS.	CUBIC FT.	LIST PRICE
D x W x H					
DPLDCHN5424	1.3 x 24 x 54	65	18	1.62	\$759
DPLDCHN5430	1.3 x 30 x 54	70	23	2.08	\$826
DPLDCHN5436	1.3 x 36 x 54	70	27	2.47	\$900
DPLDCHN5442	1.3 x 42 x 54	70	32	2.85	\$971
DPLDCHN5448	1.3 x 48 x 54	70	37	3.25	\$1040
DPLDCHN5454	1.3 x 54 x 54	70	42	3.63	\$1112
DPLDCHN5460	1.3 x 60 x 54	70	47	4.02	\$1184
DPLDCHN6624	1.3 x 24 x 66	65	23	2.04	\$842
DPLDCHN6630	1.3 x 30 x 66	70	29	2.52	\$922
DPLDCHN6636	1.3 x 36 x 66	70	35	3	\$998
DPLDCHN6642	1.3 x 42 x 66	70	41	3.46	\$1074
DPLDCHN6648	1.3 x 48 x 66	70	47	3.93	\$1154
DPLDCHN6654	1.3 x 54 x 66	70	53	4.40	\$1234
DPLDCHN6660	1.3 x 60 x 66	70	59	4.90	\$1310

Leveler on one leg and double locking caster base on the other. Freestanding.

LINKING PANEL ACCESSORIES



Wall Connection

MODEL#	DIMENSIONS	FREIGHT CLASS	WT./LBS.	CUBIC FT.	LIST PRICE
DPLWA54	2 x 2 x 54	70	2.3	0.13	\$178
DPLWA66	2 x 2 x 66	65	3.5	0.15	\$203

Connects linking panels to walls. Available in Designer White (**DWT**) or Tungsten (**TUN**) paint finish. Kit consists of vertical extrusion, charcoal PVC cover and hinge kits.

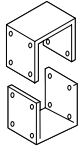

Expanding Kit

DPLEKIT	2 x 2 x 3	70	1	.05	\$310
---------	-----------	----	---	-----	--------------

Connects two linking panels in a straight line. This kit will accommodate any special width by overlapping the panels. Available in Designer White (**DWT**) or Tungsten (**TUN**) paint finish. Kit consists of a top and bottom bracket and all necessary hardware.

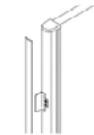

Door and Door Catch Kit

DPDC01	1.3 x 3 x 6	60	2	.05	\$195
--------	-------------	----	---	-----	--------------

Converts any linking panel into a door. Available in Designer White (**DWT**) or Tungsten (**TUN**) paint finish. Kit consists of striker plate, two hinge kits, single caster foot assembly and 1" caster.

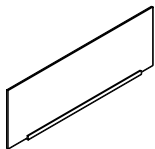

PET Felt Over Panel

DPLOP24	1.05 x 24 x 16.8	70	1.74	.39	\$161
DPLOP30	1.05 x 30 x 16.8	150	2.20	.49	\$191
DPLOP36	1.05 x 36 x 16.8	150	2.67	.59	\$223
DPLOP42	1.05 x 42 x 16.8	150	3.14	.70	\$247
DPLOP48	1.05 x 48 x 16.8	150	3.60	.80	\$368
DPLOP54	1.05 x 54 x 16.8	150	4.07	.90	\$398
DPLOP60	1.05 x 60 x 16.8	150	4.53	1.01	\$431

For laminate panels. Sits atop laminate panel and bridges the gap between the 66"H laminate linking panel and top of the consultation booth. Available in Designer White (**DWT**) or Tungsten (**TUN**) paint finish. Kit contains aluminum extrusion and felt insert.

Required Specifications

Finish