

# seating

## Private + Public + Individual + Group Applications

Application guidelines.....	57	GC Citi.....	138
Adeline.....	58	GC Comet.....	139
Bishop.....	60	GC Islands.....	140
Calidon.....	61	GC Sidero.....	141
Chap.....	69	GC Sirena.....	151
Coast.....	71	GC Vitrola.....	157
Collingwood.....	72	GC Vion.....	153
Comprise.....	74	GC Wind.....	155
Desmond.....	92	Janna.....	160
Desmond HT.....	93	Nourish.....	161
Doctor Buddy.....	95	Oakville.....	165
Dreme.....	96	Primacare.....	166
Drift.....	99	River+.....	232
Erin.....	100	Senator.....	233
Flap.....	102	Sleep-Eez.....	234
Foot Activated Stools.....	104	Splash.....	105
Frolick.....	105	Strand.....	235
Gala II.....	110	Willow.....	241
GC Beach.....	111	Wingback.....	255
GC Belong.....	112		

SERIES	WOOD	METAL	BARIATRIC SEATING	DINING / CAFETERIA	GUEST SEATING	LOBBIES	LOUNGE / WAITING	OFFICE / MEETING	PATIENT ROOMS	RESIDENT ROOMS	STACKING	TREATMENT / EXAM ROOMS
ADELINE		•	•		•	•	•		•	•		•
BISHOP	•					•	•			•		
CALIDON	•		•		•	•	•		•	•		•
CHAP	•			•	•	•	•	•	•	•		
COAST	•						•		•	•		
COLLINGWOOD	•			•	•	•	•		•	•		
COMPRISE		•	•		•	•	•		•	•		•
DESMOND	•			•	•	•	•	•	•	•		
DESMOND HT		•	•	•	•	•	•	•	•	•		
DOCTOR BUDDY		•		•				•	•	•		•
DREME									•	•		
ERIN	•	•		•	•	•	•		•	•		
FLAP				•	•						•	•
FOOT ACTIVATED STOOLS				•				•	•	•		•
FROLICK		•	•	•	•	•	•	•	•	•	•	•
GALA II		•						•				•
GC BEACH	•			•	•	•	•	•	•	•		
GC BELONG		•	•		•	•	•		•	•		•
GC CITI		•			•	•	•					
GC COMET	•	•	•	•	•	•	•	•	•	•	•	•
GC ISLANDS	•			•	•	•	•	•	•	•		
GC SIDERO		•	•	•	•	•	•	•	•	•	•	•
GC SIRENA	•			•	•	•	•	•	•	•		
GC VION								•				
GC VITROLA	•		•		•	•	•		•	•		
GC WIND		•				•	•	•	•	•		
JANNA	•			•	•		•	•	•	•		•
NOURISH		•	•				•		•	•		•
OAKVILLE	•				•	•	•		•	•		
OTTOMANS	•	•			•	•	•		•	•		•
PRIMACARE	•		•	•	•	•	•		•	•		•
PRIMACARE HT		•	•	•	•	•	•		•	•		•
PRIMACARE MODULAR	•		•	•	•	•	•					
PRIMACARE WINGBACK	•	•	•		•	•	•		•	•		
SENATOR	•	•				•	•		•	•		
SLEEP-EEZ					•				•	•		
SPLASH		•		•	•	•	•	•	•	•	•	•
STRAND	•	•	•		•	•	•		•	•		•
THROW PILLOWS						•	•			•		
WILLOW		•	•	•	•	•	•	•	•	•	•	•
WINGBACK	•				•	•	•		•	•		

**ADELINE**



**model GC7680**  
Curved high flex back armchair



**model GC7693**  
Straight high fixed back armchair, sled base



**model GC7694**  
Straight low fixed back armchair, bariatric

**Two Textile Application**



**model GC7692**  
Straight high fixed back armchair

**STANDARD FEATURES**

- The Adeline series is an ideal solution for patient or guest seating. The series includes fixed and flex back patient chairs with a choice between models with curved upper back or a straight upper back design. The straight top back design offers an upper, contoured headrest area. A low, straight back bariatric model is also available.
- The flex back moves with the user, providing comfort and support while seated.
- Sleek oval tube steel frame available in powder coat, painted finishes. See options.
- Armcaps are available in standard healthcare urethane finishes. See options.
- Seats have a seamless, waterfall front edge and include an underseat, water resistant, coated liner. Select sealed underside (**SU**) for added protection. See upcharge. Standard seat height on all models is 18"
- Seat and back are standard with high density Ultracell foam and include a clean out space.
- Sealed seat seams may be specified with approved coated textiles (vinyl, silicone, polyurethane) to mitigate liquid penetration at seams. Specify (**SE**) for sealed seat seams. See upcharge.
- Curved back models have zipper closures. Straight back models have a staple strip closure. For sealed back seams, specify (**SWZ**) Sealed Back Seams with Zipper for curved back models and (**S2**) Sealed Back Seams on straight back models. See upcharge.
- Note: minor puckering is common with the addition of sealed seams due to material buildup at corners.
- A moisture barrier is available on seats to create an impervious barrier between the upholstery cover and cushion, specify (**MB**). See upcharge. Moisture barrier is not recommended with coated textiles (vinyl, silicone, polyurethane, etc.). Moisture barrier **may not be specified** when sealed seams are selected on seats.
- Bariatric model GC7694 has a low, straight back with a 28" wide seat. An upholstered, structural side panel is included on either side of the frame. Choose a coordinating Allante FFree vinyl color to complement armcap colors, see options.
- Standard with Black, nylon glides. An optional, natural nylon, non-marking glide is available.
- Optional tamperproof fasteners (**TF**) are available. See upcharge.
- Active weight capacity is 350 lbs. for standard seating and 750 lbs. for Bariatric seating.





- Chairs may be specified with contrasting fabrics. Specify seat cushion separate from back cushion. For pricing, start with the base price and add applicable graded textile upcharges for both back and seat textile selections.
- The blended textile matrix does not apply to this series when specified as noted above. For alternate textile applications, contact Customer Care.
- The series is covered under Global's Healthcare warranty for 12 years, 24/7 use when specified with approved healthcare textiles and maintained according to warranty.
- For healthcare textiles and finish options, visit the website at [globalfurnituregroup.com](http://globalfurnituregroup.com)
- Can be upholstered in standard Global textiles if healthcare compliance is not required.
- Shipped fully assembled.

Add option codes in the following order:

- **Model number**  
Enter model number
- **Back Textile**  
Specify back textile
- **Seat Textile**  
Specify seat textile
- **Seat Underside**  
(**CL**) Coated textile liner. No upcharge.  
(**SU**) Sealed underside. Add \$49. For Bariatric, add \$73.
- **Frame Finish**  
(**TBL**) Black  
(**TFO**) Fog  
(**TKA**) Kalua  
(**TLA**) Latte  
(**TMO**) Mocha  
(**TNE**) Nevada  
(**TSH**) Shadow  
(**TOA**) Toast  
(**TTU**) Tungsten
- **Armcap Finish**  
(**BLK**) Black  
(**KAL**) Kalua  
(**LAB**) Latte  
(**J52**) Mocha  
(**SHW**) Shadow  
(**TOA**) Toast
- **Side Panel Finish** (Bariatric chair only)  
Specify Allante FFree Vinyl color to coordinate with armcap finish as noted:  
For TOA:  
(**A12**) Allante Gibraltar A12F  
(**A01**) Allante Illusion A01F  
For SHW:  
(**A12**) Allante Gibraltar A12F  
For LAB:  
(**A01**) Allante Illusion A01F  
For BLK:  
(**A16**) Allante Ink Black A16F  
For J52:  
(**A08**) Allante Warm Smoke A08F  
For KAL:  
(**A23**) Allante Chocolate Sundae A23F
- **Glides**  
(**BK**) Black nylon glide for most floor surfaces. No upcharge.  
(**NM**) Natural, non-marking nylon glide for most floor surfaces. No upcharge.
- **Back Seams**  
(**NS**) No sealed seams  
(**SWZ**) Sealed back seams and waterproof zipper (*curved back models only*). Add \$70.  
(**S2**) Sealed back seams (*straight back models only*). Add \$52. For Bariatric, add \$110.
- **Seat Seams**  
(**NS**) No sealed seams  
(**SE**) Sealed seat seams. Add \$15. For Bariatric, add \$20.
- **Seat Moisture Barrier** (not available with sealed seams)  
(**NB**) No barrier  
(**MB**) Moisture barrier on seat. Add \$137. For Bariatric, add \$169.
- **Tamperproof Fasteners**  
(**RS**) Standard fasteners  
(**TP**) Tamperproof Fasteners. Add \$32.

DESCRIPTION	MODEL#/ FEATURES	STANDARD TEXTILE GRADES											
		COM/1	2	3	4	5	6	7	8	9	10	11	12
	<b>GC7680</b> Base Price:												
	Back upcharge:	\$-42	+0	+\$34	+\$83	+\$152	+\$180	+\$239	+\$333	+\$403	+\$479	+\$639	+\$807
	Seat upcharge:	\$-25	+0	+\$21	+\$50	+\$91	+\$108	+\$144	+\$200	+\$242	+\$288	+\$384	+\$484
		OVERALL DIMENSIONS			SEAT DIMENSIONS			BACK DIMENSIONS					
		W	D	H	W	D	H	W	H				
<b>Curved High Flex Back Armchair</b> COM Yardage: Back: 1.25; Seat: .75 Freight Class: 250 Product Weight (lbs.): 40 Cubic Feet Per Carton: 20	Active weight 350 lbs.	25.5	28	45	19.5	18	18	18	27				

# SEATING

DESCRIPTION	MODEL#/ FEATURES	STANDARD TEXTILE GRADES											
		COM/1	2	3	4	5	6	7	8	9	10	11	12
 <p><b>Curved High Fixed Back Armchair</b> COM Yardage: Back: 1.25; Seat: .75 Freight Class: 250 Product Weight (lbs.): 46 Cubic Feet Per Carton: 20</p>	<b>GC7681</b> Base Price:	<b>\$1971</b>											
	Back upcharge:	<b>-\$42</b>	<b>+0</b>	<b>+\$34</b>	<b>+\$83</b>	<b>+\$152</b>	<b>+\$180</b>	<b>+\$239</b>	<b>+\$333</b>	<b>+\$403</b>	<b>+\$479</b>	<b>+\$639</b>	<b>+\$807</b>
	Seat upcharge:	<b>-\$25</b>	<b>+0</b>	<b>+\$21</b>	<b>+\$50</b>	<b>+\$91</b>	<b>+\$108</b>	<b>+\$144</b>	<b>+\$200</b>	<b>+\$242</b>	<b>+\$288</b>	<b>+\$384</b>	<b>+\$484</b>
	<b>OVERALL DIMENSIONS</b>			<b>SEAT DIMENSIONS</b>			<b>BACK DIMENSIONS</b>						
		<b>W</b>	<b>D</b>	<b>H</b>	<b>W</b>	<b>D</b>	<b>H</b>	<b>W</b>	<b>H</b>				
	25.5	28	45	19.5	18	18	18	27					
 <p><b>Straight High Fixed Back Armchair</b> COM Yardage: Back: 1.25; Seat: .75 Freight Class: 250 Product Weight (lbs.): 45 Cubic Feet Per Carton: 20</p>	<b>GC7692</b> Base Price:	<b>\$1835</b>											
	Back upcharge:	<b>-\$42</b>	<b>+0</b>	<b>+\$34</b>	<b>+\$83</b>	<b>+\$152</b>	<b>+\$180</b>	<b>+\$239</b>	<b>+\$333</b>	<b>+\$403</b>	<b>+\$479</b>	<b>+\$639</b>	<b>+\$807</b>
	Seat upcharge:	<b>-\$25</b>	<b>+0</b>	<b>+\$21</b>	<b>+\$50</b>	<b>+\$91</b>	<b>+\$108</b>	<b>+\$144</b>	<b>+\$200</b>	<b>+\$242</b>	<b>+\$288</b>	<b>+\$384</b>	<b>+\$484</b>
	<b>OVERALL DIMENSIONS</b>			<b>SEAT DIMENSIONS</b>			<b>BACK DIMENSIONS</b>						
		<b>W</b>	<b>D</b>	<b>H</b>	<b>W</b>	<b>D</b>	<b>H</b>	<b>W</b>	<b>H</b>				
	25.5	26.5	45	19.5	18.5	18	20	27					
 <p><b>Straight Low Fixed Back Armchair, Bariatric</b> COM Yardage: Back: 3.25 Freight Class: 250 Product Weight (lbs.): 71 Cubic Feet Per Carton: 23</p>	<b>GC7694</b> Base Price:	<b>\$2751</b>											
	Back upcharge:	<b>-\$67</b>	<b>+0</b>	<b>+\$54</b>	<b>+\$132</b>	<b>+\$242</b>	<b>+\$288</b>	<b>+\$382</b>	<b>+\$532</b>	<b>+\$644</b>	<b>+\$766</b>	<b>+\$1022</b>	<b>+\$1290</b>
	Seat upcharge:	<b>-\$42</b>	<b>+0</b>	<b>+\$34</b>	<b>+\$83</b>	<b>+\$152</b>	<b>+\$180</b>	<b>+\$239</b>	<b>+\$333</b>	<b>+\$403</b>	<b>+\$479</b>	<b>+\$639</b>	<b>+\$807</b>
	<b>OVERALL DIMENSIONS</b>			<b>SEAT DIMENSIONS</b>			<b>BACK DIMENSIONS</b>						
		<b>W</b>	<b>D</b>	<b>H</b>	<b>W</b>	<b>D</b>	<b>H</b>	<b>W</b>	<b>H</b>				
	32.5	26.5	40.5	28	18.5	18	27	23.5					
 <p><b>Straight High Flex Back Armchair</b> COM Yardage: 2 Freight Class: 250 Product Weight (lbs.): 43 Cubic Feet Per Carton: 20</p>	<b>GC7696</b> Base Price:	<b>\$1834</b>											
	Back upcharge:	<b>-\$42</b>	<b>+0</b>	<b>+\$34</b>	<b>+\$83</b>	<b>+\$152</b>	<b>+\$180</b>	<b>+\$239</b>	<b>+\$333</b>	<b>+\$403</b>	<b>+\$479</b>	<b>+\$639</b>	<b>+\$807</b>
	Seat upcharge:	<b>-\$25</b>	<b>+0</b>	<b>+\$21</b>	<b>+\$50</b>	<b>+\$91</b>	<b>+\$108</b>	<b>+\$144</b>	<b>+\$200</b>	<b>+\$242</b>	<b>+\$288</b>	<b>+\$384</b>	<b>+\$484</b>
	<b>OVERALL DIMENSIONS</b>			<b>SEAT DIMENSIONS</b>			<b>BACK DIMENSIONS</b>						
		<b>W</b>	<b>D</b>	<b>H</b>	<b>W</b>	<b>D</b>	<b>H</b>	<b>W</b>	<b>H</b>				
	25.5	26.5	45	19.5	18.5	18	20	27					
 <p><b>Straight High Fixed Back Armchair, Sled Base</b> COM Yardage: Back: 1.25; Seat: .75 Freight Class: 250 Product Weight (lbs.): 47 Cubic Feet Per Carton: 20</p>	<b>GC7693</b> Base Price:	<b>\$1942</b>											
	Back upcharge:	<b>-\$42</b>	<b>+0</b>	<b>+\$34</b>	<b>+\$83</b>	<b>+\$152</b>	<b>+\$180</b>	<b>+\$239</b>	<b>+\$333</b>	<b>+\$403</b>	<b>+\$479</b>	<b>+\$639</b>	<b>+\$807</b>
	Seat upcharge:	<b>-\$25</b>	<b>+0</b>	<b>+\$21</b>	<b>+\$50</b>	<b>+\$91</b>	<b>+\$108</b>	<b>+\$144</b>	<b>+\$200</b>	<b>+\$242</b>	<b>+\$288</b>	<b>+\$384</b>	<b>+\$484</b>
	<b>OVERALL DIMENSIONS</b>			<b>SEAT DIMENSIONS</b>			<b>BACK DIMENSIONS</b>						
		<b>W</b>	<b>D</b>	<b>H</b>	<b>W</b>	<b>D</b>	<b>H</b>	<b>W</b>	<b>H</b>				
	25.5	26.5	45	19.5	18.5	18	20	27					

**BISHOP**



model GC3751

**STANDARD FEATURES**

- Bishop offers a classic, traditional, rolled arm style design.
- Features removable and replaceable seat cushions
- Wood frame and hardwood block legs are available in a variety of finishes: erry (ACM), English Oak (EOM), Espresso Cafe (ECM), Fruitwood (TFM), Honey (AHM), Mahogany (TMM), Maple (AVM), Natural Walnut (NLW), Noce Biondo (NBM), Noce Grigio (NGM), Noce Leggero (NEM), Noce Medio (NMM), Sandy Beach (SKM), and Walnut (TWM). Please specify.
- For added comfort, seat and back are standard with high density Ultracell foam.
- Opaque non-marking glides are standard
- For healthcare textiles and finish options, visit the website at [globalfurnituregroup.com](http://globalfurnituregroup.com)
- Can be upholstered in standard Global textiles if healthcare compliance is not required.
- Shipped fully assembled.
- Standard glide is plastic.

**OPTIONAL FEATURES**

- For non-slip glides, specify **(NS)**. Add \$37
- For moisture barrier on seat, please specify **(MB)**. Add \$204 per seat.

**SUGGESTED APPLICATIONS**

- Lobbies
- Lounge/Waiting
- Resident rooms

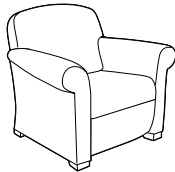
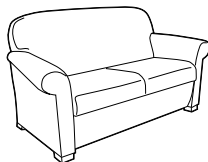
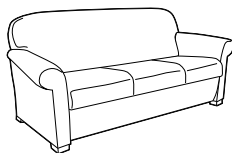
DESCRIPTION	MODEL#/ FEATURES	STANDARD TEXTILE GRADES											
		COM	2	3	4	5	6	7	8	9	10	11	12
 <p><b>Lounge Chair</b> COM Yardage: 7.25 Freight Class: 250 Product Weight (lbs.): 75 Cubic Feet Per Carton: 30.25</p> <p>Active weight 300 lbs. Loose seat cushion.</p>	<b>GC3751</b>	\$2737	\$3000	\$3219	\$3535	\$3986	\$4159	\$4555	\$5293	\$5668	\$6358	\$7315	\$8500
	<b>OVERALL DIMENSIONS</b>			<b>SEAT DIMENSIONS</b>			<b>BACK DIMENSIONS</b>						
	<b>W</b>	<b>D</b>	<b>H</b>	<b>W</b>	<b>D</b>	<b>H</b>	<b>W</b>	<b>H</b>					
	37	32	34.5	21	18.5	17	28	17.5					
 <p><b>Two Seat Sofa</b> COM Yardage: 8.75 Freight Class: 250 Product Weight (lbs.): 112 Cubic Feet Per Carton: 55.75</p> <p>Active weight 300 lbs./seat. Loose seat cushions.</p>	<b>GC3752</b>	\$3866	\$4183	\$4445	\$4830	\$5375	\$5579	\$6055	\$6953	\$7401	\$8235	\$9390	\$10821
	<b>OVERALL DIMENSIONS</b>			<b>SEAT DIMENSIONS</b>			<b>BACK DIMENSIONS</b>						
	<b>W</b>	<b>D</b>	<b>H</b>	<b>W</b>	<b>D</b>	<b>H</b>	<b>W</b>	<b>H</b>					
	63.5	32	34.5	47.5	18.5	17	55	17.5					
 <p><b>Three Seat Sofa</b> COM Yardage: 12 Freight Class: 250 Product Weight (lbs.): 155 Cubic Feet Per Carton: 74.75</p> <p>Active weight 300 lbs./seat. Loose seat cushions.</p>	<b>GC3753</b>	\$5715	\$6103	\$6744	\$7263	\$7992	\$8265	\$8909	\$10112	\$10712	\$11832	\$13387	\$15306
	<b>OVERALL DIMENSIONS</b>			<b>SEAT DIMENSIONS</b>			<b>BACK DIMENSIONS</b>						
	<b>W</b>	<b>D</b>	<b>H</b>	<b>W</b>	<b>D</b>	<b>H</b>	<b>W</b>	<b>H</b>					
	90	32	34.5	74	18.5	17	82	17.5					

CALIDON



**GC36305**  
Wood Lounge Single Seat



**GC36301**  
Wood Guest Single Seat



**GC36308**  
Fully Upholstered Lounge Single Seat



For Calidon tables, see page 66.

EXAMPLE CALIDON ORDER CODE:

GC36308	PU75	PU75	AAM	NBS
Model #	Back/Arm textile	Seat textile	Frame Finish	Sealed Back Seams
NSS	NB	NM	SRT	
Sealed Seat Seams	Moisture Barrier	Glides	Power	

STANDARD FEATURES

- Calidon series consists of wood frame guest, lounge, bariatric and bench seating in addition to fully upholstered lounge seating. Freestanding and tandem/bridge tables also available to complement the line.
  - Calidon is designed for the rigors of high use environments. Lounge units include metal frame supports.
  - The seating in this series is available to specify with two textiles, one for the seat cushion and one for the back and arms (see model image).
  - For pricing, start with the base price and add both back/arms graded textile upcharge and the seat graded textile upcharge.
  - Frame design features a wall saver leg to prevent back contact and damage to walls.
  - All guest and lounge chairs feature a clean out between seat and back, replaceable seat cushions and tall legs for ease of cleaning.
  - For added comfort, seats are standard with high density Ultracell foam.
  - Active weight capacity up to 400 lbs/seat for standard seating; up to 600 lbs for bariatric seating .
  - For healthcare textiles, visit the website at [globalfurnituregroup.com](http://globalfurnituregroup.com).
  - Textiles with a minimum of 100,000 double rubs must be specified to meet Global's 24/7 warranty coverage.
  - Can be upholstered in standard Global textiles if Healthcare 24/7 warranty compliance is not required.
  - For alternate textile applications, contact Global specials. The Blended Textile matrix does not apply to this series.
  - Tandem table models connect to guest seating only. See Calidon tables.
  - No seating or bench models gang together.
  - Shipped fully assembled.
- OPTIONAL FEATURES**
- All guest and lounge models can be specified with or without armcaps. Urethane armcaps are available on Wood arm guest and lounge chairs. Solid surface armcaps are available on all chair models. Armcaps are field replaceable, securely fastened with metal-to-metal connectors. Armcaps cannot be retrofitted in the field on units with no existing armcaps.
  - Fully upholstered lounge chairs can be specified with a tamperproof Black power/USB unit, which includes one AC outlet, two 10 watt USB ports, and a 10 ft long power cord. Power is factory installed and must be specified at time of order. Add **\$251** each. Power locations vary by model. See power location diagram.
  - For moisture barrier on seat, specify **(MB)**. Upcharges vary, see model.
  - To add sealed seams, specify **(SBS)** for seat back and arms and/or **(SSS)** for seat. Upcharges vary, see model.
  - A tamperproof power unit is available to specify in various locations on closed arm lounge models only. See diagrams.

SUGGESTED APPLICATIONS

- Guest seating
- Lobby/Lounge
- Treatment/Exam rooms

Please add option codes in the following order:

- **Model number**  
See models.  
For Calidon tables, refer to 66
- **Back/Arm Textile**  
Specify textile code. See model grade upcharges.
- **Seat Textile**  
Specify textile code. See model grade upcharges.
- **Armcap option**  
**(FNA)** No armcaps  
**(FAC)** With armcaps. Upcharges vary, see model.
- **Frame finish**  
**(AAM)** Absolute  
**(BKM)** Black  
**(ACM)** Cherry  
**(EOM)** English Oak  
**(ECM)** Espresso Cafe  
**(TFM)** Fruitwood  
**(HGM)** Grey  
**(AHM)** Honey  
**(JOM)** Jet Onyx  
**(TMM)** Mahogany  
**(AVM)** Maple  
**(WHM)** White  
**(MWM)** Medium Walnut  
**(NLW)** Natural Walnut  
**(ASM)** Night  
**(NBM)** Noce Biondo  
**(NGM)** Noce Grigio  
**(NEM)** Noce Leggero  
**(NMM)** Noce Medio  
**(SBM)** Sandy Beach  
**(SKM)** Shaker Cherry  
**(TWM)** Walnut  
**(WTM)** WC Cream  
**(WCM)** Winter Cherry
- **Armcap finish**  
**(SSU)** Urethane (for wood arm models of guest and lounge seating with FAC specified).  
Urethane finishes (upcharges vary, see model):  
**(BLK)** Black  
**(KAL)** Kalua  
**(LAB)** Latte  
**(J52)** Mocha  
**(SHW)** Shadow  
**(TOA)** Toast  
**(CO)** Solid Surface (for all wood and fully upholstered arm models with FAC specified).  
Solid Surface Finishes:  
Grade 1: (Upcharges vary, see model)  
**(SWH)** Designer White  
Grade 2: (Upcharges vary, see model)  
**(SBT)** Beige Tempest  
**(SBX)** Black Onyx Mirage  
**(SMG)** Milk Glass Spectra  
**(SFW)** Frosty White Mirage  
**(SHS)** Hot Stone  
**(SNM)** Northern Melange
- **Sealed Back Seams** (Contact Customer Care for approved textiles.)  
**(NBS)** No sealed back seams  
**(SBS)** Sealed back seams. Upcharges vary, see model.
- **Sealed Seat Seams** (Contact Customer Care for approved textiles.)  
**(NSS)** No sealed seat seams  
**(SSS)** Sealed seat seams. Upcharges vary, see model.
- **Glides**  
**(NM)** Non-marking  
**(NS)** Non-slip  
Guest single seat, bariatric and lounge chairs, add \$31.  
Guest two seater, add \$47.  
Guest three seater, add \$60.
- **Moisture Barrier** (seat only) (Not available with Sealed Seams)  
**(NB)** No moisture barrier  
**(MB)** Moisture barrier. Upcharges vary, see model.
- **Power/USB unit position** (lounge models only). Add **\$251**.  
**(NPM)** No power  
**(TPM)** Tamperproof power unit  
**(J)** Black  
**(SRT)** Side right  
**(SLT)** Side left  
**(FLT)** Front left (three seater only)  
**(FRT)** Front right (three seater only)  
**(CRF)** Center front (two seater only)  
**(SLR)** Side left and right. Add **\$498**.  
**(FLR)** Front left and right. Add **\$498**.

## POWER LOCATION DIAGRAM

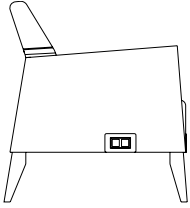

Right Side Power (**SRT**)  
Models GC36308, GC36309 and GC36310

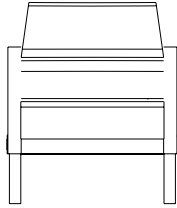

Front Power Not Available  
Model GC36308

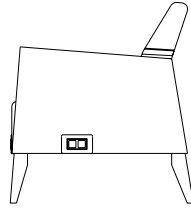

Left Side Power (**SLT**)  
Models GC36308, GC36309 and GC36310

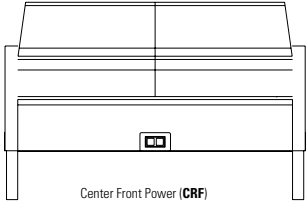



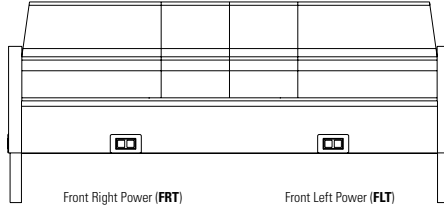







Center Front Power (**CRF**)  
Model GC36309 only





Front Right Power (**FRT**)  
Model GC36310 only

Front Left Power (**FLT**)  
Model GC36310 only

DESCRIPTION	MODEL#/ FEATURES	STANDARD TEXTILE GRADES											
		1/COM	2	3	4	5	6	7	8	9	10	11	12
 <p><b>Wood Guest Single Seat</b> COM Yardage: Back: 0.9; Seat: 1 Freight Class: 250 Product Weight (lbs.): 38 Cubic Feet Per Carton: 16.5</p>	<b>GC36301</b>	Base Price:	<b>\$1261</b>										
	Back upcharge:	<b>+0</b>	<b>+\$31</b>	<b>+\$55</b>	<b>+\$90</b>	<b>+\$140</b>	<b>+\$161</b>	<b>+\$203</b>	<b>+\$271</b>	<b>+\$321</b>	<b>+\$376</b>	<b>+\$491</b>	<b>+\$611</b>
	Seat upcharge:	<b>+0</b>	<b>+\$34</b>	<b>+\$61</b>	<b>+\$100</b>	<b>+\$155</b>	<b>+\$178</b>	<b>+\$225</b>	<b>+\$300</b>	<b>+\$356</b>	<b>+\$417</b>	<b>+\$545</b>	<b>+\$679</b>
	Active weight 400 lbs.	<b>OVERALL DIMENSIONS</b>			<b>SEAT DIMENSIONS</b>			<b>BACK DIMENSIONS</b>					
		<b>W</b>	<b>D</b>	<b>H</b>	<b>W</b>	<b>D</b>	<b>H</b>	<b>W</b>	<b>H</b>				
	23.5	26.5	34.5	21.5	18	18	21.5	16.5					
 <p><b>Wood Guest Two Seater, Full Center Arm</b> COM Yardage: Back: 1.8; Seat: 2 Freight Class: 250 Product Weight (lbs.): 68 Cubic Feet Per Carton: 31.75</p>	<b>GC36302</b>	Base Price:	<b>\$2333</b>										
	Back upcharge:	<b>+0</b>	<b>+\$62</b>	<b>+\$109</b>	<b>+\$180</b>	<b>+\$278</b>	<b>+\$320</b>	<b>+\$406</b>	<b>+\$541</b>	<b>+\$641</b>	<b>+\$751</b>	<b>+\$981</b>	<b>+\$1222</b>
	Seat upcharge:	<b>+0</b>	<b>+\$68</b>	<b>+\$121</b>	<b>+\$199</b>	<b>+\$309</b>	<b>+\$355</b>	<b>+\$450</b>	<b>+\$600</b>	<b>+\$712</b>	<b>+\$834</b>	<b>+\$1089</b>	<b>+\$1357</b>
	Active weight 400 lbs./seat	<b>OVERALL DIMENSIONS</b>			<b>SEAT DIMENSIONS</b>			<b>BACK DIMENSIONS</b>					
		<b>W</b>	<b>D</b>	<b>H</b>	<b>W</b>	<b>D</b>	<b>H</b>	<b>W</b>	<b>H</b>				
	46	26.5	34.5	21.5	18	18	21.5	16.5					
 <p><b>Wood Guest Three Seater, Full Center Arms</b> COM Yardage: Back: 2.7; Seat: 3 Freight Class: 250 Product Weight (lbs.): 101 Cubic Feet Per Carton: 47.5</p>	<b>GC36303</b>	Base Price:	<b>\$3435</b>										
	Back upcharge:	<b>+0</b>	<b>+\$92</b>	<b>+\$163</b>	<b>+\$268</b>	<b>+\$417</b>	<b>+\$479</b>	<b>+\$608</b>	<b>+\$810</b>	<b>+\$961</b>	<b>+\$1126</b>	<b>+\$1471</b>	<b>+\$1833</b>
	Seat upcharge:	<b>+0</b>	<b>+\$102</b>	<b>+\$181</b>	<b>+\$298</b>	<b>+\$463</b>	<b>+\$532</b>	<b>+\$675</b>	<b>+\$899</b>	<b>+\$1067</b>	<b>+\$1251</b>	<b>+\$1634</b>	<b>+\$2036</b>
	Active weight 400 lbs./seat	<b>OVERALL DIMENSIONS</b>			<b>SEAT DIMENSIONS</b>			<b>BACK DIMENSIONS</b>					
		<b>W</b>	<b>D</b>	<b>H</b>	<b>W</b>	<b>D</b>	<b>H</b>	<b>W</b>	<b>H</b>				
	68	26.5	34.5	21.5	18	18	21.5	16.5					
 <p><b>Wood Guest Bariatric Chair</b> COM Yardage: Back: 1.25; Seat: 1.25 Freight Class: 250 Product Weight (lbs.): 55 Cubic Feet Per Carton: 22.25</p>	<b>GC36304</b>	Base Price:	<b>\$1928</b>										
	Back upcharge:	<b>+0</b>	<b>+\$43</b>	<b>+\$76</b>	<b>+\$125</b>	<b>+\$194</b>	<b>+\$222</b>	<b>+\$282</b>	<b>+\$375</b>	<b>+\$446</b>	<b>+\$522</b>	<b>+\$681</b>	<b>+\$849</b>
	Seat upcharge:	<b>+0</b>	<b>+\$43</b>	<b>+\$76</b>	<b>+\$125</b>	<b>+\$194</b>	<b>+\$222</b>	<b>+\$282</b>	<b>+\$375</b>	<b>+\$446</b>	<b>+\$522</b>	<b>+\$681</b>	<b>+\$849</b>
	Active weight 600 lbs.	<b>OVERALL DIMENSIONS</b>			<b>SEAT DIMENSIONS</b>			<b>BACK DIMENSIONS</b>					
		<b>W</b>	<b>D</b>	<b>H</b>	<b>W</b>	<b>D</b>	<b>H</b>	<b>W</b>	<b>H</b>				
	32.75	26.5	34.5	31	18	18	30.5	16.5					
 <p><b>Wood Lounge Single Seat</b> COM Yardage: Back: 1.25; Seat: 1.25 Freight Class: 250 Product Weight (lbs.): 49 Cubic Feet Per Carton: 18.25</p>	<b>GC36305</b>	Base Price:	<b>\$1762</b>										
	Back upcharge:	<b>+0</b>	<b>+\$43</b>	<b>+\$76</b>	<b>+\$125</b>	<b>+\$194</b>	<b>+\$222</b>	<b>+\$282</b>	<b>+\$375</b>	<b>+\$446</b>	<b>+\$522</b>	<b>+\$681</b>	<b>+\$849</b>
	Seat upcharge:	<b>+0</b>	<b>+\$43</b>	<b>+\$76</b>	<b>+\$125</b>	<b>+\$194</b>	<b>+\$222</b>	<b>+\$282</b>	<b>+\$375</b>	<b>+\$446</b>	<b>+\$522</b>	<b>+\$681</b>	<b>+\$849</b>
	Active weight 400 lbs.	<b>OVERALL DIMENSIONS</b>			<b>SEAT DIMENSIONS</b>			<b>BACK DIMENSIONS</b>					
		<b>W</b>	<b>D</b>	<b>H</b>	<b>W</b>	<b>D</b>	<b>H</b>	<b>W</b>	<b>H</b>				
	25.75	29.5	32.5	24	21	16	23.5	16.5					

DESCRIPTION	MODEL#/ FEATURES	STANDARD TEXTILE GRADES												
		1/COM	2	3	4	5	6	7	8	9	10	11	12	
 <p><b>Wood Lounge Two Seater</b> COM Yardage: Back: 1.75; Seat: 2.25 Freight Class: 250 Product Weight (lbs.): 77 Cubic Feet Per Carton: 32.75</p>	GC36306	Base Price: <b>\$2478</b>												
		Back upcharge:	+0	+\$60	+\$106	+\$175	+\$271	+\$311	+\$394	+\$525	+\$623	+\$731	+\$953	+\$1188
		Seat upcharge:	+0	+\$76	+\$137	+\$224	+\$348	+\$399	+\$507	+\$675	+\$801	+\$938	+\$1225	+\$1527
		Active weight 400 lbs./seat	<b>OVERALL DIMENSIONS</b>			<b>SEAT DIMENSIONS</b>			<b>BACK DIMENSIONS</b>					
			W	D	H	W	D	H	W	H				
		47.5	29.5	32.5	45	21	16	44.5	16.5					
	Add \$177 for Urethane armcaps Add \$432 for (CO) Grade 1 armcaps Add \$457 for (CO) Grade 2 armcaps Add \$264 for (MB) Add \$51 for (SSS), \$67 for (SBS)													
 <p><b>Wood Lounge Three Seater</b> COM Yardage: Back: 2.5; Seat: 2.75 Freight Class: 250 Product Weight (lbs.): 109 Cubic Feet Per Carton: 50.75</p>	GC36307	Base Price: <b>\$3098</b>												
		Back upcharge:	+0	+\$85	+\$151	+\$248	+\$386	+\$444	+\$563	+\$750	+\$890	+\$1043	+\$1361	+\$1697
		Seat upcharge:	+0	+\$93	+\$166	+\$274	+\$425	+\$488	+\$619	+\$824	+\$978	+\$1147	+\$1498	+\$1867
		Active weight 400 lbs./seat	<b>OVERALL DIMENSIONS</b>			<b>SEAT DIMENSIONS</b>			<b>BACK DIMENSIONS</b>					
			W	D	H	W	D	H	W	H				
		70.5	29.5	32.5	68	21	16	67.5	16.5					
	Add \$177 for Urethane armcaps Add \$432 for (CO) Grade 1 armcaps Add \$457 for (CO) Grade 2 armcaps Add \$394 for (MB) Add \$67 for (SSS), \$85 for (SBS)													
 <p><b>Fully Upholstered Lounge Single Seat</b> COM Yardage: Back/Arm: 2.75; Seat: 1.25 Freight Class: 250 Product Weight (lbs.): 58 Cubic Feet Per Carton: 18.75</p>	GC36308	Base Price: <b>\$1998</b>												
		Back/Arm upcharge:	+0	+\$93	+\$166	+\$274	+\$425	+\$488	+\$619	+\$824	+\$978	+\$1147	+\$1498	+\$1867
		Seat upcharge:	+0	+\$43	+\$76	+\$125	+\$194	+\$222	+\$282	+\$375	+\$446	+\$522	+\$681	+\$849
		Active weight 400 lbs.	<b>OVERALL DIMENSIONS</b>			<b>SEAT DIMENSIONS</b>			<b>BACK DIMENSIONS</b>					
			W	D	H	W	D	H	W	H				
		27.5	29.5	33.5	24	21	16	23.5	17.5					
	Add \$426 for (CO) Grade 1 armcaps Add \$455 for (CO) Grade 2 armcaps Add \$133 for (MB) Add \$38 for (SSS), \$151 for (SBS) Power/USB unit available.													
 <p><b>Fully Upholstered Lounge Two Seater</b> COM Yardage: Back/Arm: 3.5; Seat: 2.25 Freight Class: 250 Product Weight (lbs.): 89 Cubic Feet Per Carton: 33.75</p>	GC36309	Base Price: <b>\$2685</b>												
		Back/Arm upcharge:	+0	+\$119	+\$211	+\$348	+\$540	+\$621	+\$788	+\$1049	+\$1245	+\$1460	+\$1906	+\$2375
		Seat upcharge:	+0	+\$76	+\$137	+\$224	+\$348	+\$399	+\$507	+\$675	+\$801	+\$938	+\$1225	+\$1527
		Active weight 400 lbs./seat	<b>OVERALL DIMENSIONS</b>			<b>SEAT DIMENSIONS</b>			<b>BACK DIMENSIONS</b>					
			W	D	H	W	D	H	W	H				
		49.5	29.5	33.5	44.5	18	16	45.5	17.5					
	Add \$426 for (CO) Grade 1 armcaps Add \$455 for (CO) Grade 2 armcaps Add \$264 for (MB) Add \$55 for (SSS), \$169 for (SBS) Power/USB unit available.													
 <p><b>Fully Upholstered Lounge Three Seater</b> COM Yardage: Back/Arm: 4.25; Seat: 2.75 Freight Class: 250 Product Weight (lbs.): 123 Cubic Feet Per Carton: 52</p>	GC36310	Base Price: <b>\$3372</b>												
		Back/Arm upcharge:	+0	+\$144	+\$257	+\$422	+\$656	+\$754	+\$956	+\$1274	+\$1512	+\$1772	+\$2314	+\$2884
		Seat upcharge:	+0	+\$93	+\$166	+\$274	+\$425	+\$488	+\$619	+\$824	+\$978	+\$1147	+\$1498	+\$1867
		Active weight 400 lbs./seat	<b>OVERALL DIMENSIONS</b>			<b>SEAT DIMENSIONS</b>			<b>BACK DIMENSIONS</b>					
			W	D	H	W	D	H	W	H				
		71.5	29.5	33.5	66.5	18	16	67.5	17.5					
	Add \$426 for (CO) Grade 1 armcaps Add \$455 for (CO) Grade 2 armcaps Add \$394 for (MB) Add \$70 for (SSS), \$189 for (SBS) Power/USB unit available.													

DESCRIPTION	MODEL#/ FEATURES	STANDARD TEXTILE GRADES												
		1/COM	2	3	4	5	6	7	8	9	10	11	12	
 <p><b>Single Seat Bench</b> COM Yardage: 1 Freight Class: 150 Product Weight (lbs.): 41 Cubic Feet Per Carton: 10</p>	<b>GC36311</b>	Base Price:	<b>\$1350</b>											
		Seat upcharge:	<b>+0</b>	<b>+\$34</b>	<b>+\$61</b>	<b>+\$100</b>	<b>+\$155</b>	<b>+\$178</b>	<b>+\$225</b>	<b>+\$300</b>	<b>+\$356</b>	<b>+\$417</b>	<b>+\$545</b>	<b>+\$679</b>
		Active weight 400 lbs.	<b>OVERALL DIMENSIONS</b>			<b>SEAT DIMENSIONS</b>			<b>BACK DIMENSIONS</b>					
			<b>W</b>	<b>D</b>	<b>H</b>	<b>W</b>	<b>D</b>	<b>H</b>	<b>W</b>	<b>H</b>				
			24	28	18	24	26.75	18						
		Add \$133 for <b>(MB)</b> Add \$33 for <b>(SSS)</b>												
 <p><b>Two Seat Bench</b> COM Yardage: 2 Freight Class: 250 Product Weight (lbs.): 61 Cubic Feet Per Carton: 18.75</p>	<b>GC36312</b>	Base Price:	<b>\$2135</b>											
		Seat upcharge:	<b>+0</b>	<b>+\$68</b>	<b>+\$121</b>	<b>+\$199</b>	<b>+\$309</b>	<b>+\$355</b>	<b>+\$450</b>	<b>+\$600</b>	<b>+\$712</b>	<b>+\$834</b>	<b>+\$1089</b>	<b>+\$1357</b>
		Active weight 400 lbs./seat	<b>OVERALL DIMENSIONS</b>			<b>SEAT DIMENSIONS</b>			<b>BACK DIMENSIONS</b>					
			<b>W</b>	<b>D</b>	<b>H</b>	<b>W</b>	<b>D</b>	<b>H</b>	<b>W</b>	<b>H</b>				
			48	28	18	48	26.75	18						
		Add \$264 for <b>(MB)</b> Add \$85 for <b>(SSS)</b>												
 <p><b>Three Seat Bench</b> COM Yardage: 3 Freight Class: 250 Product Weight (lbs.): 97 Cubic Feet Per Carton: 27.75</p>	<b>GC36313</b>	Base Price:	<b>\$2547</b>											
		Seat upcharge:	<b>+0</b>	<b>+\$102</b>	<b>+\$181</b>	<b>+\$298</b>	<b>+\$463</b>	<b>+\$532</b>	<b>+\$675</b>	<b>+\$899</b>	<b>+\$1067</b>	<b>+\$1251</b>	<b>+\$1634</b>	<b>+\$2036</b>
		Active weight 400 lbs./seat	<b>OVERALL DIMENSIONS</b>			<b>SEAT DIMENSIONS</b>			<b>BACK DIMENSIONS</b>					
			<b>W</b>	<b>D</b>	<b>H</b>	<b>W</b>	<b>D</b>	<b>H</b>	<b>W</b>	<b>H</b>				
			72	28	18	72	26.75	18						
		Add \$394 for <b>(MB)</b> Add \$94 for <b>(SSS)</b>												

CALIDON TABLES



Square end table - 22"  
GC36314



Rectangular Coffee Table  
GC36317



Tandem Side Table, Right  
GC36319R



For Calidon seating, refer to page 61.

EXAMPLE CALIDON TABLE ORDER CODE:

GC36319R	-HP	-ACJ	-CNT
Model #	Top material	Laminate finish	Power

TABLE TOP FINISHES:

See finishes section on page 259 for solid wood/laminate coordination chart.

Thermally fused laminate (LP):

- Absolute Acajou (ACJ)
- Asian Night (ASN)
- Avant Cherry (AWC)
- Avant Honey (AWH)
- Black (BLK)
- Blizzard (BZD)
- Brushed Cobalt (BRC)
- Clear Maple (CMB)
- Custom Grey (CGY)
- Dark Espresso (DES)
- Designer White (DWT)
- Fashionista (FAS)
- First Class (FCL)
- Noce Biondo (NBL)
- Noce Grigio (NGL)
- Noce Leggero (NEL)
- Noce Medio (NML)
- Quartered Mahogany (QTM)
- Sheer Beauty (SBY)
- Stonedust (SDT)
- Walnut Heights (WHE)
- White Chocolate (WHC)
- Winter Cherry (WCR)

High pressure laminate (HP):

- Absolute Acajou (ACJ)
- Asian Night (ASN)
- Avant Cherry (AWC)
- Avant Honey (AWH)
- Black (BLK)
- Blizzard (BZD)
- Brushed Cobalt (BRC)
- Clear Maple (CMB)
- Custom Grey (CGY)
- Dark Espresso (DES)
- Designer White (DWT)
- Fashionista (FAS)
- First Class (FCL)
- Noce Biondo (NBL)
- Noce Grigio (NGL)
- Noce Leggero (NEL)
- Noce Medio (NML)
- Quartered Mahogany (QTM)
- Sheer Beauty (SBY)
- Stonedust (SDT)
- Walnut Heights (WHE)
- White Chocolate (WHC)
- Winter Cherry (WCR)

Ultra matte high pressure laminate (UM):

- Black (BLK)
- Blizzard (BZD)
- Custom Grey (CGY)
- Designer White (DWT)
- Stonedust (SDT)
- Storm Grey (SOG)

Solid Surface\* (CO):

- Grade 1:**
- (SWH) Designer White
- Grade 2:**
- (SBT) Beige Tempest
- (SBX) Black Onyx Mirage
- (SMG) Milk Glass Spectra
- (SFW) Frosty White Mirage
- (SHS) Hot Stone
- (SNM) Northern Melange

\*For detailed material information, please reference WilsonArt's Solid Surface collection.

STANDARD FEATURES

- A variety of wood leg tables are available, including various height end tables, coffee tables and tandem tables.
- Wood legs/aprons are specifiable in Global solid wood seating finishes.
- Table tops are 1" thick, available in thermally fused laminate (LP), high pressure laminate (HP), ultra matte high pressure laminate (UM), and solid surface (CO). Upcharges vary, see model for pricing.
- Laminate top tables include 2mm color coordinating PVC edgeband.
- Tandem/bridge table models (GC36318 to GC36321) connect to Calidon guest seating only and include ganging brackets.
- Tandem tables are specified left or right, as seated.

OPTIONAL FEATURES

- A tamper resistant power/USB unit is optional for laminate top, tandem in-line, 30 degree, 90 degree and freestanding square end tables only. Unit is black; includes one AC outlet, two 10-watt USB-A ports, matching faceplate and a 10 ft. long 3-prong power cord. The power unit is located centered 1.5" from the edge of the surface. See power location diagrams for reference. Add \$378.

SUGGESTED APPLICATIONS







- Lounge/Lobby
- Resident rooms
- Patient rooms
- Private office

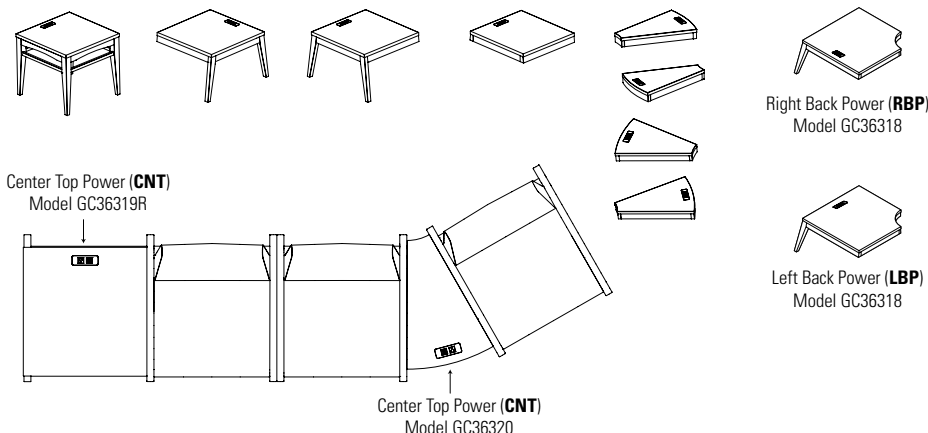



Please add option codes in the following order:

- **Model number**  
GC36314 to GC36317 Freestanding tables  
GC36318 to GC36321 Tandem/bridge tables  
GC36324 to GC36326 23"H Freestanding tables  
For Calidon seating, refer to page 61.
- **Top material (LP)** Thermally fused laminate. Specify finish; see LP finishes.  
**(HP)** High pressure laminate. Upcharges vary; see model. Specify finish; see HP finishes.  
**(UM)** Ultra matte high pressure laminate. Upcharges vary; see model. Specify finish; see UM finishes.  
**(CO)** Solid surface. Upcharges vary; see model. Specify finish; see CO finishes and grades.
- **Leg finish**  
**(AAM)** Absolute  
**(BKM)** Black  
**(ACM)** Cherry  
**(EOM)** English Oak  
**(ECM)** Espresso Cafe  
**(TFM)** Fruitwood  
**(HGM)** Grey  
**(AHM)** Honey  
**(JOM)** Jet Onyx  
**(TMM)** Mahogany  
**(AVM)** Maple  
**(WHM)** White  
**(MWM)** Medium Walnut  
**(NLW)** Natural Walnut  
**(NSM)** Night  
**(NBM)** Noce Biondo  
**(NGM)** Noce Grigio  
**(NEM)** Noce Leggero  
**(NMM)** Noce Medio  
**(SBM)** Sandy Beach  
**(SKM)** Shaker Cherry  
**(TWM)** Walnut  
**(WTM)** WC Cream  
**(WCM)** Winter Cherry
- **Power/USB unit position** (laminate tandem and end tables with laminate tops only).  
**(NPM)** No power  
**(CNT)** Center top power. Jet Black. Add \$378.  
**(RBP)** Right back top power. Jet Black. Add \$378.  
**(LBP)** Left back top power. Jet Black. Add \$378.

POWER LOCATION DIAGRAM

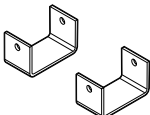

TABLES	MODEL#	DIMENSIONS	FREIGHT CLASS	WT./LBS.	CUBIC FT.	LIST PRICE
	GC36314	22 x 22 x 20.25	150	36	7.75	<b>\$872</b>
<b>Square End Table, 22" x 22" x 20.25" H</b>		<ul style="list-style-type: none"> <li>• Pricing shown for a thermally fused laminate top (LP).</li> <li>• For a high pressure laminate top (HP), add <b>\$69</b>.</li> <li>• For an ultra matte high pressure laminate top (UM), add <b>\$255</b>.</li> <li>• For a solid surface top (CO), add <b>\$1130</b> for Grade 1 and add <b>\$1388</b> for Grade 2.</li> </ul> <p>Coordinating edge on laminate surfaces with solid wood frame and legs. 1 per carton. Power/USB unit can be specified in the surface of laminate top tables (CNT). Add <b>\$378</b>.</p>				
	GC36324	22 x 22 x 23	150	23.5	6.75	<b>\$1031</b>
<b>Square End Table, 22" x 22" x 23" H</b>		<ul style="list-style-type: none"> <li>• Pricing shown for a thermally fused laminate top (LP).</li> <li>• For a high pressure laminate top (HP), add <b>\$69</b>.</li> <li>• For an ultra matte high pressure laminate top (UM), add <b>\$255</b>.</li> <li>• For a solid surface top (CO), add <b>\$1130</b> for Grade 1 and add <b>\$1388</b> for Grade 2.</li> </ul> <p>Coordinating edge on laminate surfaces with solid wood frame and legs. 1 per carton. Power/USB unit can be specified in the surface of laminate top tables (CNT). Add <b>\$378</b>.</p>				
	GC36325	22 x 12 x 23	125	34	10.75	<b>\$888</b>
<b>Rectangular End Table, 23" H</b>		<ul style="list-style-type: none"> <li>• Pricing shown for a thermally fused laminate top (LP).</li> <li>• For a high pressure laminate top (HP), add <b>\$57</b>.</li> <li>• For an ultra matte high pressure laminate top (UM), add <b>\$179</b>.</li> <li>• For a solid surface top (CO), add <b>\$933</b> for Grade 1 and add <b>\$1120</b> for Grade 2.</li> </ul> <p>Coordinating edge on laminate surfaces with solid wood frame and legs. 1 per carton. Power/USB unit can be specified in the surface of laminate top tables (CNT). Add <b>\$378</b>.</p>				
	GC36326	24 x 25 x 23	150	34	12.75	<b>\$1142</b>
<b>Corner 30° End Table, 23" H</b>		<ul style="list-style-type: none"> <li>• Pricing shown for a thermally fused laminate top (LP).</li> <li>• For a high pressure laminate top (HP), add <b>\$74</b>.</li> <li>• For an ultra matte high pressure laminate top (UM), add <b>\$255</b>.</li> <li>• For a solid surface top (CO), add <b>\$1282</b> for Grade 1 and add <b>\$1545</b> for Grade 2.</li> </ul> <p>Coordinating edge on laminate surfaces with solid wood frame and legs. 1 per carton. Power/USB unit can be specified in the surface of laminate top tables (CNT). Add <b>\$378</b>.</p>				
	GC36315	24 x 24 x 17.25	250	37	9.5	<b>\$905</b>
<b>Square Coffee Table, 24"</b>		<ul style="list-style-type: none"> <li>• Pricing shown for a thermally fused laminate top (LP).</li> <li>• For a high pressure laminate top (HP), add <b>\$69</b>.</li> <li>• For an ultra matte high pressure laminate top (UM), add <b>\$255</b>.</li> <li>• For a solid surface top (CO), add <b>\$1372</b> for Grade 1 and add <b>\$1694</b> for Grade 2.</li> </ul> <p>Coordinating edge on laminate surfaces with solid wood frame and legs. 1 per carton.</p>				
	GC36316	36 x 36 x 17.25	250	65	18.25	<b>\$1082</b>
<b>Square Coffee Table, 36"</b>		<ul style="list-style-type: none"> <li>• Pricing shown for a thermally fused laminate top (LP).</li> <li>• For a high pressure laminate top (HP), add <b>\$148</b>.</li> <li>• For an ultra matte high pressure laminate top (UM), add <b>\$357</b>.</li> <li>• For a solid surface top (CO), add <b>\$3143</b> for Grade 1 and add <b>\$3787</b> for Grade 2.</li> </ul> <p>Coordinating edge on laminate surfaces with solid wood frame and legs. 1 per carton.</p>				
	GC36317	24 x 48 x 17.25	250	56	16.5	<b>\$1185</b>
<b>Rectangular Coffee Table</b>		<ul style="list-style-type: none"> <li>• Pricing shown for a thermally fused laminate top (LP).</li> <li>• For a high pressure laminate top (HP), add <b>\$134</b>.</li> <li>• For an ultra matte high pressure laminate top (UM), add <b>\$357</b>.</li> <li>• For a solid surface top (CO), add <b>\$2618</b> for Grade 1 and add <b>\$3054</b> for Grade 2.</li> </ul> <p>Coordinating edge on laminate surfaces with solid wood frame and legs. 1 per carton.</p>				

TABLES	MODEL#	DIMENSIONS	FREIGHT CLASS	WT/LBS.	CUBIC FT.	LIST PRICE
	GC36318	31.25 x 31.25 x 15.75	250	46	14.5	<b>\$1082</b>
<b>Corner Table, 90°</b>						<ul style="list-style-type: none"> <li>• Pricing shown for a thermally fused laminate top (LP).</li> <li>• For a high pressure laminate top (HP), add <b>\$110</b>.</li> <li>• For an ultra matte high pressure laminate top (UM), add <b>\$255</b>.</li> <li>• For a solid surface top (CO), add <b>\$2718</b> for Grade 1 and add <b>\$3249</b> for Grade 2.</li> </ul> <p>Coordinating edge on laminate surfaces with solid wood frame and legs. Must be connected between two guest chairs. Includes two sets of U-channel connectors and hardware. 1 per carton. Power/USB unit can be specified in the surface of laminate top tables (RBP) or (LBP). Add <b>\$378</b>. See power location diagram for placement.</p>
	GC36319L	26.5 x 22.25 x 15.75	250	20	6.75	<b>\$755</b>
<b>Tandem Side Table, Left</b>						<ul style="list-style-type: none"> <li>• Pricing shown for a thermally fused laminate top (LP).</li> <li>• For a high pressure laminate top (HP), add <b>\$69</b>.</li> <li>• For an ultra matte high pressure laminate top (UM), add <b>\$255</b>.</li> <li>• For a solid surface top (CO), add <b>\$1149</b> for Grade 1 and add <b>\$1384</b> for Grade 2.</li> </ul> <p>Coordinating edge on laminate surfaces with solid wood frame and legs. Must be connected to a guest chair. Includes one set of U-channel connectors and hardware. 1 per carton. Power/USB unit can be specified in the surface of laminate top tables (CNT). Add <b>\$378</b>.</p>
	GC36319R	26.5 x 22.25 x 15.75	250	20	6.75	<b>\$755</b>
<b>Tandem Side Table, Right</b>						<ul style="list-style-type: none"> <li>• Pricing shown for a thermally fused laminate top (LP).</li> <li>• For a high pressure laminate top (HP), add <b>\$69</b>.</li> <li>• For an ultra matte high pressure laminate top (UM), add <b>\$255</b>.</li> <li>• For a solid surface top (CO), add <b>\$1149</b> for Grade 1 and add <b>\$1384</b> for Grade 2.</li> </ul> <p>Coordinating edge on laminate surfaces with solid wood frame and legs. Must be connected to a guest chair. Includes one set of U-channel connectors and hardware. 1 per carton. Power/USB unit can be specified in the surface of laminate top tables (CNT). Add <b>\$378</b>.</p>
	GC36320	22.5 x 15.75 x 3	92.5	16	1.5	<b>\$594</b>
<b>Corner Table, 30 Degree</b>						<ul style="list-style-type: none"> <li>• Pricing shown for a thermally fused laminate top (LP).</li> <li>• For a high pressure laminate top (HP), add <b>\$69</b>.</li> <li>• For an ultra matte high pressure laminate top (UM), add <b>\$179</b>.</li> <li>• For a solid surface top (CO), add <b>\$961</b> for Grade 1 and add <b>\$1154</b> for Grade 2.</li> </ul> <p>Coordinating edge on laminate surfaces with solid wood frame and legs. Must be connected between two guest chairs. Includes two sets of U-channel connectors and hardware. 1 per carton. Power/USB unit can be specified in the surface of laminate top tables (CNT). Add <b>\$378</b>.</p>
	GC36321	21 x 23.5 x 3	92.5	20	1.9	<b>\$630</b>
<b>In-Line Table, Square</b>						<ul style="list-style-type: none"> <li>• Pricing shown for a thermally fused laminate top (LP).</li> <li>• For a high pressure laminate top (HP), add <b>\$69</b>.</li> <li>• For an ultra matte high pressure laminate top (UM), add <b>\$255</b>.</li> <li>• For a solid surface top (CO), add <b>\$994</b> for Grade 1 and add <b>\$1225</b> for Grade 2.</li> </ul> <p>Coordinating edge on laminate surfaces with solid wood frame and legs. Must be connected between two guest chairs. Includes two sets of U-channel connectors and hardware. 1 per carton. Power/USB unit can be specified in the surface of laminate top tables (CNT). Add <b>\$378</b>.</p>
	GC36322	2.87 x 1.5 x 1.62	70	0.75	0.03	<b>\$51</b>
<b>U-Channel (set of 2)</b>						Includes hardware. 4 sets per carton.

CHAP™



Wood Back Armchair model 1010



Upholstered Back Armchair model 1015



Upholstered Round Back Armchair model 1004



Wood Round Back Armchair model 1005





STANDARD FEATURES

- Chap offers mid-century modern styling in a finely crafted beechwood armchair series.
- Straight and round back models have upholstered seats with upholstered or open wood frame backs.
- Straight back models are available with exposed wood or upholstered front seat rails.
- For reorders of discontinued models 1002 and 1003, use models 1004 and 1005 with 18" reduced seat depth.
- Custom stain matching is not available on models 1004 and 1005.
- Chairs are standard with a black liner under seat cushion. An underseat panel (USP) is available which conceals seat structure. It is covered with a coated textile and secured with tamperproof fasteners.
- For graded pricing, select model base price. Add graded textile upcharges for seat or for upholstered back models, both seat and back.
- The Blended Textile matrix does not apply to this series.
- Upholstery options include fabric, coated textiles and leather.
- Chap series is covered under Global's Limited Lifetime warranty, for single shift use.
- For multi-shift environments, and coverage under Globalcare's 24/7 warranty, Ultracell foam - 24/7 warranty (UC) must be selected.
- Textiles with a minimum of 100,000 double rubs must be specified to meet Global's 24/7 warranty coverage. For healthcare textiles, visit the website at globalfurnituregroup.com.
- Does not stack.
- Custom stain matching is not available on round back models.

Please add option codes in the following order:

- **Model number**  
Specify model number
- **Back textile**  
Specify textile code
- **Seat textile**  
Specify textile code
- **Frame finish** (Round back models)  
1004 and 1005 available in select finishes (\*).  
(AAM) Absolute\*  
(BKM) Black\*  
(ACM) Cherry\*  
(EOM) English Oak  
(ECM) Espresso Cafe\*  
(TFM) Fruitwood  
(HGM) Gray  
(AHM) Honey  
(TMM) Mahogany\*  
(AVM) Maple  
(MWM) Medium Walnut\*  
(NLW) Natural Walnut  
(ASM) Night\*  
(NBM) Noce Biondo  
(NGM) Noce Grigio  
(NEM) Noce Leggero  
(NMM) Noce Medio\*  
(SKM) Shaker Cherry\*  
(TWM) Walnut\*  
(WTM) WC Cream\*  
(WHM) White\*  
(WCM) Winter Cherry
- **Glides**  
(XG) No Glide for Carpeted Surfaces.  
(NM) White Non-marking Nylon Glide for most floor surfaces. Add \$36  
(SG) Steel Cushioned Glide for carpeted surfaces. Add \$36  
(FG) Felt Glide for most hard floor surfaces. Add \$36  
(RG) Rubber Non-slip Glide for most hard floor surfaces. Add \$36
- **Sealed Seams** (on approved coated textiles)  
(NS) No sealed seams  
(SSS) Sealed seat seams. Add \$67
- **Moisture barrier** (seat only, not available with sealed seams)  
(NB) No moisture barrier. No upcharge  
(MB) Moisture barrier. Add \$113.
- **Seat foam**  
(SF) Standard foam  
(UC) Ultracell foam - 24/7 warranty
- **Seat underside**  
(USL) Under seat liner  
(USP) Under seat panel. Add \$84

DESCRIPTION	FEATURES	MODEL#																										
		1/COM	2	3	4	5	6	7	8	9	10	11	12															
 Wood Back Armchair w/ Upholstered Seat Front COM Yardage: 1 Freight Class: 250 Product Weight (lbs.): 33 Cubic Feet Per Carton: 15.75	Does not stack. Active weight 350 lbs. Ergonomic Features M, N	1010	\$1379	\$1413	\$1440	\$1479	\$1534	\$1557	\$1604	\$1679	\$1735	\$1796	\$1924	\$2058														
		<table border="1"> <thead> <tr> <th colspan="3">OVERALL DIMENSIONS</th> <th colspan="3">SEAT DIMENSIONS</th> <th colspan="2">BACK DIMENSIONS</th> </tr> <tr> <th>W</th> <th>D</th> <th>H</th> <th>W</th> <th>D</th> <th>H</th> <th>W</th> <th>H</th> </tr> </thead> <tbody> <tr> <td>25.5</td> <td>25</td> <td>31</td> <td>21</td> <td>20</td> <td>18</td> <td>20.5</td> <td>13.5</td> </tr> </tbody> </table>			OVERALL DIMENSIONS			SEAT DIMENSIONS			BACK DIMENSIONS		W	D	H	W	D	H	W	H	25.5	25	31	21	20	18	20.5	13.5
OVERALL DIMENSIONS			SEAT DIMENSIONS			BACK DIMENSIONS																						
W	D	H	W	D	H	W	H																					
25.5	25	31	21	20	18	20.5	13.5																					

DESCRIPTION	FEATURES	MODEL#	STANDARD TEXTILE GRADES											
			1/COM	2	3	4	5	6	7	8	9	10	11	12
 <p><b>Upholstered Back Armchair w/ Upholstered Seat Front</b> COM Yardage: Back: .75; Seat: .75 Freight Class: 250 Product Weight (lbs.): 33 Cubic Feet Per Carton: 15.75</p>	<p>1011</p> <p>Base Price: <b>\$1388</b> Seat upcharge: <b>+0</b> Back upcharge: <b>+0</b></p> <p>Does not stack. Active weight 350 lbs. Ergonomic Features M, N</p> <p><b>RTA 00</b></p>													
		<b>OVERALL DIMENSIONS</b>			<b>SEAT DIMENSIONS</b>			<b>BACK DIMENSIONS</b>						
		<b>W</b>	<b>D</b>	<b>H</b>	<b>W</b>	<b>D</b>	<b>H</b>	<b>W</b>	<b>H</b>					
		25.5	25	31.5	21	20	18	20.5	13.5					
 <p><b>Wood Back Armchair w/ Wood Front Rail</b> COM Yardage: 1 Freight Class: 250 Product Weight (lbs.): 33 Cubic Feet Per Carton: 15.75</p>	<p>1014</p> <p>Does not stack. Active weight 350 lbs. Ergonomic Features M, N</p> <p><b>RTA 00</b></p>													
		<b>OVERALL DIMENSIONS</b>			<b>SEAT DIMENSIONS</b>			<b>BACK DIMENSIONS</b>						
		<b>W</b>	<b>D</b>	<b>H</b>	<b>W</b>	<b>D</b>	<b>H</b>	<b>W</b>	<b>H</b>					
		25.5	25	31	21	20	18	20.5	13.5					
 <p><b>Upholstered Back Armchair w/ Wood Front Rail</b> COM Yardage: Back: .75; Seat: .75 Freight Class: 250 Product Weight (lbs.): 33 Cubic Feet Per Carton: 15.75</p>	<p>1015</p> <p>Base Price: <b>\$1388</b> Seat upcharge: <b>+0</b> Back upcharge: <b>+0</b></p> <p>Does not stack. Active weight 350 lbs. Ergonomic Features M, N</p> <p><b>RTA 00</b></p>													
		<b>OVERALL DIMENSIONS</b>			<b>SEAT DIMENSIONS</b>			<b>BACK DIMENSIONS</b>						
		<b>W</b>	<b>D</b>	<b>H</b>	<b>W</b>	<b>D</b>	<b>H</b>	<b>W</b>	<b>H</b>					
		25.5	25	31.5	21	20	18	20.5	13.5					
 <p><b>Upholstered Roundback Armchair w/ Upholstered Seat Front</b> COM Yardage: Back: .75 ; Seat: .75 Freight Class: 300 Product Weight (lbs.): 26 Cubic Feet Per Carton: 13.25</p>	<p>1004</p> <p>Base Price: <b>\$1570</b> Seat upcharge: <b>+0</b> Back upcharge: <b>+0</b></p> <p>Does not stack. Active weight 350 lbs. Ergonomic Features M, N</p> <p><b>RTA 00</b></p>													
		<b>OVERALL DIMENSIONS</b>			<b>SEAT DIMENSIONS</b>			<b>BACK DIMENSIONS</b>						
		<b>W</b>	<b>D</b>	<b>H</b>	<b>W</b>	<b>D</b>	<b>H</b>	<b>W</b>	<b>H</b>					
		24.5	22.5	30	22	18	18	20	12.5					
 <p><b>Round Wood Back Armchair w/ Upholstered Seat Front</b> COM Yardage: 1 Freight Class: 300 Product Weight (lbs.): 25 Cubic Feet Per Carton: 13.25</p>	<p>1005</p> <p>Does not stack. Active weight 350 lbs. Ergonomic Features M, N</p> <p><b>RTA 00</b></p>													
		<b>OVERALL DIMENSIONS</b>			<b>SEAT DIMENSIONS</b>			<b>BACK DIMENSIONS</b>						
		<b>W</b>	<b>D</b>	<b>H</b>	<b>W</b>	<b>D</b>	<b>H</b>	<b>W</b>	<b>H</b>					
		24.5	22.5	30	22	18	18	20	12.5					

COAST

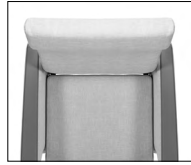

Clean out space around seat cushions for easy housekeeping

model GC4172

EXAMPLE COAST ORDER CODE:

GC4172	-LX21	-SS	-ST	-	-
Model #	Textile	Armcaps	Glides	Moisture Barrier	Sealed Seams

STANDARD FEATURES

- The smooth low range glide adds relaxing motion while you sink back and coast in this ultra-comfortable chair.
- Adjustable non-marking glides are standard
- For added comfort, seats are standard with high density Ultracell foam.
- Cleanout space is provided between the seat and back cushions for easy housekeeping.
- Arms on the glider are fixed with a grip allowing the user to easily enter and exit from the chair. Combined with a smooth low-range motion mechanism, this eliminates the need for a locking mechanism
- Standard with Black Urethane fully extended arms with a grip for ease of entry and exit from chair.
- Seamless front upholstery method on the seat cushion prevents eventual breakdown of seams causing liquid penetration into the foam.
- For healthcare textiles and finish options, visit the website at [www.globalfurnituregroup.com](http://www.globalfurnituregroup.com)
- Can be upholstered in standard Global textiles only if healthcare compliance is not required.
- Shipped fully assembled.

OPTIONAL FEATURES

- For non-slip glides, please specify **(NS)**. Add **\$37**.
- To add sealed seams to your product, contact Customer Care. Upcharges vary
- For moisture barrier **(MB)** (Seat Only) - Add \$137 list upcharge.
- Tablet arm with spill collector on the edge is available, offered in Black Phenolic material. Tablet rotates so it can be positioned for any user activity and can fold down to store beside the chair when not being used. From seated position, specify **(LT)** for left hand tablet or **(RT)** for right hand tablet. Add **\$1070**. For tablet on both sides, specify **(TB)**. Add **\$2136**.

SUGGESTED APPLICATIONS

- Patient rooms
- Resident rooms
- Lounge/Waiting

Please add option codes in the following order:

- **Model number**  
**GC4172** Glider/motion chair
- **Textile**  
Specify fabric code.
- **Armcap finish**  
**(BLK)** Black Urethane armcap  
**(LAB)** Latte Urethane armcap  
**(KAL)** Kalua Urethane armcap  
**(J52)** Mocha Urethane armcap  
**(SHW)** Shadow Urethane armcap  
**(TOA)** Toast Urethane armcap  
**(AAM)** Absolute wood armcap  
**(ACM)** Cherry wood armcap  
**(EOM)** English Oak wood armcap  
**(ECM)** Espresso Cafe wood armcap  
**(HGM)** Gray wood armcap  
**(AHM)** Honey wood armcap  
**(JOM)** Jet Onyx wood armcap  
**(AVM)** Maple wood armcap  
**(MWM)** Medium Walnut wood armcap  
**(NLW)** Natural Walnut wood armcap  
**(ASM)** Night wood armcap  
**(NBM)** Noce Biondo wood armcap  
**(NGM)** Noce Grigio wood armcap  
**(NEM)** Noce Leggero wood armcap  
**(NMM)** Noce Medio wood armcap  
**(SBM)** Sandy Beach wood armcap  
**(SKM)** Shaker Cherry wood armcap  
**(TFM)** Fruitwood wood armcap  
**(TMM)** Mahogany wood armcap  
**(TWM)** Walnut wood armcap  
**(WTM)** WC Cream wood armcap  
**(WHM)** White wood armcap  
**(WCM)** Winter Cherry wood armcap
- **Glides**  
**(ST)** Adjustable non-marking glides  
**(NS)** Adjustable non-slip glides
- **Moisture Barrier**  
**(MB)** Seat only
- **Sealed seams**  
**(SS)** All sealed seams

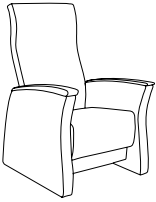
DESCRIPTION	MODEL#/ FEATURES	STANDARD TEXTILE GRADES												
		COM	2	3	4	5	6	7	8	9	10	11	12	
 <p><b>Glider / Motion Chair</b> COM Yardage: 5.5 Freight Class: 250 Product Weight (lbs.): 115 Cubic Feet Per Carton: 29.5</p>	<p>Active weight 350 lbs.</p> <p>Specify armcap: wood or Urethane.</p>	<b>GC4172</b>	<b>\$2637</b>	<b>\$2819</b>	<b>\$2972</b>	<b>\$3194</b>	<b>\$3509</b>	<b>\$3659</b>	<b>\$3946</b>	<b>\$4404</b>	<b>\$4755</b>	<b>\$5147</b>	<b>\$5952</b>	<b>\$6813</b>
		OVERALL DIMENSIONS			SEAT DIMENSIONS			BACK DIMENSIONS						
		<b>W</b>	<b>D</b>	<b>H</b>	<b>W</b>	<b>D</b>	<b>H</b>	<b>W</b>	<b>H</b>					
		30	31.5	43.5	21.5	19.5	18	22	28					

COLLINGWOOD



model GC36511  
High back lounge chair

STANDARD FEATURES

- Collingwood offers a cozy, streamlined design with classic curves.
- The series is available to specify with two textiles, one for the seat cushion and one for the back, arms and front rail (see model image).
- For pricing, start with the base price and add both back/arms graded textile upcharge and the seat graded textile upcharge.
- A clean through design is provided around the seat cushion for easy housekeeping.
- Seat cushion is mechanically removable, if required.
- For added comfort, the seat cushions are standard with high density Ultracell foam.
- The seat underside is sealed with a non-porous material to support housekeeping and infection control protocols.
- Legs are standard in wood or urethane (see upcharge).
- Choose from standard non-marking glides, steel cushioned glides, rubber non-slip glides, or felt glides (upcharges apply).
- The Globalcare warranty (for healthcare and 24/7 environments) applies for all Collingwood models when performance textiles are selected. Visit the website at [globalfurnituregroup.com/healthcare](http://globalfurnituregroup.com/healthcare).
- Global's standard lifetime warranty applies when approved standard Global textiles are selected.
- For alternate textile applications, contact Global specials. The Blended Textile matrix does not apply to this series.
- Shipped fully assembled.

SUGGESTED APPLICATIONS



- Dining/Cafeteria
- Guest seating
- Lobbies
- Lounge/Waiting
- Patient rooms
- Resident rooms

Add option codes in the following order:

- **Model number**  
GC36510 Low back lounge chair  
GC36511 High back lounge chair
- **Back/Arm Textile**  
Specify textile code. See model grade upcharges.
- **Seat Textile**  
Specify textile code. See model grade upcharges.
- **Leg Finish (Wood)**  
(AAM) Absolute (MWM) Medium Walnut  
(BKM) Black (NLW) Natural Walnut  
(ACM) Cherry (ASM) Night  
(EOM) English Oak (NBM) Noce Biondo  
(ECM) Espresso Cafe (NGM) Noce Grigio  
(TFM) Fruitwood (NEM) Noce Leggero  
(HGM) Grey (NMM) Noce Medio  
(AHM) Honey (SBM) Sandy Beach  
(JOM) Jet Onyx (SKM) Shaker Cherry  
(TMM) Mahogany (TWM) Walnut  
(AVM) Maple (WTM) WC Cream  
(WHM) White (WCM) Winter Cherry
- **Leg Finish (Urethane)** Add \$193  
(BLK) Black (KAL) Kalua  
(LAB) Latte (J52) Mocha  
(SHW) Shadow (TOA) Toast
- **Glides**  
(NM) Non-marking glide. No upcharge.  
(RG) Rubber, non-slip glide. Add \$36.  
(SG) Steel cushion glide. Add \$36.  
(FG) Felt glide. Add \$36.
- **Sealed Back Seams** (Contact Customer Care for approved textiles)  
(NBS) No sealed back seams  
(SBS) Sealed back seams. See model for upcharge.
- **Sealed Seat Seams** (Contact Customer Care for approved textiles)  
(NSS) No sealed seat seams  
(SSS) Sealed seat seams. Add \$35.
- **Moisture Barrier** (Not available with Sealed Seams.)  
(NB) No moisture barrier.  
(MB) Moisture barrier (seat only). Add \$117.

EXAMPLE COLLINGWOOD ORDER CODE:

GC36510	CE90	CE90	AVM	NM	NBS	NSS	NB
Model #	Back/arm textile	Seat textile	Leg finish	Glide	Sealed Back Seams	Sealed Seat Seams	Moisture Barrier

DESCRIPTION	MODEL#/ FEATURES	STANDARD TEXTILE GRADES												
		1/COM	2	3	4	5	6	7	8	9	10	11	12	
 <p><b>Low Back Lounge Chair</b>                      COM Yardage: Back/Arm: 3.25; Seat: 1.25                      Freight Class: 250                      Product Weight (lbs.): 55                      Cubic Feet Per Carton: 19.25</p>	<b>GC36510</b> Base Price:	<b>\$2274</b>												
	Back/Arm upcharge:	<b>+0</b>	<b>+\$110</b>	<b>+\$197</b>	<b>+\$320</b>	<b>+\$491</b>	<b>+\$570</b>	<b>+\$718</b>	<b>+\$957</b>	<b>+\$1136</b>	<b>+\$1328</b>	<b>+\$1736</b>	<b>+\$2161</b>	
	Seat upcharge:	<b>+0</b>	<b>+\$43</b>	<b>+\$76</b>	<b>+\$124</b>	<b>+\$189</b>	<b>+\$220</b>	<b>+\$277</b>	<b>+\$369</b>	<b>+\$437</b>	<b>+\$511</b>	<b>+\$668</b>	<b>+\$832</b>	
	<b>OVERALL DIMENSIONS</b>			<b>SEAT DIMENSIONS</b>			<b>BACK DIMENSIONS</b>							
	<b>W</b>	<b>D</b>	<b>H</b>	<b>W</b>	<b>D</b>	<b>H</b>	<b>W</b>	<b>H</b>						
	28	27.25	28	21	19	18	21.5	12.5						
	Active weight 350 lbs. Replaceable seat cushion. Add \$69 for (SBS), \$35 for (SSS)													
	 <p><b>High Back Lounge Chair</b>                      COM Yardage: Back/Arm: 3.75; Seat: 1.25                      Freight Class: 250                      Product Weight (lbs.): 56                      Cubic Feet Per Carton: 22.5</p>	<b>GC36511</b> Base Price:	<b>\$2334</b>											
		Back/Arm upcharge:	<b>+0</b>	<b>+\$127</b>	<b>+\$226</b>	<b>+\$369</b>	<b>+\$567</b>	<b>+\$658</b>	<b>+\$828</b>	<b>+\$1105</b>	<b>+\$1311</b>	<b>+\$1532</b>	<b>+\$2003</b>	<b>+\$2493</b>
		Seat upcharge:	<b>+0</b>	<b>+\$43</b>	<b>+\$76</b>	<b>+\$124</b>	<b>+\$189</b>	<b>+\$220</b>	<b>+\$277</b>	<b>+\$369</b>	<b>+\$437</b>	<b>+\$511</b>	<b>+\$668</b>	<b>+\$832</b>
<b>OVERALL DIMENSIONS</b>			<b>SEAT DIMENSIONS</b>			<b>BACK DIMENSIONS</b>								
<b>W</b>		<b>D</b>	<b>H</b>	<b>W</b>	<b>D</b>	<b>H</b>	<b>W</b>	<b>H</b>						
28		28.5	35.5	21	19	18	21.5	17						
Active weight 350 lbs. Replaceable seat cushion. Add \$79 for (SBS), \$35 for (SSS)														

## COMPRISE



**model C2020LA**  
Medium Back Single Seat with Arms,  
Freestanding



**model C4T20T**  
Rectangular End Table, Freestanding

## Two Textile Application



**model C4030LA**  
Medium Back Bariatric Single Seat  
with Arms, Freestanding



For Comprise Modular components, see page 84

## STANDARD FEATURES

- Comprise series features a refined, modern design with versatile freestanding and modular guest seating. The series achieves high durability with nylon arms and legs on a metal rail structure; engineered for rigorous healthcare and high-traffic environments, it maximizes long-term value with fully replaceable and field reconfigurable components, ensuring a significant return on investment.
- Freestanding models: The series includes 1, 2 and 3 seat freestanding chairs and benches; freestanding combination models including 1 and 2 seat models with 10" table tops; bariatric chairs and benches; and, freestanding tables to complement the series.
- Freestanding models are shipped fully assembled.
- Modular components: The series offers all components required to build endless runs of seats, benches and connecting tables within the parameters outlined. See Comprise Modular on page 84 for components, planning and specifying.
- Chair backs are upholstered, molded foam, available in high or medium back heights. Backs have replaceable upholstery covers with zippered bottom seams. Zippers are standard with tabs removed. A waterproof zipper is standard when sealed back seams are specified.
- Seats have a seamless, waterfall front edge, with highly durable, molded high density foam and include an underseat, water resistant, coated lining (CL). For added security and infection prevention, order sealed lining (SU), see upcharges. The sealed lining option seals the staple strip making it tamper resistant and leak proof.
- For use with approved coated textiles (vinyl, silicone, polyurethane), optional sealed seams are available to mitigate liquid penetration at seams. Specify (SWZ) for back sealed seams with waterproof zipper, and (SE) for sealed seat seams, see upcharges. *Note: minor puckering is common with the addition of sealed seams due to material buildup at corners on seats and backs to mitigate liquid penetration at seams.*
- For moisture barrier on seat, specify (MB). Moisture barrier is not recommended with water resistant textiles and may not be used in conjunction with sealed seams.
- Offsets and cleanout around all sides of seats simplify cleaning with easy to wipe surfaces and reduced number of materials used for simplified cleaning and infection control.
- Glass filled nylon, easy to grip loop arms and legs offered in 5 different colors.
- Painted metal rails match arm and leg finish.
- An optional matching painted metal armless rail shroud is available to cover the set of rails, visible between the seats in multi-seat, armless configurations. The shroud provides a single, cleanable surface across the rails. Specify (ARS), see upcharges. The armless shroud can also be field installed on existing layouts (specify modular model C4PRSN).
- Standard with color matching nylon glides (ST), suitable for most surfaces. Natural nylon, non-marking glides (NM) are also available.

- Matching wallsaver feet (WS) are optional on freestanding seating and benches. Upcharges vary, see model. Freestanding models receive two wallsaver feet. Please note, with wallsaver glides on chairs, there is an additional 1.3" in depth on medium back models, 0.88" on high back models. Specify color to match legs.
- Floor mount (FM) glides are optional in Black only. Upcharges vary, see model.
- Table tops are standard in thermally fused laminate (TFL). High pressure laminate (HPL) and Solid Surface (CO) are also available. Upcharges vary, see model.
- Tamperproof fasteners (TP) are optional on all models. Upcharges vary, see model.
- Seating models may be specified with contrasting fabrics. Specify seat cushion separate from back. For pricing, start with the base price and add grade upcharges for both seat and back selections. *Note: the blended textile matrix does not apply to this series when specified as noted above.*
- For healthcare textiles, visit the website at [globalfurnituregroup.com](http://globalfurnituregroup.com).
- Comprise is covered under Global Healthcare 12 year, 24/7 warranty when upholstered with approved healthcare textiles.
- Can be upholstered in standard Global textiles if healthcare compliance is not required.
- Warranted to support up to 400 lbs. active weight capacity per seat for standard size seating and 600 lbs. for bariatric seating.
- Power/charging units are specified separately for field installation. See Comprise Modular on page 84. Each unit includes a tamper resistant simplex, USB-A and USB-C charging ports. Choose undermount or clamp-mount for use under/on tables and table tops. Available Black (B) or White (W) with 10' long cord. Connecting tables and end tables are pre-drilled for undermount power attachment.





Add option codes in the following order:

- Model number**  
Specify model number.
- Back textile**  
Specify textile code. See model grade upcharges.
- Seat textile**  
Specify textile code. See model grade upcharges.
- Leg, Arm, Rail finish**  
(BLK) Night (SHW) Shadow  
(FOG) Fog (TOA) Toast  
(LAB) Latte
- Armless Rail Shroud** (matches rail finish)  
(NRS) No rail shroud.  
(ARS) Armless rail shroud. Add \$161.
- Glides**  
(ST) Color matching Nylon glide for most surfaces.  
(NM) Non-marking glide. No upcharge.  
(FM) Black floor mounted glide. Upcharges vary, see model.
- Wallsaver Foot**  
(NWS) No wallsaver foot.  
(WS) Wallsaver foot. Upcharges vary, see model.
- Fasteners**  
(RS) Standard fastener.  
(TP) Tamperproof fastener. Upcharges vary, see model.
- Back seams**  
(NS) No sealed seams.  
(SWZ) Sealed seams with waterproof zipper. Upcharges vary, see model. Contact CustomerCare for approved textiles.
- Seat seams**  
(NS) No sealed seams.  
(SE) Sealed seat seams. Upcharges vary, see model. Contact CustomerCare for approved textiles.
- Seat underside**  
(CL) Coated lining.  
(SU) Sealed lining. Upcharges vary, see model.
- Moisture Barrier** (seat only, not available with sealed seams)  
(NB) No moisture barrier. No upcharge.  
(MB) Moisture barrier. Add \$100 per seat. For bariatric models, add \$150 per seat.
- Table Surface Type**  
(TFL) Thermally fused laminate.  
(HPL) High pressure laminate. Upcharges vary, see model.  
(CO) Solid surface. Upcharges vary, see model.
- Top finish (TFL or HPL)**  
(ACJ) Absolute Acajou  
(ASN) Asian Night  
(AWC) Avant Cherry  
(AWH) Avant Honey  
(BLK) Black  
(BZD) Blizzard  
(BRC) Brushed Cobalt  
(CMB) Clear Maple  
(CGY) Custom Grey  
(DES) Dark Espresso  
(DWT) Designer White  
(FAS) Fashionista  
(FCL) First Class  
(NBL) Noce Biondo  
(NGL) Noce Grigio  
(NEL) Noce Leggero  
(NML) Noce Medio  
(QTM) Quartered Mahogany  
(SBY) Sheer Beauty  
(SDT) Stonedust  
(SOG) Storm Grey  
(WHE) Walnut Heights  
(WHC) White Chocolate  
(WCR) Winter Cherry
- Top finish (solid surface)**  
Grade 1:  
(SWH) Designer White  
Grade 2:  
(SBT) Beige Tempest  
(SBX) Black Onyx Mirage  
(SMG) Milk Glass Spectra  
(SFW) Frosty White Mirage  
(SHS) Hot Stone  
(SNM) Northern Melange





## EXAMPLE COMPRISE ORDER CODE:





C4150LA	-VY20	-VY22	-CL	-TOA	-ST	-NWS	-NS	-NS	-NB	-RS	-HPL	-ACJ
Model #	Back textile	Seat textile	Seat underside	Leg, arm, rail finish	Glide type	Wallsaver foot	Sealed Back Seams	Sealed Seat Seams	Moisture Barrier	Fasteners	Surface type	Finish







DESCRIPTION	FEATURES	MODEL#	STANDARD TEXTILE GRADES											
			1/COM	2	3	4	5	6	7	8	9	10	11	12
 <p><b>Medium Back Two Seat Chair with Arms, no center arm Freestanding</b> COM Yardage: Back/Arms: 1.5; Seat: 1.5 Freight Class: 125 Product Weight (lbs.): 87 Cubic Feet Per Carton: 14</p>	<p><b>C4040LA</b> Base Price: <b>\$2473</b></p> <p>Back/Arm upcharge: <b>+0 +\$51 +\$92 +\$150 +\$233 +\$267 +\$338 +\$450 +\$534 +\$626 +\$818 +\$1019</b></p> <p>Seat upcharge: <b>+0 +\$51 +\$92 +\$150 +\$233 +\$267 +\$338 +\$450 +\$534 +\$626 +\$818 +\$1019</b></p>													
	<p><b>OVERALL DIMENSIONS</b></p> <p><b>W D H</b></p>													
	<p><b>SEAT DIMENSIONS</b></p> <p><b>W D H</b></p>													
	<p><b>BACK DIMENSIONS</b></p> <p><b>W H</b></p>													
	<p>46.5 24 33 21.5 19 18 20 15.5</p>													
	<p>Add \$87 for (SWZ), \$51 for (SE) Add \$90 for (SU) Add \$32 for (TP) Add \$16 for (WS), \$28 for (FM) Active weight 400 lbs. per seat.</p>	<p><b>RTA 00</b></p>												1 per carton
 <p><b>Medium Back Two Seat Chair with Arms, center arm Freestanding</b> COM Yardage: Back/Arms: 1.5; Seat: 1.5 Freight Class: 250 Product Weight (lbs.): 93 Cubic Feet Per Carton: 26.75</p>	<p><b>C4041LA</b> Base Price: <b>\$2783</b></p> <p>Back/Arm upcharge: <b>+0 +\$51 +\$92 +\$150 +\$233 +\$267 +\$338 +\$450 +\$534 +\$626 +\$818 +\$1019</b></p> <p>Seat upcharge: <b>+0 +\$51 +\$92 +\$150 +\$233 +\$267 +\$338 +\$450 +\$534 +\$626 +\$818 +\$1019</b></p>													
	<p><b>OVERALL DIMENSIONS</b></p> <p><b>W D H</b></p>													
	<p><b>SEAT DIMENSIONS</b></p> <p><b>W D H</b></p>													
	<p><b>BACK DIMENSIONS</b></p> <p><b>W H</b></p>													
	<p>46.5 24 33 21.5 19 18 20 15.5</p>													
	<p>Add \$87 for (SWZ), \$51 for (SE) Add \$90 for (SU) Add \$48 for (TP) Add \$16 for (WS), \$28 for (FM) Active weight 400 lbs. per seat.</p>	<p><b>RTA 00</b></p>												1 per carton
 <p><b>Medium Back Two Seat Chair, Armless Freestanding</b> COM Yardage: Back/Arms: 1.5; Seat: 1.5 Freight Class: 250 Product Weight (lbs.): 86 Cubic Feet Per Carton: 26.75</p>	<p><b>C4040LN</b> Base Price: <b>\$2149</b></p> <p>Back/Arm upcharge: <b>+0 +\$51 +\$92 +\$150 +\$233 +\$267 +\$338 +\$450 +\$534 +\$626 +\$818 +\$1019</b></p> <p>Seat upcharge: <b>+0 +\$51 +\$92 +\$150 +\$233 +\$267 +\$338 +\$450 +\$534 +\$626 +\$818 +\$1019</b></p>													
	<p><b>OVERALL DIMENSIONS</b></p> <p><b>W D H</b></p>													
	<p><b>SEAT DIMENSIONS</b></p> <p><b>W D H</b></p>													
	<p><b>BACK DIMENSIONS</b></p> <p><b>W H</b></p>													
	<p>44 24 33 21.5 19 18 20 15.5</p>													
	<p>Add \$87 for (SWZ), \$51 for (SE) Add \$90 for (SU) Add \$16 for (TP) Add \$16 for (WS), \$28 for (FM) Active weight 400 lbs. per seat.</p>	<p><b>RTA 00</b></p>												1 per carton
 <p><b>Medium Back Three Seat Chair, with Arms, no center arm Freestanding</b> COM Yardage: Back/Arms: 2.25; Seat: 2.25 Freight Class: 250 Product Weight (lbs.): 120 Cubic Feet Per Carton: 39.75</p>	<p><b>C4060LA</b> Base Price: <b>\$3380</b></p> <p>Back/Arm upcharge: <b>+0 +\$77 +\$138 +\$225 +\$349 +\$401 +\$507 +\$675 +\$801 +\$939 +\$1227 +\$1528</b></p> <p>Seat upcharge: <b>+0 +\$77 +\$138 +\$225 +\$349 +\$401 +\$507 +\$675 +\$801 +\$939 +\$1227 +\$1528</b></p>													
	<p><b>OVERALL DIMENSIONS</b></p> <p><b>W D H</b></p>													
	<p><b>SEAT DIMENSIONS</b></p> <p><b>W D H</b></p>													
	<p><b>BACK DIMENSIONS</b></p> <p><b>W H</b></p>													
	<p>68.75 24 33 21.5 19 18 20 15.5</p>													
	<p>Add \$131 for (SWZ), \$76 for (SE) Add \$135 for (SU) Add \$40 for (TP) Add \$16 for (WS), \$28 for (FM) Active weight 400 lbs. per seat.</p>	<p><b>RTA 00</b></p>												1 per carton
 <p><b>Medium Back Three Seat Chair, w/Arms, center arms Freestanding</b> COM Yardage: Back/Arms: 2.25; Seat: 2.25 Freight Class: 250 Product Weight (lbs.): 126 Cubic Feet Per Carton: 39.75</p>	<p><b>C4061LA</b> Base Price: <b>\$4000</b></p> <p>Back/Arm upcharge: <b>+0 +\$77 +\$138 +\$225 +\$349 +\$401 +\$507 +\$675 +\$801 +\$939 +\$1227 +\$1528</b></p> <p>Seat upcharge: <b>+0 +\$77 +\$138 +\$225 +\$349 +\$401 +\$507 +\$675 +\$801 +\$939 +\$1227 +\$1528</b></p>													
	<p><b>OVERALL DIMENSIONS</b></p> <p><b>W D H</b></p>													
	<p><b>SEAT DIMENSIONS</b></p> <p><b>W D H</b></p>													
	<p><b>BACK DIMENSIONS</b></p> <p><b>W H</b></p>													
	<p>68.75 24 33 21.5 19 18 20 15.5</p>													
	<p>Add \$131 for (SWZ), \$76 for (SE) Add \$135 for (SU) Add \$71 for (TP) Add \$16 for (WS), \$28 for (FM) Active weight 400 lbs. per seat.</p>	<p><b>RTA 00</b></p>												1 per carton





# SEATING

DESCRIPTION	FEATURES	MODEL#	STANDARD TEXTILE GRADES												
			1/COM	2	3	4	5	6	7	8	9	10	11	12	
 <p><b>Medium Back Three Seat Chair, Armless Freestanding</b> COM Yardage: Back/Arms: 2.25; Seat: 2.25 Freight Class: 250 Product Weight (lbs.): 114 Cubic Feet Per Carton: 39.75</p>	<p><b>C4060LN</b> Base Price: <b>\$3056</b></p> <p>Back/Arm upcharge: <b>+0 +\$77 +\$138 +\$225 +\$349 +\$401 +\$507 +\$675 +\$801 +\$939 +\$1227 +\$1528</b></p> <p>Seat upcharge: <b>+0 +\$77 +\$138 +\$225 +\$349 +\$401 +\$507 +\$675 +\$801 +\$939 +\$1227 +\$1528</b></p>	<b>OVERALL DIMENSIONS</b>			<b>SEAT DIMENSIONS</b>			<b>BACK DIMENSIONS</b>							
		<b>W</b>	<b>D</b>	<b>H</b>	<b>W</b>	<b>D</b>	<b>H</b>	<b>W</b>	<b>H</b>						
		66.25	24	33	21.5	19	18	20	15.5						
		<p>Add \$131 for (SWZ), \$76 for (SE) Add \$135 for (SU) Add \$24 for (TP) Add \$16 for (WS), \$28 for (FM) Active weight 400 lbs. per seat.</p>													
		<b>RTA 00</b>	1 per carton												
 <p><b>Medium Back Bariatric Single Seat Chair w/arms Freestanding</b> COM Yardage: Back/Arms: 1.5; Seat: 1 Freight Class: 250 Product Weight (lbs.): 65.5 Cubic Feet Per Carton: 20</p>	<p><b>C4030LA</b> Base Price: <b>\$2084</b></p> <p>Back/Arm upcharge: <b>+0 +\$51 +\$92 +\$150 +\$233 +\$267 +\$338 +\$450 +\$534 +\$626 +\$818 +\$1019</b></p> <p>Seat upcharge: <b>+0 +\$34 +\$61 +\$100 +\$155 +\$178 +\$225 +\$300 +\$356 +\$417 +\$545 +\$679</b></p>	<b>OVERALL DIMENSIONS</b>			<b>SEAT DIMENSIONS</b>			<b>BACK DIMENSIONS</b>							
		<b>W</b>	<b>D</b>	<b>H</b>	<b>W</b>	<b>D</b>	<b>H</b>	<b>W</b>	<b>H</b>						
		34	24	33	31.5	19	18	29.5	15.5						
		<p>Add \$66 for (SWZ), \$29 for (SE) Add \$68 for (SU) Add \$24 for (TP) Add \$16 for (WS), \$28 for (FM) Active weight 600 lbs.</p>													
		<b>RTA 00</b>	1 per carton												
 <p><b>Medium Back Bariatric Single Seat Chair, Armless Freestanding</b> COM Yardage: Back/Arms: 1.5; Seat: 1 Freight Class: 250 Product Weight (lbs.): 59.5 Cubic Feet Per Carton: 20</p>	<p><b>C4030LN</b> Base Price: <b>\$1760</b></p> <p>Back/Arm upcharge: <b>+0 +\$51 +\$92 +\$150 +\$233 +\$267 +\$338 +\$450 +\$534 +\$626 +\$818 +\$1019</b></p> <p>Seat upcharge: <b>+0 +\$34 +\$61 +\$100 +\$155 +\$178 +\$225 +\$300 +\$356 +\$417 +\$545 +\$679</b></p>	<b>OVERALL DIMENSIONS</b>			<b>SEAT DIMENSIONS</b>			<b>BACK DIMENSIONS</b>							
		<b>W</b>	<b>D</b>	<b>H</b>	<b>W</b>	<b>D</b>	<b>H</b>	<b>W</b>	<b>H</b>						
		31.5	24	33	31.5	19	18	29.5	15.5						
		<p>Add \$66 for (SWZ), \$29 for (SE) Add \$68 for (SU) Add \$8 for (TP) Add \$16 for (WS), \$28 for (FM) Active weight 600 lbs.</p>													
		<b>RTA 00</b>	1 per carton												
 <p><b>High Back Single Seat w/arms Freestanding</b> COM Yardage: Back/Arms: 1; Seat: 0.75 Freight Class: 250 Product Weight (lbs.): 57.5 Cubic Feet Per Carton: 15.75</p>	<p><b>C4020HA</b> Base Price: <b>\$1686</b></p> <p>Back/Arm upcharge: <b>+0 +\$34 +\$61 +\$100 +\$155 +\$178 +\$225 +\$300 +\$356 +\$417 +\$545 +\$679</b></p> <p>Seat upcharge: <b>+0 +\$26 +\$46 +\$75 +\$117 +\$134 +\$169 +\$225 +\$267 +\$313 +\$409 +\$510</b></p>	<b>OVERALL DIMENSIONS</b>			<b>SEAT DIMENSIONS</b>			<b>BACK DIMENSIONS</b>							
		<b>W</b>	<b>D</b>	<b>H</b>	<b>W</b>	<b>D</b>	<b>H</b>	<b>W</b>	<b>H</b>						
		24	24.5	37	21.5	19	18	20	19.5						
		<p>Add \$47 for (SWZ), \$26 for (SE) Add \$45 for (SU) Add \$24 for (TP) Add \$16 for (WS), \$28 for (FM) Active weight 400 lbs.</p>													
		<b>RTA 00</b>	1 per carton												
 <p><b>High Back Single Seat, Armless, Freestanding</b> COM Yardage: Back/Arms: 1; Seat: 0.75 Freight Class: 250 Product Weight (lbs.): 51 Cubic Feet Per Carton: 15.75</p>	<p><b>C4020HN</b> Base Price: <b>\$1362</b></p> <p>Back/Arm upcharge: <b>+0 +\$34 +\$61 +\$100 +\$155 +\$178 +\$225 +\$300 +\$356 +\$417 +\$545 +\$679</b></p> <p>Seat upcharge: <b>+0 +\$26 +\$46 +\$75 +\$117 +\$134 +\$169 +\$225 +\$267 +\$313 +\$409 +\$510</b></p>	<b>OVERALL DIMENSIONS</b>			<b>SEAT DIMENSIONS</b>			<b>BACK DIMENSIONS</b>							
		<b>W</b>	<b>D</b>	<b>H</b>	<b>W</b>	<b>D</b>	<b>H</b>	<b>W</b>	<b>H</b>						
		21.5	24.5	37	21.5	19	18	20	19.5						
		<p>Add \$47 for (SWZ), \$26 for (SE) Add \$45 for (SU) Add \$8 for (TP) Add \$16 for (WS), \$28 for (FM) Active weight 400 lbs.</p>													
		<b>RTA 00</b>	1 per carton												





DESCRIPTION	FEATURES	MODEL#	STANDARD TEXTILE GRADES											
			1/COM	2	3	4	5	6	7	8	9	10	11	12
 <p><b>High Back Two Seat Chair w/arms, no center arm Freestanding</b> COM Yardage: Back/Arms: 2; Seat: 1.5 Freight Class: 150 Product Weight (lbs.): 90 Cubic Feet Per Carton: 15.75</p>	<b>C4040HA</b> Base Price: <b>\$2565</b> Back/Arm upcharge: <b>+0</b> Seat upcharge: <b>+0</b>													
 <p><b>High Back Two Seat Chair w/arms, center arm Freestanding</b> COM Yardage: Back/Arms: 2; Seat: 1.5 Freight Class: 125 Product Weight (lbs.): 96 Cubic Feet Per Carton: 15.75</p>	<b>C4041HA</b> Base Price: <b>\$2875</b> Back/Arm upcharge: <b>+0</b> Seat upcharge: <b>+0</b>													
 <p><b>High Back Two Seat Chair, Armless Freestanding</b> COM Yardage: Back/Arms: 2; Seat: 1.5 Freight Class: 150 Product Weight (lbs.): 84 Cubic Feet Per Carton: 15.75</p>	<b>C4040HN</b> Base Price: <b>\$2288</b> Back/Arm upcharge: <b>+0</b> Seat upcharge: <b>+0</b>													
 <p><b>High Back Three Seat Chair, w/Arms, no center arm Freestanding</b> COM Yardage: Back/Arms: 3; Seat: 2.25 Freight Class: 250 Product Weight (lbs.): 129.5 Cubic Feet Per Carton: 43.75</p>	<b>C4060HA</b> Base Price: <b>\$3519</b> Back/Arm upcharge: <b>+0</b> Seat upcharge: <b>+0</b>													
 <p><b>High Back Three Seat Chair, w/Arms, center arms Freestanding</b> COM Yardage: Back/Arms: 3; Seat: 2.25 Freight Class: 250 Product Weight (lbs.): 135.5 Cubic Feet Per Carton: 43.75</p>	<b>C4061HA</b> Base Price: <b>\$4139</b> Back/Arm upcharge: <b>+0</b> Seat upcharge: <b>+0</b>													





# SEATING



DESCRIPTION	FEATURES	MODEL#	STANDARD TEXTILE GRADES														
			1/COM	2	3	4	5	6	7	8	9	10	11	12			
 <p><b>High Back Three Seat Chair, Armless Freestanding</b> COM Yardage: Back/Arms: 3; Seat: 2.25 Freight Class: 250 Product Weight (lbs.): 123.5 Cubic Feet Per Carton: 43.75</p>		<b>C4060HN</b>	Base Price:	<b>\$3195</b>													
			Back/Arm upcharge:	<b>+0</b>	<b>+\$102</b>	<b>+\$183</b>	<b>+\$300</b>	<b>+\$465</b>	<b>+\$534</b>	<b>+\$675</b>	<b>+\$900</b>	<b>+\$1068</b>	<b>+\$1251</b>	<b>+\$1635</b>	<b>+\$2037</b>		
			Seat upcharge:	<b>+0</b>	<b>+\$77</b>	<b>+\$138</b>	<b>+\$225</b>	<b>+\$349</b>	<b>+\$401</b>	<b>+\$507</b>	<b>+\$675</b>	<b>+\$801</b>	<b>+\$939</b>	<b>+\$1227</b>	<b>+\$1528</b>		
			<b>OVERALL DIMENSIONS</b>			<b>SEAT DIMENSIONS</b>			<b>BACK DIMENSIONS</b>								
			<b>W</b>	<b>D</b>	<b>H</b>	<b>W</b>	<b>D</b>	<b>H</b>	<b>W</b>	<b>H</b>							
			66.25	24.5	37	21.5	19	18	20	19.5							
					<b>RTA 00</b>	1 per carton											
 <p><b>High Back Bariatric Single Seat Chair w/arms Freestanding</b> COM Yardage: Back/Arms: 1.75; Seat: 1 Freight Class: 250 Product Weight (lbs.): 69 Cubic Feet Per Carton: 22.25</p>		<b>C4030HA</b>	Base Price:	<b>\$2153</b>													
			Back/Arm upcharge:	<b>+0</b>	<b>+\$60</b>	<b>+\$107</b>	<b>+\$175</b>	<b>+\$272</b>	<b>+\$312</b>	<b>+\$394</b>	<b>+\$525</b>	<b>+\$623</b>	<b>+\$730</b>	<b>+\$954</b>	<b>+\$1189</b>		
			Seat upcharge:	<b>+0</b>	<b>+\$34</b>	<b>+\$61</b>	<b>+\$100</b>	<b>+\$155</b>	<b>+\$178</b>	<b>+\$225</b>	<b>+\$300</b>	<b>+\$356</b>	<b>+\$417</b>	<b>+\$545</b>	<b>+\$679</b>		
			<b>OVERALL DIMENSIONS</b>			<b>SEAT DIMENSIONS</b>			<b>BACK DIMENSIONS</b>								
			<b>W</b>	<b>D</b>	<b>H</b>	<b>W</b>	<b>D</b>	<b>H</b>	<b>W</b>	<b>H</b>							
			34	24.5	37	31.5	19	18	29.5	19.5							
					<b>RTA 00</b>	1 per carton											
 <p><b>High Back Bariatric Single Seat Chair, Armless Freestanding</b> COM Yardage: Back/Arms: 1.75; Seat: 1 Freight Class: 250 Product Weight (lbs.): 63 Cubic Feet Per Carton: 22.25</p>		<b>C4030HN</b>	Base Price:	<b>\$1829</b>													
			Back/Arm upcharge:	<b>+0</b>	<b>+\$60</b>	<b>+\$107</b>	<b>+\$175</b>	<b>+\$272</b>	<b>+\$312</b>	<b>+\$394</b>	<b>+\$525</b>	<b>+\$623</b>	<b>+\$730</b>	<b>+\$954</b>	<b>+\$1189</b>		
			Seat upcharge:	<b>+0</b>	<b>+\$34</b>	<b>+\$61</b>	<b>+\$100</b>	<b>+\$155</b>	<b>+\$178</b>	<b>+\$225</b>	<b>+\$300</b>	<b>+\$356</b>	<b>+\$417</b>	<b>+\$545</b>	<b>+\$679</b>		
			<b>OVERALL DIMENSIONS</b>			<b>SEAT DIMENSIONS</b>			<b>BACK DIMENSIONS</b>								
			<b>W</b>	<b>D</b>	<b>H</b>	<b>W</b>	<b>D</b>	<b>H</b>	<b>W</b>	<b>H</b>							
			31.5	24.5	37	31.5	19	18	29.5	19.5							
					<b>RTA 00</b>	1 per carton											
 <p><b>Single Seat Bench w/Arms Freestanding</b> COM Yardage: 1 Freight Class: 250 Product Weight (lbs.): 39 Cubic Feet Per Carton: 10.75</p>		<b>C4B20A</b>		<b>\$1283</b>	<b>\$1317</b>	<b>\$1344</b>	<b>\$1383</b>	<b>\$1438</b>	<b>\$1461</b>	<b>\$1508</b>	<b>\$1583</b>	<b>\$1639</b>	<b>\$1700</b>	<b>\$1828</b>	<b>\$1962</b>		
			<b>OVERALL DIMENSIONS</b>			<b>SEAT DIMENSIONS</b>			<b>BACK DIMENSIONS</b>								
			<b>W</b>	<b>D</b>	<b>H</b>	<b>W</b>	<b>D</b>	<b>H</b>	<b>W</b>	<b>H</b>							
			24	24	25.5	21.5	21.5	18	--	--							
						<b>RTA 00</b>	1 per carton										
 <p><b>Single Seat Bench, Armless Freestanding</b> COM Yardage: 1 Freight Class: 150 Product Weight (lbs.): 32 Cubic Feet Per Carton: 8</p>		<b>C4B20N</b>		<b>\$959</b>	<b>\$993</b>	<b>\$1020</b>	<b>\$1059</b>	<b>\$1114</b>	<b>\$1137</b>	<b>\$1184</b>	<b>\$1259</b>	<b>\$1315</b>	<b>\$1376</b>	<b>\$1504</b>	<b>\$1638</b>		
			<b>OVERALL DIMENSIONS</b>			<b>SEAT DIMENSIONS</b>			<b>BACK DIMENSIONS</b>								
			<b>W</b>	<b>D</b>	<b>H</b>	<b>W</b>	<b>D</b>	<b>H</b>	<b>W</b>	<b>H</b>							
			21.5	24	18	21.5	21.5	18	--	--							
						<b>RTA 00</b>	1 per carton										

DESCRIPTION	FEATURES	MODEL#		STANDARD TEXTILE GRADES											
		1/COM	2	3	4	5	6	7	8	9	10	11	12		
 <p><b>Two Seat Bench w/Arms, no center arm</b>  <b>Freestanding</b>                      COM Yardage: 1.75                      Freight Class: 250                      Product Weight (lbs.): 64                      Cubic Feet Per Carton: 19.75</p>	Add \$19 for (SE) Add \$90 for (SU) Add \$32 for (TP) Add \$16 for (WS), \$28 for (FM) Active weight 400 lbs. per seat.	<b>C4B40A</b>	<b>\$1741</b>	<b>\$1801</b>	<b>\$1848</b>	<b>\$1916</b>	<b>\$2013</b>	<b>\$2053</b>	<b>\$2135</b>	<b>\$2266</b>	<b>\$2364</b>	<b>\$2471</b>	<b>\$2695</b>	<b>\$2930</b>	
		<b>OVERALL DIMENSIONS</b>			<b>SEAT DIMENSIONS</b>			<b>BACK DIMENSIONS</b>							
		<b>W</b>	<b>D</b>	<b>H</b>	<b>W</b>	<b>D</b>	<b>H</b>	<b>W</b>	<b>H</b>						
44	24	25.5	21.5	21.5	18	--	--								
		<b>RTA 00</b>	1 per carton												
 <p><b>Two Seat Bench w/Arms, center arm</b>  <b>Freestanding</b>                      COM Yardage: 1.75                      Freight Class: 250                      Product Weight (lbs.): 67.5                      Cubic Feet Per Carton: 19.75</p>	Add \$19 for (SE) Add \$90 for (SU) Add \$48 for (TP) Add \$16 for (WS), \$28 for (FM) Active weight 400 lbs. per seat.	<b>C4B41A</b>	<b>\$2051</b>	<b>\$2111</b>	<b>\$2158</b>	<b>\$2226</b>	<b>\$2323</b>	<b>\$2363</b>	<b>\$2445</b>	<b>\$2576</b>	<b>\$2674</b>	<b>\$2781</b>	<b>\$3005</b>	<b>\$3240</b>	
		<b>OVERALL DIMENSIONS</b>			<b>SEAT DIMENSIONS</b>			<b>BACK DIMENSIONS</b>							
		<b>W</b>	<b>D</b>	<b>H</b>	<b>W</b>	<b>D</b>	<b>H</b>	<b>W</b>	<b>H</b>						
44	24	25.5	21.5	21.5	18	--	--								
		<b>RTA 00</b>	1 per carton												
 <p><b>Two Seat Bench, Armless</b>  <b>Freestanding</b>                      COM Yardage: 1.75                      Freight Class: 250                      Product Weight (lbs.): 55                      Cubic Feet Per Carton: 14.75</p>	Add \$19 for (SE) Add \$90 for (SU) Add \$16 for (TP) Add \$16 for (WS), \$28 for (FM) Active weight 400 lbs. per seat.	<b>C4B40N</b>	<b>\$1417</b>	<b>\$1477</b>	<b>\$1524</b>	<b>\$1592</b>	<b>\$1689</b>	<b>\$1729</b>	<b>\$1811</b>	<b>\$1942</b>	<b>\$2040</b>	<b>\$2147</b>	<b>\$2371</b>	<b>\$2606</b>	
		<b>OVERALL DIMENSIONS</b>			<b>SEAT DIMENSIONS</b>			<b>BACK DIMENSIONS</b>							
		<b>W</b>	<b>D</b>	<b>H</b>	<b>W</b>	<b>D</b>	<b>H</b>	<b>W</b>	<b>H</b>						
41.5	24	18	21.5	21.5	18	--	--								
		<b>RTA 00</b>	1 per carton												
 <p><b>Three Seat Bench w/Arms, no center arms</b>  <b>Freestanding</b>                      COM Yardage: 2                      Freight Class: 250                      Product Weight (lbs.): 74                      Cubic Feet Per Carton: 29</p>	Add \$29 for (SE) Add \$135 for (SU) Add \$40 for (TP) Add \$16 for (WS), \$28 for (FM) Active weight 400 lbs. per seat.	<b>C4B60A</b>	<b>\$2200</b>	<b>\$2268</b>	<b>\$2322</b>	<b>\$2400</b>	<b>\$2510</b>	<b>\$2556</b>	<b>\$2650</b>	<b>\$2800</b>	<b>\$2912</b>	<b>\$3034</b>	<b>\$3290</b>	<b>\$3558</b>	
		<b>OVERALL DIMENSIONS</b>			<b>SEAT DIMENSIONS</b>			<b>BACK DIMENSIONS</b>							
		<b>W</b>	<b>D</b>	<b>H</b>	<b>W</b>	<b>D</b>	<b>H</b>	<b>W</b>	<b>H</b>						
68.75	24	25.5	21.5	21.5	18	--	--								
		<b>RTA 00</b>	1 per carton												
 <p><b>Three Seat Bench w/Arms, center arms</b>  <b>Freestanding</b>                      COM Yardage: 2                      Freight Class: 250                      Product Weight (lbs.): 77.5                      Cubic Feet Per Carton: 29</p>	Add \$29 for (SE) Add \$135 for (SU) Add \$71 for (TP) Add \$16 for (WS), \$28 for (FM) Active weight 400 lbs. per seat.	<b>C4B61A</b>	<b>\$2820</b>	<b>\$2888</b>	<b>\$2942</b>	<b>\$3020</b>	<b>\$3130</b>	<b>\$3176</b>	<b>\$3270</b>	<b>\$3420</b>	<b>\$3532</b>	<b>\$3654</b>	<b>\$3910</b>	<b>\$4178</b>	
		<b>OVERALL DIMENSIONS</b>			<b>SEAT DIMENSIONS</b>			<b>BACK DIMENSIONS</b>							
		<b>W</b>	<b>D</b>	<b>H</b>	<b>W</b>	<b>D</b>	<b>H</b>	<b>W</b>	<b>H</b>						
68.75	24	25.5	21.5	21.5	18	--	--								
		<b>RTA 00</b>	1 per carton												

# SEATING

DESCRIPTION	FEATURES	MODEL#													
		1/COM	2	3	4	5	6	7	8	9	10	11	12		
 <p><b>Three Seat Bench, Armless Freestanding</b>                      COM Yardage: 2                      Freight Class: 250                      Product Weight (lbs.): 66.5                      Cubic Feet Per Carton: 22</p>	<p>Add \$29 for (SE)                      Add \$135 for (SU)                      Add \$24 for (TP)                      Add \$16 for (WS), \$28 for (FM)                      Active weight 400 lbs. per seat.</p>	<b>C4B60N</b>	\$1875	\$1943	\$1997	\$2075	\$2185	\$2231	\$2325	\$2475	\$2587	\$2709	\$2965	\$3233	
		<b>OVERALL DIMENSIONS</b>			<b>SEAT DIMENSIONS</b>			<b>BACK DIMENSIONS</b>							
		<b>W</b>	<b>D</b>	<b>H</b>	<b>W</b>	<b>D</b>	<b>H</b>	<b>W</b>	<b>H</b>						
		66.25	24	18	21.5	21.5	18	--	--						
			<b>RTA 00</b>	1 per carton											
 <p><b>Single Seat Bariatric Bench w/Arms Freestanding</b>                      COM Yardage: 1                      Freight Class: 250                      Product Weight (lbs.): 47                      Cubic Feet Per Carton: 14.75</p>	<p>Add \$10 for (SE)                      Add \$68 for (SU)                      Add \$24 for (TP)                      Add \$16 for (WS), \$28 for (FM)                      Active weight 600 lbs.</p>	<b>C4B30A</b>	\$1514	\$1548	\$1575	\$1614	\$1669	\$1692	\$1739	\$1814	\$1870	\$1931	\$2059	\$2193	
		<b>OVERALL DIMENSIONS</b>			<b>SEAT DIMENSIONS</b>			<b>BACK DIMENSIONS</b>							
		<b>W</b>	<b>D</b>	<b>H</b>	<b>W</b>	<b>D</b>	<b>H</b>	<b>W</b>	<b>H</b>						
		34	24	25.5	31.5	21.5	18	--	--						
			<b>RTA 00</b>	1 per carton											
 <p><b>Single Seat Bariatric Bench, Armless Freestanding</b>                      COM Yardage: 1                      Freight Class: 250                      Product Weight (lbs.): 40                      Cubic Feet Per Carton: 11.25</p>	<p>Add \$10 for (SE)                      Add \$68 for (SU)                      Add \$8 for (TP)                      Add \$16 for (WS), \$28 for (FM)                      Active weight 600 lbs.</p>	<b>C4B30N</b>	\$1190	\$1224	\$1251	\$1290	\$1345	\$1368	\$1415	\$1490	\$1546	\$1607	\$1735	\$1869	
		<b>OVERALL DIMENSIONS</b>			<b>SEAT DIMENSIONS</b>			<b>BACK DIMENSIONS</b>							
		<b>W</b>	<b>D</b>	<b>H</b>	<b>W</b>	<b>D</b>	<b>H</b>	<b>W</b>	<b>H</b>						
		31.5	24	18	31.5	21.5	18	--	--						
			<b>RTA 00</b>	1 per carton											
 <p><b>Rectangular End Table Freestanding</b>                      COM Yardage: n/a                      Freight Class: 125                      Product Weight (lbs.): 50.5                      Cubic Feet Per Carton: 8.25</p>	<p>Add \$95 for (HPL)                      Add \$1395 for (CO) Grade 1 top                      Add \$1501 for (CO) Grade 2 top                      Add \$8 for (TP)                      Add \$16 for (WS), \$28 for (FM)</p>	<b>C4T20T</b>	\$760												
		<b>OVERALL DIMENSIONS</b>			<b>SEAT DIMENSIONS</b>			<b>BACK DIMENSIONS</b>							
		<b>W</b>	<b>D</b>	<b>H</b>	<b>W</b>	<b>D</b>	<b>H</b>	<b>W</b>	<b>H</b>						
		24	22	15.75	--	--	--	--	--						
			<b>RTA 00</b>	1 per carton											
 <p><b>Rectangular Coffee Table, Freestanding</b>                      COM Yardage: n/a                      Freight Class: 125                      Product Weight (lbs.): 81                      Cubic Feet Per Carton: 11.25</p>	<p>Add \$100 for (HPL) top                      Add \$1671 for (CO) Grade 1 top                      Add \$1834 for (CO) Grade 2 top                      Add \$8 for (TP)                      Add \$28 for (FM)</p>	<b>C4T30T</b>	\$871												
		<b>OVERALL DIMENSIONS</b>			<b>SEAT DIMENSIONS</b>			<b>BACK DIMENSIONS</b>							
		<b>W</b>	<b>D</b>	<b>H</b>	<b>W</b>	<b>D</b>	<b>H</b>	<b>W</b>	<b>H</b>						
		34	22	15.75	--	--	--	--	--						
			<b>RTA 00</b>	1 per carton											

DESCRIPTION	FEATURES	MODEL#	STANDARD TEXTILE GRADES											
			1/COM	2	3	4	5	6	7	8	9	10	11	12
 <p><b>Rectangular Coffee Table, Freestanding</b> COM Yardage: n/a Freight Class: 125 Product Weight (lbs.): 108.5 Cubic Feet Per Carton: 14.5</p>	<p><b>C4T40T</b></p> <p>Add \$118 for (HPL) top Add \$1952 for (CO) Grade 1 top Add \$2155 for (CO) Grade 2 top Add \$8 for (TP) Add \$28 for (FM)</p>	<b>\$1042</b>												
			<b>OVERALL DIMENSIONS</b>			<b>SEAT DIMENSIONS</b>			<b>BACK DIMENSIONS</b>					
			<b>W</b>	<b>D</b>	<b>H</b>	<b>W</b>	<b>D</b>	<b>H</b>	<b>W</b>	<b>H</b>				
			46	22	15.75	--	--	--	--	--				
			<b>RTA 00</b>	1 per carton										
 <p><b>Medium Back Single Seat w/arms, 10 in. Table - Right Freestanding</b> COM Yardage: Back: 0.75; Seat: 0.75 Freight Class: 250 Product Weight (lbs.): 68.5 Cubic Feet Per Carton: 20</p>	<p><b>C4130LA</b> Base Price:</p> <p>Back/Arm upcharge:</p> <p>Seat upcharge:</p> <p>Add \$44 for (SWZ), \$26 for (SE) Add \$45 for (SU) Add \$42 for (HPL) top Add \$677 for (CO) Grade 1 top Add \$716 for (CO) Grade 2 top Add \$36 for (TP) Add \$24 for (WS), \$42 for (FM) Active weight 400 lbs.</p>	<b>\$1968</b>	1/COM	2	3	4	5	6	7	8	9	10	11	12
			<b>+0</b>	<b>+\$26</b>	<b>+\$46</b>	<b>+\$75</b>	<b>+\$117</b>	<b>+\$134</b>	<b>+\$169</b>	<b>+\$225</b>	<b>+\$267</b>	<b>+\$313</b>	<b>+\$409</b>	<b>+\$510</b>
			<b>+0</b>	<b>+\$26</b>	<b>+\$46</b>	<b>+\$75</b>	<b>+\$117</b>	<b>+\$134</b>	<b>+\$169</b>	<b>+\$225</b>	<b>+\$267</b>	<b>+\$313</b>	<b>+\$409</b>	<b>+\$510</b>
			<b>OVERALL DIMENSIONS</b>			<b>SEAT DIMENSIONS</b>			<b>BACK DIMENSIONS</b>					
<b>W</b>	<b>D</b>	<b>H</b>	<b>W</b>	<b>D</b>	<b>H</b>	<b>W</b>	<b>H</b>							
33.25	24	33	21.5	19	18	20	15.5							
			<b>RTA 00</b>	1 per carton										
 <p><b>Medium Back Single Seat, Armless, 10 in. Table - Right Freestanding</b> COM Yardage: Back: 0.75; Seat: 0.75 Freight Class: 250 Product Weight (lbs.): 62 Cubic Feet Per Carton: 20</p>	<p><b>C4130LN</b> Base Price:</p> <p>Back/Arm upcharge:</p> <p>Seat upcharge:</p> <p>Add \$44 for (SWZ), \$26 for (SE) Add \$45 for (SU) Add \$42 for (HPL) top Add \$677 for (CO) Grade 1 top Add \$716 for (CO) Grade 2 top Add \$12 for (TP) Add \$24 for (WS), \$42 for (FM) Active weight 400 lbs.</p>	<b>\$1496</b>	1/COM	2	3	4	5	6	7	8	9	10	11	12
			<b>+0</b>	<b>+\$26</b>	<b>+\$46</b>	<b>+\$75</b>	<b>+\$117</b>	<b>+\$134</b>	<b>+\$169</b>	<b>+\$225</b>	<b>+\$267</b>	<b>+\$313</b>	<b>+\$409</b>	<b>+\$510</b>
			<b>+0</b>	<b>+\$26</b>	<b>+\$46</b>	<b>+\$75</b>	<b>+\$117</b>	<b>+\$134</b>	<b>+\$169</b>	<b>+\$225</b>	<b>+\$267</b>	<b>+\$313</b>	<b>+\$409</b>	<b>+\$510</b>
			<b>OVERALL DIMENSIONS</b>			<b>SEAT DIMENSIONS</b>			<b>BACK DIMENSIONS</b>					
<b>W</b>	<b>D</b>	<b>H</b>	<b>W</b>	<b>D</b>	<b>H</b>	<b>W</b>	<b>H</b>							
32	24	33	21.5	19	18	20	15.5							
			<b>RTA 00</b>	1 per carton										
 <p><b>Medium Back Single Seat w/arms, 10 in. Table - Left Freestanding</b> COM Yardage: Back: 0.75; Seat: 0.75 Freight Class: 250 Product Weight (lbs.): 68.5 Cubic Feet Per Carton: 20</p>	<p><b>C4132LA</b> Base Price:</p> <p>Back/Arm upcharge:</p> <p>Seat upcharge:</p> <p>Add \$44 for (SWZ), \$26 for (SE) Add \$45 for (SU) Add \$42 for (HPL) top Add \$677 for (CO) Grade 1 top Add \$716 for (CO) Grade 2 top Add \$36 for (TP) Add \$24 for (WS), \$42 for (FM) Active weight 400 lbs.</p>	<b>\$1968</b>	1/COM	2	3	4	5	6	7	8	9	10	11	12
			<b>+0</b>	<b>+\$26</b>	<b>+\$46</b>	<b>+\$75</b>	<b>+\$117</b>	<b>+\$134</b>	<b>+\$169</b>	<b>+\$225</b>	<b>+\$267</b>	<b>+\$313</b>	<b>+\$409</b>	<b>+\$510</b>
			<b>+0</b>	<b>+\$26</b>	<b>+\$46</b>	<b>+\$75</b>	<b>+\$117</b>	<b>+\$134</b>	<b>+\$169</b>	<b>+\$225</b>	<b>+\$267</b>	<b>+\$313</b>	<b>+\$409</b>	<b>+\$510</b>
			<b>OVERALL DIMENSIONS</b>			<b>SEAT DIMENSIONS</b>			<b>BACK DIMENSIONS</b>					
<b>W</b>	<b>D</b>	<b>H</b>	<b>W</b>	<b>D</b>	<b>H</b>	<b>W</b>	<b>H</b>							
33.25	24	33	21.5	19	18	20	15.5							
			<b>RTA 00</b>	1 per carton										
 <p><b>Medium Back Single Seat, Armless, 10 in. Table - Left Freestanding</b> COM Yardage: Back: 0.75; Seat: 0.75 Freight Class: 250 Product Weight (lbs.): 62 Cubic Feet Per Carton: 20</p>	<p><b>C4132LN</b> Base Price:</p> <p>Back/Arm upcharge:</p> <p>Seat upcharge:</p> <p>Add \$44 for (SWZ), \$26 for (SE) Add \$45 for (SU) Add \$42 for (HPL) top Add \$677 for (CO) Grade 1 top Add \$716 for (CO) Grade 2 top Add \$12 for (TP) Add \$24 for (WS), \$42 for (FM) Active weight 400 lbs.</p>	<b>\$1496</b>	1/COM	2	3	4	5	6	7	8	9	10	11	12
			<b>+0</b>	<b>+\$26</b>	<b>+\$46</b>	<b>+\$75</b>	<b>+\$117</b>	<b>+\$134</b>	<b>+\$169</b>	<b>+\$225</b>	<b>+\$267</b>	<b>+\$313</b>	<b>+\$409</b>	<b>+\$510</b>
			<b>+0</b>	<b>+\$26</b>	<b>+\$46</b>	<b>+\$75</b>	<b>+\$117</b>	<b>+\$134</b>	<b>+\$169</b>	<b>+\$225</b>	<b>+\$267</b>	<b>+\$313</b>	<b>+\$409</b>	<b>+\$510</b>
			<b>OVERALL DIMENSIONS</b>			<b>SEAT DIMENSIONS</b>			<b>BACK DIMENSIONS</b>					
<b>W</b>	<b>D</b>	<b>H</b>	<b>W</b>	<b>D</b>	<b>H</b>	<b>W</b>	<b>H</b>							
32	24	33	21.5	19	18	20	15.5							
			<b>RTA 00</b>	1 per carton										

DESCRIPTION	FEATURES	MODEL#	STANDARD TEXTILE GRADES											
			1/COM	2	3	4	5	6	7	8	9	10	11	12
 <p><b>Medium Back Two Seat Chair w/Arms, no center arms</b>  <b>10 in. Center Table, Freestanding</b>                      COM Yardage: Back: 1.5; Seat: 1.5                      Freight Class: 250                      Product Weight (lbs.): 106.5                      Cubic Feet Per Carton: 29.75</p>	<p><b>C4150LA</b> Base Price: <b>\$2686</b></p> <p>Back/Arm upcharge: <b>+0</b> + <b>\$51</b> + <b>\$92</b> + <b>\$150</b> + <b>\$233</b> + <b>\$267</b> + <b>\$338</b> + <b>\$450</b> + <b>\$534</b> + <b>\$626</b> + <b>\$818</b> + <b>\$1019</b></p> <p>Seat upcharge: <b>+0</b> + <b>\$51</b> + <b>\$92</b> + <b>\$150</b> + <b>\$233</b> + <b>\$267</b> + <b>\$338</b> + <b>\$450</b> + <b>\$534</b> + <b>\$626</b> + <b>\$818</b> + <b>\$1019</b></p> <p>Add \$87 for (SWZ), \$51 for (SE)                      Add \$90 for (SU)                      Add \$42 for (HPL) top                      Add \$677 for (CO) Grade 1 top                      Add \$716 for (CO) Grade 2 top                      Add \$36 for (TP)                      Add \$16 for (WS), \$28 for (FM)                      Active weight 400 lbs. per seat.</p>	<p><b>OVERALL DIMENSIONS</b></p> <p>W D H</p>			<p><b>SEAT DIMENSIONS</b></p> <p>W D H</p>			<p><b>BACK DIMENSIONS</b></p> <p>W H</p>						
	56.75 24 33			21.5 19 18			20 15.5							
	<p><b>RTA 00</b> 1 per carton</p>													
	 <p><b>Medium Back Two Seat Chair w/Arms, center arms</b>  <b>10 in. Center Table, Freestanding</b>                      COM Yardage: Back: 1.5; Seat: 1.5                      Freight Class: 250                      Product Weight (lbs.): 113.5                      Cubic Feet Per Carton: 32.75</p>	<p><b>C4151LA</b> Base Price: <b>\$3306</b></p> <p>Back/Arm upcharge: <b>+0</b> + <b>\$51</b> + <b>\$92</b> + <b>\$150</b> + <b>\$233</b> + <b>\$267</b> + <b>\$338</b> + <b>\$450</b> + <b>\$534</b> + <b>\$626</b> + <b>\$818</b> + <b>\$1019</b></p> <p>Seat upcharge: <b>+0</b> + <b>\$51</b> + <b>\$92</b> + <b>\$150</b> + <b>\$233</b> + <b>\$267</b> + <b>\$338</b> + <b>\$450</b> + <b>\$534</b> + <b>\$626</b> + <b>\$818</b> + <b>\$1019</b></p> <p>Add \$87 for (SWZ), \$51 for (SE)                      Add \$90 for (SU)                      Add \$42 for (HPL) top                      Add \$677 for (CO) Grade 1 top                      Add \$716 for (CO) Grade 2 top                      Add \$67 for (TP)                      Add \$16 for (WS), \$28 for (FM)                      Active weight 400 lbs. per seat.</p>	<p><b>OVERALL DIMENSIONS</b></p> <p>W D H</p>			<p><b>SEAT DIMENSIONS</b></p> <p>W D H</p>			<p><b>BACK DIMENSIONS</b></p> <p>W H</p>					
		56.75 24 33			21.5 19 18			20 15.5						
		<p><b>RTA 00</b> 1 per carton</p>												
		 <p><b>Medium Back Two Seat Chair, Armless</b>  <b>10 in. Center Table, Freestanding</b>                      COM Yardage: Back: 1.5; Seat: 1.5                      Freight Class: 250                      Product Weight (lbs.): 100.5                      Cubic Feet Per Carton: 32.75</p>	<p><b>C4150LN</b> Base Price: <b>\$2362</b></p> <p>Back/Arm upcharge: <b>+0</b> + <b>\$51</b> + <b>\$92</b> + <b>\$150</b> + <b>\$233</b> + <b>\$267</b> + <b>\$338</b> + <b>\$450</b> + <b>\$534</b> + <b>\$626</b> + <b>\$818</b> + <b>\$1019</b></p> <p>Seat upcharge: <b>+0</b> + <b>\$51</b> + <b>\$92</b> + <b>\$150</b> + <b>\$233</b> + <b>\$267</b> + <b>\$338</b> + <b>\$450</b> + <b>\$534</b> + <b>\$626</b> + <b>\$818</b> + <b>\$1019</b></p> <p>Add \$87 for (SWZ), \$51 for (SE)                      Add \$90 for (SU)                      Add \$42 for (HPL) top                      Add \$677 for (CO) Grade 1 top                      Add \$716 for (CO) Grade 2 top                      Add \$20 for (TP)                      Add \$16 for (WS), \$28 for (FM)                      Active weight 400 lbs. per seat.</p>	<p><b>OVERALL DIMENSIONS</b></p> <p>W D H</p>			<p><b>SEAT DIMENSIONS</b></p> <p>W D H</p>			<p><b>BACK DIMENSIONS</b></p> <p>W H</p>				
			54.25 24 33			21.5 19 18			20 15.5					
			<p><b>RTA 00</b> 1 per carton</p>											

## COMPRISE MODULAR



### STANDARD FEATURES

- Comprise series features a refined, modern design with versatile freestanding and modular guest seating. The series achieves high durability with nylon arms and legs on a metal rail structure; engineered for rigorous healthcare and high-traffic environments, it maximizes long-term value with fully replaceable and field reconfigurable components, ensuring a significant return on investment.
- For standard features and option descriptions, see Comprise pg. 74. To see each modular component specification options, please refer to the [build-it feature](#) on the website.

### Modular Components

- The series offers all components required to build endless runs of seats, benches and connecting tables within the parameters outlined.
- Modular components are shipped separately for field assembly.
- The modular design is based on rail sizes, determining number of tops (seat & back, bench seat and/or table top) that they support.

### Modular Structural Components

- Rails are available in 11" modular lengths, from 22" to 66". Rails are non-handed. Each rail assembly includes two rails (front and back) and requires legs to support each end (end leg or center connecting legs). Specify finish to match legs.
- End legs, end legs with arms, center connecting legs and center connecting legs with arms are non-handed and shipped with hardware to attach the units to rails. Specify finish to match legs.
- Center connecting tables are available in either 10" or 22" widths. These kits include rails, tabletop and hardware. They connect between center connecting legs only. Specify rail finish to match legs.
- 90- and 120-degree center connecting tables are corner tables. They include rails, corner leg and corner tabletop with connecting hardware. Corner connecting tables connect between center connecting legs only. Specify rail and leg finish to match adjacent legs.
- Bariatric single seat tops and bariatric benches include rails and must mount between end or center connecting legs. Specify rail finish to match legs.

### Rail-Mounted Components

- Single seats and single bench seats include attachment hardware to mount on rails (specified separately). Seats are shipped preassembled with back attached to seat.
- Center arm (C4PCA) mounts on rails between rail-mounted single seats, benches and tables. The arm is non-handed and includes hardware. Select finish to match end legs and rails.
- 10" and 22" single table tops, no rail (C4PT10R and C4PT20R) mount to rails. 10" table tops mount on either end of a 32" rail or centered on a 54" rail only. 22" table tops mount along rail in standard seat locations. Attachment hardware is included.

- Armless rail shrouds (C4PRSN) attach to the rail between rail-mounted components where a center arm is not desired. The shroud is not required, but recommended to cover the rails visible between components to provide a cleanable surface between components. Specify finish to match rail.

### Specification Steps for Comprise Modular

#### Plan the layout:

- Determine length of run(s) required. Comprise rails are based on 11" increments, with lengths starting at 22" up to 66"; supporting 1, 2 and 3 seat positions. 32" and 54" rail lengths support a combination of one or two seats or benches with 10" tables.

#### Specify Legs and Rails:

- Beginning a run with an **end leg**: legs and arms are non-handed; specification can begin from either end of run. Specify the end leg (with or without arm).
- Beginning a run with a **connecting end table**: end tables are non-handed; planning can begin from either end of a run. Specify the end table, then specify a center connecting leg (with or without arm).
- Specify a rail of desired length. Select the appropriate length of rail needed for seating, benching or tabletop sections. Specify rail finish to match leg finish.

#### Connecting Rail Sections:

- **Required**: a center connecting leg with or without arm must be specified to connect one rail to another. Connecting legs and arms are non-handed. Specify finish to match rails and legs.

#### Spanning Rail Sections with Connecting Tables:

- Center connecting tables include rails. Support the end of rail by first specifying a center connecting leg. Next, specify either a 10" or 22" center connecting table. Then specify a center connecting leg before continuing the run with additional rails.

#### Corner Connecting Tables:

- 90- and 120-degree center connecting tables include rails. Support the end of the rail by first specifying a center connecting leg. Next, specify either a 90 or 120 degree center connecting table. Then specify a center connecting leg before continuing the run with additional rails.

#### Modular Bariatric Seats and Bariatric Benches:

- Bariatric seats and benches include rails and may be positioned at end-of-runs or mid-run. Bariatric modular units must be used in combination with their supplied, unique rails and require legs on either end (end legs or center connecting legs).

#### Ending the Modular Run:

- To end a run, specify an end leg (with or without arms) at the end of the last rail.
- To end a run with a connecting end table, first specify a center connecting leg (with or without arms) at the end of the last rail, then specify the connecting end table.

#### Rail-Mounted Components

- Single seats, single benches, 22" table tops and center arms are available to specify on top of rails. Each module can be placed along the rails at 22" increments. Center arms mount between rail-mounted components. Center arms cannot mount at ends of rails.
- 10" table tops mount on ends of 32" rails or centered on 54" rails.

#### Final Details:

- Wallsaver foot is optional on all modular leg assemblies and recommended when seating is configured against a wall.
- Armless rail shroud, ordered separately (C4PRSN) is recommended to cover rails visible between seats, benches and tables wherever rail-mounted center arms are not used.
- Undermount and clamp mount power units may be specified for use on tables. Connecting tables, rail-mount tables and end tables include pre-drilled holes for undermount power.

### Two Textile Application



model C4030LA  
Medium Back Bariatric Single Seat  
with Arms, Freestanding































For Comprise Freestanding components,  
see page 74

# SEATING





# COMPRISE™ MODULAR GANGING APPLICATION GUIDE

C

				C4PR30 22" single position rail		C4PR30 32" rail for single seat / 10" table top		C4PR40 44" two position rail		C4PR50 54" rail for two seat w/ center 10" table top		C4PR60 66" three position rail			
															
				connects to	ganged application	connects to	ganged application	connects to	ganged application	connects to	ganged application	connects to	ganged application		
	C4PEGN end leg, armless	connects directly to the rail	For end of a run	●	required at either end of run	●	required at either end of run	●	required at either end of run	●	required at either end of run	●	required at either end of run		
	C4PEGA end leg w/arm			●	required at either end of run	●	required at either end of run	●	required at either end of run	●	required at either end of run	●	required at either end of run	●	required at either end of run
	C4PCGN center connecting leg, armless			●	required between each set of rails	●	required between each set of rails	●	required between each set of rails	●	required between each set of rails	●	required between each set of rails	●	required between each set of rails
	C4PCGA center connecting leg w/arm			●	required between each set of rails	●	required between each set of rails	●	required between each set of rails	●	required between each set of rails	●	required between each set of rails	●	required between each set of rails
	C4PCA center arm			X	n/a	●	one per rail	●	up to two per rail	●	up to two per rail	●	up to two per rail	●	up to two per rail
	C4P20L medium back single seat top, no rail			●	one per rail	●	one per rail	●	up to two per rail	●	up to two per rail	●	up to two per rail	●	up to three per rail
	C4PB20 single seat bench top, no rail			●	one per rail	X	n/a	●	up to two per rails	X	n/a	●	up to three per rail	●	up to three per rail
	C4PT20R 22" single table top, no rail			X	n/a	●	one per rail left or right (single wide component)	X	n/a	●	one required in center position	X	n/a	●	two optional between two seat/bench and tabletop
	C4PT10R 10" table top, no rail			X	n/a	●	one optional between seat/bench and tabletop	●	two optional between two seat/bench and tabletop	●	two optional between two seat/bench and tabletop	●	two optional between two seat/bench and tabletop	●	two optional between two seat/bench and tabletop
	C4PRSN armless shroud			●	optional at either end of run (requires two connecting legs)	●	optional at either end of run (requires connecting leg)	●	optional at either end of run (requires connecting leg)	●	optional at either end of run (requires connecting leg)	●	optional at either end of run (requires connecting leg)	●	optional at either end of run (requires connecting leg)
	C4P30L medium back bariatric single seat top w/rail	connects to adjacent rail through connecting leg	Includes rails and end legs. Can only gang with center connecting leg	●	optional at either end of run (requires connecting leg)	●	optional at either end of run (requires connecting leg)	●	optional at either end of run (requires connecting leg)	●	optional at either end of run (requires connecting leg)	●	optional at either end of run (requires connecting leg)		
	C4PB30 bariatric single seat bench top w/rail			●	optional at either end of run (requires connecting leg)	●	optional at either end of run (requires connecting leg)	●	optional at either end of run (requires connecting leg)	●	optional at either end of run (requires connecting leg)	●	optional at either end of run (requires connecting leg)	●	optional at either end of run (requires connecting leg)
	C4PT2EG 22" connecting end table w/rail and end leg			●	optional at either end of run (requires two connecting legs)	●	optional at either end of run (requires two connecting legs)	●	optional at either end of run (requires two connecting legs)	●	optional at either end of run (requires two connecting legs)	●	optional at either end of run (requires two connecting legs)	●	optional at either end of run (requires two connecting legs)
	C4PT1EG 10" connecting end table w/rail and end leg			●	optional at either end of run (requires two connecting legs)	●	optional at either end of run (requires two connecting legs)	●	optional at either end of run (requires two connecting legs)	●	optional at either end of run (requires two connecting legs)	●	optional at either end of run (requires two connecting legs)	●	optional at either end of run (requires two connecting legs)
	C4PT20G 22" center connecting table w/rail			●	optional at either end of run (requires two connecting legs)	●	optional at either end of run (requires two connecting legs)	●	optional at either end of run (requires two connecting legs)	●	optional at either end of run (requires two connecting legs)	●	optional at either end of run (requires two connecting legs)	●	optional at either end of run (requires two connecting legs)
	C4PT10G 10" center connecting table w/rail			●	optional at either end of run (requires two connecting legs)	●	optional at either end of run (requires two connecting legs)	●	optional at either end of run (requires two connecting legs)	●	optional at either end of run (requires two connecting legs)	●	optional at either end of run (requires two connecting legs)	●	optional at either end of run (requires two connecting legs)
	C4PT90G 90° center connecting table w/rail			●	optional at either end of run (requires two connecting legs)	●	optional at either end of run (requires two connecting legs)	●	optional at either end of run (requires two connecting legs)	●	optional at either end of run (requires two connecting legs)	●	optional at either end of run (requires two connecting legs)	●	optional at either end of run (requires two connecting legs)
	C4PT12G 120° center connecting table w/rail			●	optional at either end of run (requires two connecting legs)	●	optional at either end of run (requires two connecting legs)	●	optional at either end of run (requires two connecting legs)	●	optional at either end of run (requires two connecting legs)	●	optional at either end of run (requires two connecting legs)	●	optional at either end of run (requires two connecting legs)

DESCRIPTION	FEATURES	MODEL#	STANDARD TEXTILE GRADES																	
			1/COM	2	3	4	5	6	7	8	9	10	11	12						
 <p><b>Medium Back Single Seat Top, no rail</b>  <b>Modular component</b>            COM Yardage: Back: 0.75; Seat: 0.75            Freight Class: 250            Product Weight (lbs.): 31.5            Cubic Feet Per Carton: 8</p>	<b>C4P20L</b>	Base Price:	<b>\$792</b>																	
	Back/Arm upcharge:	<b>+0</b>	<b>+\$26</b>	<b>+\$46</b>	<b>+\$75</b>	<b>+\$117</b>	<b>+\$134</b>	<b>+\$169</b>	<b>+\$225</b>	<b>+\$267</b>	<b>+\$313</b>	<b>+\$409</b>	<b>+\$510</b>							
	Seat upcharge:	<b>+0</b>	<b>+\$26</b>	<b>+\$46</b>	<b>+\$75</b>	<b>+\$117</b>	<b>+\$134</b>	<b>+\$169</b>	<b>+\$225</b>	<b>+\$267</b>	<b>+\$313</b>	<b>+\$409</b>	<b>+\$510</b>							
	<b>OVERALL DIMENSIONS</b>	<b>SEAT DIMENSIONS</b>			<b>BACK DIMENSIONS</b>															
		<b>W</b>	<b>D</b>	<b>H</b>	<b>W</b>	<b>D</b>	<b>H</b>	<b>W</b>	<b>H</b>											
	21.5	24	19.5	21.5	19	--	20	15.5												
			<b>RTA 00</b>		1 per carton															
 <p><b>High Back Single Seat Top, no rail</b>  <b>Modular component</b>            COM Yardage: Back: 1; Seat: 0.75            Freight Class: 250            Product Weight (lbs.): 33.5            Cubic Feet Per Carton: 10.75</p>	<b>C4P20H</b>	Base Price:	<b>\$843</b>																	
	Back/Arm upcharge:	<b>+0</b>	<b>+\$34</b>	<b>+\$61</b>	<b>+\$100</b>	<b>+\$155</b>	<b>+\$178</b>	<b>+\$225</b>	<b>+\$300</b>	<b>+\$356</b>	<b>+\$417</b>	<b>+\$545</b>	<b>+\$679</b>							
	Seat upcharge:	<b>+0</b>	<b>+\$26</b>	<b>+\$46</b>	<b>+\$75</b>	<b>+\$117</b>	<b>+\$134</b>	<b>+\$169</b>	<b>+\$225</b>	<b>+\$267</b>	<b>+\$313</b>	<b>+\$409</b>	<b>+\$510</b>							
	<b>OVERALL DIMENSIONS</b>	<b>SEAT DIMENSIONS</b>			<b>BACK DIMENSIONS</b>															
		<b>W</b>	<b>D</b>	<b>H</b>	<b>W</b>	<b>D</b>	<b>H</b>	<b>W</b>	<b>H</b>											
	21.5	24	23.5	21.5	19	--	20	19.5												
			<b>RTA 00</b>		1 per carton															
 <p><b>Medium Back Bariatric Single Seat Top w/rail</b>  <b>Modular component</b>            COM Yardage: Back: 1.5; Seat: 1            Freight Class: 150            Product Weight (lbs.): 49.5            Cubic Feet Per Carton: 11.25</p>	<b>C4P30L</b>	Base Price:	<b>\$1352</b>																	
	Back/Arm upcharge:	<b>+0</b>	<b>+\$51</b>	<b>+\$92</b>	<b>+\$150</b>	<b>+\$233</b>	<b>+\$267</b>	<b>+\$338</b>	<b>+\$450</b>	<b>+\$534</b>	<b>+\$626</b>	<b>+\$818</b>	<b>+\$1019</b>							
	Seat upcharge:	<b>+0</b>	<b>+\$34</b>	<b>+\$61</b>	<b>+\$100</b>	<b>+\$155</b>	<b>+\$178</b>	<b>+\$225</b>	<b>+\$300</b>	<b>+\$356</b>	<b>+\$417</b>	<b>+\$545</b>	<b>+\$679</b>							
	<b>OVERALL DIMENSIONS</b>	<b>SEAT DIMENSIONS</b>			<b>BACK DIMENSIONS</b>															
		<b>W</b>	<b>D</b>	<b>H</b>	<b>W</b>	<b>D</b>	<b>H</b>	<b>W</b>	<b>H</b>											
	31.5	24	21.5	31.5	19	--	29.5	15.5												
			<b>RTA 00</b>		1 per carton															
 <p><b>High Back Bariatric Single Seat Top w/rail</b>  <b>Modular component</b>            COM Yardage: Back: 1.75; Seat: 1            Freight Class: 250            Product Weight (lbs.): 53.5            Cubic Feet Per Carton: 14.75</p>	<b>C4P30H</b>	Base Price:	<b>\$1426</b>																	
	Back/Arm upcharge:	<b>+0</b>	<b>+\$60</b>	<b>+\$107</b>	<b>+\$175</b>	<b>+\$272</b>	<b>+\$312</b>	<b>+\$394</b>	<b>+\$525</b>	<b>+\$623</b>	<b>+\$730</b>	<b>+\$954</b>	<b>+\$1189</b>							
	Seat upcharge:	<b>+0</b>	<b>+\$34</b>	<b>+\$61</b>	<b>+\$100</b>	<b>+\$155</b>	<b>+\$178</b>	<b>+\$225</b>	<b>+\$300</b>	<b>+\$356</b>	<b>+\$417</b>	<b>+\$545</b>	<b>+\$679</b>							
	<b>OVERALL DIMENSIONS</b>	<b>SEAT DIMENSIONS</b>			<b>BACK DIMENSIONS</b>															
		<b>W</b>	<b>D</b>	<b>H</b>	<b>W</b>	<b>D</b>	<b>H</b>	<b>W</b>	<b>H</b>											
	31.5	24.5	25.5	31.5	19	--	29.5	19.5												
			<b>RTA 00</b>		1 per carton															
 <p><b>Single Seat Bench Top, no rail</b>  <b>Modular component</b>            COM Yardage: 1            Freight Class: 125            Product Weight (lbs.): 11.5            Cubic Feet Per Carton: 1.5</p>	<b>C4PB20</b>		<b>\$408</b>	<b>\$442</b>	<b>\$469</b>	<b>\$508</b>	<b>\$563</b>	<b>\$586</b>	<b>\$633</b>	<b>\$708</b>	<b>\$764</b>	<b>\$825</b>	<b>\$953</b>	<b>\$1087</b>						
	<b>OVERALL DIMENSIONS</b>	<b>SEAT DIMENSIONS</b>			<b>BACK DIMENSIONS</b>															
		<b>W</b>	<b>D</b>	<b>H</b>	<b>W</b>	<b>D</b>	<b>H</b>	<b>W</b>	<b>H</b>											
		21.5	18.75	4.5	--	--	--	--	--											
			<b>RTA 00</b>		1 per carton															













DESCRIPTION	FEATURES	MODEL#		STANDARD TEXTILE GRADES											
		1/COM	2	3	4	5	6	7	8	9	10	11	12		
 <p><b>66 in. Three Position Rail</b>  <b>Modular component</b>                      COM Yardage: n/a                      Freight Class: 70                      Product Weight (lbs.): 5.5                      Cubic Feet Per Carton: 0.25</p>	<p>Each position supports 1 single top, single seat bench top or 22" table top.                      Allows up to 2 center arms.                      Each end requires 1 end leg or connecting leg with or without arms.</p>	<b>C4PR60</b>		<b>\$278</b>											
		<p><b>OVERALL DIMENSIONS</b></p> <p>W D H</p>			<p><b>SEAT DIMENSIONS</b></p> <p>W D H</p>			<p><b>BACK DIMENSIONS</b></p> <p>W H</p>							
		1 61.5 2			-- -- --			-- --							
						1 per carton									
 <p><b>End Leg, Armless</b>  <b>Modular component</b>                      COM Yardage: n/a                      Freight Class: 100                      Product Weight (lbs.): 10                      Cubic Feet Per Carton: 1.2</p>	<p>Connects to rails ends.                      Can be used in left or right position.</p>	<b>C4PEGN</b>		<b>\$207</b>											
		<p><b>OVERALL DIMENSIONS</b></p> <p>W D H</p>			<p><b>SEAT DIMENSIONS</b></p> <p>W D H</p>			<p><b>BACK DIMENSIONS</b></p> <p>W H</p>							
		21 4.5 14			-- -- --			-- --							
						Add \$16 for (WS), \$14 for (FM) 1 per carton									
 <p><b>End Leg with Arm</b>  <b>Modular component</b>                      COM Yardage: n/a                      Freight Class: 150                      Product Weight (lbs.): 11                      Cubic Feet Per Carton: 2.7</p>	<p>Connects to rails ends.                      Can be used in left or right position.</p>	<b>C4PEGA</b>		<b>\$371</b>											
		<p><b>OVERALL DIMENSIONS</b></p> <p>W D H</p>			<p><b>SEAT DIMENSIONS</b></p> <p>W D H</p>			<p><b>BACK DIMENSIONS</b></p> <p>W H</p>							
		22.25 5.75 25.5			-- -- --			-- --							
						Add \$16 for (TP) Add \$16 for (WS), \$14 for (FM) 1 per carton									
 <p><b>Center Connecting Leg, Armless</b>  <b>Modular component</b>                      COM Yardage: n/a                      Freight Class: 250                      Product Weight (lbs.): 9.5                      Cubic Feet Per Carton: 2.5</p>	<p>Used in between two sets of rails to connect them.</p>	<b>C4PCGN</b>		<b>\$276</b>											
		<p><b>OVERALL DIMENSIONS</b></p> <p>W D H</p>			<p><b>SEAT DIMENSIONS</b></p> <p>W D H</p>			<p><b>BACK DIMENSIONS</b></p> <p>W H</p>							
		22.25 9.75 13.5			-- -- --			-- --							
						Add \$16 for (WS), \$14 for (FM) 1 per carton									
 <p><b>Center Connecting Leg with Arm</b>  <b>Modular component</b>                      COM Yardage: n/a                      Freight Class: 150                      Product Weight (lbs.): 11.5                      Cubic Feet Per Carton: 2.2</p>	<p>Used in between two sets of rails to connect them.</p>	<b>C4PCGA</b>		<b>\$440</b>											
		<p><b>OVERALL DIMENSIONS</b></p> <p>W D H</p>			<p><b>SEAT DIMENSIONS</b></p> <p>W D H</p>			<p><b>BACK DIMENSIONS</b></p> <p>W H</p>							
		22.25 9.75 25.5			-- -- --			-- --							
						Add \$16 for (TP) Add \$16 for (WS), \$14 for (FM) 1 per carton									



# SEATING

# COMPRISE™ MODULAR

C

DESCRIPTION	FEATURES	MODEL#													
		1/COM	2	3	4	5	6	7	8	9	10	11	12		
 <p><b>Center Arm</b>  <b>Modular component</b>                      COM Yardage: n/a                      Freight Class: 300                      Product Weight (lbs.): 7.5                      Cubic Feet Per Carton: 4.1</p>	<b>C4PCA</b>	<b>\$311</b>													
		<b>OVERALL DIMENSIONS</b>			<b>SEAT DIMENSIONS</b>			<b>BACK DIMENSIONS</b>							
		<b>W</b>	<b>D</b>	<b>H</b>	<b>W</b>	<b>D</b>	<b>H</b>	<b>W</b>	<b>H</b>						
		17.5	3.25	3.25	--	--	--	--	--						
		Used in between two tops, not to be used on top of armless legs.													
		Add \$16 for <b>(TP)</b>						1 per carton							
 <p><b>10 in. Table Top, no rail</b>  <b>Modular component</b>                      COM Yardage: n/a                      Freight Class: 70                      Product Weight (lbs.): 13                      Cubic Feet Per Carton: 0.7</p>	<b>C4PT10R</b>	<b>\$139</b>													
		<b>OVERALL DIMENSIONS</b>			<b>SEAT DIMENSIONS</b>			<b>BACK DIMENSIONS</b>							
		<b>W</b>	<b>D</b>	<b>H</b>	<b>W</b>	<b>D</b>	<b>H</b>	<b>W</b>	<b>H</b>						
		10	19	2	--	--	--	--	--						
		To be used on C4PR30 and C4PR50 only.													
		Add \$42 for <b>(HPL)</b> top						1 per carton							
		Add \$677 for <b>(CO)</b> Grade 1 top													
		Add \$716 for <b>(CO)</b> Grade 2 top													
		Add \$4 for <b>(TP)</b>													
 <p><b>22 in. Single Table Top, no rail</b>  <b>Modular component</b>                      COM Yardage: n/a                      Freight Class: 70                      Product Weight (lbs.): 26.5                      Cubic Feet Per Carton: 1.2</p>	<b>C4PT20R</b>	<b>\$241</b>													
		<b>OVERALL DIMENSIONS</b>			<b>SEAT DIMENSIONS</b>			<b>BACK DIMENSIONS</b>							
		<b>W</b>	<b>D</b>	<b>H</b>	<b>W</b>	<b>D</b>	<b>H</b>	<b>W</b>	<b>H</b>						
		19	21.5	2	--	--	--	--	--						
		To be used as 1 position on a rail.													
		Add \$78 for <b>(HPL)</b> top						1 per carton							
		Add \$1400 for <b>(CO)</b> Grade 1 top													
		Add \$1483 for <b>(CO)</b> Grade 2 top													
		Add \$8 for <b>(TP)</b>													
 <p><i>Left</i>      <i>Right</i></p> <p><b>10 in. Connecting End Table w/Rail and End Leg</b>  <b>Ganging component</b>                      COM Yardage: n/a                      Freight Class: 150                      Product Weight (lbs.): 23.5                      Cubic Feet Per Carton: 4.6</p>	<b>C4PT1EG</b>	<b>\$450</b>													
		<b>OVERALL DIMENSIONS</b>			<b>SEAT DIMENSIONS</b>			<b>BACK DIMENSIONS</b>							
		<b>W</b>	<b>D</b>	<b>H</b>	<b>W</b>	<b>D</b>	<b>H</b>	<b>W</b>	<b>H</b>						
		10	22.25	16	--	--	--	--	--						
		Gangs to center connecting leg w/arms or armless.													
		Can be used in left or right position.													
		Add \$42 for <b>(HPL)</b> top						1 per carton							
		Add \$677 for <b>(CO)</b> Grade 1 top													
		Add \$716 for <b>(CO)</b> Grade 2 top													
		Add \$4 for <b>(TP)</b>													
		Add \$16 for <b>(WS)</b> , \$14 for <b>(FM)</b>													
 <p><i>Left</i>      <i>Right</i></p> <p><b>22 in. Connecting End Table w/Rail and End Leg</b>  <b>Ganging component</b>                      COM Yardage: n/a                      Freight Class: 300                      Product Weight (lbs.): 8                      Cubic Feet Per Carton: 8</p>	<b>C4PT2EG</b>	<b>\$625</b>													
		<b>OVERALL DIMENSIONS</b>			<b>SEAT DIMENSIONS</b>			<b>BACK DIMENSIONS</b>							
		<b>W</b>	<b>D</b>	<b>H</b>	<b>W</b>	<b>D</b>	<b>H</b>	<b>W</b>	<b>H</b>						
		21.5	22.25	16	--	--	--	--	--						
		Gangs to center connecting leg w/arms or armless.													
		Can be used in left or right position.													
		Add \$78 for <b>(HPL)</b> top						1 per carton							
		Add \$1400 for <b>(CO)</b> Grade 1 top													
		Add \$1483 for <b>(CO)</b> Grade 2 top													
		Add \$8 for <b>(TP)</b>													
		Add \$16 for <b>(WS)</b> , \$14 for <b>(FM)</b>													

DESCRIPTION	FEATURES	MODEL#		STANDARD TEXTILE GRADES																			
		1/COM	2	3	4	5	6	7	8	9	10	11	12										
 <p><b>10 in. Center Connecting Table w/Rail Ganging component</b> COM Yardage: n/a Freight Class: 85 Product Weight (lbs.): 15 Cubic Feet Per Carton: 1.2</p>	<p>Gangs to center connecting leg w/arms or armless. Add \$42 for (HPL) top Add \$677 for (CO) Grade 1 top Add \$716 for (CO) Grade 2 top Add \$4 for (TP)</p>	<b>C4PT10G</b>		<b>\$250</b>																			
		<b>OVERALL DIMENSIONS</b>			<b>SEAT DIMENSIONS</b>			<b>BACK DIMENSIONS</b>															
		<b>W</b>	<b>D</b>	<b>H</b>	<b>W</b>	<b>D</b>	<b>H</b>	<b>W</b>	<b>H</b>														
	10	19	3.75	--	--	--	--	--															
												1 per carton											
 <p><b>22 in. Center Connecting Table w/Rail Ganging component</b> COM Yardage: n/a Freight Class: 70 Product Weight (lbs.): 31 Cubic Feet Per Carton: 2</p>	<p>Gangs to center connecting leg w/arms or armless. Add \$78 for (HPL) top Add \$1400 for (CO) Grade 1 top Add \$1483 for (CO) Grade 2 top Add \$8 for (TP)</p>	<b>C4PT20G</b>		<b>\$385</b>																			
		<b>OVERALL DIMENSIONS</b>			<b>SEAT DIMENSIONS</b>			<b>BACK DIMENSIONS</b>															
		<b>W</b>	<b>D</b>	<b>H</b>	<b>W</b>	<b>D</b>	<b>H</b>	<b>W</b>	<b>H</b>														
	19	21.5	3.75	--	--	--	--	--															
												1 per carton											
 <p><b>90° Center Connecting Table w/Rail Ganging component</b> COM Yardage: n/a Freight Class: 150 Product Weight (lbs.): 62.5 Cubic Feet Per Carton: 12.5</p>	<p>Gangs to center connecting leg w/arms or armless. Add \$105 for (HPL) top Add \$1653 for (CO) Grade 1 top Add \$1848 for (CO) Grade 2 top Add \$8 for (TP)</p>	<b>C4PT90G</b>		<b>\$968</b>																			
		<b>OVERALL DIMENSIONS</b>			<b>SEAT DIMENSIONS</b>			<b>BACK DIMENSIONS</b>															
		<b>W</b>	<b>D</b>	<b>H</b>	<b>W</b>	<b>D</b>	<b>H</b>	<b>W</b>	<b>H</b>														
	29	29	16	--	--	--	--	--															
												1 per carton											
 <p><b>120° Center Connecting Table w/Rail Ganging component</b> COM Yardage: n/a Freight Class: 150 Product Weight (lbs.): 54 Cubic Feet Per Carton: 12</p>	<p>Gangs to center connecting leg w/arms or armless. Add \$105 for (HPL) top Add \$1653 for (CO) Grade 1 top Add \$1848 for (CO) Grade 2 top Add \$8 for (TP)</p>	<b>C4PT12G</b>		<b>\$926</b>																			
		<b>OVERALL DIMENSIONS</b>			<b>SEAT DIMENSIONS</b>			<b>BACK DIMENSIONS</b>															
		<b>W</b>	<b>D</b>	<b>H</b>	<b>W</b>	<b>D</b>	<b>H</b>	<b>W</b>	<b>H</b>														
	26.25	30	16	--	--	--	--	--															
												1 per carton											
 <p><b>Armless Rail Shroud</b> COM Yardage: n/a Freight Class: 70 Product Weight (lbs.): 1 Cubic Feet Per Carton: 0.2</p>		<b>C4PRSN</b>		<b>\$161</b>																			
		<b>OVERALL DIMENSIONS</b>			<b>SEAT DIMENSIONS</b>			<b>BACK DIMENSIONS</b>															
		<b>W</b>	<b>D</b>	<b>H</b>	<b>W</b>	<b>D</b>	<b>H</b>	<b>W</b>	<b>H</b>														
	6.75	10.25	2.5	--	--	--	--	--															
												1 per carton											

DESCRIPTION	FEATURES	MODEL#													
		1/COM	2	3	4	5	6	7	8	9	10	11	12		
 <p><b>Power Unit, Undermount Attachment</b>                      COM Yardage: n/a                      Freight Class: 70                      Product Weight (lbs.): 3                      Cubic Feet Per Carton: 2</p>	<p><b>SU2P10U</b></p> <p>Includes 1 AC and 2 USB-A ports                      Tamper resistant with 10' cord.                      Available in Jet Black (B) or White (W).</p>	<b>OVERALL DIMENSIONS</b>			<b>SEAT DIMENSIONS</b>			<b>BACK DIMENSIONS</b>							
		<b>W</b>	<b>D</b>	<b>H</b>	<b>W</b>	<b>D</b>	<b>H</b>	<b>W</b>	<b>H</b>						
		1.69	4.05	2.77	--	--	--	--	--						
										1 per carton					
 <p><b>Power Unit, Clamp Attachment</b>                      COM Yardage: n/a                      Freight Class: 70                      Product Weight (lbs.): 3                      Cubic Feet Per Carton: 0.5</p>	<p><b>SU2P10C</b></p> <p>Includes 1 AC and 2 USB-A ports                      Tamper resistant with 10' cord.                      Available in Jet Black (B) or White (W).</p>	<b>OVERALL DIMENSIONS</b>			<b>SEAT DIMENSIONS</b>			<b>BACK DIMENSIONS</b>							
		<b>W</b>	<b>D</b>	<b>H</b>	<b>W</b>	<b>D</b>	<b>H</b>	<b>W</b>	<b>H</b>						
		1.69	4.05	2.77	--	--	--	--	--						
										1 per carton					

DESMOND

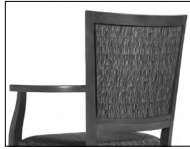

model GC4162

STANDARD FEATURES





- Clean lines and a contoured picture frame style back coordinate with any decor.
- Arms incorporate a firm grip extension to assist users in the entry and exit from the chair.
- Additional support rails on the legs ensure strength and durability.
- For added comfort, seats are standard with high density Ultracell bio foam
- Opaque non-marking glides are standard
- For Globalcare textiles and wood finish options, visit the website at [globalfurnituregroup.com](http://globalfurnituregroup.com)
- Models ending in FC have front casters
- Shipped fully assembled

OPTIONAL FEATURES

- For non-slip glides specify (NS). Add \$37
- To add sealed seams to your product's back only contact Customer Care. Upcharges vary
- For moisture barrier (MB) (seat only) - Add \$137.

SUGGESTED APPLICATIONS

- Dining/Cafeteria
- Guest seating
- Lobbies
- Lounge/Waiting
- Office/Meeting
- Patient rooms
- Resident rooms

DESCRIPTION	MODEL#/ FEATURES	STANDARD TEXTILE GRADES											
 <p><b>Armchair</b> COM Yardage: 1.25 Freight Class: 300 Product Weight (lbs.): 24 Cubic Feet Per Carton: 14.5</p>	<p>GC4162</p> <p>Active weight 300 lbs.</p>	COM	2	3	4	5	6	7	8	9	10	11	12
		\$1475	\$1507	\$1547	\$1599	\$1673	\$1705	\$1774	\$1880	\$1962	\$2054	\$2241	\$2440
		OVERALL DIMENSIONS			SEAT DIMENSIONS			BACK DIMENSIONS					
		W	D	H	W	D	H	W	H				
		24	22.5	36	22.5	18	17.5	17.5	18.5				
 <p><b>Armchair w/Front Casters</b> COM Yardage: 1.25 Freight Class: 300 Product Weight (lbs.): 24 Cubic Feet Per Carton: 14.5</p>	<p>GC4162FC</p> <p>Active weight 300 lbs.</p>	COM	2	3	4	5	6	7	8	9	10	11	12
		\$1574	\$1606	\$1646	\$1698	\$1772	\$1804	\$1873	\$1979	\$2060	\$2151	\$2339	\$2538
		OVERALL DIMENSIONS			SEAT DIMENSIONS			BACK DIMENSIONS					
		W	D	H	W	D	H	W	H				
		24	22.5	36	22.5	18	17.5	17.5	18.5				
 <p><b>Side Chair</b> COM Yardage: 1.25 Freight Class: 300 Product Weight (lbs.): 22 Cubic Feet Per Carton: 14.5</p>	<p>GC4165</p> <p>Active weight 300 lbs.</p>	COM	2	3	4	5	6	7	8	9	10	11	12
		\$1352	\$1389	\$1425	\$1477	\$1548	\$1583	\$1646	\$1751	\$1830	\$1920	\$2102	\$2299
		OVERALL DIMENSIONS			SEAT DIMENSIONS			BACK DIMENSIONS					
		W	D	H	W	D	H	W	H				
		22.5	22.5	36	22.5	18	17.5	17.5	18.5				
 <p><b>Side Chair w/Front Casters</b> COM Yardage: 1.25 Freight Class: 300 Product Weight (lbs.): 22 Cubic Feet Per Carton: 14.5</p>	<p>GC4165FC</p> <p>Active weight 300 lbs.</p>	COM	2	3	4	5	6	7	8	9	10	11	12
		\$1451	\$1488	\$1524	\$1576	\$1647	\$1682	\$1745	\$1850	\$1929	\$2019	\$2201	\$2397
		OVERALL DIMENSIONS			SEAT DIMENSIONS			BACK DIMENSIONS					
		W	D	H	W	D	H	W	H				
		22.5	22.5	36	22.5	18	17.5	17.5	18.5				

## DESMOND HT



model GC4290

### EXAMPLE DESMOND HT ORDER CODE:

GC4290	-LX21	-TBL	-PT	-BK	-MB
Model #	Textile	Frame	Armcaps	Glides	Moisture Barrier

### STANDARD FEATURES

- Desmond HT is a metal framed chair with residential design while ensuring maximum strength and durability within very challenging applications.
- Available with four-legged metal welded frame with or without arms; with rear casters that allow the caregiver to tip and move chair without lifting. Model GC4292 has a lift-assist mechanism and rear casters. The caregiver steps on the lift-assist in turning the chair and moving the occupant to and from a table.
- Models with rear casters also allow the caregiver to turn the chair with occupant seated for better access to wheelchair or walker.
- The welded metal frame, welded cross rails on lower frame, metal-to-metal fasteners on seat pan, back insert and urethane armcaps enhance strength and durability, ensuring its performance in the most rigorous environments.
- Urethane armcaps are comfortable, durable, cleanable and replaceable. Designed to offer proper support while seated and the forward extension allows the occupant to use with confidence when getting in or out of the chair.
- For added comfort and long term performance the seat cushion is standard with high density Ultracell bio foam
- The underside of the seat pan is moisture resistant, and the cushions have no exposed seams to support improved housekeeping and infection prevention practices
- For Globalcare textiles and finish options, visit the website at [globalfurnituregroup.com](http://globalfurnituregroup.com).
- Can be upholstered in standard Global textiles if Healthcare compliance is not required.
- Shipped fully assembled.

### SUGGESTED APPLICATIONS

- Dining/Cafeteria
- Office/Meeting
- Guest seating
- Patient rooms
- Lobbies
- Resident rooms
- Lounge/Waiting
- Bariatric seating (model GC4293)

### OPTIONAL FEATURES

- To add additional weight to your product, contact Customer Care for more information.
- Moisture Barrier (**MB**) (Seat Only) - Add \$137 list upcharge.

Please add option codes in the following order:

- Model number**
  - GC4290** Metal armchair
  - GC4291** Metal armchair w/two rear swivel casters
  - GC4292** Metal armchair w/two rear swivel casters and lift mechanism
  - GC4293** Metal bariatric armchair
  - GC4294** Metal side chair, armless
  - Add (**33**) to model # if CAL TB 133 is required.
- Textile**  
Specify fabric code.
- Frame finish**
  - (**TBL**) Black
  - (**TIV**) Cloud
  - (**TDW**) Designer White
  - (**TFO**) Fog
  - (**TFR**) Frost
  - (**TKA**) Kalua
  - (**TLA**) Latte
  - (**TMO**) Mocha
  - (**TNE**) Nevada
  - (**TSN**) Sand
  - (**TSH**) Shadow
  - (**TOA**) Toast
  - (**TTU**) Tungsten
- Armcap finish**
  - (**BLK**) Black
  - (**KAL**) Kalua
  - (**LAB**) Latte
  - (**J52**) Mocha
  - (**SHW**) Shadow
  - (**TOA**) Toast
- Glides**
  - (**BK**) Black plastic glides
- Moisture Barrier**
  - (**MB**) Seat only

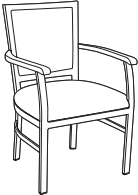
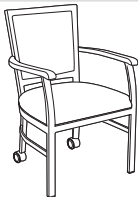
DESCRIPTION	MODEL#/ FEATURES	STANDARD TEXTILE GRADES											
		COM	2	3	4	5	6	7	8	9	10	11	12
 <p><b>Metal Armchair</b> COM Yardage: 1.25 Freight Class: 250 Product Weight (lbs.): 41 Cubic Feet Per Carton: 13.75</p>	GC4290	\$1466	\$1503	\$1540	\$1592	\$1664	\$1697	\$1762	\$1866	\$1944	\$2035	\$2218	\$2413
	Active weight 350 lbs.												
			OVERALL DIMENSIONS			SEAT DIMENSIONS			BACK DIMENSIONS				
		W	D	H	W	D	H	W	H				
		24.5	23.5	35.75	23	19	18.5	18	17.5				
 <p><b>Metal Armchair w/Two Rear Swivel Casters</b> COM Yardage: 1.25 Freight Class: 250 Product Weight (lbs.): 41 Cubic Feet Per Carton: 13.75</p>	GC4291	\$1616	\$1653	\$1690	\$1742	\$1814	\$1847	\$1912	\$2016	\$2094	\$2185	\$2368	\$2563
	Active weight 350 lbs.												
			OVERALL DIMENSIONS			SEAT DIMENSIONS			BACK DIMENSIONS				
		W	D	H	W	D	H	W	H				
		24.5	23.5	35.75	23	19	18.5	18	17.5				

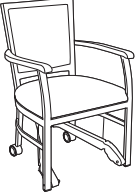
DESCRIPTION	MODEL#/ FEATURES	STANDARD TEXTILE GRADES											
		COM	2	3	4	5	6	7	8	9	10	11	12
 <p><b>Metal Armchair w/Two Rear Swivel Casters &amp; Lift Mech.</b> Active weight 350 lbs. COM Yardage: 1.25 Freight Class: 250 Product Weight (lbs.): 44 Cubic Feet Per Carton: 13.75</p>	GC4292	\$2133	\$2170	\$2206	\$2258	\$2329	\$2363	\$2427	\$2532	\$2610	\$2701	\$2883	\$3079
	OVERALL DIMENSIONS			SEAT DIMENSIONS			BACK DIMENSIONS						
	W	D	H	W	D	H	W	H					
	24.5	23.5	35.75	23	19	18.5	18	17.5					

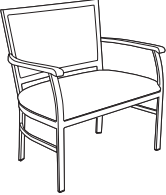
 <p><b>Metal Bariatric Armchair</b> COM Yardage: 2.25 Freight Class: 250 Product Weight (lbs.): 48 Cubic Feet Per Carton: 20</p>	GC4293	\$1947	\$2019	\$2083	\$2171	\$2303	\$2364	\$2485	\$2669	\$2814	\$2973	\$3303	\$3655
	OVERALL DIMENSIONS			SEAT DIMENSIONS			BACK DIMENSIONS						
	W	D	H	W	D	H	W	H					
Active weight 500 lbs.	35.5	23.5	35.75	34	19	18.5	29	17.5					

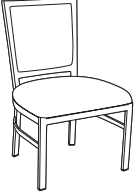
 <p><b>Metal Side Chair, Armless</b> COM Yardage: 1.25 Freight Class: 250 Product Weight (lbs.): 36 Cubic Feet Per Carton: 13.75</p>	GC4294	\$1322	\$1359	\$1396	\$1448	\$1520	\$1553	\$1618	\$1722	\$1800	\$1891	\$2074	\$2269
	OVERALL DIMENSIONS			SEAT DIMENSIONS			BACK DIMENSIONS						
	W	D	H	W	D	H	W	H					
Active weight 350 lbs.	23	23.5	35.75	23	19	18.5	18	17.5					

DOCTOR BUDDY



model GC1104



model GC1111

STANDARD FEATURES





- Doctor Buddy is the perfect stool to provide comfort when performing office tasks or as an examination or feeding stool when caring for others.
- For the right comfort and support when performing tasks, select Doctor Buddy with or without a back.
- Seat and back can be upholstered in vinyl or fabric. Seat is standard with high density Ultracell foam cushion.
- Models available with backrests: GC1111 & GC1113
- Moisture resistant protection on the underside of seat pan.
- GC1104, GC1109, GC1111 & GC1113: 16" seat diameter
- Black five-legged injection-molded base standard
- (C65) casters are standard
- For healthcare textiles, visit the website at [globalfurnituregroup.com/healthcare](http://globalfurnituregroup.com/healthcare).
- Can be upholstered in standard Global textiles if healthcare compliance is not required.

STANDARD FEATURES

- **Casters/Glides**
- (C65) Dual wheel carpet casters. No upcharge
- (C65R) Dual wheel hard floor casters. Add \$71.
- (C7) Set of 5 large Black slipper glides (for all surfaces). Can replace any Global casters. Glide is same height as casters. No upcharge.
- Moisture barrier on seat, specify (MB). Add \$108.
- Sealed seat seams (and back), specify (SS). Upcharges vary, see model.
- Height adjustable footrest, specify (R2). Add \$99.

SUGGESTED APPLICATIONS

- Dining/Cafeteria
- Office/Meeting
- Patient rooms
- Resident rooms
- Treatment/Exam rooms

DESCRIPTION	MODEL#/ FEATURES	STANDARD TEXTILE GRADES											
		1	2	3	4	5	6	7	8	9	10	11	12
 <p><b>16" Dia. Swivel Stool, 5" Pneumatic, 22" Base</b> COM Yardage: 0.75 Freight Class: 150 Product Weight (lbs.): 15 Cubic Feet Per Carton: 2.9</p>	<p>GC1104</p> <p>Active weight 300 lbs. Add \$18 for (SS).</p>	\$503	\$532	\$556	\$587	\$635	\$656	\$691	\$770	\$805	\$878	\$977	\$1099
		OVERALL DIMENSIONS			SEAT DIMENSIONS			BACK DIMENSIONS					
		W	D	H	W	D	H	W	H				
			16	16	18.5	16	--	16.5 - 21.5	--	--			
 <p><b>16" Dia. Swivel Stool, 10" Pneumatic, 22" Base</b> COM Yardage: 0.75 Freight Class: 125 Product Weight (lbs.): 18 Cubic Feet Per Carton: 2.9</p>	<p>GC1109</p> <p>Active weight 300 lbs. Add \$18 for (SS).</p>	\$534	\$565	\$586	\$619	\$667	\$689	\$723	\$802	\$836	\$911	\$1010	\$1130
		OVERALL DIMENSIONS			SEAT DIMENSIONS			BACK DIMENSIONS					
		W	D	H	W	D	H	W	H				
			16	16	27.5	16	--	22.5 - 32.5	--	--			
 <p><b>16" Dia. Swivel Stool w/back, 5" Pneumatic, 24" Base</b> COM Yardage: 1 Freight Class: 250 Product Weight (lbs.): 32 Cubic Feet Per Carton: 11.25</p>	<p>GC1111</p> <p>Active weight 300 lbs. Add \$35 for (SS).</p>	\$801	\$839	\$868	\$910	\$969	\$995	\$1046	\$1126	\$1188	\$1253	\$1391	\$1536
		OVERALL DIMENSIONS			SEAT DIMENSIONS			BACK DIMENSIONS					
		W	D	H	W	D	H	W	H				
			16.5	20.5	29.75	16.5	15.5	16 - 21	14	11.25			
 <p><b>16" Dia. Swivel Stool w/back, 10" Pneumatic, 24" Base</b> COM Yardage: 1 Freight Class: 250 Product Weight (lbs.): 34 Cubic Feet Per Carton: 13.25</p>	<p>GC1113</p> <p>Active weight 300 lbs. Add \$35 for (SS).</p>	\$834	\$872	\$901	\$943	\$1002	\$1028	\$1079	\$1159	\$1221	\$1286	\$1424	\$1569
		OVERALL DIMENSIONS			SEAT DIMENSIONS			BACK DIMENSIONS					
		W	D	H	W	D	H	W	H				
			16.5	20.5	38.75	16.5	15.5	22.5 - 32.5	14	11.25			

DREME



Sleeper with back and arms  
model GC35042

EXAMPLE DREME ORDER CODE:

GC35042	-LE50	-	-BM21	-LPN	-AWH
---------	-------	---	-------	------	------

Model #	Textile	Arm/tablet location	Sleep surface textile	Front panel type (LPN, UPN, LPP, UPP)	Laminate panel finish
---------	---------	---------------------	-----------------------	---------------------------------------	-----------------------

-SRL	-TOA	-MB
------	------	-----

Storage	Leg finish/caster option	Moisture barrier
---------	--------------------------	------------------



Drawer box surface

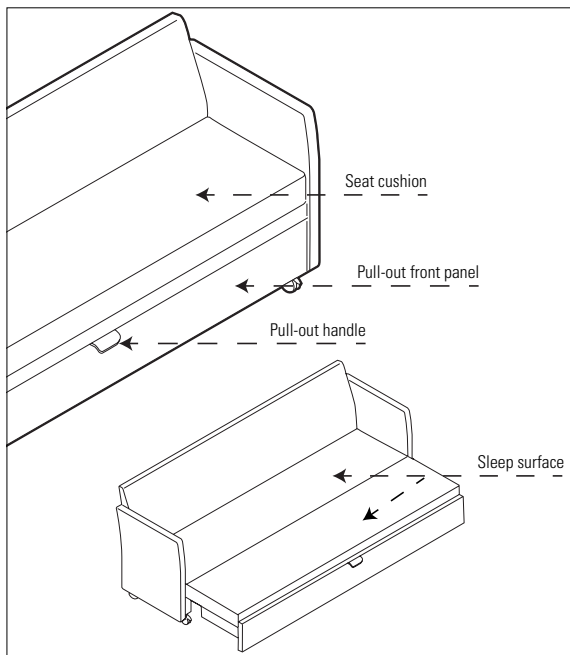

STANDARD FEATURES

- Dreme has a compact, comfortable design that offers a place to sit and converts into a generous sleep surface with a simple pull and flip. A variety of models include backless/armless benches and 3-seater sofa models with or without arms and tablets.
- The seat deck is a clean through metal platform for superior strength.
- The seat/sleep cushion is attached to the unit with straps held in place by metal-to-metal fasteners allowing sheets to be tucked in place.
- Straps can be unfastened for field replacement of the cushion, if required for any reason.
- A clean through is located at the back of the seat cushion, extending to the floor supporting ease of cleaning.
- The seat cushion folds open to create a 36" deep sleep surface area. Foam is standard high density Ultracell, for enhanced comfort and long-term performance.
- A pull-out section below the seat deck slides forward to support the sleep surface.
- The sleep surface cushion and drawer box covering are upholstered in Bantam vinyl to ensure moisture barrier protection. These surfaces are 9:1 (water to bleach) cleanable. Please select **(BM)** color. See Morbern Bantam textile card for color samples. All other surfaces can be specified in your textile of choice.
- A curved, chrome pull handle is standard on the pull-out front panel of all Dreme models.
- The pull-out is supported by four heavy duty non-locking, swivel casters when in sleep position and is standard without storage.
- Dreme requires zero wall clearance to open into sleep position.
- Standard configuration for all models: two metal legs in front position, two non-locking swivel casters in back position (to assist with moving the unit). Optional front, locking, swivel casters **(FC)** are available. Add **\$85**.
- Legs are available in all Globalcare metal paint finishes.
- Models with a tablet are available with left, right or both sofa arms. On models with both arms, specify left **(LT)**, right **(RT)** or **(TB)** for tablets on both arms (add **\$342** for **TB**). Tablet and arms are designated based on seated position. The tablet surfaces attach to the outside of the arm. The tablet rotates up and can be swiveled over the arm into place for use by the occupant. The strong, oval tablet is a soft black colored, non-porous, phenolic material with a no-spill edge.
- Interior sleep surface: 79"L x 37"W
- All textiles are railroaded across all Dreme components.
- For healthcare textiles, visit the website at [globalfurnituregroup.com/healthcare](http://globalfurnituregroup.com/healthcare).
- Can be upholstered in standard Global textiles if healthcare compliance is not required.

OPTIONAL FEATURES

- The pull-out is available with a storage compartment option. The storage compartment is divided into two sides, both with clean through spaces, and is finished in Storm Grey (SOG) laminate. The storage compartment must be ordered at time of original order and cannot be retrofitted, specify **(SRB)**. Add **\$472**.
- Storage compartment lids have a pneumatic lift support, allowing the lid to stay open when accessing the interior storage area.
- An optional seamless drawer liner is available for the storage compartments, as a set of two. Liners can be removed for ease of maintenance, specify **(SRL)**. Add **\$939**.
- Pull-out front panel is available with or without power units, and either upholstered or laminate. Specify one of the following:  
**(LPN)** laminate panel  
**(UPN)** upholstered panel  
**(LPP)** laminate panel with power. Add **\$252**.  
**(UPP)** upholstered panel with power. Add **\$252**. Select from all standard laminate finishes.
- The optional power unit is located on the front panel, center front position. The tamper-resistant unit includes one power and two, USB-A, 10 watt charging ports with an 8 ft. long power cord. When the pull-out is in the open position, the remaining power cord length is 6 ft. The power module is Black with Black face plate and must be specified at time of order.
- **Leg finish/caster option:**  
**(TBL)** Black  
**(TKA)** Kalua  
**(TLA)** Latte  
**(TMO)** Mocha  
**(TSH)** Shadow  
**(TOA)** Toast  
**(TTU)** Tungsten  
**(FC)** Front, locking, swivel casters. Add **\$85**. (Casters are Black with Taupe center)
- **Sleep Surface Finish:**  
**(BM21)** Apple  
**(BM25)** Cosmic  
**(BM23)** Dove  
**(BM26)** Firelight  
**(BM22)** Ghost  
**(BM27)** Ginger  
**(BM24)** Iron  
**(BM20)** Rabbit  
**(BM28)** Tropical  
See finishes at [globalfurnituregroup.com/workplace/resources/textiles](http://globalfurnituregroup.com/workplace/resources/textiles) - Global Carded Textiles
- For moisture barrier on full seat and sleeping surface, specify **(MB)**. Add **\$547**.
- To add sealed seams to your product, specify **(SS)**. Add **\$512**.

SUGGESTED APPLICATIONS

- Lounge
- Patient rooms
- Resident rooms
- Treatment/Exam rooms

# SEATING

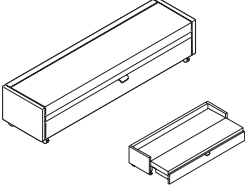
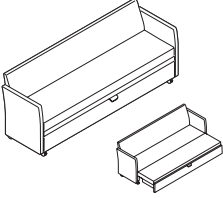
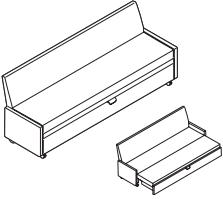
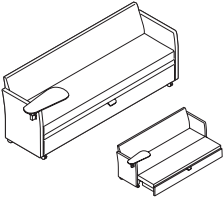
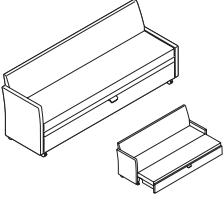
DESCRIPTION	MODEL#/ FEATURES	STANDARD TEXTILE GRADES											
		COM	2	3	4	5	6	7	8	9	10	11	12
 <p><b>Armless Sleeper</b> COM Yardage: 9.5 Freight Class: 125 Product Weight (lbs.): 158 Cubic Feet Per Carton: 22.75</p>	<b>GC35041NA</b>	\$5461	\$5810	\$6092	\$6517	\$7114	\$7395	\$7937	\$8800	\$9466	\$10207	\$11729	\$13355
		<b>OVERALL DIMENSIONS</b>			<b>SEAT DIMENSIONS</b>			<b>BACK DIMENSIONS</b>					
		<b>W</b>	<b>D</b>	<b>H</b>	<b>W</b>	<b>D</b>	<b>H</b>	<b>W</b>	<b>H</b>				
	Active weight 450 lbs.	82	23	18.5	78	--	18.5						
 <p><b>Sleeper w/Back and Arms</b> COM Yardage: 11.75 Freight Class: 150 Product Weight (lbs.): 210 Cubic Feet Per Carton: 46.25</p>	<b>GC35042</b>	\$6194	\$6612	\$6952	\$7459	\$8176	\$8514	\$9165	\$10204	\$11004	\$11892	\$13721	\$15674
		<b>OVERALL DIMENSIONS</b>			<b>SEAT DIMENSIONS</b>			<b>BACK DIMENSIONS</b>					
		<b>W</b>	<b>D</b>	<b>H</b>	<b>W</b>	<b>D</b>	<b>H</b>	<b>W</b>	<b>H</b>				
	Active weight 450 lbs.	82	25	32.5	78	18	18.5	78	14				
 <p><b>Armless Sleeper w/Back</b> COM Yardage: 11.45 Freight Class: 150 Product Weight (lbs.): 190 Cubic Feet Per Carton: 46.25</p>	<b>GC35042NA</b>	\$6023	\$6423	\$6749	\$7237	\$7924	\$8245	\$8870	\$9863	\$10630	\$11482	\$13236	\$15105
		<b>OVERALL DIMENSIONS</b>			<b>SEAT DIMENSIONS</b>			<b>BACK DIMENSIONS</b>					
		<b>W</b>	<b>D</b>	<b>H</b>	<b>W</b>	<b>D</b>	<b>H</b>	<b>W</b>	<b>H</b>				
	Active weight 450 lbs.	82	25	32.5	78	18	18.5	78	14				
 <p><b>Sleeper w/Back, Arms and Tablet</b> COM Yardage: 11.75 Freight Class: 150 Product Weight (lbs.): 210 Cubic Feet Per Carton: 48.5</p>	<b>GC35042T</b>	\$6557	\$6968	\$7303	\$7801	\$8507	\$8838	\$9478	\$10500	\$11287	\$12158	\$13958	\$15877
		Specify (LT) for left tablet or (RT) for right tablet. Specify (TB) for tablet on both arms. Add \$342.											
		<b>OVERALL DIMENSIONS</b>			<b>SEAT DIMENSIONS</b>			<b>BACK DIMENSIONS</b>					
	Active weight 450 lbs.	86	25	32.5	78	18	18.5	78	14				
 <p><b>Sleeper w/Back and one Arm</b> COM Yardage: 11.95 Freight Class: 150 Product Weight (lbs.): 200 Cubic Feet Per Carton: 46.25</p>	<b>GC35043</b>	\$6194	\$6612	\$6952	\$7459	\$8176	\$8514	\$9165	\$10204	\$11004	\$11892	\$13721	\$15674
		Specify (AR) for right arm or (AL) for left arm.											
		<b>OVERALL DIMENSIONS</b>			<b>SEAT DIMENSIONS</b>			<b>BACK DIMENSIONS</b>					
	Active weight 450 lbs.	82	25	32.5	78	18	18.5	78	14				

DESCRIPTION

MODEL#/ FEATURES

STANDARD TEXTILE GRADES

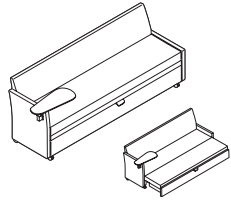

	COM	2	3	4	5	6	7	8	9	10	11	12
<b>GC35043T</b>	<b>\$6575</b>	<b>\$6968</b>	<b>\$7289</b>	<b>\$7765</b>	<b>\$8442</b>	<b>\$8759</b>	<b>\$9372</b>	<b>\$10348</b>	<b>\$11103</b>	<b>\$11938</b>	<b>\$13661</b>	<b>\$15498</b>

Specify (RT) for right arm or (LT) for left arm.

**Sleeper w/Back, Single Arm and Tablet**  
 COM Yardage: 11.25  
 Freight Class: 150  
 Product Weight (lbs.): 205  
 Cubic Feet Per Carton: 47.5

Active weight 450 lbs.

OVERALL DIMENSIONS			SEAT DIMENSIONS			BACK DIMENSIONS	
W	D	H	W	D	H	W	H
86	25	32.5	78	18	18.5	78	14



Change is the constant that each new generation brings to the table. Drift™ seating encourages people to come together with new ideas, new priorities and new ways of thinking. The welcoming look is ideal for collaborative spaces in the workplace to community spaces in healthcare.

The series includes lounge and side chairs, bar and counter stools, and task swivel models, connecting people and places wherever the day takes us. The wood base four-leg and swivel models, available in a wide range of popular finishes, bring added warmth to this contemporary seating series.

To see the full Drift series, please refer to the Seating price list at: [globalfurnituregroup.com/workplace/resources/price-lists](https://globalfurnituregroup.com/workplace/resources/price-lists)

#### Features and Benefits

- Soft seat and contoured back and arms provide the perfect balance of style and comfort
- Side chairs available in six base types: sled, wood 4-leg, wood 4-prong swivel, chrome 4-prong swivel, high 4-star swivel and 5-star base on casters
- Lounge chairs available in four base types: sled, wood 4-leg, wood 4-star swivel and Chrome 4-prong swivel
- Counter and bar height stools available with three base types: sled, wood 4-leg, and Chrome 4-star swivel.
- Lounge seating available with 17" seat height with a classic lounge angle or 18" seat height with a reduced back angle for ease of sitting and standing.
- Ottomans have a weighted bottom to maintain upright position.
- P and PH suffix models available with arm and head patches for increased durability
- For ease of cleaning, side and lounge chair models with "F" suffix have flip-forward seats.
- All Drift seating is assembled using tamper proof screws.
- Drift seating is designed for 300 lb. capacity.
- Available to specify with two textiles, one for the seat cushion and one for the back and arms.
- For environmental certifications, please visit [globalfurnituregroup.com](https://globalfurnituregroup.com).

#### Options

- Sealed back seams and sealed seat seams
- Moisture barrier (seat only)
- Variety of glide options (wood base and sled base models)

ERIN



**model GC36531**  
Armless Guest Chair,  
Metal Legs



**model GC36532**  
Guest Armchair,  
Wood Legs

**STANDARD FEATURES**

- Erin offers a streamlined silhouette brimming with mid-century modern style.
- A rounded arch gently curves around and under the seat to give extra support to a user's upper back and sides, while creating an open clean-out space at the back of the cushion.
- The series is available to specify with two textiles, one for the seat cushion and one for the back, arms and front rail (see model image).
- For pricing, start with the base price and add both back/arms graded textile upcharge and the seat graded textile upcharge.
- Tapered legs add style and elegance.
- Legs are available in wood or metal painted/plated finishes (noted).
- The seat underside is sealed with a non-porous material to support housekeeping and infection control protocols.
- Additional improved cleaning options include sealed seams (back and/or seat) and moisture barrier (seat). Upcharges apply.
- Assembled with tamper-resistant fasteners for greater security.
- For added comfort, the seat cushions are standard with high density Ultracell foam.
- Glides are self-leveling. Choose from standard non-marking glides, rubber non-slip glides or felt glides (upcharges apply).
- The Globalcare warranty (for healthcare and 24/7 environments) applies for all Erin GC models when performance textiles are selected. Visit the website at [globalfurnituregroup.com/healthcare](http://globalfurnituregroup.com/healthcare).
- Global's standard lifetime warranty applies when approved standard Global textiles are selected.
- For alternate textile applications, contact Global specials. The Blended Textile matrix does not apply to this series.
- Shipped fully assembled.

**SUGGESTED APPLICATIONS**

- Dining/Cafeteria
- Guest seating
- Lobbies
- Lounge/Waiting
- Patient rooms
- Resident rooms





**OPTIONAL FEATURES**

Please add option codes in the following order:

- **Model number**  
**GC36530** Guest armless chair, wood legs  
**GC36531** Guest armless chair, metal legs  
**GC36532** Guest armchair, wood legs  
**GC36533** Guest armchair, metal legs
- **Back/Arm Textile**  
Specify textile code. See model grade upcharges.
- **Seat Textile**  
Specify textile code. See model grade upcharges.
- **Wood leg finish** (models GC36530 and GC36532)  
**(AAM)** Absolute **(MWM)** Medium Walnut  
**(BKM)** Black **(NLW)** Natural Walnut  
**(ACM)** Cherry **(ASM)** Night  
**(EOM)** English Oak **(NBM)** Noce Biondo  
**(ECM)** Espresso Cafe **(NGM)** Noce Grigio  
**(TFM)** Fruitwood **(NEM)** Noce Leggero  
**(HGM)** Grey **(NMM)** Noce Medio  
**(AHM)** Honey **(SBM)** Sandy Beach  
**(JOM)** Jet Onyx **(SKM)** Shaker Cherry  
**(TMM)** Mahogany **(TWM)** Walnut  
**(AVM)** Maple **(WTM)** WC Cream  
**(WHM)** White **(WCM)** Winter Cherry
- **Metal leg finish** (models GC36531 and GC36533)  
**(CHM)** Chrome **(TTU)** Tungsten  
**(TBL)** Black **(TKA)** Kalua  
**(TLA)** Latte **(TMO)** Mocha  
**(TSH)** Shadow **(TOA)** Toast
- **Glides**  
**(NM)** Non-marking glide. No upcharge  
**(RG)** Rubber, non-slip glide. Add \$64.  
**(FG)** Felt glide. Add \$64.
- **Sealed Back Seams** (Contact Customer Care for approved textiles)  
**(NBS)** No sealed back seams  
**(SBS)** Sealed back seams. Upcharges vary, see model.
- **Sealed Seat Seams** (Contact Customer Care for approved textiles)  
**(NSS)** No sealed seat seams  
**(SSS)** Sealed seat seams. Add \$22.
- **Moisture Barrier** (Not available with Sealed Seams)  
**(NB)** No moisture barrier.  
**(MB)** Moisture barrier (seat only). Add \$117.

**EXAMPLE ERIN ORDER CODE:**

GC36530	CE90	CE90	AAM	NM	NBS	NSS	NB
Model #	Seat/Arm textile	Seat textile	Leg finish	Glide	Sealed Back Seams	Sealed Seat Seams	Moisture Barrier

DESCRIPTION	MODEL#/ FEATURES	STANDARD TEXTILE GRADES											
		1/COM	2	3	4	5	6	7	8	9	10	11	12
 <p><b>Armless Guest Chair, Wood Legs</b> COM Yardage: Back/Arm: 1.75; Seat: 1 Freight Class: 250 Product Weight (lbs.): 32.5 Cubic Feet Per Carton: 13.25</p>	<b>GC36530</b> Base Price:	<b>\$1997</b>											
	Back/Arm upcharge:	<b>+0</b>	<b>+\$60</b>	<b>+\$106</b>	<b>+\$175</b>	<b>+\$271</b>	<b>+\$311</b>	<b>+\$394</b>	<b>+\$525</b>	<b>+\$623</b>	<b>+\$731</b>	<b>+\$953</b>	<b>+\$1188</b>
	Seat upcharge:	<b>+0</b>	<b>+\$34</b>	<b>+\$61</b>	<b>+\$100</b>	<b>+\$155</b>	<b>+\$178</b>	<b>+\$225</b>	<b>+\$300</b>	<b>+\$356</b>	<b>+\$417</b>	<b>+\$545</b>	<b>+\$679</b>
	<b>OVERALL DIMENSIONS</b>			<b>SEAT DIMENSIONS</b>			<b>BACK DIMENSIONS</b>						
	W D H			W D H			W H						
	24 22.25 34			19 18 19			15 15.5						
	Active weight 350 lbs.	Add \$52 for (SBS), \$22 for (SSS)											
 <p><b>Armless Guest Chair, Metal Legs</b> COM Yardage: Back/Arm: 1.75; Seat: 1 Freight Class: 250 Product Weight (lbs.): 34.5 Cubic Feet Per Carton: 13.25</p>	<b>GC36531</b> Base Price:	<b>\$1901</b>											
	Back/Arm upcharge:	<b>+0</b>	<b>+\$60</b>	<b>+\$106</b>	<b>+\$175</b>	<b>+\$271</b>	<b>+\$311</b>	<b>+\$394</b>	<b>+\$525</b>	<b>+\$623</b>	<b>+\$731</b>	<b>+\$953</b>	<b>+\$1188</b>
	Seat upcharge:	<b>+0</b>	<b>+\$34</b>	<b>+\$61</b>	<b>+\$100</b>	<b>+\$155</b>	<b>+\$178</b>	<b>+\$225</b>	<b>+\$300</b>	<b>+\$356</b>	<b>+\$417</b>	<b>+\$545</b>	<b>+\$679</b>
	<b>OVERALL DIMENSIONS</b>			<b>SEAT DIMENSIONS</b>			<b>BACK DIMENSIONS</b>						
	W D H			W D H			W H						
	24 22.25 34			19 18 19			15 15.5						
	Active weight 350 lbs.	Add \$52 for (SBS), \$22 for (SSS)											
 <p><b>Guest Armchair, Wood Legs</b> COM Yardage: Back/Arm: 1.75; Seat: 1 Freight Class: 250 Product Weight (lbs.): 33 Cubic Feet Per Carton: 13.25</p>	<b>GC36532</b> Base Price:	<b>\$1997</b>											
	Back/Arm upcharge:	<b>+0</b>	<b>+\$60</b>	<b>+\$106</b>	<b>+\$175</b>	<b>+\$271</b>	<b>+\$311</b>	<b>+\$394</b>	<b>+\$525</b>	<b>+\$623</b>	<b>+\$731</b>	<b>+\$953</b>	<b>+\$1188</b>
	Seat upcharge:	<b>+0</b>	<b>+\$34</b>	<b>+\$61</b>	<b>+\$100</b>	<b>+\$155</b>	<b>+\$178</b>	<b>+\$225</b>	<b>+\$300</b>	<b>+\$356</b>	<b>+\$417</b>	<b>+\$545</b>	<b>+\$679</b>
	<b>OVERALL DIMENSIONS</b>			<b>SEAT DIMENSIONS</b>			<b>BACK DIMENSIONS</b>						
	W D H			W D H			W H						
	24 22 34.25			19 18.5 18.5			17 15.75						
	Active weight 350 lbs.	Add \$55 for (SBS), \$22 for (SSS)											
 <p><b>Guest Armchair, Metal Legs</b> COM Yardage: Back/Arm: 1.75; Seat: 1 Freight Class: 250 Product Weight (lbs.): 35 Cubic Feet Per Carton: 13.25</p>	<b>GC36533</b> Base Price:	<b>\$1901</b>											
	Back/Arm upcharge:	<b>+0</b>	<b>+\$60</b>	<b>+\$106</b>	<b>+\$175</b>	<b>+\$271</b>	<b>+\$311</b>	<b>+\$394</b>	<b>+\$525</b>	<b>+\$623</b>	<b>+\$731</b>	<b>+\$953</b>	<b>+\$1188</b>
	Seat upcharge:	<b>+0</b>	<b>+\$34</b>	<b>+\$61</b>	<b>+\$100</b>	<b>+\$155</b>	<b>+\$178</b>	<b>+\$225</b>	<b>+\$300</b>	<b>+\$356</b>	<b>+\$417</b>	<b>+\$545</b>	<b>+\$679</b>
	<b>OVERALL DIMENSIONS</b>			<b>SEAT DIMENSIONS</b>			<b>BACK DIMENSIONS</b>						
	W D H			W D H			W H						
	24 22 34.25			19 18.5 18.5			17 15.75						
	Active weight 350 lbs.	Add \$55 for (SBS), \$22 for (SSS)											

FLAP™



**Folding Chair**  
model 6775

**STANDARD FEATURES**

- A modern design, high quality, lightweight, all polymer folding chair intended for use indoors or outdoors. Products must be stored inside during extreme and inclement weather. See Global's Outdoor Furniture warranty for additional information.
- Weather resistant, UV resistant, stain resistant, 100% non-ferrous, and recyclable design that is 1:10 bleach solution cleanable.
- Chair legs are equipped with clear non-marking glides as standard. Suitable for outdoor environments, carpet and hard surface flooring
- Chairs are stocked in 2 colors:  
Alloy (**ALY**)  
Milk (**MLK**)
- No upholstery options available
- Rated to 275 lbs.
- Single chair folds flat to 2.2" (55 mm).
- Flap achieves its strength and durability using glass filled polymer. Evidence of this material may be visible on the surface and is often more evident in darker colors.
- Two Flap Wall Hooks, sold individually, support either one (6776S) or two (6776) folded Flap chairs. Mounting hardware not included. Recommended mounting into stud. These Milk (**MLK**) colored plastic hooks mount on walls or inside closets and wardrobe cabinets providing easy access to extra seating.  
-A single chair and hook require 3.7" (94 mm) minimum clearance from wall. Two adhesive wall bumpers are provided in box, recommended for use when mounting behind doors.  
- Two chairs and hook require 7.3" (185 mm) minimum clearance from wall. Wall bumpers not included.
- Flap Ganging Brackets (6778) are sold 12 to a box. These translucent, frosted plastic brackets attach across two adjacent chairs, just above or below the seat to provide temporary ganging for organized events.



- The Flap Dolly (6777), ordered separately, supports up to 24 chairs folded and stacked flat. Includes strap to secure chairs for storage and transport.

Please add option codes in the following order

- **Model number**  
6775 Folding Chair  
6776 Wall Hook  
6777 Dolly  
6778 Ganging Brackets
- **Chair Color**  
(ALY) Alloy  
(MLK) Milk

**EXAMPLE OF FLAP ORDER CODE:**

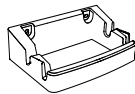
6775	ALY
Model Number	Finish

DESCRIPTION	MODEL#/ FEATURES	STANDARD TEXTILE GRADES												
		1	2	3	4	5	6	7	8	9	10	11	12	
 <b>Folding Chair</b> COM Yardage: N/A Freight Class: 100 Product Weight (lbs.): 13.5 Cubic Feet Per Carton: 1.6	<b>6775</b>  Shipped 2 per box. Ordered as each.	<b>\$226</b>												
	<b>OVERALL DIMENSIONS</b>			<b>SEAT DIMENSIONS</b>			<b>BACK DIMENSIONS</b>							
	<b>W</b>	<b>D</b>	<b>H</b>	<b>W</b>	<b>D</b>	<b>H</b>	<b>W</b>	<b>D</b>	<b>H</b>	<b>W</b>	<b>D</b>	<b>H</b>	<b>H</b>	
	19	21.5	33.5	16	16.5	18.5	18.5	18.5	18.5	18.5	18.5	18.5	18.5	18.5
	<span style="background-color: black; color: white; padding: 2px;">RTA 00</span> <b>FedEx</b> 2 per carton (pricing and specifications are for one chair)													
 <b>Flap Wall Hook, Two Chairs</b> COM Yardage: N/A Freight Class: 70 Product Weight (lbs.): 0.75 Cubic Feet Per Carton: 0.2	<b>6776</b>	<b>\$57</b>												
	<b>OVERALL DIMENSIONS</b>			<b>SEAT DIMENSIONS</b>			<b>BACK DIMENSIONS</b>							
	<b>W</b>	<b>D</b>	<b>H</b>	<b>W</b>	<b>D</b>	<b>H</b>	<b>W</b>	<b>D</b>	<b>H</b>	<b>W</b>	<b>D</b>	<b>H</b>	<b>H</b>	
	9	6	2.75	9	6	2.75	9	6	2.75	9	6	2.75	9	
	<span style="background-color: black; color: white; padding: 2px;">RTA 00</span> <b>FedEx</b>  1 per carton													

# SEATING

# FLAP™

F

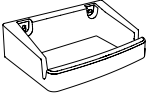
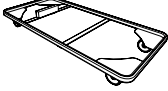
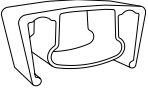
DESCRIPTION	MODEL#/ FEATURES	STANDARD TEXTILE GRADES													
		1	2	3	4	5	6	7	8	9	10	11	12		
 <p><b>Flap Wall Hook, Single Chair</b>                      COM Yardage: N/A                      Freight Class: 70                      Product Weight (lbs.): 0.75                      Cubic Feet Per Carton: 0.2</p>	<b>6776S</b>	<b>\$57</b>													
	OVERALL DIMENSIONS			SEAT DIMENSIONS			BACK DIMENSIONS								
	W	D	H	W	D	H	W	H							
	8.5	3.7	2.25												
				RTA 00			FedEx ups			1 per carton					
 <p><b>Dolly for Flap Folding Chairs</b>                      COM Yardage: N/A                      Freight Class: 150                      Product Weight (lbs.): 23                      Cubic Feet Per Carton: 4.5</p>	<b>6777</b>	<b>\$648</b>													
	OVERALL DIMENSIONS			SEAT DIMENSIONS			BACK DIMENSIONS								
	W	D	H	W	D	H	W	H							
	20.75	44	5.25												
				RTA 00			FedEx ups			1 per carton					
 <p><b>Flap Ganging Bracket (box of 12)</b>                      COM Yardage: N/A                      Freight Class: 70                      Product Weight (lbs.): 0.29                      Cubic Feet Per Carton: 0.03</p>	<b>6778</b>	<b>\$199</b>													
	OVERALL DIMENSIONS			SEAT DIMENSIONS			BACK DIMENSIONS								
	W	D	H	W	D	H	W	H							
	0	0	0												
				RTA 00			FedEx ups			12 per carton (pricing and specifications are for box of 12)					

FOOT ACTIVATED STOOLS



model GC9604FG

model GC9668FG

STANDARD FEATURES

- Foot activated stools allow the occupant to adjust the gas cylinder by pressing on the ring below the base with their foot, which frees up hands to manage other tasks while working in a lab.
- Raise the seat by pressing on the ring before sitting; or lower the seat by pressing on the ring while seated.
- Swivel stool with 8" gas cylinder provides seat height range of 21.5" to 29.5".
- Seamless upholstered seat cushion is constructed from high density Ultracell foam.
- Underside of seat cushion is finished with polyurethane.
- 14" seat diameter with 25" diameter Black five prong injection molded base.
- Standard with dual wheel hard floor casters (C10R).
- For Globalcare textiles and finish options, visit the website at [globalfurnituregroup.com](http://globalfurnituregroup.com).
- Can be upholstered in standard Global textiles only if Healthcare compliance is not required.

OPTIONAL FEATURES

- To respond to higher expectations for housekeeping and infection prevention, seat underside can be completely sealed. Contact Customer Care for upcharge.

SUGGESTED APPLICATIONS

- Dining/Cafeteria
- Office/Meeting
- Patient rooms
- Resident rooms
- Treatment/Exam rooms

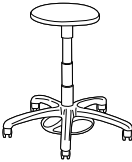
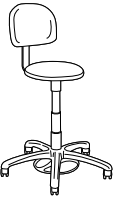
DESCRIPTION	MODEL#/ FEATURES	STANDARD TEXTILE GRADES											
		COM	2	3	4	5	6	7	8	9	10	11	12
 <p><b>Lab Swivel Stool</b> COM Yardage: 0.75 Freight Class: 250 Product weight (lbs.): 25 Cubic Feet per Carton: 9.75</p>	GC9604FG	\$826	\$849	\$874	\$904	\$951	\$973	\$1013	\$1077	\$1128	\$1184	\$1299	\$1421
		OVERALL DIMENSIONS			SEAT DIMENSIONS			BACK DIMENSIONS					
		W	D	H	W	D	H	W	H				
		14	14	25.5	14	--	21.5-29.5						
 <p><b>Lab Swivel Stool w/Small Upholstered Back</b> COM Yardage: 1 Freight Class: 250 Product weight (lbs.): 32 Cubic Feet per Carton: 13</p>	GC9668FG	\$975	\$1007	\$1038	\$1081	\$1141	\$1169	\$1224	\$1310	\$1378	\$1454	\$1604	\$1768
		OVERALL DIMENSIONS			SEAT DIMENSIONS			BACK DIMENSIONS					
		W	D	H	W	D	H	W	H				
		14	14	38	14	--	21.5-29.5	14	12.5				



model GC3001

model GC3011

### Three different back constructions



Separate panel piece closes the lower back to conceal the support bracket. Offered in **Frolick** series on select models.



Single piece back with a pullover style upholstery cover and support bracket fastened on the outer back. Offered on select **Frolick** models.



Two piece back covering the back support brackets when fastened in place. Offered in **Splash** series.

### STANDARD FEATURES



- Frolick and Splash are multi-purpose stacking chairs that share generous width between the arms, great comfort, and a frame built for greater strength and stability. Each series offers a different back design with special features to best address the application and infection control practices.
- Standard size models offer 19" seat width with 21.5" clearance between the armrests. Bariatric size models offer 31.5" seat width with 33.5" clearance between the armrests.
- For a smaller scale bariatric chair, refer to GC Comet #GC2180 which offers 18.5" seat width with 28" clearance between armrests
- Heavy duty round, tubular gusseted frames.
- Active weight capacity is up to 300 lbs. for standard models, and 500 lbs. for Bariatric models.
- Protective Shadow finished seat shroud is standard on the underside of all models (except bariatric models GC3003 and GC3023).
- To respond to higher expectations for housekeeping and infection control practices, select models with a one-piece back. Description of back is noted with each model
- Wallsaver rear legs eliminate accidental damage to walls.
- Armrests are fiberglass reinforced Nylon and have a flat profile. Fully extended to front of seat edge to assist in entry and exit from the chair.
- Armrests are standard in Black.
- For added comfort, seats are standard with high density Ultracell bio foam
- Four legged standard size models stack 5 high without dolly and 8 high on GC3010 dolly.
- **Four legged Bariatric models stack 2 high only** - No dolly available.
- Sled base models do not stack
- For ganging brackets, see Model 2180 in the Global Seating List Price Book.
- On armless models, Black frames are standard with Black glides and front leg caps. All other frame colors are standard with Shadow glides and front leg caps.
- For textiles and finish options, visit the website at [globalfurnituregroup.com/healthcare](http://globalfurnituregroup.com/healthcare)
- Can be upholstered in standard Global textiles only if Healthcare compliance is not required.

### OPTIONAL FEATURES

- A selection of glide options is available. Glides must be chosen to best suit flooring type and site conditions.
- For hard surface floors, please specify opaque non-marking glides (**WH**). No upcharge.
- Glides with felt pads (**FG**) are available for vinyl sheet, cork or laminate flooring. Please specify. Add **\$64**.
- Glides with rubber pads (**RG**) are available for vinyl, hardwood, laminate, stone or ceramic flooring. Please specify. Add **\$64**.
- Armrests available in Shadow (**SHW**) and Toast (**TOA**). Please Specify. Add **\$35**.
- To add sealed seams to your product contact Customer Care. Upcharges vary
- For moisture barrier on seat, add \$137 per seat. For bariatric models - Add \$209 per seat.
- **Frame finish**  
Painted finishes - no upcharge:  
(**TBL**) Black  
(**TBZ**) Buzz Blue  
(**TCC**) Cactus  
(**TCR**) Carrot  
(**TIV**) Cloud  
(**TDW**) Designer White  
(**TDJ**) Dijon  
(**TEG**) Eggplant  
(**TFO**) Fog  
(**TFR**) Frost  
(**TIN**) Ink  
(**TKA**) Kalua  
(**TLA**) Latte  
(**TMO**) Mocha  
(**TNE**) Nevada  
(**TSN**) Sand  
(**TSR**) Scarlet  
(**TSH**) Shadow  
(**TOA**) Toast  
(**TTU**) Tungsten  
Plated finish - see models for upcharge:  
(**CHM**) Chrome

### SUGGESTED APPLICATIONS

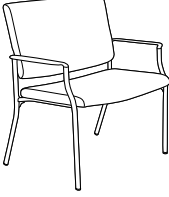
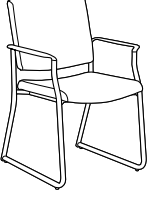
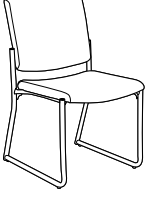

- Bariatric seating (Frolick)
- Dining/Cafeteria
- Guest seating
- Lobbies
- Lounge/Waiting
- Office/Meeting
- Patient rooms
- Resident rooms
- Stacking
- Treatment/Exam Rooms



DESCRIPTION	MODEL#/ FEATURES	STANDARD TEXTILE GRADES											
		COM	2	3	4	5	6	7	8	9	10	11	12
 <p><b>Frolick Stacking Armchair</b> 4 Leg Base, Rectangular back with concealed attachment                      COM Yardage: 1.25                      Freight Class: 250                      Product Weight (lbs.): 24                      Cubic Feet Per Carton: 6.67</p>	GC3001	\$864	\$901	\$941	\$994	\$1068	\$1096	\$1161	\$1283	\$1342	\$1459	\$1616	\$1811
		OVERALL DIMENSIONS			SEAT DIMENSIONS			BACK DIMENSIONS					
		W	D	H	W	D	H	W	H				
		25	24.5	36	19	18	18.5	19.5	17				
 <p><b>Frolick Stacking Chair</b> Armless, 4 Leg Base, Rectangular back with concealed attachment                      COM Yardage: 1.25                      Freight Class: 250                      Product Weight (lbs.): 22                      Cubic Feet Per Carton: 6.67</p>	GC3002	\$824	\$865	\$903	\$958	\$1032	\$1060	\$1125	\$1247	\$1306	\$1420	\$1580	\$1776
		OVERALL DIMENSIONS			SEAT DIMENSIONS			BACK DIMENSIONS					
		W	D	H	W	D	H	W	H				
		21	24.5	36	19	18	18.5	19.5	17				
 <p><b>Frolick Bariatric Stacking Armchair</b> 4 Leg Base, Rectangular back with concealed attachment                      COM Yardage: 2.25                      Freight Class: 300                      Product Weight (lbs.): 42                      Cubic Feet Per Carton: 26.5</p>	GC3003	\$1574	\$1648	\$1717	\$1812	\$1945	\$1995	\$2114	\$2331	\$2444	\$2649	\$2932	\$3284
		OVERALL DIMENSIONS			SEAT DIMENSIONS			BACK DIMENSIONS					
		W	D	H	W	D	H	W	H				
		37	24.5	36.5	31.5	18	18.5	32	18.5				
 <p><b>Frolick Armchair</b> Sled Base, Rectangular back with concealed attachment                      COM Yardage: 1.25                      Freight Class: 250                      Product Weight (lbs.): 32                      Cubic Feet Per Carton: 13.75</p>	GC3021	\$894	\$935	\$975	\$1028	\$1102	\$1130	\$1195	\$1317	\$1376	\$1493	\$1648	\$1844
		OVERALL DIMENSIONS			SEAT DIMENSIONS			BACK DIMENSIONS					
		W	D	H	W	D	H	W	H				
		25	24.5	36	18	17	18.5	18.75	18				
 <p><b>Frolick Armless Chair</b> Sled Base, Rectangular back with concealed attachment                      COM Yardage: 1.25                      Freight Class: 250                      Product Weight (lbs.): 30                      Cubic Feet Per Carton: 13.75</p>	GC3022	\$858	\$895	\$935	\$988	\$1062	\$1090	\$1155	\$1277	\$1336	\$1453	\$1608	\$1805
		OVERALL DIMENSIONS			SEAT DIMENSIONS			BACK DIMENSIONS					
		W	D	H	W	D	H	W	H				
		21	24.5	36	19	18	18.5	19.5	17				

# SEATING

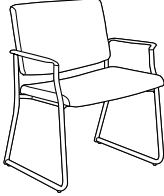
# FROLICK™ & SPLASH™

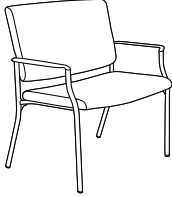
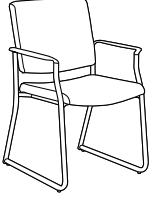
F

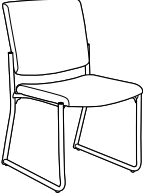
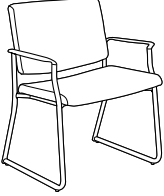

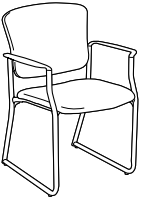
DESCRIPTION	MODEL#/ FEATURES	STANDARD TEXTILE GRADES											
		COM	2	3	4	5	6	7	8	9	10	11	12
 <p><b>Frolick Bariatric Armchair</b> Sled Base, Rectangular back with concealed attachment                      COM Yardage: 2.25                      Freight Class: 300                      Product Weight (lbs.): 47                      Cubic Feet Per Carton: 26.5</p> <p>Active weight 500 lbs.  <b>Does not stack.</b>                      Chrome (CHM) frame finish, add \$318.</p>	<b>GC3023</b>	\$1674	\$1748	\$1817	\$1912	\$2045	\$2095	\$2214	\$2431	\$2544	\$2750	\$3033	\$3386
	<b>OVERALL DIMENSIONS</b>			<b>SEAT DIMENSIONS</b>			<b>BACK DIMENSIONS</b>						
	<b>W</b>	<b>D</b>	<b>H</b>	<b>W</b>	<b>D</b>	<b>H</b>	<b>W</b>	<b>H</b>					
	37	24.5	36.5	31.5	18	18.5	32	18.5					
 <p><b>Frolick Stacking Armchair</b> 4 Leg Base, Rectangular back                      COM Yardage: 1.25                      Freight Class: 250                      Product Weight (lbs.): 24                      Cubic Feet Per Carton: 6.67</p> <p>Active weight 300 lbs.                      Single piece back with pullover style upholstery cover with <b>exposed support brackets</b> on the outer back.                      Stacks 5 high on floor.                      Chrome (CHM) frame finish, add \$190.</p>	<b>GC3031</b>	\$864	\$901	\$941	\$994	\$1068	\$1096	\$1161	\$1283	\$1342	\$1459	\$1616	\$1811
	<b>OVERALL DIMENSIONS</b>			<b>SEAT DIMENSIONS</b>			<b>BACK DIMENSIONS</b>						
	<b>W</b>	<b>D</b>	<b>H</b>	<b>W</b>	<b>D</b>	<b>H</b>	<b>W</b>	<b>H</b>					
	25	24.5	36	19	18	18.5	19.5	17					
 <p><b>Frolick Stacking Chair</b> Armless, 4 Leg Base, Rectangular back                      COM Yardage: 1.25                      Freight Class: 250                      Product Weight (lbs.): 21                      Cubic Feet Per Carton: 6.67</p> <p>Active weight 300 lbs.                      Single piece back with pullover style upholstery cover with <b>exposed support brackets</b> on the outer back.                      Stacks 5 high on floor.                      Chrome (CHM) frame finish, add \$170.</p>	<b>GC3032</b>	\$824	\$865	\$905	\$958	\$1032	\$1060	\$1125	\$1247	\$1306	\$1423	\$1580	\$1776
	<b>OVERALL DIMENSIONS</b>			<b>SEAT DIMENSIONS</b>			<b>BACK DIMENSIONS</b>						
	<b>W</b>	<b>D</b>	<b>H</b>	<b>W</b>	<b>D</b>	<b>H</b>	<b>W</b>	<b>H</b>					
	21	24.5	36	19	18	18.5	19.5	17					
 <p><b>Frolick Bariatric Stacking Armchair</b> 4 Leg Base, Rectangular back                      COM Yardage: 2.25                      Freight Class: 300                      Product Weight (lbs.): 42                      Cubic Feet Per Carton: 26.5</p> <p>Active weight 500 lbs.                      Single piece back with pullover style upholstery cover with <b>exposed support brackets</b> on the outer back.                      Chrome (CHM) frame finish, add \$265.                      Stacks 2 high.</p>	<b>GC3033</b>	\$1574	\$1648	\$1717	\$1812	\$1945	\$1995	\$2114	\$2331	\$2444	\$2649	\$2932	\$3284
	<b>OVERALL DIMENSIONS</b>			<b>SEAT DIMENSIONS</b>			<b>BACK DIMENSIONS</b>						
	<b>W</b>	<b>D</b>	<b>H</b>	<b>W</b>	<b>D</b>	<b>H</b>	<b>W</b>	<b>H</b>					
	37	24.5	36.5	31.5	18	18.5	32	18.5					
 <p><b>Frolick Armchair</b> Sled Base, Rectangular back                      COM Yardage: 1.25                      Freight Class: 250                      Product Weight (lbs.): 32                      Cubic Feet Per Carton: 13.75</p> <p>Active weight 300 lbs.                      Single piece back with pullover style upholstery cover with <b>exposed support brackets</b> on the outer back.  <b>Does not stack.</b>                      Chrome (CHM) frame finish, add \$226.</p>	<b>GC3034</b>	\$894	\$935	\$975	\$1028	\$1102	\$1130	\$1195	\$1317	\$1376	\$1493	\$1648	\$1844
	<b>OVERALL DIMENSIONS</b>			<b>SEAT DIMENSIONS</b>			<b>BACK DIMENSIONS</b>						
	<b>W</b>	<b>D</b>	<b>H</b>	<b>W</b>	<b>D</b>	<b>H</b>	<b>W</b>	<b>H</b>					
	25	24.5	36	18	17	18.5	18.75	18					

DESCRIPTION	MODEL#/ FEATURES	STANDARD TEXTILE GRADES											
		COM	2	3	4	5	6	7	8	9	10	11	12
 <p><b>Frolick Armless Chair</b> Sled Base, Rectangular back COM Yardage: 1.25 Freight Class: 250 Product Weight (lbs.): 30 Cubic Feet Per Carton: 13.75</p>	<b>GC3035</b>	\$858	\$895	\$935	\$988	\$1062	\$1090	\$1155	\$1277	\$1336	\$1453	\$1608	\$1805
	<b>OVERALL DIMENSIONS</b>			<b>SEAT DIMENSIONS</b>			<b>BACK DIMENSIONS</b>						
	W	D	H	W	D	H	W	H					
	21	24.5	36	19	18	18.5	19.5	17					
<p>Active weight 300 lbs. Single piece back with pullover style upholstery cover with <b>exposed support brackets</b> on the outer back. <b>Does not stack.</b> Chrome (CHM) frame finish, add \$204.</p>													
 <p><b>Frolick Bariatric Armchair</b> Sled Base, Rectangular back COM Yardage: 2.25 Freight Class: 300 Product Weight (lbs.): 47 Cubic Feet Per Carton: 26.5</p>	<b>GC3036</b>	\$1674	\$1748	\$1817	\$1912	\$2045	\$2095	\$2214	\$2431	\$2544	\$2750	\$3033	\$3386
	<b>OVERALL DIMENSIONS</b>			<b>SEAT DIMENSIONS</b>			<b>BACK DIMENSIONS</b>						
	W	D	H	W	D	H	W	H					
	37	24.5	36.5	31.5	18	18.5	32	18.5					
<p>Active weight 500 lbs. Single piece back with pullover style upholstery cover with <b>exposed support brackets</b> on the outer back. Chrome (CHM) frame finish, add \$318. <b>Does not stack.</b></p>													
 <p><b>Splash Stacking Armchair</b> 4 Leg Base, Fan back with concealed attachment COM Yardage: 1.25 Freight Class: 250 Product Weight (lbs.): 25.33 Cubic Feet Per Carton: 6.67</p>	<b>GC3011</b>	\$864	\$901	\$941	\$994	\$1067	\$1096	\$1160	\$1283	\$1342	\$1459	\$1616	\$1811
	<b>OVERALL DIMENSIONS</b>			<b>SEAT DIMENSIONS</b>			<b>BACK DIMENSIONS</b>						
	W	D	H	W	D	H	W	H					
	25	24.25	35.5	19.5	18.5	18.5	20	17.5					
<p>Active weight 300 lbs. Stacks 5 high on floor. Chrome (CHM) frame finish, add \$190.</p>													
 <p><b>Splash Stacking Chair</b> Armless, 4 Leg Base, Fan back with concealed attachment COM Yardage: 1.25 Freight Class: 250 Product Weight (lbs.): 22.33 Cubic Feet Per Carton: 6.67</p>	<b>GC3012</b>	\$824	\$865	\$903	\$958	\$1032	\$1060	\$1125	\$1247	\$1306	\$1420	\$1580	\$1776
	<b>OVERALL DIMENSIONS</b>			<b>SEAT DIMENSIONS</b>			<b>BACK DIMENSIONS</b>						
	W	D	H	W	D	H	W	H					
	21	24.25	35.5	19.5	18.5	18.5	20	17.5					
<p>Active weight 300 lbs. Stacks 5 high on floor. Chrome (CHM) frame finish, add \$170.</p>													
 <p><b>Splash Armchair</b> Sled Base, Fan back with concealed attachment COM Yardage: 1.25 Freight Class: 250 Product Weight (lbs.): 34 Cubic Feet Per Carton: 17</p>	<b>GC3013</b>	\$894	\$935	\$975	\$1028	\$1101	\$1130	\$1194	\$1317	\$1376	\$1493	\$1650	\$1845
	<b>OVERALL DIMENSIONS</b>			<b>SEAT DIMENSIONS</b>			<b>BACK DIMENSIONS</b>						
	W	D	H	W	D	H	W	H					
	25	24.25	35.5	19.5	18.5	18.5	20	17.5					
<p>Active weight 300 lbs. <b>Does not stack.</b> Chrome (CHM) frame finish, add \$226.</p>													

# SEATING

# FROLICK™ & SPLASH™

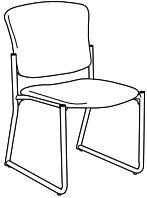
F

DESCRIPTION	MODEL#/ FEATURES	STANDARD TEXTILE GRADES											
		COM	2	3	4	5	6	7	8	9	10	11	12
 <p><b>Splash Side Chair</b> Sled Base, Fan back with concealed attachment                      COM Yardage: 1.25                      Freight Class: 250                      Product Weight (lbs.): 32                      Cubic Feet Per Carton: 13.75</p>	<b>GC3014</b>	\$858	\$895	\$935	\$988	\$1062	\$1090	\$1155	\$1277	\$1336	\$1450	\$1608	\$1805
		<b>OVERALL DIMENSIONS</b> W    D    H			<b>SEAT DIMENSIONS</b> W    D    H			<b>BACK DIMENSIONS</b> W    H					
		21	24.25	35.5	19.5	18.5	18.5	20	17.5				
		<b>Does not stack.</b>											
		Chrome (CHM) frame finish, add \$204.											
		<b>LIST PRICE</b>											
	<b>GC3010</b>	<b>\$385</b>											
 <p><b>Dolly for Frolick and Splash standard size, four leg chairs</b>                      COM Yardage: --                      Freight Class: 150                      Product Weight (lbs.): 16                      Cubic Feet Per Carton: 3.8</p>		<b>OVERALL DIMENSIONS</b> W    D    H			<b>SEAT DIMENSIONS</b> W    D    H			<b>BACK DIMENSIONS</b> W    H					
			0	0	0								
		<b>Allows chairs to stack up to 8 high.</b>											

GALA II

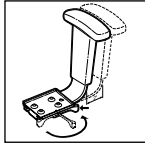

Vari-Width (WA) width adjustable arm extensions are standard.

model GC13012, medium back

Synchro-tilter mechanism (-0)

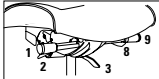

ADJUSTMENTS

- (1) Tilt tension
- (2) Pneumatic seat height
- (3) Back angle
- Back/lumbar height
- (8) Sliding seat depth
- (9) Multi position tilt lock
- Synchro tilt action
- Anti kick back

Ergonomic features:

A, B, C, D, E, G, H, L, M, N, Q, R, U

STANDARD FEATURES

- Gala II is designed to provide exceptional support and comfort throughout the work day.
- Vertical back height ratchet adjustment of 5.25" is standard.
- Back support upright is 3" wide for extra strength.
- One-piece curved back features a pull over style upholstery cover for easy housekeeping and infection prevention practices.
- Standard with Global's high quality Soft Descent™ pneumatic lift which slowly and gently lowers the seat height of the chair making it easy to obtain the exact seat height you desire.
- Standard with height adjustable arms (3B) with self-skinned urethane (SSU) armcaps.
- Vari-Width (WA) width adjustable arm extensions are standard. Allows the arms to move away from the seat by 2" on each side to accommodate various users.
- Waterfall seamless seat front design with high density Ultracell foam for superior comfort and longevity
- Underside of seat pan is completely sealed for ease of cleaning.
- Side activated sliding seat depth adjustment (MD) is standard on synchro-tilter.
- Five prong, injection molded, fiberglass reinforced nylon Black base with dual wheel carpet casters (C65).
- For Globalcare textiles and finish options, visit the website at [globalfurnituregroup.com](http://globalfurnituregroup.com).
- Can be upholstered in standard Global textiles if Healthcare compliance is not required.
- To meet higher standards for housekeeping and infection control, Gala II has a seamless seat and one stitch pull over back upholstery, while still offering soft curves to the design. Note: Vinyl and woven treated textiles are thicker in nature and will experience wrinkles on some curves or corners as a result.

OPTIONAL FEATURES

- Optional hard floor casters (C65R) are available. Add \$76.

SUGGESTED APPLICATIONS

- Office/Meeting
- Caregiver Workstations

DESCRIPTION	MODEL#/ FEATURES	STANDARD TEXTILE GRADES											
		COM	2	3	4	5	6	7	8	9	10	11	12
 <p><b>Medium Back Synchro-Tilter</b>                      COM Yardage: 1.9                      Freight Class: 150                      Product Weight (lbs.): 53                      Cubic Feet Per Carton: 10.5</p>	GC13012	\$1089	\$1161	\$1229	\$1320	\$1453	\$1514	\$1631	\$1821	\$1969	\$2130	\$2463	\$2820
		OVERALL DIMENSIONS			SEAT DIMENSIONS			BACK DIMENSIONS					
		W	D	H	W	D	H	W	H				
		24.5	23.5	39	20.5	17-18	16.5-21.5	20	20.5				

## GC BEACH



model GC4077



model GC4078

### STANDARD FEATURES

- Elegant wood seating with a choice of an upholstered or vertical wood slat back.
- Frame construction is beech hardwood.
- Legs are equipped with White non-marking polypropylene glides. Suitable for both carpet and hard surface flooring.
- All cushions are fixed and non-removable.
- Cushions are made with highly resilient foam and seats are equipped with a synthetic rubberized webbing suspension system for extra comfort
- Seat cushion underside is finished with Black polyurethane
- Does not stack
- For Globalcare textiles and finish options, visit the website at [globalfurnituregroup.com](http://globalfurnituregroup.com).
- Can be upholstered in standard Global textiles if Healthcare compliance is not required.

### OPTIONAL FEATURES

- Wood frame available in Absolute (AAM), Black (BKM), Cherry (ACM), English Oak (EOM), Espresso Cafe (ECM), Fruitwood (TFM), Gray (HGM), Honey (AHM), Mahogany (TMM), Maple (AVM), Medium Walnut (MWM), Natural Walnut (NLW), Night (ASM), Noce Biondo (NBM), Noce Grigio (NGM), Noce Leggero (NEM), Noce Medio (NMM), Sandy Beach (SKM), Shaker Cherry (SKM), Silver Oak (SOM), Walnut (TWM), WC Cream (WTM), White (WHM) and Winter Cherry (WCM). Please specify.
- For moisture barrier on seat, please specify **(MB)**. - Add \$137 per seat.

### SUGGESTED APPLICATIONS

- Dining/Cafeteria
- Guest seating
- Lobbies
- Lounge/Waiting
- Office/Meeting
- Patient rooms
- Resident rooms

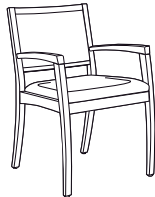
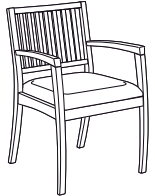
DESCRIPTION	MODEL#/ FEATURES	STANDARD TEXTILE GRADES											
		COM	2	3	4	5	6	7	8	9	10	11	12
 <p><b>Armchair w/Upholstered Back</b> COM Yardage: 1 Freight Class: 300 Product Weight (lbs.): 20 Cubic Feet Per Carton: 13.25</p>	<b>GC4077</b>	\$1010	\$1043	\$1074	\$1117	\$1181	\$1210	\$1268	\$1354	\$1425	\$1503	\$1655	\$1826
	Active weight 300 lbs. Does not stack.	<b>OVERALL DIMENSIONS</b>			<b>SEAT DIMENSIONS</b>			<b>BACK DIMENSIONS</b>					
		W	D	H	W	D	H	W	H				
		22	22.25	33.5	19.5	18.5	18.75	19.5	15.5				
 <p><b>Armchair w/Vertical Wood Slat Back</b> COM Yardage: 1 Freight Class: 300 Product Weight (lbs.): 20 Cubic Feet Per Carton: 13.25</p>	<b>GC4078</b>	\$1038	\$1071	\$1102	\$1145	\$1209	\$1238	\$1296	\$1389	\$1453	\$1531	\$1697	\$1868
	Active weight 300 lbs. Does not stack.	<b>OVERALL DIMENSIONS</b>			<b>SEAT DIMENSIONS</b>			<b>BACK DIMENSIONS</b>					
		W	D	H	W	D	H	W	H				
		22	22.25	33.5	19.5	19	18.75	19.5	15.5				

## GC-BELONG



model GC4231HB

model GC4231HB

## STANDARD FEATURES

- The GC Belong series was developed for active and transient spaces and environments with rigorous demands.
- Elliptical metal tube frame is available in Black (TBL), Cloud (TIV), Designer White (TDW), Fog (TFO), Frost (TFR), Kalua (TKA), Latte (TLA), Mocha (TMO), Nevada (TNE), Sand (TSN), Shadow (TSH), Toast (TOA) and Tungsten (TTU). Specify finish.
- Urethane armcaps are available in Black (BLK), Kalua (KAL), Latte (LAB), Mocha (J52), Shadow (SHW), and Toast (TOA).
- Wood armcaps are also available in Absolute (AAM), Black (BKM), Cherry (ACM), English Oak (EOM), Espresso Cafe (ECM), Fruitwood (TFM), Gray (HGM), Honey (AHM), Mahogany (TMM), Maple (AVM), Medium Walnut (MWM), Natural Walnut (NLW), Night (ASM), Noce Biondo (NBM), Noce Grigio (NGM), Noce Leggero (NEM), Noce Medio (NMM), Sandy Beach (SKM), Shaker Cherry (SKM), Silver Oak (SOM), Walnut (TWM), WC Cream (WTM), White (WHM) and Winter Cherry (WCM). Refer to individual models for upcharge.
- The frame can be weighted and made with tamperproof fasteners for greater security in more challenging mental health spaces or correctional facilities.
- Active weight capacity is 500 lbs. per seat position; 750 lbs. for bariatric seating.
- The seat and back are removable and field replaceable.
- For added comfort, seats are standard with high density Ultracell foam.
- All seat frames feature a wallsaver design to prevent back contact with wall. **Note:** In order to allow full flex of the back on models GC4242, GC4242HB, GC4243 and GC4243HB, a 10.5" wall clearance is required.
- Ottomans and Benches do not have wallsaver legs.
- Standard seat height on all models is 18.5"
- Standard with Black glides
- Select models are offered with casters on the rear legs. These casters allow for ease of movement in support of housekeeping efforts or repositioning seating within a space. **They are not intended for patient transfer.**

- Clean out space is provided between the seat and back cushions for easier housekeeping.
- **Left and Right position reference** is determined from the seated position.
- Flex back models feature a torsion control mechanism which allows the back to move 14° in a soothing rocking motion.
- For healthcare textiles and wood finish options, visit the website at [globalfurnituregroup.com](http://globalfurnituregroup.com)
- Can be upholstered in standard Global textiles if healthcare compliance is not required.

## OPTIONAL FEATURES

- For hardsurface floors, specify opaque, non-marking glides (NM). No upcharge.
- For moisture barrier on seat, specify (MB). Add \$137 per seat. For bariatric models, Add \$209 per seat.
- As an option, seams can be sealed to prevent penetration of fluids through the stitching. Contact Customer Care for approved textiles.  
Low Back Models - **Add \$120** list upcharge per seat  
Low Back Bariatric Models - **Add \$127** list upcharge per seat  
High Back Models - **Add \$130** list upcharge per seat  
High Back Bariatric Models - **Add \$138** list upcharge per seat  
Split-Back Models - **Add \$190** list upcharge per seat  
Ottoman - **Add \$43** list upcharge  
Benches: **Add \$52** list upcharge for one seat, **Add \$112** for two seat models, and **Add \$167** for three seat models.

## SUGGESTED APPLICATIONS

- Bariatric seating
- Guest seating
- Lobbies
- Lounge/Waiting
- Patient/Resident rooms
- Treatment/Exam rooms

## GC BELONG BENCHES &amp; BRIDGES

- Units with links can only gang with a bridge. They CANNOT gang directly with another link unit. (Link units have side brackets.)
- Available in one, two or three seat models.
- A bridge unit suspends between 2 other units using their links. A bridge is NOT freestanding. (A bridge does not have legs.)
- Benches have no front or back facing distinction so models with links can be reversed.
- All bridge models can be ganged to seat units with link.

## GC BELONG TABLE BRIDGES

- Table heights are 16"
- 1" thick tops are available in thermally fused laminate (LP) and high pressure laminate (HP). Please select the appropriate model number for the finish you prefer.
- 2mm edging color coordinated with laminate finish is standard for all tops. Finish must be specified at the time of order.
- Refer to the following lists when selecting a finish color. Must specify both a top color and leg finish when ordering.

## Thermally Fused Laminate (LP) Tops

Absolute Acajou (ACJ)  
Asian Night (ASN)  
Avant Cherry (AWC)  
Avant Honey (AWH)  
Blizzard (BZD)  
Brushed Cobalt (BRC)  
Clear Maple (CMB)  
Custom Grey (CGY)  
Dark Espresso (DES)  
Designer White (DWT)  
Fashionista (FAS)  
First Class (FCL)  
Noce Biondo (NBL)  
Noce Grigio (NGL)  
Noce Leggero (NEL)  
Noce Medio (NML)  
Quartered Mahogany (QTM)  
Sheer Beauty (SBY)  
Stonedust (SDT)  
Walnut Heights (WHE)  
White Chocolate (WHC)  
Winter Cherry (WCR)

## High Pressure Laminate (HP) Tops

Absolute Acajou (ACJ)  
Asian Night (ASN)  
Avant Cherry (W357)  
Avant Honey (W356)  
Blizzard (BZD)  
Brushed Cobalt (BRC)  
Clear Maple (CMB)  
Custom Grey (CGY)  
Dark Espresso (W142)  
Designer White (DWT)  
Fashionista (FAS)  
First Class (FCL)  
Noce Biondo (NBL)  
Noce Grigio (NGL)  
Noce Leggero (NEL)  
Noce Medio (NML)  
Quartered Mahogany (QTM)  
Sheer Beauty (SBY)  
Stonedust (SDT)  
Walnut Heights (WHE)  
White Chocolate (WHC)  
Winter Cherry (WCR)

**LOW BACK**

	GC4230	GC4231	GC4232	GC4234	GC4233	GC4235	GC4236
Freestanding units							
Ganging units with link on Left side		GC4231L	GC4232L	GC4234L	GC4233L	GC4235L	GC4236L
Ganging units with link on Right side		GC4231R	GC4232R	GC4234R	GC4233R	GC4235R	GC4236R
Ganging units with links on Both sides		GC4231B	GC4232B	GC4234B	GC4233B	GC4235B	GC4236B

**HIGH BACK**

	GC4230HB	GC4231HB	GC4232HB	GC4234HB	GC4233HB	GC4235HB	GC4236HB
Freestanding units							
Ganging units with link on Left side		GC4231HBL	GC4232HBL	GC4234HBL	GC4233HBL	GC4235HBL	GC4236HBL
Ganging units with link on Right side		GC4231HBR	GC4232HBR	GC4234HBR	GC4233HBR	GC4235HBR	GC4236HBR
Ganging units with links on Both sides		GC4231HBB	GC4232HBB	GC4234HBB	GC4233HBB	GC4235HBB	GC4236HBB

Non ganging units with casters



Ganging Bariatric units with link on Both side



Non ganging Bariatric units



Non ganging Flexback units



Non ganging Split Back units



Ganging Bariatric units with link on Left side



Non ganging Flexback units with casters



Non ganging Split Back units with casters



Ganging Bariatric units with link on Right side



Hip Height Chair with wedged cushion, 24" Seat Height



**BENCHES & BRIDGES**

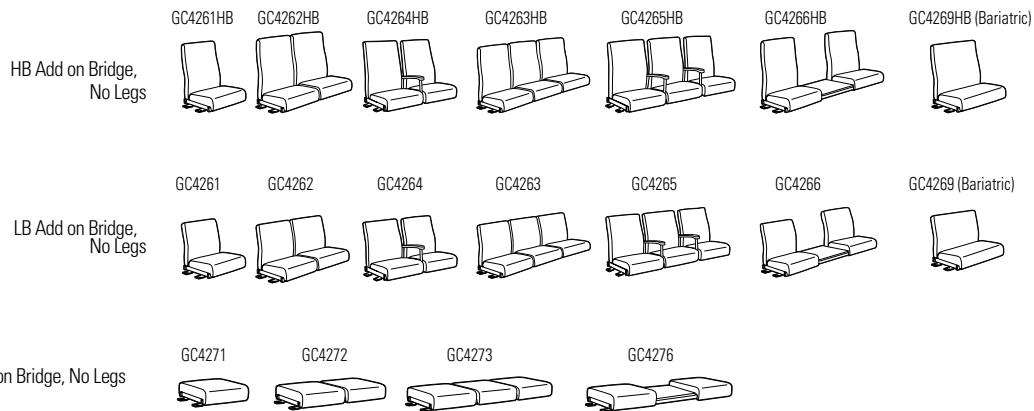
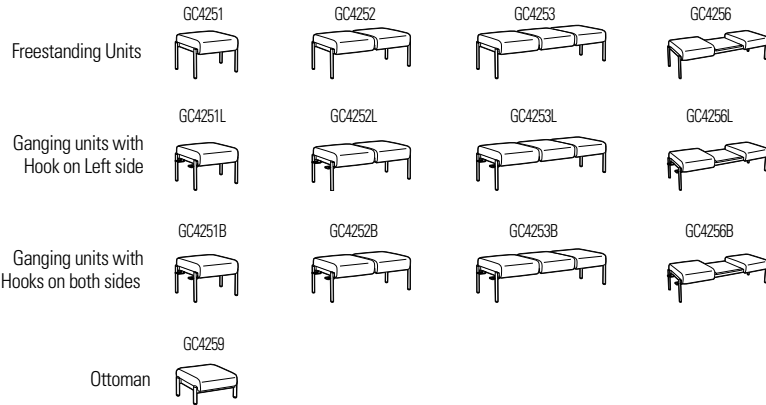

**TABLES**

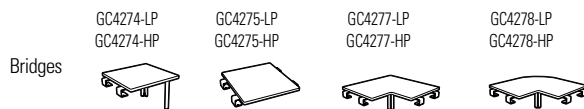

- A bridge unit suspends between 2 other units with legs and is supported by their linking brackets
- A bridge unit is **not** freestanding and cannot be made freestanding
- Units with legs and links can only gang with a bridge. They **cannot** gang directly with another link unit with legs.
- Bridges **cannot** gang directly with another bridge

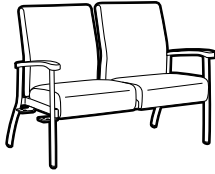

1, 2 or 3 seat chair with integrated ganging bracket

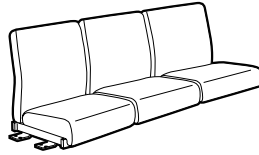

Any seating bridge unit connects to:

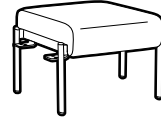

1, 2 or 3 seat bench with integrated ganging bracket

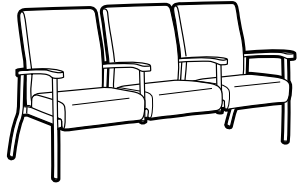

1, 2 or 3 seat chair with integrated ganging bracket

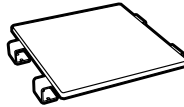

Any table bridge unit connects to:

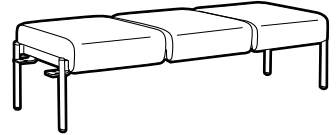

1, 2 or 3 seat bench with integrated ganging bracket

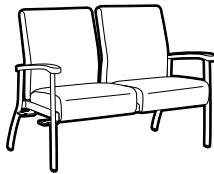

1, 2 or 3 seat chair with integrated ganging bracket

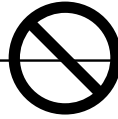

**CANNOT connect to**

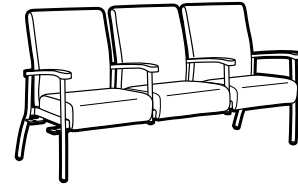

1, 2 or 3 seat chair with integrated ganging bracket



Any table bridge unit

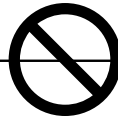

**CANNOT connect to**

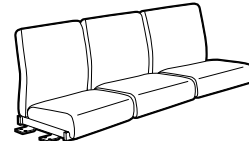

Any seating bridge unit



Any seating bridge unit

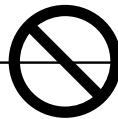

**CANNOT connect to**

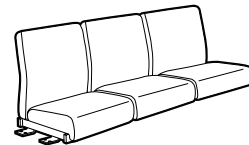

Any seating bridge unit



Any table bridge unit



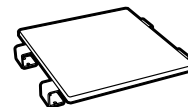

**CANNOT connect to**





Any table bridge unit

PACKAGE 1	Description	Qty	Model Number	Dimensions	Ydg.	Freight Class	Wt./Lbs.	Cu. Ft.	List Price
	Low Back Three Seat Chair	4	GC4235	26 x 74.5 x 37.5	5	250	142	65.25	\$4799
	<b>PACKAGE TOTAL</b> (* Please Note: List Prices shown are for the standard Grade 2 vinyl/standard finishes.)								<b>\$19,196</b>

PACKAGE 2	Description	Qty	Model Number	Dimensions	Ydg.	Freight Class	Wt./Lbs.	Cu. Ft.	List Price
	Low Back Three Seat Chair	1	GC4233B	26 x 72.75 x 37.5	5	250	134	65.25	\$4245
	Low Back Armchair, Left	1	GC4231L	28 x 26.5 x 37.5	1.75	250	53.5	20.25	\$1953
	Low Back Armchair, Right	1	GC4231R	28 x 26.5 x 37.5	1.75	250	53.5	20.25	\$1953
	End Corner Table Bridge	2	GC4277-HP	35 x 35 x 16	--	125	45	6	\$1067
<b>PACKAGE TOTAL</b> (* Please Note: List Prices shown are for the standard Grade 2 vinyl/standard laminate.)								<b>\$10,285</b>	

PACKAGE 3	Description	Qty	Model Number	Dimensions	Ydg.	Freight Class	Wt./Lbs.	Cu. Ft.	List Price
	Low Back Three Seat Chair	1	GC4235R	26 x 74.5 x 37.5	5	250	143	65.25	\$4848
	Bariatric Low Back Armchair, Left	1	GC4241L	28 x 37.5 x 37.5	3	250	71	30.5	\$2546
	Low Back Armchair, Left	1	GC4231L	28 x 26.5 x 37.5	1.75	250	53.5	20.25	\$1953
	Low Back Armchair, Right	1	GC4231R	28 x 26.5 x 37.5	1.75	250	53.5	20.25	\$1953
	End Corner Table Bridge	1	GC4277-HP	35 x 35 x 16	--	125	45	6	\$1067
	Rectangular Coffee Table	1	GC4283-HP	54 x 22 x 16	--	125	37	6	\$1536
	Square Table Top	1	GC4275-HP	23 x 23 x 1	--	150	18	3.4	\$661
<b>PACKAGE TOTAL</b> (* Please Note: List Prices shown are for the standard Grade 2 vinyl/standard laminate.)								<b>\$14,564</b>	

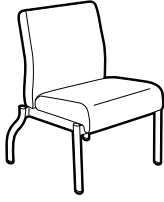
# SEATING

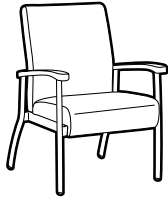
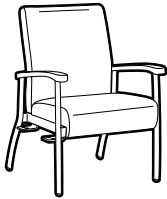
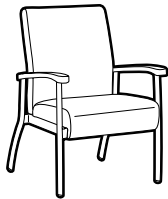
DESCRIPTION	MODEL#	STANDARD FABRIC GRADES											
		COM	2	3	4	5	6	7	8	9	10	11	12
 <p><b>Low Back Chair</b> Armless COM Yardage: 1.75 Freight Class: 250 Product Weight (lbs.): 45.5 Cubic Feet Per Carton: 20.25</p>	GC4230	\$1461	\$1521	\$1578	\$1654	\$1762	\$1803	\$1901	\$2082	\$2169	\$2337	\$2567	\$2853
	Active weight 500 lbs.	OVERALL DIMENSIONS			SEAT DIMENSIONS			BACK DIMENSIONS					
		W	D	H	W	D	H	W	H				
		24.75	28	37.5	22	18	18	21.5	19.5				
 <p><b>High Back Chair</b> Armless COM Yardage: 2 Freight Class: 250 Product Weight (lbs.): 49.5 Cubic Feet Per Carton: 20.25</p>	GC4230HB	\$1537	\$1606	\$1670	\$1757	\$1881	\$1928	\$2037	\$2243	\$2345	\$2536	\$2800	\$3126
	Active weight 500 lbs.	OVERALL DIMENSIONS			SEAT DIMENSIONS			BACK DIMENSIONS					
		W	D	H	W	D	H	W	H				
		24.75	28	42.5	22	18	18	21.5	24.5				
 <p><b>Low Back Armchair</b> COM Yardage: 1.75 Freight Class: 250 Product Weight (lbs.): 53.5 Cubic Feet Per Carton: 20.25</p>	GC4231	\$1779	\$1840	\$1895	\$1972	\$2081	\$2121	\$2218	\$2400	\$2488	\$2656	\$2886	\$3170
	Active weight 500 lbs. Wood armcap option - <b>Add \$189</b>	OVERALL DIMENSIONS			SEAT DIMENSIONS			BACK DIMENSIONS					
		W	D	H	W	D	H	W	H				
		26.5	28	37.5	22	18	18	21.5	19.5				
 <p><b>Low Back Armchair</b> Right COM Yardage: 1.75 Freight Class: 250 Product Weight (lbs.): 53.5 Cubic Feet Per Carton: 20.25</p>	GC4231R	\$1890	\$1953	\$2008	\$2085	\$2193	\$2234	\$2331	\$2513	\$2601	\$2768	\$2998	\$3283
	Active weight 500 lbs. Wood armcap option - <b>Add \$189</b>	OVERALL DIMENSIONS			SEAT DIMENSIONS			BACK DIMENSIONS					
		W	D	H	W	D	H	W	H				
		26.5	28	37.5	22	18	18	21.5	19.5				
 <p><b>Low Back Armchair</b> Left COM Yardage: 1.75 Freight Class: 250 Product Weight (lbs.): 53.5 Cubic Feet Per Carton: 20.25</p>	GC4231L	\$1890	\$1953	\$2008	\$2085	\$2193	\$2234	\$2331	\$2513	\$2601	\$2768	\$2998	\$3283
	Active weight 500 lbs. Wood armcap option - <b>Add \$189</b>	OVERALL DIMENSIONS			SEAT DIMENSIONS			BACK DIMENSIONS					
		W	D	H	W	D	H	W	H				
		26.5	28	37.5	22	18	18	21.5	19.5				

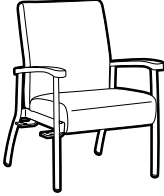
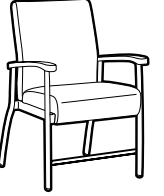
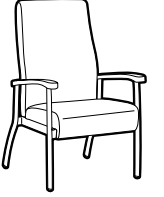
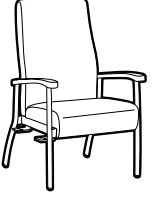
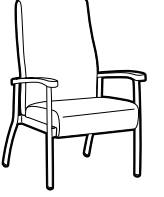
DESCRIPTION	MODEL#	STANDARD FABRIC GRADES											
		COM	2	3	4	5	6	7	8	9	10	11	12
 <p><b>Low Back Armchair</b> Left &amp; Right COM Yardage: 1.75 Freight Class: 250 Product Weight (lbs.): 53.5 Cubic Feet Per Carton: 20.25</p>	<b>GC4231B</b>	\$1938	\$2001	\$2056	\$2134	\$2241	\$2283	\$2379	\$2561	\$2649	\$2816	\$3047	\$3333
		<b>OVERALL DIMENSIONS</b>			<b>SEAT DIMENSIONS</b>			<b>BACK DIMENSIONS</b>					
		<b>W</b>	<b>D</b>	<b>H</b>	<b>W</b>	<b>D</b>	<b>H</b>	<b>W</b>	<b>H</b>				
		26.5	28	37.5	22	18	18	21.5	19.5				
 <p><b>Low Back Armchair</b> Post Surgery. Designed to immobilize the pelvis and hip joints after surgery. COM Yardage: 1.75 Freight Class: 250 Product Weight (lbs.): 57.5 Cubic Feet Per Carton: 24.25</p>	<b>GC4231-24</b> 24" Seat Height	\$2122	\$2183	\$2238	\$2315	\$2424	\$2464	\$2561	\$2743	\$2831	\$2999	\$3228	\$3513
		<b>OVERALL DIMENSIONS</b>			<b>SEAT DIMENSIONS</b>			<b>BACK DIMENSIONS</b>					
		<b>W</b>	<b>D</b>	<b>H</b>	<b>W</b>	<b>D</b>	<b>H</b>	<b>W</b>	<b>H</b>				
		26.5	28.75	43.5	22	18	24	21.5	19.5				
 <p><b>High Back Armchair</b> COM Yardage: 2 Freight Class: 250 Product Weight (lbs.): 58.5 Cubic Feet Per Carton: 20.25</p>	<b>GC4231HB</b>	\$1899	\$1966	\$2033	\$2119	\$2244	\$2291	\$2398	\$2605	\$2706	\$2898	\$3162	\$3489
		<b>OVERALL DIMENSIONS</b>			<b>SEAT DIMENSIONS</b>			<b>BACK DIMENSIONS</b>					
		<b>W</b>	<b>D</b>	<b>H</b>	<b>W</b>	<b>D</b>	<b>H</b>	<b>W</b>	<b>H</b>				
		26.5	28	42.5	22	18	18	21.5	24.5				
 <p><b>High Back Armchair</b> Right COM Yardage: 2 Freight Class: 250 Product Weight (lbs.): 58.5 Cubic Feet Per Carton: 20.25</p>	<b>GC4231HBR</b>	\$1948	\$2017	\$2082	\$2168	\$2294	\$2341	\$2449	\$2655	\$2757	\$2948	\$3212	\$3538
		<b>OVERALL DIMENSIONS</b>			<b>SEAT DIMENSIONS</b>			<b>BACK DIMENSIONS</b>					
		<b>W</b>	<b>D</b>	<b>H</b>	<b>W</b>	<b>D</b>	<b>H</b>	<b>W</b>	<b>H</b>				
		26.5	28	42.5	22	18	18	21.5	24.5				
 <p><b>High Back Armchair</b> Left COM Yardage: 2 Freight Class: 250 Product Weight (lbs.): 58.5 Cubic Feet Per Carton: 20.25</p>	<b>GC4231HBL</b>	\$1948	\$2017	\$2082	\$2168	\$2294	\$2341	\$2449	\$2655	\$2757	\$2948	\$3212	\$3538
		<b>OVERALL DIMENSIONS</b>			<b>SEAT DIMENSIONS</b>			<b>BACK DIMENSIONS</b>					
		<b>W</b>	<b>D</b>	<b>H</b>	<b>W</b>	<b>D</b>	<b>H</b>	<b>W</b>	<b>H</b>				
		26.5	28	42.5	22	18	18	21.5	24.5				

# SEATING

# GC-BELONG

G

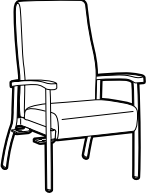
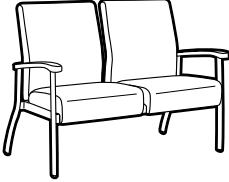
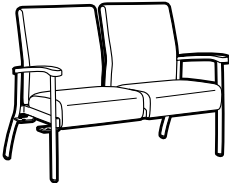
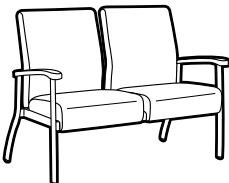
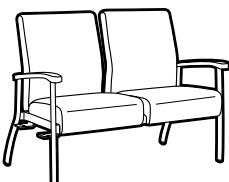
DESCRIPTION	MODEL#	STANDARD FABRIC GRADES											
		COM	2	3	4	5	6	7	8	9	10	11	12
 <p><b>High Back Armchair Left &amp; Right</b>                      COM Yardage: 2                      Freight Class: 250                      Product Weight (lbs.): 60.5                      Cubic Feet Per Carton: 20.25</p>	<b>GC4231HBB</b>  Active weight 500 lbs. Wood armcap option - <b>Add \$189</b>	\$1995	\$2063	\$2127	\$2214	\$2338	\$2385	\$2494	\$2700	\$2802	\$2993	\$3257	\$3583
		<b>OVERALL DIMENSIONS</b>			<b>SEAT DIMENSIONS</b>			<b>BACK DIMENSIONS</b>					
		W	D	H	W	D	H	W	H				
 <p><b>Low Back Two Seat Chair No Center Arm</b>                      COM Yardage: 3.5                      Freight Class: 250                      Product Weight (lbs.): 94                      Cubic Feet Per Carton: 43</p>	<b>GC4232</b>  Active weight 500 lbs./seat. Wood armcap option - <b>Add \$189</b>	\$2875	\$2998	\$3108	\$3260	\$3477	\$3562	\$3753	\$4112	\$4293	\$4622	\$5086	\$5655
		<b>OVERALL DIMENSIONS</b>			<b>SEAT DIMENSIONS</b>			<b>BACK DIMENSIONS</b>					
		W	D	H	W	D	H	W	H				
 <p><b>Low Back Two Seat Chair No Center Arm, Right</b>                      COM Yardage: 3.5                      Freight Class: 250                      Product Weight (lbs.): 95                      Cubic Feet Per Carton: 43</p>	<b>GC4232R</b>  Active weight 500 lbs./seat. Wood armcap option - <b>Add \$189</b>	\$2920	\$3045	\$3153	\$3305	\$3523	\$3608	\$3799	\$4156	\$4337	\$4668	\$5132	\$5701
		<b>OVERALL DIMENSIONS</b>			<b>SEAT DIMENSIONS</b>			<b>BACK DIMENSIONS</b>					
		W	D	H	W	D	H	W	H				
 <p><b>Low Back Two Seat Chair No Center Arm, Left</b>                      COM Yardage: 3.5                      Freight Class: 250                      Product Weight (lbs.): 95                      Cubic Feet Per Carton: 43</p>	<b>GC4232L</b>  Active weight 500 lbs./seat. Wood armcap option - <b>Add \$189</b>	\$2920	\$3045	\$3153	\$3305	\$3523	\$3608	\$3799	\$4156	\$4337	\$4668	\$5132	\$5701
		<b>OVERALL DIMENSIONS</b>			<b>SEAT DIMENSIONS</b>			<b>BACK DIMENSIONS</b>					
		W	D	H	W	D	H	W	H				
 <p><b>Low Back Two Seat Chair No Center Arm, Left &amp; Right</b>                      COM Yardage: 3.5                      Freight Class: 250                      Product Weight (lbs.): 96                      Cubic Feet Per Carton: 43</p>	<b>GC4232B</b>  Active weight 500 lbs./seat. Wood armcap option - <b>Add \$189</b>	\$2968	\$3093	\$3199	\$3353	\$3571	\$3655	\$3845	\$4203	\$4382	\$4715	\$5178	\$5749
		<b>OVERALL DIMENSIONS</b>			<b>SEAT DIMENSIONS</b>			<b>BACK DIMENSIONS</b>					
		W	D	H	W	D	H	W	H				

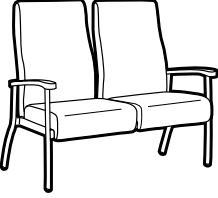
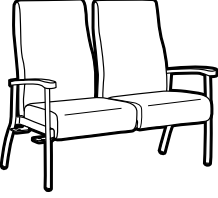
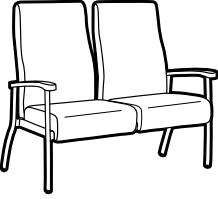
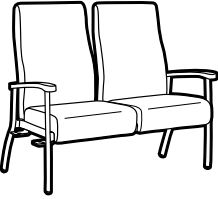
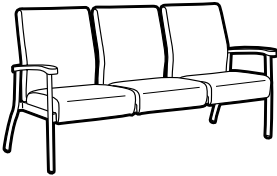
DESCRIPTION	MODEL#	STANDARD FABRIC GRADES											
		COM	2	3	4	5	6	7	8	9	10	11	12
 <p><b>High Back Two Seat Chair</b> No Center Arm COM Yardage: 4 Freight Class: 300 Product Weight (lbs.): 95 Cubic Feet Per Carton: 56.5</p>	GC4232HB	\$3082	\$3225	\$3347	\$3523	\$3772	\$3865	\$4084	\$4493	\$4700	\$5080	\$5610	\$6263
		OVERALL DIMENSIONS			SEAT DIMENSIONS			BACK DIMENSIONS					
		W	D	H	W	D	H	W	H				
 <p><b>High Back Two Seat Chair</b> No Center Arm, Right COM Yardage: 4 Freight Class: 300 Product Weight (lbs.): 96 Cubic Feet Per Carton: 56.5</p>	GC4232HBR	\$3126	\$3270	\$3394	\$3568	\$3817	\$3910	\$4129	\$4538	\$4745	\$5125	\$5655	\$6308
		OVERALL DIMENSIONS			SEAT DIMENSIONS			BACK DIMENSIONS					
		W	D	H	W	D	H	W	H				
 <p><b>High Back Two Seat Chair</b> No Center Arm, Left COM Yardage: 4 Freight Class: 300 Product Weight (lbs.): 96 Cubic Feet Per Carton: 56.5</p>	GC4232HBL	\$3126	\$3270	\$3394	\$3568	\$3817	\$3910	\$4129	\$4538	\$4745	\$5125	\$5655	\$6308
		OVERALL DIMENSIONS			SEAT DIMENSIONS			BACK DIMENSIONS					
		W	D	H	W	D	H	W	H				
 <p><b>High Back Two Seat Chair</b> No Center Arm, Left &amp; Right COM Yardage: 4 Freight Class: 300 Product Weight (lbs.): 98 Cubic Feet Per Carton: 56.5</p>	GC4232HBB	\$3173	\$3317	\$3439	\$3615	\$3862	\$3956	\$4175	\$4583	\$4791	\$5169	\$5701	\$6353
		OVERALL DIMENSIONS			SEAT DIMENSIONS			BACK DIMENSIONS					
		W	D	H	W	D	H	W	H				
 <p><b>Low Back Three Seat Chair</b> No Center Arm COM Yardage: 5 Freight Class: 250 Product Weight (lbs.): 132 Cubic Feet Per Carton: 65.25</p>	GC4233	\$3971	\$4151	\$4301	\$4519	\$4829	\$4948	\$5221	\$5732	\$5987	\$6464	\$7126	\$7945
		OVERALL DIMENSIONS			SEAT DIMENSIONS			BACK DIMENSIONS					
		W	D	H	W	D	H	W	H				

# SEATING

# GC-BELONG

G

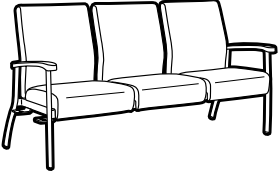
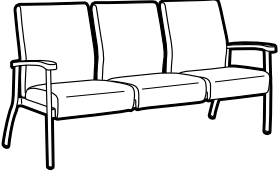
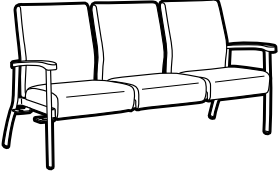
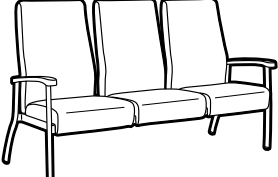
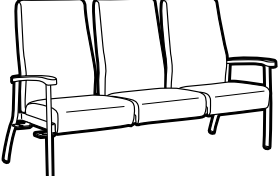
DESCRIPTION	MODEL#	STANDARD FABRIC GRADES											
		COM	2	3	4	5	6	7	8	9	10	11	12
 <p><b>Low Back Three Seat Chair</b> No Center Arm, Right COM Yardage: 5 Freight Class: 250 Product Weight (lbs.): 134 Cubic Feet Per Carton: 65.25</p>	<b>GC4233R</b>	\$4017	\$4197	\$4348	\$4568	\$4876	\$4995	\$5267	\$5781	\$6036	\$6512	\$7174	\$7992
	<b>OVERALL DIMENSIONS</b>			<b>SEAT DIMENSIONS</b>			<b>BACK DIMENSIONS</b>						
	<b>W</b>	<b>D</b>	<b>H</b>	<b>W</b>	<b>D</b>	<b>H</b>	<b>W</b>	<b>H</b>					
	72.75	26	37.5	70	18	18	70	19.5					
 <p><b>Low Back Three Seat Chair</b> No Center Arm, Left COM Yardage: 5 Freight Class: 250 Product Weight (lbs.): 134 Cubic Feet Per Carton: 65.25</p>	<b>GC4233L</b>	\$4017	\$4197	\$4348	\$4568	\$4876	\$4995	\$5267	\$5781	\$6036	\$6512	\$7174	\$7992
	<b>OVERALL DIMENSIONS</b>			<b>SEAT DIMENSIONS</b>			<b>BACK DIMENSIONS</b>						
	<b>W</b>	<b>D</b>	<b>H</b>	<b>W</b>	<b>D</b>	<b>H</b>	<b>W</b>	<b>H</b>					
	72.75	26	37.5	70	18	18	70	19.5					
 <p><b>Low Back Three Seat Chair</b> No Center Arm, Left &amp; Right COM Yardage: 5 Freight Class: 250 Product Weight (lbs.): 134 Cubic Feet Per Carton: 65.25</p>	<b>GC4233B</b>	\$4067	\$4245	\$4396	\$4614	\$4925	\$5046	\$5316	\$5828	\$6088	\$6560	\$7222	\$8039
	<b>OVERALL DIMENSIONS</b>			<b>SEAT DIMENSIONS</b>			<b>BACK DIMENSIONS</b>						
	<b>W</b>	<b>D</b>	<b>H</b>	<b>W</b>	<b>D</b>	<b>H</b>	<b>W</b>	<b>H</b>					
	72.75	26	37.5	70	18	18	70	19.5					
 <p><b>High Back Three Seat Chair</b> No Center Arm COM Yardage: 5.75 Freight Class: 300 Product Weight (lbs.): 138 Cubic Feet Per Carton: 80.75</p>	<b>GC4233HB</b>	\$4208	\$4413	\$4588	\$4840	\$5196	\$5335	\$5646	\$6233	\$6531	\$7079	\$7840	\$8777
	<b>OVERALL DIMENSIONS</b>			<b>SEAT DIMENSIONS</b>			<b>BACK DIMENSIONS</b>						
	<b>W</b>	<b>D</b>	<b>H</b>	<b>W</b>	<b>D</b>	<b>H</b>	<b>W</b>	<b>H</b>					
	72.75	26	42.5	70	18	18	70	24.5					
 <p><b>High Back Three Seat Chair</b> No Center Arm, Right COM Yardage: 5.75 Freight Class: 300 Product Weight (lbs.): 140 Cubic Feet Per Carton: 80.75</p>	<b>GC4233HBR</b>	\$4255	\$4461	\$4635	\$4887	\$5243	\$5380	\$5692	\$6282	\$6576	\$7124	\$7887	\$8825
	<b>OVERALL DIMENSIONS</b>			<b>SEAT DIMENSIONS</b>			<b>BACK DIMENSIONS</b>						
	<b>W</b>	<b>D</b>	<b>H</b>	<b>W</b>	<b>D</b>	<b>H</b>	<b>W</b>	<b>H</b>					
	72.75	26	42.5	70	18	18	70	24.5					

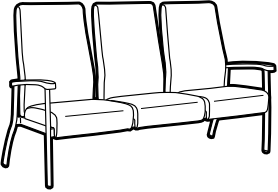
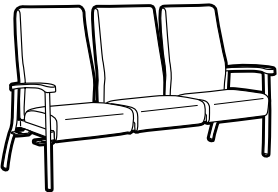
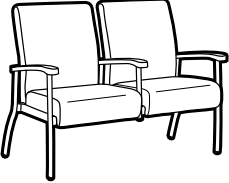
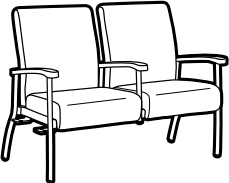
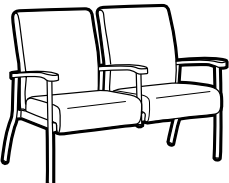
DESCRIPTION	MODEL#	STANDARD FABRIC GRADES											
		COM	2	3	4	5	6	7	8	9	10	11	12
 <p><b>High Back Three Seat Chair</b> No Center Arm, Left COM Yardage: 5.75 Freight Class: 300 Product Weight (lbs.): 140 Cubic Feet Per Carton: 80.75</p>	<b>GC4233HBL</b>  Active weight 500 lbs./seat. Wood armcap option - <b>Add \$189</b>	\$4255	\$4461	\$4635	\$4887	\$5243	\$5380	\$5692	\$6282	\$6576	\$7124	\$7887	\$8825
		<b>OVERALL DIMENSIONS</b>			<b>SEAT DIMENSIONS</b>			<b>BACK DIMENSIONS</b>					
		<b>W</b>	<b>D</b>	<b>H</b>	<b>W</b>	<b>D</b>	<b>H</b>	<b>W</b>	<b>H</b>				
			72.75	26	42.5	70	18	18	70	24.5			
 <p><b>High Back Three Seat Chair</b> No Center Arm, Left &amp; Right COM Yardage: 5.75 Freight Class: 300 Product Weight (lbs.): 140 Cubic Feet Per Carton: 80.75</p>	<b>GC4233HBB</b>  Active weight 500 lbs./seat. Wood armcap option - <b>Add \$189</b>	\$4300	\$4506	\$4680	\$4932	\$5288	\$5425	\$5739	\$6326	\$6621	\$7169	\$7932	\$8870
		<b>OVERALL DIMENSIONS</b>			<b>SEAT DIMENSIONS</b>			<b>BACK DIMENSIONS</b>					
		<b>W</b>	<b>D</b>	<b>H</b>	<b>W</b>	<b>D</b>	<b>H</b>	<b>W</b>	<b>H</b>				
			72.75	26	42.5	70	18	18	70	24.5			
 <p><b>Low Back Two Seat Chair</b> Half Center Arm COM Yardage: 3.5 Freight Class: 250 Product Weight (lbs.): 100 Cubic Feet Per Carton: 43</p>	<b>GC4234</b>  Active weight 500 lbs./seat. Wood armcap option - <b>Add \$279</b>	\$3245	\$3371	\$3479	\$3631	\$3849	\$3933	\$4123	\$4481	\$4660	\$4993	\$5456	\$6027
		<b>OVERALL DIMENSIONS</b>			<b>SEAT DIMENSIONS</b>			<b>BACK DIMENSIONS</b>					
		<b>W</b>	<b>D</b>	<b>H</b>	<b>W</b>	<b>D</b>	<b>H</b>	<b>W</b>	<b>H</b>				
			50.75	26	37.5	22	18	18	21.5	19.5			
 <p><b>Low Back Two Seat Chair</b> Half Center Arm, Right COM Yardage: 3.5 Freight Class: 250 Product Weight (lbs.): 101 Cubic Feet Per Carton: 43</p>	<b>GC4234R</b>  Active weight 500 lbs./seat. Wood armcap option - <b>Add \$279</b>	\$3293	\$3416	\$3524	\$3676	\$3894	\$3979	\$4169	\$4527	\$4708	\$5039	\$5503	\$6072
		<b>OVERALL DIMENSIONS</b>			<b>SEAT DIMENSIONS</b>			<b>BACK DIMENSIONS</b>					
		<b>W</b>	<b>D</b>	<b>H</b>	<b>W</b>	<b>D</b>	<b>H</b>	<b>W</b>	<b>H</b>				
			50.75	26	37.5	22	18	18	21.5	19.5			
 <p><b>Low Back Two Seat Chair</b> Half Center Arm, Left COM Yardage: 3.5 Freight Class: 250 Product Weight (lbs.): 101 Cubic Feet Per Carton: 43</p>	<b>GC4234L</b>  Active weight 500 lbs./seat. Wood armcap option - <b>Add \$279</b>	\$3293	\$3416	\$3524	\$3676	\$3894	\$3979	\$4169	\$4527	\$4708	\$5039	\$5503	\$6072
		<b>OVERALL DIMENSIONS</b>			<b>SEAT DIMENSIONS</b>			<b>BACK DIMENSIONS</b>					
		<b>W</b>	<b>D</b>	<b>H</b>	<b>W</b>	<b>D</b>	<b>H</b>	<b>W</b>	<b>H</b>				
			50.75	26	37.5	22	18	18	21.5	19.5			

# SEATING

# GC-BELONG

G

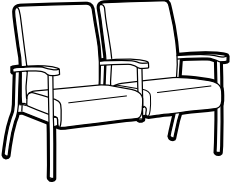
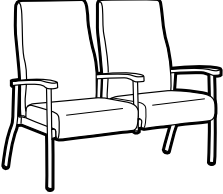
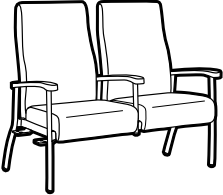
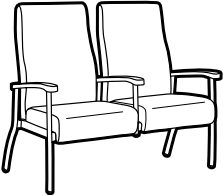
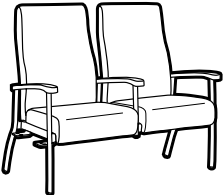
DESCRIPTION	MODEL#	STANDARD FABRIC GRADES											
		COM	2	3	4	5	6	7	8	9	10	11	12
 <p><b>Low Back Two Seat Chair</b> Half Center Arm, Left &amp; Right COM Yardage: 3.5 Freight Class: 250 Product Weight (lbs.): 102 Cubic Feet Per Carton: 43</p>	<b>GC4234B</b>	\$3340	\$3465	\$3573	\$3727	\$3943	\$4028	\$4218	\$4576	\$4756	\$5088	\$5551	\$6121
	<b>OVERALL DIMENSIONS</b>			<b>SEAT DIMENSIONS</b>			<b>BACK DIMENSIONS</b>						
	W	D	H	W	D	H	W	H					
	50.75	26	37.5	22	18	18	21.5	19.5					
 <p><b>High Back Two Seat Chair</b> Half Center Arm COM Yardage: 4 Freight Class: 300 Product Weight (lbs.): 104 Cubic Feet Per Carton: 56.5</p>	<b>GC4234HB</b>	\$3534	\$3678	\$3800	\$3975	\$4225	\$4318	\$4537	\$4946	\$5152	\$5533	\$6062	\$6714
	<b>OVERALL DIMENSIONS</b>			<b>SEAT DIMENSIONS</b>			<b>BACK DIMENSIONS</b>						
	W	D	H	W	D	H	W	H					
	50.75	26	42.5	22	18	18	21.5	24.5					
 <p><b>High Back Two Seat Chair</b> Half Center Arm, Right COM Yardage: 4 Freight Class: 300 Product Weight (lbs.): 104 Cubic Feet Per Carton: 56.5</p>	<b>GC4234HBR</b>	\$3584	\$3728	\$3852	\$4026	\$4275	\$4369	\$4587	\$4996	\$5203	\$5583	\$6113	\$6766
	<b>OVERALL DIMENSIONS</b>			<b>SEAT DIMENSIONS</b>			<b>BACK DIMENSIONS</b>						
	W	D	H	W	D	H	W	H					
	50.75	26	42.5	22	18	18	21.5	24.5					
 <p><b>High Back Two Seat Chair</b> Half Center Arm, Left COM Yardage: 4 Freight Class: 300 Product Weight (lbs.): 104 Cubic Feet Per Carton: 56.5</p>	<b>GC4234HBL</b>	\$3584	\$3728	\$3852	\$4026	\$4275	\$4369	\$4587	\$4996	\$5203	\$5583	\$6113	\$6766
	<b>OVERALL DIMENSIONS</b>			<b>SEAT DIMENSIONS</b>			<b>BACK DIMENSIONS</b>						
	W	D	H	W	D	H	W	H					
	50.75	26	42.5	22	18	18	21.5	24.5					
 <p><b>High Back Two Seat Chair</b> Half Center Arm, Left &amp; Right COM Yardage: 4 Freight Class: 300 Product Weight (lbs.): 108 Cubic Feet Per Carton: 56.5</p>	<b>GC4234HBB</b>	\$3633	\$3777	\$3899	\$4075	\$4324	\$4417	\$4635	\$5043	\$5251	\$5632	\$6161	\$6813
	<b>OVERALL DIMENSIONS</b>			<b>SEAT DIMENSIONS</b>			<b>BACK DIMENSIONS</b>						
	W	D	H	W	D	H	W	H					
	50.75	26	42.5	22	18	18	21.5	24.5					

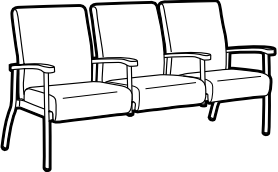
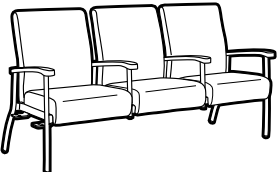
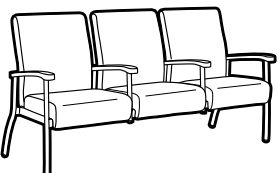
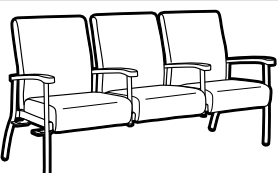
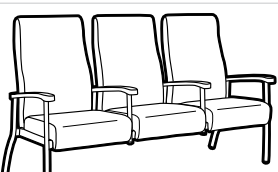
DESCRIPTION	MODEL#	STANDARD FABRIC GRADES											
		COM	2	3	4	5	6	7	8	9	10	11	12
 <p><b>Low Back Three Seat Chair</b> Half Center Arms COM Yardage: 5 Freight Class: 250 Product Weight (lbs.): 142 Cubic Feet Per Carton: 65.25</p>	GC4235	\$4621	\$4799	\$4952	\$5172	\$5479	\$5600	\$5871	\$6384	\$6642	\$7116	\$7778	\$8596
		OVERALL DIMENSIONS			SEAT DIMENSIONS			BACK DIMENSIONS					
		W	D	H	W	D	H	W	H				
			74.5	26	37.5	22	18	18	21.5	19.5			
 <p><b>Low Back Three Seat Chair</b> Half Center Arms, Right COM Yardage: 5 Freight Class: 250 Product Weight (lbs.): 143 Cubic Feet Per Carton: 65.25</p>	GC4235R	\$4668	\$4848	\$4999	\$5219	\$5528	\$5649	\$5919	\$6433	\$6689	\$7165	\$7827	\$8644
		OVERALL DIMENSIONS			SEAT DIMENSIONS			BACK DIMENSIONS					
		W	D	H	W	D	H	W	H				
			74.5	26	37.5	22	18	18	21.5	19.5			
 <p><b>Low Back Three Seat Chair</b> Half Center Arms, Left COM Yardage: 5 Freight Class: 250 Product Weight (lbs.): 143 Cubic Feet Per Carton: 65.25</p>	GC4235L	\$4668	\$4848	\$4999	\$5219	\$5528	\$5649	\$5919	\$6433	\$6689	\$7165	\$7827	\$8644
		OVERALL DIMENSIONS			SEAT DIMENSIONS			BACK DIMENSIONS					
		W	D	H	W	D	H	W	H				
			74.5	26	37.5	22	18	18	21.5	19.5			
 <p><b>Low Back Three Seat Chair</b> Half Center Arms, Left &amp; Right COM Yardage: 5 Freight Class: 250 Product Weight (lbs.): 144 Cubic Feet Per Carton: 65.25</p>	GC4235B	\$4715	\$4893	\$5044	\$5264	\$5573	\$5694	\$5964	\$6477	\$6736	\$7210	\$7872	\$8689
		OVERALL DIMENSIONS			SEAT DIMENSIONS			BACK DIMENSIONS					
		W	D	H	W	D	H	W	H				
			74.5	26	37.5	22	18	18	21.5	19.5			
 <p><b>High Back Three Seat Chair</b> Half Center Arms COM Yardage: 5.75 Freight Class: 300 Product Weight (lbs.): 148 Cubic Feet Per Carton: 80.75</p>	GC4235HB	\$4893	\$5097	\$5274	\$5525	\$5882	\$6020	\$6332	\$6919	\$7217	\$7765	\$8525	\$9462
		OVERALL DIMENSIONS			SEAT DIMENSIONS			BACK DIMENSIONS					
		W	D	H	W	D	H	W	H				
			74.5	26	42.5	22	18	18	21.5	24.5			

# SEATING

# GC-BELONG

G

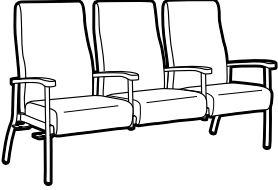
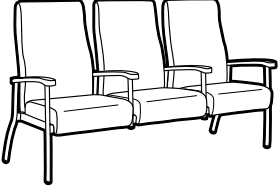
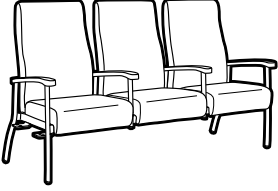
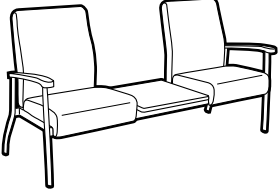
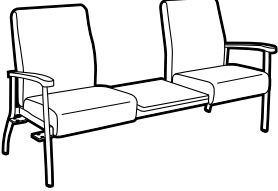
DESCRIPTION	MODEL#	STANDARD FABRIC GRADES											
		COM	2	3	4	5	6	7	8	9	10	11	12
 <p><b>High Back Three Seat Chair</b> Half Center Arms, Right COM Yardage: 5.75 Freight Class: 300 Product Weight (lbs.): 159 Cubic Feet Per Carton: 80.75</p>	<b>GC4235HBR</b>	\$4941	\$5147	\$5318	\$5573	\$5928	\$6066	\$6378	\$6967	\$7262	\$7809	\$8573	\$9511
		<b>OVERALL DIMENSIONS</b>			<b>SEAT DIMENSIONS</b>			<b>BACK DIMENSIONS</b>					
		W	D	H	W	D	H	W	H				
			74.5	26	42.5	22	18	18	21.5	24.5			
Active weight 500 lbs./seat. Wood armcap option - <b>Add \$373</b>													
 <p><b>High Back Three Seat Chair</b> Half Center Arms, Left COM Yardage: 5.75 Freight Class: 300 Product Weight (lbs.): 159 Cubic Feet Per Carton: 80.75</p>	<b>GC4235HBL</b>	\$4941	\$5147	\$5318	\$5573	\$5928	\$6066	\$6378	\$6967	\$7262	\$7809	\$8573	\$9511
		<b>OVERALL DIMENSIONS</b>			<b>SEAT DIMENSIONS</b>			<b>BACK DIMENSIONS</b>					
		W	D	H	W	D	H	W	H				
			74.5	26	42.5	22	18	18	21.5	24.5			
Active weight 500 lbs./seat. Wood armcap option - <b>Add \$373</b>													
 <p><b>High Back Three Seat Chair</b> Half Center Arms, Left &amp; Right COM Yardage: 5.75 Freight Class: 300 Product Weight (lbs.): 160 Cubic Feet Per Carton: 80.75</p>	<b>GC4235HBB</b>	\$4988	\$5194	\$5369	\$5621	\$5976	\$6113	\$6427	\$7014	\$7309	\$7857	\$8620	\$9558
		<b>OVERALL DIMENSIONS</b>			<b>SEAT DIMENSIONS</b>			<b>BACK DIMENSIONS</b>					
		W	D	H	W	D	H	W	H				
			74.5	26	42.5	22	18	18	21.5	24.5			
Active weight 500 lbs./seat. Wood armcap option - <b>Add \$373</b>													
 <p><b>Low Back Two Seat Chair with Table</b> Center Table Top, No Center Arms COM Yardage: 3.5 Freight Class: 300 Product Weight (lbs.): 106 Cubic Feet Per Carton: 65.25</p>	<b>GC4236</b>	\$3742	\$3867	\$3973	\$4127	\$4344	\$4428	\$4619	\$4976	\$5155	\$5488	\$5952	\$6523
		<b>OVERALL DIMENSIONS</b>			<b>SEAT DIMENSIONS</b>			<b>BACK DIMENSIONS</b>					
		W	D	H	W	D	H	W	H				
			72.75	26	37.5	44	18	18	44	19.5			
Wood armcap option - <b>Add \$189</b> Active weight 500 lbs./seat. • Table top only offered in High Pressure Laminate													
 <p><b>Low Back Two Seat Chair with Table</b> Center Table Top, No Center Arms, Right COM Yardage: 3.5 Freight Class: 300 Product Weight (lbs.): 107 Cubic Feet Per Carton: 65.25</p>	<b>GC4236R</b>	\$3788	\$3913	\$4019	\$4173	\$4390	\$4474	\$4665	\$5022	\$5202	\$5534	\$5999	\$6568
		<b>OVERALL DIMENSIONS</b>			<b>SEAT DIMENSIONS</b>			<b>BACK DIMENSIONS</b>					
		W	D	H	W	D	H	W	H				
			72.75	26	37.5	44	18	18	44	19.5			
Wood armcap option - <b>Add \$189</b> Active weight 500 lbs./seat. • Table top only offered in High Pressure Laminate													

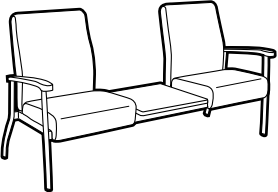
DESCRIPTION	MODEL#	STANDARD FABRIC GRADES											
		COM	2	3	4	5	6	7	8	9	10	11	12
 <p><b>Low Back Two Seat Chair with Table</b> Center Table Top, No Center Arms, Left                      COM Yardage: 3.5                      Freight Class: 300                      Product Weight (lbs.): 107                      Cubic Feet Per Carton: 65.25</p>	<b>GC4236L</b>	\$3788	\$3913	\$4019	\$4173	\$4390	\$4474	\$4665	\$5022	\$5202	\$5534	\$5999	\$6568
			<b>OVERALL DIMENSIONS</b> W D H			<b>SEAT DIMENSIONS</b> W D H			<b>BACK DIMENSIONS</b> W H				
		72.75	26	37.5	44	18	18	44	19.5				

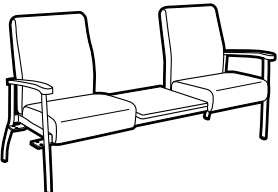
 <p><b>Low Back Two Seat Chair with Table</b> Center Table Top, No Center Arms, Left &amp; Right                      COM Yardage: 3.5                      Freight Class: 300                      Product Weight (lbs.): 108                      Cubic Feet Per Carton: 65.25</p>	<b>GC4236B</b>	\$3837	\$3962	\$4068	\$4221	\$4439	\$4524	\$4714	\$5072	\$5250	\$5584	\$6046	\$6618
			<b>OVERALL DIMENSIONS</b> W D H			<b>SEAT DIMENSIONS</b> W D H			<b>BACK DIMENSIONS</b> W H				
		72.75	26	37.5	44	18	18	44	19.5				

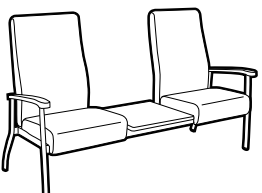
 <p><b>High Back Two Seat Chair with Table</b> Center Table Top, No Center Arms                      COM Yardage: 4                      Freight Class: 300                      Product Weight (lbs.): 110                      Cubic Feet Per Carton: 80.75</p>	<b>GC4236HB</b>	\$4006	\$4149	\$4273	\$4447	\$4696	\$4790	\$5008	\$5419	\$5624	\$6004	\$6534	\$7187
			<b>OVERALL DIMENSIONS</b> W D H			<b>SEAT DIMENSIONS</b> W D H			<b>BACK DIMENSIONS</b> W H				
		72.75	26	42.5	44	18	18	44	24.5				

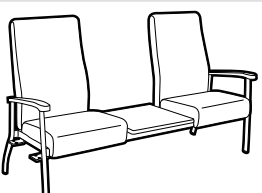
 <p><b>High Back Two Seat Chair with Table</b> Center Table Top, No Center Arms, Right                      COM Yardage: 4                      Freight Class: 300                      Product Weight (lbs.): 111                      Cubic Feet Per Carton: 80.75</p>	<b>GC4236HBR</b>	\$4050	\$4194	\$4316	\$4492	\$4741	\$4834	\$5052	\$5460	\$5668	\$6049	\$6578	\$7230
			<b>OVERALL DIMENSIONS</b> W D H			<b>SEAT DIMENSIONS</b> W D H			<b>BACK DIMENSIONS</b> W H				
		72.75	26	42.5	44	18	18	44	24.5				

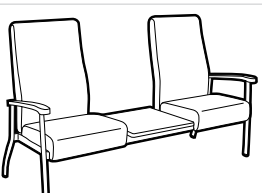
 <p><b>High Back Two Seat Chair with Table</b> Center Table Top, No Center Arms, Left                      COM Yardage: 4                      Freight Class: 300                      Product Weight (lbs.): 111                      Cubic Feet Per Carton: 80.75</p>	<b>GC4236HBL</b>	\$4050	\$4194	\$4316	\$4492	\$4741	\$4834	\$5052	\$5460	\$5668	\$6049	\$6578	\$7230
			<b>OVERALL DIMENSIONS</b> W D H			<b>SEAT DIMENSIONS</b> W D H			<b>BACK DIMENSIONS</b> W H				
		72.75	26	42.5	44	18	18	44	24.5				

DESCRIPTION	MODEL#	STANDARD FABRIC GRADES											
		COM	2	3	4	5	6	7	8	9	10	11	12

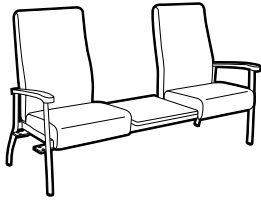

	COM	2	3	4	5	6	7	8	9	10	11	12
<b>GC4236HBB</b>	<b>\$4097</b>	<b>\$4241</b>	<b>\$4363</b>	<b>\$4539</b>	<b>\$4788</b>	<b>\$4880</b>	<b>\$5099</b>	<b>\$5509</b>	<b>\$5715</b>	<b>\$6096</b>	<b>\$6625</b>	<b>\$7277</b>

OVERALL DIMENSIONS			SEAT DIMENSIONS			BACK DIMENSIONS	
W	D	H	W	D	H	W	H
72.75	26	42.5	44	18	18	44	24.5

**High Back Two Seat Chair with Table** Center Table Top, No Center Arms, Left & Right  
 COM Yardage: 4  
 Freight Class: 300  
 Product Weight (lbs.): 114  
 Cubic Feet Per Carton: 80.75  
 Wood armcap option - **Add \$189**  
 Active weight 500 lbs./seat.  
 • Table top only offered in High Pressure Laminate

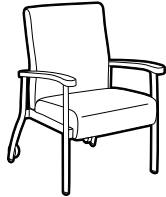

	COM	2	3	4	5	6	7	8	9	10	11	12
<b>GC4240</b>	<b>\$2072</b>	<b>\$2132</b>	<b>\$2189</b>	<b>\$2265</b>	<b>\$2373</b>	<b>\$2414</b>	<b>\$2512</b>	<b>\$2693</b>	<b>\$2780</b>	<b>\$2948</b>	<b>\$3178</b>	<b>\$3464</b>

OVERALL DIMENSIONS			SEAT DIMENSIONS			BACK DIMENSIONS	
W	D	H	W	D	H	W	H
26.75	27.5	37.5	22	18	18	21.5	19.5

**Low Back Armchair** Casters  
 COM Yardage: 1.75  
 Freight Class: 250  
 Product Weight (lbs.): 49  
 Cubic Feet Per Carton: 20.25  
 Active weight 500 lbs.  
 Wood armcap option - **Add \$189**

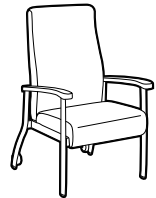

	COM	2	3	4	5	6	7	8	9	10	11	12
<b>GC4240HB</b>	<b>\$2150</b>	<b>\$2219</b>	<b>\$2283</b>	<b>\$2370</b>	<b>\$2494</b>	<b>\$2541</b>	<b>\$2650</b>	<b>\$2856</b>	<b>\$2958</b>	<b>\$3149</b>	<b>\$3413</b>	<b>\$3739</b>

OVERALL DIMENSIONS			SEAT DIMENSIONS			BACK DIMENSIONS	
W	D	H	W	D	H	W	H
26.75	27.5	42.5	22	18	18	21.5	24.5

**High Back Armchair** Casters  
 COM Yardage: 2  
 Freight Class: 250  
 Product Weight (lbs.): 54  
 Cubic Feet Per Carton: 22.25  
 Active weight 500 lbs.  
 Wood armcap option - **Add \$189**

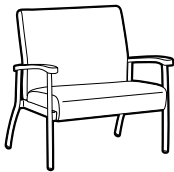

	COM	2	3	4	5	6	7	8	9	10	11	12
<b>GC4241</b>	<b>\$2395</b>	<b>\$2501</b>	<b>\$2593</b>	<b>\$2726</b>	<b>\$2912</b>	<b>\$2982</b>	<b>\$3148</b>	<b>\$3454</b>	<b>\$3607</b>	<b>\$3894</b>	<b>\$4290</b>	<b>\$4780</b>

OVERALL DIMENSIONS			SEAT DIMENSIONS			BACK DIMENSIONS	
W	D	H	W	D	H	W	H
37.5	28	37.5	32.5	18	18	32.5	19.5

**Bariatric Low Back Armchair**  
 COM Yardage: 3  
 Freight Class: 250  
 Product Weight (lbs.): 70  
 Cubic Feet Per Carton: 30.5  
 Active weight 750 lbs.  
 Wood armcap option - **Add \$189**  
 Armless Bariatric models are not available.

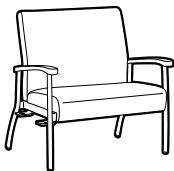

	COM	2	3	4	5	6	7	8	9	10	11	12
<b>GC4241R</b>	<b>\$2439</b>	<b>\$2546</b>	<b>\$2639</b>	<b>\$2771</b>	<b>\$2957</b>	<b>\$3027</b>	<b>\$3193</b>	<b>\$3499</b>	<b>\$3653</b>	<b>\$3939</b>	<b>\$4336</b>	<b>\$4825</b>

OVERALL DIMENSIONS			SEAT DIMENSIONS			BACK DIMENSIONS	
W	D	H	W	D	H	W	H
37.5	28	37.5	32.5	18	18	32.5	19.5

**Bariatric Low Back Armchair** Right  
 COM Yardage: 3  
 Freight Class: 250  
 Product Weight (lbs.): 71  
 Cubic Feet Per Carton: 30.5  
 Active weight 750 lbs.  
 Wood armcap option - **Add \$189**  
 Armless Bariatric models are not available.

DESCRIPTION	MODEL#	STANDARD FABRIC GRADES																							
		COM	2	3	4	5	6	7	8	9	10	11	12												
 <p><b>Bariatric Low Back Armchair Left</b> COM Yardage: 3 Freight Class: 250 Product Weight (lbs.): 71 Cubic Feet Per Carton: 30.5</p>	<b>GC4241L</b>	\$2439	\$2546	\$2639	\$2771	\$2957	\$3027	\$3193	\$3499	\$3653	\$3939	\$4336	\$4825												
	<p>Active weight 750 lbs. Wood armcap option - <b>Add \$189</b></p> <p><i>Armless Bariatric models are <u>not</u> available.</i></p>	<table border="1"> <thead> <tr> <th colspan="3">OVERALL DIMENSIONS</th> <th colspan="3">SEAT DIMENSIONS</th> <th colspan="2">BACK DIMENSIONS</th> </tr> <tr> <th>W</th> <th>D</th> <th>H</th> <th>W</th> <th>D</th> <th>H</th> <th>W</th> <th>H</th> </tr> </thead> <tbody> <tr> <td>37.5</td> <td>28</td> <td>37.5</td> <td>32.5</td> <td>18</td> <td>18</td> <td>32.5</td> <td>19.5</td> </tr> </tbody> </table>	OVERALL DIMENSIONS			SEAT DIMENSIONS			BACK DIMENSIONS		W	D	H	W	D	H	W	H	37.5	28	37.5	32.5	18	18	32.5
OVERALL DIMENSIONS			SEAT DIMENSIONS			BACK DIMENSIONS																			
W	D	H	W	D	H	W	H																		
37.5	28	37.5	32.5	18	18	32.5	19.5																		

DESCRIPTION	MODEL#	STANDARD FABRIC GRADES																							
		COM	2	3	4	5	6	7	8	9	10	11	12												
 <p><b>Bariatric Low Back Armchair Left &amp; Right</b> COM Yardage: 3 Freight Class: 250 Product Weight (lbs.): 71 Cubic Feet Per Carton: 30.5</p>	<b>GC4241B</b>	\$2485	\$2592	\$2685	\$2818	\$3005	\$3074	\$3239	\$3546	\$3699	\$3986	\$4383	\$4871												
	<p>Active weight 750 lbs. Wood armcap option - <b>Add \$189</b></p> <p><i>Armless Bariatric models are <u>not</u> available.</i></p>	<table border="1"> <thead> <tr> <th colspan="3">OVERALL DIMENSIONS</th> <th colspan="3">SEAT DIMENSIONS</th> <th colspan="2">BACK DIMENSIONS</th> </tr> <tr> <th>W</th> <th>D</th> <th>H</th> <th>W</th> <th>D</th> <th>H</th> <th>W</th> <th>H</th> </tr> </thead> <tbody> <tr> <td>37.5</td> <td>28</td> <td>37.5</td> <td>32.5</td> <td>18</td> <td>18</td> <td>32.5</td> <td>19.5</td> </tr> </tbody> </table>	OVERALL DIMENSIONS			SEAT DIMENSIONS			BACK DIMENSIONS		W	D	H	W	D	H	W	H	37.5	28	37.5	32.5	18	18	32.5
OVERALL DIMENSIONS			SEAT DIMENSIONS			BACK DIMENSIONS																			
W	D	H	W	D	H	W	H																		
37.5	28	37.5	32.5	18	18	32.5	19.5																		

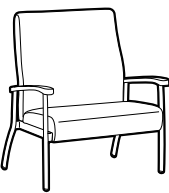
DESCRIPTION	MODEL#	STANDARD FABRIC GRADES																							
		COM	2	3	4	5	6	7	8	9	10	11	12												
 <p><b>Bariatric High Back Armchair</b> COM Yardage: 3.25 Freight Class: 250 Product Weight (lbs.): 73 Cubic Feet Per Carton: 30.5</p>	<b>GC4241HB</b>	\$2719	\$2834	\$2934	\$3075	\$3280	\$3356	\$3534	\$3864	\$4031	\$4341	\$4771	\$5304												
	<p>Active weight 750 lbs. Wood armcap option - <b>Add \$189</b></p> <p><i>Armless Bariatric models are <u>not</u> available.</i></p>	<table border="1"> <thead> <tr> <th colspan="3">OVERALL DIMENSIONS</th> <th colspan="3">SEAT DIMENSIONS</th> <th colspan="2">BACK DIMENSIONS</th> </tr> <tr> <th>W</th> <th>D</th> <th>H</th> <th>W</th> <th>D</th> <th>H</th> <th>W</th> <th>H</th> </tr> </thead> <tbody> <tr> <td>37.5</td> <td>28</td> <td>43</td> <td>32.5</td> <td>18</td> <td>18</td> <td>32.5</td> <td>24.5</td> </tr> </tbody> </table>	OVERALL DIMENSIONS			SEAT DIMENSIONS			BACK DIMENSIONS		W	D	H	W	D	H	W	H	37.5	28	43	32.5	18	18	32.5
OVERALL DIMENSIONS			SEAT DIMENSIONS			BACK DIMENSIONS																			
W	D	H	W	D	H	W	H																		
37.5	28	43	32.5	18	18	32.5	24.5																		

DESCRIPTION	MODEL#	STANDARD FABRIC GRADES																							
		COM	2	3	4	5	6	7	8	9	10	11	12												
 <p><b>Bariatric High Back Armchair Right</b> COM Yardage: 3.25 Freight Class: 250 Product Weight (lbs.): 74 Cubic Feet Per Carton: 30.5</p>	<b>GC4241HBR</b>	\$2768	\$2884	\$2984	\$3129	\$3330	\$3406	\$3584	\$3914	\$4081	\$4392	\$4821	\$5354												
	<p>Active weight 750 lbs. Wood armcap option - <b>Add \$189</b></p> <p><i>Armless Bariatric models are <u>not</u> available.</i></p>	<table border="1"> <thead> <tr> <th colspan="3">OVERALL DIMENSIONS</th> <th colspan="3">SEAT DIMENSIONS</th> <th colspan="2">BACK DIMENSIONS</th> </tr> <tr> <th>W</th> <th>D</th> <th>H</th> <th>W</th> <th>D</th> <th>H</th> <th>W</th> <th>H</th> </tr> </thead> <tbody> <tr> <td>37.5</td> <td>28</td> <td>43</td> <td>32.5</td> <td>18</td> <td>18</td> <td>32.5</td> <td>24.5</td> </tr> </tbody> </table>	OVERALL DIMENSIONS			SEAT DIMENSIONS			BACK DIMENSIONS		W	D	H	W	D	H	W	H	37.5	28	43	32.5	18	18	32.5
OVERALL DIMENSIONS			SEAT DIMENSIONS			BACK DIMENSIONS																			
W	D	H	W	D	H	W	H																		
37.5	28	43	32.5	18	18	32.5	24.5																		

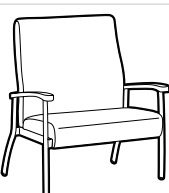
DESCRIPTION	MODEL#	STANDARD FABRIC GRADES																							
		COM	2	3	4	5	6	7	8	9	10	11	12												
 <p><b>Bariatric High Back Armchair Left</b> COM Yardage: 3.25 Freight Class: 250 Product Weight (lbs.): 74 Cubic Feet Per Carton: 30.5</p>	<b>GC4241HBL</b>	\$2768	\$2884	\$2984	\$3129	\$3330	\$3406	\$3584	\$3914	\$4081	\$4392	\$4821	\$5354												
	<p>Active weight 750 lbs. Wood armcap option - <b>Add \$189</b></p> <p><i>Armless Bariatric models are <u>not</u> available.</i></p>	<table border="1"> <thead> <tr> <th colspan="3">OVERALL DIMENSIONS</th> <th colspan="3">SEAT DIMENSIONS</th> <th colspan="2">BACK DIMENSIONS</th> </tr> <tr> <th>W</th> <th>D</th> <th>H</th> <th>W</th> <th>D</th> <th>H</th> <th>W</th> <th>H</th> </tr> </thead> <tbody> <tr> <td>37.5</td> <td>28</td> <td>43</td> <td>32.5</td> <td>18</td> <td>18</td> <td>32.5</td> <td>24.5</td> </tr> </tbody> </table>	OVERALL DIMENSIONS			SEAT DIMENSIONS			BACK DIMENSIONS		W	D	H	W	D	H	W	H	37.5	28	43	32.5	18	18	32.5
OVERALL DIMENSIONS			SEAT DIMENSIONS			BACK DIMENSIONS																			
W	D	H	W	D	H	W	H																		
37.5	28	43	32.5	18	18	32.5	24.5																		

# SEATING

# GC-BELONG

G

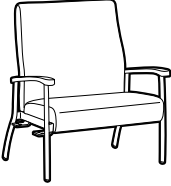
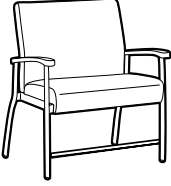
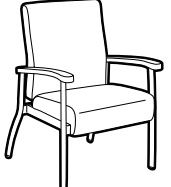
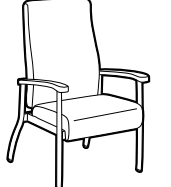
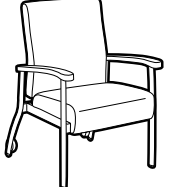
DESCRIPTION	MODEL#	STANDARD FABRIC GRADES											
		COM	2	3	4	5	6	7	8	9	10	11	12
 <p><b>Bariatric High Back Armchair</b> Left &amp; Right COM Yardage: 3.25 Freight Class: 250 Product Weight (lbs.): 74 Cubic Feet Per Carton: 30.50</p>	<b>GC4241HBB</b>	\$2816	\$2932	\$3032	\$3177	\$3379	\$3455	\$3633	\$3964	\$4129	\$4440	\$4873	\$5402
		OVERALL DIMENSIONS			SEAT DIMENSIONS			BACK DIMENSIONS					
		W	D	H	W	D	H	W	H				
		37.5	28	43	32.5	18	18	32.5	24.5				
		Active weight 750 lbs. Wood armcap option - <b>Add \$189</b> <i>Armless Bariatric models are <u>not</u> available.</i>											
 <p><b>Bariatric Low Back Armchair</b> Post Surgery. Designed to immobilize the pelvis and hip joints after surgery. COM Yardage: 3 Freight Class: 250 Product Weight (lbs.): 76 Cubic Feet Per Carton: 33.5</p>	<b>GC4241-24</b>	\$2793	\$2901	\$2993	\$3126	\$3312	\$3382	\$3546	\$3854	\$4007	\$4294	\$4691	\$5179
		24" Seat Height											
		OVERALL DIMENSIONS			SEAT DIMENSIONS			BACK DIMENSIONS					
		W	D	H	W	D	H	W	H				
		37.5	28.75	43.5	32.5	18	24	32.5	19.5				
		Active weight 750 lbs. Wood armcap option - <b>Add \$189</b> <i>Armless Bariatric models are <u>not</u> available.</i>											
 <p><b>Low Back Armchair</b> Flex Back COM Yardage: 1.75 Freight Class: 250 Product Weight (lbs.): 53 Cubic Feet Per Carton: 20.25</p>	<b>GC4242</b>	\$2469	\$2532	\$2587	\$2664	\$2772	\$2814	\$2910	\$3092	\$3180	\$3347	\$3578	\$3862
		OVERALL DIMENSIONS			SEAT DIMENSIONS			BACK DIMENSIONS					
			W	D	H	W	D	H	W	H			
		26.5	28	37.5	22	18	18	21.5	19.5				
		Active weight 500 lbs. Wood armcap option - <b>Add \$189</b>											
 <p><b>High Back Armchair</b> Flex Back COM Yardage: 2 Freight Class: 250 Product Weight (lbs.): 61 Cubic Feet Per Carton: 22.25</p>	<b>GC4242HB</b>	\$2550	\$2617	\$2684	\$2770	\$2895	\$2942	\$3052	\$3256	\$3357	\$3549	\$3813	\$4140
		OVERALL DIMENSIONS			SEAT DIMENSIONS			BACK DIMENSIONS					
			W	D	H	W	D	H	W	H			
		26.5	28	43	22	18	18	21.5	24.5				
		Active weight 500 lbs. Wood armcap option - <b>Add \$189</b>											
 <p><b>Low Back Armchair</b> Flex Back, Casters COM Yardage: 1.75 Freight Class: 250 Product Weight (lbs.): 49 Cubic Feet Per Carton: 20.25</p>	<b>GC4243</b>	\$2617	\$2678	\$2733	\$2810	\$2919	\$2959	\$3056	\$3238	\$3327	\$3494	\$3723	\$4008
		OVERALL DIMENSIONS			SEAT DIMENSIONS			BACK DIMENSIONS					
			W	D	H	W	D	H	W	H			
		26.75	27.5	37.5	22	18	18	21.5	19.5				
		Active weight 500 lbs. Wood armcap option - <b>Add \$189</b>											

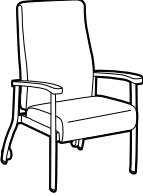
DESCRIPTION	MODEL#	STANDARD FABRIC GRADES											
		COM	2	3	4	5	6	7	8	9	10	11	12
 <p><b>High Back Armchair</b> Flex Back, Casters COM Yardage: 2 Freight Class: 250 Product Weight (lbs.): 51 Cubic Feet Per Carton: 22.25</p>	GC4243HB	\$2700	\$2768	\$2833	\$2919	\$3045	\$3092	\$3200	\$3405	\$3507	\$3699	\$3963	\$4289
		OVERALL DIMENSIONS			SEAT DIMENSIONS			BACK DIMENSIONS					
		W	D	H	W	D	H	W	H				
			26.75	27.5	42.5	22	18	18	21.5	24.5			

 <p><b>High Back Armchair</b> Split Back COM Yardage: 2.25 Freight Class: 250 Product Weight (lbs.): 54 Cubic Feet Per Carton: 20.25</p>	GC4244HB	\$2401	\$2481	\$2551	\$2649	\$2791	\$2842	\$2964	\$3196	\$3311	\$3526	\$3823	\$4191
		OVERALL DIMENSIONS			SEAT DIMENSIONS			BACK DIMENSIONS					
		W	D	H	W	D	H	W	H				
			26.75	26	42.5	22	18	18	21.5	24.5			

 <p><b>High Back Armchair</b> Split Back, Casters COM Yardage: 2.25 Freight Class: 250 Product Weight (lbs.): 54 Cubic Feet Per Carton: 20.25</p>	GC4245HB	\$2549	\$2627	\$2698	\$2796	\$2938	\$2989	\$3114	\$3343	\$3458	\$3673	\$3971	\$4337
		OVERALL DIMENSIONS			SEAT DIMENSIONS			BACK DIMENSIONS					
		W	D	H	W	D	H	W	H				
			26.75	26	42.5	22	18	18	21.5	24.5			

 <p><b>Single Seat Bench</b> COM Yardage: 1.5 Freight Class: 250 Product Weight (lbs.): 30 Cubic Feet Per Carton: 13</p>	GC4251	\$1219	\$1270	\$1318	\$1384	\$1478	\$1511	\$1594	\$1748	\$1825	\$1970	\$2167	\$2412
		OVERALL DIMENSIONS			SEAT DIMENSIONS			BACK DIMENSIONS					
		W	D	H	W	D	H	W	H				
			24.75	26.5	18								

 <p><b>Single Seat Bench</b> Left COM Yardage: 1.5 Freight Class: 250 Product Weight (lbs.): 31 Cubic Feet Per Carton: 13</p>	GC4251L	\$1265	\$1317	\$1365	\$1431	\$1526	\$1562	\$1642	\$1795	\$1872	\$2017	\$2216	\$2459
		OVERALL DIMENSIONS			SEAT DIMENSIONS			BACK DIMENSIONS					
		W	D	H	W	D	H	W	H				
			25.75	26.5	18								

# SEATING

# GC-BELONG

G

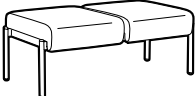
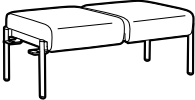
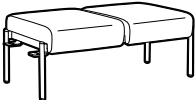
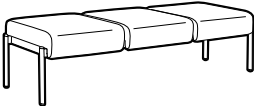
DESCRIPTION	MODEL#	STANDARD FABRIC GRADES											
		COM	2	3	4	5	6	7	8	9	10	11	12
 <p><b>Single Seat Bench</b> Left &amp; Right COM Yardage: 1.5 Freight Class: 250 Product Weight (lbs.): 32 Cubic Feet Per Carton: 13</p>	<b>GC4251B</b>	\$1317	\$1366	\$1414	\$1480	\$1575	\$1611	\$1691	\$1844	\$1921	\$2066	\$2265	\$2509
		<b>OVERALL DIMENSIONS</b> W D H			<b>SEAT DIMENSIONS</b> W D H			<b>BACK DIMENSIONS</b> W H					
	Active weight 500 lbs.	26.75	26.5	18									
 <p><b>Two Seat Bench</b> COM Yardage: 2.25 Freight Class: 250 Product Weight (lbs.): 53 Cubic Feet Per Carton: 23</p>	<b>GC4252</b>	\$2212	\$2292	\$2362	\$2460	\$2602	\$2653	\$2775	\$3007	\$3122	\$3337	\$3634	\$4002
		<b>OVERALL DIMENSIONS</b> W D H			<b>SEAT DIMENSIONS</b> W D H			<b>BACK DIMENSIONS</b> W H					
	Active weight 500 lbs./seat.	47.75	26.5	18									
 <p><b>Two Seat Bench</b> Left COM Yardage: 2.25 Freight Class: 250 Product Weight (lbs.): 54 Cubic Feet Per Carton: 23</p>	<b>GC4252L</b>	\$2262	\$2340	\$2411	\$2508	\$2650	\$2702	\$2823	\$3055	\$3171	\$3386	\$3684	\$4050
		<b>OVERALL DIMENSIONS</b> W D H			<b>SEAT DIMENSIONS</b> W D H			<b>BACK DIMENSIONS</b> W H					
	Active weight 500 lbs./seat.	48.75	26.5	18									
 <p><b>Two Seat Bench</b> Left &amp; Right COM Yardage: 2.25 Freight Class: 250 Product Weight (lbs.): 55 Cubic Feet Per Carton: 23</p>	<b>GC4252B</b>	\$2312	\$2390	\$2461	\$2559	\$2701	\$2752	\$2873	\$3106	\$3221	\$3436	\$3734	\$4100
		<b>OVERALL DIMENSIONS</b> W D H			<b>SEAT DIMENSIONS</b> W D H			<b>BACK DIMENSIONS</b> W H					
	Active weight 500 lbs./seat.	49.75	26.5	18									
 <p><b>Three Seat Bench</b> COM Yardage: 3 Freight Class: 250 Product Weight (lbs.): 73 Cubic Feet Per Carton: 33.25</p>	<b>GC4253</b>	\$3240	\$3346	\$3439	\$3571	\$3759	\$3827	\$3993	\$4299	\$4453	\$4740	\$5136	\$5625
		<b>OVERALL DIMENSIONS</b> W D H			<b>SEAT DIMENSIONS</b> W D H			<b>BACK DIMENSIONS</b> W H					
	Active weight 500 lbs./seat.	70.75	26.5	18									

DESCRIPTION	MODEL#	STANDARD FABRIC GRADES											
		COM	2	3	4	5	6	7	8	9	10	11	12

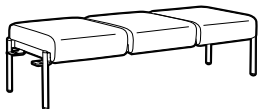

**Three Seat Bench Left**  
 COM Yardage: 3  
 Freight Class: 250  
 Product Weight (lbs.): 74  
 Cubic Feet Per Carton: 33.25

Active weight 500 lbs./seat.

OVERALL DIMENSIONS			SEAT DIMENSIONS			BACK DIMENSIONS	
W	D	H	W	D	H	W	H
71.75	26.5	18					

COM	2	3	4	5	6	7	8	9	10	11	12	
<b>GC4253L</b>	<b>\$3292</b>	<b>\$3398</b>	<b>\$3490</b>	<b>\$3623</b>	<b>\$3809</b>	<b>\$3879</b>	<b>\$4043</b>	<b>\$4351</b>	<b>\$4504</b>	<b>\$4791</b>	<b>\$5188</b>	<b>\$5676</b>

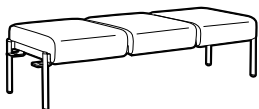

**Three Seat Bench Left & Right**  
 COM Yardage: 3  
 Freight Class: 250  
 Product Weight (lbs.): 75  
 Cubic Feet Per Carton: 33.25

Active weight 500 lbs./seat.

OVERALL DIMENSIONS			SEAT DIMENSIONS			BACK DIMENSIONS	
W	D	H	W	D	H	W	H
72.75	26.5	18					

COM	2	3	4	5	6	7	8	9	10	11	12	
<b>GC4256</b>	<b>\$3156</b>	<b>\$3233</b>	<b>\$3304</b>	<b>\$3402</b>	<b>\$3544</b>	<b>\$3595</b>	<b>\$3720</b>	<b>\$3949</b>	<b>\$4064</b>	<b>\$4279</b>	<b>\$4577</b>	<b>\$4943</b>

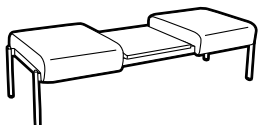

**Two Seat Bench with Table Center Table Top**  
 COM Yardage: 2.25  
 Freight Class: 250  
 Product Weight (lbs.): 68  
 Cubic Feet Per Carton: 33.25

Active weight 500 lbs./seat.

OVERALL DIMENSIONS			SEAT DIMENSIONS			BACK DIMENSIONS	
W	D	H	W	D	H	W	H
70.75	26.5	18					

• Table top only offered in High Pressure Laminate

COM	2	3	4	5	6	7	8	9	10	11	12	
<b>GC4256L</b>	<b>\$3204</b>	<b>\$3285</b>	<b>\$3356</b>	<b>\$3453</b>	<b>\$3595</b>	<b>\$3647</b>	<b>\$3768</b>	<b>\$4000</b>	<b>\$4115</b>	<b>\$4330</b>	<b>\$4629</b>	<b>\$4995</b>

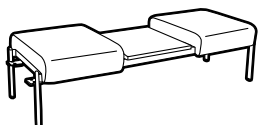

**Two Seat Bench with Table Center Table Top, Left**  
 COM Yardage: 2.25  
 Freight Class: 250  
 Product Weight (lbs.): 72  
 Cubic Feet Per Carton: 33.25

Active weight 500 lbs./seat.

OVERALL DIMENSIONS			SEAT DIMENSIONS			BACK DIMENSIONS	
W	D	H	W	D	H	W	H
71.75	26.5	18					

• Table top only offered in High Pressure Laminate

COM	2	3	4	5	6	7	8	9	10	11	12	
<b>GC4256B</b>	<b>\$3253</b>	<b>\$3331</b>	<b>\$3402</b>	<b>\$3500</b>	<b>\$3641</b>	<b>\$3693</b>	<b>\$3814</b>	<b>\$4047</b>	<b>\$4162</b>	<b>\$4377</b>	<b>\$4675</b>	<b>\$5041</b>

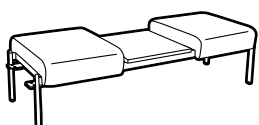

**Two Seat Bench with Table Center Table Top, Left & Right**  
 COM Yardage: 2.25  
 Freight Class: 250  
 Product Weight (lbs.): 70  
 Cubic Feet Per Carton: 33.25

Active weight 500 lbs./seat.

OVERALL DIMENSIONS			SEAT DIMENSIONS			BACK DIMENSIONS	
W	D	H	W	D	H	W	H
72.75	26.5	18					

• Table top only offered in High Pressure Laminate

DESCRIPTION	MODEL#	STANDARD FABRIC GRADES											
		COM	2	3	4	5	6	7	8	9	10	11	12
	GC4259	\$907	\$941	\$976	\$1019	\$1081	\$1106	\$1160	\$1263	\$1314	\$1409	\$1539	\$1704

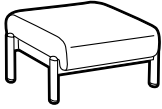

**Ottoman** Angled cushion top.  
 COM Yardage: 1  
 Freight Class: 150  
 Product Weight (lbs.): 16  
 Cubic Feet Per Carton: 3.6

Active weight 500 lbs./seat.

OVERALL DIMENSIONS			SEAT DIMENSIONS			BACK DIMENSIONS	
W	D	H	W	D	H	W	H
17.75	19	10.5					

DESCRIPTION	MODEL#	STANDARD FABRIC GRADES											
		COM	2	3	4	5	6	7	8	9	10	11	12
	GC4261	\$1269	\$1329	\$1386	\$1462	\$1570	\$1611	\$1709	\$1890	\$1977	\$2145	\$2375	\$2661

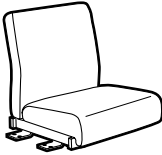

**Low Back Single Seat Armless Bridge** Left & Right  
 COM Yardage: 1.75  
 Freight Class: 250  
 Product Weight (lbs.): 36  
 Cubic Feet Per Carton: 13

Active weight 500 lbs.  
**Not freestanding.**  
 Suspends between 2 units via linking brackets.

OVERALL DIMENSIONS			SEAT DIMENSIONS			BACK DIMENSIONS	
W	D	H	W	D	H	W	H
26.75	24	25.5	22	18	--	21.5	19.5

DESCRIPTION	MODEL#	STANDARD FABRIC GRADES											
		COM	2	3	4	5	6	7	8	9	10	11	12
	GC4261HB	\$1339	\$1408	\$1473	\$1559	\$1685	\$1732	\$1840	\$2046	\$2148	\$2339	\$2603	\$2929

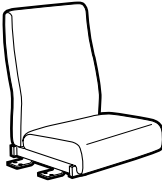

**High Back Single Seat Armless Bridge** Left & Right  
 COM Yardage: 2  
 Freight Class: 250  
 Product Weight (lbs.): 41  
 Cubic Feet Per Carton: 14.5

Active weight 500 lbs.  
**Not freestanding.**  
 Suspends between 2 units via linking brackets.

OVERALL DIMENSIONS			SEAT DIMENSIONS			BACK DIMENSIONS	
W	D	H	W	D	H	W	H
26.75	24	30.5	22	18	--	21.5	24.5

DESCRIPTION	MODEL#	STANDARD FABRIC GRADES											
		COM	2	3	4	5	6	7	8	9	10	11	12
	GC4262	\$2423	\$2548	\$2656	\$2808	\$3026	\$3111	\$3301	\$3659	\$3840	\$4171	\$4634	\$5204

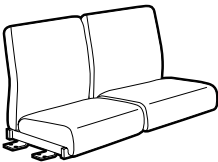

**Low Back Two Seat Armless Bridge** Left & Right  
 COM Yardage: 3.5  
 Freight Class: 250  
 Product Weight (lbs.): 66  
 Cubic Feet Per Carton: 23

Active weight 500 lbs./seat.  
**Not freestanding.**  
 Suspends between 2 units via linking brackets.

OVERALL DIMENSIONS			SEAT DIMENSIONS			BACK DIMENSIONS	
W	D	H	W	D	H	W	H
49.75	24	25.5	44	18	--	44	19.5

DESCRIPTION	MODEL#	STANDARD FABRIC GRADES											
		COM	2	3	4	5	6	7	8	9	10	11	12
	GC4262HB	\$2569	\$2713	\$2835	\$3011	\$3260	\$3353	\$3571	\$3979	\$4187	\$4568	\$5097	\$5749

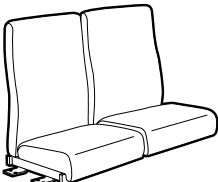

**High Back Two Seat Armless Bridge** Left & Right  
 COM Yardage: 4  
 Freight Class: 250  
 Product Weight (lbs.): 72  
 Cubic Feet Per Carton: 24

Active weight 500 lbs./seat.  
**Not freestanding.**  
 Suspends between 2 units via linking brackets.

OVERALL DIMENSIONS			SEAT DIMENSIONS			BACK DIMENSIONS	
W	D	H	W	D	H	W	H
49.75	24	30.5	44	18	--	44	24.5

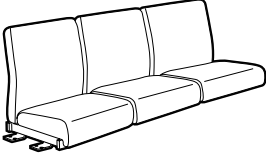
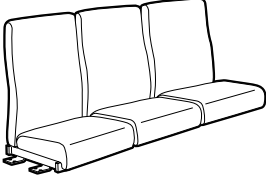
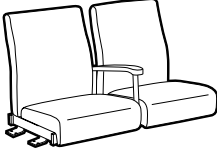
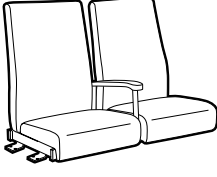
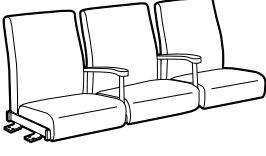
DESCRIPTION	MODEL#	STANDARD FABRIC GRADES											
		COM	2	3	4	5	6	7	8	9	10	11	12
 <p><b>Low Back Three Seat Armless Bridge</b> Left &amp; Right COM Yardage: 5 Freight Class: 300 Product Weight (lbs.): 74 Cubic Feet Per Carton: 38.75</p>	GC4263	\$3528	\$3706	\$3857	\$4079	\$4386	\$4507	\$4777	\$5291	\$5547	\$6023	\$6685	\$7502
		OVERALL DIMENSIONS			SEAT DIMENSIONS			BACK DIMENSIONS					
		W	D	H	W	D	H	W	H				
			72.75	24	25.5	70	18	--	70	19.5			
<p>Active weight 500 lbs./seat. <b>Not freestanding.</b> Suspends between 2 units via linking brackets.</p>													
 <p><b>High Back Three Seat Armless Bridge</b> Left &amp; Right COM Yardage: 5.75 Freight Class: 250 Product Weight (lbs.): 80 Cubic Feet Per Carton: 38.75</p>	GC4263HB	\$3763	\$3969	\$4143	\$4395	\$4751	\$4888	\$5200	\$5789	\$6084	\$6632	\$7395	\$8333
		OVERALL DIMENSIONS			SEAT DIMENSIONS			BACK DIMENSIONS					
		W	D	H	W	D	H	W	H				
			72.75	24	30.5	70	18	--	70	24.5			
<p>Active weight 500 lbs./seat. <b>Not freestanding.</b> Suspends between 2 units via linking brackets.</p>													
 <p><b>Low Back Two Seat Bridge</b> Half Center Arm, Left &amp; Right COM Yardage: 3.5 Freight Class: 250 Product Weight (lbs.): 58 Cubic Feet Per Carton: 27.25</p>	GC4264	\$2916	\$3039	\$3147	\$3299	\$3517	\$3602	\$3792	\$4150	\$4330	\$4662	\$5124	\$5695
		OVERALL DIMENSIONS			SEAT DIMENSIONS			BACK DIMENSIONS					
		W	D	H	W	D	H	W	H				
			50.75	24	25.5	22	18	--	21.5	19.5			
<p>Active weight 500 lbs./seat. <b>Not freestanding.</b> Suspends between 2 units via linking brackets. Wood armcap option - <b>Add \$50</b></p>													
 <p><b>High Back Two Seat Bridge</b> Half Center Arm, Left &amp; Right COM Yardage: 4 Freight Class: 250 Product Weight (lbs.): 68 Cubic Feet Per Carton: 27.25</p>	GC4264HB	\$3068	\$3212	\$3334	\$3510	\$3759	\$3852	\$4070	\$4480	\$4686	\$5067	\$5596	\$6248
		OVERALL DIMENSIONS			SEAT DIMENSIONS			BACK DIMENSIONS					
		W	D	H	W	D	H	W	H				
			50.75	24	30.5	22	18	--	21.5	24.5			
<p>Active weight 500 lbs./seat. <b>Not freestanding.</b> Suspends between 2 units via linking brackets. Wood armcap option - <b>Add \$50</b></p>													
 <p><b>Low Back Three Seat Bridge</b> Half Center Arms, Left &amp; Right COM Yardage: 5 Freight Class: 250 Product Weight (lbs.): 78 Cubic Feet Per Carton: 38.75</p>	GC4265	\$4384	\$4562	\$4713	\$4933	\$5244	\$5363	\$5634	\$6148	\$6405	\$6880	\$7541	\$8359
		OVERALL DIMENSIONS			SEAT DIMENSIONS			BACK DIMENSIONS					
		W	D	H	W	D	H	W	H				
			74.25	24	25.5	22	18	--	21.5	19.5			
<p>Active weight 500 lbs./seat. <b>Not freestanding.</b> Suspends between 2 units via linking brackets. Wood armcap option - <b>Add \$95</b></p>													

# SEATING

# GC-BELONG

G

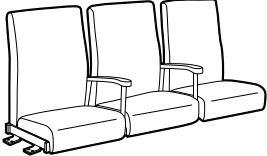
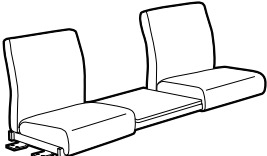
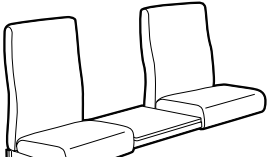
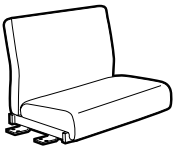
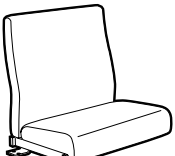
DESCRIPTION	MODEL#	STANDARD FABRIC GRADES											
		COM	2	3	4	5	6	7	8	9	10	11	12
 <p><b>High Back Three Seat Bridge</b> Half Center Arms, Left &amp; Right                      COM Yardage: 5.75                      Freight Class: 250                      Product Weight (lbs.): 86                      Cubic Feet Per Carton: 38.75</p> <p><b>Not freestanding.</b>                      Suspends between 2 units via linking brackets.                      Wood armcap option - <b>Add \$95</b></p>	<b>GC4265HB</b>	\$4619	\$4825	\$5000	\$5252	\$5608	\$5744	\$6058	\$6645	\$6940	\$7488	\$8251	\$9189
	Active weight 500 lbs./seat.	<b>OVERALL DIMENSIONS</b>			<b>SEAT DIMENSIONS</b>			<b>BACK DIMENSIONS</b>					
		W	D	H	W	D	H	W	H				
		74.25	24	30.5	22	18	--	21.5	24.5				
 <p><b>Low Back Two Seat Armless Bridge</b> Center Table Top, Left &amp; Right                      COM Yardage: 3.5                      Freight Class: 300                      Product Weight (lbs.): 60                      Cubic Feet Per Carton: 38.75</p> <p><b>Not freestanding.</b>                      Suspends between 2 units via linking brackets.                      • Table top only offered in High Pressure Laminate</p>	<b>GC4266</b>	\$3573	\$3698	\$3804	\$3958	\$4176	\$4260	\$4450	\$4808	\$4987	\$5320	\$5783	\$6354
	Active weight 500 lbs./seat.	<b>OVERALL DIMENSIONS</b>			<b>SEAT DIMENSIONS</b>			<b>BACK DIMENSIONS</b>					
		W	D	H	W	D	H	W	H				
		72.75	24	25.5	22	18	--	21.5	19.5				
 <p><b>High Back Two Seat Armless Bridge</b> Center Table Top, Left &amp; Right                      COM Yardage: 4                      Freight Class: 300                      Product Weight (lbs.): 66                      Cubic Feet Per Carton: 38.75</p> <p><b>Not freestanding.</b>                      Suspends between 2 units via linking brackets.                      • Table top only offered in High Pressure Laminate</p>	<b>GC4266HB</b>	\$3727	\$3870	\$3992	\$4168	\$4417	\$4510	\$4729	\$5138	\$5345	\$5725	\$6255	\$6908
	Active weight 500 lbs./seat.	<b>OVERALL DIMENSIONS</b>			<b>SEAT DIMENSIONS</b>			<b>BACK DIMENSIONS</b>					
		W	D	H	W	D	H	W	H				
		72.75	24	30.5	22	18	--	21.5	24.5				
 <p><b>Bariatric Low Back Armless Bridge</b> Left &amp; Right                      COM Yardage: 3                      Freight Class: 300                      Product Weight (lbs.): 44                      Cubic Feet Per Carton: 26.5</p> <p>Active weight 750 lbs.  <b>Not freestanding.</b>                      Suspends between 2 units via linking brackets.</p>	<b>GC4269</b>	\$1859	\$1966	\$2058	\$2191	\$2377	\$2447	\$2613	\$2919	\$3072	\$3359	\$3756	\$4245
		<b>OVERALL DIMENSIONS</b>			<b>SEAT DIMENSIONS</b>			<b>BACK DIMENSIONS</b>					
		W	D	H	W	D	H	W	H				
		37.5	24	25.5	32.5	18	--	32.5	19.5				
 <p><b>Bariatric High Back Armless Bridge</b> Left &amp; Right                      COM Yardage: 3.25                      Freight Class: 300                      Product Weight (lbs.): 50                      Cubic Feet Per Carton: 26.5</p> <p>Active weight 750 lbs.  <b>Not freestanding.</b>                      Suspends between 2 units via linking brackets.</p>	<b>GC4269HB</b>	\$1977	\$2093	\$2193	\$2334	\$2540	\$2616	\$2794	\$3123	\$3290	\$3601	\$4033	\$4560
		<b>OVERALL DIMENSIONS</b>			<b>SEAT DIMENSIONS</b>			<b>BACK DIMENSIONS</b>					
		W	D	H	W	D	H	W	H				
		37.5	24	30.5	32.5	18	--	32.5	24.5				

DESCRIPTION	MODEL#	STANDARD FABRIC GRADES											
		COM	2	3	4	5	6	7	8	9	10	11	12

<b>GC4271</b>	<b>\$1173</b>	<b>\$1224</b>	<b>\$1272</b>	<b>\$1338</b>	<b>\$1432</b>	<b>\$1465</b>	<b>\$1548</b>	<b>\$1702</b>	<b>\$1779</b>	<b>\$1924</b>	<b>\$2121</b>	<b>\$2366</b>
---------------	---------------	---------------	---------------	---------------	---------------	---------------	---------------	---------------	---------------	---------------	---------------	---------------

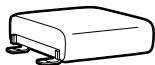

**Single Seat Bench Bridge** Left & Right  
 COM Yardage: 1.5  
 Freight Class: 100  
 Product Weight (lbs.): 24  
 Cubic Feet Per Carton: 2.9

Active weight 500 lbs.  
**Not freestanding.**  
 Suspends between 2 units via linking brackets.

OVERALL DIMENSIONS			SEAT DIMENSIONS			BACK DIMENSIONS	
W	D	H	W	D	H	W	H
24.75	26.5	6					

<b>GC4272</b>	<b>\$2136</b>	<b>\$2214</b>	<b>\$2284</b>	<b>\$2382</b>	<b>\$2524</b>	<b>\$2575</b>	<b>\$2697</b>	<b>\$2929</b>	<b>\$3044</b>	<b>\$3259</b>	<b>\$3556</b>	<b>\$3924</b>
---------------	---------------	---------------	---------------	---------------	---------------	---------------	---------------	---------------	---------------	---------------	---------------	---------------



**Two Seat Bench Bridge** Left & Right  
 COM Yardage: 2.25  
 Freight Class: 125  
 Product Weight (lbs.): 64  
 Cubic Feet Per Carton: 9.25

Active weight 500 lbs./seat.  
**Not freestanding.**  
 Suspends between 2 units via linking brackets.

OVERALL DIMENSIONS			SEAT DIMENSIONS			BACK DIMENSIONS	
W	D	H	W	D	H	W	H
49.75	26.5	6					

<b>GC4273</b>	<b>\$3164</b>	<b>\$3270</b>	<b>\$3363</b>	<b>\$3495</b>	<b>\$3683</b>	<b>\$3751</b>	<b>\$3917</b>	<b>\$4223</b>	<b>\$4377</b>	<b>\$4664</b>	<b>\$5060</b>	<b>\$5549</b>
---------------	---------------	---------------	---------------	---------------	---------------	---------------	---------------	---------------	---------------	---------------	---------------	---------------

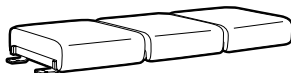

**Three Seat Bench Bridge** Left & Right  
 COM Yardage: 3  
 Freight Class: 125  
 Product Weight (lbs.): 68  
 Cubic Feet Per Carton: 9.25

Active weight 500 lbs./seat.  
**Not freestanding.**  
 Suspends between 2 units via linking brackets.

OVERALL DIMENSIONS			SEAT DIMENSIONS			BACK DIMENSIONS	
W	D	H	W	D	H	W	H
72.75	26.5	6					

<b>GC4276</b>	<b>\$2977</b>	<b>\$3057</b>	<b>\$3128</b>	<b>\$3225</b>	<b>\$3367</b>	<b>\$3419</b>	<b>\$3540</b>	<b>\$3772</b>	<b>\$3888</b>	<b>\$4102</b>	<b>\$4401</b>	<b>\$4767</b>
---------------	---------------	---------------	---------------	---------------	---------------	---------------	---------------	---------------	---------------	---------------	---------------	---------------

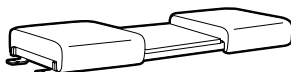

**Two Seat Bench Bridge** Center Table Top, Left & Right  
 COM Yardage: 2.25  
 Freight Class: 250  
 Product Weight (lbs.): 32  
 Cubic Feet Per Carton: 9.25

Active weight 500 lbs./seat.  
**Not freestanding.**  
 Suspends between 2 units via linking brackets.  
 • Table top only offered in High Pressure Laminate

OVERALL DIMENSIONS			SEAT DIMENSIONS			BACK DIMENSIONS	
W	D	H	W	D	H	W	H
72.75	26	6					

TABLE BRIDGES	MODEL#	DIMENSIONS	FREIGHT CLASS	WT/LBS.	CUBIC FT.	LIST PRICE
---------------	--------	------------	---------------	---------	-----------	------------

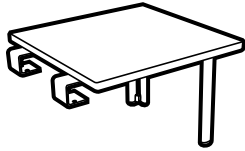

**End Table Bridge, Not Freestanding**

GC4274-LP	23 x 23 x 16	125	25	3.4	<b>\$839</b>
GC4274-HP	23 x 23 x 16	125	25	3.4	<b>\$897</b>

- For a thermally fused laminate top (LP), specify model GC4274-LP.
- For a high pressure laminate top (HP), specify model GC4274-HP.

**1 end suspends to a seating unit via linking brackets.** 1" thick top with coordinating 3mm edge. Oval steel tube legs Reversible.

GC4275-LP	23 x 23 x 1	150	18	3.4	<b>\$587</b>
GC4275-HP	23 x 23 x 1	150	18	3.4	<b>\$661</b>

- For a thermally fused laminate top (LP), specify model GC4275-LP.
- For a high pressure laminate top (HP), specify model GC4275-HP.

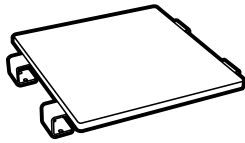

**Square Table Top, Not Freestanding**

**Suspends between two seating units via linking brackets.** 1" thick top with coordinating 3mm edge. No legs. Reversible.

GC4277-LP	35 x 35 x 16	125	45	6	<b>\$935</b>
GC4277-HP	35 x 35 x 16	125	45	6	<b>\$1067</b>

- For a thermally fused laminate top (LP), specify model GC4277-LP.
- For a high pressure laminate top (HP), specify model GC4277-HP.



**End Corner Table Bridge Not Freestanding**

**Suspends between two seating units via linking brackets.** 1" thick top with coordinating 3mm edge. Oval steel tube legs. Can be used for right or left corner.

GC4278-LP	35 x 35 x 16	125	45	6	<b>\$935</b>
GC4278-HP	35 x 35 x 16	125	45	6	<b>\$1067</b>

- For a thermally fused laminate top (LP), specify model GC4278-LP.
- For a high pressure laminate top (HP), specify model GC4278-HP.



**End Corner Curve Table Bridge Not Freestanding**

**Suspends between two seating units via linking brackets.** 1" thick top with coordinating 3mm edge. Oval steel tube legs. Can be used for right or left corner.

GC-CITI



model GC7875



5" tubular metal leg  
(shown in Tungsten)



5" tapered wood leg  
(shown in Maple)

STANDARD FEATURES

- Fully upholstered contemporary design, complements timeless decor. Proportions are compact, 31" deep, works well in public spaces, lounges and lobbies.
- The steel leg brings a lightness of scale, while satisfying the need for accessibility
- GC Citi seat legs are 5" high tubular metal, standard in a Tungsten finish.
- The seat is fastened into place and removable over an open frame structure eliminating all barriers and traps below the surface.
- The seat cushion is fully encased by the upholstery with a nylon zippered opening for access if replacement is required. This method of upholstery when using Crypton or vinyl textiles prevents the interior construction from contact with spills and body fluids that could affect the products long-term performance
- Models have removable cushions. Cushions feature removable covers
- The interior wood frame has an interlocking construction providing superior strength and long-term durability
- Arm height on all models is 25"
- Casters are not available on this series
- For added comfort, seats are standard with high density Ultracell foam
- For healthcare textiles and finish options, visit the website at [www.globalfurnituregroup.com](http://www.globalfurnituregroup.com)
- Can be upholstered in standard Global textiles only if Healthcare compliance is not required.
- Shipped fully assembled

OPTIONAL FEATURES

- To add sealed seams to your product, contact customer care. Upcharges vary.
- For moisture barrier on seat, specify **(MB)**. Add \$199.
- Leg Type**  
**(MTL)** Metal legs  
**(WDL)** Wood legs. Add \$333.
- Leg Finish**  
**(TBL)** Black  
**(TTU)** Tungsten  
**(CHM)** Chrome. Add \$102. Please specify.
- Wood leg finish:**  
**(AAM)** Absolute  
**(BKM)** Black  
**(ACM)** Cherry  
**(EOM)** English Oak  
**(ECM)** Espresso Cafe  
**(TFM)** Fruitwood  
**(HGM)** Grey  
**(AHM)** Honey  
**(JOM)** Jet Onyx  
**(TMM)** Mahogany  
**(AVM)** Maple  
**(WHM)** White  
**(MWM)** Medium Walnut  
**(NLW)** Natural Walnut  
**(ASM)** Night  
**(NBM)** Noce Biondo  
**(NGM)** Noce Grigio  
**(NEM)** Noce Leggero  
**(NMM)** Noce Medio  
**(SBM)** Sandy Beach  
**(SKM)** Shaker Cherry  
**(TWM)** Walnut  
**(WTM)** WC Cream  
**(WCM)** Winter Cherry
- Glide Type** (wood legs)  
**(NM)** White, non-marking nylon glide for most surfaces. No upcharge.  
**(SG)** Steel cushioned glide for carpeted surfaces. Add \$36.  
**(RG)** Rubber, non-slip glide for most hard floor surfaces. Add \$36.  
**(FG)** Felt glide for most hard floor surfaces. Add \$36.

SUGGESTED APPLICATIONS

- Guest seating
- Lobbies
- Lounge/Waiting
- Resident rooms

DESCRIPTION	MODEL#	STANDARD FABRIC GRADES											
		COM	2	3	4	5	6	7	8	9	10	11	12
	GC7875	\$2075	\$2260	\$2415	\$2642	\$2963	\$3115	\$3405	\$3871	\$4228	\$4627	\$5447	\$6321
<b>Lounge Chair</b> COM Yardage: 4.75 Freight Class: 250 Product Weight (lbs.): 67 Cubic Feet Per Carton: 21	Active weight 300 lbs.												
		OVERALL DIMENSIONS			SEAT DIMENSIONS			BACK DIMENSIONS					
		W	D	H	W	D	H	W	H				
		30	31	30	22	19.5	17.5	22	12.5				

GC-COMET



model GC2180 (TUN)



Black Plastic Arms



Wallsaver Leg

STANDARD FEATURES

- The rounded steel frame and durable seat cushion will ensure years of use.
- Black plastic arms are standard.
- This bariatric model has been specially designed in consultation with healthcare specialists to meet the needs of larger individuals.
- Reinforced steel seat frame accommodates users up to 500 pounds.
- For added comfort, seats are standard with high density Ultracell bio foam.
- The steel frame is available in Black (TBL), Buzz Blue (TBZ), Cactus (TCC), Carrot (TCR), Cloud (TIV), Designer White (TDW), Dijon (TDJ), Eggplant (TEG), Fog (TFO), Frost (TFR), Ink (TIN), Kalua (TKA), Latte (TLA), Mocha (TMO), Nevada (TNE), Sand (TSN), Scarlet (TSR), Shadow (TSH), Toast (TOA) and Tungsten (TTU). Please specify.
- Standard glide is a plastic dome shape on back legs, flat glide on front legs.
- Bariatric models stack 2 high on floor. No dolly available.
- For Globalcare textiles and finish options, visit the website at globalfurnituregroup.com
- Can be upholstered in standard Global textiles only if Healthcare compliance is not required.
- Shipped fully assembled

OPTIONAL FEATURES

- Plastic arms available in Shadow (SHW) and Toast (TOA). Please specify. Add \$47.
- A selection of glide options is available. Glides must be chosen to best suit flooring type and site conditions.
- Steel cushioned glides (B) are available - Add \$33.
- Glides with felt pads (FG) are available for vinyl sheet, cork or laminate flooring. Please specify. Add \$64.
- Glides with rubber pads (RG) are available for vinyl, hardwood, laminate, stone or ceramic flooring. Please specify. Add \$64.
- For moisture barrier on seat, specify (MB). Add \$204.
- **Frame finish**  
Painted finishes - no upcharge:  
(TBL) Black  
(TBZ) Buzz Blue  
(TCC) Cactus  
(TCR) Carrot  
(TIV) Cloud  
(TDW) Designer White  
(TDJ) Dijon  
(TEG) Eggplant  
(TFO) Fog  
(TFR) Frost  
(TIN) Ink  
(TKA) Kalua  
(TLA) Latte  
(TMO) Mocha  
(TNE) Nevada  
(TSN) Sand  
(TSR) Scarlet  
(TSH) Shadow  
(TOA) Toast  
(TTU) Tungsten  
Plated finish - Add \$36:  
(CHM) Chrome

SUGGESTED APPLICATIONS

- Bariatric seating
- Patient Rooms
- Waiting Areas
- Exam Rooms
- Guest Seating
- Dining Rooms

DESCRIPTION	MODEL#	STANDARD FABRIC GRADES											
		COM	2	3	4	5	6	7	8	9	10	11	12
 <p><b>Bariatric Lounge Chair</b> COM Yardage: 1.75 Freight Class: 300 Product Weight (lbs.): 44 Cubic Feet Per Carton: 23</p>	GC2180	\$1311	\$1372	\$1427	\$1504	\$1613	\$1653	\$1750	\$1932	\$2020	\$2188	\$2418	\$2702
		Active weight 500 lbs.											
		OVERALL DIMENSIONS			SEAT DIMENSIONS			BACK DIMENSIONS					
		W	D	H	W	D	H	W	H				
		31.5	27	38	26.5	18.5	18	26.5	20				

GC ISLANDS



model GC4075



model GC4076

STANDARD FEATURES



- GC Islands offers wood guest seating with contemporary styling.
- Two back styles: Upholstered back pad or horizontal wood slat back.
- Legs are equipped with White non-marking polypropylene glides. Suitable for both carpet and hard surface flooring.
- All cushions are fixed and non-removable.
- Cushions are made with highly resilient foam and seats are equipped with a synthetic rubberized webbing suspension system for extra comfort
- Seat cushion underside is finished with a Black impermeable surface material
- Does not stack
- For Globalcare textiles and finish options, visit the website at [globalfurnituregroup.com](http://globalfurnituregroup.com).
- Can be upholstered in standard Global textiles if Healthcare compliance is not required.

OPTIONAL FEATURES

- Wood frame available in Absolute (AAM), Black (BKM), Cherry (ACM), English Oak (EOM), Espresso Cafe (ECM), Fruitwood (TFM), Gray (HGM), Honey (AHM), Mahogany (TMM), Maple (AVM), Medium Walnut (MWM), Natural Walnut (NLW), Night (ASM), Noce Biondo (NBM), Noce Grigio (NGM), Noce Leggero (NEM), Noce Medio (NMM), Sandy Beach (SKM), Shaker Cherry (SKM), Silver Oak (SOM), Walnut (TWM), WC Cream (WTM), White (WHM) and Winter Cherry (WCM). Please specify.
- For moisture barrier on seat, specify (MB). Add \$137 per seat.
- Back sealed seam available, please specify (S2). Add \$41.

SUGGESTED APPLICATIONS

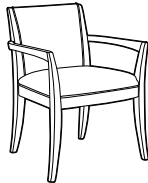
- Dining/Cafeteria
- Guest seating
- Lobbies
- Lounge/Waiting
- Office/Meeting
- Patient rooms
- Resident rooms

DESCRIPTION	MODEL#	STANDARD FABRIC GRADES											
		COM	2	3	4	5	6	7	8	9	10	11	12
 <p><b>Armchair w/Upholstered Back</b> COM Yardage: 1.5 Freight Class: 300 Product Weight (lbs.): 25 Cubic Feet Per Carton: 13.25</p>	GC4075	\$1073	\$1120	\$1167	\$1237	\$1330	\$1373	\$1453	\$1589	\$1695	\$1810	\$2049	\$2297
		OVERALL DIMENSIONS			SEAT DIMENSIONS			BACK DIMENSIONS					
		W	D	H	W	D	H	W	H				
Active weight 300 lbs. Does not stack.		24.5	23.5	32	20.5	18	18.5	19	13				
 <p><b>Armchair w/Horizontal Wood Slat Back</b> COM Yardage: 1 Freight Class: 300 Product Weight (lbs.): 25 Cubic Feet Per Carton: 13.25</p>	GC4076	\$1160	\$1193	\$1224	\$1274	\$1339	\$1364	\$1425	\$1511	\$1583	\$1653	\$1819	\$1985
		OVERALL DIMENSIONS			SEAT DIMENSIONS			BACK DIMENSIONS					
		W	D	H	W	D	H	W	H				
Active weight 300 lbs. Does not stack.		24.5	23.5	32	20.5	18	18.5	19	13				

GC SIDERO™



model GC6923

STANDARD FEATURES

- GC Sidero is a collection of contemporary multi-purpose stacking chairs with a sculptured look, featuring wide, curved arms and a round tubular wall-saver steel frame.
- Available in arm and armless models (except on bariatric models) with three seat widths, two back heights, and a four-legged and sled base frame.
- Offers options that allow the chair to meet rigorous infection prevention control requirements.
- Compound curved back provides comfort and support in multiple seating positions
- Rugged steel frame made from round welded steel tubing 7/8" dia.
- Frames feature a wall saver design to prevent back contact with wall
- Standard glide is durable Black polypropylene
- For added comfort, seats are standard with high density Ultracell bio foam
- Three seat widths: 19.5" (standard size), 24" (mid size) and 30" (bariatric).
- Two different back constructions are offered:
  1. Concealed back attachment: two piece back covering the back support brackets when fastened in place.
  2. Single piece back with a pullover style upholstery cover and support bracket fastened on the outer back.
- Low back and high back models are available:
  1. Low back version is available on all three seat widths: 15.5" high.
  2. High back version on 19" and 24" seat widths: 21" high.
  3. High back version on bariatric 30" seat width: 21.75" high.
- Fiberglass nylon reinforced arms have a generous width and extend to the front of the seat. They offer additional support and help to stabilize users as they sit or exit the chair. Available in Black only.
- Select GC Sidero models are equipped with a polypropylene seat shroud that helps avoid frame imprints on upholstered seats when chairs are stacked. Protective seat shroud is standard on all 19.5" seat width models.
- 30" Bariatric and 24" seat width models do not have a seat shroud and are standard with a vinyl covered seat underside.
- Active weight capacity for 19.5" seat width models is up to 300 lbs., and up to 500 lbs for 24" seat width and Bariatric models.
- For healthcare textiles and finish options, visit the website at [globalfurnituregroup.com](http://globalfurnituregroup.com).
- Can be upholstered in standard Global textiles if healthcare compliance is not required.





OPTIONAL FEATURES

- To respond to higher expectations for housekeeping and infection prevention, single piece back underside and all seat pan undersides can be completely sealed and seat shroud (if standard on the model) would be removed.
  - For standard models with single piece back, please specify **(BSS)**. Add **\$76**.
  - For standard models with concealed attachment back, please specify **(STS)**. Add **\$69**.
  - For 24" width models with single piece back, please specify **(BSS)**. Add **\$89**.
  - For 24" width models with concealed attachment back, please specify **(STS)**. Add **\$69**.
  - For bariatric models with single piece back, please specify **(BSS)**. Add **\$108**.
  - For bariatric models with concealed attachment back, please specify **(STS)**. Add **\$70**.
- Chrome frame available, please specify **(CHM)**. Add **\$47** list upcharge.
- A selection of glide options is available. Glides must be chosen to best suit flooring type and site conditions.
  - For hard surface floors, please specify opaque non-marking glides **(NM)**. No upcharge.
  - Steel cushioned glides **(B)** are available on four legged models. Add **\$33** list upcharge.
  - Glides with felt pads **(FG)** are available for vinyl sheet, cork or laminate flooring. Please specify. Add **\$64**.
  - Glides with rubber pads **(RG)** are available for vinyl, hardwood, laminate, stone or ceramic flooring. Please specify. Add **\$64**.
- Seams can be sealed to prevent penetration of fluids through the stitching. Sealed seams are only available with select textiles. Please contact CustomerCare for more information.
- Moisture Barrier for 19.5" seat width - Add \$137 list upcharge per seat. For 24" seat width models - Add \$137 list upcharge per seat.. For Bariatric models - Add \$209 list upcharge per seat.
- **Frame finish**  
 Painted finishes - no upcharge:  
**(TBL)** Black  
**(TIV)** Cloud  
**(TDW)** Designer White  
**(TFO)** Fog  
**(TFR)** Frost  
**(TKA)** Kalua  
**(TLA)** Latte  
**(TMO)** Mocha  
**(TNE)** Nevada  
**(TSN)** Sand  
**(TSH)** Shadow  
**(TOA)** Toast  
**(TTU)** Tungsten  
 Plated finish - Add \$47:  
**(CHM)** Chrome





SEAT WIDTH	STACKING CAPABILITIES
19.5"	Four-legged armchairs and side chairs can stack up to 5 high on the floor or 8 high on dolly #2125WS. Sled base armchairs and side chairs do not stack.
24" midsize	Four-legged armchairs and side chairs can stack up to 5 high on the floor. No dolly is available. Sled base armchairs and side chairs do not stack.
30" bariatric	Four-legged armchairs can stack up to 2 high on the floor. No dolly is available. Sled base models do not stack.





SUGGESTED APPLICATIONS

- Bariatric seating (some models)
- Dining/Cafeteria
- Guest seating
- Lobbies
- Lounge/Waiting
- Office/Meeting
- Patient rooms
- Resident rooms
- Stacking
- Treatment/Exam rooms





DESCRIPTION	MODEL#	STANDARD FABRIC GRADES												
		COM	2	3	4	5	6	7	8	9	10	11	12	
 <p><b>LB Stacking Armchair, 4 Leg Base</b> with concealed attachment                      COM Yardage: 1.25                      Freight Class: 250                      Product Weight (lbs.): 29                      Cubic Feet Per Carton: 13.5</p>	<b>GC6900</b>	\$713	\$780	\$837	\$920	\$1040	\$1096	\$1202	\$1376	\$1508	\$1653	\$1955	\$2279	
		OVERALL DIMENSIONS			SEAT DIMENSIONS			BACK DIMENSIONS						
		W	D	H	W	D	H	W	H					
		25.5	24	33	19.5	18	17.5	19	15.5					
 <p><b>HB Stacking Armchair, 4 Leg Base</b> with concealed attachment                      COM Yardage: 1.75                      Freight Class: 250                      Product Weight (lbs.): 33                      Cubic Feet Per Carton: 15.25</p>	<b>GC6900HB</b>	\$868	\$943	\$1010	\$1105	\$1241	\$1304	\$1425	\$1622	\$1774	\$1939	\$2285	\$2652	
		OVERALL DIMENSIONS			SEAT DIMENSIONS			BACK DIMENSIONS						
		W	D	H	W	D	H	W	H					
		25.5	24	38.5	19.5	18	17.5	19	21					
 <p><b>LB Stacking Chair, 4 Leg Base</b> with concealed attachment                      COM Yardage: 1.25                      Freight Class: 250                      Product Weight (lbs.): 26                      Cubic Feet Per Carton: 11.25</p>	<b>GC6901</b>	\$670	\$736	\$798	\$879	\$998	\$1056	\$1162	\$1333	\$1466	\$1611	\$1912	\$2237	
		OVERALL DIMENSIONS			SEAT DIMENSIONS			BACK DIMENSIONS						
		W	D	H	W	D	H	W	H					
		21	24	33	19.5	18	17.5	19	15.5					
 <p><b>HB Stacking Chair, 4 Leg Base</b> with concealed attachment                      COM Yardage: 1.75                      Freight Class: 250                      Product Weight (lbs.): 30                      Cubic Feet Per Carton: 14.5</p>	<b>GC6901HB</b>	\$822	\$897	\$964	\$1059	\$1195	\$1258	\$1379	\$1576	\$1728	\$1893	\$2239	\$2606	
		OVERALL DIMENSIONS			SEAT DIMENSIONS			BACK DIMENSIONS						
		W	D	H	W	D	H	W	H					
		21	24	38.5	19.5	18	17.5	19	21					
 <p><b>LB Armchair, Sled Base</b> with concealed attachment                      COM Yardage: 1.25                      Freight Class: 250                      Product Weight (lbs.): 32                      Cubic Feet Per Carton: 13.5</p>	<b>GC6902</b>	\$938	\$1005	\$1062	\$1146	\$1265	\$1321	\$1427	\$1601	\$1735	\$1881	\$2181	\$2504	
		OVERALL DIMENSIONS			SEAT DIMENSIONS			BACK DIMENSIONS						
		W	D	H	W	D	H	W	H					
		25.5	24	33	19.5	18	17.5	19	15.5					



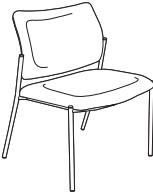

# SEATING

DESCRIPTION	MODEL#	STANDARD FABRIC GRADES											
		COM	2	3	4	5	6	7	8	9	10	11	12
 <p><b>HB Armchair, Sled Base</b> with concealed attachment COM Yardage: 1.75 Freight Class: 250 Product Weight (lbs.): 36 Cubic Feet Per Carton: 15.25</p> <p>Active weight 300 lbs. <b>Does not stack.</b></p>	<b>GC6902HB</b>	\$1013	\$1088	\$1155	\$1250	\$1386	\$1449	\$1570	\$1767	\$1919	\$2084	\$2430	\$2797
	<b>OVERALL DIMENSIONS</b>			<b>SEAT DIMENSIONS</b>			<b>BACK DIMENSIONS</b>						
	<b>W</b>	<b>D</b>	<b>H</b>	<b>W</b>	<b>D</b>	<b>H</b>	<b>W</b>	<b>H</b>					
	25.5	24	38.5	19.5	18	17.5	19	21					
 <p><b>LB Side Chair, Sled Base</b> with concealed attachment COM Yardage: 1.25 Freight Class: 250 Product Weight (lbs.): 30 Cubic Feet Per Carton: 11.25</p> <p>Active weight 300 lbs. <b>Does not stack.</b></p>	<b>GC6903</b>	\$889	\$954	\$1011	\$1095	\$1214	\$1270	\$1376	\$1550	\$1684	\$1830	\$2130	\$2453
	<b>OVERALL DIMENSIONS</b>			<b>SEAT DIMENSIONS</b>			<b>BACK DIMENSIONS</b>						
	<b>W</b>	<b>D</b>	<b>H</b>	<b>W</b>	<b>D</b>	<b>H</b>	<b>W</b>	<b>H</b>					
	21	24	33	19.5	18	17.5	19	15.5					
 <p><b>HB Side Chair, Sled Base</b> with concealed attachment COM Yardage: 1.75 Freight Class: 250 Product Weight (lbs.): 34 Cubic Feet Per Carton: 14.5</p> <p>Active weight 300 lbs. <b>Does not stack.</b></p>	<b>GC6903HB</b>	\$1056	\$1130	\$1199	\$1295	\$1431	\$1492	\$1617	\$1810	\$1961	\$2127	\$2475	\$2842
	<b>OVERALL DIMENSIONS</b>			<b>SEAT DIMENSIONS</b>			<b>BACK DIMENSIONS</b>						
	<b>W</b>	<b>D</b>	<b>H</b>	<b>W</b>	<b>D</b>	<b>H</b>	<b>W</b>	<b>H</b>					
	21	24	38.5	19.5	18	17.5	19	21					
 <p><b>Low Back Stacking Chair 4 Leg Base</b> COM Yardage: 1.25 Freight Class: 250 Product Weight (lbs.): 26 Cubic Feet Per Carton: 11.25</p> <p>Active weight 300 lbs. Single piece back with pullover style upholstery cover with <b>exposed support brackets</b> on the outer back.</p>	<b>GC6912</b>	\$690	\$736	\$782	\$840	\$923	\$963	\$1041	\$1163	\$1257	\$1360	\$1576	\$1807
	<b>OVERALL DIMENSIONS</b>			<b>SEAT DIMENSIONS</b>			<b>BACK DIMENSIONS</b>						
	<b>W</b>	<b>D</b>	<b>H</b>	<b>W</b>	<b>D</b>	<b>H</b>	<b>W</b>	<b>H</b>					
	21	24	33	19.5	18	17.5	19	15.5					
 <p><b>High Back Stacking Chair 4 Leg Base</b> COM Yardage: 1.75 Freight Class: 250 Product Weight (lbs.): 30 Cubic Feet Per Carton: 14.5</p> <p>Active weight 300 lbs. Single piece back with pullover style upholstery cover with <b>exposed support brackets</b> on the outer back.</p>	<b>GC6912HB</b>	\$831	\$897	\$954	\$1038	\$1157	\$1213	\$1319	\$1493	\$1627	\$1773	\$2073	\$2396
	<b>OVERALL DIMENSIONS</b>			<b>SEAT DIMENSIONS</b>			<b>BACK DIMENSIONS</b>						
	<b>W</b>	<b>D</b>	<b>H</b>	<b>W</b>	<b>D</b>	<b>H</b>	<b>W</b>	<b>H</b>					
	21	24	38.5	19.5	18	17.5	19	21					



DESCRIPTION	MODEL#	STANDARD FABRIC GRADES											
		COM	2	3	4	5	6	7	8	9	10	11	12
 <p><b>LB Stacking Armchair, 4 Leg Base</b> COM Yardage: 1.25 Freight Class: 250 Product Weight (lbs.): 29 Cubic Feet Per Carton: 13.5</p>	<b>GC6913</b>	\$734	\$780	\$826	\$884	\$967	\$1007	\$1085	\$1207	\$1301	\$1404	\$1620	\$1851
	<b>OVERALL DIMENSIONS</b>			<b>SEAT DIMENSIONS</b>			<b>BACK DIMENSIONS</b>						
	<b>W</b>	<b>D</b>	<b>H</b>	<b>W</b>	<b>D</b>	<b>H</b>	<b>W</b>	<b>H</b>					
	25.5	24	33	19.5	18	17.5	19	15.5					
Active weight 300 lbs. Single piece back with pullover style upholstery cover with <b>exposed support brackets</b> on the outer back.													
 <p><b>HB Stacking Armchair, 4 Leg Base</b> COM Yardage: 1.75 Freight Class: 250 Product Weight (lbs.): 33 Cubic Feet Per Carton: 15.25</p>	<b>GC6913HB</b>	\$876	\$943	\$1000	\$1083	\$1203	\$1259	\$1365	\$1539	\$1671	\$1816	\$2118	\$2442
	<b>OVERALL DIMENSIONS</b>			<b>SEAT DIMENSIONS</b>			<b>BACK DIMENSIONS</b>						
	<b>W</b>	<b>D</b>	<b>H</b>	<b>W</b>	<b>D</b>	<b>H</b>	<b>W</b>	<b>H</b>					
	25.5	24	38.5	19.5	18	17.5	19	21					
Active weight 300 lbs. Single piece back with pullover style upholstery cover with <b>exposed support brackets</b> on the outer back.													
 <p><b>LB Armchair, Sled Base</b> COM Yardage: 1.25 Freight Class: 250 Product Weight (lbs.): 32 Cubic Feet Per Carton: 13.5</p>	<b>GC6914</b>	\$959	\$1005	\$1051	\$1110	\$1194	\$1233	\$1311	\$1433	\$1527	\$1631	\$1849	\$2077
	<b>OVERALL DIMENSIONS</b>			<b>SEAT DIMENSIONS</b>			<b>BACK DIMENSIONS</b>						
	<b>W</b>	<b>D</b>	<b>H</b>	<b>W</b>	<b>D</b>	<b>H</b>	<b>W</b>	<b>H</b>					
	25.5	24	33	19.5	18	17.5	19	15.5					
Active weight 300 lbs. Single piece back with pullover style upholstery cover with <b>exposed support brackets</b> on the outer back.													
 <p><b>LB Armchair, Sled Base</b> COM Yardage: 1.75 Freight Class: 250 Product Weight (lbs.): 36 Cubic Feet Per Carton: 15.25</p>	<b>GC6914HB</b>	\$1112	\$1177	\$1234	\$1318	\$1437	\$1493	\$1599	\$1773	\$1907	\$2053	\$2353	\$2676
	<b>OVERALL DIMENSIONS</b>			<b>SEAT DIMENSIONS</b>			<b>BACK DIMENSIONS</b>						
	<b>W</b>	<b>D</b>	<b>H</b>	<b>W</b>	<b>D</b>	<b>H</b>	<b>W</b>	<b>H</b>					
	25.5	24	38.5	19.5	18	17.5	19	21					
Active weight 300 lbs. Single piece back with pullover style upholstery cover with <b>exposed support brackets</b> on the outer back. <b>Does not stack.</b>													
 <p><b>Low Back Side Chair, Sled Base</b> COM Yardage: 1.25 Freight Class: 250 Product Weight (lbs.): 30 Cubic Feet Per Carton: 11.25</p>	<b>GC6915</b>	\$908	\$954	\$1000	\$1059	\$1143	\$1182	\$1260	\$1382	\$1476	\$1580	\$1798	\$2026
	<b>OVERALL DIMENSIONS</b>			<b>SEAT DIMENSIONS</b>			<b>BACK DIMENSIONS</b>						
	<b>W</b>	<b>D</b>	<b>H</b>	<b>W</b>	<b>D</b>	<b>H</b>	<b>W</b>	<b>H</b>					
	21	24	33	19.5	18	17.5	19	15.5					
Active weight 300 lbs. Single piece back with pullover style upholstery cover with <b>exposed support brackets</b> on the outer back. <b>Does not stack.</b>													

# SEATING

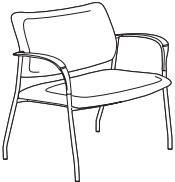
DESCRIPTION	MODEL#	STANDARD FABRIC GRADES											
		COM	2	3	4	5	6	7	8	9	10	11	12
 <p><b>HB Side Chair, Sled Base</b> COM Yardage: 1.75 Freight Class: 250 Product Weight (lbs.): 34 Cubic Feet Per Carton: 14.5</p>	<b>GC6915HB</b>	\$1064	\$1130	\$1192	\$1273	\$1392	\$1450	\$1556	\$1727	\$1860	\$2005	\$2306	\$2631
	<b>OVERALL DIMENSIONS</b>			<b>SEAT DIMENSIONS</b>			<b>BACK DIMENSIONS</b>						
	<b>W</b>	<b>D</b>	<b>H</b>	<b>W</b>	<b>D</b>	<b>H</b>	<b>W</b>	<b>H</b>					
	21	24	38.5	19.5	18	17.5	19	21					
<p>Active weight 300 lbs. Single piece back with pullover style upholstery cover with <b>exposed support brackets</b> on the outer back.</p>													
 <p><b>LB Midsize Stacking Armchair, 4 Leg Base</b> COM Yardage: 1.75 Freight Class: 250 Product Weight (lbs.): 34 Cubic Feet Per Carton: 16.</p>	<b>GC6916</b>	\$1067	\$1133	\$1195	\$1276	\$1395	\$1453	\$1559	\$1730	\$1863	\$2008	\$2309	\$2634
	<b>OVERALL DIMENSIONS</b>			<b>SEAT DIMENSIONS</b>			<b>BACK DIMENSIONS</b>						
	<b>W</b>	<b>D</b>	<b>H</b>	<b>W</b>	<b>D</b>	<b>H</b>	<b>W</b>	<b>H</b>					
	30.5	24	33	24	18	17.5	24	15.5					
<p>Active weight 500 lbs. Single piece back with pullover style upholstery cover with <b>exposed support brackets</b> on the outer back.</p>													
 <p><b>HB Midsize Stacking Armchair, 4 Leg Base</b> COM Yardage: 2 Freight Class: 250 Product Weight (lbs.): 37 Cubic Feet Per Carton: 18.25</p>	<b>GC6916HB</b>	\$1220	\$1295	\$1362	\$1457	\$1593	\$1656	\$1777	\$1974	\$2126	\$2291	\$2637	\$3004
	<b>OVERALL DIMENSIONS</b>			<b>SEAT DIMENSIONS</b>			<b>BACK DIMENSIONS</b>						
	<b>W</b>	<b>D</b>	<b>H</b>	<b>W</b>	<b>D</b>	<b>H</b>	<b>W</b>	<b>H</b>					
	30.5	24	38.5	24	18	17.5	24	21					
<p>Active weight 500 lbs. Single piece back with pullover style upholstery cover with <b>exposed support brackets</b> on the outer back.</p>													
 <p><b>LB Midsize Stacking Chair, 4 Leg Base</b> COM Yardage: 1.75 Freight Class: 250 Product Weight (lbs.): 30 Cubic Feet Per Carton: 14.5</p>	<b>GC6917</b>	\$1023	\$1089	\$1151	\$1232	\$1351	\$1409	\$1515	\$1686	\$1819	\$1964	\$2265	\$2590
	<b>OVERALL DIMENSIONS</b>			<b>SEAT DIMENSIONS</b>			<b>BACK DIMENSIONS</b>						
	<b>W</b>	<b>D</b>	<b>H</b>	<b>W</b>	<b>D</b>	<b>H</b>	<b>W</b>	<b>H</b>					
	26	24	33	24	18	17.5	24	15.5					
<p>Active weight 500 lbs. Single piece back with pullover style upholstery cover with <b>exposed support brackets</b> on the outer back.</p>													
 <p><b>HB Midsize Stacking Chair, 4 Leg Base</b> COM Yardage: 2 Freight Class: 300 Product Weight (lbs.): 33 Cubic Feet Per Carton: 17.75</p>	<b>GC6917HB</b>	\$1175	\$1250	\$1317	\$1412	\$1548	\$1611	\$1732	\$1929	\$2081	\$2246	\$2592	\$2959
	<b>OVERALL DIMENSIONS</b>			<b>SEAT DIMENSIONS</b>			<b>BACK DIMENSIONS</b>						
	<b>W</b>	<b>D</b>	<b>H</b>	<b>W</b>	<b>D</b>	<b>H</b>	<b>W</b>	<b>H</b>					
	26	24	38.5	24	18	17.5	24	21					
<p>Active weight 500 lbs. Single piece back with pullover style upholstery cover with <b>exposed support brackets</b> on the outer back.</p>													



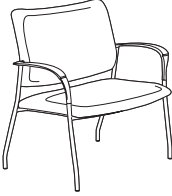
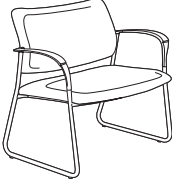
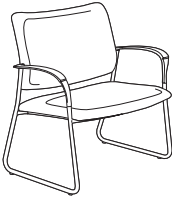

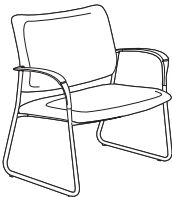
DESCRIPTION	MODEL#	STANDARD FABRIC GRADES											
		COM	2	3	4	5	6	7	8	9	10	11	12
 <p><b>LB Midsize Armchair, Sled Base</b> COM Yardage: 1.75 Freight Class: 250 Product Weight (lbs.): 36 Cubic Feet Per Carton: 16</p>	<b>GC6918</b>	<b>\$1318</b>	<b>\$1384</b>	<b>\$1446</b>	<b>\$1529</b>	<b>\$1646</b>	<b>\$1704</b>	<b>\$1810</b>	<b>\$1981</b>	<b>\$2114</b>	<b>\$2259</b>	<b>\$2560</b>	<b>\$2885</b>
	<b>OVERALL DIMENSIONS</b>		<b>SEAT DIMENSIONS</b>			<b>BACK DIMENSIONS</b>							
	<b>W</b>	<b>D</b>	<b>H</b>	<b>W</b>	<b>D</b>	<b>H</b>	<b>W</b>	<b>H</b>					
Active weight 500 lbs. COM Yardage: 1.75 Freight Class: 250 Product Weight (lbs.): 36 Cubic Feet Per Carton: 16		30.5	24	33	24	18	17.5	24	15.5	Single piece back with pullover style upholstery cover with <b>exposed support brackets</b> on the outer back.			
 <p><b>HB Midsize Armchair, Sled Base</b> COM Yardage: 2 Freight Class: 250 Product Weight (lbs.): 39 Cubic Feet Per Carton: 18.25</p>	<b>GC6918HB</b>	<b>\$1483</b>	<b>\$1558</b>	<b>\$1627</b>	<b>\$1723</b>	<b>\$1859</b>	<b>\$1920</b>	<b>\$2045</b>	<b>\$2238</b>	<b>\$2389</b>	<b>\$2555</b>	<b>\$2903</b>	<b>\$3270</b>
	<b>OVERALL DIMENSIONS</b>		<b>SEAT DIMENSIONS</b>			<b>BACK DIMENSIONS</b>							
	<b>W</b>	<b>D</b>	<b>H</b>	<b>W</b>	<b>D</b>	<b>H</b>	<b>W</b>	<b>H</b>					
Active weight 500 lbs. COM Yardage: 2 Freight Class: 250 Product Weight (lbs.): 39 Cubic Feet Per Carton: 18.25		30.5	24	38.5	24	18	17.5	24	21	Single piece back with pullover style upholstery cover with <b>exposed support brackets</b> on the outer back.			
 <p><b>LB Midsize Side Chair, Sled Base</b> COM Yardage: 1.75 Freight Class: 250 Product Weight (lbs.): 34 Cubic Feet Per Carton: 14.5</p>	<b>GC6919</b>	<b>\$1271</b>	<b>\$1336</b>	<b>\$1398</b>	<b>\$1481</b>	<b>\$1598</b>	<b>\$1656</b>	<b>\$1762</b>	<b>\$1933</b>	<b>\$2066</b>	<b>\$2211</b>	<b>\$2512</b>	<b>\$2837</b>
	<b>OVERALL DIMENSIONS</b>		<b>SEAT DIMENSIONS</b>			<b>BACK DIMENSIONS</b>							
	<b>W</b>	<b>D</b>	<b>H</b>	<b>W</b>	<b>D</b>	<b>H</b>	<b>W</b>	<b>H</b>					
Active weight 500 lbs. COM Yardage: 1.75 Freight Class: 250 Product Weight (lbs.): 34 Cubic Feet Per Carton: 14.5		26	24	33	24	18	17.5	24	15.5	Single piece back with pullover style upholstery cover with <b>exposed support brackets</b> on the outer back.			
 <p><b>HB Midsize Side Chair, Sled Base</b> COM Yardage: 2.5 Freight Class: 250 Product Weight (lbs.): 37 Cubic Feet Per Carton: 17.75</p>	<b>GC6919HB</b>	<b>\$1438</b>	<b>\$1513</b>	<b>\$1580</b>	<b>\$1675</b>	<b>\$1811</b>	<b>\$1874</b>	<b>\$1995</b>	<b>\$2192</b>	<b>\$2344</b>	<b>\$2509</b>	<b>\$2855</b>	<b>\$3222</b>
	<b>OVERALL DIMENSIONS</b>		<b>SEAT DIMENSIONS</b>			<b>BACK DIMENSIONS</b>							
	<b>W</b>	<b>D</b>	<b>H</b>	<b>W</b>	<b>D</b>	<b>H</b>	<b>W</b>	<b>H</b>					
Active weight 500 lbs. COM Yardage: 2.5 Freight Class: 250 Product Weight (lbs.): 37 Cubic Feet Per Carton: 17.75		26	24	38.5	24	18	17.5	24	21	Single piece back with pullover style upholstery cover with <b>exposed support brackets</b> on the outer back.			
 <p><b>LB Bariatric Stacking Armchair, 4 Leg Base</b> COM Yardage: 2.5 Freight Class: 250 Product Weight (lbs.): 46 Cubic Feet Per Carton: 20.5</p>	<b>GC6920</b>	<b>\$1416</b>	<b>\$1512</b>	<b>\$1596</b>	<b>\$1712</b>	<b>\$1886</b>	<b>\$1966</b>	<b>\$2120</b>	<b>\$2363</b>	<b>\$2551</b>	<b>\$2757</b>	<b>\$3192</b>	<b>\$3652</b>
	<b>OVERALL DIMENSIONS</b>		<b>SEAT DIMENSIONS</b>			<b>BACK DIMENSIONS</b>							
	<b>W</b>	<b>D</b>	<b>H</b>	<b>W</b>	<b>D</b>	<b>H</b>	<b>W</b>	<b>H</b>					
Active weight 500 lbs. COM Yardage: 2.5 Freight Class: 250 Product Weight (lbs.): 46 Cubic Feet Per Carton: 20.5		36.5	26	33	30	18	17.5	30	15.5	Single piece back with pullover style upholstery cover with <b>exposed support brackets</b> on the outer back.			

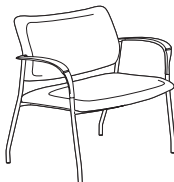
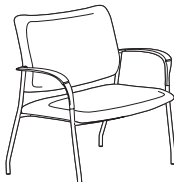
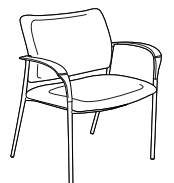
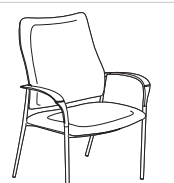
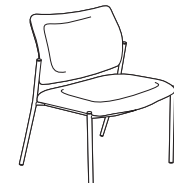
# SEATING

DESCRIPTION	MODEL#	STANDARD FABRIC GRADES											
		COM	2	3	4	5	6	7	8	9	10	11	12
 <p><b>HB Bariatric Stacking Armchair, 4 Leg Base</b>                      COM Yardage: 2.75                      Freight Class: 300                      Product Weight (lbs.): 47                      Cubic Feet Per Carton: 22.5</p>	<b>GC6920HB</b>	\$1485	\$1591	\$1683	\$1816	\$2004	\$2092	\$2262	\$2532	\$2743	\$2975	\$3453	\$3962
		OVERALL DIMENSIONS			SEAT DIMENSIONS			BACK DIMENSIONS					
		W	D	H	W	D	H	W	H				
		36.5	26	38.5	30	18	17.5	30	21				
		Active weight 500 lbs. Single piece back with pullover style upholstery cover with <b>exposed support brackets</b> on the outer back.											
 <p><b>LB Bariatric Armchair, Sled Base</b>                      COM Yardage: 2.5                      Freight Class: 250                      Product Weight (lbs.): 48                      Cubic Feet Per Carton: 20.5</p>	<b>GC6921</b>	\$1696	\$1792	\$1876	\$1998	\$2166	\$2246	\$2400	\$2643	\$2831	\$3040	\$3472	\$3932
		OVERALL DIMENSIONS			SEAT DIMENSIONS			BACK DIMENSIONS					
		W	D	H	W	D	H	W	H				
		36.5	26	33	30	18	17.5	30	15.5				
		Active weight 500 lbs. Single piece back with pullover style upholstery cover with <b>exposed support brackets</b> on the outer back. <b>Does not stack.</b>											
 <p><b>HB Bariatric Armchair, Sled Base</b>                      COM Yardage: 3                      Freight Class: 300                      Product Weight (lbs.): 51                      Cubic Feet Per Carton: 22.5</p>	<b>GC6921HB</b>	\$1680	\$1790	\$1889	\$2020	\$2214	\$2305	\$2480	\$2761	\$2975	\$3215	\$3708	\$4235
		OVERALL DIMENSIONS			SEAT DIMENSIONS			BACK DIMENSIONS					
		W	D	H	W	D	H	W	H				
		36.5	26	38.5	30	18	17.5	30	21				
		Active weight 500 lbs. Single piece back with pullover style upholstery cover with <b>exposed support brackets</b> on the outer back. <b>Does not stack.</b>											
 <p><b>LB Bariatric Stacking Armchair, Sled Base with concealed attachment</b>                      COM Yardage: 2.5                      Freight Class: 250                      Product Weight (lbs.): 48                      Cubic Feet Per Carton: 20.5</p>	<b>GC6922</b>	\$1696	\$1792	\$1876	\$1998	\$2166	\$2246	\$2400	\$2643	\$2831	\$3040	\$3472	\$3932
		OVERALL DIMENSIONS			SEAT DIMENSIONS			BACK DIMENSIONS					
		W	D	H	W	D	H	W	H				
		36.5	26	33	30	18	17.5	30	15.5				
		Active weight 500 lbs.											
 <p><b>HB Bariatric Stacking Armchair, Sled Base with concealed attachment</b>                      COM Yardage: 3                      Freight Class: 300                      Product Weight (lbs.): 51                      Cubic Feet Per Carton: 22.5</p>	<b>GC6922HB</b>	\$1680	\$1790	\$1889	\$2020	\$2214	\$2305	\$2480	\$2761	\$2975	\$3215	\$3708	\$4235
		OVERALL DIMENSIONS			SEAT DIMENSIONS			BACK DIMENSIONS					
		W	D	H	W	D	H	W	H				
		36.5	26	38.5	30	18	17.5	30	21				
		Active weight 500 lbs.											

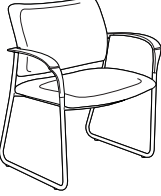
DESCRIPTION	MODEL#	STANDARD FABRIC GRADES											
		COM	2	3	4	5	6	7	8	9	10	11	12
 <p><b>LB Bariatric Stacking Armchair, 4 Leg Base</b> with concealed attachment            COM Yardage: 2.5            Freight Class: 250            Product Weight (lbs.): 46            Cubic Feet Per Carton: 20.5            Active weight 500 lbs.</p>	<b>GC6923</b>	<b>\$1416</b>	<b>\$1512</b>	<b>\$1596</b>	<b>\$1712</b>	<b>\$1886</b>	<b>\$1966</b>	<b>\$2120</b>	<b>\$2363</b>	<b>\$2551</b>	<b>\$2757</b>	<b>\$3192</b>	<b>\$3652</b>
	<b>OVERALL DIMENSIONS</b>			<b>SEAT DIMENSIONS</b>			<b>BACK DIMENSIONS</b>						
	<b>W</b>	<b>D</b>	<b>H</b>	<b>W</b>	<b>D</b>	<b>H</b>	<b>W</b>	<b>H</b>					
	36.5	26	33	30	18	17.5	30	15.5					
 <p><b>HB Bariatric Stacking Armchair, 4 Leg Base</b> with concealed attachment            COM Yardage: 3            Freight Class: 250            Product Weight (lbs.): 47            Cubic Feet Per Carton: 22.5            Active weight 500 lbs.</p>	<b>GC6923HB</b>	<b>\$1485</b>	<b>\$1591</b>	<b>\$1683</b>	<b>\$1816</b>	<b>\$2004</b>	<b>\$2092</b>	<b>\$2262</b>	<b>\$2532</b>	<b>\$2743</b>	<b>\$2975</b>	<b>\$3453</b>	<b>\$3962</b>
	<b>OVERALL DIMENSIONS</b>			<b>SEAT DIMENSIONS</b>			<b>BACK DIMENSIONS</b>						
	<b>W</b>	<b>D</b>	<b>H</b>	<b>W</b>	<b>D</b>	<b>H</b>	<b>W</b>	<b>H</b>					
	36.5	26	38.5	30	18	17.5	30	21					
 <p><b>LB Midsize Stacking Armchair, 4 Leg Base</b> with concealed attachment            COM Yardage: 2.5            Freight Class: 250            Product Weight (lbs.): 34            Cubic Feet Per Carton: 16            Active weight 500 lbs.</p>	<b>GC6924</b>	<b>\$1037</b>	<b>\$1133</b>	<b>\$1217</b>	<b>\$1339</b>	<b>\$1507</b>	<b>\$1587</b>	<b>\$1741</b>	<b>\$1984</b>	<b>\$2172</b>	<b>\$2381</b>	<b>\$2813</b>	<b>\$3273</b>
	<b>OVERALL DIMENSIONS</b>			<b>SEAT DIMENSIONS</b>			<b>BACK DIMENSIONS</b>						
	<b>W</b>	<b>D</b>	<b>H</b>	<b>W</b>	<b>D</b>	<b>H</b>	<b>W</b>	<b>H</b>					
	30.5	24	33	24	18	17.5	24	15.5					
 <p><b>HB Midsize Stacking Armchair, 4 Leg Base</b> with concealed attachment            COM Yardage: 2.75            Freight Class: 250            Product Weight (lbs.): 38            Cubic Feet Per Carton: 18.25            Active weight 500 lbs.</p>	<b>GC6924HB</b>	<b>\$1190</b>	<b>\$1295</b>	<b>\$1387</b>	<b>\$1519</b>	<b>\$1705</b>	<b>\$1792</b>	<b>\$1962</b>	<b>\$2229</b>	<b>\$2438</b>	<b>\$2668</b>	<b>\$3142</b>	<b>\$3647</b>
	<b>OVERALL DIMENSIONS</b>			<b>SEAT DIMENSIONS</b>			<b>BACK DIMENSIONS</b>						
	<b>W</b>	<b>D</b>	<b>H</b>	<b>W</b>	<b>D</b>	<b>H</b>	<b>W</b>	<b>H</b>					
	30.5	24	38.5	24	18	17.5	24	21					
 <p><b>LB Midsize Stacking Chair, 4 Leg Base</b> with concealed attachment            COM Yardage: 2.5            Freight Class: 250            Product Weight (lbs.): 30            Cubic Feet Per Carton: 14.5            Active weight 500 lbs.</p>	<b>GC6925</b>	<b>\$993</b>	<b>\$1089</b>	<b>\$1173</b>	<b>\$1295</b>	<b>\$1463</b>	<b>\$1543</b>	<b>\$1697</b>	<b>\$1940</b>	<b>\$2128</b>	<b>\$2337</b>	<b>\$2769</b>	<b>\$3229</b>
	<b>OVERALL DIMENSIONS</b>			<b>SEAT DIMENSIONS</b>			<b>BACK DIMENSIONS</b>						
	<b>W</b>	<b>D</b>	<b>H</b>	<b>W</b>	<b>D</b>	<b>H</b>	<b>W</b>	<b>H</b>					
	26	24	33	24	18	17.5	24	15.5					

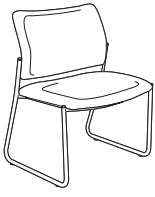
# SEATING

DESCRIPTION	MODEL#	STANDARD FABRIC GRADES											
		COM	2	3	4	5	6	7	8	9	10	11	12
 <p><b>HB Midsize Stacking Chair, 4 Leg Base</b> with concealed attachment            COM Yardage: 2.75            Freight Class: 300            Product Weight (lbs.): 33            Cubic Feet Per Carton: 17.75</p>	GC6925HB	\$1146	\$1250	\$1342	\$1474	\$1660	\$1747	\$1917	\$2184	\$2393	\$2623	\$3097	\$3602
		OVERALL DIMENSIONS			SEAT DIMENSIONS			BACK DIMENSIONS					
		W	D	H	W	D	H	W	H				
 <p><b>LB Midsize Armchair, Sled Base</b> with concealed attachment            COM Yardage: 2.5            Freight Class: 250            Product Weight (lbs.): 36            Cubic Feet Per Carton: 16</p>	GC6926	\$1288	\$1384	\$1468	\$1590	\$1758	\$1838	\$1992	\$2235	\$2423	\$2632	\$3064	\$3524
		OVERALL DIMENSIONS			SEAT DIMENSIONS			BACK DIMENSIONS					
		W	D	H	W	D	H	W	H				
 <p><b>HB Midsize Armchair, Sled Base</b> with concealed attachment            COM Yardage: 2.75            Freight Class: 250            Product Weight (lbs.): 39            Cubic Feet Per Carton: 18.25</p>	GC6926HB	\$1452	\$1558	\$1650	\$1782	\$1968	\$2055	\$2225	\$2492	\$2700	\$2931	\$3405	\$3910
		OVERALL DIMENSIONS			SEAT DIMENSIONS			BACK DIMENSIONS					
		W	D	H	W	D	H	W	H				
 <p><b>LB Midsize Side Chair, Sled Base</b> with concealed attachment            COM Yardage: 2.5            Freight Class: 250            Product Weight (lbs.): 34            Cubic Feet Per Carton: 14.5</p>	GC6927	\$1240	\$1336	\$1420	\$1542	\$1710	\$1790	\$1944	\$2187	\$2375	\$2584	\$3016	\$3476
		OVERALL DIMENSIONS			SEAT DIMENSIONS			BACK DIMENSIONS					
		W	D	H	W	D	H	W	H				
 <p><b>HB Midsize Side Chair, Sled Base</b> with concealed attachment            COM Yardage: 2.75            Freight Class: 250            Product Weight (lbs.): 37            Cubic Feet Per Carton: 17.75</p>	GC6927HB	\$1408	\$1513	\$1605	\$1737	\$1923	\$2010	\$2180	\$2447	\$2656	\$2886	\$3360	\$3865
		OVERALL DIMENSIONS			SEAT DIMENSIONS			BACK DIMENSIONS					
		W	D	H	W	D	H	W	H				

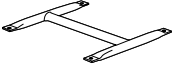
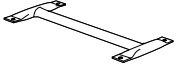
DESCRIPTION	MODEL#	STANDARD FABRIC GRADES								
 <p><b>Metal Ganging Connector for Armchairs</b>                      Freight Class: 92.5                      Product Weight (lbs.): 4                      Cubic Feet Per Carton: 0.4</p>	GC6928	LIST PRICE								
		\$120								
		OVERALL DIMENSIONS			SEAT DIMENSIONS			BACK DIMENSIONS		
		W	D	H	W	D	H	W	H	
			12	13.75	1					
 <p><b>Metal Ganging Connector for Armless Chairs</b>                      Freight Class: 100                      Product Weight (lbs.): 3.5                      Cubic Feet Per Carton: 0.4</p>	GC6929	LIST PRICE								
		\$120								
		OVERALL DIMENSIONS			SEAT DIMENSIONS			BACK DIMENSIONS		
		W	D	H	W	D	H	W	H	
			7.87	13.75	1					

## GC SIRENA™



model GC3380



model GC3380RTL/M

## STANDARD FEATURES



- The size and scale of this chair permits it to be used in smaller areas, where space is a consideration and style cannot be compromised. The soft curves and comfortable fit make this the right solution for creating group seating areas or in confined spaces.
- Complementary round foot design is available in Black only.
- For tablet models, please specify left hand or right hand tablet at time of order (determined from the seated position). See models below.
- Tablets rotate and are non-removable. Overall tablet size is 17" W by 14" D.
- Laminate tablet surfaces are 1.5" thick.
- **(C1M)** dual wheel carpet casters are standard on select models.
- The interior wood frame is an interlocking construction providing superior strength and long-term durability.
- Clean out space is provided around the seat pan for easy housekeeping and infection prevention practices
- Seat cushion can be removed if replacement is required
- For added comfort, seats are standard with high density Ultracell foam.
- For textile options, visit the website at [globalfurnituregroup.com/healthcare](http://globalfurnituregroup.com/healthcare)
- Can be upholstered in standard Global textiles if healthcare compliance is not required.

## OPTIONAL FEATURES

- Wood legs are available offered in the following Global wood finishes: Absolute (AAM), Cherry (ACM), English Oak (EOM), Espresso Cafe (ECM), Fruitwood (TFM), Gray (HGM), Honey (AHM), Jet Onyx (JOM), Mahogany (TMM), Maple (AVM), Medium Walnut (MWM), Natural Walnut (NLW), Night (ASM), Noce Biondo (NBM), Noce Grigio (NGM), Noce Leggero (NEM), Noce Medio (NMM), Sandy Beach (SBM), Shaker Cherry (SKM), Walnut (TWM), White (WHM), WC Cream (WTM) and Winter Cherry (WCM).
- Laminate tablets are offered in the following laminate finishes: Absolute Acajou (ACJ), Asian Night (ASN), Avant Cherry (AWC), Avant Honey (AWH), Black (BLK), Blizzard (BZD), Brushed Cobalt (BRC), Clear Maple (CMB), Custom Grey (CGY), Dark Espresso (DES), Designer White (DWT), Fashionista (FAS), First Class (FCL), Noce Biondo (NBM), Noce Leggero (NEM), Noce Grigio (NGM), Noce Medio (NMM), Quartered Mahogany (QTM), Sheer Beauty (SBY), Stonedust (SDT), Walnut Heights (WHE), White Chocolate (WHC) and Winter Cherry (WCR). Please specify
- To add sealed seams to your product, contact CustomerCare for more information.
- For moisture barrier on seat, please specify **(MB)**. Add \$179.

## SUGGESTED APPLICATIONS

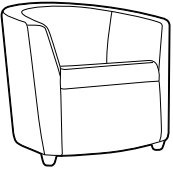
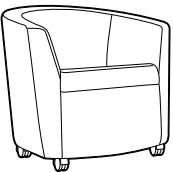
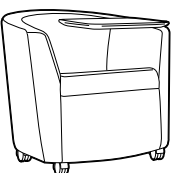
- Dining/Cafeteria
- Guest seating
- Lobbies
- Lounge/Waiting
- Office/Meeting
- Patient rooms
- Resident rooms

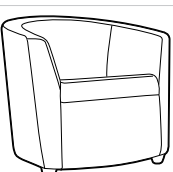
DESCRIPTION	MODEL#	STANDARD FABRIC GRADES											
		COM	2	3	4	5	6	7	8	9	10	11	12
 <p><b>Club Chair w/Seat Clean Out</b> COM Yardage: 4.25 Freight Class: 250 Product Weight (lbs.): 52 Cubic Feet Per Carton: 19.25</p>	GC3380	\$1802	\$1953	\$2083	\$2269	\$2535	\$2660	\$2899	\$3283	\$3579	\$3911	\$4585	\$5305
		OVERALL DIMENSIONS			SEAT DIMENSIONS			BACK DIMENSIONS					
		W	D	H	W	D	H	W	H				
		30.5	29.5	28.5	20	20	17.5	19	11.5				
 <p><b>Club Chair on Casters w/Seat Clean Out</b> COM Yardage: 4.25 Freight Class: 250 Product Weight (lbs.): 52 Cubic Feet Per Carton: 19.25</p>	GC3380C	\$1814	\$1965	\$2091	\$2277	\$2539	\$2665	\$2902	\$3282	\$3574	\$3901	\$4569	\$5286
		OVERALL DIMENSIONS			SEAT DIMENSIONS			BACK DIMENSIONS					
		W	D	H	W	D	H	W	H				
		30.5	29.5	29.5	20	20	18	19	12.5				
 <p><b>Club Chair on Casters w/Seat Clean Out and LP Tablet - Left</b> COM Yardage: 4.25 Freight Class: 250 Product Weight (lbs.): 62 Cubic Feet Per Carton: 19.25</p>	GC3380CLTL	\$2378	\$2529	\$2656	\$2842	\$3104	\$3230	\$3468	\$3847	\$4138	\$4466	\$5135	\$5852
		OVERALL DIMENSIONS			SEAT DIMENSIONS			BACK DIMENSIONS					
		W	D	H	W	D	H	W	H				
		32	29.5	29.5	20	20	18	19	12.5				
 <p><b>Club Chair on Casters w/Seat Clean Out and LP Tablet - Right</b> COM Yardage: 4.25 Freight Class: 250 Product Weight (lbs.): 62 Cubic Feet Per Carton: 19.25</p>	GC3380CRTL	\$2378	\$2529	\$2656	\$2842	\$3104	\$3230	\$3468	\$3847	\$4138	\$4466	\$5135	\$5852
		OVERALL DIMENSIONS			SEAT DIMENSIONS			BACK DIMENSIONS					
		W	D	H	W	D	H	W	H				
		32	29.5	29.5	20	20	18	19	12.5				
 <p><b>Weighted Club Chair w/Seat Clean Out</b> COM Yardage: 4.25 Freight Class: 150 Product Weight (lbs.): 108 Cubic Feet Per Carton: 19.25</p>	GC3380-CW	\$2012	\$2162	\$2288	\$2474	\$2736	\$2862	\$3099	\$3479	\$3771	\$4098	\$4766	\$5483
		OVERALL DIMENSIONS			SEAT DIMENSIONS			BACK DIMENSIONS					
		W	D	H	W	D	H	W	H				
		30.5	29.5	28.5	20	20	17.5	19	11.5				

## GC VION



model GC6322-0

### STANDARD FEATURES

- GC Vion is a comprehensive seating series offering a family of models to address multiple applications: task, management and conference.
- Series offers mid and high back models with either a mesh or upholstered back.
- Mechanism available: synchro tilter (-0).
- All models are standard with height and width adjustable arms (**AS**) that feature a front to back sliding armcap.
- Standard with Global's high quality Soft Descent™ pneumatic lift which slowly and gently lowers the seat height of the chair, making it easy to obtain the desired position.
- Side activated sliding seat depth adjustment (**MD**) is standard on synchro-tilter with back angle adjustment.
- Standard with Black five prong, injection molded, fiberglass reinforced nylon Governor base (**B7**) with dual wheel carpet casters (**C1**).
- Mesh back models are available in 10 standard Vion colors: Aqua (**MS75**), Black (**MS69**), Black Cherry (**MS76**), Blue (**MS72**), Dust (**MS77**), Ivory (**MS78**), Natural (**MS74**), Paprika (**MS79**), Rope (**MS73**) and Stone (**MS71**).
- Underside of the seat is upholstered in a coated textile. The joining of the textiles on the underside of the seat pan is sealed on all models.
- Upholstered back models feature black fabric Jenny (**JN02**) on the back side as standard.
- Check textile availability prior to specifying upholstery material. Materials must meet or exceed 100,000 double rubs to comply with Globalcare's 24/7 seating textile warranty.

### OPTIONAL FEATURES

- Vion back frames, arms and bases are available in three colors: Black, Shadow and Fog. See Vion finishes chart for options and upcharges. Armcaps are always Black.
- Mesh back models are also available in 10 Dimension Mesh colors: Black (**DBK**), Fog (**DST**), Chalk (**DCL**), Shadow (**DGM**), Charcoal (**DCH**), Sand (**DSD**), and Pool Blue (**DPB**). Add **\$29**
- Petite seat models (2" shorter and 2" narrower than the standard size seat) are available. Specify (**ST**) for standard seat or (**P**) for petite seat. No upcharge.
- An optional moisture barrier is available for the seat cushion. Specify (**NB**) for no moisture barrier, no upcharge, or (**MB**) for Moisture Barrier. Add \$124.
- Sealed seams are available on the seat of GC Vion models when specified with approved coated textile. Contact Customer Care for availability. Specify (**NS**) for no sealed seams, no upcharge, or (**SE**) for sealed seat seams. Add **\$23**.
- For hard surface flooring casters, please specify (**C9R**). Add **\$76**.
- Two featured "T" arm options that include height and width adjusting arms, one with sliding arm caps (**AS**) and one without sliding arm caps (**AF**). Also, available is a stylish fixed urethane arm (**C**) for conference/management environments.
- For additional arm/caster options, please refer to the Arm and Caster section of the Seating List Price Book. *Optional casters may be priced higher than the standard casters for your chair and the difference will be charged. Lower priced optional casters will not be credited.*

VION FINISHES - TASK SEATING				
Back Frame	Base	Specify Code	Arm Option	Specify Code
Black	Black	BLK no upcharge	Adj. "T" arm ( <b>Black</b> ) Adj. "T" arm, fixed armcap ( <b>Black</b> )	AS AF AC
Black	Polished Aluminum	BAU Add \$177	Adj. "T" arm ( <b>Black</b> , Chrome accent) Adj. "T" arm, fixed armcap ( <b>Black</b> , Chrome accent) Fixed "C" arm ( <b>Black</b> ) Fixed "C" arm ( <b>Polished Aluminum</b> )	A C CA - Add \$214
Shadow	Shadow	SHW Add \$81	Adj. "T" arm ( <b>Shadow</b> ) Adj. "T" arm, fixed armcap ( <b>Shadow</b> )	SHA SHF SHR
Shadow	Polished Aluminum	SAU Add \$295	Adj. "T" arm ( <b>Shadow</b> , Chrome accent) Adj. "T" arm, fixed armcap ( <b>Shadow</b> , Chrome accent) Fixed "C" arm ( <b>Shadow</b> ) Fixed "C" arm ( <b>Polished Aluminum</b> )	SHD SHC CA - Add \$214
Fog	Fog	FOG Add \$81	Adj. "T" arm ( <b>Fog</b> ) Adj. "T" arm, fixed armcap ( <b>Fog</b> )	FA FF FC
Fog	Polished Aluminum	FAU Add \$295	Adj. "T" arm ( <b>Fog</b> , Chrome accent) Adj. "T" arm, fixed armcap ( <b>Fog</b> , Chrome accent) Fixed "C" arm ( <b>Fog</b> ) Fixed "C" arm ( <b>Polished Aluminum</b> )	CF CC CA - Add \$214

\* All arms have Black Urethane Armcaps.

### MECHANISMS:

Synchro-tilter mechanism (-0)

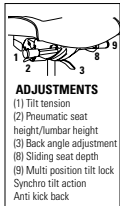



- ADJUSTMENTS**
- (1) Tilt tension
  - (2) Pneumatic seat height/lumbar height
  - (3) Back angle adjustment
  - (8) Sliding seat depth
  - (9) Multi position tilt lock
  - Synchro tilt action
  - Anti kick back

**Ergonomic features:**  
A, B, C, E, G, H, L, M, N, O, U

### EXAMPLE GC VION ORDER CODE:

GC3622-0	-BAU	-MS76	-ST	-ST	-AF15
Model #	Finish	Mesh	Seat size	Seat foam	Seat upholstery

-AF	-EE	-MB	-NS	-5L
Arms	Casters	Moisture barrier	Sealed seams	Pneumatic lift

DESCRIPTION	MODEL#	STANDARD FABRIC GRADES											
		COM	2	3	4	5	6	7	8	9	10	11	12
 <p><b>MB Synchro-Tilter w/Back Angle Adj.</b>, mesh back                      COM Yardage: 1                      Freight Class: 150                      Product Weight (lbs.): 58                      Cubic Feet Per Carton: 10.5</p>	GC6322-0	\$1377	\$1406	1434	1474	1528	1553	\$1603	\$1683	\$1742	1812	1950	2099
		OVERALL DIMENSIONS			SEAT DIMENSIONS			BACK DIMENSIONS					
		W	D	H	W	D	H	W	H				
		25.5	24	39.5	20	17-20	17.5-22.5	18.5	21				
 <p><b>HB Synchro-Tilter w/Back Angle Adj.</b>, upholstered back, standard seat                      COM Yardage: 1.25                      Freight Class: 150                      Product Weight (lbs.): 61                      Cubic Feet Per Carton: 10.5</p>	GC6331-0	\$1429	\$1465	\$1500	\$1548	\$1616	\$1649	\$1711	\$1810	\$1885	\$1971	\$2145	\$2331
		OVERALL DIMENSIONS			SEAT DIMENSIONS			BACK DIMENSIONS					
		W	D	H	W	D	H	W	H				
		25.5	24	41.5	20	17-20	17.5-22.5	18.5	23				



GC-WIND



Removable Seat Cushion



Tubular Steel Leg

model 3361HB



model 3363HB

STANDARD FEATURES



- An attractive, sleek and modern lounge series on Chrome tubular legs.
- Seat cushions are easily removable for cleaning and the open frame is great for housekeeping access. Cushion covers are removable.
- For added comfort, seats are standard with high density Ultracell bio foam.
- Frame available in Black (TBL), Buzz Blue (TBZ), Cactus (TCC), Carrot (TCR), Chrome (CHM), Cloud (TIV), Designer White (TDW), Dijon (TDJ), Eggplant (TEG), Fog (TFO), Frost (TFR), Ink (TIN), Kalua (TKA), Latte (TLA), Mocha (TMO), Nevada (TNE), Sand (TSN), Scarlet (TSR), Shadow (TSH), Toast (TOA) and Tungsten (TTU).
- Standard glide is plastic.
- For Globalcare textiles and finish options, visit the website at www.globalfurnituregroup.com
- This product can be upholstered in standard Global textiles only if Healthcare compliance is not required.
- Shipped fully assembled



OPTIONAL FEATURES

- For hard surface floors, please specify opaque non-marking glides (NM). No upcharge.
- To add sealed seams to your product contact Customer Care. Upcharges vary
- Moisture Barrier (seat only) - **Add \$204** list upcharge for Lounge Chair. For 2 seat sofa - **Add \$404** list upcharge and for 3 seat sofa - **Add \$598**.
- **Frame finish**  
Painted finishes. No upcharge.  
(TBL) Black (TIN) Ink  
(TBZ) Buzz Blue (TKA) Kalua  
(TCC) Cactus (TLA) Latte  
(TCR) Carrot (TMO) Mocha  
(TIV) Cloud (TNE) Nevada  
(TDW) Designer White (TSA) Sand  
(TDJ) Dijon (TSR) Scarlet  
(TEG) Eggplant (TSH) Shadow  
(TFO) Fog (TOA) Toast  
(TFR) Frost (TTU) Tungsten  
Plated finish. See models for upcharges.  
(CHM) Chrome  
(BCH) Brushed Chrome

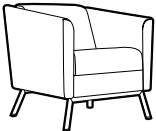
SUGGESTED APPLICATIONS

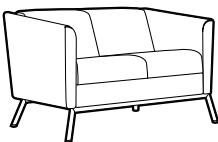
- Lobbies
- Lounge / Waiting
- Office / Meeting
- Patient rooms
- Resident rooms

DESCRIPTION	MODEL#	STANDARD FABRIC GRADES											
		COM	2	3	4	5	6	7	8	9	10	11	12
 <p><b>Lounge Chair</b> COM Yardage: 4.25 Freight Class: 250 Product Weight (lbs.): 62 Cubic Feet Per Carton: 16.5</p>	<p><b>GC3361</b></p> <p>Removable seat cushion. Active weight 300 lbs.</p>	\$2666	\$2851	\$3007	\$3233	\$3554	\$3706	\$3996	\$4462	\$4820	\$5219	\$6039	\$6912
		<b>OVERALL DIMENSIONS</b>			<b>SEAT DIMENSIONS</b>			<b>BACK DIMENSIONS</b>					
		W	D	H	W	D	H	W	H				
			27.5	29	28.5	19.5	19	17	19	12			
 <p><b>High Back Lounge Chair</b> COM Yardage: 4.75 Freight Class: 250 Product Weight (lbs.): 69 Cubic Feet Per Carton: 23</p>	<p><b>GC3361HB</b></p> <p>Removable seat cushion. Active weight 300 lbs.</p>	\$2420	\$2605	\$2760	\$2986	\$3307	\$3457	\$3749	\$4214	\$4573	\$4970	\$5792	\$6663
		<b>OVERALL DIMENSIONS</b>			<b>SEAT DIMENSIONS</b>			<b>BACK DIMENSIONS</b>					
		W	D	H	W	D	H	W	H				
			27.5	29	36	19.5	19	17	19	19.5			
 <p><b>Two Seat Sofa</b> COM Yardage: 7.25 Freight Class: 250 Product Weight (lbs.): 102 Cubic Feet Per Carton: 30</p>	<p><b>GC3362</b></p> <p>Removable seat cushion. Active weight 300 lbs./seat</p>	\$3272	\$3551	\$3783	\$4125	\$4610	\$4839	\$5280	\$5979	\$6519	\$7120	\$8356	\$9675
		<b>OVERALL DIMENSIONS</b>			<b>SEAT DIMENSIONS</b>			<b>BACK DIMENSIONS</b>					
		W	D	H	W	D	H	W	H				
			54.5	29	28.5	46.5	19	17	46.5	12			

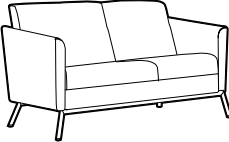
DESCRIPTION	MODEL#	STANDARD FABRIC GRADES											
		COM	2	3	4	5	6	7	8	9	10	11	12
 <b>High Back Two Seat Sofa</b> COM Yardage: 8 Freight Class: 250 Product Weight (lbs.): 107 Cubic Feet Per Carton: 44.75	<b>GC3362HB</b>  Removable seat cushion. Active weight 300 lbs./seat	<b>\$3377</b>	<b>\$3651</b>	<b>\$4066</b>	<b>\$4415</b>	<b>\$4910</b>	<b>\$5100</b>	<b>\$5536</b>	<b>\$6353</b>	<b>\$6763</b>	<b>\$7520</b>	<b>\$8577</b>	<b>\$9881</b>
		<b>OVERALL DIMENSIONS</b>			<b>SEAT DIMENSIONS</b>			<b>BACK DIMENSIONS</b>					
		<b>W</b>	<b>D</b>	<b>H</b>	<b>W</b>	<b>D</b>	<b>H</b>	<b>W</b>	<b>H</b>				
		54.5	29	36	46.5	19	17	46.5	19.5				
 <b>Three Seat Sofa</b> COM Yardage: 10.5 Freight Class: 250 Product Weight (lbs.): 135 Cubic Feet Per Carton: 42.5	<b>GC3363</b>  Removable seat cushion. Active weight 300 lbs./seat	<b>\$4096</b>	<b>\$4504</b>	<b>\$4838</b>	<b>\$5334</b>	<b>\$6037</b>	<b>\$6367</b>	<b>\$7004</b>	<b>\$8019</b>	<b>\$8799</b>	<b>\$9669</b>	<b>\$11460</b>	<b>\$13371</b>
		<b>OVERALL DIMENSIONS</b>			<b>SEAT DIMENSIONS</b>			<b>BACK DIMENSIONS</b>					
		<b>W</b>	<b>D</b>	<b>H</b>	<b>W</b>	<b>D</b>	<b>H</b>	<b>W</b>	<b>H</b>				
		78	29	28.5	70.5	19	17	70.5	12				
 <b>High Back Three Seat Sofa</b> COM Yardage: 12.25 Freight Class: 250 Product Weight (lbs.): 140 Cubic Feet Per Carton: 62.25	<b>GC3363HB</b>  Removable seat cushion. Active weight 300 lbs./seat	<b>\$4207</b>	<b>\$4629</b>	<b>\$5216</b>	<b>\$5751</b>	<b>\$6514</b>	<b>\$6800</b>	<b>\$7461</b>	<b>\$8713</b>	<b>\$9343</b>	<b>\$10506</b>	<b>\$12124</b>	<b>\$14118</b>
		<b>OVERALL DIMENSIONS</b>			<b>SEAT DIMENSIONS</b>			<b>BACK DIMENSIONS</b>					
		<b>W</b>	<b>D</b>	<b>H</b>	<b>W</b>	<b>D</b>	<b>H</b>	<b>W</b>	<b>H</b>				
		78	29	36	70.5	19	17	70.5	19.5				
		Frame finish upcharges: Chrome (CHM), no upcharge. Brushed Chrome (BCH), add \$224.											

## GC VITROLA



**model GC8271LB**  
Low Back Lounge Chair



**model GC8271HB**  
High Back Lounge Chair

### Two Textile Application



### EXAMPLE OAKVILLE ORDER CODE:

GC8271HB	-WA50	-WA50	NC	-
Model #	Back/arms textile	Seat textile	Armcap type	Armcap finish

-WOD	-BKM	-NBS	-NSS	-NB
Leg type	Leg finish	Back seams	Seat seams	Moisture barrier

### STANDARD FEATURES

- Classic soft seating upholstery design with swooping arms.
- Available in two back heights.
- Features a cleanout at back of seat cushion.
- Arms are standard fully upholstered. Arm caps are available in Urethane or Solid Surface. See upcharges.
- Durable, steel seat structure.
- The seat underside is covered with non-porous material for ease of cleaning.
- The seat cushion is mechanically removable for replacement.
- Back spring structure provides comfort and durability.
- For added comfort, seats are standard with high density Ultracell foam.
- Tapered legs are standard in maple wood or optional Urethane, see upcharge.
- Models are standard with White non-marking nylon glides. See Glide Type for additional glide options.
- Sealed seams are available on chair backs and arms and/or seats (see model upcharges).
- A moisture barrier may be added to seat cushions only (see model upcharges). Not available with sealed seams.
- GC Vitrola is covered under Global Healthcare 12 year, 24/7 warranty when upholstered with minimum 100,000 DR textile. For healthcare textiles, visit the website at [globalfurnituregroup.com](http://globalfurnituregroup.com).
- Can be upholstered in standard Global textiles if healthcare compliance is not required. Global's Limited Lifetime warranty applies.
- The series is available with contrasting fabrics. Specify arms, back and front rail separate from seat cushion (see model image).
- For pricing, start with the base price and add both back/arms graded textile upcharge and the seat graded textile upcharge.
- For alternate textile applications, contact Global specials. The Blended Textile matrix does not apply to this series.
- Shipped fully assembled
- GC Vitrola standard seating has 350 lb. capacity per seat; 600 lbs. for bariatric chairs.





### SUGGESTED APPLICATIONS

- Lobbies
- Lounge/Waiting
- Patient rooms
- Resident rooms





### OPTIONAL FEATURES

Add option codes in the following order:

- **Model number**  
Specify model number.
- **Back and arm textile**  
Specify textile code. See model grade upcharges.
- **Seat textile**  
Specify textile code. See model grade upcharges.
- **Armcap type**  
(NC) No armcap  
(SSU) Urethane armcap. Add \$171.  
(CO) Solid surface armcap. See color grade upcharge.
- **Armcap finish (urethane)**  
(BLK) Black (J52) Mocha  
(KAL) Kalua (SHW) Shadow  
(LAB) Latte (TOA) Toast
- **Armcap finish (solid surface)**  
Grade 1 - Add \$417:  
(SWH) Designer White  
Grade 2 - Add \$440:  
(SBT) Beige Tempest  
(SBX) Black Onyx Mirage  
(SMG) Milk Glass Spectra  
(SFW) Frosty White Mirage  
(SHS) Hot Stone  
(SNM) Northern Melange
- **Leg type**  
(WOD) Wood. No upcharge.  
(SSU) Urethane. Add \$205.
- **Leg finish (wood)**  
(AAM) Absolute (MWM) Medium Walnut  
(BKM) Black (NLW) Natural Walnut  
(ACM) Cherry (ASM) Night  
(EOM) English Oak (NBM) Noce Biondo  
(ECM) Espresso Cafe (NGM) Noce Grigio  
(TFM) Fruitwood (NEM) Noce Leggero  
(HGM) Grey (NMM) Noce Medio  
(AHM) Honey (SBM) Sandy Beach  
(JOM) Jet Onyx (SKM) Shaker Cherry  
(TMM) Mahogany (TWM) Walnut  
(AVM) Maple (WTM) WC Cream  
(WHM) White (WCM) Winter Cherry
- **Leg finish (urethane)**  
(BLK) Black (J52) Mocha  
(KAL) Kalua (SHW) Shadow  
(LAB) Latte (TOA) Toast
- **Fastener type**  
(RS) Standard fasteners.  
(TP) Tamperproof fasteners. Add \$94.
- **Glide type**  
(NM) Non-marking glide. Standard.  
(SG) Steel cushion glide. Add \$36.  
(RG) Rubber, non-slip glide. Add \$36.  
(FG) Felt glide. Add \$36.
- **Back and arm seams** (Contact Customer Care for approved textiles.)  
(NS) No sealed seams.  
(SBS) Sealed back and arm seams. See model upcharge.
- **Seat seams** (Contact Customer Care for approved textiles.)  
(NS) No sealed seams.  
(SSS) Sealed seat seams. See model upcharge.
- **Moisture Barrier** (seat only, not available with sealed seams)  
(NB) No moisture barrier. No upcharge.  
(MB) Moisture barrier. See model upcharge.

DESCRIPTION	MODEL#	STANDARD TEXTILE GRADES											
		1/COM	2	3	4	5	6	7	8	9	10	11	12
 <p><b>Lounge Chair</b> COM Yardage: Back/Arms: 4.5; Seat: 1.25 Freight Class: 250 Product Weight (lbs.): 74.5 Cubic Feet Per Carton: 20.25</p>	<b>GC8271LB</b>	Base Price: <b>\$2210</b>											
	Back/Arm upcharge:	+0	+\$152	+\$272	+\$447	+\$694	+\$798	+\$1012	+\$1349	+\$1601	+\$1876	+\$2450	+\$3054
	Seat upcharge:	+0	+\$43	+\$76	+\$125	+\$194	+\$222	+\$282	+\$375	+\$446	+\$522	+\$681	+\$849
		<b>OVERALL DIMENSIONS</b>			<b>SEAT DIMENSIONS</b>			<b>BACK DIMENSIONS</b>					
		<b>W</b>	<b>D</b>	<b>H</b>	<b>W</b>	<b>D</b>	<b>H</b>	<b>W</b>	<b>H</b>				
	Active weight 350 lbs.	28.25	32.25	34.25	21.5	19.25	18.5	22.5	15.75				
							<b>RTA 00</b>	1 per carton					
 <p><b>High Back Lounge Chair</b> COM Yardage: Back/Arms: 5; Seat: 1.25 Freight Class: 250 Product Weight (lbs.): 83.5 Cubic Feet Per Carton: 28.25</p>	<b>GC8271HB</b>	Base Price: <b>\$2332</b>											
	Back/Arm upcharge:	+0	+\$169	+\$301	+\$496	+\$771	+\$887	+\$1124	+\$1499	+\$1778	+\$2084	+\$2722	+\$3392
	Seat upcharge:	+0	+\$43	+\$76	+\$125	+\$194	+\$222	+\$282	+\$375	+\$446	+\$522	+\$681	+\$849
		<b>OVERALL DIMENSIONS</b>			<b>SEAT DIMENSIONS</b>			<b>BACK DIMENSIONS</b>					
		<b>W</b>	<b>D</b>	<b>H</b>	<b>W</b>	<b>D</b>	<b>H</b>	<b>W</b>	<b>H</b>				
	Active weight 350 lbs.	28.25	33.75	42	21.5	19.25	18.5	22.5	23.5				
							<b>RTA 00</b>	1 per carton					
 <p><b>Bariatric Lounge Chair</b> COM Yardage: Back/Arms: 5; Seat: 1.25 Freight Class: 250 Product Weight (lbs.): 79 Cubic Feet Per Carton: 30</p>	<b>GC8271BLB</b>	Base Price: <b>\$3053</b>											
	Back/Arm upcharge:	+0	+\$169	+\$301	+\$496	+\$771	+\$887	+\$1124	+\$1499	+\$1778	+\$2084	+\$2722	+\$3392
	Seat upcharge:	+0	+\$43	+\$76	+\$125	+\$194	+\$222	+\$282	+\$375	+\$446	+\$522	+\$681	+\$849
		<b>OVERALL DIMENSIONS</b>			<b>SEAT DIMENSIONS</b>			<b>BACK DIMENSIONS</b>					
		<b>W</b>	<b>D</b>	<b>H</b>	<b>W</b>	<b>D</b>	<b>H</b>	<b>W</b>	<b>H</b>				
	Active weight 600 lbs.	39	32.25	34.25	32	19.25	18.5	33	15.75				
							<b>RTA 00</b>	1 per carton					
 <p><b>High Back Bariatric Lounge Chair</b> COM Yardage: Back/Arms: 5.75; Seat: 1.25 Freight Class: 250 Product Weight (lbs.): 88.5 Cubic Feet Per Carton: 36.5</p>	<b>GC8271BHB</b>	Base Price: <b>\$3187</b>											
	Back/Arm upcharge:	+0	+\$195	+\$347	+\$571	+\$887	+\$1020	+\$1293	+\$1723	+\$2045	+\$2397	+\$3131	+\$3902
	Seat upcharge:	+0	+\$43	+\$76	+\$125	+\$194	+\$222	+\$282	+\$375	+\$446	+\$522	+\$681	+\$849
		<b>OVERALL DIMENSIONS</b>			<b>SEAT DIMENSIONS</b>			<b>BACK DIMENSIONS</b>					
		<b>W</b>	<b>D</b>	<b>H</b>	<b>W</b>	<b>D</b>	<b>H</b>	<b>W</b>	<b>H</b>				
	Active weight 600 lbs.	39	33.75	42	32	19.25	18.5	33	23.5				
							<b>RTA 00</b>	1 per carton					
 <p><b>Two Seat Sofa</b> COM Yardage: Back/Arms: 5; Seat: 1.5 Freight Class: 250 Product Weight (lbs.): 100 Cubic Feet Per Carton: 39.75</p>	<b>GC8272LB</b>	Base Price: <b>\$3321</b>											
	Back/Arm upcharge:	+0	+\$169	+\$301	+\$496	+\$771	+\$887	+\$1124	+\$1499	+\$1778	+\$2084	+\$2722	+\$3392
	Seat upcharge:	+0	+\$51	+\$91	+\$149	+\$232	+\$266	+\$338	+\$450	+\$534	+\$626	+\$817	+\$1019
		<b>OVERALL DIMENSIONS</b>			<b>SEAT DIMENSIONS</b>			<b>BACK DIMENSIONS</b>					
		<b>W</b>	<b>D</b>	<b>H</b>	<b>W</b>	<b>D</b>	<b>H</b>	<b>W</b>	<b>H</b>				
	Active weight 350 lbs./seat	50.5	32.25	34.25	43.5	19.25	18.5	43.5	15.75				
							<b>RTA 00</b>	1 per carton					

# SEATING

DESCRIPTION	MODEL#	STANDARD TEXTILE GRADES												
		1/COM	2	3	4	5	6	7	8	9	10	11	12	
 <p><b>High Back Two Seat Sofa</b> COM Yardage: Back/Arms: 6; Seat: 1.5 Freight Class: 250 Product Weight (lbs.): 116.5 Cubic Feet Per Carton: 48.25</p>	<b>GC8272HB</b>	Base Price:	<b>\$3506</b>											
	Back/Arm upcharge:	+0	+\$203	+\$361	+\$596	+\$925	+\$1064	+\$1349	+\$1798	+\$2134	+\$2501	+\$3267	+\$4071	
	Seat upcharge:	+0	+\$51	+\$91	+\$149	+\$232	+\$266	+\$338	+\$450	+\$534	+\$626	+\$817	+\$1019	
	<b>OVERALL DIMENSIONS</b>	<b>SEAT DIMENSIONS</b>			<b>BACK DIMENSIONS</b>									
	W	D	H	W	D	H	W	H						
Active weight 350 lbs./seat	50.5	33.75	42	43.5	19.25	18.5	43.5	23.5						
Moisture barrier (MB), add \$225 Sealed seams (SBS), add \$215 Sealed seat seams (SSS), add \$45	<b>RTA 00</b>	1 per carton												
 <p><b>Three Seat Sofa</b> COM Yardage: Back/Arms: 6.25; Seat: 2 Freight Class: 250 Product Weight (lbs.): 133 Cubic Feet Per Carton: 56.75</p>	<b>GC8273LB</b>	Base Price:	<b>\$4435</b>											
	Back/Arm upcharge:	+0	+\$169	+\$301	+\$496	+\$771	+\$887	+\$1124	+\$1499	+\$1778	+\$2084	+\$2722	+\$3392	
	Seat upcharge:	+0	+\$51	+\$91	+\$149	+\$232	+\$266	+\$338	+\$450	+\$534	+\$626	+\$817	+\$1019	
	<b>OVERALL DIMENSIONS</b>	<b>SEAT DIMENSIONS</b>			<b>BACK DIMENSIONS</b>									
	W	D	H	W	D	H	W	H						
Active weight 350 lbs./seat	71.5	32.25	34.25	65	19.25	18.5	65	15.75						
Moisture barrier (MB), add \$337 Sealed seams (SBS), add \$218 Sealed seat seams (SSS), add \$69	<b>RTA 00</b>	1 per carton												
 <p><b>High Back Three Seat Sofa</b> COM Yardage: Back/Arms: 7.25; Seat: 2 Freight Class: 250 Product Weight (lbs.): 153.5 Cubic Feet Per Carton: 68.75</p>	<b>GC8273HB</b>	Base Price:	<b>\$4704</b>											
	Back/Arm upcharge:	+0	+\$245	+\$437	+\$720	+\$1118	+\$1285	+\$1630	+\$2173	+\$2579	+\$3022	+\$3947	+\$4919	
	Seat upcharge:	+0	+\$68	+\$121	+\$199	+\$309	+\$355	+\$450	+\$600	+\$712	+\$834	+\$1089	+\$1357	
	<b>OVERALL DIMENSIONS</b>	<b>SEAT DIMENSIONS</b>			<b>BACK DIMENSIONS</b>									
	W	D	H	W	D	H	W	H						
Active weight 350 lbs./seat	71.5	33.75	42	65	19.25	18.5	65	23.5						
Moisture barrier (MB), add \$337 Sealed seams (SBS), add \$246 Sealed seat seams (SSS), add \$69	<b>RTA 00</b>	1 per carton												
 <p><b>Bench</b> COM Yardage: 1.5 Freight Class: 250 Product Weight (lbs.): 30.5 Cubic Feet Per Carton: 8</p>	<b>GC8275</b>	List Price:	<b>\$992</b>	<b>\$1043</b>	<b>\$1083</b>	<b>\$1141</b>	<b>\$1224</b>	<b>\$1258</b>	<b>\$1330</b>	<b>\$1442</b>	<b>\$1526</b>	<b>\$1618</b>	<b>\$1809</b>	<b>\$2011</b>
	<b>OVERALL DIMENSIONS</b>	<b>SEAT DIMENSIONS</b>			<b>BACK DIMENSIONS</b>									
	W	D	H	W	D	H	W	H						
	Active weight 350 lbs.	24	24	18	0	0	18							
	Moisture barrier (MB), add \$113 Sealed seat seams (SSS), add \$23	<b>RTA 00</b>	1 per carton											
 <p><b>Bariatric Width Bench</b> COM Yardage: 2 Freight Class: 150 Product Weight (lbs.): 39 Cubic Feet Per Carton: 8</p>	<b>GC8275B</b>	List Price:	<b>\$1179</b>	<b>\$1247</b>	<b>\$1300</b>	<b>\$1378</b>	<b>\$1488</b>	<b>\$1534</b>	<b>\$1629</b>	<b>\$1779</b>	<b>\$1891</b>	<b>\$2013</b>	<b>\$2268</b>	<b>\$2536</b>
	<b>OVERALL DIMENSIONS</b>	<b>SEAT DIMENSIONS</b>			<b>BACK DIMENSIONS</b>									
	W	D	H	W	D	H	W	H						
	Active weight 350 lbs.	34	24	18	0	0	18							
	Moisture barrier (MB), add \$169 Sealed seat seams (SSS), add \$23	<b>RTA 00</b>	1 per carton											

JANNA



model GC7609

STANDARD FEATURES



- Very often tight spaces create a challenge when additional seating is required for guests. Janna's unique folding frame is the perfect solution for temporary seating, especially where space is at a premium.
- Molded wood veneer frame.
- Concealed folding mechanism uses metal-to-metal construction details with lock tight fasteners.
- For added comfort, seats are standard with high density foam.
- Non-marking nylon glides are standard.
- For healthcare textiles, visit the website at [globalfurnituregroup.com](http://globalfurnituregroup.com).
- Can be upholstered in standard Global textiles if Healthcare compliance is not required
- Shipped fully assembled.

OPTIONAL FEATURES

- **Wood frame finish.** Please specify.
  - (AAM) Absolute
  - (BKM) Black
  - (ACM) Cherry
  - (EOM) English Oak
  - (ECM) Espresso Cafe
  - (TFM) Fruitwood
  - (HGM) Grey
  - (AHM) Honey
  - (JOM) Jet Onyx
  - (TMM) Mahogany
  - (AVM) Maple
  - (WHM) White
  - (MWM) Medium Walnut
  - (NLW) Natural Walnut
  - (ASM) Night
  - (NBM) Noce Biondo
  - (NGM) Noce Grigio
  - (NEM) Noce Leggero
  - (NMM) Noce Medio
  - (SBM) Sandy Beach
  - (SKM) Shaker Cherry
  - (TWM) Walnut
  - (WTM) WC Cream
  - (WCM) Winter Cherry
- Optional cushion glide is available - **Add \$18** list upcharge.
- Optional wall bracket (model GC7607) allows chairs to be conveniently stored while not in use. (Underside of chair seat is predrilled to accept wall bracket.)
- For moisture barrier (seat only), **Add \$137** list upcharge.

SUGGESTED APPLICATIONS

- Dining/Cafeteria
- Guest seating
- Lounge/Waiting
- Office/Meeting
- Patient rooms
- Resident rooms
- Treatment/Exam

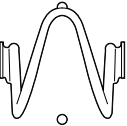
DESCRIPTION	MODEL#	STANDARD FABRIC GRADES											
		COM	2	3	4	5	6	7	8	9	10	11	12
 <p><b>Folding Chair</b> Upholstered Back COM Yardage: 1 Freight Class: 150 Product Weight (lbs.): 19 Cubic Feet Per Carton: 3.5</p>	GC7609	\$739	\$772	\$805	\$850	\$910	\$936	\$990	\$1092	\$1143	\$1240	\$1371	\$1534
		OVERALL DIMENSIONS			SEAT DIMENSIONS			BACK DIMENSIONS					
		W	D	H	W	D	H	W	H				
		19	22.5	32.5	16	17.5	18.5	16	13.5				
 <p><b>Folding Chair</b> Wood Back COM Yardage: 1 Freight Class: 150 Product Weight (lbs.): 19 Cubic Feet Per Carton: 3.5</p>	GC7611	\$839	\$873	\$908	\$951	\$1013	\$1038	\$1092	\$1194	\$1246	\$1341	\$1472	\$1636
		OVERALL DIMENSIONS			SEAT DIMENSIONS			BACK DIMENSIONS					
		W	D	H	W	D	H	W	H				
		19	22.5	32.5	16	17.5	18.5	16	13.5				
 <p><b>Wall Mounting Bracket.</b> For Janna series only. Allows for hanging a chair on the wall or behind a door. COM Yardage: -- Freight Class: 70 Product Weight (lbs.): 1.5 Cubic Feet Per Carton: 0.1</p>	GC7607	List Price											
		\$69											
		OVERALL DIMENSIONS			SEAT DIMENSIONS			BACK DIMENSIONS					
	W	D	H	W	D	H	W	H					
		3	1.5	3.5									

**If ordering after the original purchase, specify GC7607.**  
**For complete set at time of order - specify WLHK. Add \$70.**  
 Two (one pair) per package in chrome finish. One bracket connects to the underside of the chair seat. The second bracket connects to the wall or door.

## NOURISH



**GC3681FXH**  
High back patient chair, flex back, fixed height



**GC3683F**  
High back patient chair, Schukra depth adjustable headrest, flex back



**GC3685**  
Bariatric high back patient chair



Patient transfer arm



Adjustable lumbar support



Rear foot rail, casters and height adjustable legs



Back push bar

### Two Textile Application



**model GC3681**  
High back patient chair

### STANDARD FEATURES







- Nourish is an innovative, state-of-the-art patient chair, developed in consultation with leading healthcare professionals. It embraces the body, cultivating comfort during periods of recovery.
  - All chair models have left and right, easy to operate transfer arms. Transfer arms allow users to easily transfer in and out of the chair and provide easy access to assist the user.
  - Models with fixed legs have a standard seat height of 18.5".
  - Models with adjustable legs have adjustment pins to conveniently adapt seat heights from 17" to 20". 20" seat height models (-20) have a seat height adjustment range of 20" to 23". Front and back legs can be adjusted separately allowing modification of seat pitch, forward or rearward.
  - Models with rear casters allow for 'tip and move' so the chair can be conveniently relocated while unoccupied. Optional Back Push Bar (**PBR**) and Rear Foot Rail (**RFR**) are each available to aid staff in relocating the chair (not for patient transport, see upcharges. Back Push Bar and Rear Foot Rail match frame finish. Note, Rear Foot Rail is not available on model GC3698 (4 manual locking caster model).
  - Select models have a unique Schukra depth adjustable headrest solution integrated inside the back near the user's neck area. The depth is controlled by a handle on the lower outer back cushion.
  - Schukra depth adjustable lumbar support for additional comfort is standard on select models.
  - Standard models have minimal flex to the back. Flex back models (F model suffix) have additional back movement.
  - Seats have a seamless, waterfall front edge, with highly durable, molded high density foam and a coated liner (**CL**) underside. For added protection, specify (**SU**) sealed underside to include a sealed staple strip.
  - Metal frame is available in several paint finishes.
  - The arm structure finish is Tungsten with a urethane armcap, available in five finishes.
  - Sealed seams may be specified with approved coated textiles (vinyl, silicone, polyurethane) to mitigate liquid penetration at seams. Specify (**SWZ**) for sealed back seams with waterproof zipper and (**SE**) for sealed seat seams. Upcharges apply. Note: minor puckering is common with the addition of sealed seams due to material buildup at corners.
  - A moisture barrier is available on seats and ottoman cushion to create an impervious barrier between the upholstery cover and cushion, specify (**MB**). See upcharges. Moisture barrier is not recommended with coated textiles (vinyl, silicone, polyurethane, etc.) and **may not be specified** when sealed seat seams are selected.
  - Available to specify with two textiles, one for the seat cushion and one for the back (see model image). For pricing, start with the base price and add both back graded textile upcharge and seat graded textile upcharge.
  - The Blended Textile matrix does not apply to this series.
  - Nourish is covered under Global's 12-yr, 24/7 warranty. Textiles with a minimum of 100,000 double rubs must be specified.
  - For healthcare textile and finish options, visit the website at [globalfurnituregroup.com](http://globalfurnituregroup.com).
  - Can be upholstered in standard Global textiles if high traffic, heavy duty or multi-shift compliance is not required. Global's limited lifetime warranty applies.
- Shipped fully assembled.
  - Active weight capacity for standard single seat is 350 lbs. and 750 lbs for bariatric seating.
- Add option codes in the following order:
- Model number**  
Specify model number
  - Back Textile**  
Specify textile code.
  - Seat Textile**  
Specify textile code.
  - Rear Foot Rail (RFR)** (matches frame finish) (**NFR**) No foot rail. (**RFR**) Rear foot rail. Add \$85. For bariatric model, add \$170.
  - Frame Finish**  
(**TBL**) Black  
(**TIV**) Cloud  
(**TDW**) Designer White  
(**TFO**) Fog  
(**TFR**) Frost  
(**TKA**) Kalua  
(**TLA**) Latte  
(**TMO**) Mocha  
(**TNE**) Nevada  
(**TSN**) Sand  
(**TSH**) Shadow  
(**TOA**) Toast  
(**TTU**) Tungsten
  - Back Push Bar** (matches frame finish) (**NBR**) No push bar (**PBR**) Back push bar. Add \$159.
  - Armcap Finish**  
(**BLK**) Black  
(**KAL**) Kalua  
(**LAB**) Latte  
(**J52**) Mocha  
(**SHW**) Shadow  
(**TOA**) Toast
  - Sealed Seat Underside**  
(**CL**) Coated liner. No upcharge.  
(**SU**) Sealed seat underside. Add \$53. For bariatric, add \$64. For ottoman, add \$35.
  - Back Seams**  
(**NS**) No sealed seams  
(**SWZ**) Sealed back seams with waterproof zipper. Add \$64. For bariatric, add \$103.
  - Seat Seams**  
(**NS**) No sealed seat seams  
(**SE**) Sealed seat seams. Add \$25. For bariatric, add \$28. For ottoman, add \$21.
  - Moisture Barrier** (seat only, not available with sealed seams) (**NB**) No moisture barrier. (**MB**) Moisture barrier. Add \$137. For bariatric, add \$195.



### SUGGESTED APPLICATIONS



- Bariatric seating (model GC3685)
- Lounge/Waiting
- Patient rooms
- Resident rooms
- Treatment/Exam rooms



### EXAMPLE NOURISH ORDER CODE:





GC3681	FU75	FU75	NFR	TMO	NBR	J52	ST	NS	NS	NB
Model #	Back textile	Seat textile	Foot Rail	Frame finish	Push Bar	Armcap Finish	Seat Underside	Back Seams	Seat Seams	Moisture Barrier

DESCRIPTION		MODEL# / FEATURES		STANDARD TEXTILE GRADES													
				COM	2	3	4	5	6	7	8	9	10	11	12		
				<b>GC3681</b> Base Price:	<b>\$3007</b>												
				Adjustable height													
				<b>GC3681-20</b> Base Price:	<b>\$3075</b>												
				Adjustable height, 20"													
				<b>GC3681XH</b> Base Price:	<b>\$2673</b>												
				Fixed 18.5" height													
				Back upcharge:	<b>\$-42</b>	<b>+0</b>	<b>+\$34</b>	<b>+\$83</b>	<b>+\$151</b>	<b>+\$180</b>	<b>+\$240</b>	<b>+\$333</b>	<b>+\$404</b>	<b>+\$479</b>	<b>+\$639</b>	<b>+\$807</b>	
				Seat upcharge:	<b>\$-25</b>	<b>+0</b>	<b>+\$21</b>	<b>+\$50</b>	<b>+\$91</b>	<b>+\$108</b>	<b>+\$144</b>	<b>+\$200</b>	<b>+\$242</b>	<b>+\$289</b>	<b>+\$383</b>	<b>+\$485</b>	
				<b>OVERALL DIMENSIONS</b>				<b>SEAT DIMENSIONS</b>			<b>BACK DIMENSIONS</b>						
				<b>W</b>	<b>D</b>	<b>H</b>	<b>W</b>	<b>D</b>	<b>H</b>	<b>W</b>	<b>H</b>						
				28.5	29	45.5	20	18.5	17-20	20	29						
				28.5	29	48.5	20	18.5	20-23	20	29						
<b>High Back Patient Chair</b>				Active weight 350 lbs.													
COM Yardage: Back: 1.25; Seat: .75																	
Freight Class: 300																	
Product Weight (lbs.): 56																	
Cubic Feet Per Carton: 33.5																	
				<b>GC3681F</b> Base Price:	<b>\$3381</b>												
				Adjustable height													
				<b>GC3681-20F</b> Base Price:	<b>\$3449</b>												
				Adjustable height, 20"													
				<b>GC3681FXH</b> Base Price:	<b>\$3040</b>												
				Fixed 18.5" height													
				Back upcharge:	<b>\$-42</b>	<b>+0</b>	<b>+\$34</b>	<b>+\$83</b>	<b>+\$151</b>	<b>+\$180</b>	<b>+\$240</b>	<b>+\$333</b>	<b>+\$404</b>	<b>+\$479</b>	<b>+\$639</b>	<b>+\$807</b>	
				Seat upcharge:	<b>\$-25</b>	<b>+0</b>	<b>+\$21</b>	<b>+\$50</b>	<b>+\$91</b>	<b>+\$108</b>	<b>+\$144</b>	<b>+\$200</b>	<b>+\$242</b>	<b>+\$289</b>	<b>+\$383</b>	<b>+\$485</b>	
				<b>OVERALL DIMENSIONS</b>				<b>SEAT DIMENSIONS</b>			<b>BACK DIMENSIONS</b>						
				<b>W</b>	<b>D</b>	<b>H</b>	<b>W</b>	<b>D</b>	<b>H</b>	<b>W</b>	<b>H</b>						
				28.5	29	45.5	20	18.5	17-20	20	29						
				28.5	29	48.5	20	18.5	20-23	20	29						
<b>High Back Patient Chair, Flex Back</b>				Active weight 350 lbs.													
COM Yardage: Back: 1.25; Seat: .75																	
Freight Class: 300																	
Product Weight (lbs.): 56																	
Cubic Feet Per Carton: 33.5																	
				<b>GC3682</b> Base Price:	<b>\$3181</b>												
				Adjustable height													
				<b>GC3682-20</b> Base Price:	<b>\$3250</b>												
				Adjustable height, 20"													
				<b>GC3682XH</b> Base Price:	<b>\$3033</b>												
				Fixed 18.5" height													
				Back upcharge:	<b>\$-42</b>	<b>+0</b>	<b>+\$34</b>	<b>+\$83</b>	<b>+\$151</b>	<b>+\$180</b>	<b>+\$240</b>	<b>+\$333</b>	<b>+\$404</b>	<b>+\$479</b>	<b>+\$639</b>	<b>+\$807</b>	
				Seat upcharge:	<b>\$-25</b>	<b>+0</b>	<b>+\$21</b>	<b>+\$50</b>	<b>+\$91</b>	<b>+\$108</b>	<b>+\$144</b>	<b>+\$200</b>	<b>+\$242</b>	<b>+\$289</b>	<b>+\$383</b>	<b>+\$485</b>	
				<b>OVERALL DIMENSIONS</b>				<b>SEAT DIMENSIONS</b>			<b>BACK DIMENSIONS</b>						
				<b>W</b>	<b>D</b>	<b>H</b>	<b>W</b>	<b>D</b>	<b>H</b>	<b>W</b>	<b>H</b>						
				28.5	29	45.5	20	18.5	17-20	20	29						
				28.5	29	48.5	20	18.5	20-23	20	29						
<b>High Back Patient Chair, Schukra depth adjustable lumbar</b>				Active weight 350 lbs.													
COM Yardage: Back: 1.25; Seat: .75																	
Freight Class: 300																	
Product Weight (lbs.): 56																	
Cubic Feet Per Carton: 33.5																	

DESCRIPTION	MODEL#/FEATURES	STANDARD FABRIC GRADES											
		COM	2	3	4	5	6	7	8	9	10	11	12
 Adjustable height	<b>GC3682F</b> Base Price: Adjustable height <b>\$3557</b>												
	<b>GC3682-20F</b> Base Price: Adjustable height, 20" <b>\$3625</b>												
 Fixed 18.5" height	<b>GC3682FXH</b> Base Price: Fixed 18.5" height <b>\$3408</b>												
	Back upcharge: <b>\$-42</b> <b>+0</b> <b>+\$34</b> <b>+\$83</b> <b>+\$151</b> <b>+\$180</b> <b>+\$240</b> <b>+\$333</b> <b>+\$404</b> <b>+\$479</b> <b>+\$639</b> <b>+\$807</b>												
	Seat upcharge: <b>\$-25</b> <b>+0</b> <b>+\$21</b> <b>+\$50</b> <b>+\$91</b> <b>+\$108</b> <b>+\$144</b> <b>+\$200</b> <b>+\$242</b> <b>+\$289</b> <b>+\$383</b> <b>+\$485</b>												
	<b>OVERALL DIMENSIONS</b>	<b>SEAT DIMENSIONS</b>			<b>BACK DIMENSIONS</b>								
	<b>W</b> <b>D</b> <b>H</b>	<b>W</b>	<b>D</b>	<b>H</b>	<b>W</b>	<b>D</b>	<b>H</b>	<b>W</b>	<b>H</b>				
	28.5    29    45.5 28.5    29    48.5	20	18.5	17-20	20	18.5	20-23	20	29				
<b>High Back Patient Chair with Schukra depth adjustable lumbar, Flex Back</b> COM Yardage: Back: 1.25; Seat: .75    Active weight 350 lbs. Freight Class: 300 Product Weight (lbs.): 56 Cubic Feet Per Carton: 33.5													

DESCRIPTION	MODEL#/FEATURES	STANDARD FABRIC GRADES											
		COM	2	3	4	5	6	7	8	9	10	11	12
 Adjustable height	<b>GC3683</b> Base Price: Adjustable height <b>\$3356</b>												
	<b>GC3683-20</b> Base Price: Adjustable height, 20" <b>\$3424</b>												
 Fixed 18.5" height	<b>GC3683XH</b> Base Price: Fixed 18.5" height <b>\$3215</b>												
	Back upcharge: <b>\$-42</b> <b>+0</b> <b>+\$34</b> <b>+\$83</b> <b>+\$151</b> <b>+\$180</b> <b>+\$240</b> <b>+\$333</b> <b>+\$404</b> <b>+\$479</b> <b>+\$639</b> <b>+\$807</b>												
	Seat upcharge: <b>\$-25</b> <b>+0</b> <b>+\$21</b> <b>+\$50</b> <b>+\$91</b> <b>+\$108</b> <b>+\$144</b> <b>+\$200</b> <b>+\$242</b> <b>+\$289</b> <b>+\$383</b> <b>+\$485</b>												
	<b>OVERALL DIMENSIONS</b>	<b>SEAT DIMENSIONS</b>			<b>BACK DIMENSIONS</b>								
	<b>W</b> <b>D</b> <b>H</b>	<b>W</b>	<b>D</b>	<b>H</b>	<b>W</b>	<b>D</b>	<b>H</b>	<b>W</b>	<b>H</b>				
	28.5    29    45.5 28.5    29    48.5	20	18.5	17-20	20	18.5	20-23	20	29				
<b>High Back Patient Chair, Schukra depth adjustable headrest</b> COM Yardage: Back: 1.25; Seat: .75    Active weight 350 lbs. Freight Class: 300 Product Weight (lbs.): 56 Cubic Feet Per Carton: 33.5													

DESCRIPTION	MODEL#/FEATURES	STANDARD FABRIC GRADES											
		COM	2	3	4	5	6	7	8	9	10	11	12
 Adjustable height	<b>GC3683F</b> Base Price: Adjustable height <b>\$3731</b>												
	<b>GC3683-20F</b> Base Price: Adjustable height, 20" <b>\$3798</b>												
 Fixed 18.5" height	<b>GC3683FXH</b> Base Price: Fixed 18.5" height <b>\$3590</b>												
	Back upcharge: <b>\$-42</b> <b>+0</b> <b>+\$34</b> <b>+\$83</b> <b>+\$151</b> <b>+\$180</b> <b>+\$240</b> <b>+\$333</b> <b>+\$404</b> <b>+\$479</b> <b>+\$639</b> <b>+\$807</b>												
	Seat upcharge: <b>\$-25</b> <b>+0</b> <b>+\$21</b> <b>+\$50</b> <b>+\$91</b> <b>+\$108</b> <b>+\$144</b> <b>+\$200</b> <b>+\$242</b> <b>+\$289</b> <b>+\$383</b> <b>+\$485</b>												
	<b>OVERALL DIMENSIONS</b>	<b>SEAT DIMENSIONS</b>			<b>BACK DIMENSIONS</b>								
	<b>W</b> <b>D</b> <b>H</b>	<b>W</b>	<b>D</b>	<b>H</b>	<b>W</b>	<b>D</b>	<b>H</b>	<b>W</b>	<b>H</b>				
	28.5    29    45.5 28.5    29    48.5	20	18.5	17-20	20	18.5	20-23	20	29				
<b>High Back Patient Chair, Schukra depth adjustable headrest, Flex Back</b> COM Yardage: Back: 1.25; Seat: .75    Active weight 350 lbs. Freight Class: 300 Product Weight (lbs.): 56 Cubic Feet Per Carton: 33.5													

DESCRIPTION	MODEL# / FEATURES	STANDARD TEXTILE GRADES											
		COM	2	3	4	5	6	7	8	9	10	11	12
 <p>Adjustable height      Fixed 18.5" height</p>	<b>GC3684</b> Base Price: <b>\$3706</b> Adjustable height												
	<b>GC3684-20</b> Base Price: <b>\$3770</b> Adjustable height, 20"												
	<b>GC3684XH</b> Base Price: <b>\$3564</b> Fixed 18.5" height												
	Back upcharge:	<b>-\$42</b>	<b>+0</b>	<b>+\$34</b>	<b>+\$83</b>	<b>+\$151</b>	<b>+\$180</b>	<b>+\$240</b>	<b>+\$333</b>	<b>+\$404</b>	<b>+\$479</b>	<b>+\$639</b>	<b>+\$807</b>
	Seat upcharge:	<b>-\$25</b>	<b>+0</b>	<b>+\$21</b>	<b>+\$50</b>	<b>+\$91</b>	<b>+\$108</b>	<b>+\$144</b>	<b>+\$200</b>	<b>+\$242</b>	<b>+\$289</b>	<b>+\$383</b>	<b>+\$485</b>
	<b>OVERALL DIMENSIONS</b>	<b>SEAT DIMENSIONS</b>			<b>BACK DIMENSIONS</b>								
	<b>W D H</b>	<b>W</b>	<b>D</b>	<b>H</b>	<b>W</b>	<b>D</b>	<b>H</b>	<b>W</b>	<b>H</b>				
	28.5 29 45.5	20	18.5	17-20	20	18.5	20-23	20	29				
	28.5 29 48.5	20	18.5	20-23	20	18.5	20-23	20	29				
<b>High Back Patient Chair, Schukra depth adjustable lumbar &amp; headrest</b> COM Yardage: Back: 1.25; Seat: .75 Freight Class: 300 Product Weight (lbs.): 56 Cubic Feet Per Carton: 33.5	Active weight 350 lbs.												
 <p>Adjustable height      Fixed 18.5" height</p>	<b>GC3684F</b> Base Price: <b>\$4081</b> Adjustable height												
	<b>GC3684-20F</b> Base Price: <b>\$4147</b> Adjustable height, 20"												
	<b>GC3684FXH</b> Base Price: <b>\$3941</b> Fixed 18.5" height												
	Back upcharge:	<b>-\$42</b>	<b>+0</b>	<b>+\$34</b>	<b>+\$83</b>	<b>+\$151</b>	<b>+\$180</b>	<b>+\$240</b>	<b>+\$333</b>	<b>+\$404</b>	<b>+\$479</b>	<b>+\$639</b>	<b>+\$807</b>
	Seat upcharge:	<b>-\$25</b>	<b>+0</b>	<b>+\$21</b>	<b>+\$50</b>	<b>+\$91</b>	<b>+\$108</b>	<b>+\$144</b>	<b>+\$200</b>	<b>+\$242</b>	<b>+\$289</b>	<b>+\$383</b>	<b>+\$485</b>
	<b>OVERALL DIMENSIONS</b>	<b>SEAT DIMENSIONS</b>			<b>BACK DIMENSIONS</b>								
	<b>W D H</b>	<b>W</b>	<b>D</b>	<b>H</b>	<b>W</b>	<b>D</b>	<b>H</b>	<b>W</b>	<b>H</b>				
	28.5 29 45.5	20	18.5	17-20	20	18.5	20-23	20	29				
	28.5 29 48.5	20	18.5	20-23	20	18.5	20-23	20	29				
<b>High Back Patient Chair with Schukra depth adjustable lumbar &amp; headrest, Flex Back</b> COM Yardage: Back: 1.25; Seat: .75 Freight Class: 300 Product Weight (lbs.): 56 Cubic Feet Per Carton: 33.5	Active weight 350 lbs.												
	<b>GC3685</b> Base Price: <b>\$3724</b>												
	Back upcharge:	<b>-\$75</b>	<b>+0</b>	<b>+\$61</b>	<b>+\$148</b>	<b>+\$272</b>	<b>+\$323</b>	<b>+\$431</b>	<b>+\$599</b>	<b>+\$725</b>	<b>+\$862</b>	<b>+\$1149</b>	<b>+\$1451</b>
	Seat upcharge:	<b>-\$33</b>	<b>+0</b>	<b>+\$27</b>	<b>+\$66</b>	<b>+\$121</b>	<b>+\$144</b>	<b>+\$191</b>	<b>+\$266</b>	<b>+\$322</b>	<b>+\$383</b>	<b>+\$511</b>	<b>+\$645</b>
	<b>OVERALL DIMENSIONS</b>	<b>SEAT DIMENSIONS</b>			<b>BACK DIMENSIONS</b>								
	<b>W D H</b>	<b>W</b>	<b>D</b>	<b>H</b>	<b>W</b>	<b>D</b>	<b>H</b>	<b>W</b>	<b>H</b>				
	40 29 47	35	18.5	18.5	35	29							
<b>Bariatric High Back Patient Chair</b> COM Yardage: Back: 2.25; Seat: 1 Freight Class: 300 Product Weight (lbs.): 70 Cubic Feet Per Carton: 45	Active weight 750 lbs. Fixed height legs.												
	<b>GC3686</b>	<b>\$908</b>	<b>\$941</b>	<b>\$968</b>	<b>\$1007</b>	<b>\$1062</b>	<b>\$1085</b>	<b>\$1132</b>	<b>\$1207</b>	<b>\$1263</b>	<b>\$1324</b>	<b>\$1452</b>	<b>\$1586</b>
	<b>OVERALL DIMENSIONS</b> <b>W D H</b>	<b>W</b>	<b>D</b>	<b>H</b>	<b>W</b>	<b>D</b>	<b>H</b>	<b>W</b>	<b>H</b>				
	17 17.5 12.5												
<b>Ottoman</b> COM Yardage: 1 Freight Class: 150 Product Weight (lbs.): 18 Cubic Feet Per Carton: 3.6	Active weight 350 lbs.												
	Can be stored beneath any Nourish chair when not in use.												

OAKVILLE



model GC36500  
High back lounge chair

STANDARD FEATURES

- Oakville offers a modern take on wingback seating for social settings, resident rooms and lounge areas.
- The seating in this series is available to specify with two textiles, one for the seat cushion and one for the back, arms and front rail (see model image).
- For pricing, start with the base price and add both back/arms graded textile upcharge and the seat graded textile upcharge.
- A clean through design is provided around the seat cushion for easy housekeeping.
- Legs are available in wood or urethane (see upcharge).
- Choose from standard non-marking glides, steel cushioned glides, rubber non-slip glides, or felt glides (upcharges apply).
- The seat underside is sealed with a non-porous material to support housekeeping and infection control protocols.
- For added comfort, seat cushions are standard with high density Ultracell foam.
- The Global warranty (for healthcare and 24/7 environments) applies for all Oakville models when performance textiles are selected. Visit the website at [globalfurnituregroup.com/healthcare](http://globalfurnituregroup.com/healthcare).
- Global's standard lifetime warranty applies when approved standard Global textiles are selected.
- For alternate textile applications, contact Global specials. The Blended Textile matrix does not apply to this series.
- Shipped fully assembled.

SUGGESTED APPLICATIONS

- Guest seating
- Lobbies
- Lounge/Waiting
- Patient rooms
- Resident rooms

Add option codes in the following order:

- **Model number**  
**GC36500** High back lounge chair
- **Back/Arm Textile**  
Specify textile code. See model grade upcharges.
- **Seat Textile**  
Specify textile code. See model grade upcharges.
- **Leg Finish (Wood)**
  - (AAM) Absolute
  - (BKM) Black
  - (ACM) Cherry
  - (EOM) English Oak
  - (ECM) Espresso Cafe
  - (TFM) Fruitwood
  - (HGM) Grey
  - (AHM) Honey
  - (JOM) Jet Onyx
  - (TMM) Mahogany
  - (AVM) Maple
  - (WHM) White
  - (MWM) Medium Walnut
  - (NLW) Natural Walnut
  - (ASM) Night
  - (NBM) Noce Biondo
  - (NGM) Noce Grigio
  - (NEM) Noce Leggero
  - (NMM) Noce Medio
  - (SBM) Sandy Beach
  - (SKM) Shaker Cherry
  - (TWM) Walnut
  - (WTM) WC Cream
  - (WCM) Winter Cherry
- **Leg Finish (Urethane)** Add \$91.
  - (BLK) Black
  - (LAB) Latte
  - (SHW) Shadow
  - (KAL) Kalua
  - (J52) Mocha
  - (TOA) Toast
- **Glides**
  - (NM) Non-marking glide. Standard.
  - (RG) Rubber, non-slip glide. Add \$36.
  - (SG) Steel cushion glide. Add \$36.
  - (FG) Felt glide. Add \$36.
- **Sealed Back Seams** (Contact Customer Care for approved textiles)
  - (NBS) No sealed back seams
  - (SBS) Sealed back seams. Add \$176.
- **Sealed Seat Seams** (Contact Customer Care for approved textiles)
  - (NSS) No sealed seat seams
  - (SSS) Sealed seat seams. Add \$34.
- **Moisture Barrier** (Not available with Sealed Seams)
  - (NB) No moisture barrier.
  - (MB) Moisture barrier (seat only). Add \$117.

EXAMPLE OAKVILLE ORDER CODE:

GC36500	CE90	CE90	AVM	NM	NBS	NSS	NB
Model #	Back/Arm textile	Seat textile	Leg finish	Glide	Sealed Back Seams	Sealed Seat Seams	Moisture Barrier

DESCRIPTION	MODEL#/ FEATURES	STANDARD TEXTILE GRADES												
		1/COM	2	3	4	5	6	7	8	9	10	11	12	
 <b>High Back Lounge Chair</b> COM Yardage: Back/Arm: 4.25; Seat: 1.25 Freight Class: 250 Product Weight (lbs.): 75.5 Cubic Feet Per Carton: 19.25	GC36500	Base Price:	\$2956											
		Back/Arm upcharge:	+0	+\$144	+\$257	+\$422	+\$656	+\$754	+\$956	+\$1274	+\$1512	+\$1772	+\$2314	+\$2884
		Seat upcharge:	+0	+\$43	+\$76	+\$125	+\$194	+\$222	+\$282	+\$375	+\$446	+\$522	+\$681	+\$849
		<b>OVERALL DIMENSIONS</b>												
		<b>SEAT DIMENSIONS</b>												
		<b>BACK DIMENSIONS</b>												
		W	D	H	W	D	H	W	H					
		30	30	41.25	20.5	21	18.5	21.75	23.75					
		Active weight 350 lbs.												
		Replaceable seat cushion.												



GC3616W Dining armchair with open arms

Primacare™ set a benchmark for healthcare seating. All the features, all the looks and quite possibly the most extensive offering of its kind for both acute care and long-term care applications.

Under the skin of every Primacare chair is a heart of solid steel waiting to meet the rigorous demands of any environment.

The Primacare series includes more than 40 models that extend from patient rooms to waiting areas, dining rooms to treatment centers including bariatric hip chair solutions.

**FEATURES**



Open arms



Closed arms - fully upholstered side panels on select models



Arm grip extension - to assist getting in and out of the chair safely

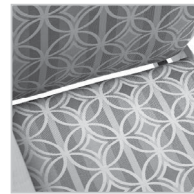

Separate seat and back - provides clean out for housekeeping staff



Fold down headrest - to provide access for caregiver assistance



Removable upholstery - for ease of cleaning and replacement

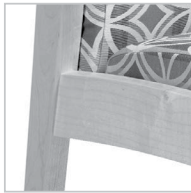

Solid wood frame - in hardwood for long life and a warm look



Metal-to-metal connector - provides unparalleled strength and durability



Metal mesh pan - superior comfort and hygiene for patient incontinence



Wall safe legs - offer first contact to protect walls and chair backs on most models

**AVAILABLE TEXTILES AND FINISHES**

Please see the Healthcare Textile and Finishes section at [www.globalfurnituregroup.com](http://www.globalfurnituregroup.com) for all details including wood finishes.

**SUGGESTED APPLICATIONS**

- Bariatric seating (some models)
- Dining/Cafeteria
- Guest seating
- Lobbies
- Lounge/Waiting
- Patient rooms
- Resident rooms
- Treatment/Exam rooms

**DINING** - available with wood or metal frames



**GUEST** - available with wood or metal frames



**PATIENT** - available with wood or metal frames



**HIP CHAIRS** - available with wood or metal frames



**LOUNGE** - available with wood or metal legs



\*Upholstered closed arm panels are available on wood frame models (dining, lounge and low back guest armchairs) and all metal frame models.

**FULLY UPHOLSTERED LOUNGE** - available with wood or urethane legs



**WINGBACK ARMCHAIR** - available with wood or urethane armcaps and legs



PRIMACARE DINING



model GC3616CA (HT)



model GC3616W (Wood)

STANDARD FEATURES

- Primacare is a family of products offering the most significant return on investment approach in the industry since every component can be repaired or replaced on site.
- **High traffic (HT) models:** Metal frame with die cast zinc connectors and metal-to-metal fasteners. Available in the following finishes: Black (TBL), Cloud (TIV), Designer White (TDW), Fog (TFO), Frost (TFR), Kalua (TKA), Latte (TLA), Mocha (TMO), Nevada (TNE), Sand (TSN), Shadow (TSH), Toast (TOA) and Tungsten (TTU).
- **Wood models:** Solid hardwood frame with die cast zinc connectors and metal-to-metal fastening. Available in the following finishes: Absolute (AAM), Cherry (ACM), English Oak (EOM), Espresso Cafe (ECM), Fruitwood (TFM), Gray (HGM), Honey (AHM), Jet Onyx (JOM), Mahogany (TMM), Maple (AVM), Medium Walnut (MWM), Natural Walnut (NLW), Night (ASM), Noce Biondo (NBM), Noce Grigio (NGM), Noce Leggero (NEM), Noce Medio (NMM), Sandy Beach (SBM), Shaker Cherry (SKM), Walnut (TWM), White (WHM), WC Cream (WTM) and Winter Cherry (WCM).
- Armcaps are securely fastened with metal-to-metal connectors which allow for field replacement if required.
- Easy grip forward extending armcap on models with arms.
- Wood armcaps are standard.
- Replaceable seat covers and replaceable and/or removable seat cushions are standard.
- Waterfall cleanout between the seat and back cushions.
- Models are standard with metal mesh seat deck. For behavioral health applications, the metal mesh seat deck can be covered with a solid moisture resistant surface, held in place with tamperproof fasteners. Contact your Global sales rep for a special quotation.
- All seat frames feature a wall saver design to prevent back contact with wall.
- **GC3616WCA** and **GC3616CA** have upholstered panel arm inserts closing the arm. (Closed arm panels are designed to be replaceable. Request a special quote to have them secured with tamperproof fasteners.)
- Model **GC3616RCEZ** has a lift-assist mechanism and rear casters. The caregiver steps on the lift-assist foot lever to assist in turning the chair and moving the occupant to and from a table.
- For healthcare textile options, visit the website at [www.globalfurnituregroup.com](http://www.globalfurnituregroup.com).
- Can be upholstered in standard Global textiles if healthcare compliance is not required.

- It is recommended that High Traffic (HT) models be specified in textiles that meet or exceed 100,000 double rubs for added abrasion performance.
- Shipped fully assembled.
- **HIGH TRAFFIC (HT) MODELS ARE LISTED FIRST, FOLLOWED BY WOOD MODELS.**

OPTIONAL FEATURES

- Urethane armcaps are available. See far left column "High traffic (HT) models" for finishes. Please specify. *Refer to individual models for availability and pricing.*
- For moisture barrier on seat, specify (MB). Add \$137 per seat.
- To add sealed seams to your product contact Customer Care. Upcharges vary.
- For Primacare tables, see page 52.

SUGGESTED APPLICATIONS

- Dining/Cafeteria
- Guest seating
- Lobbies
- Lounge/Waiting
- Patient rooms
- Resident rooms

DESCRIPTION MODEL# / FEATURES STANDARD TEXTILE GRADES



**Dining Chair, Open Arms (HT)**  
COM Yardage: 1.5  
Freight Class: 150  
Product Weight (lbs.): 58  
Cubic Feet Per Carton: 13.25

MODEL# / FEATURES	COM	2	3	4	5	6	7	8	9	10	11	12
<b>GC3616</b> Metal	\$1746	\$1797	\$1845	\$1909	\$2004	\$2037	\$2119	\$2273	\$2350	\$2495	\$2692	\$2937
<b>OVERALL DIMENSIONS</b>			<b>SEAT DIMENSIONS</b>			<b>BACK DIMENSIONS</b>						
	<b>W</b>	<b>D</b>	<b>H</b>	<b>W</b>	<b>D</b>	<b>H</b>	<b>W</b>	<b>H</b>				
	23	23	34.5	19	17.5	18	19	16.5				

Active weight 500 lbs.  
Urethane armcap option - **Add \$110 list upcharge**



**Dining Chair, Closed Arms (HT)**  
COM Yardage: 2  
Freight Class: 150  
Product Weight (lbs.): 66  
Cubic Feet Per Carton: 13.25

MODEL# / FEATURES	COM	2	3	4	5	6	7	8	9	10	11	12
<b>GC3616CA</b> Metal	\$2005	\$2074	\$2134	\$2224	\$2347	\$2394	\$2502	\$2710	\$2812	\$3003	\$3266	\$3593
<b>OVERALL DIMENSIONS</b>			<b>SEAT DIMENSIONS</b>			<b>BACK DIMENSIONS</b>						
	<b>W</b>	<b>D</b>	<b>H</b>	<b>W</b>	<b>D</b>	<b>H</b>	<b>W</b>	<b>H</b>				
	23	23	34.5	19	17.5	18	19	16.5				

Active weight 500 lbs.  
Urethane armcap option - **Add \$110 list upcharge**

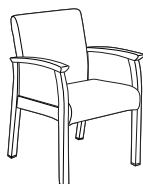

**Dining Chair, Closed Arms, Laminate Panels (HT)**  
COM Yardage: 1.5  
Freight Class: 150  
Product Weight (lbs.): 66  
Cubic Feet Per Carton: 13.25

MODEL# / FEATURES	COM	2	3	4	5	6	7	8	9	10	11	12
<b>GC3616CAL</b> Metal	\$2361	\$2407	\$2450	\$2509	\$2594	\$2632	\$2708	\$2827	\$2920	\$3026	\$3240	\$3466
<b>OVERALL DIMENSIONS</b>			<b>SEAT DIMENSIONS</b>			<b>BACK DIMENSIONS</b>						
	<b>W</b>	<b>D</b>	<b>H</b>	<b>W</b>	<b>D</b>	<b>H</b>	<b>W</b>	<b>H</b>				
	23	23	34.5	19	17.5	18	19	16.5				

Active weight 500 lbs.  
Urethane armcap option - **Add \$110 list upcharge**

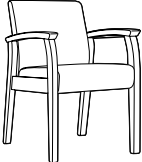
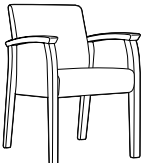
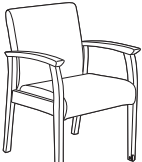
DESCRIPTION	MODEL#	STANDARD FABRIC GRADES											
		COM	2	3	4	5	6	7	8	9	10	11	12
 <p>Allows caregiver to gently move a seated person to and from a table.</p> <p><b>Dining Chair, Open Arms, Rear Swivel Casters &amp; Lift Mech (HT)</b>                      COM Yardage: 1.5                      Freight Class: 150                      Product Weight (lbs.): 59                      Cubic Feet Per Carton: 13.25</p>	GC3616RCEZ Metal	\$2789	\$2789	\$2836	\$2901	\$2995	\$3038	\$3121	\$3255	\$3356	\$3470	\$3706	\$3956
		OVERALL DIMENSIONS			SEAT DIMENSIONS			BACK DIMENSIONS					
		W	D	H	W	D	H	W	H				
		23	23	34.5	19	17.5	18	19	16.5				
		Active weight 500 lbs. Urethane armcap option - Add \$110 list upcharge											
 <p><b>Dining Chair, Open Arms (Wood)</b>                      COM Yardage: 1.5                      Freight Class: 250                      Product Weight (lbs.): 50                      Cubic Feet Per Carton: 13.25</p>	GC3616W Wood	\$1440	\$1489	\$1537	\$1602	\$1697	\$1730	\$1814	\$1966	\$2042	\$2187	\$2386	\$2629
		OVERALL DIMENSIONS			SEAT DIMENSIONS			BACK DIMENSIONS					
		W	D	H	W	D	H	W	H				
		23	23	34.5	19	17.5	18	19	16.5				
		Active weight 350 lbs. Urethane armcap option - Add \$110 list upcharge											
 <p><b>Dining Chair, Closed Arms (Wood)</b>                      COM Yardage: 2                      Freight Class: 150                      Product Weight (lbs.): 58                      Cubic Feet Per Carton: 13.25</p>	GC3616WCA Wood	\$1650	\$1717	\$1779	\$1868	\$1992	\$2041	\$2149	\$2354	\$2455	\$2647	\$2911	\$3237
		OVERALL DIMENSIONS			SEAT DIMENSIONS			BACK DIMENSIONS					
		W	D	H	W	D	H	W	H				
		23	23	34.5	19	17.5	18	19	16.5				
		Active weight 350 lbs. Urethane armcap option - Add \$110 list upcharge											
 <p><b>Dining Chair, Open Arms, Front Casters (Wood)</b>                      COM Yardage: 1.5                      Freight Class: 250                      Product Weight (lbs.): 50                      Cubic Feet Per Carton: 13.25</p>	GC3616WFC Wood	\$1607	\$1656	\$1704	\$1768	\$1864	\$1897	\$1980	\$2133	\$2209	\$2354	\$2552	\$2798
		OVERALL DIMENSIONS			SEAT DIMENSIONS			BACK DIMENSIONS					
		W	D	H	W	D	H	W	H				
		23	23	34.5	19	17.5	18	19	16.5				
		Active weight 350 lbs. Urethane armcap option - Add \$110 list upcharge											

PRIMACARE GUEST



model GC3620CA (HT)



model GC3625W (Wood)

STANDARD FEATURES

- Primacare is a family of products offering the most significant return on investment approach in the industry since every component can be repaired or replaced on site.
- **High traffic (HT) models:** Metal frame with die cast zinc connectors and metal-to-metal fasteners. Available in the following finishes: Black (TBL), Cloud (TIV), Designer White (TDW), Fog (TFO), Frost (TFR), Kalua (TKA), Latte (TLA), Mocha (TMO), Nevada (TNE), Sand (TSN), Shadow (TSH), Toast (TOA) and Tungsten (TTU).
- **Wood models:** Solid hardwood frame with die cast zinc connectors and metal-to-metal fastening. Available in the following finishes: Absolute (AAM), Cherry (ACM), English Oak (EOM), Espresso Cafe (ECM), Fruitwood (TFM), Gray (HGM), Honey (AHM), Jet Onyx (JOM), Mahogany (TMM), Maple (AVM), Medium Walnut (MWM), Natural Walnut (NLW), Night (ASM), Noce Biondo (NBM), Noce Grigio (NGM), Noce Leggero (NEM), Noce Medio (NMM), Sandy Beach (SBM), Shaker Cherry (SKM), Walnut (TWM), White (WHM), WC Cream (WTM) and Winter Cherry (WCM).
- Armcaps are securely fastened with metal-to-metal connectors which allow for field replacement if required.
- Easy grip forward extending armcap on models with arms.
- Wood armcaps are standard.

- Replaceable seat covers and replaceable and/or removable seat cushions are standard.
- Waterfall cleanout between the seat and back cushions.
- Models are standard with metal mesh seat deck. For behavioral health applications, the metal mesh seat deck can be covered with a solid moisture resistant surface, held in place with tamperproof fasteners.
- All seat frames feature a wall saver design to prevent back contact with wall.
- Models ending in **CA / ARC**, have upholstered panel arm inserts closing the arm. (Closed arm panels are designed to be replaceable.
- For healthcare textile options, visit the website at [www.globalfurnituregroup.com](http://www.globalfurnituregroup.com).
- Can be upholstered in standard Global textiles if healthcare compliance is not required.
- It is recommended that High Traffic (HT) models be specified in textiles that meet or exceed 100,000 double rubs for added abrasion performance.
- Shipped fully assembled.
- **High traffic (HT) models are listed first, followed by wood models.**

OPTIONAL FEATURES

- Urethane armcaps are available. Please specify. Refer to individual models for availability and pricing.
- For moisture barrier (seat only), add \$137 list upcharge per seat. For Bariatric Models: GC3637, GC3637W, GC3637CA and GC3637WCA - **Add \$209** list upcharge per seat.
- To add sealed seams to your product contact Customer Care. Upcharges vary.
- For Primacare tables, see page 52.

SUGGESTED APPLICATIONS

- Bariatric seating
- Guest seating
- Lobbies
- Lounge/Waiting
- Patient rooms
- Resident rooms

DESCRIPTION

MODEL# / FEATURES

STANDARD TEXTILE GRADES

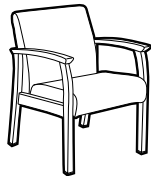

**LB Armchair, Open Arms (HT)**  
COM Yardage: 1.75  
Freight Class: 250  
Product Weight (lbs.): 62  
Cubic Feet Per Carton: 17.5

	COM	2	3	4	5	6	7	8	9	10	11	12
<b>GC3620</b> Metal	\$2083	\$2143	\$2198	\$2276	\$2383	\$2425	\$2521	\$2701	\$2790	\$2958	\$3188	\$3475
<b>GC3620F</b> Metal flex back	\$2605	\$2669	\$2722	\$2800	\$2908	\$2948	\$3044	\$3224	\$3314	\$3483	\$3714	\$3998
<b>OVERALL DIMENSIONS</b>			<b>SEAT DIMENSIONS</b>			<b>BACK DIMENSIONS</b>						
	<b>W</b>	<b>D</b>	<b>H</b>	<b>W</b>	<b>D</b>	<b>H</b>	<b>W</b>	<b>H</b>				
	25	27	33	20.5	17.5	18	20.5	15				

Active weight 500 lbs.  
Urethane armcap option - **Add \$110 list upcharge**

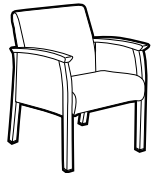

**LB Armchair, Closed Arms (HT)**  
COM Yardage: 2.75  
Freight Class: 150  
Product Weight (lbs.): 72  
Cubic Feet Per Carton: 17.5

	COM	2	3	4	5	6	7	8	9	10	11	12
<b>GC3620CA</b> Metal	\$2363	\$2460	\$2544	\$2666	\$2837	\$2900	\$3052	\$3333	\$3474	\$3736	\$4100	\$4547
<b>GC3620FCA</b> Metal flex back	\$2888	\$2985	\$3069	\$3189	\$3360	\$3425	\$3576	\$3858	\$3999	\$4261	\$4625	\$5073
<b>OVERALL DIMENSIONS</b>			<b>SEAT DIMENSIONS</b>			<b>BACK DIMENSIONS</b>						
	<b>W</b>	<b>D</b>	<b>H</b>	<b>W</b>	<b>D</b>	<b>H</b>	<b>W</b>	<b>H</b>				
	25	27	33	20.5	17.5	18	20.5	15				

Active weight 500 lbs.  
Urethane armcap option - **Add \$110 list upcharge**

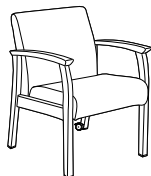

**LB Armchair, Open Arms, Rear Tip & Move Wheels (HT)**  
COM Yardage: 1.75  
Freight Class: 250  
Product Weight (lbs.): 62  
Cubic Feet Per Carton: 23

	COM	2	3	4	5	6	7	8	9	10	11	12
<b>GC3620RC</b> Metal	\$2243	\$2304	\$2359	\$2436	\$2545	\$2585	\$2682	\$2864	\$2952	\$3120	\$3350	\$3634
<b>OVERALL DIMENSIONS</b>			<b>SEAT DIMENSIONS</b>			<b>BACK DIMENSIONS</b>						
	<b>W</b>	<b>D</b>	<b>H</b>	<b>W</b>	<b>D</b>	<b>H</b>	<b>W</b>	<b>H</b>				
	25	29.5	33	20.5	17.5	18	20.5	15				

Active weight 500 lbs.  
Urethane armcap option - **Add \$110 list upcharge**

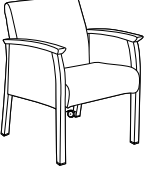
DESCRIPTION	MODEL#	STANDARD FABRIC GRADES											
		COM	2	3	4	5	6	7	8	9	10	11	12
 <p><b>GC3620CARC</b> Metal</p>		\$2530	\$2627	\$2711	\$2831	\$3001	\$3066	\$3218	\$3500	\$3640	\$3902	\$4265	\$4714
		OVERALL DIMENSIONS			SEAT DIMENSIONS			BACK DIMENSIONS					
		W	D	H	W	D	H	W	H				
		25	29.5	33	20.5	17.5	18	20.5	15				
<p><b>LB Armchair, Closed Arms, Rear Tip &amp; Move Wheels (HT)</b> COM Yardage: 2.75 Freight Class: 250 Product Weight (lbs.): 72 Cubic Feet Per Carton: 23</p>		<p>Active weight 500 lbs. Urethane armcap option - <b>Add \$110 list upcharge</b></p>											

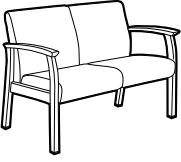
DESCRIPTION	MODEL#	STANDARD FABRIC GRADES											
		COM	2	3	4	5	6	7	8	9	10	11	12
 <p><b>GC3621</b> Metal</p>		\$3369	\$3486	\$3584	\$3726	\$3927	\$4007	\$4183	\$4514	\$4680	\$4992	\$5423	\$5950
		OVERALL DIMENSIONS			SEAT DIMENSIONS			BACK DIMENSIONS					
		W	D	H	W	D	H	W	H				
		45	27	33	40	17.5	18	40	15				
<p><b>LB Two Seat Chair, No Center Arm, Open Arms (HT)</b> COM Yardage: 3.25 Freight Class: 250 Product Weight (lbs.): 92 Cubic Feet Per Carton: 43</p>		<p>Active weight 500 lbs./seat Urethane armcap option - <b>Add \$110 list upcharge</b></p>											

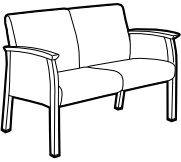

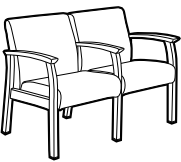
DESCRIPTION	MODEL#	STANDARD FABRIC GRADES											
		COM	2	3	4	5	6	7	8	9	10	11	12
 <p><b>GC3621CA</b> Metal</p>		\$3671	\$3802	\$3915	\$4081	\$4313	\$4401	\$4605	\$4993	\$5183	\$5540	\$6035	\$6650
		OVERALL DIMENSIONS			SEAT DIMENSIONS			BACK DIMENSIONS					
		W	D	H	W	D	H	W	H				
		45	27	33	40	17.5	18	40	15				
<p><b>LB Two Seat Chair, No Center Arm, Closed Arms (HT)</b> COM Yardage: 3.75 Freight Class: 250 Product Weight (lbs.): 100 Cubic Feet Per Carton: 43</p>		<p>Active weight 500 lbs./seat Urethane armcap option - <b>Add \$110 list upcharge</b></p>											

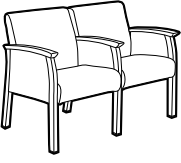
DESCRIPTION	MODEL#	STANDARD FABRIC GRADES											
		COM	2	3	4	5	6	7	8	9	10	11	12
 <p><b>GC3622</b> Metal</p>		\$3803	\$3921	\$4019	\$4161	\$4367	\$4440	\$4618	\$4949	\$5117	\$5426	\$5856	\$6385
		OVERALL DIMENSIONS			SEAT DIMENSIONS			BACK DIMENSIONS					
		W	D	H	W	D	H	W	H				
		46	27	33	20.5	17.5	18	20.5	15				
<p><b>LB Two Seat Chair, Full Center Arm, Open Arms (HT)</b> COM Yardage: 3.25 Freight Class: 250 Product Weight (lbs.): 98 Cubic Feet Per Carton: 43</p>		<p>Active weight 500 lbs./seat Urethane armcap option - <b>Add \$164 list upcharge</b></p>											

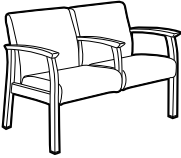
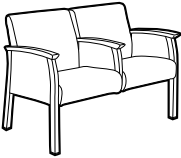
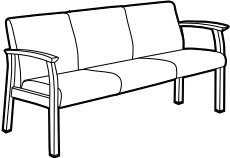
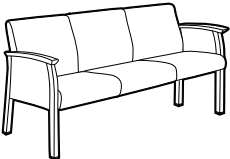
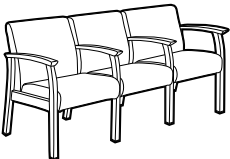

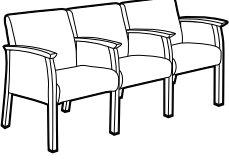
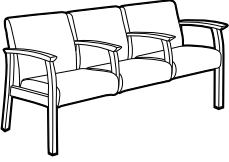
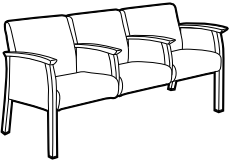
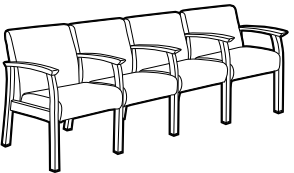
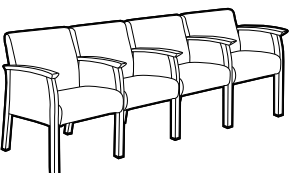
DESCRIPTION	MODEL#	STANDARD FABRIC GRADES											
		COM	2	3	4	5	6	7	8	9	10	11	12
 <p><b>GC3622CA</b> Metal</p>		\$4234	\$4396	\$4529	\$4729	\$5008	\$5114	\$5359	\$5820	\$6052	\$6480	\$7073	\$7808
		OVERALL DIMENSIONS			SEAT DIMENSIONS			BACK DIMENSIONS					
		W	D	H	W	D	H	W	H				
		46	27	33	20.5	17.5	18	20.5	15				
<p><b>LB Two Seat Chair, Full Center Arm, Closed Arms (HT)</b> COM Yardage: 4.5 Freight Class: 250 Product Weight (lbs.): 118 Cubic Feet Per Carton: 43</p>		<p>Active weight 500 lbs./seat Urethane armcap option - <b>Add \$164 list upcharge</b></p>											

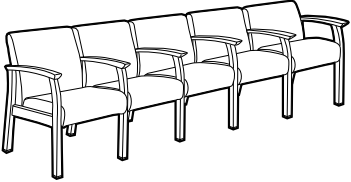
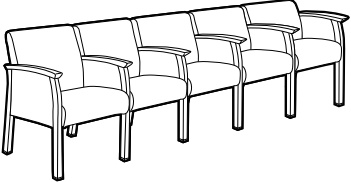
DESCRIPTION	MODEL#	STANDARD FABRIC GRADES											
		COM	2	3	4	5	6	7	8	9	10	11	12
 <p><b>LB Two Seat Chair, Half Center Arm, Open Arms (HT)</b>                      COM Yardage: 3.25                      Freight Class: 250                      Product Weight (lbs.): 94                      Cubic Feet Per Carton: 43</p>	<b>GC3623</b> Metal	\$3734	\$3849	\$3949	\$4089	\$4295	\$4371	\$4549	\$4879	\$5046	\$5356	\$5785	\$6319
		OVERALL DIMENSIONS			SEAT DIMENSIONS			BACK DIMENSIONS					
		W	D	H	W	D	H	W	H				
			46	27	33	20.5	17.5	18	20.5	15			
<p>Active weight 500 lbs./seat                      Urethane armcap option - <b>Add \$164 list upcharge</b></p>													
 <p><b>LB Two Seat Chair, Half Center Arm, Closed Arms (HT)</b>                      COM Yardage: 4.5                      Freight Class: 250                      Product Weight (lbs.): 106                      Cubic Feet Per Carton: 43</p>	<b>GC3623CA</b> Metal	\$4162	\$4324	\$4458	\$4657	\$4936	\$5042	\$5288	\$5748	\$5980	\$6408	\$7001	\$7741
		OVERALL DIMENSIONS			SEAT DIMENSIONS			BACK DIMENSIONS					
		W	D	H	W	D	H	W	H				
			46	27	33	20.5	17.5	18	20.5	15			
<p>Active weight 500 lbs./seat                      Urethane armcap option - <b>Add \$164 list upcharge</b></p>													
 <p><b>LB Three Seat Chair, No Center Arms, Open Arms (HT)</b>                      COM Yardage: 4.25                      Freight Class: 250                      Product Weight (lbs.): 137                      Cubic Feet Per Carton: 65.25</p>	<b>GC3624</b> Metal	\$4574	\$4711	\$4828	\$4995	\$5234	\$5348	\$5565	\$5908	\$6176	\$6472	\$7081	\$7730
		OVERALL DIMENSIONS			SEAT DIMENSIONS			BACK DIMENSIONS					
		W	D	H	W	D	H	W	H				
			65	27	33	60	17.5	18	60	15			
<p>Active weight 500 lbs./seat                      Urethane armcap option - <b>Add \$110 list upcharge</b></p>													
 <p><b>LB Three Seat Chair, No Center Arms, Closed Arms (HT)</b>                      COM Yardage: 5.25                      Freight Class: 250                      Product Weight (lbs.): 147                      Cubic Feet Per Carton: 65.25</p>	<b>GC3624CA</b> Metal	\$4840	\$5028	\$5187	\$5417	\$5741	\$5866	\$6152	\$6690	\$6960	\$7458	\$8154	\$9011
		OVERALL DIMENSIONS			SEAT DIMENSIONS			BACK DIMENSIONS					
		W	D	H	W	D	H	W	H				
			65	27	33	60	17.5	18	60	15			
<p>Active weight 500 lbs./seat                      Urethane armcap option - <b>Add \$110 list upcharge</b></p>													
 <p><b>LB Three Seat Chair, Full Center Arms, Open Arms (HT)</b>                      COM Yardage: 4.75                      Freight Class: 250                      Product Weight (lbs.): 162                      Cubic Feet Per Carton: 65.25</p>	<b>GC3625</b> Metal	\$5409	\$5580	\$5725	\$5931	\$6228	\$6340	\$6598	\$7085	\$7328	\$7780	\$8410	\$9183
		OVERALL DIMENSIONS			SEAT DIMENSIONS			BACK DIMENSIONS					
		W	D	H	W	D	H	W	H				
			69	27	33	20.5	17.5	18	20.5	15			
<p>Active weight 500 lbs./seat                      Urethane armcap option - <b>Add \$216 list upcharge</b></p>													

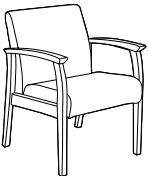
DESCRIPTION	MODEL#	STANDARD FABRIC GRADES											
		COM	2	3	4	5	6	7	8	9	10	11	12
 <p><b>LB Three Seat Chair, Full Center Arms, Closed Arms (HT)</b>                      COM Yardage: 6.25                      Freight Class: 250                      Product Weight (lbs.): 172                      Cubic Feet Per Carton: 65.25</p>	<b>GC3625CA</b> Metal	\$5985	\$6212	\$6400	\$6671	\$7062	\$7207	\$7548	\$8190	\$8511	\$9105	\$9929	\$10953
		<b>OVERALL DIMENSIONS</b> W D H			<b>SEAT DIMENSIONS</b> W D H			<b>BACK DIMENSIONS</b> W H					
		69	27	33	20.5	17.5	18	20.5	15				
		Active weight 500 lbs./seat Urethane armcap option - <b>Add \$216 list upcharge</b>											
 <p><b>LB Three Seat Chair, Half Center Arms, Open Arms (HT)</b>                      COM Yardage: 4.75                      Freight Class: 250                      Product Weight (lbs.): 147                      Cubic Feet Per Carton: 65.25</p>	<b>GC3626</b> Metal	\$5267	\$5437	\$5580	\$5790	\$6085	\$6196	\$6453	\$6942	\$7184	\$7637	\$8266	\$9040
		<b>OVERALL DIMENSIONS</b> W D H			<b>SEAT DIMENSIONS</b> W D H			<b>BACK DIMENSIONS</b> W H					
		69	27	33	20.5	17.5	18	20.5	15				
		Active weight 500 lbs./seat Urethane armcap option - <b>Add \$216 list upcharge</b>											
 <p><b>LB Three Seat Chair, Half Center Arms, Closed Arms (HT)</b>                      COM Yardage: 6.25                      Freight Class: 250                      Product Weight (lbs.): 157                      Cubic Feet Per Carton: 65.25</p>	<b>GC3626CA</b> Metal	\$5847	\$6070	\$6258	\$6536	\$6920	\$7067	\$7408	\$8048	\$8369	\$8964	\$9791	\$10813
		<b>OVERALL DIMENSIONS</b> W D H			<b>SEAT DIMENSIONS</b> W D H			<b>BACK DIMENSIONS</b> W H					
		69	27	33	20.5	17.5	18	20.5	15				
		Active weight 500 lbs./seat Urethane armcap option - <b>Add \$216 list upcharge</b>											
 <p><b>LB Four Seat Chair, Full Center Arms, Open Arms (HT)</b>                      COM Yardage: 6                      Freight Class: 150                      Product Weight (lbs.): 197                      Cubic Feet Per Carton: 43</p>	<b>GC3628</b> Metal	\$7814	\$8029	\$8210	\$8470	\$8846	\$8990	\$9313	\$9928	\$10234	\$10805	\$11602	\$12582
		<b>OVERALL DIMENSIONS</b> W D H			<b>SEAT DIMENSIONS</b> W D H			<b>BACK DIMENSIONS</b> W H					
		93	27	33	20.5	17.5	18	20.5	15				
		Active weight 500 lbs./seat Urethane armcap option - <b>Add \$268 list upcharge</b> • Shipped RTA (Ready to Assemble) in 2 cartons											
 <p><b>LB Four Seat Chair, Full Center Arms, Closed Arms (HT)</b>                      COM Yardage: 8                      Freight Class: 150                      Product Weight (lbs.): 207                      Cubic Feet Per Carton: 43</p>	<b>GC3628CA</b> Metal	\$8529	\$8818	\$9056	\$9409	\$9905	\$10095	\$10528	\$11348	\$11758	\$12520	\$13579	\$14886
		<b>OVERALL DIMENSIONS</b> W D H			<b>SEAT DIMENSIONS</b> W D H			<b>BACK DIMENSIONS</b> W H					
		93	27	33	20.5	17.5	18	20.5	15				
		Active weight 500 lbs./seat Urethane armcap option - <b>Add \$268 list upcharge</b> • Shipped RTA (Ready to Assemble) in 2 cartons											

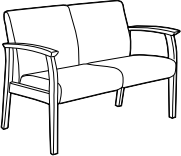
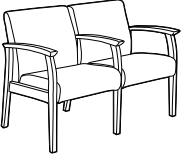
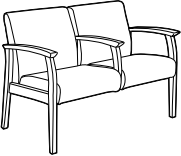
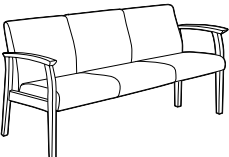
DESCRIPTION	MODEL#	STANDARD FABRIC GRADES											
		COM	2	3	4	5	6	7	8	9	10	11	12
 <p><b>LB Five Seat Chair, Full Center Arms, Open Arms (HT)</b>                      COM Yardage: 7.5                      Freight Class: 150                      Product Weight (lbs.): 249                      Cubic Feet Per Carton: 43</p>	<b>GC3630</b> Metal	\$8578	\$8850	\$9074	\$9403	\$9870	\$10046	\$10454	\$11221	\$11607	\$12323	\$13315	\$14539
		<b>OVERALL DIMENSIONS</b>			<b>SEAT DIMENSIONS</b>			<b>BACK DIMENSIONS</b>					
		<b>W</b>	<b>D</b>	<b>H</b>	<b>W</b>	<b>D</b>	<b>H</b>	<b>W</b>	<b>H</b>				
		115	27	33	20.5	17.5	18	20.5	15				
<p>Active weight 500 lbs./seat                      Urethane armcap option - <b>Add \$320 list upcharge</b></p> <p>• Shipped RTA (Ready to Assemble) in 2 cartons</p>													
 <p><b>LB Five Seat Chair, Full Center Arms, Closed Arms (HT)</b>                      COM Yardage: 10                      Freight Class: 125                      Product Weight (lbs.): 261                      Cubic Feet Per Carton: 43</p>	<b>GC3630CA</b> Metal	\$9437	\$9799	\$10098	\$10537	\$11158	\$11393	\$11938	\$12964	\$13474	\$14428	\$15751	\$17384
		<b>OVERALL DIMENSIONS</b>			<b>SEAT DIMENSIONS</b>			<b>BACK DIMENSIONS</b>					
		<b>W</b>	<b>D</b>	<b>H</b>	<b>W</b>	<b>D</b>	<b>H</b>	<b>W</b>	<b>H</b>				
		115	27	33	20.5	17.5	18	20.5	15				
<p>Active weight 500 lbs./seat                      Urethane armcap option - <b>Add \$320 list upcharge</b></p> <p>• Shipped RTA (Ready to Assemble) in 2 cartons</p>													
 <p><b>Bariatric LB Armchair, Open Arms (HT)</b>                      COM Yardage: 2.5                      Freight Class: 250                      Product Weight (lbs.): 78                      Cubic Feet Per Carton: 26.5</p>	<b>GC3637</b> Metal	\$2719	\$2809	\$2887	\$2996	\$3149	\$3208	\$3345	\$3602	\$3731	\$3969	\$4298	\$4708
		<b>OVERALL DIMENSIONS</b>			<b>SEAT DIMENSIONS</b>			<b>BACK DIMENSIONS</b>					
		<b>W</b>	<b>D</b>	<b>H</b>	<b>W</b>	<b>D</b>	<b>H</b>	<b>W</b>	<b>H</b>				
		35	27	33	30	17.5	18	30	15				
<p>Active weight 500 lbs.                      Urethane armcap option - <b>Add \$110 list upcharge</b></p>													
 <p><b>Bariatric LB Armchair, Closed Arms (HT)</b>                      COM Yardage: 3.5                      Freight Class: 250                      Product Weight (lbs.): 88                      Cubic Feet Per Carton: 26.5</p>	<b>GC3637CA</b> Metal	\$2997	\$3123	\$3229	\$3382	\$3600	\$3683	\$3874	\$4232	\$4410	\$4744	\$5207	\$5779
		<b>OVERALL DIMENSIONS</b>			<b>SEAT DIMENSIONS</b>			<b>BACK DIMENSIONS</b>					
		<b>W</b>	<b>D</b>	<b>H</b>	<b>W</b>	<b>D</b>	<b>H</b>	<b>W</b>	<b>H</b>				
		35	27	33	30	17.5	18	30	15				
<p>Active weight 500 lbs.                      Urethane armcap option - <b>Add \$110 list upcharge</b></p>													
 <p><b>LB Single Seat Armchair, Open Arms (Wood)</b>                      COM Yardage: 1.75                      Freight Class: 250                      Product Weight (lbs.): 50                      Cubic Feet Per Carton: 17.5</p>	<b>GC3620W</b> Wood	\$1716	\$1776	\$1831	\$1909	\$2016	\$2058	\$2156	\$2337	\$2423	\$2591	\$2821	\$3108
		<b>GC3620WF</b> Wood flex back	\$2239	\$2300	\$2353	\$2431	\$2540	\$2580	\$2675	\$2855	\$2947	\$3114	\$3345
	<b>OVERALL DIMENSIONS</b>			<b>SEAT DIMENSIONS</b>			<b>BACK DIMENSIONS</b>						
	<b>W</b>	<b>D</b>	<b>H</b>	<b>W</b>	<b>D</b>	<b>H</b>	<b>W</b>	<b>H</b>					
25	27	33	20.5	17.5	18	20.5	15						
<p>Active weight 350 lbs.                      Urethane armcap option - <b>Add \$110 list upcharge</b></p>													

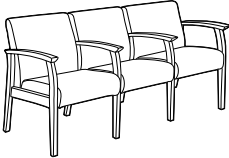
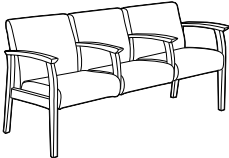
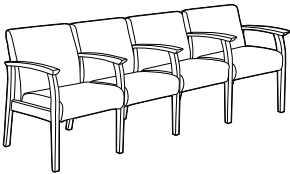
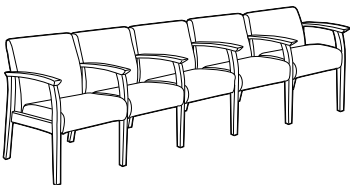
DESCRIPTION	MODEL#	STANDARD FABRIC GRADES											
		COM	2	3	4	5	6	7	8	9	10	11	12
 <p><b>LB Single Seat Armchair, Closed Arms (Wood)</b>                      COM Yardage: 2.75                      Freight Class: 250                      Product Weight (lbs.): 60                      Cubic Feet Per Carton: 17.5</p>	<b>GC3620WCA</b> Wood	\$1943	\$2039	\$2124	\$2245	\$2416	\$2479	\$2630	\$2914	\$3054	\$3315	\$3679	\$4125
		OVERALL DIMENSIONS			SEAT DIMENSIONS			BACK DIMENSIONS					
		W	D	H	W	D	H	W	H				
			25	27	33	20.5	17.5	18	20.5	15			
		Active weight 350 lbs. Urethane armcap option - <b>Add \$110 list upcharge</b>											
 <p><b>LB Two Seat Chair, No Center Arm, Open Arms (Wood)</b>                      COM Yardage: 3.25                      Freight Class: 300                      Product Weight (lbs.): 80                      Cubic Feet Per Carton: 43</p>	<b>GC3621W</b> Wood	\$2772	\$2888	\$2987	\$3128	\$3334	\$3409	\$3586	\$3916	\$4083	\$4395	\$4823	\$5354
		OVERALL DIMENSIONS			SEAT DIMENSIONS			BACK DIMENSIONS					
		W	D	H	W	D	H	W	H				
			45	27	33	40	17.5	18	40	15			
		Active weight 350 lbs./seat Urethane armcap option - <b>Add \$110 list upcharge</b>											
 <p><b>LB Two Seat Chair, Full Center Arm, Open Arms (Wood)</b>                      COM Yardage: 3.25                      Freight Class: 250                      Product Weight (lbs.): 86                      Cubic Feet Per Carton: 43</p>	<b>GC3622W</b> Wood	\$3130	\$3248	\$3346	\$3488	\$3694	\$3767	\$3945	\$4276	\$4443	\$4753	\$5184	\$5714
		OVERALL DIMENSIONS			SEAT DIMENSIONS			BACK DIMENSIONS					
		W	D	H	W	D	H	W	H				
			46	27	33	20.5	17.5	18	20.5	15			
		Active weight 350 lbs./seat Urethane armcap option - <b>Add \$164 list upcharge</b>											
 <p><b>LB Two Seat Chair, Half Center Arm, Open Arms (Wood)</b>                      COM Yardage: 3.25                      Freight Class: 300                      Product Weight (lbs.): 82                      Cubic Feet Per Carton: 43</p>	<b>GC3623W</b> Wood	\$3073	\$3189	\$3287	\$3430	\$3630	\$3710	\$3887	\$4219	\$4385	\$4695	\$5126	\$5656
		OVERALL DIMENSIONS			SEAT DIMENSIONS			BACK DIMENSIONS					
		W	D	H	W	D	H	W	H				
			46	27	33	20.5	17.5	18	20.5	15			
		Active weight 350 lbs./seat Urethane armcap option - <b>Add \$164 list upcharge</b>											
 <p><b>LB Three Seat Chair, No Center Arm, Open Arms (Wood)</b>                      COM Yardage: 4.25                      Freight Class: 300                      Product Weight (lbs.): 125                      Cubic Feet Per Carton: 65.25</p>	<b>GC3624W</b> Wood	\$3750	\$3902	\$4029	\$4215	\$4480	\$4580	\$4812	\$5249	\$5465	\$5870	\$6432	\$7129
		OVERALL DIMENSIONS			SEAT DIMENSIONS			BACK DIMENSIONS					
		W	D	H	W	D	H	W	H				
			65	27	33	60	17.5	18	60	15			
		Active weight 350 lbs./seat Urethane armcap option - <b>Add \$110 list upcharge</b>											

DESCRIPTION	MODEL#	STANDARD FABRIC GRADES											
		COM	2	3	4	5	6	7	8	9	10	11	12
 <p><b>GC3625W</b> Wood</p> <p><b>LB Three Seat Chair, Full Center Arms, Open Arms (Wood)</b> COM Yardage: 4.75 Freight Class: 250 Product Weight (lbs.): 150 Cubic Feet Per Carton: 65.25</p> <p>Active weight 350 lbs./seat Urethane armcap option - <b>Add \$216 list upcharge</b></p>		COM	2	3	4	5	6	7	8	9	10	11	12
		\$4451	\$4621	\$4766	\$4974	\$5269	\$5380	\$5640	\$6127	\$6368	\$6823	\$7450	\$8227
		<b>OVERALL DIMENSIONS</b>			<b>SEAT DIMENSIONS</b>			<b>BACK DIMENSIONS</b>					
		W	D	H	W	D	H	W	H				
		69	27	33	20.5	17.5	18	20.5	15				
 <p><b>GC3626W</b> Wood</p> <p><b>LB Three Seat Chair, Half Center Arms, Open Arms (Wood)</b> COM Yardage: 4.75 Freight Class: 250 Product Weight (lbs.): 135 Cubic Feet Per Carton: 65.25</p> <p>Active weight 350 lbs./seat Urethane armcap option - <b>Add \$216 list upcharge</b></p>		COM	2	3	4	5	6	7	8	9	10	11	12
		\$4334	\$4504	\$4649	\$4857	\$5152	\$5263	\$5522	\$6009	\$6251	\$6706	\$7333	\$8107
		<b>OVERALL DIMENSIONS</b>			<b>SEAT DIMENSIONS</b>			<b>BACK DIMENSIONS</b>					
		W	D	H	W	D	H	W	H				
		69	27	33	20.5	17.5	18	20.5	15				
 <p><b>GC3628W</b> Wood</p> <p><b>LB Four Seat Chair, Full Center Arms, Open Arms (Wood)</b> COM Yardage: 6 Freight Class: 150 Product Weight (lbs.): 185 Cubic Feet Per Carton: 43</p> <p>Active weight 350 lbs./seat Urethane armcap option - <b>Add \$268 list upcharge</b></p> <ul style="list-style-type: none"> <li>• Shipped RTA (Ready to Assemble) in 2 cartons</li> </ul>		COM	2	3	4	5	6	7	8	9	10	11	12
		\$6434	\$6649	\$6830	\$7095	\$7466	\$7610	\$7934	\$8551	\$8854	\$9426	\$10223	\$11202
		<b>OVERALL DIMENSIONS</b>			<b>SEAT DIMENSIONS</b>			<b>BACK DIMENSIONS</b>					
		W	D	H	W	D	H	W	H				
		93	27	33	20.5	17.5	18	20.5	15				
 <p><b>GC3630W</b> Wood</p> <p><b>LB Five Seat Chair, Full Center Arms, Open Arms (Wood)</b> COM Yardage: 7.5 Freight Class: 150 Product Weight (lbs.): 227 Cubic Feet Per Carton: 43</p> <p>Active weight 350 lbs./seat Urethane armcap option - <b>Add \$320 list upcharge</b></p> <ul style="list-style-type: none"> <li>• Shipped RTA (Ready to Assemble) in 2 cartons</li> </ul>		COM	2	3	4	5	6	7	8	9	10	11	12
		\$7058	\$7330	\$7554	\$7883	\$8349	\$8525	\$8933	\$9702	\$10087	\$10800	\$11793	\$13019
		<b>OVERALL DIMENSIONS</b>			<b>SEAT DIMENSIONS</b>			<b>BACK DIMENSIONS</b>					
		W	D	H	W	D	H	W	H				
		115	27	33	20.5	17.5	18	20.5	15				
 <p><b>GC3637W</b> Wood</p> <p><b>Bariatric LB Armchair, Open Arms (Wood)</b> COM Yardage: 2.5 Freight Class: 250 Product Weight (lbs.): 66 Cubic Feet Per Carton: 26.5</p> <p>Active weight 500 lbs. Urethane armcap option - <b>Add \$110 list upcharge</b></p>		COM	2	3	4	5	6	7	8	9	10	11	12
		\$2239	\$2326	\$2404	\$2515	\$2671	\$2730	\$2865	\$3122	\$3250	\$3488	\$3818	\$4228
		<b>OVERALL DIMENSIONS</b>			<b>SEAT DIMENSIONS</b>			<b>BACK DIMENSIONS</b>					
		W	D	H	W	D	H	W	H				
		35	27	33	30	17.5	18	30	15				

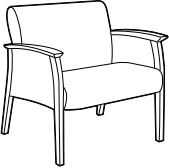
DESCRIPTION	MODEL#	STANDARD FABRIC GRADES												
		COM	2	3	4	5	6	7	8	9	10	11	12	
 <p><b>Bariatric LB Armchair, Closed Arms (Wood)</b>                      COM Yardage: 3.5                      Freight Class: 250                      Product Weight (lbs.): 76                      Cubic Feet Per Carton: 26.5</p>	<b>GC3637WCA</b>	<b>\$2448</b>	<b>\$2573</b>	<b>\$2681</b>	<b>\$2833</b>	<b>\$3051</b>	<b>\$3135</b>	<b>\$3326</b>	<b>\$3683</b>	<b>\$3864</b>	<b>\$4196</b>	<b>\$4659</b>	<b>\$5229</b>	
	Wood													
		OVERALL DIMENSIONS			SEAT DIMENSIONS			BACK DIMENSIONS						
		W	D	H	W	D	H	W	H					
		35	27	33	30	17.5	18	30	15					

Active weight 500 lbs.  
 Urethane armcap option - **Add \$110 list upcharge**

PRIMACARE PATIENT



model GC3631 (HT)



model GC3632W (Wood)

STANDARD FEATURES

- Primacare is a family of products offering the most significant return on investment approach in the industry since every component can be repaired or replaced on site.
- High traffic (HT) models:** Metal frame with die cast zinc connectors and metal-to-metal fasteners. Available in the following finishes: Black (TBL), Cloud (TIV), Designer White (TDW), Fog (TFO), Frost (TFR), Kalua (TKA), Latte (TLA), Mocha (TMO), Nevada (TNE), Sand (TSN), Shadow (TSH), Toast (TOA) and Tungsten (TTU).
- Wood models:** Solid hardwood frame with die cast zinc connectors and metal-to-metal fastening. Available in the following finishes: Absolute (AAM), Cherry (ACM), English Oak (EOM), Espresso Cafe (ECM), Fruitwood (TFM), Gray (HGM), Honey (AHM), Jet Onyx (JOM), Mahogany (TMM), Maple (AVM), Medium Walnut (MWM), Natural Walnut (NLW), Night (ASM), Noce Biondo (NBM), Noce Grigio (NGM), Noce Leggero (NEM), Noce Medio (NMM), Sandy Beach (SBM), Shaker Cherry (SKM), Walnut (TWM), White (WHM), WC Cream (WTM) and Winter Cherry (WCM).
- Armcaps are securely fastened with metal-to-metal connectors which allow for field replacement if required.
- Easy grip forward extending armcap on models with arms.
- Replaceable seat covers and replaceable and/or removable seat cushions are standard.

- Wood armcaps are standard.
- Waterfall cleanout between the seat and back cushions.
- Models are standard with metal mesh seat deck. For behavioral health applications, the metal mesh seat deck can be covered with a solid moisture resistant surface, held in place with tamperproof fasteners. Contact your sales rep for a special quotation.
- All seat frames feature a wall saver design to prevent back contact with wall.
- Models ending in **CA / ARC**, have upholstered panel arm inserts closing the arm. Closed arm panels are designed to be replaceable.
- For healthcare textile options, visit the website at [www.globalfurnituregroup.com](http://www.globalfurnituregroup.com).
- Can be upholstered in standard Global textiles if healthcare compliance is not required.
- It is recommended that High Traffic (HT) models be specified in textiles that meet or exceed 100,000 double rubs for added abrasion performance.
- Shipped fully assembled.
- High traffic (HT) models are listed first, followed by wood models.**

OPTIONAL FEATURES

- Urethane armcaps are available. Please specify. Refer to individual models for availability and pricing.
- For moisture barrier (seat only), add **\$137** list upcharge per seat. For Bariatric Models: GC3638W, GC3639W, GC3640W, GC3640WCA, and GC3656W - **Add \$209** list upcharge per seat.
- To add sealed seams to your product contact Customer Care. Upcharges vary.
- For Primacare tables, see page 52.

SUGGESTED APPLICATIONS

- Bariatric seating
- Guest seating
- Lobbies
- Lounge/Waiting
- Patient rooms
- Resident rooms
- Treatment/Exam rooms

DESCRIPTION	MODEL# / FEATURES	STANDARD TEXTILE GRADES											
		COM	2	3	4	5	6	7	8	9	10	11	12
<p><b>MB Armchair Open Arms (HT)</b> COM Yardage: 1.75 Freight Class: 250 Product Weight (lbs.): 64 Cubic Feet Per Carton: 17.5</p>	<p><b>GC3631</b> Metal</p> <p><b>GC3631F</b> Metal flex back</p>	\$2198	\$2261	\$2316	\$2394	\$2501	\$2543	\$2638	\$2816	\$2908	\$3075	\$3306	\$3593
	<p><b>OVERALL DIMENSIONS</b> W D H</p> <p><b>SEAT DIMENSIONS</b> W D H</p> <p><b>BACK DIMENSIONS</b> W H</p>	25	27	36.5	20.5	17.5	18	20.5	18				
	Active weight 500 lbs. Urethane armcap option - <b>Add \$110 list upcharge</b>												
<p><b>MB Armchair Closed Arms (HT)</b> COM Yardage: 2.75 Freight Class: 150 Product Weight (lbs.): 76 Cubic Feet Per Carton: 17.5</p>	<p><b>GC3631CA</b> Metal</p> <p><b>GC3631FCA</b> Metal flex back</p>	\$2520	\$2617	\$2700	\$2824	\$2992	\$3057	\$3208	\$3490	\$3631	\$3893	\$4257	\$4703
	<p><b>OVERALL DIMENSIONS</b> W D H</p> <p><b>SEAT DIMENSIONS</b> W D H</p> <p><b>BACK DIMENSIONS</b> W H</p>	25	27	36.5	20.5	17.5	18	20.5	18				
	Active weight 500 lbs. Urethane armcap option - <b>Add \$110 list upcharge</b>												
<p><b>MB Armchair Open Arms, Rear Tip &amp; Move Wheels (HT)</b> COM Yardage: 1.75 Freight Class: 250 Product Weight (lbs.): 64 Cubic Feet Per Carton: 23</p>	<p><b>GC3631RC</b> Metal</p>	\$2351	\$2414	\$2469	\$2546	\$2655	\$2695	\$2792	\$2974	\$3062	\$3230	\$3460	\$3744
	<p><b>OVERALL DIMENSIONS</b> W D H</p> <p><b>SEAT DIMENSIONS</b> W D H</p> <p><b>BACK DIMENSIONS</b> W H</p>	25	29.5	36.5	20.5	17.5	18	20.5	18				
	Active weight 500 lbs. Urethane armcap option - <b>Add \$110 list upcharge</b>												





DESCRIPTION	MODEL#	STANDARD FABRIC GRADES											
		COM	2	3	4	5	6	7	8	9	10	11	12
	<b>GC3631CARC</b>	\$2689	\$2786	\$2869	\$2992	\$3160	\$3226	\$3378	\$3658	\$3800	\$4062	\$4426	\$4873
	Metal												
		OVERALL DIMENSIONS			SEAT DIMENSIONS			BACK DIMENSIONS					
		W	D	H	W	D	H	W	H				
		25	29.5	36.5	20.5	17.5	18	20.5	18				
<b>MB Armchair, Closed Arms, Rear Tip &amp; Move Wheels (HT)</b> COM Yardage: 2.75 Freight Class: 250 Product Weight (lbs.): 76 Cubic Feet Per Carton: 23		Active weight 500 lbs. Urethane armcap option - <b>Add \$110 list upcharge</b>											

DESCRIPTION	MODEL#	STANDARD FABRIC GRADES											
		COM	2	3	4	5	6	7	8	9	10	11	12
	<b>GC3632</b>	\$2461	\$2539	\$2609	\$2707	\$2848	\$2900	\$3021	\$3254	\$3369	\$3584	\$3880	\$4248
	Metal												
		OVERALL DIMENSIONS			SEAT DIMENSIONS			BACK DIMENSIONS					
		W	D	H	W	D	H	W	H				
		25	27	48.5	20.5	17.5	18	20.5	30				
<b>HB Armchair, Open Arms, Split Back (HT)</b> COM Yardage: 2.25 Freight Class: 250 Product Weight (lbs.): 72 Cubic Feet Per Carton: 27.5		Active weight 500 lbs. Fold away headrest. Urethane armcap option - <b>Add \$110 list upcharge</b>											

DESCRIPTION	MODEL#	STANDARD FABRIC GRADES											
		COM	2	3	4	5	6	7	8	9	10	11	12
	<b>GC3632CA</b>	\$2789	\$2895	\$2986	\$3116	\$3305	\$3374	\$3540	\$3846	\$3998	\$4285	\$4683	\$5172
	Metal												
		OVERALL DIMENSIONS			SEAT DIMENSIONS			BACK DIMENSIONS					
		W	D	H	W	D	H	W	H				
		25	27	48.5	20.5	17.5	18	20.5	30				
<b>HB Armchair, Closed Arms, Split Back (HT)</b> COM Yardage: 3 Freight Class: 250 Product Weight (lbs.): 84 Cubic Feet Per Carton: 27.5		Active weight 500 lbs. Fold away headrest. Urethane armcap option - <b>Add \$110 list upcharge</b>											

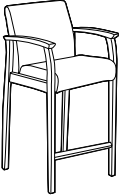
DESCRIPTION	MODEL#	STANDARD FABRIC GRADES											
		COM	2	3	4	5	6	7	8	9	10	11	12
	<b>GC3632RC</b>	\$2629	\$2706	\$2777	\$2875	\$3016	\$3068	\$3189	\$3422	\$3536	\$3751	\$4050	\$4416
	Metal												
		OVERALL DIMENSIONS			SEAT DIMENSIONS			BACK DIMENSIONS					
		W	D	H	W	D	H	W	H				
		25	29.5	48.5	20.5	17.5	18	20.5	30				
<b>HB Armchair, Open Arms, Split Back, Rear Tip &amp; Move Wheels (HT)</b> COM Yardage: 2.25 Freight Class: 250 Product Weight (lbs.): 72 Cubic Feet Per Carton: 27.5		Active weight 500 lbs. Fold away headrest. Urethane armcap option - <b>Add \$110 list upcharge</b>											

DESCRIPTION	MODEL#	STANDARD FABRIC GRADES											
		COM	2	3	4	5	6	7	8	9	10	11	12
	<b>GC3632CARC</b>	\$2955	\$3062	\$3154	\$3283	\$3471	\$3541	\$3706	\$4013	\$4167	\$4452	\$4850	\$5339
	Metal												
		OVERALL DIMENSIONS			SEAT DIMENSIONS			BACK DIMENSIONS					
		W	D	H	W	D	H	W	H				
		25	29.5	48.5	20.5	17.5	18	20.5	30				
<b>HB Armchair, Closed Arms, Split Back, Rear Tip &amp; Move Wheels (HT)</b> COM Yardage: 3 Freight Class: 250 Product Weight (lbs.): 84 Cubic Feet Per Carton: 27.5		Active weight 500 lbs. Fold away headrest. Urethane armcap option - <b>Add \$110 list upcharge</b>											

DESCRIPTION	MODEL#	STANDARD FABRIC GRADES											
		COM	2	3	4	5	6	7	8	9	10	11	12
 <p>Designed to immobilize the pelvis and hip joints after surgery.</p> <p><b>LB Hip Armchair, Open Arms - Post Surgery (HT)</b>                      COM Yardage: 1.5                      Freight Class: 250                      Product Weight (lbs.): 67                      Cubic Feet Per Carton: 20</p>	<b>GC3636</b>	\$2847	\$2898	\$2947	\$3011	\$3105	\$3143	\$3222	\$3375	\$3452	\$3596	\$3795	\$4038
	Metal												
	<b>OVERALL DIMENSIONS</b>			<b>SEAT DIMENSIONS</b>			<b>BACK DIMENSIONS</b>						
	W	D	H	W	D	H	W	H					
	23	26	40.5	19	17.5	25.5	19	15.5					
Active weight 500 lbs. Urethane armcap option - <b>Add \$110 list upcharge</b>													
 <p><b>Bariatric MB Armchair, Open Arms (HT)</b>                      COM Yardage: 2.75                      Freight Class: 250                      Product Weight (lbs.): 94                      Cubic Feet Per Carton: 30.5</p>	<b>GC3638</b>	\$2829	\$2926	\$3010	\$3133	\$3301	\$3366	\$3518	\$3799	\$3941	\$4202	\$4568	\$5014
	Metal												
	<b>OVERALL DIMENSIONS</b>			<b>SEAT DIMENSIONS</b>			<b>BACK DIMENSIONS</b>						
	W	D	H	W	D	H	W	H					
	35	27	36.5	30	17.5	18	30	18					
Active weight 500 lbs. Urethane armcap option - <b>Add \$110 list upcharge</b>													
 <p><b>Bariatric MB Armchair, Closed Arms (HT)</b>                      COM Yardage: 3.75                      Freight Class: 250                      Product Weight (lbs.): 104                      Cubic Feet Per Carton: 30.5</p>	<b>GC3638CA</b>	\$3150	\$3282	\$3395	\$3561	\$3793	\$3880	\$4085	\$4469	\$4663	\$5019	\$5514	\$6128
	Metal												
	<b>OVERALL DIMENSIONS</b>			<b>SEAT DIMENSIONS</b>			<b>BACK DIMENSIONS</b>						
	W	D	H	W	D	H	W	H					
	35	27	36.5	30	17.5	18	30	18					
Active weight 500 lbs. Urethane armcap option - <b>Add \$110 list upcharge</b>													
 <p><b>Bariatric HB Armchair, Open Arms, Split Back (HT)</b>                      COM Yardage: 3.75                      Freight Class: 250                      Product Weight (lbs.): 77                      Cubic Feet Per Carton: 33</p>	<b>GC3639</b>	\$3150	\$3282	\$3395	\$3561	\$3793	\$3880	\$4085	\$4469	\$4663	\$5019	\$5514	\$6128
	Metal												
	<b>OVERALL DIMENSIONS</b>			<b>SEAT DIMENSIONS</b>			<b>BACK DIMENSIONS</b>						
	W	D	H	W	D	H	W	H					
	35	27	48.5	30	17.5	18	30	30					
Active weight 500 lbs. Fold away headrest. Urethane armcap option - <b>Add \$110 list upcharge</b>													
 <p><b>Bariatric HB Armchair, Closed Arms, Split Back (HT)</b>                      COM Yardage: 4.75                      Freight Class: 250                      Product Weight (lbs.): 108                      Cubic Feet Per Carton: 33</p>	<b>GC3639CA</b>	\$3464	\$3637	\$3777	\$3988	\$4282	\$4394	\$4655	\$5139	\$5384	\$5836	\$6463	\$7240
	Metal												
	<b>OVERALL DIMENSIONS</b>			<b>SEAT DIMENSIONS</b>			<b>BACK DIMENSIONS</b>						
	W	D	H	W	D	H	W	H					
	35	27	48.5	30	17.5	18	30	30					
Active weight 500 lbs. Fold away headrest. Urethane armcap option - <b>Add \$110 list upcharge</b>													



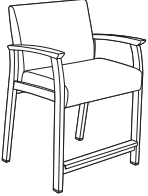

DESCRIPTION	MODEL#	STANDARD FABRIC GRADES											
		COM	2	3	4	5	6	7	8	9	10	11	12
 <p><b>Bariatric HB Armchair, Closed Arms (HT)</b>                      COM Yardage: 4.5                      Freight Class: 250                      Product Weight (lbs.): 108                      Cubic Feet Per Carton: 33</p>	<b>GC3656CA</b>	\$3238	\$3400	\$3534	\$3733	\$4012	\$4118	\$4363	\$4824	\$5056	\$5483	\$6077	\$6812
	Metal												
		OVERALL DIMENSIONS			SEAT DIMENSIONS			BACK DIMENSIONS					
		W	D	H	W	D	H	W	H				
		35	27	48.5	30	17.5	18	30	30				
		Active weight 500 lbs. Urethane armcap option - <b>Add \$110 list upcharge</b>											

 <p>Designed to immobilize the pelvis and hip joints after surgery.</p> <p><b>Wide Hip Armchair, Open Arms - Post Surgery (HT)</b>                      COM Yardage: 1.5                      Freight Class: 250                      Product Weight (lbs.): 78                      Cubic Feet Per Carton: 20</p>	<b>GC3657</b>	\$3504	\$3556	\$3605	\$3670	\$3764	\$3801	\$3881	\$4034	\$4111	\$4256	\$4455	\$4698
	Metal												
		OVERALL DIMENSIONS			SEAT DIMENSIONS			BACK DIMENSIONS					
		W	D	H	W	D	H	W	H				
		28	25	41	24	17.5	26	24	15.5				
		Active weight 500 lbs. Urethane armcap option - <b>Add \$110 list upcharge</b>											

 <p><b>MB Armchair, Open Arms (Wood)</b>                      COM Yardage: 1.75                      Freight Class: 250                      Product Weight (lbs.): 52                      Cubic Feet Per Carton: 20</p>	<b>GC3631W</b>	\$1833	\$1896	\$1953	\$2029	\$2137	\$2178	\$2274	\$2456	\$2544	\$2711	\$2942	\$3228
	Wood												
	<b>GC3631WF</b>	\$2323	\$2386	\$2441	\$2518	\$2627	\$2667	\$2764	\$2946	\$3034	\$3202	\$3432	\$3716
	Wood flex back												
		OVERALL DIMENSIONS			SEAT DIMENSIONS			BACK DIMENSIONS					
		W	D	H	W	D	H	W	H				
		25	27	36.5	20.5	17.5	18	20.5	18				
		Active weight 350 lbs. Urethane armcap option - <b>Add \$110 list upcharge</b>											

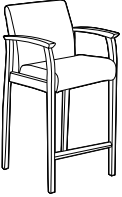
 <p><b>HB Armchair, Open Arms, Split Back (Wood)</b>                      COM Yardage: 2.25                      Freight Class: 250                      Product Weight (lbs.): 60                      Cubic Feet Per Carton: 27.5</p>	<b>GC3632W</b>	\$2037	\$2114	\$2185	\$2282	\$2424	\$2476	\$2597	\$2829	\$2945	\$3160	\$3458	\$3824
	Wood												
	<b>GC3632WF</b>	\$2547	\$2627	\$2696	\$2794	\$2933	\$2987	\$3109	\$3340	\$3456	\$3670	\$3968	\$4336
	Wood flex back												
		OVERALL DIMENSIONS			SEAT DIMENSIONS			BACK DIMENSIONS					
		W	D	H	W	D	H	W	H				
		25	27	48.5	20.5	17.5	18	20.5	30				
		Active weight 350 lbs. Fold away headrest. Urethane armcap option - <b>Add \$110 list upcharge</b>											

 <p>Designed to immobilize the pelvis and hip joints after surgery.</p> <p><b>LB Hip Armchair, Open Arms - Post Surgery (Wood)</b>                      COM Yardage: 1.5                      Freight Class: 250                      Product Weight (lbs.): 57                      Cubic Feet Per Carton: 20</p>	<b>GC3636W</b>	\$2531	\$2583	\$2632	\$2697	\$2791	\$2828	\$2908	\$3061	\$3138	\$3283	\$3482	\$3725
	Wood												
		OVERALL DIMENSIONS			SEAT DIMENSIONS			BACK DIMENSIONS					
		W	D	H	W	D	H	W	H				
		23	26	40.5	19	17.5	25.5	19	15.5				
		Active weight 350 lbs. Urethane armcap option - <b>Add \$110 list upcharge</b>											

DESCRIPTION	MODEL#	STANDARD FABRIC GRADES																																					
		COM	2	3	4	5	6	7	8	9	10	11	12																										
 <p><b>Bariatric MB Armchair, Open Arms (Wood)</b>                      COM Yardage: 2.75                      Freight Class: 250                      Product Weight (lbs.): 82                      Cubic Feet Per Carton: 30.5</p>	<b>GC3638W</b>	\$2325	\$2418	\$2618	\$2742	\$2910	\$2978	\$3125	\$3409	\$3549	\$3811	\$4176	\$4623																										
	Wood																																						
	<table border="1"> <thead> <tr> <th colspan="3">OVERALL DIMENSIONS</th> <th colspan="3">SEAT DIMENSIONS</th> <th colspan="3">BACK DIMENSIONS</th> </tr> <tr> <th>W</th> <th>D</th> <th>H</th> <th>W</th> <th>D</th> <th>H</th> <th>W</th> <th colspan="2">H</th> </tr> </thead> <tbody> <tr> <td>35</td> <td>27</td> <td>36.5</td> <td>30</td> <td>17.5</td> <td>18</td> <td>30</td> <td colspan="2">18</td> </tr> </tbody> </table>	OVERALL DIMENSIONS			SEAT DIMENSIONS			BACK DIMENSIONS			W	D	H	W	D	H	W	H		35	27	36.5	30	17.5	18	30	18												
OVERALL DIMENSIONS			SEAT DIMENSIONS			BACK DIMENSIONS																																	
W	D	H	W	D	H	W	H																																
35	27	36.5	30	17.5	18	30	18																																

Active weight 500 lbs.  
 Urethane armcap option - **Add \$110 list upcharge**

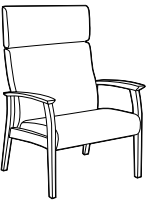
DESCRIPTION	MODEL#	STANDARD FABRIC GRADES																																					
		COM	2	3	4	5	6	7	8	9	10	11	12																										
 <p><b>Bariatric HB Armchair, Open Arms, Split Back (Wood)</b>                      COM Yardage: 3.75                      Freight Class: 300                      Product Weight (lbs.): 65                      Cubic Feet Per Carton: 33</p>	<b>GC3639W</b>	\$2566	\$2698	\$2812	\$2977	\$3210	\$3300	\$3502	\$3890	\$4078	\$4438	\$4932	\$5546																										
	Wood																																						
	<table border="1"> <thead> <tr> <th colspan="3">OVERALL DIMENSIONS</th> <th colspan="3">SEAT DIMENSIONS</th> <th colspan="3">BACK DIMENSIONS</th> </tr> <tr> <th>W</th> <th>D</th> <th>H</th> <th>W</th> <th>D</th> <th>H</th> <th>W</th> <th colspan="2">H</th> </tr> </thead> <tbody> <tr> <td>35</td> <td>27</td> <td>48.5</td> <td>30</td> <td>17.5</td> <td>18</td> <td>30</td> <td colspan="2">30</td> </tr> </tbody> </table>	OVERALL DIMENSIONS			SEAT DIMENSIONS			BACK DIMENSIONS			W	D	H	W	D	H	W	H		35	27	48.5	30	17.5	18	30	30												
OVERALL DIMENSIONS			SEAT DIMENSIONS			BACK DIMENSIONS																																	
W	D	H	W	D	H	W	H																																
35	27	48.5	30	17.5	18	30	30																																

Active weight 500 lbs. Fold away headrest.  
 Urethane armcap option - **Add \$110 list upcharge**

DESCRIPTION	MODEL#	STANDARD FABRIC GRADES																																					
		COM	2	3	4	5	6	7	8	9	10	11	12																										
 <p><b>HB Armchair, Open Arms (Wood)</b>                      COM Yardage: 2.5                      Freight Class: 250                      Product Weight (lbs.): 60                      Cubic Feet Per Carton: 27.5</p>	<b>GC3655W</b>	\$1901	\$1989	\$2067	\$2177	\$2331	\$2393	\$2525	\$2784	\$2912	\$3151	\$3481	\$3890																										
	Wood																																						
	<table border="1"> <thead> <tr> <th colspan="3">OVERALL DIMENSIONS</th> <th colspan="3">SEAT DIMENSIONS</th> <th colspan="3">BACK DIMENSIONS</th> </tr> <tr> <th>W</th> <th>D</th> <th>H</th> <th>W</th> <th>D</th> <th>H</th> <th>W</th> <th colspan="2">H</th> </tr> </thead> <tbody> <tr> <td>25</td> <td>27</td> <td>48.5</td> <td>20.5</td> <td>17.5</td> <td>18</td> <td>20.5</td> <td colspan="2">30</td> </tr> </tbody> </table>	OVERALL DIMENSIONS			SEAT DIMENSIONS			BACK DIMENSIONS			W	D	H	W	D	H	W	H		25	27	48.5	20.5	17.5	18	20.5	30												
OVERALL DIMENSIONS			SEAT DIMENSIONS			BACK DIMENSIONS																																	
W	D	H	W	D	H	W	H																																
25	27	48.5	20.5	17.5	18	20.5	30																																

Active weight 350 lbs.  
 Urethane armcap option - **Add \$110 list upcharge**

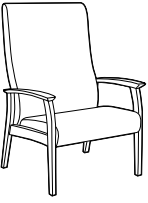
DESCRIPTION	MODEL#	STANDARD FABRIC GRADES																																					
		COM	2	3	4	5	6	7	8	9	10	11	12																										
 <p><b>Bariatric HB Armchair, Open Arms (Wood)</b>                      COM Yardage: 3.5                      Freight Class: 250                      Product Weight (lbs.): 65                      Cubic Feet Per Carton: 30.75</p>	<b>GC3656W</b>	\$2388	\$2511	\$2619	\$2771	\$2989	\$3074	\$3264	\$3622	\$3802	\$4134	\$4597	\$5167																										
	Wood																																						
	<table border="1"> <thead> <tr> <th colspan="3">OVERALL DIMENSIONS</th> <th colspan="3">SEAT DIMENSIONS</th> <th colspan="3">BACK DIMENSIONS</th> </tr> <tr> <th>W</th> <th>D</th> <th>H</th> <th>W</th> <th>D</th> <th>H</th> <th>W</th> <th colspan="2">H</th> </tr> </thead> <tbody> <tr> <td>35</td> <td>27</td> <td>48.5</td> <td>30</td> <td>17.5</td> <td>18</td> <td>30</td> <td colspan="2">30</td> </tr> </tbody> </table>	OVERALL DIMENSIONS			SEAT DIMENSIONS			BACK DIMENSIONS			W	D	H	W	D	H	W	H		35	27	48.5	30	17.5	18	30	30												
OVERALL DIMENSIONS			SEAT DIMENSIONS			BACK DIMENSIONS																																	
W	D	H	W	D	H	W	H																																
35	27	48.5	30	17.5	18	30	30																																

Active weight 500 lbs.  
 Urethane armcap option - **Add \$110 list upcharge**

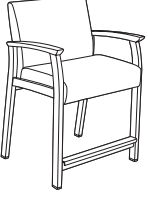
DESCRIPTION	MODEL#	STANDARD FABRIC GRADES																																					
		COM	2	3	4	5	6	7	8	9	10	11	12																										
 <p>Designed to immobilize the pelvis and hip joints after surgery.</p> <p><b>Wide Hip Armchair, Open Arms - Post Surgery (HT)</b>                      COM Yardage: 1.5                      Freight Class: 250                      Product Weight (lbs.): 64                      Cubic Feet Per Carton: 20</p>	<b>GC3657W</b>	\$2942	\$3000	\$3051	\$3125	\$3226	\$3274	\$3366	\$3512	\$3624	\$3752	\$4011	\$4287																										
	Wood																																						
	<table border="1"> <thead> <tr> <th colspan="3">OVERALL DIMENSIONS</th> <th colspan="3">SEAT DIMENSIONS</th> <th colspan="3">BACK DIMENSIONS</th> </tr> <tr> <th>W</th> <th>D</th> <th>H</th> <th>W</th> <th>D</th> <th>H</th> <th>W</th> <th colspan="2">H</th> </tr> </thead> <tbody> <tr> <td>28</td> <td>25</td> <td>41</td> <td>24</td> <td>17.5</td> <td>26</td> <td>24</td> <td colspan="2">15.5</td> </tr> </tbody> </table>	OVERALL DIMENSIONS			SEAT DIMENSIONS			BACK DIMENSIONS			W	D	H	W	D	H	W	H		28	25	41	24	17.5	26	24	15.5												
OVERALL DIMENSIONS			SEAT DIMENSIONS			BACK DIMENSIONS																																	
W	D	H	W	D	H	W	H																																
28	25	41	24	17.5	26	24	15.5																																

Active weight 500 lbs.  
 Urethane armcap option - **Add \$110 list upcharge**

PRIMACARE LOUNGE



model GC3641 (HT)



model GC3641W (Wood)

STANDARD FEATURES

- Primacare is a family of products offering the most significant return on investment approach in the industry since every component can be repaired or replaced on site.
- High traffic (HT) models:** Metal frame and urethane armcaps with die cast zinc connectors and metal-to-metal fasteners. Available in the following finishes: Black (TBL), Cloud (TIV), Designer White (TDW), Fog (TFO), Frost (TFR), Kalua (TKA), Latte (TLA), Mocha (TMO), Nevada (TNE), Sand (TSN), Shadow (TSH), Toast (TOA) and Tungsten (TTU).
- Wood models:** Solid hardwood frame with die cast zinc connectors and metal-to-metal fastening. Available in the following finishes: Absolute (AAM), Cherry (ACM), English Oak (EOM), Espresso Cafe (ECM), Fruitwood (TFM), Gray (HGM), Honey (AHM), Jet Onyx (JOM), Mahogany (TMM), Maple (AVM), Medium Walnut (MWM), Natural Walnut (NLW), Night (ASM), Noce Biondo (NBM), Noce Grigio (NGM), Noce Leggero (NEM), Noce Medio (NMM), Sandy Beach (SBM), Shaker Cherry (SKM), Walnut (TWM), White (WHM), WC Cream (WTM) and Winter Cherry (WCM).
- Armcaps are securely fastened with metal-to-metal connectors which allow for field replacement if required.
- Easy grip forward extending armcap on models with arms.
- Replaceable seat covers and replaceable and/or removable seat cushions are standard.
- Waterfall cleanout between the seat and back cushions.
- Models are standard with metal mesh seat deck. For behavioral health applications, the metal mesh seat deck can be covered with a solid moisture resistant surface, held in place with tamperproof fasteners. Contact your sales rep for a special quotation.
- All seat frames feature a wall saver design to prevent back contact with wall.
- Models ending in **CA** have upholstered panel arm inserts closing the arm. (Closed arm panels are designed to be replaceable).
- For healthcare textile options, visit the website at [globalfurnituregroup.com](http://globalfurnituregroup.com).
- Can be upholstered in standard Global textiles if healthcare compliance is not required.
- It is recommended that High Traffic (HT) models be specified in textiles that meet or exceed 100,000 double rubs for added abrasion performance.
- Shipped fully assembled.
- High traffic (HT) models are listed first, followed by wood models.**

OPTIONAL FEATURES

- High traffic (HT) models:** Wood armcaps are available. See far left column "Wood models" for finishes. Please specify. No upcharge.
- High traffic (HT) and wood models:** Urethane armcaps are available. Please specify. Refer to individual models for availability and pricing.
- For moisture barrier (seat only), add **\$204** list upcharge per seat. For bariatric models: GC3640, GC3640CA, GC3640W, and GC3640WCA - Add **\$209** list upcharge per seat.
- To add sealed seams to your product contact Customer Care. Upcharges vary.
- For Primacare tables, see page 52.

SUGGESTED APPLICATIONS

- Bariatric seating
- Guest seating
- Lobbies
- Lounge/Waiting
- Patient rooms
- Resident rooms

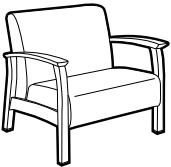
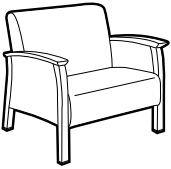
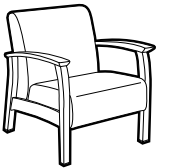
DESCRIPTION	MODEL# / FEATURES	STANDARD TEXTILE GRADES																											
		COM	2	3	4	5	6	7	8	9	10	11	12																
 <p><b>Bariatric Lounge Chair, Open Arms (HT)</b> COM Yardage: 3.25 Freight Class: 250 Product Weight (lbs.): 109 Cubic Feet Per Carton: 49.5</p>	GC3640 Metal	\$3519	\$3637	\$3732	\$3876	\$4083	\$4158	\$4334	\$4663	\$4832	\$5142	\$5573	\$6101																
	<p><b>OVERALL DIMENSIONS</b></p> <table border="1"> <tr> <th>W</th> <th>D</th> <th>H</th> </tr> <tr> <td>40</td> <td>32</td> <td>33</td> </tr> </table> <p><b>SEAT DIMENSIONS</b></p> <table border="1"> <tr> <th>W</th> <th>D</th> <th>H</th> </tr> <tr> <td>36</td> <td>20</td> <td>17.25</td> </tr> </table> <p><b>BACK DIMENSIONS</b></p> <table border="1"> <tr> <th>W</th> <th>H</th> </tr> <tr> <td>36</td> <td>16</td> </tr> </table>	W	D	H	40	32	33	W	D	H	36	20	17.25	W	H	36	16	Active weight 500 lbs. Urethane armcap option - <b>Add \$130 list upcharge</b>											
	W	D	H																										
40	32	33																											
W	D	H																											
36	20	17.25																											
W	H																												
36	16																												
<p>• For users up to 500 lbs.</p>																													
 <p><b>Bariatric Lounge Chair, Closed Arms (HT)</b> COM Yardage: 5.75 Freight Class: 250 Product Weight (lbs.): 119 Cubic Feet Per Carton: 49.5</p>	GC3640CA Metal	\$3788	\$3993	\$4168	\$4419	\$4776	\$4912	\$5224	\$5813	\$6110	\$6656	\$7419	\$8356																
	<p><b>OVERALL DIMENSIONS</b></p> <table border="1"> <tr> <th>W</th> <th>D</th> <th>H</th> </tr> <tr> <td>40</td> <td>32</td> <td>33</td> </tr> </table> <p><b>SEAT DIMENSIONS</b></p> <table border="1"> <tr> <th>W</th> <th>D</th> <th>H</th> </tr> <tr> <td>36</td> <td>20</td> <td>17.25</td> </tr> </table> <p><b>BACK DIMENSIONS</b></p> <table border="1"> <tr> <th>W</th> <th>H</th> </tr> <tr> <td>36</td> <td>16</td> </tr> </table>	W	D	H	40	32	33	W	D	H	36	20	17.25	W	H	36	16	Active weight 500 lbs. Urethane armcap option - <b>Add \$130 list upcharge</b>											
	W	D	H																										
40	32	33																											
W	D	H																											
36	20	17.25																											
W	H																												
36	16																												
<p>• For users up to 500 lbs.</p>																													
 <p><b>Lounge Chair, Open Arms (HT)</b> COM Yardage: 2.5 Freight Class: 250 Product Weight (lbs.): 78 Cubic Feet Per Carton: 29.5</p>	GC3641 Metal	\$2829	\$2918	\$2996	\$3105	\$3258	\$3317	\$3453	\$3710	\$3840	\$4077	\$4408	\$4819																
	<p><b>OVERALL DIMENSIONS</b></p> <table border="1"> <tr> <th>W</th> <th>D</th> <th>H</th> </tr> <tr> <td>29</td> <td>32</td> <td>33</td> </tr> </table> <p><b>SEAT DIMENSIONS</b></p> <table border="1"> <tr> <th>W</th> <th>D</th> <th>H</th> </tr> <tr> <td>23</td> <td>20</td> <td>17.25</td> </tr> </table> <p><b>BACK DIMENSIONS</b></p> <table border="1"> <tr> <th>W</th> <th>H</th> </tr> <tr> <td>22.5</td> <td>16</td> </tr> </table>	W	D	H	29	32	33	W	D	H	23	20	17.25	W	H	22.5	16	Active weight 500 lbs. Urethane armcap option - <b>Add \$130 list upcharge</b>											
	W	D	H																										
29	32	33																											
W	D	H																											
23	20	17.25																											
W	H																												
22.5	16																												
<p>• For users up to 500 lbs.</p>																													

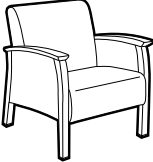
DESCRIPTION	MODEL#	STANDARD FABRIC GRADES																																					
		COM	2	3	4	5	6	7	8	9	10	11	12																										
 <p><b>Lounge Chair, Closed Arms (HT)</b> COM Yardage: 3.75 Freight Class: 250 Product Weight (lbs.): 91 Cubic Feet Per Carton: 29.5</p>	<b>GC3641CA</b>	\$3142	\$3273	\$3386	\$3551	\$3784	\$3872	\$4077	\$4464	\$4654	\$5011	\$5506	\$6121																										
	Metal																																						
	<table border="1"> <thead> <tr> <th colspan="3">OVERALL DIMENSIONS</th> <th colspan="3">SEAT DIMENSIONS</th> <th colspan="3">BACK DIMENSIONS</th> </tr> <tr> <th>W</th> <th>D</th> <th>H</th> <th>W</th> <th>D</th> <th>H</th> <th>W</th> <th>H</th> <th></th> </tr> </thead> <tbody> <tr> <td>29</td> <td>32</td> <td>33</td> <td>23</td> <td>20</td> <td>17.25</td> <td>22.5</td> <td>16</td> <td></td> </tr> </tbody> </table>	OVERALL DIMENSIONS			SEAT DIMENSIONS			BACK DIMENSIONS			W	D	H	W	D	H	W	H		29	32	33	23	20	17.25	22.5	16												
OVERALL DIMENSIONS			SEAT DIMENSIONS			BACK DIMENSIONS																																	
W	D	H	W	D	H	W	H																																
29	32	33	23	20	17.25	22.5	16																																

Active weight 500 lbs.  
Urethane armcap option - **Add \$130 list upcharge**

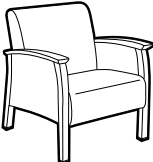
DESCRIPTION	MODEL#	STANDARD FABRIC GRADES																																					
		COM	2	3	4	5	6	7	8	9	10	11	12																										
 <p><b>Lounge Chair, Closed Arms, Laminate Panels (HT)</b> COM Yardage: 2.5 Freight Class: 250 Product Weight (lbs.): 91 Cubic Feet Per Carton: 29.5</p>	<b>GC3641CAL</b>	\$3520	\$3598	\$3667	\$3765	\$3904	\$3971	\$4096	\$4299	\$4453	\$4626	\$4983	\$5361																										
	Metal																																						
	<table border="1"> <thead> <tr> <th colspan="3">OVERALL DIMENSIONS</th> <th colspan="3">SEAT DIMENSIONS</th> <th colspan="3">BACK DIMENSIONS</th> </tr> <tr> <th>W</th> <th>D</th> <th>H</th> <th>W</th> <th>D</th> <th>H</th> <th>W</th> <th>H</th> <th></th> </tr> </thead> <tbody> <tr> <td>29</td> <td>32</td> <td>33</td> <td>23</td> <td>20</td> <td>17.25</td> <td>22.5</td> <td>16</td> <td></td> </tr> </tbody> </table>	OVERALL DIMENSIONS			SEAT DIMENSIONS			BACK DIMENSIONS			W	D	H	W	D	H	W	H		29	32	33	23	20	17.25	22.5	16												
OVERALL DIMENSIONS			SEAT DIMENSIONS			BACK DIMENSIONS																																	
W	D	H	W	D	H	W	H																																
29	32	33	23	20	17.25	22.5	16																																

Active weight 500 lbs.  
Urethane armcap option - **Add \$130 list upcharge**

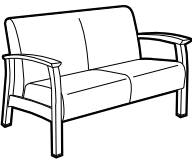
DESCRIPTION	MODEL#	STANDARD FABRIC GRADES																																					
		COM	2	3	4	5	6	7	8	9	10	11	12																										
 <p><b>Two Seat Sofa, Open Arms (HT)</b> COM Yardage: 4 Freight Class: 250 Product Weight (lbs.): 122 Cubic Feet Per Carton: 49.5</p>	<b>GC3642</b>	\$4077	\$4220	\$4341	\$4518	\$4765	\$4861	\$5078	\$5488	\$5695	\$6072	\$6604	\$7258																										
	Metal																																						
	<table border="1"> <thead> <tr> <th colspan="3">OVERALL DIMENSIONS</th> <th colspan="3">SEAT DIMENSIONS</th> <th colspan="3">BACK DIMENSIONS</th> </tr> <tr> <th>W</th> <th>D</th> <th>H</th> <th>W</th> <th>D</th> <th>H</th> <th>W</th> <th>H</th> <th></th> </tr> </thead> <tbody> <tr> <td>52</td> <td>32</td> <td>33</td> <td>48</td> <td>20</td> <td>17.25</td> <td>48</td> <td>16</td> <td></td> </tr> </tbody> </table>	OVERALL DIMENSIONS			SEAT DIMENSIONS			BACK DIMENSIONS			W	D	H	W	D	H	W	H		52	32	33	48	20	17.25	48	16												
OVERALL DIMENSIONS			SEAT DIMENSIONS			BACK DIMENSIONS																																	
W	D	H	W	D	H	W	H																																
52	32	33	48	20	17.25	48	16																																

Active weight 500 lbs./seat  
Urethane armcap option - **Add \$130 list upcharge**

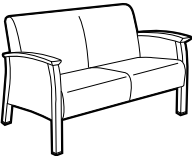
DESCRIPTION	MODEL#	STANDARD FABRIC GRADES																																					
		COM	2	3	4	5	6	7	8	9	10	11	12																										
 <p><b>Two Seat Sofa, Closed Arms (HT)</b> COM Yardage: 5.5 Freight Class: 250 Product Weight (lbs.): 132 Cubic Feet Per Carton: 49.5</p>	<b>GC3642CA</b>	\$4378	\$4577	\$4742	\$4985	\$5328	\$5455	\$5757	\$6318	\$6602	\$7124	\$7851	\$8750																										
	Metal																																						
	<table border="1"> <thead> <tr> <th colspan="3">OVERALL DIMENSIONS</th> <th colspan="3">SEAT DIMENSIONS</th> <th colspan="3">BACK DIMENSIONS</th> </tr> <tr> <th>W</th> <th>D</th> <th>H</th> <th>W</th> <th>D</th> <th>H</th> <th>W</th> <th>H</th> <th></th> </tr> </thead> <tbody> <tr> <td>52</td> <td>32</td> <td>33</td> <td>48</td> <td>20</td> <td>17.25</td> <td>48</td> <td>16</td> <td></td> </tr> </tbody> </table>	OVERALL DIMENSIONS			SEAT DIMENSIONS			BACK DIMENSIONS			W	D	H	W	D	H	W	H		52	32	33	48	20	17.25	48	16												
OVERALL DIMENSIONS			SEAT DIMENSIONS			BACK DIMENSIONS																																	
W	D	H	W	D	H	W	H																																
52	32	33	48	20	17.25	48	16																																

Active weight 500 lbs./seat  
Urethane armcap option - **Add \$130 list upcharge**

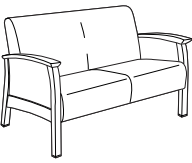
DESCRIPTION	MODEL#	STANDARD FABRIC GRADES																																					
		COM	2	3	4	5	6	7	8	9	10	11	12																										
 <p><b>Two Seat Sofa, Closed Arms, Laminate Panels (HT)</b> COM Yardage: 4 Freight Class: 250 Product Weight (lbs.): 132 Cubic Feet Per Carton: 49.5</p>	<b>GC3642CAL</b>	\$4763	\$4891	\$5000	\$5158	\$5380	\$5484	\$5687	\$6010	\$6257	\$6535	\$7104	\$7709																										
	Metal																																						
	<table border="1"> <thead> <tr> <th colspan="3">OVERALL DIMENSIONS</th> <th colspan="3">SEAT DIMENSIONS</th> <th colspan="3">BACK DIMENSIONS</th> </tr> <tr> <th>W</th> <th>D</th> <th>H</th> <th>W</th> <th>D</th> <th>H</th> <th>W</th> <th>H</th> <th></th> </tr> </thead> <tbody> <tr> <td>52</td> <td>32</td> <td>33</td> <td>48</td> <td>20</td> <td>17.25</td> <td>48</td> <td>16</td> <td></td> </tr> </tbody> </table>	OVERALL DIMENSIONS			SEAT DIMENSIONS			BACK DIMENSIONS			W	D	H	W	D	H	W	H		52	32	33	48	20	17.25	48	16												
OVERALL DIMENSIONS			SEAT DIMENSIONS			BACK DIMENSIONS																																	
W	D	H	W	D	H	W	H																																
52	32	33	48	20	17.25	48	16																																

Active weight 500 lbs./seat  
Urethane armcap option - **Add \$130 list upcharge**

# SEATING

# PRIMACARE™ LOUNGE P

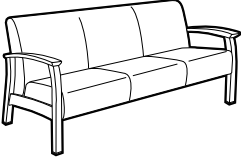
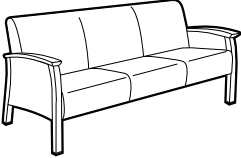
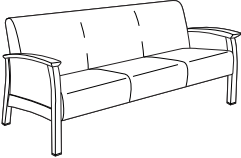
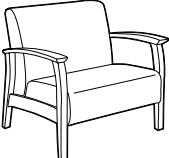
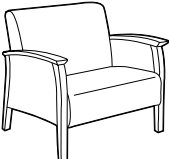
DESCRIPTION	MODEL#	STANDARD FABRIC GRADES											
		COM	2	3	4	5	6	7	8	9	10	11	12
 <b>Three Seat Sofa, Open Arms (HT)</b> COM Yardage: 6.25 Freight Class: 250 Product Weight (lbs.): 173 Cubic Feet Per Carton: 69.5	<b>GC3643</b> Metal	\$5775	\$5999	\$6186	\$6458	\$6849	\$6994	\$7335	\$7977	\$8297	\$8890	\$9719	\$10740
		OVERALL DIMENSIONS			SEAT DIMENSIONS			BACK DIMENSIONS					
		W	D	H	W	D	H	W	H				
			75	32	33	71	20	17.25		71	16		
			Active weight 500 lbs./seat Urethane armcap option - <b>Add \$130 list upcharge</b>										
 <b>Three Seat Sofa, Closed Arms (HT)</b> COM Yardage: 7.5 Freight Class: 250 Product Weight (lbs.): 183 Cubic Feet Per Carton: 69.5	<b>GC3643CA</b> Metal	\$6086	\$6355	\$6580	\$6908	\$7374	\$7550	\$7959	\$8727	\$9112	\$9828	\$10818	\$12045
		OVERALL DIMENSIONS			SEAT DIMENSIONS			BACK DIMENSIONS					
		W	D	H	W	D	H	W	H				
			75	32	33	71	20	17.25		71	16		
			Active weight 500 lbs./seat Urethane armcap option - <b>Add \$130 list upcharge</b>										
 <b>Three Seat Sofa, Closed Arms, Laminate Panels (HT)</b> COM Yardage: 6.25 Freight Class: 250 Product Weight (lbs.): 183 Cubic Feet Per Carton: 69.5	<b>GC3643CAL</b> Metal	\$6452	\$6655	\$6822	\$7068	\$7417	\$7581	\$7898	\$8400	\$8789	\$9221	\$10109	\$11058
		OVERALL DIMENSIONS			SEAT DIMENSIONS			BACK DIMENSIONS					
		W	D	H	W	D	H	W	H				
			75	32	33	71	20	17.25		71	16		
			Active weight 500 lbs./seat Urethane armcap option - <b>Add \$130 list upcharge</b>										
 <b>Bariatric Lounge Chair, Open Arms (Wood)</b> COM Yardage: 3.25 Freight Class: 300 Product Weight (lbs.): 97 Cubic Feet Per Carton: 49.5	<b>GC3640W</b> Wood	\$2895	\$3011	\$3110	\$3252	\$3457	\$3532	\$3709	\$4041	\$4206	\$4518	\$4946	\$5477
		OVERALL DIMENSIONS			SEAT DIMENSIONS			BACK DIMENSIONS					
		W	D	H	W	D	H	W	H				
			40	32	33	36	20	17.25		36	16		
			Active weight 500 lbs. Urethane armcap option - <b>Add \$130 list upcharge</b>										
 <b>Bariatric Lounge Chair, Closed Arms (Wood)</b> COM Yardage: 5.75 Freight Class: 250 Product Weight (lbs.): 107 Cubic Feet Per Carton: 49.5	<b>GC3640WCA</b> Wood	\$3099	\$3307	\$3478	\$3731	\$4089	\$4224	\$4538	\$5126	\$5422	\$5969	\$6729	\$7669
		OVERALL DIMENSIONS			SEAT DIMENSIONS			BACK DIMENSIONS					
		W	D	H	W	D	H	W	H				
			40	32	33	36	20	17.25		36	16		
			Active weight 500 lbs. Urethane armcap option - <b>Add \$130 list upcharge</b>										

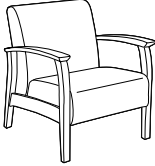
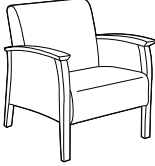
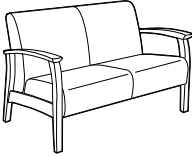
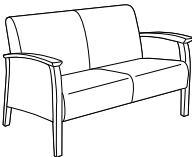
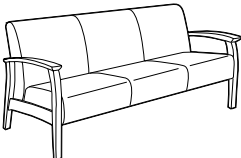
DESCRIPTION	MODEL#	STANDARD FABRIC GRADES											
		COM	2	3	4	5	6	7	8	9	10	11	12
 <p><b>Lounge Chair, Open Arms (Wood)</b>                      COM Yardage: 2.5                      Freight Class: 250                      Product Weight (lbs.): 66                      Cubic Feet Per Carton: 29.5</p>	<b>GC3641W</b> Wood	\$2324	\$2413	\$2491	\$2602	\$2755	\$2817	\$2952	\$3208	\$3336	\$3574	\$3905	\$4314
		OVERALL DIMENSIONS			SEAT DIMENSIONS			BACK DIMENSIONS					
		W	D	H	W	D	H	W	H				
			29	32	33	23	20	17.25	22.5	16			
			Active weight 350 lbs. Urethane armcap option - <b>Add \$130 list upcharge</b>										
 <p><b>Lounge Chair, Closed Arms (Wood)</b>                      COM Yardage: 3.75                      Freight Class: 250                      Product Weight (lbs.): 79                      Cubic Feet Per Carton: 29.5</p>	<b>GC3641WCA</b> Wood	\$2559	\$2691	\$2805	\$2971	\$3203	\$3293	\$3495	\$3883	\$4075	\$4431	\$4924	\$5539
		OVERALL DIMENSIONS			SEAT DIMENSIONS			BACK DIMENSIONS					
		W	D	H	W	D	H	W	H				
			29	32	33	23	20	17.25	22.5	16			
			Active weight 350 lbs. Urethane armcap option - <b>Add \$130 list upcharge</b>										
 <p><b>Two Seat Sofa, Open Arms (Wood)</b>                      COM Yardage: 4                      Freight Class: 250                      Product Weight (lbs.): 110                      Cubic Feet Per Carton: 49.5</p>	<b>GC3642W</b> Wood	\$3353	\$3496	\$3618	\$3794	\$4041	\$4135	\$4354	\$4764	\$4970	\$5351	\$5877	\$6532
		OVERALL DIMENSIONS			SEAT DIMENSIONS			BACK DIMENSIONS					
		W	D	H	W	D	H	W	H				
			52	32	33	48	20	17.25	48	16			
			Active weight 350 lbs./seat Urethane armcap option - <b>Add \$130 list upcharge</b>										
 <p><b>Two Seat Sofa, Closed Arms (Wood)</b>                      COM Yardage: 5.5                      Freight Class: 250                      Product Weight (lbs.): 120                      Cubic Feet Per Carton: 49.5</p>	<b>GC3642WCA</b> Wood	\$3596	\$3791	\$3957	\$4199	\$4538	\$4668	\$4968	\$5532	\$5814	\$6337	\$7065	\$7963
		OVERALL DIMENSIONS			SEAT DIMENSIONS			BACK DIMENSIONS					
		W	D	H	W	D	H	W	H				
			52	32	33	48	20	17.25	48	16			
			Active weight 350 lbs./seat Urethane armcap option - <b>Add \$130 list upcharge</b>										
 <p><b>Three Seat Sofa, Open Arms (Wood)</b>                      COM Yardage: 6.25                      Freight Class: 250                      Product Weight (lbs.): 161                      Cubic Feet Per Carton: 69.5</p>	<b>GC3643W</b> Wood	\$4745	\$4967	\$5157	\$5433	\$5819	\$5969	\$6306	\$6946	\$7270	\$7861	\$8690	\$9710
		OVERALL DIMENSIONS			SEAT DIMENSIONS			BACK DIMENSIONS					
		W	D	H	W	D	H	W	H				
			75	32	33	71	20	17.25	71	16			
			Active weight 350 lbs./seat Urethane armcap option - <b>Add \$130 list upcharge</b>										

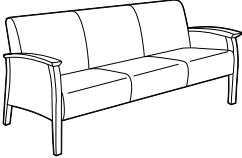
DESCRIPTION	MODEL#	STANDARD FABRIC GRADES												
		COM	2	3	4	5	6	7	8	9	10	11	12	
 <p><b>Three Seat Sofa, Closed Arms (Wood)</b>                      COM Yardage: 7.5                      Freight Class: 250                      Product Weight (lbs.): 171                      Cubic Feet Per Carton: 69.5</p>	<b>GC3643WCA</b>	<b>\$4990</b>	<b>\$5263</b>	<b>\$5484</b>	<b>\$5816</b>	<b>\$6282</b>	<b>\$6458</b>	<b>\$6866</b>	<b>\$7635</b>	<b>\$8020</b>	<b>\$8733</b>	<b>\$9725</b>	<b>\$10951</b>	
	Wood													
		OVERALL DIMENSIONS			SEAT DIMENSIONS			BACK DIMENSIONS						
		W	D	H	W	D	H	W	H					
		75	32	33	71	20	17.25	71	16					
		Active weight 350 lbs./seat Urethane armcap option - <b>Add \$130 list upcharge</b>												

**PRIMACARE FULLY UPHOLSTERED LOUNGE**



model GC3676HB



model GC3677

**STANDARD FEATURES**

- Primacare is a family of products offering the most significant return on investment approach in the industry since every component can be repaired or replaced on site.
- Standard with fully upholstered arms and Black urethane legs.
- Solid hardwood frame with die cast zinc connectors and metal-to-metal fastening.
- Replaceable seat covers and replaceable and/or removable seat cushions are standard.
- Waterfall cleanout between the seat and back cushions.
- Models are standard with metal mesh seat deck. For behavioral health applications, the metal mesh seat deck can be covered with a solid moisture resistant surface, held in place with tamperproof fasteners. Contact your sales rep for a special quotation.
- All seat frames feature a wall saver design to prevent back contact with wall.
- For healthcare textile options, visit the website at [www.globalfurnituregroup.com](http://www.globalfurnituregroup.com).
- Can be upholstered in standard Global textiles if healthcare compliance is not required.
- Shipped fully assembled.

**OPTIONAL FEATURES**

- Optional urethane armcaps available in the following finishes: Black (**BLK**), Latte (**LAB**), Kalua (**KAL**), Mocha (**J52**), Shadow (**SHW**), and Toast (**TOA**). Add \$468.
- Optional wood legs and armcaps available in the following finishes: Absolute (AAM), Cherry (ACM), English Oak (EOM), Espresso Cafe (ECM), Fruitwood (TFM), Gray (HGM), Honey (AHM), Jet Onyx (JOM), Mahogany (TMM), Maple (AVM), Medium Walnut (MWM), Natural Walnut (NLW), Night (ASM), Noce Biondo (NBM), Noce Grigio (NGM), Noce Leggero (NEM), Noce Medio (NMM), Sandy Beach (SBM), Walnut (TWM), White (WHM), WC Cream (WTM) and Winter Cherry (WCM). See features column for upcharges.
- When specified with armcaps: armcaps are securely fastened with metal-to-metal connectors which allow for field replacement if required.
- For moisture barrier on seat, please specify (**MB**). **Add \$204** list upcharge per seat.
- To add sealed seams to your product contact Customer Care. Upcharges vary.
- For Primacare tables, see page 52

**SUGGESTED APPLICATIONS**

- Guest seating
- Patient rooms
- Lobbies
- Resident rooms
- Lounge/Waiting

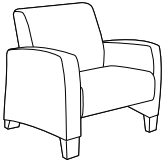
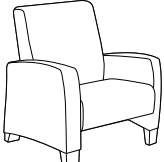
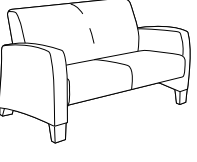
DESCRIPTION	MODEL# / FEATURES	STANDARD TEXTILE GRADES											
		COM	2	3	4	5	6	7	8	9	10	11	12
 <p><b>Lounge Chair, Fully Upholstered Arms, Urethane legs</b> COM Yardage: 6.25 Freight Class: 250 Product Weight (lbs.): 95 Cubic Feet Per Carton: 29.5</p> <p>Active weight 350 lbs.</p> <p>Optional wood legs - no charge. Urethane or wood armcap option - <b>Add \$468 list upcharge</b></p>	<b>GC3676</b>	\$2451	\$2678	\$2865	\$3138	\$3527	\$3674	\$4015	\$4656	\$4976	\$5571	\$6398	\$7420
				<b>OVERALL DIMENSIONS</b>			<b>SEAT DIMENSIONS</b>			<b>BACK DIMENSIONS</b>			
				<b>W</b>	<b>D</b>	<b>H</b>	<b>W</b>	<b>D</b>	<b>H</b>	<b>W</b>	<b>H</b>		
			32.5	29	33	23	20	17.25	23	16			
 <p><b>HB Lounge Chair, Fully Upholstered Arms, Urethane legs</b> COM Yardage: 6.5 Freight Class: 250 Product Weight (lbs.): 114 Cubic Feet Per Carton: 29.5</p> <p>Active weight 350 lbs.</p> <p>Optional wood legs - no charge. Urethane or wood armcap option - <b>Add \$468 list upcharge</b></p>	<b>GC3676HB</b>	\$2515	\$2779	\$2999	\$3319	\$3772	\$3946	\$4343	\$5093	\$5467	\$6166	\$7132	\$8327
				<b>OVERALL DIMENSIONS</b>			<b>SEAT DIMENSIONS</b>			<b>BACK DIMENSIONS</b>			
				<b>W</b>	<b>D</b>	<b>H</b>	<b>W</b>	<b>D</b>	<b>H</b>	<b>W</b>	<b>H</b>		
			32.5	29	36	23	20	17.25	23	19			
 <p><b>Two Seat Sofa, Fully Upholstered Arms, Urethane legs</b> COM Yardage: 7.5 Freight Class: 250 Product Weight (lbs.): 135 Cubic Feet Per Carton: 56.25</p> <p>Active weight 350 lbs.</p> <p>Optional wood legs - no charge. Urethane or wood armcap option - <b>Add \$468 list upcharge</b></p>	<b>GC3677</b>	\$3594	\$3863	\$4088	\$4415	\$4882	\$5060	\$5466	\$6234	\$6621	\$7333	\$8326	\$9552
				<b>OVERALL DIMENSIONS</b>			<b>SEAT DIMENSIONS</b>			<b>BACK DIMENSIONS</b>			
				<b>W</b>	<b>D</b>	<b>H</b>	<b>W</b>	<b>D</b>	<b>H</b>	<b>W</b>	<b>H</b>		
			55.5	29	33	45.5	20	17.25	45.5	16			

# SEATING

# PRIMACARE™ FULLY UPHOLSTERED LOUNGE

P

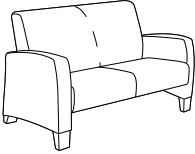
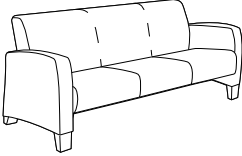
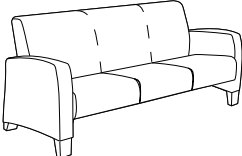
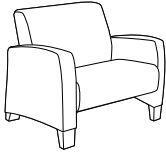
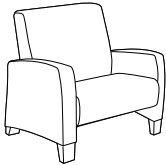
DESCRIPTION	MODEL#	STANDARD FABRIC GRADES											
		COM	2	3	4	5	6	7	8	9	10	11	12
 <p><b>GC3677HB</b></p> <p>Active weight 350 lbs.</p> <p><b>HB Two Seat Sofa, Fully Upholstered Arms, Urethane legs</b>            COM Yardage: 7.75            Freight Class: 250            Product Weight (lbs.): 142            Cubic Feet Per Carton: 56.25</p> <p>Optional wood legs - no charge.            Urethane or wood armcap option - <b>Add \$468 list upcharge</b></p>		COM	2	3	4	5	6	7	8	9	10	11	12
	\$3747	\$4064	\$4323	\$4708	\$5248	\$5453	\$5928	\$6822	\$7267	\$8100	\$9251	\$10677	
	<b>OVERALL DIMENSIONS</b>			<b>SEAT DIMENSIONS</b>			<b>BACK DIMENSIONS</b>						
	W	D	H	W	D	H	W	H					
	55.5	29	36	45.5	20	17.25	45.5	19					
 <p><b>GC3678</b></p> <p>Active weight 350 lbs.</p> <p><b>Three Seat Sofa, Fully Upholstered Arms, Urethane legs</b>            COM Yardage: 9            Freight Class: 250            Product Weight (lbs.): 181            Cubic Feet Per Carton: 69.5</p> <p>Optional wood legs - no charge.            Urethane or wood armcap option - <b>Add \$468 list upcharge</b></p>		COM	2	3	4	5	6	7	8	9	10	11	12
	\$4977	\$5303	\$5571	\$5967	\$6525	\$6738	\$7229	\$8149	\$8611	\$9469	\$10657	\$12128	
	<b>OVERALL DIMENSIONS</b>			<b>SEAT DIMENSIONS</b>			<b>BACK DIMENSIONS</b>						
	W	D	H	W	D	H	W	H					
	78.5	29	33	68.5	20	17.25	68.5	16					
 <p><b>GC3678HB</b></p> <p>Active weight 350 lbs.</p> <p><b>HB Three Seat Sofa, Fully Upholstered Arms, Urethane legs</b>            COM Yardage: 9.25            Freight Class: 250            Product Weight (lbs.): 188            Cubic Feet Per Carton: 69.5</p> <p>Optional wood legs - no charge.            Urethane or wood armcap option - <b>Add \$468 list upcharge</b></p>		COM	2	3	4	5	6	7	8	9	10	11	12
	\$5228	\$5605	\$5915	\$6370	\$7019	\$7264	\$7829	\$8895	\$9430	\$10422	\$11796	\$13496	
	<b>OVERALL DIMENSIONS</b>			<b>SEAT DIMENSIONS</b>			<b>BACK DIMENSIONS</b>						
	W	D	H	W	D	H	W	H					
	78.5	29	36	68.5	20	17.25	68.5	19					
 <p><b>GC3679</b></p> <p>Active weight 500 lbs.</p> <p><b>Bariatric Lounge Chair, Fully Upholstered Arms, Urethane legs</b>            COM Yardage: 6.5            Freight Class: 250            Product Weight (lbs.): 107            Cubic Feet Per Carton: 37.75</p> <p>Optional wood legs - no charge.            Urethane or wood armcap option - <b>Add \$468 list upcharge</b></p>		COM	2	3	4	5	6	7	8	9	10	11	12
	\$3379	\$3614	\$3809	\$4095	\$4496	\$4652	\$5007	\$5671	\$6004	\$6623	\$7484	\$8542	
	<b>OVERALL DIMENSIONS</b>			<b>SEAT DIMENSIONS</b>			<b>BACK DIMENSIONS</b>						
	W	D	H	W	D	H	W	H					
	42	29	33	32	20	17.25	32	16					
 <p><b>GC3679HB</b></p> <p>Active weight 500 lbs.</p> <p><b>HB Bariatric Lounge Chair, Fully Upholstered Arms, Urethane legs</b>            COM Yardage: 6.75            Freight Class: 250            Product Weight (lbs.): 121            Cubic Feet Per Carton: 37.75</p> <p>Optional wood legs - no charge.            Urethane or wood armcap option - <b>Add \$468 list upcharge</b></p>		COM	2	3	4	5	6	7	8	9	10	11	12
	\$3491	\$3766	\$3992	\$4326	\$4798	\$4979	\$5389	\$6169	\$6557	\$7281	\$8286	\$9524	
	<b>OVERALL DIMENSIONS</b>			<b>SEAT DIMENSIONS</b>			<b>BACK DIMENSIONS</b>						
	W	D	H	W	D	H	W	H					
	42	29	36	32	20	17.25	32	19					

PRIMACARE WINGBACK



model GC3694HB



model GC3692HB

STANDARD FEATURES



- Primacare is a family of products offering the most significant return on investment approach in the industry since every component can be repaired or replaced on site.
- Legs and armcaps are available in urethane (6 colors) or wood, with upcharge.
- Legs are standard with white nylon glides (1"OD, 0.5" thick)
- Easy grip forward extending armcaps are securely fastened with metal-to-metal connectors which allow for field replacement if required.
- For added comfort, seat and back are standard with high density foam.
- Replaceable seat covers and replaceable and/or removable seat cushions are standard.
- Seat cushion has a seamless waterfall front and clean out between and around the seat and back cushions.
- Models are standard with metal mesh seat deck. For mental health applications, the metal mesh seat deck can be covered with a solid moisture resistant surface, held in place with tamperproof fasteners. Contact your sales rep for a special quotation.
- For healthcare textile options, visit the website at [globalfurnituregroup.com](http://globalfurnituregroup.com)
- Can be upholstered in standard Global textiles if healthcare compliance is not required.



OPTIONAL FEATURES

- Optional urethane legs and armcaps available in the following finishes: Black (BLK), Latte (LAB), Kalua (KAL), Mocha (J52), Shadow (SHW) and Toast (TOA). No upcharge.
- For optional wood legs and armcaps, refer to the Seating wood finishes in the Textiles + Finishes section.  
For wood armcaps: Add \$143  
For wood legs: Add \$169
- For moisture barrier on seat, please specify (MB).  
For single seat model, add \$161.  
For two seat model, add \$320.  
For bariatric model, add \$214.  
For standard ottoman, add \$137.  
For bariatric ottoman, add \$209.
- To add sealed seams to your product, contact Customer Care. Upcharges vary.
- For Primacare tables, see page 52

SUGGESTED APPLICATIONS

- Bariatric seating
- Lobbies
- Lounge/Waiting
- Guest seating
- Patient rooms
- Resident rooms

DESCRIPTION	MODEL# / FEATURES	STANDARD TEXTILE GRADES											
		COM	2	3	4	5	6	7	8	9	10	11	12
 <p><b>Single Seat Wingback Armchair</b> COM Yardage: 6.25 Freight Class: 250 Product weight (lbs.): 94 Cubic Feet Per Carton: 29</p>	<b>GC3691HB</b>	\$3439	\$3650	\$3816	\$4060	\$4403	\$4547	\$4845	\$5312	\$5662	\$6045	\$6842	\$7681
	Active weight 350 lbs.	<b>OVERALL DIMENSIONS</b>			<b>SEAT DIMENSIONS</b>			<b>BACK DIMENSIONS</b>					
		<b>W</b>	<b>D</b>	<b>H</b>	<b>W</b>	<b>D</b>	<b>H</b>	<b>W</b>	<b>H</b>				
		30.5	28.5	45.5	22.5	18	19	19	26				
 <p><b>Two Seat Wingback Armchair</b> COM Yardage: 9.5 Freight Class: 250 Product weight (lbs.): 163 Cubic Feet Per Carton: 52.5</p>	<b>GC3692HB</b>	\$4743	\$5063	\$5315	\$5685	\$6206	\$6427	\$6878	\$7589	\$8121	\$8702	\$9914	\$11188
	Active weight 350 lbs/seat.	<b>OVERALL DIMENSIONS</b>			<b>SEAT DIMENSIONS</b>			<b>BACK DIMENSIONS</b>					
		<b>W</b>	<b>D</b>	<b>H</b>	<b>W</b>	<b>D</b>	<b>H</b>	<b>W</b>	<b>H</b>				
		57.5	28.5	45.5	50	18	19	45	26				
 <p><b>Bariatric Single Seat Wingback Armchair</b> COM Yardage: 8.25 Freight Class: 250 Product weight (lbs.): 130 Cubic Feet Per Carton: 35.5</p>	<b>GC3694HB</b>	\$3896	\$4174	\$4393	\$4715	\$5167	\$5358	\$5751	\$6368	\$6830	\$7335	\$8387	\$9494
	Active weight 600 lbs.	<b>OVERALL DIMENSIONS</b>			<b>SEAT DIMENSIONS</b>			<b>BACK DIMENSIONS</b>					
		<b>W</b>	<b>D</b>	<b>H</b>	<b>W</b>	<b>D</b>	<b>H</b>	<b>W</b>	<b>H</b>				
		38	28.5	45.5	31	18	19	26.5	26				

DESCRIPTION	MODEL#	STANDARD FABRIC GRADES											
		COM	2	3	4	5	6	7	8	9	10	11	12
 <p><b>Standard Size Ottoman</b> COM Yardage: 1.25 Freight Class: 250 Product weight (lbs.): 17 Cubic Feet Per Carton: 4.7</p>	<b>GC3695</b>	\$927	\$968	\$1009	\$1063	\$1143	\$1178	\$1248	\$1360	\$1446	\$1542	\$1740	\$1950
	Active weight 350 lbs.	<b>OVERALL DIMENSIONS</b>			<b>SEAT DIMENSIONS</b>			<b>BACK DIMENSIONS</b>					
		<b>W</b>	<b>D</b>	<b>H</b>	<b>W</b>	<b>D</b>	<b>H</b>	<b>W</b>	<b>H</b>				
		23	18	15.75	-	-	-	-	-				
 <p><b>Bariatric Ottoman</b> COM Yardage: 1.75 Freight Class: 250 Product Weight (lbs.): 20 Cubic Feet Per Carton: 9</p>	<b>GC3696</b>	\$1170	\$1231	\$1286	\$1363	\$1470	\$1523	\$1620	\$1776	\$1898	\$2032	\$2308	\$2601
	Active weight 500 lbs.	<b>OVERALL DIMENSIONS</b>			<b>SEAT DIMENSIONS</b>			<b>BACK DIMENSIONS</b>					
		<b>W</b>	<b>D</b>	<b>H</b>	<b>W</b>	<b>D</b>	<b>H</b>	<b>W</b>	<b>H</b>				
		31.25	18	15.75	-	-	-	-	-				

PRIMACARE RECLINERS



model GC3605 (shown with optional headrest GC3607)



model GC3606

STANDARD FEATURES

- Designed for space conscious environments (fully reclines with only 9" of wall clearance).
- Built to withstand the rigors of high use environments (seat and back feature heavy-gauge no-sag springs and a painted steel seat frame).
- Removable covers on the seat and back allow for easy cleaning, maintenance or replacement.
- The back is ergonomically designed to follow the natural spinal curve and includes integrated lumbar support.
- The back cushion has a matching removable cloth cover over the upper back cushion held in place with Velcro for easy adjustment or removal for cleaning and replacement. An add-on, contoured adjustable headrest is available, sold separately. Specify GC3607.
- For added comfort, seats are standard with high density Ultracell foam
- Waterfall seamless front upholstered design with removable seat cushion for easy cleaning and protection against bacteria.
- Primacare recliners are offered with easy grip forward extending armcaps, securely fastened with metal-to-metal connectors, allowing for field replacement if required. Armcaps are offered in wood (on both GC3605 and GC3606 models) and urethane (on GC3605 model only).
- Recline release handles are located below both armrests for easy access and activation.
- Recliner mechanism frame rests on rubber glides, supporting the chair. Legs and casters are not available.
- Sealed seat seams are available on approved coated textiles (vinyl, etc.), see upcharges. Note: minor puckering is common with the addition of sealed seams due to material buildup at corners.
- For a moisture barrier on seat, specify **(MB)**. Moisture barrier is not recommended with water resistant textiles and may not be used in conjunction with sealed seams.
- Active weight capacity is 350 lbs.
- For healthcare textile options, visit the website at [globalfurnituregroup.com](http://globalfurnituregroup.com).
- Primacare is covered under Global Healthcare 12 year, 24/7 warranty when upholstered with minimum 100,000 DR textile, maintained using the textile's recommended chemicals and procedures.
- Can be upholstered in standard Global textiles if healthcare compliance is not required.
- Shipped easy to assemble.

Add option codes in the following order:

- **Model number**  
Specify model number.
- **Textile**  
Specify textile code.
- **Armcap finish**  
**Wood** (no upcharge):
 

<b>(AAM)</b> Absolute	<b>(ASM)</b> Night
<b>(ACM)</b> Cherry	<b>(NBM)</b> Noce Biondo
<b>(EOM)</b> English Oak	<b>(NGM)</b> Noce Grigio
<b>(ECM)</b> Espresso Cafe	<b>(NEM)</b> Noce Leggero
<b>(TFM)</b> Fruitwood	<b>(NMM)</b> Noce Medio
<b>(HGM)</b> Grey	<b>(SBM)</b> Sandy Beach
<b>(AHM)</b> Honey	<b>(SKM)</b> Shaker Cherry
<b>(JOM)</b> Jet Onyx	<b>(TWM)</b> Walnut
<b>(TMM)</b> Mahogany	<b>(WTM)</b> WC Cream
<b>(AVM)</b> Maple	<b>(WHM)</b> White
<b>(MWM)</b> Medium Walnut	<b>(WCM)</b> Winter Cherry
- **Urethane armcap finishes:** Available on GC3605 only, add \$274.
 

<b>(BLK)</b> Black	<b>(J52)</b> Mocha
<b>(KAL)</b> Kalua	<b>(SHW)</b> Shadow
<b>(LAB)</b> Latte	<b>(TOA)</b> Toast
- **Seat Moisture Barrier** (not available with sealed seams)  
**(NB)** No moisture barrier. No upcharge.  
**(MB)** Moisture Barrier. Add \$204.
- **Sealed Seams** (not available with moisture barrier)  
**(STD)** No sealed seams.  
**(SEALS)** Sealed seat seams (not available with moisture barrier. Add \$320.
- For Primacare tables, see page 52



SUGGESTED APPLICATIONS

- Guest seating
- Lobbies
- Lounge/Waiting
- Patient rooms
- Resident rooms
- Treatment/Exam rooms

# SEATING

# PRIMACARE™ RECLINERS

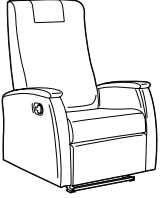
P

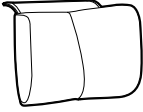
DESCRIPTION	MODEL# / FEATURES	STANDARD TEXTILE GRADES											
		COM	2	3	4	5	6	7	8	9	10	11	12
 <p><b>Recliner, Solid Wood Armcaps, Full Span</b>                      COM Yardage: 6.5                      Freight Class: 150                      Product Weight (lbs.): 110                      Cubic Feet Per Carton: 22.75</p>	<b>GC3605</b>	\$3421	\$3643	\$4014	\$4301	\$4702	\$4858	\$5208	\$5877	\$6211	\$6827	\$7685	\$8751
		<b>OVERALL DIMENSIONS</b> W    D    H			<b>SEAT DIMENSIONS</b> W    D    H			<b>BACK DIMENSIONS</b> W    H					
	Head mat & replaceable seat cushion. Active weight 350 lbs. Urethane armcap option - <b>Add \$274 list upcharge</b> • <i>Not available with casters</i>	29.5	34.5	45.5	21.5	20	17	21.5	28				
 <p><b>Recliner, Solid Wood Armcaps, Front Only</b>                      COM Yardage: 6.5                      Freight Class: 150                      Product Weight (lbs.): 110                      Cubic Feet Per Carton: 22.75</p>	<b>GC3606</b>	\$3245	\$3467	\$3828	\$4115	\$4518	\$4672	\$5026	\$5692	\$6026	\$6643	\$7503	\$8566
		<b>OVERALL DIMENSIONS</b> W    D    H			<b>SEAT DIMENSIONS</b> W    D    H			<b>BACK DIMENSIONS</b> W    H					
	Head mat & replaceable seat cushion. Active weight 350 lbs. • <i>Not available with casters</i>	29.5	34.5	45.5	21.5	20	17	21.5	28				
 <p><b>Headrest for Primacare Recliners</b>                      COM Yardage: 1.25                      Freight Class: 250                      Product Weight (lbs.): 3                      Cubic Feet Per Carton: 1</p>	<b>GC3607</b>	\$143	\$184	\$235	\$290	\$368	\$400	\$465	\$593	\$657	\$776	\$941	\$1146
		<b>OVERALL DIMENSIONS</b> W    D    H			<b>SEAT DIMENSIONS</b> W    D    H			<b>BACK DIMENSIONS</b> W    H					
		14	4	9.5									

**PRIMACARE MOTION RECLINERS**

**STANDARD FEATURES**



model GC3608M (shown with optional casters)

- Primacare Motion Recliner offers 3 recline positions with optional reverse recline position, providing the perfect comfort for relaxation, recovery and quiet moments of rest in private or public areas. Offered with fixed arms, fold-down arms, individual locking casters and central locking casters.
- Primacare Motion Recliners include standard base, "M" suffix models and central locking caster, "C" suffix models.
- Models are available with fold-down arm(s) on left, right or both sides of chair. Fold-down arms include a black knob, located on the back of the arm. To activate, pull knob and gently fold arm down. To secure, fold arm back up. Note: handed models and options are defined from the user's view.
- All motion recliners include standard features such as removable seat and back covers, and a replaceable Ultracell foam seat cushion with a waterfall front edge.
- Ultracell back foam is designed to support and follow the natural curve of the spine with integrated lumbar support.
- The back cushion has a matching removable cloth cover over the upper back cushion held in place with Velcro for easy adjustment or removal for cleaning and replacement. An add-on, contoured adjustable headrest is available, sold separately. Specify GC3607.

**Two Textile Application**



- A cleanout gap is standard on both sides of the seat cushion.
- Seat and back deck construction are a heavy gauge no-sag spring design with a painted steel seat frame.
- Models are standard with Urethane, easy grip forward extending armcaps.
- Wood and solid surface armcaps are available, see upcharges.
- Armcaps are securely fastened with metal-to-metal connectors and are field replaceable.
- Models without central locking casters are standard with wood legs (WOD) and available with 3" manual locking casters (CST), see upcharge.
- Models may be specified with contrasting fabrics. Specify seat cushion separate from back, arms and footrest. *Note: the blended textile matrix is not applicable to this series when specified as noted above.*
- For healthcare textiles, visit the website at [globalfurnituregroup.com](http://globalfurnituregroup.com).
- Primacare is covered under Global Healthcare 12 year, 24/7 warranty when upholstered with minimum 100,000 DR textile, maintained using the textile's recommended chemicals and procedures.
- Can be upholstered in standard Global textiles if healthcare compliance is not required.
- Warranted to support up to 400 lbs. active weight capacity.
- Shipped partially knocked down.

**MOBILITY OPTIONS**

- For manual locking caster option (CST), select casters configured with front fixed, rear swivel for ease of steering (LCF), or with four swivel for ease of positioning in tight spaces (LCS).
- Models with "C" suffix are standard with central locking casters with lock, steer and move, multi-function foot activation paddle, located on either side of the chair.

- Central locking caster control: red paddle end down locks the caster, keeping the chair in place. Green paddle down fixes the rear casters with swivel front casters for directional steering of the chair. Paddle in horizontal position leaves chair to move in any direction.
- A polished Chrome push bar handle (PBR) option is available for models specified with casters (and central locking casters) to aid in movement of the chair. See upcharge. *Note: Primacare Motion Recliner is not for use as a patient transfer chair.*

**ACCESSORIES**

- A Black, phenolic tablet arm with spill collector groove is available. Specify right (RT), left (LT) or both sides (TB) of the chair. See upcharges. Each tablet adds 4" to the width of the chair. Tablet requires 5.5" of clearance to operate. The tablet pivots for use and stores by lifting gently and rotating down to the side of the chair. Tablets are not compatible on fold-down arms.
- A foot tray (FT) is available, see upcharge. The Gray laminate surface has a Black edge and slides out from below the chair to support users' feet when footrest isn't extended. Tray supports up to 40lbs. The tray is not a step.
- Caregiver activated reverse recline (RR) is available, providing a 4th extended recline position, see upcharge. To activate, with chair in the fully reclined position, step down on the Black lever, located below either arm, and push down on the back rest.
- Accessory hook (AH) is available. Specify right (AHR), left (AHL), or both (AHB). See upcharges.
- For moisture barrier on seat, specify (MB). Moisture barrier is not recommended with water resistant textiles and may not be used in conjunction with sealed seams.
- Sealed seams are available on approved coated textiles (vinyl, etc.), specify (SBS) for back and arms and/or (SSS) for seat, see upcharges. Note: minor puckering is common with the addition of sealed seams due to material buildup at corners.

Add option codes in the following order:



- **Model number**  
Specify model number.
- **Back and arm textile**  
Specify textile code. See model grade upcharges.
- **Seat textile**  
Specify textile code. See model grade upcharges.
- **Armcap type**  
(SSU) Urethane armcaps, standard  
(WOD) Wood armcaps, Add \$144.  
(CO) Solid surface armcap. See grade upcharge.
- **Armcap finish (urethane)**  
(BLK) Black (J52) Mocha  
(KAL) Kalua (SHW) Shadow  
(LAB) Latte (TOA) Toast
- **Armcap finish (solid surface)**  
Grade 1 - Add \$973:  
(SWH) Designer White  
Grade 2 - Add \$1049:  
(SBT) Beige Tempest  
(SBX) Black Onyx Mirage  
(SMG) Milk Glass Spectra  
(SFW) Frosty White Mirage  
(SHS) Hot Stone  
(SNM) Northern Melange





- **Armcap finish (wood)**  
(AAM) Absolute (MWM) Medium Walnut  
(BKM) Black (NLW) Natural Walnut  
(ACM) Cherry (ASM) Night  
(EOM) English Oak (NBM) Noce Biondo  
(ECM) Espresso Cafe (NGM) Noce Grigio  
(TFM) Fruitwood (NEM) Noce Leggero  
(HGM) Grey (NMM) Noce Medio  
(AHM) Honey (SBM) Sandy Beach  
(JOM) Jet Onyx (SKM) Shaker Cherry  
(TMM) Mahogany (TWM) Walnut  
(AVM) Maple (WTM) WC Cream  
(WHM) White (WCM) Winter Cherry
- **Base Type** (for models without central locking casters)  
(WOD) Wood leg (standard)  
(CST) Casters. Add \$69.
- **Leg Finish** (for wood (WOD) base type)  
(AAM) Absolute (MWM) Medium Walnut  
(BKM) Black (NLW) Natural Walnut  
(ACM) Cherry (ASM) Night  
(EOM) English Oak (NBM) Noce Biondo  
(ECM) Espresso Cafe (NGM) Noce Grigio  
(TFM) Fruitwood (NEM) Noce Leggero  
(HGM) Grey (NMM) Noce Medio  
(AHM) Honey (SBM) Sandy Beach  
(JOM) Jet Onyx (SKM) Shaker Cherry  
(TMM) Mahogany (TWM) Walnut  
(AVM) Maple (WTM) WC Cream  
(WHM) White (WCM) Winter Cherry
- **Caster** (for casters (CST) base type)  
(LCF) 3" Gray manual locking front fixed and rear casters for most floor surfaces.  
(LCS) 3" Gray manual locking all swivel casters for most floor surfaces.
- **Pushbar**  
(NPB) No pushbar  
(PBR) Chrome pushbar. Add \$108.
- **Foot Tray**  
(NT) No foot tray  
(FT) Foot tray. Add \$315.
- **Accessory hook**  
Please check applicable options for each model.  
(NH) No accessory hook.  
(AHR) Accessory hook, Right. Add \$27.  
(AHL) Accessory hook, Left. Add \$27.  
(AHB) Accessory hook, Left and Right. Add \$53.
- **Reverse Recline**  
(NR) No reverse recline  
(RR) Reverse recline. Add \$163.
- **Tablet**  
(NT) No tablet  
(LT) Left tablet. Add \$937.  
(RT) Right tablet. Add \$937.  
(TB) Left and right tablets. Add \$1874.
- **Back and arm seams** (Contact Customer Care for approved textiles.)  
(NS) No sealed seams.  
(SBS) Sealed back and arm seams. Add \$135.
- **Seat seams** (Contact Customer Care for approved textiles.)  
(NS) No sealed seams.  
(SSS) Sealed seat seams. Add \$53.
- **Moisture Barrier** (seat only, not available with sealed seams)  
(NB) No moisture barrier. No upcharge.  
(MB) Moisture barrier. Add \$160.

EXAMPLE PRIMACARE MOTION RECLINER ORDER CODE:

GC3608M	-WA50	-WA50	-SSU	-TOA	-CST	-LCF	-NPB	-NFT	-NH	-NR	-NT	-NS	-NS	-NB
Model #	Back/arms textile	Seat textile	Armcap type	Armcap finish	Base type	Caster type	Pushbar	Foot Tray	Accessory Hook	Reverse Recline	Tablet	Sealed Back Seams	Sealed Seat Seams	Moisture Barrier



DESCRIPTION	FEATURES	MODEL#			STANDARD TEXTILE GRADES											
		1/COM	2	3	4	5	6	7	8	9	10	11	12			
 <p><b>Motion Recliner</b> COM Yardage: Back/Arms: 5; Seat: 1.5 Freight Class: 150 Product Weight (lbs.): 133 Cubic Feet Per Carton: 27.75</p>	GC3608M	Base Price:	\$3717													
	Back/Arm upcharge:	\$-160	+0	+\$125	+\$310	+\$570	+\$680	+\$905	+\$1260	+\$1525	+\$1815	+\$2420	+\$3055			
	Seat upcharge:	\$-48	+0	+\$38	+\$93	+\$171	+\$204	+\$272	+\$378	+\$458	+\$545	+\$726	+\$917			
	<b>OVERALL DIMENSIONS</b>			<b>SEAT DIMENSIONS</b>			<b>BACK DIMENSIONS</b>									
		W	D	H	W	D	H	W	H							
	30	39	46.5	24	20	20	22.5	29								
	Accepts RT, LT, or TB tablet.		Accepts AHR, AHL or AHB accessory hook.		Active weight 400 lbs.		RTA 1		1 per carton							
 <p><b>Motion Recliner, Right fold down arm</b> COM Yardage: Back/Arms: 5.25; Seat: 1.5 Freight Class: 150 Product Weight (lbs.): 134 Cubic Feet Per Carton: 27.75</p>	GC3618MFR	Base Price:	\$4784													
	Back/Arm upcharge:	\$-168	+0	+\$132	+\$326	+\$599	+\$714	+\$951	+\$1323	+\$1602	+\$1906	+\$2541	+\$3208			
	Seat upcharge:	\$-48	+0	+\$38	+\$93	+\$171	+\$204	+\$272	+\$378	+\$458	+\$545	+\$726	+\$917			
	<b>OVERALL DIMENSIONS</b>			<b>SEAT DIMENSIONS</b>			<b>BACK DIMENSIONS</b>									
		W	D	H	W	D	H	W	H							
	30	39	46.5	24	20	20	22.5	29								
	Accepts LT tablet.		Accepts AHL accessory hook.		Active weight 400 lbs.		RTA 1		1 per carton							
 <p><b>Motion Recliner, Left fold down arm</b> COM Yardage: Back/Arms: 5.25; Seat: 1.5 Freight Class: 150 Product Weight (lbs.): 134 Cubic Feet Per Carton: 27.75</p>	GC3618MFL	Base Price:	\$4784													
	Back/Arm upcharge:	\$-168	+0	+\$132	+\$326	+\$599	+\$714	+\$951	+\$1323	+\$1602	+\$1906	+\$2541	+\$3208			
	Seat upcharge:	\$-48	+0	+\$38	+\$93	+\$171	+\$204	+\$272	+\$378	+\$458	+\$545	+\$726	+\$917			
	<b>OVERALL DIMENSIONS</b>			<b>SEAT DIMENSIONS</b>			<b>BACK DIMENSIONS</b>									
		W	D	H	W	D	H	W	H							
	30	39	46.5	24	20	20	22.5	29								
	Accepts RT tablet.		Accepts AHR accessory hook.		Active weight 400 lbs.		RTA 1		1 per carton							

DESCRIPTION	FEATURES	MODEL#	STANDARD TEXTILE GRADES											
			1/COM	2	3	4	5	6	7	8	9	10	11	12
 <p><b>Motion Recliner, Right &amp; Left fold down arms</b> COM Yardage: Back/Arms: 5.5; Seat: 1.5 Freight Class: 150 Product Weight (lbs.): 135 Cubic Feet Per Carton: 27.75</p>	<b>GC3618MFB</b> Base Price:  Back/Arm upcharge:  Seat upcharge:	\$5851												
		\$-176 +0 +\$138 +\$341 +\$627 +\$748 +\$996 +\$1386 +\$1678 +\$1997 +\$2662 +\$3361												
		\$-48 +0 +\$38 +\$93 +\$171 +\$204 +\$272 +\$378 +\$458 +\$545 +\$726 +\$917												
	<b>OVERALL DIMENSIONS</b>			<b>SEAT DIMENSIONS</b>			<b>BACK DIMENSIONS</b>							
	W D H			W D H			W H							
	30 39 46.5			24 20 20			22.5 29							
<p>Does not accept tablet. Accessory hook by special request. Active weight 400 lbs.</p>		RTA 1	1 per carton											
 <p><b>Motion Recliner, central locking casters</b> COM Yardage: Back/Arms: 5; Seat: 1.5 Freight Class: 250 Product Weight (lbs.): 149 Cubic Feet Per Carton: 43.25</p>	<b>GC3608MC</b> Base Price:  Back/Arm upcharge:  Seat upcharge:	\$6068												
		\$-160 +0 +\$125 +\$310 +\$570 +\$680 +\$905 +\$1260 +\$1525 +\$1815 +\$2420 +\$3055												
		\$-48 +0 +\$38 +\$93 +\$171 +\$204 +\$272 +\$378 +\$458 +\$545 +\$726 +\$917												
	<b>OVERALL DIMENSIONS</b>			<b>SEAT DIMENSIONS</b>			<b>BACK DIMENSIONS</b>							
	W D H			W D H			W H							
	30 39 46.5			24 20 20			22.5 29							
<p>Accepts RT, LT, or TB tablet. Accepts AHR, AHL or AHB accessory hook. Active weight 400 lbs.</p>		RTA 1	1 per carton											
 <p><b>Motion Recliner, Right fold down arm, central locking casters</b> COM Yardage: Back/Arms: 5.25; Seat: 1.5 Freight Class: 150 Product Weight (lbs.): 134 Cubic Feet Per Carton: 27.75</p>	<b>GC3618MFRC</b> Base Price:  Back/Arm upcharge:  Seat upcharge:	\$6926												
		\$-168 +0 +\$132 +\$326 +\$599 +\$714 +\$951 +\$1323 +\$1602 +\$1906 +\$2541 +\$3208												
		\$-48 +0 +\$38 +\$93 +\$171 +\$204 +\$272 +\$378 +\$458 +\$545 +\$726 +\$917												
	<b>OVERALL DIMENSIONS</b>			<b>SEAT DIMENSIONS</b>			<b>BACK DIMENSIONS</b>							
	W D H			W D H			W H							
	34.5 39 46.5			24 20 20			22.5 29							
<p>Accepts LT tablet. Accepts AHL accessory hook. Active weight 400 lbs.</p>		RTA 1	1 per carton											
 <p><b>Motion Recliner, Left fold down arm, central locking casters</b> COM Yardage: Back/Arms: 5.25; Seat: 1.5 Freight Class: 250 Product Weight (lbs.): 150 Cubic Feet Per Carton: 43.25</p>	<b>GC3618MFLC</b> Base Price:  Back/Arm upcharge:  Seat upcharge:	\$6926												
		\$-168 +0 +\$132 +\$326 +\$599 +\$714 +\$951 +\$1323 +\$1602 +\$1906 +\$2541 +\$3208												
		\$-48 +0 +\$38 +\$93 +\$171 +\$204 +\$272 +\$378 +\$458 +\$545 +\$726 +\$917												
	<b>OVERALL DIMENSIONS</b>			<b>SEAT DIMENSIONS</b>			<b>BACK DIMENSIONS</b>							
	W D H			W D H			W H							
	34.5 39 46.5			24 20 20			22.5 29							
<p>Accepts RT tablet. Accepts AHR accessory hook. Active weight 400 lbs.</p>		RTA 1	1 per carton											
 <p><b>Motion Recliner, Right &amp; Left fold down arms, central locking casters</b> COM Yardage: Back/Arms: 5.5; Seat: 1.5 Freight Class: 250 Product Weight (lbs.): 151 Cubic Feet Per Carton: 43.25</p>	<b>GC3618MFBC</b> Base Price:  Back/Arm upcharge:  Seat upcharge:	\$7923												
		\$-176 +0 +\$138 +\$341 +\$627 +\$748 +\$996 +\$1386 +\$1678 +\$1997 +\$2662 +\$3361												
		\$-48 +0 +\$38 +\$93 +\$171 +\$204 +\$272 +\$378 +\$458 +\$545 +\$726 +\$917												
	<b>OVERALL DIMENSIONS</b>			<b>SEAT DIMENSIONS</b>			<b>BACK DIMENSIONS</b>							
	W D H			W D H			W H							
	34.5 39 46.5			24 20 20			22.5 29							
<p>Does not accept tablet. Accessory hook by special request. Active weight 400 lbs.</p>		RTA 1	1 per carton											

DESCRIPTION	MODEL#	STANDARD FABRIC GRADES											
		COM	2	3	4	5	6	7	8	9	10	11	12

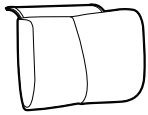

GC3607	\$143	\$184	\$235	\$290	\$368	\$400	\$465	\$593	\$657	\$776	\$941	\$1146
--------	-------	-------	-------	-------	-------	-------	-------	-------	-------	-------	-------	--------

OVERALL DIMENSIONS			SEAT DIMENSIONS			BACK DIMENSIONS	
W	D	H	W	D	H	W	H
14	4	9.5					

**Headrest for Primacare Recliners**

COM Yardage: 1.25  
 Freight Class: 250  
 Product Weight (lbs.): 3  
 Cubic Feet Per Carton: 1

PRIMACARE SLEEPERS



model GC3610SW



model GC3610SW pulled out

STANDARD FEATURES

- Primacare sleepers are ideal for space-constrained lounges and patient rooms providing sleeping space for one to two people. With zero wall clearance required, the sleeper is easy for one person to open and close. It is part of the Primacare healthcare collection for coordination of design across environments.
- Single unit sleep surface available in 24.5"W x 77"L (GC3610SW) and 30"W x 77"L (GC3610XW). Double unit (GC3610D) has two independently operated 24.5"W x 77"L sleep surfaces, each with standard underseat storage.
- Sleeper extends by pulling castered storage forward.
- Models are standard with four Black locking 3" dual wheel hard surface casters (C83R) to support the arm frame, and with non-locking casters to support the pull-out storage compartment.
- Tapered wood legs (WOD) are optional; available in all Global wood finishes, see upcharge. Non-locking casters remain on the pull out.
- Models are standard with Urethane, easy grip forward extending armcaps.
- Wood (WOD) and solid surface (CO) armcaps are available, see upcharges.
- Armcaps are securely fastened with metal-to-metal connectors and are field replaceable.
- Seat and back offer a 3.5" thick dual density ultra cell foam cushion for enhanced long term comfort.
- Seat cushion has a seamless waterfall front edge.
- Two concealed fabric pull tabs are located at the top of the back cushions. These allow the extended sleeping platform to be easily returned to a seated position.
- A Black, phenolic tablet arm with spill collector groove is available. Specify right (RT), left (LT) or both sides (TB) of the chair. See upcharges. Each tablet adds 4" to the width of the chair. Tablet requires 5.5" of clearance to operate. The tablet pivots for use and stores by lifting gently and rotating down to the side of the chair.
- Models may be specified with contrasting fabrics. Specify seat and back cushions separate from arms and front foot rail. For pricing, start with the base price and add both back/seat graded textile upcharge and the arms/front rail graded textile upcharge. *Note: the blended textile matrix is not applicable to this series when specified as noted above.*
- Carded healthcare textiles with a minimum of 100,000 double rubs must be specified to meet Global's 24/7 warranty coverage. For healthcare textiles, visit the website at [globalfurnituregroup.com](http://globalfurnituregroup.com).
- When specified with approved, non-healthcare Global carded textiles, Global's limited lifetime warranty for 8hr, 5 days/week use applies.
- Warranted to support up to 350 lbs. active weight capacity per seat.
- Shipped fully assembled.

INFECTION CONTROL AND BED BUG

RESISTANCE OPTIONS

- Several optional features are available for improved cleanability, to control moisture, and to reduce the risk of bed bugs.
- For woven textiles without a moisture resistant coating or backing, a moisture barrier (MB) is available to minimize moisture penetrating to the seat cushion. Moisture barrier is not recommended with water resistant textiles and may not be used in conjunction with sealed seams.
- For approved coated textiles (i.e. vinyl, silicone), sealed seams are available. Specify (SWZ) for sealed seams and waterproof zipper to prevent moisture or insects from penetrating seat and back cushion, see upcharges. For sealed seams on arms specify (S3), see models for upcharges.
- Note: minor puckering is common with the addition of sealed seams due to material buildup at corners.
- Underside of seat is standard with a coated lining (CL). For added protection and bed bug resistance, a sealed staple strip on the underside of the arms is available. Specify sealed lining (SU), see upcharge.

Add option codes in the following order:

- **Model number**  
Specify model number.
- **Seat/back textile**  
Specify textile code. See model grade upcharges.
- **Arms/front rail textile**  
Specify textile code. See model grade upcharges.
- **Base Type**  
(CST) Casters (standard)  
(WOD) Wood legs. Add \$232.
- **Leg Finish** (for wood (WOD) base type)  
(AAM) Absolute (NEM) Noce Leggero  
(ACM) Cherry (NGM) Noce Grigio  
(AHM) Honey (NMM) Noce Medio  
(ASM) Night (NLW) Natural Walnut  
(AVM) Maple (SBM) Sandy Beach  
(BKM) Black (SKM) Shaker Cherry  
(ECM) Espresso Cafe (TFM) Fruitwood  
(EOM) English Oak (TMM) Mahogany  
(HGM) Grey (TWM) Walnut  
(JOM) Jet Onyx (WCM) Winter Cherry  
(MWM) Medium Walnut (WHM) White  
(NBM) Noce Biondo (WTM) WC Cream
- **Armcap type**  
(SSU) Urethane armcaps, standard  
(WOD) Wood armcaps, Add \$144.  
(CO) Solid surface armcaps. See grade upcharge.
- **Armcap finish - urethane**  
(BLK) Black (J52) Mocha  
(KAL) Kalua (SHW) Shadow  
(LAB) Latte (TOA) Toast
- **Armcap finish - wood**  
(AAM) Absolute (NEM) Noce Leggero  
(ACM) Cherry (NGM) Noce Grigio  
(AHM) Honey (NMM) Noce Medio  
(ASM) Night (NLW) Natural Walnut  
(AVM) Maple (SBM) Sandy Beach  
(BKM) Black (SKM) Shaker Cherry  
(ECM) Espresso Cafe (TFM) Fruitwood  
(EOM) English Oak (TMM) Mahogany  
(HGM) Grey (TWM) Walnut  
(JOM) Jet Onyx (WCM) Winter Cherry  
(MWM) Medium Walnut (WHM) White  
(NBM) Noce Biondo (WTM) WC Cream
- **Armcap finish (solid surface)**  
Grade 1 - Add \$973:  
(SWH) Designer White  
Grade 2 - Add \$1049:  
(SBT) Beige Tempest  
(SBX) Black Onyx Mirage  
(SMG) Milk Glass Spectra  
(SFW) Frosty White Mirage  
(SHS) Hot Stone  
(SNM) Northern Melange
- **Tablet**  
(NT) No tablet  
(LT) Left tablet. Add \$937.  
(RT) Right tablet. Add \$937.  
(TB) Left and right tablets. Add \$1874.
- **Seat/back seams** (Contact Customer Care for approved textiles.)  
(NS) Standard seams.  
(SWZ) Sealed seams with waterproof zipper. See models for upcharges.
- **Arms/front rail seams** (Contact Customer Care for approved textiles.)  
(NS) Standard seams.  
(S3) Sealed seams, see models for upcharges.
- **Moisture Barrier** (seat only, not available with sealed seams)  
(NB) No moisture barrier.  
(MB) Moisture barrier. See models for upcharge.
- **Seat Underside**  
(CL) Coated lining (standard).  
(SU) Sealed lining. Add \$375.

DESCRIPTION	MODEL#	STANDARD FABRIC GRADES
-------------	--------	------------------------

**EXAMPLE PRIMACARE SLEEPER ORDER CODE:**

GC3610SW	-NS	-VY20	-NS	-VY30	-CST	-SSU	-TOA	-NT	-NB	-CL	-USC
Model #	Seat/Back seams	Seat/Back textile	Arms/front rail seams	Arms/front rail textile	Base type	Armcap type	Armcap finish	Tablet	Moisture Barrier	Frame underside	Underseat storage

DESCRIPTION	MODEL# / FEATURES	STANDARD TEXTILE GRADES											
-------------	-------------------	-------------------------	--	--	--	--	--	--	--	--	--	--	--



**Single Sleeper Chair**  
 COM Yardage: Seat/Back: 3.75; Arms/Rail: 3.75  
 Freight Class: 250  
 Product Weight (lbs.): 116  
 Cubic Feet Per Carton: 32.25

**GC3610SW** Base Price:  
 Seat/Back upcharge:  
 Arms/Front Rail upcharge:

	1/COM	2	3	4	5	6	7	8	9	10	11	12
Base Price:		<b>\$4603</b>										
Seat/Back upcharge:	<b>-\$126</b>	<b>+0</b>	<b>+\$102</b>	<b>+\$248</b>	<b>+\$454</b>	<b>+\$540</b>	<b>+\$717</b>	<b>+\$998</b>	<b>+\$1208</b>	<b>+\$1437</b>	<b>+\$1917</b>	<b>+\$2419</b>
Arms/Front Rail upcharge:	<b>-\$126</b>	<b>+0</b>	<b>+\$102</b>	<b>+\$248</b>	<b>+\$454</b>	<b>+\$540</b>	<b>+\$717</b>	<b>+\$998</b>	<b>+\$1208</b>	<b>+\$1437</b>	<b>+\$1917</b>	<b>+\$2419</b>
<b>OVERALL DIMENSIONS</b>			<b>SEAT DIMENSIONS</b>			<b>BACK DIMENSIONS</b>						
	<b>W</b>	<b>D</b>	<b>H</b>	<b>W</b>	<b>D</b>	<b>H</b>	<b>W</b>	<b>H</b>				
	31.5	37.5	38	24	20	18	24	21				
Active weight 350 lbs.												
Add \$224 for (SWZ), \$70 for (S3)												
Add \$479 for moisture barrier (MB)	<b>RTA 00</b>	1 per carton										

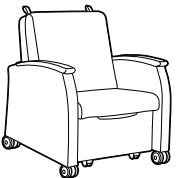

**Single Sleeper Chair, Wide**  
 COM Yardage: Seat/Back: 5; Arms/Rail: 4  
 Freight Class: 250  
 Product Weight (lbs.): 140  
 Cubic Feet Per Carton: 36.75

**GC3610XW** Base Price:  
 Seat/Back upcharge:  
 Arms/Front Rail upcharge:

	COM	2	3	4	5	6	7	8	9	10	11	12
Base Price:		<b>\$4950</b>										
Seat/Back upcharge:	<b>-\$168</b>	<b>+0</b>	<b>+\$135</b>	<b>+\$330</b>	<b>+\$605</b>	<b>+\$720</b>	<b>+\$955</b>	<b>+\$1330</b>	<b>+\$1610</b>	<b>+\$1915</b>	<b>+\$2555</b>	<b>+\$3225</b>
Arms/Front Rail upcharge:	<b>-\$135</b>	<b>+0</b>	<b>+\$108</b>	<b>+\$264</b>	<b>+\$484</b>	<b>+\$576</b>	<b>+\$764</b>	<b>+\$1064</b>	<b>+\$1288</b>	<b>+\$1532</b>	<b>+\$2044</b>	<b>+\$2580</b>
<b>OVERALL DIMENSIONS</b>			<b>SEAT DIMENSIONS</b>			<b>BACK DIMENSIONS</b>						
	<b>W</b>	<b>D</b>	<b>H</b>	<b>W</b>	<b>D</b>	<b>H</b>	<b>W</b>	<b>H</b>				
	37	37.5	38	30	20	18	30	21				
Active weight 350 lbs.												
Add \$260 for (SWZ), \$70 for (S3)												
Add \$479 for moisture barrier (MB)	<b>RTA 00</b>	1 per carton										

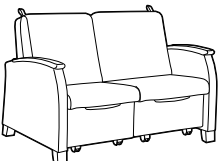

**Double Sleeper Chair**  
 COM Yardage: Seat/Back: 7.5; Arms/Rail: 4.5  
 Freight Class: 250  
 Product Weight (lbs.): 215  
 Cubic Feet Per Carton: 60

**GC3610D** Base Price:  
 Seat/Back upcharge:  
 Arms/Front Rail upcharge:

	COM	2	3	4	5	6	7	8	9	10	11	12
Base Price:		<b>\$8306</b>										
Seat/Back upcharge:	<b>-\$253</b>	<b>+0</b>	<b>+\$203</b>	<b>+\$495</b>	<b>+\$908</b>	<b>+\$1080</b>	<b>+\$1433</b>	<b>+\$1995</b>	<b>+\$2415</b>	<b>+\$2873</b>	<b>+\$3833</b>	<b>+\$4838</b>
Arms/Front Rail upcharge:	<b>-\$143</b>	<b>+0</b>	<b>+\$115</b>	<b>+\$281</b>	<b>+\$515</b>	<b>+\$612</b>	<b>+\$812</b>	<b>+\$1131</b>	<b>+\$1369</b>	<b>+\$1628</b>	<b>+\$2172</b>	<b>+\$2742</b>
<b>OVERALL DIMENSIONS</b>			<b>SEAT DIMENSIONS</b>			<b>BACK DIMENSIONS</b>						
	<b>W</b>	<b>D</b>	<b>H</b>	<b>W</b>	<b>D</b>	<b>H</b>	<b>W</b>	<b>H</b>				
	56	36	38	48	19.5	18	48	21				
Active weight 350 lbs. per seat.												
Add \$447 for (SWZ), \$70 for (S3)												
Add \$957 for moisture barrier (MB)	<b>RTA 00</b>	1 per carton										

PRIMACARE BENCHES



model GC3651 (HT)



model GC3652W (Wood)

STANDARD FEATURES

- Primacare is a family of products offering the most significant return on investment approach in the industry since every component can be repaired or replaced on site.
- **High traffic (HT) models:** Metal frame with die cast zinc connectors and metal-to-metal fasteners. Available in the following finishes: Black (TBL), Cloud (TIV), Designer White (TDW), Fog (TFO), Frost (TFR), Kalua (TKA), Latte (TLA), Mocha (TMO), Nevada (TNE), Sand (TSN), Shadow (TSH), Toast (TOA) and Tungsten (TTU).
- **Wood models:** Solid hardwood frame with die cast zinc connectors and metal-to-metal fastening. Available in the following finishes: Absolute (AAM), Cherry (ACM), English Oak (EOM), Espresso Cafe (ECM), Fruitwood (TFM), Gray (HGM), Honey (AHM), Jet Onyx (JOM), Mahogany (TMM), Maple (AVM), Medium Walnut (MWM), Natural Walnut (NLW), Night (ASM), Noce Biondo (NBM), Noce Grigio (NGM), Noce Leggero (NEM), Noce Medio (NMM), Sandy Beach (SBM), Shaker Cherry (SKM), Walnut (TWM), White (WHM), WC Cream (WTM) and Winter Cherry (WCM).
- Replaceable and/or removable cushions are standard.
- For healthcare textile options, visit the website at [www.globalfurnituregroup.com/healthcare](http://www.globalfurnituregroup.com/healthcare).
- Can be upholstered in standard Global textiles if healthcare compliance is not required.
- It is recommended that High Traffic (HT) models be specified in textiles that meet or exceed 100,000 double rubs for added abrasion performance.
- Shipped fully assembled.
- **HIGH TRAFFIC (HT) MODELS ARE LISTED FIRST, FOLLOWED BY WOOD MODELS.**

OPTIONAL FEATURES

- For moisture barrier on seat, please specify (MB). Add \$137 per seat.
- To add sealed seams to your product contact Customer Care. Upcharges vary.
- For Primacare tables, see page 52

SUGGESTED APPLICATIONS

- Guest seating
- Patient rooms
- Lounge/Waiting
- Resident rooms

DESCRIPTION MODEL# / FEATURES STANDARD TEXTILE GRADES

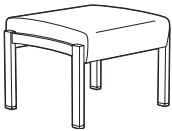

Single Seat Bench (HT)

COM Yardage: 1.25  
Freight Class: 250  
Product Weight (lbs.): 31  
Cubic Feet Per Carton: 9.75

COM	2	3	4	5	6	7	8	9	10	11	12	
<b>GC3651</b>	<b>\$1856</b>	<b>\$1902</b>	<b>\$1948</b>	<b>\$2007</b>	<b>\$2091</b>	<b>\$2130</b>	<b>\$2208</b>	<b>\$2330</b>	<b>\$2424</b>	<b>\$2528</b>	<b>\$2746</b>	<b>\$2974</b>

Metal

Active weight 350 lbs.

OVERALL DIMENSIONS			SEAT DIMENSIONS			BACK DIMENSIONS	
W	D	H	W	D	H	W	H
26.5	22.5	19					

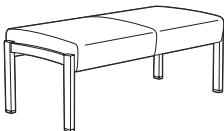

Two Seat Bench

COM Yardage: 2  
Freight Class: 250  
Product Weight (lbs.): 48  
Cubic Feet Per Carton: 20.25

COM	2	3	4	5	6	7	8	9	10	11	12	
<b>GC3652</b>	<b>\$2925</b>	<b>\$3000</b>	<b>\$3069</b>	<b>\$3165</b>	<b>\$3301</b>	<b>\$3362</b>	<b>\$3487</b>	<b>\$3680</b>	<b>\$3831</b>	<b>\$4001</b>	<b>\$4345</b>	<b>\$4712</b>

Metal

Active weight 350 lbs./seat

OVERALL DIMENSIONS			SEAT DIMENSIONS			BACK DIMENSIONS	
W	D	H	W	D	H	W	H
49.5	22.5	19					

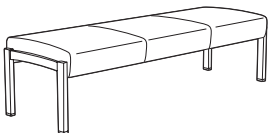

Three Seat Bench

COM Yardage: 2.75  
Freight Class: 250  
Product Weight (lbs.): 66  
Cubic Feet Per Carton: 28.75

COM	2	3	4	5	6	7	8	9	10	11	12	
<b>GC3653</b>	<b>\$3994</b>	<b>\$4099</b>	<b>\$4191</b>	<b>\$4323</b>	<b>\$4509</b>	<b>\$4596</b>	<b>\$4766</b>	<b>\$5033</b>	<b>\$5241</b>	<b>\$5472</b>	<b>\$5946</b>	<b>\$6451</b>

Metal

Active weight 350 lbs./seat

OVERALL DIMENSIONS			SEAT DIMENSIONS			BACK DIMENSIONS	
W	D	H	W	D	H	W	H
72.5	22.5	19					

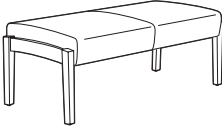
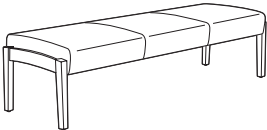
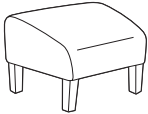
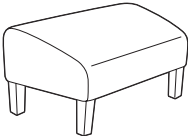
DESCRIPTION	MODEL#	STANDARD FABRIC GRADES												
		COM	2	3	4	5	6	7	8	9	10	11	12	
 <b>Single Seat Bench (Wood)</b> COM Yardage: 1.25 Freight Class: 250 Product Weight (lbs.): 26 Cubic Feet Per Carton: 9.75	<b>GC3651W</b> Wood  Active weight 350 lbs./seat	\$1596	\$1640	\$1686	\$1745	\$1829	\$1868	\$1946	\$2068	\$2162	\$2266	\$2484	\$2712	
		OVERALL DIMENSIONS			SEAT DIMENSIONS			BACK DIMENSIONS						
		W	D	H	W	D	H	W	H					
			26.5	22.5	19									
 <b>Two Seat Bench (Wood)</b> COM Yardage: 2 Freight Class: 250 Product Weight (lbs.): 41 Cubic Feet Per Carton: 20.25	<b>GC3652W</b> Wood  Active weight 350 lbs./seat	\$2551	\$2624	\$2693	\$2789	\$2925	\$2986	\$3111	\$3304	\$3455	\$3625	\$3969	\$4336	
		OVERALL DIMENSIONS			SEAT DIMENSIONS			BACK DIMENSIONS						
		W	D	H	W	D	H	W	H					
			49.5	22.5	19									
 <b>Three Seat Bench (Wood)</b> COM Yardage: 2.75 Freight Class: 250 Product Weight (lbs.): 61 Cubic Feet Per Carton: 28.75	<b>GC3653W</b> Wood  Active weight 350 lbs./seat	\$3500	\$3606	\$3698	\$3830	\$4016	\$4103	\$4273	\$4540	\$4748	\$4979	\$5453	\$5958	
		OVERALL DIMENSIONS			SEAT DIMENSIONS			BACK DIMENSIONS						
		W	D	H	W	D	H	W	H					
			72.5	22.5	19									
 <b>Standard Size Ottoman</b> COM Yardage: 1.25 Freight Class: 250 Product weight (lbs.): 17 Cubic Feet Per Carton: 4.7	<b>GC3695</b>  Active weight 350 lbs.  Standard leg is Black Urethane.  Optional Urethane colors or wood legs. No upcharge.	\$927	\$968	\$1009	\$1063	\$1143	\$1178	\$1248	\$1360	\$1446	\$1542	\$1740	\$1950	
		OVERALL DIMENSIONS			SEAT DIMENSIONS			BACK DIMENSIONS						
		W	D	H	W	D	H	W	H					
			23	18	15.75	-	-	-	-	-	-	-		
 <b>Bariatric Ottoman</b> COM Yardage: 1.75 Freight Class: 250 Product Weight (lbs.): 20 Cubic Feet Per Carton: 9	<b>GC3696</b>  Active weight 500 lbs.  Standard leg is Black Urethane.  Optional Urethane colors or wood legs. No upcharge.	\$1170	\$1231	\$1286	\$1363	\$1470	\$1523	\$1620	\$1776	\$1898	\$2032	\$2308	\$2601	
		OVERALL DIMENSIONS			SEAT DIMENSIONS			BACK DIMENSIONS						
		W	D	H	W	D	H	W	H					
			31.25	18	15.75	-	-	-	-	-	-	-		

## PRIMACARE MODULAR



## STANDARD FEATURES

- Modular seating tops: Linking applications are available for medium and high back patient top units, low back guest top units and lounge top units.
- All modular seating top units are complete with frame and cushions. Leg/arm frames are ordered separately according to the desired specification.
- Frame design features a wall saver leg to prevent damage to walls. Frame construction ensures metal-to-metal fastening.
- For leg/arm frames and modular tables with power/USB module, refer to models ending in "M". Module includes two power outlets, four USB charging ports and a 6 foot long power cord. Available in Black or White (must be specified at time of order).
- Replaceable and/or removable seat and back cushions with replaceable cushion covers are standard.
- Seat cushion has a seamless waterfall front and clean out between and around the seat and back cushions.
- All **(CA)** models have closed upholstered arm panel inserts at each arm position.
- For added comfort, seats are standard with high density foam.
- Active weight capacity up to 500 lbs/seat when using metal frame, fully upholstered frame or on bariatric models; up to 350 lbs/seat when using wood frame.
- For textile options, visit the website at [www.globalfurnituregroup.com](http://www.globalfurnituregroup.com).
- Can be upholstered in standard Global textiles if healthcare compliance is not required.
- Left and right position reference is determined from the seated position.

## SUGGESTED APPLICATIONS

- Bariatric seating
- Guest seating
- Lobbies
- Lounge/Waiting

## OPTIONAL FEATURES

- Urethane finishes are available on armcaps and on models with urethane legs in the following: Black (BLK), Latte (LAB), Kalua (KAL), Mocha (J52), Shadow (SHW) and Toast (TOA). Refer to individual models for availability and pricing.
- Metal leg/arm frames are available in the following finishes: Black (TBL), Cloud (TIV), Designer White (TDW), Fog (TFO), Frost (TFR), Kalua (TKA), Latte (TLA), Mocha (TMO), Nevada (TNE), Sand (TSN), Shadow (TSH), Toast (TOA) and Tungsten (TTU).
- Wood legs and armcaps available in the following finishes: Absolute (AAM), Cherry (ACM), English Oak (EOM), Espresso Cafe (ECM), Fruitwood (TFM), Gray (HGM), Honey (AHM), Jet Onyx (JOM), Mahogany (TMM), Maple (AVM), Medium Walnut (MWM), Natural Walnut (NLW), Night (ASM), Noce Biondo (NBM), Noce Grigio (NGM), Noce Leggero (NEM), Noce Medio (NMM), Sandy Beach (SBM), Shaker Cherry (SKM), Walnut (TWM), White (WHM), WC Cream (WTM) and Winter Cherry (WCM). Refer to individual models for availability and pricing.
- Armcaps are securely fastened with metal-to-metal connectors which allows for field replacement if required. *Armcaps cannot be retrofitted in the field on units with no existing armcaps.*
- For moisture barrier on seat, please specify **(MB)**. Add \$137 per seat. For bariatric/lounge models, - Add \$209 per seat.
- To add sealed seams to your product contact Customer Care. Upcharges vary.

For Primacare freestanding tables, see page 52

For Primacare Modular tables, see page 216

For Primacare Modular lounge tables, see page 227

## MODULAR TABLES

Modular tables are offered with wood or metal legs. 1" thick table tops are available in high pressure laminate (HP). Please select the appropriate model number for the finish you prefer.

**Note:** Modular tables are shipped KD (knock down) as per the published cube and weight. For Primacare freestanding tables, see page 52.

## High Pressure Laminate (HP)

Absolute Acajou (ACJ)	First Class (FCL)
Asian Night (ASN)	Noce Biondo (NBL)
Avant Cherry (W357)	Noce Grigio (NGL)
Avant Honey (W356)	Noce Leggero (NEL)
Blizzard (BZD)	Noce Medio (NML)
Brushed Cobalt (BRC)	Quartered Mahogany (QTM)
Clear Maple (CMB)	Sheer Beauty (SBY)
Custom Grey (CGY)	Stonedust (SDT)
Dark Espresso (W142)	Walnut Heights (WHE)
Designer White (DWT)	White Chocolate (WHC)
Fashionista (FAS)	Winter Cherry (WCR)

## Metal leg and frame finishes:

Available in Black (TBL), Cloud (TIV), Designer White (TDW), Fog (TFO), Frost (TFR), Kalua (TKA), Latte (TLA), Mocha (TMO), Nevada (TNE), Sand (TSN), Shadow (TSH), Toast (TOA) and Tungsten (TTU).

## SHIPPING INFORMATION:

Product components and parts will be shipped knocked down (KD). Weight and volume are indicated with each item KD. They will not be shipped assembled.

## Assembled with drawing:

Product orders that are part of a linked application may require a combination of complete units and components for build up to achieve the limitless configurations that are possible. CAD drawing must be submitted with order when requesting units ship assembled.

Global will provide assembled units under the following conditions:

1. Detailed drawing clearly indicating:
  - The layout and location of each model number being ordered (see sample following).
  - If multiple textiles are used - textile color codes must be clearly identified on drawing.
2. Global will carton assemble orders to a maximum of 3 regular seat positions, which is the largest carton available.
3. Global reserves the right to determine the best method of assembly based on the information provided with the order.

PACKAGE 1 - Primacare HT

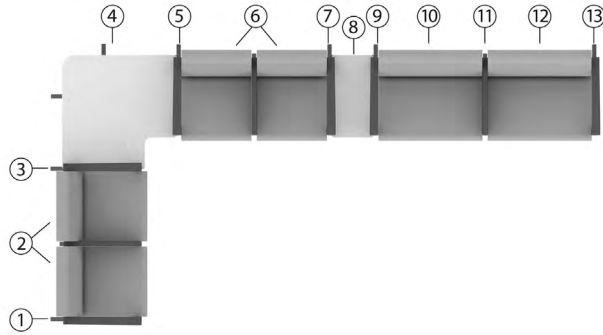

Always call out components as if seated in the chairs.

Item	Description	Qty.	Model #	Dimensions (D x W x H)	Ydg.	Frts. Class	Wt. Lbs.	Cu. Ft.	List Price	Ext. Price
1	Right End Frame with Right Armcap	1	GC3620RA	27 x 2.5 x 26.5	--	125	10	1.4	\$621	\$621
2, 6	Guest Low Back Two Seat Top w/Half Center Arm	2	GC3623TOP	25 x 42 x 19	3.25	300	68	43	\$2896	\$5792
3, 7	Seat to Table Center Linking Frame w/Left Armcap	2	GC3622TLA	27 x 2.5 x 26.5	--	125	10	1.4	\$677	\$1354
4	Right Corner Table	1	GC3671R-HP	33 x 33 x 17	--	125	45	6	\$1586	\$1586
5, 9	Seat to Table Center Linking Frame w/Right Armcap	2	GC3622TRA	27 x 2.5 x 26.5	--	125	10	1.4	\$677	\$1354
8	Narrow Center Table	1	GC3673-HP	23.87 x 12 x 5.5	--	100	18	2.1	\$867	\$867
10, 12	Bariatric Top, Guest Low Back	2	GC3637TOP	25 x 30 x 19	2.5	250	53	26.5	\$1826	\$3652
11	Seat to Seat Center Linking Frame w/Narrow Armcap	1	GC3622LA	27 x 2.5 x 26.5	--	125	10	1.4	\$693	\$693
13	Left End Frame with Left Armcap	1	GC3620LA	27 x 2.5 x 26.5	--	125	10	1.4	\$621	\$621

PACKAGE TOTAL

\$16,540

(\*Please Note: List Prices shown are for the standard Grade 2 vinyl/standard finishes.)

PACKAGE 2 - Primacare HT

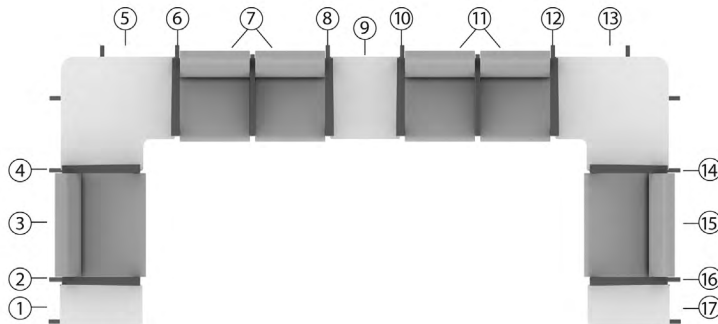

Always call out components as if seated in the chairs.

Item	Description	Qty.	Model #	Dimensions (D x W x H)	Ydg.	Frts. Class	Wt. Lbs.	Cu. Ft.	List Price	Ext. Price
1	Narrow Right End Table	1	GC3675R-HP	23.87 x 12 x 17	--	100	18	2.1	\$1295	\$1295
2, 6, 10, 14	Seat to Table Center Linking Frame w/Right Armcap	4	GC3622TRA	27 x 2.5 x 26.5	--	125	10	1.4	\$677	\$2708
3, 15	Guest Low Back Bariatric Top	2	GC3637TOP	25 x 30 x 19	2.5	250	53	26.5	\$1826	\$3652
4, 8, 12, 16	Seat to Table Center Linking Frame w/Left Armcap	4	GC3622TLA	27 x 2.5 x 26.5	--	125	10	1.4	\$677	\$2708
5	Right Corner Table	1	GC3671R-HP	33 x 33 x 17	--	125	45	6	\$1586	\$1586
7, 11	Guest Low Back Two Seat Top w/Half Center Arm	2	GC3623TOP	25 x 42 x 19	3.25	300	68	43	\$2896	\$5792
9	Regular Center Table	1	GC3672-HP	23.87 x 20.25 x 5.5	--	150	20	3.4	\$892	\$892
13	Left Corner Table	1	GC3671L-HP	33 x 33 x 17	--	100	54	6	\$1586	\$1586
17	Narrow Left End Table	1	GC3675L-HP	23.87 x 12 x 17	--	100	18	2.1	\$1295	\$1295

PACKAGE TOTAL

\$21,514

(\*Please Note: List Prices shown are for the standard Grade 2 vinyl/standard finishes.)

PACKAGE 3 - Primacare Wood

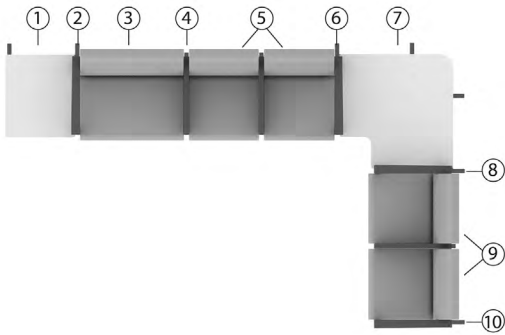

Always call out components as if seated in the chairs.

Item	Description	Qty.	Model #	Dimensions (D x W x H)	Ydg.	Frts. Class	Wt. Lbs.	Cu. Ft.	List Price	Ext. Price
1	Right End Run Table	1	GC3674WR-HP	23.87 x 20.25 x 17	--	150	19	3.4	\$1231	\$1231
2, 8	Seat to Table Center Linking Frame w/Right Armcap	2	GC3622WTRA	27 x 2.5 x 26.5	--	150	8	1.4	\$498	\$996
3	Guest Low Back Bariatric Top	1	GC3637TOP	25 x 30 x 19	2.5	250	53	26.5	\$1826	\$1826
4	Seat to Seat Center Linking Frame w/Narrow Armcap	1	GC3622WLA	27 x 2.5 x 26.5	--	150	8	1.4	\$460	\$460
5, 9	Guest Low Back Two Seat Top w/Half Center Arm	2	GC3623WTOP	25 x 42 x 19	3.25	300	68	43	\$2576	\$5152
6	Seat to Table Center Linking Frame w/Left Armcap	1	GC3622WTLA	27 x 2.5 x 26.5	--	150	8	1.4	\$498	\$498
7	Left Corner Table	1	GC3671WL-HP	33 x 33 x 17	--	100	54	6	\$1502	\$1502
10	Left End Frame w/Left Armcap	1	GC3620WLA	23 x 2 x 26	--	125	10	1.4	\$445	\$445

**PACKAGE TOTAL**

**\$12,110**

(\*Please Note: List Prices shown are for the standard Grade 2 vinyl/standard finishes.)

MODULAR TOP UNITS	SINGLE SEAT BARIATRIC		TWO SEATER, NO CENTER ARM	TWO SEATER, CENTER ARM		THREE SEATER, NO CENTER ARMS	THREE SEATER, TWO ARMS	
	medium back		medium back	medium back	high back	medium back	medium back	high back
<b>Guest seating</b>	GC3620TOP 	GC3637TOP 	GC3621TOP 	GC3623TOP GC3623WTOP 	GC3623HB-TOP GC3623WHB-TOP 	GC3624TOP 	GC3626TOP GC3626WTOP 	GC3626HB-TOP GC3626WHB-TOP 
<b>Patient seating</b>	medium back			GC3623CATOP 	GC3623HBCA-TOP 		GC3626CATOP 	GC3626HBCA-TOP 
	GC3631TOP 	GC3638TOP 						

LEG / ARM FRAMES	Wood frame: Must select armcap Metal frame: Standard with Black SSU armcap (see notes for wood and SSU finish options)										
	LEFT, OPEN		RIGHT, OPEN		LEFT, CLOSED		RIGHT, CLOSED		LEFT, CLOSED LAMINATE PANEL	RIGHT, CLOSED LAMINATE PANEL	
<b>Metal (HT) End</b>	GC3620LA 	GC3620LAM 	GC3620RA 	GC3620RAM 	GC3620LCA 	GC3620LCAM 	GC3620RCA 	GC3620RCAM 	GC3620LCA 	GC3620RCA 	
<b>Wood End</b>	GC3620WLA 	GC3620WLAM 	GC3620WRA 	GC3620WRAM 							
<b>Metal (HT) Center</b>	GC3622LA 				GC3622LCA 				GC3622LCA 		
<b>Wood Center</b>	GC3622WLA 										
<b>Metal (HT) Center table linking</b>	GC3622TLA 	GC3622TRA 		GC3622TLCA 		GC3622TRCA 		GC3622TLCAL 	GC3622TRCAL 		
<b>Wood Center table linking</b>	GC3622WTLA 	GC3622WTRA 									

For frame with power/USB module\*, refer to models ending in "M"

**End Frame: Armless**

Metal End	LEFT	RIGHT
	GC3620LNA 	GC3620RNA 
Wood End	GC3620WLNA 	GC3620WRNA 

**Central Linking Frame: Armless**

Metal	CENTER
GC3622LNA 	
Wood	GC3622WLNA 

(Center = link both sides)

\*Power module includes two power outlets, four USB charging ports and a 6 foot long power cord. Available in Black or White (must be specified at time of order). Power module is mounted on the frame below seat support rail.

DESCRIPTION	MODEL#		STANDARD FABRIC GRADES	
-------------	--------	--	------------------------	--

**MODULAR TABLES** Tables include legs to support table top (except for center tables). All tables have a metal frame.

	LEFT		RIGHT	
<b>Corner</b> (high pressure laminate top with <b>metal legs</b> )	GC3671L-HP 	GC3671LM-HP 	GC3671R-HP 	GC3671RM-HP 
<b>Corner</b> (high pressure laminate top with <b>wood legs</b> )	GC3671WL-HP 	GC3671WLM-HP 	GC3671WR-HP 	GC3671WRM-HP 
<b>Center</b> (high pressure laminate top, connects to metal or wood frame)	GC3672-HP 	GC3672M-HP 		
<b>Narrow Center</b> (high pressure laminate top, connects to metal or wood frame)	GC3673-HP 	GC3673M-HP 		
<b>End</b> (high pressure laminate top with <b>metal legs</b> )	GC3674L-HP 	GC3674LM-HP 	GC3674R-HP 	GC3674RM-HP 
<b>End</b> (high pressure laminate top with <b>wood legs</b> )	GC3674WL-HP 	GC3674WLM-HP 	GC3674WR-HP 	GC3674WRM-HP 
<b>Narrow End</b> (high pressure laminate top with <b>metal legs</b> )	GC3675L-HP 	GC3675LM-HP 	GC3675R-HP 	GC3675RM-HP 
<b>Narrow End</b> (high pressure laminate top with <b>wood legs</b> )	GC3675WL-HP 	GC3675WLM-HP 	GC3675WR-HP 	GC3675WRM-HP 

For table with power/USB module\*, refer to models ending in "M"

\*Power module includes two power outlets, four USB charging ports and a 6 foot long power cord. Available in Black or White (must be specified at time of order). Power module is mounted **on surface** on narrow tables; mounted **in surface** on larger tables (as shown above).

# SEATING

# PRIMACARE™ MODULAR - GUEST/PATIENT

P

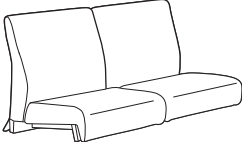
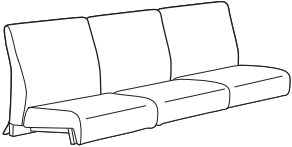
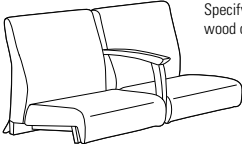
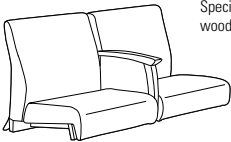
DESCRIPTION	MODEL#	STANDARD FABRIC GRADES																																			
		COM	2	3	4	5	6	7	8	9	10	11	12																								
  <b>LB Guest Single Seat Top</b> COM Yardage: 1.75 Freight Class: 250 Product Weight (lbs.): 16 Cubic Feet Per Carton: 10	<b>GC3620TOP</b>	\$1086	\$1147	\$1202	\$1279	\$1388	\$1428	\$1525	\$1707	\$1795	\$1963	\$2193	\$2477																								
	<table border="1"> <thead> <tr> <th colspan="3">OVERALL DIMENSIONS</th> <th colspan="3">SEAT DIMENSIONS</th> <th colspan="2">BACK DIMENSIONS</th> </tr> <tr> <th>W</th> <th>D</th> <th>H</th> <th>W</th> <th>D</th> <th>H</th> <th>W</th> <th>H</th> </tr> </thead> <tbody> <tr> <td>20.5</td> <td>25</td> <td>19</td> <td>20.5</td> <td>17.5</td> <td>--</td> <td>20.5</td> <td>15</td> </tr> </tbody> </table>	OVERALL DIMENSIONS			SEAT DIMENSIONS			BACK DIMENSIONS		W	D	H	W	D	H	W	H	20.5	25	19	20.5	17.5	--	20.5	15	Single frame guest top unit with 1 low back cushion and 1 seat cushion. <b>Must be connected to a full arm/leg frame.</b>											
	OVERALL DIMENSIONS			SEAT DIMENSIONS			BACK DIMENSIONS																														
W	D	H	W	D	H	W	H																														
20.5	25	19	20.5	17.5	--	20.5	15																														
  <b>LB Guest Two Seat Top, No Center Arm</b> COM Yardage: 3.25 Freight Class: 300 Product Weight (lbs.): 72 Cubic Feet Per Carton: 43	<b>GC3621TOP</b>	\$2407	\$2523	\$2623	\$2768	\$2969	\$3045	\$3223	\$3555	\$3720	\$4030	\$4463	\$4993																								
	<table border="1"> <thead> <tr> <th colspan="3">OVERALL DIMENSIONS</th> <th colspan="3">SEAT DIMENSIONS</th> <th colspan="2">BACK DIMENSIONS</th> </tr> <tr> <th>W</th> <th>D</th> <th>H</th> <th>W</th> <th>D</th> <th>H</th> <th>W</th> <th>H</th> </tr> </thead> <tbody> <tr> <td>40</td> <td>25</td> <td>19</td> <td>40</td> <td>17.5</td> <td>--</td> <td>40</td> <td>15</td> </tr> </tbody> </table>	OVERALL DIMENSIONS			SEAT DIMENSIONS			BACK DIMENSIONS		W	D	H	W	D	H	W	H	40	25	19	40	17.5	--	40	15	Double frame guest top unit with 2 low back cushions and 2 seat cushions. <b>Must be connected to a full arm/leg frame.</b>											
	OVERALL DIMENSIONS			SEAT DIMENSIONS			BACK DIMENSIONS																														
W	D	H	W	D	H	W	H																														
40	25	19	40	17.5	--	40	15																														
  <b>LB Guest Three Seat Top, No Center Arm</b> COM Yardage: 4.25 Freight Class: 300 Product Weight (lbs.): 82 Cubic Feet Per Carton: 65.25	<b>GC3624TOP</b>	\$3663	\$3814	\$3940	\$4127	\$4392	\$4492	\$4723	\$5158	\$5377	\$5782	\$6344	\$7038																								
	<table border="1"> <thead> <tr> <th colspan="3">OVERALL DIMENSIONS</th> <th colspan="3">SEAT DIMENSIONS</th> <th colspan="2">BACK DIMENSIONS</th> </tr> <tr> <th>W</th> <th>D</th> <th>H</th> <th>W</th> <th>D</th> <th>H</th> <th>W</th> <th>H</th> </tr> </thead> <tbody> <tr> <td>60</td> <td>25</td> <td>19</td> <td>60</td> <td>17.5</td> <td>--</td> <td>60</td> <td>15</td> </tr> </tbody> </table>	OVERALL DIMENSIONS			SEAT DIMENSIONS			BACK DIMENSIONS		W	D	H	W	D	H	W	H	60	25	19	60	17.5	--	60	15	Triple frame guest top unit with 3 low back cushions and 3 seat cushions. <b>Must be connected to a full arm/leg frame.</b>											
	OVERALL DIMENSIONS			SEAT DIMENSIONS			BACK DIMENSIONS																														
W	D	H	W	D	H	W	H																														
60	25	19	60	17.5	--	60	15																														
 Specify armcap: wood or Urethane.	<b>GC3623TOP</b> Metal	\$2779	\$2896	\$2995	\$3141	\$3342	\$3418	\$3596	\$3928	\$4093	\$4403	\$4836	\$5366																								
	<b>GC3623WTOP</b> Wood	\$2459	\$2576	\$2674	\$2821	\$3022	\$3098	\$3276	\$3608	\$3773	\$4082	\$4513	\$5043																								
	<table border="1"> <thead> <tr> <th colspan="3">OVERALL DIMENSIONS</th> <th colspan="3">SEAT DIMENSIONS</th> <th colspan="2">BACK DIMENSIONS</th> </tr> <tr> <th>W</th> <th>D</th> <th>H</th> <th>W</th> <th>D</th> <th>H</th> <th>W</th> <th>H</th> </tr> </thead> <tbody> <tr> <td>42</td> <td>25</td> <td>19</td> <td>20.5</td> <td>17.5</td> <td>--</td> <td>20.5</td> <td>15</td> </tr> </tbody> </table>	OVERALL DIMENSIONS			SEAT DIMENSIONS			BACK DIMENSIONS		W	D	H	W	D	H	W	H	42	25	19	20.5	17.5	--	20.5	15	Double low back frame guest top, 2 back and 2 seat cushions. Urethane armcap option - <b>Add \$56 list upcharge</b> <b>Must be connected to a full arm/leg frame.</b>											
OVERALL DIMENSIONS			SEAT DIMENSIONS			BACK DIMENSIONS																															
W	D	H	W	D	H	W	H																														
42	25	19	20.5	17.5	--	20.5	15																														
 Specify armcap: wood or Urethane.	<b>GC3623CATOP</b> Metal	\$2931	\$3056	\$3164	\$3316	\$3534	\$3618	\$3809	\$4166	\$4347	\$4679	\$5142	\$5712																								
	<table border="1"> <thead> <tr> <th colspan="3">OVERALL DIMENSIONS</th> <th colspan="3">SEAT DIMENSIONS</th> <th colspan="2">BACK DIMENSIONS</th> </tr> <tr> <th>W</th> <th>D</th> <th>H</th> <th>W</th> <th>D</th> <th>H</th> <th>W</th> <th>H</th> </tr> </thead> <tbody> <tr> <td>42</td> <td>25</td> <td>19</td> <td>20.5</td> <td>17.5</td> <td>--</td> <td>20.5</td> <td>15</td> </tr> </tbody> </table>	OVERALL DIMENSIONS			SEAT DIMENSIONS			BACK DIMENSIONS		W	D	H	W	D	H	W	H	42	25	19	20.5	17.5	--	20.5	15	Double low back frame guest top, 2 back and 2 seat cushions. Urethane armcap option - <b>Add \$56 list upcharge</b> <b>Must be connected to a full arm/leg frame.</b>											
	OVERALL DIMENSIONS			SEAT DIMENSIONS			BACK DIMENSIONS																														
W	D	H	W	D	H	W	H																														
42	25	19	20.5	17.5	--	20.5	15																														

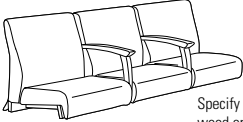
DESCRIPTION	MODEL#	STANDARD FABRIC GRADES											
		COM	2	3	4	5	6	7	8	9	10	11	12
 <p>Specify armcap: wood or Urethane.</p>	<b>GC3626TOP</b>	\$4412	\$4582	\$4725	\$4936	\$5230	\$5342	\$5600	\$6087	\$6330	\$6783	\$7412	\$8190
	Metal												
	<b>GC3626WTOP</b>	\$3814	\$3985	\$4128	\$4339	\$4633	\$4745	\$5003	\$5490	\$5733	\$6185	\$6814	\$7588
	Wood												
		<b>OVERALL DIMENSIONS</b>			<b>SEAT DIMENSIONS</b>			<b>BACK DIMENSIONS</b>					
		<b>W</b>	<b>D</b>	<b>H</b>	<b>W</b>	<b>D</b>	<b>H</b>	<b>W</b>	<b>H</b>				
<b>LB Guest Three Seat Top, Open Center Arms</b> COM Yardage: 4.75 Freight Class: 300 Product Weight (lbs.): 77 Cubic Feet Per Carton: 65.25	Triple low back frame guest top, 3 back and 3 seat cushions. Due to the size and weight, this top requires at least 3 installers. Urethane armcap option - <b>Add \$110 list upcharge</b> <b>Must be connected to a full arm/leg frame.</b>	64	25	19	20.5	17.5	--	20.5	15				

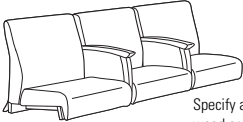
DESCRIPTION	MODEL#	STANDARD FABRIC GRADES											
		COM	2	3	4	5	6	7	8	9	10	11	12
 <p>Specify armcap: wood or Urethane.</p>	<b>GC3626CATOP</b>	\$4709	\$4908	\$5075	\$5317	\$5659	\$5786	\$6088	\$6650	\$6933	\$7455	\$8183	\$9081
	Metal												
		<b>OVERALL DIMENSIONS</b>			<b>SEAT DIMENSIONS</b>			<b>BACK DIMENSIONS</b>					
		<b>W</b>	<b>D</b>	<b>H</b>	<b>W</b>	<b>D</b>	<b>H</b>	<b>W</b>	<b>H</b>				
<b>LB Guest Three Seat Top, Closed Center Arms</b> COM Yardage: 5.5 Freight Class: 300 Product Weight (lbs.): 83 Cubic Feet Per Carton: 65.25	Triple low back frame guest top, 3 back and 3 seat cushions. Due to the size and weight, this top requires at least 3 installers. Urethane armcap option - <b>Add \$110 list upcharge</b> <b>Must be connected to a full arm/leg frame.</b>	64	25	19	20.5	17.5	--	20.5	15				

DESCRIPTION	MODEL#	STANDARD FABRIC GRADES											
		COM	2	3	4	5	6	7	8	9	10	11	12
	<b>GC3631TOP</b>	\$1146	\$1207	\$1262	\$1339	\$1448	\$1488	\$1585	\$1767	\$1855	\$2023	\$2253	\$2537
		<b>OVERALL DIMENSIONS</b>			<b>SEAT DIMENSIONS</b>			<b>BACK DIMENSIONS</b>					
		<b>W</b>	<b>D</b>	<b>H</b>	<b>W</b>	<b>D</b>	<b>H</b>	<b>W</b>	<b>H</b>				
<b>MB Patient Top</b> COM Yardage: 1.75 Freight Class: 150 Product Weight (lbs.): 42 Cubic Feet Per Carton: 10	Single mid back frame patient top, with 1 back and 1 seat cushion. <b>Must be connected to a full arm/leg frame.</b>	20.5	25	22	20.5	17.5	--	20.5	18				

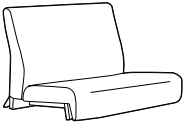
DESCRIPTION	MODEL#	STANDARD FABRIC GRADES											
		COM	2	3	4	5	6	7	8	9	10	11	12
	<b>GC3637TOP</b>	\$1738	\$1826	\$1904	\$2015	\$2168	\$2230	\$2365	\$2621	\$2749	\$2987	\$3318	\$3727
		<b>OVERALL DIMENSIONS</b>			<b>SEAT DIMENSIONS</b>			<b>BACK DIMENSIONS</b>					
		<b>W</b>	<b>D</b>	<b>H</b>	<b>W</b>	<b>D</b>	<b>H</b>	<b>W</b>	<b>H</b>				
<b>LB Bariatric Guest Top</b> COM Yardage: 2.5 Freight Class: 250 Product Weight (lbs.): 53 Cubic Feet Per Carton: 26.5	Single low back frame bariatric guest top, with 1 back and 1 seat cushion. <b>Must be connected to a full arm/leg frame.</b>	30	25	19	30	17.5	--	30	15				

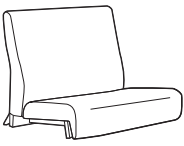
DESCRIPTION	MODEL#	STANDARD FABRIC GRADES											
		COM	2	3	4	5	6	7	8	9	10	11	12
	<b>GC3638TOP</b>	\$1852	\$1949	\$2034	\$2156	\$2326	\$2389	\$2541	\$2824	\$2964	\$3225	\$3591	\$4037
		<b>OVERALL DIMENSIONS</b>			<b>SEAT DIMENSIONS</b>			<b>BACK DIMENSIONS</b>					
		<b>W</b>	<b>D</b>	<b>H</b>	<b>W</b>	<b>D</b>	<b>H</b>	<b>W</b>	<b>H</b>				
<b>MB Bariatric Patient Top</b> COM Yardage: 2.75 Freight Class: 250 Product Weight (lbs.): 62 Cubic Feet Per Carton: 30.5	Single mid back frame bariatric patient top, with 1 back and 1 seat cushion. <b>Must be connected to a full arm/leg frame.</b>	30	25	22	30	17.5	--	30	18				

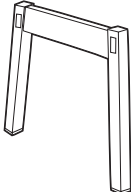
DESCRIPTION	MODEL#	STANDARD FABRIC GRADES								
		List Price								
	<b>GC3620LNA</b>	<b>\$516</b>								
	Metal									
	<b>GC3620WLNA</b>	<b>\$276</b>								
	Wood									
		OVERALL DIMENSIONS			SEAT DIMENSIONS			BACK DIMENSIONS		
		W	D	H	W	D	H	W	H	
<b>Left End Frame, Armless</b> COM Yardage: -- Freight Class: 150 Product Weight (lbs.): 5 Cubic Feet Per Carton: 1.2		1.25	24.25	16						
		<b>Does not allow linking to other units or tables.</b>								

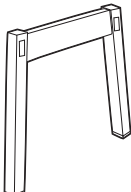
DESCRIPTION	MODEL#	STANDARD FABRIC GRADES								
		List Price								
	<b>GC3620RNA</b>	<b>\$516</b>								
	Metal									
	<b>GC3620WRNA</b>	<b>\$276</b>								
	Wood									
		OVERALL DIMENSIONS			SEAT DIMENSIONS			BACK DIMENSIONS		
		W	D	H	W	D	H	W	H	
<b>Right End Frame, Armless</b> COM Yardage: -- Freight Class: 150 Product Weight (lbs.): 5 Cubic Feet Per Carton: 1.2		1.25	24.25	16						
		<b>Does not allow linking to other units or tables.</b>								

DESCRIPTION	MODEL#	STANDARD FABRIC GRADES										
		List Price										
	<b>GC3620LA</b>	<b>\$621</b>										
	<b>GC3620LAM</b> (w/power)	<b>\$2008</b>										
	<b>GC3620WLA</b>	<b>\$445</b>										
	<b>GC3620WLAM</b> (w/power)	<b>\$1800</b>										
		OVERALL DIMENSIONS			SEAT DIMENSIONS			BACK DIMENSIONS				
		W	D	H	W	D	H	W	H			
<b>Left End Frame, Open Arm</b> COM Yardage: -- Freight Class: 125 Product Weight (lbs.): 10 Cubic Feet Per Carton: 1.4		2.5	27	26.5								
		Specify armcap: wood or Urethane.										
		For use in <b>left</b> side finished position of guest and/or patient seating units. • Models GC3620LAM and GC3620WLAM have <b>power/USB</b> module (not shown). <b>Does not allow linking to other units or tables.</b> Urethane armcap option - <b>Add \$56 list upcharge</b>										

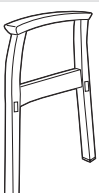
DESCRIPTION	MODEL#	STANDARD FABRIC GRADES										
		List Price										
	<b>GC3620RA</b> (Metal)	<b>\$621</b>										
	<b>GC3620RAM</b> (w/power)	<b>\$2008</b>										
	<b>GC3620WRA</b> (Wood)	<b>\$445</b>										
	<b>GC3620WRAM</b> (w/power)	<b>\$1800</b>										
		OVERALL DIMENSIONS			SEAT DIMENSIONS			BACK DIMENSIONS				
		W	D	H	W	D	H	W	H			
<b>Right End Frame, Open Arm</b> COM Yardage: -- Freight Class: 125 Product Weight (lbs.): 10 Cubic Feet Per Carton: 1.4		2.5	27	26.5								
		Specify armcap: wood or Urethane.										
		For use in <b>right</b> side finished position of guest and/or patient seating units. • Models GC3620RAM and GC3620WRAM have <b>power/USB</b> module (not shown). <b>Does not allow linking to other units or tables.</b> Urethane armcap option - <b>Add \$56 list upcharge</b>										

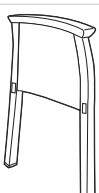
DESCRIPTION	MODEL#	STANDARD FABRIC GRADES												
		COM	2	3	4	5	6	7	8	9	10	11	12	
	<b>GC3620LCA</b> (Metal)	<b>\$764</b>	<b>\$786</b>	<b>\$809</b>	<b>\$837</b>	<b>\$877</b>	<b>\$894</b>	<b>\$926</b>	<b>\$995</b>	<b>\$1027</b>	<b>\$1091</b>	<b>\$1178</b>	<b>\$1178</b>	
	<b>GC3620LCAM</b> (w/power)	<b>\$2176</b>	<b>\$2197</b>	<b>\$2220</b>	<b>\$2248</b>	<b>\$2289</b>	<b>\$2307</b>	<b>\$2345</b>	<b>\$2404</b>	<b>\$2448</b>	<b>\$2498</b>	<b>\$2601</b>	<b>\$2710</b>	
		OVERALL DIMENSIONS			SEAT DIMENSIONS			BACK DIMENSIONS						
		W	D	H	W	D	H	W	H					
<b>Left End Frame, Closed Arm</b> COM Yardage: 0.65 Freight Class: 92.5 Product Weight (lbs.): 15 Cubic Feet Per Carton: 1.4		2.5	27	26.5										
		Specify armcap: wood or Urethane.												
		For use in <b>left</b> side finished position of guest and/or patient seating units. • Model GC3620LCAM has <b>power/USB</b> module (not shown). <b>Does not allow linking to other units or tables.</b> Urethane armcap option - <b>Add \$56 list upcharge</b>												

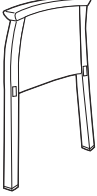
DESCRIPTION	MODEL#	STANDARD FABRIC GRADES											
		COM	2	3	4	5	6	7	8	9	10	11	12
	GC3620RCA (metal)	\$764	\$786	\$811	\$837	\$878	\$895	\$927	\$996	\$1027	\$1092	\$1178	\$1283
	GC3620RCAM (w/power)	\$2176	\$2197	\$2220	\$2248	\$2289	\$2307	\$2345	\$2404	\$2448	\$2498	\$2601	\$2710
<p>Right End Frame, Closed Arm</p> <p>COM Yardage: 0.65                      Freight Class: 92.5                      Product Weight (lbs.): 15                      Cubic Feet Per Carton: 1.4</p>	Specify armcap: wood or Urethane.	OVERALL DIMENSIONS			SEAT DIMENSIONS			BACK DIMENSIONS					
		W	D	H	W	D	H	W	H				
		2.5	27	26.5									

For use in **right** side finished position of guest and/or patient seating units.  
 • Model GC3620RCAM has **power/USB** module (not shown)  
**Does not allow linking to other units or tables.**  
 Urethane armcap option - **Add \$56 list upcharge**

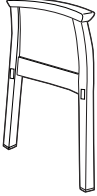
DESCRIPTION	MODEL#	STANDARD FABRIC GRADES											
		COM	2	3	4	5	6	7	8	9	10	11	12
	GC3620LCAL	List Price											
	Metal	\$1009											
<p>Left End Frame, Closed Arm, Laminate Panel</p> <p>COM Yardage: --                      Freight Class: 85                      Product Weight (lbs.): 18                      Cubic Feet Per Carton: 1.4</p>	Specify armcap: wood or Urethane.	OVERALL DIMENSIONS			SEAT DIMENSIONS			BACK DIMENSIONS					
		W	D	H	W	D	H	W	H				
		2.5	27	26.5									

For use in **left** side finished position of guest and/or patient seating units.  
**Does not allow linking to other units or tables.**  
 Urethane armcap option - **Add \$56 list upcharge**

DESCRIPTION	MODEL#	STANDARD FABRIC GRADES											
		COM	2	3	4	5	6	7	8	9	10	11	12
	GC3620RCAL	List Price											
	Metal	\$1009											
<p>Right End Frame, Closed Arm, Laminate Panel</p> <p>COM Yardage: --                      Freight Class: 85                      Product Weight (lbs.): 18                      Cubic Feet Per Carton: 1.4</p>	Specify armcap: wood or Urethane.	OVERALL DIMENSIONS			SEAT DIMENSIONS			BACK DIMENSIONS					
		W	D	H	W	D	H	W	H				
		2.5	27	26.5									

For use in **left** side finished position of guest and/or patient seating units.  
**Does not allow linking to other units or tables.**  
 Urethane armcap option - **Add \$56 list upcharge**

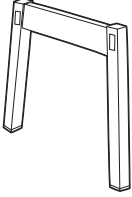
DESCRIPTION	MODEL#	STANDARD FABRIC GRADES											
		COM	2	3	4	5	6	7	8	9	10	11	12
	GC3622LNA	List Price											
	Metal	\$535											
	GC3622WLNA	List Price											
	Wood	\$295											
<p>Seat to Seat Central Linking Frame, Armless</p> <p>COM Yardage: --                      Freight Class: 150                      Product Weight (lbs.): Metal: 5 / Wood: 4                      Cubic Feet Per Carton: 1.2</p>		OVERALL DIMENSIONS			SEAT DIMENSIONS			BACK DIMENSIONS					
		W	D	H	W	D	H	W	H				
		1.25	24.25	16									

For **linking** guest and/or patient top seating units.  
**Does not allow linking to other units or tables.**

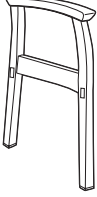

DESCRIPTION	MODEL#	STANDARD FABRIC GRADES											
		COM	2	3	4	5	6	7	8	9	10	11	12
	GC3622LA	List Price											
	Metal	\$693											
	GC3622WLA	List Price											
	Wood	\$460											
<p>Center Frame, Open Arm</p> <p>COM Yardage: --                      Freight Class: 125                      Product Weight (lbs.) Metal: 10 / Wood: 8                      Cubic Feet Per Carton: 1.4</p>	Specify armcap: wood or Urethane.	OVERALL DIMENSIONS			SEAT DIMENSIONS			BACK DIMENSIONS					
		W	D	H	W	D	H	W	H				
		2.5	27	26.5									



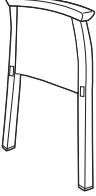

For **linking** guest and/or patient top seating units.  
 Urethane armcap option - **Add \$56 list upcharge**

# SEATING

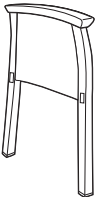
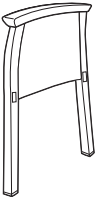
# PRIMACARE™ MODULAR - GUEST/PATIENT

P



DESCRIPTION	MODEL#	STANDARD FABRIC GRADES												
		COM	2	3	4	5	6	7	8	9	10	11	12	
 <p><b>Center Frame, Closed Arm</b> COM Yardage: 0.65 Freight Class: 92.5 Product Weight (lbs.) Metal: 15 / Wood: 10 Cubic Feet Per Carton: 1.4</p>	<b>GC3622LCA</b>	\$781	\$802	\$825	\$853	\$894	\$911	\$943	\$1012	\$1043	\$1107	\$1192	\$1298	
	<p>Specify armcap: wood or Urethane.</p>	<b>OVERALL DIMENSIONS</b> W D H			<b>SEAT DIMENSIONS</b> W D H			<b>BACK DIMENSIONS</b> W H						
		2.5	27	26.5	For <b>linking</b> guest and/or patient top seating units.  Urethane armcap option - <b>Add \$56 list upcharge</b>									
 <p><b>Center Frame, Open Arm</b> COM Yardage: -- Freight Class: 125 Product Weight (lbs.) Metal: 10 / Wood: 8 Cubic Feet Per Carton: 1.4</p>		List Price												
	<b>GC3622TLA</b>	\$677												
	<b>GC3622WTLA</b>	\$498												
	Specify armcap: wood or Urethane.	<b>OVERALL DIMENSIONS</b> W D H			<b>SEAT DIMENSIONS</b> W D H			<b>BACK DIMENSIONS</b> W H						
		2.5	27	26.5	For <b>linking</b> guest and/or patient top seating units to modular table on the <b>left</b> side of the frame.  Urethane armcap option - <b>Add \$56 list upcharge</b>									
 <p><b>Center Frame, Open Arm</b> COM Yardage: -- Freight Class: 125 Product Weight (lbs.) Metal: 10 / Wood: 8 Cubic Feet Per Carton: 1.4</p>		List Price												
	<b>GC3622TRA</b>	\$677												
	<b>GC3622WTRA</b>	\$498												
	Specify armcap: wood or Urethane.	<b>OVERALL DIMENSIONS</b> W D H			<b>SEAT DIMENSIONS</b> W D H			<b>BACK DIMENSIONS</b> W H						
		2.5	27	26.5	For <b>linking</b> guest and/or patient top seating units to modular table on the <b>right</b> side of the frame.  Urethane armcap option - <b>Add \$56 list upcharge</b>									
 <p><b>Center Frame, Closed Arm</b> COM Yardage: 0.65 Freight Class: 92.5 Product Weight (lbs.) Metal: 15 / Wood: 10 Cubic Feet Per Carton: 1.4</p>		COM	2	3	4	5	6	7	8	9	10	11	12	
	<b>GC3622TLCA</b>	\$816	\$838	\$863	\$889	\$930	\$947	\$979	\$1048	\$1079	\$1144	\$1230	\$1335	
	Specify armcap: wood or Urethane.	<b>OVERALL DIMENSIONS</b> W D H			<b>SEAT DIMENSIONS</b> W D H			<b>BACK DIMENSIONS</b> W H						
		2.5	27	26.5	For <b>linking</b> guest and/or patient top seating units to modular table on the <b>left</b> side of the frame.  Urethane armcap option - <b>Add \$56 list upcharge</b>									
 <p><b>Center Frame, Closed Arm</b> COM Yardage: 0.65 Freight Class: 92.5 Product Weight (lbs.) Metal: 15 / Wood: 10 Cubic Feet Per Carton: 1.4</p>		COM	2	3	4	5	6	7	8	9	10	11	12	
	<b>GC3622TRCA</b>	\$816	\$838	\$863	\$889	\$930	\$947	\$979	\$1048	\$1079	\$1144	\$1230	\$1335	
	Specify armcap: wood or Urethane.	<b>OVERALL DIMENSIONS</b> W D H			<b>SEAT DIMENSIONS</b> W D H			<b>BACK DIMENSIONS</b> W H						
		2.5	27	26.5	For <b>linking</b> guest and/or patient top seating units to modular table on the <b>right</b> side of the frame.  Urethane armcap option - <b>Add \$56 list upcharge</b>									

DESCRIPTION	MODEL#	STANDARD FABRIC GRADES							
		List Price							
	<b>GC3616SSULACAP</b>	<b>\$187</b>							
	Urethane								
	<b>GC3616WLACAP</b>	<b>\$223</b>							
	Wood								
		<b>OVERALL DIMENSIONS</b>			<b>SEAT DIMENSIONS</b>			<b>BACK DIMENSIONS</b>	
		<b>W</b>	<b>D</b>	<b>H</b>	<b>W</b>	<b>D</b>	<b>H</b>	<b>W</b>	<b>H</b>
<b>Dining Armcap, Left</b> COM Yardage: -- Freight Class: 250 Product Weight (lbs.) Urethane: 2 / Wood: 1.5 Cubic Feet Per Carton: 0.6		0	0	0					
		Armcap with hardware for dining top seating units. <i>For field replacement only.</i>							
	<b>GC3616SSURACAP</b>	<b>\$187</b>							
	Urethane								
	<b>GC3616WRACAP</b>	<b>\$223</b>							
	Wood								
		<b>OVERALL DIMENSIONS</b>			<b>SEAT DIMENSIONS</b>			<b>BACK DIMENSIONS</b>	
		<b>W</b>	<b>D</b>	<b>H</b>	<b>W</b>	<b>D</b>	<b>H</b>	<b>W</b>	<b>H</b>
<b>Dining Armcap, Right</b> COM Yardage: -- Freight Class: 250 Product Weight (lbs.) Urethane: 2 / Wood: 1.5 Cubic Feet Per Carton: 0.6		0	0	0					
		Armcap with hardware dining top seating units. <i>For field replacement only.</i>							
	<b>GC3620SSULACAP</b>	<b>\$187</b>							
	Urethane								
	<b>GC3620WLACAP</b>	<b>\$223</b>							
	Wood								
		<b>OVERALL DIMENSIONS</b>			<b>SEAT DIMENSIONS</b>			<b>BACK DIMENSIONS</b>	
		<b>W</b>	<b>D</b>	<b>H</b>	<b>W</b>	<b>D</b>	<b>H</b>	<b>W</b>	<b>H</b>
<b>Guest/Patient Armcap, Left</b> COM Yardage: -- Freight Class: 150 Product Weight (lbs.) Urethane: 2.5 / Wood: 2 Cubic Feet Per Carton: 0.6		0	0	0					
		Armcap with hardware for guest/patient top seating units. <i>For field replacement only.</i>							
	<b>GC3620SSURACAP</b>	<b>\$187</b>							
	Urethane								
	<b>GC3620WRACAP</b>	<b>\$223</b>							
	Wood								
		<b>OVERALL DIMENSIONS</b>			<b>SEAT DIMENSIONS</b>			<b>BACK DIMENSIONS</b>	
		<b>W</b>	<b>D</b>	<b>H</b>	<b>W</b>	<b>D</b>	<b>H</b>	<b>W</b>	<b>H</b>
<b>Guest/Patient Armcap, Right</b> COM Yardage: -- Freight Class: 150 Product Weight (lbs.) Urethane: 2.5 / Wood: 2 Cubic Feet Per Carton: 0.6		0	0	0					
		Armcap with hardware for guest/patient top seating units. <i>For field replacement only.</i>							
	<b>GC3622SSULACAP</b>	<b>\$187</b>							
	(Urethane)								
	<b>GC3622WLACAP</b>	<b>\$223</b>							
	(wood)								
		<b>OVERALL DIMENSIONS</b>			<b>SEAT DIMENSIONS</b>			<b>BACK DIMENSIONS</b>	
		<b>W</b>	<b>D</b>	<b>H</b>	<b>W</b>	<b>D</b>	<b>H</b>	<b>W</b>	<b>H</b>
<b>Narrow Center Armcap</b> COM Yardage: -- Freight Class: 70 Product Weight (lbs.) Urethane: 1.5 / Wood: 1.5 Cubic Feet Per Carton: 0.6		0	0	0					
		Armcap with hardware for guest/patient top seating units. <i>For field replacement only.</i>							

# SEATING

# PRIMACARE™ MODULAR - GUEST/PATIENT

P

DESCRIPTION	MODEL#	STANDARD FABRIC GRADES							
		List Price							
	<b>GC3641SSULACAP</b>	<b>\$210</b>							
	Urethane								
	<b>GC3641WLACAP</b>	<b>\$264</b>							
	Wood								
		OVERALL DIMENSIONS			SEAT DIMENSIONS			BACK DIMENSIONS	
		W	D	H	W	D	H	W	H
<b>Lounge Armcap, Left</b> COM Yardage: -- Freight Class: 150 Product Weight (lbs.) Urethane: 2.5 / Wood: 2 Cubic Feet Per Carton: 0.6		3	26.75	1.5					
		Armcap with hardware <b>for Lounge chair</b> <i>For field replacement only.</i>							
	<b>GC3641SSURACAP</b>	<b>\$210</b>							
	Urethane								
	<b>GC3641WRACAP</b>	<b>\$264</b>							
	Wood								
		OVERALL DIMENSIONS			SEAT DIMENSIONS			BACK DIMENSIONS	
		W	D	H	W	D	H	W	H
<b>Lounge Armcap, Right</b> COM Yardage: -- Freight Class: 150 Product Weight (lbs.) Urethane: 2.5 / Wood: 2 Cubic Feet Per Carton: 0.6		3	26.75	1.5					
		Armcap with hardware <b>for Lounge chair</b> <i>For field replacement only.</i>							

**Modular tables:**

Tops are 1" thick.

Wooden leg tables:

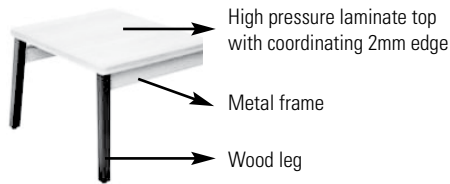

Metal leg tables:

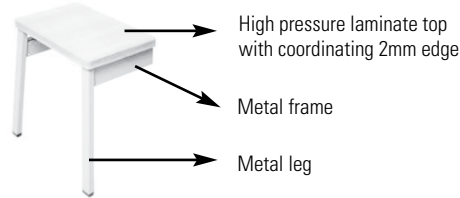

**Table top finishes:**

**High Pressure Laminate (HP)**

- Absolute Acajou (ACJ)
- Asian Night (ASN)
- Avant Cherry (W357)
- Avant Honey (W356)
- Blizzard (BZD)
- Brushed Cobalt (BRC)
- Clear Maple (CMB)
- Custom Grey (CGY)
- Dark Espresso (W142)
- Designer White (DWT)
- Fashionista (FAS)
- First Class (FCL)
- Noce Biondo (NBL)
- Noce Grigio (NGL)
- Noce Leggero (NEL)
- Noce Medio (NML)
- Quartered Mahogany (QTM)
- Sheer Beauty (SBL)
- Stonedust (SDT)
- Walnut Heights (WHE)
- White Chocolate (WHC)
- Winter Cherry (WCR)

**Wooden leg finishes (top, base, legs & apron)**

- Absolute (AAM)
- Cherry (ACM)
- English Oak (EOM)
- Espresso Cafe (ECM)
- Fruitwood (TFM)
- Gray (HGM)
- Honey (AHM)
- Jet Onyx (JOM)
- Mahogany (TMM)
- Maple (AVM)
- Medium Walnut (MWM)
- Natural Walnut (NLW)
- Night (ASM)
- Noce Biondo (NBM)
- Noce Grigio (NGM)
- Noce Leggero (NEM)
- Noce Medio (NMM)
- Sandy Beach (SBM)
- Shaker Cherry (SKM)
- Walnut (TWM)
- White (WHM)
- WC Cream (WTM)
- Winter Cherry (WCM)

**Metal leg finishes:**

Black (TBL), Cloud (TIV), Designer White (TDW), Fog (TFO), Frost (TFR), Kalua (TKA), Latte (TLA), Mocha (TMO), Nevada (TNE), Sand (TSN), Shadow (TSH), Toast (TOA) and Tungsten (TTU).

**Metal frame finishes:**

Black (TBL), Cloud (TIV), Designer White (TDW), Fog (TFO), Frost (TFR), Kalua (TKA), Latte (TLA), Mocha (TMO), Nevada (TNE), Sand (TSN), Shadow (TSH), Toast (TOA) and Tungsten (TTU).

**Power/USB modules:**

For modular tables with power/USB module, refer to models ending in "M". Power module includes two power outlets, four USB charging ports and a 6 foot long power cord. Available in Black or White (must be specified at time of order). Power module is mounted **on surface** on narrow tables; mounted **in surface** on larger tables.



On surface power module on narrow tables







In surface power module on larger tables

# SEATING

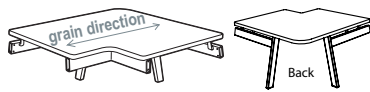
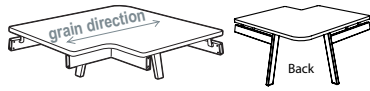
# PRIMACARE™ MODULAR - TABLES

P



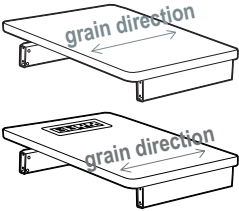
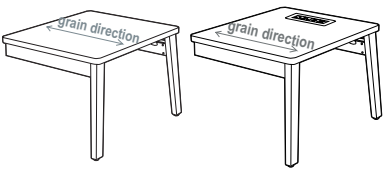
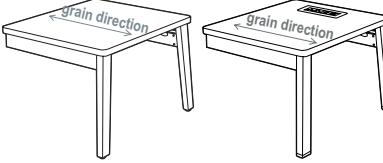
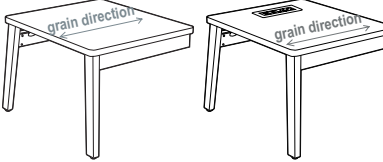
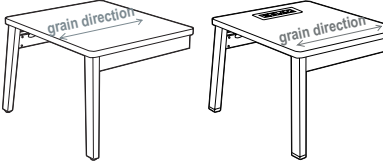

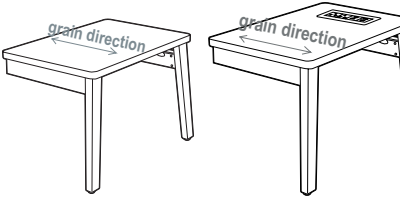
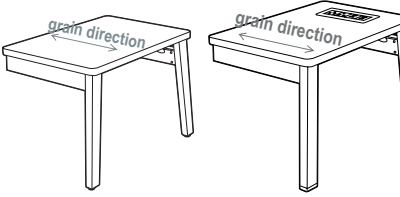
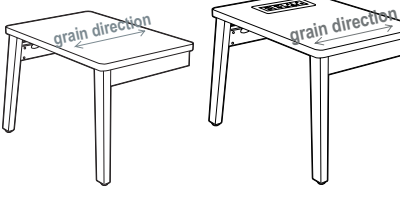
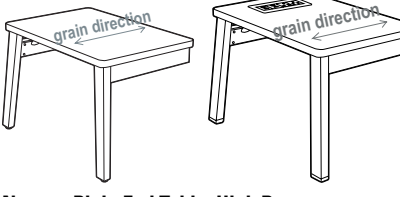
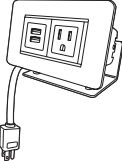



DESCRIPTION	MODEL#	STANDARD FABRIC GRADES					
 <p>Left Corner Table, HP for Wood Frame</p>	GC3671WL-HP	33 x 33 x 17	100	54	6	\$1502	
	GC3671WLM-HP with power					\$2918	
						<ul style="list-style-type: none"> <li>Model GC3671WLM-HP has a <b>power/USB</b> module mounted in surface.</li> </ul>	
						Coordinating 2mm edge. Must be connected to full arm and leg with <b>wood</b> frames (GC3622WTLA/WTRA). This table allows for kneespace when specifying chairs in a corner position. 1 per carton.	
						<ul style="list-style-type: none"> <li>Includes 2 rear wood legs (not shown)</li> </ul>	
 <p>Left Corner Table, HP for Metal Frame</p>	GC3671L-HP	33 x 33 x 17	100	54	6	\$1586	
	GC3671LM-HP with power					\$3017	
						<ul style="list-style-type: none"> <li>Model GC3671LM-HP has a <b>power/USB</b> module mounted in surface.</li> </ul>	
						Coordinating 2mm edge. Must be connected to full arm and leg with <b>metal</b> frames (GC3622TLA/TRA). This table allows for kneespace when specifying chairs in a corner position. 1 per carton.	
						<ul style="list-style-type: none"> <li>Includes 2 rear metal legs (not shown)</li> </ul>	
 <p>Right Corner Table, HP for Wood Frame</p>	GC3671WR-HP	33 x 33 x 17	100	54	6	\$1502	
	GC3671WRM-HP with power					\$2918	
						<ul style="list-style-type: none"> <li>Model GC3671WRM-HP has a <b>power/USB</b> module mounted in surface.</li> </ul>	
						Coordinating 2mm edge. Must be connected to full arm and leg with <b>wood</b> frames (GC3622WTLA/WTRA). This table allows for kneespace when specifying chairs in a corner position. 1 per carton.	
						<ul style="list-style-type: none"> <li>Includes 2 rear wood legs (not shown)</li> </ul>	
 <p>Right Corner Table, HP for Metal Frame</p>	GC3671R-HP	33 x 33 x 17	125	45	6	\$1586	
	GC3671RM-HP with power					\$3017	
						<ul style="list-style-type: none"> <li>Model GC3671RM-HP has a <b>power/USB</b> module mounted in surface.</li> </ul>	
						Coordinating 2mm edge. Must be connected to full arm and leg with <b>metal</b> frames (GC3622TLA/TRA). This table allows for kneespace when specifying chairs in a corner position. 1 per carton.	
						<ul style="list-style-type: none"> <li>Includes 2 rear metal legs (not shown)</li> </ul>	
 <p>Center Table, High Pressure</p>	GC3672-HP	23.87 x 20.25 x 5.5	150	20	3.4	\$892	
	GC3672M-HP with power					\$2247	
						<ul style="list-style-type: none"> <li>Model GC3672M-HP has a <b>power/USB</b> module mounted in surface.</li> </ul>	
						Coordinating 2mm edge. Regular center table for <b>wood</b> or <b>metal</b> (HT) frame. Must be connected to full arm and leg with <b>metal</b> or <b>wood</b> frames (GC3622TLA/TRA, GC3622TLCA/TRCA, GC3622WTLA/WTRA). 1 per carton.	

DESCRIPTION	MODEL#	STANDARD FABRIC GRADES					
 <p><b>Narrow Center Table, High Pressure</b></p>	GC3673-HP	23.87 x 12 x 5.5	100	18	2.1	<b>\$867</b>	
	GC3673M-HP with power					<b>\$2401</b>	
						<ul style="list-style-type: none"> <li>Model GC3673M-HP has a <b>power/USB</b> module mounted on surface.</li> </ul>	
		Coordinating 2mm edge. Narrow center table for <b>wood or metal</b> (HT) frame. Must be connected to full arm and leg with <b>metal</b> or <b>wood</b> frames (GC3622TLA/TRA, GC3622TLCA/TRCA, GC3622WTLA/WTRA). 1 per carton					
 <p><b>Left End Table, High Pressure for Wood Frame</b></p>	GC3674WL-HP	23.87 x 20.25 x 17	150	20	3.4	<b>\$1231</b>	
	GC3674WLM-HP with power					<b>\$2617</b>	
						<ul style="list-style-type: none"> <li>Model GC3674WLM-HP has a <b>power/USB</b> module mounted in surface.</li> </ul>	
		Coordinating 2mm edge. Must be connected to full arm and leg with <b>wood</b> frames (GC3622WTLA). 1 per carton.					
 <p><b>Left End Table, High Pressure for Metal Frame</b></p>	GC3674L-HP	23.87 x 20.25 x 17	150	20	3.4	<b>\$1319</b>	
	GC3674LM-HP with power					<b>\$2714</b>	
						<ul style="list-style-type: none"> <li>Model GC3674LM-HP has a <b>power/USB</b> module mounted in surface.</li> </ul>	
		Coordinating 2mm edge. Must be connected to full arm and leg with <b>metal</b> frames (GC3622TLA). 1 per carton.					
 <p><b>Right End Table, High Pressure for Wood Frame</b></p>	GC3674WR-HP	23.87 x 20.25 x 17	150	20	3.4	<b>\$1231</b>	
	GC3674WRM-HP with power					<b>\$2617</b>	
						<ul style="list-style-type: none"> <li>Model GC3674WRM-HP has a <b>power/USB</b> module mounted in surface.</li> </ul>	
		Coordinating 2mm edge. Must be connected to full arm and leg with <b>wood</b> frames (GC3622WTRA). 1 per carton.					
 <p><b>Right End Table, High Pressure for Metal Frame</b></p>	GC3674R-HP	23.87 x 20.25 x 17	150	20	3.4	<b>\$1319</b>	
	GC3674RM-HP with power					<b>\$2714</b>	
						<ul style="list-style-type: none"> <li>Model GC3674RM-HP has a <b>power/USB</b> module mounted in surface.</li> </ul>	
		Coordinating 2mm edge. Must be connected to full arm and leg with <b>metal</b> frames (GC3622TRA). 1 per carton.					

DESCRIPTION		MODEL#	STANDARD FABRIC GRADES				
		GC3675WL-HP	23.87 x 12 x 17	100	18	2.1	\$1206
		GC3675WLM-HP with power					\$2804
<p><b>Narrow Left End Table, High Pressure for Wood Frame</b></p> <p>Coordinating 2mm edge. Must be connected to full arm and leg with <b>wood</b> frames (GC3622WTLA). 1 per carton.</p>							
		GC3675L-HP	23.87 x 12 x 17	100	18	2.1	\$1295
		GC3675LM-HP with power					\$2910
<p><b>Narrow Left End Table, High Pressure for Metal Frame</b></p> <p>Coordinating 2mm edge. Must be connected to full arm and leg with <b>metal</b> frames (GC3622TLA). 1 per carton.</p>							
		GC3675WR-HP	23.87 x 12 x 17	100	18	2.1	\$1206
		GC3675WRM-HP with power					\$2804
<p><b>Narrow Right End Table, High Pressure for Wood Frame</b></p> <p>Coordinating 2mm edge. Must be connected to full arm and leg with <b>wood</b> frames (GC3622WTLA). 1 per carton.</p>							
		GC3675R-HP	23.87 x 12 x 17	100	18	2.1	\$1295
		GC3675RM-HP with power					\$2910
<p><b>Narrow Right End Table, High Pressure for Metal Frame</b></p> <p>Coordinating 2mm edge. Must be connected to full arm and leg with <b>metal</b> frames (GC3622TLA). 1 per carton.</p>							
		GC36410	-- x -- x --	250	2	1	\$776
<p><b>On Surface Power/Data Module</b></p> <p>Surface top mount power/data module with one power outlet, two USB charging ports. 6 foot cord. White. Can be mounted to all freestanding and modular tables.</p>							























MODULAR LOUNGE	MODEL#	DIMENSIONS D x W x H	FREIGHT CLASS	WT/LBS.	CUBIC FT.	LIST PRICE
----------------	--------	-------------------------	---------------	---------	-----------	------------

**MODULAR TOP UNITS** **FOR MODULAR LOUNGE AND FULLY UPHOLSTERED LOUNGE**

	SINGLE SEAT	BARIATRIC	TWO SEATER	THREE SEATER
<b>Lounge Seating</b>	GC3641TOP 	GC3640TOP 	GC3642TOP 	GC3643TOP 
<b>High Back Lounge Seating</b>	GC3676HBTOP 	GC3679HBTOP 	GC3677HBTOP 	GC3678HBTOP 

**LEG / ARM FRAMES** **FOR MODULAR LOUNGE**



**Metal frame: Standard with Black Urethane armcap (see notes for wood and urethane finish options) | Wood frame: Must select armcap**

	LEFT, OPEN	RIGHT, OPEN	LEFT, CLOSED	RIGHT, CLOSED	LEFT, CLOSED LAMINATE PANEL	RIGHT, CLOSED LAMINATE PANEL
<b>Metal (HT) End</b>	GC3641LA 	GC3641LAM 	GC3641RA 	GC3641RAM 	GC3641LCA 	GC3641LCAM 
<b>Wood End</b>	GC3641WLA 	GC3641WLAM 	GC3641WRA 	GC3641WRAM 	GC3641WLCA 	GC3641WLCAM 
<b>Metal (HT) Center</b>	GC36406LA 		GC36406LCA 		GC36406LCAL 	
<b>Wood, Center</b>	GC36406WLA 					
<b>Metal (HT) Center table linking</b>	GC36406TLA 	GC3622TRA 	GC36406TLCA 		GC36406TRCA 	GC36406TRCAL 
<b>Wood Center table linking</b>	GC36406WTLA 	GC3622WTRA 				

For frame with power/USB module\*, add "M" after model number

**LEG / ARM FRAMES** **FOR FULLY UPHOLSTERED MODULAR LOUNGE**

**Standard with Black Urethane legs (see notes for wood and urethane finish options)**  
**Optional armcap in wood or urethane (cannot be retrofitted in the field if the frame is ordered without armcap)**

<b>Fully Upholstered End</b>	LEFT GC3676LA 	RIGHT GC3676RA 
<b>Fully Upholstered Center</b>	GC3676CFA 	

(Center = link both sides)

\*Power module includes two power outlets, four USB charging ports and a 6 foot long power cord.  
 Available in Black or White (must be specified at time of order). Power module is mounted on the frame below seat support rail.

DESCRIPTION

MODEL# / FEATURES

STANDARD TEXTILE GRADES

**MODULAR TABLES FOR MODULAR LOUNGE AND FULLY UPHOLSTERED LOUNGE**

Tables include legs to support table top (except for center tables). All tables have a metal frame.

LEFT

RIGHT

**Corner**

GC36403L-HP

GC36403LM-HP

GC36403R-HP

GC36403RM-HP

(high pressure laminate top with **metal legs**)



**Corner**

GC36403WL-HP

GC36403WLM-HP

GC36403WR-HP

GC36403WRM-HP

(high pressure laminate top with **wood legs**)



**Center**

GC36401-HP

GC36401M-HP

(high pressure laminate top, connects to metal or wood frame)



**Narrow Center**

GC36402-HP

GC36402M-HP

(high pressure laminate top, connects to metal or wood frame)



**End**

GC36404L-HP

GC36404LM-HP

GC36404R-HP

GC36404RM-HP

(high pressure laminate top with **metal legs**)



**End**

GC36404WL-HP

GC36404WLM-HP

GC36404WR-HP

GC36404WRM-HP

(high pressure laminate top with **wood legs**)

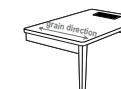

**Narrow End**

GC36405L-HP

GC36405LM-HP

GC36405R-HP

GC36405RM-HP

(high pressure laminate top with **metal legs**)



**Narrow End**

GC36405WL-HP

GC36405WLM-HP

GC36405WR-HP

GC36405WRM-HP

(high pressure laminate top with **wood legs**)



For table with power/USB module\*, refer to models ending in "M"

\* Power module includes two power outlets, four USB charging ports and a 6 foot long power cord. Available in Black or White (must be specified at time of order). Power module is mounted **on surface** on narrow tables; mounted **in surface** on larger tables (as shown above).

DESCRIPTION MODEL# / FEATURES STANDARD TEXTILE GRADES

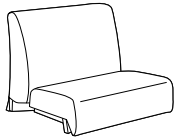

**Lounge Bariatric Top**  
COM Yardage: 3.25  
Freight Class: 300  
Product Weight (lbs.): 97  
Cubic Feet Per Carton: 49.5

	COM	2	3	4	5	6	7	8	9	10	11	12
<b>GC3640TOP</b>	<b>\$2401</b>	<b>\$2518</b>	<b>\$2616</b>	<b>\$2759</b>	<b>\$2965</b>	<b>\$3058</b>	<b>\$3241</b>	<b>\$3537</b>	<b>\$3762</b>	<b>\$4016</b>	<b>\$4531</b>	<b>\$5085</b>

Active weight: see notes.

Single frame lounge top unit with 1 back and 1 seat cushion.

**Must be connected to a full arm/leg frame.**

OVERALL DIMENSIONS			SEAT DIMENSIONS			BACK DIMENSIONS	
W	D	H	W	D	H	W	H
36	32	25	36	20	-	36	16

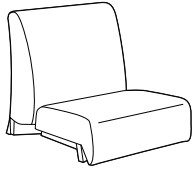

**Lounge Single Seater Top**  
COM Yardage: 2.5  
Freight Class: 250  
Product Weight (lbs.): 66  
Cubic Feet Per Carton: 29.5

	COM	2	3	4	5	6	7	8	9	10	11	12
<b>GC3641TOP</b>	<b>\$1724</b>	<b>\$1813</b>	<b>\$1889</b>	<b>\$2001</b>	<b>\$2155</b>	<b>\$2231</b>	<b>\$2373</b>	<b>\$2596</b>	<b>\$2772</b>	<b>\$2966</b>	<b>\$3361</b>	<b>\$3786</b>

Active weight: see notes.

Single frame lounge top unit with 1 back and 1 seat cushion.

**Must be connected to a full arm/leg frame.**

OVERALL DIMENSIONS			SEAT DIMENSIONS			BACK DIMENSIONS	
W	D	H	W	D	H	W	H
25	32	25	23	20	-	22.5	16

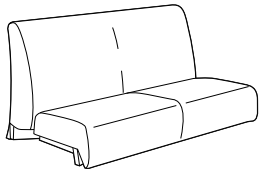

**Lounge Two Seater Top**  
COM Yardage: 4  
Freight Class: 250  
Product Weight (lbs.): 110  
Cubic Feet Per Carton: 49.5

	COM	2	3	4	5	6	7	8	9	10	11	12
<b>GC3642TOP</b>	<b>\$3054</b>	<b>\$3196</b>	<b>\$3320</b>	<b>\$3494</b>	<b>\$3746</b>	<b>\$3863</b>	<b>\$4091</b>	<b>\$4450</b>	<b>\$4729</b>	<b>\$5039</b>	<b>\$5673</b>	<b>\$6354</b>

Active weight: see notes.

Double frame lounge top unit with 2 back and 2 seat cushions.

**Must be connected to a full arm/leg frame.**

OVERALL DIMENSIONS			SEAT DIMENSIONS			BACK DIMENSIONS	
W	D	H	W	D	H	W	H
48	32	25	48	20	-	48	16

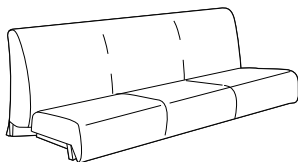

**Lounge Three Seater Top**  
COM Yardage: 6.25  
Freight Class: 250  
Product Weight (lbs.): 161  
Cubic Feet Per Carton: 69.5

	COM	2	3	4	5	6	7	8	9	10	11	12
<b>GC3643TOP</b>	<b>\$5037</b>	<b>\$5264</b>	<b>\$5452</b>	<b>\$5730</b>	<b>\$6118</b>	<b>\$6303</b>	<b>\$6656</b>	<b>\$7220</b>	<b>\$7655</b>	<b>\$8137</b>	<b>\$9132</b>	<b>\$10195</b>

**Due to the size and weight, this top requires at least 3 installers.**

Active weight: see notes.

Triple frame lounge top unit with 3 back and 3 seat cushions.

**Must be connected to a full arm/leg frame.**

OVERALL DIMENSIONS			SEAT DIMENSIONS			BACK DIMENSIONS	
W	D	H	W	D	H	W	H
71	32	25	71	20	-	71	16

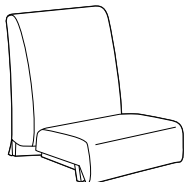

**HB Lounge Single Seater Top**  
COM Yardage: 6.5  
Freight Class: 250  
Product Weight (lbs.): 92  
Cubic Feet Per Carton: 29.5

	COM	2	3	4	5	6	7	8	9	10	11	12
<b>GC3676HB-TOP</b>	<b>\$1673</b>	<b>\$1905</b>	<b>\$2099</b>	<b>\$2382</b>	<b>\$2783</b>	<b>\$2972</b>	<b>\$3339</b>	<b>\$3918</b>	<b>\$4367</b>	<b>\$4865</b>	<b>\$5889</b>	<b>\$6985</b>

Active weight: see notes.

Single high back frame lounge top, 1 back and 1 seat cushion.

**Must be connected to a full arm/leg frame.**

OVERALL DIMENSIONS			SEAT DIMENSIONS			BACK DIMENSIONS	
W	D	H	W	D	H	W	H
23	29	36	23	20	-	23	19

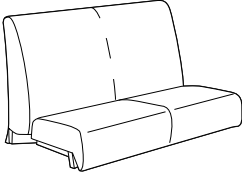
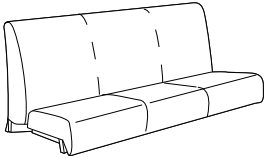
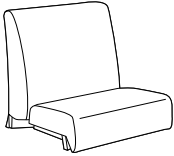
DESCRIPTION	MODEL# / FEATURES	STANDARD TEXTILE GRADES											
		COM	2	3	4	5	6	7	8	9	10	11	12
 <p><b>HB Lounge Two Seater Top</b> COM Yardage: 7.75 Freight Class: 250 Product Weight (lbs.): 117 Cubic Feet Per Carton: 56.25</p>	<b>GC3677HB-TOP</b>	\$3110	\$3387	\$3615	\$3954	\$4434	\$4661	\$5094	\$5788	\$6321	\$6914	\$8137	\$9442
	Active weight: see notes.	<b>OVERALL DIMENSIONS</b>			<b>SEAT DIMENSIONS</b>			<b>BACK DIMENSIONS</b>					
		<b>W</b>	<b>D</b>	<b>H</b>	<b>W</b>	<b>D</b>	<b>H</b>	<b>W</b>	<b>H</b>				
	Double high back frame lounge top unit with 2 back and 2 seat cushions.	45.5	29	36	45.5	20	-	45.5	19				
<b>Must be connected to a full arm/leg frame.</b>													
 <p><b>HB Lounge Three Seater Top</b> COM Yardage: 9.25 Freight Class: 250 Product Weight (lbs.): 158 Cubic Feet Per Carton: 69.5</p>	<b>GC3678HB-TOP</b>	\$5215	\$5547	\$5820	\$6224	\$6796	\$7065	\$7584	\$8412	\$9049	\$9757	\$11216	\$12771
	Active weight: see notes.	<b>OVERALL DIMENSIONS</b>			<b>SEAT DIMENSIONS</b>			<b>BACK DIMENSIONS</b>					
		<b>W</b>	<b>D</b>	<b>H</b>	<b>W</b>	<b>D</b>	<b>H</b>	<b>W</b>	<b>H</b>				
	Triple high back frame lounge top unit with 3 back and 3 seat cushions.	68.5	29	36	68.5	20	--	71	19				
<b>Must be connected to a full arm/leg frame.</b>													
 <p><b>HB Lounge Bariatric Top</b> COM Yardage: 6.75 Freight Class: 250 Product Weight (lbs.): 96 Cubic Feet Per Carton: 37.75</p>	<b>GC3679HB-TOP</b>	\$2615	\$2858	\$3058	\$3352	\$3770	\$3967	\$4346	\$4950	\$5415	\$5932	\$6997	\$8132
	Active weight: see notes.	<b>OVERALL DIMENSIONS</b>			<b>SEAT DIMENSIONS</b>			<b>BACK DIMENSIONS</b>					
		<b>W</b>	<b>D</b>	<b>H</b>	<b>W</b>	<b>D</b>	<b>H</b>	<b>W</b>	<b>H</b>				
	Single high back frame bariatric lounge top, 1 back and 1 seat cushion.	32	29	36	32	20	--	32	19				
<b>Must be connected to a full arm/leg frame.</b>													

DESCRIPTION MODEL# / FEATURES STANDARD TEXTILE GRADES

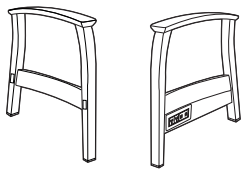

List price	
GC3641LA (metal)	\$810
GC3641LAM (w/power)	\$2133
GC3641WLA (wood)	\$546
GC3641WLAM (wood)	\$1869

Specify armcap:  
wood or Urethane.

OVERALL DIMENSIONS			SEAT DIMENSIONS			BACK DIMENSIONS	
W	D	H	W	D	H	W	H
3.5	29	25.25	-	-	-	-	-

For use in **left** side finished position of lounge seating units.  
 • Models GC3641LAM and GC3641WLAM have **power/USB module**  
**Does not allow linking to other units or tables.**  
 Urethane armcap option - **Add \$56 list upcharge**

**Lounge Left End Frame, Open Arm**  
 COM Yardage: --  
 Freight Class: 150  
 Product Weight (lbs.): metal: 9.67 | wood: 11  
 Cubic Feet Per Carton: 2.1

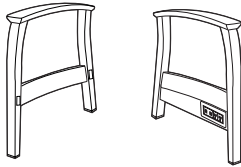

List price	
GC3641RA (metal)	\$810
GC3641RAM (w/power)	\$2133
GC3641WRA (wood)	\$546
GC3641WRAM (w/power)	\$1869

Specify armcap:  
wood or Urethane.

OVERALL DIMENSIONS			SEAT DIMENSIONS			BACK DIMENSIONS	
W	D	H	W	D	H	W	H
3.5	29	25.25	-	-	-	-	-

For use in **right** side finished position of lounge seating units.  
 • Models GC3641RAM and GC3641WRAM have **power/USB module**  
**Does not allow linking to other units or tables.**  
 Urethane armcap option - **Add \$56 list upcharge**

**Lounge Right End Frame, Open Arm**  
 COM Yardage: --  
 Freight Class: 150  
 Product Weight (lbs.): metal: 9.67 | wood: 11  
 Cubic Feet Per Carton: 2.1

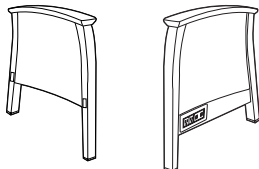

	COM	2	3	4	5	6	7	8	9	10	11	12
GC3641LCA (metal)	\$1021	\$1045	\$1070	\$1101	\$1150	\$1171	\$1212	\$1281	\$1334	\$1390	\$1508	\$1634
GC3641LCAM (w/power)	\$2354	\$2378	\$2403	\$2438	\$2484	\$2505	\$2547	\$2615	\$2667	\$2728	\$2846	\$2972
GC3641WLCAM (w/power)	\$2031	\$2063	\$2096	\$2141	\$2201	\$2231	\$2288	\$2379	\$2451	\$2529	\$2686	\$2856

Specify armcap:  
wood or Urethane.

OVERALL DIMENSIONS			SEAT DIMENSIONS			BACK DIMENSIONS	
W	D	H	W	D	H	W	H
3.5	29	25.25	-	-	-	-	-

For use in **left** side finished position of lounge seating units.  
 • Models GC3641LCAM and GC3641WLCAM have **power/USB module**  
**Does not allow linking to other units or tables.**  
 Urethane armcap option - **Add \$56 list upcharge**

**Lounge Left End Frame, Closed Arm**  
 COM Yardage: 0.75  
 Freight Class: 150  
 Product Weight (lbs.): metal: 10.17 | wood: 11  
 Cubic Feet Per Carton: 2.1

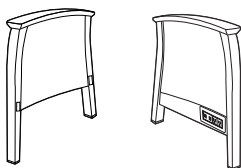

	COM	2	3	4	5	6	7	8	9	10	11	12
GC3641RCA (metal)	\$1021	\$1045	\$1070	\$1101	\$1150	\$1171	\$1212	\$1281	\$1334	\$1390	\$1508	\$1634
GC3641RCAM (w/power)	\$2354	\$2378	\$2403	\$2438	\$2484	\$2505	\$2547	\$2615	\$2667	\$2728	\$2846	\$2972
GC3641WRCAM (w/power)	\$2031	\$2063	\$2096	\$2141	\$2201	\$2231	\$2288	\$2379	\$2451	\$2529	\$2686	\$2856

Specify armcap:  
wood or Urethane.

OVERALL DIMENSIONS			SEAT DIMENSIONS			BACK DIMENSIONS	
W	D	H	W	D	H	W	H
3.5	29	25.25	-	-	-	-	-

For use in **right** side finished position of lounge seating units.  
 • Models GC3641RCAM and GC3641WRCAM have **power/USB module**  
**Does not allow linking to other units or tables.**  
 Urethane armcap option - **Add \$56 list upcharge**

**Lounge Right End Frame, Closed Arm**  
 COM Yardage: 0.75  
 Freight Class: 150  
 Product Weight (lbs.): metal: 10.17 | wood: 11  
 Cubic Feet Per Carton: 2.1

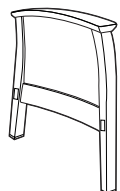

List Price	
GC3641LCAL	\$1150



Metal



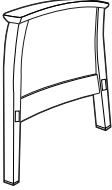
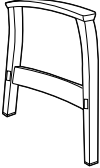
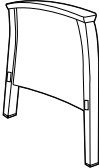
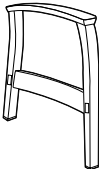

Specify armcap:  
wood or Urethane.

OVERALL DIMENSIONS			SEAT DIMENSIONS			BACK DIMENSIONS	
W	D	H	W	D	H	W	H
3.5	29	25.25	-	-	-	-	-

For use in **left** side finished position of lounge seating units.  
**Does not allow linking to other units or tables.**  
 Urethane armcap option - **Add \$56 list upcharge**

**Lounge Left End Frame, Closed Arm, Laminate Panel**  
 COM Yardage: --  
 Freight Class: 100  
 Product Weight (lbs.): 18  
 Cubic Feet Per Carton: 2.1

DESCRIPTION	MODEL# / FEATURES	STANDARD TEXTILE GRADES											
		List Price											
	<b>GC3641RCAL</b> (metal)	<b>\$1150</b>											
	Specify armcap: wood or Urethane.	<b>OVERALL DIMENSIONS</b>			<b>SEAT DIMENSIONS</b>			<b>BACK DIMENSIONS</b>					
		<b>W</b>	<b>D</b>	<b>H</b>	<b>W</b>	<b>D</b>	<b>H</b>	<b>W</b>	<b>H</b>				
<b>Lounge Right End Frame, Closed Arm, Laminate Panel</b> COM Yardage: -- Freight Class: 100 Product Weight (lbs.): 18 Cubic Feet Per Carton: 2.1	For use in <b>right</b> side finished position of lounge seating units.  <b>Does not allow linking to other units or tables.</b> Urethane armcap option - <b>Add \$56 list upcharge</b>	3.5	29	25.25									
		List price											
	<b>GC36406LA</b> (metal)	<b>\$810</b>											
	Specify armcap: wood or Urethane.	<b>OVERALL DIMENSIONS</b>			<b>SEAT DIMENSIONS</b>			<b>BACK DIMENSIONS</b>					
		<b>W</b>	<b>D</b>	<b>H</b>	<b>W</b>	<b>D</b>	<b>H</b>	<b>W</b>	<b>H</b>				
<b>Lounge Center Frame, Open Arm</b> COM Yardage: -- Freight Class: 300 Product Weight (lbs.): metal: 2.24   wood: 11 Cubic Feet Per Carton: 2.1	For linking lounge top seating units together only.  Urethane armcap option - <b>Add \$56 list upcharge</b>	3.5	29	25.25	-	-	-	-	-				
		COM	2	3	4	5	6	7	8	9	10	11	12
	<b>GC36406LCA</b> (metal)	<b>\$1033</b>	<b>\$1057</b>	<b>\$1084</b>	<b>\$1117</b>	<b>\$1165</b>	<b>\$1187</b>	<b>\$1226</b>	<b>\$1295</b>	<b>\$1349</b>	<b>\$1408</b>	<b>\$1526</b>	<b>\$1653</b>
	Specify armcap: wood or Urethane.	<b>OVERALL DIMENSIONS</b>			<b>SEAT DIMENSIONS</b>			<b>BACK DIMENSIONS</b>					
		<b>W</b>	<b>D</b>	<b>H</b>	<b>W</b>	<b>D</b>	<b>H</b>	<b>W</b>	<b>H</b>				
<b>Lounge Center Frame, Closed Arm</b> COM Yardage: 0.75 Freight Class: 150 Product Weight (lbs.): metal: 8.87   wood: 11 Cubic Feet Per Carton: 2.1	For linking lounge top seating units together only.  Urethane armcap option - <b>Add \$56 list upcharge</b>	3.5	29	25.25	-	-	-	-	-				
		List price											
	<b>GC36406TLA</b> (metal)	<b>\$810</b>											
	Specify armcap: wood or Urethane.	<b>OVERALL DIMENSIONS</b>			<b>SEAT DIMENSIONS</b>			<b>BACK DIMENSIONS</b>					
		<b>W</b>	<b>D</b>	<b>H</b>	<b>W</b>	<b>D</b>	<b>H</b>	<b>W</b>	<b>H</b>				
<b>Lounge Center Frame, Open Arm</b> COM Yardage: -- Freight Class: 300 Product Weight (lbs.): metal: 11   wood: 11 Cubic Feet Per Carton: 2.1	For linking lounge top seating units to modular table on the <b>left</b> side of the frame.  Urethane armcap option - <b>Add \$56 list upcharge</b>	3.5	29	25.25	-	-	-	-	-				
		List price											
	<b>GC36406TRA</b> (metal)	<b>\$810</b>											
	(wood) Specify armcap: wood or Urethane.	<b>OVERALL DIMENSIONS</b>			<b>SEAT DIMENSIONS</b>			<b>BACK DIMENSIONS</b>					
		<b>W</b>	<b>D</b>	<b>H</b>	<b>W</b>	<b>D</b>	<b>H</b>	<b>W</b>	<b>H</b>				
<b>Lounge Center Frame, Open Arm</b> COM Yardage: -- Freight Class: 300 Product Weight (lbs.): metal: 11   wood: 11 Cubic Feet Per Carton: 2.1	For linking lounge top seating units to modular table on the <b>right</b> side of the frame.  Urethane armcap option - <b>Add \$56 list upcharge</b>	3.5	29	25.25	-	-	-	-	-				

DESCRIPTION	MODEL# / FEATURES	STANDARD TEXTILE GRADES											
		COM	2	3	4	5	6	7	8	9	10	11	12
 <p><b>Lounge Center Frame, Closed Arm</b> COM Yardage: 0.75 Freight Class: 150 Product Weight (lbs.): metal: 8.87   wood: 11 Cubic Feet Per Carton: 2.1</p>	<b>GC36406TLCA</b> (metal)	\$1033	\$1057	\$1084	\$1117	\$1165	\$1187	\$1226	\$1295	\$1349	\$1408	\$1526	\$1653
	Specify armcap: wood or Urethane.	<b>OVERALL DIMENSIONS</b>			<b>SEAT DIMENSIONS</b>			<b>BACK DIMENSIONS</b>					
		<b>W</b>	<b>D</b>	<b>H</b>	<b>W</b>	<b>D</b>	<b>H</b>	<b>W</b>	<b>H</b>				
	For linking lounge top seating units to modular table on the <b>left</b> side of the frame.	3.5	29	25.25	-	-	-	-	-				
	Urethane armcap option - <b>Add \$56 list upcharge</b>												
 <p><b>Lounge Center Frame, Closed Arm</b> COM Yardage: 0.75 Freight Class: 150 Product Weight (lbs.): metal: 8.87   wood: 11 Cubic Feet Per Carton: 2.1</p>	<b>GC36406TRCA</b> (metal)	\$1033	\$1057	\$1084	\$1117	\$1165	\$1187	\$1226	\$1295	\$1349	\$1408	\$1526	\$1653
	Specify armcap: wood or SSU.	<b>OVERALL DIMENSIONS</b>			<b>SEAT DIMENSIONS</b>			<b>BACK DIMENSIONS</b>					
		<b>W</b>	<b>D</b>	<b>H</b>	<b>W</b>	<b>D</b>	<b>H</b>	<b>W</b>	<b>H</b>				
	For linking lounge top seating units to modular table on the <b>right</b> side of the frame.	3.5	29	25.25	-	-	-	-	-				
	Urethane armcap option - <b>Add \$56 list upcharge</b>												
 <p><b>Center Frame, Fully Upholstered Arm</b> COM Yardage: 1.75 Freight Class: 150 Product Weight (lbs.): 35 Cubic Feet Per Carton: 6</p>	<b>GC3676CFA</b>	\$652	\$713	\$768	\$845	\$952	\$1005	\$1102	\$1258	\$1380	\$1514	\$1790	\$2083
	Specify leg finish: wood or SSU.	<b>OVERALL DIMENSIONS</b>			<b>SEAT DIMENSIONS</b>			<b>BACK DIMENSIONS</b>					
	Optional wood or Urethane armcap. Please specify. Add \$218.	<b>W</b>	<b>D</b>	<b>H</b>	<b>W</b>	<b>D</b>	<b>H</b>	<b>W</b>	<b>H</b>				
	For <b>linking</b> lounge top seating units together or to modular table.	5	29	25.25	-	-	-	-	-				
 <p><b>Left End Frame, Fully Upholstered Arm</b> COM Yardage: 1.75 Freight Class: 250 Product Weight (lbs.): 20 Cubic Feet Per Carton: 6</p>	<b>GC3676LA</b>	\$652	\$713	\$768	\$845	\$952	\$1005	\$1102	\$1258	\$1380	\$1514	\$1790	\$2083
	Specify leg finish: wood or Urethane.	<b>OVERALL DIMENSIONS</b>			<b>SEAT DIMENSIONS</b>			<b>BACK DIMENSIONS</b>					
	Optional wood or Urethane armcap. Please specify. Add \$218.	<b>W</b>	<b>D</b>	<b>H</b>	<b>W</b>	<b>D</b>	<b>H</b>	<b>W</b>	<b>H</b>				
	For use in <b>left</b> side finished position of lounge seating units. <b>Does not allow linking to other units or tables.</b>	5	29	25.25	-	-	-	-	-				
 <p><b>Right End Frame, Fully Upholstered Arm</b> COM Yardage: 1.75 Freight Class: 250 Product Weight (lbs.): 20 Cubic Feet Per Carton: 6</p>	<b>GC3676RA</b>	\$652	\$713	\$768	\$845	\$952	\$1005	\$1102	\$1258	\$1380	\$1514	\$1790	\$2083
	Specify leg finish: wood or Urethane.	<b>OVERALL DIMENSIONS</b>			<b>SEAT DIMENSIONS</b>			<b>BACK DIMENSIONS</b>					
	Optional wood or Urethane armcap. Please specify. Add \$218.	<b>W</b>	<b>D</b>	<b>H</b>	<b>W</b>	<b>D</b>	<b>H</b>	<b>W</b>	<b>H</b>				
	For use in <b>right</b> side finished position of lounge seating units. <b>Does not allow linking to other units or tables.</b>	5	29	25.25	-	-	-	-	-				

**Modular tables for use with modular lounge and fully upholstered lounge units:**

Tops are 1" thick.

**Wooden leg tables:**

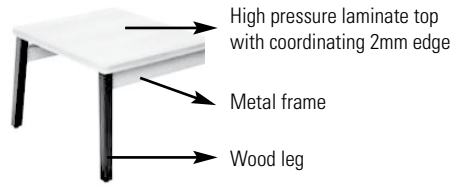

**Metal leg tables:**

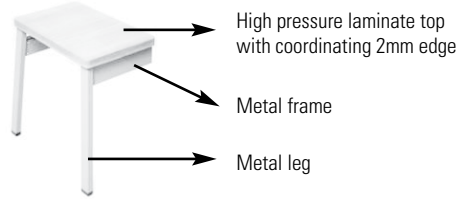

**Table top finishes:**

**High Pressure Laminate (HP)**

- |                       |                          |
|-----------------------|--------------------------|
| Absolute Acajou (ACJ) | First Class (FCL)        |
| Asian Night (ASN)     | Noce Biondo (NBL)        |
| Avant Cherry (W357)   | Noce Grigio (NGL)        |
| Avant Honey (W356)    | Noce Leggero (NEL)       |
| Blizzard (BZD)        | Noce Medio (NML)         |
| Brushed Cobalt (BRC)  | Quartered Mahogany (QTM) |
| Clear Maple (CMB)     | Sheer Beauty (SBY)       |
| Custom Grey (CGY)     | Stonedust (SDT)          |
| Dark Espresso (W142)  | Walnut Heights (WHE)     |
| Designer White (DWT)  | White Chocolate (WHC)    |
| Fashionista (FAS)     | Winter Cherry (WCR)      |

**Wood leg finishes (top, base, legs & apron):**

- |                     |                      |                     |
|---------------------|----------------------|---------------------|
| Absolute (AAM)      | Medium Walnut (MWM)  | White (WHM)         |
| Cherry (ACM)        | Natural Walnut (NLW) | WC Cream (WTM)      |
| English Oak (EOM)   | Night (ASM)          | Winter Cherry (WCM) |
| Espresso Cafe (ECM) | Noce Biondo (NBM)    |                     |
| Fruitwood (TFM)     | Noce Grigio (NGM)    |                     |
| Gray (HGM)          | Noce Leggero (NEM)   |                     |
| Honey (AHM)         | Noce Medio (NMM)     |                     |
| Jet Onyx (JOM)      | Sandy Beach (SBM)    |                     |
| Mahogany (TMM)      | Shaker Cherry (SKM)  |                     |
| Maple (AVM)         | Walnut (TWM)         |                     |

**Metal leg finishes:**

Black (TBL), Cloud (TIV), Designer White (TDW), Fog (TFO), Frost (TFR), Kalua (TKA), Latte (TLA), Mocha (TMO), Nevada (TNE), Sand (TSN), Shadow (TSH), Toast (TOA) and Tungsten (TTU).

**Metal frame finishes:**

Black (TBL), Cloud (TIV), Designer White (TDW), Fog (TFO), Frost (TFR), Kalua (TKA), Latte (TLA), Mocha (TMO), Nevada (TNE), Sand (TSN), Shadow (TSH), Toast (TOA) and Tungsten (TTU).

**Power/USB modules:**



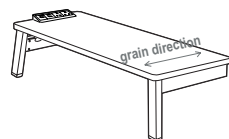



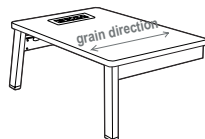

For modular tables with power/USB module, refer to models ending in "M". Module includes two power outlets, four USB charging ports and a 6 foot long power cord. Available in Black or White (must be specified at time of order). Power module is mounted **on surface** on narrow tables; mounted **in surface** on larger tables.





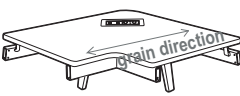

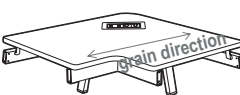
On surface power module on narrow tables



In surface power module on larger tables

DESCRIPTION	MODEL# / FEATURES	STANDARD TEXTILE GRADES				
  <b>Center Table, High Pressure</b>	GC36401-HP	28 x 20.25 x 13	125	23	3.5	<b>\$1166</b>
	GC36401M-HP With power					<b>\$2414</b>
	<ul style="list-style-type: none"> <li>Model GC36401M-HP has <b>power/USB</b> module mounted in surface.</li> </ul>	Coordinating 2mm edge. Regular center table for <b>wood or metal lounge</b> frame. Must be connected to full arm and leg with <b>lounge</b> frames (GC36406TLA/TRA, GC36406TLCA/TRCA). 1 per carton.				
  <b>Narrow Center Table, High Pressure</b>	GC36402-HP	28 x 12 x 13	100	20	2.1	<b>\$1119</b>
	GC36402M-HP With power					<b>\$2364</b>
	<ul style="list-style-type: none"> <li>Model GC36402M-HP has <b>power/USB</b> module mounted in surface.</li> </ul>	Coordinating 2mm edge. Narrow center table for <b>wood or metal lounge</b> frame. Must be connected to full arm and leg with <b>lounge</b> frames (GC36406TLA/TRA, GC36406TLCA/TRCA, GC36406TLCA/TRCA). 1 per carton.				
  <b>Left Corner Table, High Pressure Wood Legs</b>	GC36403WL-HP	37.12 x 37.12 x 13	125	46	6	<b>\$2021</b>
	GC36403WLM-HP With power					<b>\$3269</b>
	<ul style="list-style-type: none"> <li>Model GC36403WLM-HP has <b>power/USB</b> module mounted in surface.</li> </ul>	Coordinating 2mm edge. Must be connected to full arm and leg with <b>wood lounge</b> frames. This table allows for kneespace when specifying chairs in a corner position. 1 per carton. <ul style="list-style-type: none"> <li>Includes 2 rear wood legs (not shown).</li> </ul>				
  <b>Left Corner Table, High Pressure Metal Legs</b>	GC36403L-HP	37.12 x 37.12 x 13	125	46	6	<b>\$2120</b>
	GC36403LM-HP With power					<b>\$3368</b>
	<ul style="list-style-type: none"> <li>Model GC36403LM-HP has <b>power/USB</b> module mounted in surface.</li> </ul>	Coordinating 2mm edge. Must be connected to full arm and leg with <b>metal lounge</b> frames (GC36406TLA/TRA, GC36406TLCA/TRCA). This table allows for kneespace when specifying chairs in a corner position. 1 per carton. <ul style="list-style-type: none"> <li>Includes 2 rear metal legs (not shown).</li> </ul>				
  <b>Right Corner Table, High Pressure Wood Legs</b>	GC36403WR-HP	37.12 x 37.12 x 13	125	46	6	<b>\$2021</b>
	GC36403WRM-HP With power					<b>\$3269</b>
	<ul style="list-style-type: none"> <li>Model GC36403WRM-HP has <b>power/USB</b> module mounted in surface.</li> </ul>	Coordinating 2mm edge. Must be connected to full arm and leg with <b>wood lounge</b> frames. This table allows for kneespace when specifying chairs in a corner position. 1 per carton. <ul style="list-style-type: none"> <li>Includes 2 rear wood legs (not shown).</li> </ul>				

DESCRIPTION	MODEL# / FEATURES	STANDARD TEXTILE GRADES				
 <p><b>Right Corner Table, High Pressure Metal Legs</b></p>	GC36403R-HP	37.12 x 37.12 x 13	125	46	6	<b>\$2120</b>
	GC36403RM-HP With power					<b>\$3368</b>
	<ul style="list-style-type: none"> <li>Model GC36403RM-HP has <b>power/USB</b> module mounted in surface.</li> </ul>					
	Coordinating 2mm edge. Must be connected to full arm and leg with <b>metal lounge</b> frames (GC36406TLA/TRA, GC36406TLCA/TRCA). This table allows for kneespace when specifying chairs in a corner position. 1 per carton.					
 <p><b>Left End Table, High Pressure Wood Legs</b></p>	GC36404WL-HP	28 x 20.25 x 13	125	23	3.5	<b>\$1552</b>
	GC36404WLM-HP With power					<b>\$2800</b>
	<ul style="list-style-type: none"> <li>Model GC36404WLM-HP has <b>power/USB</b> module mounted in surface.</li> </ul>					
	Coordinating 2mm edge. Must be connected to full arm and leg with <b>wood lounge</b> frames. 1 per carton.					
 <p><b>Left End Table, High Pressure Metal Legs</b></p>	GC36404L-HP	28 x 20.25 x 13	125	23	3.5	<b>\$1649</b>
	GC36404LM-HP With power					<b>\$2896</b>
	<ul style="list-style-type: none"> <li>Model GC36404LM-HP has <b>power/USB</b> module mounted in surface.</li> </ul>					
	Coordinating 2mm edge. Must be connected to full arm and leg with <b>metal lounge</b> frames (GC36406TLA or GC36406TLCA). 1 per carton.					
 <p><b>Right End Table, High Pressure Wood Legs</b></p>	GC36404WR-HP	28 x 20.25 x 13	125	23	3.5	<b>\$1552</b>
	GC36404WRM-HP With power					<b>\$2800</b>
	<ul style="list-style-type: none"> <li>Model GC36404WRM-HP has <b>power/USB</b> module mounted in surface.</li> </ul>					
	Coordinating 2mm edge. Must be connected to full arm and leg with <b>wood lounge</b> frames. 1 per carton.					

MODULAR TABLES	MODEL#	DIMENSIONS	FREIGHT CLASS	WT/LBS.	CUBIC FT.	LIST PRICE
----------------	--------	------------	---------------	---------	-----------	------------

D x W x H

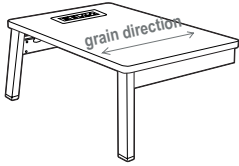
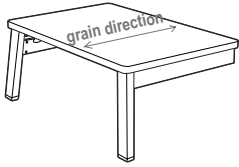

**Right End Table, High Pressure Metal Legs**

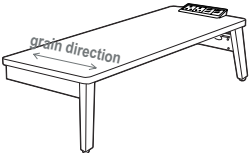
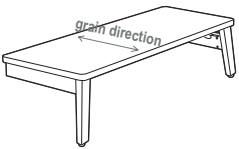

**Narrow Left End Table, High Pressure Wood Legs**

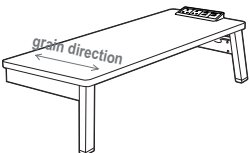
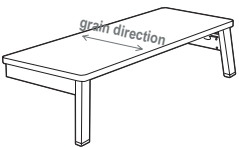

**Narrow Left End Table, High Pressure Metal legs**

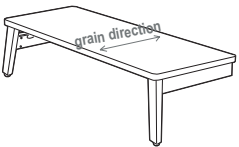

**Narrow Right End Table, High Pressure Wood Legs**

GC36404R-HP	28 x 20.25 x 13	125	23	3.5	<b>\$1649</b>
-------------	-----------------	-----	----	-----	---------------

GC36404RM-HP With power					<b>\$2896</b>
----------------------------	--	--	--	--	---------------

- Model GC36404RM-HP has **power/USB** module mounted in surface.

Coordinating 2mm edge. Must be connected to full arm and leg with **metal lounge** frames (GC36406TRA or GC36406TRCA). 1 per carton.

GC36405WL-HP	28 x 12 x 13	100	20	2.1	<b>\$1482</b>
--------------	--------------	-----	----	-----	---------------

GC36405WLM-HP With power					<b>\$2728</b>
-----------------------------	--	--	--	--	---------------

- Model GC36405WLM-HP has **power/USB** module mounted on surface.

Coordinating 2mm edge. Must be connected to full arm and leg with **wood lounge** frames. 1 per carton.

GC36405L-HP	28 x 12 x 13	100	20	2.1	<b>\$1580</b>
-------------	--------------	-----	----	-----	---------------

GC36405LM-HP With power					<b>\$2828</b>
----------------------------	--	--	--	--	---------------

- Model GC36405LM-HP has **power/USB** module mounted on surface.

Coordinating 2mm edge. Must be connected to full arm and leg with **metal lounge** frames (GC36406TLA or GC36406TLCA). 1 per carton.

GC36405WR-HP	28 x 12 x 13	100	20	2.1	<b>\$1482</b>
--------------	--------------	-----	----	-----	---------------

GC36405WRM-HP With power					<b>\$2728</b>
-----------------------------	--	--	--	--	---------------

- Model GC36405WRM-HP has **power/USB** module mounted on surface.

Coordinating 2mm edge. Must be connected to full arm and leg with **wood lounge** frames. 1 per carton.

DESCRIPTION	MODEL# / FEATURES	STANDARD TEXTILE GRADES				
-------------	-------------------	-------------------------	--	--	--	--

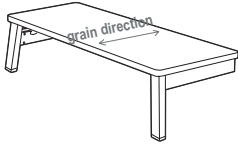

GC36405R-HP	28 x 12 x 13	100	20	2.1	<b>\$1580</b>
-------------	--------------	-----	----	-----	---------------

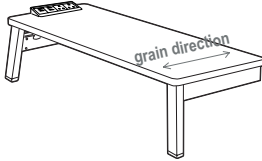

GC36405RM-HP With power					<b>\$2828</b>
----------------------------	--	--	--	--	---------------

- Model GC36405RM-HP has **power/USB** module mounted on surface.

**Narrow Right End Table, High Pressure Metal Legs**

Coordinating 2mm edge. Must be connected to full arm and leg with **metal lounge** frames (GC36406TRA or GC36406TRCA). 1 per carton.



**On Surface Power/Data Module**

GC36410	-- x -- x --	250	2	1	<b>\$776</b>
---------	--------------	-----	---	---	--------------

Surface top mount power/data module with one power outlet, two USB charging ports. 6 foot cord. White. Can be mounted to all freestanding and modular tables.



Meet River+™, the next generation of our highly popular River lounge series. Now with industry-leading support for workplace, education and healthcare, River+ performs at three times the BIFMA standard for true 24/7 applications in demanding environments. All models have been active weight tested to 600 lbs. including bariatric use. Multiple back and seat heights, 120-degree configurations and modular Aluminum arms are just a few of the many options that will make it yours.

To see the full River+ series, please refer to the Seating price list at: [globalfurnituregroup.com/workplace/resources/price-lists](http://globalfurnituregroup.com/workplace/resources/price-lists)

#### Features and Benefits

- A modular series that is composed of straight, curved and corner lounge sections, a wide assortment of benches and tables, and media hearths.
- Lounge and linking tables can be linked together in any combination to create a wide variety of layouts. Ganging hardware is standard and is factory installed. Ganging hardware swivels out of the way when not in use.
- Seating frames are constructed of heavy duty plywood, and are made for active environments. Seats are high density with highly resilient foam.
- River+ seating is rated for an active weight up to 600 lbs. per seat and 24/7 use.
- For 24/7 use and/or heavy duty application use, Global's Heavy Duty warranty is only on models specified with performance textiles, rated for 150,000 double rubs or more.
- A clean-out gap is created by seat-to-back connector brackets available in three finishes.
- The tapered legs are made of welded steel. The standard leg height is 6.5" with optional 3" and 8" legs available on select models. The leg height makes it easy to clean under the product.
- Modular, polished Aluminum loop arms can be relocated and retrofit to support changing layouts.
- A back shelf is available on most units in many laminate finishes.
- For improved safety, housekeeping and infection control, optional features include: sealed seams, sealed seat underside, and tamperproof bottom enclosures.
- For easy user access, optional power units are available for specification in a variety of locations across most River+ lounges, benches, and tables.
- For environmental certifications, please visit [globalfurnituregroup.com](http://globalfurnituregroup.com).

## SENATOR



model GC3392

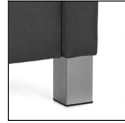

### STANDARD FEATURES

- The flared back design and creative curves enhance any healthcare environment without sacrificing comfort.
- Waterfall seamless front upholstered design with removable seat cushions for easy cleaning and protecting against bacteria.
- For added comfort, seats are standard with high density foam.
- Standard with wood legs.
- For healthcare textiles and wood finish options, visit the website at [globalfurnituregroup.com](http://globalfurnituregroup.com).
- Can be upholstered in standard Global textiles if healthcare compliance is not required.
- Shipped fully assembled.

### OPTIONAL FEATURES

- Optional metal legs are available in Black (TBL), Kalua (TKA), Latte (TLA), Mocha (TMO), Shadow (TSH), Toast (TOA) and Tungsten (TTU). Please specify. No upcharge.
- For non-slip glides, specify (NS) - Add \$37.
- For moisture barrier on seat, please specify (MB). Add \$204 per seat.

### SUGGESTED APPLICATIONS

- Lobbies
- Lounge/Waiting
- Patient rooms
- Resident rooms

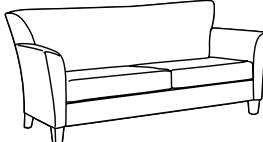
DESCRIPTION	MODEL# / FEATURES	STANDARD TEXTILE GRADES											
		COM	2	3	4	5	6	7	8	9	10	11	12
 <p><b>Armchair</b> COM Yardage: 5.25 Freight Class: 250 Product Weight (lbs.): 66 Cubic Feet Per Carton: 28.5</p>	GC3391	\$2867	\$3032	\$3330	\$3555	\$3878	\$3997	\$4278	\$4803	\$5068	\$5557	\$6239	\$7074
		OVERALL DIMENSIONS			SEAT DIMENSIONS			BACK DIMENSIONS					
		W	D	H	W	D	H	W	H				
	Active weight 300lbs.	34	32.25	36	19.5	19	17.5	28	18.5				
 <p><b>Two Seat Sofa</b> COM Yardage: 8.25 Freight Class: 300 Product Weight (lbs.): 100 Cubic Feet Per Carton: 55.75</p>	GC3392	\$4032	\$4298	\$4744	\$5099	\$5602	\$5793	\$6234	\$7059	\$7473	\$8243	\$9314	\$10628
		OVERALL DIMENSIONS			SEAT DIMENSIONS			BACK DIMENSIONS					
		W	D	H	W	D	H	W	H				
	Active weight 300lbs./seat.	61	32.25	36	46	19	17.5	56	18.5				
 <p><b>Three Seat Sofa</b> COM Yardage: 9.5 Freight Class: 250 Product Weight (lbs.): 125 Cubic Feet Per Carton: 62.25</p>	GC3393	\$5204	\$5505	\$6046	\$6457	\$7035	\$7254	\$7760	\$8714	\$9190	\$10077	\$11307	\$12825
		OVERALL DIMENSIONS			SEAT DIMENSIONS			BACK DIMENSIONS					
		W	D	H	W	D	H	W	H				
	Active weight 300lbs./seat.	76	32.25	36	61	19	17.5	71	18.5				

SLEEP-EEZ



model GC3614

STANDARD FEATURES

- Sleep-Eez provides incredible comfort, requires zero wall clearance and can be easily opened and closed by one person.
- It can be adjusted to create three functional positions: a chair, a chaise lounge and a sleep surface.
- The heavy duty steel mechanism will provide long-term performance.
- Commercial grade casters are standard. Front casters are non-swivel manual locking. Back casters are non-locking and swivel for better steering when moving the chair.
- Clean out space is provided between the seat and back cushions for housekeeping and infection prevention control.
- Sleep-Eez's construction allows for on-site replacement of all components, eliminating down time and enhancing the product's life.
- Standard with Black urethane fully extended arms with a grip for ease of entry and exit from chair.
- For healthcare textile options, visit the website at [www.globalfurnituregroup.com](http://www.globalfurnituregroup.com).
- Can be upholstered in standard Global textiles if healthcare compliance is not required.
- Ships fully assembled.
- Measurements:  
Chair: 34.5"W x 37"D x 34.25"H  
Chaise lounge: 34.5"W x 64"D x 34.25"H  
Sleep surface: 24"W x 77"D

OPTIONAL FEATURES

- For moisture barrier on seat, please specify **(MB)**. Add \$204.
- To add sealed seams to your product, please specify **(SS)**. Add \$362.

SUGGESTED APPLICATIONS

- Lobbies
- Lounge/Waiting
- Office/Meeting
- Patient rooms
- Resident rooms
- Treatment/Exam rooms

Please add option codes in the following order:

- **Model number**  
**GC3614** Single sleeper chair
- **Textile**  
Specify fabric code.
- **Armcap finish**  
**(BLK)** Black Urethane armcap  
**(LAB)** Latte Urethane armcap  
**(KAL)** Kalua Urethane armcap  
**(J52)** Mocha Urethane armcap  
**(SHW)** Shadow Urethane armcap  
**(TOA)** Toast Urethane armcap  
**(AAM)** Absolute wood armcap  
**(ACM)** Cherry wood armcap  
**(EOM)** English Oak wood armcap  
**(ECM)** Espresso Cafe wood armcap  
**(HGM)** Gray wood armcap  
**(AHM)** Honey wood armcap  
**(JOM)** Jet Onyx wood armcap  
**(AVM)** Maple wood armcap  
**(MWM)** Medium Walnut wood armcap  
**(NLW)** Natural Walnut wood armcap  
**(ASM)** Night wood armcap  
**(NBM)** Noce Biondo wood armcap  
**(NGM)** Noce Grigio wood armcap  
**(NEM)** Noce Leggero wood armcap  
**(NMM)** Noce Medio wood armcap  
**(SBM)** Sandy Beach wood armcap  
**(SKM)** Shaker Cherry wood armcap  
**(TFM)** Fruitwood wood armcap  
**(TMM)** Mahogany wood armcap  
**(TWM)** Walnut wood armcap  
**(WTM)** WC Cream wood armcap  
**(WHM)** White wood armcap  
**(WCM)** Winter Cherry wood armcap
- **Moisture Barrier**  
**(MB)** Seat only
- **Sealed Seams**  
**(SS)** All sealed seams

EXAMPLE SLEEP-EEZ ORDER CODE:

GC3614	-LX21	-PT	-MB	-SS
Model #	Textile	Armcaps	Moisture Barrier	Sealed Seams

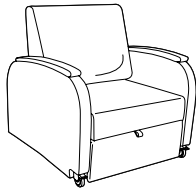
DESCRIPTION	MODEL#	STANDARD TEXTILE GRADES											
		COM	2	3	4	5	6	7	8	9	10	11	12
 <p><b>Single Sleeper Chair</b> COM Yardage: 8.5 Freight Class: 150 Product weight (lbs.): 160 Cubic Feet per Carton: 38</p>	GC3614	\$5263	\$5572	\$5827	\$6199	\$6733	\$6981	\$7462	\$8228	\$8823	\$9481	\$10832	\$12275
	Active weight 350 lbs.												
		OVERALL DIMENSIONS			SEAT DIMENSIONS			BACK DIMENSIONS					
		W	D	H	W	D	H	W	H				
		35	37	35	27.5	21	17.5	27.5	18.5				

STRAND



model GC3707HB



model GC3702

FEATURES



- Strand is the perfect synthesis of versatility, comfort, durability and value pricing. Strand offers a pleasing look in a diverse range of solutions from single patient room chairs to waiting areas and public spaces.
- All models are standard in oval metal tube frame.
- Frame available in Black (TBL), Cloud (TIV), Designer White (TDW), Fog (TFO), Frost (TFR), Kalua (TKA), Latte (TLA), Mocha (TMO), Nevada (TNE), Sand (TSN), Shadow (TSH), Toast (TOA) and Tungsten (TTU).
- The frame can be weighted and made with tamper proof fasteners for greater security in more challenging mental health spaces or correctional facilities.
- Armcaps are standard in Black urethane.
- **Left and Right Position Reference** is determined based on being seated in the chair.
- The seat and back are removable and field replaceable.
- For added comfort, seats are standard with high density foam.
- All seat frames feature a wall saver design to prevent back contact with wall. Footstool and benches do not have wall saver legs.
- Standard seat height on all models is 18".
- Cleanout space is provided between the seat and back cushions for easy housekeeping.
- Standard with Black plastic glides.
- Select models are offered with rear tip and move wheels. To activate wheels, tilt the chair back so the casters are in contact with the floor. This feature makes it easy to relocate the chair while unoccupied.
- Flex back models allow the back to move in a soothing rocking motion.
- Active weight capacity for standard single seat is 350 lbs. and 750 lbs for bariatric seating.
- For healthcare textiles and finish options, visit the website at [www.globalfurnituregroup.com](http://www.globalfurnituregroup.com)
- Can be upholstered in standard Global textiles if healthcare compliance is not required.

OPTIONAL FEATURES

- Wood armcaps are also available in all healthcare wood seating finishes.  
Single Seat - Add \$189  
Two Seater - Add \$279.  
Three Seater - Add \$373.
- Non-marking White glides are available. Please specify (WH). No upcharge.
- For moisture barrier on seat, add **\$137** per seat. For bariatric models - Add **\$209** per seat.
- As an option, seams can be sealed to prevent penetration of fluids through the stitching. Contact Customer Care for approved textiles.  
For Low Back Models - Add \$75 per seat.  
For Low Back Bariatric Models - Add \$80 per seat.  
For High Back Models - Add \$87 per seat.  
For High Back Bariatric Models - Add \$90 per seat.  
For Split-Back models - Add \$131  
For Ottoman - Add \$23  
For Single Seat Bench - Add \$30  
For Two Seat Bench - Add \$59  
For Three Seat Bench - Add \$87

SUGGESTED APPLICATIONS

- Bariatric seating (some models)
- Guest seating
- Lobbies
- Lounge/Waiting
- Patient rooms
- Resident rooms
- Treatment/Exam rooms

DESCRIPTION	MODEL#	STANDARD FABRIC GRADES											
		COM	2	3	4	5	6	7	8	9	10	11	12
 <b>Low Back Single Seat Armless Chair</b> COM Yardage: 1.75 Freight Class: 250 Product Weight (lbs.): 43 Cubic Feet Per Carton: 17.5	GC3700	\$1326	\$1387	\$1442	\$1519	\$1627	\$1669	\$1765	\$1947	\$2034	\$2202	\$2432	\$2717
	Active weight 350 lbs.	<b>OVERALL DIMENSIONS</b>			<b>SEAT DIMENSIONS</b>			<b>BACK DIMENSIONS</b>					
		W	D	H	W	D	H	W	H				
		24.5	27.5	34.5	22	18.5	18	21.5	17				
 <b>LB Single Seat Armchair</b> COM Yardage: 1.75 Freight Class: 250 Product Weight (lbs.): 48 Cubic Feet Per Carton: 17.5	GC3701	\$1581	\$1644	\$1699	\$1776	\$1884	\$1925	\$2022	\$2204	\$2291	\$2459	\$2689	\$2974
	Active weight 350 lbs. Wood armcap option - Add \$189	<b>OVERALL DIMENSIONS</b>			<b>SEAT DIMENSIONS</b>			<b>BACK DIMENSIONS</b>					
		W	D	H	W	D	H	W	H				
		25.5	27.5	34.5	22	18.5	18	21.5	17				

DESCRIPTION	MODEL#	STANDARD FABRIC GRADES											
		COM	2	3	4	5	6	7	8	9	10	11	12
 <p>Designed to immobilize the pelvis and hip joints after surgery.</p> <p><b>LB Hip Armchair, Post Surgery</b> COM Yardage: 1.75 Freight Class: 250 Product Weight (lbs.): 53 Cubic Feet Per Carton: 17.5</p>	<b>GC3701-24</b>	<b>\$1938</b>	<b>\$2001</b>	<b>\$2056</b>	<b>\$2134</b>	<b>\$2241</b>	<b>\$2283</b>	<b>\$2379</b>	<b>\$2561</b>	<b>\$2650</b>	<b>\$2816</b>	<b>\$3047</b>	<b>\$3333</b>
	24" seat height	<b>OVERALL DIMENSIONS</b>			<b>SEAT DIMENSIONS</b>			<b>BACK DIMENSIONS</b>					
		<b>W</b>	<b>D</b>	<b>H</b>	<b>W</b>	<b>D</b>	<b>H</b>	<b>W</b>	<b>H</b>				
		25.5	27.5	40.5	22	18.5	24	21.5	17				

 <p><b>HB Single Seat Armchair</b> COM Yardage: 2 Freight Class: 250 Product Weight (lbs.): 53 Cubic Feet Per Carton: 20</p>	<b>GC3701HB</b>	<b>\$1823</b>	<b>\$1891</b>	<b>\$1956</b>	<b>\$2042</b>	<b>\$2168</b>	<b>\$2215</b>	<b>\$2323</b>	<b>\$2529</b>	<b>\$2630</b>	<b>\$2822</b>	<b>\$3086</b>	<b>\$3412</b>
	Active weight 350 lbs. Wood armcap option - <b>Add \$189</b>	<b>OVERALL DIMENSIONS</b>			<b>SEAT DIMENSIONS</b>			<b>BACK DIMENSIONS</b>					
		<b>W</b>	<b>D</b>	<b>H</b>	<b>W</b>	<b>D</b>	<b>H</b>	<b>W</b>	<b>H</b>				
		25.5	27.5	42.5	22	18	18	21.5	25				

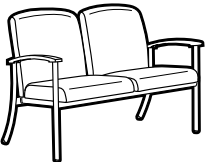
 <p><b>LB Two Seat Chair, No Center Arm</b> COM Yardage: 3.25 Freight Class: 300 Product Weight (lbs.): 68 Cubic Feet Per Carton: 43</p>	<b>GC3702</b>	<b>\$2494</b>	<b>\$2610</b>	<b>\$2710</b>	<b>\$2855</b>	<b>\$3056</b>	<b>\$3132</b>	<b>\$3310</b>	<b>\$3640</b>	<b>\$3807</b>	<b>\$4117</b>	<b>\$4550</b>	<b>\$5080</b>
	Active weight 350 lbs./seat Wood armcap option - <b>Add \$189</b>	<b>OVERALL DIMENSIONS</b>			<b>SEAT DIMENSIONS</b>			<b>BACK DIMENSIONS</b>					
		<b>W</b>	<b>D</b>	<b>H</b>	<b>W</b>	<b>D</b>	<b>H</b>	<b>W</b>	<b>H</b>				
		49.75	27.5	34.5	44	18.5	18	43	17				

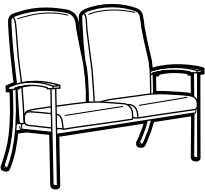
 <p><b>HB Two Seat Chair, No Center Arm</b> COM Yardage: 3.75 Freight Class: 300 Product Weight (lbs.): 75 Cubic Feet Per Carton: 56.5</p>	<b>GC3702HB</b>	<b>\$2873</b>	<b>\$3003</b>	<b>\$3120</b>	<b>\$3283</b>	<b>\$3516</b>	<b>\$3606</b>	<b>\$3811</b>	<b>\$4196</b>	<b>\$4388</b>	<b>\$4744</b>	<b>\$5238</b>	<b>\$5854</b>
	Active weight 350 lbs./seat Wood armcap option - <b>Add \$189</b>	<b>OVERALL DIMENSIONS</b>			<b>SEAT DIMENSIONS</b>			<b>BACK DIMENSIONS</b>					
		<b>W</b>	<b>D</b>	<b>H</b>	<b>W</b>	<b>D</b>	<b>H</b>	<b>W</b>	<b>H</b>				
		49.75	27.5	42.5	44	18.5	18	43	25				

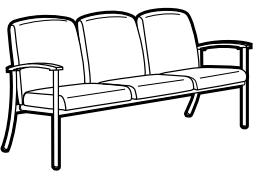
 <p><b>LB Three Seat Chair, No Center Arms</b> COM Yardage: 4.5 Freight Class: 300 Product Weight (lbs.): 90 Cubic Feet Per Carton: 65.25</p>	<b>GC3703</b>	<b>\$3485</b>	<b>\$3644</b>	<b>\$3781</b>	<b>\$3978</b>	<b>\$4260</b>	<b>\$4365</b>	<b>\$4609</b>	<b>\$5069</b>	<b>\$5302</b>	<b>\$5729</b>	<b>\$6326</b>	<b>\$7061</b>
	Active weight 350 lbs./seat Wood armcap option - <b>Add \$189</b>	<b>OVERALL DIMENSIONS</b>			<b>SEAT DIMENSIONS</b>			<b>BACK DIMENSIONS</b>					
		<b>W</b>	<b>D</b>	<b>H</b>	<b>W</b>	<b>D</b>	<b>H</b>	<b>W</b>	<b>H</b>				
		71.25	27.5	34.5	66	18.5	18	64.5	17				

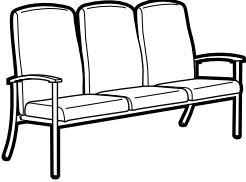
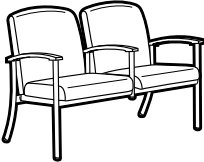
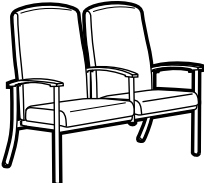
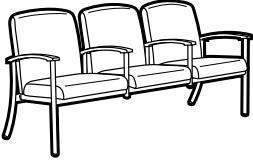
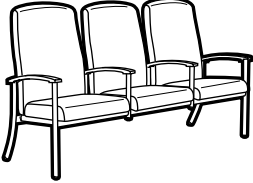
DESCRIPTION	MODEL#	STANDARD FABRIC GRADES											
		COM	2	3	4	5	6	7	8	9	10	11	12
 <p><b>HB Three Seat Chair, No Center Arms</b>                      COM Yardage: 5.25                      Freight Class: 300                      Product Weight (lbs.): 96                      Cubic Feet Per Carton: 80.75</p>	<b>GC3703HB</b>  Active weight 350 lbs./seat Wood armcap option - <b>Add \$189</b>	\$3907	\$4093	\$4254	\$4485	\$4811	\$4936	\$5221	\$5757	\$6029	\$6526	\$7222	\$8078
		<b>OVERALL DIMENSIONS</b>			<b>SEAT DIMENSIONS</b>			<b>BACK DIMENSIONS</b>					
		W	D	H	W	D	H	W	H				
			71.25	27.5	42.5	66	18.5	18	64.5	25			
 <p><b>LB Two Seat Chair, Half Center Arm</b>                      COM Yardage: 3.25                      Freight Class: 300                      Product Weight (lbs.): 73                      Cubic Feet Per Carton: 43</p>	<b>GC3704</b>  Active weight 350 lbs./seat Wood armcap option - <b>Add \$279</b>	\$2757	\$2873	\$2972	\$3118	\$3319	\$3395	\$3573	\$3905	\$4070	\$4380	\$4813	\$5343
		<b>OVERALL DIMENSIONS</b>			<b>SEAT DIMENSIONS</b>			<b>BACK DIMENSIONS</b>					
		W	D	H	W	D	H	W	H				
			49.75	27.5	34.5	22	18.5	18	21.5	17			
 <p><b>HB Two Seat Chair, Half Center Arm</b>                      COM Yardage: 3.75                      Freight Class: 300                      Product Weight (lbs.): 79                      Cubic Feet Per Carton: 56.5</p>	<b>GC3704HB</b>  Active weight 350 lbs./seat Wood armcap option - <b>Add \$279</b>	\$3140	\$3270	\$3387	\$3550	\$3783	\$3873	\$4078	\$4463	\$4655	\$5011	\$5505	\$6121
		<b>OVERALL DIMENSIONS</b>			<b>SEAT DIMENSIONS</b>			<b>BACK DIMENSIONS</b>					
		W	D	H	W	D	H	W	H				
			49.75	27.5	42.5	44	18.5	18	43	25			
 <p><b>LB Three Seat Chair, Half Center Arms</b>                      COM Yardage: 4.5                      Freight Class: 300                      Product Weight (lbs.): 100                      Cubic Feet Per Carton: 65.25</p>	<b>GC3705</b>  Active weight 350 lbs./seat Wood armcap option - <b>Add \$373</b>	\$4011	\$4172	\$4309	\$4506	\$4788	\$4893	\$5136	\$5597	\$5830	\$6257	\$6854	\$7589
		<b>OVERALL DIMENSIONS</b>			<b>SEAT DIMENSIONS</b>			<b>BACK DIMENSIONS</b>					
		W	D	H	W	D	H	W	H				
			71.25	27.5	34.5	22	18.5	18	21.5	17			
 <p><b>HB Three Seat Chair, Half Center Arms</b>                      COM Yardage: 5.25                      Freight Class: 300                      Product Weight (lbs.): 100                      Cubic Feet Per Carton: 80.75</p>	<b>GC3705HB</b>  Active weight 350 lbs./seat Wood armcap option - <b>Add \$373</b>	\$4433	\$4621	\$4782	\$5011	\$5337	\$5464	\$5749	\$6285	\$6553	\$7054	\$7750	\$8604
		<b>OVERALL DIMENSIONS</b>			<b>SEAT DIMENSIONS</b>			<b>BACK DIMENSIONS</b>					
		W	D	H	W	D	H	W	H				
			71.25	27.5	42.5	66	18.5	18	64.5	25			

DESCRIPTION	MODEL#	STANDARD FABRIC GRADES											
		COM	2	3	4	5	6	7	8	9	10	11	12
 <p><b>LB Armchair, Rear Tip &amp; Move Wheels</b> COM Yardage: 1.75 Freight Class: 250 Product Weight (lbs.): 48 Cubic Feet Per Carton: 17.5</p>	<b>GC3707</b>	\$1745	\$1806	\$1861	\$1938	\$2046	\$2088	\$2184	\$2366	\$2454	\$2621	\$2852	\$3136
		OVERALL DIMENSIONS			SEAT DIMENSIONS			BACK DIMENSIONS					
		W	D	H	W	D	H	W	H				
		25.5	27.5	34.5	22	18.5	18	21.5	17				

Active weight 350 lbs.  
Wood armcap option - **Add \$189**

DESCRIPTION	MODEL#	STANDARD FABRIC GRADES											
		COM	2	3	4	5	6	7	8	9	10	11	12
 <p><b>HB Armchair, Rear Tip &amp; Move Wheels</b> COM Yardage: 2 Freight Class: 250 Product Weight (lbs.): 50 Cubic Feet Per Carton: 20</p>	<b>GC3707HB</b>	\$1985	\$2051	\$2118	\$2204	\$2329	\$2376	\$2486	\$2690	\$2794	\$2983	\$3247	\$3574
		OVERALL DIMENSIONS			SEAT DIMENSIONS			BACK DIMENSIONS					
		W	D	H	W	D	H	W	H				
		25.5	27.5	42.5	22	18	18	21	25				

Active weight 350 lbs.  
Wood armcap option - **Add \$189**

DESCRIPTION	MODEL#	STANDARD FABRIC GRADES											
		COM	2	3	4	5	6	7	8	9	10	11	12
 <p><b>Bariatric LB Armchair</b> COM Yardage: 2.75 Freight Class: 250 Product Weight (lbs.): 60 Cubic Feet Per Carton: 26.5</p>	<b>GC3711</b>	\$1996	\$2093	\$2178	\$2300	\$2471	\$2533	\$2685	\$2968	\$3108	\$3369	\$3735	\$4181
		OVERALL DIMENSIONS			SEAT DIMENSIONS			BACK DIMENSIONS					
		W	D	H	W	D	H	W	H				
		36	27.5	34.5	32.5	18	18	31	17				

Active weight 750 lbs.  
Wood armcap option - **Add \$189**

Armless Bariatric models are not available.

DESCRIPTION	MODEL#	STANDARD FABRIC GRADES											
		COM	2	3	4	5	6	7	8	9	10	11	12
 <p><b>Bariatric HB Armchair</b> COM Yardage: 3.25 Freight Class: 250 Product Weight (lbs.): 66 Cubic Feet Per Carton: 30.5</p>	<b>GC3711HB</b>	\$2211	\$2329	\$2428	\$2570	\$2775	\$2850	\$3029	\$3359	\$3525	\$3836	\$4266	\$4796
		OVERALL DIMENSIONS			SEAT DIMENSIONS			BACK DIMENSIONS					
		W	D	H	W	D	H	W	H				
		36	27.5	42.5	32.5	18	18	31	25				

Active weight 750 lbs.  
Wood armcap option - **Add \$189**

Armless Bariatric models are not available.

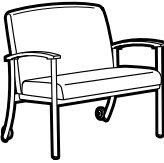
DESCRIPTION	MODEL#	STANDARD FABRIC GRADES											
		COM	2	3	4	5	6	7	8	9	10	11	12
 <p><b>Bariatric LB Armchair, Rear Tip &amp; Move Wheels</b> COM Yardage: 2.75 Freight Class: 250 Product Weight (lbs.): 60 Cubic Feet Per Carton: 26.5</p>	<b>GC3712</b>	\$2161	\$2257	\$2345	\$2465	\$2635	\$2698	\$2849	\$3133	\$3272	\$3534	\$3900	\$4345
		OVERALL DIMENSIONS			SEAT DIMENSIONS			BACK DIMENSIONS					
		W	D	H	W	D	H	W	H				
		36	27.5	34.5	32.5	18	18	31	17				

Active weight 750 lbs.  
Wood armcap option - **Add \$189**

Armless Bariatric models are not available.



DESCRIPTION	MODEL#	STANDARD FABRIC GRADES											
		COM	2	3	4	5	6	7	8	9	10	11	12

<b>GC3722</b>	<b>\$1681</b>	<b>\$1742</b>	<b>\$1799</b>	<b>\$1875</b>	<b>\$1983</b>	<b>\$2024</b>	<b>\$2120</b>	<b>\$2302</b>	<b>\$2390</b>	<b>\$2557</b>	<b>\$2788</b>	<b>\$3074</b>
---------------	---------------	---------------	---------------	---------------	---------------	---------------	---------------	---------------	---------------	---------------	---------------	---------------

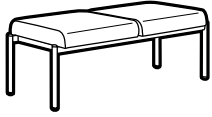

**Two Seat Bench**

COM Yardage: 1.75  
 Freight Class: 250  
 Product Weight (lbs.): 48  
 Cubic Feet Per Carton: 23

Active weight 350 lbs./seat

OVERALL DIMENSIONS			SEAT DIMENSIONS			BACK DIMENSIONS	
W	D	H	W	D	H	W	H
47.5	23.5	18					

DESCRIPTION	MODEL#	STANDARD FABRIC GRADES											
		COM	2	3	4	5	6	7	8	9	10	11	12

<b>GC3723</b>	<b>\$2191</b>	<b>\$2259</b>	<b>\$2323</b>	<b>\$2410</b>	<b>\$2534</b>	<b>\$2581</b>	<b>\$2691</b>	<b>\$2896</b>	<b>\$2998</b>	<b>\$3189</b>	<b>\$3453</b>	<b>\$3779</b>
---------------	---------------	---------------	---------------	---------------	---------------	---------------	---------------	---------------	---------------	---------------	---------------	---------------

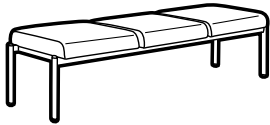

**Three Seat Bench**

COM Yardage: 2  
 Freight Class: 250  
 Product Weight (lbs.): 68  
 Cubic Feet Per Carton: 33.25

Active weight 350 lbs./seat

OVERALL DIMENSIONS			SEAT DIMENSIONS			BACK DIMENSIONS	
W	D	H	W	D	H	W	H
70	23.5	18					

WILLOW



**model W5AUUG**  
Armchair, Upholstered Seat & Back



Wipeable shroud edge does not collect debris



No visible brackets or upholstery staples

Arm Options



Waterfall Arm (WFA)



Forward Grip Assist (GAA)

	Willow Chair Stacking Capability	
	Stacks on floor	Stacks on dolly
<b>Four leg arm and armless chairs with glides only</b>		
Poly/poly chairs	up to 6 high	up to 10 high
Upholstered chairs	up to 4 high	up to 8 high
Bariatric Models	up to 4 high	up to 8 high
<b>Four leg bar and counter stools</b>		
Stools with arms	Does not stack	N/A
Armless stools	up to 4 high	N/A

Plastic Component Finish Matching Chart		
Chair Types	Seat Shroud	Arms and Back Shroud
Poly back and seat	Matches seat/back	Matches seat/back
Upholstered back and seat	Specify	Specify
Poly back/upholstered seat	Specify	Specify
Upholstered back/poly seat	Matches seat	Specify



For linking tables, see page 252.

EXAMPLE WILLOW ORDER CODE:

W5AUU	PU75	NS	PU75	WFA	BLK
Model #	Back Textile	Seat	Seat Textile	Arm Style	Seat Shroud Finish
CHM	ST	BLK	NS	NB	
Frame Finish	Glide Type	Glide Finish	Back seams	Moisture Barrier	

STANDARD FEATURES

- Willow's durable design and open, welcoming form will ensure years of use. Freestanding chairs are available with four legs or sled base, in seated standard or bariatric widths. Additional models include hip, counter and bar height stools. Freestanding and corner, in-line and end tables are also available to complement the line.
- Seated height chairs may be ganged with ganging brackets or with in-line and corner tables.
- Plastic seats and backs, reinforced nylon arms, back shrouds and seat shrouds are available in a wide range of colors. See finish chart for matching color components.
- Tubular steel frame is available in 20 paint finishes and 4 plated finishes (upcharge applies).
- Frame design features a wall saver leg to prevent contact with walls.
- Active weight capacity is 300 lbs. for four-leg seating with casters, 400 lbs. for seating on glides and 600 lbs. for 30" wide bariatric and parent/child models.
- Plastic seat shrouds are standard on all models.
- Upholstered seats have no seams for ease of cleaning.
- Four-leg chairs with glides are stackable, see matrix. Stacking of caster models is not recommended due to damage to plastic and upholstery.
- Armless counter and bar height stools are stackable on the floor only. See chart for details.
- Four-leg and stool models are available with a variety of glide types. Glides must be chosen to best suit flooring type and site conditions. For more information, refer to glide selection chart.
- Tables used with Willow armchairs require 28" clearance under the surface top; counter height stools require 34.25" clearance; bar height stools require 40.25" clearance.
- Sled base models have nylon colored glides, non-marking natural glides for use on most floor surfaces, or no glides for use on carpeted floors.
- For healthcare textiles, visit the website at [globalfurnituregroup.com](http://globalfurnituregroup.com).
- Check textile availability prior to specifying upholstery material.
- The series is available to specify with two textiles on upholstered seat and back models. For pricing, start with the base price and add applicable graded textile upcharges for the back and the seat.
- The blended textile matrix does not apply to this series.
- The series is designed for use across a range of facilities and is covered under Global's limited lifetime warranty for single-shift use. Specify for approved textiles.
- Shipped fully assembled.

OPTIONAL FEATURES

- Additional weight (CW) of 24 lbs. is available. Weighted four-leg chairs are not stackable.
- Power/USB units are available, ordered separately, for use with in-line, corner and end tables. See model for details.
- Tables are pre-drilled for field installation of undermount power. Clamp mount units are available. Order power units separately for field installation.
- Moisture barrier may be specified on seats.
- Sled base models offer a floor mount (FM) option. See upcharges. Mounting hardware not included.

Add option codes in the following order:





- Model number**  
Enter model number.
- Back, Seat and Seat Shroud Finish** (plastic back and seat models)  
Plastic finishes:  





<b>(BZB)</b> Buzz Blue	<b>(KAL)</b> Kalua
<b>(CCT)</b> Cactus	<b>(LAB)</b> Latte
<b>(CRO)</b> Carrot	<b>(J52)</b> Mocha
<b>(IVC)</b> Cloud	<b>(BLK)</b> Night
<b>(DJN)</b> Dijon	<b>(SND)</b> Sand
<b>(EGP)</b> Eggplant	<b>(SAR)</b> Scarlet
<b>(FOG)</b> Fog	<b>(SHW)</b> Shadow
<b>(FRO)</b> Frost	<b>(TOA)</b> Toast
<b>(INK)</b> Ink	
- Back Finish** (plastic back and upholstered seat models)  
See Plastic finishes.
- Back Textile** (for upholstered back models)  
Specify back textile.
- Seat Textile** (for upholstered seat models)  
Specify seat textile.
- Arm Style** (for chairs with arms)  
**(WFA)** Waterfall arm  
**(GAA)** Grip assist arm. Add \$35.
- Arm and Back Shroud Finish**  
See Plastic finishes.
- Seat and Seat Shroud Finish** (for upholstered back and plastic seat models).  
See Plastic finishes.
- Leg Type** (for sled base models)  
**(NF)** No floor mount  
**(FM)** Floor mounted. Add \$13.
- Frame finish**  
Paint finishes:  
Black **(TBL)**, Buzz Blue **(TBZ)**, Cactus **(TCC)**, Carrot **(TCR)**, Cloud **(TIV)**, Designer White **(TDW)**, Dijon **(TDJ)**, Eggplant **(TEG)**, Fog **(TFO)**, Frost **(TFR)**, Ink **(TIN)**, Kalua **(TKA)**, Latte **(TLA)**, Mocha **(TMO)**, Nevada **(TNE)**, Sand **(TSN)**, Scarlet **(TSR)**, Shadow **(TSH)**, Toast **(TOA)** and Tungsten **(TTU)**.  
Plated finishes - see chart on page 242 for upcharges:  
**(CHM)** Chrome  
**(BCH)** Brushed Chrome
- Glide type** (four leg glides)  
**(ST)** Nylon, colored glide for most surfaces  
**(NM)** White, non-marking Nylon glide for most surfaces  
**(SG)** Steel cushion glide for carpeted surfaces. Add \$36.  
**(FG)** Felt glide for most hard floor surfaces. Add \$36.  
**(RG)** Rubber, non-slip glide for most hard floor surfaces. Add \$36.
- Glide type** (sled bases)  
**(ST)** Nylon, colored glide for most surfaces  
**(NM)** White, non-marking Nylon glide for most surfaces  
**(XG)** No glide for carpeted surfaces
- Glide Finish** (ST glides)  
**(BLK)** Black  
**(SND)** Sand
- Caster Type** (caster models)  
**(C114)** 2" caster for carpeted surface  
**(C114R)** 2" caster for most hard floor surfaces. Add \$53.
- Back Seams**  
**(NS)** No sealed back seams  
**(SBS)** Sealed back seams
- Moisture Barrier** (on seat)  
**(NB)** No moisture barrier.  
**(MB)** Moisture barrier. Add \$107. For bariatric, add \$161.





DESCRIPTION MODEL# STANDARD FABRIC GRADES





	GLIDES							
	Standard colored (ST) + non-marking (NM) glides - standard height		Steel cushion (SG) glides - 0.313" higher than standard		Felt pad (FG) glides - 0.375" higher than standard		Rubber non-slip (RG) glides - 0.563" higher than standard	
	SEAT HEIGHT (in)	ARM HEIGHT (in)	SEAT HEIGHT (in)	ARM HEIGHT (in)	SEAT HEIGHT (in)	ARM HEIGHT (in)	SEAT HEIGHT (in)	ARM HEIGHT (in)
<b>ARMCHAIRS</b>								
Plastic seat, standard arms	17	26.75	17.31	27.06	17.38	27.13	17.56	27.31
Plastic seat, grip assist arms	17	27	17.31	27.31	17.38	27.38	17.56	27.56
Upholstered seat, standard arms	18.25	26.75	18.56	27.06	18.63	27.13	18.81	27.31
Upholstered seat, grip assist arms	18.25	27	18.56	27.31	18.63	27.38	18.81	27.56
<b>COUNTER STOOLS WITH ARMS</b>								
Plastic seat, standard arms	23.25	33	23.56	33.31	23.63	33.38	23.81	33.56
Plastic seat, grip assist arms	23.25	33.25	23.56	33.56	23.63	33.63	23.81	33.81
Upholstered seat, standard arms	24.25	33	24.56	33.31	24.63	33.38	24.81	33.56
Upholstered seat, grip assist arms	24.25	33.25	24.56	33.56	24.63	33.63	24.81	33.81
<b>BAR STOOLS WITH ARMS</b>								
Plastic seat, standard arms	29.25	39	29.56	39.31	29.63	39.38	29.81	39.56
Plastic seat, grip assist arms	29.25	39.25	29.56	39.56	29.63	39.63	29.81	39.81
Upholstered seat, standard arms	30.25	39	30.56	39.31	30.63	39.38	30.81	39.56
Upholstered seat, grip assist arms	30.25	39.25	30.56	39.56	30.63	39.63	30.81	39.81

PLATED FRAME FINISH UPCHARGES		
	Chrome (CHM)	Brushed Chrome (BCH)
<b>FOUR LEG BASE</b>		
Standard, arm and armless	\$42	\$147
Bariatric	\$71	\$229
Hip chairs, standard and bariatric	\$71	\$229
Counter stools, arm and armless	\$75	\$244
Bar stools, arm and armless	\$75	\$244
<b>SLED BASE</b>		
Standard, arm and armless	\$53	\$180
Bariatric	\$71	\$229

DESCRIPTION	MODEL#	STANDARD FABRIC GRADES											
 <p><b>Armchair, Polypropylene Back and Seat</b> COM Yardage: n/a Freight Class: 250 Product Weight (lbs.): 20.88 Cubic Feet Per Carton: 5.56</p>		List Price											
	<b>W5APPG</b> with glides	<b>\$563</b>											
	<b>W5APPC</b> with casters	<b>\$707</b>											
		<b>OVERALL DIMENSIONS</b>			<b>SEAT DIMENSIONS</b>			<b>BACK DIMENSIONS</b>					
		<b>W</b>	<b>D</b>	<b>H</b>	<b>W</b>	<b>D</b>	<b>H</b>	<b>W</b>	<b>H</b>				
		24.25	23.5	32	17.75	17.5	17	16	16				
		Active weight with casters 300 lbs.; does not stack. Active weight with glides 400 lbs.; stacks 4 high on floor. 2 per carton (pricing and specifications are for one seat unit)											
 <p><b>Armchair, Upholstered Back and Polypropylene Seat</b> COM Yardage: 0.5 Freight Class: 250 Product Weight (lbs.): 21.88 Cubic Feet Per Carton: 5.56</p>		1/COM	2	3	4	5	6	7	8	9	10	11	12
	<b>W5AUPG</b> with glides	<b>\$662</b>	<b>\$679</b>	<b>\$693</b>	<b>\$712</b>	<b>\$740</b>	<b>\$751</b>	<b>\$775</b>	<b>\$812</b>	<b>\$841</b>	<b>\$871</b>	<b>\$935</b>	<b>\$1002</b>
	<b>W5AUPC</b> with casters	<b>\$780</b>	<b>\$797</b>	<b>\$811</b>	<b>\$830</b>	<b>\$858</b>	<b>\$869</b>	<b>\$893</b>	<b>\$930</b>	<b>\$959</b>	<b>\$989</b>	<b>\$1053</b>	<b>\$1120</b>
		<b>OVERALL DIMENSIONS</b>			<b>SEAT DIMENSIONS</b>			<b>BACK DIMENSIONS</b>					
		<b>W</b>	<b>D</b>	<b>H</b>	<b>W</b>	<b>D</b>	<b>H</b>	<b>W</b>	<b>H</b>				
		24.25	21.75	32.25	17.75	16.75	17	16.5	16				
		Active weight with casters 300 lbs.; does not stack. Active weight with glides 400 lbs.; stacks 4 high on floor. Add \$16 for (SBS) 2 per carton (pricing and specifications are for one seat unit)											
 <p><b>Armchair, Polypropylene Back and Upholstered Seat</b> COM Yardage: 0.75 Freight Class: 250 Product Weight (lbs.): 21.38 Cubic Feet Per Carton: 5.56</p>		1/COM	2	3	4	5	6	7	8	9	10	11	12
	<b>W5APUG</b> with glides	<b>\$662</b>	<b>\$688</b>	<b>\$708</b>	<b>\$737</b>	<b>\$779</b>	<b>\$795</b>	<b>\$831</b>	<b>\$887</b>	<b>\$929</b>	<b>\$976</b>	<b>\$1071</b>	<b>\$1172</b>
	<b>W5APUC</b> with casters	<b>\$780</b>	<b>\$806</b>	<b>\$826</b>	<b>\$855</b>	<b>\$897</b>	<b>\$913</b>	<b>\$949</b>	<b>\$1005</b>	<b>\$1047</b>	<b>\$1094</b>	<b>\$1189</b>	<b>\$1290</b>
		<b>OVERALL DIMENSIONS</b>			<b>SEAT DIMENSIONS</b>			<b>BACK DIMENSIONS</b>					
		<b>W</b>	<b>D</b>	<b>H</b>	<b>W</b>	<b>D</b>	<b>H</b>	<b>W</b>	<b>H</b>				
		24.25	23.5	32	18.25	17.75	18.25	16	15.25				
		Active weight with casters 300 lbs.; does not stack. Active weight with glides 400 lbs.; stacks 4 high on floor. 2 per carton (pricing and specifications are for one seat unit)											
 <p><b>Armchair, Upholstered Back and Seat</b> COM Yardage: Back: 0.5; Seat: 0.75 Freight Class: 250 Product Weight (lbs.): 21.88 Cubic Feet Per Carton: 5.56</p>		1/COM	2	3	4	5	6	7	8	9	10	11	12
	<b>W5AUUG</b> with glides	Base Price: <b>\$696</b> Seat upcharge: <b>+0</b> Back upcharge: <b>+0</b>	<b>+\$26</b>	<b>+\$46</b>	<b>+\$75</b>	<b>+\$117</b>	<b>+\$133</b>	<b>+\$169</b>	<b>+\$225</b>	<b>+\$267</b>	<b>+\$314</b>	<b>+\$409</b>	<b>+\$510</b>
	<b>W5AUUC</b> with casters	Base Price: <b>\$847</b> Seat upcharge: <b>+0</b> Back upcharge: <b>+0</b>	<b>+\$17</b>	<b>+\$31</b>	<b>+\$50</b>	<b>+\$78</b>	<b>+\$89</b>	<b>+\$113</b>	<b>+\$150</b>	<b>+\$179</b>	<b>+\$209</b>	<b>+\$273</b>	<b>+\$340</b>
		<b>OVERALL DIMENSIONS</b>			<b>SEAT DIMENSIONS</b>			<b>BACK DIMENSIONS</b>					
		<b>W</b>	<b>D</b>	<b>H</b>	<b>W</b>	<b>D</b>	<b>H</b>	<b>W</b>	<b>H</b>				
		24.25	22	32.25	18.25	17	18.25	16.5	15.25				
		Active weight with casters 300 lbs.; does not stack. Active weight with glides 400 lbs.; stacks 4 high on floor. Add \$16 for (SBS) 2 per carton (pricing and specifications are for one seat unit)											

DESCRIPTION	MODEL#	STANDARD FABRIC GRADES											
 <p><b>Armless Chair, Polypropylene Back and Seat</b> COM Yardage: n/a Freight Class: 250 Product Weight (lbs.): 18 Cubic Feet Per Carton: 4.63</p>		List Price											
	<b>W5NPPG</b> with glides	<b>\$513</b>											
	<b>W5NPPC</b> with casters	<b>\$656</b>											
		<b>OVERALL DIMENSIONS</b>			<b>SEAT DIMENSIONS</b>			<b>BACK DIMENSIONS</b>					
	<b>W</b>	<b>D</b>	<b>H</b>	<b>W</b>	<b>D</b>	<b>H</b>	<b>W</b>	<b>H</b>	<b>W</b>	<b>H</b>	<b>W</b>	<b>H</b>	
	20.75	23.5	32	17.75	17.5	17	16	16					
	Active weight with casters 300 lbs.; does not stack. Active weight with glides 400 lbs.; stacks 6 high on floor. 2 per carton (pricing and specifications are for one seat unit)												
 <p><b>Armless Chair, Upholstered Back and Polypropylene Seat</b> COM Yardage: 0.5 Freight Class: 250 Product Weight (lbs.): 18.5 Cubic Feet Per Carton: 4.63</p>		1/COM	2	3	4	5	6	7	8	9	10	11	12
	<b>W5NUPG</b> with glides	<b>\$610</b>	<b>\$627</b>	<b>\$641</b>	<b>\$660</b>	<b>\$688</b>	<b>\$699</b>	<b>\$723</b>	<b>\$760</b>	<b>\$789</b>	<b>\$819</b>	<b>\$883</b>	<b>\$950</b>
	<b>W5NUPC</b> with casters	<b>\$727</b>	<b>\$744</b>	<b>\$758</b>	<b>\$777</b>	<b>\$805</b>	<b>\$816</b>	<b>\$840</b>	<b>\$877</b>	<b>\$906</b>	<b>\$936</b>	<b>\$1000</b>	<b>\$1067</b>
		<b>OVERALL DIMENSIONS</b>			<b>SEAT DIMENSIONS</b>			<b>BACK DIMENSIONS</b>					
	<b>W</b>	<b>D</b>	<b>H</b>	<b>W</b>	<b>D</b>	<b>H</b>	<b>W</b>	<b>H</b>	<b>W</b>	<b>H</b>	<b>W</b>	<b>H</b>	
	20.75	23.5	32.25	17.75	16.75	17	16.5	16					
	Active weight with casters 300 lbs.; does not stack. Active weight with glides 400 lbs.; stacks 4 high on floor. Add \$16 for (SBS) 2 per carton (pricing and specifications are for one seat unit)												
 <p><b>Armless Chair, Polypropylene Back and Upholstered Seat</b> COM Yardage: 0.75 Freight Class: 250 Product Weight (lbs.): 18.5 Cubic Feet Per Carton: 4.63</p>		1/COM	2	3	4	5	6	7	8	9	10	11	12
	<b>W5NPUG</b> with glides	<b>\$610</b>	<b>\$636</b>	<b>\$656</b>	<b>\$685</b>	<b>\$727</b>	<b>\$743</b>	<b>\$779</b>	<b>\$835</b>	<b>\$877</b>	<b>\$924</b>	<b>\$1019</b>	<b>\$1120</b>
	<b>W5NPUC</b> with casters	<b>\$727</b>	<b>\$753</b>	<b>\$773</b>	<b>\$802</b>	<b>\$844</b>	<b>\$860</b>	<b>\$896</b>	<b>\$952</b>	<b>\$994</b>	<b>\$1041</b>	<b>\$1136</b>	<b>\$1237</b>
		<b>OVERALL DIMENSIONS</b>			<b>SEAT DIMENSIONS</b>			<b>BACK DIMENSIONS</b>					
	<b>W</b>	<b>D</b>	<b>H</b>	<b>W</b>	<b>D</b>	<b>H</b>	<b>W</b>	<b>H</b>	<b>W</b>	<b>H</b>	<b>W</b>	<b>H</b>	
	20.75	23.5	32	18.25	17.75	18.25	16	15.25					
	Active weight with casters 300 lbs.; does not stack. Active weight with glides 400 lbs.; stacks 4 high on floor. 2 per carton (pricing and specifications are for one seat unit)												
 <p><b>Armless Chair, Upholstered Back and Seat</b> COM Yardage: Back: 0.5; Seat: 0.75 Freight Class: 150 Product Weight (lbs.): 19 Cubic Feet Per Carton: 4.63</p>		1/COM	2	3	4	5	6	7	8	9	10	11	12
	<b>W5NUUG</b> with glides	Base Price: <b>\$646</b> Seat upcharge: <b>+0</b> Back upcharge: <b>+0</b>	<b>+\$26</b>	<b>+\$46</b>	<b>+\$75</b>	<b>+\$117</b>	<b>+\$133</b>	<b>+\$169</b>	<b>+\$225</b>	<b>+\$267</b>	<b>+\$314</b>	<b>+\$409</b>	<b>+\$510</b>
	<b>W5NUUC</b> with casters	Base Price: <b>\$794</b> Seat upcharge: <b>+0</b> Back upcharge: <b>+0</b>	<b>+\$17</b>	<b>+\$31</b>	<b>+\$50</b>	<b>+\$78</b>	<b>+\$89</b>	<b>+\$113</b>	<b>+\$150</b>	<b>+\$179</b>	<b>+\$209</b>	<b>+\$273</b>	<b>+\$340</b>
		<b>OVERALL DIMENSIONS</b>			<b>SEAT DIMENSIONS</b>			<b>BACK DIMENSIONS</b>					
	<b>W</b>	<b>D</b>	<b>H</b>	<b>W</b>	<b>D</b>	<b>H</b>	<b>W</b>	<b>H</b>	<b>W</b>	<b>H</b>	<b>W</b>	<b>H</b>	
	20.75	23.5	32.25	18.25	17	18.25	16.5	15.25					
	Active weight with casters 300 lbs.; does not stack. Active weight with glides 400 lbs.; stacks 4 high on floor. Add \$16 for (SBS). 2 per carton (pricing and specifications are for one seat unit)												

DESCRIPTION	MODEL#	STANDARD FABRIC GRADES												
		1/COM	2	3	4	5	6	7	8	9	10	11	12	
 <p><b>Bariatric Armchair, Upholstered Back and Seat</b> COM Yardage: Back: 0.75; Seat: 1 Freight Class: 250 Product Weight (lbs.): 41 Cubic Feet Per Carton: 20.5</p>	<b>W530AUU</b>	Base Price:	<b>\$1091</b>											
		Seat upcharge:	<b>+0</b>	<b>+\$34</b>	<b>+\$61</b>	<b>+\$100</b>	<b>+\$155</b>	<b>+\$178</b>	<b>+\$225</b>	<b>+\$300</b>	<b>+\$356</b>	<b>+\$417</b>	<b>+\$545</b>	<b>+\$679</b>
		Back upcharge:	<b>+0</b>	<b>+\$26</b>	<b>+\$46</b>	<b>+\$75</b>	<b>+\$117</b>	<b>+\$133</b>	<b>+\$169</b>	<b>+\$225</b>	<b>+\$267</b>	<b>+\$314</b>	<b>+\$409</b>	<b>+\$510</b>
				<b>OVERALL DIMENSIONS</b>			<b>SEAT DIMENSIONS</b>			<b>BACK DIMENSIONS</b>				
			<b>W</b>	<b>D</b>	<b>H</b>	<b>W</b>	<b>D</b>	<b>H</b>	<b>W</b>	<b>H</b>				
			35.25	23.5	32.25	29	17	18.25	26.75	15.25				
			Active weight 600 lbs. Stacks 4 high on floor. Caster model not available. Add \$25 for (SBS). One per carton (pricing and specifications are for one seat unit)											
 <p><b>Bariatric Armless Chair, Upholstered Back and Seat</b> COM Yardage: Back: 0.75; Seat: 1 Freight Class: 250 Product Weight (lbs.): 37.5 Cubic Feet Per Carton: 16.75</p>	<b>W530NUU</b>	Base Price:	<b>\$1040</b>											
		Seat upcharge:	<b>+0</b>	<b>+\$34</b>	<b>+\$61</b>	<b>+\$100</b>	<b>+\$155</b>	<b>+\$178</b>	<b>+\$225</b>	<b>+\$300</b>	<b>+\$356</b>	<b>+\$417</b>	<b>+\$545</b>	<b>+\$679</b>
		Back upcharge:	<b>+0</b>	<b>+\$26</b>	<b>+\$46</b>	<b>+\$75</b>	<b>+\$117</b>	<b>+\$133</b>	<b>+\$169</b>	<b>+\$225</b>	<b>+\$267</b>	<b>+\$314</b>	<b>+\$409</b>	<b>+\$510</b>
				<b>OVERALL DIMENSIONS</b>			<b>SEAT DIMENSIONS</b>			<b>BACK DIMENSIONS</b>				
			<b>W</b>	<b>D</b>	<b>H</b>	<b>W</b>	<b>D</b>	<b>H</b>	<b>W</b>	<b>H</b>				
			31.75	23.5	32.25	29	17	0	26.75	15.25				
			Active weight 600 lbs. Stacks 4 high on floor. Caster model not available. Add \$25 for (SBS). One per carton (pricing and specifications are for one seat unit)											
 <p><b>Armchair, Sled Base, Polypropylene Back and Seat</b> COM Yardage: n/a Freight Class: 250 Product Weight (lbs.): 29.5 Cubic Feet Per Carton: 13.25</p>	<b>W6APP</b>	List Price	<b>\$722</b>											
			<b>OVERALL DIMENSIONS</b>			<b>SEAT DIMENSIONS</b>			<b>BACK DIMENSIONS</b>					
			<b>W</b>	<b>D</b>	<b>H</b>	<b>W</b>	<b>D</b>	<b>H</b>	<b>W</b>	<b>H</b>				
				24.25	23.75	32	17.75	17.75	17.75	16	16			
			Active weight 400 lbs. Does not stack.											
 <p><b>Armchair, Sled Base, Upholstered Back and Polypropylene Seat</b> COM Yardage: 0.5 Freight Class: 250 Product Weight (lbs.): 30 Cubic Feet Per Carton: 13.25</p>	<b>W6AUP</b>		<b>\$794</b>	<b>\$811</b>	<b>\$825</b>	<b>\$844</b>	<b>\$872</b>	<b>\$883</b>	<b>\$907</b>	<b>\$944</b>	<b>\$973</b>	<b>\$1003</b>	<b>\$1067</b>	<b>\$1134</b>
			<b>OVERALL DIMENSIONS</b>			<b>SEAT DIMENSIONS</b>			<b>BACK DIMENSIONS</b>					
			<b>W</b>	<b>D</b>	<b>H</b>	<b>W</b>	<b>D</b>	<b>H</b>	<b>W</b>	<b>H</b>				
				24.25	23.75	32.25	17.75	17.75	17.75	16.5	16			
			Active weight 400 lbs. Does not stack. Add \$16 for (SBS).											
 <p><b>Armchair, Sled Base, Polypropylene Back and Upholstered Seat</b> COM Yardage: 0.75 Freight Class: 250 Product Weight (lbs.): 30 Cubic Feet Per Carton: 13.25</p>	<b>W6APU</b>		<b>\$794</b>	<b>\$820</b>	<b>\$840</b>	<b>\$869</b>	<b>\$911</b>	<b>\$927</b>	<b>\$963</b>	<b>\$1019</b>	<b>\$1061</b>	<b>\$1108</b>	<b>\$1203</b>	<b>\$1304</b>
			<b>OVERALL DIMENSIONS</b>			<b>SEAT DIMENSIONS</b>			<b>BACK DIMENSIONS</b>					
			<b>W</b>	<b>D</b>	<b>H</b>	<b>W</b>	<b>D</b>	<b>H</b>	<b>W</b>	<b>H</b>				
				24.25	23.75	32	18.25	17.75	18.25	16	15.25			
			Active weight 400 lbs. Does not stack.											

DESCRIPTION	MODEL#	STANDARD FABRIC GRADES												
		1/COM	2	3	4	5	6	7	8	9	10	11	12	
 <p><b>Armchair, Sled Base, Upholstered Back and Seat</b> COM Yardage: Back: 0.5; Seat: 0.75 Freight Class: 250 Product Weight (lbs.): 30.5 Cubic Feet Per Carton: 13.25</p>	<p>Active weight 400 lbs. Does not stack.</p> <p>Add \$16 for (SBS).</p>	Base Price:	<b>\$860</b>											
		Seat upcharge:	<b>+0</b>	<b>+\$26</b>	<b>+\$46</b>	<b>+\$75</b>	<b>+\$117</b>	<b>+\$133</b>	<b>+\$169</b>	<b>+\$225</b>	<b>+\$267</b>	<b>+\$314</b>	<b>+\$409</b>	<b>+\$510</b>
		Back upcharge:	<b>+0</b>	<b>+\$17</b>	<b>+\$31</b>	<b>+\$50</b>	<b>+\$78</b>	<b>+\$89</b>	<b>+\$113</b>	<b>+\$150</b>	<b>+\$179</b>	<b>+\$209</b>	<b>+\$273</b>	<b>+\$340</b>
		<b>OVERALL DIMENSIONS</b>	<b>SEAT DIMENSIONS</b>			<b>BACK DIMENSIONS</b>								
		<b>W</b>	<b>D</b>	<b>H</b>	<b>W</b>	<b>D</b>	<b>H</b>	<b>W</b>	<b>H</b>					
		24.25	23.75	32.25	18.25	16.5	18.25	16.5	15.25					
 <p><b>Armless Chair, Sled Base, Polypropylene Back and Seat</b> COM Yardage: n/a Freight Class: 250 Product Weight (lbs.): 26.5 Cubic Feet Per Carton: 11.75</p>	<p>Active weight 400 lbs. Does not stack.</p>	List Price												
		Model#	<b>W6NPP</b>											
		Price	<b>\$669</b>											
		<b>OVERALL DIMENSIONS</b>	<b>SEAT DIMENSIONS</b>			<b>BACK DIMENSIONS</b>								
		<b>W</b>	<b>D</b>	<b>H</b>	<b>W</b>	<b>D</b>	<b>H</b>	<b>W</b>	<b>H</b>					
		20.75	23.5	32	17.75	17.75	17.75	16	16					
 <p><b>Armless Chair, Sled Base, Upholstered Back and Polypropylene Seat</b> COM Yardage: n/a Freight Class: 250 Product Weight (lbs.): 27 Cubic Feet Per Carton: 11.75</p>	<p>Active weight 400 lbs. Does not stack.</p> <p>Add \$16 for (SBS)</p>	1/COM	2	3	4	5	6	7	8	9	10	11	12	
		Price	<b>\$742</b>	<b>\$759</b>	<b>\$773</b>	<b>\$792</b>	<b>\$820</b>	<b>\$831</b>	<b>\$855</b>	<b>\$892</b>	<b>\$921</b>	<b>\$951</b>	<b>\$1015</b>	<b>\$1082</b>
		<b>OVERALL DIMENSIONS</b>	<b>SEAT DIMENSIONS</b>			<b>BACK DIMENSIONS</b>								
				<b>W</b>	<b>D</b>	<b>H</b>	<b>W</b>	<b>D</b>	<b>H</b>	<b>W</b>	<b>H</b>			
		20.75	23.5	32.25	17.75	17.75	17.75	16.5	16					
 <p><b>Armless Chair, Sled Base, Polypropylene Back and Upholstered Seat</b> COM Yardage: 0.75 Freight Class: 250 Product Weight (lbs.): 27 Cubic Feet Per Carton: 11.75</p>	<p>Active weight 400 lbs. Does not stack.</p>	List Price												
		Model#	<b>W6NPU</b>											
		Price	<b>\$742</b>	<b>\$768</b>	<b>\$788</b>	<b>\$817</b>	<b>\$859</b>	<b>\$875</b>	<b>\$911</b>	<b>\$967</b>	<b>\$1009</b>	<b>\$1056</b>	<b>\$1151</b>	<b>\$1252</b>
		<b>OVERALL DIMENSIONS</b>	<b>SEAT DIMENSIONS</b>			<b>BACK DIMENSIONS</b>								
		<b>W</b>	<b>D</b>	<b>H</b>	<b>W</b>	<b>D</b>	<b>H</b>	<b>W</b>	<b>H</b>					
		20.75	23.5	32	18.25	17.75	18.25	16	15.25					
 <p><b>Armless Chair, Sled Base, Upholstered Back and Seat</b> COM Yardage: Back: 0.5; Seat: 0.75 Freight Class: 250 Product Weight (lbs.): 27.5 Cubic Feet Per Carton: 11.75</p>	<p>Active weight 400 lbs. Does not stack.</p> <p>Add \$16 for (SBS).</p>	1/COM	2	3	4	5	6	7	8	9	10	11	12	
		Base Price:	<b>\$809</b>											
		Seat upcharge:	<b>+0</b>	<b>+\$26</b>	<b>+\$46</b>	<b>+\$75</b>	<b>+\$117</b>	<b>+\$133</b>	<b>+\$169</b>	<b>+\$225</b>	<b>+\$267</b>	<b>+\$314</b>	<b>+\$409</b>	<b>+\$510</b>
		Back upcharge:	<b>+0</b>	<b>+\$17</b>	<b>+\$31</b>	<b>+\$50</b>	<b>+\$78</b>	<b>+\$89</b>	<b>+\$113</b>	<b>+\$150</b>	<b>+\$179</b>	<b>+\$209</b>	<b>+\$273</b>	<b>+\$340</b>
<b>OVERALL DIMENSIONS</b>	<b>SEAT DIMENSIONS</b>			<b>BACK DIMENSIONS</b>										
		<b>W</b>	<b>D</b>	<b>H</b>	<b>W</b>	<b>D</b>	<b>H</b>	<b>W</b>	<b>H</b>					
		20.75	23.5	32.25	18.25	16.5	18.25	16.5	15.25					





DESCRIPTION	MODEL#	STANDARD FABRIC GRADES												
		1/COM	2	3	4	5	6	7	8	9	10	11	12	
	<b>W630AUU</b>	Base Price:	<b>\$1223</b>											
		Seat upcharge:	<b>+0</b>	<b>+\$34</b>	<b>+\$61</b>	<b>+\$100</b>	<b>+\$155</b>	<b>+\$178</b>	<b>+\$225</b>	<b>+\$300</b>	<b>+\$356</b>	<b>+\$417</b>	<b>+\$545</b>	<b>+\$679</b>
		Back upcharge:	<b>+0</b>	<b>+\$26</b>	<b>+\$46</b>	<b>+\$75</b>	<b>+\$117</b>	<b>+\$133</b>	<b>+\$169</b>	<b>+\$225</b>	<b>+\$267</b>	<b>+\$314</b>	<b>+\$409</b>	<b>+\$510</b>
		<b>OVERALL DIMENSIONS</b>			<b>SEAT DIMENSIONS</b>			<b>BACK DIMENSIONS</b>						
		<b>W</b>	<b>D</b>	<b>H</b>	<b>W</b>	<b>D</b>	<b>H</b>	<b>W</b>	<b>H</b>					
		35.25	23.5	32.25	29	17	18.25	26.75	15.25					
<b>Bariatric Armchair, Sled Base, Upholstered Back and Seat</b> COM Yardage: Back: 0.75; Seat: 1 Freight Class: 250 Product Weight (lbs.): 45 Cubic Feet Per Carton: 20.5		Active weight 600 lbs. Does not stack. Add \$25 for (SBS).												





DESCRIPTION	MODEL#	STANDARD FABRIC GRADES												
		1/COM	2	3	4	5	6	7	8	9	10	11	12	
	<b>W630NUU</b>	Base Price:	<b>\$1172</b>											
		Seat upcharge:	<b>+0</b>	<b>+\$34</b>	<b>+\$61</b>	<b>+\$100</b>	<b>+\$155</b>	<b>+\$178</b>	<b>+\$225</b>	<b>+\$300</b>	<b>+\$356</b>	<b>+\$417</b>	<b>+\$545</b>	<b>+\$679</b>
		Back upcharge:	<b>+0</b>	<b>+\$26</b>	<b>+\$46</b>	<b>+\$75</b>	<b>+\$117</b>	<b>+\$133</b>	<b>+\$169</b>	<b>+\$225</b>	<b>+\$267</b>	<b>+\$314</b>	<b>+\$409</b>	<b>+\$510</b>
		<b>OVERALL DIMENSIONS</b>			<b>SEAT DIMENSIONS</b>			<b>BACK DIMENSIONS</b>						
		<b>W</b>	<b>D</b>	<b>H</b>	<b>W</b>	<b>D</b>	<b>H</b>	<b>W</b>	<b>H</b>					
		31.75	23.5	32.25	29	17	18.25	26.75	15.25					
<b>Bariatric Armless Chair, Sled Base, Upholstered Back and Seat</b> COM Yardage: Back: 0.75; Seat: 1 Freight Class: 250 Product Weight (lbs.): 41.5 Cubic Feet Per Carton: 16.75		Active weight 600 lbs. Does not stack. Add \$25 for (SBS).												





DESCRIPTION	MODEL#	STANDARD FABRIC GRADES											
		1/COM	2	3	4	5	6	7	8	9	10	11	12
	<b>W5CSAPP</b>	List Price											
		<b>\$790</b>											
			<b>OVERALL DIMENSIONS</b>			<b>SEAT DIMENSIONS</b>			<b>BACK DIMENSIONS</b>				
		<b>W</b>	<b>D</b>	<b>H</b>	<b>W</b>	<b>D</b>	<b>H</b>	<b>W</b>	<b>H</b>				
		24.25	23.5	38.25	17.75	17.15	23.25	16	16				
<b>Counter Stool with Arms, Polypropylene Back and Seat</b> COM Yardage: n/a Freight Class: 250 Product Weight (lbs.): 32.5 Cubic Feet Per Carton: 15		Active weight 400 lbs. Does not stack.											





DESCRIPTION	MODEL#	STANDARD FABRIC GRADES												
		1/COM	2	3	4	5	6	7	8	9	10	11	12	
	<b>W5CSAUP</b>	<b>\$861</b>	<b>\$878</b>	<b>\$892</b>	<b>\$911</b>	<b>\$939</b>	<b>\$950</b>	<b>\$974</b>	<b>\$1011</b>	<b>\$1040</b>	<b>\$1070</b>	<b>\$1134</b>	<b>\$1201</b>	
			<b>OVERALL DIMENSIONS</b>			<b>SEAT DIMENSIONS</b>			<b>BACK DIMENSIONS</b>					
			<b>W</b>	<b>D</b>	<b>H</b>	<b>W</b>	<b>D</b>	<b>H</b>	<b>W</b>	<b>H</b>				
		24.25	23.5	38.25	17.75	16.5	23.25	16.5	16					
<b>Counter Stool with Arms, Upholstered Back and Polypropylene Seat</b> COM Yardage: 0.5 Freight Class: 250 Product Weight (lbs.): 33 Cubic Feet Per Carton: 15		Active weight 400 lbs. Does not stack. Add \$16 for (SBS).												

DESCRIPTION	MODEL#	STANDARD FABRIC GRADES												
		1/COM	2	3	4	5	6	7	8	9	10	11	12	
	<b>W5CSAPU</b>	<b>\$861</b>	<b>\$887</b>	<b>\$907</b>	<b>\$936</b>	<b>\$978</b>	<b>\$994</b>	<b>\$1030</b>	<b>\$1086</b>	<b>\$1128</b>	<b>\$1175</b>	<b>\$1270</b>	<b>\$1371</b>	
			<b>OVERALL DIMENSIONS</b>			<b>SEAT DIMENSIONS</b>			<b>BACK DIMENSIONS</b>					
			<b>W</b>	<b>D</b>	<b>H</b>	<b>W</b>	<b>D</b>	<b>H</b>	<b>W</b>	<b>H</b>				
		24.25	23.5	38.25	18.25	17.75	24.25	16	15.25					
<b>Counter Stool with Arms, Polypropylene Back and Upholstered Seat</b> COM Yardage: 0.75 Freight Class: 250 Product Weight (lbs.): 33 Cubic Feet Per Carton: 15		Active weight 400 lbs. Does not stack.												

DESCRIPTION	MODEL#	STANDARD FABRIC GRADES											
		1/COM	2	3	4	5	6	7	8	9	10	11	12
 <p><b>Counter Stool with Arms, Upholstered Back and Seat</b> COM Yardage: Back: 0.5; Seat: 0.75 Freight Class: 250 Product Weight (lbs.): 33.5 Cubic Feet Per Carton: 15</p>	<b>W5CSAAU</b> Base Price: Seat upcharge: Back upcharge:	<b>\$929</b>											
		+0    +\$26    +\$46    +\$75    +\$117    +\$133    +\$169    +\$225    +\$267    +\$314    +\$409    +\$510 +0    +\$17    +\$31    +\$50    +\$78    +\$89    +\$113    +\$150    +\$179    +\$209    +\$273    +\$340											
		OVERALL DIMENSIONS			SEAT DIMENSIONS			BACK DIMENSIONS					
		W	D	H	W	D	H	W	H				
		24.25	23.5	38.25	18.25	17	24.25	16.5	15.25				
<p>Active weight 400 lbs. Does not stack. Add \$16 for (SBS).</p>													
 <p><b>Armless Counter Stool, Polypropylene Back and Seat</b> COM Yardage: n/a Freight Class: 250 Product Weight (lbs.): 29.5 Cubic Feet Per Carton: 13.75</p>	<b>W5CSNPP</b>	List Price											
		<b>\$737</b>											
		OVERALL DIMENSIONS			SEAT DIMENSIONS			BACK DIMENSIONS					
		W	D	H	W	D	H	W	H				
		21.75	23.5	38.25	17.75	17.15	23.25	16	16				
<p>Active weight 400 lbs. Stacks 4 high on floor.</p>													
 <p><b>Armless Counter Stool, Upholstered Back and Polypropylene Seat</b> COM Yardage: 0.5 Freight Class: 250 Product Weight (lbs.): 30 Cubic Feet Per Carton: 13.75</p>	<b>W5CSNUP</b>	1/COM											
		<b>\$810    \$827    \$841    \$860    \$888    \$899    \$923    \$960    \$989    \$1019    \$1083    \$1150</b>											
		OVERALL DIMENSIONS			SEAT DIMENSIONS			BACK DIMENSIONS					
		W	D	H	W	D	H	W	H				
		21.75	23.5	38.25	17.75	16.5	23.25	16.5	16				
<p>Active weight 400 lbs. Stacks 4 high on floor. Add \$16 for (SBS).</p>													
 <p><b>Armless Counter Stool, Polypropylene Back and Upholstered Seat</b> COM Yardage: 0.75 Freight Class: 250 Product Weight (lbs.): 30 Cubic Feet Per Carton: 13.75</p>	<b>W5CSNPU</b>	1/COM											
		<b>\$810    \$836    \$856    \$885    \$927    \$943    \$979    \$1035    \$1077    \$1124    \$1219    \$1320</b>											
		OVERALL DIMENSIONS			SEAT DIMENSIONS			BACK DIMENSIONS					
		W	D	H	W	D	H	W	H				
		21.75	23.5	38.25	18.25	17.75	24.25	16	15.25				
<p>Active weight 400 lbs. Stacks 4 high on floor.</p>													
 <p><b>Armless Counter Stool, Upholstered Back and Seat</b> COM Yardage: Back: 0.5; Seat: 0.75 Freight Class: 250 Product Weight (lbs.): 30.5 Cubic Feet Per Carton: 13.75</p>	<b>W5CSNUU</b> Base Price: Seat upcharge: Back upcharge:	<b>\$876</b>											
		+0    +\$26    +\$46    +\$75    +\$117    +\$133    +\$169    +\$225    +\$267    +\$314    +\$409    +\$510 +0    +\$17    +\$31    +\$50    +\$78    +\$89    +\$113    +\$150    +\$179    +\$209    +\$273    +\$340											
		OVERALL DIMENSIONS			SEAT DIMENSIONS			BACK DIMENSIONS					
		W	D	H	W	D	H	W	H				
		21.75	23.5	38.25	18.25	17	24.25	16.5	15.25				
<p>Active weight 400 lbs. Stacks 4 high on floor. Add \$16 for (SBS).</p>													

DESCRIPTION	MODEL#	STANDARD FABRIC GRADES												
 <p><b>Bar Stool with Arms, Polypropylene Back and Seat</b> COM Yardage: n/a Freight Class: 250 Product Weight (lbs.): 34.5 Cubic Feet Per Carton: 17</p>		List Price												
	<b>W5BSAPP</b>	<b>\$801</b>												
		OVERALL DIMENSIONS			SEAT DIMENSIONS			BACK DIMENSIONS						
		W	D	H	W	D	H	W	H					
		24.25	23.5	44	17.75	17.5	29.25	16	16					
 <p><b>Bar Stool with Arms, Upholstered Back and Polypropylene Seat</b> COM Yardage: 0.5 Freight Class: 250 Product Weight (lbs.): 35 Cubic Feet Per Carton: 17</p>		1/COM 2 3 4 5 6 7 8 9 10 11 12												
	<b>W5BSAUP</b>	<b>\$874</b>	<b>\$891</b>	<b>\$905</b>	<b>\$924</b>	<b>\$952</b>	<b>\$963</b>	<b>\$987</b>	<b>\$1024</b>	<b>\$1053</b>	<b>\$1083</b>	<b>\$1147</b>	<b>\$1214</b>	
		OVERALL DIMENSIONS			SEAT DIMENSIONS			BACK DIMENSIONS						
		W	D	H	W	D	H	W	H					
		24.25	23.5	44.5	17.75	16.5	29.25	16.5	16					
 <p><b>Bar Stool with Arms, Polypropylene Back and Upholstered Seat</b> COM Yardage: 0.75 Freight Class: 250 Product Weight (lbs.): 35 Cubic Feet Per Carton: 17</p>		1/COM 2 3 4 5 6 7 8 9 10 11 12												
	<b>W5BSAPU</b>	<b>\$874</b>	<b>\$891</b>	<b>\$905</b>	<b>\$924</b>	<b>\$952</b>	<b>\$963</b>	<b>\$987</b>	<b>\$1024</b>	<b>\$1053</b>	<b>\$1083</b>	<b>\$1147</b>	<b>\$1214</b>	
		OVERALL DIMENSIONS			SEAT DIMENSIONS			BACK DIMENSIONS						
		W	D	H	W	D	H	W	H					
		24.25	23.5	44	18.25	17.5	30.25	16	15.25					
 <p><b>Bar Stool with Arms, Upholstered Back and Seat</b> COM Yardage: Back: 0.5; Seat: 0.75 Freight Class: 250 Product Weight (lbs.): 35.5 Cubic Feet Per Carton: 17</p>		1/COM 2 3 4 5 6 7 8 9 10 11 12												
	<b>W5BSAAU</b>	Base Price: <b>\$941</b>	Seat upcharge: <b>+\$0</b>	<b>+\$26</b>	<b>+\$46</b>	<b>+\$75</b>	<b>+\$117</b>	<b>+\$133</b>	<b>+\$169</b>	<b>+\$225</b>	<b>+\$267</b>	<b>+\$314</b>	<b>+\$409</b>	<b>+\$510</b>
		Back upcharge: <b>+\$0</b>	<b>+\$17</b>	<b>+\$31</b>	<b>+\$50</b>	<b>+\$78</b>	<b>+\$89</b>	<b>+\$113</b>	<b>+\$150</b>	<b>+\$179</b>	<b>+\$209</b>	<b>+\$273</b>	<b>+\$340</b>	
		OVERALL DIMENSIONS			SEAT DIMENSIONS			BACK DIMENSIONS						
		W	D	H	W	D	H	W	H					
		24.25	23.5	44.5	18.25	16.75	30.25	16.5	15.25					
 <p><b>Armless Bar Stool, Polypropylene Back and Seat</b> COM Yardage: n/a Freight Class: 250 Product Weight (lbs.): 31.5 Cubic Feet Per Carton: 15.75</p>		List Price												
	<b>W5BSNPP</b>	<b>\$750</b>												
		OVERALL DIMENSIONS			SEAT DIMENSIONS			BACK DIMENSIONS						
		W	D	H	W	D	H	W	H					
		20.75	23.5	44	17.75	17.5	29.25	16	16					

DESCRIPTION	MODEL#	STANDARD FABRIC GRADES													
		1/COM	2	3	4	5	6	7	8	9	10	11	12		
 <p><b>Armless Bar Stool, Upholstered Back and Polypropylene Seat</b>                      COM Yardage: 0.5                      Freight Class: 250                      Product Weight (lbs.): 32                      Cubic Feet Per Carton: 15.75</p>	<b>W5BSNUP</b>	\$822	\$839	\$853	\$872	\$900	\$911	\$935	\$972	\$1001	\$1031	\$1095	\$1162		
	<b>OVERALL DIMENSIONS</b>			<b>SEAT DIMENSIONS</b>			<b>BACK DIMENSIONS</b>								
	<b>W</b>	<b>D</b>	<b>H</b>	<b>W</b>	<b>D</b>	<b>H</b>	<b>W</b>	<b>H</b>							
	20.75	23.5	44.5	17.75	16.5	29.25	16.5	16							
 <p><b>Armless Bar Stool, Polypropylene Back and Upholstered Seat</b>                      COM Yardage: 0.75                      Freight Class: 250                      Product Weight (lbs.): 32                      Cubic Feet Per Carton: 15.75</p>	<b>W5BSNPU</b>	\$822	\$848	\$868	\$897	\$939	\$955	\$991	\$1047	\$1089	\$1136	\$1231	\$1332		
	<b>OVERALL DIMENSIONS</b>			<b>SEAT DIMENSIONS</b>			<b>BACK DIMENSIONS</b>								
	<b>W</b>	<b>D</b>	<b>H</b>	<b>W</b>	<b>D</b>	<b>H</b>	<b>W</b>	<b>H</b>							
	20.75	23.5	44	18.25	17.5	30.25	16	15.25							
 <p><b>Armless Bar Stool, Upholstered Back and Seat</b>                      COM Yardage: Back: 0.5; Seat: 0.75                      Freight Class: 250                      Product Weight (lbs.): 32.5                      Cubic Feet Per Carton: 15.75</p>	<b>W5BSNUU</b>	Base Price: \$889	Seat upcharge: +0	Back upcharge: +0	+ \$26	+ \$46	+ \$75	+ \$117	+ \$133	+ \$169	+ \$225	+ \$267	+ \$314	+ \$409	+ \$510
	<b>OVERALL DIMENSIONS</b>			<b>SEAT DIMENSIONS</b>			<b>BACK DIMENSIONS</b>								
	<b>W</b>	<b>D</b>	<b>H</b>	<b>W</b>	<b>D</b>	<b>H</b>	<b>W</b>	<b>H</b>							
	20.75	23.5	44.5	18.25	16.75	30.25	16.5	15.25							
 <p><b>Hip Chair, Polypropylene Back and Seat</b>                      COM Yardage: n/a                      Freight Class: 250                      Product Weight (lbs.): 35.5                      Cubic Feet Per Carton: 17.75</p>	<b>W524APP</b>	List Price \$814													
	<b>OVERALL DIMENSIONS</b>			<b>SEAT DIMENSIONS</b>			<b>BACK DIMENSIONS</b>								
	<b>W</b>	<b>D</b>	<b>H</b>	<b>W</b>	<b>D</b>	<b>H</b>	<b>W</b>	<b>H</b>							
	24.25	24.25	38	17.75	17.5	22.25	16	16							
 <p><b>Hip Chair, Upholstered Back and Polypropylene Seat</b>                      COM Yardage: 0.5                      Freight Class: 250                      Product Weight (lbs.): 36                      Cubic Feet Per Carton: 17.75</p>	<b>W524AUP</b>	\$886	\$903	\$917	\$936	\$964	\$975	\$999	\$1036	\$1065	\$1095	\$1159	\$1226		
	<b>OVERALL DIMENSIONS</b>			<b>SEAT DIMENSIONS</b>			<b>BACK DIMENSIONS</b>								
	<b>W</b>	<b>D</b>	<b>H</b>	<b>W</b>	<b>D</b>	<b>H</b>	<b>W</b>	<b>H</b>							
	24.25	24.25	38.25	17.75	16.5	22.25	16.5	16.25							

DESCRIPTION	MODEL#	STANDARD FABRIC GRADES												
		1/COM	2	3	4	5	6	7	8	9	10	11	12	
 <p><b>Hip Chair, Polypropylene Back and Upholstered Seat</b> COM Yardage: 0.75 Freight Class: 250 Product Weight (lbs.): 36 Cubic Feet Per Carton: 17.75</p>	<b>W524APU</b>	\$886	\$912	\$932	\$961	\$1003	\$1019	\$1055	\$1111	\$1153	\$1200	\$1295	\$1396	
		<b>OVERALL DIMENSIONS</b>			<b>SEAT DIMENSIONS</b>			<b>BACK DIMENSIONS</b>						
		<b>W</b>	<b>D</b>	<b>H</b>	<b>W</b>	<b>D</b>	<b>H</b>	<b>W</b>	<b>H</b>					
		24.25	24.25	38	18.25	17.5	23.25	16	15.25					
Active weight 400 lbs. Does not stack.														
 <p><b>Hip Chair, Upholstered Back and Seat</b> COM Yardage: Back: 0.5; Seat: 0.75 Freight Class: 250 Product Weight (lbs.): 36.5 Cubic Feet Per Carton: 17.75</p>	<b>W524AUU</b>	Base Price: <b>\$952</b>												
		Seat upcharge:	<b>+0</b>	<b>+\$26</b>	<b>+\$46</b>	<b>+\$75</b>	<b>+\$117</b>	<b>+\$133</b>	<b>+\$169</b>	<b>+\$225</b>	<b>+\$267</b>	<b>+\$314</b>	<b>+\$409</b>	<b>+\$510</b>
		Back upcharge:	<b>+0</b>	<b>+\$17</b>	<b>+\$31</b>	<b>+\$50</b>	<b>+\$78</b>	<b>+\$89</b>	<b>+\$113</b>	<b>+\$150</b>	<b>+\$179</b>	<b>+\$209</b>	<b>+\$273</b>	<b>+\$340</b>
		<b>OVERALL DIMENSIONS</b>			<b>SEAT DIMENSIONS</b>			<b>BACK DIMENSIONS</b>						
<b>W</b>	<b>D</b>	<b>H</b>	<b>W</b>	<b>D</b>	<b>H</b>	<b>W</b>	<b>H</b>							
24.25	24.25	38.25	18.25	16.5	23.25	16.5	15.25							
Active weight 400 lbs. Does not stack.  Add \$16 for (SBS).														
 <p><b>Bariatric Hip Chair, Upholstered Back and Seat</b> COM Yardage: Back: 0.75; Seat: 1 Freight Class: 250 Product Weight (lbs.): 50 Cubic Feet Per Carton: 23.75</p>	<b>W324AUU</b>	Base Price: <b>\$1254</b>												
		Seat upcharge:	<b>+0</b>	<b>+\$34</b>	<b>+\$61</b>	<b>+\$100</b>	<b>+\$155</b>	<b>+\$178</b>	<b>+\$225</b>	<b>+\$300</b>	<b>+\$356</b>	<b>+\$417</b>	<b>+\$545</b>	<b>+\$679</b>
		Back upcharge:	<b>+0</b>	<b>+\$26</b>	<b>+\$46</b>	<b>+\$75</b>	<b>+\$117</b>	<b>+\$133</b>	<b>+\$169</b>	<b>+\$225</b>	<b>+\$267</b>	<b>+\$314</b>	<b>+\$409</b>	<b>+\$510</b>
		<b>OVERALL DIMENSIONS</b>			<b>SEAT DIMENSIONS</b>			<b>BACK DIMENSIONS</b>						
<b>W</b>	<b>D</b>	<b>H</b>	<b>W</b>	<b>D</b>	<b>H</b>	<b>W</b>	<b>H</b>							
35.25	24.25	38.5	29	17.5	23.25	26.75	15.25							
Active weight 600 lbs. Does not stack.  Add \$25 for (SBS).														
 <p><b>Dolly</b> COM Yardage: n/a Freight Class: 150 Product Weight (lbs.): 16 Cubic Feet Per Carton: 3.5</p>	<b>WDOL</b>	List Price												
		<b>\$368</b>												
		<b>OVERALL DIMENSIONS</b>			<b>SEAT DIMENSIONS</b>			<b>BACK DIMENSIONS</b>						
		<b>W</b>	<b>D</b>	<b>H</b>	<b>W</b>	<b>D</b>	<b>H</b>	<b>W</b>	<b>H</b>					
22	23.75	9.25												
Accommodates 10 standard 4-legged chairs.														
 <p><b>Bariatric Dolly</b> COM Yardage: n/a Freight Class: 250 Product Weight (lbs.): 19 Cubic Feet Per Carton: 5</p>	<b>WDOL30</b>	List Price												
		<b>\$408</b>												
		<b>OVERALL DIMENSIONS</b>			<b>SEAT DIMENSIONS</b>			<b>BACK DIMENSIONS</b>						
		<b>W</b>	<b>D</b>	<b>H</b>	<b>W</b>	<b>D</b>	<b>H</b>	<b>W</b>	<b>H</b>					
32.12	23.75	9.25												
Accommodates 4 bariatric 4-legged chairs.														

WILLOW LINKING TABLES



**WPT12G**  
120 degree corner linking table



**WPT12GL**  
End linking table, left



For Willow seating, see page 241.

STANDARD FEATURES







- Linking tables can be used together in any combination with Willow four-leg or sled chairs to create a wide variety of layouts.
- Connecting hardware is included.
- Legs and ganging brackets are available in 20 paint finishes and 4 plated finishes.
- All tables are laminate, choose thermally fused or high pressure, and feature a flat edge with edgeband.
- Tables are available with a variety of glide types. Glides must be chosen to best suit flooring type and site conditions. See Glide Type.
- All tables (except 9" In-line Linking) are pre-drilled for center front, field installed, undermount power. Specified separately.
- Undermount power unit (SU2P10U) includes 1 AC and 2 USB-A charging ports with a 10' power cord and 3-prong plug, specify Jet Black or White. Power units do not link.
- Clamp mount (SU2P10C) power, with 1 AC and 2 USB-A charging ports with a 10' power cord, available Jet Black or White. These units can be mounted on the back edge of all linking tables. Specified separately for field installation. Power units do not link.



Add option codes in the following order:

- **Model number**  
Enter model number.
- **Surface Type**  
(**TFL**) Thermally fused laminate  
(**HPL**) High pressure laminate
- **Top finish**  
(**ACJ**) Absolute Acajou  
(**ASN**) Asian Night  
(**AWC**) Avant Cherry  
(**AWH**) Avant Honey  
(**BLK**) Black  
(**BZD**) Blizzard  
(**BRC**) Brushed Cobalt  
(**CMB**) Clear Maple  
(**CGY**) Custom Grey  
(**DES**) Dark Espresso  
(**DWT**) Designer White  
(**FAS**) Fashionista  
(**FCL**) First Class  
(**NBL**) Noce Biondo  
(**NGL**) Noce Grigio  
(**NEL**) Noce Leggero  
(**NML**) Noce Medio  
(**QTM**) Quartered Mahogany  
(**SBY**) Sheer Beauty  
(**SDT**) Stonedust  
(**SOG**) Storm Grey  
(**WCR**) Winter Cherry  
(**WHC**) White Chocolate  
(**WHE**) Walnut Heights
- **Leg Finish** (for tables with legs)  
Paint finishes:  
Black (**TBL**), Buzz Blue (**TBZ**), Cactus (**TCC**), Carrot (**TCR**), Cloud (**TIV**), Designer White (**TDW**), Dijon (**TDJ**), Eggplant (**TEG**), Fog (**TFO**), Frost (**TFR**), Ink (**TIN**), Kalua (**TKA**), Latte (**TLA**), Mocha (**TMO**), Nevada (**TNE**), Sand (**TSN**), Scarlet (**TSR**), Shadow (**TSH**), Toast (**TOA**) and Tungsten (**TTU**).  
Plated finishes:  
(**CHM**) Chrome. Add \$45.  
(**BCH**) Brushed Chrome. Add \$156.
- **Bracket Finish** (for linking tables and ganging bracket)  
Paint finishes:  
Black (**TBL**), Cloud (**TIV**), Designer White (**TDW**), Fog (**TFO**), Frost (**TFR**), Kalua (**TKA**), Latte (**TLA**), Mocha (**TMO**), Nevada (**TNE**), Sand (**TSN**), Shadow (**TSH**), Toast (**TOA**) and Tungsten (**TTU**).
- **Glide type** (for models with legs)  
(**ST**) Nylon colored glide for most surfaces  
(**NM**) White, non-marking Nylon glide for most surfaces  
(**SG**) Steel cushion glide for carpeted surfaces. Add \$9 for models with one leg. Add \$16 for models with two legs.  
(**FG**) Felt glide for most hard floor surfaces. Add \$9 for models with one leg. Add \$16 for models with two legs.  
(**RG**) Rubber, non-slip glide for most hard floor surfaces. Add \$9 for models with one leg. Add \$16 for models with two legs.
- **Glide Finish** (for ST glides only)  
(**BLK**) Black  
(**SND**) Sand

EXAMPLE WILLOW TABLE ORDER CODE:

WPT90G	HPL	ACJ	-CHM	-ST	-SND
Model #	Surface type	Top finish	Leg finish	Glide type	Glide finish

LINKING TABLES	MODEL#	DIMENSIONS	FREIGHT CLASS	WT/LBS.	CUBIC FT.	LIST PRICE
 <p><b>90° Corner Linking Table</b></p>	WPT90G	26.12 x 26.12 x 17.62	100	24	2.6	<b>\$592</b>
						<ul style="list-style-type: none"> <li>• Pricing shown for a thermally fused laminate top (LP).</li> <li>• For a high pressure laminate top (HP), add <b>\$152</b>.</li> </ul> <p>Coordinating edge on laminate surfaces with metal frame and legs. Must be connected to a four-leg or sled base chair. Includes one set of U-channel connectors and hardware. 1 per carton. Shipped KD for assembly on site.</p>
 <p><b>120° Corner Linking Table</b></p>	WPT12G	31 x 12.62 x 17.5	92.5	16.5	1.5	<b>\$509</b>
						<ul style="list-style-type: none"> <li>• Pricing shown for a thermally fused laminate top (LP).</li> <li>• For a high pressure laminate top (HP), add <b>\$98</b>.</li> </ul> <p>Coordinating edge on laminate surfaces with metal frame and legs. Must be connected to a four-leg or sled base chair. Includes one set of U-channel connectors and hardware. 1 per carton. Shipped KD for assembly on site.</p>
 <p><b>16" In-Line Linking Table</b></p>	WPT16G	15 x 16 x 2.75	85	12	0.9	<b>\$333</b>
						<ul style="list-style-type: none"> <li>• Pricing shown for a thermally fused laminate top (LP).</li> <li>• For a high pressure laminate top (HP), add <b>\$62</b>.</li> </ul> <p>Coordinating edge on laminate surfaces with metal frame and legs. Must be connected to a four-leg or sled base chair. Includes one set of U-channel connectors and hardware. 1 per carton. Shipped KD for assembly on site.</p>
 <p><b>9" In-Line Linking Table</b></p>	WPT09G		85	8.5	0.7	<b>\$259</b>
						<ul style="list-style-type: none"> <li>• Pricing shown for a thermally fused laminate top (LP).</li> <li>• For a high pressure laminate top (HP), add <b>\$44</b>.</li> </ul> <p>Coordinating edge on laminate surfaces with metal frame and legs. Must be connected to a four-leg or sled base chair. Includes one set of U-channel connectors and hardware. 1 per carton. Shipped KD for assembly on site.</p>
 <p><b>End Linking Table</b></p>	WPTEGL (Left) WPTEGR (Right)	15 x 14 x 17.62	85	13	1	<b>\$516</b>
						<ul style="list-style-type: none"> <li>• Pricing shown for a thermally fused laminate top (LP).</li> <li>• For a high pressure laminate top (HP), add <b>\$59</b>.</li> </ul> <p>Coordinating edge on laminate surfaces with metal frame and legs. Must be connected to a four-leg or sled base chair. Includes one set of U-channel connectors and hardware. 1 per carton. Shipped KD for assembly on site.</p>
 <p><b>Ganging Bracket</b></p>	WPGBRK	9 x 15 x 1.25	300	2	2	<b>\$114</b>
						<p>For use between two seated height arm or armless chairs where table top is not desired. Not for use with stools. Does not accept power units. 1 per carton.</p>

POWER	MODEL#	DIMENSIONS	FREIGHT CLASS	WT/LBS.	CUBIC FT.	LIST PRICE
 <p><b>Power Unit, Clamp Attachment</b></p>	SU2P10C		70	0.01	0.5	<b>\$588</b>
<p>Tamper-resistant clamp mount power, with 1 AC and 2 USB-A charging ports with a 10' power cord and 3-prong plug. Available in Jet Black or White. Can be mounted on the back edge of all linking tables. Must be specified separately for field installation. Power units do not link.</p>						
 <p><b>Power Unit, Under Mount Attachment</b></p>	SU2P10U		70	0.01	2	<b>\$556</b>
<p>Tamper-resistant undermount power, with 1 AC and 2 USB-A charging ports with a 10' power cord and 3-prong plug. Available in Jet Black or White. Must be specified separately for field installation. Power units do not link.</p>						

WINGBACK



model GC3787C

STANDARD FEATURES

- Traditional styling, easy to exit and features removable and replaceable seats.
- For added comfort, seats are standard with high density foam.
- Standard glide is plastic.
- Wood legs are available in a variety of finishes. Available in Maple wood only species.
- For textile and finish options, visit the website at [globalfurnituregroup.com](http://globalfurnituregroup.com)
- Can be upholstered in standard Global textiles if Healthcare compliance is not required.
- Shipped fully assembled.

OPTIONAL FEATURES

- For non-slip glides specify (NS) - Add **\$37**
- For moisture barrier (seat only) - Add **\$204** per seat.

SUGGESTED APPLICATIONS

- Guest seating
- Lobbies
- Lounge/Waiting
- Patient rooms
- Resident rooms

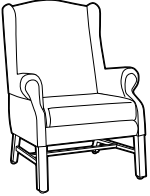
DESCRIPTION	MODEL#	STANDARD TEXTILE GRADES											
		COM	2	3	4	5	6	7	8	9	10	11	12
 <p><b>HB Armchair, Chippendale Legs</b>                      COM Yardage: 4.75                      Freight Class: 250                      Product Weight (lbs.): 50                      Cubic Feet Per Carton: 22.25</p>	GC3787C	\$1950	\$2101	\$2342	\$2547	\$2836	\$2947	\$3200	\$3677	\$3913	\$4352	\$4968	\$5731
		<p><b>OVERALL DIMENSIONS</b></p> <p>W      D      H</p>			<p><b>SEAT DIMENSIONS</b></p> <p>W      D      H</p>			<p><b>BACK DIMENSIONS</b></p> <p>W      H</p>					
		29	30	39	19.5	18	17.5	19.5	22				

Active weight 300 lbs.  
Removable seat cushion.

OTTOMANS



model GC3346

STANDARD FEATURES

- Designed to coordinate with healthcare seating.
- Standard glide is plastic.
- Wood legs are available in a variety of finishes.
- For textiles and finish options, visit the website at [www.globalfurnituregroup.com](http://www.globalfurnituregroup.com)
- Can be upholstered in standard Global textiles only if Healthcare compliance is not required.
- Shipped fully assembled.

OPTIONAL FEATURES

- For hard surface floors, please specify opaque non-marking glides (**NM**). No upcharge.
- For non-slip glides, please specify (**NS**). Add **\$37**.
- Optional metal leg is available. Offered in Black (**TBL**), Latte (**TLA**), Toast (**TOA**), Tungsten (**TTU**), Shadow (**TSH**), Mocha (**TMO**), and Kalua (**TKA**). Please specify. No upcharge.

SUGGESTED APPLICATIONS

- Guest seating
- Lobbies
- Lounge/Waiting
- Patient rooms
- Resident rooms
- Treatment/Exam

DESCRIPTION	MODEL#	STANDARD TEXTILE GRADES											
		COM	2	3	4	5	6	7	8	9	10	11	12
 <b>Ottoman</b> Block Legs COM Yardage: 1.25 Freight Class: 150 Product Weight (lbs.): 20 Cubic Feet Per Carton: 4.6	GC3346	\$1536	\$1580	\$1621	\$1675	\$1755	\$1786	\$1853	\$1979	\$2046	\$2163	\$2331	\$2533
			<b>OVERALL DIMENSIONS</b> W D H			<b>SEAT DIMENSIONS</b> W D H			<b>BACK DIMENSIONS</b> W H				
		17.5	19.5	15	--	--	15						

THROW PILLOWS



model GCTP1515

STANDARD FEATURES

- Throw pillows complement decor by adding a personal touch.
- Colors and patterns enhance and add to the overall design
- Velcro closure allows for covers to be changed
- Can be upholstered in standard Global textiles only if Healthcare compliance is not required.
- For a complete list of healthcare textile, visit the website at [globalfurnituregroup.com](http://globalfurnituregroup.com)

SUGGESTED APPLICATIONS

- Lobbies
- Lounge/Waiting
- Resident rooms

DESCRIPTION	MODEL#	STANDARD TEXTILE GRADES											
		COM	2	3	4	5	6	7	8	9	10	11	12
 <b>15" x 15" Square Throw Pillow</b> COM Yardage: 0.75 Freight Class: 70 Product Weight (lbs.): 1 Cubic Feet Per Carton: 1.3	GCTP1515	\$215	\$236	\$272	\$304	\$349	\$368	\$404	\$483	\$520	\$590	\$687	\$806
			<b>OVERALL DIMENSIONS</b> W D H			<b>SEAT DIMENSIONS</b> W D H			<b>BACK DIMENSIONS</b> W H				
		15	15	6									
 <b>20" x 20" Square Throw Pillow</b> COM Yardage: 0.75 Freight Class: 70 Product Weight (lbs.): 1.5 Cubic Feet Per Carton: 1.3	GCTP2020	\$259	\$282	\$307	\$337	\$384	\$406	\$450	\$510	\$566	\$617	\$733	\$852
			<b>OVERALL DIMENSIONS</b> W D H			<b>SEAT DIMENSIONS</b> W D H			<b>BACK DIMENSIONS</b> W H				
		20	20	6									

# textiles + finishes