

seating

Private + Public + Individual + Group Applications

Application guidelines.....	61	GC Citi.....	123
Bishop.....	62	GC Comet.....	124
Calidon.....	63	GC Islands.....	125
Chap.....	70	GC Sidero.....	126
Coast.....	72	GC Sirena.....	136
Collingwood.....	73	GC Vion.....	138
Desmond.....	75	GC Wind.....	140
Desmond HT.....	76	Janna.....	142
Doctor Buddy.....	78	Nourish.....	143
Dreme.....	79	Oakville.....	147
Drift.....	82	Primacare.....	148
Erin.....	83	River+.....	214
Flap.....	85	Senator.....	215
Foot Activated Stools.....	87	Sleep-Eez.....	216
Frolick.....	88	Splash.....	88
Gala II.....	93	Strand.....	217
GC Beach.....	94	Willow.....	223
GC Belong.....	95	Wingback.....	236

SERIES	WOOD	METAL	BARIATRIC SEATING	DINING / CAFETERIA	GUEST SEATING	LOBBIES	LOUNGE / WAITING	OFFICE / MEETING	PATIENT ROOMS	RESIDENT ROOMS	STACKING	TREATMENT / EXAM ROOMS
BISHOP	•					•	•			•		
CALIDON	•		•		•	•	•		•	•		•
CHAP	•			•	•	•	•	•	•	•		
COAST	•						•		•	•		
COLLINGWOOD	•			•	•	•	•		•	•		
DESMOND	•			•	•	•	•	•	•	•		
DESMOND HT		•	•	•	•	•	•	•	•	•		
DOCTOR BUDDY		•		•				•	•	•		•
DREME									•	•		
ERIN	•	•		•	•	•	•		•	•		
FLAP				•	•						•	•
FOOT ACTIVATED STOOLS				•				•	•	•		•
FROLICK		•	•	•	•	•	•	•	•	•	•	•
GALA II		•						•				•
GC BEACH	•			•	•	•	•	•	•	•		
GC BELONG		•	•		•	•	•		•	•		•
GC CITI		•			•	•	•					
GC COMET	•	•	•	•	•	•	•	•	•	•	•	•
GC ISLANDS	•			•	•	•	•	•	•	•		
GC SIDERO		•	•	•	•	•	•	•	•	•	•	•
GC SIRENA	•			•	•	•	•	•	•	•		
GC VION								•				
GC WIND		•				•	•	•	•	•		
JANNA	•			•	•		•	•	•	•		•
NOURISH		•	•				•		•	•		•
OAKVILLE	•				•	•	•		•	•		
OTTOMANS	•	•			•	•	•		•	•		•
PRIMACARE	•		•	•	•	•	•		•	•		•
PRIMACARE HT		•	•	•	•	•	•		•	•		•
PRIMACARE MODULAR	•		•	•	•	•	•					
PRIMACARE WINGBACK	•	•	•		•	•	•		•	•		
SENATOR	•	•				•	•		•	•		
SLEEP-EEZ					•				•	•		
SPLASH		•		•	•	•	•	•	•	•	•	•
STRAND	•	•	•		•	•	•		•	•		•
THROW PILLOWS						•	•			•		
WILLOW		•	•	•	•	•	•	•	•	•	•	•
WINGBACK	•				•	•	•		•	•		

TABLES	MODEL#	DIMENSIONS	FREIGHT CLASS	WT/LBS.	CUBIC FT.	LIST PRICE
--------	--------	------------	---------------	---------	-----------	------------

BISHOP



model GC3751

D x W x H

STANDARD FEATURES

- Bishop offers a classic, traditional, rolled arm style design.
- Features removable and replaceable seat cushions
- Wood frame and hardwood block legs are available in a variety of finishes: erry (ACM), English Oak (EOM), Espresso Cafe (ECM), Fruitwood (TFM), Honey (AHM), Mahogany (TMM), Maple (AVM), Natural Walnut (NLW), Noce Biondo (NBM), Noce Grigio (NGM), Noce Leggero (NEM), Noce Medio (NMM), Sandy Beach (SKM), and Walnut (TWM). Please specify.
- For added comfort, seat and back are standard with high density Ultracell foam.
- Opaque non-marking glides are standard
- For healthcare textiles and finish options, visit the website at globalfurnituregroup.com
- Can be upholstered in standard Global textiles if healthcare compliance is not required.
- Shipped fully assembled.
- Standard glide is plastic.

OPTIONAL FEATURES

- For non-slip glides, specify **(NS)**. Add \$35
- For moisture barrier on seat, please specify **(MB)**. Add \$193 per seat.

SUGGESTED APPLICATIONS

- Lobbies
- Lounge/Waiting
- Resident rooms

DESCRIPTION	MODEL#	STANDARD FABRIC GRADES											
-------------	--------	------------------------	--	--	--	--	--	--	--	--	--	--	--

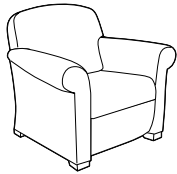

	COM	2	3	4	5	6	7	8	9	10	11	12
GC3751	\$2593	\$2843	\$3050	\$3350	\$3777	\$3941	\$4316	\$5016	\$5371	\$6025	\$6933	\$8056

OVERALL DIMENSIONS			SEAT DIMENSIONS			BACK DIMENSIONS	
W	D	H	W	D	H	W	H
37	32	34.5	21	18.5	17	28	17.5

Lounge Chair
 COM Yardage: 7.25
 Freight Class: 250
 Product Weight (lbs.): 75
 Cubic Feet Per Carton: 30.25

Active weight 300 lbs.
 Loose seat cushion.

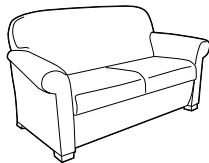

	COM	2	3	4	5	6	7	8	9	10	11	12
GC3752	\$3663	\$3964	\$4212	\$4577	\$5093	\$5287	\$5738	\$6589	\$7014	\$7804	\$8899	\$10255

OVERALL DIMENSIONS			SEAT DIMENSIONS			BACK DIMENSIONS	
W	D	H	W	D	H	W	H
63.5	32	34.5	47.5	18.5	17	55	17.5

Two Seat Sofa
 COM Yardage: 8.75
 Freight Class: 250
 Product Weight (lbs.): 112
 Cubic Feet Per Carton: 55.75

Active weight 300 lbs./seat.
 Loose seat cushions.

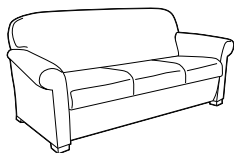

	COM	2	3	4	5	6	7	8	9	10	11	12
GC3753	\$5416	\$5784	\$6391	\$6883	\$7574	\$7833	\$8443	\$9584	\$10152	\$11214	\$12688	\$14507

OVERALL DIMENSIONS			SEAT DIMENSIONS			BACK DIMENSIONS	
W	D	H	W	D	H	W	H
90	32	34.5	74	18.5	17	82	17.5

Three Seat Sofa
 COM Yardage: 12
 Freight Class: 250
 Product Weight (lbs.): 155
 Cubic Feet Per Carton: 74.75

Active weight 300 lbs./seat.
 Loose seat cushions.

CALIDON



GC36305
Wood Lounge Single Seat,



GC36301
Wood Guest Single Seat



GC36308
Fully Upholstered Lounge Single Seat



For Calidon tables, see 67.

EXAMPLE CALIDON ORDER CODE:

GC36308	PU75	PU75	AAM	NBS
Model #	Back/Arm textile	Seat textile	Frame Finish	Sealed Back Seams

NSS	NB	NM	SRT
Sealed Seat Seams	Moisture Barrier	Glides	Power

STANDARD FEATURES

- Calidon series consists of wood frame guest, lounge, bariatric and bench seating in addition to fully upholstered lounge seating. Freestanding and tandem/bridge tables also available to complement the line.
- Calidon is designed for the rigors of high use environments. Lounge units include metal frame supports.
- The seating in this series is available to specify with two textiles, one for the seat cushion and one for the back and arms (see model image).
- For pricing, start with the base price and add both back/arms graded textile upcharge and the seat graded textile upcharge.
- Frame design features a wall saver leg to prevent back contact and damage to walls.
- All guest and lounge chairs feature a clean out between seat and back, replaceable seat cushions and tall legs for ease of cleaning.
- For added comfort, seats are standard with high density Ultracell foam.
- Active weight capacity up to 400 lbs/seat for standard seating; up to 600 lbs for bariatric seating.
- For healthcare textiles, visit the website at globalfurnituregroup.com.
- Textiles with a minimum of 100,000 double rubs must be specified to meet Global's 24/7 warranty coverage.
- Can be upholstered in standard Global textiles if Healthcare 24/7 warranty compliance is not required.
- For alternate textile applications, contact Global specials. The Blended Textile matrix does not apply to this series.
- Tandem table models connect to guest seating only. See Calidon tables.
- No seating or bench models gang together.
- Shipped fully assembled.

OPTIONAL FEATURES

- All guest and lounge models can be specified with or without armcaps. Urethane armcaps are available on Wood arm guest and lounge chairs. Solid surface armcaps are available on all chair models. Armcaps are field replaceable, securely fastened with metal-to-metal connectors. Armcaps cannot be retrofitted in the field on units with no existing armcaps.
- Fully upholstered lounge chairs can be specified with a tamperproof Black power/USB unit, which includes one AC outlet, two 10 watt USB ports, and a 10 ft long power cord. Power is factory installed and must be specified at time of order. Add **\$237** each. Power locations vary by model. See power location diagram.
- For moisture barrier on seat, specify **(MB)**. Upcharges vary, see model.
- To add sealed seams, specify **(SBS)** for seat back and arms and/or **(SSS)** for seat. Upcharges vary, see model.
- A tamperproof power unit is available to specify in various locations on closed arm lounge models only. See diagrams.

SUGGESTED APPLICATIONS



- Guest seating
- Lobby/Lounge
- Treatment/Exam rooms



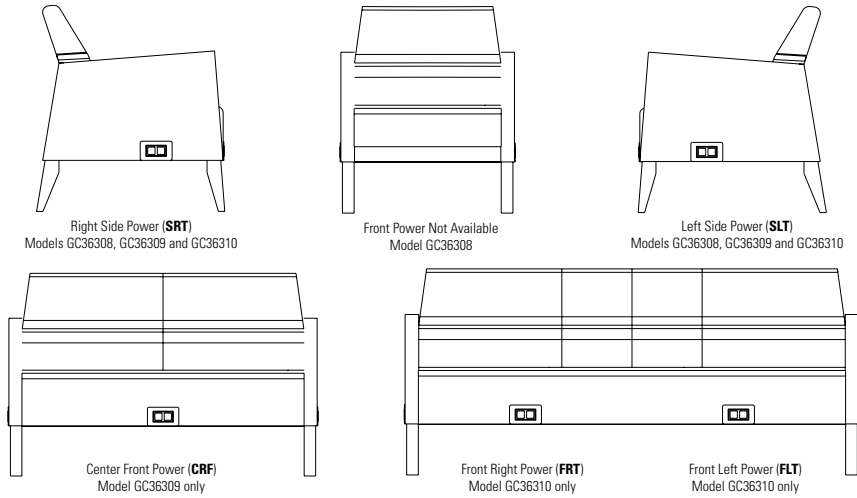

Please add option codes in the following order:





- **Model number**
See models.
For Calidon tables, refer to 67
- **Back/Arm Textile**
Specify textile code. See model grade upcharges.
- **Seat Textile**
Specify textile code. See model grade upcharges.
- **Armcap option**
(FNA) No armcaps
(FAC) With armcaps. Upcharges vary, see model.
- **Frame finish**
(AAM) Absolute
(CJM) Charcoal Java
(ACM) Cherry
(EMM) Empire Mahogany
(EOM) English Oak
(ECM) Espresso Cafe
(TFM) Fruitwood
(HGM) Grey
(HOM) Harvest Oak
(AHM) Honey
(JOM) Jet Onyx
(LHM) Light Honey
(TMM) Mahogany
(AVM) Maple
(MWM) Medium Walnut
(ASM) Night
(NBM) Noce Biondo
(NGM) Noce Grigio
(NEM) Noce Leggero
(NMM) Noce Medio
(SBM) Sandy Beach
(SKM) Shaker Cherry
(SOM) Silver Oak
(TWM) Walnut
(WTM) WC Cream
(WHM) White
(WCM) Winter Cherry
- **Armcap finish**
(SSU) Urethane (for wood arm models of guest and lounge seating with FAC specified). Urethane finishes (upcharges vary, see model):
(BLK) Black
(KAL) Kalua
(LAB) Latte
(J52) Mocha
(SHW) Shadow
(TOA) Toast
(CO) Solid Surface (for all wood and fully upholstered arm models with FAC specified).
Solid Surface Finishes:
Grade 1: (Upcharges vary, see model)
(SWH) Designer White
Grade 2: (Upcharges vary, see model)
(SBT) Beige Tempest
(SBX) Black Onyx Mirage
(SMG) Milk Glass Spectra
(SFW) Frosty White Mirage
(SHS) Hot Stone
(SNM) Northern Melange
- **Sealed Back Seams** (Contact Customer Care for approved textiles.)
(NBS) No sealed back seams
(SBS) Sealed back seams. Upcharges vary, see model.
- **Sealed Seat Seams** (Contact Customer Care for approved textiles.)
(NSS) No sealed seat seams
(SSS) Sealed seat seams. Upcharges vary, see model.
- **Glides**
(NM) Non-marking
(NS) Non-slip
Guest single seat, bariatric and lounge chairs, add \$29.
Guest two seater, Add \$44.
Guest three seater, add \$56.
- **Moisture Barrier** (seat only) (Not available with Sealed Seams)
(NB) No moisture barrier
(MB) Moisture barrier. Upcharges vary, see model.
- **Power/USB unit position** (lounge models only). Add **\$237**.
(NPM) No power
(TPM) Tamperproof power unit
(J) Black
(SRT) Side right
(SLT) Side left
(FLT) Front left (three seater only)
(FRT) Front right (three seater only)
(CRF) Center front (two seater only)
(SLR) Side left and right. Add **\$472**.
(FLR) Front left and right. Add **\$472**.

POWER LOCATION DIAGRAM



DESCRIPTION	MODEL#/ FEATURES	STANDARD TEXTILE GRADES											
		1/COM	2	3	4	5	6	7	8	9	10	11	12
 Wood Guest Single Seat COM Yardage: Back: 0.9; Seat: 1 Freight Class: 250 Product Weight (lbs.): 38 Cubic Feet Per Carton: 16.5	GC36301 Base Price:	\$1195											
	Back upcharge:	+0	+\$29	+\$52	+\$85	+\$132	+\$152	+\$192	+\$256	+\$304	+\$356	+\$465	+\$579
	Seat upcharge:	+0	+\$32	+\$57	+\$94	+\$146	+\$168	+\$213	+\$284	+\$337	+\$395	+\$516	+\$643
	OVERALL DIMENSIONS W D H	23.5	26.5	34.5									
	SEAT DIMENSIONS W D H	21.5	18	18									
BACK DIMENSIONS W H	21.5	16.5											
Active weight 400 lbs.													
 Wood Guest Two Seater, Full Center Arm COM Yardage: Back: 1.8; Seat: 2 Freight Class: 250 Product Weight (lbs.): 68 Cubic Feet Per Carton: 31.75	GC36302 Base Price:	\$2211											
	Back upcharge:	+0	+\$58	+\$103	+\$170	+\$263	+\$303	+\$384	+\$512	+\$607	+\$711	+\$929	+\$1158
	Seat upcharge:	+0	+\$64	+\$114	+\$188	+\$292	+\$336	+\$426	+\$568	+\$674	+\$790	+\$1032	+\$1286
	OVERALL DIMENSIONS W D H	46	26.5	34.5									
	SEAT DIMENSIONS W D H	21.5	18	18									
BACK DIMENSIONS W H	21.5	16.5											
Active weight 400 lbs./seat													
 Wood Guest Three Seater, Full Center Arms COM Yardage: Back: 2.7; Seat: 3 Freight Class: 250 Product Weight (lbs.): 101 Cubic Feet Per Carton: 47.5	GC36303 Base Price:	\$3255											
	Back upcharge:	+0	+\$87	+\$154	+\$254	+\$395	+\$454	+\$576	+\$767	+\$910	+\$1067	+\$1394	+\$1737
	Seat upcharge:	+0	+\$96	+\$171	+\$282	+\$438	+\$504	+\$639	+\$852	+\$1011	+\$1185	+\$1548	+\$1929
	OVERALL DIMENSIONS W D H	68	26.5	34.5									
	SEAT DIMENSIONS W D H	21.5	18	18									
BACK DIMENSIONS W H	21.5	16.5											
Active weight 400 lbs./seat													

DESCRIPTION	MODEL#/ FEATURES	STANDARD TEXTILE GRADES												
		1/COM	2	3	4	5	6	7	8	9	10	11	12	
 <p>Wood Guest Bariatric Chair COM Yardage: Back: 1.25; Seat: 1.25 Freight Class: 250 Product Weight (lbs.): 55 Cubic Feet Per Carton: 22.25</p>	GC36304	Base Price:	\$1827											
	Back upcharge:	+0	+\$40	+\$72	+\$118	+\$183	+\$210	+\$267	+\$355	+\$422	+\$494	+\$645	+\$804	
	Seat upcharge:	+0	+\$40	+\$72	+\$118	+\$183	+\$210	+\$267	+\$355	+\$422	+\$494	+\$645	+\$804	
	Active weight 600 lbs.	OVERALL DIMENSIONS			SEAT DIMENSIONS			BACK DIMENSIONS						
		W	D	H	W	D	H	W	H					
	32.75	26.5	34.5	31	18	18	30.5	16.5						
	Add \$111 for Urethane armcaps Add \$390 for (CO) Grade 1 armcaps Add \$414 for (CO) Grade 2 armcaps Add \$187 for (MB) Add \$27 for (SSS), \$44 for (SBS)													
 <p>Wood Lounge Single Seat COM Yardage: Back: 1.25; Seat: 1.25 Freight Class: 250 Product Weight (lbs.): 49 Cubic Feet Per Carton: 18.25</p>	GC36305	Base Price:	\$1670											
	Back upcharge:	+0	+\$40	+\$72	+\$118	+\$183	+\$210	+\$267	+\$355	+\$422	+\$494	+\$645	+\$804	
	Seat upcharge:	+0	+\$40	+\$72	+\$118	+\$183	+\$210	+\$267	+\$355	+\$422	+\$494	+\$645	+\$804	
	Active weight 400 lbs.	OVERALL DIMENSIONS			SEAT DIMENSIONS			BACK DIMENSIONS						
		W	D	H	W	D	H	W	H					
	25.75	29.5	32.5	24	21	16	23.5	16.5						
	Add \$167 for Urethane armcaps Add \$409 for (CO) Grade 1 armcaps Add \$433 for (CO) Grade 2 armcaps Add \$126 for (MB) Add \$33 for (SSS), \$45 for (SBS)													
 <p>Wood Lounge Two Seater COM Yardage: Back: 1.75; Seat: 2.25 Freight Class: 250 Product Weight (lbs.): 77 Cubic Feet Per Carton: 32.75</p>	GC36306	Base Price:	\$2348											
	Back upcharge:	+0	+\$56	+\$100	+\$165	+\$256	+\$294	+\$373	+\$497	+\$590	+\$692	+\$903	+\$1126	
	Seat upcharge:	+0	+\$72	+\$129	+\$212	+\$329	+\$378	+\$480	+\$639	+\$759	+\$889	+\$1161	+\$1447	
	Active weight 400 lbs./seat	OVERALL DIMENSIONS			SEAT DIMENSIONS			BACK DIMENSIONS						
		W	D	H	W	D	H	W	H					
	47.5	29.5	32.5	45	21	16	44.5	16.5						
	Add \$167 for Urethane armcaps Add \$409 for (CO) Grade 1 armcaps Add \$433 for (CO) Grade 2 armcaps Add \$250 for (MB) Add \$48 for (SSS), \$63 for (SBS)													
 <p>Wood Lounge Three Seater COM Yardage: Back: 2.5; Seat: 2.75 Freight Class: 250 Product Weight (lbs.): 109 Cubic Feet Per Carton: 50.75</p>	GC36307	Base Price:	\$2936											
	Back upcharge:	+0	+\$80	+\$143	+\$235	+\$365	+\$420	+\$533	+\$710	+\$843	+\$988	+\$1290	+\$1608	
	Seat upcharge:	+0	+\$88	+\$157	+\$259	+\$402	+\$462	+\$586	+\$781	+\$927	+\$1087	+\$1419	+\$1769	
	Active weight 400 lbs./seat	OVERALL DIMENSIONS			SEAT DIMENSIONS			BACK DIMENSIONS						
		W	D	H	W	D	H	W	H					
	70.5	29.5	32.5	68	21	16	67.5	16.5						
	Add \$167 for Urethane armcaps Add \$409 for (CO) Grade 1 armcaps Add \$433 for (CO) Grade 2 armcaps Add \$373 for (MB) Add \$63 for (SSS), \$80 for (SBS)													
 <p>Fully Upholstered Lounge Single Seat COM Yardage: Back/Arm: 2.75; Seat: 1.25 Freight Class: 250 Product Weight (lbs.): 58 Cubic Feet Per Carton: 18.75</p>	GC36308	Base Price:	\$1893											
	Back/Arm upcharge:	+0	+\$88	+\$157	+\$259	+\$402	+\$462	+\$586	+\$781	+\$927	+\$1087	+\$1419	+\$1769	
	Seat upcharge:	+0	+\$40	+\$72	+\$118	+\$183	+\$210	+\$267	+\$355	+\$422	+\$494	+\$645	+\$804	
	Active weight 400 lbs.	OVERALL DIMENSIONS			SEAT DIMENSIONS			BACK DIMENSIONS						
		W	D	H	W	D	H	W	H					
	27.5	29.5	33.5	24	21	16	23.5	17.5						
	Add \$403 for (CO) Grade 1 armcaps Add \$431 for (CO) Grade 2 armcaps Add \$126 for (MB) Add \$36 for (SSS), \$143 for (SBS) Power/USB unit available.													

DESCRIPTION	MODEL#/ FEATURES	STANDARD TEXTILE GRADES												
		1/COM	2	3	4	5	6	7	8	9	10	11	12	
 <p>Fully Upholstered Lounge Two Seater COM Yardage: Back/Arm: 3.5; Seat: 2.25 Freight Class: 250 Product Weight (lbs.): 89 Cubic Feet Per Carton: 33.75</p>	GC36309	Base Price:	\$2545											
		Back/Arm upcharge:	+0	+\$112	+\$200	+\$329	+\$511	+\$588	+\$746	+\$994	+\$1180	+\$1383	+\$1806	+\$2251
		Seat upcharge:	+0	+\$72	+\$129	+\$212	+\$329	+\$378	+\$480	+\$639	+\$759	+\$889	+\$1161	+\$1447
		Active weight 400 lbs./seat	OVERALL DIMENSIONS			SEAT DIMENSIONS			BACK DIMENSIONS					
			W	D	H	W	D	H	W	H				
		49.5	29.5	33.5	44.5	18	16	45.5	17.5					
		Add \$403 for (CO) Grade 1 armcaps Add \$431 for (CO) Grade 2 armcaps Add \$250 for (MB) Add \$52 for (SSS), \$160 for (SBS) Power/USB unit available.												
 <p>Fully Upholstered Lounge Three Seater COM Yardage: Back/Arm: 4.25; Seat: 2.75 Freight Class: 250 Product Weight (lbs.): 123 Cubic Feet Per Carton: 52</p>	GC36310	Base Price:	\$3196											
		Back/Arm upcharge:	+0	+\$136	+\$243	+\$400	+\$621	+\$714	+\$906	+\$1207	+\$1433	+\$1679	+\$2193	+\$2733
		Seat upcharge:	+0	+\$88	+\$157	+\$259	+\$402	+\$462	+\$586	+\$781	+\$927	+\$1087	+\$1419	+\$1769
		Active weight 400 lbs./seat	OVERALL DIMENSIONS			SEAT DIMENSIONS			BACK DIMENSIONS					
			W	D	H	W	D	H	W	H				
		71.5	29.5	33.5	66.5	18	16	67.5	17.5					
		Add \$403 for (CO) Grade 1 armcaps Add \$431 for (CO) Grade 2 armcaps Add \$373 for (MB) Add \$86 for (SSS), \$179 for (SBS) Power/USB unit available.												
 <p>Single Seat Bench COM Yardage: 1 Freight Class: 150 Product Weight (lbs.): 41 Cubic Feet Per Carton: 10</p>	GC36311	Base Price:	\$1279											
		Seat upcharge:	+0	+\$32	+\$57	+\$94	+\$146	+\$168	+\$213	+\$284	+\$337	+\$395	+\$516	+\$643
		Active weight 400 lbs.	OVERALL DIMENSIONS			SEAT DIMENSIONS			BACK DIMENSIONS					
			W	D	H	W	D	H	W	H				
			24	28	18	24	26.75	18						
		Add \$126 for (MB) Add \$31 for (SSS)												
 <p>Two Seat Bench COM Yardage: 2 Freight Class: 250 Product Weight (lbs.): 61 Cubic Feet Per Carton: 18.75</p>	GC36312	Base Price:	\$2023											
		Seat upcharge:	+0	+\$64	+\$114	+\$188	+\$292	+\$336	+\$426	+\$568	+\$674	+\$790	+\$1032	+\$1286
		Active weight 400 lbs./seat	OVERALL DIMENSIONS			SEAT DIMENSIONS			BACK DIMENSIONS					
			W	D	H	W	D	H	W	H				
			48	28	18	48	26.75	18						
		Add \$250 for (MB) Add \$61 for (SSS)												
 <p>Three Seat Bench COM Yardage: 3 Freight Class: 250 Product Weight (lbs.): 97 Cubic Feet Per Carton: 27.75</p>	GC36313	Base Price:	\$2414											
		Seat upcharge:	+0	+\$96	+\$171	+\$282	+\$438	+\$504	+\$639	+\$852	+\$1011	+\$1185	+\$1548	+\$1929
		Active weight 400 lbs./seat	OVERALL DIMENSIONS			SEAT DIMENSIONS			BACK DIMENSIONS					
			W	D	H	W	D	H	W	H				
			72	28	18	72	26.75	18						
		Add \$373 for (MB) Add \$89 for (SSS)												

CALIDON TABLES



Square end table - 22"
GC36314



Rectangular Coffee Table
GC36317



Tandem Side Table, Right
GC36319R

EXAMPLE CALIDON TABLE ORDER CODE:

GC36319R	-HP	-ACJ	-CNT
Model #	Top material	Laminate finish	Power

TABLE TOP FINISHES:

See finishes section on page 240 for solid wood/laminate coordination chart.

Thermally fused laminate (LP):

- Absolute Acajou (ACJ)
- Asian Night (ASN)
- Avant Cherry (AWC)
- Avant Honey (AWH)
- Black (BLK)
- Brushed Cobalt (BRC)
- Clear Maple (CMB)
- Dark Espresso (DES)
- Designer White (DWT)
- Fashionista (FAS)
- First Class (FCL)
- Noce Biondo (NBL)
- Noce Grigio (NGL)
- Noce Leggero (NEL)
- Noce Medio (NML)
- Quartered Mahogany (QTM)
- Sheer Beauty (SBY)
- Walnut Heights (WHE)
- White Chocolate (WHC)
- Winter Cherry (WCR)

High pressure laminate (HP):

- Absolute Acajou (ACJ)
- Asian Night (ASN)
- Avant Cherry (AWC)
- Avant Honey (AWH)
- Black (BLK)
- Brushed Cobalt (BRC)
- Clear Maple (CMB)
- Dark Espresso (DES)
- Designer White (DWT)
- Fashionista (FAS)
- First Class (FCL)
- Noce Biondo (NBL)
- Noce Grigio (NGL)
- Noce Leggero (NEL)
- Noce Medio (NML)
- Quartered Mahogany (QTM)
- Sheer Beauty (SBY)
- Walnut Heights (WHE)
- White Chocolate (WHC)
- Winter Cherry (WCR)

Solid Surface* (CO):

- Grade 1:
(SWH) Designer White
- Grade 2:
(SBT) Beige Tempest
(SBX) Black Onyx Mirage
(SMG) Milk Glass Spectra
(SFW) Frosty White Mirage
(SHS) Hot Stone
(SNM) Northern Melange

*For detailed material information, please reference WilsonArt's Solid Surface collection.

TABLE STANDARD FEATURES

- A variety of wood leg tables are available. The wood legs/frames are specifiable in the same wood seating finishes.
- Table tops are 1" thick, available in thermally fused laminate (LP), high pressure laminate (HP), and solid surface (CO). Upcharges vary, see model for pricing.
- Laminate top tables include color coordinating vinyl edge band.
- Tandem/bridge table models (GC36318 to GC36321) connect to guest seating only and include ganging brackets.
- Tandem tables are specified left or right, as seated.

TABLE OPTIONAL FEATURES

- A tamperproof tabletop power unit may be specified on laminate top, tandem and square end tables only. Specify **CNT**. Add **\$358**. The power unit is located centered 1.5" from the edge of the surface. See power location diagrams for reference.

SUGGESTED APPLICATIONS

- Lounge/Lobby
- Patient rooms
- Resident rooms
- Private office

Please add option codes in the following order:

- **Table model number**
GC36314 to **GC36317** Freestanding tables
GC36318 to **GC36321** Tandem/bridge tables
For Calidon seating, refer to 63.
- **Top Material (tables)**
(LP) Thermally fused laminate. Specify finish - See LP finishes.
(HP) High pressure laminate. Upcharges vary - see model. Specify finish - see HP finishes.
(CO) Solid surface. Upcharges vary - see model. Specify finish - see CO finishes and grades.
- **Leg finish**
(AAM) Absolute **(MWM)** Medium Walnut
(CJM) Charcoal Java **(ASM)** Night
(ACM) Cherry **(NBM)** Noce Biondo
(EMM) Empire Mahogany **(NGM)** Noce Grigio
(EOM) English Oak **(NEM)** Noce Leggero
(ECM) Espresso Cafe **(NMM)** Noce Medio
(TFM) Fruitwood **(SBM)** Sandy Beach
(HGM) Grey **(SKM)** Shaker Cherry
(HOM) Harvest Oak **(SOM)** Silver Oak
(AHM) Honey **(TWM)** Walnut
(JOM) Jet Onyx **(WTM)** WC Cream
(LHM) Light Honey **(WHM)** White
(TMM) Mahogany **(WCM)** Winter Cherry
(AVM) Maple
- **Power/USB unit position** (tandem and square side tables with laminate tops only).
(NPM) No power
(CNT) Center top power. Jet Black. Add **\$358**.
(RBP) Right back top power. Jet Black. Add **\$358**.
(LBP) Left back top power. Jet Black. Add **\$358**.

POWER LOCATION DIAGRAM

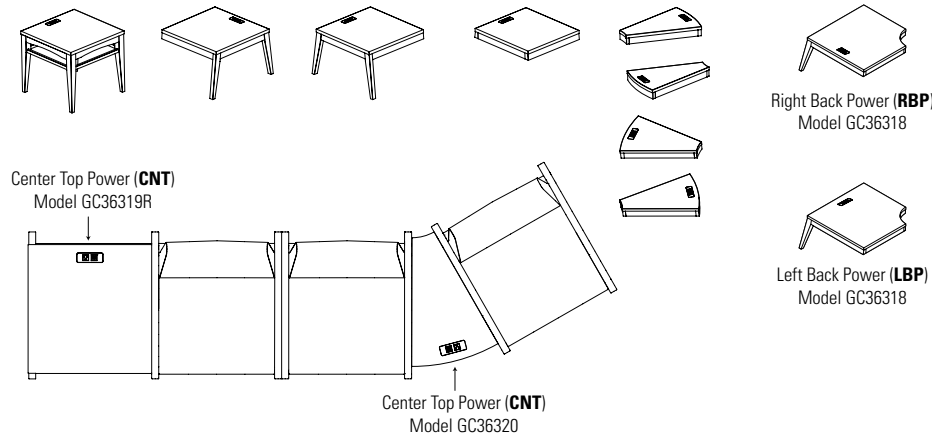

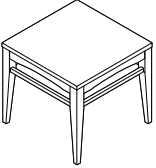
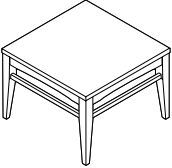
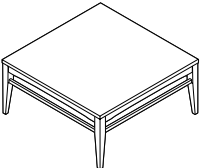
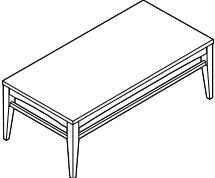
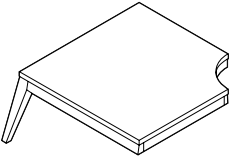
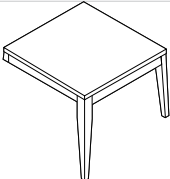
TABLES	MODEL#	DIMENSIONS	FREIGHT CLASS	WT/LBS.	CUBIC FT.	LIST PRICE
	GC36314	22 x 22 x 20.25	150	36	7.75	\$826
Square End Table - 22"						<ul style="list-style-type: none"> • Pricing shown for a thermally fused laminate top (LP). • For a high pressure laminate top (HP), add \$65. • For a solid surface top (CO), add \$1071 for Grade 1 and add \$1315 for Grade 2. <p>Coordinating edge on laminate surfaces with solid wood frame and legs. 1 per carton. Power/USB unit can be specified in the surface of laminate top tables (CNT). Add \$358.</p>
	GC36315	24 x 24 x 17.25	250	37	9.5	\$857
Square Coffee Table - 24"						<ul style="list-style-type: none"> • Pricing shown for a thermally fused laminate top (LP). • For a high pressure laminate top (HP), add \$65. • For a solid surface top (CO), add \$1300 for Grade 1 and add \$1605 for Grade 2. <p>Coordinating edge on laminate surfaces with solid wood frame and legs. 1 per carton.</p>
	GC36316	36 x 36 x 17.25	250	65	18.25	\$1025
Square Coffee Table - 36"						<ul style="list-style-type: none"> • Pricing shown for a thermally fused laminate top (LP). • For a high pressure laminate top (HP), add \$140. • For a solid surface top (CO), add \$2979 for Grade 1 and add \$3589 for Grade 2. <p>Coordinating edge on laminate surfaces with solid wood frame and legs. 1 per carton.</p>
	GC36317	24 x 48 x 17.25	250	56	16.5	\$1123
Rectangular Coffee Table						<ul style="list-style-type: none"> • Pricing shown for a thermally fused laminate top (LP). • For a high pressure laminate top (HP), add \$127. • For a solid surface top (CO), add \$2481 for Grade 1 and add \$2894 for Grade 2. <p>Coordinating edge on laminate surfaces with solid wood frame and legs. 1 per carton.</p>
	GC36318	31.25 x 31.25 x 15.75	250	46	14.5	\$1025
Corner Table, 90°						<ul style="list-style-type: none"> • Pricing shown for a thermally fused laminate top (LP). • For a high pressure laminate top (HP), add \$104. • For a solid surface top (CO), add \$2576 for Grade 1 and add \$3079 for Grade 2. <p>Coordinating edge on laminate surfaces with solid wood frame and legs. Must be connected between two guest chairs. Includes two sets of U-channel connectors and hardware. 1 per carton. Power/USB unit can be specified in the surface of laminate top tables (RBP) or (LBP). Add \$358. See power location diagram for placement.</p>
	GC36319L	26.5 x 22.25 x 15.75	250	20	6.75	\$715
Tandem Side Table, Left						<ul style="list-style-type: none"> • Pricing shown for a thermally fused laminate top (LP). • For a high pressure laminate top (HP), add \$65. • For a solid surface top (CO), add \$1089 for Grade 1 and add \$1311 for Grade 2. <p>Coordinating edge on laminate surfaces with solid wood frame and legs. Must be connected to a guest chair. Includes one set of U-channel connectors and hardware. 1 per carton. Power/USB unit can be specified in the surface of laminate top tables (CNT). Add \$358.</p>

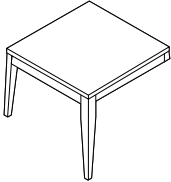
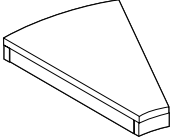
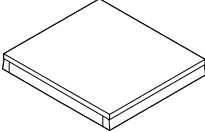
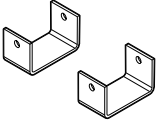
TABLES	MODEL#	DIMENSIONS	FREIGHT CLASS	WT./LBS.	CUBIC FT.	LIST PRICE
 <p>Tandem Side Table, Right</p>	GC36319R	26.5 x 22.25 x 15.75	250	20	6.75	\$715
						<ul style="list-style-type: none"> • Pricing shown for a thermally fused laminate top (LP). • For a high pressure laminate top (HP), add \$65. • For a solid surface top (CO), add \$1089 for Grade 1 and add \$1311 for Grade 2. <p>Coordinating edge on laminate surfaces with solid wood frame and legs. Must be connected to a guest chair. Includes one set of U-channel connectors and hardware. 1 per carton. Power/USB unit can be specified in the surface of laminate top tables (CNT). Add \$358.</p>
 <p>Corner Table, 30 Degree</p>	GC36320	22.5 x 15.75 x 3	92.5	16	1.5	\$563
						<ul style="list-style-type: none"> • Pricing shown for a thermally fused laminate top (LP). • For a high pressure laminate top (HP), add \$65. • For a solid surface top (CO), add \$910 for Grade 1 and add \$1093 for Grade 2. <p>Coordinating edge on laminate surfaces with solid wood frame and legs. Must be connected between two guest chairs. Includes two sets of U-channel connectors and hardware. 1 per carton. Power/USB unit can be specified in the surface of laminate top tables (CNT). Add \$358.</p>
 <p>In-Line Table, Square</p>	GC36321	21 x 23.5 x 3	92.5	20	1.9	\$597
						<ul style="list-style-type: none"> • Pricing shown for a thermally fused laminate top (LP). • For a high pressure laminate top (HP), add \$65. • For a solid surface top (CO), add \$942 for Grade 1 and add \$1161 for Grade 2. <p>Coordinating edge on laminate surfaces with solid wood frame and legs. Must be connected between two guest chairs. Includes two sets of U-channel connectors and hardware. 1 per carton. Power/USB unit can be specified in the surface of laminate top tables (CNT). Add \$358.</p>
 <p>U-Channel (set of 2)</p>	GC36322	2.87 x 1.5 x 1.62	70	0.75	0.03	\$48
						Includes hardware. 4 sets per carton.

CHAP™



Wood Back Armchair model 1010



Upholstered Back Armchair model 1015



Upholstered Round Back Armchair model 1004



Wood Round Back Armchair model 1005

STANDARD FEATURES





- Chap offers mid-century modern styling in a finely crafted beechwood armchair series.
- Straight and round back models have upholstered seats with upholstered or open wood frame backs.
- Straight back models are available with exposed wood or upholstered front seat rails.
- For reorders of discontinued models 1002 and 1003, use models 1004 and 1005 with 18" reduced seat depth.
- Custom stain matching is not available on models 1004 and 1005.
- Chairs are standard with a black liner under seat cushion. An underseat panel (USP) is available which conceals seat structure. It is covered with a coated textile and secured with tamperproof fasteners.
- For graded pricing, select model base price. Add graded textile upcharges for seat or for upholstered back models, both seat and back.
- The Blended Textile matrix does not apply to this series.
- Upholstery options include fabric, coated textiles and leather.
- Chap series is covered under Global's Limited Lifetime warranty, for single shift use.
- For multi-shift environments, and coverage under Globalcare's 24/7 warranty, Ultracell foam - 24/7 warranty (UC) must be selected.
- Textiles with a minimum of 100,000 double rubs must be specified to meet Global's 24/7 warranty coverage. For healthcare textiles, visit the website at globalfurnituregroup.com.
- Does not stack.
- Custom stain matching is not available on round back models.

Please add option codes in the following order:

- **Model number**
Specify model number
- **Back textile**
Specify textile code
- **Seat textile**
Specify textile code
- **Frame finish** (Round back models)
1004 and 1005 available in select finishes (*).
(AAM) Absolute*
(BKM) Black*
(ACM) Cherry*
(EOM) English Oak
(ECM) Espresso Cafe*
(TFM) Fruitwood
(HGM) Gray
(AHM) Honey
(TMM) Mahogany*
(AVM) Maple
(MWM) Medium Walnut*
(NLW) Natural Walnut
(ASM) Night*
(NBM) Noce Biondo
(NGM) Noce Grigio
(NEM) Noce Leggero
(NMM) Noce Medio*
(SKM) Shaker Cherry*
(TWM) Walnut*
(WTM) WC Cream*
(WHM) White*
(WCM) Winter Cherry
- **Glides**
(XG) No Glide for Carpeted Surfaces.
(NM) White Non-marking Nylon Glide for most floor surfaces. Add \$34
(SG) Steel Cushioned Glide for carpeted surfaces. Add \$34
(FG) Felt Glide for most hard floor surfaces. Add \$34
(RG) Rubber Non-slip Glide for most hard floor surfaces. Add \$34
- **Sealed Seams** (on approved coated textiles)
(NS) No sealed seams
(SSS) Sealed seat seams. Add \$63
- **Moisture barrier** (seat only, not available with sealed seams)
(NB) No moisture barrier. No upcharge
(MB) Moisture barrier. Add \$107.
- **Seat foam**
(SF) Standard foam
(UC) Ultracell foam - 24/7 warranty
- **Seat underside**
(USL) Under seat liner
(USP) Under seat panel. Add \$79

DESCRIPTION	FEATURES	MODEL#												STANDARD TEXTILE GRADES												
		1/COM	2	3	4	5	6	7	8	9	10	11	12	1	2	3	4	5	6	7	8	9	10	11	12	
 Wood Back Armchair w/ Upholstered Seat Front COM Yardage: 1 Freight Class: 250 Product Weight (lbs.): 33 Cubic Feet Per Carton: 15.75	Does not stack. Active weight 350 lbs. Ergonomic Features M, N	1010	\$1307	\$1339	\$1364	\$1401	\$1453	\$1475	\$1520	\$1591	\$1644	\$1702	\$1823	\$1950												
					OVERALL DIMENSIONS			SEAT DIMENSIONS			BACK DIMENSIONS															
			W	D	H	W	D	H	W	D	H	W	H													
			25.5	25	31	21	20	18	20.5	13.5																

RTA 00

DESCRIPTION	FEATURES	MODEL#													
		1/COM	2	3	4	5	6	7	8	9	10	11	12		
 <p>Upholstered Back Armchair w/ Upholstered Seat Front COM Yardage: Back: .75; Seat: .75 Freight Class: 250 Product Weight (lbs.): 33 Cubic Feet Per Carton: 15.75</p>	<p>Does not stack. Active weight 350 lbs. Ergonomic Features M, N</p>	1011	Base Price:	\$1315											
		Seat upcharge:	+0	\$24	\$43	\$71	\$110	\$126	\$160	\$213	\$253	\$297	\$387	\$483	
		Back upcharge:	+0	\$24	\$43	\$71	\$110	\$126	\$160	\$213	\$253	\$297	\$387	\$483	
		OVERALL DIMENSIONS			SEAT DIMENSIONS			BACK DIMENSIONS							
			W	D	H	W	D	H	W	H					
			25.5	25	31.5	21	20	18	20.5	13.5					
			RTA 00												
 <p>Wood Back Armchair w/ Wood Front Rail COM Yardage: 1 Freight Class: 250 Product Weight (lbs.): 33 Cubic Feet Per Carton: 15.75</p>	<p>Does not stack. Active weight 350 lbs. Ergonomic Features M, N</p>	1014		\$1307	\$1339	\$1364	\$1401	\$1453	\$1475	\$1520	\$1591	\$1644	\$1702	\$1823	\$1950
		OVERALL DIMENSIONS			SEAT DIMENSIONS			BACK DIMENSIONS							
					W	D	H	W	D	H	W	H			
					25.5	25	31	21	20	18	20.5	13.5			
			RTA 00												
 <p>Upholstered Back Armchair w/ Wood Front Rail COM Yardage: Back: .75; Seat: .75 Freight Class: 250 Product Weight (lbs.): 33 Cubic Feet Per Carton: 15.75</p>	<p>Does not stack. Active weight 350 lbs. Ergonomic Features M, N</p>	1015	Base Price:	\$1315											
		Seat upcharge:	+0	\$24	\$43	\$71	\$110	\$126	\$160	\$213	\$253	\$297	\$387	\$483	
		Back upcharge:	+0	\$24	\$43	\$71	\$110	\$126	\$160	\$213	\$253	\$297	\$387	\$483	
		OVERALL DIMENSIONS			SEAT DIMENSIONS			BACK DIMENSIONS							
			W	D	H	W	D	H	W	H					
			25.5	25	31.5	21	20	18	20.5	13.5					
			RTA 00												
 <p>Upholstered Roundback Armchair w/ Upholstered Seat Front COM Yardage: Back: .75 ; Seat: .75 Freight Class: 300 Product Weight (lbs.): 26 Cubic Feet Per Carton: 13.25</p>	<p>Does not stack. Active weight 350 lbs. Ergonomic Features M, N</p>	1004	Base Price:	\$1488											
		Seat upcharge:	+0	\$24	\$43	\$71	\$110	\$126	\$160	\$213	\$253	\$297	\$387	\$483	
		Back upcharge:	+0	\$24	\$43	\$71	\$110	\$126	\$160	\$213	\$253	\$297	\$387	\$483	
		OVERALL DIMENSIONS			SEAT DIMENSIONS			BACK DIMENSIONS							
			W	D	H	W	D	H	W	H					
			24.5	22.5	30	22	18	18	20	12.5					
			RTA 00												
 <p>Round Wood Back Armchair w/ Upholstered Seat Front COM Yardage: 1 Freight Class: 300 Product Weight (lbs.): 25 Cubic Feet Per Carton: 13.25</p>	<p>Does not stack. Active weight 350 lbs. Ergonomic Features M, N</p>	1005		\$1310	\$1342	\$1367	\$1404	\$1456	\$1478	\$213	\$1594	\$1647	\$1705	\$1826	\$1953
		OVERALL DIMENSIONS			SEAT DIMENSIONS			BACK DIMENSIONS							
					W	D	H	W	D	H	W	H			
					24.5	22.5	30	22	18	18	20	12.5			
			RTA 00												

COAST

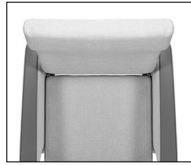

Clean out space around seat cushions for easy housekeeping

model GC4172

EXAMPLE COAST ORDER CODE:

GC4172	-LX21	-SS	-ST	-	-
Model #	Textile	Armcaps	Glides	Moisture Barrier	Sealed Seams

STANDARD FEATURES

- The smooth low range glide adds relaxing motion while you sink back and coast in this ultra-comfortable chair.
- Adjustable non-marking glides are standard
- For added comfort, seats are standard with high density Ultracell foam.
- Cleanout space is provided between the seat and back cushions for easy housekeeping.
- Arms on the glider are fixed with a grip allowing the user to easily enter and exit from the chair. Combined with a smooth low-range motion mechanism, this eliminates the need for a locking mechanism
- Standard with Black Urethane fully extended arms with a grip for ease of entry and exit from chair.
- Seamless front upholstery method on the seat cushion prevents eventual breakdown of seams causing liquid penetration into the foam.
- For healthcare textiles and finish options, visit the website at www.globalfurnituregroup.com
- Can be upholstered in standard Global textiles only if healthcare compliance is not required.
- Shipped fully assembled.

OPTIONAL FEATURES

- For non-slip glides, please specify **(NS)**. Add **\$35**.
- To add sealed seams to your product, contact Customer Care. Upcharges vary
- For moisture barrier **(MB)** (Seat Only) - Add \$129 list upcharge.
- Tablet arm with spill collector on the edge is available, offered in Black Phenolic material. Tablet rotates so it can be positioned for any user activity and can fold down to store beside the chair when not being used. From seated position, specify **(LT)** for left hand tablet or **(RT)** for right hand tablet. Add **\$1014**. For tablet on both sides, specify **(TB)**. Add **\$2024**.

SUGGESTED APPLICATIONS

- Patient rooms
- Resident rooms
- Lounge/Waiting

Please add option codes in the following order:

- **Model number**
GC4172 Glider/motion chair
- **Textile**
Specify fabric code.
- **Armcap finish**
(SS) Black Urethane armcap
(LT) Latte Urethane armcap
(KL) Kalua Urethane armcap
(MA) Mocha Urethane armcap
(SW) Shadow Urethane armcap
(TO) Toast Urethane armcap
(AB) Absolute wood armcap
(CJ) Charcoal Java wood armcap
(AC) Cherry wood armcap
(EP) Empire Mahogany wood armcap
(EM) English Oak wood armcap
(EC) Espresso Cafe wood armcap
(HG) Gray wood armcap
(HA) Harvest Oak wood armcap
(AH) Honey wood armcap
(JO) Jet Onyx wood armcap
(LH) Light Honey wood armcap
(AV) Maple wood armcap
(MW) Medium Walnut wood armcap
(NL) Natural Walnut wood armcap
(AT) Night wood armcap
(BI) Noce Biondo wood armcap
(GI) Noce Grigio wood armcap
(EI) Noce Leggero wood armcap
(MI) Noce Medio wood armcap
(SB) Sandy Beach wood armcap
(SK) Shaker Cherry wood armcap
(SM) Silver Oak wood armcap
(TF) Tiger Fruitwood wood armcap
(TM) Tiger Mahogany wood armcap
(TL) Tiger Walnut wood armcap
(WR) WC Cream wood armcap
(WE) White wood armcap
(WC) Winter Cherry wood armcap
- **Glides**
(ST) Adjustable non-marking glides
(NS) Adjustable non-slip glides
- **Moisture Barrier**
(MB) Seat only
- **Sealed seams**
(SS) All sealed seams

DESCRIPTION	MODEL#/ FEATURES	STANDARD TEXTILE GRADES												
		COM	2	3	4	5	6	7	8	9	10	11	12	
 <p>Glider / Motion Chair COM Yardage: 5.5 Freight Class: 250 Product Weight (lbs.): 115 Cubic Feet Per Carton: 29.5</p>	<p>Active weight 350 lbs.</p> <p>Specify armcap: wood or Urethane.</p>	GC4172	\$2499	\$2672	\$2817	\$3027	\$3326	\$3468	\$3740	\$4174	\$4507	\$4878	\$5641	\$6457
		OVERALL DIMENSIONS			SEAT DIMENSIONS			BACK DIMENSIONS						
			W	D	H	W	D	H	W	H				
			30	31.5	43.5	21.5	19.5	18	22	28				

COLLINGWOOD



model GC36511
High back lounge chair

STANDARD FEATURES

- Collingwood offers a cozy, streamlined design with classic curves.
- The series is available to specify with two textiles, one for the seat cushion and one for the back, arms and front rail (see model image).
- For pricing, start with the base price and add both back/arms graded textile upcharge and the seat graded textile upcharge.
- A clean through design is provided around the seat cushion for easy housekeeping.
- Seat cushion is mechanically removable, if required.
- For added comfort, the seat cushions are standard with high density Ultracell foam.
- The seat underside is sealed with a non-porous material to support housekeeping and infection control protocols.
- Legs are standard in wood or urethane (see upcharge).
- Choose from standard non-marking glides, steel cushioned glides, rubber non-slip glides, or felt glides (upcharges apply).
- The Globalcare warranty (for healthcare and 24/7 environments) applies for all Collingwood models when performance textiles are selected. Visit the website at globalfurnituregroup.com/healthcare.
- Global's standard lifetime warranty applies when approved standard Global textiles are selected.
- For alternate textile applications, contact Global specials. The Blended Textile matrix does not apply to this series.
- Shipped fully assembled.

SUGGESTED APPLICATIONS

- Dining/Cafeteria
- Guest seating
- Lobbies
- Lounge/Waiting
- Patient rooms
- Resident rooms

Add option codes in the following order:



- **Model number**
GC36510 Low back lounge chair
GC36511 High back lounge chair
- **Back/Arm Textile**
Specify textile code. See model grade upcharges.
- **Seat Textile**
Specify textile code. See model grade upcharges.
- **Leg Finish (Wood)**

(AAM) Absolute	(MWM) Medium Walnut
(BKM) Black	(NLW) Natural Walnut
(CJM) Charcoal Java	(ASN) Night
(ACM) Cherry	(NBM) Noce Biondo
(EMM) Empire Mahogany	(NGM) Noce Grigio
(EOM) English Oak	(NEM) Noce Leggero
(ECM) Espresso Cafe	(NMM) Noce Medio
(TFM) Fruitwood	(SBM) Sandy Beach
(HGM) Grey	(SKM) Shaker Cherry
(HOM) Harvest Oak	(SOM) Silver Oak
(AHM) Honey	(TWM) Walnut
(JOM) Jet Onyx	(WTM) WC Cream
(LHM) Light Honey	(WHM) White
(TMM) Mahogany	(WCM) Winter Cherry
(AVM) Maple	
- **Leg Finish (Urethane)** Add \$182

(BLK) Black	(KAL) Kalua
(LAB) Latte	(J52) Mocha
(SHW) Shadow	(TOA) Toast
- **Glides**
(NM) Non-marking glide. No upcharge.
(RG) Rubber, non-slip glide. Add \$34.
(SG) Steel cushion glide. Add \$34.
(FG) Felt glide. Add \$34.
- **Sealed Back Seams** (Contact Customer Care for approved textiles)
(NBS) No sealed back seams
(SBS) Sealed back seams. See model for upcharge.
- **Sealed Seat Seams** (Contact Customer Care for approved textiles)
(NSS) No sealed seat seams
(SSS) Sealed seat seams. Add \$33.
- **Moisture Barrier** (Not available with Sealed Seams.)
(NB) No moisture barrier.
(MB) Moisture barrier (seat only). Add \$110.

EXAMPLE COLLINGWOOD ORDER CODE:

GC36510	CE90	CE90	AVM	NM	NBS	NSS	NB
Model #	Back/arm textile	Seat textile	Leg finish	Glide	Sealed Back Seams	Sealed Seat Seams	Moisture Barrier

DESCRIPTION	MODEL#/ FEATURES	STANDARD TEXTILE GRADES											
		1/COM	2	3	4	5	6	7	8	9	10	11	12
 <p>Low Back Lounge Chair COM Yardage: Back/Arm: 3.25; Seat: 1.25 Freight Class: 250 Product Weight (lbs.): 55 Cubic Feet Per Carton: 19.25</p>	GC36510 Base Price:	\$2155											
	Back/Arm upcharge:	+0	+\$104	+\$186	+\$303	+\$465	+\$540	+\$680	+\$907	+\$1076	+\$1258	+\$1645	+\$2048
	Seat upcharge:	+0	+\$40	+\$72	+\$117	+\$179	+\$208	+\$262	+\$349	+\$414	+\$484	+\$633	+\$788
	OVERALL DIMENSIONS	SEAT DIMENSIONS			BACK DIMENSIONS								
	W D H	W D H	W H										
	28	27.25	28	21	19	18	21.5	12.5					
	Active weight 350 lbs. Replaceable seat cushion. Add \$65 for (SBS), \$33 for (SSS)												
 <p>High Back Lounge Chair COM Yardage: Back/Arm: 3.75; Seat: 1.25 Freight Class: 250 Product Weight (lbs.): 56 Cubic Feet Per Carton: 22.5</p>	GC36511 Base Price:	\$2212											
	Back/Arm upcharge:	+0	+\$120	+\$214	+\$349	+\$537	+\$623	+\$784	+\$1047	+\$1242	+\$1452	+\$1898	+\$2363
	Seat upcharge:	+0	+\$40	+\$72	+\$117	+\$179	+\$208	+\$262	+\$349	+\$414	+\$484	+\$633	+\$788
	OVERALL DIMENSIONS	SEAT DIMENSIONS			BACK DIMENSIONS								
	W D H	W D H	W H										
	28	28.5	35.5	21	19	18	21.5	17					
	Active weight 350 lbs. Replaceable seat cushion. Add \$74 for (SBS), \$33 for (SSS)												

DESMOND

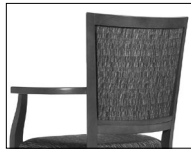

model GC4162

STANDARD FEATURES





- Clean lines and a contoured picture frame style back coordinate with any decor.
- Arms incorporate a firm grip extension to assist users in the entry and exit from the chair.
- Additional support rails on the legs ensure strength and durability.
- For added comfort, seats are standard with high density Ultracell bio foam
- Opaque non-marking glides are standard
- For Globalcare textiles and wood finish options, visit the website at globalfurnituregroup.com
- Models ending in FC have front casters
- Shipped fully assembled

OPTIONAL FEATURES

- For non-slip glides specify **(NS)**. Add \$35
- To add sealed seams to your product's back only contact Customer Care. Upcharges vary
- For moisture barrier **(MB)** (seat only) - Add \$129.

SUGGESTED APPLICATIONS

- Dining/Cafeteria
- Guest seating
- Lobbies
- Lounge/Waiting
- Office/Meeting
- Patient rooms
- Resident rooms

DESCRIPTION	MODEL#/ FEATURES	STANDARD TEXTILE GRADES											
		COM	2	3	4	5	6	7	8	9	10	11	12
 Armchair COM Yardage: 1.25 Freight Class: 300 Product Weight (lbs.): 24 Cubic Feet Per Carton: 14.5	GC4162	\$1397	\$1428	\$1465	\$1515	\$1585	\$1615	\$1681	\$1781	\$1859	\$1946	\$2123	\$2312
	Active weight 300 lbs.	OVERALL DIMENSIONS			SEAT DIMENSIONS			BACK DIMENSIONS					
		W	D	H	W	D	H	W	H				
	24	22.5	36	22.5	18	17.5	17.5	18.5					
 Armchair w/Front Casters COM Yardage: 1.25 Freight Class: 300 Product Weight (lbs.): 24 Cubic Feet Per Carton: 14.5	GC4162FC	\$1491	\$1522	\$1559	\$1609	\$1679	\$1709	\$1775	\$1875	\$1952	\$2038	\$2216	\$2405
	Active weight 300 lbs.	OVERALL DIMENSIONS			SEAT DIMENSIONS			BACK DIMENSIONS					
		W	D	H	W	D	H	W	H				
	24	22.5	36	22.5	18	17.5	17.5	18.5					
 Side Chair COM Yardage: 1.25 Freight Class: 300 Product Weight (lbs.): 22 Cubic Feet Per Carton: 14.5	GC4165	\$1280	\$1316	\$1350	\$1399	\$1466	\$1499	\$1559	\$1659	\$1734	\$1819	\$1991	\$2178
	Active weight 300 lbs.	OVERALL DIMENSIONS			SEAT DIMENSIONS			BACK DIMENSIONS					
		W	D	H	W	D	H	W	H				
	22.5	22.5	36	22.5	18	17.5	17.5	18.5					
 Side Chair w/Front Casters COM Yardage: 1.25 Freight Class: 300 Product Weight (lbs.): 22 Cubic Feet Per Carton: 14.5	GC4165FC	\$1374	\$1410	\$1444	\$1493	\$1560	\$1593	\$1653	\$1753	\$1828	\$1913	\$2085	\$2271
	Active weight 300 lbs.	OVERALL DIMENSIONS			SEAT DIMENSIONS			BACK DIMENSIONS					
		W	D	H	W	D	H	W	H				
	22.5	22.5	36	22.5	18	17.5	17.5	18.5					

DESMOND HT



model GC4290

EXAMPLE DESMOND HT ORDER CODE:

GC4290	-LX21	-TBL	-PT	-BK	-MB
Model #	Textile	Frame	Armcaps	Glides	Moisture Barrier

STANDARD FEATURES

- Desmond HT is a metal framed chair with residential design while ensuring maximum strength and durability within very challenging applications.
- Available with four-legged metal welded frame with or without arms; with rear casters that allow the caregiver to tip and move chair without lifting. A bariatric model is available.
- Models with rear casters also allow the caregiver to turn the chair with occupant seated for better access to wheelchair or walker.
- The welded metal frame, welded cross rails on lower frame, metal-to-metal fasteners on seat pan, back insert and urethane armcaps enhance strength and durability, ensuring its performance in the most rigorous environments.
- Urethane armcaps are comfortable, durable, cleanable and replaceable. Designed to offer proper support while seated and the forward extension allows the occupant to use with confidence when getting in or out of the chair.
- For added comfort and long term performance the seat cushion is standard with high density Ultracell bio foam
- The underside of the seat pan is moisture resistant, and the cushions have no exposed seams to support improved housekeeping and infection prevention practices
- For Globalcare textiles and finish options, visit the website at globalfurnituregroup.com.
- Can be upholstered in standard Global textiles if Healthcare compliance is not required.
- Shipped fully assembled.

SUGGESTED APPLICATIONS

- Dining/Cafeteria
- Guest seating
- Lobbies
- Lounge/Waiting
- Office/Meeting
- Patient rooms
- Resident rooms
- Bariatric seating (model GC4293)

OPTIONAL FEATURES

- To add additional weight to your product, contact Customer Care for more information.
- Moisture Barrier (**MB**) (Seat Only) - Add \$129 list upcharge.

Please add option codes in the following order:

- **Model number**
GC4290 Metal armchair
GC4291 Metal armchair w/two rear swivel casters
GC4293 Metal bariatric armchair
GC4294 Metal side chair, armless
 - Add **(33)** to model # if CAL TB 133 is required.
- **Textile**
 Specify fabric code.
- **Frame finish**
(TBL) Black
(TIV) Cloud
(TDW) Designer White
(TFO) Fog
(TFR) Frost
(TKA) Kalua
(TLA) Latte
(TMO) Mocha
(TNE) Nevada
(TSN) Sand
(TSH) Shadow
(TOA) Toast
(TTU) Tungsten
- **Armcap finish**
(SS) Black
(KL) Kalua
(LT) Latte
(MC) Mocha
(SW) Shadow
(TO) Toast
- **Glides**
(BK) Black plastic glides
- **Moisture Barrier**
(MB) Seat only

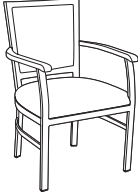
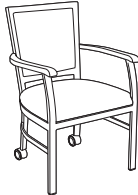
DESCRIPTION	MODEL#/ FEATURES	STANDARD TEXTILE GRADES											
		COM	2	3	4	5	6	7	8	9	10	11	12
 Metal Armchair COM Yardage: 1.25 Freight Class: 250 Product Weight (lbs.): 41 Cubic Feet Per Carton: 13.75	GC4290	\$1388	\$1424	\$1459	\$1508	\$1576	\$1607	\$1669	\$1768	\$1842	\$1928	\$2101	\$2286
		OVERALL DIMENSIONS			SEAT DIMENSIONS			BACK DIMENSIONS					
		W	D	H	W	D	H	W	H	W	H		
		24.5	23.5	35.75	23	19	18.5	18	17.5				
 Metal Armchair w/Two Rear Swivel Casters COM Yardage: 1.25 Freight Class: 250 Product Weight (lbs.): 41 Cubic Feet Per Carton: 13.75	GC4291	\$1530	\$1566	\$1601	\$1650	\$1718	\$1749	\$1811	\$1910	\$1984	\$2070	\$2243	\$2428
		OVERALL DIMENSIONS			SEAT DIMENSIONS			BACK DIMENSIONS					
		W	D	H	W	D	H	W	H	W	H		
		24.5	23.5	35.75	23	19	18.5	18	17.5				

SEATING

DESMOND HT

D

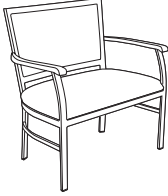
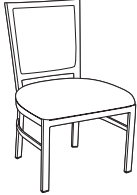
DESCRIPTION	MODEL#/ FEATURES	STANDARD TEXTILE GRADES											
		COM	2	3	4	5	6	7	8	9	10	11	12
 <p>Metal Bariatric Armchair COM Yardage: 2.25 Freight Class: 250 Product Weight (lbs.): 48 Cubic Feet Per Carton: 20</p>	GC4293	\$1844	\$1913	\$1973	\$2057	\$2182	\$2240	\$2354	\$2529	\$2666	\$2817	\$3130	\$3463
	Active weight 500 lbs.												
		OVERALL DIMENSIONS			SEAT DIMENSIONS			BACK DIMENSIONS					
		W	D	H	W	D	H	W	H				
	35.5	23.5	35.75	34	19	18.5	29	17.5					
 <p>Metal Side Chair, Armless COM Yardage: 1.25 Freight Class: 250 Product Weight (lbs.): 36 Cubic Feet Per Carton: 13.75</p>	GC4294	\$1252	\$1288	\$1323	\$1372	\$1440	\$1471	\$1533	\$1632	\$1706	\$1792	\$1965	\$2150
	Active weight 350 lbs.												
		OVERALL DIMENSIONS			SEAT DIMENSIONS			BACK DIMENSIONS					
		W	D	H	W	D	H	W	H				
	23	23.5	35.75	23	19	18.5	18	17.5					

DOCTOR BUDDY



model GC1104



model GC1111

STANDARD FEATURES





- Doctor Buddy is the perfect stool to provide comfort when performing office tasks or as an examination or feeding stool when caring for others.
- For the right comfort and support when performing tasks, select Doctor Buddy with or without a back.
- Seat and back can be upholstered in vinyl or fabric. Seat is standard with high density Ultracell foam cushion.
- Models available with backrests: GC1111 & GC1113
- Moisture resistant protection on the underside of seat pan.
- GC1104, GC1109, GC1111 & GC1113: 16" seat diameter
- Black five-legged injection-molded base standard
- (C65) casters are standard
- For healthcare textiles, visit the website at globalfurnituregroup.com/healthcare.
- Can be upholstered in standard Global textiles if healthcare compliance is not required.

STANDARD FEATURES

- **Casters/Glides**
(C65) Dual wheel carpet casters. No upcharge
(C65R) Dual wheel hard floor casters. Add \$67.
(C7) Set of 5 large Black slipper glides (for all surfaces). Can replace any Global casters. Glide is same height as casters. No upcharge.
- Moisture barrier on seat, specify **(MB)**. Add \$102.
- Sealed seat seams (and back), specify **(SS)**. Upcharges vary, see model.
- Height adjustable footrest, specify **(R2)**. Add \$93.

SUGGESTED APPLICATIONS

- Dining/Cafeteria
- Office/Meeting
- Patient rooms
- Resident rooms
- Treatment/Exam rooms

DESCRIPTION	MODEL#/ FEATURES	STANDARD TEXTILE GRADES											
		1	2	3	4	5	6	7	8	9	10	11	12
 <p>16" Dia. Swivel Stool, 5" Pneumatic, 22" Base COM Yardage: 0.75 Freight Class: 150 Product Weight (lbs.): 15 Cubic Feet Per Carton: 2.9</p>	<p>GC1104</p> <p>Active weight 300 lbs. Add \$17 for (SS).</p>	\$476	\$503	\$526	\$555	\$601	\$621	\$654	\$729	\$762	\$831	\$925	\$1040
		OVERALL DIMENSIONS			SEAT DIMENSIONS			BACK DIMENSIONS					
		W	D	H	W	D	H	W	H				
			16	16	18.5	16	--	16.5 - 21.5	--	--			
 <p>16" Dia. Swivel Stool, 10" Pneumatic, 22" Base COM Yardage: 0.75 Freight Class: 125 Product Weight (lbs.): 18 Cubic Feet Per Carton: 2.9</p>	<p>GC1109</p> <p>Active weight 300 lbs. Add \$17 for (SS).</p>	\$506	\$535	\$555	\$586	\$632	\$652	\$685	\$760	\$792	\$863	\$957	\$1070
		OVERALL DIMENSIONS			SEAT DIMENSIONS			BACK DIMENSIONS					
		W	D	H	W	D	H	W	H				
			16	16	27.5	16	--	22.5 - 32.5	--	--			
 <p>16" Dia. Swivel Stool w/back, 5" Pneumatic, 24" Base COM Yardage: 1 Freight Class: 250 Product Weight (lbs.): 32 Cubic Feet Per Carton: 11.25</p>	<p>GC1111</p> <p>Active weight 300 lbs. Add \$33 for (SS).</p>	\$759	\$795	\$822	\$862	\$918	\$942	\$991	\$1067	\$1125	\$1187	\$1318	\$1455
		OVERALL DIMENSIONS			SEAT DIMENSIONS			BACK DIMENSIONS					
		W	D	H	W	D	H	W	H				
			16.5	20.5	29.75	16.5	15.5	16 - 21	14	11.25			
 <p>16" Dia. Swivel Stool w/back, 10" Pneumatic, 24" Base COM Yardage: 1 Freight Class: 250 Product Weight (lbs.): 34 Cubic Feet Per Carton: 13.25</p>	<p>GC1113</p> <p>Active weight 300 lbs. Add \$33 for (SS).</p>	\$790	\$826	\$853	\$893	\$949	\$973	\$1022	\$1098	\$1156	\$1218	\$1349	\$1486
		OVERALL DIMENSIONS			SEAT DIMENSIONS			BACK DIMENSIONS					
		W	D	H	W	D	H	W	H				
			16.5	20.5	38.75	16.5	15.5	22.5 - 32.5	14	11.25			

DREME



Sleeper with back and arms
model GC35042

EXAMPLE DREME ORDER CODE:

GC35042	-LE50	-	-BM21	-LPN	-AWH
---------	-------	---	-------	------	------

Model #	Textile	Arm/tablet location	Sleep surface textile	Front panel type (LPN, UPN, LPP, UPP)	Laminate panel finish
---------	---------	---------------------	-----------------------	---------------------------------------	-----------------------

-SRL	-TOA	-MB
------	------	-----

Storage	Leg finish/caster option	Moisture barrier
---------	--------------------------	------------------



Drawer box surface

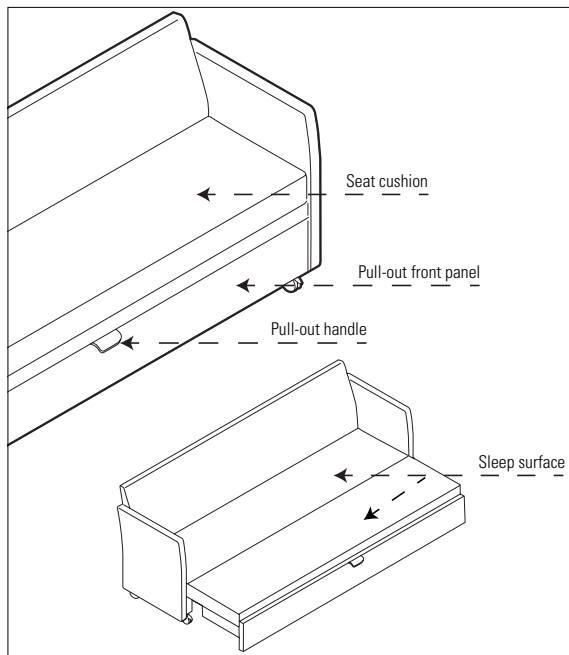

STANDARD FEATURES

- Dreme has a compact, comfortable design that offers a place to sit and converts into a generous sleep surface with a simple pull and flip. A variety of models include backless/armless benches and 3-seater sofa models with or without arms and tablets.
- The seat deck is a clean through metal platform for superior strength.
- The seat/sleep cushion is attached to the unit with straps held in place by metal-to-metal fasteners allowing sheets to be tucked in place.
- Straps can be unfastened for field replacement of the cushion, if required for any reason.
- A clean through is located at the back of the seat cushion, extending to the floor supporting ease of cleaning.
- The seat cushion folds open to create a 36" deep sleep surface area. Foam is standard high density Ultracell, for enhanced comfort and long-term performance.
- A pull-out section below the seat deck slides forward to support the sleep surface.
- The sleep surface cushion and drawer box covering are upholstered in Bantam vinyl to ensure moisture barrier protection. These surfaces are 9:1 (water to bleach) cleanable. Please select **(BM)** color. See Morbern Bantam textile card for color samples. All other surfaces can be specified in your textile of choice.
- A curved, chrome pull handle is standard on the pull-out front panel of all Dreme models.
- The pull-out is supported by four heavy duty non-locking, swivel casters when in sleep position and is standard without storage.
- Dreme requires zero wall clearance to open into sleep position.
- Standard configuration for all models: two metal legs in front position, two non-locking swivel casters in back position (to assist with moving the unit). Optional front, locking, swivel casters **(FC)** are available. Add **\$80**.
- Legs are available in all Globalcare metal paint finishes.
- Models with a tablet are available with left, right or both sofa arms. On models with both arms, specify left **(LT)**, right **(RT)** or **(TB)** for tablets on both arms (add **\$324** for **TB**). Tablet and arms are designated based on seated position. The tablet surfaces attach to the outside of the arm. The tablet rotates up and can be swiveled over the arm into place for use by the occupant. The strong, oval tablet is a soft black colored, non-porous, phenolic material with a no-spill edge.
- Interior sleep surface: 79" L x 37" W
- All textiles are railroaded across all Dreme components.
- For healthcare textiles, visit the website at globalfurnituregroup.com/healthcare.
- Can be upholstered in standard Global textiles if healthcare compliance is not required.

OPTIONAL FEATURES

- The pull-out is available with a storage compartment option. The storage compartment is divided into two sides, both with clean through spaces, and is finished in Storm Grey (SOG) laminate. The storage compartment must be ordered at time of original order and cannot be retrofitted, specify **(SRB)**. Add **\$447**.
- Storage compartment lids have a pneumatic lift support, allowing the lid to stay open when accessing the interior storage area.
- An optional seamless drawer liner is available for the storage compartments, as a set of two. Liners can be removed for ease of maintenance, specify **(SRL)**. Add **\$890**.
- Pull-out front panel is available with or without power units, and either upholstered or laminate. Specify one of the following: **(LPN)** laminate panel **(UPN)** high-density panel **(LPP)** laminate panel with power. Add **\$238**. **(UPP)** upholstered panel with power. Add **\$238**. Select from all standard laminate finishes.
- The optional power unit is located on the front panel, center front position. The tamper-resistant unit includes one power and two, USB-A, 10 watt charging ports with an 8 ft. long power cord. When the pull-out is in the open position, the remaining power cord length is 6 ft. The power module is Black with Black face plate and must be specified at time of order.
- **Leg finish/caster option:** **(TBL)** Black **(TKA)** Kalua **(TLA)** Latte **(TMO)** Mocha **(TSH)** Shadow **(TOA)** Toast **(TTU)** Tungsten **(FC)** Front, locking, swivel casters. Add **\$80**. (Casters are Black with Taupe center)
- **Sleep Surface Finish:** **(BM21)** Apple **(BM25)** Cosmic **(BM23)** Dove **(BM26)** Firelight **(BM22)** Ghost **(BM27)** Ginger **(BM24)** Iron **(BM20)** Rabbit **(BM28)** Tropical
See finishes at globalfurnituregroup.com/workplace/resources/textiles - Global Carded Textiles
- For moisture barrier on full seat and sleeping surface, specify **(MB)**. Add **\$518**.
- To add sealed seams to your product, specify **(SS)**. Add **\$485**.

SUGGESTED APPLICATIONS

- Lounge
- Patient rooms
- Resident rooms
- Treatment/Exam rooms

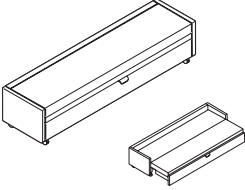
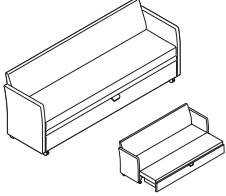
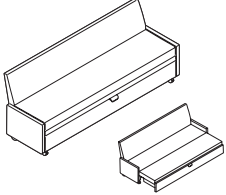
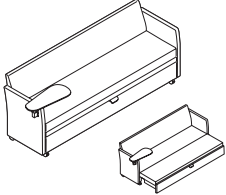
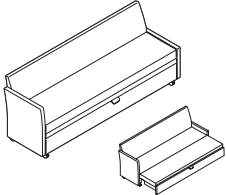
DESCRIPTION	MODEL#/ FEATURES	STANDARD TEXTILE GRADES											
		COM	2	3	4	5	6	7	8	9	10	11	12
 <p>Armless Sleeper COM Yardage: 9.5 Freight Class: 125 Product Weight (lbs.): 158 Cubic Feet Per Carton: 22.75</p>	GC35041NA	\$5176	\$5507	\$5774	\$6177	\$6743	\$7009	\$7523	\$8341	\$8972	\$9674	\$11117	\$12658
	Active weight 450 lbs.	OVERALL DIMENSIONS W D H			SEAT DIMENSIONS W D H			BACK DIMENSIONS W H					
		82	23	18.5	78	--	18.5						
 <p>Sleeper w/Back and Arms COM Yardage: 11.75 Freight Class: 150 Product Weight (lbs.): 210 Cubic Feet Per Carton: 46.25</p>	GC35042	\$5870	\$6267	\$6589	\$7069	\$7749	\$8069	\$8686	\$9671	\$10430	\$11271	\$13005	\$14856
	Active weight 450 lbs.	OVERALL DIMENSIONS W D H			SEAT DIMENSIONS W D H			BACK DIMENSIONS W H					
		82	25	32.5	78	18	18.5	78	14				
 <p>Armless Sleeper w/Back COM Yardage: 11.45 Freight Class: 150 Product Weight (lbs.): 190 Cubic Feet Per Carton: 46.25</p>	GC35042NA	\$5708	\$6088	\$6397	\$6859	\$7510	\$7815	\$8407	\$9348	\$10075	\$10883	\$12545	\$14317
	Active weight 450 lbs.	OVERALL DIMENSIONS W D H			SEAT DIMENSIONS W D H			BACK DIMENSIONS W H					
		82	25	32.5	78	18	18.5	78	14				
 <p>Sleeper w/Back, Arms and Tablet COM Yardage: 11.75 Freight Class: 150 Product Weight (lbs.): 210 Cubic Feet Per Carton: 48.5</p>	GC35042T	\$6214	\$6604	\$6921	\$7393	\$8062	\$8376	\$8983	\$9951	\$10697	\$11523	\$13229	\$15048
	Active weight 450 lbs.	OVERALL DIMENSIONS W D H			SEAT DIMENSIONS W D H			BACK DIMENSIONS W H					
	Specify (LT) for left tablet or (RT) for right tablet. Specify (TB) for tablet on both arms. Add \$324.	86	25	32.5	78	18	18.5	78	14				
 <p>Sleeper w/Back and one Arm COM Yardage: 11.95 Freight Class: 150 Product Weight (lbs.): 200 Cubic Feet Per Carton: 46.25</p>	GC35043	\$5870	\$6267	\$6589	\$7069	\$7749	\$8069	\$8686	\$9671	\$10430	\$11271	\$13005	\$14856
	Active weight 450 lbs.	OVERALL DIMENSIONS W D H			SEAT DIMENSIONS W D H			BACK DIMENSIONS W H					
	Specify (AR) for right arm or (AL) for left arm.	82	25	32.5	78	18	18.5	78	14				

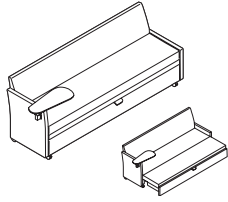
DESCRIPTION	MODEL#/ FEATURES	STANDARD TEXTILE GRADES											
		COM	2	3	4	5	6	7	8	9	10	11	12
 <p>Sleeper w/Back, Single Arm and Tablet COM Yardage: 11.25 Freight Class: 150 Product Weight (lbs.): 205 Cubic Feet Per Carton: 47.5</p>	GC35043T	\$6231	\$6604	\$6908	\$7359	\$8001	\$8301	\$8882	\$9807	\$10523	\$11314	\$12948	\$14689
	Specify (RT) for right arm or (LT) for left arm.												
		OVERALL DIMENSIONS			SEAT DIMENSIONS			BACK DIMENSIONS					
		W	D	H	W	D	H	W	H				
	Active weight 450 lbs.	86	25	32.5	78	18	18.5	78	14				



Change is the constant that each new generation brings to the table. Drift™ seating encourages people to come together with new ideas, new priorities and new ways of thinking. The welcoming look is ideal for collaborative spaces in the workplace to community spaces in healthcare.

The series includes lounge and side chairs, bar and counter stools, and task swivel models, connecting people and places wherever the day takes us. The wood base four-leg and swivel models, available in a wide range of popular finishes, bring added warmth to this contemporary seating series.

To see the full Drift series, please refer to the Seating price list at: globalfurnituregroup.com/workplace/resources/price-lists

Features and Benefits

- Soft seat and contoured back and arms provide the perfect balance of style and comfort
- Side chairs available in six base types: sled, wood 4-leg, wood 4-prong swivel, chrome 4-prong swivel, high 4-star swivel and 5-star base on casters
- Lounge chairs available in four base types: sled, wood 4-leg, wood 4-star swivel and Chrome 4-prong swivel
- Counter and bar height stools available with three base types: sled, wood 4-leg, and Chrome 4-star swivel.
- Lounge seating available with 17" seat height with a classic lounge angle or 18" seat height with a reduced back angle for ease of sitting and standing.
- Ottomans have a weighted bottom to maintain upright position.
- P and PH suffix models available with arm and head patches for increased durability
- For ease of cleaning, side and lounge chair models with "F" suffix have flip-forward seats.
- All Drift seating is assembled using tamper proof screws.
- Drift seating is designed for 300 lb. capacity.
- Available to specify with two textiles, one for the seat cushion and one for the back and arms.
- For environmental certifications, please visit globalfurnituregroup.com.

Options

- Sealed back seams and sealed seat seams
- Moisture barrier (seat only)
- Variety of glide options (wood base and sled base models)

ERIN



model GC36531
Armless Guest Chair,
Metal Legs



model GC36532
Guest Armchair,
Wood Legs

STANDARD FEATURES

- Erin offers a streamlined silhouette brimming with mid-century modern style.
- A rounded arch gently curves around and under the seat to give extra support to a user's upper back and sides, while creating an open clean-out space at the back of the cushion.
- The series is available to specify with two textiles, one for the seat cushion and one for the back, arms and front rail (see model image).
- For pricing, start with the base price and add both back/arms graded textile upcharge and the seat graded textile upcharge.
- Tapered legs add style and elegance.
- Legs are available in wood or metal painted/plated finishes (noted).
- The seat underside is sealed with a non-porous material to support housekeeping and infection control protocols.
- Additional improved cleaning options include sealed seams (back and/or seat) and moisture barrier (seat). Upcharges apply.
- Assembled with tamper-resistant fasteners for greater security.
- For added comfort, the seat cushions are standard with high density Ultracell foam.
- Glides are self-leveling. Choose from standard non-marking glides, rubber non-slip glides or felt glides (upcharges apply).
- The Globalcare warranty (for healthcare and 24/7 environments) applies for all Erin GC models when performance textiles are selected. Visit the website at globalfurnituregroup.com/healthcare.
- Global's standard lifetime warranty applies when approved standard Global textiles are selected.
- For alternate textile applications, contact Global specials. The Blended Textile matrix does not apply to this series.
- Shipped fully assembled.

SUGGESTED APPLICATIONS

- Dining/Cafeteria
- Guest seating
- Lobbies
- Lounge/Waiting
- Patient rooms
- Resident rooms





OPTIONAL FEATURES

Please add option codes in the following order:

- **Model number**
GC36530 Guest armless chair, wood legs
GC36531 Guest armless chair, metal legs
GC36532 Guest armchair, wood legs
GC36533 Guest armchair, metal legs
- **Back/Arm Textile**
Specify textile code. See model grade upcharges.
- **Seat Textile**
Specify textile code. See model grade upcharges.
- **Wood leg finish** (models GC36530 and GC36532)
(**AAM**) Absolute (**MWM**) Medium Walnut
(**BKM**) Black (**NLW**) Natural Walnut
(**CJM**) Charcoal Java (**ASM**) Night
(**ACM**) Cherry (**NBM**) Noce Biondo
(**EMM**) Empire Mahogany (**NGM**) Noce Grigio
(**EOM**) English Oak (**NEM**) Noce Leggero
(**ECM**) Espresso Cafe (**NMM**) Noce Medio
(**TFM**) Fruitwood (**SBM**) Sandy Beach
(**HGM**) Grey (**SKM**) Shaker Cherry
(**HOM**) Harvest Oak (**SOM**) Silver Oak
(**AHM**) Honey (**TWM**) Walnut
(**JOM**) Jet Onyx (**WTM**) WC Cream
(**LHM**) Light Honey (**WHM**) White
(**TMM**) Mahogany (**WCM**) Winter Cherry
(**AVM**) Maple
- **Metal leg finish** (models GC36531 and GC36533)
(**CHM**) Chrome (**TTU**) Tungsten
(**TBL**) Black (**TKA**) Kalua
(**TLA**) Latte (**TMO**) Mocha
(**TSH**) Shadow (**TOA**) Toast
- **Glides**
(**NM**) Non-marking glide. No upcharge
(**RG**) Rubber, non-slip glide. Add \$60.
(**FG**) Felt glide. Add \$60.
- **Sealed Back Seams** (Contact Customer Care for approved textiles)
(**NBS**) No sealed back seams
(**SBS**) Sealed back seams. Upcharges vary, see model.
- **Sealed Seat Seams** (Contact Customer Care for approved textiles)
(**NSS**) No sealed seat seams
(**SSS**) Sealed seat seams. Add \$20.
- **Moisture Barrier** (Not available with Sealed Seams)
(**NB**) No moisture barrier.
(**MB**) Moisture barrier (seat only). Add \$110.

EXAMPLE ERIN ORDER CODE:

GC36530	CE90	CE90	AAM	NM	NBS	NSS	NB
Model #	Seat/Arm textile	Seat textile	Leg finish	Glide	Sealed Back Seams	Sealed Seat Seams	Moisture Barrier

DESCRIPTION	MODEL#/ FEATURES	STANDARD TEXTILE GRADES											
		1/COM	2	3	4	5	6	7	8	9	10	11	12
	GC36530 Base Price:	\$1892											
	Back/Arm upcharge:	+0	+\$56	+\$100	+\$165	+\$256	+\$294	+\$373	+\$497	+\$590	+\$692	+\$903	+\$1126
	Seat upcharge:	+0	+\$32	+\$57	+\$94	+\$146	+\$168	+\$213	+\$284	+\$337	+\$395	+\$516	+\$643
	OVERALL DIMENSIONS			SEAT DIMENSIONS			BACK DIMENSIONS						
	W D H			W D H			W H						
	24 22.25 34			19 18 19			15 15.5						
Armless Guest Chair, Wood Legs COM Yardage: Back/Arm: 1.75; Seat: 1 Freight Class: 250 Product Weight (lbs.): 32.5 Cubic Feet Per Carton: 13.25		Active weight 350 lbs. Add \$49 for (SBS), \$20 for (SSS)											
	GC36531 Base Price:	\$1801											
	Back/Arm upcharge:	+0	+\$56	+\$100	+\$165	+\$256	+\$294	+\$373	+\$497	+\$590	+\$692	+\$903	+\$1126
	Seat upcharge:	+0	+\$32	+\$57	+\$94	+\$146	+\$168	+\$213	+\$284	+\$337	+\$395	+\$516	+\$643
	OVERALL DIMENSIONS			SEAT DIMENSIONS			BACK DIMENSIONS						
	W D H			W D H			W H						
	24 22.25 34			19 18 19			15 15.5						
Armless Guest Chair, Metal Legs COM Yardage: Back/Arm: 1.75; Seat: 1 Freight Class: 250 Product Weight (lbs.): 34.5 Cubic Feet Per Carton: 13.25		Active weight 350 lbs. Add \$49 for (SBS), \$20 for (SSS)											
	GC36532 Base Price:	\$1892											
	Back/Arm upcharge:	+0	+\$56	+\$100	+\$165	+\$256	+\$294	+\$373	+\$497	+\$590	+\$692	+\$903	+\$1126
	Seat upcharge:	+0	+\$32	+\$57	+\$94	+\$146	+\$168	+\$213	+\$284	+\$337	+\$395	+\$516	+\$643
	OVERALL DIMENSIONS			SEAT DIMENSIONS			BACK DIMENSIONS						
	W D H			W D H			W H						
	24 22 34.25			19 18.5 18.5			17 15.75						
Guest Armchair, Wood Legs COM Yardage: Back/Arm: 1.75; Seat: 1 Freight Class: 250 Product Weight (lbs.): 33 Cubic Feet Per Carton: 13.25		Active weight 350 lbs. Add \$52 for (SBS), \$20 for (SSS)											
	GC36533 Base Price:	\$1801											
	Back/Arm upcharge:	+0	+\$56	+\$100	+\$165	+\$256	+\$294	+\$373	+\$497	+\$590	+\$692	+\$903	+\$1126
	Seat upcharge:	+0	+\$32	+\$57	+\$94	+\$146	+\$168	+\$213	+\$284	+\$337	+\$395	+\$516	+\$643
	OVERALL DIMENSIONS			SEAT DIMENSIONS			BACK DIMENSIONS						
	W D H			W D H			W H						
	24 22 34.25			19 18.5 18.5			17 15.75						
Guest Armchair, Metal Legs COM Yardage: Back/Arm: 1.75; Seat: 1 Freight Class: 250 Product Weight (lbs.): 35 Cubic Feet Per Carton: 13.25		Active weight 350 lbs. Add \$52 for (SBS), \$20 for (SSS)											

FLAP™



Folding Chair
model 6775

STANDARD FEATURES





- A modern design, high quality, lightweight, all polymer folding chair intended for use indoors or outdoors. Products must be stored inside during extreme and inclement weather. See Global's Outdoor Furniture warranty for additional information.
- Weather resistant, UV resistant, stain resistant, 100% non-ferrous, and recyclable design that is 1:10 bleach solution cleanable.
- Chair legs are equipped with clear non-marking glides as standard. Suitable for outdoor environments, carpet and hard surface flooring
- Chairs are stocked in 2 colors:
Alloy (**ALY**)
Milk (**MLK**)
- No upholstery options available
- Rated to 275 lbs.
- Single chair folds flat to 2.2" (55 mm).
- Flap achieves its strength and durability using glass filled polymer. Evidence of this material may be visible on the surface and is often more evident in darker colors.
- The Flap Wall Hook (6776), sold individually, supports up to two folded Flap chairs. This Milk (**MLK**) colored plastic hook mounts on walls or inside closets and wardrobe cabinets providing easy access to extra seating. Two chairs on Wall Hook measure 7.3" (185 mm) deep off wall. Mounting hardware not included. Recommended mounting into stud.
- Flap Ganging Brackets (6778) are sold 12 to a box. These translucent, frosted plastic brackets attach across two adjacent chairs, just above or below the seat to provide temporary ganging for organized events.
- The Flap Dolly (6777), ordered separately, supports up to 24 chairs folded and stacked flat. Includes strap to secure chairs for storage and transport.





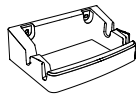

Please add option codes in the following order

- **Model number**
6775 Folding Chair
6776 Wall Hook
6777 Dolly
6778 Ganging Brackets
- **Chair Color**
(ALY) Alloy
(MLK) Milk

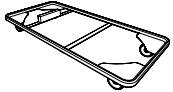
EXAMPLE OF FLAP ORDER CODE:

6775	ALY
Model Number	Finish

DESCRIPTION	MODEL#/ FEATURES	STANDARD TEXTILE GRADES														
		1	2	3	4	5	6	7	8	9	10	11	12			
 <p>Folding Chair COM Yardage: N/A Freight Class: 100 Product Weight (lbs.): 13.5 Cubic Feet Per Carton: 1.6</p>	<p>6775</p> <p>\$214</p> <p>Shipped 2 per box. Ordered as eaches.</p>															
		OVERALL DIMENSIONS			SEAT DIMENSIONS			BACK DIMENSIONS								
		W	D	H	W	D	H	W	H							
		19	21.5	33.5	16	16.5	18.5	18.5	16							
				2 per carton (pricing and specifications are for one chair)												
 <p>Flap Wall Hook COM Yardage: N/A Freight Class: 70 Product Weight (lbs.): 0.75 Cubic Feet Per Carton: 0.2</p>	<p>6776</p> <p>\$48</p>															
		OVERALL DIMENSIONS			SEAT DIMENSIONS			BACK DIMENSIONS								
		W	D	H	W	D	H	W	H							
		9	6	2.75												
				1 per carton												

DESCRIPTION	MODEL#/ FEATURES	STANDARD TEXTILE GRADES												
		1	2	3	4	5	6	7	8	9	10	11	12	
 <p>Dolly for Flap Folding Chairs COM Yardage: N/A Freight Class: 150 Product Weight (lbs.): 23 Cubic Feet Per Carton: 4.5</p>	6777	\$614												
		OVERALL DIMENSIONS W D H			SEAT DIMENSIONS W D H			BACK DIMENSIONS W H						
		20.75	44	5.25										
		Holds up to 24 Flap folded chairs. Includes tether strap.				1 per carton								
 <p>Flap Ganging Bracket (box of 12) COM Yardage: N/A Freight Class: 70 Product Weight (lbs.): 0.29 Cubic Feet Per Carton: 0.03</p>	6778	\$188												
		OVERALL DIMENSIONS W D H			SEAT DIMENSIONS W D H			BACK DIMENSIONS W H						
		0	0	0										
						12 per carton (pricing and specifications are for box of 12)								

FOOT ACTIVATED STOOLS



STANDARD FEATURES

- Foot activated stools allow the occupant to adjust the gas cylinder by pressing on the ring below the base with their foot, which frees up hands to manage other tasks while working in a lab.
- Raise the seat by pressing on the ring before sitting; or lower the seat by pressing on the ring while seated.
- Swivel stool with 8" gas cylinder provides seat height range of 21.5" to 29.5".
- Seamless upholstered seat cushion is constructed from high density Ultracell foam.
- Underside of seat cushion is finished with polyurethane.
- 14" seat diameter with 25" diameter Black five prong injection molded base.
- Standard with dual wheel hard floor casters (C10R).
- For Globalcare textiles and finish options, visit the website at globalfurnituregroup.com.
- Can be upholstered in standard Global textiles only if Healthcare compliance is not required.

OPTIONAL FEATURES

- To respond to higher expectations for housekeeping and infection prevention, seat underside can be completely sealed. Contact Customer Care for upcharge.

SUGGESTED APPLICATIONS

- Dining/Cafeteria
- Office/Meeting
- Patient rooms
- Resident rooms
- Treatment/Exam rooms

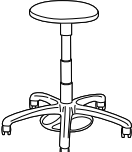
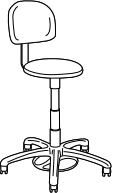
DESCRIPTION	MODEL#/ FEATURES	STANDARD TEXTILE GRADES											
		COM	2	3	4	5	6	7	8	9	10	11	12
 <p>Lab Swivel Stool COM Yardage: 0.75 Freight Class: 250 Product weight (lbs.): 25 Cubic Feet per Carton: 9.75</p>	GC9604FG	\$782	\$804	\$827	\$856	\$900	\$921	\$959	\$1020	\$1068	\$1121	\$1230	\$1346
		OVERALL DIMENSIONS			SEAT DIMENSIONS			BACK DIMENSIONS					
		W	D	H	W	D	H	W	H				
		14	14	25.5	14	--	21.5-29.5						
 <p>Lab Swivel Stool w/Small Upholstered Back COM Yardage: 1 Freight Class: 250 Product weight (lbs.): 32 Cubic Feet per Carton: 13</p>	GC9668FG	\$923	\$954	\$983	\$1024	\$1081	\$1107	\$1159	\$1241	\$1305	\$1377	\$1519	\$1675
		OVERALL DIMENSIONS			SEAT DIMENSIONS			BACK DIMENSIONS					
		W	D	H	W	D	H	W	H				
		14	14	38	14	--	21.5-29.5	14	12.5				

FROLICK & SPLASH



model GC3001

model GC3011

Three different back constructions



Separate panel piece closes the lower back to conceal the support bracket. Offered in **Frolick** series on select models.



Single piece back with a pullover style upholstery cover and support bracket fastened on the outer back. Offered on select **Frolick** models.



Two piece back covering the back support brackets when fastened in place. Offered in **Splash** series.

STANDARD FEATURES

- Frolick and Splash are multi-purpose stacking chairs that share generous width between the arms, great comfort, and a frame built for greater strength and stability. Each series offers a different back design with special features to best address the application and infection control practices.
- Standard size models offer 19" seat width with 21.5" clearance between the armrests. Bariatric size models offer 31.5" seat width with 33.5" clearance between the armrests.
- For a smaller scale bariatric chair, refer to GC Comet #GC2180 which offers 18.5" seat width with 28" clearance between armrests
- Heavy duty round, tubular gusseted frames.
- Active weight capacity is up to 300 lbs. for standard models, and 500 lbs. for Bariatric models.
- Protective Shadow finished seat shroud is standard on the underside of all models (except bariatric models GC3003 and GC3023).
- To respond to higher expectations for housekeeping and infection control practices, select models with a one-piece back. Description of back is noted with each model
- Wallsaver rear legs eliminate accidental damage to walls.
- Armrests are fiberglass reinforced Nylon and have a flat profile. Fully extended to front of seat edge to assist in entry and exit from the chair.
- Armrests are standard in Black.
- For added comfort, seats are standard with high density Ultracell bio foam
- Four legged standard size models stack 5 high without dolly and 8 high on GC3010 dolly.
- **Four legged Bariatric models stack 2 high only** - No dolly available.
- Sled base models do not stack
- For ganging brackets, see Model 2180 in the Global Seating List Price Book.
- On armless models, Black frames are standard with Black glides and front leg caps. All other frame colors are standard with Shadow glides and front leg caps.
- For textiles and finish options, visit the website at globalfurnituregroup.com/healthcare
- Can be upholstered in standard Global textiles only if Healthcare compliance is not required.

OPTIONAL FEATURES

- A selection of glide options is available. Glides must be chosen to best suit flooring type and site conditions.
- For hard surface floors, please specify opaque non-marking glides (**WH**). No upcharge.
- Glides with felt pads (**FG**) are available for vinyl sheet, cork or laminate flooring. Please specify. Add **\$60**.
- Glides with rubber pads (**RG**) are available for vinyl, hardwood, laminate, stone or ceramic flooring. Please specify. Add **\$60**.
- Armrests available in Shadow (**SHW**) and Toast (**TOA**). Please Specify. Add **\$35**.
- To add sealed seams to your product contact Customer Care. Upcharges vary
- For moisture barrier on seat, add \$129 per seat. For bariatric models - Add \$198 per seat.
- **Frame finish**
Painted finishes - no upcharge:
(**TBL**) Black
(**TBZ**) Buzz Blue
(**TCC**) Cactus
(**TCR**) Carrot
(**TIV**) Cloud
(**TDW**) Designer White
(**TDJ**) Dijon
(**TEG**) Eggplant
(**TFO**) Fog
(**TFR**) Frost
(**TIN**) Ink
(**TKA**) Kalua
(**TLA**) Latte
(**TMO**) Mocha
(**TNE**) Nevada
(**TSN**) Sand
(**TSR**) Scarlet
(**TSH**) Shadow
(**TOA**) Toast
(**TTU**) Tungsten
Plated finish - see models for upcharge:
(**CHM**) Chrome

SUGGESTED APPLICATIONS

- Bariatric seating (Frolick)
- Dining/Cafeteria
- Guest seating
- Lobbies
- Lounge/Waiting
- Office/Meeting
- Patient rooms
- Resident rooms
- Stacking
- Treatment/Exam Rooms

DESCRIPTION	MODEL#/ FEATURES	STANDARD TEXTILE GRADES											
		COM	2	3	4	5	6	7	8	9	10	11	12
 Frolick Stacking Armchair 4 Leg Base, Rectangular back with concealed attachment COM Yardage: 1.25 Freight Class: 250 Product Weight (lbs.): 24 Cubic Feet Per Carton: 6.67	GC3001	\$818	\$854	\$891	\$942	\$1012	\$1038	\$1100	\$1216	\$1272	\$1382	\$1531	\$1716
			OVERALL DIMENSIONS W D H			SEAT DIMENSIONS W D H			BACK DIMENSIONS W H				
		25	24.5	36	19	18	18.5	19.5	17				

 Frolick Stacking Chair Armless, 4 Leg Base, Rectangular back with concealed attachment COM Yardage: 1.25 Freight Class: 250 Product Weight (lbs.): 22 Cubic Feet Per Carton: 6.67	GC3002	\$780	\$819	\$855	\$907	\$977	\$1003	\$1065	\$1181	\$1237	\$1345	\$1496	\$1682
			OVERALL DIMENSIONS W D H			SEAT DIMENSIONS W D H			BACK DIMENSIONS W H				
		21	24.5	36	19	18	18.5	19.5	17				

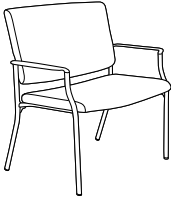
 Frolick Bariatric Stacking Armchair 4 Leg Base, Rectangular back with concealed attachment COM Yardage: 2.25 Freight Class: 300 Product Weight (lbs.): 42 Cubic Feet Per Carton: 26.5	GC3003	\$1491	\$1562	\$1627	\$1717	\$1843	\$1890	\$2003	\$2209	\$2316	\$2510	\$2779	\$3112
			OVERALL DIMENSIONS W D H			SEAT DIMENSIONS W D H			BACK DIMENSIONS W H				
		37	24.5	36.5	31.5	18	18.5	32	18.5				

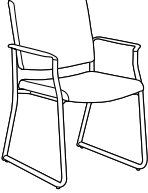
 Frolick Armchair Sled Base, Rectangular back with concealed attachment COM Yardage: 1.25 Freight Class: 250 Product Weight (lbs.): 32 Cubic Feet Per Carton: 13.75	GC3021	\$847	\$886	\$923	\$974	\$1044	\$1070	\$1132	\$1248	\$1304	\$1414	\$1561	\$1747
			OVERALL DIMENSIONS W D H			SEAT DIMENSIONS W D H			BACK DIMENSIONS W H				
		25	24.5	36	18	17	18.5	18.75	18				

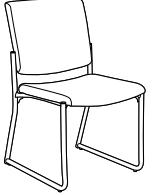
 Frolick Armless Chair Sled Base, Rectangular back with concealed attachment COM Yardage: 1.25 Freight Class: 250 Product Weight (lbs.): 30 Cubic Feet Per Carton: 13.75	GC3022	\$812	\$848	\$885	\$936	\$1006	\$1032	\$1094	\$1210	\$1266	\$1376	\$1523	\$1710
			OVERALL DIMENSIONS W D H			SEAT DIMENSIONS W D H			BACK DIMENSIONS W H				
		21	24.5	36	19	18	18.5	19.5	17				

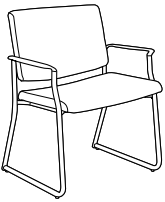
DESCRIPTION	MODEL#/ FEATURES	STANDARD TEXTILE GRADES											
		COM	2	3	4	5	6	7	8	9	10	11	12
 <p>Frolick Bariatric Armchair Sled Base, Rectangular back with concealed attachment COM Yardage: 2.25 Freight Class: 300 Product Weight (lbs.): 47 Cubic Feet Per Carton: 26.5</p>	GC3023	\$1585	\$1656	\$1721	\$1811	\$1937	\$1984	\$2097	\$2303	\$2410	\$2605	\$2874	\$3208
	OVERALL DIMENSIONS			SEAT DIMENSIONS			BACK DIMENSIONS						
	W	D	H	W	D	H	W	H					
	37	24.5	36.5	31.5	18	18.5	32	18.5					

 <p>Frolick Stacking Armchair 4 Leg Base, Rectangular back COM Yardage: 1.25 Freight Class: 250 Product Weight (lbs.): 24 Cubic Feet Per Carton: 6.67</p>	GC3031	\$818	\$854	\$891	\$942	\$1012	\$1038	\$1100	\$1216	\$1272	\$1382	\$1531	\$1716
	OVERALL DIMENSIONS			SEAT DIMENSIONS			BACK DIMENSIONS						
	W	D	H	W	D	H	W	H					
	25	24.5	36	19	18	18.5	19.5	17					

 <p>Frolick Stacking Chair Armless, 4 Leg Base, Rectangular back COM Yardage: 1.25 Freight Class: 250 Product Weight (lbs.): 21 Cubic Feet Per Carton: 6.67</p>	GC3032	\$780	\$819	\$856	\$907	\$977	\$1003	\$1065	\$1181	\$1237	\$1347	\$1496	\$1682
	OVERALL DIMENSIONS			SEAT DIMENSIONS			BACK DIMENSIONS						
	W	D	H	W	D	H	W	H					
	21	24.5	36	19	18	18.5	19.5	17					

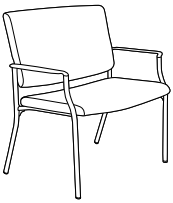

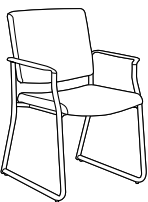
 <p>Frolick Bariatric Stacking Armchair 4 Leg Base, Rectangular back COM Yardage: 2.25 Freight Class: 300 Product Weight (lbs.): 42 Cubic Feet Per Carton: 26.5</p>	GC3033	\$1491	\$1562	\$1627	\$1717	\$1843	\$1890	\$2003	\$2209	\$2316	\$2510	\$2779	\$3112
	OVERALL DIMENSIONS			SEAT DIMENSIONS			BACK DIMENSIONS						
	W	D	H	W	D	H	W	H					
	37	24.5	36.5	31.5	18	18.5	32	18.5					



 <p>Frolick Armchair Sled Base, Rectangular back COM Yardage: 1.25 Freight Class: 250 Product Weight (lbs.): 32 Cubic Feet Per Carton: 13.75</p>	GC3034	\$847	\$886	\$923	\$974	\$1044	\$1070	\$1132	\$1248	\$1304	\$1414	\$1561	\$1747
	OVERALL DIMENSIONS			SEAT DIMENSIONS			BACK DIMENSIONS						
	W	D	H	W	D	H	W	H					
	25	24.5	36	18	17	18.5	18.75	18					

SEATING

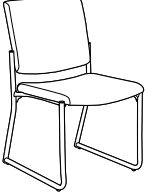
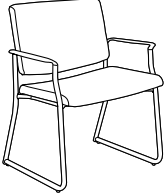
FROLICK™ & SPLASH™

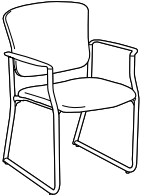
F

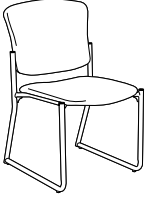
DESCRIPTION	MODEL#/ FEATURES	STANDARD TEXTILE GRADES											
		COM	2	3	4	5	6	7	8	9	10	11	12
 <p>Frolick Armless Chair Sled Base, Rectangular back COM Yardage: 1.25 Freight Class: 250 Product Weight (lbs.): 30 Cubic Feet Per Carton: 13.75</p>	GC3035	\$812	\$848	\$885	\$936	\$1006	\$1032	\$1094	\$1210	\$1266	\$1376	\$1523	\$1710
	OVERALL DIMENSIONS			SEAT DIMENSIONS			BACK DIMENSIONS						
	W	D	H	W	D	H	W	H					
	21	24.5	36	19	18	18.5	19.5	17					
		Active weight 300 lbs. Single piece back with pullover style upholstery cover with exposed support brackets on the outer back. Does not stack. Chrome (CHM) frame finish, add \$193.											
 <p>Frolick Bariatric Armchair Sled Base, Rectangular back COM Yardage: 2.25 Freight Class: 300 Product Weight (lbs.): 47 Cubic Feet Per Carton: 26.5</p>	GC3036	\$1585	\$1656	\$1721	\$1811	\$1937	\$1984	\$2097	\$2303	\$2410	\$2605	\$2874	\$3208
	OVERALL DIMENSIONS			SEAT DIMENSIONS			BACK DIMENSIONS						
	W	D	H	W	D	H	W	H					
	37	24.5	36.5	31.5	18	18.5	32	18.5					
		Active weight 500 lbs. Single piece back with pullover style upholstery cover with exposed support brackets on the outer back. Chrome (CHM) frame finish, add \$301. Does not stack.											
 <p>Splash Stacking Armchair 4 Leg Base, Fan back with concealed attachment COM Yardage: 1.25 Freight Class: 250 Product Weight (lbs.): 25.33 Cubic Feet Per Carton: 6.67</p>	GC3011	\$818	\$854	\$891	\$942	\$1011	\$1038	\$1099	\$1216	\$1272	\$1382	\$1531	\$1716
	OVERALL DIMENSIONS			SEAT DIMENSIONS			BACK DIMENSIONS						
	W	D	H	W	D	H	W	H					
	25	24.25	35.5	19.5	18.5	18.5	20	17.5					
		Active weight 300 lbs. Stacks 5 high on floor. Chrome (CHM) frame finish, add \$180.											
 <p>Splash Stacking Chair Armless, 4 Leg Base, Fan back with concealed attachment COM Yardage: 1.25 Freight Class: 250 Product Weight (lbs.): 22.33 Cubic Feet Per Carton: 6.67</p>	GC3012	\$780	\$819	\$855	\$907	\$977	\$1003	\$1065	\$1181	\$1237	\$1345	\$1496	\$1682
	OVERALL DIMENSIONS			SEAT DIMENSIONS			BACK DIMENSIONS						
	W	D	H	W	D	H	W	H					
	21	24.25	35.5	19.5	18.5	18.5	20	17.5					
		Active weight 300 lbs. Stacks 5 high on floor. Chrome (CHM) frame finish, add \$161.											
 <p>Splash Armchair Sled Base, Fan back with concealed attachment COM Yardage: 1.25 Freight Class: 250 Product Weight (lbs.): 34 Cubic Feet Per Carton: 17</p>	GC3013	\$847	\$886	\$923	\$974	\$1043	\$1070	\$1131	\$1248	\$1304	\$1414	\$1563	\$1748
	OVERALL DIMENSIONS			SEAT DIMENSIONS			BACK DIMENSIONS						
	W	D	H	W	D	H	W	H					
	25	24.25	35.5	19.5	18.5	18.5	20	17.5					
		Active weight 300 lbs. Does not stack. Chrome (CHM) frame finish, add \$214.											

DESCRIPTION	MODEL#/ FEATURES	STANDARD TEXTILE GRADES											
		COM	2	3	4	5	6	7	8	9	10	11	12
 <p>Splash Side Chair Sled Base, Fan back with concealed attachment COM Yardage: 1.25 Freight Class: 250 Product Weight (lbs.): 32 Cubic Feet Per Carton: 13.75</p>	GC3014	\$812	\$848	\$885	\$936	\$1006	\$1032	\$1094	\$1210	\$1266	\$1374	\$1523	\$1710
	OVERALL DIMENSIONS			SEAT DIMENSIONS			BACK DIMENSIONS						
	W	D	H	W	D	H	W	H					
	21	24.25	35.5	19.5	18.5	18.5	20	17.5					
		LIST PRICE											
	GC3010	\$364											
 <p>Dolly for Frolick and Splash standard size, four leg chairs COM Yardage: -- Freight Class: 150 Product Weight (lbs.): 16 Cubic Feet Per Carton: 3.8</p>		OVERALL DIMENSIONS			SEAT DIMENSIONS			BACK DIMENSIONS					
		W	D	H	W	D	H	W	H				
		0	0	0									
			Allows chairs to stack up to 8 high.										

GALA II

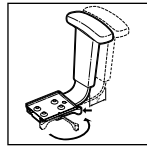

Vari-Width (WA) width adjustable arm extensions are standard.

model GC13012, medium back

Synchro-tilter mechanism (-0)

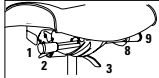

ADJUSTMENTS

- (1) Tilt tension
- (2) Pneumatic seat height
- (3) Back angle
- Back/lumbar height
- (8) Sliding seat depth
- (9) Multi position tilt lock
- Synchro tilt action
- Anti kick back

Ergonomic features:

A, B, C, D, E, G, H, L, M, N, Q, R, U

STANDARD FEATURES

- Gala II is designed to provide exceptional support and comfort throughout the work day.
- Vertical back height ratchet adjustment of 5.25" is standard.
- Back support upright is 3" wide for extra strength.
- One-piece curved back features a pull over style upholstery cover for easy housekeeping and infection prevention practices.
- Standard with Global's high quality Soft Descent™ pneumatic lift which slowly and gently lowers the seat height of the chair making it easy to obtain the exact seat height you desire.
- Standard with height adjustable arms (3B) with self-skinned urethane (SSU) armcaps.
- Vari-Width (WA) width adjustable arm extensions are standard. Allows the arms to move away from the seat by 2" on each side to accommodate various users.
- Waterfall seamless seat front design with high density Ultracell foam for superior comfort and longevity
- Underside of seat pan is completely sealed for ease of cleaning.
- Side activated sliding seat depth adjustment (MD) is standard on synchro-tilter.
- Five prong, injection molded, fiberglass reinforced nylon Black base with dual wheel carpet casters (C65).
- For Globalcare textiles and finish options, visit the website at globalfurnituregroup.com.
- Can be upholstered in standard Global textiles if Healthcare compliance is not required.
- To meet higher standards for housekeeping and infection control, Gala II has a seamless seat and one stitch pull over back upholstery, while still offering soft curves to the design. Note: Vinyl and woven treated textiles are thicker in nature and will experience wrinkles on some curves or corners as a result.

OPTIONAL FEATURES

- Optional hard floor casters (C65R) are available. Add \$72.

SUGGESTED APPLICATIONS

- Office/Meeting
- Caregiver Workstations

DESCRIPTION	MODEL#/ FEATURES	STANDARD TEXTILE GRADES											
		COM	2	3	4	5	6	7	8	9	10	11	12
 <p>Medium Back Synchro-Tilter COM Yardage: 1.9 Freight Class: 150 Product Weight (lbs.): 53 Cubic Feet Per Carton: 10.5</p>	GC13012	\$1031	\$1100	\$1164	\$1250	\$1376	\$1434	\$1545	\$1725	\$1865	\$2018	\$2334	\$2672
		OVERALL DIMENSIONS			SEAT DIMENSIONS			BACK DIMENSIONS					
		W	D	H	W	D	H	W	H				
		24.5	23.5	39	20.5	17-18	16.5-21.5	20	20.5				

GC BEACH



model GC4077



model GC4078

STANDARD FEATURES

- Elegant wood seating with a choice of an upholstered or vertical wood slat back.
- Frame construction is beech hardwood.
- Legs are equipped with White non-marking polypropylene glides. Suitable for both carpet and hard surface flooring.
- All cushions are fixed and non-removable.
- Cushions are made with highly resilient foam and seats are equipped with a synthetic rubberized webbing suspension system for extra comfort
- Seat cushion underside is finished with Black polyurethane
- Does not stack
- For Globalcare textiles and finish options, visit the website at globalfurnituregroup.com.
- Can be upholstered in standard Global textiles if Healthcare compliance is not required.

OPTIONAL FEATURES

- Wood frame available in Absolute (AAM), Black (BKM), Cherry (ACM), English Oak (EOM), Espresso Cafe (ECM), Fruitwood (TFM), Gray (HGM), Honey (AHM), Mahogany (TMM), Maple (AVM), Medium Walnut (MWM), Natural Walnut (NLW), Night (ASM), Noce Biondo (NBM), Noce Grigio (NGM), Noce Leggero (NEM), Noce Medio (NMM), Sandy Beach (SKM), Shaker Cherry (SKM), Silver Oak (SOM), Walnut (TWM), WC Cream (WTM), White (WHM) and Winter Cherry (WCM). Please specify.
- For moisture barrier on seat, please specify **(MB)**. - Add \$129 per seat.

SUGGESTED APPLICATIONS

- Dining/Cafeteria
- Guest seating
- Lobbies
- Lounge/Waiting
- Office/Meeting
- Patient rooms
- Resident rooms

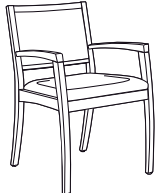
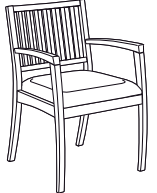
DESCRIPTION	MODEL#/ FEATURES	STANDARD TEXTILE GRADES											
		COM	2	3	4	5	6	7	8	9	10	11	12
 <p>Armchair w/Upholstered Back COM Yardage: 1 Freight Class: 300 Product Weight (lbs.): 20 Cubic Feet Per Carton: 13.25</p>	GC4077	\$956	\$988	\$1017	\$1058	\$1118	\$1146	\$1201	\$1282	\$1350	\$1424	\$1568	\$1730
		OVERALL DIMENSIONS			SEAT DIMENSIONS			BACK DIMENSIONS					
		W	D	H	W	D	H	W	H				
		22	22.25	33.5	19.5	18.5	18.75	19.5	15.5				
 <p>Armchair w/Vertical Wood Slat Back COM Yardage: 1 Freight Class: 300 Product Weight (lbs.): 20 Cubic Feet Per Carton: 13.25</p>	GC4078	\$983	\$1015	\$1044	\$1085	\$1145	\$1173	\$1228	\$1316	\$1377	\$1451	\$1608	\$1770
		OVERALL DIMENSIONS			SEAT DIMENSIONS			BACK DIMENSIONS					
		W	D	H	W	D	H	W	H				
		22	22.25	33.5	19.5	19	18.75	19.5	15.5				

GC-BELONG



model GC4231HB

model GC4231HB

STANDARD FEATURES

- The GC Belong series was developed for active and transient spaces and environments with rigorous demands.
- Elliptical metal tube frame is available in Black (TBL), Cloud (TIV), Designer White (TDW), Fog (TFO), Frost (TFR), Kalua (TKA), Latte (TLA), Mocha (TMO), Nevada (TNE), Sand (TSN), Shadow (TSH), Toast (TOA) and Tungsten (TTU). Specify finish.
- Urethane armcaps are available in Black (BLK), Kalua (KAL), Latte (LAB), Mocha (J52), Shadow (SHW), and Toast (TOA).
- Wood armcaps are also available in Absolute (AAM), Black (BKM), Cherry (ACM), English Oak (EOM), Espresso Cafe (ECM), Fruitwood (TFM), Gray (HGM), Honey (AHM), Mahogany (TMM), Maple (AVM), Medium Walnut (MWM), Natural Walnut (NLW), Night (ASM), Noce Biondo (NBM), Noce Grigio (NGM), Noce Leggero (NEM), Noce Medio (NMM), Sandy Beach (SKM), Shaker Cherry (SKM), Silver Oak (SOM), Walnut (TWM), WC Cream (WTM), White (WHM) and Winter Cherry (WCM). Refer to individual models for upcharge.
- The frame can be weighted and made with tamperproof fasteners for greater security in more challenging mental health spaces or correctional facilities.
- Active weight capacity is 500 lbs. per seat position; 750 lbs. for bariatric seating.
- The seat and back are removable and field replaceable.
- For added comfort, seats are standard with high density Ultracell foam.
- All seat frames feature a wallsaver design to prevent back contact with wall. **Note:** In order to allow full flex of the back on models GC4242, GC4242HB, GC4243 and GC4243HB, a 10.5" wall clearance is required.
- Ottomans and Benches do not have wallsaver legs.
- Standard seat height on all models is 18.5"
- Seat height on GC4231-24 and GC4241-24 is 24"
- Standard with Black glides
- Select models are offered with casters on the rear legs. These casters allow for ease of movement in support of housekeeping efforts or repositioning seating within a space. **They are not intended for patient transfer.**

- Clean out space is provided between the seat and back cushions for easier housekeeping.
- **Left and Right position reference** is determined from the seated position.
- Flex back models feature a torsion control mechanism which allows the back to move 14° in a soothing rocking motion.
- For healthcare textiles and wood finish options, visit the website at globalfurnituregroup.com
- Can be upholstered in standard Global textiles if healthcare compliance is not required.

OPTIONAL FEATURES

- For hardsurface floors, specify opaque, non-marking glides (NM). No upcharge.
- For moisture barrier on seat, specify (MB). Add \$129 per seat. For bariatric models, Add \$198 per seat.
- As an option, seams can be sealed to prevent penetration of fluids through the stitching. Contact Customer Care for approved textiles.
Low Back Models - **Add \$113** list upcharge per seat
Low Back Bariatric Models - **Add \$120** list upcharge per seat
High Back Models - **Add \$123** list upcharge per seat
High Back Bariatric Models - **Add \$130** list upcharge per seat
Split-Back Models - **Add \$180** list upcharge per seat
Ottoman - **Add \$40** list upcharge
Benches: **Add \$49** list upcharge for one seat, **Add \$106** for two seat models, and **Add \$158** for three seat models.
- Complementary tables are offered as part of this series in either high pressure or thermally fused laminate tops.

SUGGESTED APPLICATIONS

- Bariatric seating
- Guest seating
- Lobbies
- Lounge/Waiting
- Patient/Resident rooms
- Treatment/Exam rooms

GC BELONG BENCHES & BRIDGES

- Units with links can only gang with a bridge. They CANNOT gang directly with another link unit. (Link units have side brackets.)
- Available in one, two or three seat models.
- A bridge unit suspends between 2 other units using their links. A bridge is NOT freestanding. (A bridge does not have legs.)
- Benches have no front or back facing distinction so models with links can be reversed.
- All bridge models can be ganged to seat units with link.

GC BELONG TABLES

- Table heights are 16"
- 1" thick tops are available in thermally fused laminate (LP) and high pressure laminate (HP). Please select the appropriate model number for the finish you prefer.
- 2mm edging color coordinated with laminate finish is standard for all tops. Finish must be specified at the time of order.
- Refer to the following lists when selecting a finish color. Must specify both a top color and leg finish when ordering.















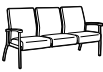













Thermally Fused Laminate (LP)

Absolute Acajou (ACJ)
Asian Night (ASN)
Avant Cherry (AWC)
Avant Honey (AWH)
Brushed Cobalt (BRC)
Clear Maple (CMB)
Dark Espresso (DES)
Designer White (DWT)
Fashionista (FAS)
First Class (FCL)
Noce Biondo (NBL)
Noce Grigio (NGL)
Noce Leggero (NEL)
Noce Medio (NML)
Quartered Mahogany (QTM)
Sheer Beauty (SBY)
Walnut Heights (WHE)
White Chocolate (WHC)
Winter Cherry (WCR)





























High Pressure Laminate (HP)

Absolute Acajou (ACJ)
Asian Night (ASN)
Avant Cherry (W357)
Avant Honey (W356)
Brushed Cobalt (BRC)
Clear Maple (CMB)
Dark Espresso (W142)
Designer White (DWT)
Fashionista (FAS)
First Class (FCL)
Noce Biondo (NBL)
Noce Grigio (NGL)
Noce Leggero (NEL)
Noce Medio (NML)
Quartered Mahogany (QTM)
Sheer Beauty (SBY)
Walnut Heights (WHE)
White Chocolate (WHC)
Winter Cherry (WCR)

LOW BACK

	GC4230	GC4231	GC4232	GC4234	GC4233	GC4235	GC4236
Freestanding units							
Ganging units with link on Left side	GC4230L 	GC4231L 	GC4232L 	GC4234L 	GC4233L 	GC4235L 	GC4236L 
Ganging units with link on Right side	GC4230R 	GC4231R 	GC4232R 	GC4234R 	GC4233R 	GC4235R 	GC4236R 
Ganging units with links on Both sides	GC4230B 	GC4231B 	GC4232B 	GC4234B 	GC4233B 	GC4235B 	GC4236B 

HIGH BACK

Freestanding units	GC4230HB 	GC4231HB 	GC4232HB 	GC4234HB 	GC4233HB 	GC4235HB 	GC4236HB 
Ganging units with link on Left side	GC4230HBL 	GC4231HBL 	GC4232HBL 	GC4234HBL 	GC4233HBL 	GC4235HBL 	GC4236HBL 
Ganging units with link on Right side	GC4230HBR 	GC4231HBR 	GC4232HBR 	GC4234HBR 	GC4233HBR 	GC4235HBR 	GC4236HBR 
Ganging units with links on Both sides	GC4230HBB 	GC4231HBB 	GC4232HBB 	GC4234HBB 	GC4233HBB 	GC4235HBB 	GC4236HBB 

Non ganging units with casters



Ganging Bariatric units with link on Both side



Non ganging Bariatric units



Non ganging Flexback units



Non ganging Split Back units



Ganging Bariatric units with link on Left side



Non ganging Flexback units with casters



Non ganging Split Back units with casters



Ganging Bariatric units with link on Right side



Hip Height Chair with wedged cushion, 24" Seat Height



BENCHES & BRIDGES

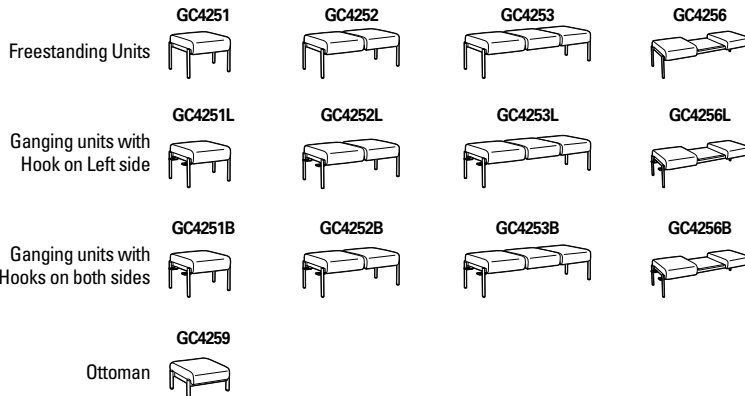

TABLES

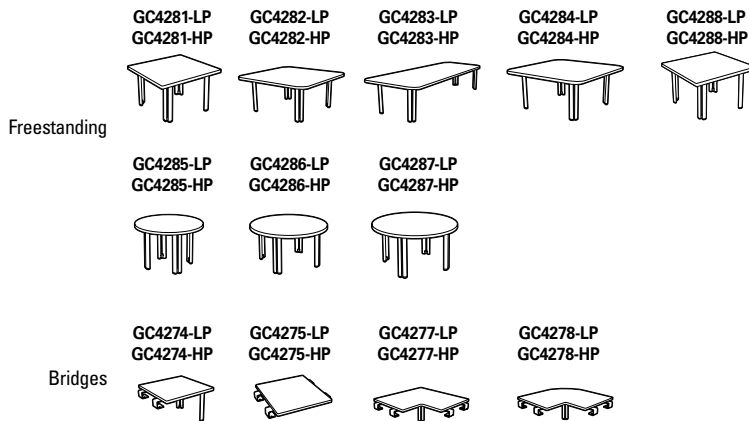

- A bridge unit suspends between 2 other units with legs and is supported by their linking brackets
- A bridge unit is **not** freestanding and cannot be made freestanding
- Units with legs and links can only gang with a bridge. They **cannot** gang directly with another link unit with legs
- Bridges **cannot** gang directly with another bridge

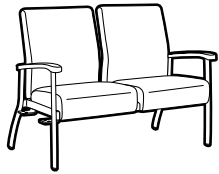

1, 2 or 3 seat chair with integrated ganging bracket

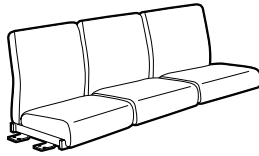

Any seating bridge unit connects to:



1, 2 or 3 seat bench with integrated ganging bracket



1, 2 or 3 seat chair with integrated ganging bracket



Any table bridge unit connects to:

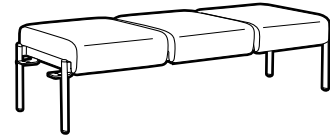

1, 2 or 3 seat bench with integrated ganging bracket

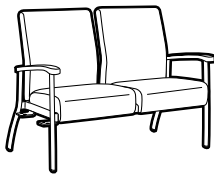

1, 2 or 3 seat chair with integrated ganging bracket



CANNOT connect to



1, 2 or 3 seat chair with integrated ganging bracket



Any table bridge unit



CANNOT connect to

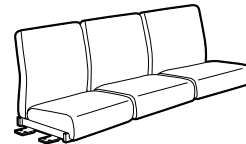

Any seating bridge unit



Any seating bridge unit



CANNOT connect to

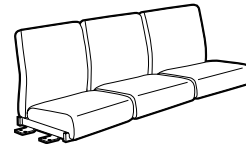

Any seating bridge unit



Any table bridge unit



CANNOT connect to

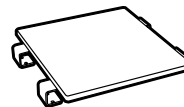

Any table bridge unit

PACKAGE 1



Description
Low Back Three Seat Chair

Qty	Model Number	Dimensions	Ydg.	Freight Class	Wt./Lbs.	Cu. Ft.	List Price
4	GC4235	26 x 74.5 x 37.5	5	250	142	65.25	\$4548

PACKAGE TOTAL **\$18,192**
 (* Please Note: List Prices shown are for the standard Grade 2 vinyl/standard finishes.)

PACKAGE 2



Description
Low Back Three Seat Chair
Low Back Armchair, Left
Low Back Armchair, Right
End Corner Table Bridge

Qty	Model Number	Dimensions	Ydg.	Freight Class	Wt./Lbs.	Cu. Ft.	List Price
1	GC4233B	26 x 72.75 x 37.5	5	250	134	65.25	\$4023
1	GC4231L	28 x 26.5 x 37.5	1.75	250	53.5	20.25	\$1851
1	GC4231R	28 x 26.5 x 37.5	1.75	250	53.5	20.25	\$1851
2	GC4277-HP	35 x 35 x 16	--	125	45	6	\$1011

PACKAGE TOTAL **\$9747**
 (* Please Note: List Prices shown are for the standard Grade 2 vinyl/standard laminate.)

PACKAGE 3

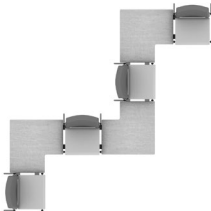

Description
Low Back Armless Chair
Low Back Armless Chair, Right
Low Back Armless Chair, Left
End Corner Table Bridge

Qty	Model Number	Dimensions	Ydg.	Freight Class	Wt./Lbs.	Cu. Ft.	List Price
2	GC4230B	28 x 26.75 x 37.5	1.75	250	45.5	20.25	\$1535
1	GC4230R	28 x 25.75 x 37.5	1.75	250	45.5	20.25	\$1489
1	GC4230L	28 x 25.75 x 37.5	1.75	250	45.5	20.25	\$1489
3	GC4277-HP	35 x 35 x 16	--	125	45	6	\$1011

PACKAGE TOTAL **\$9081**
 (* Please Note: List Prices shown are for the standard Grade 2 vinyl/standard laminate.)



PACKAGE 4



Description
Low Back Three Seat Chair
Bariatric Low Back Armchair, Left
Low Back Armchair, Left
Low Back Armchair, Right
End Corner Table Bridge
Rectangular Coffee Table
Square Table Top

Qty	Model Number	Dimensions	Ydg.	Freight Class	Wt./Lbs.	Cu. Ft.	List Price
1	GC4235R	26 x 74.5 x 37.5	5	250	143	65.25	\$4595
1	GC4241L	28 x 37.5 x 37.5	3	250	71	30.5	\$2413
1	GC4231L	28 x 26.5 x 37.5	1.75	250	53.5	20.25	\$1851
1	GC4231R	28 x 26.5 x 37.5	1.75	250	53.5	20.25	\$1851
1	GC4277-HP	35 x 35 x 16	--	125	45	6	\$1011
1	GC4283-HP	54 x 22 x 16	--	125	37	6	\$1455
1	GC4275-HP	23 x 23 x 1	--	150	18	3.4	\$626

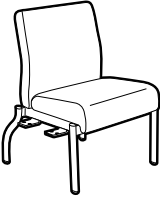
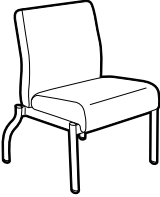
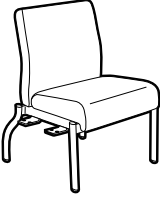
PACKAGE TOTAL **\$13,802**
 (* Please Note: List Prices shown are for the standard Grade 2 vinyl/standard laminate.)

DESCRIPTION	MODEL#	STANDARD FABRIC GRADES											
		COM	2	3	4	5	6	7	8	9	10	11	12
 <p>Low Back Chair Armless COM Yardage: 1.75 Freight Class: 250 Product Weight (lbs.): 45.5 Cubic Feet Per Carton: 20.25</p>	GC4230	\$1384	\$1441	\$1495	\$1567	\$1669	\$1708	\$1801	\$1972	\$2055	\$2214	\$2432	\$2703
		OVERALL DIMENSIONS			SEAT DIMENSIONS			BACK DIMENSIONS					
		W	D	H	W	D	H	W	H				
Active weight 500 lbs.		24.75	28	37.5	22	18	18	21.5	19.5				
 <p>Low Back Chair Armless, Right COM Yardage: 1.75 Freight Class: 250 Product Weight (lbs.): 45.5 Cubic Feet Per Carton: 20.25</p>	GC4230R	\$1429	\$1489	\$1541	\$1614	\$1716	\$1755	\$1847	\$2019	\$2103	\$2261	\$2479	\$2749
		OVERALL DIMENSIONS			SEAT DIMENSIONS			BACK DIMENSIONS					
		W	D	H	W	D	H	W	H				
Active weight 500 lbs.		25.75	28	37.5	22	18	18	21.5	19.5				
 <p>Low Back Chair Armless, Left COM Yardage: 1.75 Freight Class: 250 Product Weight (lbs.): 45.5 Cubic Feet Per Carton: 20.25</p>	GC4230L	\$1429	\$1489	\$1541	\$1614	\$1716	\$1755	\$1847	\$2019	\$2103	\$2261	\$2479	\$2749
		OVERALL DIMENSIONS			SEAT DIMENSIONS			BACK DIMENSIONS					
		W	D	H	W	D	H	W	H				
Active weight 500 lbs.		25.75	28	37.5	22	18	18	21.5	19.5				
 <p>Low Back Chair Armless, Left & Right COM Yardage: 1.75 Freight Class: 250 Product Weight (lbs.): 45.5 Cubic Feet Per Carton: 20.25</p>	GC4230B	\$1475	\$1535	\$1587	\$1660	\$1762	\$1802	\$1893	\$2065	\$2149	\$2307	\$2526	\$2795
		OVERALL DIMENSIONS			SEAT DIMENSIONS			BACK DIMENSIONS					
		W	D	H	W	D	H	W	H				
Active weight 500 lbs.		26.75	28	37.5	22	18	18	21.5	19.5				
 <p>High Back Chair Armless COM Yardage: 2 Freight Class: 250 Product Weight (lbs.): 49.5 Cubic Feet Per Carton: 20.25</p>	GC4230HB	\$1456	\$1522	\$1582	\$1665	\$1782	\$1827	\$1930	\$2125	\$2222	\$2403	\$2653	\$2962
		OVERALL DIMENSIONS			SEAT DIMENSIONS			BACK DIMENSIONS					
		W	D	H	W	D	H	W	H				
Active weight 500 lbs.		24.75	28	42.5	22	18	18	21.5	24.5				

SEATING

GC-BELONG

G

DESCRIPTION	MODEL#	STANDARD FABRIC GRADES											
-------------	--------	------------------------	--	--	--	--	--	--	--	--	--	--	--



MODEL#	COM	2	3	4	5	6	7	8	9	10	11	12
GC4230HBR	\$1504	\$1570	\$1630	\$1713	\$1830	\$1877	\$1979	\$2173	\$2270	\$2451	\$2702	\$3011

OVERALL DIMENSIONS			SEAT DIMENSIONS			BACK DIMENSIONS	
W	D	H	W	D	H	W	H
25.75	28	42.5	22	18	18	21.5	24.5

High Back Chair Armless, Right
COM Yardage: 2
Freight Class: 250
Product Weight (lbs.): 49.5
Cubic Feet Per Carton: 20.25

Active weight 500 lbs.



MODEL#	COM	2	3	4	5	6	7	8	9	10	11	12
GC4230HBL	\$1504	\$1570	\$1630	\$1713	\$1830	\$1877	\$1979	\$2173	\$2270	\$2451	\$2702	\$3011

OVERALL DIMENSIONS			SEAT DIMENSIONS			BACK DIMENSIONS	
W	D	H	W	D	H	W	H
25.75	28	42.5	22	18	18	21.5	24.5

High Back Chair Armless, Left
COM Yardage: 2
Freight Class: 250
Product Weight (lbs.): 49.5
Cubic Feet Per Carton: 20.25

Active weight 500 lbs.



MODEL#	COM	2	3	4	5	6	7	8	9	10	11	12
GC4230HBB	\$1550	\$1616	\$1677	\$1759	\$1878	\$1923	\$2025	\$2220	\$2316	\$2498	\$2748	\$3057

OVERALL DIMENSIONS			SEAT DIMENSIONS			BACK DIMENSIONS	
W	D	H	W	D	H	W	H
26.75	28	42.5	22	18	18	21.5	24.5

High Back Chair Armless, Left & Right
COM Yardage: 2
Freight Class: 250
Product Weight (lbs.): 51.5
Cubic Feet Per Carton: 20.25

Active weight 500 lbs.

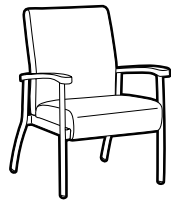

MODEL#	COM	2	3	4	5	6	7	8	9	10	11	12
GC4231	\$1686	\$1744	\$1796	\$1869	\$1972	\$2010	\$2102	\$2274	\$2358	\$2517	\$2735	\$3004

OVERALL DIMENSIONS			SEAT DIMENSIONS			BACK DIMENSIONS	
W	D	H	W	D	H	W	H
26.5	28	37.5	22	18	18	21.5	19.5

Low Back Armchair
COM Yardage: 1.75
Freight Class: 250
Product Weight (lbs.): 53.5
Cubic Feet Per Carton: 20.25

Active weight 500 lbs.
Wood armcap option - **Add \$179**

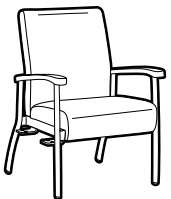

MODEL#	COM	2	3	4	5	6	7	8	9	10	11	12
GC4231R	\$1791	\$1851	\$1903	\$1976	\$2078	\$2117	\$2209	\$2381	\$2465	\$2623	\$2841	\$3111

OVERALL DIMENSIONS			SEAT DIMENSIONS			BACK DIMENSIONS	
W	D	H	W	D	H	W	H
26.5	28	37.5	22	18	18	21.5	19.5

Low Back Armchair Right
COM Yardage: 1.75
Freight Class: 250
Product Weight (lbs.): 53.5
Cubic Feet Per Carton: 20.25

Active weight 500 lbs.
Wood armcap option - **Add \$179**

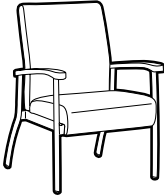
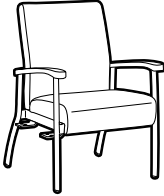
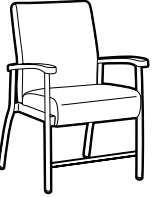
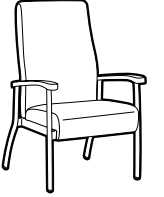
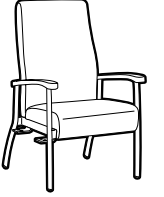
DESCRIPTION	MODEL#	STANDARD FABRIC GRADES											
		COM	2	3	4	5	6	7	8	9	10	11	12
 <p>Low Back Armchair Left COM Yardage: 1.75 Freight Class: 250 Product Weight (lbs.): 53.5 Cubic Feet Per Carton: 20.25</p>	GC4231L	\$1791	\$1851	\$1903	\$1976	\$2078	\$2117	\$2209	\$2381	\$2465	\$2623	\$2841	\$3111
		OVERALL DIMENSIONS			SEAT DIMENSIONS			BACK DIMENSIONS					
		W	D	H	W	D	H	W	H				
Active weight 500 lbs. Wood armcap option - Add \$179		26.5	28	37.5	22	18	18	21.5	19.5				
 <p>Low Back Armchair Left & Right COM Yardage: 1.75 Freight Class: 250 Product Weight (lbs.): 53.5 Cubic Feet Per Carton: 20.25</p>	GC4231B	\$1836	\$1896	\$1948	\$2022	\$2123	\$2163	\$2254	\$2426	\$2510	\$2668	\$2887	\$3158
		OVERALL DIMENSIONS			SEAT DIMENSIONS			BACK DIMENSIONS					
		W	D	H	W	D	H	W	H				
Active weight 500 lbs. Wood armcap option - Add \$179		26.5	28	37.5	22	18	18	21.5	19.5				
 <p>Low Back Armchair Post Surgery. Designed to immobilize the pelvis and hip joints after surgery. COM Yardage: 1.75 Freight Class: 250 Product Weight (lbs.): 57.5 Cubic Feet Per Carton: 24.25</p>	GC4231-24 24" Seat Height	\$2011	\$2069	\$2121	\$2194	\$2297	\$2335	\$2427	\$2599	\$2683	\$2842	\$3059	\$3329
		OVERALL DIMENSIONS			SEAT DIMENSIONS			BACK DIMENSIONS					
		W	D	H	W	D	H	W	H				
Active weight 500 lbs. Wood armcap option - Add \$179		26.5	28.75	43.5	22	18	24	21.5	19.5				
 <p>High Back Armchair COM Yardage: 2 Freight Class: 250 Product Weight (lbs.): 58.5 Cubic Feet Per Carton: 20.25</p>	GC4231HB	\$1799	\$1863	\$1926	\$2008	\$2126	\$2171	\$2272	\$2468	\$2564	\$2746	\$2996	\$3306
		OVERALL DIMENSIONS			SEAT DIMENSIONS			BACK DIMENSIONS					
		W	D	H	W	D	H	W	H				
Active weight 500 lbs. Wood armcap option - Add \$179		26.5	28	42.5	22	18	18	21.5	24.5				
 <p>High Back Armchair Right COM Yardage: 2 Freight Class: 250 Product Weight (lbs.): 58.5 Cubic Feet Per Carton: 20.25</p>	GC4231HBR	\$1845	\$1911	\$1972	\$2054	\$2173	\$2218	\$2320	\$2515	\$2612	\$2793	\$3043	\$3352
		OVERALL DIMENSIONS			SEAT DIMENSIONS			BACK DIMENSIONS					
		W	D	H	W	D	H	W	H				
Active weight 500 lbs. Wood armcap option - Add \$179		26.5	28	42.5	22	18	18	21.5	24.5				

SEATING

GC-BELONG

G

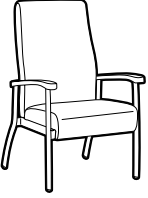
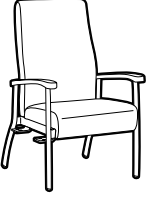
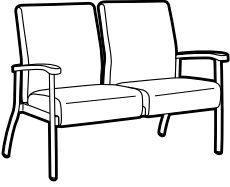
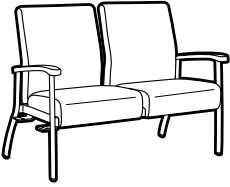
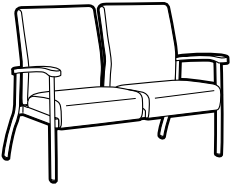
DESCRIPTION	MODEL#	STANDARD FABRIC GRADES											
		COM	2	3	4	5	6	7	8	9	10	11	12
 <p>High Back Armchair Left COM Yardage: 2 Freight Class: 250 Product Weight (lbs.): 58.5 Cubic Feet Per Carton: 20.25</p>	GC4231HBL	\$1845	\$1911	\$1972	\$2054	\$2173	\$2218	\$2320	\$2515	\$2612	\$2793	\$3043	\$3352
		OVERALL DIMENSIONS			SEAT DIMENSIONS			BACK DIMENSIONS					
		W	D	H	W	D	H	W	H				
		26.5	28	42.5	22	18	18	21.5	24.5				
 <p>High Back Armchair Left & Right COM Yardage: 2 Freight Class: 250 Product Weight (lbs.): 60.5 Cubic Feet Per Carton: 20.25</p>	GC4231HBB	\$1890	\$1955	\$2015	\$2098	\$2215	\$2260	\$2363	\$2558	\$2655	\$2836	\$3086	\$3395
		OVERALL DIMENSIONS			SEAT DIMENSIONS			BACK DIMENSIONS					
		W	D	H	W	D	H	W	H				
		26.5	28	42.5	22	18	18	21.5	24.5				
 <p>Low Back Two Seat Chair No Center Arm COM Yardage: 3.5 Freight Class: 250 Product Weight (lbs.): 94 Cubic Feet Per Carton: 43</p>	GC4232	\$2724	\$2841	\$2945	\$3089	\$3295	\$3375	\$3556	\$3896	\$4068	\$4380	\$4820	\$5359
		OVERALL DIMENSIONS			SEAT DIMENSIONS			BACK DIMENSIONS					
		W	D	H	W	D	H	W	H				
		49.75	26	37.5	44	18	18	44	19.5				
 <p>Low Back Two Seat Chair No Center Arm, Right COM Yardage: 3.5 Freight Class: 250 Product Weight (lbs.): 95 Cubic Feet Per Carton: 43</p>	GC4232R	\$2767	\$2886	\$2988	\$3132	\$3339	\$3419	\$3600	\$3939	\$4110	\$4424	\$4864	\$5403
		OVERALL DIMENSIONS			SEAT DIMENSIONS			BACK DIMENSIONS					
		W	D	H	W	D	H	W	H				
		49.75	26	37.5	44	18	18	44	19.5				
 <p>Low Back Two Seat Chair No Center Arm, Left COM Yardage: 3.5 Freight Class: 250 Product Weight (lbs.): 95 Cubic Feet Per Carton: 43</p>	GC4232L	\$2767	\$2886	\$2988	\$3132	\$3339	\$3419	\$3600	\$3939	\$4110	\$4424	\$4864	\$5403
		OVERALL DIMENSIONS			SEAT DIMENSIONS			BACK DIMENSIONS					
		W	D	H	W	D	H	W	H				
		49.75	26	37.5	44	18	18	44	19.5				

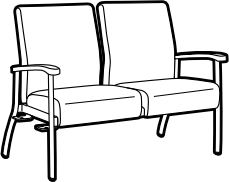
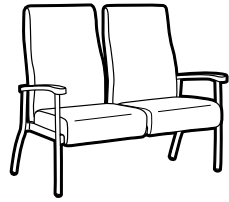
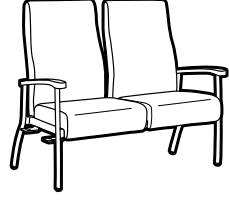
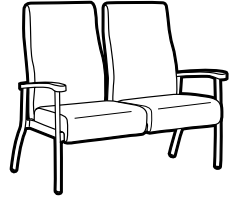
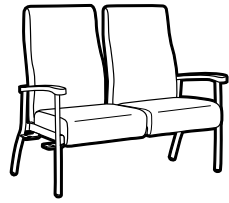
DESCRIPTION	MODEL#	STANDARD FABRIC GRADES											
		COM	2	3	4	5	6	7	8	9	10	11	12
 <p>Low Back Two Seat Chair No Center Arm, Left & Right COM Yardage: 3.5 Freight Class: 250 Product Weight (lbs.): 96 Cubic Feet Per Carton: 43</p>	GC4232B	\$2812	\$2931	\$3031	\$3177	\$3384	\$3463	\$3643	\$3983	\$4152	\$4468	\$4907	\$5448
		OVERALL DIMENSIONS			SEAT DIMENSIONS			BACK DIMENSIONS					
		W	D	H	W	D	H	W	H				
			49.75	26	37.5	44	18	18	44	19.5			
 <p>High Back Two Seat Chair No Center Arm COM Yardage: 4 Freight Class: 300 Product Weight (lbs.): 95 Cubic Feet Per Carton: 56.5</p>	GC4232HB	\$2920	\$3056	\$3171	\$3338	\$3574	\$3662	\$3870	\$4257	\$4454	\$4814	\$5316	\$5935
		OVERALL DIMENSIONS			SEAT DIMENSIONS			BACK DIMENSIONS					
		W	D	H	W	D	H	W	H				
			49.75	26	42.5	44	18	18	44	24.5			
 <p>High Back Two Seat Chair No Center Arm, Right COM Yardage: 4 Freight Class: 300 Product Weight (lbs.): 96 Cubic Feet Per Carton: 56.5</p>	GC4232HBR	\$2962	\$3099	\$3216	\$3381	\$3617	\$3705	\$3913	\$4300	\$4497	\$4857	\$5359	\$5978
		OVERALL DIMENSIONS			SEAT DIMENSIONS			BACK DIMENSIONS					
		W	D	H	W	D	H	W	H				
			49.75	26	42.5	44	18	18	44	24.5			
 <p>High Back Two Seat Chair No Center Arm, Left COM Yardage: 4 Freight Class: 300 Product Weight (lbs.): 96 Cubic Feet Per Carton: 56.5</p>	GC4232HBL	\$2962	\$3099	\$3216	\$3381	\$3617	\$3705	\$3913	\$4300	\$4497	\$4857	\$5359	\$5978
		OVERALL DIMENSIONS			SEAT DIMENSIONS			BACK DIMENSIONS					
		W	D	H	W	D	H	W	H				
			49.75	26	42.5	44	18	18	44	24.5			
 <p>High Back Two Seat Chair No Center Arm, Left & Right COM Yardage: 4 Freight Class: 300 Product Weight (lbs.): 98 Cubic Feet Per Carton: 56.5</p>	GC4232HBB	\$3007	\$3144	\$3259	\$3426	\$3660	\$3749	\$3957	\$4344	\$4541	\$4899	\$5403	\$6021
		OVERALL DIMENSIONS			SEAT DIMENSIONS			BACK DIMENSIONS					
		W	D	H	W	D	H	W	H				
			49.75	26	42.5	44	18	18	44	24.5			

SEATING

GC-BELONG

G

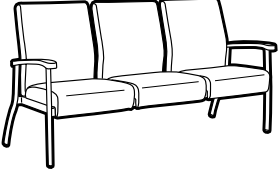
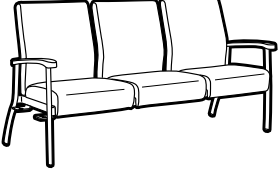
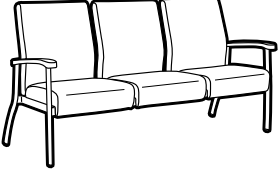
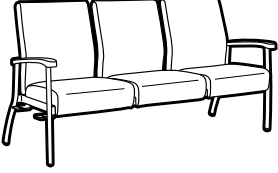
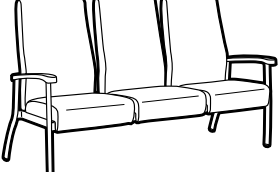
DESCRIPTION	MODEL#	STANDARD FABRIC GRADES											
		COM	2	3	4	5	6	7	8	9	10	11	12
 <p>Low Back Three Seat Chair No Center Arm COM Yardage: 5 Freight Class: 250 Product Weight (lbs.): 132 Cubic Feet Per Carton: 65.25</p>	GC4233	\$3763	\$3934	\$4076	\$4282	\$4576	\$4689	\$4948	\$5432	\$5674	\$6126	\$6753	\$7530
		OVERALL DIMENSIONS			SEAT DIMENSIONS			BACK DIMENSIONS					
		W	D	H	W	D	H	W	H				
			72.75	26	37.5	70	18	18		70	19.5		
Active weight 500 lbs./seat. Wood armcap option - Add \$179													
 <p>Low Back Three Seat Chair No Center Arm, Right COM Yardage: 5 Freight Class: 250 Product Weight (lbs.): 134 Cubic Feet Per Carton: 65.25</p>	GC4233R	\$3807	\$3978	\$4121	\$4329	\$4621	\$4734	\$4992	\$5479	\$5721	\$6172	\$6799	\$7575
		OVERALL DIMENSIONS			SEAT DIMENSIONS			BACK DIMENSIONS					
		W	D	H	W	D	H	W	H				
			72.75	26	37.5	70	18	18		70	19.5		
Active weight 500 lbs./seat. Wood armcap option - Add \$179													
 <p>Low Back Three Seat Chair No Center Arm, Left COM Yardage: 5 Freight Class: 250 Product Weight (lbs.): 134 Cubic Feet Per Carton: 65.25</p>	GC4233L	\$3807	\$3978	\$4121	\$4329	\$4621	\$4734	\$4992	\$5479	\$5721	\$6172	\$6799	\$7575
		OVERALL DIMENSIONS			SEAT DIMENSIONS			BACK DIMENSIONS					
		W	D	H	W	D	H	W	H				
			72.75	26	37.5	70	18	18		70	19.5		
Active weight 500 lbs./seat. Wood armcap option - Add \$179													
 <p>Low Back Three Seat Chair No Center Arm, Left & Right COM Yardage: 5 Freight Class: 250 Product Weight (lbs.): 134 Cubic Feet Per Carton: 65.25</p>	GC4233B	\$3854	\$4023	\$4166	\$4372	\$4667	\$4782	\$5038	\$5523	\$5769	\$6217	\$6844	\$7619
		OVERALL DIMENSIONS			SEAT DIMENSIONS			BACK DIMENSIONS					
		W	D	H	W	D	H	W	H				
			72.75	26	37.5	70	18	18		70	19.5		
Active weight 500 lbs./seat. Wood armcap option - Add \$179													
 <p>High Back Three Seat Chair No Center Arm COM Yardage: 5.75 Freight Class: 300 Product Weight (lbs.): 138 Cubic Feet Per Carton: 80.75</p>	GC4233HB	\$3987	\$4182	\$4347	\$4586	\$4924	\$5055	\$5350	\$5907	\$6189	\$6709	\$7430	\$8318
		OVERALL DIMENSIONS			SEAT DIMENSIONS			BACK DIMENSIONS					
		W	D	H	W	D	H	W	H				
			72.75	26	42.5	70	18	18		70	24.5		
Active weight 500 lbs./seat. Wood armcap option - Add \$179													

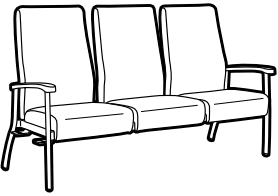
DESCRIPTION	MODEL#	STANDARD FABRIC GRADES											
		COM	2	3	4	5	6	7	8	9	10	11	12
 <p>High Back Three Seat Chair No Center Arm, Right COM Yardage: 5.75 Freight Class: 300 Product Weight (lbs.): 140 Cubic Feet Per Carton: 80.75</p>	GC4233HBR	\$4032	\$4228	\$4392	\$4631	\$4969	\$5099	\$5394	\$5954	\$6232	\$6752	\$7475	\$8364
		OVERALL DIMENSIONS			SEAT DIMENSIONS			BACK DIMENSIONS					
		W	D	H	W	D	H	W	H				
			72.75	26	42.5	70	18	18	70	24.5			

Active weight 500 lbs./seat.
Wood armcap option - **Add \$179**

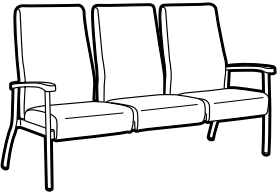
 <p>High Back Three Seat Chair No Center Arm, Left COM Yardage: 5.75 Freight Class: 300 Product Weight (lbs.): 140 Cubic Feet Per Carton: 80.75</p>	GC4233HBL	\$4032	\$4228	\$4392	\$4631	\$4969	\$5099	\$5394	\$5954	\$6232	\$6752	\$7475	\$8364
		OVERALL DIMENSIONS			SEAT DIMENSIONS			BACK DIMENSIONS					
		W	D	H	W	D	H	W	H				
			72.75	26	42.5	70	18	18	70	24.5			

Active weight 500 lbs./seat.
Wood armcap option - **Add \$179**

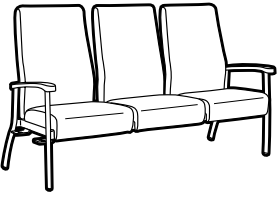
 <p>High Back Three Seat Chair No Center Arm, Left & Right COM Yardage: 5.75 Freight Class: 300 Product Weight (lbs.): 140 Cubic Feet Per Carton: 80.75</p>	GC4233HBB	\$4075	\$4271	\$4435	\$4674	\$5012	\$5142	\$5439	\$5996	\$6275	\$6795	\$7518	\$8407
		OVERALL DIMENSIONS			SEAT DIMENSIONS			BACK DIMENSIONS					
		W	D	H	W	D	H	W	H				
			72.75	26	42.5	70	18	18	70	24.5			

Active weight 500 lbs./seat.
Wood armcap option - **Add \$179**

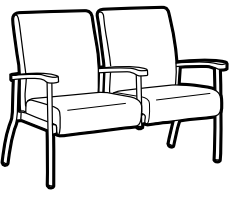
 <p>Low Back Two Seat Chair Half Center Arm COM Yardage: 3.5 Freight Class: 250 Product Weight (lbs.): 100 Cubic Feet Per Carton: 43</p>	GC4234	\$3075	\$3195	\$3297	\$3441	\$3648	\$3727	\$3907	\$4247	\$4416	\$4732	\$5171	\$5712
		OVERALL DIMENSIONS			SEAT DIMENSIONS			BACK DIMENSIONS					
		W	D	H	W	D	H	W	H				
			50.75	26	37.5	22	18	18	21.5	19.5			

Active weight 500 lbs./seat.
Wood armcap option - **Add \$264**

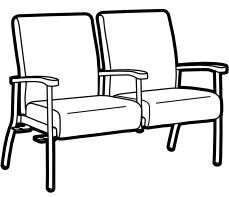
 <p>Low Back Two Seat Chair Half Center Arm, Right COM Yardage: 3.5 Freight Class: 250 Product Weight (lbs.): 101 Cubic Feet Per Carton: 43</p>	GC4234R	\$3120	\$3237	\$3339	\$3483	\$3690	\$3770	\$3950	\$4290	\$4461	\$4775	\$5215	\$5754
		OVERALL DIMENSIONS			SEAT DIMENSIONS			BACK DIMENSIONS					
		W	D	H	W	D	H	W	H				
			50.75	26	37.5	22	18	18	21.5	19.5			

Active weight 500 lbs./seat.
Wood armcap option - **Add \$264**

SEATING

GC-BELONG

G

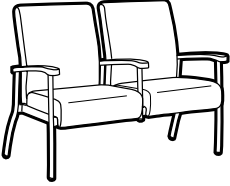
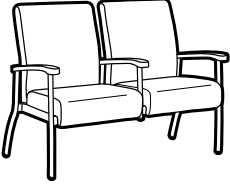
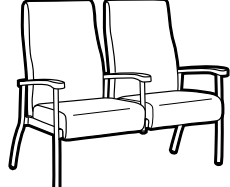
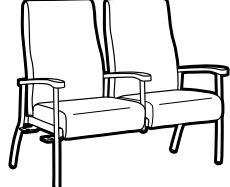
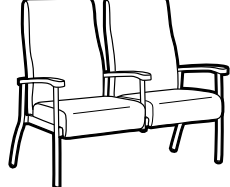
DESCRIPTION	MODEL#	STANDARD FABRIC GRADES											
		COM	2	3	4	5	6	7	8	9	10	11	12
 <p>Low Back Two Seat Chair Half Center Arm, Left COM Yardage: 3.5 Freight Class: 250 Product Weight (lbs.): 101 Cubic Feet Per Carton: 43</p>	GC4234L	\$3120	\$3237	\$3339	\$3483	\$3690	\$3770	\$3950	\$4290	\$4461	\$4775	\$5215	\$5754
		OVERALL DIMENSIONS			SEAT DIMENSIONS			BACK DIMENSIONS					
		W	D	H	W	D	H	W	H				
			50.75	26	37.5	22	18	18	21.5	19.5			
 <p>Low Back Two Seat Chair Half Center Arm, Left & Right COM Yardage: 3.5 Freight Class: 250 Product Weight (lbs.): 102 Cubic Feet Per Carton: 43</p>	GC4234B	\$3165	\$3284	\$3386	\$3532	\$3737	\$3817	\$3997	\$4337	\$4507	\$4822	\$5261	\$5801
		OVERALL DIMENSIONS			SEAT DIMENSIONS			BACK DIMENSIONS					
		W	D	H	W	D	H	W	H				
			50.75	26	37.5	22	18	18	21.5	19.5			
 <p>High Back Two Seat Chair Half Center Arm COM Yardage: 4 Freight Class: 300 Product Weight (lbs.): 104 Cubic Feet Per Carton: 56.5</p>	GC4234HB	\$3349	\$3486	\$3601	\$3767	\$4004	\$4092	\$4300	\$4687	\$4883	\$5244	\$5745	\$6363
		OVERALL DIMENSIONS			SEAT DIMENSIONS			BACK DIMENSIONS					
		W	D	H	W	D	H	W	H				
			50.75	26	42.5	22	18	18	21.5	24.5			
 <p>High Back Two Seat Chair Half Center Arm, Right COM Yardage: 4 Freight Class: 300 Product Weight (lbs.): 104 Cubic Feet Per Carton: 56.5</p>	GC4234HBR	\$3396	\$3533	\$3650	\$3815	\$4051	\$4140	\$4347	\$4734	\$4931	\$5291	\$5793	\$6412
		OVERALL DIMENSIONS			SEAT DIMENSIONS			BACK DIMENSIONS					
		W	D	H	W	D	H	W	H				
			50.75	26	42.5	22	18	18	21.5	24.5			
 <p>High Back Two Seat Chair Half Center Arm, Left COM Yardage: 4 Freight Class: 300 Product Weight (lbs.): 104 Cubic Feet Per Carton: 56.5</p>	GC4234HBL	\$3396	\$3533	\$3650	\$3815	\$4051	\$4140	\$4347	\$4734	\$4931	\$5291	\$5793	\$6412
		OVERALL DIMENSIONS			SEAT DIMENSIONS			BACK DIMENSIONS					
		W	D	H	W	D	H	W	H				
			50.75	26	42.5	22	18	18	21.5	24.5			

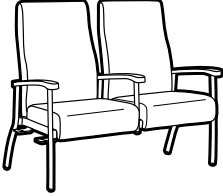
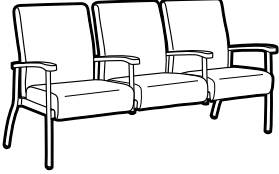
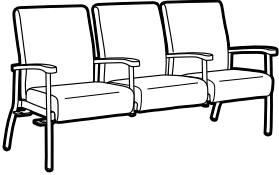
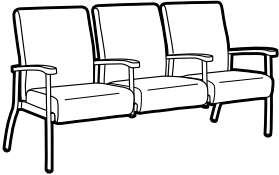
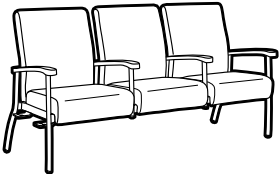
DESCRIPTION	MODEL#	STANDARD FABRIC GRADES											
		COM	2	3	4	5	6	7	8	9	10	11	12
 <p>High Back Two Seat Chair Half Center Arm, Left & Right COM Yardage: 4 Freight Class: 300 Product Weight (lbs.): 108 Cubic Feet Per Carton: 56.5</p>	GC4234HBB	\$3443	\$3580	\$3695	\$3862	\$4098	\$4186	\$4393	\$4780	\$4977	\$5338	\$5839	\$6457
		OVERALL DIMENSIONS			SEAT DIMENSIONS			BACK DIMENSIONS					
		W	D	H	W	D	H	W	H				
			50.75	26	42.5	22	18	18	21.5	24.5			
 <p>Low Back Three Seat Chair Half Center Arms COM Yardage: 5 Freight Class: 250 Product Weight (lbs.): 142 Cubic Feet Per Carton: 65.25</p>	GC4235	\$4379	\$4548	\$4693	\$4901	\$5192	\$5307	\$5564	\$6050	\$6294	\$6744	\$7371	\$8147
		OVERALL DIMENSIONS			SEAT DIMENSIONS			BACK DIMENSIONS					
		W	D	H	W	D	H	W	H				
			74.5	26	37.5	22	18	18	21.5	19.5			
 <p>Low Back Three Seat Chair Half Center Arms, Right COM Yardage: 5 Freight Class: 250 Product Weight (lbs.): 143 Cubic Feet Per Carton: 65.25</p>	GC4235R	\$4424	\$4595	\$4738	\$4946	\$5239	\$5354	\$5610	\$6097	\$6340	\$6791	\$7418	\$8193
		OVERALL DIMENSIONS			SEAT DIMENSIONS			BACK DIMENSIONS					
		W	D	H	W	D	H	W	H				
			74.5	26	37.5	22	18	18	21.5	19.5			
 <p>Low Back Three Seat Chair Half Center Arms, Left COM Yardage: 5 Freight Class: 250 Product Weight (lbs.): 143 Cubic Feet Per Carton: 65.25</p>	GC4235L	\$4424	\$4595	\$4738	\$4946	\$5239	\$5354	\$5610	\$6097	\$6340	\$6791	\$7418	\$8193
		OVERALL DIMENSIONS			SEAT DIMENSIONS			BACK DIMENSIONS					
		W	D	H	W	D	H	W	H				
			74.5	26	37.5	22	18	18	21.5	19.5			
 <p>Low Back Three Seat Chair Half Center Arms, Left & Right COM Yardage: 5 Freight Class: 250 Product Weight (lbs.): 144 Cubic Feet Per Carton: 65.25</p>	GC4235B	\$4468	\$4637	\$4780	\$4988	\$5281	\$5396	\$5652	\$6138	\$6383	\$6833	\$7460	\$8235
		OVERALL DIMENSIONS			SEAT DIMENSIONS			BACK DIMENSIONS					
		W	D	H	W	D	H	W	H				
			74.5	26	37.5	22	18	18	21.5	19.5			

SEATING

GC-BELONG

G

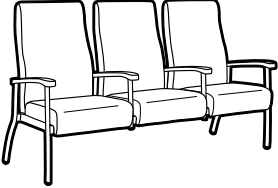
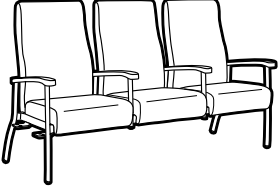
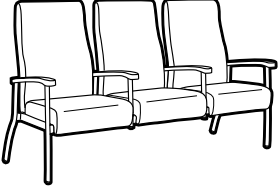
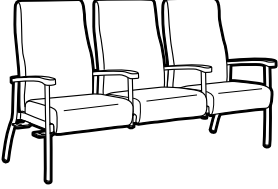
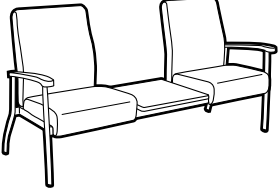
DESCRIPTION	MODEL#	STANDARD FABRIC GRADES											
		COM	2	3	4	5	6	7	8	9	10	11	12
 <p>High Back Three Seat Chair Half Center Arms COM Yardage: 5.75 Freight Class: 300 Product Weight (lbs.): 148 Cubic Feet Per Carton: 80.75</p>	GC4235HB	\$4637	\$4831	\$4998	\$5236	\$5575	\$5705	\$6001	\$6558	\$6840	\$7359	\$8080	\$8968
		OVERALL DIMENSIONS			SEAT DIMENSIONS			BACK DIMENSIONS					
		W	D	H	W	D	H	W	H				
			74.5	26	42.5	22	18	18	21.5	24.5			
 <p>High Back Three Seat Chair Half Center Arms, Right COM Yardage: 5.75 Freight Class: 300 Product Weight (lbs.): 159 Cubic Feet Per Carton: 80.75</p>	GC4235HBR	\$4682	\$4878	\$5040	\$5281	\$5618	\$5749	\$6044	\$6603	\$6882	\$7401	\$8125	\$9014
		OVERALL DIMENSIONS			SEAT DIMENSIONS			BACK DIMENSIONS					
		W	D	H	W	D	H	W	H				
			74.5	26	42.5	22	18	18	21.5	24.5			
 <p>High Back Three Seat Chair Half Center Arms, Left COM Yardage: 5.75 Freight Class: 300 Product Weight (lbs.): 159 Cubic Feet Per Carton: 80.75</p>	GC4235HBL	\$4682	\$4878	\$5040	\$5281	\$5618	\$5749	\$6044	\$6603	\$6882	\$7401	\$8125	\$9014
		OVERALL DIMENSIONS			SEAT DIMENSIONS			BACK DIMENSIONS					
		W	D	H	W	D	H	W	H				
			74.5	26	42.5	22	18	18	21.5	24.5			
 <p>High Back Three Seat Chair Half Center Arms, Left & Right COM Yardage: 5.75 Freight Class: 300 Product Weight (lbs.): 160 Cubic Feet Per Carton: 80.75</p>	GC4235HBB	\$4727	\$4923	\$5088	\$5327	\$5664	\$5794	\$6091	\$6648	\$6927	\$7447	\$8170	\$9059
		OVERALL DIMENSIONS			SEAT DIMENSIONS			BACK DIMENSIONS					
		W	D	H	W	D	H	W	H				
			74.5	26	42.5	22	18	18	21.5	24.5			
 <p>Low Back Two Seat Chair with Table Center Table Top, No Center Arms COM Yardage: 3.5 Freight Class: 300 Product Weight (lbs.): 106 Cubic Feet Per Carton: 65.25</p>	GC4236	\$3546	\$3665	\$3765	\$3911	\$4117	\$4196	\$4377	\$4716	\$4885	\$5201	\$5641	\$6182
		OVERALL DIMENSIONS			SEAT DIMENSIONS			BACK DIMENSIONS					
		W	D	H	W	D	H	W	H				
			72.75	26	37.5	44	18	18	44	19.5			

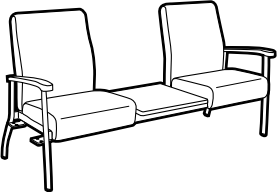
DESCRIPTION	MODEL#	STANDARD FABRIC GRADES											
		COM	2	3	4	5	6	7	8	9	10	11	12
 <p>Low Back Two Seat Chair with Table Center Table Top, No Center Arms, Right COM Yardage: 3.5 Freight Class: 300 Product Weight (lbs.): 107 Cubic Feet Per Carton: 65.25</p>	GC4236R	\$3590	\$3709	\$3809	\$3955	\$4161	\$4240	\$4421	\$4760	\$4930	\$5245	\$5686	\$6225
		OVERALL DIMENSIONS W D H			SEAT DIMENSIONS W D H			BACK DIMENSIONS W H					
		72.75	26	37.5	44	18	18	44	19.5				

Wood armcap option - **Add \$179**
 Active weight 500 lbs./seat.
 • Table top only offered in High Pressure Laminate

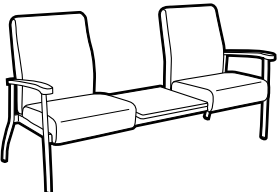
DESCRIPTION	MODEL#	STANDARD FABRIC GRADES											
		COM	2	3	4	5	6	7	8	9	10	11	12
 <p>Low Back Two Seat Chair with Table Center Table Top, No Center Arms, Left COM Yardage: 3.5 Freight Class: 300 Product Weight (lbs.): 107 Cubic Feet Per Carton: 65.25</p>	GC4236L	\$3590	\$3709	\$3809	\$3955	\$4161	\$4240	\$4421	\$4760	\$4930	\$5245	\$5686	\$6225
		OVERALL DIMENSIONS W D H			SEAT DIMENSIONS W D H			BACK DIMENSIONS W H					
		72.75	26	37.5	44	18	18	44	19.5				

Wood armcap option - **Add \$179**
 Active weight 500 lbs./seat.
 • Table top only offered in High Pressure Laminate

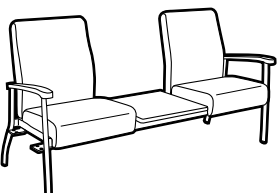
DESCRIPTION	MODEL#	STANDARD FABRIC GRADES											
		COM	2	3	4	5	6	7	8	9	10	11	12
 <p>Low Back Two Seat Chair with Table Center Table Top, No Center Arms, Left & Right COM Yardage: 3.5 Freight Class: 300 Product Weight (lbs.): 108 Cubic Feet Per Carton: 65.25</p>	GC4236B	\$3636	\$3755	\$3855	\$4000	\$4207	\$4287	\$4467	\$4807	\$4975	\$5292	\$5730	\$6272
		OVERALL DIMENSIONS W D H			SEAT DIMENSIONS W D H			BACK DIMENSIONS W H					
		72.75	26	37.5	44	18	18	44	19.5				

Wood armcap option - **Add \$179**
 Active weight 500 lbs./seat.
 • Table top only offered in High Pressure Laminate

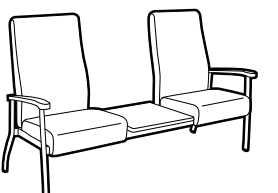
DESCRIPTION	MODEL#	STANDARD FABRIC GRADES											
		COM	2	3	4	5	6	7	8	9	10	11	12
 <p>High Back Two Seat Chair with Table Center Table Top, No Center Arms COM Yardage: 4 Freight Class: 300 Product Weight (lbs.): 110 Cubic Feet Per Carton: 80.75</p>	GC4236HB	\$3796	\$3932	\$4049	\$4214	\$4450	\$4539	\$4746	\$5135	\$5330	\$5690	\$6192	\$6811
		OVERALL DIMENSIONS W D H			SEAT DIMENSIONS W D H			BACK DIMENSIONS W H					
		72.75	26	42.5	44	18	18	44	24.5				

Wood armcap option - **Add \$179**
 Active weight 500 lbs./seat.
 • Table top only offered in High Pressure Laminate

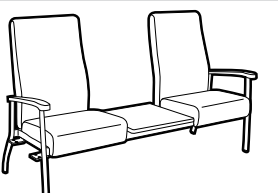

DESCRIPTION	MODEL#	STANDARD FABRIC GRADES											
		COM	2	3	4	5	6	7	8	9	10	11	12
 <p>High Back Two Seat Chair with Table Center Table Top, No Center Arms, Right COM Yardage: 4 Freight Class: 300 Product Weight (lbs.): 111 Cubic Feet Per Carton: 80.75</p>	GC4236HBR	\$3838	\$3975	\$4090	\$4257	\$4493	\$4581	\$4788	\$5175	\$5372	\$5733	\$6234	\$6852
		OVERALL DIMENSIONS W D H			SEAT DIMENSIONS W D H			BACK DIMENSIONS W H					
		72.75	26	42.5	44	18	18	44	24.5				

Wood armcap option - **Add \$179**
 Active weight 500 lbs./seat.
 • Table top only offered in High Pressure Laminate

SEATING

GC-BELONG

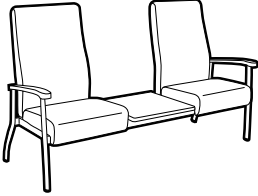
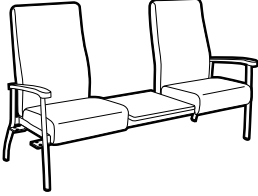
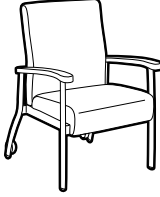
G

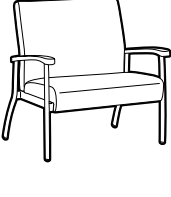
DESCRIPTION	MODEL#	STANDARD FABRIC GRADES											
		COM	2	3	4	5	6	7	8	9	10	11	12
 <p>High Back Two Seat Chair with Table Center Table Top, No Center Arms, Left COM Yardage: 4 Freight Class: 300 Product Weight (lbs.): 111 Cubic Feet Per Carton: 80.75</p>	GC4236HBL	\$3838	\$3975	\$4090	\$4257	\$4493	\$4581	\$4788	\$5175	\$5372	\$5733	\$6234	\$6852
		OVERALL DIMENSIONS			SEAT DIMENSIONS			BACK DIMENSIONS					
		W	D	H	W	D	H	W	H				
		72.75	26	42.5	44	18	18	44	24.5				
		Wood armcap option - Add \$179 Active weight 500 lbs./seat. • Table top only offered in High Pressure Laminate											
 <p>High Back Two Seat Chair with Table Center Table Top, No Center Arms, Left & Right COM Yardage: 4 Freight Class: 300 Product Weight (lbs.): 114 Cubic Feet Per Carton: 80.75</p>	GC4236HBB	\$3882	\$4019	\$4134	\$4301	\$4537	\$4624	\$4832	\$5220	\$5416	\$5777	\$6278	\$6896
		OVERALL DIMENSIONS			SEAT DIMENSIONS			BACK DIMENSIONS					
		W	D	H	W	D	H	W	H				
		72.75	26	42.5	44	18	18	44	24.5				
		Wood armcap option - Add \$179 Active weight 500 lbs./seat. • Table top only offered in High Pressure Laminate											
 <p>Low Back Armchair Casters COM Yardage: 1.75 Freight Class: 250 Product Weight (lbs.): 49 Cubic Feet Per Carton: 20.25</p>	GC4240	\$1963	\$2020	\$2074	\$2146	\$2248	\$2287	\$2380	\$2551	\$2634	\$2793	\$3011	\$3282
		OVERALL DIMENSIONS			SEAT DIMENSIONS			BACK DIMENSIONS					
		W	D	H	W	D	H	W	H				
		26.75	27.5	37.5	22	18	18	21.5	19.5				
		Active weight 500 lbs. Wood armcap option - Add \$179											
 <p>High Back Armchair Casters COM Yardage: 2 Freight Class: 250 Product Weight (lbs.): 54 Cubic Feet Per Carton: 22.25</p>	GC4240HB	\$2037	\$2103	\$2163	\$2246	\$2363	\$2408	\$2511	\$2706	\$2803	\$2984	\$3234	\$3543
		OVERALL DIMENSIONS			SEAT DIMENSIONS			BACK DIMENSIONS					
		W	D	H	W	D	H	W	H				
		26.75	27.5	42.5	22	18	18	21.5	24.5				
		Active weight 500 lbs. Wood armcap option - Add \$179											
 <p>Bariatric Low Back Armchair COM Yardage: 3 Freight Class: 250 Product Weight (lbs.): 70 Cubic Feet Per Carton: 30.5</p>	GC4241	\$2269	\$2370	\$2457	\$2583	\$2759	\$2825	\$2983	\$3273	\$3418	\$3690	\$4065	\$4530
		OVERALL DIMENSIONS			SEAT DIMENSIONS			BACK DIMENSIONS					
		W	D	H	W	D	H	W	H				
		37.5	28	37.5	32.5	18	18	32.5	19.5				
		Active weight 750 lbs. Wood armcap option - Add \$179 Armless Bariatric models are <u>not</u> available.											

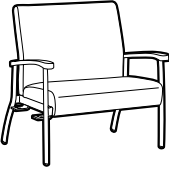
DESCRIPTION	MODEL#	STANDARD FABRIC GRADES											
		COM	2	3	4	5	6	7	8	9	10	11	12
 <p>Bariatric Low Back Armchair Right COM Yardage: 3 Freight Class: 250 Product Weight (lbs.): 71 Cubic Feet Per Carton: 30.5</p>	GC4241R	\$2311	\$2413	\$2501	\$2626	\$2802	\$2868	\$3026	\$3316	\$3462	\$3733	\$4109	\$4573
		OVERALL DIMENSIONS			SEAT DIMENSIONS			BACK DIMENSIONS					
		W	D	H	W	D	H	W	H				
		37.5	28	37.5	32.5	18	18	32.5	19.5				
		Active weight 750 lbs. Wood armcap option - Add \$179 <i>Armless Bariatric models are <u>not</u> available.</i>											

DESCRIPTION	MODEL#	STANDARD FABRIC GRADES											
		COM	2	3	4	5	6	7	8	9	10	11	12
 <p>Bariatric Low Back Armchair Left COM Yardage: 3 Freight Class: 250 Product Weight (lbs.): 71 Cubic Feet Per Carton: 30.5</p>	GC4241L	\$2311	\$2413	\$2501	\$2626	\$2802	\$2868	\$3026	\$3316	\$3462	\$3733	\$4109	\$4573
		OVERALL DIMENSIONS			SEAT DIMENSIONS			BACK DIMENSIONS					
		W	D	H	W	D	H	W	H				
		37.5	28	37.5	32.5	18	18	32.5	19.5				
		Active weight 750 lbs. Wood armcap option - Add \$179 <i>Armless Bariatric models are <u>not</u> available.</i>											

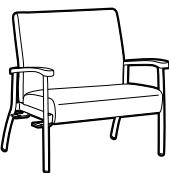
DESCRIPTION	MODEL#	STANDARD FABRIC GRADES											
		COM	2	3	4	5	6	7	8	9	10	11	12
 <p>Bariatric Low Back Armchair Left & Right COM Yardage: 3 Freight Class: 250 Product Weight (lbs.): 71 Cubic Feet Per Carton: 30.5</p>	GC4241B	\$2354	\$2456	\$2544	\$2670	\$2847	\$2912	\$3069	\$3360	\$3505	\$3777	\$4153	\$4616
		OVERALL DIMENSIONS			SEAT DIMENSIONS			BACK DIMENSIONS					
		W	D	H	W	D	H	W	H				
		37.5	28	37.5	32.5	18	18	32.5	19.5				
		Active weight 750 lbs. Wood armcap option - Add \$179 <i>Armless Bariatric models are <u>not</u> available.</i>											

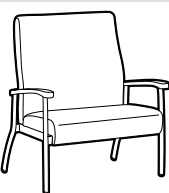
DESCRIPTION	MODEL#	STANDARD FABRIC GRADES											
		COM	2	3	4	5	6	7	8	9	10	11	12
 <p>Bariatric High Back Armchair COM Yardage: 3.25 Freight Class: 250 Product Weight (lbs.): 73 Cubic Feet Per Carton: 30.5</p>	GC4241HB	\$2577	\$2686	\$2780	\$2914	\$3108	\$3180	\$3349	\$3662	\$3820	\$4114	\$4522	\$5027
		OVERALL DIMENSIONS			SEAT DIMENSIONS			BACK DIMENSIONS					
		W	D	H	W	D	H	W	H				
		37.5	28	43	32.5	18	18	32.5	24.5				
		Active weight 750 lbs. Wood armcap option - Add \$179 <i>Armless Bariatric models are <u>not</u> available.</i>											

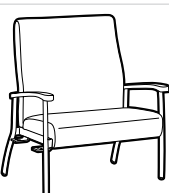
DESCRIPTION	MODEL#	STANDARD FABRIC GRADES											
		COM	2	3	4	5	6	7	8	9	10	11	12
 <p>Bariatric High Back Armchair Right COM Yardage: 3.25 Freight Class: 250 Product Weight (lbs.): 74 Cubic Feet Per Carton: 30.5</p>	GC4241HBR	\$2623	\$2733	\$2827	\$2965	\$3155	\$3227	\$3396	\$3709	\$3867	\$4162	\$4569	\$5074
		OVERALL DIMENSIONS			SEAT DIMENSIONS			BACK DIMENSIONS					
		W	D	H	W	D	H	W	H				
		37.5	28	43	32.5	18	18	32.5	24.5				
		Active weight 750 lbs. Wood armcap option - Add \$179 <i>Armless Bariatric models are <u>not</u> available.</i>											

SEATING

GC-BELONG

G

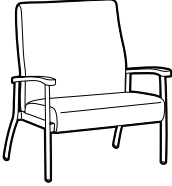
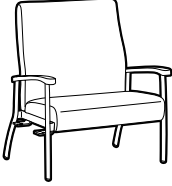
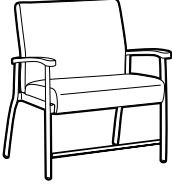
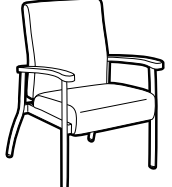
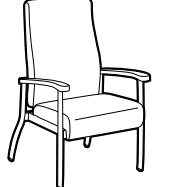
DESCRIPTION	MODEL#	STANDARD FABRIC GRADES											
		COM	2	3	4	5	6	7	8	9	10	11	12
 <p>Bariatric High Back Armchair Left COM Yardage: 3.25 Freight Class: 250 Product Weight (lbs.): 74 Cubic Feet Per Carton: 30.5</p>	GC4241HBL	\$2623	\$2733	\$2827	\$2965	\$3155	\$3227	\$3396	\$3709	\$3867	\$4162	\$4569	\$5074
		OVERALL DIMENSIONS			SEAT DIMENSIONS			BACK DIMENSIONS					
		W	D	H	W	D	H	W	H				
			37.5	28	43	32.5	18	18	32.5	24.5			
<p>Active weight 750 lbs. Wood armcap option - Add \$179</p> <p><i>Armless Bariatric models are <u>not</u> available.</i></p>													
 <p>Bariatric High Back Armchair Left & Right COM Yardage: 3.25 Freight Class: 250 Product Weight (lbs.): 74 Cubic Feet Per Carton: 30.50</p>	GC4241HBB	\$2669	\$2779	\$2873	\$3011	\$3202	\$3274	\$3443	\$3757	\$3913	\$4208	\$4618	\$5120
		OVERALL DIMENSIONS			SEAT DIMENSIONS			BACK DIMENSIONS					
		W	D	H	W	D	H	W	H				
			37.5	28	43	32.5	18	18	32.5	24.5			
<p>Active weight 750 lbs. Wood armcap option - Add \$179</p> <p><i>Armless Bariatric models are <u>not</u> available.</i></p>													
 <p>Bariatric Low Back Armchair Post Surgery. Designed to immobilize the pelvis and hip joints after surgery. COM Yardage: 3 Freight Class: 250 Product Weight (lbs.): 76 Cubic Feet Per Carton: 33.5</p>	GC4241-24 24" Seat Height	\$2646	\$2749	\$2836	\$2962	\$3138	\$3204	\$3360	\$3652	\$3797	\$4069	\$4445	\$4908
		OVERALL DIMENSIONS			SEAT DIMENSIONS			BACK DIMENSIONS					
		W	D	H	W	D	H	W	H				
			37.5	28.75	43.5	32.5	18	24	32.5	19.5			
<p>Wood armcap option - Add \$179 Active weight 750 lbs. <i>Armless Bariatric models are <u>not</u> available.</i></p>													
 <p>Low Back Armchair Flex Back COM Yardage: 1.75 Freight Class: 250 Product Weight (lbs.): 53 Cubic Feet Per Carton: 20.25</p>	GC4242	\$2340	\$2400	\$2452	\$2525	\$2627	\$2667	\$2758	\$2930	\$3014	\$3172	\$3391	\$3660
		OVERALL DIMENSIONS			SEAT DIMENSIONS			BACK DIMENSIONS					
		W	D	H	W	D	H	W	H				
			26.5	28	37.5	22	18	18	21.5	19.5			
<p>Active weight 500 lbs. Wood armcap option - Add \$179</p>													
 <p>High Back Armchair Flex Back COM Yardage: 2 Freight Class: 250 Product Weight (lbs.): 61 Cubic Feet Per Carton: 22.25</p>	GC4242HB	\$2416	\$2480	\$2543	\$2625	\$2743	\$2788	\$2892	\$3085	\$3181	\$3363	\$3613	\$3923
		OVERALL DIMENSIONS			SEAT DIMENSIONS			BACK DIMENSIONS					
		W	D	H	W	D	H	W	H				
			26.5	28	43	22	18	18	21.5	24.5			
<p>Active weight 500 lbs. Wood armcap option - Add \$179</p>													

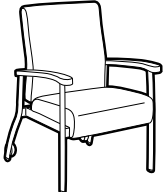

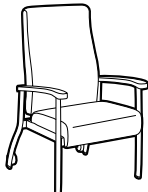
DESCRIPTION	MODEL#	STANDARD FABRIC GRADES																							
		COM	2	3	4	5	6	7	8	9	10	11	12												
 <p>Low Back Armchair Flex Back, Casters COM Yardage: 1.75 Freight Class: 250 Product Weight (lbs.): 49 Cubic Feet Per Carton: 20.25</p>	GC4243	\$2480	\$2538	\$2590	\$2663	\$2766	\$2804	\$2896	\$3068	\$3153	\$3311	\$3528	\$3798												
	<p>Active weight 500 lbs. Wood armcap option - Add \$179</p>	<table border="1"> <thead> <tr> <th colspan="3">OVERALL DIMENSIONS</th> <th colspan="3">SEAT DIMENSIONS</th> <th colspan="2">BACK DIMENSIONS</th> </tr> <tr> <th>W</th> <th>D</th> <th>H</th> <th>W</th> <th>D</th> <th>H</th> <th>W</th> <th>H</th> </tr> </thead> <tbody> <tr> <td>26.75</td> <td>27.5</td> <td>37.5</td> <td>22</td> <td>18</td> <td>18</td> <td>21.5</td> <td>19.5</td> </tr> </tbody> </table>	OVERALL DIMENSIONS			SEAT DIMENSIONS			BACK DIMENSIONS		W	D	H	W	D	H	W	H	26.75	27.5	37.5	22	18	18	21.5
OVERALL DIMENSIONS			SEAT DIMENSIONS			BACK DIMENSIONS																			
W	D	H	W	D	H	W	H																		
26.75	27.5	37.5	22	18	18	21.5	19.5																		

DESCRIPTION	MODEL#	STANDARD FABRIC GRADES																							
		COM	2	3	4	5	6	7	8	9	10	11	12												
 <p>High Back Armchair Flex Back, Casters COM Yardage: 2 Freight Class: 250 Product Weight (lbs.): 51 Cubic Feet Per Carton: 22.25</p>	GC4243HB	\$2558	\$2623	\$2684	\$2766	\$2885	\$2930	\$3032	\$3226	\$3323	\$3505	\$3755	\$4064												
	<p>Active weight 500 lbs. Wood armcap option - Add \$179</p>	<table border="1"> <thead> <tr> <th colspan="3">OVERALL DIMENSIONS</th> <th colspan="3">SEAT DIMENSIONS</th> <th colspan="2">BACK DIMENSIONS</th> </tr> <tr> <th>W</th> <th>D</th> <th>H</th> <th>W</th> <th>D</th> <th>H</th> <th>W</th> <th>H</th> </tr> </thead> <tbody> <tr> <td>26.75</td> <td>27.5</td> <td>42.5</td> <td>22</td> <td>18</td> <td>18</td> <td>21.5</td> <td>24.5</td> </tr> </tbody> </table>	OVERALL DIMENSIONS			SEAT DIMENSIONS			BACK DIMENSIONS		W	D	H	W	D	H	W	H	26.75	27.5	42.5	22	18	18	21.5
OVERALL DIMENSIONS			SEAT DIMENSIONS			BACK DIMENSIONS																			
W	D	H	W	D	H	W	H																		
26.75	27.5	42.5	22	18	18	21.5	24.5																		

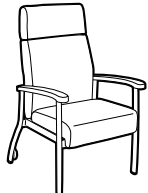
DESCRIPTION	MODEL#	STANDARD FABRIC GRADES																							
		COM	2	3	4	5	6	7	8	9	10	11	12												
 <p>High Back Armchair Split Back COM Yardage: 2.25 Freight Class: 250 Product Weight (lbs.): 54 Cubic Feet Per Carton: 20.25</p>	GC4244HB	\$2275	\$2351	\$2417	\$2510	\$2644	\$2693	\$2808	\$3028	\$3137	\$3341	\$3623	\$3971												
	<p>Active weight 500 lbs. Wood armcap option - Add \$179</p>	<table border="1"> <thead> <tr> <th colspan="3">OVERALL DIMENSIONS</th> <th colspan="3">SEAT DIMENSIONS</th> <th colspan="2">BACK DIMENSIONS</th> </tr> <tr> <th>W</th> <th>D</th> <th>H</th> <th>W</th> <th>D</th> <th>H</th> <th>W</th> <th>H</th> </tr> </thead> <tbody> <tr> <td>26.75</td> <td>26</td> <td>42.5</td> <td>22</td> <td>18</td> <td>18</td> <td>21.5</td> <td>24.5</td> </tr> </tbody> </table>	OVERALL DIMENSIONS			SEAT DIMENSIONS			BACK DIMENSIONS		W	D	H	W	D	H	W	H	26.75	26	42.5	22	18	18	21.5
OVERALL DIMENSIONS			SEAT DIMENSIONS			BACK DIMENSIONS																			
W	D	H	W	D	H	W	H																		
26.75	26	42.5	22	18	18	21.5	24.5																		

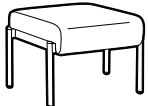
DESCRIPTION	MODEL#	STANDARD FABRIC GRADES																							
		COM	2	3	4	5	6	7	8	9	10	11	12												
 <p>High Back Armchair Split Back, Casters COM Yardage: 2.25 Freight Class: 250 Product Weight (lbs.): 54 Cubic Feet Per Carton: 20.25</p>	GC4245HB	\$2416	\$2490	\$2557	\$2650	\$2784	\$2833	\$2951	\$3168	\$3277	\$3481	\$3763	\$4110												
	<p>Active weight 500 lbs. Wood armcap option - Add \$179</p>	<table border="1"> <thead> <tr> <th colspan="3">OVERALL DIMENSIONS</th> <th colspan="3">SEAT DIMENSIONS</th> <th colspan="2">BACK DIMENSIONS</th> </tr> <tr> <th>W</th> <th>D</th> <th>H</th> <th>W</th> <th>D</th> <th>H</th> <th>W</th> <th>H</th> </tr> </thead> <tbody> <tr> <td>26.75</td> <td>26</td> <td>42.5</td> <td>22</td> <td>18</td> <td>18</td> <td>21.5</td> <td>24.5</td> </tr> </tbody> </table>	OVERALL DIMENSIONS			SEAT DIMENSIONS			BACK DIMENSIONS		W	D	H	W	D	H	W	H	26.75	26	42.5	22	18	18	21.5
OVERALL DIMENSIONS			SEAT DIMENSIONS			BACK DIMENSIONS																			
W	D	H	W	D	H	W	H																		
26.75	26	42.5	22	18	18	21.5	24.5																		

DESCRIPTION	MODEL#	STANDARD FABRIC GRADES																							
		COM	2	3	4	5	6	7	8	9	10	11	12												
 <p>Single Seat Bench COM Yardage: 1.5 Freight Class: 250 Product Weight (lbs.): 30 Cubic Feet Per Carton: 13</p>	GC4251	\$1154	\$1203	\$1248	\$1311	\$1400	\$1431	\$1510	\$1656	\$1729	\$1866	\$2053	\$2285												
	<p>Active weight 500 lbs.</p>	<table border="1"> <thead> <tr> <th colspan="3">OVERALL DIMENSIONS</th> <th colspan="3">SEAT DIMENSIONS</th> <th colspan="2">BACK DIMENSIONS</th> </tr> <tr> <th>W</th> <th>D</th> <th>H</th> <th>W</th> <th>D</th> <th>H</th> <th>W</th> <th>H</th> </tr> </thead> <tbody> <tr> <td>24.75</td> <td>26.5</td> <td>18</td> <td></td> <td></td> <td></td> <td></td> <td></td> </tr> </tbody> </table>	OVERALL DIMENSIONS			SEAT DIMENSIONS			BACK DIMENSIONS		W	D	H	W	D	H	W	H	24.75	26.5	18				
OVERALL DIMENSIONS			SEAT DIMENSIONS			BACK DIMENSIONS																			
W	D	H	W	D	H	W	H																		
24.75	26.5	18																							

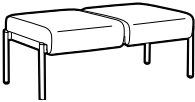
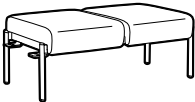
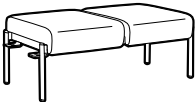
DESCRIPTION	MODEL#	STANDARD FABRIC GRADES											
		COM	2	3	4	5	6	7	8	9	10	11	12
 <p>Single Seat Bench Left COM Yardage: 1.5 Freight Class: 250 Product Weight (lbs.): 31 Cubic Feet Per Carton: 13</p>	GC4251L	\$1198	\$1248	\$1293	\$1356	\$1446	\$1480	\$1556	\$1701	\$1774	\$1911	\$2100	\$2330
		OVERALL DIMENSIONS			SEAT DIMENSIONS			BACK DIMENSIONS					
		W	D	H	W	D	H	W	H				
		Active weight 500 lbs.	25.75	26.5	18								
 <p>Single Seat Bench Left & Right COM Yardage: 1.5 Freight Class: 250 Product Weight (lbs.): 32 Cubic Feet Per Carton: 13</p>	GC4251B	\$1247	\$1294	\$1339	\$1402	\$1492	\$1526	\$1602	\$1747	\$1820	\$1957	\$2146	\$2377
		OVERALL DIMENSIONS			SEAT DIMENSIONS			BACK DIMENSIONS					
		W	D	H	W	D	H	W	H				
		Active weight 500 lbs.	26.75	26.5	18								
 <p>Two Seat Bench COM Yardage: 2.25 Freight Class: 250 Product Weight (lbs.): 53 Cubic Feet Per Carton: 23</p>	GC4252	\$2096	\$2172	\$2238	\$2331	\$2465	\$2514	\$2629	\$2849	\$2958	\$3162	\$3444	\$3792
		OVERALL DIMENSIONS			SEAT DIMENSIONS			BACK DIMENSIONS					
		W	D	H	W	D	H	W	H				
		Active weight 500 lbs./seat.	47.75	26.5	18								
 <p>Two Seat Bench Left COM Yardage: 2.25 Freight Class: 250 Product Weight (lbs.): 54 Cubic Feet Per Carton: 23</p>	GC4252L	\$2144	\$2218	\$2285	\$2377	\$2511	\$2561	\$2675	\$2895	\$3005	\$3209	\$3491	\$3838
		OVERALL DIMENSIONS			SEAT DIMENSIONS			BACK DIMENSIONS					
		W	D	H	W	D	H	W	H				
		Active weight 500 lbs./seat.	48.75	26.5	18								
 <p>Two Seat Bench Left & Right COM Yardage: 2.25 Freight Class: 250 Product Weight (lbs.): 55 Cubic Feet Per Carton: 23</p>	GC4252B	\$2191	\$2265	\$2332	\$2425	\$2559	\$2608	\$2722	\$2943	\$3052	\$3256	\$3538	\$3885
		OVERALL DIMENSIONS			SEAT DIMENSIONS			BACK DIMENSIONS					
		W	D	H	W	D	H	W	H				
		Active weight 500 lbs./seat.	49.75	26.5	18								

DESCRIPTION	MODEL#	STANDARD FABRIC GRADES											
		COM	2	3	4	5	6	7	8	9	10	11	12

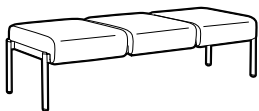

Three Seat Bench
 COM Yardage: 3
 Freight Class: 250
 Product Weight (lbs.): 73
 Cubic Feet Per Carton: 33.25

Active weight 500 lbs./seat.

OVERALL DIMENSIONS			SEAT DIMENSIONS			BACK DIMENSIONS	
W	D	H	W	D	H	W	H
70.75	26.5	18					

COM	2	3	4	5	6	7	8	9	10	11	12	
GC4253	\$3070	\$3171	\$3259	\$3384	\$3562	\$3626	\$3784	\$4074	\$4220	\$4492	\$4867	\$5331

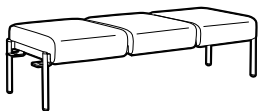

Three Seat Bench Left
 COM Yardage: 3
 Freight Class: 250
 Product Weight (lbs.): 74
 Cubic Feet Per Carton: 33.25

Active weight 500 lbs./seat.

OVERALL DIMENSIONS			SEAT DIMENSIONS			BACK DIMENSIONS	
W	D	H	W	D	H	W	H
71.75	26.5	18					

COM	2	3	4	5	6	7	8	9	10	11	12	
GC4253L	\$3119	\$3220	\$3307	\$3433	\$3609	\$3675	\$3831	\$4123	\$4268	\$4540	\$4916	\$5379

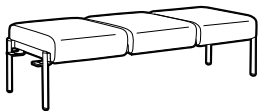

Three Seat Bench Left & Right
 COM Yardage: 3
 Freight Class: 250
 Product Weight (lbs.): 75
 Cubic Feet Per Carton: 33.25

Active weight 500 lbs./seat.

OVERALL DIMENSIONS			SEAT DIMENSIONS			BACK DIMENSIONS	
W	D	H	W	D	H	W	H
72.75	26.5	18					

COM	2	3	4	5	6	7	8	9	10	11	12	
GC4253B	\$3165	\$3266	\$3353	\$3479	\$3655	\$3721	\$3879	\$4169	\$4314	\$4586	\$4962	\$5429

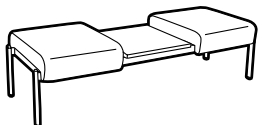

Two Seat Bench with Table Center Table Top
 COM Yardage: 2.25
 Freight Class: 250
 Product Weight (lbs.): 68
 Cubic Feet Per Carton: 33.25

Active weight 500 lbs./seat.

• Table top only offered in High Pressure Laminate

OVERALL DIMENSIONS			SEAT DIMENSIONS			BACK DIMENSIONS	
W	D	H	W	D	H	W	H
70.75	26.5	18					

COM	2	3	4	5	6	7	8	9	10	11	12	
GC4256	\$2991	\$3064	\$3131	\$3224	\$3358	\$3407	\$3525	\$3742	\$3851	\$4055	\$4337	\$4684

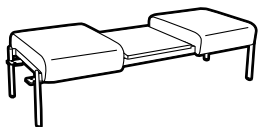



Two Seat Bench with Table Center Table Top, Left
 COM Yardage: 2.25
 Freight Class: 250
 Product Weight (lbs.): 72
 Cubic Feet Per Carton: 33.25

Active weight 500 lbs./seat.

• Table top only offered in High Pressure Laminate

OVERALL DIMENSIONS			SEAT DIMENSIONS			BACK DIMENSIONS	
W	D	H	W	D	H	W	H
71.75	26.5	18					

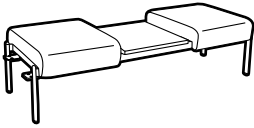
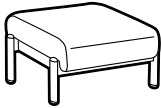
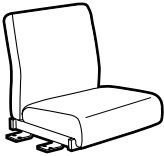
COM	2	3	4	5	6	7	8	9	10	11	12	
GC4256L	\$3036	\$3113	\$3180	\$3272	\$3406	\$3456	\$3570	\$3790	\$3899	\$4103	\$4386	\$4733

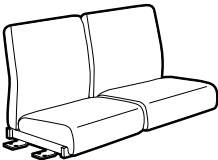

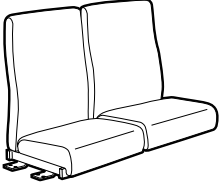
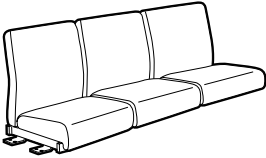
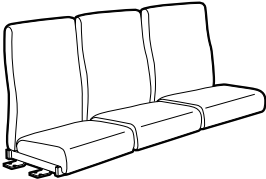
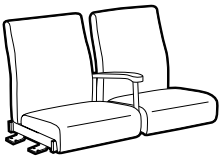
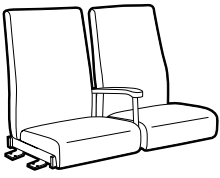
DESCRIPTION	MODEL#	STANDARD FABRIC GRADES											
		COM	2	3	4	5	6	7	8	9	10	11	12
 Two Seat Bench with Table Center Table Top, Left & Right COM Yardage: 2.25 Freight Class: 250 Product Weight (lbs.): 70 Cubic Feet Per Carton: 33.25	GC4256B	\$3083	\$3157	\$3224	\$3317	\$3450	\$3500	\$3614	\$3835	\$3944	\$4148	\$4430	\$4777
		OVERALL DIMENSIONS			SEAT DIMENSIONS			BACK DIMENSIONS					
		W	D	H	W	D	H	W	H				
		72.75	26.5	18									
		• Table top only offered in High Pressure Laminate											
 Ottoman Angled cushion top. COM Yardage: 1 Freight Class: 150 Product Weight (lbs.): 16 Cubic Feet Per Carton: 3.6	GC4259	\$858	\$891	\$924	\$964	\$1023	\$1047	\$1098	\$1196	\$1244	\$1334	\$1457	\$1614
		OVERALL DIMENSIONS			SEAT DIMENSIONS			BACK DIMENSIONS					
		W	D	H	W	D	H	W	H				
		17.75	19	10.5									
 Low Back Single Seat Armless Bridge Left & Right COM Yardage: 1.75 Freight Class: 250 Product Weight (lbs.): 36 Cubic Feet Per Carton: 13	GC4261	\$1202	\$1259	\$1313	\$1385	\$1487	\$1526	\$1619	\$1790	\$1873	\$2032	\$2250	\$2521
		OVERALL DIMENSIONS			SEAT DIMENSIONS			BACK DIMENSIONS					
		W	D	H	W	D	H	W	H				
		26.75	24	25.5	22	18	--	21.5	19.5				
		Active weight 500 lbs. Not freestanding. Suspends between 2 units via linking brackets.											
 High Back Single Seat Armless Bridge Left & Right COM Yardage: 2 Freight Class: 250 Product Weight (lbs.): 41 Cubic Feet Per Carton: 14.5	GC4261HB	\$1268	\$1334	\$1395	\$1477	\$1596	\$1641	\$1743	\$1938	\$2035	\$2216	\$2466	\$2775
		OVERALL DIMENSIONS			SEAT DIMENSIONS			BACK DIMENSIONS					
		W	D	H	W	D	H	W	H				
		26.75	24	30.5	22	18	--	21.5	24.5				
		Active weight 500 lbs. Not freestanding. Suspends between 2 units via linking brackets.											
 Low Back Two Seat Armless Bridge Left & Right COM Yardage: 3.5 Freight Class: 250 Product Weight (lbs.): 66 Cubic Feet Per Carton: 23	GC4262	\$2296	\$2415	\$2517	\$2661	\$2868	\$2948	\$3128	\$3468	\$3639	\$3953	\$4392	\$4932
		OVERALL DIMENSIONS			SEAT DIMENSIONS			BACK DIMENSIONS					
		W	D	H	W	D	H	W	H				
		49.75	24	25.5	44	18	--	44	19.5				
		Active weight 500 lbs./seat. Not freestanding. Suspends between 2 units via linking brackets.											

DESCRIPTION	MODEL#	STANDARD FABRIC GRADES											
		COM	2	3	4	5	6	7	8	9	10	11	12
 <p>High Back Two Seat Armless Bridge Left & Right COM Yardage: 4 Freight Class: 250 Product Weight (lbs.): 72 Cubic Feet Per Carton: 24</p>	GC4262HB	\$2434	\$2571	\$2686	\$2853	\$3089	\$3177	\$3384	\$3771	\$3968	\$4329	\$4830	\$5448
		OVERALL DIMENSIONS			SEAT DIMENSIONS			BACK DIMENSIONS					
		W	D	H	W	D	H	W	H				
		49.75	24	30.5	44	18	--	44	24.5				
		Active weight 500 lbs./seat. Not freestanding. Suspends between 2 units via linking brackets.											
 <p>Low Back Three Seat Armless Bridge Left & Right COM Yardage: 5 Freight Class: 300 Product Weight (lbs.): 74 Cubic Feet Per Carton: 38.75</p>	GC4263	\$3343	\$3512	\$3655	\$3865	\$4156	\$4271	\$4527	\$5014	\$5257	\$5708	\$6335	\$7110
		OVERALL DIMENSIONS			SEAT DIMENSIONS			BACK DIMENSIONS					
		W	D	H	W	D	H	W	H				
		72.75	24	25.5	70	18	--	70	19.5				
		Active weight 500 lbs./seat. Not freestanding. Suspends between 2 units via linking brackets.											
 <p>High Back Three Seat Armless Bridge Left & Right COM Yardage: 5.75 Freight Class: 250 Product Weight (lbs.): 80 Cubic Feet Per Carton: 38.75</p>	GC4263HB	\$3566	\$3762	\$3926	\$4165	\$4503	\$4633	\$4928	\$5487	\$5766	\$6286	\$7009	\$7898
		OVERALL DIMENSIONS			SEAT DIMENSIONS			BACK DIMENSIONS					
		W	D	H	W	D	H	W	H				
		72.75	24	30.5	70	18	--	70	24.5				
		Active weight 500 lbs./seat. Not freestanding. Suspends between 2 units via linking brackets.											
 <p>Low Back Two Seat Bridge Half Center Arm, Left & Right COM Yardage: 3.5 Freight Class: 250 Product Weight (lbs.): 58 Cubic Feet Per Carton: 27.25</p>	GC4264	\$2763	\$2880	\$2982	\$3126	\$3333	\$3413	\$3593	\$3933	\$4103	\$4418	\$4856	\$5397
		OVERALL DIMENSIONS			SEAT DIMENSIONS			BACK DIMENSIONS					
		W	D	H	W	D	H	W	H				
		50.75	24	25.5	22	18	--	21.5	19.5				
		Active weight 500 lbs./seat. Not freestanding. Suspends between 2 units via linking brackets. Wood armcap option - Add \$47											
 <p>High Back Two Seat Bridge Half Center Arm, Left & Right COM Yardage: 4 Freight Class: 250 Product Weight (lbs.): 68 Cubic Feet Per Carton: 27.25</p>	GC4264HB	\$2907	\$3044	\$3159	\$3326	\$3562	\$3650	\$3857	\$4245	\$4441	\$4802	\$5303	\$5921
		OVERALL DIMENSIONS			SEAT DIMENSIONS			BACK DIMENSIONS					
		W	D	H	W	D	H	W	H				
		50.75	24	30.5	22	18	--	21.5	24.5				
		Active weight 500 lbs./seat. Not freestanding. Suspends between 2 units via linking brackets. Wood armcap option - Add \$47											

SEATING

GC-BELONG

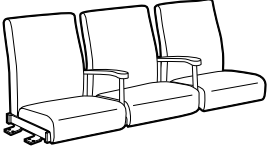
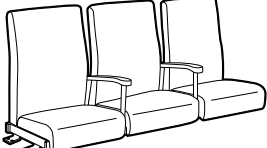
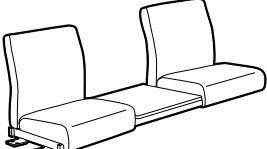
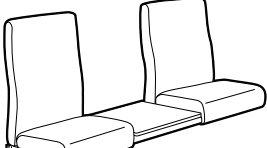
G

DESCRIPTION	MODEL#	STANDARD FABRIC GRADES											
		COM	2	3	4	5	6	7	8	9	10	11	12
 <p>Low Back Three Seat Bridge Half Center Arms, Left & Right COM Yardage: 5 Freight Class: 250 Product Weight (lbs.): 78 Cubic Feet Per Carton: 38.75</p>	GC4265	\$4155	\$4324	\$4467	\$4675	\$4970	\$5083	\$5340	\$5827	\$6070	\$6521	\$7147	\$7923
		<p>Active weight 500 lbs./seat. Not freestanding. Suspends between 2 units via linking brackets. Wood armcap option - Add \$90</p>											
		OVERALL DIMENSIONS			SEAT DIMENSIONS			BACK DIMENSIONS					
		W	D	H	W	D	H	W	H				
		74.25	24	25.5	22	18	--	21.5	19.5				
 <p>High Back Three Seat Bridge Half Center Arms, Left & Right COM Yardage: 5.75 Freight Class: 250 Product Weight (lbs.): 86 Cubic Feet Per Carton: 38.75</p>	GC4265HB	\$4377	\$4573	\$4738	\$4977	\$5315	\$5444	\$5741	\$6298	\$6577	\$7097	\$7820	\$8709
		<p>Active weight 500 lbs./seat. Not freestanding. Suspends between 2 units via linking brackets. Wood armcap option - Add \$90</p>											
		OVERALL DIMENSIONS			SEAT DIMENSIONS			BACK DIMENSIONS					
		W	D	H	W	D	H	W	H				
		74.25	24	30.5	22	18	--	21.5	24.5				
 <p>Low Back Two Seat Armless Bridge Center Table Top, Left & Right COM Yardage: 3.5 Freight Class: 300 Product Weight (lbs.): 60 Cubic Feet Per Carton: 38.75</p>	GC4266	\$3386	\$3505	\$3605	\$3751	\$3958	\$4037	\$4217	\$4557	\$4726	\$5042	\$5481	\$6022
		<p>Active weight 500 lbs./seat. Not freestanding. Suspends between 2 units via linking brackets. • Table top only offered in High Pressure Laminate</p>											
		OVERALL DIMENSIONS			SEAT DIMENSIONS			BACK DIMENSIONS					
		W	D	H	W	D	H	W	H				
		72.75	24	25.5	22	18	--	21.5	19.5				
 <p>High Back Two Seat Armless Bridge Center Table Top, Left & Right COM Yardage: 4 Freight Class: 300 Product Weight (lbs.): 66 Cubic Feet Per Carton: 38.75</p>	GC4266HB	\$3532	\$3668	\$3783	\$3950	\$4186	\$4274	\$4482	\$4869	\$5066	\$5426	\$5928	\$6547
		<p>Active weight 500 lbs./seat. Not freestanding. Suspends between 2 units via linking brackets. • Table top only offered in High Pressure Laminate</p>											
		OVERALL DIMENSIONS			SEAT DIMENSIONS			BACK DIMENSIONS					
		W	D	H	W	D	H	W	H				
		72.75	24	30.5	22	18	--	21.5	24.5				
 <p>Bariatric Low Back Armless Bridge Left & Right COM Yardage: 3 Freight Class: 300 Product Weight (lbs.): 44 Cubic Feet Per Carton: 26.5</p>	GC4269	\$1761	\$1863	\$1950	\$2076	\$2252	\$2318	\$2476	\$2766	\$2911	\$3183	\$3559	\$4023
		<p>Active weight 750 lbs. Not freestanding. Suspends between 2 units via linking brackets.</p>											
		OVERALL DIMENSIONS			SEAT DIMENSIONS			BACK DIMENSIONS					
		W	D	H	W	D	H	W	H				
		37.5	24	25.5	32.5	18	--	32.5	19.5				

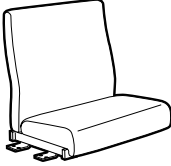
DESCRIPTION	MODEL#	STANDARD FABRIC GRADES											
		COM	2	3	4	5	6	7	8	9	10	11	12
 <p>Bariatric High Back Armless Bridge Left & Right COM Yardage: 3.25 Freight Class: 300 Product Weight (lbs.): 50 Cubic Feet Per Carton: 26.5</p>	GC4269HB	\$1873	\$1983	\$2077	\$2211	\$2406	\$2478	\$2647	\$2959	\$3117	\$3412	\$3821	\$4321
	<p>Active weight 750 lbs. Not freestanding. Suspends between 2 units via linking brackets.</p>												
		OVERALL DIMENSIONS			SEAT DIMENSIONS			BACK DIMENSIONS					
		W	D	H	W	D	H	W	H				
		37.5	24	30.5	32.5	18	--	32.5	24.5				

DESCRIPTION	MODEL#	STANDARD FABRIC GRADES											
		COM	2	3	4	5	6	7	8	9	10	11	12
 <p>Single Seat Bench Bridge Left & Right COM Yardage: 1.5 Freight Class: 100 Product Weight (lbs.): 24 Cubic Feet Per Carton: 2.9</p>	GC4271	\$1111	\$1160	\$1205	\$1268	\$1357	\$1388	\$1467	\$1613	\$1686	\$1823	\$2010	\$2242
	<p>Active weight 500 lbs. Not freestanding. Suspends between 2 units via linking brackets.</p>												
		OVERALL DIMENSIONS			SEAT DIMENSIONS			BACK DIMENSIONS					
		W	D	H	W	D	H	W	H				
		24.75	26.5	6									

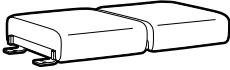
DESCRIPTION	MODEL#	STANDARD FABRIC GRADES											
		COM	2	3	4	5	6	7	8	9	10	11	12
 <p>Two Seat Bench Bridge Left & Right COM Yardage: 2.25 Freight Class: 125 Product Weight (lbs.): 64 Cubic Feet Per Carton: 9.25</p>	GC4272	\$2024	\$2098	\$2164	\$2257	\$2391	\$2440	\$2555	\$2775	\$2884	\$3088	\$3370	\$3718
	<p>Active weight 500 lbs./seat. Not freestanding. Suspends between 2 units via linking brackets.</p>												
		OVERALL DIMENSIONS			SEAT DIMENSIONS			BACK DIMENSIONS					
		W	D	H	W	D	H	W	H				
		49.75	26.5	6									

DESCRIPTION	MODEL#	STANDARD FABRIC GRADES											
		COM	2	3	4	5	6	7	8	9	10	11	12
 <p>Three Seat Bench Bridge Left & Right COM Yardage: 3 Freight Class: 125 Product Weight (lbs.): 68 Cubic Feet Per Carton: 9.25</p>	GC4273	\$2998	\$3099	\$3187	\$3312	\$3490	\$3554	\$3712	\$4002	\$4148	\$4420	\$4795	\$5259
	<p>Active weight 500 lbs./seat. Not freestanding. Suspends between 2 units via linking brackets.</p>												
		OVERALL DIMENSIONS			SEAT DIMENSIONS			BACK DIMENSIONS					
		W	D	H	W	D	H	W	H				
		72.75	26.5	6									

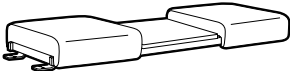
DESCRIPTION	MODEL#	STANDARD FABRIC GRADES											
		COM	2	3	4	5	6	7	8	9	10	11	12
 <p>Two Seat Bench Bridge Center Table Top, Left & Right COM Yardage: 2.25 Freight Class: 250 Product Weight (lbs.): 32 Cubic Feet Per Carton: 9.25</p>	GC4276	\$2821	\$2897	\$2964	\$3056	\$3190	\$3240	\$3354	\$3574	\$3684	\$3887	\$4170	\$4517
	<p>Active weight 500 lbs./seat. Not freestanding. Suspends between 2 units via linking brackets. • Table top only offered in High Pressure Laminate</p>												
		OVERALL DIMENSIONS			SEAT DIMENSIONS			BACK DIMENSIONS					
		W	D	H	W	D	H	W	H				
		72.75	26	6									

DESCRIPTION	MODEL#	STANDARD FABRIC GRADES				
-------------	--------	------------------------	--	--	--	--

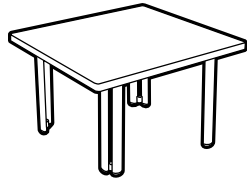

Rectangular End Table

GC4281-LP	22 x 18 x 16	100	30	3.4	\$967
GC4281-HP	22 x 18 x 16	100	30	3.4	\$1093

- For a thermally fused laminate top (LP), specify model GC4281-LP.
- For a high pressure laminate top (HP), specify model GC4281-HP.

1" thick top with coordinating 3mm edge. Oval steel tube legs

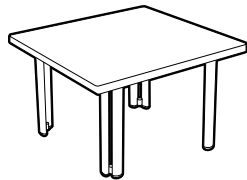

Square End Table

GC4288-LP	23 x 23 x 16	100	31	3.4	\$1104
GC4288-HP	23 x 23 x 16	100	31	3.4	\$1227

- For a thermally fused laminate top (LP), specify model GC4288-LP.
- For a high pressure laminate top (HP), specify model GC4288-HP.

1" thick top with coordinating 3mm edge. Oval steel tube legs.



Square End Table

GC4282-LP	30 x 30 x 16	150	34	6	\$1239
GC4282-HP	30 x 30 x 16	150	34	6	\$1383

- For a thermally fused laminate top (LP), specify model GC4282-LP.
- For a high pressure laminate top (HP), specify model GC4282-HP.

1" thick top with coordinating 3mm edge. Oval steel tube legs.

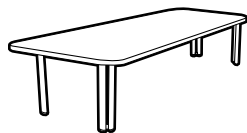

Rectangular Coffee Table

GC4283-LP	54 x 22 x 16	125	37	6	\$1248
GC4283-HP	54 x 22 x 16	125	37	6	\$1455

- For a thermally fused laminate top (LP), specify model GC4283-LP.
- For a high pressure laminate top (HP), specify model GC4283-HP.

1" thick top with coordinating 3mm edge. Oval steel tube legs



Square Coffee Table

GC4284-LP	36 x 36 x 16	125	37	6	\$1302
GC4284-HP	36 x 36 x 16	125	37	6	\$1455

- For a thermally fused laminate top (LP), specify model GC4284-LP.
- For a high pressure laminate top (HP), specify model GC4284-HP.

1" thick top with coordinating 3mm edge. Oval steel tube legs

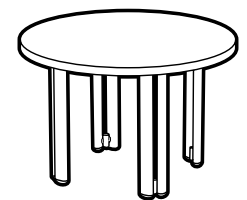

Round Coffee Table - 24" Diameter

GC4285-LP	24 x 24 x 16	100	33	3.4	\$1213
GC4285-HP	24 x 24 x 16	100	33	3.4	\$1311

- For a thermally fused laminate top (LP), specify model GC4285-LP.
- For a high pressure laminate top (HP), specify model GC4285-HP.

1" thick top with coordinating 3mm edge. Oval steel tube legs

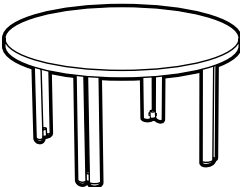
DESCRIPTION	MODEL#	STANDARD FABRIC GRADES				
	GC4286-LP	30 x 30 x 16	150	34	6	\$1218
	GC4286-HP	30 x 30 x 16	150	34	6	\$1311

Round Coffee Table - 30" Diameter

- For a thermally fused laminate top (LP), specify model GC4286-LP.
- For a high pressure laminate top (HP), specify model GC4286-HP.

1" thick top with coordinating 3mm edge. Oval steel tube legs

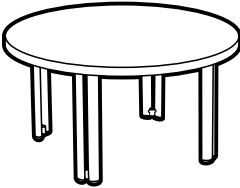
	GC4287-LP	36 x 36 x 16	125	37	6	\$1379
	GC4287-HP	36 x 36 x 16	125	37	6	\$1530

Round Coffee Table 36" Diameter

- For a thermally fused laminate top (LP), specify model GC4287-LP.
- For a high pressure laminate top (HP), specify model GC4287-HP.

1" thick top with coordinating 3mm edge. Oval steel tube legs

TABLE BRIDGES	MODEL#	DIMENSIONS	FREIGHT CLASS	WT/LBS.	CUBIC FT.	LIST PRICE
---------------	--------	------------	---------------	---------	-----------	------------

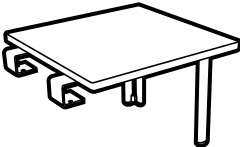
	GC4274-LP	23 x 23 x 16	125	25	3.4	\$795
	GC4274-HP	23 x 23 x 16	125	25	3.4	\$850

End Table Bridge, Not Freestanding

- For a thermally fused laminate top (LP), specify model GC4274-LP.
- For a high pressure laminate top (HP), specify model GC4274-HP.

1 end suspends to a seating unit via linking brackets. 1" thick top with coordinating 3mm edge. Oval steel tube legs Reversible.

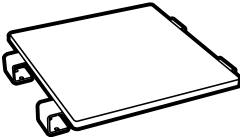
	GC4275-LP	23 x 23 x 1	150	18	3.4	\$556
	GC4275-HP	23 x 23 x 1	150	18	3.4	\$626

Square Table Top, Not Freestanding

- For a thermally fused laminate top (LP), specify model GC4275-LP.
- For a high pressure laminate top (HP), specify model GC4275-HP.

Suspends between two seating units via linking brackets. 1" thick top with coordinating 3mm edge. No legs. Reversible.

	GC4277-LP	35 x 35 x 16	125	45	6	\$886
	GC4277-HP	35 x 35 x 16	125	45	6	\$1011

End Corner Table Bridge Not Freestanding

- For a thermally fused laminate top (LP), specify model GC4277-LP.
- For a high pressure laminate top (HP), specify model GC4277-HP.

Suspends between two seating units via linking brackets. 1" thick top with coordinating 3mm edge. Oval steel tube legs Can be used for right or left corner.

	GC4278-LP	35 x 35 x 16	125	45	6	\$886
	GC4278-HP	35 x 35 x 16	125	45	6	\$1011

End Corner Curve Table Bridge Not Freestanding

- For a thermally fused laminate top (LP), specify model GC4278-LP.
- For a high pressure laminate top (HP), specify model GC4278-HP.

Suspends between two seating units via linking brackets. 1" thick top with coordinating 3mm edge. Oval steel tube legs Can be used for right or left corner.

DESCRIPTION MODEL# STANDARD FABRIC GRADES

GC-CITI



model GC7875



5" tubular metal leg (shown in Tungsten)



5" tapered wood leg (shown in Maple)

STANDARD FEATURES

- Fully upholstered contemporary design, complements timeless decor. Proportions are compact, 31" deep, works well in public spaces, lounges and lobbies.
- The steel leg brings a lightness of scale, while satisfying the need for accessibility
- GC Citi seat legs are 5" high tubular metal, standard in a Tungsten finish.
- The seat is fastened into place and removable over an open frame structure eliminating all barriers and traps below the surface.
- The seat cushion is fully encased by the upholstery with a nylon zippered opening for access if replacement is required. This method of upholstery when using Crypton or vinyl textiles prevents the interior construction from contact with spills and body fluids that could affect the products long-term performance
- Models have removable cushions. Cushions feature removable covers
- The interior wood frame has an interlocking construction providing superior strength and long-term durability
- Arm height on all models is 25".
- Casters are not available on this series
- For added comfort, seats are standard with high density Ultracell foam
- For healthcare textiles and finish options, visit the website at www.globalfurnituregroup.com
- Can be upholstered in standard Global textiles only if Healthcare compliance is not required.
- Shipped fully assembled

OPTIONAL FEATURES

- To add sealed seams to your product, contact customer care. Upcharges vary.
- For moisture barrier on seat, specify **(MB)**. Add \$188.
- Leg Type**
(MTL) Metal legs
(WDL) Wood legs. Add \$315.
- Leg Finish**
(TBL) Black
(TTU) Tungsten
(CHM) Chrome. Add \$110. Please specify.
- Wood leg finish:**
(AAM) Absolute
(BKM) Black
(CJM) Charcoal Java
(ACM) Cherry
(EMM) Empire Mahogany
(EOM) English Oak
(ECM) Espresso Cafe
(TFM) Fruitwood
(HGM) Grey
(HOM) Harvest Oak
(AHM) Honey
(JOM) Jet Onyx
(LHM) Light Honey
(TMM) Mahogany
(AVM) Maple
(MWM) Medium Walnut
(NLW) Natural Walnut
(ASM) Night
(NBM) Noce Biondo
(NGM) Noce Grigio
(NEM) Noce Leggero
(NMM) Noce Medio
(SBM) Sandy Beach
(SKM) Shaker Cherry
(SOM) Silver Oak
(TWM) Walnut
(WTM) WC Cream
(WHM) White
(WCM) Winter Cherry
- Glide Type** (wood legs)
(NM) White, non-marking nylon glide for most surfaces. No upcharge.
(SG) Steel cushioned glide for carpeted surfaces. Add \$34.
(RG) Rubber, non-slip glide for most hard floor surfaces. Add \$34.
(FG) Felt glide for most hard floor surfaces. Add \$34.

SUGGESTED APPLICATIONS

- Guest seating
- Lobbies
- Lounge/Waiting
- Resident rooms

DESCRIPTION MODEL# STANDARD FABRIC GRADES

	COM	2	3	4	5	6	7	8	9	10	11	12
GC7875	\$1966	\$2142	\$2288	\$2504	\$2808	\$2952	\$3227	\$3669	\$4007	\$4385	\$5162	\$5991



Lounge Chair
COM Yardage: 4.75
Freight Class: 250
Product Weight (lbs.): 67
Cubic Feet Per Carton: 21

Active weight 300 lbs.

OVERALL DIMENSIONS			SEAT DIMENSIONS			BACK DIMENSIONS	
W	D	H	W	D	H	W	H
30	31	30	22	19.5	17.5	22	12.5

GC-COMET



model GC2180 (TUN)



Black Plastic Arms

Wallsaver Leg

STANDARD FEATURES

- The rounded steel frame and durable seat cushion will ensure years of use.
- Black plastic arms are standard.
- This bariatric model has been specially designed in consultation with healthcare specialists to meet the needs of larger individuals.
- Reinforced steel seat frame accommodates users up to 500 pounds.
- For added comfort, seats are standard with high density Ultracell bio foam.
- The steel frame is available in Black (TBL), Buzz Blue (TBZ), Cactus (TCC), Carrot (TCR), Cloud (TIV), Designer White (TDW), Dijon (TDJ), Eggplant (TEG), Fog (TFO), Frost (TFR), Ink (TIN), Kalua (TKA), Latte (TLA), Mocha (TMO), Nevada (TNE), Sand (TSN), Scarlet (TSR), Shadow (TSH), Toast (TOA) and Tungsten (TTU). Please specify.
- Standard glide is a plastic dome shape on back legs, flat glide on front legs.
- Bariatric models stack 2 high on floor. No dolly available.
- For Globalcare textiles and finish options, visit the website at globalfurnituregroup.com
- Can be upholstered in standard Global textiles only if Healthcare compliance is not required.
- Shipped fully assembled

OPTIONAL FEATURES

- Plastic arms available in Shadow (SHW) and Toast (TOA). Please specify. Add \$44.
- A selection of glide options is available. Glides must be chosen to best suit flooring type and site conditions.
- Steel cushioned glides (B) are available - Add \$31.
- Glides with felt pads (FG) are available for vinyl sheet, cork or laminate flooring. Please specify. Add \$60.
- Glides with rubber pads (RG) are available for vinyl, hardwood, laminate, stone or ceramic flooring. Please specify. Add \$60.
- For moisture barrier on seat, specify (MB). Add \$193.
- **Frame finish**
Painted finishes - no upcharge:
(TBL) Black
(TBZ) Buzz Blue
(TCC) Cactus
(TCR) Carrot
(TIV) Cloud
(TDW) Designer White
(TDJ) Dijon
(TEG) Eggplant
(TFO) Fog
(TFR) Frost
(TIN) Ink
(TKA) Kalua
(TLA) Latte
(TMO) Mocha
(TNE) Nevada
(TSN) Sand
(TSR) Scarlet
(TSH) Shadow
(TOA) Toast
(TTU) Tungsten
Plated finish - Add \$34:
(CHM) Chrome

SUGGESTED APPLICATIONS

- Bariatric seating
- Patient Rooms
- Waiting Areas
- Exam Rooms
- Guest Seating
- Dining Rooms

DESCRIPTION	MODEL#	STANDARD FABRIC GRADES											
		COM	2	3	4	5	6	7	8	9	10	11	12
 <p>Bariatric Lounge Chair COM Yardage: 1.75 Freight Class: 300 Product Weight (lbs.): 44 Cubic Feet Per Carton: 23</p>	GC2180	\$1242	\$1300	\$1352	\$1425	\$1528	\$1566	\$1658	\$1830	\$1914	\$2073	\$2291	\$2560
		OVERALL DIMENSIONS			SEAT DIMENSIONS			BACK DIMENSIONS					
		W	D	H	W	D	H	W	H				
		31.5	27	38	26.5	18.5	18	26.5	20				

Active weight 500 lbs.

GC ISLANDS



model GC4075



model GC4076

STANDARD FEATURES



- GC Islands offers wood guest seating with contemporary styling.
- Two back styles: Upholstered back pad or horizontal wood slat back.
- Legs are equipped with White non-marking polypropylene glides. Suitable for both carpet and hard surface flooring.
- All cushions are fixed and non-removable.
- Cushions are made with highly resilient foam and seats are equipped with a synthetic rubberized webbing suspension system for extra comfort
- Seat cushion underside is finished with a Black impermeable surface material
- Does not stack
- For Globalcare textiles and finish options, visit the website at globalfurnituregroup.com.
- Can be upholstered in standard Global textiles if Healthcare compliance is not required.

OPTIONAL FEATURES

- Wood frame available in Absolute (AAM), Black (BKM), Cherry (ACM), English Oak (EOM), Espresso Cafe (ECM), Fruitwood (TFM), Gray (HGM), Honey (AHM), Mahogany (TMM), Maple (AVM), Medium Walnut (MWM), Natural Walnut (NLW), Night (ASM), Noce Biondo (NBM), Noce Grigio (NGM), Noce Leggero (NEM), Noce Medio (NMM), Sandy Beach (SKM), Shaker Cherry (SKM), Silver Oak (SOM), Walnut (TWM), WC Cream (WTM), White (WHM) and Winter Cherry (WCM). Please specify.
- For moisture barrier on seat, specify **(MB)**. Add **\$129** per seat.
- Back sealed seam available, please specify **(S2)**. Add **\$38**.

SUGGESTED APPLICATIONS

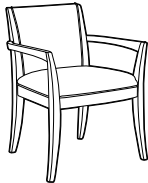
- Dining/Cafeteria
- Guest seating
- Lobbies
- Lounge/Waiting
- Office/Meeting
- Patient rooms
- Resident rooms

DESCRIPTION	MODEL#	STANDARD FABRIC GRADES											
		COM	2	3	4	5	6	7	8	9	10	11	12
 <p>Armchair w/Upholstered Back COM Yardage: 1.5 Freight Class: 300 Product Weight (lbs.): 25 Cubic Feet Per Carton: 13.25</p>	GC4075	\$1016	\$1061	\$1105	\$1171	\$1260	\$1300	\$1376	\$1505	\$1606	\$1715	\$1941	\$2176
		OVERALL DIMENSIONS			SEAT DIMENSIONS			BACK DIMENSIONS					
		W	D	H	W	D	H	W	H				
			24.5	23.5	32	20.5	18	18.5	19	13			
 <p>Armchair w/Horizontal Wood Slat Back COM Yardage: 1 Freight Class: 300 Product Weight (lbs.): 25 Cubic Feet Per Carton: 13.25</p>	GC4076	\$1098	\$1130	\$1159	\$1206	\$1268	\$1292	\$1349	\$1431	\$1499	\$1566	\$1723	\$1880
		OVERALL DIMENSIONS			SEAT DIMENSIONS			BACK DIMENSIONS					
		W	D	H	W	D	H	W	H				
			24.5	23.5	32	20.5	18	18.5	19	13			

GC SIDERO™



model GC6923

STANDARD FEATURES

- GC Sidero is a collection of contemporary multi-purpose stacking chairs with a sculptured look, featuring wide, curved arms and a round tubular wall saver steel frame.
- Available in arm and armless models (except on bariatric models) with three seat widths, two back heights, and a four-legged and sled base frame.
- Offers options that allow the chair to meet rigorous infection prevention control requirements.
- Compound curved back provides comfort and support in multiple seating positions
- Rugged steel frame made from round welded steel tubing 7/8" dia.
- Frames feature a wall saver design to prevent back contact with wall
- Standard glide is durable Black polypropylene
- For added comfort, seats are standard with high density Ultracell bio foam
- Three seat widths: 19.5" (standard size), 24" (mid size) and 30" (bariatric).
- Two different back constructions are offered:
 1. Concealed back attachment: two piece back covering the back support brackets when fastened in place.
 2. Single piece back with a pullover style upholstery cover and support bracket fastened on the outer back.
- Low back and high back models are available:
 1. Low back version is available on all three seat widths: 15.5" high.
 2. High back version on 19" and 24" seat widths: 21" high.
 3. High back version on bariatric 30" seat width: 21.75" high.
- Fiberglass nylon reinforced arms have a generous width and extend to the front of the seat. They offer additional support and help to stabilize users as they sit or exit the chair. Available in Black only.
- Select GC Sidero models are equipped with a polypropylene seat shroud that helps avoid frame imprints on upholstered seats when chairs are stacked. Protective seat shroud is standard on all 19.5" seat width models.
- 30" Bariatric and 24" seat width models do not have a seat shroud and are standard with a vinyl covered seat underside.
- Active weight capacity for 19.5" seat width models is up to 300 lbs., and up to 500 lbs for 24" seat width and Bariatric models.
- For healthcare textiles and finish options, visit the website at globalfurnituregroup.com.
- Can be upholstered in standard Global textiles if healthcare compliance is not required.





OPTIONAL FEATURES





- To respond to higher expectations for housekeeping and infection prevention, single piece back underside and all seat pan undersides can be completely sealed and seat shroud (if standard on the model) would be removed.
 - For standard models with single piece back, please specify **(BSS)**. Add **\$72**.
 - For standard models with concealed attachment back, please specify **(STS)**. Add **\$47**.
 - For 24" width models with single piece back, please specify **(BSS)**. Add **\$84**.
 - For 24" width models with concealed attachment back, please specify **(STS)**. Add **\$65**.
 - For bariatric models with single piece back, please specify **(BSS)**. Add **\$102**.
 - For bariatric models with concealed attachment back, please specify **(STS)**. Add **\$66**.
- Chrome frame available, please specify **(CHM)**. Add **\$44** list upcharge.
- A selection of glide options is available. Glides must be chosen to best suit flooring type and site conditions.
 - For hard surface floors, please specify opaque non-marking glides **(NM)**. No upcharge.
 - Steel cushioned glides **(B)** are available on four legged models. Add **\$31** list upcharge.
 - Glides with felt pads **(FG)** are available for vinyl sheet, cork or laminate flooring. Please specify. Add **\$60**.
 - Glides with rubber pads **(RG)** are available for vinyl, hardwood, laminate, stone or ceramic flooring. Please specify. Add **\$60**.
- Seams can be sealed to prevent penetration of fluids through the stitching. Sealed seams are only available with select textiles. Please contact CustomerCare for more information.
- Moisture Barrier for 19.5" seat width - Add \$129 list upcharge per seat. For 24" seat width models - Add \$129 list upcharge per seat. For Bariatric models - Add \$198 list upcharge per seat.
- **Frame finish**
Painted finishes - no upcharge:
 - (TBL)** Black
 - (TIV)** Cloud
 - (TDW)** Designer White
 - (TFO)** Fog
 - (TFR)** Frost
 - (TKA)** Kalua
 - (TLA)** Latte
 - (TMO)** Mocha
 - (TNE)** Nevada
 - (TSN)** Sand
 - (TSH)** Shadow
 - (TOA)** Toast
 - (TTU)** Tungsten
 - Plated finish - Add \$44:
 - (CHM)** Chrome



SEAT WIDTH	STACKING CAPABILITIES
19.5"	Four-legged armchairs and side chairs can stack up to 5 high on the floor or 8 high on dolly #2125WS. Sled base armchairs and side chairs do not stack.
24" midsize	Four-legged armchairs and side chairs can stack up to 5 high on the floor. No dolly is available. Sled base armchairs and side chairs do not stack.
30" bariatric	Four-legged armchairs can stack up to 2 high on the floor. No dolly is available. Sled base models do not stack.

SUGGESTED APPLICATIONS

- Bariatric seating (some models)
- Dining/Cafeteria
- Guest seating
- Lobbies
- Lounge/Waiting
- Office/Meeting
- Patient rooms
- Resident rooms
- Stacking
- Treatment/Exam rooms

DESCRIPTION	MODEL#	STANDARD FABRIC GRADES											
		COM	2	3	4	5	6	7	8	9	10	11	12
 <p>LB Stacking Armchair, 4 Leg Base with concealed attachment COM Yardage: 1.25 Freight Class: 250 Product Weight (lbs.): 29 Cubic Feet Per Carton: 13.5</p>	GC6900	\$675	\$739	\$793	\$871	\$985	\$1038	\$1139	\$1303	\$1429	\$1566	\$1852	\$2159
		OVERALL DIMENSIONS			SEAT DIMENSIONS			BACK DIMENSIONS					
		W	D	H	W	D	H	W	H				
		25.5	24	33	19.5	18	17.5	19	15.5				
 <p>HB Stacking Armchair, 4 Leg Base with concealed attachment COM Yardage: 1.75 Freight Class: 250 Product Weight (lbs.): 33 Cubic Feet Per Carton: 15.25</p>	GC6900HB	\$821	\$893	\$956	\$1046	\$1175	\$1235	\$1349	\$1536	\$1680	\$1837	\$2165	\$2512
		OVERALL DIMENSIONS			SEAT DIMENSIONS			BACK DIMENSIONS					
		W	D	H	W	D	H	W	H				
		25.5	24	38.5	19.5	18	17.5	19	21				
 <p>LB Stacking Chair, 4 Leg Base with concealed attachment COM Yardage: 1.25 Freight Class: 250 Product Weight (lbs.): 26 Cubic Feet Per Carton: 11.25</p>	GC6901	\$634	\$697	\$755	\$832	\$945	\$1000	\$1100	\$1262	\$1388	\$1526	\$1811	\$2119
		OVERALL DIMENSIONS			SEAT DIMENSIONS			BACK DIMENSIONS					
		W	D	H	W	D	H	W	H				
		21	24	33	19.5	18	17.5	19	15.5				
 <p>HB Stacking Chair, 4 Leg Base with concealed attachment COM Yardage: 1.75 Freight Class: 250 Product Weight (lbs.): 30 Cubic Feet Per Carton: 14.5</p>	GC6901HB	\$778	\$850	\$913	\$1003	\$1132	\$1192	\$1306	\$1493	\$1637	\$1794	\$2122	\$2469
		OVERALL DIMENSIONS			SEAT DIMENSIONS			BACK DIMENSIONS					
		W	D	H	W	D	H	W	H				
		21	24	38.5	19.5	18	17.5	19	21				
 <p>LB Armchair, Sled Base with concealed attachment COM Yardage: 1.25 Freight Class: 250 Product Weight (lbs.): 32 Cubic Feet Per Carton: 13.5</p>	GC6902	\$888	\$952	\$1006	\$1085	\$1198	\$1251	\$1352	\$1516	\$1643	\$1782	\$2066	\$2372
		OVERALL DIMENSIONS			SEAT DIMENSIONS			BACK DIMENSIONS					
		W	D	H	W	D	H	W	H				
		25.5	24	33	19.5	18	17.5	19	15.5				

DESCRIPTION	MODEL#	STANDARD FABRIC GRADES											
		COM	2	3	4	5	6	7	8	9	10	11	12
 <p>HB Armchair, Sled Base with concealed attachment COM Yardage: 1.75 Freight Class: 250 Product Weight (lbs.): 36 Cubic Feet Per Carton: 15.25</p> <p>Active weight 300 lbs. Does not stack.</p>	GC6902HB	\$959	\$1031	\$1094	\$1184	\$1313	\$1373	\$1487	\$1674	\$1818	\$1975	\$2303	\$2650
	OVERALL DIMENSIONS			SEAT DIMENSIONS			BACK DIMENSIONS						
	W	D	H	W	D	H	W	H					
	25.5	24	38.5	19.5	18	17.5	19	21					
 <p>LB Side Chair, Sled Base with concealed attachment COM Yardage: 1.25 Freight Class: 250 Product Weight (lbs.): 30 Cubic Feet Per Carton: 11.25</p> <p>Active weight 300 lbs. Does not stack.</p>	GC6903	\$842	\$904	\$958	\$1037	\$1150	\$1203	\$1304	\$1468	\$1595	\$1734	\$2018	\$2324
	OVERALL DIMENSIONS			SEAT DIMENSIONS			BACK DIMENSIONS						
	W	D	H	W	D	H	W	H					
	21	24	33	19.5	18	17.5	19	15.5					
 <p>HB Side Chair, Sled Base with concealed attachment COM Yardage: 1.75 Freight Class: 250 Product Weight (lbs.): 34 Cubic Feet Per Carton: 14.5</p> <p>Active weight 300 lbs. Does not stack.</p>	GC6903HB	\$1000	\$1071	\$1136	\$1227	\$1356	\$1414	\$1532	\$1715	\$1858	\$2016	\$2345	\$2693
	OVERALL DIMENSIONS			SEAT DIMENSIONS			BACK DIMENSIONS						
	W	D	H	W	D	H	W	H					
	21	24	38.5	19.5	18	17.5	19	21					
 <p>Low Back Stacking Chair 4 Leg Base COM Yardage: 1.25 Freight Class: 250 Product Weight (lbs.): 26 Cubic Feet Per Carton: 11.25</p> <p>Active weight 300 lbs. Single piece back with pullover style upholstery cover with exposed support brackets on the outer back.</p>	GC6912	\$653	\$697	\$740	\$795	\$874	\$912	\$986	\$1101	\$1190	\$1288	\$1493	\$1712
	OVERALL DIMENSIONS			SEAT DIMENSIONS			BACK DIMENSIONS						
	W	D	H	W	D	H	W	H					
	21	24	33	19.5	18	17.5	19	15.5					
 <p>High Back Stacking Chair 4 Leg Base COM Yardage: 1.75 Freight Class: 250 Product Weight (lbs.): 30 Cubic Feet Per Carton: 14.5</p> <p>Active weight 300 lbs. Single piece back with pullover style upholstery cover with exposed support brackets on the outer back.</p>	GC6912HB	\$787	\$850	\$904	\$983	\$1096	\$1149	\$1250	\$1414	\$1541	\$1680	\$1964	\$2270
	OVERALL DIMENSIONS			SEAT DIMENSIONS			BACK DIMENSIONS						
	W	D	H	W	D	H	W	H					
	21	24	38.5	19.5	18	17.5	19	21					

DESCRIPTION	MODEL#	STANDARD FABRIC GRADES											
		COM	2	3	4	5	6	7	8	9	10	11	12
 <p>LB Stacking Armchair, 4 Leg Base COM Yardage: 1.25 Freight Class: 250 Product Weight (lbs.): 29 Cubic Feet Per Carton: 13.5</p>	GC6913	\$695	\$739	\$782	\$837	\$916	\$954	\$1028	\$1143	\$1232	\$1330	\$1535	\$1754
	OVERALL DIMENSIONS			SEAT DIMENSIONS			BACK DIMENSIONS						
	W	D	H	W	D	H	W	H					
	25.5	24	33	19.5	18	17.5	19	15.5					
Active weight 300 lbs. Single piece back with pullover style upholstery cover with exposed support brackets on the outer back.													
 <p>HB Stacking Armchair, 4 Leg Base COM Yardage: 1.75 Freight Class: 250 Product Weight (lbs.): 33 Cubic Feet Per Carton: 15.25</p>	GC6913HB	\$829	\$893	\$947	\$1025	\$1139	\$1192	\$1293	\$1457	\$1583	\$1720	\$2006	\$2313
	OVERALL DIMENSIONS			SEAT DIMENSIONS			BACK DIMENSIONS						
	W	D	H	W	D	H	W	H					
	25.5	24	38.5	19.5	18	17.5	19	21					
Active weight 300 lbs. Single piece back with pullover style upholstery cover with exposed support brackets on the outer back.													
 <p>LB Armchair, Sled Base COM Yardage: 1.25 Freight Class: 250 Product Weight (lbs.): 32 Cubic Feet Per Carton: 13.5</p>	GC6914	\$908	\$952	\$995	\$1051	\$1131	\$1168	\$1242	\$1357	\$1446	\$1545	\$1752	\$1968
	OVERALL DIMENSIONS			SEAT DIMENSIONS			BACK DIMENSIONS						
	W	D	H	W	D	H	W	H					
	25.5	24	33	19.5	18	17.5	19	15.5					
Active weight 300 lbs. Single piece back with pullover style upholstery cover with exposed support brackets on the outer back.													
 <p>LB Armchair, Sled Base COM Yardage: 1.75 Freight Class: 250 Product Weight (lbs.): 36 Cubic Feet Per Carton: 15.25</p>	GC6914HB	\$1053	\$1115	\$1169	\$1248	\$1361	\$1414	\$1515	\$1679	\$1806	\$1945	\$2229	\$2535
	OVERALL DIMENSIONS			SEAT DIMENSIONS			BACK DIMENSIONS						
	W	D	H	W	D	H	W	H					
	25.5	24	38.5	19.5	18	17.5	19	21					
Active weight 300 lbs. Single piece back with pullover style upholstery cover with exposed support brackets on the outer back. Does not stack.													
 <p>Low Back Side Chair, Sled Base COM Yardage: 1.25 Freight Class: 250 Product Weight (lbs.): 30 Cubic Feet Per Carton: 11.25</p>	GC6915	\$860	\$904	\$947	\$1003	\$1083	\$1120	\$1194	\$1309	\$1398	\$1497	\$1704	\$1920
	OVERALL DIMENSIONS			SEAT DIMENSIONS			BACK DIMENSIONS						
	W	D	H	W	D	H	W	H					
	21	24	33	19.5	18	17.5	19	15.5					
Active weight 300 lbs. Single piece back with pullover style upholstery cover with exposed support brackets on the outer back. Does not stack.													

DESCRIPTION	MODEL#	STANDARD FABRIC GRADES											
		COM	2	3	4	5	6	7	8	9	10	11	12
 <p>HB Side Chair, Sled Base COM Yardage: 1.75 Freight Class: 250 Product Weight (lbs.): 34 Cubic Feet Per Carton: 14.5</p>	GC6915HB	\$1008	\$1071	\$1129	\$1206	\$1319	\$1374	\$1474	\$1636	\$1762	\$1900	\$2185	\$2493
			OVERALL DIMENSIONS			SEAT DIMENSIONS			BACK DIMENSIONS				
			W	D	H	W	D	H	W	H			
		21	24	38.5	19.5	18	17.5	19	21				

Active weight 300 lbs.
Single piece back with pullover style upholstery cover with **exposed support brackets** on the outer back.

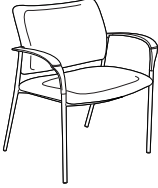
DESCRIPTION	MODEL#	STANDARD FABRIC GRADES											
		COM	2	3	4	5	6	7	8	9	10	11	12
 <p>LB Midsize Stacking Armchair, 4 Leg Base COM Yardage: 1.75 Freight Class: 250 Product Weight (lbs.): 34 Cubic Feet Per Carton: 16.</p>	GC6916	\$1010	\$1073	\$1131	\$1208	\$1321	\$1376	\$1476	\$1638	\$1764	\$1902	\$2187	\$2495
			OVERALL DIMENSIONS			SEAT DIMENSIONS			BACK DIMENSIONS				
			W	D	H	W	D	H	W	H			
		30.5	24	33	24	18	17.5	24	15.5				

Active weight 500 lbs.
Single piece back with pullover style upholstery cover with **exposed support brackets** on the outer back.

DESCRIPTION	MODEL#	STANDARD FABRIC GRADES											
		COM	2	3	4	5	6	7	8	9	10	11	12
 <p>HB Midsize Stacking Armchair, 4 Leg Base COM Yardage: 2 Freight Class: 250 Product Weight (lbs.): 37 Cubic Feet Per Carton: 18.25</p>	GC6916HB	\$1155	\$1227	\$1290	\$1380	\$1509	\$1569	\$1683	\$1870	\$2014	\$2171	\$2499	\$2846
			OVERALL DIMENSIONS			SEAT DIMENSIONS			BACK DIMENSIONS				
			W	D	H	W	D	H	W	H			
		30.5	24	38.5	24	18	17.5	24	21				



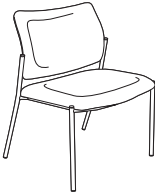

Active weight 500 lbs.
Single piece back with pullover style upholstery cover with **exposed support brackets** on the outer back.





DESCRIPTION	MODEL#	STANDARD FABRIC GRADES											
		COM	2	3	4	5	6	7	8	9	10	11	12
 <p>LB Midsize Stacking Chair, 4 Leg Base COM Yardage: 1.75 Freight Class: 250 Product Weight (lbs.): 30 Cubic Feet Per Carton: 14.5</p>	GC6917	\$969	\$1032	\$1090	\$1167	\$1280	\$1335	\$1435	\$1597	\$1723	\$1861	\$2146	\$2454
			OVERALL DIMENSIONS			SEAT DIMENSIONS			BACK DIMENSIONS				
			W	D	H	W	D	H	W	H			
		26	24	33	24	18	17.5	24	15.5				

Active weight 500 lbs.
Single piece back with pullover style upholstery cover with **exposed support brackets** on the outer back.

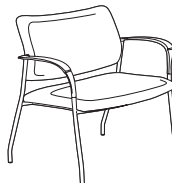

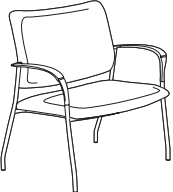
DESCRIPTION	MODEL#	STANDARD FABRIC GRADES											
		COM	2	3	4	5	6	7	8	9	10	11	12
 <p>HB Midsize Stacking Chair, 4 Leg Base COM Yardage: 2 Freight Class: 300 Product Weight (lbs.): 33 Cubic Feet Per Carton: 17.75</p>	GC6917HB	\$1112	\$1184	\$1247	\$1337	\$1466	\$1526	\$1640	\$1827	\$1971	\$2128	\$2456	\$2803
			OVERALL DIMENSIONS			SEAT DIMENSIONS			BACK DIMENSIONS				
			W	D	H	W	D	H	W	H			
		26	24	38.5	24	18	17.5	24	21				



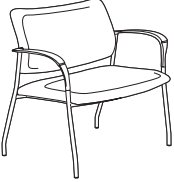
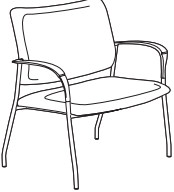
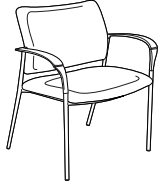

Active weight 500 lbs.
Single piece back with pullover style upholstery cover with **exposed support brackets** on the outer back.

DESCRIPTION	MODEL#	STANDARD FABRIC GRADES											
		COM	2	3	4	5	6	7	8	9	10	11	12
 <p>LB Midsize Armchair, Sled Base COM Yardage: 1.75 Freight Class: 250 Product Weight (lbs.): 36 Cubic Feet Per Carton: 16</p>	GC6918	\$1248	\$1311	\$1369	\$1448	\$1559	\$1614	\$1714	\$1876	\$2002	\$2140	\$2425	\$2733
		OVERALL DIMENSIONS			SEAT DIMENSIONS			BACK DIMENSIONS					
		W	D	H	W	D	H	W	H				
		30.5	24	33	24	18	17.5	24	15.5				
<p>Active weight 500 lbs. Single piece back with pullover style upholstery cover with exposed support brackets on the outer back.</p>													
 <p>HB Midsize Armchair, Sled Base COM Yardage: 2 Freight Class: 250 Product Weight (lbs.): 39 Cubic Feet Per Carton: 18.25</p>	GC6918HB	\$1404	\$1476	\$1541	\$1632	\$1761	\$1819	\$1937	\$2120	\$2263	\$2421	\$2750	\$3098
		OVERALL DIMENSIONS			SEAT DIMENSIONS			BACK DIMENSIONS					
		W	D	H	W	D	H	W	H				
		30.5	24	38.5	24	18	17.5	24	21				
<p>Active weight 500 lbs. Single piece back with pullover style upholstery cover with exposed support brackets on the outer back.</p>													
 <p>LB Midsize Side Chair, Sled Base COM Yardage: 1.75 Freight Class: 250 Product Weight (lbs.): 34 Cubic Feet Per Carton: 14.5</p>	GC6919	\$1204	\$1266	\$1324	\$1403	\$1514	\$1569	\$1669	\$1831	\$1957	\$2095	\$2380	\$2688
		OVERALL DIMENSIONS			SEAT DIMENSIONS			BACK DIMENSIONS					
		W	D	H	W	D	H	W	H				
		26	24	33	24	18	17.5	24	15.5				
<p>Active weight 500 lbs. Single piece back with pullover style upholstery cover with exposed support brackets on the outer back.</p>													
 <p>HB Midsize Side Chair, Sled Base COM Yardage: 2 Freight Class: 250 Product Weight (lbs.): 37 Cubic Feet Per Carton: 17.75</p>	GC6919HB	\$1362	\$1434	\$1497	\$1587	\$1716	\$1776	\$1890	\$2077	\$2221	\$2378	\$2706	\$3053
		OVERALL DIMENSIONS			SEAT DIMENSIONS			BACK DIMENSIONS					
		W	D	H	W	D	H	W	H				
		26	24	38.5	24	18	17.5	24	21				
<p>Active weight 500 lbs. Single piece back with pullover style upholstery cover with exposed support brackets on the outer back.</p>													
 <p>LB Bariatric Stacking Armchair, 4 Leg Base COM Yardage: 2.5 Freight Class: 250 Product Weight (lbs.): 46 Cubic Feet Per Carton: 20.5</p>	GC6920	\$1342	\$1433	\$1512	\$1622	\$1787	\$1863	\$2009	\$2239	\$2417	\$2613	\$3025	\$3461
		OVERALL DIMENSIONS			SEAT DIMENSIONS			BACK DIMENSIONS					
		W	D	H	W	D	H	W	H				
		36.5	26	33	30	18	17.5	30	15.5				
<p>Active weight 500 lbs. Single piece back with pullover style upholstery cover with exposed support brackets on the outer back.</p>													

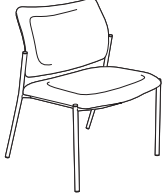
DESCRIPTION	MODEL#	STANDARD FABRIC GRADES											
		COM	2	3	4	5	6	7	8	9	10	11	12
 <p>HB Bariatric Stacking Armchair, 4 Leg Base COM Yardage: 2.75 Freight Class: 300 Product Weight (lbs.): 47 Cubic Feet Per Carton: 22.5</p>	GC6920HB	\$1407	\$1508	\$1595	\$1721	\$1899	\$1982	\$2144	\$2399	\$2599	\$2819	\$3272	\$3755
		OVERALL DIMENSIONS W D H			SEAT DIMENSIONS W D H			BACK DIMENSIONS W H					
	Active weight 500 lbs. Single piece back with pullover style upholstery cover with exposed support brackets on the outer back.	36.5	26	38.5	30	18	17.5	30	21				
 <p>LB Bariatric Armchair, Sled Base COM Yardage: 2.5 Freight Class: 250 Product Weight (lbs.): 48 Cubic Feet Per Carton: 20.5</p>	GC6921	\$1607	\$1698	\$1777	\$1893	\$2052	\$2128	\$2274	\$2504	\$2682	\$2880	\$3290	\$3726
		OVERALL DIMENSIONS W D H			SEAT DIMENSIONS W D H			BACK DIMENSIONS W H					
	Active weight 500 lbs. Single piece back with pullover style upholstery cover with exposed support brackets on the outer back. Does not stack.	36.5	26	33	30	18	17.5	30	15.5				
 <p>HB Bariatric Armchair, Sled Base COM Yardage: 3 Freight Class: 300 Product Weight (lbs.): 51 Cubic Feet Per Carton: 22.5</p>	GC6921HB	\$1591	\$1696	\$1789	\$1914	\$2097	\$2184	\$2350	\$2616	\$2819	\$3046	\$3514	\$4013
		OVERALL DIMENSIONS W D H			SEAT DIMENSIONS W D H			BACK DIMENSIONS W H					
	Active weight 500 lbs. Single piece back with pullover style upholstery cover with exposed support brackets on the outer back. Does not stack.	36.5	26	38.5	30	18	17.5	30	21				
 <p>LB Bariatric Stacking Armchair, Sled Base with concealed attachment COM Yardage: 2.5 Freight Class: 250 Product Weight (lbs.): 48 Cubic Feet Per Carton: 20.5</p>	GC6922	\$1607	\$1698	\$1777	\$1893	\$2052	\$2128	\$2274	\$2504	\$2682	\$2880	\$3290	\$3726
		OVERALL DIMENSIONS W D H			SEAT DIMENSIONS W D H			BACK DIMENSIONS W H					
	Active weight 500 lbs.	36.5	26	33	30	18	17.5	30	15.5				
 <p>HB Bariatric Stacking Armchair, Sled Base with concealed attachment COM Yardage: 3 Freight Class: 300 Product Weight (lbs.): 51 Cubic Feet Per Carton: 22.5</p>	GC6922HB	\$1591	\$1696	\$1789	\$1914	\$2097	\$2184	\$2350	\$2616	\$2819	\$3046	\$3514	\$4013
		OVERALL DIMENSIONS W D H			SEAT DIMENSIONS W D H			BACK DIMENSIONS W H					
	Active weight 500 lbs.	36.5	26	38.5	30	18	17.5	30	21				

SEATING

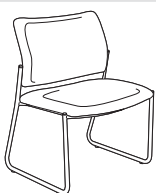
DESCRIPTION	MODEL#	STANDARD FABRIC GRADES											
 <p>LB Bariatric Stacking Armchair, 4 Leg Base with concealed attachment COM Yardage: 2.5 Freight Class: 250 Product Weight (lbs.): 46 Cubic Feet Per Carton: 20.5</p>		COM	2	3	4	5	6	7	8	9	10	11	12
	GC6923	\$1342	\$1433	\$1512	\$1622	\$1787	\$1863	\$2009	\$2239	\$2417	\$2613	\$3025	\$3461
			OVERALL DIMENSIONS			SEAT DIMENSIONS			BACK DIMENSIONS				
		W	D	H	W	D	H	W	H				
		36.5	26	33	30	18	17.5	30	15.5				
 <p>HB Bariatric Stacking Armchair, 4 Leg Base with concealed attachment COM Yardage: 3 Freight Class: 250 Product Weight (lbs.): 47 Cubic Feet Per Carton: 22.5</p>		COM	2	3	4	5	6	7	8	9	10	11	12
	GC6923HB	\$1407	\$1508	\$1595	\$1721	\$1899	\$1982	\$2144	\$2399	\$2599	\$2819	\$3272	\$3755
			OVERALL DIMENSIONS			SEAT DIMENSIONS			BACK DIMENSIONS				
		W	D	H	W	D	H	W	H				
		36.5	26	38.5	30	18	17.5	30	21				
 <p>LB Midsize Stacking Armchair, 4 Leg Base with concealed attachment COM Yardage: 2.5 Freight Class: 250 Product Weight (lbs.): 34 Cubic Feet Per Carton: 16</p>		COM	2	3	4	5	6	7	8	9	10	11	12
	GC6924	\$982	\$1073	\$1152	\$1268	\$1427	\$1503	\$1649	\$1879	\$2057	\$2255	\$2665	\$3101
			OVERALL DIMENSIONS			SEAT DIMENSIONS			BACK DIMENSIONS				
		W	D	H	W	D	H	W	H				
		30.5	24	33	24	18	17.5	24	15.5				
 <p>HB Midsize Stacking Armchair, 4 Leg Base with concealed attachment COM Yardage: 2.75 Freight Class: 250 Product Weight (lbs.): 38 Cubic Feet Per Carton: 18.25</p>		COM	2	3	4	5	6	7	8	9	10	11	12
	GC6924HB	\$1127	\$1227	\$1314	\$1439	\$1615	\$1698	\$1859	\$2112	\$2310	\$2528	\$2977	\$3456
			OVERALL DIMENSIONS			SEAT DIMENSIONS			BACK DIMENSIONS				
		W	D	H	W	D	H	W	H				
		30.5	24	38.5	24	18	17.5	24	21				
 <p>LB Midsize Stacking Chair, 4 Leg Base with concealed attachment COM Yardage: 2.5 Freight Class: 250 Product Weight (lbs.): 30 Cubic Feet Per Carton: 14.5</p>		COM	2	3	4	5	6	7	8	9	10	11	12
	GC6925	\$941	\$1032	\$1111	\$1227	\$1386	\$1462	\$1608	\$1838	\$2016	\$2214	\$2624	\$3060
			OVERALL DIMENSIONS			SEAT DIMENSIONS			BACK DIMENSIONS				
		W	D	H	W	D	H	W	H				
		26	24	33	24	18	17.5	24	15.5				

DESCRIPTION	MODEL#	STANDARD FABRIC GRADES											
		COM	2	3	4	5	6	7	8	9	10	11	12
 <p>HB Midsize Stacking Chair, 4 Leg Base with concealed attachment COM Yardage: 2.75 Freight Class: 300 Product Weight (lbs.): 33 Cubic Feet Per Carton: 17.75</p>	GC6925HB	\$1085	\$1184	\$1271	\$1396	\$1572	\$1655	\$1816	\$2069	\$2267	\$2485	\$2934	\$3413
		OVERALL DIMENSIONS			SEAT DIMENSIONS			BACK DIMENSIONS					
		W	D	H	W	D	H	W	H				
 <p>LB Midsize Armchair, Sled Base with concealed attachment COM Yardage: 2.5 Freight Class: 250 Product Weight (lbs.): 36 Cubic Feet Per Carton: 16</p>	GC6926	\$1220	\$1311	\$1390	\$1506	\$1665	\$1741	\$1887	\$2117	\$2295	\$2493	\$2903	\$3339
		OVERALL DIMENSIONS			SEAT DIMENSIONS			BACK DIMENSIONS					
		W	D	H	W	D	H	W	H				
 <p>HB Midsize Armchair, Sled Base with concealed attachment COM Yardage: 2.75 Freight Class: 250 Product Weight (lbs.): 39 Cubic Feet Per Carton: 18.25</p>	GC6926HB	\$1375	\$1476	\$1563	\$1688	\$1864	\$1947	\$2108	\$2361	\$2558	\$2777	\$3226	\$3705
		OVERALL DIMENSIONS			SEAT DIMENSIONS			BACK DIMENSIONS					
		W	D	H	W	D	H	W	H				
 <p>LB Midsize Side Chair, Sled Base with concealed attachment COM Yardage: 2.5 Freight Class: 250 Product Weight (lbs.): 34 Cubic Feet Per Carton: 14.5</p>	GC6927	\$1175	\$1266	\$1345	\$1461	\$1620	\$1696	\$1842	\$2072	\$2250	\$2448	\$2858	\$3294
		OVERALL DIMENSIONS			SEAT DIMENSIONS			BACK DIMENSIONS					
		W	D	H	W	D	H	W	H				
 <p>HB Midsize Side Chair, Sled Base with concealed attachment COM Yardage: 2.75 Freight Class: 250 Product Weight (lbs.): 37 Cubic Feet Per Carton: 17.75</p>	GC6927HB	\$1334	\$1434	\$1521	\$1646	\$1822	\$1905	\$2066	\$2319	\$2517	\$2735	\$3184	\$3663
		OVERALL DIMENSIONS			SEAT DIMENSIONS			BACK DIMENSIONS					
		W	D	H	W	D	H	W	H				

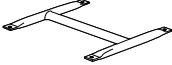
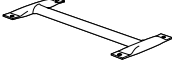
DESCRIPTION	MODEL#	STANDARD FABRIC GRADES						
	GC6928	LIST PRICE						
		\$113						
		OVERALL DIMENSIONS			SEAT DIMENSIONS			BACK DIMENSIONS
		W	D	H	W	D	H	W
Metal Ganging Connector for Armchairs Freight Class: 92.5 Product Weight (lbs.): 4 Cubic Feet Per Carton: 0.4		12	13.75	1				
	GC6929	LIST PRICE						
		\$113						
		OVERALL DIMENSIONS			SEAT DIMENSIONS			BACK DIMENSIONS
		W	D	H	W	D	H	W
Metal Ganging Connector for Armless Chairs Freight Class: 100 Product Weight (lbs.): 3.5 Cubic Feet Per Carton: 0.4		7.87	13.75	1				

DESCRIPTION MODEL# STANDARD FABRIC GRADES

GC SIRENA™



model GC3380



model GC3380RTL/M

STANDARD FEATURES

- The size and scale of this chair permits it to be used in smaller areas, where space is a consideration and style cannot be compromised. The soft curves and comfortable fit make this the right solution for creating group seating areas or in confined spaces.
- Complementary round foot design is available in Black only.
- For tablet models, please specify left hand or right hand tablet at time of order (determined from the seated position). See models below.
- Tablets rotate and are non-removable. Overall tablet size is 17"W by 14"D.
- Laminate tablet surfaces are 1.5" thick.
- (C1M) dual wheel carpet casters are standard on select models.
- The interior wood frame is an interlocking construction providing superior strength and long-term durability.
- Clean out space is provided around the seat pan for easy housekeeping and infection prevention practices
- Seat cushion can be removed if replacement is required
- For added comfort, seats are standard with high density Ultracell foam.
- For textile options, visit the website at globalfurnituregroup.com/healthcare
- Can be upholstered in standard Global textiles if healthcare compliance is not required.

OPTIONAL FEATURES

- Laminate finishes are offered in the following laminate finishes: Absolute Acajou (ACJ), Asian Night (ASN), Avant Cherry (AWC), Avant Honey (AWH), Black (BLK), Brushed Cobalt (BRC), Clear Maple (CMB), Dark Espresso (DES), Designer White (DWT), Fashionista (FAS), First Class (FCL), Noce Biondo (NBM), Noce Leggero (NEM), Noce Grigio (NGM), Noce Medio (NMM), Quartered Mahogany (QTM), Sheer Beauty (SBY), Walnut Heights (WHE), White Chocolate (WHC) and Winter Cherry (WVCR). Please specify
- To add sealed seams to your product, contact CustomerCare for more information.
- For moisture barrier on seat, please specify (MB). Add \$169.

SUGGESTED APPLICATIONS

- Dining/Cafeteria
- Guest seating
- Lobbies
- Lounge/Waiting
- Office/Meeting
- Patient rooms
- Resident rooms

DESCRIPTION MODEL# / FEATURES STANDARD TEXTILE GRADES

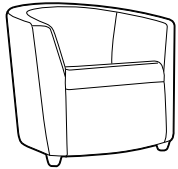

Club Chair w/Seat Clean Out
COM Yardage: 4.25
Freight Class: 250
Product Weight (lbs.): 52
Cubic Feet Per Carton: 19.25

MODEL# / FEATURES	COM	2	3	4	5	6	7	8	9	10	11	12
GC3380	\$1707	\$1851	\$1974	\$2150	\$2402	\$2521	\$2747	\$3111	\$3392	\$3706	\$4345	\$5028

OVERALL DIMENSIONS			SEAT DIMENSIONS			BACK DIMENSIONS	
W	D	H	W	D	H	W	H
30.5	29.5	28.5	20	20	17.5	19	11.5

Active weight 300 lbs.

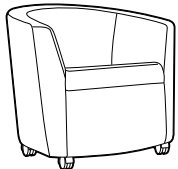

Club Chair on Casters w/Seat Clean Out
COM Yardage: 4.25
Freight Class: 250
Product Weight (lbs.): 52
Cubic Feet Per Carton: 19.25

MODEL# / FEATURES	COM	2	3	4	5	6	7	8	9	10	11	12
GC3380C	\$1718	\$1862	\$1981	\$2157	\$2406	\$2525	\$2750	\$3110	\$3387	\$3697	\$4330	\$5009

OVERALL DIMENSIONS			SEAT DIMENSIONS			BACK DIMENSIONS	
W	D	H	W	D	H	W	H
30.5	29.5	29.5	20	20	18	19	12.5

Active weight 300 lbs.

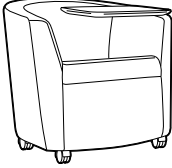
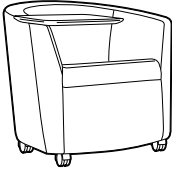
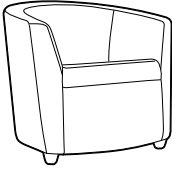
DESCRIPTION	MODEL#	STANDARD FABRIC GRADES											
		COM	2	3	4	5	6	7	8	9	10	11	12
 <p>Club Chair on Casters w/Seat Clean Out and LP Tablet - Left COM Yardage: 4.25 Freight Class: 250 Product Weight (lbs.): 62 Cubic Feet Per Carton: 19.25</p>	GC3380CLTL	\$2253	\$2397	\$2517	\$2693	\$2942	\$3061	\$3287	\$3646	\$3922	\$4233	\$4867	\$5546
		OVERALL DIMENSIONS			SEAT DIMENSIONS			BACK DIMENSIONS					
		W	D	H	W	D	H	W	H				
			32	29.5	29.5	20	20	18		19		12.5	
 <p>Club Chair on Casters w/Seat Clean Out and LP Tablet - Right COM Yardage: 4.25 Freight Class: 250 Product Weight (lbs.): 62 Cubic Feet Per Carton: 19.25</p>	GC3380CRTL	\$2253	\$2397	\$2517	\$2693	\$2942	\$3061	\$3287	\$3646	\$3922	\$4233	\$4867	\$5546
		OVERALL DIMENSIONS			SEAT DIMENSIONS			BACK DIMENSIONS					
		W	D	H	W	D	H	W	H				
			32	29.5	29.5	20	20	18		19		12.5	
 <p>Weighted Club Chair w/Seat Clean Out COM Yardage: 4.25 Freight Class: 150 Product Weight (lbs.): 108 Cubic Feet Per Carton: 19.25</p>	GC3380-CW	\$1906	\$2049	\$2168	\$2344	\$2593	\$2712	\$2937	\$3297	\$3574	\$3884	\$4517	\$5196
		OVERALL DIMENSIONS			SEAT DIMENSIONS			BACK DIMENSIONS					
		W	D	H	W	D	H	W	H				
			30.5	29.5	28.5	20	20	17.5		19		11.5	

GC VION



model GC6322-4 (BLK-C)

STANDARD FEATURES

- GC Vion is a comprehensive seating series offering a family of models to address multiple applications: task, management and conference.
- Series offers mid and high back models with either a mesh or upholstered back.
- Mechanism options available: synchro tilter (-0) and tilter (-4).
- All models are standard with height and width adjustable arms (**AS**) that feature a front to back sliding armcap.
- Standard with Global's high quality Soft Descent™ pneumatic lift which slowly and gently lowers the seat height of the chair, making it easy to obtain the desired position.
- Side activated sliding seat depth adjustment (**MD**) is standard on synchro-tilter with back angle adjustment.
- Standard with Black five prong, injection molded, fiberglass reinforced nylon Governor base (**B7**) with dual wheel carpet casters (**C1**).
- Mesh back models are available in 10 standard Vion colors: Aqua (**MS75**), Black (**MS69**), Black Cherry (**MS76**), Blue (**MS72**), Dust (**MS77**), Ivory (**MS78**), Natural (**MS74**), Paprika (**MS79**), Rope (**MS73**) and Stone (**MS71**).
- Underside of the seat is upholstered in a coated textile. The joining of the textiles on the underside of the seat pan is sealed on all models.
- Upholstered back models feature black fabric Jenny (**JN02**) on the back side as standard.
- Check textile availability prior to specifying upholstery material. Materials must meet or exceed 100,000 double rubs to comply with Globalcare's 24/7 seating textile warranty.

OPTIONAL FEATURES

- Vion back frames, arms and bases are available in three colors: Black, Shadow and Fog. See Vion finishes chart for options and upcharges. Armcaps are always Black.
- Mesh back models are also available in 10 Dimension Mesh colors: Black (**DBK**), Fog (**DST**), Chalk (**DCL**), Shadow (**DGM**), Charcoal (**DCH**), Sand (**DSD**), Cobalt (**DCO**), Pool Blue (**DPB**), Citrus (**DCT**) and Berry (**DBE**). Add \$27
- Petite seat models (2" shorter and 2" narrower than the standard size seat) are available. Specify (**ST**) for standard seat or (**P**) for petite seat. No upcharge.
- An optional moisture barrier is available for the seat cushion. Specify (**NB**) for no moisture barrier, no upcharge, or (**MB**) for Moisture Barrier. Add \$117.
- Sealed seams are available on the seat of GC Vion models when specified with approved coated textile. Contact Customer Care for availability. Specify (**NS**) for no sealed seams, no upcharge, or (**SE**) for sealed seat seams. Add \$26.
- For hard surface flooring casters, please specify (**C9R**). Add \$72.
- Two featured "T" arm options that include height and width adjusting arms, one with sliding arm caps (**AS**) and one without sliding arm caps (**AF**). Also, available is a stylish fixed urethane arm (**C**) for conference/management environments.
- For additional arm/caster options, please refer to the Arm and Caster section of the Seating List Price Book. *Optional casters for your chair and the difference will be charged. Lower priced optional casters will not be credited.*

VION FINISHES - TASK SEATING				
Back Frame	Base	Specify Code	Arm Option	Specify Code
Black	Black	BLK no upcharge	Adj. "T" arm (Black) Adj. "T" arm, fixed armcap (Black)	AS AF AC
Black	Polished Aluminum	BAU Add \$167	Adj. "T" arm (Black , Chrome accent) Adj. "T" arm, fixed armcap (Black , Chrome accent) Fixed "C" arm (Black) Fixed "C" arm (Polished Aluminum)	A C CA - Add \$202
Shadow	Shadow	SHW Add \$76	Adj. "T" arm (Shadow) Adj. "T" arm, fixed armcap (Shadow)	SHA SHF SHR
Shadow	Polished Aluminum	SAU Add \$241	Adj. "T" arm (Shadow , Chrome accent) Adj. "T" arm, fixed armcap (Shadow , Chrome accent) Fixed "C" arm (Shadow) Fixed "C" arm (Polished Aluminum)	SHD SHC CA - Add \$202
Fog	Fog	FOG Add \$76	Adj. "T" arm (Fog) Adj. "T" arm, fixed armcap (Fog)	FA FF
Fog	Polished Aluminum	FAU Add \$241	Adj. "T" arm (Fog , Chrome accent) Adj. "T" arm, fixed armcap (Fog , Chrome accent) Fixed "C" arm (Fog) Fixed "C" arm (Polished Aluminum)	FC CF CC CA - Add \$202

* All arms have Black Urethane Armcaps.

MECHANISMS:

Synchro-tilter mechanism (-0)

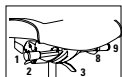

ADJUSTMENTS
 (1) Tilt tension
 (2) Pneumatic seat height/lumbar height
 (3) Back angle adjustment
 (8) Sliding seat depth
 (9) Multi position tilt lock
 Synchro tilt action
 Anti kick back

Ergonomic features:

A, B, C, E, G, H, L, M, N, Q, U

Tilter (-4)

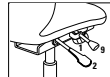

ADJUSTMENTS
 (1) Tilt tension
 (2) Pneumatic seat height
 (8) Manual seat depth
 (9) Chair tilt lock

Ergonomic features:









A, B, C, E, H, M, N, Q, S, U

EXAMPLE GC VION ORDER CODE:

GC3622-0	-BAU	-MS76	-ST	-ST	-AF15
----------	------	-------	-----	-----	-------

Model # Finish Mesh Seat size Seat foam Seat upholstery

-AF	-EE	-MB	-NS	-5L
Arms	Casters	Moisture barrier	Sealed seams	Pneumatic lift

DESCRIPTION	MODEL#	STANDARD FABRIC GRADES											
		COM	2	3	4	5	6	7	8	9	10	11	12
 <p>MB Synchro-Tilter w/Back Angle Adj., mesh back COM Yardage: 1 Freight Class: 150 Product Weight (lbs.): 58 Cubic Feet Per Carton: 10.5</p>	GC6322-0	\$1304	\$1332	1358	1396	1447	1471	\$1518	\$1594	\$1650	1716	1847	1988
	OVERALL DIMENSIONS			SEAT DIMENSIONS			BACK DIMENSIONS						
	W	D	H	W	D	H	W	H					
	25.5	24	39.5	20	17-20	17.5-22.5	18.5	21					
						RTA 2							
 <p>MB Tilter, mesh back COM Yardage: 1 Freight Class: 150 Product Weight (lbs.): 52 Cubic Feet Per Carton: 10.5</p>	GC6322-4	\$1160	\$1188	1218	1257	1312	1336	\$1387	\$1467	\$1529	\$1597	\$1736	\$1887
	OVERALL DIMENSIONS			SEAT DIMENSIONS			BACK DIMENSIONS						
	W	D	H	W	D	H	W	H					
	25.5	24	37.5	20	17.5	16-21	18.5	21					
						RTA 2							
 <p>HB Synchro-Tilter w/Back Angle Adj., upholstered back, standard seat COM Yardage: 1.25 Freight Class: 150 Product Weight (lbs.): 61 Cubic Feet Per Carton: 10.5</p>	GC6331-0	\$1353	\$1388	\$1421	\$1466	\$1531	\$1562	\$1621	\$1715	\$1786	\$1867	\$2032	\$2208
	OVERALL DIMENSIONS			SEAT DIMENSIONS			BACK DIMENSIONS						
	W	D	H	W	D	H	W	H					
	25.5	24	41.5	20	17-20	17.5-22.5	18.5	23					
						RTA 2							
 <p>HB Tilter, upholstered back, standard seat COM Yardage: 1.25 Freight Class: 150 Product Weight (lbs.): 55 Cubic Feet Per Carton: 10.5</p>	GC6331-4	\$1177	\$1213	\$1247	\$1293	\$1360	\$1392	\$1452	\$1548	\$1624	\$1706	\$1876	\$2058
	OVERALL DIMENSIONS			SEAT DIMENSIONS			BACK DIMENSIONS						
	W	D	H	W	D	H	W	H					
	25.5	24	39.25	20	17.5	16-21	18.5	23					
						RTA 2							

GC-WIND



Removable Seat Cushion Tubular Steel Leg

model 3361HB



model 3363HB

STANDARD FEATURES



- An attractive, sleek and modern lounge series on Chrome tubular legs.
- Seat cushions are easily removable for cleaning and the open frame is great for housekeeping access. Cushion covers are removable.
- For added comfort, seats are standard with high density Ultracell bio foam.
- Frame available in Black (TBL), Buzz Blue (TBZ), Cactus (TCC), Carrot (TCR), Chrome (CHM), Cloud (TIV), Designer White (TDW), Dijon (TDJ), Eggplant (TEG), Fog (TFO), Frost (TFR), Ink (TIN), Kalua (TKA), Latte (TLA), Mocha (TMO), Nevada (TNE), Sand (TSN), Scarlet (TSR), Shadow (TSH), Toast (TOA) and Tungsten (TTU).
- Standard glide is plastic.
- For Globalcare textiles and finish options, visit the website at www.globalfurnituregroup.com
- This product can be upholstered in standard Global textiles only if Healthcare compliance is not required.
- Shipped fully assembled

OPTIONAL FEATURES

- For hard surface floors, please specify opaque non-marking glides (NM). No upcharge.
- To add sealed seams to your product contact Customer Care. Upcharges vary
- Moisture Barrier (seat only) - **Add \$193** list upcharge for Lounge Chair. For 2 seat sofa - **Add \$382** list upcharge and for 3 seat sofa - **Add \$566**.
- **Frame finish**
Painted finishes. No upcharge.
(TBL) Black (TIN) Ink
(TBZ) Buzz Blue (TKA) Kalua
(TCC) Cactus (TLA) Latte
(TCR) Carrot (TMO) Mocha
(TIV) Cloud (TNE) Nevada
(TDW) Designer White (TSA) Sand
(TDJ) Dijon (TSR) Scarlet
(TEG) Eggplant (TSH) Shadow
(TFO) Fog (TOA) Toast
(TFR) Frost (TTU) Tungsten
Plated finish. See models for upcharges.
(CHM) Chrome (SBR) Satin Brass
(BCH) Brushed Chrome (ACO) Antique Copper

SUGGESTED APPLICATIONS

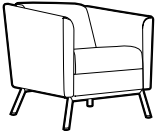
- Lobbies
- Lounge / Waiting
- Office / Meeting
- Patient rooms
- Resident rooms

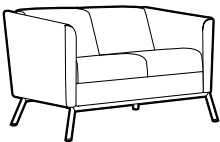
DESCRIPTION	MODEL#	STANDARD FABRIC GRADES											
		COM	2	3	4	5	6	7	8	9	10	11	12
 <p>Lounge Chair COM Yardage: 4.25 Freight Class: 250 Product Weight (lbs.): 62 Cubic Feet Per Carton: 16.5</p> <p>Frame finish upcharges: Chrome (CHM), no upcharge. Brushed Chrome (BCH), add \$156. Satin Brass (SBR) or Antique Copper (ACO), add \$331</p>	GC3361	\$2526	\$2702	\$2849	\$3064	\$3368	\$3512	\$3787	\$4229	\$4568	\$4946	\$5723	\$6551
	Removable seat cushion. Active weight 300 lbs.	OVERALL DIMENSIONS			SEAT DIMENSIONS			BACK DIMENSIONS					
		W	D	H	W	D	H	W	H				
		27.5	29	28.5	19.5	19	17	19	12				
 <p>High Back Lounge Chair COM Yardage: 4.75 Freight Class: 250 Product Weight (lbs.): 69 Cubic Feet Per Carton: 23</p> <p>Frame finish upcharges: Chrome (CHM), no upcharge. Brushed Chrome (BCH), add \$156.sw Satin Brass (SBR) or Antique Copper (ACO), add \$331.</p>	GC3361HB	\$2293	\$2469	\$2615	\$2830	\$3134	\$3276	\$3553	\$3994	\$4334	\$4710	\$5489	\$6315
	Removable seat cushion. Active weight 300 lbs.	OVERALL DIMENSIONS			SEAT DIMENSIONS			BACK DIMENSIONS					
		W	D	H	W	D	H	W	H				
		27.5	29	36	19.5	19	17	19	19.5				
 <p>Two Seat Sofa COM Yardage: 7.25 Freight Class: 250 Product Weight (lbs.): 102 Cubic Feet Per Carton: 30</p> <p>Frame finish upcharges: Chrome (CHM), no upcharge. Brushed Chrome (BCH), add \$189. Satin Brass (SBR) or Antique Copper (ACO), add \$414.</p>	GC3362	\$3100	\$3365	\$3584	\$3909	\$4368	\$4585	\$5003	\$5666	\$6178	\$6747	\$7919	\$9169
	Removable seat cushion. Active weight 300 lbs./seat	OVERALL DIMENSIONS			SEAT DIMENSIONS			BACK DIMENSIONS					
		W	D	H	W	D	H	W	H				
		54.5	29	28.5	46.5	19	17	46.5	12				

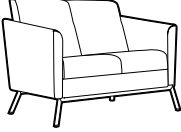
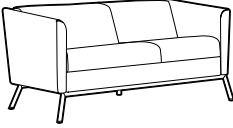
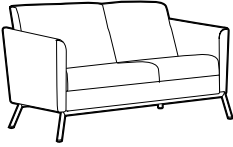
DESCRIPTION	MODEL#	STANDARD FABRIC GRADES											
		COM	2	3	4	5	6	7	8	9	10	11	12
 <p>High Back Two Seat Sofa COM Yardage: 8 Freight Class: 250 Product Weight (lbs.): 107 Cubic Feet Per Carton: 44.75</p>	<p>GC3362HB</p> <p>Removable seat cushion Active weight 300 lbs./seat</p>	\$3200	\$3460	\$3853	\$4184	\$4653	\$4833	\$5246	\$6021	\$6409	\$7127	\$8129	\$9365
		OVERALL DIMENSIONS			SEAT DIMENSIONS			BACK DIMENSIONS					
		W	D	H	W	D	H	W	H				
		54.5	29	36	46.5	19	17	46.5	19.5				
 <p>Three Seat Sofa COM Yardage: 10.5 Freight Class: 250 Product Weight (lbs.): 135 Cubic Feet Per Carton: 42.5</p>	<p>GC3363</p> <p>Removable seat cushion. Active weight 300 lbs./seat</p>	\$3882	\$4269	\$4585	\$5055	\$5722	\$6034	\$6638	\$7600	\$8340	\$9164	\$10862	\$12673
		OVERALL DIMENSIONS			SEAT DIMENSIONS			BACK DIMENSIONS					
		W	D	H	W	D	H	W	H				
		78	29	28.5	70.5	19	17	70.5	12				
 <p>High Back Three Seat Sofa COM Yardage: 12.25 Freight Class: 250 Product Weight (lbs.): 140 Cubic Feet Per Carton: 62.25</p>	<p>GC3363HB</p> <p>Removable seat cushion. Active weight 300 lbs./seat</p>	\$3987	\$4387	\$4943	\$5450	\$6173	\$6444	\$7071	\$8258	\$8855	\$9957	\$11491	\$13381
		OVERALL DIMENSIONS			SEAT DIMENSIONS			BACK DIMENSIONS					
		W	D	H	W	D	H	W	H				
		78	29	36	70.5	19	17	70.5	19.5				

JANNA



model GC7609

STANDARD FEATURES



- Very often tight spaces create a challenge when additional seating is required for guests. Janna's unique folding frame is the perfect solution for temporary seating, especially where space is at a premium.
- Molded wood veneer frame.
- Concealed folding mechanism uses metal-to-metal construction details with lock tight fasteners.
- For added comfort, seats are standard with high density foam.
- Non-marking nylon glides are standard.
- For healthcare textiles, visit the website at globalfurnituregroup.com.
- Can be upholstered in standard Global textiles if Healthcare compliance is not required
- Shipped fully assembled.

OPTIONAL FEATURES

- Wood frame available in Absolute (AAM), Black (BKM), Cherry (ACM), English Oak (EOM), Espresso Cafe (ECM), Fruitwood (TFM), Gray (HGM), Honey (AHM), Mahogany (TMM), Maple (AVM), Medium Walnut (MWM), Natural Walnut (NLW), Night (ASM), Noce Biondo (NBM), Noce Grigio (NGM), Noce Leggero (NEM), Noce Medio (NMM), Sandy Beach (SKM), Shaker Cherry (SKM), Silver Oak (SOM), Walnut (TWM), WC Cream (WTM), White (WHM) and Winter Cherry (WCM). Please specify.
- Optional cushion glide is available - **Add \$17** list upcharge.
- Optional wall bracket (model GC7607) allows chairs to be conveniently stored while not in use. (Underside of chair seat is predrilled to accept wall bracket.)
- For moisture barrier (seat only), **Add \$129** list upcharge.

SUGGESTED APPLICATIONS

- Dining/Cafeteria
- Guest seating
- Lounge/Waiting
- Office/Meeting
- Patient rooms
- Resident rooms
- Treatment/Exam

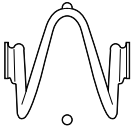
DESCRIPTION	MODEL#	STANDARD FABRIC GRADES											
		COM	2	3	4	5	6	7	8	9	10	11	12
 <p>Folding Chair Upholstered Back COM Yardage: 1 Freight Class: 150 Product Weight (lbs.): 19 Cubic Feet Per Carton: 3.5</p>	GC7609	\$699	\$731	\$762	\$804	\$861	\$886	\$937	\$1034	\$1082	\$1174	\$1298	\$1453
		OVERALL DIMENSIONS			SEAT DIMENSIONS			BACK DIMENSIONS					
		W	D	H	W	D	H	W	H				
		19	22.5	32.5	16	17.5	18.5	16	13.5				
 <p>Folding Chair Wood Back COM Yardage: 1 Freight Class: 150 Product Weight (lbs.): 19 Cubic Feet Per Carton: 3.5</p>	GC7611	\$794	\$827	\$860	\$900	\$959	\$983	\$1034	\$1131	\$1180	\$1270	\$1394	\$1550
		OVERALL DIMENSIONS			SEAT DIMENSIONS			BACK DIMENSIONS					
		W	D	H	W	D	H	W	H				
		19	22.5	32.5	16	17.5	18.5	16	13.5				
 <p>Wall Mounting Bracket. For Janna series only. Allows for hanging a chair on the wall or behind a door. COM Yardage: -- Freight Class: 70 Product Weight (lbs.): 1.5 Cubic Feet Per Carton: 0.1</p>	GC7607	List Price											
		\$65											
		OVERALL DIMENSIONS			SEAT DIMENSIONS			BACK DIMENSIONS					
	W	D	H	W	D	H	W	H					
		3	1.5	3.5									
		<p>If ordering after the original purchase, specify GC7607. For complete set at time of order - specify WH. Add \$66. Two (one pair) per package in chrome finish. One bracket connects to the underside of the chair seat. The second bracket connects to the wall or door.</p>											

DESCRIPTION MODEL#/FEATURES STANDARD FABRIC GRADES

NOURISH



GC3681FXH

GC3683F

GC3685



Headrest adjustment handle



Casters and height adjustable legs



Transfer arm

STANDARD FEATURES

- Nourish is an innovative, state-of-the-art patient chair, developed in consultation with leading healthcare professionals. It embraces the body, cultivating comfort during periods of recovery.
- All chair models have left and right, easy to operate transfer arms. Transfer arms allow users to easily transfer in and out of the chair and provide easy access to assist the user.
- Models with fixed legs have a standard seat height of 18.5".
- Models with adjustable legs have adjustment pins to conveniently adapt seat heights from 17" to 20". 20" seat height models (-20) have a seat height adjustment range of 20" to 23". Front and back legs can be adjusted separately allowing modification of seat pitch, forward or rearward.
- Models with rear casters allow for 'tip and move' so the chair can be conveniently relocated while unoccupied. The optional push bar aids staff in moving the chair (see upcharge). Push bar matches frame finish.
- Select models have a unique Schukra depth adjustable headrest solution integrated inside the back near the user's neck area. The depth is controlled by a handle on the lower outer back cushion.
- Schukra depth adjustable lumbar support for additional comfort is standard on select models.
- Standard models have minimal flex to the back. Flex back models (F model suffix) have additional back movement.
- For added comfort, seats are standard with high density Ultracell foam.
- Metal frame is available in several paint finishes.
- The arm structure finish is Tungsten with a urethane armcap, available in five finishes.
- Available to specify with two textiles, one for the seat cushion and one for the back (see model image). For pricing, start with the base price and add both back graded textile upcharge and seat graded textile upcharge.
- The Blended Textile matrix does not apply to this series.
- Nourish is covered under Globalcare's 12-yr, 24/7 warranty. Textiles with a minimum of 100,000 double rubs must be specified.
- For healthcare textile and finish options, visit the website at globalfurnituregroup.com.
- Can be upholstered in standard Global textiles if high traffic, heavy duty or multi-shift compliance is not required. Globalcare's limited lifetime warranty applies.
- Shipped fully assembled.
- Active weight capacity for standard single seat is 350 lbs. and 750 lbs for bariatric seating.

Add option codes in the following order:







- **Model number**
Specify model number
- **Back Textile**
Specify textile code.
- **Seat Textile**
Specify textile code.
- **Frame Finish**
(**TBL**) Black
(**TIV**) Cloud
(**TDW**) Designer White
(**TFO**) Fog
(**TFR**) Frost
(**TKA**) Kalua
(**TLA**) Latte
(**TMO**) Mocha
(**TNE**) Nevada
(**TSN**) Sand
(**TSH**) Shadow
(**TOA**) Toast
(**TTU**) Tungsten
- **Back Push Bar** (matches frame finish)
(**NBR**) No push bar
(**PBR**) Back push bar. Add \$150.
- **Armcap Finish**
(**BLK**) Black
(**LAB**) Latte
(**J52**) Mocha
(**SHW**) Shadow
(**TOA**) Toast
- **Sealed Seat Underside**
(**ST**) None
(**SU**) Sealed seat underside. Add \$50.
For bariatric, add \$60.
For ottoman, add \$33.
- **Moisture Barrier** (seat only, not available with sealed seams)
(**NB**) No moisture barrier.
(**MB**) Moisture barrier. Add \$129. For bariatric, add \$184.
- **Back Seams**
(**NS**) No sealed seams
(**SBS**) Sealed back seams. Add \$60; bariatric add \$97.
- **Seat Seams**
(**NS**) No sealed seat seams
(**SSS**) Sealed seat seams. Add \$23; bariatric add \$26.



SUGGESTED APPLICATIONS



- Bariatric seating (model GC3685)
- Lounge/Waiting
- Patient rooms
- Resident rooms
- Treatment/Exam rooms



EXAMPLE NOURISH ORDER CODE:



GC3681	FU75	FU75	TMO	NBR	J52	ST	NB	NS	NS
Model #	Back textile	Seat textile	Frame finish	Push Bar	Armcap Finish	Seat Underside	Moisture Barrier	Back Seams	Seat Seams



DESCRIPTION	MODEL# / FEATURES	STANDARD TEXTILE GRADES											
		COM	2	3	4	5	6	7	8	9	10	11	12
 Adjustable height	GC3681 Base Price: Adjustable height	\$2850											
	GC3681-20 Base Price: Adjustable height, 20"	\$2914											
 Fixed 18.5" height	GC3681XH Base Price: Fixed 18.5" height	\$2533											
	Back upcharge:	\$-40	+0	+\$32	+\$78	+\$143	+\$170	+\$227	+\$315	+\$382	+\$454	+\$605	+\$764
	Seat upcharge:	\$-24	+0	+\$19	+\$47	+\$86	+\$102	+\$136	+\$189	+\$229	+\$273	+\$363	+\$459
		OVERALL DIMENSIONS			SEAT DIMENSIONS			BACK DIMENSIONS					
		W	D	H	W	D	H	W	H				
		28.5	29	45.5	20	18.5	17-20	20	29				
		28.5	29	48.5	20	18.5	20-23	20	29				
High Back Patient Chair COM Yardage: Back: 1.25; Seat: .75 Freight Class: 300 Product Weight (lbs.): 56 Cubic Feet Per Carton: 33.5	Active weight 350 lbs.												
 Adjustable height	GC3681F Base Price: Adjustable height	\$3204											
	GC3681-20F Base Price: Adjustable height, 20"	\$3269											
 Fixed 18.5" height	GC3681FXH Base Price: Fixed 18.5" height	\$2881											
	Back upcharge:	\$-40	+0	+\$32	+\$78	+\$143	+\$170	+\$227	+\$315	+\$382	+\$454	+\$605	+\$764
	Seat upcharge:	\$-24	+0	+\$19	+\$47	+\$86	+\$102	+\$136	+\$189	+\$229	+\$273	+\$363	+\$459
		OVERALL DIMENSIONS			SEAT DIMENSIONS			BACK DIMENSIONS					
		W	D	H	W	D	H	W	H				
		28.5	29	45.5	20	18.5	17-20	20	29				
		28.5	29	48.5	20	18.5	20-23	20	29				
High Back Patient Chair, Flex Back COM Yardage: Back: 1.25; Seat: .75 Freight Class: 300 Product Weight (lbs.): 56 Cubic Feet Per Carton: 33.5	Active weight 350 lbs.												
 Adjustable height	GC3682 Base Price: Adjustable height	\$3015											
	GC3682-20 Base Price: Adjustable height, 20"	\$3080											
 Fixed 18.5" height	GC3682XH Base Price: Fixed 18.5" height	\$2874											
	Back upcharge:	\$-40	+0	+\$32	+\$78	+\$143	+\$170	+\$227	+\$315	+\$382	+\$454	+\$605	+\$764
	Seat upcharge:	\$-24	+0	+\$19	+\$47	+\$86	+\$102	+\$136	+\$189	+\$229	+\$273	+\$363	+\$459
		OVERALL DIMENSIONS			SEAT DIMENSIONS			BACK DIMENSIONS					
		W	D	H	W	D	H	W	H				
		28.5	29	45.5	20	18.5	17-20	20	29				
		28.5	29	48.5	20	18.5	20-23	20	29				
High Back Patient Chair, Schukra depth adjustable lumbar COM Yardage: Back: 1.25; Seat: .75 Freight Class: 300 Product Weight (lbs.): 56 Cubic Feet Per Carton: 33.5	Active weight 350 lbs.												

DESCRIPTION	MODEL#/FEATURES	STANDARD FABRIC GRADES											
		COM	2	3	4	5	6	7	8	9	10	11	12
 Adjustable height	GC3682F Base Price: Adjustable height	\$3371											
	GC3682-20F Base Price: Adjustable height, 20"	\$3436											
 Fixed 18.5" height	GC3682FXH Base Price: Fixed 18.5" height	\$3230											
	Back upcharge:	\$-40	+0	+\$32	+\$78	+\$143	+\$170	+\$227	+\$315	+\$382	+\$454	+\$605	+\$764
	Seat upcharge:	\$-24	+0	+\$19	+\$47	+\$86	+\$102	+\$136	+\$189	+\$229	+\$273	+\$363	+\$459
		OVERALL DIMENSIONS			SEAT DIMENSIONS			BACK DIMENSIONS					
		W	D	H	W	D	H						
		28.5	29	45.5	20	18.5	17-20						
		28.5	29	48.5	20	18.5	20-23						
High Back Patient Chair with Schukra depth adjustable lumbar, Flex Back COM Yardage: Back: 1.25; Seat: .75 Freight Class: 300 Product Weight (lbs.): 56 Cubic Feet Per Carton: 33.5		Active weight 350 lbs.											

DESCRIPTION	MODEL#/FEATURES	STANDARD FABRIC GRADES											
		COM	2	3	4	5	6	7	8	9	10	11	12
 Adjustable height	GC3683 Base Price: Adjustable height	\$3181											
	GC3683-20 Base Price: Adjustable height, 20"	\$3245											
 Fixed 18.5" height	GC3683XH Base Price: Fixed 18.5" height	\$3047											
	Back upcharge:	\$-40	+0	+\$32	+\$78	+\$143	+\$170	+\$227	+\$315	+\$382	+\$454	+\$605	+\$764
	Seat upcharge:	\$-24	+0	+\$19	+\$47	+\$86	+\$102	+\$136	+\$189	+\$229	+\$273	+\$363	+\$459
		OVERALL DIMENSIONS			SEAT DIMENSIONS			BACK DIMENSIONS					
		W	D	H	W	D	H						
		28.5	29	45.5	20	18.5	17-20						
		28.5	29	48.5	20	18.5	20-23						
High Back Patient Chair, Schukra depth adjustable headrest COM Yardage: Back: 1.25; Seat: .75 Freight Class: 300 Product Weight (lbs.): 56 Cubic Feet Per Carton: 33.5		Active weight 350 lbs.											

DESCRIPTION	MODEL#/FEATURES	STANDARD FABRIC GRADES											
		COM	2	3	4	5	6	7	8	9	10	11	12
 Adjustable height	GC3683F Base Price: Adjustable height	\$3536											
	GC3683-20F Base Price: Adjustable height, 20"	\$3600											
 Fixed 18.5" height	GC3683FXH Base Price: Fixed 18.5" height	\$3402											
	Back upcharge:	\$-40	+0	+\$32	+\$78	+\$143	+\$170	+\$227	+\$315	+\$382	+\$454	+\$605	+\$764
	Seat upcharge:	\$-24	+0	+\$19	+\$47	+\$86	+\$102	+\$136	+\$189	+\$229	+\$273	+\$363	+\$459
		OVERALL DIMENSIONS			SEAT DIMENSIONS			BACK DIMENSIONS					
		W	D	H	W	D	H						
		28.5	29	45.5	20	18.5	17-20						
		28.5	29	48.5	20	18.5	20-23						
High Back Patient Chair, Schukra depth adjustable headrest, Flex Back COM Yardage: Back: 1.25; Seat: .75 Freight Class: 300 Product Weight (lbs.): 56 Cubic Feet Per Carton: 33.5		Active weight 350 lbs.											

DESCRIPTION	MODEL# / FEATURES	STANDARD TEXTILE GRADES											
		COM	2	3	4	5	6	7	8	9	10	11	12
 Adjustable height	GC3684 Base Price: \$3512 Adjustable height												
	GC3684-20 Base Price: \$3573 Adjustable height, 20"												
 Fixed 18.5" height	GC3684XH Base Price: \$3378 Fixed 18.5" height												
	Back upcharge: \$-40 +0 +\$32 +\$78 +\$143 +\$170 +\$227 +\$315 +\$382 +\$454 +\$605 +\$764 Seat upcharge: \$-24 +0 +\$19 +\$47 +\$86 +\$102 +\$136 +\$189 +\$229 +\$273 +\$363 +\$459												
		OVERALL DIMENSIONS			SEAT DIMENSIONS			BACK DIMENSIONS					
		W	D	H	W	D	H	W	H				
		28.5	29	45.5	20	18.5	17-20	20	29				
		28.5	29	48.5	20	18.5	20-23	20	29				
High Back Patient Chair, Schukra depth adjustable lumbar & headrest COM Yardage: Back: 1.25; Seat: .75 Active weight 350 lbs. Freight Class: 300 Product Weight (lbs.): 56 Cubic Feet Per Carton: 33.5													

DESCRIPTION	MODEL# / FEATURES	STANDARD TEXTILE GRADES											
		COM	2	3	4	5	6	7	8	9	10	11	12
 Adjustable height	GC3684F Base Price: \$3868 Adjustable height												
	GC3684-20F Base Price: \$3930 Adjustable height, 20"												
 Fixed 18.5" height	GC3684FXH Base Price: \$3735 Fixed 18.5" height												
	Back upcharge: \$-40 +0 +\$32 +\$78 +\$143 +\$170 +\$227 +\$315 +\$382 +\$454 +\$605 +\$764 Seat upcharge: \$-24 +0 +\$19 +\$47 +\$86 +\$102 +\$136 +\$189 +\$229 +\$273 +\$363 +\$459												
		OVERALL DIMENSIONS			SEAT DIMENSIONS			BACK DIMENSIONS					
		W	D	H	W	D	H	W	H				
		28.5	29	45.5	20	18.5	17-20	20	29				
		28.5	29	48.5	20	18.5	20-23	20	29				
High Back Patient Chair with Schukra depth adjustable lumbar & headrest, Flex Back COM Yardage: Back: 1.25; Seat: .75 Active weight 350 lbs. Freight Class: 300 Product Weight (lbs.): 56 Cubic Feet Per Carton: 33.5													

DESCRIPTION	MODEL# / FEATURES	STANDARD TEXTILE GRADES												
		COM	2	3	4	5	6	7	8	9	10	11	12	
	GC3685 Base Price: \$3529													
	Back upcharge: \$-72 +0 +\$57 +\$140 +\$257 +\$306 +\$408 +\$567 +\$687 +\$817 +\$1089 +\$1375													
	Seat upcharge: \$-32 +0 +\$25 +\$62 +\$114 +\$136 +\$181 +\$252 +\$305 +\$363 +\$484 +\$611													
		OVERALL DIMENSIONS			SEAT DIMENSIONS			BACK DIMENSIONS						
		W	D	H	W	D	H	W	H					
		40	29	47	35	18.5	18.5	35	29					
Bariatric High Back Patient Chair COM Yardage: Back: 2.25; Seat: 1 Active weight 750 lbs. Fixed height legs. Freight Class: 300 Product Weight (lbs.): 70 Cubic Feet Per Carton: 45														

DESCRIPTION	MODEL# / FEATURES	STANDARD TEXTILE GRADES												
		COM	2	3	4	5	6	7	8	9	10	11	12	
	GC3686	\$859	\$891	\$916	\$953	\$1005	\$1027	\$1072	\$1143	\$1196	\$1254	\$1375	\$1502	
			OVERALL DIMENSIONS			SEAT DIMENSIONS			BACK DIMENSIONS					
			W	D	H	W	D	H	W	H				
			17	17.5	12.5									
Ottoman COM Yardage: 1 Active weight 350 lbs. Freight Class: 150 Product Weight (lbs.): 18 Cubic Feet Per Carton: 3.6 Can be stored beneath any Nourish chair when not in use.														

OAKVILLE



model GC36500
High back lounge chair

STANDARD FEATURES

- Oakville offers a modern take on wingback seating for social settings, resident rooms and lounge areas.
- The seating in this series is available to specify with two textiles, one for the seat cushion and one for the back, arms and front rail (see model image).
- For pricing, start with the base price and add both back/arms graded textile upcharge and the seat graded textile upcharge.
- A clean through design is provided around the seat cushion for easy housekeeping.
- Legs are available in wood or urethane (see upcharge).
- Choose from standard non-marking glides, steel cushioned glides, rubber non-slip glides, or felt glides (upcharges apply).
- The seat underside is sealed with a non-porous material to support housekeeping and infection control protocols.
- For added comfort, seat cushions are standard with high density Ultracell foam.
- The Globalcare warranty (for healthcare and 24/7 environments) applies for all Oakville models when performance textiles are selected. Visit the website at globalfurnituregroup.com/healthcare.
- Global's standard lifetime warranty applies when approved standard Global textiles are selected.
- For alternate textile applications, contact Global specials. The Blended Textile matrix does not apply to this series.
- Shipped fully assembled.

SUGGESTED APPLICATIONS

- Guest seating
- Lobbies
- Lounge/Waiting
- Patient rooms
- Resident rooms

Add option codes in the following order:

- **Model number**
GC36500 High back lounge chair
- **Back/Arm Textile**
Specify textile code. See model grade upcharges.
- **Seat Textile**
Specify textile code. See model grade upcharges.
- **Leg Finish (Wood)**
 - (AAM) Absolute
 - (BKM) Black
 - (CJM) Charcoal Java
 - (ACM) Cherry
 - (EMM) Empire Mahogany
 - (EOM) English Oak
 - (ECM) Espresso Cafe
 - (TFM) Fruitwood
 - (HGM) Grey
 - (HOM) Harvest Oak
 - (AHM) Honey
 - (JOM) Jet Onyx
 - (LHM) Light Honey
 - (TMM) Mahogany
 - (AVM) Maple
 - (MWM) Medium Walnut
 - (NLW) Natural Walnut
 - (ASM) Night
 - (NBM) Noce Biondo
 - (NGM) Noce Grigio
 - (NEM) Noce Leggero
 - (NMM) Noce Medio
 - (SBM) Sandy Beach
 - (SKM) Shaker Cherry
 - (SOM) Silver Oak
 - (TWM) Walnut
 - (WTM) WC Cream
 - (WHM) White
 - (WCM) Winter Cherry
- **Leg Finish (Urethane)** Add \$86.
 - (BLK) Black
 - (LAB) Latte
 - (SHW) Shadow
 - (KAL) Kalua
 - (J52) Mocha
 - (TOA) Toast
- **Glides**
 - (NM) Non-marking glide. Standard.
 - (RG) Rubber, non-slip glide. Add \$34.
 - (SG) Steel cushion glide. Add \$34.
 - (FG) Felt glide. Add \$34.
- **Sealed Back Seams** (Contact Customer Care for approved textiles)
 - (NBS) No sealed back seams
 - (SBS) Sealed back seams. Add \$166.
- **Sealed Seat Seams** (Contact Customer Care for approved textiles)
 - (NSS) No sealed seat seams
 - (SSS) Sealed seat seams. Add \$32.
- **Moisture Barrier** (Not available with Sealed Seams)
 - (NB) No moisture barrier.
 - (MB) Moisture barrier (seat only). Add \$110.

EXAMPLE OAKVILLE ORDER CODE:

GC36500	CE90	CE90	AVM	NM	NBS	NSS	NB
Model #	Back/Arm textile	Seat textile	Leg finish	Glide	Sealed Back Seams	Sealed Seat Seams	Moisture Barrier

DESCRIPTION	MODEL#/ FEATURES	STANDARD TEXTILE GRADES												
		1/COM	2	3	4	5	6	7	8	9	10	11	12	
 High Back Lounge Chair COM Yardage: Back/Arm: 4.25; Seat: 1.25 Freight Class: 250 Product Weight (lbs.): 75.5 Cubic Feet Per Carton: 19.25	GC36500	Base Price:	\$2801											
		Back/Arm upcharge:	+0	+\$136	+\$243	+\$400	+\$621	+\$714	+\$906	+\$1207	+\$1433	+\$1679	+\$2193	+\$2733
		Seat upcharge:	+0	+\$40	+\$72	+\$118	+\$183	+\$210	+\$267	+\$355	+\$422	+\$494	+\$645	+\$804
		OVERALL DIMENSIONS												
		W	D	H										
		30	30	41.25										
					SEAT DIMENSIONS									
					W	D	H							
					20.5	21	18.5							
								BACK DIMENSIONS						
								W	H					
								21.75	23.75					



GC3616W Dining armchair with open arms

Primacare™ set a benchmark for healthcare seating. All the features, all the looks and quite possibly the most extensive offering of its kind for both acute care and long-term care applications.

Under the skin of every Primacare chair is a heart of solid steel waiting to meet the rigorous demands of any environment.

The Primacare series includes more than 40 models that extend from patient rooms to waiting areas, dining rooms to treatment centers including bariatric hip chair solutions.

FEATURES



Open arms



Closed arms - fully upholstered side panels



Arm grip extension - to assist getting in and out of the chair safely

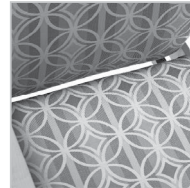

Separate seat and back - provides clean out for housekeeping staff



Fold down headrest - to provide access for caregiver assistance



Removable upholstery - for ease of cleaning and replacement



Solid wood frame - in hardwood for long life and a warm look



Metal-to-metal connector - provides unparalleled strength and durability



Metal mesh pan - superior comfort and hygiene for patient incontinence



Wall safe legs - offer first contact to protect walls and chair backs on most models

AVAILABLE TEXTILES AND FINISHES

Please see the Globalcare Textile and Finishes section at www.globalfurnituregroup.com for all details including wood finishes.

SUGGESTED APPLICATIONS

- Bariatric seating (some models)
- Dining/Cafeteria
- Guest seating
- Lobbies
- Lounge/Waiting
- Patient rooms
- Resident rooms
- Treatment/Exam rooms

DINING - available with wood or metal frames



GUEST - available with wood or metal frames



PATIENT - available with wood or metal frames



HIP CHAIRS - available with wood or metal frames



LOUNGE - available with wood or metal legs



FULLY UPHOLSTERED LOUNGE - available with wood or metal legs

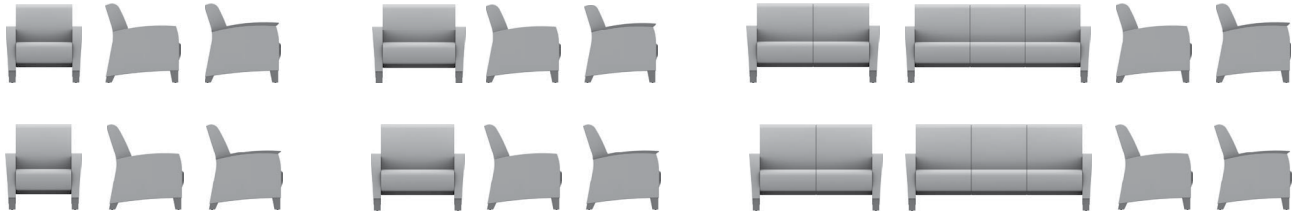

WINGBACK ARMCHAIR - available with wood or metal armcaps and legs



RECLINERS - available with wood or metal armcaps



SLEEPERS - available with wood or metal armcaps



BENCHES - available with wood or metal legs



MODULAR GUEST/PATIENT - see page 154.

PRIMACARE DINING



model GC3616CA (HT)



model GC3616W (Wood)

STANDARD FEATURES

- Primacare is a family of products offering the most significant return on investment approach in the industry since every component can be repaired or replaced on site.
- High traffic (HT) models:** Metal frame with die cast zinc connectors and metal-to-metal fasteners. Available in the following finishes: Black (TBL), Cloud (TIV), Designer White (TDW), Fog (TFO), Frost (TFR), Kalua (TKA), Latte (TLA), Mocha (TMO), Nevada (TNE), Sand (TSN), Shadow (TSH), Toast (TOA) and Tungsten (TTU).
- Wood models:** Solid hardwood frame with die cast zinc connectors and metal-to-metal fastening. Available in the following finishes: Absolute (AAM), Charcoal Java (CJM), Cherry (ACM), Empire Mahogany (EMM), English Oak (EOM), Espresso Cafe (ECM), Fruitwood (TFM), Gray (HGM), Harvest Oak (HOM), Honey (AHM), Jet Onyx (JOM), Light Honey (LHM), Mahogany (TMM), Maple (AVM), Medium Walnut (MWM), Natural Walnut (NLW), Night (ASM), Noce Biondo (NBM), Noce Grigio (NGM), Noce Leggero (NEM), Noce Medio (NMM), Sandy Beach (SBM), Shaker Cherry (SKM), Silver Oak (SOM), Walnut (TWM), White (WHM), WC Cream (WTM) and Winter Cherry (WCM).
- Armchairs are securely fastened with metal-to-metal connectors which allow for field replacement if required.
- Easy grip forward extending armcap on models with arms.
- Wood armchairs are standard.
- Replaceable seat covers and replaceable and/or removable seat cushions are standard.
- Waterfall cleanout between the seat and back cushions.
- Models are standard with metal mesh seat deck. For behavioral health applications, the metal mesh seat deck can be covered with a solid moisture resistant surface, held in place with tamperproof fasteners. Contact your Global sales rep for a special quotation.
- All seat frames feature a wall saver design to prevent back contact with wall.
- GC3616WCA** and **GC3616CA** have upholstered panel arm inserts closing the arm. (Closed arm panels are designed to be replaceable. Request a special quote to have them secured with tamperproof fasteners.)
- For healthcare textile options, visit the website at www.globalfurnituregroup.com.
- Can be upholstered in standard Global textiles if healthcare compliance is not required.
- It is recommended that High Traffic (HT) models be specified in textiles that meet or exceed 100,000 double rubs for added abrasion performance.
- Shipped fully assembled.

- HIGH TRAFFIC (HT) MODELS ARE LISTED FIRST, FOLLOWED BY WOOD MODELS.**

OPTIONAL FEATURES

- Urethane armchairs are available. See far left column "High traffic (HT) models" for finishes. Please specify. *Refer to individual models for availability and pricing.*
- For moisture barrier on seat, specify (MB). Add \$129 per seat.
- To add sealed seams to your product contact Customer Care. Upcharges vary.
- For Primacare tables, see page 56.

SUGGESTED APPLICATIONS

- Dining/Cafeteria
- Guest seating
- Lobbies
- Lounge/Waiting
- Patient rooms
- Resident rooms

DESCRIPTION	MODEL# / FEATURES	STANDARD TEXTILE GRADES											
-------------	-------------------	-------------------------	--	--	--	--	--	--	--	--	--	--	--



Dining Chair, Open Arms (HT)
COM Yardage: 1.5
Freight Class: 150
Product Weight (lbs.): 58
Cubic Feet Per Carton: 13.25

	COM	2	3	4	5	6	7	8	9	10	11	12
GC3616 Metal	\$1654	\$1703	\$1748	\$1809	\$1899	\$1930	\$2008	\$2154	\$2227	\$2364	\$2551	\$2783
OVERALL DIMENSIONS			SEAT DIMENSIONS			BACK DIMENSIONS						
	W	D	H	W	D	H	W	H				
	23	23	34.5	19	17.5	18	19	16.5				

Active weight 500 lbs.
Urethane armcap option - **Add \$104 list upcharge**



Dining Chair, Closed Arms (HT)
COM Yardage: 2
Freight Class: 150
Product Weight (lbs.): 66
Cubic Feet Per Carton: 13.25

	COM	2	3	4	5	6	7	8	9	10	11	12
GC3616CA Metal	\$1899	\$1965	\$2021	\$2107	\$2223	\$2268	\$2370	\$2567	\$2664	\$2845	\$3094	\$3404
OVERALL DIMENSIONS			SEAT DIMENSIONS			BACK DIMENSIONS						
	W	D	H	W	D	H	W	H				
	23	23	34.5	19	17.5	18	19	16.5				

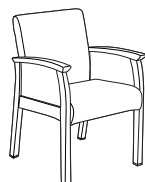

Active weight 500 lbs.
Urethane armcap option - **Add \$104 list upcharge**



Dining Chair, Closed Arms, Laminate Panels (HT)
COM Yardage: 1.5
Freight Class: 150
Product Weight (lbs.): 66
Cubic Feet Per Carton: 13.25

	COM	2	3	4	5	6	7	8	9	10	11	12
GC3616CAL Metal	\$2237	\$2281	\$2321	\$2377	\$2458	\$2494	\$2566	\$2679	\$2767	\$2867	\$3070	\$3284
OVERALL DIMENSIONS			SEAT DIMENSIONS			BACK DIMENSIONS						
	W	D	H	W	D	H	W	H				
	23	23	34.5	19	17.5	18	19	16.5				

Active weight 500 lbs.
Urethane armcap option - **Add \$104 list upcharge**

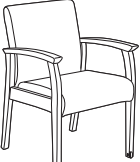
DESCRIPTION	MODEL#	STANDARD FABRIC GRADES											
		COM	2	3	4	5	6	7	8	9	10	11	12
 <p>Dining Chair, Open Arms (Wood) COM Yardage: 1.5 Freight Class: 250 Product Weight (lbs.): 50 Cubic Feet Per Carton: 13.25</p>	GC3616W	\$1364	\$1411	\$1456	\$1518	\$1608	\$1639	\$1719	\$1863	\$1935	\$2072	\$2261	\$2491
	Wood												
	Active weight 350 lbs.	23	23	34.5	19	17.5	18	19	16.5				
	Urethane armcap option - Add \$104 list upcharge												
 <p>Dining Chair, Closed Arms (Wood) COM Yardage: 2 Freight Class: 150 Product Weight (lbs.): 58 Cubic Feet Per Carton: 13.25</p>	GC3616WCA	\$1563	\$1627	\$1685	\$1770	\$1887	\$1934	\$2036	\$2230	\$2326	\$2508	\$2758	\$3067
	Wood												
	Active weight 350 lbs.	23	23	34.5	19	17.5	18	19	16.5				
	Urethane armcap option - Add \$104 list upcharge												
 <p>Dining Chair, Open Arms, Front Casters (Wood) COM Yardage: 1.5 Freight Class: 250 Product Weight (lbs.): 50 Cubic Feet Per Carton: 13.25</p>	GC3616WFC	\$1522	\$1569	\$1614	\$1675	\$1766	\$1797	\$1876	\$2021	\$2093	\$2230	\$2418	\$2651
	Wood												
	Active weight 350 lbs.	23	23	34.5	19	17.5	18	19	16.5				
	Urethane armcap option - Add \$104 list upcharge												

PRIMACARE GUEST



model GC3620CA (HT)



model GC3625W (Wood)

STANDARD FEATURES

- Primacare is a family of products offering the most significant return on investment approach in the industry since every component can be repaired or replaced on site.
- **High traffic (HT) models:** Metal frame with die cast zinc connectors and metal-to-metal fasteners. Available in the following finishes: Black (TBL), Cloud (TIV), Designer White (TDW), Fog (TFO), Frost (TFR), Kalua (TKA), Latte (TLA), Mocha (TMO), Nevada (TNE), Sand (TSN), Shadow (TSH), Toast (TOA) and Tungsten (TTU).
- **Wood models:** Solid hardwood frame with die cast zinc connectors and metal-to-metal fastening. Available in the following finishes: Absolute (AAM), Charcoal Java (CJM), Cherry (ACM), Empire Mahogany (EMM), English Oak (EOM), Espresso Cafe (ECM), Fruitwood (TFM), Gray (HGM), Harvest Oak (HOM), Honey (AHM), Jet Onyx (JOM), Light Honey (LHM), Mahogany (TMM), Maple (AVM), Medium Walnut (MWM), Natural Walnut (NLW), Night (ASM), Noce Biondo (NBM), Noce Grigio (NGM), Noce Leggero (NEM), Noce Medio (NMM), Sandy Beach (SBM), Shaker Cherry (SKM), Silver Oak (SOM), Walnut (TWM), White (WHM), WC Cream (WTM) and Winter Cherry (WCM).
- Armcaps are securely fastened with metal-to-metal connectors which allow for field replacement if required.
- Easy grip forward extending armcap on models with arms.

- Wood armcaps are standard.
- Replaceable seat covers and replaceable and/or removable seat cushions are standard.
- Waterfall cleanout between the seat and back cushions.
- Models are standard with metal mesh seat deck. For behavioral health applications, the metal mesh seat deck can be covered with a solid moisture resistant surface, held in place with tamperproof fasteners. Contact your sales rep for a special quotation.
- All seat frames feature a wall saver design to prevent back contact with wall.
- Models ending in **CA / ARC**, have upholstered panel arm inserts closing the arm. (Closed arm panels are designed to be replaceable. Request a special quote to have them secured with tamperproof fasteners.)
- For Globalcare textile options, visit the website at www.globalfurnituregroup.com.
- Can be upholstered in standard Global textiles if healthcare compliance is not required.
- It is recommended that High Traffic (HT) models be specified in textiles that meet or exceed 100,000 double rubs for added abrasion performance.
- Shipped fully assembled.
- **High traffic (HT) models are listed first, followed by wood models.**

OPTIONAL FEATURES

- Urethane armcaps are available. Please specify. Refer to individual models for availability and pricing.
- For moisture barrier (seat only), add \$129 list upcharge per seat. For Bariatric Models: GC3637, GC3637W, GC3637CA and GC3637WCA - **Add \$198** list upcharge per seat.
- To add sealed seams to your product contact Customer Care. Upcharges vary.
- For Primacare tables, see page 56.

SUGGESTED APPLICATIONS

- Bariatric seating
- Guest seating
- Lobbies
- Lounge/Waiting
- Patient rooms
- Resident rooms

DESCRIPTION MODEL# / FEATURES STANDARD TEXTILE GRADES



LB Armchair, Open Arms (HT)
COM Yardage: 1.75
Freight Class: 250
Product Weight (lbs.): 62
Cubic Feet Per Carton: 17.5

COM	2	3	4	5	6	7	8	9	10	11	12	
GC3620	\$1974	\$2031	\$2083	\$2157	\$2258	\$2298	\$2389	\$2559	\$2644	\$2803	\$3021	\$3293
Metal												
GC3620F	\$2468	\$2529	\$2579	\$2653	\$2755	\$2793	\$2884	\$3055	\$3140	\$3300	\$3519	\$3788
Metal flex back												
OVERALL DIMENSIONS			SEAT DIMENSIONS			BACK DIMENSIONS						
W	D	H	W	D	H	W	H					
25	27	33	20.5	17.5	18	20.5	15					

Active weight 500 lbs.
Urethane armcap option - **Add \$104 list upcharge**

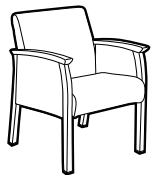

LB Armchair, Closed Arms (HT)
COM Yardage: 2.75
Freight Class: 150
Product Weight (lbs.): 72
Cubic Feet Per Carton: 17.5

COM	2	3	4	5	6	7	8	9	10	11	12	
GC3620CA	\$2239	\$2331	\$2410	\$2526	\$2688	\$2748	\$2892	\$3158	\$3292	\$3540	\$3885	\$4309
Metal												
GC3620FCA	\$2737	\$2829	\$2908	\$3022	\$3184	\$3246	\$3389	\$3656	\$3790	\$4038	\$4383	\$4808
Metal flex back												
OVERALL DIMENSIONS			SEAT DIMENSIONS			BACK DIMENSIONS						
W	D	H	W	D	H	W	H					
25	27	33	20.5	17.5	18	20.5	15					

Active weight 500 lbs.
Urethane armcap option - **Add \$104 list upcharge**

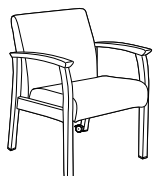

LB Armchair, Open Arms, Rear Tip & Move Wheels (HT)
COM Yardage: 1.75
Freight Class: 250
Product Weight (lbs.): 62
Cubic Feet Per Carton: 23

COM	2	3	4	5	6	7	8	9	10	11	12	
GC3620RC	\$2125	\$2183	\$2235	\$2308	\$2411	\$2449	\$2541	\$2713	\$2797	\$2956	\$3174	\$3443
Metal												
OVERALL DIMENSIONS			SEAT DIMENSIONS			BACK DIMENSIONS						
W	D	H	W	D	H	W	H					
25	29.5	33	20.5	17.5	18	20.5	15					

Active weight 500 lbs.
Urethane armcap option - **Add \$104 list upcharge**

DESCRIPTION MODEL# STANDARD FABRIC GRADES

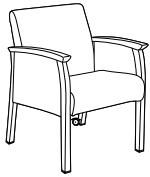

COM	2	3	4	5	6	7	8	9	10	11	12	
GC3620CARC	\$2398	\$2490	\$2569	\$2683	\$2844	\$2906	\$3050	\$3317	\$3450	\$3698	\$4042	\$4468

Metal

OVERALL DIMENSIONS			SEAT DIMENSIONS			BACK DIMENSIONS	
W	D	H	W	D	H	W	H
25	29.5	33	20.5	17.5	18	20.5	15

LB Armchair, Closed Arms, Rear Tip & Move Wheels (HT)
 COM Yardage: 2.75
 Freight Class: 250
 Product Weight (lbs.): 72
 Cubic Feet Per Carton: 23

Active weight 500 lbs.
 Urethane armcap option - **Add \$104 list upcharge**

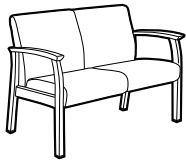

COM	2	3	4	5	6	7	8	9	10	11	12	
GC3621	\$3193	\$3304	\$3396	\$3531	\$3722	\$3797	\$3964	\$4278	\$4435	\$4731	\$5140	\$5639

Metal

OVERALL DIMENSIONS			SEAT DIMENSIONS			BACK DIMENSIONS	
W	D	H	W	D	H	W	H
45	27	33	40	17.5	18	40	15

LB Two Seat Chair, No Center Arm, Open Arms (HT)
 COM Yardage: 3.25
 Freight Class: 250
 Product Weight (lbs.): 92
 Cubic Feet Per Carton: 43

Active weight 500 lbs./seat
 Urethane armcap option - **Add \$104 list upcharge**

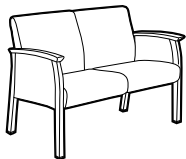

COM	2	3	4	5	6	7	8	9	10	11	12	
GC3621CA	\$3478	\$3603	\$3710	\$3867	\$4087	\$4170	\$4364	\$4731	\$4912	\$5250	\$5719	\$6302

Metal

OVERALL DIMENSIONS			SEAT DIMENSIONS			BACK DIMENSIONS	
W	D	H	W	D	H	W	H
45	27	33	40	17.5	18	40	15

LB Two Seat Chair, No Center Arm, Closed Arms (HT)
 COM Yardage: 3.75
 Freight Class: 250
 Product Weight (lbs.): 100
 Cubic Feet Per Carton: 43

Active weight 500 lbs./seat
 Urethane armcap option - **Add \$104 list upcharge**

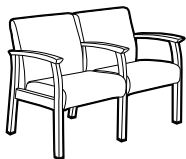

COM	2	3	4	5	6	7	8	9	10	11	12	
GC3622	\$3604	\$3716	\$3808	\$3943	\$4138	\$4207	\$4376	\$4690	\$4849	\$5142	\$5550	\$6051

Metal

OVERALL DIMENSIONS			SEAT DIMENSIONS			BACK DIMENSIONS	
W	D	H	W	D	H	W	H
46	27	33	20.5	17.5	18	20.5	15

LB Two Seat Chair, Full Center Arm, Open Arms (HT)
 COM Yardage: 3.25
 Freight Class: 250
 Product Weight (lbs.): 98
 Cubic Feet Per Carton: 43

Active weight 500 lbs./seat
 Urethane armcap option - **Add \$155 list upcharge**

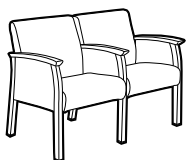

COM	2	3	4	5	6	7	8	9	10	11	12	
GC3622CA	\$4012	\$4166	\$4292	\$4481	\$4746	\$4846	\$5078	\$5515	\$5735	\$6141	\$6703	\$7400

Metal

OVERALL DIMENSIONS			SEAT DIMENSIONS			BACK DIMENSIONS	
W	D	H	W	D	H	W	H
46	27	33	20.5	17.5	18	20.5	15

LB Two Seat Chair, Full Center Arm, Closed Arms (HT)
 COM Yardage: 4.5
 Freight Class: 250
 Product Weight (lbs.): 118
 Cubic Feet Per Carton: 43

Active weight 500 lbs./seat
 Urethane armcap option - **Add \$155 list upcharge**

SEATING

PRIMACARE™ GUEST P

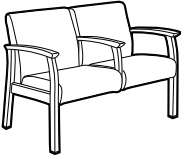
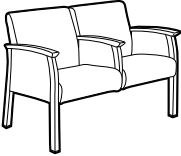
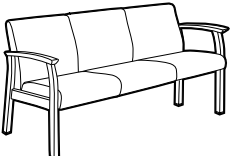
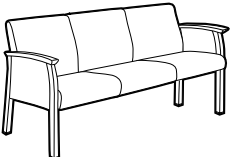
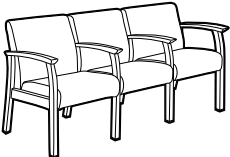
DESCRIPTION	MODEL#	STANDARD FABRIC GRADES											
		COM	2	3	4	5	6	7	8	9	10	11	12
 <p>LB Two Seat Chair, Half Center Arm, Open Arms (HT) COM Yardage: 3.25 Freight Class: 250 Product Weight (lbs.): 94 Cubic Feet Per Carton: 43</p>	GC3623 Metal	\$3539	\$3648	\$3742	\$3875	\$4070	\$4142	\$4311	\$4624	\$4782	\$5076	\$5483	\$5989
		OVERALL DIMENSIONS			SEAT DIMENSIONS			BACK DIMENSIONS					
		W	D	H	W	D	H	W	H				
			46	27	33	20.5	17.5	18	20.5	15			
Active weight 500 lbs./seat Urethane armcap option - Add \$155 list upcharge													
 <p>LB Two Seat Chair, Half Center Arm, Closed Arms (HT) COM Yardage: 4.5 Freight Class: 250 Product Weight (lbs.): 106 Cubic Feet Per Carton: 43</p>	GC3623CA Metal	\$3944	\$4098	\$4225	\$4413	\$4678	\$4778	\$5011	\$5447	\$5667	\$6073	\$6635	\$7336
		OVERALL DIMENSIONS			SEAT DIMENSIONS			BACK DIMENSIONS					
		W	D	H	W	D	H	W	H				
			46	27	33	20.5	17.5	18	20.5	15			
Active weight 500 lbs./seat Urethane armcap option - Add \$155 list upcharge													
 <p>LB Three Seat Chair, No Center Arms, Open Arms (HT) COM Yardage: 4.25 Freight Class: 250 Product Weight (lbs.): 137 Cubic Feet Per Carton: 65.25</p>	GC3624 Metal	\$4335	\$4465	\$4575	\$4734	\$4960	\$5068	\$5274	\$5599	\$5853	\$6134	\$6711	\$7326
		OVERALL DIMENSIONS			SEAT DIMENSIONS			BACK DIMENSIONS					
		W	D	H	W	D	H	W	H				
			65	27	33	60	17.5	18	60	15			
Active weight 500 lbs./seat Urethane armcap option - Add \$104 list upcharge													
 <p>LB Three Seat Chair, No Center Arms, Closed Arms (HT) COM Yardage: 5.25 Freight Class: 250 Product Weight (lbs.): 147 Cubic Feet Per Carton: 65.25</p>	GC3624CA Metal	\$4586	\$4765	\$4915	\$5133	\$5440	\$5559	\$5830	\$6340	\$6596	\$7068	\$7728	\$8540
		OVERALL DIMENSIONS			SEAT DIMENSIONS			BACK DIMENSIONS					
		W	D	H	W	D	H	W	H				
			65	27	33	60	17.5	18	60	15			
Active weight 500 lbs./seat Urethane armcap option - Add \$104 list upcharge													
 <p>LB Three Seat Chair, Full Center Arms, Open Arms (HT) COM Yardage: 4.75 Freight Class: 250 Product Weight (lbs.): 162 Cubic Feet Per Carton: 65.25</p>	GC3625 Metal	\$5126	\$5289	\$5426	\$5621	\$5903	\$6009	\$6253	\$6715	\$6945	\$7374	\$7971	\$8704
		OVERALL DIMENSIONS			SEAT DIMENSIONS			BACK DIMENSIONS					
		W	D	H	W	D	H	W	H				
			69	27	33	20.5	17.5	18	20.5	15			
Active weight 500 lbs./seat Urethane armcap option - Add \$204 list upcharge													

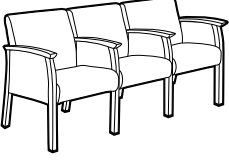
DESCRIPTION	MODEL#	STANDARD FABRIC GRADES											
		COM	2	3	4	5	6	7	8	9	10	11	12
 <p>GC3625CA Metal</p>		\$5672	\$5888	\$6066	\$6323	\$6693	\$6831	\$7154	\$7762	\$8067	\$8630	\$9411	\$10381
	OVERALL DIMENSIONS			SEAT DIMENSIONS			BACK DIMENSIONS						
			W	D	H	W	D	H	W	H			
<p>LB Three Seat Chair, Full Center Arms, Closed Arms (HT) COM Yardage: 6.25 Freight Class: 250 Product Weight (lbs.): 172 Cubic Feet Per Carton: 65.25</p>			69	27	33	20.5	17.5	18	20.5	15			
			Active weight 500 lbs./seat			Urethane armcap option - Add \$204 list upcharge							

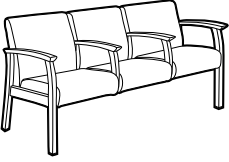
DESCRIPTION	MODEL#	STANDARD FABRIC GRADES											
		COM	2	3	4	5	6	7	8	9	10	11	12
 <p>GC3626 Metal</p>		\$4991	\$5153	\$5288	\$5487	\$5767	\$5872	\$6116	\$6579	\$6808	\$7238	\$7834	\$8568
	OVERALL DIMENSIONS			SEAT DIMENSIONS			BACK DIMENSIONS						
			W	D	H	W	D	H	W	H			
<p>LB Three Seat Chair, Half Center Arms, Open Arms (HT) COM Yardage: 4.75 Freight Class: 250 Product Weight (lbs.): 147 Cubic Feet Per Carton: 65.25</p>			69	27	33	20.5	17.5	18	20.5	15			
			Active weight 500 lbs./seat			Urethane armcap option - Add \$204 list upcharge							

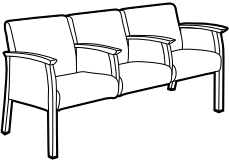
DESCRIPTION	MODEL#	STANDARD FABRIC GRADES											
		COM	2	3	4	5	6	7	8	9	10	11	12
 <p>GC3626CA Metal</p>		\$5541	\$5753	\$5931	\$6194	\$6558	\$6698	\$7021	\$7627	\$7932	\$8496	\$9280	\$10248
	OVERALL DIMENSIONS			SEAT DIMENSIONS			BACK DIMENSIONS						
			W	D	H	W	D	H	W	H			
<p>LB Three Seat Chair, Half Center Arms, Closed Arms (HT) COM Yardage: 6.25 Freight Class: 250 Product Weight (lbs.): 157 Cubic Feet Per Carton: 65.25</p>			69	27	33	20.5	17.5	18	20.5	15			
			Active weight 500 lbs./seat			Urethane armcap option - Add \$204 list upcharge							

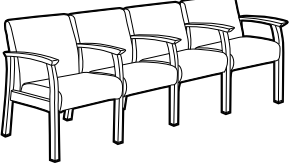
DESCRIPTION	MODEL#	STANDARD FABRIC GRADES											
		COM	2	3	4	5	6	7	8	9	10	11	12
 <p>GC3628 Metal</p>		\$7406	\$7610	\$7781	\$8028	\$8384	\$8520	\$8827	\$9410	\$9700	\$10241	\$10996	\$11925
	OVERALL DIMENSIONS			SEAT DIMENSIONS			BACK DIMENSIONS						
			W	D	H	W	D	H	W	H			
<p>LB Four Seat Chair, Full Center Arms, Open Arms (HT) COM Yardage: 6 Freight Class: 150 Product Weight (lbs.): 197 Cubic Feet Per Carton: 43</p>			93	27	33	20.5	17.5	18	20.5	15			
			Active weight 500 lbs./seat			Urethane armcap option - Add \$254 list upcharge							
			• Shipped RTA (Ready to Assemble) in 2 cartons										

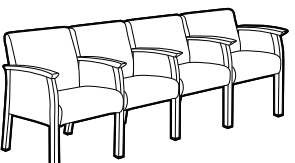
DESCRIPTION	MODEL#	STANDARD FABRIC GRADES											
		COM	2	3	4	5	6	7	8	9	10	11	12
 <p>GC3628CA Metal</p>		\$8084	\$8358	\$8583	\$8918	\$9388	\$9568	\$9978	\$10756	\$11144	\$11867	\$12870	\$14109
	OVERALL DIMENSIONS			SEAT DIMENSIONS			BACK DIMENSIONS						
			W	D	H	W	D	H	W	H			
<p>LB Four Seat Chair, Full Center Arms, Closed Arms (HT) COM Yardage: 8 Freight Class: 150 Product Weight (lbs.): 207 Cubic Feet Per Carton: 43</p>			93	27	33	20.5	17.5	18	20.5	15			
			Active weight 500 lbs./seat			Urethane armcap option - Add \$254 list upcharge							
			• Shipped RTA (Ready to Assemble) in 2 cartons										

SEATING

PRIMACARE™ GUEST P

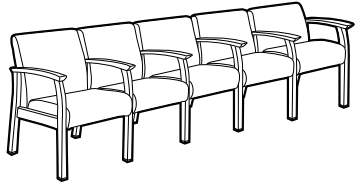
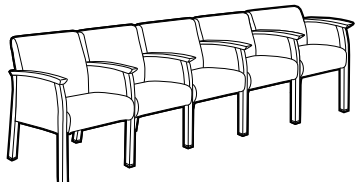
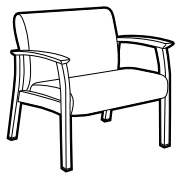
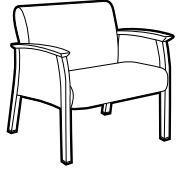
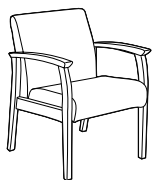
DESCRIPTION	MODEL#	STANDARD FABRIC GRADES												
		COM	2	3	4	5	6	7	8	9	10	11	12	
 <p>LB Five Seat Chair, Full Center Arms, Open Arms (HT) COM Yardage: 7.5 Freight Class: 150 Product Weight (lbs.): 249 Cubic Feet Per Carton: 43</p>	GC3630 Metal	\$8130	\$8388	\$8600	\$8912	\$9354	\$9521	\$9908	\$10635	\$11001	\$11679	\$12620	\$13780	
		OVERALL DIMENSIONS			SEAT DIMENSIONS			BACK DIMENSIONS						
		W	D	H	W	D	H	W	H					
			115	27	33	20.5	17.5	18	20.5	15				
Active weight 500 lbs./seat Urethane armcap option - Add \$303 list upcharge • Shipped RTA (Ready to Assemble) in 2 cartons														
 <p>LB Five Seat Chair, Full Center Arms, Closed Arms (HT) COM Yardage: 10 Freight Class: 125 Product Weight (lbs.): 261 Cubic Feet Per Carton: 43</p>	GC3630CA Metal	\$8944	\$9288	\$9571	\$9987	\$10576	\$10798	\$11315	\$12288	\$12771	\$13675	\$14929	\$16477	
		OVERALL DIMENSIONS			SEAT DIMENSIONS			BACK DIMENSIONS						
		W	D	H	W	D	H	W	H					
			115	27	33	20.5	17.5	18	20.5	15				
Active weight 500 lbs./seat Urethane armcap option - Add \$303 list upcharge • Shipped RTA (Ready to Assemble) in 2 cartons														
 <p>Bariatric LB Armchair, Open Arms (HT) COM Yardage: 2.5 Freight Class: 250 Product Weight (lbs.): 78 Cubic Feet Per Carton: 26.5</p>	GC3637 Metal	\$2576	\$2662	\$2735	\$2839	\$2984	\$3040	\$3170	\$3413	\$3535	\$3761	\$4073	\$4462	
		OVERALL DIMENSIONS			SEAT DIMENSIONS			BACK DIMENSIONS						
		W	D	H	W	D	H	W	H					
			35	27	33	30	17.5	18	30	15				
Active weight 500 lbs. Urethane armcap option - Add \$104 list upcharge														
 <p>Bariatric LB Armchair, Closed Arms (HT) COM Yardage: 3.5 Freight Class: 250 Product Weight (lbs.): 88 Cubic Feet Per Carton: 26.5</p>	GC3637CA Metal	\$2840	\$2960	\$3060	\$3205	\$3412	\$3490	\$3671	\$4011	\$4179	\$4496	\$4935	\$5477	
		OVERALL DIMENSIONS			SEAT DIMENSIONS			BACK DIMENSIONS						
		W	D	H	W	D	H	W	H					
			35	27	33	30	17.5	18	30	15				
Active weight 500 lbs. Urethane armcap option - Add \$104 list upcharge														
 <p>LB Single Seat Armchair, Open Arms (Wood) COM Yardage: 1.75 Freight Class: 250 Product Weight (lbs.): 50 Cubic Feet Per Carton: 17.5</p>	GC3620W Wood	\$1626	\$1683	\$1735	\$1809	\$1910	\$1950	\$2043	\$2214	\$2296	\$2455	\$2673	\$2945	
		GC3620WF Wood flex back	\$2122	\$2180	\$2230	\$2304	\$2407	\$2445	\$2535	\$2706	\$2793	\$2951	\$3170	\$3440
			OVERALL DIMENSIONS			SEAT DIMENSIONS			BACK DIMENSIONS					
W	D		H	W	D	H	W	H						
			25	27	33	20.5	17.5	18	20.5	15				
Active weight 350 lbs. Urethane armcap option - Add \$104 list upcharge														

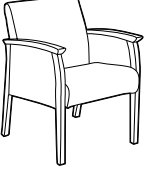
DESCRIPTION	MODEL#	STANDARD FABRIC GRADES											
		COM	2	3	4	5	6	7	8	9	10	11	12
	GC3620WCA	\$1841	\$1932	\$2012	\$2127	\$2289	\$2349	\$2492	\$2761	\$2894	\$3141	\$3486	\$3909
	Wood												
	GC3620WFCA	\$2335	\$2427	\$2505	\$2622	\$2781	\$2843	\$2988	\$3254	\$3388	\$3635	\$3981	\$4405
	Wood flex back												
		OVERALL DIMENSIONS			SEAT DIMENSIONS			BACK DIMENSIONS					
		W	D	H	W	D	H	W	H				
		25	27	33	20.5	17.5	18	20.5	15				
LB Single Seat Armchair, Closed Arms (Wood)		Active weight 350 lbs. Urethane armcap option - Add \$104 list upcharge											
COM Yardage: 2.75													
Freight Class: 250													
Product Weight (lbs.): 60													
Cubic Feet Per Carton: 17.5													

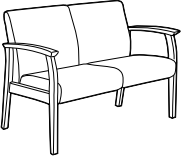
DESCRIPTION	MODEL#	STANDARD FABRIC GRADES											
		COM	2	3	4	5	6	7	8	9	10	11	12
	GC3621W	\$2627	\$2737	\$2830	\$2964	\$3159	\$3230	\$3398	\$3711	\$3869	\$4165	\$4571	\$5074
	Wood												
		OVERALL DIMENSIONS			SEAT DIMENSIONS			BACK DIMENSIONS					
		W	D	H	W	D	H	W	H				
		45	27	33	40	17.5	18	40	15				
LB Two Seat Chair, No Center Arm, Open Arms (Wood)		Active weight 350 lbs./seat Urethane armcap option - Add \$104 list upcharge											
COM Yardage: 3.25													
Freight Class: 300													
Product Weight (lbs.): 80													
Cubic Feet Per Carton: 43													

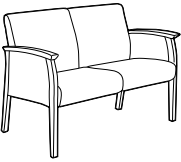
DESCRIPTION	MODEL#	STANDARD FABRIC GRADES											
		COM	2	3	4	5	6	7	8	9	10	11	12
	GC3621WCA	\$2857	\$2985	\$3091	\$3248	\$3469	\$3551	\$3746	\$4113	\$4294	\$4632	\$5100	\$5682
	Wood												
		OVERALL DIMENSIONS			SEAT DIMENSIONS			BACK DIMENSIONS					
		W	D	H	W	D	H	W	H				
		45	27	33	40	17.5	18	40	15				
LB Two Seat Chair, No Center Arm, Closed Arms (Wood)		Active weight 350 lbs./seat Urethane armcap option - Add \$104 list upcharge											
COM Yardage: 3.75													
Freight Class: 250													
Product Weight (lbs.): 90													
Cubic Feet Per Carton: 43													

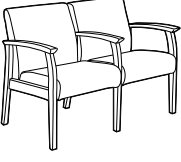
DESCRIPTION	MODEL#	STANDARD FABRIC GRADES											
		COM	2	3	4	5	6	7	8	9	10	11	12
	GC3622W	\$2966	\$3078	\$3170	\$3305	\$3500	\$3569	\$3738	\$4052	\$4210	\$4504	\$4913	\$5415
	Wood												
		OVERALL DIMENSIONS			SEAT DIMENSIONS			BACK DIMENSIONS					
		W	D	H	W	D	H	W	H				
		46	27	33	20.5	17.5	18	20.5	15				
LB Two Seat Chair, Full Center Arm, Open Arms (Wood)		Active weight 350 lbs./seat Urethane armcap option - Add \$155 list upcharge											
COM Yardage: 3.25													
Freight Class: 250													
Product Weight (lbs.): 86													
Cubic Feet Per Carton: 43													

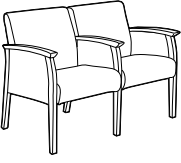
DESCRIPTION	MODEL#	STANDARD FABRIC GRADES											
		COM	2	3	4	5	6	7	8	9	10	11	12
	GC3622WCA	\$3297	\$3450	\$3577	\$3766	\$4032	\$4131	\$4363	\$4800	\$5020	\$5426	\$5991	\$6688
	Wood												
		OVERALL DIMENSIONS			SEAT DIMENSIONS			BACK DIMENSIONS					
		W	D	H	W	D	H	W	H				
		46	27	33	20.5	17.5	18	20.5	15				
LB Two Seat Chair, Full Center Arm, Closed Arms (Wood)		Active weight 350 lbs./seat Urethane armcap option - Add \$155 list upcharge											
COM Yardage: 4.5													
Freight Class: 250													
Product Weight (lbs.): 106													
Cubic Feet Per Carton: 43													

SEATING

PRIMACARE™ GUEST P

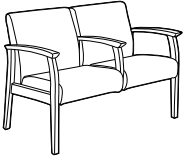
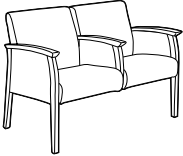
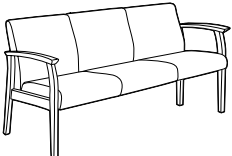
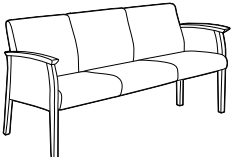
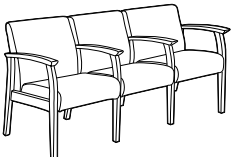
DESCRIPTION	MODEL#	STANDARD FABRIC GRADES											
		COM	2	3	4	5	6	7	8	9	10	11	12
 <p>LB Two Seat Chair, Half Center Arm, Open Arms (Wood) COM Yardage: 3.25 Freight Class: 300 Product Weight (lbs.): 82 Cubic Feet Per Carton: 43</p>	GC3623W Wood	\$2912	\$3022	\$3114	\$3250	\$3440	\$3515	\$3683	\$3998	\$4155	\$4449	\$4858	\$5360
		OVERALL DIMENSIONS			SEAT DIMENSIONS			BACK DIMENSIONS					
		W	D	H	W	D	H	W	H				
			46	27	33	20.5	17.5	18	20.5	15			
Active weight 350 lbs./seat Urethane armcap option - Add \$155 list upcharge													
 <p>LB Two Seat Chair, Half Center Arm, Closed Arms (Wood) COM Yardage: 4.5 Freight Class: 250 Product Weight (lbs.): 92 Cubic Feet Per Carton: 43</p>	GC3623WCA Wood	\$3240	\$3394	\$3520	\$3709	\$3976	\$4075	\$4306	\$4744	\$4963	\$5369	\$5935	\$6631
		OVERALL DIMENSIONS			SEAT DIMENSIONS			BACK DIMENSIONS					
		W	D	H	W	D	H	W	H				
			46	27	33	20.5	17.5	18	20.5	15			
Active weight 350 lbs./seat Urethane armcap option - Add \$155 list upcharge													
 <p>LB Three Seat Chair, No Center Arm, Open Arms (Wood) COM Yardage: 4.25 Freight Class: 300 Product Weight (lbs.): 125 Cubic Feet Per Carton: 65.25</p>	GC3624W Wood	\$3553	\$3698	\$3818	\$3994	\$4245	\$4340	\$4560	\$4974	\$5179	\$5563	\$6096	\$6756
		OVERALL DIMENSIONS			SEAT DIMENSIONS			BACK DIMENSIONS					
		W	D	H	W	D	H	W	H				
			65	27	33	60	17.5	18	60	15			
Active weight 350 lbs./seat Urethane armcap option - Add \$104 list upcharge													
 <p>LB Three Seat Chair, No Center Arm, Closed Arms (Wood) COM Yardage: 5.25 Freight Class: 250 Product Weight (lbs.): 135 Cubic Feet Per Carton: 65.25</p>	GC3624WCA Wood	\$3770	\$3947	\$4097	\$4315	\$4625	\$4741	\$5012	\$5522	\$5778	\$6252	\$6910	\$7722
		OVERALL DIMENSIONS			SEAT DIMENSIONS			BACK DIMENSIONS					
		W	D	H	W	D	H	W	H				
			65	27	33	60	17.5	18	60	15			
Active weight 350 lbs./seat Urethane armcap option - Add \$104 list upcharge													
 <p>LB Three Seat Chair, Full Center Arms, Open Arms (Wood) COM Yardage: 4.75 Freight Class: 250 Product Weight (lbs.): 150 Cubic Feet Per Carton: 65.25</p>	GC3625W Wood	\$4218	\$4380	\$4517	\$4714	\$4994	\$5099	\$5345	\$5807	\$6035	\$6467	\$7061	\$7798
		OVERALL DIMENSIONS			SEAT DIMENSIONS			BACK DIMENSIONS					
		W	D	H	W	D	H	W	H				
			69	27	33	20.5	17.5	18	20.5	15			
Active weight 350 lbs./seat Urethane armcap option - Add \$204 list upcharge													

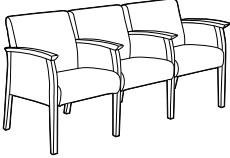
DESCRIPTION	MODEL#	STANDARD FABRIC GRADES											
		COM	2	3	4	5	6	7	8	9	10	11	12
 <p>GC3625WCA Wood</p>		\$4663	\$4876	\$5053	\$5311	\$5681	\$5820	\$6143	\$6750	\$7055	\$7618	\$8402	\$9369
		OVERALL DIMENSIONS			SEAT DIMENSIONS			BACK DIMENSIONS					
		W	D	H	W	D	H	W	H				
<p>LB Three Seat Chair, Full Center Arms, Closed Arms (Wood) COM Yardage: 6.25 Freight Class: 250 Product Weight (lbs.): 160 Cubic Feet Per Carton: 65.25</p>		69	27	33	20.5	17.5	18	20.5	15				
		Active weight 350 lbs./seat Urethane armcap option - Add \$204 list upcharge											

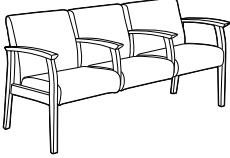
DESCRIPTION	MODEL#	STANDARD FABRIC GRADES											
		COM	2	3	4	5	6	7	8	9	10	11	12
 <p>GC3626W Wood</p>		\$4107	\$4269	\$4406	\$4603	\$4883	\$4988	\$5233	\$5695	\$5924	\$6356	\$6950	\$7684
		OVERALL DIMENSIONS			SEAT DIMENSIONS			BACK DIMENSIONS					
		W	D	H	W	D	H	W	H				
<p>LB Three Seat Chair, Half Center Arms, Open Arms (Wood) COM Yardage: 4.75 Freight Class: 250 Product Weight (lbs.): 135 Cubic Feet Per Carton: 65.25</p>		69	27	33	20.5	17.5	18	20.5	15				
		Active weight 350 lbs./seat Urethane armcap option - Add \$204 list upcharge											

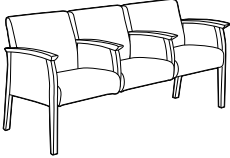
DESCRIPTION	MODEL#	STANDARD FABRIC GRADES											
		COM	2	3	4	5	6	7	8	9	10	11	12
 <p>GC3626WCA Wood</p>		\$4553	\$4765	\$4943	\$5203	\$5571	\$5713	\$6034	\$6640	\$6945	\$7507	\$8292	\$9259
		OVERALL DIMENSIONS			SEAT DIMENSIONS			BACK DIMENSIONS					
		W	D	H	W	D	H	W	H				
<p>LB Three Seat Chair, Half Center Arms, Closed Arms (Wood) COM Yardage: 6.25 Freight Class: 250 Product Weight (lbs.): 145 Cubic Feet Per Carton: 65.25</p>		69	27	33	20.5	17.5	18	20.5	15				
		Active weight 350 lbs./seat Urethane armcap option - Add \$204 list upcharge											

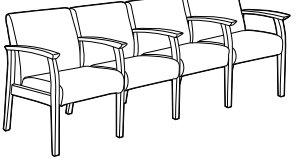
DESCRIPTION	MODEL#	STANDARD FABRIC GRADES											
		COM	2	3	4	5	6	7	8	9	10	11	12
 <p>GC3628W Wood</p>		\$6098	\$6302	\$6473	\$6724	\$7076	\$7212	\$7520	\$8104	\$8392	\$8934	\$9689	\$10617
		OVERALL DIMENSIONS			SEAT DIMENSIONS			BACK DIMENSIONS					
		W	D	H	W	D	H	W	H				
<p>LB Four Seat Chair, Full Center Arms, Open Arms (Wood) COM Yardage: 6 Freight Class: 150 Product Weight (lbs.): 185 Cubic Feet Per Carton: 43</p>		93	27	33	20.5	17.5	18	20.5	15				
		Active weight 350 lbs./seat Urethane armcap option - Add \$254 list upcharge											
		• Shipped RTA (Ready to Assemble) in 2 cartons											

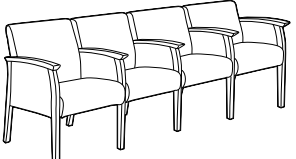
DESCRIPTION	MODEL#	STANDARD FABRIC GRADES											
		COM	2	3	4	5	6	7	8	9	10	11	12
 <p>GC3628WCA Wood</p>		\$6648	\$6923	\$7149	\$7481	\$7952	\$8133	\$8543	\$9323	\$9709	\$10433	\$11435	\$12673
		OVERALL DIMENSIONS			SEAT DIMENSIONS			BACK DIMENSIONS					
		W	D	H	W	D	H	W	H				
<p>LB Four Seat Chair, Full Center Arms, Closed Arms (Wood) COM Yardage: 8 Freight Class: 150 Product Weight (lbs.): 195 Cubic Feet Per Carton: 43</p>		93	27	33	20.5	17.5	18	20.5	15				
		Active weight 350 lbs./seat Urethane armcap option - Add \$254 list upcharge											
		• Shipped RTA (Ready to Assemble) in 2 cartons											

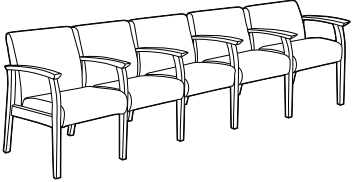
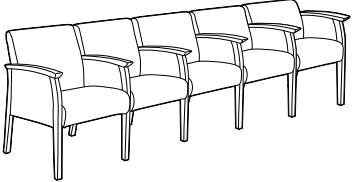
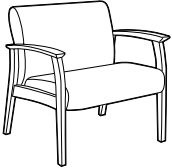
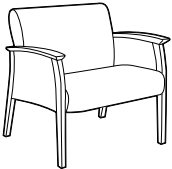
DESCRIPTION	MODEL#	STANDARD FABRIC GRADES											
		COM	2	3	4	5	6	7	8	9	10	11	12
 <p>LB Five Seat Chair, Full Center Arms, Open Arms (Wood) COM Yardage: 7.5 Freight Class: 150 Product Weight (lbs.): 227 Cubic Feet Per Carton: 43</p>	<p>GC3630W Wood</p>	\$6689	\$6947	\$7159	\$7471	\$7912	\$8079	\$8466	\$9195	\$9560	\$10236	\$11177	\$12339
		OVERALL DIMENSIONS			SEAT DIMENSIONS			BACK DIMENSIONS					
		W	D	H	W	D	H	W	H				
		115	27	33	20.5	17.5	18	20.5	15				
<p>Active weight 350 lbs./seat Urethane armcap option - Add \$303 list upcharge</p> <p>• Shipped RTA (Ready to Assemble) in 2 cartons</p>													
 <p>LB Five Seat Chair, Full Center Arms, Closed Arms (Wood) COM Yardage: 10 Freight Class: 250 Product Weight (lbs.): 237 Cubic Feet Per Carton: 43</p>	<p>GC3630WCA Wood</p>	\$7349	\$7692	\$7973	\$8389	\$8980	\$9203	\$9720	\$10692	\$11175	\$12077	\$13331	\$14880
		OVERALL DIMENSIONS			SEAT DIMENSIONS			BACK DIMENSIONS					
		W	D	H	W	D	H	W	H				
		115	27	33	20.5	17.5	18	20.5	15				
<p>Active weight 350 lbs./seat Urethane armcap option - Add \$303 list upcharge</p> <p>• Shipped RTA (Ready to Assemble) in 2 cartons</p>													
 <p>Bariatric LB Armchair, Open Arms (Wood) COM Yardage: 2.5 Freight Class: 250 Product Weight (lbs.): 66 Cubic Feet Per Carton: 26.5</p>	<p>GC3637W Wood</p>	\$2121	\$2204	\$2277	\$2383	\$2531	\$2586	\$2714	\$2958	\$3079	\$3305	\$3618	\$4006
		OVERALL DIMENSIONS			SEAT DIMENSIONS			BACK DIMENSIONS					
		W	D	H	W	D	H	W	H				
		35	27	33	30	17.5	18	30	15				
<p>Active weight 500 lbs. Urethane armcap option - Add \$104 list upcharge</p>													
 <p>Bariatric LB Armchair, Closed Arms (Wood) COM Yardage: 3.5 Freight Class: 250 Product Weight (lbs.): 76 Cubic Feet Per Carton: 26.5</p>	<p>GC3637WCA Wood</p>	\$2319	\$2438	\$2540	\$2684	\$2891	\$2970	\$3151	\$3490	\$3661	\$3976	\$4415	\$4955
		OVERALL DIMENSIONS			SEAT DIMENSIONS			BACK DIMENSIONS					
		W	D	H	W	D	H	W	H				
		35	27	33	30	17.5	18	30	15				
<p>Active weight 500 lbs. Urethane armcap option - Add \$104 list upcharge</p>													

PRIMACARE PATIENT



model GC3631 (HT)



model GC3632WCA (Wood)

STANDARD FEATURES

- Primacare is a family of products offering the most significant return on investment approach in the industry since every component can be repaired or replaced on site.
- **High traffic (HT) models:** Metal frame with die cast zinc connectors and metal-to-metal fasteners. Available in the following finishes: Black (TBL), Cloud (TIV), Designer White (TDW), Fog (TFO), Frost (TFR), Kalua (TKA), Latte (TLA), Mocha (TMO), Nevada (TNE), Sand (TSN), Shadow (TSH), Toast (TOA) and Tungsten (TTU).
- **Wood models:** Solid hardwood frame with die cast zinc connectors and metal-to-metal fastening. Available in the following finishes: Absolute (AAM), Charcoal Java (CJM), Cherry (ACM), Empire Mahogany (EMM), English Oak (EOM), Espresso Cafe (ECM), Fruitwood (TFM), Gray (HGM), Harvest Oak (HOM), Honey (AHM), Jet Onyx (JOM), Light Honey (LHM), Mahogany (TMM), Maple (AVM), Medium Walnut (MWM), Natural Walnut (NLW), Night (ASM), Noce Biondo (NBM), Noce Grigio (NGM), Noce Leggero (NEM), Noce Medio (NMM), Sandy Beach (SBM), Shaker Cherry (SKM), Silver Oak (SOM), Walnut (TWM), White (WHM), WC Cream (WTM) and Winter Cherry (WCM).
- Armcaps are securely fastened with metal-to-metal connectors which allow for field replacement if required.
- Easy grip forward extending armcap on models with arms.

- Replaceable seat covers and replaceable and/or removable seat cushions are standard.
- Wood armcaps are standard.
- Waterfall cleanout between the seat and back cushions.
- Models are standard with metal mesh seat deck. For behavioral health applications, the metal mesh seat deck can be covered with a solid moisture resistant surface, held in place with tamperproof fasteners. Contact your sales rep for a special quotation.
- All seat frames feature a wall saver design to prevent back contact with wall.
- Models ending in **CA / ARC**, have upholstered panel arm inserts closing the arm. (Closed arm panels are designed to be replaceable. Request a special quote to have them secured with tamperproof fasteners.)
- For Globalcare textile options, visit the website at www.globalfurnituregroup.com.
- Can be upholstered in standard Global textiles if healthcare compliance is not required.
- It is recommended that High Traffic (HT) models be specified in textiles that meet or exceed 100,000 double rubs for added abrasion performance.
- Shipped fully assembled.
- **High traffic (HT) models are listed first, followed by wood models.**

OPTIONAL FEATURES

- Urethane armcaps are available. Please specify. Refer to individual models for availability and pricing.
- For moisture barrier (seat only), add **\$129** list upcharge per seat. For Bariatric Models: GC3638W, GC3638WCA, GC3639W, GC3639WCA, GC3640W, GC3640WCA, GC3656W and GC3656WCA - **Add \$198** list upcharge per seat.
- To add sealed seams to your product contact Customer Care. Upcharges vary.
- For Primacare tables, see page 56.

SUGGESTED APPLICATIONS

- Bariatric seating
- Guest seating
- Lobbies
- Lounge/Waiting
- Patient rooms
- Resident rooms
- Treatment/Exam rooms

DESCRIPTION MODEL# / FEATURES STANDARD TEXTILE GRADES



MB Armchair Open Arms (HT)
COM Yardage: 1.75
Freight Class: 250
Product Weight (lbs.): 64
Cubic Feet Per Carton: 17.5

MODEL# / FEATURES	COM	STANDARD TEXTILE GRADES											
		2	3	4	5	6	7	8	9	10	11	12	
GC3631 Metal	\$2083	\$2143	\$2195	\$2269	\$2370	\$2410	\$2500	\$2669	\$2756	\$2914	\$3133	\$3405	
GC3631F Metal flex back	\$2586	\$2641	\$2695	\$2767	\$2873	\$2908	\$3001	\$3172	\$3256	\$3415	\$3633	\$3903	
		OVERALL DIMENSIONS			SEAT DIMENSIONS			BACK DIMENSIONS					
		W	D	H	W	D	H	W	H				
		25	27	36.5	20.5	17.5	18	20.5	18				

Active weight 500 lbs.
Urethane armcap option - **Add \$104 list upcharge**



MB Armchair Closed Arms (HT)
COM Yardage: 2.75
Freight Class: 150
Product Weight (lbs.): 76
Cubic Feet Per Carton: 17.5

MODEL# / FEATURES	COM	STANDARD TEXTILE GRADES											
		2	3	4	5	6	7	8	9	10	11	12	
GC3631CA Metal	\$2388	\$2480	\$2558	\$2676	\$2835	\$2897	\$3040	\$3307	\$3441	\$3689	\$4034	\$4457	
GC3631FCA Metal flex back	\$2887	\$2978	\$3056	\$3173	\$3333	\$3395	\$3539	\$3805	\$3939	\$4187	\$4532	\$4956	
		OVERALL DIMENSIONS			SEAT DIMENSIONS			BACK DIMENSIONS					
		W	D	H	W	D	H	W	H				
		25	27	36.5	20.5	17.5	18	20.5	18				

Active weight 500 lbs.
Urethane armcap option - **Add \$104 list upcharge**

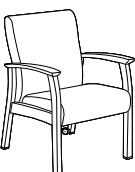

MB Armchair Open Arms, Rear Tip & Move Wheels (HT)
COM Yardage: 1.75
Freight Class: 250
Product Weight (lbs.): 64
Cubic Feet Per Carton: 23

MODEL# / FEATURES	COM	STANDARD TEXTILE GRADES											
		2	3	4	5	6	7	8	9	10	11	12	
GC3631RC Metal	\$2228	\$2288	\$2340	\$2413	\$2516	\$2554	\$2646	\$2818	\$2902	\$3061	\$3279	\$3548	
		OVERALL DIMENSIONS			SEAT DIMENSIONS			BACK DIMENSIONS					
		W	D	H	W	D	H	W	H				
		25	29.5	36.5	20.5	17.5	18	20.5	18				

Active weight 500 lbs.
Urethane armcap option - **Add \$104 list upcharge**

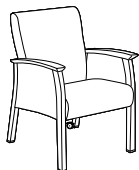
DESCRIPTION	MODEL#	STANDARD FABRIC GRADES											
		COM	2	3	4	5	6	7	8	9	10	11	12
	GC3631CARC	\$2548	\$2640	\$2718	\$2835	\$2994	\$3057	\$3201	\$3466	\$3601	\$3849	\$4194	\$4618
	Metal												
	OVERALL DIMENSIONS			SEAT DIMENSIONS			BACK DIMENSIONS						
	W	D	H	W	D	H	W	H					
MB Armchair, Closed Arms, Rear Tip & Move Wheels (HT) COM Yardage: 2.75 Freight Class: 250 Product Weight (lbs.): 76 Cubic Feet Per Carton: 23		Active weight 500 lbs. Urethane armcap option - Add \$104 list upcharge											

	GC3632	\$2332	\$2406	\$2472	\$2565	\$2698	\$2748	\$2862	\$3083	\$3192	\$3396	\$3677	\$4025
	Metal												
	GC3632F	\$2831	\$2904	\$2970	\$3063	\$3196	\$3246	\$3360	\$3581	\$3689	\$3893	\$4176	\$4523
	Metal flex back												
OVERALL DIMENSIONS			SEAT DIMENSIONS			BACK DIMENSIONS							
W	D	H	W	D	H	W	H						
HB Armchair, Open Arms, Split Back (HT) COM Yardage: 2.25 Freight Class: 250 Product Weight (lbs.): 72 Cubic Feet Per Carton: 27.5		Active weight 500 lbs. Fold away headrest. Urethane armcap option - Add \$104 list upcharge											

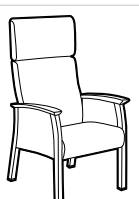
	GC3632CA	\$2643	\$2744	\$2830	\$2953	\$3132	\$3198	\$3355	\$3645	\$3789	\$4061	\$4438	\$4902
	Metal												
	GC3632FCA	\$3138	\$3240	\$3327	\$3452	\$3628	\$3694	\$3851	\$4142	\$4287	\$4559	\$4935	\$5399
	Metal flex back												
OVERALL DIMENSIONS			SEAT DIMENSIONS			BACK DIMENSIONS							
W	D	H	W	D	H	W	H						
HB Armchair, Closed Arms, Split Back (HT) COM Yardage: 3 Freight Class: 250 Product Weight (lbs.): 84 Cubic Feet Per Carton: 27.5		Active weight 500 lbs. Fold away headrest. Urethane armcap option - Add \$104 list upcharge											

	GC3632RC	\$2491	\$2564	\$2631	\$2724	\$2857	\$2907	\$3021	\$3242	\$3350	\$3554	\$3837	\$4184
	Metal												
	OVERALL DIMENSIONS			SEAT DIMENSIONS			BACK DIMENSIONS						
	W	D	H	W	D	H	W	H					
HB Armchair, Open Arms, Split Back, Rear Tip & Move Wheels (HT) COM Yardage: 2.25 Freight Class: 250 Product Weight (lbs.): 72 Cubic Feet Per Carton: 27.5		Active weight 500 lbs. Fold away headrest. Urethane armcap option - Add \$104 list upcharge											

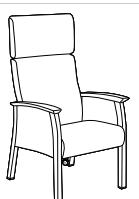
	GC3632CARC	\$2800	\$2902	\$2989	\$3111	\$3289	\$3356	\$3512	\$3803	\$3949	\$4219	\$4596	\$5060
	Metal												
	OVERALL DIMENSIONS			SEAT DIMENSIONS			BACK DIMENSIONS						
	W	D	H	W	D	H	W	H					
HB Armchair, Closed Arms, Split Back, Rear Tip & Move Wheels (HT) COM Yardage: 3 Freight Class: 250 Product Weight (lbs.): 84 Cubic Feet Per Carton: 27.5		Active weight 500 lbs. Fold away headrest. Urethane armcap option - Add \$104 list upcharge											

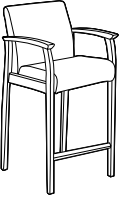
DESCRIPTION	MODEL#	STANDARD FABRIC GRADES											
		COM	2	3	4	5	6	7	8	9	10	11	12
 <p>Designed to immobilize the pelvis and hip joints after surgery.</p> <p>LB Hip Armchair, Open Arms - Post Surgery (HT) COM Yardage: 1.5 Freight Class: 250 Product Weight (lbs.): 67 Cubic Feet Per Carton: 20</p>	GC3636	\$2697	\$2746	\$2792	\$2853	\$2942	\$2978	\$3053	\$3198	\$3271	\$3407	\$3596	\$3826
	Metal												
		OVERALL DIMENSIONS			SEAT DIMENSIONS			BACK DIMENSIONS					
		W	D	H	W	D	H	W	H				
		23	26	40.5	19	17.5	25.5	19	15.5				
		Active weight 500 lbs. Urethane armcap option - Add \$104 list upcharge											

DESCRIPTION	MODEL#	STANDARD FABRIC GRADES											
		COM	2	3	4	5	6	7	8	9	10	11	12
 <p>Bariatric MB Armchair, Open Arms (HT) COM Yardage: 2.75 Freight Class: 250 Product Weight (lbs.): 94 Cubic Feet Per Carton: 30.5</p>	GC3638	\$2681	\$2773	\$2852	\$2969	\$3128	\$3190	\$3334	\$3600	\$3735	\$3982	\$4329	\$4752
	Metal												
		OVERALL DIMENSIONS			SEAT DIMENSIONS			BACK DIMENSIONS					
		W	D	H	W	D	H	W	H				
		35	27	36.5	30	17.5	18	30	18				
		Active weight 500 lbs. Urethane armcap option - Add \$104 list upcharge											

DESCRIPTION	MODEL#	STANDARD FABRIC GRADES											
		COM	2	3	4	5	6	7	8	9	10	11	12
 <p>Bariatric MB Armchair, Closed Arms (HT) COM Yardage: 3.75 Freight Class: 250 Product Weight (lbs.): 104 Cubic Feet Per Carton: 30.5</p>	GC3638CA	\$2984	\$3110	\$3217	\$3374	\$3594	\$3676	\$3871	\$4235	\$4419	\$4756	\$5225	\$5807
	Metal												
		OVERALL DIMENSIONS			SEAT DIMENSIONS			BACK DIMENSIONS					
		W	D	H	W	D	H	W	H				
		35	27	36.5	30	17.5	18	30	18				
		Active weight 500 lbs. Urethane armcap option - Add \$104 list upcharge											

DESCRIPTION	MODEL#	STANDARD FABRIC GRADES											
		COM	2	3	4	5	6	7	8	9	10	11	12
 <p>Bariatric HB Armchair, Open Arms, Split Back (HT) COM Yardage: 3.75 Freight Class: 250 Product Weight (lbs.): 77 Cubic Feet Per Carton: 33</p>	GC3639	\$2984	\$3110	\$3217	\$3374	\$3594	\$3676	\$3871	\$4235	\$4419	\$4756	\$5225	\$5807
	Metal												
		OVERALL DIMENSIONS			SEAT DIMENSIONS			BACK DIMENSIONS					
		W	D	H	W	D	H	W	H				
		35	27	48.5	30	17.5	18	30	30				
		Active weight 500 lbs. Fold away headrest. Urethane armcap option - Add \$104 list upcharge											

DESCRIPTION	MODEL#	STANDARD FABRIC GRADES											
		COM	2	3	4	5	6	7	8	9	10	11	12
 <p>Bariatric HB Armchair, Closed Arms, Split Back (HT) COM Yardage: 4.75 Freight Class: 250 Product Weight (lbs.): 108 Cubic Feet Per Carton: 33</p>	GC3639CA	\$3283	\$3447	\$3579	\$3779	\$4058	\$4164	\$4411	\$4870	\$5102	\$5531	\$6125	\$6862
	Metal												
		OVERALL DIMENSIONS			SEAT DIMENSIONS			BACK DIMENSIONS					
		W	D	H	W	D	H	W	H				
		35	27	48.5	30	17.5	18	30	30				
		Active weight 500 lbs. Fold away headrest. Urethane armcap option - Add \$104 list upcharge											

DESCRIPTION

MODEL#

STANDARD FABRIC GRADES



	COM	2	3	4	5	6	7	8	9	10	11	12
GC3655 Metal	\$2173	\$2256	\$2329	\$2433	\$2579	\$2634	\$2766	\$3007	\$3129	\$3355	\$3668	\$4056
GC3655F Metal flex back	\$2670	\$2753	\$2826	\$2932	\$3080	\$3135	\$3263	\$3506	\$3627	\$3853	\$4167	\$4554
OVERALL DIMENSIONS			SEAT DIMENSIONS			BACK DIMENSIONS						
	W	D	H	W	D	H	W	H				
	25	27	48.5	20.5	17.5	18	20.5	30				

HB Armchair, Open Arms (HT)

COM Yardage: 2.5
Freight Class: 250
Product Weight (lbs.): 72
Cubic Feet Per Carton: 27.5

Active weight 500 lbs.
Urethane armcap option - **Add \$104 list upcharge**



	COM	2	3	4	5	6	7	8	9	10	11	12
GC3655CA Metal	\$2483	\$2592	\$2686	\$2824	\$3014	\$3085	\$3253	\$3570	\$3725	\$4019	\$4428	\$4930
GC3655FCA Metal flex back	\$2978	\$3090	\$3182	\$3317	\$3508	\$3581	\$3750	\$4066	\$4222	\$4516	\$4924	\$5427
OVERALL DIMENSIONS			SEAT DIMENSIONS			BACK DIMENSIONS						
	W	D	H	W	D	H	W	H				
	25	27	48.5	20.5	17.5	18	20.5	30				

HB Armchair, Closed Arms (HT)

COM Yardage: 3.25
Freight Class: 250
Product Weight (lbs.): 84
Cubic Feet Per Carton: 27.5

Active weight 500 lbs.
Urethane armcap option - **Add \$104 list upcharge**



	COM	2	3	4	5	6	7	8	9	10	11	12
GC3655RC Metal	\$2331	\$2415	\$2488	\$2593	\$2738	\$2796	\$2923	\$3167	\$3288	\$3514	\$3827	\$4216
OVERALL DIMENSIONS			SEAT DIMENSIONS			BACK DIMENSIONS						
	W	D	H	W	D	H	W	H				
	25	29.5	48.5	20.5	17.5	18	20.5	30				

HB Armchair, Open Arms, Rear Tip & Move Wheels (HT)

COM Yardage: 2.5
Freight Class: 250
Product Weight (lbs.): 72
Cubic Feet Per Carton: 27.5

Active weight 500 lbs.
Urethane armcap option - **Add \$104 list upcharge**



	COM	2	3	4	5	6	7	8	9	10	11	12
GC3655CARC Metal	\$2641	\$2751	\$2844	\$2979	\$3173	\$3244	\$3412	\$3729	\$3884	\$4179	\$4586	\$5089
OVERALL DIMENSIONS			SEAT DIMENSIONS			BACK DIMENSIONS						
	W	D	H	W	D	H	W	H				
	25	29.5	48.5	20.5	17.5	18	20.5	30				

HB Armchair, Open Arms, Rear Tip & Move Wheels (HT)

COM Yardage: 3.25
Freight Class: 250
Product Weight (lbs.): 84
Cubic Feet Per Carton: 27.5

Active weight 500 lbs.
Urethane armcap option - **Add \$104 list upcharge**



	COM	2	3	4	5	6	7	8	9	10	11	12
GC3656 Metal	\$2765	\$2885	\$2985	\$3130	\$3336	\$3416	\$3596	\$3936	\$4106	\$4420	\$4860	\$5402
OVERALL DIMENSIONS			SEAT DIMENSIONS			BACK DIMENSIONS						
	W	D	H	W	D	H	W	H				
	35	27	48.5	30	17.5	18	30	30				

Bariatric HB Armchair, Open Arms (HT)

COM Yardage: 3.5
Freight Class: 250
Product Weight (lbs.): 79
Cubic Feet Per Carton: 33

Active weight 500 lbs.
Urethane armcap option - **Add \$104 list upcharge**

DESCRIPTION	MODEL#	STANDARD FABRIC GRADES																													
		COM	2	3	4	5	6	7	8	9	10	11	12																		
 <p>Bariatric HB Armchair, Closed Arms (HT) COM Yardage: 4.5 Freight Class: 250 Product Weight (lbs.): 108 Cubic Feet Per Carton: 33</p>	GC3656CA	\$3068	\$3222	\$3349	\$3537	\$3802	\$3902	\$4134	\$4571	\$4791	\$5196	\$5759	\$6456																		
	Metal																														
	<table border="1"> <thead> <tr> <th colspan="3">OVERALL DIMENSIONS</th> <th colspan="3">SEAT DIMENSIONS</th> <th colspan="2">BACK DIMENSIONS</th> </tr> <tr> <th>W</th> <th>D</th> <th>H</th> <th>W</th> <th>D</th> <th>H</th> <th>W</th> <th>H</th> </tr> </thead> <tbody> <tr> <td>35</td> <td>27</td> <td>48.5</td> <td>30</td> <td>17.5</td> <td>18</td> <td>30</td> <td>30</td> </tr> </tbody> </table>	OVERALL DIMENSIONS			SEAT DIMENSIONS			BACK DIMENSIONS		W	D	H	W	D	H	W	H	35	27	48.5	30	17.5	18	30	30						
OVERALL DIMENSIONS			SEAT DIMENSIONS			BACK DIMENSIONS																									
W	D	H	W	D	H	W	H																								
35	27	48.5	30	17.5	18	30	30																								

Active weight 500 lbs.
 Urethane armcap option - **Add \$104 list upcharge**

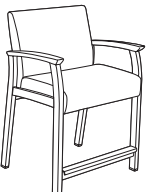
DESCRIPTION	MODEL#	STANDARD FABRIC GRADES																													
		COM	2	3	4	5	6	7	8	9	10	11	12																		
 <p>Designed to immobilize the pelvis and hip joints after surgery.</p> <p>Wide Hip Armchair, Open Arms - Post Surgery (HT) COM Yardage: 1.5 Freight Class: 250 Product Weight (lbs.): 78 Cubic Feet Per Carton: 20</p>	GC3657	\$3320	\$3370	\$3416	\$3478	\$3567	\$3602	\$3678	\$3823	\$3896	\$4033	\$4222	\$4452																		
	Metal																														
	<table border="1"> <thead> <tr> <th colspan="3">OVERALL DIMENSIONS</th> <th colspan="3">SEAT DIMENSIONS</th> <th colspan="2">BACK DIMENSIONS</th> </tr> <tr> <th>W</th> <th>D</th> <th>H</th> <th>W</th> <th>D</th> <th>H</th> <th>W</th> <th>H</th> </tr> </thead> <tbody> <tr> <td>28</td> <td>25</td> <td>41</td> <td>24</td> <td>17.5</td> <td>26</td> <td>24</td> <td>15.5</td> </tr> </tbody> </table>	OVERALL DIMENSIONS			SEAT DIMENSIONS			BACK DIMENSIONS		W	D	H	W	D	H	W	H	28	25	41	24	17.5	26	24	15.5						
OVERALL DIMENSIONS			SEAT DIMENSIONS			BACK DIMENSIONS																									
W	D	H	W	D	H	W	H																								
28	25	41	24	17.5	26	24	15.5																								

Active weight 500 lbs.
 Urethane armcap option - **Add \$104 list upcharge**

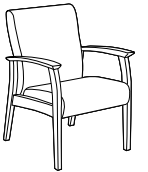
DESCRIPTION	MODEL#	STANDARD FABRIC GRADES																													
		COM	2	3	4	5	6	7	8	9	10	11	12																		
 <p>MB Armchair, Open Arms (Wood) COM Yardage: 1.75 Freight Class: 250 Product Weight (lbs.): 52 Cubic Feet Per Carton: 20</p>	GC3631W	\$1737	\$1797	\$1851	\$1923	\$2025	\$2064	\$2155	\$2327	\$2411	\$2569	\$2788	\$3059																		
	Wood																														
	GC3631WF	\$2201	\$2261	\$2313	\$2386	\$2489	\$2527	\$2619	\$2791	\$2875	\$3034	\$3252	\$3521																		
Wood flex back																															
<table border="1"> <thead> <tr> <th colspan="3">OVERALL DIMENSIONS</th> <th colspan="3">SEAT DIMENSIONS</th> <th colspan="2">BACK DIMENSIONS</th> </tr> <tr> <th>W</th> <th>D</th> <th>H</th> <th>W</th> <th>D</th> <th>H</th> <th>W</th> <th>H</th> </tr> </thead> <tbody> <tr> <td>25</td> <td>27</td> <td>36.5</td> <td>20.5</td> <td>17.5</td> <td>18</td> <td>20.5</td> <td>18</td> </tr> </tbody> </table>	OVERALL DIMENSIONS			SEAT DIMENSIONS			BACK DIMENSIONS		W	D	H	W	D	H	W	H	25	27	36.5	20.5	17.5	18	20.5	18							
OVERALL DIMENSIONS			SEAT DIMENSIONS			BACK DIMENSIONS																									
W	D	H	W	D	H	W	H																								
25	27	36.5	20.5	17.5	18	20.5	18																								

Active weight 350 lbs.
 Urethane armcap option - **Add \$104 list upcharge**

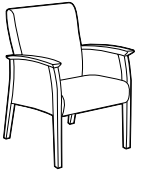
DESCRIPTION	MODEL#	STANDARD FABRIC GRADES																													
		COM	2	3	4	5	6	7	8	9	10	11	12																		
 <p>MB Armchair, Closed Arms (Wood) COM Yardage: 2.75 Freight Class: 250 Product Weight (lbs.): 62 Cubic Feet Per Carton: 17.5</p>	GC3631WCA	\$1971	\$2063	\$2143	\$2259	\$2420	\$2480	\$2624	\$2892	\$3025	\$3272	\$3619	\$4042																		
	Wood																														
	GC3631WFCA	\$2461	\$2553	\$2632	\$2748	\$2908	\$2970	\$3113	\$3380	\$3515	\$3762	\$4107	\$4532																		
Wood flex back																															
<table border="1"> <thead> <tr> <th colspan="3">OVERALL DIMENSIONS</th> <th colspan="3">SEAT DIMENSIONS</th> <th colspan="2">BACK DIMENSIONS</th> </tr> <tr> <th>W</th> <th>D</th> <th>H</th> <th>W</th> <th>D</th> <th>H</th> <th>W</th> <th>H</th> </tr> </thead> <tbody> <tr> <td>25</td> <td>27</td> <td>36.5</td> <td>20.5</td> <td>17.5</td> <td>18</td> <td>20.5</td> <td>18</td> </tr> </tbody> </table>	OVERALL DIMENSIONS			SEAT DIMENSIONS			BACK DIMENSIONS		W	D	H	W	D	H	W	H	25	27	36.5	20.5	17.5	18	20.5	18							
OVERALL DIMENSIONS			SEAT DIMENSIONS			BACK DIMENSIONS																									
W	D	H	W	D	H	W	H																								
25	27	36.5	20.5	17.5	18	20.5	18																								

Active weight 350 lbs.
 Urethane armcap option - **Add \$104 list upcharge**

DESCRIPTION	MODEL#	STANDARD FABRIC GRADES																													
		COM	2	3	4	5	6	7	8	9	10	11	12																		
 <p>HB Armchair, Open Arms, Split Back (Wood) COM Yardage: 2.25 Freight Class: 250 Product Weight (lbs.): 60 Cubic Feet Per Carton: 27.5</p>	GC3632W	\$1930	\$2003	\$2070	\$2162	\$2296	\$2346	\$2460	\$2680	\$2790	\$2994	\$3276	\$3623																		
	Wood																														
	GC3632WF	\$2414	\$2490	\$2555	\$2648	\$2780	\$2831	\$2946	\$3165	\$3275	\$3478	\$3761	\$4109																		
Wood flex back																															
<table border="1"> <thead> <tr> <th colspan="3">OVERALL DIMENSIONS</th> <th colspan="3">SEAT DIMENSIONS</th> <th colspan="2">BACK DIMENSIONS</th> </tr> <tr> <th>W</th> <th>D</th> <th>H</th> <th>W</th> <th>D</th> <th>H</th> <th>W</th> <th>H</th> </tr> </thead> <tbody> <tr> <td>25</td> <td>27</td> <td>48.5</td> <td>20.5</td> <td>17.5</td> <td>18</td> <td>20.5</td> <td>30</td> </tr> </tbody> </table>	OVERALL DIMENSIONS			SEAT DIMENSIONS			BACK DIMENSIONS		W	D	H	W	D	H	W	H	25	27	48.5	20.5	17.5	18	20.5	30							
OVERALL DIMENSIONS			SEAT DIMENSIONS			BACK DIMENSIONS																									
W	D	H	W	D	H	W	H																								
25	27	48.5	20.5	17.5	18	20.5	30																								

Active weight 350 lbs. Fold away headrest.
 Urethane armcap option - **Add \$104 list upcharge**

DESCRIPTION	MODEL#	STANDARD FABRIC GRADES											
		COM	2	3	4	5	6	7	8	9	10	11	12
 <p>HB Armchair, Closed Arms, Split Back (Wood) COM Yardage: 3 Freight Class: 250 Product Weight (lbs.): 68 Cubic Feet Per Carton: 27.5</p>	GC3632WCA	\$2167	\$2268	\$2356	\$2481	\$2657	\$2723	\$2881	\$3171	\$3317	\$3588	\$3964	\$4428
	Wood												
	GC3632WFCA	\$2668	\$2769	\$2856	\$2981	\$3157	\$3223	\$3379	\$3671	\$3816	\$4088	\$4464	\$4928
	Wood flex back												
		OVERALL DIMENSIONS			SEAT DIMENSIONS			BACK DIMENSIONS					
		W	D	H	W	D	H	W	H				
		25	27	48.5	20.5	17.5	18	20.5	30				

Active weight 350 lbs. Fold away headrest.
Urethane armcap option - **Add \$104 list upcharge**

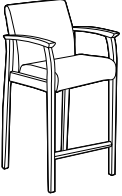
 <p>Designed to immobilize the pelvis and hip joints after surgery.</p> <p>LB Hip Armchair, Open Arms - Post Surgery (Wood) COM Yardage: 1.5 Freight Class: 250 Product Weight (lbs.): 57 Cubic Feet Per Carton: 20</p>		COM	2	3	4	5	6	7	8	9	10	11	12
	GC3636W	\$2398	\$2448	\$2494	\$2556	\$2645	\$2680	\$2756	\$2901	\$2974	\$3111	\$3300	\$3530
	Wood												
		OVERALL DIMENSIONS			SEAT DIMENSIONS			BACK DIMENSIONS					
		W	D	H	W	D	H	W	H				
		23	26	40.5	19	17.5	25.5	19	15.5				

Active weight 350 lbs.
Urethane armcap option - **Add \$104 list upcharge**

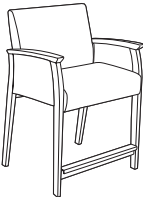
 <p>Designed to immobilize the pelvis and hip joints after surgery.</p> <p>LB Hip Armchair, Closed Arms - Post Surgery (Wood) COM Yardage: 2 Freight Class: 250 Product Weight (lbs.): 62 Cubic Feet Per Carton: 20</p>		COM	2	3	4	5	6	7	8	9	10	11	12
	GC3636WCA	\$2644	\$2716	\$2781	\$2872	\$3001	\$3059	\$3177	\$3360	\$3503	\$3664	\$3990	\$4338
	Wood												
		OVERALL DIMENSIONS			SEAT DIMENSIONS			BACK DIMENSIONS					
		W	D	H	W	D	H	W	H				
		23	26	40.5	19	17.5	25.5	19	15.5				

Active weight 350 lbs.
Urethane armcap option - **Add \$104 list upcharge**

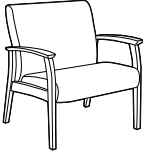
 <p>Bariatric MB Armchair, Open Arms (Wood) COM Yardage: 2.75 Freight Class: 250 Product Weight (lbs.): 82 Cubic Feet Per Carton: 30.5</p>		COM	2	3	4	5	6	7	8	9	10	11	12
	GC3638W	\$2202	\$2291	\$2480	\$2598	\$2757	\$2821	\$2961	\$3230	\$3363	\$3611	\$3957	\$4381
	Wood												
		OVERALL DIMENSIONS			SEAT DIMENSIONS			BACK DIMENSIONS					
		W	D	H	W	D	H	W	H				
		35	27	36.5	30	17.5	18	30	18				

Active weight 500 lbs.
Urethane armcap option - **Add \$104 list upcharge**

 <p>Bariatric MB Armchair, Closed Arms (Wood) COM Yardage: 3.75 Freight Class: 250 Product Weight (lbs.): 92 Cubic Feet Per Carton: 30.5</p>		COM	2	3	4	5	6	7	8	9	10	11	12
	GC3638WCA	\$2432	\$2557	\$2665	\$2821	\$3042	\$3127	\$3319	\$3686	\$3868	\$4206	\$4674	\$5257
	Wood												
		OVERALL DIMENSIONS			SEAT DIMENSIONS			BACK DIMENSIONS					
		W	D	H	W	D	H	W	H				
		35	27	36.5	30	17.5	18	30	18				

Active weight 500 lbs.
Urethane armcap option - **Add \$104 list upcharge**

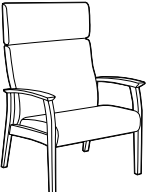
DESCRIPTION	MODEL#	STANDARD FABRIC GRADES											
		COM	2	3	4	5	6	7	8	9	10	11	12
 <p>GC3639W Wood</p>		COM	2	3	4	5	6	7	8	9	10	11	12
		\$2431	\$2557	\$2665	\$2821	\$3042	\$3127	\$3319	\$3686	\$3865	\$4206	\$4674	\$5256
		OVERALL DIMENSIONS			SEAT DIMENSIONS			BACK DIMENSIONS					
		W	D	H	W	D	H	W	H				
		35	27	48.5	30	17.5	18	30	30				

Bariatric HB Armchair, Open Arms, Split Back (Wood)
 COM Yardage: 3.75
 Freight Class: 300
 Product Weight (lbs.): 65
 Cubic Feet Per Carton: 33

Active weight 500 lbs. Fold away headrest.
 Urethane armcap option - **Add \$104 list upcharge**

 <p>GC3639WCA Wood</p>		COM	2	3	4	5	6	7	8	9	10	11	12
		\$2692	\$2854	\$2991	\$3188	\$3468	\$3574	\$3819	\$4281	\$4510	\$4940	\$5536	\$6272
		OVERALL DIMENSIONS			SEAT DIMENSIONS			BACK DIMENSIONS					
		W	D	H	W	D	H	W	H				
		35	27	48.5	30	17.5	18	30	30				

Bariatric HB Armchair, Closed Arms, Split Back (Wood)
 COM Yardage: 4.75
 Freight Class: 250
 Product Weight (lbs.): 75
 Cubic Feet Per Carton: 33

Active weight 500 lbs. Fold away headrest.
 Urethane armcap option - **Add \$104 list upcharge**

 <p>GC3655W Wood</p> <p>GC3655WF Wood flex back</p>		COM	2	3	4	5	6	7	8	9	10	11	12
		\$1801	\$1885	\$1958	\$2063	\$2209	\$2267	\$2393	\$2638	\$2759	\$2986	\$3299	\$3686
		\$2265	\$2349	\$2422	\$2528	\$2673	\$2731	\$2859	\$3102	\$3223	\$3449	\$3763	\$4150
		OVERALL DIMENSIONS			SEAT DIMENSIONS			BACK DIMENSIONS					
		W	D	H	W	D	H	W	H				
		25	27	48.5	20.5	17.5	18	20.5	30				

HB Armchair, Open Arms (Wood)
 COM Yardage: 2.5
 Freight Class: 250
 Product Weight (lbs.): 60
 Cubic Feet Per Carton: 27.5

Active weight 350 lbs.
 Urethane armcap option - **Add \$104 list upcharge**

 <p>GC3655WCA Wood</p> <p>GC3655WFCA Wood flex back</p>		COM	2	3	4	5	6	7	8	9	10	11	12
		\$2041	\$2150	\$2244	\$2382	\$2572	\$2643	\$2813	\$3126	\$3284	\$3578	\$3986	\$4491
		\$2533	\$2644	\$2737	\$2872	\$3066	\$3137	\$3305	\$3622	\$3777	\$4071	\$4479	\$4982
		OVERALL DIMENSIONS			SEAT DIMENSIONS			BACK DIMENSIONS					
		W	D	H	W	D	H	W	H				
		25	27	48.5	20.5	17.5	18	20.5	30				

HB Armchair, Closed Arms (Wood)
 COM Yardage: 3.25
 Freight Class: 250
 Product Weight (lbs.): 68
 Cubic Feet Per Carton: 27.5

Active weight 350 lbs.
 Urethane armcap option - **Add \$104 list upcharge**

 <p>GC3656W Wood</p>		COM	2	3	4	5	6	7	8	9	10	11	12
		\$2263	\$2380	\$2482	\$2626	\$2833	\$2913	\$3093	\$3433	\$3603	\$3918	\$4357	\$4897
		OVERALL DIMENSIONS			SEAT DIMENSIONS			BACK DIMENSIONS					
		W	D	H	W	D	H	W	H				
		35	27	48.5	30	17.5	18	30	30				

Bariatric HB Armchair, Open Arms (Wood)
 COM Yardage: 3.5
 Freight Class: 250
 Product Weight (lbs.): 65
 Cubic Feet Per Carton: 30.75

Active weight 500 lbs.
 Urethane armcap option - **Add \$104 list upcharge**

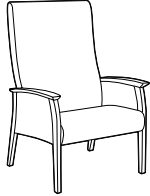
DESCRIPTION	MODEL#	STANDARD FABRIC GRADES												
		COM	2	3	4	5	6	7	8	9	10	11	12	
 <p>Bariatric HB Armchair, Closed Arms (Wood) COM Yardage: 4.5 Freight Class: 250 Product Weight (lbs.): 75 Cubic Feet Per Carton: 33</p>	GC3656WCA	\$2513	\$2668	\$2794	\$2982	\$3246	\$3346	\$3579	\$4017	\$4236	\$4642	\$5204	\$5902	
	Wood													
		OVERALL DIMENSIONS			SEAT DIMENSIONS			BACK DIMENSIONS						
		W	D	H	W	D	H	W	H					
		35	27	48.5	30	17.5	18	30	30					
		Active weight 500 lbs. Urethane armcap option - Add \$104 list upcharge												

PRIMACARE LOUNGE



model GC3641 (HT)



model GC3641W (Wood)

STANDARD FEATURES

- Primacare is a family of products offering the most significant return on investment approach in the industry since every component can be repaired or replaced on site.
- **High traffic (HT) models:** Metal frame and urethane armcaps with die cast zinc connectors and metal-to-metal fasteners. Available in the following finishes: Black (TBL), Cloud (TIV), Designer White (TDW), Fog (TFO), Frost (TFR), Kalua (TKA), Latte (TLA), Mocha (TMO), Nevada (TNE), Sand (TSN), Shadow (TSH), Toast (TOA) and Tungsten (TTU).
- **Wood models:** Solid hardwood frame and armcaps with die cast zinc connectors and metal-to-metal fastening. Available in the following finishes: Absolute (AAM), Charcoal Java (CJM), Cherry (ACM), Empire Mahogany (EMM), English Oak (EOM), Espresso Cafe (ECM), Fruitwood (TFM), Gray (HGM), Harvest Oak (HOM), Honey (AHM), Jet Onyx (JOM), Light Honey (LHM), Mahogany (TMM), Maple (AVM), Medium Walnut (MWM), Night (ASM), Natural Walnut (NLW), Noce Biondo (NBM), Noce Grigio (NGM), Noce Leggero (NEM), Noce Medio (NMM), Sandy Beach (SBM), Shaker Cherry (SKM), Silver Oak (SOM), Walnut (TWM), White (WHM), WC Cream (WTM) and Winter Cherry (WCM).
- Armcaps are securely fastened with metal-to-metal connectors which allow for field replacement if required.
- Easy grip forward extending armcap on models with arms.
- Replaceable seat covers and replaceable and/or removable seat cushions are standard.
- Waterfall cleanout between the seat and back cushions.
- Models are standard with metal mesh seat deck. For behavioral health applications, the metal mesh seat deck can be covered with a solid moisture resistant surface, held in place with tamperproof fasteners. Contact your sales rep for a special quotation.
- All seat frames feature a wall saver design to prevent back contact with wall.
- Models ending in **CA** have upholstered panel arm inserts closing the arm. (Closed arm panels are designed to be replaceable. Request a special quote to have them secured with tamperproof fasteners.)
- For Globalcare textile options, visit the website at globalfurnituregroup.com.
- Can be upholstered in standard Global textiles if healthcare compliance is not required.
- It is recommended that High Traffic (HT) models be specified in textiles that meet or exceed 100,000 double rubs for added abrasion performance.
- Shipped fully assembled.

- **High traffic (HT) models are listed first, followed by wood models.**

OPTIONAL FEATURES

- **High traffic (HT) models:** Wood armcaps are available. See far left column "Wood models" for finishes. Please specify. No upcharge.
- **High traffic (HT) and wood models:** Urethane armcaps are available. Please specify. Refer to individual models for availability and pricing.
- For moisture barrier (seat only), add **\$193** list upcharge per seat. For bariatric models: GC3640, GC3640CA, GC3640W, and GC3640WCA - Add **\$198** list upcharge per seat.
- To add sealed seams to your product contact Customer Care. Upcharges vary.
- For Primacare tables, see page page 56.

SUGGESTED APPLICATIONS

- Bariatric seating
- Guest seating
- Lobbies
- Lounge/Waiting
- Patient rooms
- Resident rooms

DESCRIPTION MODEL# / FEATURES STANDARD TEXTILE GRADES

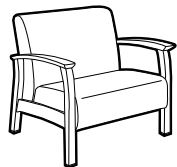

Bariatric Lounge Chair, Open Arms (HT)

COM Yardage: 3.25
Freight Class: 250
Product Weight (lbs.): 109
Cubic Feet Per Carton: 49.5

Active weight 500 lbs.
Urethane armcap option - **Add \$123 list upcharge**

COM	2	3	4	5	6	7	8	9	10	11	12	
GC3640	\$3335	\$3447	\$3537	\$3673	\$3869	\$3940	\$4107	\$4419	\$4579	\$4873	\$5282	\$5782

OVERALL DIMENSIONS			SEAT DIMENSIONS			BACK DIMENSIONS	
W	D	H	W	D	H	W	H
40	32	33	36	20	17.25	36	16

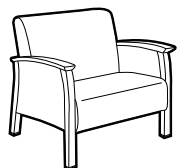

Bariatric Lounge Chair, Closed Arms (HT)

COM Yardage: 5.75
Freight Class: 250
Product Weight (lbs.): 119
Cubic Feet Per Carton: 49.5

Active weight 500 lbs.
Urethane armcap option - **Add \$123 list upcharge**

COM	2	3	4	5	6	7	8	9	10	11	12	
GC3640CA	\$3589	\$3784	\$3949	\$4187	\$4526	\$4655	\$4950	\$5509	\$5790	\$6308	\$7031	\$7919

OVERALL DIMENSIONS			SEAT DIMENSIONS			BACK DIMENSIONS	
W	D	H	W	D	H	W	H
40	32	33	36	20	17.25	36	16

- For users up to 500 lbs.

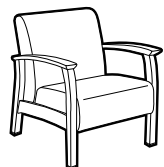

Lounge Chair, Open Arms (HT)

COM Yardage: 2.5
Freight Class: 250
Product Weight (lbs.): 78
Cubic Feet Per Carton: 29.5

Active weight 500 lbs.
Urethane armcap option - **Add \$123 list upcharge**

COM	2	3	4	5	6	7	8	9	10	11	12	
GC3641	\$2680	\$2765	\$2838	\$2942	\$3087	\$3143	\$3272	\$3515	\$3638	\$3863	\$4177	\$4566

OVERALL DIMENSIONS			SEAT DIMENSIONS			BACK DIMENSIONS	
W	D	H	W	D	H	W	H
29	32	33	23	20	17.25	22.5	16

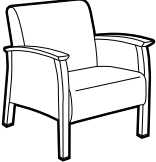
DESCRIPTION	MODEL#	STANDARD FABRIC GRADES																																			
		COM	2	3	4	5	6	7	8	9	10	11	12																								
 <p>Lounge Chair, Closed Arms (HT) COM Yardage: 3.75 Freight Class: 250 Product Weight (lbs.): 91 Cubic Feet Per Carton: 29.5</p>	GC3641CA	\$2977	\$3102	\$3209	\$3365	\$3586	\$3669	\$3864	\$4230	\$4411	\$4749	\$5218	\$5801																								
	Metal																																				
	<table border="1"> <thead> <tr> <th colspan="3">OVERALL DIMENSIONS</th> <th colspan="3">SEAT DIMENSIONS</th> <th colspan="3">BACK DIMENSIONS</th> </tr> <tr> <th>W</th> <th>D</th> <th>H</th> <th>W</th> <th>D</th> <th>H</th> <th>W</th> <th>H</th> </tr> </thead> <tbody> <tr> <td>29</td> <td>32</td> <td>33</td> <td>23</td> <td>20</td> <td>17.25</td> <td>22.5</td> <td>16</td> </tr> </tbody> </table> <p>Active weight 500 lbs. Urethane armcap option - Add \$123 list upcharge</p>	OVERALL DIMENSIONS			SEAT DIMENSIONS			BACK DIMENSIONS			W	D	H	W	D	H	W	H	29	32	33	23	20	17.25	22.5	16											
OVERALL DIMENSIONS			SEAT DIMENSIONS			BACK DIMENSIONS																															
W	D	H	W	D	H	W	H																														
29	32	33	23	20	17.25	22.5	16																														

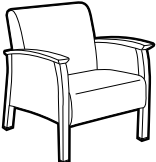
DESCRIPTION	MODEL#	STANDARD FABRIC GRADES																																			
		COM	2	3	4	5	6	7	8	9	10	11	12																								
 <p>Lounge Chair, Closed Arms, Laminate Panels (HT) COM Yardage: 2.5 Freight Class: 250 Product Weight (lbs.): 91 Cubic Feet Per Carton: 29.5</p>	GC3641CAL	\$3336	\$3410	\$3475	\$3568	\$3700	\$3763	\$3882	\$4074	\$4220	\$4384	\$4722	\$5081																								
	Metal																																				
	<table border="1"> <thead> <tr> <th colspan="3">OVERALL DIMENSIONS</th> <th colspan="3">SEAT DIMENSIONS</th> <th colspan="3">BACK DIMENSIONS</th> </tr> <tr> <th>W</th> <th>D</th> <th>H</th> <th>W</th> <th>D</th> <th>H</th> <th>W</th> <th>H</th> </tr> </thead> <tbody> <tr> <td>29</td> <td>32</td> <td>33</td> <td>23</td> <td>20</td> <td>17.25</td> <td>22.5</td> <td>16</td> </tr> </tbody> </table> <p>Active weight 500 lbs. Urethane armcap option - Add \$123 list upcharge</p>	OVERALL DIMENSIONS			SEAT DIMENSIONS			BACK DIMENSIONS			W	D	H	W	D	H	W	H	29	32	33	23	20	17.25	22.5	16											
OVERALL DIMENSIONS			SEAT DIMENSIONS			BACK DIMENSIONS																															
W	D	H	W	D	H	W	H																														
29	32	33	23	20	17.25	22.5	16																														

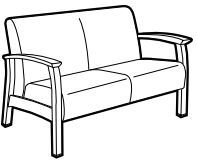
DESCRIPTION	MODEL#	STANDARD FABRIC GRADES																																			
		COM	2	3	4	5	6	7	8	9	10	11	12																								
 <p>Two Seat Sofa, Open Arms (HT) COM Yardage: 4 Freight Class: 250 Product Weight (lbs.): 122 Cubic Feet Per Carton: 49.5</p>	GC3642	\$3864	\$4000	\$4114	\$4282	\$4516	\$4607	\$4813	\$5201	\$5398	\$5755	\$6259	\$6879																								
	Metal																																				
	<table border="1"> <thead> <tr> <th colspan="3">OVERALL DIMENSIONS</th> <th colspan="3">SEAT DIMENSIONS</th> <th colspan="3">BACK DIMENSIONS</th> </tr> <tr> <th>W</th> <th>D</th> <th>H</th> <th>W</th> <th>D</th> <th>H</th> <th>W</th> <th>H</th> </tr> </thead> <tbody> <tr> <td>52</td> <td>32</td> <td>33</td> <td>48</td> <td>20</td> <td>17.25</td> <td>48</td> <td>16</td> </tr> </tbody> </table> <p>Active weight 500 lbs./seat Urethane armcap option - Add \$123 list upcharge</p>	OVERALL DIMENSIONS			SEAT DIMENSIONS			BACK DIMENSIONS			W	D	H	W	D	H	W	H	52	32	33	48	20	17.25	48	16											
OVERALL DIMENSIONS			SEAT DIMENSIONS			BACK DIMENSIONS																															
W	D	H	W	D	H	W	H																														
52	32	33	48	20	17.25	48	16																														

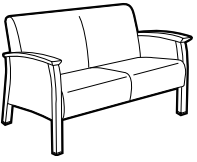
DESCRIPTION	MODEL#	STANDARD FABRIC GRADES																																			
		COM	2	3	4	5	6	7	8	9	10	11	12																								
 <p>Two Seat Sofa, Closed Arms (HT) COM Yardage: 5.5 Freight Class: 250 Product Weight (lbs.): 132 Cubic Feet Per Carton: 49.5</p>	GC3642CA	\$4149	\$4338	\$4494	\$4724	\$5049	\$5170	\$5456	\$5988	\$6257	\$6752	\$7441	\$8293																								
	Metal																																				
	<table border="1"> <thead> <tr> <th colspan="3">OVERALL DIMENSIONS</th> <th colspan="3">SEAT DIMENSIONS</th> <th colspan="3">BACK DIMENSIONS</th> </tr> <tr> <th>W</th> <th>D</th> <th>H</th> <th>W</th> <th>D</th> <th>H</th> <th>W</th> <th>H</th> </tr> </thead> <tbody> <tr> <td>52</td> <td>32</td> <td>33</td> <td>48</td> <td>20</td> <td>17.25</td> <td>48</td> <td>16</td> </tr> </tbody> </table> <p>Active weight 500 lbs./seat Urethane armcap option - Add \$123 list upcharge</p>	OVERALL DIMENSIONS			SEAT DIMENSIONS			BACK DIMENSIONS			W	D	H	W	D	H	W	H	52	32	33	48	20	17.25	48	16											
OVERALL DIMENSIONS			SEAT DIMENSIONS			BACK DIMENSIONS																															
W	D	H	W	D	H	W	H																														
52	32	33	48	20	17.25	48	16																														

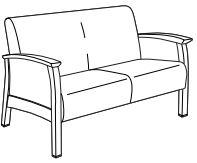
DESCRIPTION	MODEL#	STANDARD FABRIC GRADES																																			
		COM	2	3	4	5	6	7	8	9	10	11	12																								
 <p>Two Seat Sofa, Closed Arms, Laminate Panels (HT) COM Yardage: 4 Freight Class: 250 Product Weight (lbs.): 132 Cubic Feet Per Carton: 49.5</p>	GC3642CAL	\$4514	\$4636	\$4739	\$4889	\$5099	\$5198	\$5390	\$5696	\$5930	\$6194	\$6733	\$7307																								
	Metal																																				
	<table border="1"> <thead> <tr> <th colspan="3">OVERALL DIMENSIONS</th> <th colspan="3">SEAT DIMENSIONS</th> <th colspan="3">BACK DIMENSIONS</th> </tr> <tr> <th>W</th> <th>D</th> <th>H</th> <th>W</th> <th>D</th> <th>H</th> <th>W</th> <th>H</th> </tr> </thead> <tbody> <tr> <td>52</td> <td>32</td> <td>33</td> <td>48</td> <td>20</td> <td>17.25</td> <td>48</td> <td>16</td> </tr> </tbody> </table> <p>Active weight 500 lbs./seat Urethane armcap option - Add \$123 list upcharge</p>	OVERALL DIMENSIONS			SEAT DIMENSIONS			BACK DIMENSIONS			W	D	H	W	D	H	W	H	52	32	33	48	20	17.25	48	16											
OVERALL DIMENSIONS			SEAT DIMENSIONS			BACK DIMENSIONS																															
W	D	H	W	D	H	W	H																														
52	32	33	48	20	17.25	48	16																														

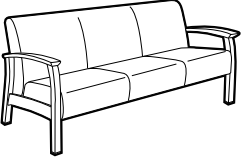
DESCRIPTION	MODEL# / FEATURES	STANDARD TEXTILE GRADES											
		COM	2	3	4	5	6	7	8	9	10	11	12
 <p>Three Seat Sofa, Open Arms (HT) COM Yardage: 6.25 Freight Class: 250 Product Weight (lbs.): 173 Cubic Feet Per Carton: 69.5</p>	GC3643 Metal	\$5473	\$5686	\$5863	\$6121	\$6491	\$6629	\$6952	\$7560	\$7864	\$8426	\$9212	\$10179
		OVERALL DIMENSIONS			SEAT DIMENSIONS			BACK DIMENSIONS					
		W	D	H	W	D	H	W	H				
		75	32	33	71	20	17.25	71	16				

Active weight 500 lbs./seat
Urethane armcap option - **Add \$123 list upcharge**

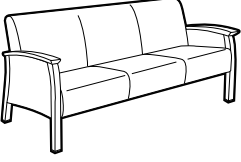
DESCRIPTION	MODEL# / FEATURES	STANDARD TEXTILE GRADES											
		COM	2	3	4	5	6	7	8	9	10	11	12
 <p>Three Seat Sofa, Closed Arms (HT) COM Yardage: 7.5 Freight Class: 250 Product Weight (lbs.): 183 Cubic Feet Per Carton: 69.5</p>	GC3643CA Metal	\$5768	\$6023	\$6236	\$6547	\$6988	\$7155	\$7543	\$8271	\$8636	\$9314	\$10253	\$11416
		OVERALL DIMENSIONS			SEAT DIMENSIONS			BACK DIMENSIONS					
		W	D	H	W	D	H	W	H				
		75	32	33	71	20	17.25	71	16				

Active weight 500 lbs./seat
Urethane armcap option - **Add \$123 list upcharge**

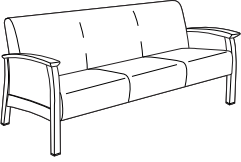
DESCRIPTION	MODEL# / FEATURES	STANDARD TEXTILE GRADES											
		COM	2	3	4	5	6	7	8	9	10	11	12
 <p>Three Seat Sofa, Closed Arms, Laminate Panels (HT) COM Yardage: 6.25 Freight Class: 250 Product Weight (lbs.): 183 Cubic Feet Per Carton: 69.5</p>	GC3643CAL Metal	\$6115	\$6308	\$6466	\$6699	\$7030	\$7185	\$7486	\$7962	\$8330	\$8740	\$9581	\$10481
		OVERALL DIMENSIONS			SEAT DIMENSIONS			BACK DIMENSIONS					
		W	D	H	W	D	H	W	H				
		75	32	33	71	20	17.25	71	16				

Active weight 500 lbs./seat
Urethane armcap option - **Add \$123 list upcharge**

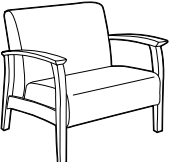
DESCRIPTION	MODEL# / FEATURES	STANDARD TEXTILE GRADES											
		COM	2	3	4	5	6	7	8	9	10	11	12
 <p>Bariatric Lounge Chair, Open Arms (Wood) COM Yardage: 3.25 Freight Class: 300 Product Weight (lbs.): 97 Cubic Feet Per Carton: 49.5</p>	GC3640W Wood	\$2744	\$2854	\$2947	\$3082	\$3276	\$3347	\$3515	\$3830	\$3986	\$4282	\$4688	\$5191
		OVERALL DIMENSIONS			SEAT DIMENSIONS			BACK DIMENSIONS					
		W	D	H	W	D	H	W	H				
		40	32	33	36	20	17.25	36	16				

Active weight 500 lbs.
Urethane armcap option - **Add \$123 list upcharge**

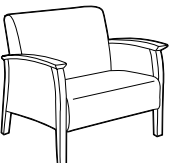
DESCRIPTION	MODEL# / FEATURES	STANDARD TEXTILE GRADES											
		COM	2	3	4	5	6	7	8	9	10	11	12
 <p>Bariatric Lounge Chair, Closed Arms (Wood) COM Yardage: 5.75 Freight Class: 250 Product Weight (lbs.): 107 Cubic Feet Per Carton: 49.5</p>	GC3640WCA Wood	\$2936	\$3134	\$3296	\$3535	\$3875	\$4003	\$4300	\$4858	\$5138	\$5657	\$6377	\$7268
		OVERALL DIMENSIONS			SEAT DIMENSIONS			BACK DIMENSIONS					
		W	D	H	W	D	H	W	H				
		40	32	33	36	20	17.25	36	16				

Active weight 500 lbs.
Urethane armcap option - **Add \$123 list upcharge**

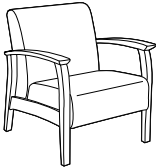
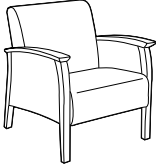
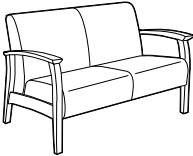
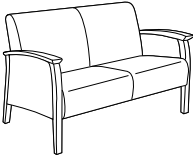
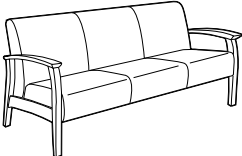
DESCRIPTION	MODEL#	STANDARD FABRIC GRADES												
		COM	2	3	4	5	6	7	8	9	10	11	12	
 <p>Lounge Chair, Open Arms (Wood) COM Yardage: 2.5 Freight Class: 250 Product Weight (lbs.): 66 Cubic Feet Per Carton: 29.5</p>	GC3641W Wood	\$2202	\$2287	\$2360	\$2466	\$2611	\$2669	\$2797	\$3040	\$3161	\$3387	\$3701	\$4088	
		OVERALL DIMENSIONS			SEAT DIMENSIONS			BACK DIMENSIONS						
		W	D	H	W	D	H	W	H					
			29	32	33	23	20	17.25	22.5		16			
			Active weight 350 lbs. Urethane armcap option - Add \$123 list upcharge											
 <p>Lounge Chair, Closed Arms (Wood) COM Yardage: 3.75 Freight Class: 250 Product Weight (lbs.): 79 Cubic Feet Per Carton: 29.5</p>	GC3641WCA Wood	\$2424	\$2550	\$2658	\$2815	\$3035	\$3120	\$3312	\$3679	\$3861	\$4199	\$4666	\$5249	
		OVERALL DIMENSIONS			SEAT DIMENSIONS			BACK DIMENSIONS						
		W	D	H	W	D	H	W	H					
			29	32	33	23	20	17.25	22.5		16			
			Active weight 350 lbs. Urethane armcap option - Add \$123 list upcharge											
 <p>Two Seat Sofa, Open Arms (Wood) COM Yardage: 4 Freight Class: 250 Product Weight (lbs.): 110 Cubic Feet Per Carton: 49.5</p>	GC3642W Wood	\$3177	\$3313	\$3428	\$3595	\$3829	\$3918	\$4126	\$4514	\$4710	\$5071	\$5569	\$6190	
		OVERALL DIMENSIONS			SEAT DIMENSIONS			BACK DIMENSIONS						
		W	D	H	W	D	H	W	H					
			52	32	33	48	20	17.25	48		16			
			Active weight 350 lbs./seat Urethane armcap option - Add \$123 list upcharge											
 <p>Two Seat Sofa, Closed Arms (Wood) COM Yardage: 5.5 Freight Class: 250 Product Weight (lbs.): 120 Cubic Feet Per Carton: 49.5</p>	GC3642WCA Wood	\$3408	\$3593	\$3750	\$3979	\$4301	\$4424	\$4708	\$5243	\$5510	\$6006	\$6696	\$7547	
		OVERALL DIMENSIONS			SEAT DIMENSIONS			BACK DIMENSIONS						
		W	D	H	W	D	H	W	H					
			52	32	33	48	20	17.25	48		16			
			Active weight 350 lbs./seat Urethane armcap option - Add \$123 list upcharge											
 <p>Three Seat Sofa, Open Arms (Wood) COM Yardage: 6.25 Freight Class: 250 Product Weight (lbs.): 161 Cubic Feet Per Carton: 69.5</p>	GC3643W Wood	\$4497	\$4708	\$4888	\$5149	\$5515	\$5657	\$5977	\$6583	\$6890	\$7451	\$8236	\$9203	
		OVERALL DIMENSIONS			SEAT DIMENSIONS			BACK DIMENSIONS						
		W	D	H	W	D	H	W	H					
			75	32	33	71	20	17.25	71		16			
			Active weight 350 lbs./seat Urethane armcap option - Add \$123 list upcharge											

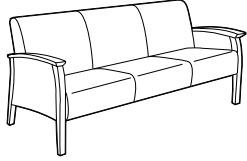
DESCRIPTION	MODEL#	STANDARD FABRIC GRADES											
		COM	2	3	4	5	6	7	8	9	10	11	12
	GC3643WCA	\$4729	\$4988	\$5197	\$5512	\$5953	\$6120	\$6507	\$7236	\$7601	\$8277	\$9217	\$10379
	Wood												

OVERALL DIMENSIONS			SEAT DIMENSIONS			BACK DIMENSIONS	
W	D	H	W	D	H	W	H
75	32	33	71	20	17.25	71	16

Three Seat Sofa, Closed Arms (Wood)
 COM Yardage: 7.5
 Freight Class: 250
 Product Weight (lbs.): 171
 Cubic Feet Per Carton: 69.5

Active weight 350 lbs./seat
 Urethane armcap option - **Add \$123 list upcharge**

SEATING

PRIMACARE™ FULLY UPHOLSTERED LOUNGE

PRIMACARE FULLY UPHOLSTERED LOUNGE



model GC3676HB



model GC3677

STANDARD FEATURES

- Primacare is a family of products offering the most significant return on investment approach in the industry since every component can be repaired or replaced on site.
- Standard with fully upholstered arms and Black urethane legs.
- Solid hardwood frame with die cast zinc connectors and metal-to-metal fastening.
- Replaceable seat covers and replaceable and/or removable seat cushions are standard.
- Waterfall cleanout between the seat and back cushions.
- Models are standard with metal mesh seat deck. For behavioral health applications, the metal mesh seat deck can be covered with a solid moisture resistant surface, held in place with tamperproof fasteners. Contact your sales rep for a special quotation.
- All seat frames feature a wall saver design to prevent back contact with wall.
- For Globalcare textile options, visit the website at www.globalfurnituregroup.com.
- Can be upholstered in standard Global textiles if healthcare compliance is not required.
- Shipped fully assembled.

OPTIONAL FEATURES

- Optional urethane armcaps available in the following finishes: Black (**BLK**), Latte (**LAB**), Kalua (**KAL**), Mocha (**J52**), Shadow (**SHW**), and Toast (**TOA**). Add \$443.
- Optional wood legs and armcaps available in the following finishes: Absolute (AAM), Charcoal Java (CJM), Cherry (ACM), Empire Mahogany (EMM), English Oak (EOM), Espresso Cafe (ECM), Fruitwood (TFM), Gray (HGM), Harvest Oak (HOM), Honey (AHM), Jet Onyx (JOM), Light Honey (LHM), Mahogany (TMM), Maple (AVM), Medium Walnut (MWM), Neutral Walnut (NLW), Night (ASM), Noce Biondo (NBM), Noce Grigio (NGM), Noce Leggero (NEM), Noce Medio (NMM), Sandy Beach (SBM), Silver Oak (SOM), Walnut (TWM), White (WHM), WC Cream (WTM) and Winter Cherry (WCM). See features column for upcharges.
- When specified with armcaps are securely fastened with metal-to-metal connectors which allow for field replacement if required.
- For moisture barrier on seat, please specify (**MB**). Add \$193 list upcharge per seat.
- To add sealed seams to your product contact Customer Care. Upcharges vary.
- For Primacare tables, see page 56

SUGGESTED APPLICATIONS

- Guest seating
- Patient rooms
- Lobbies
- Resident rooms
- Lounge/Waiting

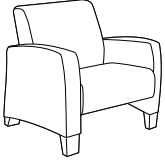
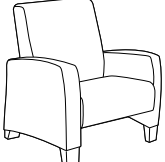
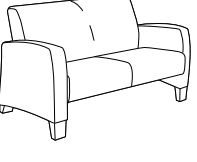
DESCRIPTION	MODEL# / FEATURES	STANDARD TEXTILE GRADES											
		COM	2	3	4	5	6	7	8	9	10	11	12
 <p>Lounge Chair, Fully Upholstered Arms, Urethane legs COM Yardage: 6.25 Freight Class: 250 Product Weight (lbs.): 95 Cubic Feet Per Carton: 29.5</p> <p>Optional wood legs - no charge. Urethane or wood armcap option - Add \$443 list upcharge</p>	GC3676	\$2322	\$2538	\$2715	\$2974	\$3342	\$3482	\$3805	\$4412	\$4716	\$5280	\$6064	\$7032
	Active weight 350 lbs.	OVERALL DIMENSIONS			SEAT DIMENSIONS			BACK DIMENSIONS					
		W	D	H	W	D	H	W	H				
		32.5	29	33	23	20	17.25	23	16				
 <p>HB Lounge Chair, Fully Upholstered Arms, Urethane legs COM Yardage: 6.5 Freight Class: 250 Product Weight (lbs.): 114 Cubic Feet Per Carton: 29.5</p> <p>Optional wood legs - no charge. Urethane or wood armcap option - Add \$443 list upcharge</p>	GC3676HB	\$2383	\$2634	\$2842	\$3145	\$3575	\$3740	\$4116	\$4827	\$5181	\$5844	\$6760	\$7892
	Active weight 350 lbs.	OVERALL DIMENSIONS			SEAT DIMENSIONS			BACK DIMENSIONS					
		W	D	H	W	D	H	W	H				
		32.5	29	36	23	20	17.25	23	19				
 <p>Two Seat Sofa, Fully Upholstered Arms, Urethane legs COM Yardage: 7.5 Freight Class: 250 Product Weight (lbs.): 135 Cubic Feet Per Carton: 56.25</p> <p>Optional wood legs - no charge. Urethane or wood armcap option - Add \$443 list upcharge</p>	GC3677	\$3406	\$3661	\$3874	\$4184	\$4626	\$4795	\$5180	\$5908	\$6275	\$6950	\$7891	\$9053
	Active weight 350 lbs.	OVERALL DIMENSIONS			SEAT DIMENSIONS			BACK DIMENSIONS					
		W	D	H	W	D	H	W	H				
		55.5	29	33	45.5	20	17.25	45.5	16				

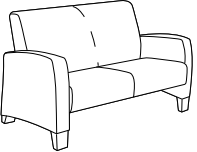
DESCRIPTION	MODEL#	STANDARD FABRIC GRADES											
		COM	2	3	4	5	6	7	8	9	10	11	12
 <p>GC3677HB</p> <p>Active weight 350 lbs.</p> <p>HB Two Seat Sofa, Fully Upholstered Arms, Urethane legs COM Yardage: 7.75 Freight Class: 250 Product Weight (lbs.): 142 Cubic Feet Per Carton: 56.25</p> <p>Optional wood legs - no charge. Urethane or wood armcap option - Add \$443 list upcharge</p>	\$3551	\$3852	\$4097	\$4462	\$4974	\$5168	\$5618	\$6466	\$6888	\$7677	\$8768	\$10120	
	OVERALL DIMENSIONS			SEAT DIMENSIONS			BACK DIMENSIONS						
	W	D	H	W	D	H	W	H					
	55.5	29	36	45.5	20	17.25	45.5	19					

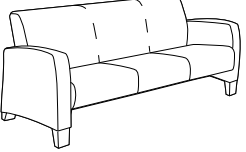
DESCRIPTION	MODEL#	STANDARD FABRIC GRADES											
		COM	2	3	4	5	6	7	8	9	10	11	12
 <p>GC3678</p> <p>Active weight 350 lbs.</p> <p>Three Seat Sofa, Fully Upholstered Arms, Urethane legs COM Yardage: 9 Freight Class: 250 Product Weight (lbs.): 181 Cubic Feet Per Carton: 69.5</p> <p>Optional wood legs - no charge. Urethane or wood armcap option - Add \$443 list upcharge</p>	\$4717	\$5026	\$5280	\$5655	\$6184	\$6386	\$6851	\$7723	\$8161	\$8974	\$10100	\$11495	
	OVERALL DIMENSIONS			SEAT DIMENSIONS			BACK DIMENSIONS						
	W	D	H	W	D	H	W	H					
	78.5	29	33	68.5	20	17.25	68.5	16					

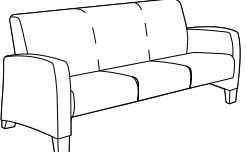
DESCRIPTION	MODEL#	STANDARD FABRIC GRADES											
		COM	2	3	4	5	6	7	8	9	10	11	12
 <p>GC3678HB</p> <p>Active weight 350 lbs.</p> <p>HB Three Seat Sofa, Fully Upholstered Arms, Urethane legs COM Yardage: 9.25 Freight Class: 250 Product Weight (lbs.): 188 Cubic Feet Per Carton: 69.5</p> <p>Optional wood legs - no charge. Urethane or wood armcap option - Add \$443 list upcharge</p>	\$4954	\$5312	\$5605	\$6037	\$6652	\$6884	\$7420	\$8430	\$8937	\$9877	\$11180	\$12791	
	OVERALL DIMENSIONS			SEAT DIMENSIONS			BACK DIMENSIONS						
	W	D	H	W	D	H	W	H					
	78.5	29	36	68.5	20	17.25	68.5	19					

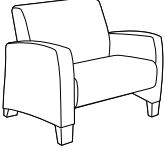
DESCRIPTION	MODEL#	STANDARD FABRIC GRADES											
		COM	2	3	4	5	6	7	8	9	10	11	12
 <p>GC3679</p> <p>Active weight 500 lbs.</p> <p>Bariatric Lounge Chair, Fully Upholstered Arms, Urethane legs COM Yardage: 6.5 Freight Class: 250 Product Weight (lbs.): 107 Cubic Feet Per Carton: 37.75</p> <p>Optional wood legs - no charge. Urethane or wood armcap option - Add \$443 list upcharge</p>	\$3202	\$3425	\$3609	\$3880	\$4261	\$4408	\$4745	\$5374	\$5690	\$6277	\$7093	\$8096	
	OVERALL DIMENSIONS			SEAT DIMENSIONS			BACK DIMENSIONS						
	W	D	H	W	D	H	W	H					
	42	29	33	32	20	17.25	32	16					

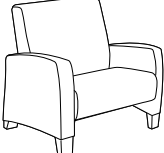
DESCRIPTION	MODEL#	STANDARD FABRIC GRADES											
		COM	2	3	4	5	6	7	8	9	10	11	12
 <p>GC3679HB</p> <p>Active weight 500 lbs.</p> <p>HB Bariatric Lounge Chair, Fully Upholstered Arms, Urethane legs COM Yardage: 6.75 Freight Class: 250 Product Weight (lbs.): 121 Cubic Feet Per Carton: 37.75</p> <p>Optional wood legs - no charge. Urethane or wood armcap option - Add \$443 list upcharge</p>	\$3308	\$3569	\$3783	\$4099	\$4547	\$4718	\$5107	\$5846	\$6214	\$6900	\$7853	\$9026	
	OVERALL DIMENSIONS			SEAT DIMENSIONS			BACK DIMENSIONS						
	W	D	H	W	D	H	W	H					
	42	29	36	32	20	17.25	32	19					

PRIMACARE WINGBACK



model GC3694HB



model GC3692HB

STANDARD FEATURES



- Primacare is a family of products offering the most significant return on investment approach in the industry since every component can be repaired or replaced on site.
- Legs and armcaps are available in urethane (6 colors) or wood, with upcharge.
- Legs are standard with white nylon glides (1"OD, 0.5" thick)
- Easy grip forward extending armcaps are securely fastened with metal-to-metal connectors which allow for field replacement if required.
- For added comfort, seat and back are standard with high density foam.
- Replaceable seat covers and replaceable and/or removable seat cushions are standard.
- Seat cushion has a seamless waterfall front and clean out between and around the seat and back cushions.
- Models are standard with metal mesh seat deck. For mental health applications, the metal mesh seat deck can be covered with a solid moisture resistant surface, held in place with tamperproof fasteners. Contact your sales rep for a special quotation.
- For healthcare textile options, visit the website at globalfurnituregroup.com
- Can be upholstered in standard Global textiles if healthcare compliance is not required.



OPTIONAL FEATURES

- Optional urethane legs and armcaps available in the following finishes: Black (**BLK**), Latte (**LAB**), Kalua (**KAL**), Mocha (**J52**), Shadow (**SHW**) and Toast (**TOA**). No upcharge.
- For optional wood legs and armcaps, refer to the Seating wood finishes in the Textiles + Finishes section.
For wood armcaps: Add \$135
For wood legs: Add \$160
- For moisture barrier on seat, please specify (**MB**).
For single seat model, add \$152.
For two seat model, add \$303.
For bariatric model, add \$202.
For standard ottoman, add \$129.
For bariatric ottoman, add \$198.
- To add sealed seams to your product, contact Customer Care. Upcharges vary.
- For Primacare tables, see page 56

SUGGESTED APPLICATIONS

- Bariatric seating
- Lobbies
- Lounge/Waiting
- Guest seating
- Patient rooms
- Resident rooms

DESCRIPTION	MODEL# / FEATURES	STANDARD TEXTILE GRADES											
		COM	2	3	4	5	6	7	8	9	10	11	12
 <p>Single Seat Wingback Armchair COM Yardage: 6.25 Freight Class: 250 Product weight (lbs.): 94 Cubic Feet Per Carton: 29</p>	GC3691HB	\$3259	\$3459	\$3616	\$3847	\$4172	\$4309	\$4591	\$5034	\$5366	\$5729	\$6484	\$7279
	Active weight 350 lbs.	OVERALL DIMENSIONS			SEAT DIMENSIONS			BACK DIMENSIONS					
		W	D	H	W	D	H	W	H				
		30.5	28.5	45.5	22.5	18	19	19	26				
 <p>Two Seat Wingback Armchair COM Yardage: 9.5 Freight Class: 250 Product weight (lbs.): 163 Cubic Feet Per Carton: 52.5</p>	GC3692HB	\$4495	\$4799	\$5037	\$5388	\$5882	\$6091	\$6519	\$7193	\$7697	\$8248	\$9397	\$10604
	Active weight 350 lbs/seat.	OVERALL DIMENSIONS			SEAT DIMENSIONS			BACK DIMENSIONS					
		W	D	H	W	D	H	W	H				
		57.5	28.5	45.5	50	18	19	45	26				
 <p>Bariatric Single Seat Wingback Armchair COM Yardage: 8.25 Freight Class: 250 Product weight (lbs.): 130 Cubic Feet Per Carton: 35.5</p>	GC3694HB	\$3692	\$3956	\$4163	\$4468	\$4897	\$5078	\$5450	\$6035	\$6473	\$6952	\$7949	\$8998
	Active weight 600 lbs.	OVERALL DIMENSIONS			SEAT DIMENSIONS			BACK DIMENSIONS					
		W	D	H	W	D	H	W	H				
		38	28.5	45.5	31	18	19	26.5	26				

DESCRIPTION	MODEL#	STANDARD FABRIC GRADES											
		COM	2	3	4	5	6	7	8	9	10	11	12
 <p>Standard Size Ottoman COM Yardage: 1.25 Freight Class: 250 Product weight (lbs.): 17 Cubic Feet Per Carton: 4.7</p>	GC3695	\$878	\$917	\$955	\$1007	\$1082	\$1116	\$1182	\$1288	\$1370	\$1461	\$1648	\$1847
	Active weight 350 lbs.	OVERALL DIMENSIONS			SEAT DIMENSIONS			BACK DIMENSIONS					
		W	D	H	W	D	H	W	H				
		23	18	15.75	-	-	-	-	-				
 <p>Bariatric Ottoman COM Yardage: 1.75 Freight Class: 250 Product Weight (lbs.): 20 Cubic Feet Per Carton: 9</p>	GC3696	\$1108	\$1166	\$1218	\$1291	\$1392	\$1442	\$1534	\$1682	\$1798	\$1925	\$2186	\$2464
	Active weight 500 lbs.	OVERALL DIMENSIONS			SEAT DIMENSIONS			BACK DIMENSIONS					
		W	D	H	W	D	H	W	H				
		31.25	18	15.75	-	-	-	-	-				

PRIMACARE RECLINERS



model GC3608



model GC3609

STANDARD FEATURES

- Primacare is a family of products offering the most significant return on investment approach in the industry since every component can be repaired or replaced on site.
- Solid hardwood frame with die cast zinc connectors and metal-to-metal fastening. Available in the following finishes: Absolute (AAM), Charcoal Java (CJM), Cherry (ACM), Empire Mahogany (EMM), English Oak (EOM), Espresso Cafe (ECM), Fruitwood (TFM), Gray (HGM), Harvest Oak (HOM), Honey (AHM), Jet Onyx (JOM), Light Honey (LHM), Mahogany (TMM), Maple (AVM), Medium Walnut (MWM), Natural Walnut (NLW), Night (ASM), Noce Biondo (NBM), Noce Grigio (NGM), Noce Leggero (NEM), Noce Medio (NMM), Sandy Beach (SBM), Shaker Cherry (SKM), Silver Oak (SOM), Walnut (TWM), White (WHM), WC Cream (WTM) and Winter Cherry (WCM).
- Armcaps are securely fastened with metal-to-metal connectors which allow for field replacement if required.
- Easy grip forward extending armcap on models with arms.
- For healthcare textile options, visit the website at globalfurnituregroup.com.
- Can be upholstered in standard Global textiles if healthcare compliance is not required.
- Shipped easy to assemble.

OPTIONAL FEATURES

- Urethane armcaps are available in the following finishes: Black (BLK), Latte (LAB), Kalua (KAL), Mocha (J52), Shadow (SHW) and Toast (TOA). Please specify. Add \$259 list upcharge.
- Urethane armcaps are not available on models GC3606 and GC3609.
- For moisture barrier on seat, please specify (MB). Add \$193 list upcharge per seat.
- For Primacare tables, see page 56

GC3608 AND GC3609 ONLY

- Tablet arm with spill collector on the edge is available, offered in Black Phenolic material. Tablet rotates so it can be positioned for any user activity and can fold down to store beside the chair when not in use. From seated position, specify (LT) for left hand tablet or (RT) for right hand tablet. Add \$1042.
- Footrest in Grey thermally fused laminate with a Black edge is available. Specify (FT). Add \$360.

SUGGESTED APPLICATIONS

- Guest seating
- Lobbies
- Lounge/Waiting
- Patient rooms
- Resident rooms
- Treatment/Exam rooms

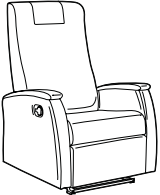
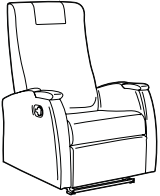
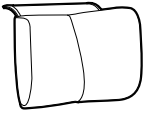
DESCRIPTION	MODEL# / FEATURES	STANDARD TEXTILE GRADES											
		COM	2	3	4	5	6	7	8	9	10	11	12
 <p>Recliner, Solid Wood Armcaps, Full Span COM Yardage: 6.5 Freight Class: 150 Product Weight (lbs.): 110 Cubic Feet Per Carton: 22.75</p>	GC3605	\$3242	\$3453	\$3804	\$4076	\$4456	\$4604	\$4936	\$5570	\$5887	\$6471	\$7284	\$8294
		OVERALL DIMENSIONS			SEAT DIMENSIONS			BACK DIMENSIONS					
		W	D	H	W	D	H	W	H				
		29.5	34.5	45.5	21.5	20	17	21.5	28				
		<p>Head mat & loose seat cushion. Active weight 350 lbs. Urethane armcap option - Add \$259 list upcharge</p> <p>• <i>Not available with casters</i></p>											
 <p>Recliner, Solid Wood Armcaps, Front Only COM Yardage: 6.5 Freight Class: 150 Product Weight (lbs.): 110 Cubic Feet Per Carton: 22.75</p>	GC3606	\$3075	\$3286	\$3628	\$3900	\$4282	\$4428	\$4763	\$5395	\$5711	\$6296	\$7111	\$8119
		OVERALL DIMENSIONS			SEAT DIMENSIONS			BACK DIMENSIONS					
		W	D	H	W	D	H	W	H				
		29.5	34.5	45.5	21.5	20	17	21.5	28				
		<p>Head mat & loose seat cushion. Active weight 350 lbs.</p> <p>• <i>Not available with casters</i></p>											
 <p>Headrest for Primacare Recliners COM Yardage: 1.25 Freight Class: 250 Product Weight (lbs.): 3 Cubic Feet Per Carton: 1</p>	GC3607	\$135	\$174	\$222	\$274	\$348	\$378	\$440	\$561	\$622	\$735	\$891	\$1085
		OVERALL DIMENSIONS			SEAT DIMENSIONS			BACK DIMENSIONS					
		W	D	H	W	D	H	W	H				
		14	4	9.5									

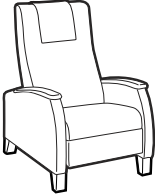
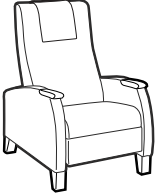
DESCRIPTION	MODEL#	STANDARD FABRIC GRADES												
		COM	2	3	4	5	6	7	8	9	10	11	12	
 <p>Motion Recliner, Solid Wood Armcaps, Full Span COM Yardage: 6.5 Freight Class: 150 Product Weight (lbs.): 120 Cubic Feet Per Carton: 27.75</p>	GC3608	\$3682	\$3893	\$4264	\$4535	\$4917	\$5063	\$5399	\$6029	\$6347	\$6933	\$7747	\$8753	
		OVERALL DIMENSIONS			SEAT DIMENSIONS			BACK DIMENSIONS						
		W	D	H	W	D	H	W	H					
		30	39	46.5	23.5	20	19	22.5	29					
 <p>Motion Recliner, Solid Wood Armcaps, Front Only COM Yardage: 6.5 Freight Class: 150 Product Weight (lbs.): 120 Cubic Feet Per Carton: 27.75</p>	GC3609	\$3515	\$3726	\$4088	\$4360	\$4742	\$4885	\$5224	\$5853	\$6172	\$6757	\$7572	\$8581	
		OVERALL DIMENSIONS			SEAT DIMENSIONS			BACK DIMENSIONS						
		W	D	H	W	D	H	W	H					
		30	39	46.5	23.5	20	19	22.5	29					
		Active weight 400 lbs. Urethane armcap option - Add \$259 list upcharge Optional 4 manual locking casters w/push bar. Specify (MRC) - no upcharge.												

PRIMACARE SLEEPERS



model GC3611



model GC3611 (pulled out)

STANDARD FEATURES

- Primacare is a family of products offering the most significant return on investment approach in the industry since every component can be repaired or replaced on site.
- Solid hardwood frame with die cast zinc connectors and metal-to-metal fastening. Available in the following finishes: Absolute (AAM), Charcoal Java (CJM), Cherry (ACM), Empire Mahogany (EMM), English Oak (EOM), Espresso Cafe (ECM), Fruitwood (TFM), Gray (HGM), Harvest Oak (HOM), Honey (AHM), Jet Onyx (JOM), Light Honey (LHM), Mahogany (TMM), Maple (AVM), Medium Walnut (MWM), Natural Walnut (NLW), Night (ASM), Noce Biondo (NBM), Noce Grigio (NGM), Noce Leggero (NEM), Noce Medio (NMM), Sandy Beach (SBM), Shaker Cherry (SKM), Silver Oak (SOM), Walnut (TWM), White (WHM), WC Cream (WTM) and Winter Cherry (WCM).
- Armcaps are securely fastened with metal-to-metal connectors which allow for field replacement if required.
- Easy grip forward extending armcap on models with arms.
- For healthcare textile options, visit the website at www.globalfurnituregroup.com.
- Can be upholstered in standard Global textiles if healthcare compliance is not required.
- Shipped fully assembled.

OPTIONAL FEATURES

- Urethane armcaps are available in the following finishes: Black (**BLK**), Latte (**LAB**), Kalua (**KAL**), Mocha (**J52**), Shadow (**SHW**) and Toast (**TOA**). Please specify. Add \$259 list upcharge.
- For moisture barrier on seat, please specify (**MB**). Add \$193 list upcharge per seat.
- For Primacare tables, see page 56

SUGGESTED APPLICATIONS

- Guest seating
- Lounge/Waiting
- Patient rooms
- Resident rooms
- Treatment/Exam rooms

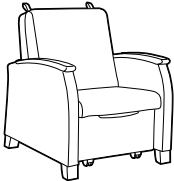
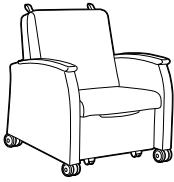
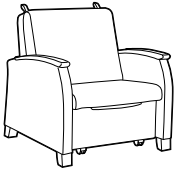
DESCRIPTION	MODEL# / FEATURES	STANDARD TEXTILE GRADES												
		COM	2	3	4	5	6	7	8	9	10	11	12	
 <p>Single Sleeper Chair, Wood Legs COM Yardage: 7.5 Freight Class: 250 Product Weight (lbs.): 116 Cubic Feet Per Carton: 32.25</p>	GC3610	\$3333	\$3591	\$3986	\$4315	\$4776	\$4951	\$5358	\$6125	\$6509	\$7219	\$8204	\$9425	
		OVERALL DIMENSIONS			SEAT DIMENSIONS			BACK DIMENSIONS						
		W	D	H	W	D	H	W	H					
		31.5	37.5	38	24	20	18	24	21					
		Sleep surface is 24.5"W x 77"L Active weight 350 lbs. Urethane armcap option - Add \$259 list upcharge												
 <p>Single Sleeper Chair, Casters COM Yardage: 7.5 Freight Class: 250 Product Weight (lbs.): 116 Cubic Feet Per Carton: 32.25</p>	GC3610C	\$3333	\$3591	\$3986	\$4315	\$4776	\$4951	\$5358	\$6125	\$6509	\$7219	\$8204	\$9425	
		OVERALL DIMENSIONS			SEAT DIMENSIONS			BACK DIMENSIONS						
		W	D	H	W	D	H	W	H					
		31.5	37.5	38	24	20	18	24	21					
		Sleep surface is 24.5"W x 77"L Active weight 350 lbs. Urethane armcap option - Add \$259 list upcharge												
 <p>Single Sleeper Chair, Wide, Wood Legs COM Yardage: 9 Freight Class: 250 Product Weight (lbs.): 140 Cubic Feet Per Carton: 36.75</p>	GC3611	\$4058	\$4352	\$4814	\$5188	\$5721	\$5922	\$6385	\$7259	\$7698	\$8512	\$9636	\$11033	
		OVERALL DIMENSIONS			SEAT DIMENSIONS			BACK DIMENSIONS						
		W	D	H	W	D	H	W	H					
		37	37.5	38	30	20	18	30	21					
		Sleep surface is 30"W x 77"L Active weight 350 lbs. Urethane armcap option - Add \$259 list upcharge												

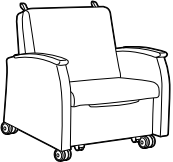
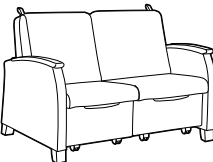
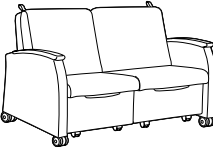
DESCRIPTION	MODEL#	STANDARD FABRIC GRADES											
		COM	2	3	4	5	6	7	8	9	10	11	12
 <p>Single Sleeper Chair, Wide, Casters COM Yardage: 9 Freight Class: 250 Product Weight (lbs.): 140 Cubic Feet Per Carton: 36.75</p>	GC3611C	\$4058	\$4352	\$4814	\$5188	\$5721	\$5922	\$6385	\$7259	\$7698	\$8512	\$9636	\$11033
		OVERALL DIMENSIONS			SEAT DIMENSIONS			BACK DIMENSIONS					
		W	D	H	W	D	H	W	H				
			37	37.5	38	30	20	18	30	21			
<p>Sleep surface is 30"W x 77"L Active weight 350 lbs. Urethane armcap option - Add \$259 list upcharge For users up to 350 lbs.</p>													
 <p>Double Sleeper Chair, Wood Legs COM Yardage: 11.75 Freight Class: 250 Product Weight (lbs.): 215 Cubic Feet Per Carton: 60</p>	GC3612	\$5268	\$5653	\$6256	\$6746	\$7437	\$7699	\$8305	\$9446	\$10017	\$11079	\$12549	\$14369
		OVERALL DIMENSIONS			SEAT DIMENSIONS			BACK DIMENSIONS					
		W	D	H	W	D	H	W	H				
			56	36	38	48	19.5	18	48	21			
<p>Sleep surface is 49"W x 77"L Active weight 350 lbs./seat Urethane armcap option - Add \$259 list upcharge</p>													
 <p>Double Sleeper Chair, Casters COM Yardage: 11.75 Freight Class: 250 Product Weight (lbs.): 215 Cubic Feet Per Carton: 60</p>	GC3612C	\$5268	\$5653	\$6256	\$6746	\$7437	\$7699	\$8305	\$9446	\$10017	\$11079	\$12549	\$14369
		OVERALL DIMENSIONS			SEAT DIMENSIONS			BACK DIMENSIONS					
		W	D	H	W	D	H	W	H				
			56	36	38	48	19.5	18	48	21			
<p>Sleep surface is 49"W x 77"L Active weight 350 lbs./seat Urethane armcap option - Add \$259 list upcharge</p>													

PRIMACARE BENCHES



model GC3651 (HT)



model GC3652W (Wood)

STANDARD FEATURES

- Primacare is a family of products offering the most significant return on investment approach in the industry since every component can be repaired or replaced on site.
- High traffic (HT) models:** Metal frame with die cast zinc connectors and metal-to-metal fasteners. Available in the following finishes: Black (TBL), Cloud (TIV), Designer White (TDW), Fog (TFO), Frost (TFR), Kalua (TKA), Latte (TLA), Mocha (TMO), Nevada (TNE), Sand (TSN), Shadow (TSH), Toast (TOA) and Tungsten (TTU).
- Wood models:** Solid hardwood frame with die cast zinc connectors and metal-to-metal fastening. Available in the following finishes: Absolute (AAM), Charcoal Java (CJM), Cherry (ACM), Empire Mahogany (EMM), English Oak (EOM), Espresso Cafe (ECM), Fruitwood (TFM), Gray (HGM), Harvest Oak (HOM), Honey (AHM), Jet Onyx (JOM), Light Honey (LHM), Mahogany (TMM), Maple (AVM), Medium Walnut (MWM), Natural Walnut (NLW), Night (ASM), Noce Biondo (NBM), Noce Grigio (NGM), Noce Leggero (NEM), Noce Medio (NMM), Sandy Beach (SBM), Shaker Cherry (SKM), Silver Oak (SOM), Walnut (TWM), White (WHM), WC Cream (WTM) and Winter Cherry (WCM).
- Replaceable and/or removable cushions are standard.
- For healthcare textile options, visit the website at www.globalfurnituregroup.com/healthcare.
- Can be upholstered in standard Global textiles if healthcare compliance is not required.
- It is recommended that High Traffic (HT) models be specified in textiles that meet or exceed 100,000 double rubs for added abrasion performance.
- Shipped fully assembled.
- HIGH TRAFFIC (HT) MODELS ARE LISTED FIRST, FOLLOWED BY WOOD MODELS.**

OPTIONAL FEATURES

- For moisture barrier on seat, please specify **(MB)**. Add \$129 per seat.
- To add sealed seams to your product contact Customer Care. Upcharges vary.
- For Primacare tables, see page 56

SUGGESTED APPLICATIONS

- Guest seating
- Patient rooms
- Lounge/Waiting
- Resident rooms

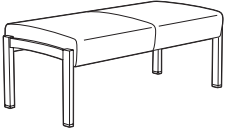
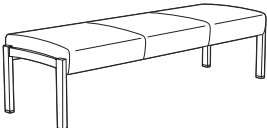
DESCRIPTION	MODEL# / FEATURES	STANDARD TEXTILE GRADES											
		COM	2	3	4	5	6	7	8	9	10	11	12
 <p>Single Seat Bench (HT) COM Yardage: 1.25 Freight Class: 250 Product Weight (lbs.): 31 Cubic Feet Per Carton: 9.75</p>	GC3651 Metal	\$1758	\$1802	\$1845	\$1901	\$1981	\$2018	\$2092	\$2207	\$2296	\$2395	\$2602	\$2818
	Active weight 350 lbs.	OVERALL DIMENSIONS			SEAT DIMENSIONS			BACK DIMENSIONS					
		W	D	H	W	D	H	W	H				
		26.5	22.5	19									
 <p>Two Seat Bench COM Yardage: 2 Freight Class: 250 Product Weight (lbs.): 48 Cubic Feet Per Carton: 20.25</p>	GC3652 Metal	\$2771	\$2843	\$2908	\$2999	\$3128	\$3186	\$3304	\$3487	\$3630	\$3791	\$4117	\$4465
	Active weight 350 lbs./seat	OVERALL DIMENSIONS			SEAT DIMENSIONS			BACK DIMENSIONS					
		W	D	H	W	D	H	W	H				
		49.5	22.5	19									
 <p>Three Seat Bench COM Yardage: 2.75 Freight Class: 250 Product Weight (lbs.): 66 Cubic Feet Per Carton: 28.75</p>	GC3653 Metal	\$3785	\$3885	\$3972	\$4097	\$4273	\$4356	\$4517	\$4770	\$4967	\$5186	\$5635	\$6114
	Active weight 350 lbs./seat	OVERALL DIMENSIONS			SEAT DIMENSIONS			BACK DIMENSIONS					
		W	D	H	W	D	H	W	H				
		72.5	22.5	19									

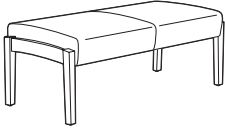
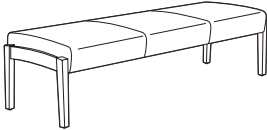
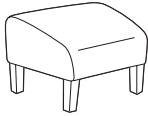
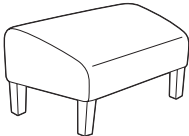
DESCRIPTION	MODEL#	STANDARD FABRIC GRADES											
		COM	2	3	4	5	6	7	8	9	10	11	12
 <p>Single Seat Bench (Wood) COM Yardage: 1.25 Freight Class: 250 Product Weight (lbs.): 26 Cubic Feet Per Carton: 9.75</p>	GC3651W Wood Active weight 350 lbs./seat	\$1512	\$1554	\$1597	\$1653	\$1733	\$1770	\$1844	\$1959	\$2048	\$2147	\$2354	\$2570
		OVERALL DIMENSIONS			SEAT DIMENSIONS			BACK DIMENSIONS					
		W	D	H	W	D	H	W	H				
			26.5	22.5	19								
 <p>Two Seat Bench (Wood) COM Yardage: 2 Freight Class: 250 Product Weight (lbs.): 41 Cubic Feet Per Carton: 20.25</p>	GC3652W Wood Active weight 350 lbs./seat	\$2417	\$2487	\$2552	\$2643	\$2772	\$2830	\$2948	\$3131	\$3274	\$3435	\$3761	\$4109
		OVERALL DIMENSIONS			SEAT DIMENSIONS			BACK DIMENSIONS					
		W	D	H	W	D	H	W	H				
			49.5	22.5	19								
 <p>Three Seat Bench (Wood) COM Yardage: 2.75 Freight Class: 250 Product Weight (lbs.): 61 Cubic Feet Per Carton: 28.75</p>	GC3653W Wood Active weight 350 lbs./seat	\$3317	\$3418	\$3505	\$3630	\$3806	\$3889	\$4050	\$4303	\$4500	\$4719	\$5168	\$5647
		OVERALL DIMENSIONS			SEAT DIMENSIONS			BACK DIMENSIONS					
		W	D	H	W	D	H	W	H				
			72.5	22.5	19								
 <p>Standard Size Ottoman COM Yardage: 1.25 Freight Class: 250 Product weight (lbs.): 17 Cubic Feet Per Carton: 4.7</p>	GC3695 Active weight 350 lbs. Standard leg is Black Urethane. Optional Urethane colors or wood legs. No upcharge.	\$878	\$917	\$955	\$1007	\$1082	\$1116	\$1182	\$1288	\$1370	\$1461	\$1648	\$1847
		OVERALL DIMENSIONS			SEAT DIMENSIONS			BACK DIMENSIONS					
		W	D	H	W	D	H	W	H				
			23	18	15.75	-	-	-	-	-	-	-	-
 <p>Bariatric Ottoman COM Yardage: 1.75 Freight Class: 250 Product Weight (lbs.): 20 Cubic Feet Per Carton: 9</p>	GC3696 Active weight 500 lbs. Standard leg is Black Urethane. Optional Urethane colors or wood legs. No upcharge.	\$1108	\$1166	\$1218	\$1291	\$1392	\$1442	\$1534	\$1682	\$1798	\$1925	\$2186	\$2464
		OVERALL DIMENSIONS			SEAT DIMENSIONS			BACK DIMENSIONS					
		W	D	H	W	D	H	W	H				
			31.25	18	15.75	-	-	-	-	-	-	-	-

PRIMACARE MODULAR



STANDARD FEATURES

- Modular seating tops: Linking applications are available for medium and high back patient top units, low back guest top units and lounge top units.
- All modular seating top units are complete with frame and cushions. Leg/arm frames are ordered separately according to the desired specification.
- Frame design features a wall saver leg to prevent damage to walls. Frame construction ensures metal-to-metal fastening.
- For leg/arm frames and modular tables with power/USB module, refer to models ending in "M". Module includes two power outlets, four USB charging ports and a 6 foot long power cord. Available in Black or White (must be specified at time of order).
- Replaceable and/or removable seat and back cushions with replaceable cushion covers are standard.
- Seat cushion has a seamless waterfall front and clean out between and around the seat and back cushions.
- All (CA) models have closed upholstered arm panel inserts at each arm position.
- For added comfort, seats are standard with high density foam.
- Active weight capacity up to 500 lbs/seat when using metal frame, fully upholstered frame or on bariatric models; up to 350 lbs/seat when using wood frame.
- For textile options, visit the website at www.globalfurnituregroup.com.
- Can be upholstered in standard Global textiles if healthcare compliance is not required.
- Left and right position reference is determined from the seated position.

SUGGESTED APPLICATIONS

- Bariatric seating
- Guest seating
- Lobbies
- Lounge/Waiting

OPTIONAL FEATURES

- Urethane finishes are available on armcaps and on models with urethane legs in the following: Black (BLK), Latte (LAB), Kalua (KAL), Mocha (J52), Shadow (SHW) and Toast (TOA). Refer to individual models for availability and pricing.
- Metal leg/arm frames are available in the following finishes: Black (TBL), Cloud (TIV), Designer White (TDW), Fog (TFO), Frost (TFR), Kalua (TKA), Latte (TLA), Mocha (TMO), Nevada (TNE), Sand (TSN), Shadow (TSH), Toast (TOA) and Tungsten (TTU).
- Wood legs and armcaps available in the following finishes: Absolute (AAM), Charcoal Java (CJM), Cherry (ACM), Empire Mahogany (EMM), English Oak (EOM), Espresso Cafe (ECM), Fruitwood (TFM), Gray (HGM), Harvest Oak (HOM), Honey (AHM), Jet Onyx (JOM), Light Honey (LHM), Mahogany (TMM), Maple (AVM), Medium Walnut (MWM), Natural Walnut (NLW), Night (ASM), Noce Biondo (NBM), Noce Grigio (NGM), Noce Leggero (NEM), Noce Medio (NMM), Sandy Beach (SBM), Shaker Cherry (SKM), Silver Oak (SOM), Walnut (TWM), White (WHM), WC Cream (WTM) and Winter Cherry (WCM). Refer to individual models for availability and pricing.
- Armcaps are securely fastened with metal-to-metal connectors which allows for field replacement if required. *Armcaps cannot be retrofitted in the field on units with no existing armcaps.*
- For moisture barrier on seat, please specify (MB). Add \$129 per seat. For bariatric/lounge models, - Add \$198 per seat.
- To add sealed seams to your product contact Customer Care. Upcharges vary.

For Primacare freestanding tables, see page 56
 For Primacare Modular tables, see page 198
 For Primacare Modular lounge tables, see page 209

MODULAR TABLES

Modular tables are offered with wood or metal legs. 1" thick table tops are available in thermally fused laminate (LP) and high pressure laminate (HP). Please select the appropriate model number for the finish you prefer.

Note: Modular tables are shipped KD (knock down) as per the published cube and weight. For Primacare freestanding tables, see page 56.

Thermally fused laminate (LP):

Absolute Acajou (ACJ)	Noce Biondo (NBL)
Asian Night (ASN)	Noce Grigio (NGL)
Avant Cherry (AWC)	Noce Leggero (NEL)
Avant Honey (AWH)	Noce Medio (NML)
Brushed Cobalt (BRC)	Quartered Mahogany (QTM)
Clear Maple (CMB)	Sheer Beauty (SBY)
Dark Espresso (DES)	Walnut Heights (WHE)
Designer White (DWT)	White Chocolate (WHC)
Fashionista (FAS)	Winter Cherry (WCR)
First Class (FCL)	

High pressure laminate (HP):

Absolute Acajou (ACJ)	Noce Biondo (NBL)
Asian Night (ASN)	Noce Grigio (NGL)
Avant Cherry (W357)	Noce Leggero (NEL)
Avant Honey (W356)	Noce Medio (NML)
Brushed Cobalt (BRC)	Quartered Mahogany (QTM)
Clear Maple (CMB)	Sheer Beauty (SBY)
Dark Espresso (W142)	Walnut Heights (WHE)
Designer White (DWT)	White Chocolate (WHC)
Fashionista (FAS)	Winter Cherry (WCR)
First Class (FCL)	

Metal leg and frame finishes:

Available in Black (TBL), Cloud (TIV), Designer White (TDW), Fog (TFO), Frost (TFR), Kalua (TKA), Latte (TLA), Mocha (TMO), Nevada (TNE), Sand (TSN), Shadow (TSH), Toast (TOA) and Tungsten (TTU).

SHIPPING INFORMATION:

Product components and parts will be shipped knocked down (KD). Weight and volume are indicated with each item KD. They will not be shipped assembled.

Assembled with drawing:

Product orders that are part of a linked application may require a combination of complete units and components for build up to achieve the limitless configurations that are possible. CAD drawing must be submitted with order when requesting units ship assembled.

Global will provide assembled units under the following conditions:

1. Detailed drawing clearly indicating:
 - The layout and location of each model number being ordered (see sample following).
 - If multiple textiles are used - textile color codes must be clearly identified on drawing.
2. Global will carton assemble orders to a maximum of 3 regular seat positions, which is the largest carton available.
3. Global reserves the right to determine the best method of assembly based on the information provided with the order.

PACKAGE 1 - Primacare HT

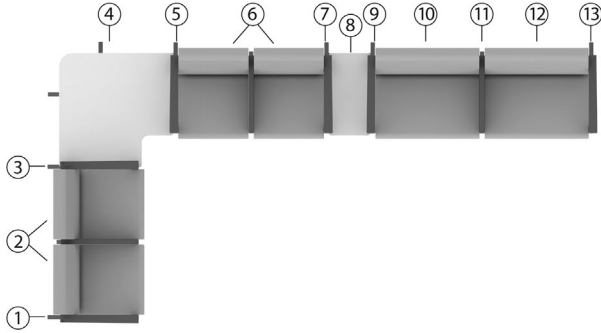

Always call out components as if seated in the chairs.

Item	Description	Qty.	Model #	Dimensions (D x W x H)	Ydg.	Frts. Class	Wt. Lbs.	Cu. Ft.	List Price	Ext. Price
1	Right End Frame with Right Armcap	1	GC3620RA	27 x 2.5 x 26.5	--	125	10	1.4	\$588	\$588
2, 6	Guest Low Back Two Seat Top w/Half Center Arm	2	GC3623TOP	25 x 42 x 19	3.25	300	68	43	\$2745	\$5490
3, 7	Seat to Table Center Linking Frame w/Left Armcap	2	GC3622TLA	27 x 2.5 x 26.5	--	125	10	1.4	\$641	\$1282
4	Right Corner Table	1	GC3671R-HP	33 x 33 x 17	--	125	45	6	\$1503	\$1503
5, 9	Seat to Table Center Linking Frame w/Right Armcap	2	GC3622TRA	27 x 2.5 x 26.5	--	125	10	1.4	\$641	\$1282
8	Narrow Center Table	1	GC3673-HP	23.87 x 12 x 5.5	--	100	18	2.1	\$821	\$821
10, 12	Bariatric Top, Guest Low Back	2	GC3637TOP	25 x 30 x 19	2.5	250	53	26.5	\$1730	\$3460
11	Seat to Seat Center Linking Frame w/Narrow Armcap	1	GC3622LA	27 x 2.5 x 26.5	--	125	10	1.4	\$656	\$656
13	Left End Frame with Left Armcap	1	GC3620LA	27 x 2.5 x 26.5	--	125	10	1.4	\$588	\$588

PACKAGE TOTAL **\$15,670**

(*Please Note: List Prices shown are for the standard Grade 2 vinyl/standard finishes.)

PACKAGE 2 - Primacare HT

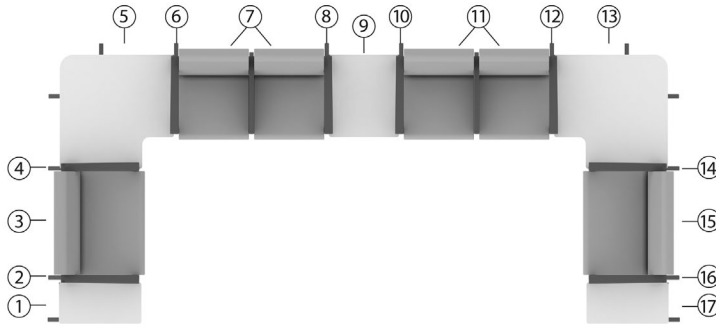

Always call out components as if seated in the chairs.

Item	Description	Qty.	Model #	Dimensions (D x W x H)	Ydg.	Frts. Class	Wt. Lbs.	Cu. Ft.	List Price	Ext. Price
1	Narrow Right End Table	1	GC3675R-HP	23.87 x 12 x 17	--	100	18	2.1	\$1227	\$1227
2, 6, 10, 14	Seat to Table Center Linking Frame w/Right Armcap	4	GC3622TRA	27 x 2.5 x 26.5	--	125	10	1.4	\$641	\$2564
3, 15	Guest Low Back Bariatric Top	2	GC3637TOP	25 x 30 x 19	2.5	250	53	26.5	\$1730	\$3460
4, 8, 12, 16	Seat to Table Center Linking Frame w/Left Armcap	4	GC3622TLA	27 x 2.5 x 26.5	--	125	10	1.4	\$641	\$2564
5	Right Corner Table	1	GC3671R-HP	33 x 33 x 17	--	125	45	6	\$1503	\$1503
7, 11	Guest Low Back Two Seat Top w/Half Center Arm	2	GC3623TOP	25 x 42 x 19	3.25	300	68	43	\$2745	\$5490
9	Regular Center Table	1	GC3672-HP	23.87 x 20.25 x 5.5	--	150	20	3.4	\$845	\$845
13	Left Corner Table	1	GC3671L-HP	33 x 33 x 17	--	100	54	6	\$1503	\$1503
17	Narrow Left End Table	1	GC3675L-HP	23.87 x 12 x 17	--	100	18	2.1	\$1227	\$1227

PACKAGE TOTAL **\$20,383**

(*Please Note: List Prices shown are for the standard Grade 2 vinyl/standard finishes.)

PACKAGE 3 - Primacare Wood

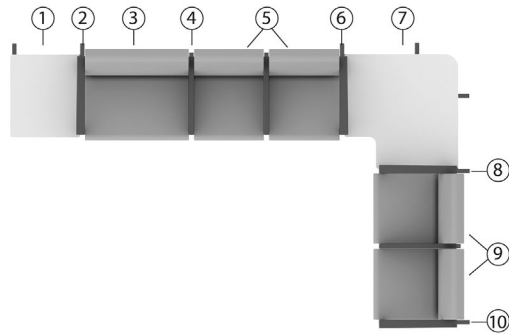

Always call out components as if seated in the chairs.

Item	Description	Qty.	Model #	Dimensions (D x W x H)	Ydg.	Frts. Class	Wt. Lbs.	Cu. Ft.	List Price	Ext. Price
1	Right End Run Table	1	GC3674WR-LP	23.87 x 20.25 x 17	--	150	19	3.4	\$1126	\$1126
2, 8	Seat to Table Center Linking Frame w/Right Armcap	2	GC3622WTRA	27 x 2.5 x 26.5	--	150	8	1.4	\$472	\$944
3	Guest Low Back Bariatric Top	1	GC3637TOP	25 x 30 x 19	2.5	250	53	26.5	\$1730	\$1730
4	Seat to Seat Center Linking Frame w/Narrow Armcap	1	GC3622WLA	27 x 2.5 x 26.5	--	150	8	1.4	\$436	\$436
5, 9	Guest Low Back Two Seat Top w/Half Center Arm	2	GC3623WTOP	25 x 42 x 19	3.25	300	68	43	\$2441	\$4882
6	Seat to Table Center Linking Frame w/Left Armcap	1	GC3622WTLA	27 x 2.5 x 26.5	--	150	8	1.4	\$472	\$472
7	Left Corner Table	1	GC3671WL-HP	33 x 33 x 17	--	100	54	6	\$1423	\$1423
10	Left End Frame w/Left Armcap	1	GC3620WLA	23 x 2 x 26	--	125	10	1.4	\$421	\$421

PACKAGE TOTAL

\$11,434

(*Please Note: List Prices shown are for the standard Grade 2 vinyl/standard finishes.)

MODULAR TOP UNITS	SINGLE SEAT BARIATRIC		SINGLE SEAT BARIATRIC		TWO SEATER, NO CENTER ARM	TWO SEATER, CENTER ARM	THREE SEATER, NO CENTER ARMS	THREE SEATER, TWO ARMS		
	medium back	high back	medium back	high back	medium back	medium back	high back	medium back	high back	
Guest seating	GC3620TOP 	GC3637TOP 	GC3655TOP 	GC3656TOP 	GC3621TOP 	GC3623TOP GC3623WVTOP 	GC3623HB-TOP GC3623WHB-TOP 	GC3624TOP 	GC3626TOP GC3626WVTOP 	GC3626HB-TOP GC3626WHB-TOP
Patient seating	GC3631TOP 	GC3638TOP 	GC3655TOP 	GC3656TOP 		GC3623CATOP GC3623WCATOP 	GC3623HBCA-TOP GC3623WHBCA-TOP 		GC3626CATOP GC3626WCATOP 	GC3626HBCA-TOP GC3626WHBCA-TOP

LEG / ARM FRAMES	Wood frame: Must select armcap Metal frame: Standard with Black SSU armcap (see notes for wood and SSU finish options)									
	LEFT, OPEN		RIGHT, OPEN		LEFT, CLOSED		RIGHT, CLOSED		LEFT, CLOSED LAMINATE PANEL	RIGHT, CLOSED LAMINATE PANEL
Metal (HT) End	GC3620LA 	GC3620LAM 	GC3620RA 	GC3620RAM 	GC3620LCA 	GC3620LCAM 	GC3620RCA 	GC3620RCAM 	GC3620LCAL 	GC3620RCAL
Wood End	GC3620WLA 	GC3620WLAM 	GC3620WRA 	GC3620WRAM 	GC3620WLCA 	GC3620WLCAM 	GC3620WRCA 	GC3620WRCAM 		
Metal (HT) Center	GC3622LA 				GC3622LCA 				GC3622LCAL 	
Wood Center	GC3622WLA 				GC3622WLCA 					
Metal (HT) Center table linking	GC3622TLA 	GC3622TRA 		GC3622TLCA 	GC3622TRCA 		GC3622TLCAL 	GC3622TRCAL 		
Wood Center table linking	GC3622WTLA 	GC3622WTRA 		GC3622WTLCA 	GC3622WTRCA 					

For frame with power/USB module*, refer to models ending in "M"

End Frame: Armless

Metal End	LEFT	RIGHT
	GC3620LNA 	GC3620RNA
Wood End	GC3620WLNA 	GC3620WRNA

Central Linking Frame: Armless

Metal	CENTER
GC3622LNA 	
Wood	GC3622WLNA

(Center = link both sides)

*Power module includes two power outlets, four USB charging ports and a 6 foot long power cord. Available in Black or White (must be specified at time of order). Power module is mounted on the frame below seat support rail.

MODULAR TABLES

Tables include legs to support table top (except for center tables). All tables have a metal frame.

	LEFT		RIGHT	
Corner (laminite top with metal legs)	GC3671L-HP	GC3671LM-HP	GC3671R-HP	GC3671RM-HP
	GC3671L-LP	GC3671LM-LP	GC3671R-LP	GC3671RM-LP
Corner (laminite top with wood legs)	GC3671WL-HP	GC3671WLM-HP	GC3671WR-HP	GC3671WRM-HP
	GC3671WL-LP	GC3671WLM-LP	GC3671WR-LP	GC3671WRM-LP
Center (laminite top, connects to metal or wood frame)	GC3672-HP	GC3672M-HP		
	GC3672-LP	GC3672M-LP		
Narrow Center (laminite top, connects to metal or wood frame)	GC3673-HP	GC3673M-HP		
	GC3673-LP	GC3673M-LP		
End (laminite top with metal legs)	GC3674L-HP	GC3674LM-HP	GC3674R-HP	GC3674RM-HP
	GC3674L-LP	GC3674LM-LP	GC3674R-LP	GC3674RM-LP
End (laminite top with wood legs)	GC3674WL-HP	GC3674WLM-HP	GC3674WR-HP	GC3674WRM-HP
	GC3674WL-LP	GC3674WLM-LP	GC3674WR-LP	GC3674WRM-LP
Narrow End (laminite top with metal legs)	GC3675L-HP	GC3675LM-HP	GC3675R-HP	GC3675RM-HP
	GC3675L-LP	GC3675LM-LP	GC3675R-LP	GC3675RM-LP
Narrow End (laminite top with wood legs)	GC3675WL-HP	GC3675WLM-HP	GC3675WR-HP	GC3675WRM-HP
	GC3675WL-LP	GC3675WLM-LP	GC3675WR-LP	GC3675WRM-LP

For table with power/USB module*, refer to models ending in "M"

*Power module includes two power outlets, four USB charging ports and a 6 foot long power cord. Available in Black or White (must be specified at time of order). Power module is mounted on surface on narrow tables; mounted in surface on larger tables (as shown above).

DESCRIPTION	MODEL#	STANDARD FABRIC GRADES																						
		COM	2	3	4	5	6	7	8	9	10	11	12											
 LB Guest Single Seat Top COM Yardage: 1.75 Freight Class: 250 Product Weight (lbs.): 36 Cubic Feet Per Carton: 10	GC3620TOP	\$1029	\$1087	\$1139	\$1212	\$1315	\$1353	\$1445	\$1617	\$1701	\$1860	\$2078	\$2347											
	<table border="1"> <thead> <tr> <th colspan="3">OVERALL DIMENSIONS</th> <th colspan="3">SEAT DIMENSIONS</th> <th colspan="2">BACK DIMENSIONS</th> </tr> <tr> <th>W</th> <th>D</th> <th>H</th> <th>W</th> <th>D</th> <th>H</th> <th>W</th> <th>H</th> </tr> </thead> <tbody> <tr> <td>20.5</td> <td>25</td> <td>19</td> <td>20.5</td> <td>17.5</td> <td>--</td> <td>20.5</td> <td>15</td> </tr> </tbody> </table> <p>Single frame guest top unit with 1 low back cushion and 1 seat cushion. Must be connected to a full arm/leg frame.</p>	OVERALL DIMENSIONS			SEAT DIMENSIONS			BACK DIMENSIONS		W	D	H	W	D	H	W	H	20.5	25	19	20.5	17.5	--	20.5
OVERALL DIMENSIONS			SEAT DIMENSIONS			BACK DIMENSIONS																		
W	D	H	W	D	H	W	H																	
20.5	25	19	20.5	17.5	--	20.5	15																	

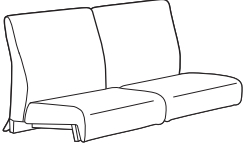
 LB Guest Two Seat Top, No Center Arm COM Yardage: 3.25 Freight Class: 300 Product Weight (lbs.): 72 Cubic Feet Per Carton: 43	GC3621TOP	\$2281	\$2391	\$2485	\$2623	\$2813	\$2885	\$3054	\$3369	\$3525	\$3819	\$4229	\$4732											
	<table border="1"> <thead> <tr> <th colspan="3">OVERALL DIMENSIONS</th> <th colspan="3">SEAT DIMENSIONS</th> <th colspan="2">BACK DIMENSIONS</th> </tr> <tr> <th>W</th> <th>D</th> <th>H</th> <th>W</th> <th>D</th> <th>H</th> <th>W</th> <th>H</th> </tr> </thead> <tbody> <tr> <td>40</td> <td>25</td> <td>19</td> <td>40</td> <td>17.5</td> <td>--</td> <td>40</td> <td>15</td> </tr> </tbody> </table> <p>Double frame guest top unit with 2 low back cushions and 2 seat cushions. Must be connected to a full arm/leg frame.</p>	OVERALL DIMENSIONS			SEAT DIMENSIONS			BACK DIMENSIONS		W	D	H	W	D	H	W	H	40	25	19	40	17.5	--	40
OVERALL DIMENSIONS			SEAT DIMENSIONS			BACK DIMENSIONS																		
W	D	H	W	D	H	W	H																	
40	25	19	40	17.5	--	40	15																	

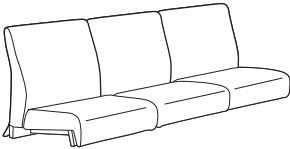
 LB Guest Three Seat Top, No Center Arm COM Yardage: 4.25 Freight Class: 300 Product Weight (lbs.): 82 Cubic Feet Per Carton: 65.25	GC3624TOP	\$3471	\$3615	\$3734	\$3911	\$4162	\$4257	\$4476	\$4888	\$5096	\$5480	\$6013	\$6670											
	<table border="1"> <thead> <tr> <th colspan="3">OVERALL DIMENSIONS</th> <th colspan="3">SEAT DIMENSIONS</th> <th colspan="2">BACK DIMENSIONS</th> </tr> <tr> <th>W</th> <th>D</th> <th>H</th> <th>W</th> <th>D</th> <th>H</th> <th>W</th> <th>H</th> </tr> </thead> <tbody> <tr> <td>60</td> <td>25</td> <td>19</td> <td>60</td> <td>17.5</td> <td>--</td> <td>60</td> <td>15</td> </tr> </tbody> </table> <p>Triple frame guest top unit with 3 low back cushions and 3 seat cushions. Must be connected to a full arm/leg frame.</p>	OVERALL DIMENSIONS			SEAT DIMENSIONS			BACK DIMENSIONS		W	D	H	W	D	H	W	H	60	25	19	60	17.5	--	60
OVERALL DIMENSIONS			SEAT DIMENSIONS			BACK DIMENSIONS																		
W	D	H	W	D	H	W	H																	
60	25	19	60	17.5	--	60	15																	

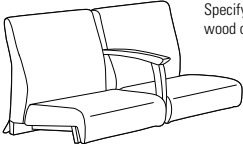

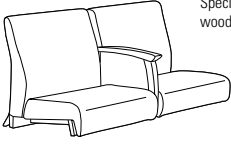
 Specify armcap: wood or Urethane.	GC3623TOP	\$2634	\$2745	\$2838	\$2977	\$3167	\$3239	\$3408	\$3723	\$3879	\$4173	\$4583	\$5086											
	GC3623WTOP	\$2330	\$2441	\$2533	\$2673	\$2863	\$2935	\$3104	\$3419	\$3575	\$3868	\$4277	\$4779											
	<table border="1"> <thead> <tr> <th colspan="3">OVERALL DIMENSIONS</th> <th colspan="3">SEAT DIMENSIONS</th> <th colspan="2">BACK DIMENSIONS</th> </tr> <tr> <th>W</th> <th>D</th> <th>H</th> <th>W</th> <th>D</th> <th>H</th> <th>W</th> <th>H</th> </tr> </thead> <tbody> <tr> <td>42</td> <td>25</td> <td>19</td> <td>20.5</td> <td>17.5</td> <td>--</td> <td>20.5</td> <td>15</td> </tr> </tbody> </table> <p>Double low back frame guest top, 2 back and 2 seat cushions. Urethane armcap option - Add \$53 list upcharge Must be connected to a full arm/leg frame.</p>	OVERALL DIMENSIONS			SEAT DIMENSIONS			BACK DIMENSIONS		W	D	H	W	D	H	W	H	42	25	19	20.5	17.5	--	20.5
OVERALL DIMENSIONS			SEAT DIMENSIONS			BACK DIMENSIONS																		
W	D	H	W	D	H	W	H																	
42	25	19	20.5	17.5	--	20.5	15																	

 Specify armcap: wood or Urethane.	GC3623CATOP	\$2777	\$2896	\$2998	\$3142	\$3349	\$3428	\$3609	\$3948	\$4119	\$4434	\$4873	\$5413											
	GC3623WCATOP	\$2451	\$2570	\$2670	\$2816	\$3023	\$3102	\$3283	\$3622	\$3793	\$4107	\$4545	\$5086											
	<table border="1"> <thead> <tr> <th colspan="3">OVERALL DIMENSIONS</th> <th colspan="3">SEAT DIMENSIONS</th> <th colspan="2">BACK DIMENSIONS</th> </tr> <tr> <th>W</th> <th>D</th> <th>H</th> <th>W</th> <th>D</th> <th>H</th> <th>W</th> <th>H</th> </tr> </thead> <tbody> <tr> <td>42</td> <td>25</td> <td>19</td> <td>20.5</td> <td>17.5</td> <td>--</td> <td>20.5</td> <td>15</td> </tr> </tbody> </table> <p>Double low back frame guest top, 2 back and 2 seat cushions. Urethane armcap option - Add \$53 list upcharge Must be connected to a full arm/leg frame.</p>	OVERALL DIMENSIONS			SEAT DIMENSIONS			BACK DIMENSIONS		W	D	H	W	D	H	W	H	42	25	19	20.5	17.5	--	20.5
OVERALL DIMENSIONS			SEAT DIMENSIONS			BACK DIMENSIONS																		
W	D	H	W	D	H	W	H																	
42	25	19	20.5	17.5	--	20.5	15																	

SEATING

PRIMACARE™ MODULAR - GUEST/PATIENT

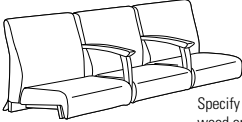
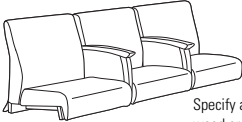
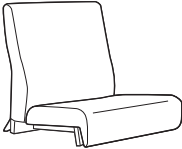
P

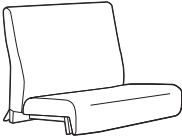
DESCRIPTION	MODEL#	STANDARD FABRIC GRADES											
		COM	2	3	4	5	6	7	8	9	10	11	12
 <p>Specify armcap: wood or Urethane.</p> <p>LB Guest Three Seat Top, Open Center Arms COM Yardage: 4.75 Freight Class: 300 Product Weight (lbs.): 77 Cubic Feet Per Carton: 65.25</p>													
	GC3626TOP	\$4181	\$4343	\$4478	\$4678	\$4957	\$5063	\$5307	\$5769	\$5999	\$6429	\$7025	\$7762
	GC3626WTOP	\$3614	\$3777	\$3912	\$4112	\$4391	\$4497	\$4741	\$5203	\$5433	\$5862	\$6458	\$7192
		OVERALL DIMENSIONS			SEAT DIMENSIONS			BACK DIMENSIONS					
		W	D	H	W	D	H	W	H				
		64	25	19	20.5	17.5	--	20.5	15				
		Triple low back frame guest top, 3 back and 3 seat cushions. Due to the size and weight, this top requires at least 3 installers. Urethane armcap option - Add \$104 list upcharge Must be connected to a full arm/leg frame.											
 <p>Specify armcap: wood or Urethane.</p> <p>LB Guest Three Seat Top, Closed Center Arms COM Yardage: 5.5 Freight Class: 300 Product Weight (lbs.): 83 Cubic Feet Per Carton: 65.25</p>													
	GC3626CATOP	\$4463	\$4652	\$4810	\$5039	\$5363	\$5484	\$5770	\$6303	\$6571	\$7066	\$7756	\$8607
	GC3626WCATOP	\$3842	\$4031	\$4187	\$4418	\$4743	\$4863	\$5149	\$5682	\$5950	\$6445	\$7135	\$7986
		OVERALL DIMENSIONS			SEAT DIMENSIONS			BACK DIMENSIONS					
		W	D	H	W	D	H	W	H				
		64	25	19	20.5	17.5	--	20.5	15				
		Triple low back frame guest top, 3 back and 3 seat cushions. Due to the size and weight, this top requires at least 3 installers. Urethane armcap option - Add \$104 list upcharge Must be connected to a full arm/leg frame.											
 <p>MB Patient Top COM Yardage: 1.75 Freight Class: 150 Product Weight (lbs.): 42 Cubic Feet Per Carton: 10</p>													
	GC3631TOP	\$1086	\$1144	\$1196	\$1269	\$1372	\$1410	\$1502	\$1674	\$1758	\$1917	\$2135	\$2404
		OVERALL DIMENSIONS			SEAT DIMENSIONS			BACK DIMENSIONS					
		W	D	H	W	D	H	W	H				
		20.5	25	22	20.5	17.5	--	20.5	18				
		Single mid back frame patient top, with 1 back and 1 seat cushion. Must be connected to a full arm/leg frame.											
 <p>LB Bariatric Guest Top COM Yardage: 2.5 Freight Class: 250 Product Weight (lbs.): 53 Cubic Feet Per Carton: 26.5</p>													
	GC3637TOP	\$1646	\$1730	\$1803	\$1909	\$2054	\$2112	\$2240	\$2483	\$2604	\$2830	\$3144	\$3531
		OVERALL DIMENSIONS			SEAT DIMENSIONS			BACK DIMENSIONS					
		W	D	H	W	D	H	W	H				
		30	25	19	30	17.5	--	30	15				
		Single low back frame bariatric guest top, with 1 back and 1 seat cushion. Must be connected to a full arm/leg frame.											
 <p>MB Bariatric Patient Top COM Yardage: 2.75 Freight Class: 250 Product Weight (lbs.): 62 Cubic Feet Per Carton: 30.5</p>													
	GC3638TOP	\$1755	\$1847	\$1927	\$2043	\$2204	\$2264	\$2408	\$2676	\$2809	\$3056	\$3403	\$3826
		OVERALL DIMENSIONS			SEAT DIMENSIONS			BACK DIMENSIONS					
		W	D	H	W	D	H	W	H				
		30	25	22	30	17.5	--	30	18				
		Single mid back frame bariatric patient top, with 1 back and 1 seat cushion. Must be connected to a full arm/leg frame.											

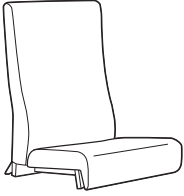
DESCRIPTION	MODEL#	STANDARD FABRIC GRADES											
		COM	2	3	4	5	6	7	8	9	10	11	12
 <p>HB Patient Top COM Yardage: 2.5 Freight Class: 250 Product Weight (lbs.): 52 Cubic Feet Per Carton: 13.25</p>	GC3655TOP	\$1174	\$1259	\$1332	\$1437	\$1583	\$1641	\$1769	\$2012	\$2133	\$2359	\$2673	\$3060
	OVERALL DIMENSIONS			SEAT DIMENSIONS			BACK DIMENSIONS						
	W	D	H	W	D	H	W	H					
	20.5	25	34	20.5	17.5	--	20.5	30					
<p>Single high back frame patient top with 1 back and 1 seat cushion.</p> <p>Must be connected to a full arm/leg frame.</p>													

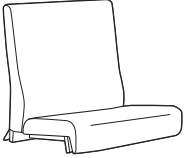
DESCRIPTION	MODEL#	STANDARD FABRIC GRADES											
		COM	2	3	4	5	6	7	8	9	10	11	12
 <p>HB Bariatric Patient Top COM Yardage: 3.5 Freight Class: 300 Product Weight (lbs.): 62 Cubic Feet Per Carton: 33</p>	GC3656TOP	\$1841	\$1960	\$2062	\$2206	\$2413	\$2492	\$2673	\$3012	\$3183	\$3498	\$3937	\$4477
	OVERALL DIMENSIONS			SEAT DIMENSIONS			BACK DIMENSIONS						
	W	D	H	W	D	H	W	H					
	30	25	34	30	17.5	--	30	30					
<p>Single high back frame bariatric patient top with 1 back and 1 seat cushion.</p> <p>Must be connected to a full arm/leg frame.</p>													

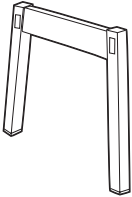
DESCRIPTION	MODEL#	STANDARD FABRIC GRADES											
		COM	2	3	4	5	6	7	8	9	10	11	12
 <p>Left End Frame, Armless COM Yardage: -- Freight Class: 150 Product Weight (lbs.): 5 Cubic Feet Per Carton: 1.2</p>		List Price											
	GC3620LNA	\$489											
	Metal												
	GC3620WLN	\$261											
Wood													
OVERALL DIMENSIONS			SEAT DIMENSIONS			BACK DIMENSIONS							
W	D	H	W	D	H	W	H						
	1.25	24.25	16										
<p>For use in left side finished position of guest and/or patient seating units.</p> <p>Does not allow linking to other units or tables.</p>													

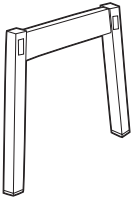
DESCRIPTION	MODEL#	STANDARD FABRIC GRADES											
		COM	2	3	4	5	6	7	8	9	10	11	12
 <p>Right End Frame, Armless COM Yardage: -- Freight Class: 150 Product Weight (lbs.): 5 Cubic Feet Per Carton: 1.2</p>		List Price											
	GC3620RNA	\$489											
	Metal												
	GC3620WRNA	\$261											
Wood													
OVERALL DIMENSIONS			SEAT DIMENSIONS			BACK DIMENSIONS							
W	D	H	W	D	H	W	H						
	1.25	24.25	16										
<p>For use in right side finished position of guest and/or patient seating units.</p> <p>Does not allow linking to other units or tables.</p>													

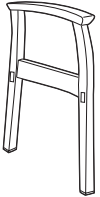
DESCRIPTION	MODEL#	STANDARD FABRIC GRADES											
		COM	2	3	4	5	6	7	8	9	10	11	12
 <p>Left End Frame, Open Arm COM Yardage: -- Freight Class: 125 Product Weight (lbs.): 10 Cubic Feet Per Carton: 1.4</p>		List Price											
	GC3620LA	\$588											
	GC3620LAM (w/power)	\$1903											
	GC3620WLA	\$421											
GC3620WLAM (w/power)	\$1706												
Specify armcap: wood or Urethane.													
OVERALL DIMENSIONS			SEAT DIMENSIONS			BACK DIMENSIONS							
W	D	H	W	D	H	W	H						
	2.5	27	26.5										
<p>For use in left side finished position of guest and/or patient seating units.</p> <p>• Models GC3620LAM and GC3620WLAM have power/USB module (not shown).</p> <p>Does not allow linking to other units or tables.</p> <p>Urethane armcap option - Add \$53 list upcharge</p>													

DESCRIPTION	MODEL#	STANDARD FABRIC GRADES							
		List Price							
	GC3620RA (Metal)	\$588							
	GC3620RAM (w/power)	\$1903							
	GC3620WRA (Wood)	\$421							
	GC3620WRAM (w/power)	\$1706							
Specify armcap: wood or Urethane.		OVERALL DIMENSIONS			SEAT DIMENSIONS			BACK DIMENSIONS	
		W	D	H	W	D	H	W	H
Right End Frame, Open Arm COM Yardage: -- Freight Class: 125 Product Weight (lbs.): 10 Cubic Feet Per Carton: 1.4		2.5	27	26.5					
		For use in right side finished position of guest and/or patient seating units.							
		• Models GC3620RAM and GC3620WRAM have power/USB module (not shown).							
		Does not allow linking to other units or tables.							
		Urethane armcap option - Add \$53 list upcharge							

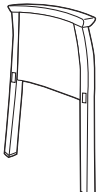
	COM	2	3	4	5	6	7	8	9	10	11	12	
	GC3620LCA (Metal)	\$724	\$745	\$766	\$793	\$831	\$847	\$877	\$943	\$973	\$1034	\$1116	\$1116
	GC3620LCAM (w/power)	\$2062	\$2082	\$2103	\$2130	\$2169	\$2186	\$2222	\$2278	\$2319	\$2367	\$2464	\$2568
	GC3620WLCA (Wood)	\$528	\$548	\$571	\$596	\$636	\$652	\$683	\$747	\$780	\$838	\$919	\$1019
	GC3620WLCAM (w/power)	\$1835	\$1855	\$1878	\$1903	\$1942	\$1960	\$1997	\$2052	\$2093	\$2140	\$2240	\$2345
Specify armcap: wood or Urethane.		OVERALL DIMENSIONS			SEAT DIMENSIONS			BACK DIMENSIONS					
		W	D	H	W	D	H	W	H				
Left End Frame, Closed Arm COM Yardage: 0.65 Freight Class: 92.5 Product Weight (lbs.): 15 Cubic Feet Per Carton: 1.4		2.5	27	26.5									
		For use in left side finished position of guest and/or patient seating units.											
		• Models GC3620LCAM and GC3620WLCAM have power/USB module (not shown).											
		Does not allow linking to other units or tables.											
		Urethane armcap option - Add \$53 list upcharge											

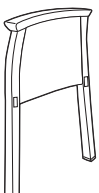
	COM	2	3	4	5	6	7	8	9	10	11	12	
	GC3620RCA (metal)	\$724	\$745	\$768	\$793	\$832	\$848	\$878	\$944	\$973	\$1035	\$1116	\$1216
	GC3620RCAM (w/power)	\$2062	\$2082	\$2103	\$2130	\$2169	\$2186	\$2222	\$2278	\$2319	\$2367	\$2464	\$2568
	GC3620WRCA (wood)	\$528	\$548	\$571	\$596	\$636	\$652	\$683	\$747	\$780	\$838	\$919	\$1019
	GC3620WRCAM (w/power)	\$1835	\$1855	\$1878	\$1903	\$1942	\$1960	\$1997	\$2052	\$2093	\$2140	\$2240	\$2345
Specify armcap: wood or Urethane.		OVERALL DIMENSIONS			SEAT DIMENSIONS			BACK DIMENSIONS					
		W	D	H	W	D	H	W	H				
Right End Frame, Closed Arm COM Yardage: 0.65 Freight Class: 92.5 Product Weight (lbs.): 15 Cubic Feet Per Carton: 1.4		2.5	27	26.5									
		For use in right side finished position of guest and/or patient seating units.											
		• Models GC3620RCAM and GC3620WRCAM have power/USB module (not shown).											
		Does not allow linking to other units or tables.											
		Urethane armcap option - Add \$53 list upcharge											

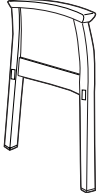
		List Price								
	GC3620LCAL	\$956								
	Metal									
	Specify armcap: wood or Urethane.		OVERALL DIMENSIONS			SEAT DIMENSIONS			BACK DIMENSIONS	
			W	D	H	W	D	H	W	H
Left End Frame, Closed Arm, Laminate Panel COM Yardage: -- Freight Class: 85 Product Weight (lbs.): 18 Cubic Feet Per Carton: 1.4		2.5	27	26.5						
		For use in left side finished position of guest and/or patient seating units.								
		Does not allow linking to other units or tables.								
		Urethane armcap option - Add \$53 list upcharge								

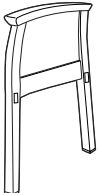
		List Price								
	GC3620RCAL	\$956								
	Metal									
	Specify armcap: wood or Urethane.		OVERALL DIMENSIONS			SEAT DIMENSIONS			BACK DIMENSIONS	
			W	D	H	W	D	H	W	H
Right End Frame, Closed Arm, Laminate Panel COM Yardage: -- Freight Class: 85 Product Weight (lbs.): 18 Cubic Feet Per Carton: 1.4		2.5	27	26.5						
		For use in right side finished position of guest and/or patient seating units.								
		Does not allow linking to other units or tables.								
		Urethane armcap option - Add \$53 list upcharge								

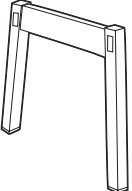
DESCRIPTION	MODEL#	STANDARD FABRIC GRADES									
		List Price									
	GC3622LNA	\$507									
	Metal										
	GC3622WLNA	\$279									
	Wood										
		OVERALL DIMENSIONS			SEAT DIMENSIONS			BACK DIMENSIONS			
		W	D	H	W	D	H	W	H		
		1.25	24.25	16							

Seat to Seat Central Linking Frame, Armless
 COM Yardage: --
 Freight Class: 150
 Product Weight (lbs.): Metal: 5 / Wood: 4
 Cubic Feet Per Carton: 1.2

For **linking** guest and/or patient top seating units.

Does not allow linking to other units or tables.

DESCRIPTION	MODEL#	STANDARD FABRIC GRADES									
		List Price									
	GC3622LA	\$656									
	Metal										
	GC3622WLA	\$436									
	Wood										
		OVERALL DIMENSIONS			SEAT DIMENSIONS			BACK DIMENSIONS			
		W	D	H	W	D	H	W	H		
		2.5	27	26.5							

Center Frame, Open Arm
 COM Yardage: --
 Freight Class: 125
 Product Weight (lbs.) Metal: 10 / Wood: 8
 Cubic Feet Per Carton: 1.4

For **linking** guest and/or patient top seating units.

Urethane armcap option - **Add \$53 list upcharge**

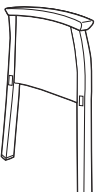
DESCRIPTION	MODEL#	STANDARD FABRIC GRADES											
		COM	2	3	4	5	6	7	8	9	10	11	12
	GC3622LCA	\$740	\$760	\$781	\$808	\$847	\$863	\$893	\$959	\$988	\$1049	\$1129	\$1230
	Metal												
	GC3622WLCA	\$543	\$563	\$586	\$611	\$651	\$666	\$696	\$762	\$791	\$853	\$932	\$1034
	Wood												
		OVERALL DIMENSIONS			SEAT DIMENSIONS			BACK DIMENSIONS					
		W	D	H	W	D	H	W	H				
		2.5	27	26.5									

Center Frame, Closed Arm
 COM Yardage: 0.65
 Freight Class: 92.5
 Product Weight (lbs.) Metal: 15 / Wood: 10
 Cubic Feet Per Carton: 1.4

For **linking** guest and/or patient top seating units.

Urethane armcap option - **Add \$53 list upcharge**

DESCRIPTION	MODEL#	STANDARD FABRIC GRADES									
		List Price									
	GC3622TLA	\$641									
	Metal										
	GC3622WTLA	\$472									
	Wood										
		OVERALL DIMENSIONS			SEAT DIMENSIONS			BACK DIMENSIONS			
		W	D	H	W	D	H	W	H		
		2.5	27	26.5							

Center Frame, Open Arm
 COM Yardage: --
 Freight Class: 125
 Product Weight (lbs.) Metal: 10 / Wood: 8
 Cubic Feet Per Carton: 1.4

For **linking** guest and/or patient top seating units to modular table on the **left** side of the frame.

Urethane armcap option - **Add \$53 list upcharge**

DESCRIPTION	MODEL#	STANDARD FABRIC GRADES									
		List Price									
	GC3622TRA	\$641									
	Metal										
	GC3622WTRA	\$472									
	Wood										
		OVERALL DIMENSIONS			SEAT DIMENSIONS			BACK DIMENSIONS			
		W	D	H	W	D	H	W	H		
		2.5	27	26.5							

Center Frame, Open Arm
 COM Yardage: --
 Freight Class: 125
 Product Weight (lbs.) Metal: 10 / Wood: 8
 Cubic Feet Per Carton: 1.4





For **linking** guest and/or patient top seating units to modular table on the **right** side of the frame.

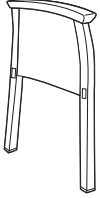
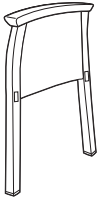

Urethane armcap option - **Add \$53 list upcharge**

SEATING

PRIMACARE™ MODULAR - GUEST/PATIENT

DESCRIPTION	MODEL#	STANDARD FABRIC GRADES											
		COM	2	3	4	5	6	7	8	9	10	11	12
 <p>GC3622TLCA Metal</p> <p>GC3622WTLCA Wood</p> <p>Specify armcap: wood or Urethane.</p>	\$773	\$794	\$817	\$842	\$881	\$897	\$927	\$993	\$1022	\$1084	\$1165	\$1265	
	\$578	\$598	\$621	\$646	\$685	\$701	\$733	\$797	\$830	\$888	\$969	\$1069	
		OVERALL DIMENSIONS			SEAT DIMENSIONS			BACK DIMENSIONS					
		W	D	H	W	D	H	W	H				
		2.5	27	26.5									
<p>Center Frame, Closed Arm COM Yardage: 0.65 Freight Class: 92.5 Product Weight (lbs.) Metal: 15 / Wood: 10 Cubic Feet Per Carton: 1.4</p>		<p>For linking guest and/or patient top seating units to modular table on the left side of the frame.</p> <p>Urethane armcap option - Add \$53 list upcharge</p>											
 <p>GC3622TRCA Metal</p> <p>GC3622WTRCA Wood</p> <p>Specify armcap: wood or Urethane.</p>	\$773	\$794	\$817	\$842	\$881	\$897	\$927	\$993	\$1022	\$1084	\$1165	\$1265	
	\$578	\$598	\$621	\$646	\$685	\$701	\$733	\$797	\$830	\$888	\$969	\$1069	
		OVERALL DIMENSIONS			SEAT DIMENSIONS			BACK DIMENSIONS					
		W	D	H	W	D	H	W	H				
		2.5	27	26.5									
<p>Center Frame, Closed Arm COM Yardage: 0.65 Freight Class: 92.5 Product Weight (lbs.) Metal: 15 / Wood: 10 Cubic Feet Per Carton: 1.4</p>		<p>For linking guest and/or patient top seating units to modular table on the right side of the frame.</p> <p>Urethane armcap option - Add \$53 list upcharge</p>											

DESCRIPTION	MODEL#	STANDARD FABRIC GRADES							
 <p>Dining Armcap, Left COM Yardage: -- Freight Class: 250 Product Weight (lbs.) Urethane: 2 / Wood: 1.5 Cubic Feet Per Carton: 0.6</p>		List Price							
	GC3616SSULACAP	\$177							
	Urethane								
	GC3616WLACAP	\$211							
	Wood								
		OVERALL DIMENSIONS			SEAT DIMENSIONS			BACK DIMENSIONS	
		W	D	H	W	D	H	W	H
		0	0	0					
		Armcap with hardware for dining top seating units. <i>For field replacement only.</i>							
 <p>Dining Armcap, Right COM Yardage: -- Freight Class: 250 Product Weight (lbs.) Urethane: 2 / Wood: 1.5 Cubic Feet Per Carton: 0.6</p>		List Price							
	GC3616SSURACAP	\$177							
	Urethane								
	GC3616WRACAP	\$211							
	Wood								
		OVERALL DIMENSIONS			SEAT DIMENSIONS			BACK DIMENSIONS	
		W	D	H	W	D	H	W	H
		0	0	0					
		Armcap with hardware dining top seating units. <i>For field replacement only.</i>							
 <p>Guest/Patient Armcap, Left COM Yardage: -- Freight Class: 150 Product Weight (lbs.) Urethane: 2.5 / Wood: 2 Cubic Feet Per Carton: 0.6</p>		List Price							
	GC3620SSULACAP	\$177							
	Urethane								
	GC3620WLACAP	\$211							
	Wood								
		OVERALL DIMENSIONS			SEAT DIMENSIONS			BACK DIMENSIONS	
		W	D	H	W	D	H	W	H
		0	0	0					
		Armcap with hardware for guest/patient top seating units. <i>For field replacement only.</i>							
 <p>Guest/Patient Armcap, Right COM Yardage: -- Freight Class: 150 Product Weight (lbs.) Urethane: 2.5 / Wood: 2 Cubic Feet Per Carton: 0.6</p>		List Price							
	GC3620SSURACAP	\$177							
	Urethane								
	GC3620WRACAP	\$211							
	Wood								
		OVERALL DIMENSIONS			SEAT DIMENSIONS			BACK DIMENSIONS	
		W	D	H	W	D	H	W	H
		0	0	0					
		Armcap with hardware for guest/patient top seating units. <i>For field replacement only.</i>							
 <p>Narrow Center Armcap COM Yardage: -- Freight Class: 70 Product Weight (lbs.) Urethane: 1.5 / Wood: 1.5 Cubic Feet Per Carton: 0.6</p>		List Price							
	GC3622SSULACAP	\$177							
	(Urethane)								
	GC3622WLACAP	\$211							
	(wood)								
		OVERALL DIMENSIONS			SEAT DIMENSIONS			BACK DIMENSIONS	
		W	D	H	W	D	H	W	H
		0	0	0					
		Armcap with hardware for guest/patient top seating units. <i>For field replacement only.</i>							

DESCRIPTION	MODEL#	STANDARD FABRIC GRADES							
		List Price							
	GC3641SSULACAP	\$199							
	Urethane								
	GC3641WLACAP	\$250							
	Wood								
		OVERALL DIMENSIONS			SEAT DIMENSIONS			BACK DIMENSIONS	
		W	D	H	W	D	H	W	H
		3	26.75	1.5					
Lounge Armcap, Left COM Yardage: -- Freight Class: 150 Product Weight (lbs.) Urethane: 2.5 / Wood: 2 Cubic Feet Per Carton: 0.6		Armcap with hardware for Lounge chair <i>For field replacement only.</i>							
		List Price							
	GC3641SSURACAP	\$199							
	Urethane								
	GC3641WRACAP	\$250							
	Wood								
		OVERALL DIMENSIONS			SEAT DIMENSIONS			BACK DIMENSIONS	
		W	D	H	W	D	H	W	H
		3	26.75	1.5					
Lounge Armcap, Right COM Yardage: -- Freight Class: 150 Product Weight (lbs.) Urethane: 2.5 / Wood: 2 Cubic Feet Per Carton: 0.6		Armcap with hardware for Lounge chair <i>For field replacement only.</i>							

Modular tables:

Tops are 1" thick.

Wooden leg tables:

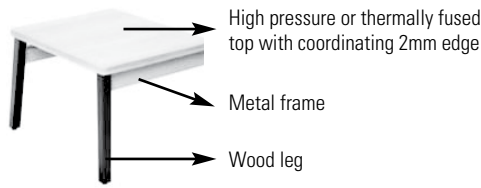

Metal leg tables:

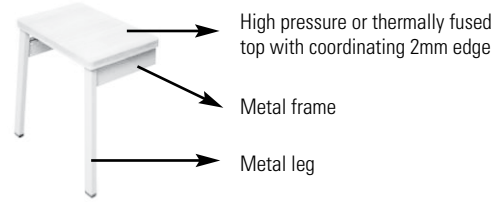

Table top finishes:

Thermally Fused Laminate (LP)

- Absolute Acajou (ACJ)
- Asian Night (ASN)
- Avant Cherry (AWC)
- Avant Honey (AWH)
- Brushed Cobalt (BRC)
- Clear Maple (CMB)
- Dark Espresso (DES)
- Designer White (DWT)
- Fashionista (FAS)
- First Class (FCL)
- Noce Biondo (NBL)
- Noce Grigio (NGL)
- Noce Leggero (NEL)
- Noce Medio (NML)
- Quartered Mahogany (QTM)
- Sheer Beauty (SBY)
- Walnut Heights (WHE)
- White Chocolate (WHC)
- Winter Cherry (WCR)

High Pressure Laminate (HP)

- Absolute Acajou (ACJ)
- Asian Night (ASN)
- Avant Cherry (W357)
- Avant Honey (W356)
- Brushed Cobalt (BRC)
- Clear Maple (CMB)
- Dark Espresso (W142)
- Designer White (DWT)
- Fashionista (FAS)
- First Class (FCL)
- Noce Biondo (NBL)
- Noce Grigio (NGL)
- Noce Leggero (NEL)
- Noce Medio (NML)
- Quartered Mahogany (QTM)
- Sheer Beauty (SBL)
- Walnut Heights (WHE)
- White Chocolate (WHC)
- Winter Cherry (WCR)

Wood leg finishes (top, base, legs & apron):

- | | | |
|-----------------------|----------------------|---------------------|
| Absolute (AAM) | Jet Onyx (JOM) | Noce Medio (NMM) |
| Charcoal Java (CJM) | Light Honey (LHM) | Sandy Beach (SBM) |
| Cherry (ACM) | Mahogany (TMM) | Shaker Cherry (SKM) |
| Empire Mahogany (EMM) | Maple (AVM) | Silver Oak (SOM) |
| English Oak (EOM) | Medium Walnut (MWM) | Walnut (TWM) |
| Espresso Cafe (ECM) | Natural Walnut (NLW) | White (WHM) |
| Fruitwood (TFM) | Night (ASM) | WC Cream (WTM) |
| Gray (HGM) | Noce Biondo (NBM) | Winter Cherry (WCM) |
| Harvest Oak (HOM) | Noce Grigio (NGM) | |
| Honey (AHM) | Noce Leggero (NEM) | |

Metal leg finishes:

Black (TBL), Cloud (TIV), Designer White (TDW), Fog (TFO), Frost (TFR), Kalua (TKA), Latte (TLA), Mocha (TMO), Nevada (TNE), Sand (TSN), Shadow (TSH), Toast (TOA) and Tungsten (TTU).

Metal frame finishes:

Black (TBL), Cloud (TIV), Designer White (TDW), Fog (TFO), Frost (TFR), Kalua (TKA), Latte (TLA), Mocha (TMO), Nevada (TNE), Sand (TSN), Shadow (TSH), Toast (TOA) and Tungsten (TTU).

Power/USB modules:

For modular tables with power/USB module, refer to models ending in "M". Power module includes two power outlets, four USB charging ports and a 6 foot long power cord. Available in Black or White (must be specified at time of order). Power module is mounted **on surface** on narrow tables; mounted **in surface** on larger tables.



On surface power module on narrow tables

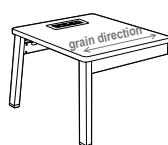

In surface power module on larger tables

DESCRIPTION	MODEL#	STANDARD FABRIC GRADES				
-------------	--------	------------------------	--	--	--	--

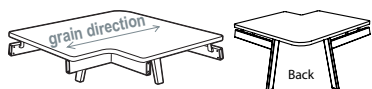

GC3671WL-LP	33 x 33 x 17	100	54	6	\$1332
GC3671WLM-LP					\$2659
GC3671WL-HP	33 x 33 x 17	100	54	6	\$1423
GC3671WLM-HP					\$2765

- For a thermally fused laminate top (LP), specify model GC3671WL-LP.
- For a high pressure laminate top (HP), specify model GC3671WL-HP.
- Models GC3671WLM-LP and GC3671WLM-HP have a **power/USB** module mounted in surface.

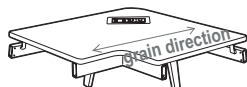

Left Corner Table, for Wood Frame

Coordinating 2mm edge. Must be connected to full arm and leg with **wood** frames. (GC3622WTLA/WTRA, GC3622WTLCA/WTRCA). This table allows for kneespace when specifying chairs in a corner position. 1 per carton.

- Includes 2 rear wood legs (not shown)

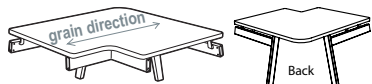

GC3671L-LP	33 x 33 x 17	100	53	6	\$1412
GC3671LM-LP					\$2753
GC3671L-HP	33 x 33 x 17	100	54	6	\$1503
GC3671LM-HP					\$2859

- For a thermally fused laminate top (LP), specify model GC3671L-LP.
- For a high pressure laminate top (HP), specify model GC3671L-HP.
- Models GC3671LM-LP and GC3671LM-HP have a **power/USB** module mounted in surface.

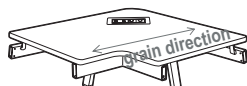

Left Corner Table, for Metal Frame

Coordinating 2mm edge. Must be connected to full arm and leg with **metal** frames. (GC3622TLA/TRA, GC3622TLCA/TRCA). This table allows for kneespace when specifying chairs in a corner position. 1 per carton.

- Includes 2 rear metal legs (not shown)

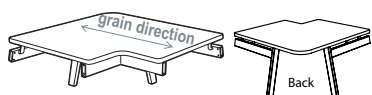

GC3671WR-LP	33 x 33 x 17	100	54	6	\$1332
GC3671WRM-LP					\$2659
GC3671WR-HP	33 x 33 x 17	100	54	6	\$1423
GC3671WRM-HP					\$2765

- For a thermally fused laminate top (LP), specify model GC3671WR-LP.
- For a high pressure laminate top (HP), specify model GC3671WR-HP.
- Models GC3671WRM-LP and GC3671WRM-HP have a **power/USB** module mounted in surface.



Right Corner Table, for Wood Frame

Coordinating 2mm edge. Must be connected to full arm and leg with **wood** frames. (GC3622WTLA/WTRA, GC3622WTLCA/WTRCA). This table allows for kneespace when specifying chairs in a corner position. 1 per carton.

- Includes 2 rear wood legs (not shown)



GC3671R-LP	33 x 33 x 17	100	54	6	\$1412
GC3671RM-LP					\$2753
GC3671R-HP	33 x 33 x 17	125	45	6	\$1503
GC3671RM-HP					\$2859

- For a thermally fused laminate top (LP), specify model GC3671R-LP.
- For a high pressure laminate top (HP), specify model GC3671R-HP.
- Models GC3671RM-LP and GC3671RM-HP have a **power/USB** module mounted in surface.



Right Corner Table, for Metal Frame

Coordinating 2mm edge. Must be connected to full arm and leg with **metal** frames (GC3622TLA/TRA, GC3622TLCA/TRCA). This table allows for kneespace when specifying chairs in a corner position. 1 per carton.

- Includes 2 rear metal legs (not shown).



GC3672-LP	23.87 x 20.25 x 5.5	150	20	3.4	\$805
GC3672M-LP					\$2082
GC3672-HP	23.87 x 20.25 x 5.5	150	20	3.4	\$845
GC3672M-HP					\$2129

- For a thermally fused laminate top (LP), specify model GC3672-LP.
- For a high pressure laminate top (HP), specify model GC3672-HP.
- Models GC3672M-LP and GC3672M-HP have a **power/USB** module mounted in surface.



Center Table

Coordinating 2mm edge. Regular center table for **wood** or **metal** (HT) frame. Must be connected to full arm and leg with **metal** or **wood** frames (GC3622TLA/TRA, GC3622TLCA/TRCA, GC3622WTLA/WTRA, GC3622WTLCA/WTRCA). 1 per carton.

DESCRIPTION	MODEL#	STANDARD FABRIC GRADES				
-------------	--------	------------------------	--	--	--	--



GC3673-LP	23.87 x 12 x 5.5	100	18	2.1	\$783
GC3673M-LP					\$2226
GC3673-HP	23.87 x 12 x 5.5	100	18	2.1	\$821
GC3673M-HP					\$2275



- For a thermally fused laminate top (LP), specify model GC3673-LP.
- For a high pressure laminate top (HP), specify model GC3673-HP.
- Models GC3673M-LP and GC3673M-HP have a **power/USB** module mounted on surface.

Narrow Center Table

Coordinating 2mm edge. Narrow center table for **wood or metal** (HT) frame. Must be connected to full arm and leg with **metal** or **wood** frames (GC3622TLA/TRA, GC3622TLCA/TRCA, GC3622WTLA/WTRA, GC3622WTLCA/WTRCA).
1 per carton

GC3674WL-LP	23.87 x 20.25 x 17	150	19	3.4	\$1126
GC3674WLM-LP					\$2434
GC3674WL-HP	23.87 x 20.25 x 17	150	20	3.4	\$1166
GC3674WLM-HP					\$2480

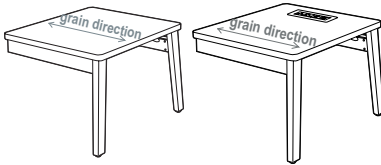

- For a thermally fused laminate top (LP), specify model GC3674WL-LP.
- For a high pressure laminate top (HP), specify model GC3674WL-HP.
- Models GC3674WLM-LP and GC3674WLM-HP have a **power/USB** module mounted in surface.

Left End Table, for Wood Frame

Coordinating 2mm edge. Must be connected to full arm and leg with **wood** frames (GC3622WTLA or GC3622WTLCA).
1 per carton.

GC3674L-LP	23.87 x 20.25 x 17	150	19	3.4	\$1208
GC3674LM-LP					\$2526
GC3674L-HP	23.87 x 20.25 x 17	150	20	3.4	\$1250
GC3674LM-HP					\$2572

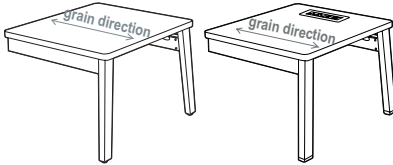

- For a thermally fused laminate top (LP), specify model GC3674L-LP.
- For a high pressure laminate top (HP), specify model GC3674L-HP.
- Models GC3674LM-LP and GC3674LM-HP have a **power/USB** module mounted in surface.

Left End Table, for Metal Frame

Coordinating 2mm edge. Must be connected to full arm and leg with **metal** frames. (GC3622TLA or GC3622TLCA).
1 per carton.

GC3674WR-LP	23.87 x 20.25 x 17	150	19	3.4	\$1126
GC3674WRM-LP					\$2434
GC3674WR-HP	23.87 x 20.25 x 17	150	20	3.4	\$1166
GC3674WRM-HP					\$2480

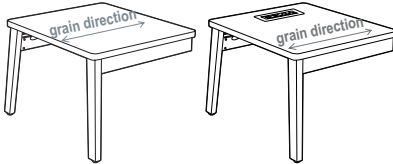

- For a thermally fused laminate top (LP), specify model GC3674WR-LP.
- For a high pressure laminate top (HP), specify model GC3674WR-HP.
- Models GC3674WRM-LP and GC3674WRM-HP have a **power/USB** module mounted in surface.

Right End Table, for Wood Frame

Coordinating 2mm edge. Must be connected to full arm and leg with **wood** frames. (GC3622WTRA or GC3622WTRCA).
1 per carton.

GC3674R-LP	23.87 x 20.25 x 17	150	19	3.4	\$1208
GC3674RM-LP					\$2526
GC3674R-HP	23.87 x 20.25 x 17	150	20	3.4	\$1250
GC3674RM-HP					\$2572

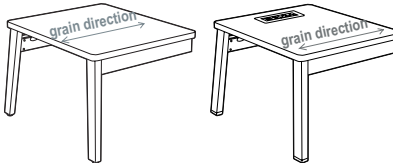

- For a thermally fused laminate top (LP), specify model GC3674R-LP.
- For a high pressure laminate top (HP), specify model GC3674R-HP.
- Models GC3674RM-LP and GC3674RM-HP have a **power/USB** module mounted in surface.

Right End Table, for Metal Frame

Coordinating 2mm edge. Must be connected to full arm and leg with **metal** frames. (GC3622TRA or GC3622TRCA).
1 per carton.

DESCRIPTION	MODEL#	STANDARD FABRIC GRADES				
-------------	--------	------------------------	--	--	--	--

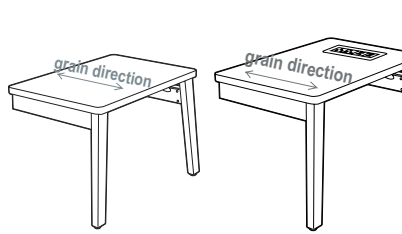

Narrow Left End Table, for Wood Frame

GC3675WL-LP	23.87 x 12 x 17	100	18	2.1	\$1101
GC3675WLM-LP					\$2607
GC3675WL-HP	23.87 x 12 x 17	100	18	2.1	\$1143
GC3675WLM-HP					\$2657

- For a thermally fused laminate top (LP), specify model GC3675WL-LP.
- For a high pressure laminate top (HP), specify model GC3675WL-HP.
- Models GC3675WLM-LP and GC3675WLM-HP have a **power/USB** module mounted on surface.

Coordinating 2mm edge. Must be connected to full arm and leg with **wood** frames. (GC3622WTLA or GC3622WTLCA). 1 per carton.

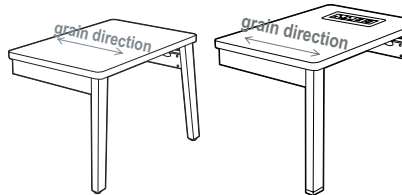

Narrow Left End Table, for Metal Frame

GC3675L-LP	23.87 x 12 x 17	100	18	2.1	\$1185
GC3675LM-LP					\$2708
GC3675L-HP	23.87 x 12 x 17	100	18	2.1	\$1227
GC3675LM-HP					\$2758

- For a thermally fused laminate top (LP), specify model GC3675L-LP.
- For a high pressure laminate top (HP), specify model GC3675L-HP.
- Models GC3675LM-LP and GC3675LM-HP have a **power/USB** module mounted on surface.

Coordinating 2mm edge. Must be connected to full arm and leg with **metal** frames. (GC3622TLA or GC3622TLCA). 1 per carton.

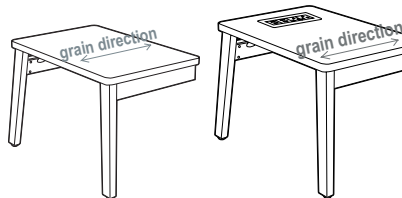

Narrow Right End Table, for Wood Frame

GC3675WR-LP	23.87 x 12 x 17	100	18	2.1	\$1101
GC3675WRM-LP					\$2607
GC3675WR-HP	23.87 x 12 x 17	100	18	2.1	\$1143
GC3675WRM-HP					\$2657

- For a thermally fused laminate top (LP), specify model GC3675WR-LP.
- For a high pressure laminate top (HP), specify model GC3675WR-HP.
- Models GC3675WRM-LP and GC3675WRM-HP have a **power/USB** module mounted on surface.

Coordinating 2mm edge. Must be connected to full arm and leg with **wood** frames. (GC3622WTLA or GC3622WTLCA). 1 per carton.

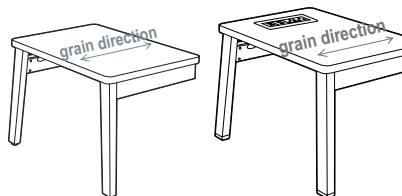

Narrow Right End Table, for Metal Frame

GC3675R-LP	23.87 x 12 x 17	100	18	2.1	\$1185
GC3675RM-LP					\$2708
GC3675R-HP	23.87 x 12 x 17	100	18	2.1	\$1227
GC3675RM-HP					\$2758

- For a thermally fused laminate top (LP), specify model GC3675R-LP.
- For a high pressure laminate top (HP), specify model GC3675R-HP.
- Models GC3675RM-LP and GC3675RM-HP have a **power/USB** module mounted on surface.

Coordinating 2mm edge. Must be connected to full arm and leg with **metal** frames. (GC3622TLA or GC3622TLCA). 1 per carton.

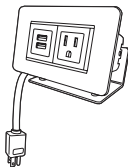









On Surface Power/Data Module

GC36410	-- x -- x --	250	2	1	\$735
---------	--------------	-----	---	---	--------------

Surface top mount power/data module with one power outlet, two USB charging ports. 6 foot cord. White. Can be mounted to all freestanding and modular tables.

































MODULAR TABLES	MODEL#	DIMENSIONS D x W x H	FREIGHT CLASS	WT/LBS.	CUBIC FT.	LIST PRICE
----------------	--------	-------------------------	---------------	---------	-----------	------------

MODULAR TOP UNITS **FOR MODULAR LOUNGE AND FULLY UPHOLSTERED LOUNGE**

	SINGLE SEAT	BARIATRIC	TWO SEATER	THREE SEATER
Lounge Seating	GC3641TOP 	GC3640TOP 	GC3642TOP 	GC3643TOP 
High Back Lounge Seating	GC3676HBTOP 	GC3679HBTOP 	GC3677HBTOP 	GC3678HBTOP 

LEG / ARM FRAMES **FOR MODULAR LOUNGE**

Metal frame: Standard with Black Urethane armcap (see notes for wood and urethane finish options) | Wood frame: Must select armcap

	LEFT, OPEN	RIGHT, OPEN	LEFT, CLOSED	RIGHT, CLOSED	LEFT, CLOSED LAMINATE PANEL	RIGHT, CLOSED LAMINATE PANEL				
Metal (HT) End	GC3641LA 	GC3641LAM 	GC3641RA 	GC3641RAM 	GC3641LCA 	GC3641LCAM 	GC3641RCA 	GC3641RCAM 	GC3641LCAL 	GC3641RCAL 
Wood End	GC3641WLA 	GC3641WLAM 	GC3641WRA 	GC3641WRAM 	GC3641WLCA 	GC3641WLCAM 	GC3641WRCA 	GC3641WRCAM 		
Metal (HT) Center	GC36406LA 			GC36406LCA 		GC36406LCAL 				
Wood, Center	GC36406WLA 			GC36406WLCA 						
Metal (HT) Center table linking	GC36406TLA 	GC3622TRA 		GC36406TLCA 	GC36406TRCA 	GC36406TLCAL 	GC36406TRCAL 			
Wood Center table linking	GC36406WTLA 	GC3622WTRA 		GC36406WTLCA 	GC36406WTRCA 					

For frame with power/USB module*, add "M" after model number

LEG / ARM FRAMES **FOR FULLY UPHOLSTERED MODULAR LOUNGE**

Standard with Black Urethane legs (see notes for wood and urethane finish options)
Optional armcap in wood or urethane (cannot be retrofitted in the field if the frame is ordered without armcap)

	LEFT	RIGHT
Fully Upholstered End	GC3676LA 	GC3676RA 
Fully Upholstered Center	GC3676CFA 	

(Center = link both sides)

*Power module includes two power outlets, four USB charging ports and a 6 foot long power cord. Available in Black or White (must be specified at time of order). Power module is mounted on the frame below seat support rail.

DESCRIPTION

MODEL# / FEATURES

STANDARD TEXTILE GRADES

MODULAR TABLES FOR MODULAR LOUNGE AND FULLY UPHOLSTERED LOUNGE

Tables include legs to support table top (except for center tables). All tables have a metal frame.

	LEFT		RIGHT	
Corner (laminated top with metal legs)	GC36403L-HP	GC36403LM-HP	GC36403R-HP	GC36403RM-HP
	GC36403L-LP	GC36403LM-LP	GC36403R-LP	GC36403RM-LP
Corner (laminated top with wood legs)	GC36403WL-HP	GC36403WLM-HP	GC36403WR-HP	GC36403WRM-HP
	GC36403WL-LP	GC36403WLM-LP	GC36403WR-LP	GC36403WRM-LP
Center (laminated top, connects to metal or wood frame)	GC36401-HP	GC36401M-HP		
	GC36401-LP	GC36401M-LP		
Narrow Center (laminated top, connects to metal or wood frame)	GC36402-HP	GC36402M-HP		
	GC36402-LP	GC36402M-LP		
End (laminated top with metal legs)	GC36404L-HP	GC36404LM-HP	GC36404R-HP	GC36404RM-HP
	GC36404L-LP	GC36404LM-LP	GC36404R-LP	GC36404RM-LP
End (laminated top with wood legs)	GC36404WL-HP	GC36404WLM-HP	GC36404WR-HP	GC36404WRM-HP
	GC36404WL-LP	GC36404WLM-LP	GC36404WR-LP	GC36404WRM-LP
Narrow End (laminated top with metal legs)	GC36405L-HP	GC36405LM-HP	GC36405R-HP	GC36405RM-HP
	GC36405L-LP	GC36405LM-LP	GC36405R-LP	GC36405RM-LP
Narrow End (laminated top with wood legs)	GC36405WL-HP	GC36405WLM-HP	GC36405WR-HP	GC36405WRM-HP
	GC36405WL-LP	GC36405WLM-LP	GC36405WR-LP	GC36405WRM-LP

For table with power/USB module*, refer to models ending in "M"

* Power module includes two power outlets, four USB charging ports and a 6 foot long power cord. Available in Black or White (must be specified at time of order). Power module is mounted on surface on narrow tables; mounted in surface on larger tables (as shown above).

DESCRIPTION MODEL# / FEATURES STANDARD TEXTILE GRADES

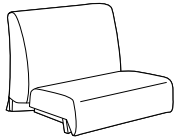

Lounge Bariatric Top
 COM Yardage: 3.25
 Freight Class: 300
 Product Weight (lbs.): 97
 Cubic Feet Per Carton: 49.5

	COM	2	3	4	5	6	7	8	9	10	11	12
GC3640TOP	\$2275	\$2386	\$2478	\$2614	\$2809	\$2897	\$3071	\$3351	\$3565	\$3805	\$4294	\$4819

Active weight: see notes.

Single frame lounge top unit with 1 back and 1 seat cushion.

Must be connected to a full arm/leg frame.

OVERALL DIMENSIONS			SEAT DIMENSIONS			BACK DIMENSIONS	
W	D	H	W	D	H	W	H
36	32	25	36	20	-	36	16

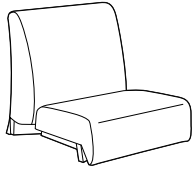

Lounge Single Seater Top
 COM Yardage: 2.5
 Freight Class: 250
 Product Weight (lbs.): 66
 Cubic Feet Per Carton: 29.5

	COM	2	3	4	5	6	7	8	9	10	11	12
GC3641TOP	\$1633	\$1718	\$1790	\$1896	\$2042	\$2114	\$2248	\$2460	\$2627	\$2810	\$3185	\$3588

Active weight: see notes.

Single frame lounge top unit with 1 back and 1 seat cushion.

Must be connected to a full arm/leg frame.

OVERALL DIMENSIONS			SEAT DIMENSIONS			BACK DIMENSIONS	
W	D	H	W	D	H	W	H
25	32	25	23	20	-	22.5	16

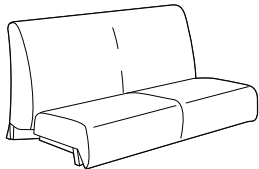

Lounge Two Seater Top
 COM Yardage: 4
 Freight Class: 250
 Product Weight (lbs.): 110
 Cubic Feet Per Carton: 49.5

	COM	2	3	4	5	6	7	8	9	10	11	12
GC3642TOP	\$2894	\$3029	\$3146	\$3311	\$3550	\$3661	\$3877	\$4217	\$4482	\$4775	\$5376	\$6022

Active weight: see notes.

Double frame lounge top unit with 2 back and 2 seat cushions.

Must be connected to a full arm/leg frame.

OVERALL DIMENSIONS			SEAT DIMENSIONS			BACK DIMENSIONS	
W	D	H	W	D	H	W	H
48	32	25	48	20	-	48	16

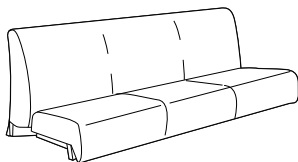

Lounge Three Seater Top
 COM Yardage: 6.25
 Freight Class: 250
 Product Weight (lbs.): 161
 Cubic Feet Per Carton: 69.5

	COM	2	3	4	5	6	7	8	9	10	11	12
GC3643TOP	\$4773	\$4989	\$5167	\$5430	\$5798	\$5973	\$6308	\$6843	\$7255	\$7712	\$8655	\$9662

Due to the size and weight, this top requires at least 3 installers.

Active weight: see notes.

Triple frame lounge top unit with 3 back and 3 seat cushions.

Must be connected to a full arm/leg frame.

OVERALL DIMENSIONS			SEAT DIMENSIONS			BACK DIMENSIONS	
W	D	H	W	D	H	W	H
71	32	25	71	20	-	71	16

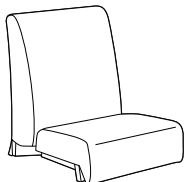

HB Lounge Single Seater Top
 COM Yardage: 6.5
 Freight Class: 250
 Product Weight (lbs.): 92
 Cubic Feet Per Carton: 29.5

	COM	2	3	4	5	6	7	8	9	10	11	12
GC3676HB-TOP	\$1585	\$1805	\$1988	\$2257	\$2637	\$2816	\$3164	\$3713	\$4138	\$4610	\$5581	\$6620

Active weight: see notes.

Single high back frame lounge top, 1 back and 1 seat cushion.

Must be connected to a full arm/leg frame.

OVERALL DIMENSIONS			SEAT DIMENSIONS			BACK DIMENSIONS	
W	D	H	W	D	H	W	H
23	29	36	23	20	-	23	19

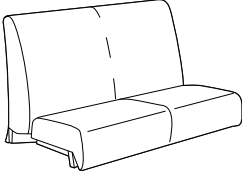
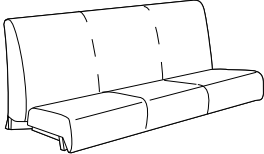
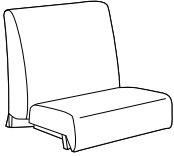
DESCRIPTION	MODEL# / FEATURES	STANDARD TEXTILE GRADES											
		COM	2	3	4	5	6	7	8	9	10	11	12
 <p>HB Lounge Two Seater Top COM Yardage: 7.75 Freight Class: 250 Product Weight (lbs.): 117 Cubic Feet Per Carton: 56.25</p>	GC3677HB-TOP	\$2947	\$3210	\$3426	\$3747	\$4202	\$4417	\$4828	\$5485	\$5991	\$6553	\$7712	\$8949
	Active weight: see notes.	OVERALL DIMENSIONS			SEAT DIMENSIONS			BACK DIMENSIONS					
		W	D	H	W	D	H	W	H				
	Double high back frame lounge top unit with 2 back and 2 seat cushions.	45.5	29	36	45.5	20	-	45.5	19				
Must be connected to a full arm/leg frame.													
 <p>HB Lounge Three Seater Top COM Yardage: 9.25 Freight Class: 250 Product Weight (lbs.): 158 Cubic Feet Per Carton: 69.5</p>	GC3678HB-TOP	\$4942	\$5257	\$5515	\$5898	\$6440	\$6695	\$7187	\$7972	\$8576	\$9247	\$10630	\$12104
	Active weight: see notes.	OVERALL DIMENSIONS			SEAT DIMENSIONS			BACK DIMENSIONS					
		W	D	H	W	D	H	W	H				
	Triple high back frame lounge top unit with 3 back and 3 seat cushions.	68.5	29	36	68.5	20	--	71	19				
Must be connected to a full arm/leg frame.													
 <p>HB Lounge Bariatric Top COM Yardage: 6.75 Freight Class: 250 Product Weight (lbs.): 96 Cubic Feet Per Carton: 37.75</p>	GC3679HB-TOP	\$2478	\$2709	\$2898	\$3177	\$3573	\$3760	\$4119	\$4691	\$5132	\$5622	\$6632	\$7708
	Active weight: see notes.	OVERALL DIMENSIONS			SEAT DIMENSIONS			BACK DIMENSIONS					
		W	D	H	W	D	H	W	H				
	Single high back frame bariatric lounge top, 1 back and 1 seat cushion.	32	29	36	32	20	--	32	19				
Must be connected to a full arm/leg frame.													

DESCRIPTION MODEL# / FEATURES STANDARD TEXTILE GRADES

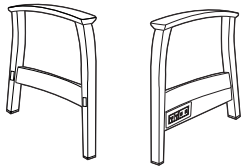

Lounge Left End Frame, Open Arm
 COM Yardage: --
 Freight Class: 150
 Product Weight (lbs.): metal: 9.67 | wood: 11
 Cubic Feet Per Carton: 2.1

List price	
GC3641LA (metal)	\$767
GC3641LAM (w/power)	\$2021
GC3641WLA (wood)	\$517
GC3641WLAM (wood)	\$1771

Specify armcap: wood or Urethane.

OVERALL DIMENSIONS			SEAT DIMENSIONS			BACK DIMENSIONS	
W	D	H	W	D	H	W	H

For use in **left** side finished position of lounge seating units.
 • Models GC3641LAM and GC3641WLAM have **power/USB module**
Does not allow linking to other units or tables.
 Urethane armcap option - **Add \$53 list upcharge**

3.5	29	25.25	-	-	-	-	-
-----	----	-------	---	---	---	---	---

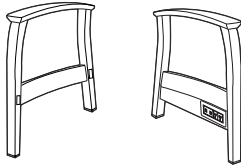

Lounge Right End Frame, Open Arm
 COM Yardage: --
 Freight Class: 150
 Product Weight (lbs.): metal: 9.67 | wood: 11
 Cubic Feet Per Carton: 2.1

List price	
GC3641RA (metal)	\$767
GC3641RAM (w/power)	\$2021
GC3641WRA (wood)	\$517
GC3641WRAM (w/power)	\$1771

Specify armcap: wood or Urethane.

OVERALL DIMENSIONS			SEAT DIMENSIONS			BACK DIMENSIONS	
W	D	H	W	D	H	W	H

For use in **right** side finished position of lounge seating units.
 • Models GC3641RAM and GC3641WRAM have **power/USB module**
Does not allow linking to other units or tables.
 Urethane armcap option - **Add \$53 list upcharge**

3.5	29	25.25	-	-	-	-	-
-----	----	-------	---	---	---	---	---

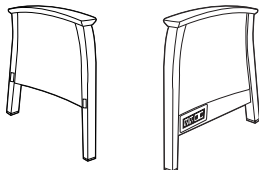

Lounge Left End Frame, Closed Arm
 COM Yardage: 0.75
 Freight Class: 150
 Product Weight (lbs.): metal: 10.17 | wood: 11
 Cubic Feet Per Carton: 2.1

	COM	2	3	4	5	6	7	8	9	10	11	12
GC3641LCA (metal)	\$967	\$990	\$1013	\$1043	\$1089	\$1109	\$1148	\$1213	\$1263	\$1317	\$1428	\$1548
GC3641LCAM (w/power)	\$2231	\$2254	\$2277	\$2310	\$2354	\$2374	\$2414	\$2478	\$2527	\$2585	\$2697	\$2817
GC3641WLCA (wood)	\$669	\$701	\$732	\$773	\$833	\$860	\$914	\$998	\$1068	\$1139	\$1290	\$1452
GC3641WLCAM (w/power)	\$1924	\$1955	\$1986	\$2028	\$2085	\$2114	\$2168	\$2254	\$2322	\$2396	\$2545	\$2706

Specify armcap: wood or Urethane.

OVERALL DIMENSIONS			SEAT DIMENSIONS			BACK DIMENSIONS	
W	D	H	W	D	H	W	H

For use in **left** side finished position of lounge seating units.
 • Models GC3641LCAM and GC3641WLCAM have **power/USB module**
Does not allow linking to other units or tables.
 Urethane armcap option - **Add \$53 list upcharge**

3.5	29	25.25	-	-	-	-	-
-----	----	-------	---	---	---	---	---

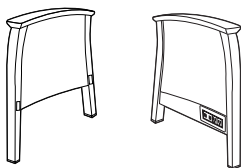

Lounge Right End Frame, Closed Arm
 COM Yardage: 0.75
 Freight Class: 150
 Product Weight (lbs.): metal: 10.17 | wood: 11
 Cubic Feet Per Carton: 2.1

	COM	2	3	4	5	6	7	8	9	10	11	12
GC3641RCA (metal)	\$967	\$990	\$1013	\$1043	\$1089	\$1109	\$1148	\$1213	\$1263	\$1317	\$1428	\$1548
GC3641RCAM (w/power)	\$2231	\$2254	\$2277	\$2310	\$2354	\$2374	\$2414	\$2478	\$2527	\$2585	\$2697	\$2817
GC3641WRCA (wood)	\$669	\$701	\$732	\$773	\$833	\$860	\$914	\$998	\$1068	\$1139	\$1290	\$1452
GC3641WRCAM (w/power)	\$1924	\$1955	\$1986	\$2028	\$2085	\$2114	\$2168	\$2254	\$2322	\$2396	\$2545	\$2706

Specify armcap: wood or Urethane.

OVERALL DIMENSIONS			SEAT DIMENSIONS			BACK DIMENSIONS	
W	D	H	W	D	H	W	H

For use in **right** side finished position of lounge seating units.
 • Models GC3641RCAM and GC3641WRCAM have **power/USB module**
Does not allow linking to other units or tables.
 Urethane armcap option - **Add \$53 list upcharge**

3.5	29	25.25	-	-	-	-	-
-----	----	-------	---	---	---	---	---

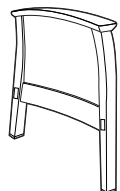

Lounge Left End Frame, Closed Arm, Laminate Panel
 COM Yardage: --
 Freight Class: 100
 Product Weight (lbs.): 18
 Cubic Feet Per Carton: 2.1

List Price	
GC3641LCAL	\$1090

Metal

Specify armcap: wood or Urethane.

OVERALL DIMENSIONS			SEAT DIMENSIONS			BACK DIMENSIONS	
W	D	H	W	D	H	W	H

For use in **left** side finished position of lounge seating units.
Does not allow linking to other units or tables.
 Urethane armcap option - **Add \$53 list upcharge**

3.5	29	25.25	-	-	-	-	-
-----	----	-------	---	---	---	---	---

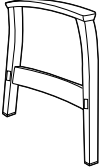
DESCRIPTION	MODEL# / FEATURES	STANDARD TEXTILE GRADES											
		List Price											
	GC3641RCAL Metal	\$1090											
	Specify armcap: wood or Urethane.	OVERALL DIMENSIONS			SEAT DIMENSIONS			BACK DIMENSIONS					
		W	D	H	W	D	H	W	H				
Lounge Right End Frame, Closed Arm, Laminate Panel COM Yardage: -- Freight Class: 100 Product Weight (lbs.): 18 Cubic Feet Per Carton: 2.1	For use in right side finished position of lounge seating units. Does not allow linking to other units or tables. Urethane armcap option - Add \$53 list upcharge	3.5	29	25.25									
		List price											
	GC36406LA (metal)	\$767											
	GC36406WLA (wood)	\$517											
	Specify armcap: wood or Urethane.	OVERALL DIMENSIONS			SEAT DIMENSIONS			BACK DIMENSIONS					
		W	D	H	W	D	H	W	H				
Lounge Center Frame, Open Arm COM Yardage: -- Freight Class: 300 Product Weight (lbs.): metal: 2.24 wood: 11 Cubic Feet Per Carton: 2.1	For linking lounge top seating units together only. Urethane armcap option - Add \$53 list upcharge	3.5	29	25.25	-	-	-	-	-				
		COM	2	3	4	5	6	7	8	9	10	11	12
	GC36406LCA (metal)	\$978	\$1001	\$1026	\$1057	\$1103	\$1124	\$1161	\$1226	\$1277	\$1333	\$1445	\$1565
	GC36406WLCA (wood)	\$669	\$701	\$734	\$774	\$833	\$861	\$915	\$1000	\$1068	\$1142	\$1291	\$1453
	Specify armcap: wood or Urethane.	OVERALL DIMENSIONS			SEAT DIMENSIONS			BACK DIMENSIONS					
		W	D	H	W	D	H	W	H				
Lounge Center Frame, Closed Arm COM Yardage: 0.75 Freight Class: 150 Product Weight (lbs.): metal: 8.87 wood: 11 Cubic Feet Per Carton: 2.1	For linking lounge top seating units together only. Urethane armcap option - Add \$53 list upcharge	3.5	29	25.25	-	-	-	-	-				
		List price											
	GC36406TLA (metal)	\$767											
	GC36406WTLA (wood)	\$517											
	Specify armcap: wood or Urethane.	OVERALL DIMENSIONS			SEAT DIMENSIONS			BACK DIMENSIONS					
		W	D	H	W	D	H	W	H				
Lounge Center Frame, Open Arm COM Yardage: -- Freight Class: 300 Product Weight (lbs.): metal: 11 wood: 11 Cubic Feet Per Carton: 2.1	For linking lounge top seating units to modular table on the left side of the frame. Urethane armcap option - Add \$53 list upcharge	3.5	29	25.25	-	-	-	-	-				
		List price											
	GC36406TRA (metal)	\$767											
	GC36406WTRA (wood)	\$517											
	Specify armcap: wood or Urethane.	OVERALL DIMENSIONS			SEAT DIMENSIONS			BACK DIMENSIONS					
		W	D	H	W	D	H	W	H				
Lounge Center Frame, Open Arm COM Yardage: -- Freight Class: 300 Product Weight (lbs.): metal: 11 wood: 11 Cubic Feet Per Carton: 2.1	For linking lounge top seating units to modular table on the right side of the frame. Urethane armcap option - Add \$53 list upcharge	3.5	29	25.25	-	-	-	-	-				

DESCRIPTION	MODEL# / FEATURES	STANDARD TEXTILE GRADES											
		COM	2	3	4	5	6	7	8	9	10	11	12
 <p>Lounge Center Frame, Closed Arm COM Yardage: 0.75 Freight Class: 150 Product Weight (lbs.): metal: 8.87 wood: 11 Cubic Feet Per Carton: 2.1</p>	GC36406TLCA (metal)	\$978	\$1001	\$1026	\$1057	\$1103	\$1124	\$1161	\$1226	\$1277	\$1333	\$1445	\$1565
	GC36406WLCA (wood) Specify armcap: wood or Urethane.	\$669	\$701	\$734	\$774	\$833	\$861	\$915	\$1000	\$1068	\$1142	\$1291	\$1453
	OVERALL DIMENSIONS	SEAT DIMENSIONS			BACK DIMENSIONS								
	W D H	W	D	H	W	D	H	W	H				
	3.5	29	25.25	-	-	-	-	-					
	Urethane armcap option - Add \$53 list upcharge												
 <p>Lounge Center Frame, Closed Arm COM Yardage: 0.75 Freight Class: 150 Product Weight (lbs.): metal: 8.87 wood: 11 Cubic Feet Per Carton: 2.1</p>	GC36406TRCA (metal)	\$978	\$1001	\$1026	\$1057	\$1103	\$1124	\$1161	\$1226	\$1277	\$1333	\$1445	\$1565
	GC36406WTRCA (wood) Specify armcap: wood or SSU.	\$669	\$701	\$734	\$774	\$833	\$861	\$915	\$1000	\$1068	\$1142	\$1291	\$1453
	OVERALL DIMENSIONS	SEAT DIMENSIONS			BACK DIMENSIONS								
	W D H	W	D	H	W	D	H	W	H				
	3.5	29	25.25	-	-	-	-	-					
	Urethane armcap option - Add \$53 list upcharge												
 <p>Center Frame, Fully Upholstered Arm COM Yardage: 1.75 Freight Class: 150 Product Weight (lbs.): 35 Cubic Feet Per Carton: 6</p>	GC3676CFA	\$617	\$675	\$727	\$800	\$901	\$951	\$1043	\$1191	\$1307	\$1434	\$1695	\$1973
	Specify leg finish: wood or SSU. Optional wood or Urethane armcap. Please specify. Add \$206.												
	OVERALL DIMENSIONS	SEAT DIMENSIONS			BACK DIMENSIONS								
	W D H	W	D	H	W	D	H	W	H				
	5	29	25.25	-	-	-	-	-					
	For linking lounge top seating units together or to modular table.												
 <p>Left End Frame, Fully Upholstered Arm COM Yardage: 1.75 Freight Class: 250 Product Weight (lbs.): 20 Cubic Feet Per Carton: 6</p>	GC3676LA	\$617	\$675	\$727	\$800	\$901	\$951	\$1043	\$1191	\$1307	\$1434	\$1695	\$1973
	Specify leg finish: wood or Urethane. Optional wood or Urethane armcap. Please specify. Add \$206.												
	OVERALL DIMENSIONS	SEAT DIMENSIONS			BACK DIMENSIONS								
	W D H	W	D	H	W	D	H	W	H				
	5	29	25.25	-	-	-	-	-					
	For use in left side finished position of lounge seating units. Does not allow linking to other units or tables.												
 <p>Right End Frame, Fully Upholstered Arm COM Yardage: 1.75 Freight Class: 250 Product Weight (lbs.): 20 Cubic Feet Per Carton: 6</p>	GC3676RA	\$617	\$675	\$727	\$800	\$901	\$951	\$1043	\$1191	\$1307	\$1434	\$1695	\$1973
	Specify leg finish: wood or Urethane. Optional wood or Urethane armcap. Please specify. Add \$206.												
	OVERALL DIMENSIONS	SEAT DIMENSIONS			BACK DIMENSIONS								
	W D H	W	D	H	W	D	H	W	H				
	5	29	25.25	-	-	-	-	-					
	For use in right side finished position of lounge seating units. Does not allow linking to other units or tables.												

Modular tables for use with modular lounge and fully upholstered lounge units:

Tops are 1" thick.

Wooden leg tables:

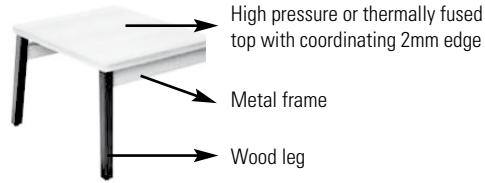

Metal leg tables:

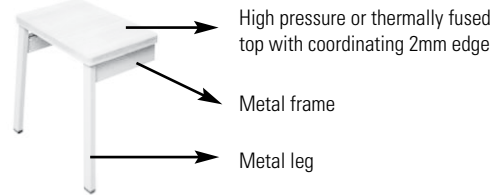

Table top finishes:

Thermally Fused Laminate (LP)

- Absolute Acajou (ACJ)
- Asian Night (ASN)
- Avant Cherry (AWC)
- Avant Honey (AWH)
- Brushed Cobalt (BRC)
- Clear Maple (CMB)
- Dark Espresso (DES)
- Designer White (DWT)
- Fashionista (FAS)
- First Class (FCL)
- Noce Biondo (NBL)
- Noce Grigio (NGL)
- Noce Leggero (NEL)
- Noce Medio (NML)
- Quartered Mahogany (QTM)
- Sheer Beauty (SBY)
- Walnut Heights (WHE)
- White Chocolate (WHC)
- Winter Cherry (WCR)

High Pressure Laminate (HP)

- Absolute Acajou (ACJ)
- Asian Night (ASN)
- Avant Cherry (W357)
- Avant Honey (W356)
- Brushed Cobalt (BRC)
- Clear Maple (CMB)
- Dark Espresso (W142)
- Designer White (DWT)
- Fashionista (FAS)
- First Class (FCL)
- Noce Biondo (NBL)
- Noce Grigio (NGL)
- Noce Leggero (NEL)
- Noce Medio (NML)
- Quartered Mahogany (QTM)
- Sheer Beauty (SBL)
- Walnut Heights (WHE)
- White Chocolate (WHC)
- Winter Cherry (WCR)

Wood leg finishes (top, base, legs & apron):

- Absolute (AAM)
- Charcoal Java (CJM)
- Cherry (ACM)
- Empire Mahogany (EMM)
- English Oak (EOM)
- Espresso Cafe (ECM)
- Fruitwood (TFM)
- Gray (HGM)
- Harvest Oak (HOM)
- Honey (AHM)

- Jet Onyx (JOM)
- Light Honey (LHM)
- Mahogany (TMM)
- Maple (AVM)
- Medium Walnut (MWM)
- Natural Walnut (NLW)
- Night (ASM)
- Noce Biondo (NBM)
- Noce Grigio (NGM)
- Noce Leggero (NEM)

- Noce Medio (NMM)
- Sandy Beach (SBM)
- Shaker Cherry (SKM)
- Silver Oak (SOM)
- Walnut (TWM)
- White (WHM)
- WC Cream (WTM)
- Winter Cherry (WCM)

Metal leg finishes:

Black (TBL), Cloud (TIV), Designer White (TDW), Fog (TFO), Frost (TFR), Kalua (TKA), Latte (TLA), Mocha (TMO), Nevada (TNE), Sand (TSN), Shadow (TSH), Toast (TOA) and Tungsten (TTU).

Metal frame finishes:

Black (TBL), Cloud (TIV), Designer White (TDW), Fog (TFO), Frost (TFR), Kalua (TKA), Latte (TLA), Mocha (TMO), Nevada (TNE), Sand (TSN), Shadow (TSH), Toast (TOA) and Tungsten (TTU).

Power/USB modules:



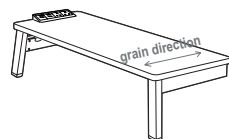

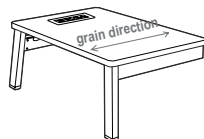

For modular tables with power/USB module, refer to models ending in "M". Module includes two power outlets, four USB charging ports and a 6 foot long power cord. Available in Black or White (must be specified at time of order). Power module is mounted **on surface** on narrow tables; mounted **in surface** on larger tables.



On surface power module on narrow tables





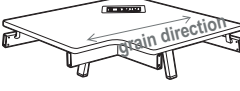





In surface power module on larger tables

DESCRIPTION	MODEL# / FEATURES	STANDARD TEXTILE GRADES				
	GC36401-LP	28 x 20.25 x 13	125	23	3.5	\$1060
	GC36401M-LP With power					\$2240
	GC36401-HP	28 x 20.25 x 13	125	23	3.5	\$1105
	GC36401M-HP With power					\$2288
Center Table	<p>Coordinating 2mm edge. Regular center table for wood or metal lounge frame. Must be connected to full arm and leg with lounge frames (GC36406TLA/TRA, GC36406TLCA/TRCA, GC36406WTLA/TRA, GC36406WTLCA/TRCA). 1 per carton.</p>					
	GC36402-LP	28 x 12 x 13	100	20	2.1	\$1011
	GC36402M-LP With power					\$2195
	GC36402-HP	28 x 12 x 13	100	20	2.1	\$1060
	GC36402M-HP With power					\$2240
Narrow Center Table	<p>Coordinating 2mm edge. Narrow center table for wood or metal lounge frame. Must be connected to full arm and leg with lounge frames (GC36406TLA/TRA, GC36406TLCA/TRCA, GC36406WTLA/TRA, GC36406WTLCA/TRCA). 1 per carton.</p>					
	GC36403WL-LP	37.12 x 37.12 x 13	125	46	6	\$1808
	GC36403WLM-LP With power					\$2993
	GC36403WL-HP	37.12 x 37.12 x 13	125	46	6	\$1915
	GC36403WLM-HP With power					\$3098
Left Corner Table, Wood Legs	<p>Coordinating 2mm edge. Must be connected to full arm and leg with wood lounge frames (GC36406WTLA/TRA, GC36406WTLCA/TRCA). This table allows for kneespace when specifying chairs in a corner position. 1 per carton.</p> <ul style="list-style-type: none"> Includes 2 rear wood legs (not shown). 					
	GC36403L-LP	37.12 x 37.12 x 13	125	46	6	\$1902
	GC36403LM-LP With power					\$3083
	GC36403L-HP	37.12 x 37.12 x 13	125	46	6	\$2009
	GC36403LM-HP With power					\$3192
Left Corner Table, Metal Legs	<p>Coordinating 2mm edge. Must be connected to full arm and leg with metal lounge frames (GC36406TLA/TRA, GC36406TLCA/TRCA). This table allows for kneespace when specifying chairs in a corner position. 1 per carton.</p> <ul style="list-style-type: none"> Includes 2 rear metal legs (not shown). 					

SEATING

PRIMACARE™ MODULAR - LOUNGE P

DESCRIPTION	MODEL# / FEATURES	STANDARD TEXTILE GRADES				
 Right Corner Table, Wood Legs	GC36403WR-LP	37.12 x 37.12 x 13	125	46	6	\$1808
	GC36403WRM-LP With power					\$2993
 Right Corner Table, Wood Legs	GC36403WR-HP	37.12 x 37.12 x 13	125	46	6	\$1915
	GC36403WRM-HP With power					\$3098
<ul style="list-style-type: none"> For a thermally fused laminate top (LP), specify model GC36403WR-LP. For a high pressure laminate top (HP), specify model GC36403WR-HP. Models GC36403WRM-LP and GC36403WRM-HP have power/USB module mounted in surface. <p>Coordinating 2mm edge. Must be connected to full arm and leg with wood lounge frames (GC36406WTLA/TRA, GC36406WTLCA/TRCA). This table allows for kneespace when specifying chairs in a corner position. 1 per carton.</p> <ul style="list-style-type: none"> Includes 2 rear wood legs (not shown). 						
 Right Corner Table, Metal Legs	GC36403R-LP	37.12 x 37.12 x 13	125	46	6	\$1902
	GC36403RM-LP With power					\$3083
 Right Corner Table, Metal Legs	GC36403R-HP	37.12 x 37.12 x 13	125	46	6	\$2009
	GC36403RM-HP With power					\$3192
<ul style="list-style-type: none"> For a thermally fused laminate top (LP), specify model GC36403R-LP. For a high pressure laminate top (HP), specify model GC36403R-HP. Models GC36403RM-LP and GC36403RM-HP have power/USB module mounted in surface. <p>Coordinating 2mm edge. Must be connected to full arm and leg with metal lounge frames (GC36406TLA/TRA, GC36406TLCA/TRCA). This table allows for kneespace when specifying chairs in a corner position. 1 per carton.</p> <ul style="list-style-type: none"> Includes 2 rear metal legs (not shown). 						
 Left End Table, Wood Legs	GC36404WL-LP	28 x 20.25 x 13	125	23	3.5	\$1416
	GC36404WLM-LP With power					\$2600
 Left End Table, Wood Legs	GC36404WL-HP	28 x 20.25 x 13	125	23	3.5	\$1471
	GC36404WLM-HP With power					\$2654
<ul style="list-style-type: none"> For a thermally fused laminate top (LP), specify model GC36404WL-LP. For a high pressure laminate top (HP), specify model GC36404WL-HP. Models GC36404WLM-LP and GC36404WLM-HP have power/USB module mounted in surface. <p>Coordinating 2mm edge. Must be connected to full arm and leg with wood lounge frames (GC36406WTLA or GC36406WTLCA). 1 per carton.</p>						
 Left End Table, Metal Legs	GC36404L-LP	28 x 20.25 x 13	125	23	3.5	\$1511
	GC36404LM-LP With power					\$2692
 Left End Table, Metal Legs	GC36404L-HP	28 x 20.25 x 13	125	23	3.5	\$1563
	GC36404LM-HP With power					\$2745
<ul style="list-style-type: none"> For a thermally fused laminate top (LP), specify model GC36404L-LP. For a high pressure laminate top (HP), specify model GC36404L-HP. Models GC36404LM-LP and GC36404LM-HP have power/USB module mounted in surface. <p>Coordinating 2mm edge. Must be connected to full arm and leg with metal lounge frames (GC36406TLA or GC36406TLCA). 1 per carton.</p>						

MODULAR TABLES

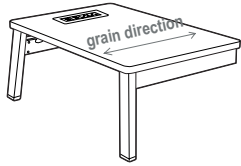
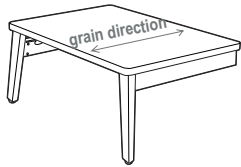

Right End Table, Wood Legs

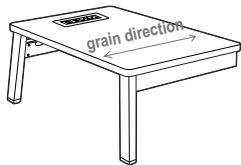
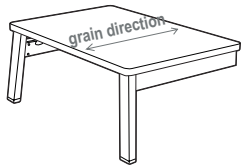

Right End Table, Metal Legs

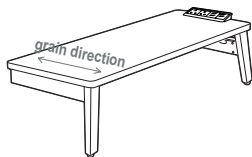
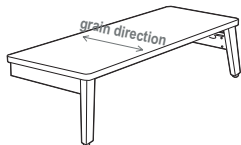

Narrow Left End Table, Wood Legs

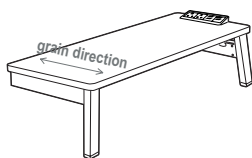
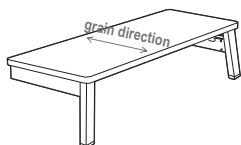

Narrow Left End Table, Metal Legs

MODEL# DIMENSIONS FREIGHT CLASS WT/LBS. CUBIC FT. LIST PRICE

D x W x H

GC36404WR-LP	28 x 20.25 x 13	125	23	3.5	\$1416
GC36404WRM-LP					\$2600
With power					

GC36404WR-HP	28 x 20.25 x 13	125	23	3.5	\$1471
GC36404WRM-HP					\$2654
With power					

- For a thermally fused laminate top (LP), specify model GC36404WR-LP.
- For a high pressure laminate top (HP), specify model GC36404WR-HP.

- Models GC36404WRM-LP and GC36404WRM-HP have **power/USB** module mounted in surface.

Coordinating 2mm edge. Must be connected to full arm and leg with **wood lounge** frames (GC36406WTRA or GC36406WTRCA). 1 per carton.

GC36404R-LP	28 x 20.25 x 13	125	23	3.5	\$1511
GC36404RM-LP					\$2692
With power					

GC36404R-HP	28 x 20.25 x 13	125	23	3.5	\$1563
GC36404RM-HP					\$2745
With power					

- For a thermally fused laminate top (LP), specify model GC36404R-LP.
- For a high pressure laminate top (HP), specify model GC36404R-HP.

- Models GC36404RM-LP and GC36404RM-HP have **power/USB** module mounted in surface.

Coordinating 2mm edge. Must be connected to full arm and leg with **metal lounge** frames (GC36406TRA or GC36406TRCA). 1 per carton.

GC36405WL-LP	28 x 12 x 13	100	20	2.1	\$1358
GC36405WLM-LP					\$2538
With power					

GC36405WL-HP	28 x 12 x 13	100	20	2.1	\$1404
GC36405WLM-HP					\$2585
With power					

- For a thermally fused laminate top (LP), specify model GC36405WL-LP.
- For a high pressure laminate top (HP), specify model GC36405WL-HP.

- Models GC36405WLM-LP and GC36405WLM-HP have **power/USB** module mounted on surface.

Coordinating 2mm edge. Must be connected to full arm and leg with **wood lounge** frames (GC36406WTLA or GC36406WTLCA). 1 per carton.

GC36405L-LP	28 x 12 x 13	100	20	2.1	\$1449
GC36405LM-LP					\$2632
With power					

GC36405L-HP	28 x 12 x 13	100	20	2.1	\$1497
GC36405LM-HP					\$2680
With power					

- For a thermally fused laminate top (LP), specify model GC36405L-LP.
- For a high pressure laminate top (HP), specify model GC36405L-HP.

- Models GC36405LM-LP and GC36405LM-HP have **power/USB** module mounted on surface.

Coordinating 2mm edge. Must be connected to full arm and leg with **metal lounge** frames (GC36406TLA or GC36406TLCA). 1 per carton.

MODULAR TABLES

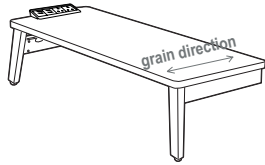
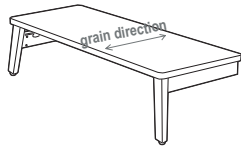

Narrow Right End Table, Wood Legs

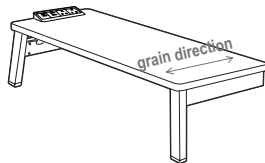
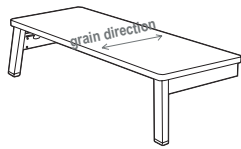

Narrow Right End Table, Metal Legs

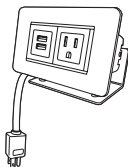

On Surface Power/Data Module

MODEL# DIMENSIONS FREIGHT CLASS WT/LBS. CUBIC FT. LIST PRICE

D x W x H

GC36405WR-LP	28 x 12 x 13	100	20	2.1	\$1358
GC36405WRM-LP					\$2538
With power					

GC36405WR-HP	28 x 12 x 13	100	20	2.1	\$1404
GC36405WRM-HP					\$2585
With power					

- For a thermally fused laminate top (LP), specify model GC36405WR-LP.
- For a high pressure laminate top (HP), specify model GC36405WR-HP.

- Models GC36405WRM-LP and GC36405WRM-HP have **power/USB** module mounted on surface.

Coordinating 2mm edge. Must be connected to full arm and leg with **wood lounge** frames (GC36406WTRA or GC36406WTRCA). 1 per carton.

GC36405R-LP	28 x 12 x 13	100	20	2.1	\$1449
GC36405RM-LP					\$2632
With power					

GC36405R-HP	28 x 12 x 13	100	20	2.1	\$1497
GC36405RM-HP					\$2680
With power					

- For a thermally fused laminate top (LP), specify model GC36405R-LP.
- For a high pressure laminate top (HP), specify model GC36405R-HP.

- Models GC36405RM-LP and GC36405RM-HP have **power/USB** module mounted on surface.

Coordinating 2mm edge. Must be connected to full arm and leg with **metal lounge** frames (GC36406TRA or GC36406TRCA). 1 per carton.

GC36410	-- x -- x --	250	2	1	\$735
---------	--------------	-----	---	---	--------------

Surface top mount power/data module with one power outlet, two USB charging ports. 6 foot cord. White. Can be mounted to all freestanding and modular tables.



Meet River+™, the next generation of our highly popular River lounge series. Now with industry-leading support for workplace, education and healthcare, River+ performs at three times the BIFMA standard for true 24/7 applications in demanding environments. All models have been active weight tested to 600 lbs. including bariatric use. Multiple back and seat heights, 120-degree configurations and modular Aluminum arms are just a few of the many options that will make it yours.

To see the full River+ series, please refer to the Seating price list at: globalfurnituregroup.com/workplace/resources/price-lists

Features and Benefits

- A modular series that is composed of straight, curved and corner lounge sections, a wide assortment of benches and tables, and media hearths.
- Lounge and linking tables can be linked together in any combination to create a wide variety of layouts. Ganging hardware is standard and is factory installed. Ganging hardware swivels out of the way when not in use.
- Seating frames are constructed of heavy duty plywood, and are made for active environments. Seats are high density with highly resilient foam.
- River+ seating is rated for an active weight up to 600 lbs. per seat and 24/7 use.
- For 24/7 use and/or heavy duty application use, Global's Heavy Duty warranty is only on models specified with performance textiles, rated for 150,000 double rubs or more.
- A clean-out gap is created by seat-to-back connector brackets available in three finishes.
- The tapered legs are made of welded steel. The standard leg height is 6.5" with optional 3" and 8" legs available on select models. The leg height makes it easy to clean under the product.
- Modular, polished Aluminum loop arms can be relocated and retrofit to support changing layouts.
- A back shelf is available on most units in many laminate finishes.
- For improved safety, housekeeping and infection control, optional features include: sealed seams, sealed seat underside, and tamperproof bottom enclosures.
- For easy user access, optional power units are available for specification in a variety of locations across most River+ lounges, benches, and tables.
- For environmental certifications, please visit globalfurnituregroup.com.

SENATOR

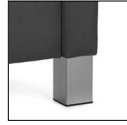

model GC3392

STANDARD FEATURES

- The flared back design and creative curves enhance any healthcare environment without sacrificing comfort.
- Waterfall seamless front upholstered design with removable seat cushions for easy cleaning and protecting against bacteria.
- For added comfort, seats are standard with high density foam.
- Standard with wood legs.
- For healthcare textiles and wood finish options, visit the website at globalfurnituregroup.com.
- Can be upholstered in standard Global textiles if healthcare compliance is not required.
- Shipped fully assembled.

OPTIONAL FEATURES

- Optional metal legs are available in Black (TBL), Kalua (TKA), Latte (TLA), Mocha (TMO), Shadow (TSH), Toast (TOA) and Tungsten (TTU). Please specify. No upcharge.
- For non-slip glides, specify (NS) - Add \$35.
- For moisture barrier on seat, please specify (MB). Add \$193 per seat.

SUGGESTED APPLICATIONS

- Lobbies
- Lounge/Waiting
- Patient rooms
- Resident rooms

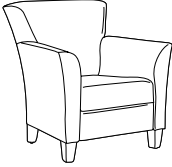
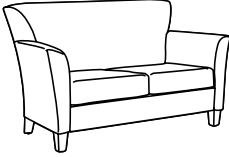
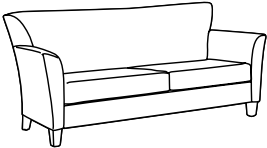
DESCRIPTION	MODEL# / FEATURES	STANDARD TEXTILE GRADES											
		COM	2	3	4	5	6	7	8	9	10	11	12
 Armchair COM Yardage: 5.25 Freight Class: 250 Product Weight (lbs.): 66 Cubic Feet Per Carton: 28.5	GC3391	\$2716	\$2873	\$3155	\$3368	\$3674	\$3787	\$4054	\$4551	\$4802	\$5266	\$5912	\$6704
	Active weight 300lbs.	OVERALL DIMENSIONS			SEAT DIMENSIONS			BACK DIMENSIONS					
		W	D	H	W	D	H	W	H				
		34	32.25	36	19.5	19	17.5	28	18.5				
 Two Seat Sofa COM Yardage: 8.25 Freight Class: 300 Product Weight (lbs.): 100 Cubic Feet Per Carton: 55.75	GC3392	\$3820	\$4073	\$4495	\$4832	\$5309	\$5490	\$5908	\$6690	\$7082	\$7812	\$8827	\$10073
	Active weight 300lbs./seat.	OVERALL DIMENSIONS			SEAT DIMENSIONS			BACK DIMENSIONS					
		W	D	H	W	D	H	W	H				
		61	32.25	36	46	19	17.5	56	18.5				
 Three Seat Sofa COM Yardage: 9.5 Freight Class: 250 Product Weight (lbs.): 125 Cubic Feet Per Carton: 62.25	GC3393	\$4932	\$5218	\$5730	\$6120	\$6668	\$6875	\$7355	\$8259	\$8710	\$9551	\$10717	\$12156
	Active weight 300lbs./seat.	OVERALL DIMENSIONS			SEAT DIMENSIONS			BACK DIMENSIONS					
		W	D	H	W	D	H	W	H				
		76	32.25	36	61	19	17.5	71	18.5				

SLEEP-EEZ



model GC3614

STANDARD FEATURES

- Sleep-Eez provides incredible comfort, requires zero wall clearance and can be easily opened and closed by one person.
- It can be adjusted to create three functional positions: a chair, a chaise lounge and a sleep surface.
- The heavy duty steel mechanism will provide long-term performance.
- Commercial grade casters are standard. Front casters are non-swivel manual locking. Back casters are non-locking and swivel for better steering when moving the chair.
- Clean out space is provided between the seat and back cushions for housekeeping and infection prevention control.
- Sleep-Eez's construction allows for on-site replacement of all components, eliminating down time and enhancing the product's life.
- Standard with Black urethane fully extended arms with a grip for ease of entry and exit from chair.
- For healthcare textile options, visit the website at www.globalfurnituregroup.com.
- Can be upholstered in standard Global textiles if healthcare compliance is not required.
- Ships fully assembled.
- Measurements:
Chair: 34.5"W x 37"D x 34.25"H
Chaise lounge: 34.5"W x 64"D x 34.25"H
Sleep surface: 24"W x 77"D

OPTIONAL FEATURES

- For moisture barrier on seat, please specify **(MB)**. Add \$193.
- To add sealed seams to your product, please specify **(SS)**. Add \$343.

SUGGESTED APPLICATIONS

- Lobbies
- Lounge/Waiting
- Office/Meeting
- Patient rooms
- Resident rooms
- Treatment/Exam rooms

Please add option codes in the following order:

- **Model number**
GC3614 Single sleeper chair
- **Textile**
Specify fabric code.
- **Armcap finish**
(SS) Black Urethane armcap
(KL) Kalua Urethane armcap
(LT) Latte Urethane armcap
(MC) Mocha Urethane armcap
(SW) Shadow Urethane armcap
(TO) Toast Urethane armcap
(AB) Absolute wood armcap
(CJ) Charcoal Java wood armcap
(AC) Cherry wood armcap
(EP) Empire Mahogany wood armcap
(EM) English Oak wood armcap
(EC) Espresso Cafe wood armcap
(HG) Gray wood armcap
(HA) Harvest Oak wood armcap
(AH) Honey wood armcap
(JO) Jet Onyx wood armcap
(LH) Light Honey wood armcap
(AV) Maple wood armcap
(MW) Medium Walnut wood armcap
(NL) Natural Walnut wood armcap
(AT) Night wood armcap
(BI) Noce Biondo wood armcap
(GI) Noce Grigio wood armcap
(EI) Noce Leggero wood armcap
(MI) Noce Medio wood armcap
(SB) Sandy Beach wood armcap
(SK) Shaker Cherry wood armcap
(SM) Silver Oak wood armcap
(TF) Tiger Fruitwood wood armcap
(TM) Tiger Mahogany wood armcap
(TL) Tiger Walnut wood armcap
(WR) WC Cream wood armcap
(WH) White wood armcap
(WC) Winter Cherry wood armcap
- **Moisture Barrier**
(MB) Seat only
- **Sealed Seams**
(SS) All sealed seams

EXAMPLE SLEEP-EEZ ORDER CODE:

GC3614	-LX21	-PT	-MB	-SS
Model #	Textile	Armcaps	Moisture Barrier	Sealed Seams

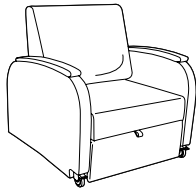
DESCRIPTION	MODEL#	STANDARD TEXTILE GRADES											
		COM	2	3	4	5	6	7	8	9	10	11	12
 <p>Single Sleeper Chair COM Yardage: 8.5 Freight Class: 150 Product weight (lbs.): 160 Cubic Feet per Carton: 38</p>	GC3614	\$4988	\$5281	\$5522	\$5875	\$6381	\$6616	\$7072	\$7798	\$8362	\$8986	\$10266	\$11634
	Active weight 350 lbs.												
		OVERALL DIMENSIONS			SEAT DIMENSIONS			BACK DIMENSIONS					
		W	D	H	W	D	H	W	H				
		35	37	35	27.5	21	17.5	27.5	18.5				

STRAND



model GC3707HB



model GC3702

FEATURES



- Strand is the perfect synthesis of versatility, comfort, durability and value pricing. Strand offers a pleasing look in a diverse range of solutions from single patient room chairs to waiting areas and public spaces.
- All models are standard in oval metal tube frame.
- Frame available in Black (**TBL**), Cloud (**TIV**), Designer White (**TDW**), Fog (**TFO**), Frost (**TFR**), Kalua (**TKA**), Latte (**TLA**), Mocha (**TMO**), Nevada (**TNE**), Sand (**TSN**), Shadow (**TSH**), Toast (**TOA**) and Tungsten (**TTU**).
- The frame can be weighted and made with tamper proof fasteners for greater security in more challenging mental health spaces or correctional facilities.
- Armcaps are standard in Black urethane.
- **Left and Right Position Reference** is determined based on being seated in the chair.
- The seat and back are removable and field replaceable.
- For added comfort, seats are standard with high density foam.
- All seat frames feature a wall saver design to prevent back contact with wall. Footstool and benches do not have wall saver legs.
- Standard seat height on all models is 18".
- Cleanout space is provided between the seat and back cushions for easy housekeeping.
- Standard with Black plastic glides.
- Select models are offered with rear tip and move wheels. To activate wheels, tilt the chair back so the casters are in contact with the floor. This feature makes it easy to relocate the chair while unoccupied.
- Flex back models allow the back to move in a soothing rocking motion.
- Active weight capacity for standard single seat is 350 lbs. and 750 lbs for bariatric seating.
- For healthcare textiles and finish options, visit the website at www.globalfurnituregroup.com
- Can be upholstered in standard Global textiles if healthcare compliance is not required.

OPTIONAL FEATURES

- Wood armcaps are also available in all healthcare wood seating finishes.
Single Seat - Add \$179
Two Seater - Add \$264.
Three Seater - Add \$353.
- Non-marking White glides are available. Please specify (**WH**). No upcharge.
- For moisture barrier on seat, add **\$129** per seat. For bariatric models - Add **\$198** per seat.
- As an option, seams can be sealed to prevent penetration of fluids through the stitching. Contact Customer Care for approved textiles.
For Low Back Models - Add \$75 per seat.
For Low Back Bariatric Models - Add \$80 per seat.
For High Back Models - Add \$87 per seat.
For High Back Bariatric Models - Add \$90 per seat.
For Split-Back models - Add \$131
For Ottoman - Add \$23
For Single Seat Bench - Add \$30
For Two Seat Bench - Add \$59
For Three Seat Bench - Add \$87
- For complementary tables, please refer to the GC-Belong **freestanding** tables, page 41 (*Not for use with GC-Belong table bridges.*)

SUGGESTED APPLICATIONS

- Bariatric seating (some models)
- Guest seating
- Lobbies
- Lounge/Waiting
- Patient rooms
- Resident rooms
- Treatment/Exam rooms

DESCRIPTION	MODEL#	STANDARD FABRIC GRADES											
		COM	2	3	4	5	6	7	8	9	10	11	12
 Low Back Single Seat Armless Chair COM Yardage: 1.75 Freight Class: 250 Product Weight (lbs.): 43 Cubic Feet Per Carton: 17.5	GC3700	\$1256	\$1314	\$1366	\$1439	\$1541	\$1581	\$1672	\$1844	\$1927	\$2086	\$2304	\$2574
		OVERALL DIMENSIONS			SEAT DIMENSIONS			BACK DIMENSIONS					
		W	D	H	W	D	H	W	H				
		24.5	27.5	34.5	22	18.5	18	21.5	17				
 LB Single Seat Armchair COM Yardage: 1.75 Freight Class: 250 Product Weight (lbs.): 48 Cubic Feet Per Carton: 17.5	GC3701	\$1498	\$1558	\$1610	\$1683	\$1785	\$1824	\$1916	\$2088	\$2171	\$2330	\$2548	\$2818
		OVERALL DIMENSIONS			SEAT DIMENSIONS			BACK DIMENSIONS					
		W	D	H	W	D	H	W	H				
		25.5	27.5	34.5	22	18.5	18	21.5	17				

Active weight 350 lbs.

Active weight 350 lbs.
Wood armcap option - Add \$179

DESCRIPTION	MODEL#	STANDARD FABRIC GRADES											
		COM	2	3	4	5	6	7	8	9	10	11	12
 <p>Designed to immobilize the pelvis and hip joints after surgery.</p> <p>LB Hip Armchair, Post Surgery COM Yardage: 1.75 Freight Class: 250 Product Weight (lbs.): 53 Cubic Feet Per Carton: 17.5</p>	GC3701-24	\$1836	\$1896	\$1948	\$2022	\$2123	\$2163	\$2254	\$2426	\$2511	\$2668	\$2887	\$3158
	24" seat height												
	OVERALL DIMENSIONS	SEAT DIMENSIONS			BACK DIMENSIONS								
	W D H	W	D	H	W	D	H	W	H				
	25.5	27.5	40.5	22	18.5	24	21.5	17					
 <p>HB Single Seat Armchair COM Yardage: 2 Freight Class: 250 Product Weight (lbs.): 53 Cubic Feet Per Carton: 20</p>	GC3701HB	\$1727	\$1792	\$1853	\$1935	\$2054	\$2099	\$2201	\$2396	\$2492	\$2674	\$2924	\$3233
	Active weight 350 lbs. Wood armcap option - Add \$179												
	OVERALL DIMENSIONS	SEAT DIMENSIONS			BACK DIMENSIONS								
	W D H	W	D	H	W	D	H	W	H				
	25.5	27.5	42.5	22	18	18	21.5	25					
 <p>LB Two Seat Chair, No Center Arm COM Yardage: 3.25 Freight Class: 300 Product Weight (lbs.): 68 Cubic Feet Per Carton: 43</p>	GC3702	\$2363	\$2473	\$2567	\$2705	\$2895	\$2967	\$3136	\$3449	\$3607	\$3901	\$4311	\$4814
	Active weight 350 lbs./seat Wood armcap option - Add \$179												
	OVERALL DIMENSIONS	SEAT DIMENSIONS			BACK DIMENSIONS								
	W D H	W	D	H	W	D	H	W	H				
	49.75	27.5	34.5	44	18.5	18	43	17					
 <p>HB Two Seat Chair, No Center Arm COM Yardage: 3.75 Freight Class: 300 Product Weight (lbs.): 75 Cubic Feet Per Carton: 56.5</p>	GC3702HB	\$2722	\$2846	\$2956	\$3111	\$3332	\$3417	\$3611	\$3976	\$4158	\$4496	\$4964	\$5548
	Active weight 350 lbs./seat Wood armcap option - Add \$179												
	OVERALL DIMENSIONS	SEAT DIMENSIONS			BACK DIMENSIONS								
	W D H	W	D	H	W	D	H	W	H				
	49.75	27.5	42.5	44	18.5	18	43	25					
 <p>LB Three Seat Chair, No Center Arms COM Yardage: 4.5 Freight Class: 300 Product Weight (lbs.): 90 Cubic Feet Per Carton: 65.25</p>	GC3703	\$3303	\$3454	\$3583	\$3770	\$4037	\$4137	\$4368	\$4804	\$5025	\$5430	\$5996	\$6692
	Active weight 350 lbs./seat Wood armcap option - Add \$179												
	OVERALL DIMENSIONS	SEAT DIMENSIONS			BACK DIMENSIONS								
	W D H	W	D	H	W	D	H	W	H				
	71.25	27.5	34.5	66	18.5	18	64.5	17					

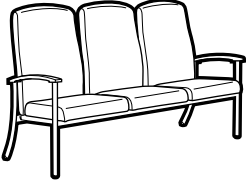
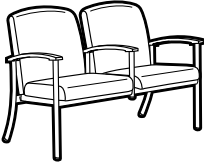
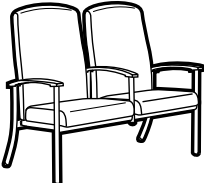
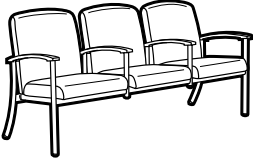
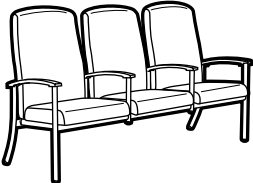
DESCRIPTION	MODEL#	STANDARD FABRIC GRADES											
		COM	2	3	4	5	6	7	8	9	10	11	12
 <p>HB Three Seat Chair, No Center Arms COM Yardage: 5.25 Freight Class: 300 Product Weight (lbs.): 96 Cubic Feet Per Carton: 80.75</p>	GC3703HB	\$3702	\$3879	\$4031	\$4250	\$4559	\$4678	\$4948	\$5456	\$5714	\$6185	\$6844	\$7656
		OVERALL DIMENSIONS			SEAT DIMENSIONS			BACK DIMENSIONS					
		W	D	H	W	D	H	W	H				
			71.25	27.5	42.5	66	18.5	18	64.5	25			
 <p>LB Two Seat Chair, Half Center Arm COM Yardage: 3.25 Freight Class: 300 Product Weight (lbs.): 73 Cubic Feet Per Carton: 43</p>	GC3704	\$2613	\$2723	\$2816	\$2955	\$3145	\$3217	\$3386	\$3701	\$3857	\$4151	\$4561	\$5064
		OVERALL DIMENSIONS			SEAT DIMENSIONS			BACK DIMENSIONS					
		W	D	H	W	D	H	W	H				
			49.75	27.5	34.5	22	18.5	18	21.5	17			
 <p>HB Two Seat Chair, Half Center Arm COM Yardage: 3.75 Freight Class: 300 Product Weight (lbs.): 79 Cubic Feet Per Carton: 56.5</p>	GC3704HB	\$2975	\$3099	\$3209	\$3364	\$3585	\$3670	\$3864	\$4229	\$4411	\$4749	\$5217	\$5801
		OVERALL DIMENSIONS			SEAT DIMENSIONS			BACK DIMENSIONS					
		W	D	H	W	D	H	W	H				
			49.75	27.5	42.5	44	18.5	18	43	25			
 <p>LB Three Seat Chair, Half Center Arms COM Yardage: 4.5 Freight Class: 300 Product Weight (lbs.): 100 Cubic Feet Per Carton: 65.25</p>	GC3705	\$3801	\$3954	\$4083	\$4270	\$4537	\$4637	\$4867	\$5304	\$5525	\$5930	\$6496	\$7192
		OVERALL DIMENSIONS			SEAT DIMENSIONS			BACK DIMENSIONS					
		W	D	H	W	D	H	W	H				
			71.25	27.5	34.5	22	18.5	18	21.5	17			
 <p>HB Three Seat Chair, Half Center Arms COM Yardage: 5.25 Freight Class: 300 Product Weight (lbs.): 100 Cubic Feet Per Carton: 80.75</p>	GC3705HB	\$4201	\$4380	\$4532	\$4749	\$5058	\$5179	\$5449	\$5957	\$6211	\$6686	\$7345	\$8155
		OVERALL DIMENSIONS			SEAT DIMENSIONS			BACK DIMENSIONS					
		W	D	H	W	D	H	W	H				
			71.25	27.5	42.5	66	18.5	18	64.5	25			

DESCRIPTION	MODEL#	STANDARD FABRIC GRADES											
		COM	2	3	4	5	6	7	8	9	10	11	12
 <p>LB Armchair, Rear Tip & Move Wheels COM Yardage: 1.75 Freight Class: 250 Product Weight (lbs.): 48 Cubic Feet Per Carton: 17.5</p>	GC3707	\$1653	\$1711	\$1763	\$1836	\$1938	\$1978	\$2069	\$2241	\$2325	\$2483	\$2702	\$2971
		OVERALL DIMENSIONS W D H			SEAT DIMENSIONS W D H			BACK DIMENSIONS W H					
		25.5	27.5	34.5	22	18.5	18	21.5	17				

Active weight 350 lbs.
 Wood armcap option - **Add \$179**

DESCRIPTION	MODEL#	STANDARD FABRIC GRADES											
		COM	2	3	4	5	6	7	8	9	10	11	12
 <p>HB Armchair, Rear Tip & Move Wheels COM Yardage: 2 Freight Class: 250 Product Weight (lbs.): 50 Cubic Feet Per Carton: 20</p>	GC3707HB	\$1881	\$1944	\$2007	\$2089	\$2207	\$2252	\$2356	\$2549	\$2648	\$2827	\$3077	\$3387
		OVERALL DIMENSIONS W D H			SEAT DIMENSIONS W D H			BACK DIMENSIONS W H					
		25.5	27.5	42.5	22	18	18	21	25				

Active weight 350 lbs.
 Wood armcap option - **Add \$179**

DESCRIPTION	MODEL#	STANDARD FABRIC GRADES											
		COM	2	3	4	5	6	7	8	9	10	11	12
 <p>Bariatric LB Armchair COM Yardage: 2.75 Freight Class: 250 Product Weight (lbs.): 60 Cubic Feet Per Carton: 26.5</p>	GC3711	\$1891	\$1983	\$2063	\$2179	\$2341	\$2400	\$2544	\$2812	\$2945	\$3192	\$3539	\$3962
		OVERALL DIMENSIONS W D H			SEAT DIMENSIONS W D H			BACK DIMENSIONS W H					
		36	27.5	34.5	32.5	18	18	31	17				



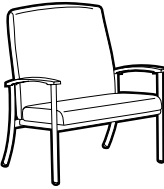

Active weight 750 lbs.
 Wood armcap option - **Add \$179**
Armless Bariatric models are not available.

DESCRIPTION	MODEL#	STANDARD FABRIC GRADES											
		COM	2	3	4	5	6	7	8	9	10	11	12
 <p>Bariatric LB Hip Armchair, Post Surgery COM Yardage: 2.75 Freight Class: 250 Product Weight (lbs.): 63 Cubic Feet Per Carton: 30.5</p> <p>Designed to immobilize the pelvis and hip joints after surgery.</p>	GC3711-24	\$2203	\$2295	\$2375	\$2492	\$2652	\$2712	\$2856	\$3124	\$3257	\$3504	\$3851	\$4274
		OVERALL DIMENSIONS W D H			SEAT DIMENSIONS W D H			BACK DIMENSIONS W H					
		36	27.5	40.5	32.5	18	24	31	17				

Active weight 750 lbs.
 Wood armcap option - **Add \$179**
Armless Bariatric models are not available.

DESCRIPTION	MODEL#	STANDARD FABRIC GRADES											
		COM	2	3	4	5	6	7	8	9	10	11	12
 <p>Bariatric HB Armchair COM Yardage: 3.25 Freight Class: 250 Product Weight (lbs.): 66 Cubic Feet Per Carton: 30.5</p>	GC3711HB	\$2095	\$2207	\$2300	\$2435	\$2629	\$2700	\$2870	\$3183	\$3340	\$3635	\$4043	\$4545
		OVERALL DIMENSIONS W D H			SEAT DIMENSIONS W D H			BACK DIMENSIONS W H					
		36	27.5	42.5	32.5	18	18	31	25				

Active weight 750 lbs.
 Wood armcap option - **Add \$179**
Armless Bariatric models are not available.

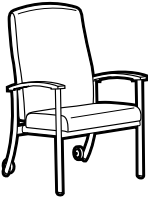
DESCRIPTION	MODEL#	STANDARD FABRIC GRADES											
		COM	2	3	4	5	6	7	8	9	10	11	12
 <p>Bariatric LB Armchair, Rear Tip & Move Wheels COM Yardage: 2.75 Freight Class: 250 Product Weight (lbs.): 60 Cubic Feet Per Carton: 26.5</p>	GC3712	\$2048	\$2139	\$2222	\$2336	\$2497	\$2557	\$2700	\$2969	\$3101	\$3349	\$3696	\$4118
	OVERALL DIMENSIONS			SEAT DIMENSIONS			BACK DIMENSIONS						
	W	D	H	W	D	H	W	H					
	36	27.5	34.5	32.5	18	18	31	17					
		Active weight 750 lbs. Wood armcap option - Add \$179 <i>Armless Bariatric models are <u>not</u> available.</i>											
 <p>Bariatric HB Armchair, Rear Tip & Move Wheels COM Yardage: 3.25 Freight Class: 250 Product Weight (lbs.): 66 Cubic Feet Per Carton: 30.5</p>	GC3712HB	\$2248	\$2358	\$2451	\$2586	\$2780	\$2852	\$3021	\$3334	\$3492	\$3786	\$4196	\$4699
	OVERALL DIMENSIONS			SEAT DIMENSIONS			BACK DIMENSIONS						
	W	D	H	W	D	H	W	H					
	36	27.5	42.5	31	18	18	30	25					
		Active weight 750 lbs. Wood armcap option - Add \$179 <i>Armless Bariatric models are <u>not</u> available.</i>											
 <p>LB Armchair, Flex Back COM Yardage: 1.75 Freight Class: 250 Product Weight (lbs.): 49 Cubic Feet Per Carton: 17.5</p>	GC3715	\$1782	\$1839	\$1893	\$1965	\$2067	\$2106	\$2199	\$2370	\$2453	\$2612	\$2830	\$3101
	OVERALL DIMENSIONS			SEAT DIMENSIONS			BACK DIMENSIONS						
	W	D	H	W	D	H	W	H					
	25.5	27.5	34.5	22	18	18	21	17					
		Active weight 350 lbs. Wood armcap option - Add \$179											
 <p>HB Armchair, Flex Back COM Yardage: 2 Freight Class: 250 Product Weight (lbs.): 50 Cubic Feet Per Carton: 20</p>	GC3715HB	\$2012	\$2076	\$2139	\$2221	\$2338	\$2384	\$2488	\$2680	\$2777	\$2958	\$3209	\$3519
	OVERALL DIMENSIONS			SEAT DIMENSIONS			BACK DIMENSIONS						
	W	D	H	W	D	H	W	H					
	25.5	27.5	42.5	22	18	18	21	25					
		Active weight 350 lbs. Wood armcap option - Add \$179											
 <p>HB Armchair, Flex Back, Rear Tip & Move Wheels COM Yardage: 2 Freight Class: 250 Product Weight (lbs.): 50 Cubic Feet Per Carton: 20</p>	GC3716HB	\$2164	\$2227	\$2290	\$2372	\$2490	\$2535	\$2639	\$2832	\$2928	\$3110	\$3360	\$3670
	OVERALL DIMENSIONS			SEAT DIMENSIONS			BACK DIMENSIONS						
	W	D	H	W	D	H	W	H					
	25.5	27.5	42.5	22	18	18	21	25					
		Active weight 350 lbs. Wood armcap option - Add \$179											

DESCRIPTION MODEL# STANDARD FABRIC GRADES



HB Armchair, Split Back
 COM Yardage: 2
 Freight Class: 250
 Product Weight (lbs.): 53
 Cubic Feet Per Carton: 20

MODEL#	COM	2	3	4	5	6	7	8	9	10	11	12
GC3717HB	\$2024	\$2089	\$2150	\$2232	\$2351	\$2396	\$2497	\$2693	\$2790	\$2971	\$3221	\$3530

Fold away headrest.
 Active weight 350 lbs.
 Wood armcap option - Add \$179

OVERALL DIMENSIONS			SEAT DIMENSIONS			BACK DIMENSIONS	
W	D	H	W	D	H	W	H
25.5	27.5	42.5	22	18	18	21.5	25

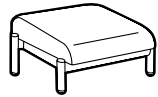

Footstool, Angled Top
 COM Yardage: 1
 Freight Class: 150
 Product Weight (lbs.): 16
 Cubic Feet Per Carton: 3.5

Stores beneath any standard seating unit.
 Active weight 350 lbs.

MODEL#	COM	2	3	4	5	6	7	8	9	10	11	12
GC3708	\$951	\$983	\$1014	\$1056	\$1113	\$1139	\$1189	\$1287	\$1336	\$1425	\$1549	\$1705

OVERALL DIMENSIONS			SEAT DIMENSIONS			BACK DIMENSIONS	
W	D	H	W	D	H	W	H
16.5	18.5	10.5					

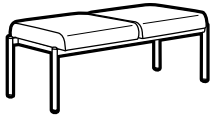

Two Seat Bench
 COM Yardage: 1.75
 Freight Class: 250
 Product Weight (lbs.): 48
 Cubic Feet Per Carton: 23

Active weight 350 lbs./seat

MODEL#	COM	2	3	4	5	6	7	8	9	10	11	12
GC3722	\$1593	\$1651	\$1705	\$1777	\$1879	\$1918	\$2009	\$2181	\$2265	\$2423	\$2642	\$2913

OVERALL DIMENSIONS			SEAT DIMENSIONS			BACK DIMENSIONS	
W	D	H	W	D	H	W	H
47.5	23.5	18					

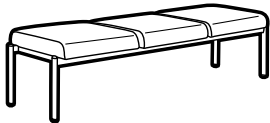

Three Seat Bench
 COM Yardage: 2
 Freight Class: 250
 Product Weight (lbs.): 68
 Cubic Feet Per Carton: 33.25

Active weight 350 lbs./seat

MODEL#	COM	2	3	4	5	6	7	8	9	10	11	12
GC3723	\$2076	\$2141	\$2201	\$2284	\$2401	\$2446	\$2550	\$2744	\$2841	\$3022	\$3272	\$3581

OVERALL DIMENSIONS			SEAT DIMENSIONS			BACK DIMENSIONS	
W	D	H	W	D	H	W	H
70	23.5	18					

WILLOW



model W5AUUG
Armchair, Upholstered Seat & Back



Wipeable shroud edge does not collect debris



No visible brackets or upholstery staples

Arm Options



Waterfall Arm (WFA)



Forward Grip Assist (GAA)

	Willow Chair Stacking Capability	
	Stacks on floor	Stacks on dolly
Four leg arm and armless chairs with glides only		
Poly/poly chairs	up to 6 high	up to 10 high
Upholstered chairs	up to 4 high	up to 8 high
Bariatric Models	up to 4 high	up to 8 high
Four leg bar and counter stools		
Stools with arms	Does not stack	N/A
Armless stools	up to 4 high	N/A

Plastic Component Finish Matching Chart		
Chair Types	Seat Shroud	Arms and Back Shroud
Poly back and seat	Matches seat/back	Matches seat/back
Upholstered back and seat	Specify	Specify
Poly back/upholstered seat	Specify	Specify
Upholstered back/poly seat	Matches seat	Specify



For linking tables, see page 233.

EXAMPLE WILLOW ORDER CODE:

W5AUU	PU75	NS	PU75	WFA	BLK
Model #	Back Textile	Seat	Seat Textile	Arm Style	Seat Shroud Finish

CHM	ST	BLK	NS	NB
Frame Finish	Glides Type	Glides Finish	Back seams	Moisture Barrier

STANDARD FEATURES

- The durable design and open, welcoming form will ensure years of use. Freestanding chairs are available with four legs or sled bases, in seated standard or bariatric widths. Additional models include hip, counter and bar height stools. Freestanding and corner, in-line and end tables are also available to complement the line.
- Seated height chairs may be ganged with ganging brackets or with in-line and corner tables.
- Plastic seats and backs, reinforced nylon arms, back shrouds and seat shrouds are available in a wide range of colors. See finish chart for matching color components.
- Tubular steel frame is available in 20 paint finishes and 4 metallic finishes (upcharge applies).
- Frame design features a wall saver leg to prevent contact with walls.
- Active weight capacity is 300 lbs. for four leg seating with casters, 400 lbs. for seating on glides and 600 lbs. for 30" wide bariatric and parent/child models.
- Plastic seat shrouds are standard on all models.
- Upholstered seats have no seams for ease of cleaning.
- Four leg chairs with glides are stackable, see matrix. Stacking of caster models is not recommended due to damage to plastic and upholstery. See chart for details.
- Armless counter and bar height stools are stackable on the floor only. See chart for details.
- Chairs and stools are available with a variety of glide types. Glides must be chosen to best suit flooring type and site conditions.
- Additional weight is available on sled base chair models only. Contact customer care for pricing.
- For healthcare textiles, visit the website at globalfurnituregroup.com.
- Check textile availability prior to specifying upholstery material.
- The series is available to specify with two textiles on upholstered seat and back models. For pricing, start with the base price and add applicable graded textile upcharges for the back and the seat.
- The blended textile matrix does not apply to this series.
- The series is designed for use across a range of facilities and is covered under Global's limited lifetime warranty for single-shift use. Specify from approved textiles.
- Shipped fully assembled.





OPTIONAL FEATURES





- Power/USB units are available, ordered separately, for use with in-line, corner and end tables. See model for details.
- Tables are pre-drilled for field installation of undermount power. Clamp mount units are available.
- Sled base models offer a floor mount (FM) option. See upcharges. Mounting hardware supplied by others.





Add option codes in the following order:

- Model number**
Enter model number.
- Back, Seat and Seat Shroud Finish** (plastic back and seat models)
Plastic finishes:

(BZB) Buzz Blue	(KAL) Kalua
(CCT) Cactus	(LAB) Latte
(CRO) Carrot	(J52) Mocha
(IVC) Cloud	(BLK) Night
(DJN) Dijon	(SND) Sand
(EGP) Eggplant	(SAR) Scarlet
(FOG) Fog	(SHW) Shadow
(FRO) Frost	(TOA) Toast
(INK) Ink	
- Back Finish** (plastic back and upholstered seat models)
See Plastic finishes.
- Back Textile** (for upholstered back models)
Specify back textile.
- Seat Textile** (for upholstered seat models)
Specify seat textile.
- Arm Style** (for chairs with arms)
(WFA) Waterfall arm
(GAA) Grip assist arm. Add \$33.
- Arm and Back Shroud Finish**
See Plastic finishes.
- Seat and Seat Shroud Finish** (for upholstered back and plastic seat models).
See Plastic finishes.
- Leg Type** (for sled base models)
(NF) No floor mount
(FM) Floor mounted. Add \$12.
- Frame finish**
Paint finishes:
Black **(TBL)**, Buzz Blue **(TBZ)**, Cactus **(TCC)**, Carrot **(TCR)**, Cloud **(TIV)**, Designer White **(TDW)**, Dijon **(TDJ)**, Eggplant **(TEG)**, Fog **(TFO)**, Frost **(TFR)**, Ink **(TIN)**, Kalua **(TKA)**, Latte **(TLA)**, Mocha **(TMO)**, Nevada **(TNE)**, Sand **(TSN)**, Scarlet **(TSR)**, Shadow **(TSH)**, Toast **(TOA)** and Tungsten **(TTU)**.
Metallic finishes:
(CHM) Chrome. Add \$67
(BCH) Brushed Chrome. Add \$217
(SBR) Satin Brass. Add \$317
(ACO) Antique Copper. Add \$317.
- Glides type** (four leg glides)
(ST) Nylon, colored glide for most surfaces
(NM) White, non-marking Nylon glide for most surfaces
(SG) Steel cushion glide for carpeted surfaces. Add \$34.
(FG) Felt glide for most hard floor surfaces. Add \$34.
(RG) Rubber, non-slip glide for most hard floor surfaces. Add \$34.
- Glides type** (sled bases)
(ST) Nylon, colored glide for most surfaces
(NM) White, non-marking Nylon glide for most surfaces
(XG) No glide for carpeted surfaces
- Glides Finish** (ST glides)
(BLK) Black
(SND) Sand
- Caster Type** (caster models)
(DC) 2" caster for carpeted surface
(RC) 2" caster for most hard floor surfaces. Add \$50.
- Back Seams**
(NS) No sealed back seams
(SBS) Sealed back seams
- Moisture Barrier** (on seat)
(NB) No moisture barrier.
(MB) Moisture barrier. Add \$101. For bariatric, add \$152.

DESCRIPTION	MODEL#	STANDARD FABRIC GRADES											
 <p>Armchair, Polypropylene Back and Seat COM Yardage: n/a Freight Class: 250 Product Weight (lbs.): 20.88 Cubic Feet Per Carton: 5.56</p>		List Price											
	W5APPG with glides	\$533											
	W5APPC with casters	\$670											
		OVERALL DIMENSIONS			SEAT DIMENSIONS			BACK DIMENSIONS					
	W	D	H	W	D	H	W	H					
	24.25	23.5	32	17.75	17.5	17	16	16					
	Active weight with casters 300 lbs.; does not stack. Active weight with glides 400 lbs.; stacks 6 high on floor. 2 per carton (pricing and specifications are for one seat unit)												
 <p>Armchair, Upholstered Back and Polypropylene Seat COM Yardage: 0.5 Freight Class: 250 Product Weight (lbs.): 21.88 Cubic Feet Per Carton: 5.56</p>		1/COM	2	3	4	5	6	7	8	9	10	11	12
	W5AUPG with glides	\$627	\$643	\$656	\$674	\$700	\$711	\$734	\$769	\$796	\$825	\$885	\$949
	W5AUPC with casters	\$739	\$755	\$768	\$786	\$812	\$823	\$846	\$881	\$908	\$937	\$997	\$1061
		OVERALL DIMENSIONS			SEAT DIMENSIONS			BACK DIMENSIONS					
	W	D	H	W	D	H	W	H					
	24.25	21.75	32.25	17.75	16.75	17	16.5	16					
	Active weight with casters 300 lbs.; does not stack. Active weight with glides 400 lbs.; stacks 4 high on floor. Add \$15 for (SBS) 2 per carton (pricing and specifications are for one seat unit)												
 <p>Armchair, Polypropylene Back and Upholstered Seat COM Yardage: 0.75 Freight Class: 250 Product Weight (lbs.): 21.38 Cubic Feet Per Carton: 5.56</p>		1/COM	2	3	4	5	6	7	8	9	10	11	12
	W5APUG with glides	\$627	\$643	\$656	\$674	\$700	\$711	\$734	\$769	\$796	\$825	\$885	\$949
	W5APUC with casters	\$739	\$755	\$768	\$786	\$812	\$823	\$846	\$881	\$908	\$937	\$997	\$1061
		OVERALL DIMENSIONS			SEAT DIMENSIONS			BACK DIMENSIONS					
	W	D	H	W	D	H	W	H					
	24.25	23.5	32	18.25	17.75	18.25	16	15.25					
	Active weight with casters 300 lbs.; does not stack. Active weight with glides 400 lbs.; stacks 4 high on floor. 2 per carton (pricing and specifications are for one seat unit)												
 <p>Armchair, Upholstered Back and Seat COM Yardage: Back: 0.5; Seat: 0.75 Freight Class: 250 Product Weight (lbs.): 21.88 Cubic Feet Per Carton: 5.56</p>		1/COM	2	3	4	5	6	7	8	9	10	11	12
	W5AUUG with glides	Base Price: \$659 Seat upcharge: +0 Back upcharge: +0	+\$24	+\$43	+\$71	+\$110	+\$126	+\$160	+\$213	+\$253	+\$297	+\$387	+\$483
	W5AUUC with casters	Base Price: \$802 Seat upcharge: +0 Back upcharge: +0	+\$16	+\$29	+\$47	+\$73	+\$84	+\$107	+\$142	+\$169	+\$198	+\$258	+\$322
		OVERALL DIMENSIONS			SEAT DIMENSIONS			BACK DIMENSIONS					
	W	D	H	W	D	H	W	H					
	24.25	22	32.25	18.25	17	18.25	16.5	15.25					
	Active weight with casters 300 lbs.; does not stack. Active weight with glides 400 lbs.; stacks 4 high on floor. Add \$15 for (SBS). 2 per carton (pricing and specifications are for one seat unit)												

DESCRIPTION	MODEL#	STANDARD FABRIC GRADES											
		List Price											
	W5NPPG with glides	\$486											
	W5NPPC with casters	\$621											
		OVERALL DIMENSIONS			SEAT DIMENSIONS			BACK DIMENSIONS					
		W	D	H	W	D	H	W	H				
		20.75	23.5	32	17.75	17.5	17	16	16				
Armless Chair, Polypropylene Back and Seat COM Yardage: n/a Freight Class: 250 Product Weight (lbs.): 18 Cubic Feet Per Carton: 4.63		Active weight with casters 300 lbs.; does not stack. Active weight with glides 400 lbs.; stacks 6 high on floor. 2 per carton (pricing and specifications are for one seat unit)											
		1/COM	2	3	4	5	6	7	8	9	10	11	12
	W5NUPG with glides	\$578	\$594	\$607	\$625	\$651	\$662	\$685	\$720	\$747	\$776	\$836	\$900
	W5NUPC with casters	\$689	\$705	\$718	\$736	\$762	\$773	\$796	\$831	\$858	\$887	\$947	\$1011
		OVERALL DIMENSIONS			SEAT DIMENSIONS			BACK DIMENSIONS					
		W	D	H	W	D	H	W	H				
		20.75	23.5	32.25	17.75	16.75	17	16.5	16				
Armless Chair, Upholstered Back and Polypropylene Seat COM Yardage: 0.5 Freight Class: 250 Product Weight (lbs.): 18.5 Cubic Feet Per Carton: 4.63		Active weight with casters 300 lbs.; does not stack. Active weight with glides 400 lbs.; stacks 4 high on floor. Add \$15 for (SBS) 2 per carton (pricing and specifications are for one seat unit)											
		1/COM	2	3	4	5	6	7	8	9	10	11	12
	W5NPUG with glides	\$578	\$602	\$621	\$649	\$688	\$704	\$738	\$791	\$831	\$875	\$965	\$1061
	W5NPUC with casters	\$689	\$713	\$732	\$760	\$799	\$815	\$849	\$902	\$942	\$986	\$1076	\$1172
		OVERALL DIMENSIONS			SEAT DIMENSIONS			BACK DIMENSIONS					
		W	D	H	W	D	H	W	H				
		20.75	23.5	32	18.25	17.75	18.25	16	15.25				
Armless Chair, Polypropylene Back and Upholstered Seat COM Yardage: 0.75 Freight Class: 250 Product Weight (lbs.): 18.5 Cubic Feet Per Carton: 4.63		Active weight with casters 300 lbs.; does not stack. Active weight with glides 400 lbs.; stacks 4 high on floor. 2 per carton (pricing and specifications are for one seat unit)											
		1/COM	2	3	4	5	6	7	8	9	10	11	12
	W5NUUG with glides	Base Price: \$612											
		Seat upcharge: +0	+\$24	+\$43	+\$71	+\$110	+\$126	+\$160	+\$213	+\$253	+\$297	+\$387	+\$483
		Back upcharge: +0	+\$16	+\$29	+\$47	+\$73	+\$84	+\$107	+\$142	+\$169	+\$198	+\$258	+\$322
	W5NUUC with casters	Base Price: \$752											
		Seat upcharge: +0	+\$24	+\$43	+\$71	+\$110	+\$126	+\$160	+\$213	+\$253	+\$297	+\$387	+\$483
		Back upcharge: +0	+\$16	+\$29	+\$47	+\$73	+\$84	+\$107	+\$142	+\$169	+\$198	+\$258	+\$322
		OVERALL DIMENSIONS			SEAT DIMENSIONS			BACK DIMENSIONS					
		W	D	H	W	D	H	W	H				
		20.75	23.5	32.25	18.25	17	18.25	16.5	15.25				
Armless Chair, Upholstered Back and Seat COM Yardage: Back: 0.5; Seat: 0.75 Freight Class: 150 Product Weight (lbs.): 19 Cubic Feet Per Carton: 4.63		Active weight with casters 300 lbs.; does not stack. Active weight with glides 400 lbs.; stacks 4 high on floor. Add \$15 for (SBS) 2 per carton (pricing and specifications are for one seat unit)											

DESCRIPTION	MODEL#	STANDARD FABRIC GRADES											
		1/COM	2	3	4	5	6	7	8	9	10	11	12
 <p>Bariatric Armchair, Upholstered Back and Seat COM Yardage: Back: 0.75; Seat: 1 Freight Class: 250 Product Weight (lbs.): 41 Cubic Feet Per Carton: 20.5</p>	W530AUU	Base Price:	\$1034										
	Seat upcharge:	+0	+\$32	+\$57	+\$94	+\$146	+\$168	+\$213	+\$284	+\$337	+\$395	+\$516	+\$643
	Back upcharge:	+0	+\$24	+\$43	+\$71	+\$110	+\$126	+\$160	+\$213	+\$253	+\$297	+\$387	+\$483
			OVERALL DIMENSIONS			SEAT DIMENSIONS			BACK DIMENSIONS				
			W	D	H	W	D	H	W	H			
			35.25	23.5	32.25	29	17	18.25	26.75	15.25			
Active weight 600 lbs. Stacks 4 high on floor. Caster model not available. Add \$23 for (SBS). One per carton (pricing and specifications are for one seat unit)													
 <p>Bariatric Armless Chair, Upholstered Back and Seat COM Yardage: Back: 0.75; Seat: 1 Freight Class: 250 Product Weight (lbs.): 37.5 Cubic Feet Per Carton: 16.75</p>	W530NUU	Base Price:	\$985										
	Seat upcharge:	+0	+\$32	+\$57	+\$94	+\$146	+\$168	+\$213	+\$284	+\$337	+\$395	+\$516	+\$643
	Back upcharge:	+0	+\$24	+\$43	+\$71	+\$110	+\$126	+\$160	+\$213	+\$253	+\$297	+\$387	+\$483
			OVERALL DIMENSIONS			SEAT DIMENSIONS			BACK DIMENSIONS				
			W	D	H	W	D	H	W	H			
			31.75	23.5	32.25	29	17	0	26.75	15.25			
Active weight 600 lbs. Stacks 4 high on floor. Caster model not available. Add \$23 for (SBS). One per carton (pricing and specifications are for one seat unit)													
 <p>Armchair, Sled Base, Polypropylene Back and Seat COM Yardage: n/a Freight Class: 250 Product Weight (lbs.): 29.5 Cubic Feet Per Carton: 13.25</p>	List Price												
	W6APP	\$684											
				OVERALL DIMENSIONS			SEAT DIMENSIONS			BACK DIMENSIONS			
			W	D	H	W	D	H	W	H			
			24.25	23.75	32	17.75	17.75	17.75	16	16			
Active weight 400 lbs. Does not stack.													
 <p>Armchair, Sled Base, Upholstered Back and Polypropylene Seat COM Yardage: 0.5 Freight Class: 250 Product Weight (lbs.): 30 Cubic Feet Per Carton: 13.25</p>		1/COM	2	3	4	5	6	7	8	9	10	11	12
	W6AUP	\$752	\$768	\$781	\$799	\$825	\$836	\$859	\$894	\$921	\$950	\$1010	\$1074
				OVERALL DIMENSIONS			SEAT DIMENSIONS			BACK DIMENSIONS			
			W	D	H	W	D	H	W	H			
			24.25	23.75	32.25	17.75	17.75	17.75	16.5	16			
Active weight 400 lbs. Does not stack. Add \$15 for (SBS).													
 <p>Armchair, Sled Base, Polypropylene Back and Upholstered Seat COM Yardage: 0.75 Freight Class: 250 Product Weight (lbs.): 30 Cubic Feet Per Carton: 13.25</p>		1/COM	2	3	4	5	6	7	8	9	10	11	12
	W6APU	\$752	\$776	\$795	\$823	\$862	\$878	\$912	\$965	\$1005	\$1049	\$1139	\$1235
				OVERALL DIMENSIONS			SEAT DIMENSIONS			BACK DIMENSIONS			
			W	D	H	W	D	H	W	H			
			24.25	23.75	32	18.25	17.75	18.25	16	15.25			
Active weight 400 lbs. Does not stack.													

DESCRIPTION	MODEL#	STANDARD FABRIC GRADES											
		1/COM	2	3	4	5	6	7	8	9	10	11	12
 <p>Armchair, Sled Base, Upholstered Back and Seat COM Yardage: Back: 0.5; Seat: 0.75 Freight Class: 250 Product Weight (lbs.): 30.5 Cubic Feet Per Carton: 13.25</p>	W6AUU Base Price: Seat upcharge: Back upcharge:	\$815											
		+0	+\$24	+\$43	+\$71	+\$110	+\$126	+\$160	+\$213	+\$253	+\$297	+\$387	+\$483
		+0	+\$32	+\$57	+\$94	+\$146	+\$168	+\$213	+\$284	+\$337	+\$395	+\$516	+\$643
		OVERALL DIMENSIONS			SEAT DIMENSIONS			BACK DIMENSIONS					
		W	D	H	W	D	H	W	H				
		24.25	23.75	32.25	18.25	16.5	18.25	16.5	15.25				
	Active weight 400 lbs. Does not stack. Add \$15 for (SBS).												

DESCRIPTION	MODEL#	List Price											
		1/COM	2	3	4	5	6	7	8	9	10	11	12
 <p>Armless Chair, Sled Base, Polypropylene Back and Seat COM Yardage: n/a Freight Class: 250 Product Weight (lbs.): 26.5 Cubic Feet Per Carton: 11.75</p>	W6NPP	\$634											
		OVERALL DIMENSIONS			SEAT DIMENSIONS			BACK DIMENSIONS					
		W	D	H	W	D	H	W	H				
		20.75	23.5	32	17.75	17.75	17.75	16	16				
	Active weight 400 lbs. Does not stack.												

DESCRIPTION	MODEL#	STANDARD FABRIC GRADES											
		1/COM	2	3	4	5	6	7	8	9	10	11	12
 <p>Armless Chair, Sled Base, Upholstered Back and Polypropylene Seat COM Yardage: n/a Freight Class: 250 Product Weight (lbs.): 27 Cubic Feet Per Carton: 11.75</p>	W6NUP	\$703	\$719	\$732	\$750	\$776	\$787	\$810	\$845	\$872	\$901	\$961	\$1025
		OVERALL DIMENSIONS			SEAT DIMENSIONS			BACK DIMENSIONS					
		W	D	H	W	D	H	W	H				
		20.75	23.5	32.25	17.75	17.75	17.75	16.5	16				
	Active weight 400 lbs. Does not stack. Add \$15 for (SBS)												

DESCRIPTION	MODEL#	List Price											
		1/COM	2	3	4	5	6	7	8	9	10	11	12
 <p>Armless Chair, Sled Base, Polypropylene Back and Upholstered Seat COM Yardage: 0.75 Freight Class: 250 Product Weight (lbs.): 27 Cubic Feet Per Carton: 11.75</p>	W6NPU	\$703	\$727	\$746	\$774	\$813	\$829	\$863	\$916	\$956	\$1000	\$1090	\$1186
		OVERALL DIMENSIONS			SEAT DIMENSIONS			BACK DIMENSIONS					
		W	D	H	W	D	H	W	H				
		20.75	23.5	32	18.25	17.75	18.25	16	15.25				
	Active weight 400 lbs. Does not stack.												

DESCRIPTION	MODEL#	STANDARD FABRIC GRADES											
		1/COM	2	3	4	5	6	7	8	9	10	11	12
 <p>Armless Chair, Sled Base, Upholstered Back and Seat COM Yardage: Back: 0.5; Seat: 0.75 Freight Class: 250 Product Weight (lbs.): 27.5 Cubic Feet Per Carton: 11.75</p>	W6NUU Base Price: Seat upcharge: Back upcharge:	\$766											
		+0	+\$24	+\$43	+\$71	+\$110	+\$126	+\$160	+\$213	+\$253	+\$297	+\$387	+\$483
		+0	+\$16	+\$29	+\$47	+\$73	+\$84	+\$107	+\$142	+\$169	+\$198	+\$258	+\$322
		OVERALL DIMENSIONS			SEAT DIMENSIONS			BACK DIMENSIONS					
		W	D	H	W	D	H	W	H				
		20.75	23.5	32.25	18.25	16.5	18.25	16.5	15.25				
	Active weight 400 lbs. Does not stack. Add \$15 for (SBS).												





DESCRIPTION	MODEL#	STANDARD FABRIC GRADES											
		1/COM	2	3	4	5	6	7	8	9	10	11	12
 <p>Bariatric Armchair, Sled Base, Upholstered Back and Seat COM Yardage: Back: 0.75; Seat: 1 Freight Class: 250 Product Weight (lbs.): 45 Cubic Feet Per Carton: 20.5</p>	W630AUU	Base Price:	\$1159										
	Seat upcharge:	+0	+\$32	+\$57	+\$94	+\$146	+\$168	+\$213	+\$284	+\$337	+\$395	+\$516	+\$643
	Back upcharge:	+0	+\$24	+\$43	+\$71	+\$110	+\$126	+\$160	+\$213	+\$253	+\$297	+\$387	+\$483
		OVERALL DIMENSIONS			SEAT DIMENSIONS			BACK DIMENSIONS					
		W	D	H	W	D	H	W	H				
		35.25	23.5	32.25	29	17	18.25	26.75	15.25				
<p>Active weight 600 lbs. Does not stack. Add \$23 for (SBS).</p>													





DESCRIPTION	MODEL#	STANDARD FABRIC GRADES											
		1/COM	2	3	4	5	6	7	8	9	10	11	12
 <p>Bariatric Armless Chair, Sled Base, Upholstered Back and Seat COM Yardage: Back: 0.75; Seat: 1 Freight Class: 250 Product Weight (lbs.): 41.5 Cubic Feet Per Carton: 16.75</p>	W630NUU	Base Price:	\$1110										
	Seat upcharge:	+0	+\$32	+\$57	+\$94	+\$146	+\$168	+\$213	+\$284	+\$337	+\$395	+\$516	+\$643
	Back upcharge:	+0	+\$24	+\$43	+\$71	+\$110	+\$126	+\$160	+\$213	+\$253	+\$297	+\$387	+\$483
		OVERALL DIMENSIONS			SEAT DIMENSIONS			BACK DIMENSIONS					
		W	D	H	W	D	H	W	H				
		31.75	23.5	32.25	29	17	18.25	26.75	15.25				
<p>Active weight 600 lbs. Does not stack. Add \$23 for (SBS).</p>													

DESCRIPTION	MODEL#	STANDARD FABRIC GRADES											
		1/COM	2	3	4	5	6	7	8	9	10	11	12
 <p>Counter Stool with Arms, Polypropylene Back and Seat COM Yardage: n/a Freight Class: 250 Product Weight (lbs.): 32.5 Cubic Feet Per Carton: 15</p>	W5CSAPP	List Price											
		\$748											
			OVERALL DIMENSIONS			SEAT DIMENSIONS			BACK DIMENSIONS				
		W	D	H	W	D	H	W	H				
		24.25	23.5	38.25	17.75	17.15	23.25	16	16				
<p>Active weight 400 lbs. Does not stack.</p>													

DESCRIPTION	MODEL#	STANDARD FABRIC GRADES												
		1/COM	2	3	4	5	6	7	8	9	10	11	12	
 <p>Counter Stool with Arms, Upholstered Back and Polypropylene Seat COM Yardage: 0.5 Freight Class: 250 Product Weight (lbs.): 33 Cubic Feet Per Carton: 15</p>	W5CSAUP	\$816	\$832	\$845	\$863	\$889	\$900	\$923	\$958	\$985	\$1014	\$1074	\$1138	
			OVERALL DIMENSIONS			SEAT DIMENSIONS			BACK DIMENSIONS					
			W	D	H	W	D	H	W	H				
		24.25	23.5	38.25	17.75	16.5	23.25	16.5	16					
<p>Active weight 400 lbs. Does not stack. Add \$15 for (SBS).</p>														

DESCRIPTION	MODEL#	STANDARD FABRIC GRADES												
		1/COM	2	3	4	5	6	7	8	9	10	11	12	
 <p>Counter Stool with Arms, Polypropylene Back and Upholstered Seat COM Yardage: 0.75 Freight Class: 250 Product Weight (lbs.): 33 Cubic Feet Per Carton: 15</p>	W5CSAPU	\$816	\$840	\$859	\$887	\$926	\$942	\$976	\$1029	\$1069	\$1113	\$1203	\$1299	
			OVERALL DIMENSIONS			SEAT DIMENSIONS			BACK DIMENSIONS					
			W	D	H	W	D	H	W	H				
		24.25	23.5	38.25	18.25	17.75	24.25	16	15.25					
<p>Active weight 400 lbs. Does not stack.</p>														

DESCRIPTION	MODEL#	STANDARD FABRIC GRADES											
		1/COM	2	3	4	5	6	7	8	9	10	11	12
 <p>Counter Stool with Arms, Upholstered Back and Seat COM Yardage: Back: 0.5; Seat: 0.75 Freight Class: 250 Product Weight (lbs.): 33.5 Cubic Feet Per Carton: 15</p>	W5CSAUU Base Price: Seat upcharge: Back upcharge:	\$880											
		+0	+\$24	+\$43	+\$71	+\$110	+\$126	+\$160	+\$213	+\$253	+\$297	+\$387	+\$483
		+0	+\$16	+\$29	+\$47	+\$73	+\$84	+\$107	+\$142	+\$169	+\$198	+\$258	+\$322
		OVERALL DIMENSIONS			SEAT DIMENSIONS			BACK DIMENSIONS					
		W	D	H	W	D	H	W	H				
		24.25	23.5	38.25	18.25	17	24.25	16.5	15.25				
	Active weight 400 lbs. Does not stack. Add \$15 for (SBS).												
 <p>Armless Counter Stool, Polypropylene Back and Seat COM Yardage: n/a Freight Class: 250 Product Weight (lbs.): 29.5 Cubic Feet Per Carton: 13.75</p>	W5CSNPP	List Price											
		\$698											
		OVERALL DIMENSIONS			SEAT DIMENSIONS			BACK DIMENSIONS					
		W	D	H	W	D	H	W	H				
		21.75	23.5	38.25	17.75	17.15	23.25	16	16				
	Active weight 400 lbs. Stacks 4 high on floor.												
 <p>Armless Counter Stool, Upholstered Back and Polypropylene Seat COM Yardage: 0.5 Freight Class: 250 Product Weight (lbs.): 30 Cubic Feet Per Carton: 13.75</p>	W5CSNUP	1/COM	2	3	4	5	6	7	8	9	10	11	12
		\$767	\$783	\$796	\$814	\$840	\$851	\$874	\$909	\$936	\$965	\$1025	\$1089
		OVERALL DIMENSIONS			SEAT DIMENSIONS			BACK DIMENSIONS					
		W	D	H	W	D	H	W	H				
		21.75	23.5	38.25	17.75	16.5	23.25	16.5	16				
	Active weight 400 lbs. Stacks 4 high on floor. Add \$15 for (SBS).												
 <p>Armless Counter Stool, Polypropylene Back and Upholstered Seat COM Yardage: 0.75 Freight Class: 250 Product Weight (lbs.): 30 Cubic Feet Per Carton: 13.75</p>	W5CSNPU	1/COM	2	3	4	5	6	7	8	9	10	11	12
		\$767	\$791	\$810	\$838	\$877	\$893	\$927	\$980	\$1020	\$1064	\$1154	\$1250
		OVERALL DIMENSIONS			SEAT DIMENSIONS			BACK DIMENSIONS					
		W	D	H	W	D	H	W	H				
		21.75	23.5	38.25	18.25	17.75	24.25	16	15.25				
	Active weight 400 lbs. Stacks 4 high on floor.												
 <p>Armless Counter Stool, Upholstered Back and Seat COM Yardage: Back: 0.5; Seat: 0.75 Freight Class: 250 Product Weight (lbs.): 30.5 Cubic Feet Per Carton: 13.75</p>	W5CSNUU Base Price: Seat upcharge: Back upcharge:	\$830											
		+0	+\$24	+\$43	+\$71	+\$110	+\$126	+\$160	+\$213	+\$253	+\$297	+\$387	+\$483
		+0	+\$16	+\$29	+\$47	+\$73	+\$84	+\$107	+\$142	+\$169	+\$198	+\$258	+\$322
		OVERALL DIMENSIONS			SEAT DIMENSIONS			BACK DIMENSIONS					
		W	D	H	W	D	H	W	H				
		21.75	23.5	38.25	18.25	17	24.25	16.5	15.25				
	Active weight 400 lbs. Stacks 4 high on floor. Add \$15 for (SBS).												

DESCRIPTION	MODEL#	STANDARD FABRIC GRADES											
 <p>Bar Stool with Arms, Polypropylene Back and Seat COM Yardage: n/a Freight Class: 250 Product Weight (lbs.): 34.5 Cubic Feet Per Carton: 17</p>		List Price											
	W5BSAPP	\$759											
		OVERALL DIMENSIONS			SEAT DIMENSIONS			BACK DIMENSIONS					
		W	D	H	W	D	H	W	H				
		24.25	23.5	44	17.75	17.5	29.25	16	16				
 <p>Bar Stool with Arms, Upholstered Back and Polypropylene Seat COM Yardage: 0.5 Freight Class: 250 Product Weight (lbs.): 35 Cubic Feet Per Carton: 17</p>		1/COM 2 3 4 5 6 7 8 9 10 11 12											
	W5BSAUP	\$828	\$844	\$857	\$875	\$901	\$912	\$935	\$970	\$997	\$1026	\$1086	\$1150
		OVERALL DIMENSIONS			SEAT DIMENSIONS			BACK DIMENSIONS					
		W	D	H	W	D	H	W	H				
		24.25	23.5	44.5	17.75	16.5	29.25	16.5	16				
 <p>Bar Stool with Arms, Polypropylene Back and Upholstered Seat COM Yardage: 0.75 Freight Class: 250 Product Weight (lbs.): 35 Cubic Feet Per Carton: 17</p>		1/COM 2 3 4 5 6 7 8 9 10 11 12											
	W5BSAPU	\$828	\$844	\$857	\$875	\$901	\$912	\$935	\$970	\$997	\$1026	\$1086	\$1150
		OVERALL DIMENSIONS			SEAT DIMENSIONS			BACK DIMENSIONS					
		W	D	H	W	D	H	W	H				
		24.25	23.5	44	18.25	17.5	30.25	16	15.25				
 <p>Bar Stool with Arms, Upholstered Back and Seat COM Yardage: Back: 0.5; Seat: 0.75 Freight Class: 250 Product Weight (lbs.): 35.5 Cubic Feet Per Carton: 17</p>		1/COM 2 3 4 5 6 7 8 9 10 11 12											
	W5BSAUA	Base Price: \$891											
		Seat upcharge: +\$0	+\$24	+\$43	+\$71	+\$110	+\$126	+\$160	+\$213	+\$253	+\$297	+\$387	+\$483
	Back upcharge: +\$0	+\$16	+\$29	+\$47	+\$73	+\$84	+\$107	+\$142	+\$169	+\$198	+\$258	+\$322	
		OVERALL DIMENSIONS			SEAT DIMENSIONS			BACK DIMENSIONS					
		W	D	H	W	D	H	W	H				
		24.25	23.5	44.5	18.25	16.75	30.25	16.5	15.25				
 <p>Armless Bar Stool, Polypropylene Back and Seat COM Yardage: n/a Freight Class: 250 Product Weight (lbs.): 31.5 Cubic Feet Per Carton: 15.75</p>		List Price											
	W5BSNPP	\$710											
		OVERALL DIMENSIONS			SEAT DIMENSIONS			BACK DIMENSIONS					
		W	D	H	W	D	H	W	H				
		20.75	23.5	44	17.75	17.5	29.25	16	16				





DESCRIPTION	MODEL#	STANDARD FABRIC GRADES											
		1/COM	2	3	4	5	6	7	8	9	10	11	12
 <p>Armless Bar Stool, Upholstered Back and Polypropylene Seat COM Yardage: 0.5 Freight Class: 250 Product Weight (lbs.): 32 Cubic Feet Per Carton: 15.75</p>	W5BSNUP	\$779	\$795	\$808	\$826	\$852	\$863	\$886	\$921	\$948	\$977	\$1037	\$1101
	OVERALL DIMENSIONS			SEAT DIMENSIONS			BACK DIMENSIONS						
	W	D	H	W	D	H	W	H					
	20.75	23.5	44.5	17.75	16.5	29.25	16.5	16					

 <p>Armless Bar Stool, Polypropylene Back and Upholstered Seat COM Yardage: 0.75 Freight Class: 250 Product Weight (lbs.): 32 Cubic Feet Per Carton: 15.75</p>	W5BSNPU	\$779	\$803	\$822	\$850	\$889	\$905	\$939	\$992	\$1032	\$1076	\$1166	\$1262
	OVERALL DIMENSIONS			SEAT DIMENSIONS			BACK DIMENSIONS						
	W	D	H	W	D	H	W	H					
	20.75	23.5	44	18.25	17.5	30.25	16	15.25					

 <p>Armless Bar Stool, Upholstered Back and Seat COM Yardage: Back: 0.5; Seat: 0.75 Freight Class: 250 Product Weight (lbs.): 32.5 Cubic Feet Per Carton: 15.75</p>	W5BSNUU	Base Price: \$842												
		Seat upcharge:	+0	+\$24	+\$43	+\$71	+\$110	+\$126	+\$160	+\$213	+\$253	+\$297	+\$387	+\$483
		Back upcharge:	+0	+\$16	+\$29	+\$47	+\$73	+\$84	+\$107	+\$142	+\$169	+\$198	+\$258	+\$322
OVERALL DIMENSIONS			SEAT DIMENSIONS			BACK DIMENSIONS								
W	D	H	W	D	H	W	H							
	20.75	23.5	44.5	18.25	16.75	30.25	16.5	15.25						

DESCRIPTION	MODEL#	List Price											
		W524APP	\$771										
 <p>Hip Chair, Polypropylene Back and Seat COM Yardage: n/a Freight Class: 250 Product Weight (lbs.): 35.5 Cubic Feet Per Carton: 17.75</p>													
	OVERALL DIMENSIONS			SEAT DIMENSIONS			BACK DIMENSIONS						
	W	D	H	W	D	H	W	H					
	24.25	24.25	38	17.75	17.5	22.25	16	16					

 <p>Hip Chair, Upholstered Back and Polypropylene Seat COM Yardage: 0.5 Freight Class: 250 Product Weight (lbs.): 36 Cubic Feet Per Carton: 17.75</p>	W524AUP	\$839	\$855	\$868	\$886	\$912	\$923	\$946	\$981	\$1008	\$1037	\$1097	\$1161
	OVERALL DIMENSIONS			SEAT DIMENSIONS			BACK DIMENSIONS						
	W	D	H	W	D	H	W	H					
	24.25	24.25	38.25	17.75	16.5	22.25	16.5	16.25					

DESCRIPTION	MODEL#	STANDARD FABRIC GRADES											
		1/COM	2	3	4	5	6	7	8	9	10	11	12
 <p>Hip Chair, Polypropylene Back and Upholstered Seat COM Yardage: 0.75 Freight Class: 250 Product Weight (lbs.): 36 Cubic Feet Per Carton: 17.75</p>	W524APU Active weight 400 lbs. Does not stack.	\$839	\$855	\$868	\$886	\$912	\$923	\$946	\$981	\$1008	\$1037	\$1097	\$1161
		OVERALL DIMENSIONS			SEAT DIMENSIONS			BACK DIMENSIONS					
		W	D	H	W	D	H	W	H				
		24.25	24.25	38	18.25	17.5	23.25	16	15.25				
 <p>Hip Chair, Upholstered Back and Seat COM Yardage: Back: 0.5; Seat: 0.75 Freight Class: 250 Product Weight (lbs.): 36.5 Cubic Feet Per Carton: 17.75</p>	W524AUU Base Price: \$902 Seat upcharge: +0 Back upcharge: +0 Active weight 400 lbs. Does not stack. Add \$15 for (SBS).	\$902											
		+0	+\$24	+\$43	+\$71	+\$110	+\$126	+\$160	+\$213	+\$253	+\$297	+\$387	+\$483
		+0	+\$16	+\$29	+\$47	+\$73	+\$84	+\$107	+\$142	+\$169	+\$198	+\$258	+\$322
		OVERALL DIMENSIONS			SEAT DIMENSIONS			BACK DIMENSIONS					
W	D	H	W	D	H	W	H						
24.25	24.25	38.25	18.25	16.5	23.25	16.5	15.25						
 <p>Bariatric Hip Chair, Upholstered Back and Seat COM Yardage: Back: 0.75; Seat: 1 Freight Class: 250 Product Weight (lbs.): 50 Cubic Feet Per Carton: 23.75</p>	W324AUU Base Price: \$1188 Seat upcharge: +0 Back upcharge: +0 Active weight 600 lbs. Does not stack. Add \$23 for (SBS).	\$1188											
		+0	+\$32	+\$57	+\$94	+\$146	+\$168	+\$213	+\$284	+\$337	+\$395	+\$516	+\$643
		+0	+\$24	+\$43	+\$71	+\$110	+\$126	+\$160	+\$213	+\$253	+\$297	+\$387	+\$483
		OVERALL DIMENSIONS			SEAT DIMENSIONS			BACK DIMENSIONS					
W	D	H	W	D	H	W	H						
35.25	24.25	38.5	29	17.5	23.25	26.75	15.25						
 <p>Dolly COM Yardage: n/a Freight Class: 150 Product Weight (lbs.): 16 Cubic Feet Per Carton: 3.5</p>	WDOL List Price: \$348 Accommodates 10 standard 4-legged chairs.	List Price											
		List Price											
		OVERALL DIMENSIONS			SEAT DIMENSIONS			BACK DIMENSIONS					
		W	D	H	W	D	H	W	H				
22	23.75	9.25											
 <p>Bariatric Dolly COM Yardage: n/a Freight Class: 250 Product Weight (lbs.): 19 Cubic Feet Per Carton: 5</p>	WDOL30 List Price: \$386 Accommodates 4 bariatric 4-legged chairs.	List Price											
		List Price											
		OVERALL DIMENSIONS			SEAT DIMENSIONS			BACK DIMENSIONS					
		W	D	H	W	D	H	W	H				
32.12	23.75	9.25											

DESCRIPTION	MODEL#	STANDARD FABRIC GRADES
-------------	--------	------------------------

WILLOW LINKING TABLES



WPT12G
120 degree corner linking table

WPTEGL
End linking table, left



For Willow seating, see page 223.

EXAMPLE WILLOW TABLE ORDER CODE:







WPT90G	HPL	ACJ	-CHM	-ST	-SND
Model #	Surface type	Top finish	Leg finish	Glide type	Glide finish



STANDARD FEATURES

- Linking tables can be used together in any combination with Willow four-leg or sled chairs to create a wide variety of layouts.
- Connecting hardware is included.
- Legs and ganging brackets are available in 20 paint finishes and 4 plated finishes.
- All tables are laminate, choose thermally fused or high pressure, and feature a flat edge with edgeband.
- Tables are available with a variety of glide types. Glides must be chosen to best suit flooring type and site conditions. See Glide Type.
- All tables (except 9" In-line Linking) are pre-drilled for center front, field installed, undermount power. Specified separately.
- Undermount power unit (SU2P10U) includes 1 AC and 2 USB-A charging ports with a 10' power cord and 3-prong plug, specify Jet Black or White. Power units do not link.
- Clamp mount (SU2P10C) power, with 1 AC and 2 USB-A charging ports with a 10' power cord, available Jet Black or White. These units can be mounted on the back edge of all linking tables. Specified separately for field installation. Power units do not link.

Add option codes in the following order:

- **Model number**
Enter model number.
- **Surface Type**
(**TFL**) Thermally fused laminate
(**HPL**) High pressure laminate
- **Top finish**
(**ACJ**) Absolute Acacia
(**ASN**) Asian Night
(**AWC**) Avant Cherry
(**AWH**) Avant Honey
(**BLK**) Black
(**BRC**) Brushed Cobalt
(**CMB**) Clear Maple
(**DES**) Dark Espresso
(**DWT**) Designer White
(**FAS**) Fashionista
(**FCL**) First Class
(**NBL**) Noce Biondo
(**NGL**) Noce Grigio
(**NEL**) Noce Leggero
(**NML**) Noce Medio
(**OTM**) Quartered Mahogany
(**SBY**) Sheer Beauty
(**SOG**) Storm Grey
(**WCR**) Winter Cherry
(**WHC**) White Chocolate
(**WHE**) Walnut Heights
- **Leg Finish** (for tables with legs)
Paint finishes:
Black (**TBL**), Buzz Blue (**TBZ**), Cactus (**TCC**), Carrot (**TCR**), Cloud (**TIV**), Designer White (**TDW**), Dijon (**TDJ**), Eggplant (**TEG**), Fog (**TFO**), Frost (**TFR**), Ink (**TIN**), Kalua (**TKA**), Latte (**TLA**), Mocha (**TMO**), Nevada (**TNE**), Sand (**TSN**), Scarlet (**TSR**), Shadow (**TSH**), Toast (**TOA**) and Tungsten (**TTU**).
Plated finishes:
(**CHM**) Chrome. Add \$42.
(**BCH**) Brushed Chrome. Add \$147.
(**SBR**) Satin Brass. Add \$217.
(**ACO**) Antique Copper. Add \$217.
- **Bracket Finish** (for linking tables and ganging bracket)
Paint finishes:
Black (**TBL**), Cloud (**TIV**), Designer White (**TDW**), Fog (**TFO**), Frost (**TFR**), Kalua (**TKA**), Latte (**TLA**), Mocha (**TMO**), Nevada (**TNE**), Sand (**TSN**), Shadow (**TSH**), Toast (**TOA**) and Tungsten (**TTU**).
- **Glide type** (for models with legs)
(**ST**) Nylon colored glide for most surfaces
(**NM**) White, non-marking Nylon glide for most surfaces
(**SG**) Steel cushion glide for carpeted surfaces. Add \$8 for models with one leg. Add \$15 for models with two legs.
(**FG**) Felt glide for most hard floor surfaces. Add \$8 for models with one leg. Add \$15 for models with two legs.
(**RG**) Rubber, non-slip glide for most hard floor surfaces. Add \$8 for models with one leg. Add \$15 for models with two legs.
- **Glide Finish** (for ST glides only)
(**BLK**) Black
(**SND**) Sand

DESCRIPTION	MODEL#	STANDARD FABRIC GRADES				
 <p>90° Corner Linking Table</p>	WPT90G	26.12 x 26.12 x 17.62	100	24	2.6	\$561
						<ul style="list-style-type: none"> • Pricing shown for a thermally fused laminate top (LP). • For a high pressure laminate top (HP), add \$144.
Coordinating edge on laminate surfaces with metal frame and legs. Must be connected to a four-leg or sled base chair. Includes one set of U-channel connectors and hardware. 1 per carton. Shipped KD for assembly on site.						
 <p>120° Corner Linking Table</p>	WPT12G	31 x 12.62 x 17.5	92.5	16.5	1.5	\$482
						<ul style="list-style-type: none"> • Pricing shown for a thermally fused laminate top (LP). • For a high pressure laminate top (HP), add \$92.
Coordinating edge on laminate surfaces with metal frame and legs. Must be connected to a four-leg or sled base chair. Includes one set of U-channel connectors and hardware. 1 per carton. Shipped KD for assembly on site.						
 <p>16" In-Line Linking Table</p>	WPT16G	15 x 16 x 2.75	85	12	0.9	\$315
						<ul style="list-style-type: none"> • Pricing shown for a thermally fused laminate top (LP). • For a high pressure laminate top (HP), add \$58.
Coordinating edge on laminate surfaces with metal frame and legs. Must be connected to a four-leg or sled base chair. Includes one set of U-channel connectors and hardware. 1 per carton. Shipped KD for assembly on site.						
 <p>9" In-Line Linking Table</p>	WPT09G		85	8.5	0.7	\$245
						<ul style="list-style-type: none"> • Pricing shown for a thermally fused laminate top (LP). • For a high pressure laminate top (HP), add \$41.
Coordinating edge on laminate surfaces with metal frame and legs. Must be connected to a four-leg or sled base chair. Includes one set of U-channel connectors and hardware. 1 per carton. Shipped KD for assembly on site.						
 <p>End Linking Table</p>	WPT EGL (Left)	15 x 14 x 17.62	85	13	1	\$489
	WPT EGR (Right)	15 x 14 x 17.62	85	13	1	\$489
						<ul style="list-style-type: none"> • Pricing shown for a thermally fused laminate top (LP). • For a high pressure laminate top (HP), add \$55.
Coordinating edge on laminate surfaces with metal frame and legs. Must be connected to a four-leg or sled base chair. Includes one set of U-channel connectors and hardware. 1 per carton. Shipped KD for assembly on site.						
 <p>Ganging Bracket</p>	WPGBRK	9 x 15 x 1.25	300	2	2	\$108
						For use between two seated height arm or armless chairs where table top is not desired. Not for use with stools. Does not accept power units. 1 per carton.

DESCRIPTION	MODEL#	STANDARD FABRIC GRADES			
 <p>Power Unit, Clamp Attachment</p> <p>Tamper-resistant clamp mount power, with 1 AC and 2 USB-A charging ports with a 10' power cord and 3-prong plug. Available in Jet Black or White. Can be mounted on the back edge of all linking tables. Must be specified separately for field installation. Power units do not link.</p>	SU2P10C	70	0.01	0.5	\$557
 <p>Power Unit, Under Mount Attachment</p> <p>Tamper-resistant undermount power, with 1 AC and 2 USB-A charging ports with a 10' power cord and 3-prong plug. Available in Jet Black or White. Must be specified separately for field installation. Power units do not link.</p>	SU2P10U	70	0.01	2	\$527

WINGBACK



model GC3787C

STANDARD FEATURES

- Traditional styling, easy to exit and features removable and replaceable seats.
- For added comfort, seats are standard with high density foam.
- Standard glide is plastic.
- Wood legs are available in a variety of finishes. Available in Maple wood only species.
- For textile and finish options, visit the website at globalfurnituregroup.com
- Can be upholstered in standard Global textiles if Healthcare compliance is not required.
- Shipped fully assembled.

OPTIONAL FEATURES

- For non-slip glides specify **(NS)** - Add **\$35**
- For moisture barrier (seat only) - Add **\$193** per seat.

SUGGESTED APPLICATIONS

- Guest seating
- Lobbies
- Lounge/Waiting
- Patient rooms
- Resident rooms

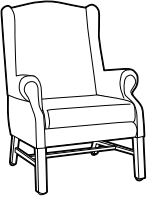
DESCRIPTION	MODEL#	STANDARD TEXTILE GRADES											
		COM	2	3	4	5	6	7	8	9	10	11	12
 <p>HB Armchair, Chippendale Legs COM Yardage: 4.75 Freight Class: 250 Product Weight (lbs.): 50 Cubic Feet Per Carton: 22.25</p>	GC3787C	\$1847	\$1991	\$2219	\$2413	\$2687	\$2792	\$3032	\$3484	\$3708	\$4124	\$4708	\$5431
		OVERALL DIMENSIONS W D H			SEAT DIMENSIONS W D H			BACK DIMENSIONS W H					
		29	30	39	19.5	18	17.5	19.5	22				

Active weight 300 lbs.
Removable seat cushion.

OTTOMANS



model GC3346

STANDARD FEATURES

- Designed to coordinate with healthcare seating.
- Standard glide is plastic.
- Wood legs are available in a variety of finishes.
- For textiles and finish options, visit the website at www.globalfurnituregroup.com
- Can be upholstered in standard Global textiles only if Healthcare compliance is not required.
- Shipped fully assembled.

OPTIONAL FEATURES

- For hard surface floors, please specify opaque non-marking glides **(NMM)**. No upcharge.
- For non-slip glides, please specify **(NS)**. Add \$35.
- Optional metal leg is available. Offered in Black **(TBL)**, Latte **(TLA)**, Toast **(TOA)**, Tungsten **(TTU)**, Shadow **(TSH)**, Mocha **(TMO)**, and Kalua **(TKA)**. Please specify. No upcharge.

SUGGESTED APPLICATIONS

- Guest seating
- Patient rooms
- Lobbies
- Resident rooms
- Lounge/Waiting
- Treatment/Exam

DESCRIPTION	MODEL#	STANDARD TEXTILE GRADES											
		COM	2	3	4	5	6	7	8	9	10	11	12

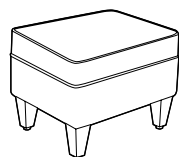

GC3346	\$1455	\$1497	\$1535	\$1587	\$1662	\$1692	\$1755	\$1875	\$1938	\$2049	\$2208	\$2400
--------	--------	--------	--------	--------	--------	--------	--------	--------	--------	--------	--------	--------

Ottoman Block Legs
COM Yardage: 1.25
Freight Class: 150
Product Weight (lbs.): 20
Cubic Feet Per Carton: 4.6

OVERALL DIMENSIONS			SEAT DIMENSIONS			BACK DIMENSIONS	
W	D	H	W	D	H	W	H

17.5	19.5	15	--	--	15		
------	------	----	----	----	----	--	--

THROW PILLOWS



model GCTP1515

STANDARD FEATURES

- Throw pillows complement decor by adding a personal touch.
- Colors and patterns enhance and add to the overall design
- Velcro closure allows for covers to be changed
- Can be upholstered in standard Global textiles only if Healthcare compliance is not required.
- For a complete list of healthcare textile, visit the website at globalfurnituregroup.com

SUGGESTED APPLICATIONS

- Lobbies
- Lounge/Waiting
- Resident rooms

DESCRIPTION	MODEL#	STANDARD TEXTILE GRADES											
		COM	2	3	4	5	6	7	8	9	10	11	12

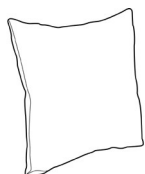

GCTP1515	\$203	\$223	\$257	\$287	\$330	\$348	\$382	\$457	\$492	\$558	\$650	\$763
----------	-------	-------	-------	-------	-------	-------	-------	-------	-------	-------	-------	-------

15" x 15" Square Throw Pillow
COM Yardage: 0.75
Freight Class: 70
Product Weight (lbs.): 1
Cubic Feet Per Carton: 1.3

OVERALL DIMENSIONS			SEAT DIMENSIONS			BACK DIMENSIONS	
W	D	H	W	D	H	W	H

15	15	6					
----	----	---	--	--	--	--	--

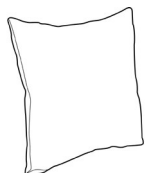

GCTP2020	\$245	\$267	\$290	\$319	\$363	\$384	\$426	\$483	\$536	\$584	\$694	\$807
----------	-------	-------	-------	-------	-------	-------	-------	-------	-------	-------	-------	-------

20" x 20" Square Throw Pillow
COM Yardage: 0.75
Freight Class: 70
Product Weight (lbs.): 1.5
Cubic Feet Per Carton: 1.3

OVERALL DIMENSIONS			SEAT DIMENSIONS			BACK DIMENSIONS	
W	D	H	W	D	H	W	H

20	20	6					
----	----	---	--	--	--	--	--