

**Healthcare Furniture**

Effective January 1, 2023 USA  
Revised November 1, 2024



PRICE LIST  
**healthcare**



# introduction

Since 1985, Global has been a primary source for furniture in hospitals and elder care facilities.

We offer a comprehensive line of products and services. Our customers appreciate and recognize our value-added consulting and problem-solving resources as this enables them to protect their investments long-term.

Global's healthcare products are specifically designed to promote enhanced levels of wellness. Our furniture solutions are migrating into commercial spaces due to the significant increase in the aging population and the need for properly designed solutions.

Our vertically integrated manufacturing supply chain allows Global to manage the process and to access and monitor the quality of materials and production standards. This vertical integration allows us to control manufacturing and delivery cycles.

We make what you need. Our solutions are suitable for high traffic, challenging public and private spaces. The product development process focuses on ensuring the product is suitable for use and can meet the many faceted challenges of today's public shared spaces.

Hospitals, medical practice centers, senior care facilities, public housing, treatment programs even veterinary clinics can have peace of mind when using healthcare furniture solutions.

Global continuously strives to achieve excellence in what we do. We are proud to have played a major role in setting some of the highest quality standards in the industry. We partner with clients to ensure we understand their needs, culture and goals.

We often modify our products when special requirements dictate the need, in order to provide the best possible solution for an application.

We are committed to producing products in the most sustainable ways ensuring they pass strict quality testing. See below for GREENGUARD and level certification information.

We value our clients and strive to build lifelong partnerships through trust, respect and successful outcomes.

## SYMBOL IDENTIFICATION



Global's certified products are in compliance with the stringent emission guidelines set by the Greenguard Environmental Institute and include all upholstered seating.

To obtain a Greenguard certificate for any product, please go to the product page on our website [www.globalfurnituregroup.com](http://www.globalfurnituregroup.com) and click on "view Greenguard certificate".



level™ certification, based on the ANSI/BIFMA e3-2012 furniture sustainability standard, sets furniture manufacturers on a path toward greater sustainability over time. Based on environmental and social criteria set forth in the standard, a product's entire supply chain is assessed.

Certification assessment includes an evaluation of specific corporate policies and guidelines and an assessment of associated company manufacturing facilities. Products must meet quantifiable milestones of environmental and social performance at every step of development.

The quantitative assessment addresses four categories: material use, energy and atmosphere impacts, human and ecosystem health and social responsibility. Manufacturers earn points in each of the four categories. The level™ brand and its numeric rating of 1, 2 or 3 indicate what threshold of certification a product has achieved. Level™ 3 is the highest rating.

## GLOBAL USA Showrooms + Distribution Centers

Marlton, New Jersey

Atlanta, Georgia

Boston, Massachusetts

Buford, Georgia

Chicago, Illinois

Cincinnati, Ohio

Dallas, Texas

Denver, Colorado

Elkridge, Maryland

Houston, Texas

Lenexa, Kansas

Miami, Florida

New York, New York

Philadelphia, Pennsylvania

Phoenix, Arizona

Renton, Washington

Sunrise, Florida

Tampa, Florida

Washington, DC

Whittier, California

# TABLE OF CONTENTS

SEATING	SEATING (cont'd)	BARIATRIC SEATING
Bishop.....page 62	Primacare benches.....page 187	Calidon.....page 63
Calidon.....page 63	Primacare dining.....page 67	Frolick.....page 88
Chap.....page 70	Primacare guest.....page 157	GC Belong.....page 95
Coast.....page 72	Primacare lounge.....page 174	GC Comet.....page 124
Collingwood.....page 73	Primacare lounge, fully upholstered.....page 179	GC Sidero.....page 126
Desmond.....page 75	Primacare modular, guest/patient.....page 192	Nourish.....page 147
Desmond HT.....page 76	Primacare modular, lounge.....page 208	Primacare lounge.....page 174
Doctor Buddy.....page 78	Primacare patient.....page 166	Primacare lounge, fully upholstered.....page 179
Dreme.....page 79	Primacare recliners.....page 183	Primacare modular, guest/patient.....page 192
Drift.....page 82	Primacare sleepers.....page 185	Primacare modular, lounge.....page 208
Erin.....page 83	Primacare wingback.....page 181	Primacare patient.....page 166
Flap.....page 85	River+.....page 218	Primacare wingback.....page 181
Foot activated stools.....page 87	Senator.....page 219	Strand.....page 221
Frolick.....page 88	Sleep-Eez.....page 220	Willow.....page 227
Gala II.....page 93	Splash.....page 88	
GC Beach.....page 94	Strand.....page 221	
GC Belong.....page 95	Willow.....page 227	
GC Comet.....page 124	Wingback.....page 241	
GC Islands.....page 125		
GC Sidero.....page 126		
GC Sirena.....page 136		
GC Vion.....page 138		
GC Vitrola.....page 142		
GC Wind.....page 140		
Janna.....page 145		
Nourish.....page 147		
Oakville.....page 73		

**TABLES**

Calidon Tables.....page 67

Drift Tables.....page 34

Enable Tables.....page 38

Floral Dining Tables.....page 40

GC-Belong Tables.....page 41

Occasional Tables.....page 44

Overbed Tables.....page 50

Primacare Tables.....page 56

Primacare Modular Tables.....page 202

Tablet Tables.....page 58

Willow Linking Tables.....page 238

Zook, Children’s Tables.....page 59

**PATIENT + RESIDENT ROOM FURNITURE**

Aldon.....page 6

Sonoma.....page 18

**ACCESSORIES**

Ottomans.....page 242

Throw pillows.....page 242

**REFERENCE**

Healthcare definitions.....page 4

Seating application guidelines.....page 61

COM Authorization Form.....page 248

Think Global-Think Green.....page 249

Textiles + Finishes.....page 244

Terms and Conditions.....page 250

Warranty.....page 252



# GLOBAL HEALTHCARE DEFINITIONS

---

Global Healthcare often requires solutions to address unique and diverse requirements within the vast range of healthcare applications. The following definitions describe the Global healthcare product solutions available.

## **ADDITIONAL WEIGHT**

For unique and demanding challenges in behavioral health facilities, products are weighted to reduce the ease of movement or lifting product to use as a weapon. The product selection and application identified will assist in determining the amount of additional weight required. Weighted product is designed for facilities looking to create safe and secure environments, while ensuring the furniture can withstand intensive use. To determine the amount of additional weight to be added to a product, contact your Global representative.

## **BED BUG RESISTANT**

Due to an increase in the presence of bed bugs within healthcare facilities, solutions have been developed to deal with the bed bug issue. The product design directly affects the level of resistance that can be achieved. For more detailed information, contact your Global representative.

## **CONTRABAND RESISTANT**

Making a product contraband resistant is a potential solution if you want upholstered and comfortable products to be finished in a manner that offers a greater level of safety. Contraband resistant finishing is added to products in high risk areas where individuals might attempt to hide contraband such as weapons (for self-harm or to cause harm to others), drugs or alcohol. It can also be part of a solution for protecting any area of the product from becoming a ligature point. The product surfaces and upholstery will be evaluated and the appropriate solutions will be applied to ensure all surfaces are sealed and safely protected. Depending on the product design, this could mean any combination of the following applications: sealed seams, sealed underside, tamperproof fasteners and/or sealed zippers. After being evaluated, solutions are applied based on the application and population being served. The result of this process would enable the caregiver to identify a potential threat as it would be apparent that the product surface was tampered with. To further assist product selection and what is required specific to a product, please contact your Global representative.

## **HIGH DENSITY ULTRACELL FOAM**

High density Ultracell foam is a non-allergenic foam manufactured from natural seed-based oils such as soybean. It significantly decreases the dependence on fossil fuels like petroleum and reduces greenhouse gas emissions. The high density of the foam provides comfortable sitting for many years before any sagging or indents appear underneath upholstery. Simply, there is more material available to allow for enhanced performance.

## **MENTAL HEALTH FURNITURE**

Mental health furniture can range from simple to complex, depending on the application and population. Global understands the unique nature and the need to offer a vast range of solutions to deal with the safety of staff and patients while respecting budgets and individual needs. This allows the client to select a product from our complete offering and then build it up to ensure the right features are included. Here are some of the optional features available: tamperproof fasteners, additional weight, floor mount brackets, puncture resistant textile and other contraband resistant features that are needed for the application. Whatever the demand, the correct solution can be built-in. For more detailed information, contact your Global representative.

## **MOISTURE BARRIER**

Moisture barrier is a textile lining with moisture repellent qualities. Moisture barrier lining is applied on the seat cushion between the upholstery cover and foam to prevent any form of moisture from getting to the foam. It is recommended when the fabric being used does not have moisture repellent qualities or when additional protection from penetration of moisture is desired. For coated textiles, the additional moisture barrier option may not be selected in conjunction with sealed seams.

## **MOISTURE AND TAMPER RESISTANT ZIPPER**

Moisture and tamper resistant zippers are available as part of the solution when requesting bed bug resistant furniture and contraband resistant solutions. In addition, this special zipper prevents liquid and moisture seepage through the zipper teeth, providing additional peace of mind. For more detailed information based on the product selection, contact your Global representative.

## **SEALED UNDERSIDE**

Sealed underside refers to the process of finishing the underside of a product to ensure no potential openings from the textile surface to the product interior on seat and/or back seams. The sealed underside solution is requested for achieving higher levels of infection prevention control for the product being ordered. The sealed underside option is noted in the price list notes with the upcharge for the respective product. For more detailed information and to determine if the sealed underside process is available on a particular product selection where it is not noted, contact your Global representative.

## **SEALED SEAMS**

The heat-sealed seams process involves sealing the back of a seam with a specially designed tape. Sealing the seam increases the integrity of the seam reducing the likelihood of seams opening over time. This tape provides additional protection against moisture seepage and prevents insects from entering the product through the stitch holes and seams. The sealed seam process is available for use on most coated textiles and is not available on woven textiles. Some coated textiles do not allow sealed seams to be used. In the event sealed seams are to be used, contact Customer Care to confirm sealed seams are approved for the coated textile selected in advance of order placement. Sealed seams cannot be specified if using the moisture barrier lining. The sealing of seams requires testing the textile to ensure acceptance of the heat-sealed tape for performance and aesthetics. For detailed instructions on textile testing and approval, contact your Global representative.

## **TAMPERPROOF**

Tamperproof fasteners can be requested for a higher level of safety. Using tamperproof fasteners ensures the fasteners cannot be interfered with (changed, opened or removed) without use of a special tool. This will prevent the tampering with, or disassembly of the product which could lead to injuries or unsuspecting harm to others. For more detailed information contact your Global representative.

aldon + sonoma

# personal room furniture



The Aldon series offers affordable and personalized furniture solutions for patient or resident rooms. Highly durable, Aldon's clean lines and simple design provide built-in quality to meet the demands of any healthcare environment. Tops, gables and backs are engineered for on-site maintenance and replacement to ensure long-term performance. The design incorporates smooth surfaces with a straight profile and durable finish options, demonstrating respect for housekeeping and infection prevention control practices. A 3mm PVC edge on tops, drawer and door fronts provides peace of mind for greater performance. The vast array of product and finish selections allow for individual choices while complementing the design objective. Aldon is the ideal balance of value and style.

#### Features and Benefits

- Tops standard with 1" thermally fused laminate with coordinating 3mm PVC edge.
- Chassis, back panels, drawer fronts, shelves and doors are constructed of ¾" thermally fused laminate.
- Constructed with NAUF (no added urea formaldehyde) particle board.
- Laminate finishes are available in a variety of colors.
- Thermofoil finishes are available on bedside cabinets.
- All chassis panels and tops can be replaced if damaged.
- Drawers are mounted on high quality precision steel full extension ball bearing slides.
- Optional high impact polystyrene insert liner can be removed for ease of room transfer and cleaning.
- Handle is attractive, easy-to-grip, arc style. Standard in Tungsten finish.
- Locks are optional on bedside cabinets, dressers and wardrobes.
- Metal legs and plinth bases available on all models.
- Casters are available on bedside cabinets.
- For proper ventilation, all units have cut-outs with grommets in the back.
- For environmental certifications, please visit [globalfurnituregroup.com](http://globalfurnituregroup.com).

**TOPS**

- Tops are field replaceable.
- Tops on all models are standard with 1" thermally fused laminate with coordinating 3mm PVC edge.
- 1" high pressure laminate tops with coordinating 3mm PVC edge are available on bedside cabinets and dressers. For a quotation, please submit a Special Request Form to your Global representative.
- Thermofoil and solid surface finishes are available on bedside cabinets only. See next page for finishes.

**CHASSIS**

- Constructed from ¾" thermally fused laminate.
- Return on investment is enhanced through the ability to replace chassis panels or tops should they become damaged.

**BACK**

- Back panels are constructed from ¾" thermally fused laminate
- Back panels are field replaceable should they become damaged

**DRAWERS**

- Drawer fronts are constructed from ¾" thermally fused laminate with 3mm PVC edge.
- Thermofoil finishes are available on bedside cabinets only.
- Mounted on high quality precision steel full extension ball bearing slides.
- Box drawer is 6" high with inside depth of 15.48".
- Drawer interiors are made of PVC-free Black vinyl particle board.
- Bottom drawer interior is fully wrapped in a Black colored durable vinyl covering.
- Soft close drawer is optional, specify **(SF)** at time of order. **Add \$50** per drawer.

**DRAWER INSERTS**

- The optional bedside cabinet drawer liner insert is constructed of high impact polystyrene, standard in White. Molded in one piece with no seams or joints to collect dust or bacteria, satin smooth and with rounded corners for easy clean up.
- Optional high impact polystyrene insert liner can be removed for ease of transferring personal belongings and cleaning.

**SHELVING**

- Structural fixed shelves and adjustable shelves are constructed of ¾" thermally fused laminate with coordinating 3mm PVC edge
- Structural fixed shelves and adjustable shelves are supported with metal brackets

**DOORS**

- Constructed of ¾" thermally fused laminate with 3mm PVC edge.
- Mounted utilizing commercial quality hinges that provide a 110° opening span for easy access to personal belongings.

**LOCKS**

- Locks are optional on bedside cabinets, dressers and wardrobes. They must be specified at time of order. Please check each model number for optional locks offered and applicable upcharges.
- Keying is available with random key, please specify **(RK)**, or keyed alike.
- For key alike numbering sequence, please specify key number 101 - 120. No upcharge.

**EDGE**

- Tops, door fronts and drawer fronts have coordinating 3mm PVC edge
- Fixed and adjustable shelves have coordinating 3mm PVC front edge
- Top radius is 1" on bedside cabinet edges

**VENTILATION**

- All units have cut-outs with grommets in the back for ventilation, reducing odor and bacteria growth.

**BASE OPTIONS**

- Metal legs, casters and Plinth base are field replaceable and interchangeable on Aldon where applicable.

**Metal Legs**

- Available on bedside cabinets, dressers and wardrobes
- Standard powder coated paint finishes are Black **(BLK)**, Blizzard **(BZD)**, Charcoal **(CHR)**, Kalua **(TKA)**, Latte **(TLA)**, Mocha **(TMO)**, Nevada **(NEV)**, Sierra **(SCA)**, Silver **(SIL)**, Taupe **(TPE)**, Toast **(TOA)** and Tungsten **(TUN)**.
- 3"high. Levelers offer .5" to .75" adjustment for increased stability and leveling.

**Casters**

- Available on bedside cabinets only
- Constructed of commercial quality, swivel dual wheel
- Front casters are manually locking, swivel dual wheel
- When ordering two locking casters, the casters will be in the front of the unit for ease of access, non-locking casters will be in the back

**Plinth Base**

- Available on bedside cabinets, dressers and wardrobes
- 3" high and standard in thermally fused laminate
- Levelers offer .5" to .75" adjustment for increased stability and leveling.

**HANDLES**

- Handles require a 128mm center point if custom styles are desired.
- Handle style must be specified at time of order.
- **A1** handle is standard, also offered in seven options below:



**A1**  
Arc - Sierra



**A3**  
Arc - Matte Chrome



**B1**  
Bow - Matte Chrome



**CM1**  
Contemporary Metal Pull -  
Matte Chrome



**CM2**  
Contemporary Metal Pull -  
Matte Black



**TM1**  
Transitional Metal Pull -  
Brushed Nickel



**TM2**  
Transitional Metal Pull -  
Matte Black



**RPH1** (add **\$62**/handle)  
Recessed - Silver

- Handles can be ordered separately (except for recessed handle). **Add \$32**. Please specify:  
**(GC-A1)**: Arc - Sierra  
**(GC-B1)**: Bow - Matte Chrome  
**(GC-CM1)**: Contemporary Metal Pull - Matte Chrome  
**(GC-CM2)**: Contemporary Metal Pull - Matte Black  
**(GC-TM1)**: Transitional Metal Pull - Brushed Nickel  
**(GC-TM2)**: Transitional Metal Pull - Matte Black
- Recessed handle **(RPH1)** must be specified at time of order. **Add \$62**/handle.
- For additional finish options, please contact your Global sales representative.
- To view handle finish options, visit [globalfurnituregroup.com](http://globalfurnituregroup.com) and go to the Sonoma finishes section.

**LAMINATE FINISHES - TOP AND CHASSIS**

- All laminate finishes are available with coordinating 3mm PVC edge:

Absolute Acajou (ACJ)	Noce Biondo (NBL)
Asian Night (ASN)	Noce Grigio (NGL)
Avant Cherry (AWC)	Noce Leggero (NEL)
Avant Honey (AWH)	Noce Medio (NML)
Black (BLK)	Quartered Mahogany (QTM)
Brushed Cobalt (BRC)	Sheer Beauty (SBY)
Clear Maple (CMB)	Storm Grey (SOG)
Dark Espresso (DES)	Walnut Heights (WHE)
Designer White (DWT)	White Chocolate (WHC)
Fashionista (FAS)	Winter Cherry (WCR)
First Class (FCL)	

**THERMOFOIL FINISHES - TOP AND FRONT (INCLUDING BOTTOM FASCIA)**

- Thermofoil finishes are available on bedside cabinets only.

Absolute Acajou (ACJ)
Clear Maple (CMB)
Custom Grey (CGY)
Dark Espresso (DES)
Designer White (DWT)
Fashionista (FAS)
First Class (FCL)
Sheer Beauty (SBY)
Storm Grey (SOG)
White Chocolate (WHC)

**SOLID SURFACE FINISHES - TOP ONLY**

- Available on bedside cabinets only. See models ending in "C1" or "C2".

**Grade 1 (C1)**

Designer White (SWH)

**Grade 2 (C2)**

Beige Tempest (SBT)

Hot Stone (SHS)

Northern Melange (SNM)

Black Onyx Mirage (SBX) Frosty White Mirage (SFW)

Milk Glass Spectra (SMG)

- For detailed material information, please reference WilsonArt's Solid Surface collection.



**Standard** - laminate top, front and case



**TH** - thermofoil top and front, laminate case



**THSC** - thermofoil top with spill guard and front, laminate case

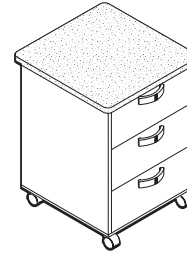

**C1/C2** - solid surface top, laminate front and case

**SPILL COLLECTOR**

- Spill collector (**SC**) is optional on the edge of bedside cabinets with Thermofoil finish only.

**CUSTOM**

- Global welcomes the opportunity to provide quotation on special requests for project business.

**SHIPPING**

- All products are shipped partially assembled, one per carton, unless otherwise noted.

BEDSIDE CABINETS	MODEL#	DIMENSIONS	FREIGHT CLASS	WT/LBS.	CUBIC FT.	LIST PRICE
------------------	--------	------------	---------------	---------	-----------	------------

D x W x H



Bedside Cabinet

GCEXBT01CN	22.14 x 21.38 x 30	92.5	96	8.5	<b>\$1221</b>
GCEXBT01CNTH	w/Thermofoil top and front				<b>\$1701</b>
GCEXBT01CNTHSC	w/Thermofoil top with spillguard and front				<b>\$1701</b>
GCEXBT01CNC1	w/solid surface top (grade 1)				<b>\$2554</b>
GCEXBT01CNC2	w/solid surface top (grade 2)				<b>\$2778</b>

Three drawers on four casters. Standard with no lock. Shipped assembled, 1 per carton.

- For lock on top drawer, specify **(LK)**. Add **\$66** list upcharge. Specify random key **(RK)** or key number 101-120.



Bedside Cabinet

GCEXBT01LN	22.14 x 21.38 x 30	92.5	96	8.5	<b>\$1300</b>
GCEXBT01LNTH	w/Thermofoil top and front				<b>\$1823</b>
GCEXBT01LNTHSC	w/Thermofoil top with spillguard and front				<b>\$1823</b>
GCEXBT01LNC1	w/solid surface top (grade 1)				<b>\$2632</b>
GCEXBT01LNC2	w/solid surface top (grade 2)				<b>\$2856</b>

Three drawers with metal legs. Standard with no lock. Shipped assembled, 1 per carton.

- For lock on top drawer, specify **(LK)**. Add **\$66** list upcharge. Specify random key **(RK)** or key number 101-120.

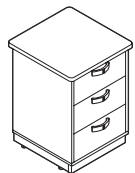





Bedside Cabinet

GCEXBT01PN	22.14 x 21.38 x 30	92.5	96	8.5	<b>\$1348</b>
GCEXBT01PNTH	w/Thermofoil top and front				<b>\$1833</b>
GCEXBT01PNTHSC	w/Thermofoil top with spillguard and front				<b>\$1833</b>
GCEXBT01PNC1	w/solid surface top (grade 1)				<b>\$2680</b>
GCEXBT01PNC2	w/solid surface top (grade 2)				<b>\$2906</b>

Three drawers on plinth base. Standard with no lock. Shipped assembled, 1 per carton.

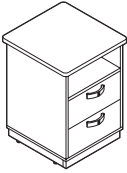
- For lock on top drawer, specify **(LK)**. Add **\$66** list upcharge. Specify random key **(RK)** or key number 101-120.

BESIDE CABINETS	MODEL#	DIMENSIONS D x W x H	FREIGHT CLASS	WT/LBS.	CUBIC FT.	LIST PRICE
 <p><b>Bedside Cabinet</b></p>	GCEXBT04CN	22.14 x 21.38 x 30	92.5	94	8.5	<b>\$1172</b>
	GCEXBT04CNTH	w/Thermofoil top and front				<b>\$1593</b>
	GCEXBT04CNTHSC	w/Thermofoil top with spillguard and front				<b>\$1593</b>
	GCEXBT04CNC1	w/solid surface top (grade 1)				<b>\$2504</b>
	GCEXBT04CNC2	w/solid surface top (grade 2)				<b>\$2730</b>
<p>One open fixed shelf and two drawers, on four casters. Standard with no lock. Shipped assembled, 1 per carton.</p> <ul style="list-style-type: none"> <li>For lock on top drawer, specify <b>(LK)</b>. Add <b>\$83</b> list upcharge. Specify random key <b>(RK)</b> or key number 101-120.</li> </ul>						
 <p><b>Bedside Cabinet</b></p>	GCEXBT04LN	22.14 x 21.38 x 30	92.5	94	8.5	<b>\$1250</b>
	GCEXBT04LNTH	w/Thermofoil top and front				<b>\$1721</b>
	GCEXBT04LNTHSC	w/Thermofoil top with spillguard and front				<b>\$1721</b>
	GCEXBT04LNC1	w/solid surface top (grade 1)				<b>\$2582</b>
	GCEXBT04LNC2	w/solid surface top (grade 2)				<b>\$2808</b>
<p>One open fixed shelf and two drawers, with metal legs. Standard with no lock. Shipped assembled, 1 per carton.</p> <ul style="list-style-type: none"> <li>For lock on top drawer, specify <b>(LK)</b>. Add <b>\$83</b> list upcharge. Specify random key <b>(RK)</b> or key number 101-120.</li> </ul>						
 <p><b>Bedside Cabinet</b></p>	GCEXBT04PN	22.14 x 21.38 x 30	92.5	94	8.5	<b>\$1284</b>
	GCEXBT04PNTH	w/Thermofoil top and front				<b>\$1711</b>
	GCEXBT04PNTHSC	w/Thermofoil top with spillguard and front				<b>\$1711</b>
	GCEXBT04PNC1	w/solid surface top (grade 1)				<b>\$2617</b>
	GCEXBT04PNC2	w/solid surface top (grade 2)				<b>\$2842</b>
<p>One open fixed shelf and two drawers, on plinth base. Standard with no lock. Shipped assembled, 1 per carton.</p> <ul style="list-style-type: none"> <li>For lock on top drawer, specify <b>(LK)</b>. Add <b>\$83</b> list upcharge. Specify random key <b>(RK)</b> or key number 101-120.</li> </ul>						

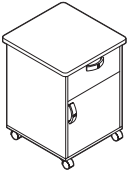
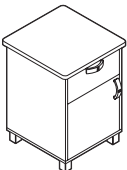
BEDSIDE CABINETS	MODEL#	DIMENSIONS D x W x H	FREIGHT CLASS	WT/LBS.	CUBIC FT.	LIST PRICE
 <p><b>Bedside Cabinet</b></p>	GCEXBT06CLN	22.14 x 21.38 x 30	92.5	92	8.5	<b>\$1113</b>
	GCEXBT06CLNTH	w/Thermofoil top and front				<b>\$1637</b>
	GCEXBT06CLNTHSC	w/Thermofoil top with spillguard and front				<b>\$1637</b>
	GCEXBT06CLNC1	w/solid surface top (grade 1)				<b>\$2446</b>
	GCEXBT06CLNC2	w/solid surface top (grade 2)				<b>\$2671</b>
<p>Top position drawer, one <b>left</b> opening door (hinges on left) with 3 position adjustable shelf behind door, on four casters. Standard with no locks. Shipped assembled, 1 per carton.</p> <ul style="list-style-type: none"> <li>• For lock on drawer, specify <b>(LK)</b>. Add <b>\$66</b> list upcharge.</li> <li>• For lock on door, specify <b>(L3)</b>. Add <b>\$66</b> list upcharge.</li> <li>• For locks on drawer and door, specify <b>(L5)</b>. Add <b>\$132</b> list upcharge.</li> <li>• Specify random key <b>(RK)</b> or key number 101-120.</li> </ul>						
 <p><b>Bedside Cabinet</b></p>	GCEXBT06CRN	22.14 x 21.38 x 30	92.5	92	8.5	<b>\$1113</b>
	GCEXBT06CRNTH	w/Thermofoil top and front				<b>\$1637</b>
	GCEXBT06CRNTHSC	w/Thermofoil top with spillguard and front				<b>\$1637</b>
	GCEXBT06CRNC1	w/solid surface top (grade 1)				<b>\$2446</b>
	GCEXBT06CRNC2	w/solid surface top (grade 2)				<b>\$2671</b>
<p>Top position drawer, one <b>right</b> opening door (hinges on right) with 3 position adjustable shelf behind door, on four casters. Standard with no locks. Shipped assembled, 1 per carton.</p> <ul style="list-style-type: none"> <li>• For lock on drawer, specify <b>(LK)</b>. Add <b>\$66</b> list upcharge.</li> <li>• For lock on door, specify <b>(L4)</b>. Add <b>\$66</b> list upcharge.</li> <li>• For locks on drawer and door, specify <b>(L6)</b>. Add <b>\$132</b> list upcharge.</li> <li>• Specify random key <b>(RK)</b> or key number 101-120.</li> </ul>						
 <p><b>Bedside Cabinet</b></p>	GCEXBT06LLN	22.14 x 21.38 x 30	92.5	92	8.5	<b>\$1186</b>
	GCEXBT06LLNTH	w/Thermofoil top and front				<b>\$1749</b>
	GCEXBT06LLNTHSC	w/Thermofoil top with spillguard and front				<b>\$1749</b>
	GCEXBT06LLNC1	w/solid surface top (grade 1)				<b>\$2518</b>
	GCEXBT06LLNC2	w/solid surface top (grade 2)				<b>\$2744</b>
<p>Top position drawer, one <b>left</b> opening door (hinges on left) with 3 position adjustable shelf behind door, with metal legs. Standard with no locks. Shipped assembled, 1 per carton.</p> <ul style="list-style-type: none"> <li>• For lock on drawer, specify <b>(LK)</b>. Add <b>\$66</b> list upcharge.</li> <li>• For lock on door, specify <b>(L3)</b>. Add <b>\$66</b> list upcharge.</li> <li>• For locks on drawer and door, specify <b>(L5)</b>. Add <b>\$132</b> list upcharge.</li> <li>• Specify random key <b>(RK)</b> or key number 101-120.</li> </ul>						

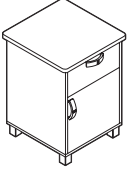
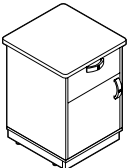
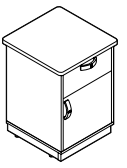

BEDSIDE CABINETS	MODEL#	DIMENSIONS D x W x H	FREIGHT CLASS	WT/LBS.	CUBIC FT.	LIST PRICE
	GCEXBT06LRN	22.14 x 21.38 x 30	92.5	92	8.5	<b>\$1186</b>
	GCEXBT06LRNTH	w/Thermofoil top and front				<b>\$1749</b>
	GCEXBT06LRNTHSC	w/Thermofoil top with spillguard and front				<b>\$1749</b>
	GCEXBT06LRNC1	w/solid surface top (grade 1)				<b>\$2518</b>
	GCEXBT06LRNC2	w/solid surface top (grade 2)				<b>\$2744</b>
	<p>Top position drawer, one <b>right</b> opening door (hinges on right) with 3 position adjustable shelf behind door, with metal legs. Standard with no locks. Shipped assembled, 1 per carton.</p> <ul style="list-style-type: none"> <li>• For lock on drawer, specify <b>(LK)</b>. Add <b>\$66</b> list upcharge.</li> <li>• For lock on door, specify <b>(L4)</b>. Add <b>\$66</b> list upcharge.</li> <li>• For locks on drawer and door, specify <b>(L6)</b>. Add <b>\$132</b> list upcharge.</li> <li>• Specify random key <b>(RK)</b> or key number 101-120.</li> </ul>					
	GCEXBT06PLN	22.14 x 21.38 x 30	92.5	92	8.5	<b>\$1186</b>
	GCEXBT06PLNTH	w/Thermofoil top and front				<b>\$1749</b>
	GCEXBT06PLNTHSC	w/Thermofoil top with spillguard and front				<b>\$1749</b>
	GCEXBT06PLNC1	w/solid surface top (grade 1)				<b>\$2518</b>
	GCEXBT06PLNC2	w/solid surface top (grade 2)				<b>\$2744</b>
	<p>Top position drawer, one <b>left</b> opening door (hinges on left) with 3 position adjustable shelf behind door, on plinth base. Standard with no locks. Shipped assembled, 1 per carton.</p> <ul style="list-style-type: none"> <li>• For lock on drawer, specify <b>(LK)</b>. Add <b>\$66</b> list upcharge.</li> <li>• For lock on door, specify <b>(L3)</b>. Add <b>\$66</b> list upcharge.</li> <li>• For locks on drawer and door, specify <b>(L5)</b>. Add <b>\$132</b> list upcharge.</li> <li>• Specify random key <b>(RK)</b> or key number 101-120.</li> </ul>					
	GCEXBT06PRN	22.14 x 21.38 x 30	92.5	92	8.5	<b>\$1186</b>
	GCEXBT06PRNTH	w/Thermofoil top and front				<b>\$1749</b>
	GCEXBT06PRNTHSC	w/Thermofoil top with spillguard and front				<b>\$1749</b>
	GCEXBT06PRNC1	w/solid surface top (grade 1)				<b>\$2518</b>
	GCEXBT06PRNC2	w/solid surface top (grade 2)				<b>\$2744</b>
	<p>Top position drawer, one <b>right</b> opening door (hinges on right) with 3 position adjustable shelf behind door, on plinth base. Standard with no locks. Shipped assembled, 1 per carton.</p> <ul style="list-style-type: none"> <li>• For lock on drawer, specify <b>(LK)</b>. Add <b>\$66</b> list upcharge.</li> <li>• For lock on door, specify <b>(L4)</b>. Add <b>\$66</b> list upcharge.</li> <li>• For locks on drawer and door, specify <b>(L6)</b>. Add <b>\$132</b> list upcharge.</li> <li>• Specify random key <b>(RK)</b> or key number 101-120.</li> </ul>					

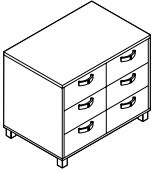
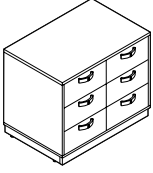
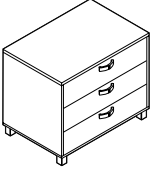
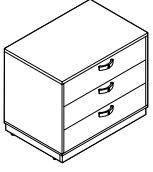
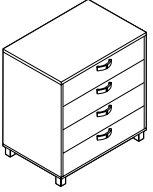
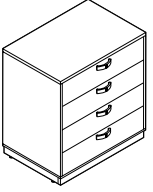
DRESSERS	MODEL#	DIMENSIONS D x W x H	FREIGHT CLASS	WT/LBS.	CUBIC FT.	LIST PRICE
	GCEXDD01LN	24.13 x 36.19 x 30	92.5	180	18	\$2185
<b>Double Dresser</b>	<p>Three drawers on each side, on metal legs. Standard with no locks. Shipped assembled, 1 per carton.</p> <ul style="list-style-type: none"> <li>• For lock on top right drawer, specify <b>(LR)</b>. Add <b>\$66</b> list upcharge.</li> <li>• For lock on top left drawer, specify <b>(LL)</b>. Add <b>\$66</b> list upcharge.</li> <li>• For lock on top right and left drawers, specify <b>(L8)</b>. Add <b>\$132</b> list upcharge.</li> <li>• Specify random key <b>(RK)</b> or key number 101-120.</li> </ul>					
	GCEXDD01PN	24.13 x 36.19 x 30	92.5	180	18	\$2259
<b>Double Dresser</b>	<p>Three drawers on each side, on plinth base. Standard with no locks. Shipped assembled, 1 per carton.</p> <ul style="list-style-type: none"> <li>• For lock on top right drawer, specify <b>(LR)</b>. Add <b>\$66</b> list upcharge.</li> <li>• For lock on top left drawer, specify <b>(LL)</b>. Add <b>\$66</b> list upcharge.</li> <li>• For lock on top right and left drawers, specify <b>(L8)</b>. Add <b>\$132</b> list upcharge.</li> <li>• Specify random key <b>(RK)</b> or key number 101-120.</li> </ul>					
	GCEXDR02LN	24.13 x 35.63 x 30	100	142	17	\$1803
<b>3 Drawer Dresser</b>	<p>Three drawers on metal legs. Standard with no lock. Shipped assembled, 1 per carton.</p> <ul style="list-style-type: none"> <li>• For lock on top drawer, specify <b>(LK)</b>. Add <b>\$66</b> list upcharge.</li> </ul>					
	GCEXDR02PN	24.13 x 35.63 x 30	100	142	17	\$1877
<b>3 Drawer Dresser</b>	<p>Three drawers on plinth base. Standard with no lock. Shipped assembled, 1 per carton.</p> <ul style="list-style-type: none"> <li>• For lock on top drawer, specify <b>(LK)</b>. Add <b>\$66</b> list upcharge.</li> </ul>					
	GCEXDR07LN	24.13 x 35.63 x 38.5	125	153	22	\$2078
<b>4 Drawer Dresser</b>	<p>Four drawers on metal legs. Standard with no lock. Shipped assembled, 1 per carton.</p> <ul style="list-style-type: none"> <li>• For lock on top drawer, specify <b>(LK)</b>. Add <b>\$66</b> list upcharge.</li> </ul>					
	GCEXDR07PN	24.13 x 35.63 x 38.5	125	153	22	\$2176
<b>4 Drawer Dresser</b>	<p>Four drawers on plinth base. Standard with no lock. Shipped assembled, 1 per carton.</p> <ul style="list-style-type: none"> <li>• For lock on top drawer, specify <b>LK</b>. Add <b>\$66</b> list upcharge.</li> </ul>					

## BEDSIDE DRAWER LINER

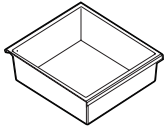

Bedside Drawer Liner

MODEL#	DIMENSIONS	FREIGHT CLASS	WT/LBS.	CUBIC FT.	LIST PRICE
	D x W x H				
GCEXLLP01	15.5 x 16.5 x 4.5	250	3.5	1	\$83

High impact polystyrene insert liner for bedside cabinet 6" drawers. Can be removed for ease of room transfer and cleaning. Shipped assembled, 1 per carton.

## WARDROBE CABINETS

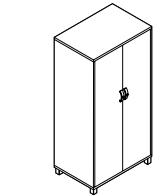

Wardrobe Cabinet

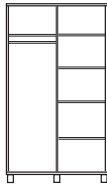

MODEL#	DIMENSIONS	FREIGHT CLASS	WT/LBS.	CUBIC FT.	LIST PRICE
GCEXWD03LN	24.13 x 35.63 x 72	125	305	43	\$2558

Inside dimensions:

- Left side top shelf: 12.85"
- Left side clothing rail area: 53.2"
- Right side with adjustable shelves area: 66.59"

Divided wardrobe with J-style safety clothing rail and shelves, on 5 metal legs. Two doors covering interior divided in two with an upper fixed shelf and J-style safety clothing rail on the left side. The right side has four adjustable shelves. For safety, anti-tip hardware is recommended. Anti-tip security kits are available separately; order product code GCAT400 and quantity required. Standard with no lock. Shipped assembled, 1 per carton.

- For one lock fastening both doors, specify **(LB)**. Add \$66 list upcharge. Specify random key **(RK)** or key number 101-120.

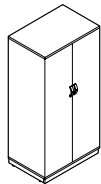

Wardrobe Cabinet

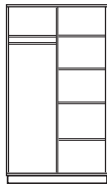

Inside dimensions:

- Left side top shelf: 12.85"
- Left side clothing rail area: 53.2"
- Right side with adjustable shelves area: 66.59"

Divided wardrobe with J-style safety clothing rail and shelves, on plinth base. Two doors covering interior divided in two with an upper fixed shelf and J-style safety clothing rail on the left side. The right side has four adjustable shelves. For safety, anti-tip hardware is recommended. Anti-tip security kits are available separately; order product code GCAT400 and quantity required. Standard with no lock. Shipped assembled, 1 per carton.

- For one lock fastening both doors, specify **(LB)**. Add \$66 list upcharge. Specify random key **(RK)** or key number 101-120.

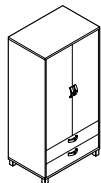

Wardrobe Cabinet

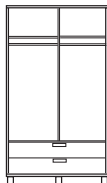

Inside dimensions:

- Left side top shelf: 7"
- Left side clothing rail area: 42"
- Right side top shelf: 7"
- Right side clothing rail area: 42"
- Top drawer: 8.25"
- Lower drawer: 8.25"

Divided wardrobe with J-style safety clothing rail and two full drawers below, on 5 metal legs. Two doors covering interior divided in two with an upper fixed shelf and J-style safety clothing rail on both sides. Two exposed drawers below. For safety, anti-tip hardware is recommended. Anti-tip security kits are available separately; order product code GCAT400 and quantity required. Standard with no locks. Shipped assembled, 1 per carton.

- For lock on right door, specify **(L4)**. Add \$132 list upcharge.
- For lock on left door, specify **(L3)**. Add \$66 list upcharge.
- For lock on both right and left doors, specify **(L2)**. Add \$132 list upcharge.
- For lock on top drawer, specify **(LK)**. Add \$66 list upcharge.
- For lock on right door and top drawer, specify **(L6)**. Add \$132 list upcharge.
- For lock on left door and top drawer, specify **(L5)**. Add \$132 list upcharge.
- For lock on right door, left door and top drawer, specify **(L9)**. Add \$198 list upcharge.
- Specify random key **(RK)** or key number 101-120.

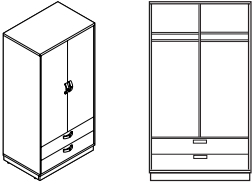
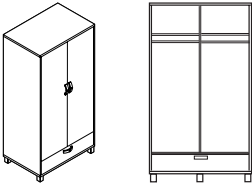
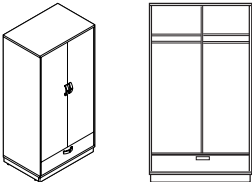
WARDROBE CABINETS	MODEL#	DIMENSIONS D x W x H	FREIGHT CLASS	WT/LBS.	CUBIC FT.	LIST PRICE
 <p><b>Wardrobe Cabinet</b></p>	GCEXWD04PN	24.13 x 35.63 x 72	125	316	43	<b>\$3253</b>
<p>Inside dimensions:</p> <ul style="list-style-type: none"> <li>• Left side top shelf: 7"</li> <li>• Left side clothing rail area: 42"</li> <li>• Right side top shelf: 7"</li> <li>• Right side clothing rail area: 42"</li> <li>• Top drawer: 8.25"</li> <li>• Lower drawer: 8.25"</li> </ul> <p>Divided wardrobe with J-style safety clothing rail and two full drawers below, on plinth base. Two doors covering interior divided in two with an upper fixed shelf and J-style safety clothing rail on both sides. Two exposed drawers below. For safety, anti-tip hardware is recommended. Anti-tip security kits are available separately; order product code GCAT400 and quantity required. Standard with no locks. Shipped assembled, 1 per carton.</p> <ul style="list-style-type: none"> <li>• For lock on right door, specify <b>(L4)</b>. Add <b>\$132</b> list upcharge.</li> <li>• For lock on left door, specify <b>(L3)</b>. Add <b>\$66</b> list upcharge.</li> <li>• For lock on both right and left doors, specify <b>(L2)</b>. Add <b>\$132</b> list upcharge.</li> <li>• For lock on top drawer, specify <b>(LK)</b>. Add <b>\$66</b> list upcharge.</li> <li>• For lock on right door and top drawer, specify <b>(L6)</b>. Add <b>\$132</b> list upcharge.</li> <li>• For lock on left door and top drawer, specify <b>(L5)</b>. Add <b>\$132</b> list upcharge.</li> <li>• For lock on right door, left door and top drawer, specify <b>(L9)</b>. Add <b>\$198</b> list upcharge.</li> <li>• Specify random key <b>(RK)</b> or key number 101-120.</li> </ul>						
 <p><b>Wardrobe Cabinet</b></p>	GCEXWD05LN	24.13 x 35.63 x 72	125	305	43	<b>\$3121</b>
<p>Inside dimensions:</p> <ul style="list-style-type: none"> <li>• Left side top shelf: 7"</li> <li>• Left side clothing rail area: 42"</li> <li>• Right side top shelf: 7"</li> <li>• Right side clothing rail area: 42"</li> <li>• Top drawer: 8.25"</li> <li>• Lower drawer: 8.25"</li> </ul> <p>Divided wardrobe with J-style safety clothing rail and two full drawers below, on 5 metal legs. Two doors covering interior divided in two with an upper fixed shelf and J-style safety clothing rail on both sides. Two exposed drawers below. For safety, anti-tip hardware is recommended. Anti-tip security kits are available separately; order product code GCAT400 and quantity required. Standard with no locks. Shipped assembled, 1 per carton.</p> <ul style="list-style-type: none"> <li>• For lock on right door, specify <b>(L4)</b>. Add <b>\$132</b> list upcharge.</li> <li>• For lock on left door, specify <b>(L3)</b>. Add <b>\$66</b> list upcharge.</li> <li>• For lock on both right and left doors, specify <b>(L2)</b>. Add <b>\$132</b> list upcharge.</li> <li>• For lock on drawer, specify <b>(LK)</b>. Add <b>\$66</b> list upcharge.</li> <li>• For lock on right door and drawer, specify <b>(L6)</b>. Add <b>\$132</b> list upcharge.</li> <li>• For lock on left door and drawer, specify <b>(L5)</b>. Add <b>\$132</b> list upcharge.</li> <li>• For locks on right door, left door and drawer, specify <b>(L9)</b>. Add <b>\$198</b> list upcharge.</li> <li>• Specify random key <b>(RK)</b> or key number 101-120.</li> </ul>						
 <p><b>Wardrobe Cabinet</b></p>	GCEXWD05PN	24.13 x 35.63 x 72	125	305	43	<b>\$3146</b>
<p>Inside dimensions:</p> <ul style="list-style-type: none"> <li>• Left side top shelf: 7"</li> <li>• Left side clothing rail area: 42"</li> <li>• Right side top shelf: 7"</li> <li>• Right side clothing rail area: 42"</li> <li>• Top drawer: 8.25"</li> <li>• Lower drawer: 8.25"</li> </ul> <p>Divided wardrobe with J-style safety clothing rail and two full drawers below, on plinth base. Two doors covering interior divided in two with an upper fixed shelf and J-style safety clothing rail on both sides. Two exposed drawers below. For safety, anti-tip hardware is recommended. Anti-tip security kits are available separately; order product code GCAT400 and quantity required. Standard with no locks. Shipped assembled, 1 per carton.</p> <ul style="list-style-type: none"> <li>• For lock on right door, specify <b>(L4)</b>. Add <b>\$132</b> list upcharge.</li> <li>• For lock on left door, specify <b>(L3)</b>. Add <b>\$66</b> list upcharge.</li> <li>• For lock on both right and left doors, specify <b>(L2)</b>. Add <b>\$132</b> list upcharge.</li> <li>• For lock on drawer, specify <b>(LK)</b>. Add <b>\$66</b> list upcharge.</li> <li>• For lock on right door and drawer, specify <b>(L6)</b>. Add <b>\$132</b> list upcharge.</li> <li>• For lock on left door and drawer, specify <b>(L5)</b>. Add <b>\$132</b> list upcharge.</li> <li>• For locks on right door, left door and drawer, specify <b>(L9)</b>. Add <b>\$198</b> list upcharge.</li> <li>• Specify random key <b>(RK)</b> or key number 101-120.</li> </ul>						

## NARROW WARDROBE CABINETS

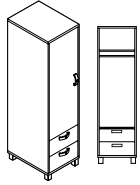

Narrow Wardrobe Cabinet

## MODEL# DIMENSIONS FREIGHT CLASS WT/LBS. CUBIC FT. LIST PRICE

D x W x H

MODEL#	DIMENSIONS	FREIGHT CLASS	WT/LBS.	CUBIC FT.	LIST PRICE
GCEXWN02LLN	24.13 x 18.63 x 72	150	136	24	\$2294

Inside dimensions:

- Top shelf: 7"
- Clothing rail area: 42"
- Top drawer: 8.25"
- Lower drawer: 8.25"

Narrow wardrobe with J-style safety clothing rail and two drawers below, on four metal legs. One **left** door (hinges on left) covering upper fixed shelf and J-style safety clothing rail. Two exposed drawers below. For safety, anti-tip hardware is recommended. Anti-tip security kits are available separately; order product code GCAT400 and quantity required. Standard with no locks. Shipped assembled, 1 per carton.

- For lock on top drawer, specify **(LK)**. Add **\$83** list upcharge.
- For lock on door, specify **(L3)**. Add **\$66** list upcharge.
- For locks on door and top drawer, specify **(L5)**. Add **\$132** list upcharge.
- Specify random key **(RK)** or key number 101-120.

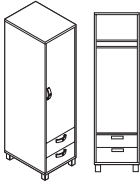

Narrow Wardrobe Cabinet

MODEL#	DIMENSIONS	FREIGHT CLASS	WT/LBS.	CUBIC FT.	LIST PRICE
GCEXWN02LRN	24.13 x 18.63 x 72	150	136	24	\$2294

Inside dimensions:

- Top shelf: 7"
- Clothing rail area: 42"
- Top drawer: 8.25"
- Lower drawer: 8.25"

Narrow wardrobe with J-style safety clothing rail and two drawers below, on four metal legs. One **right** door (hinges on right) covering upper fixed shelf and J-style safety clothing rail. Two exposed drawers below. For safety, anti-tip hardware is recommended. Anti-tip security kits are available separately; order product code GCAT400 and quantity required. Standard with no locks. Shipped assembled, 1 per carton.

- For lock on top drawer, specify **(LK)**. Add **\$83** list upcharge.
- For lock on door, specify **(L4)**. Add **\$66** list upcharge.
- For locks on door and top drawer, specify **(L6)**. Add **\$132** list upcharge.
- Specify random key **(RK)** or key number 101-120.

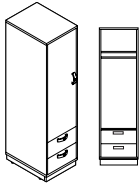

Narrow Wardrobe Cabinet

MODEL#	DIMENSIONS	FREIGHT CLASS	WT/LBS.	CUBIC FT.	LIST PRICE
GCEXWN02PLN	24.13 x 18.63 x 72	150	136	24	\$2171

Inside dimensions:

- Top shelf: 7"
- Clothing rail area: 42"
- Top drawer: 8.25"
- Lower drawer: 8.25"

Narrow wardrobe with J-style safety clothing rail and two drawers below, on plinth base. One **left** door (hinges on left) covering upper fixed shelf and J-style safety clothing rail. Two exposed drawers below. For safety, anti-tip hardware is recommended. Anti-tip security kits are available separately; order product code GCAT400 and quantity required. Standard with no locks. Shipped assembled, 1 per carton.

- For lock on top drawer, specify **(LK)**. Add **\$83** list upcharge.
- For lock on door, specify **(L3)**. Add **\$66** list upcharge.
- For locks on door and top drawer, specify **(L5)**. Add **\$132** list upcharge.
- Specify random key **(RK)** or key number 101-120.

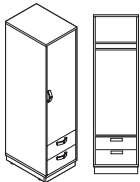

Narrow Wardrobe Cabinet

MODEL#	DIMENSIONS	FREIGHT CLASS	WT/LBS.	CUBIC FT.	LIST PRICE
GCEXWN02PRN	24.13 x 18.63 x 72	150	136	24	\$2171

Inside dimensions:

- Top shelf: 7"
- Clothing rail area: 42"
- Top drawer: 8.25"
- Lower drawer: 8.25"

Narrow wardrobe with J-style safety clothing rail and two drawers below, on plinth base. One **right** door (hinges on right) covering upper fixed shelf and J-style safety clothing rail. Two exposed drawers below. For safety, anti-tip hardware is recommended. Anti-tip security kits are available separately; order product code GCAT400 and quantity required. Standard with no locks. Shipped assembled, 1 per carton.

- For lock on top drawer, specify **(LK)**. Add **\$83** list upcharge.
- For lock on door, specify **(L4)**. Add **\$66** list upcharge.
- For locks on door and top drawer, specify **(L6)**. Add **\$132** list upcharge.
- Specify random key **(RK)** or key number 101-120.

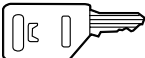
ACCESSORIES	MODEL#	DIMENSIONS	FREIGHT CLASS	WT/LBS.	CUBIC FT.	LIST PRICE
 <p><b>Replacement Lock Set</b></p>	AL00975COREK	D x W x H --	-	--	--	<b>\$62</b>
 <p><b>Replacement Key</b></p>	AL00975KEY	--	-	--	--	<b>\$25</b>
<p>Replacement core and key.</p> <hr/> <p>Replacement key for bedside cabinets, dressers and wardrobes. Specify key number __-__</p> <hr/> <p>For Aldon accessories, please refer to the models listed under Sonoma:</p> <ul style="list-style-type: none"> <li>• Safety garment hook: page 31</li> <li>• Headboards/footboards: page 32</li> <li>• Wardrobe mirror (for door 11"W x 29"H): page 32</li> </ul>						



Sonoma offers superior construction detail in an extensive selection of furniture pieces to fit the personal storage requirements of various lifestyle environments including long-term care, retirement, senior living residences and hospitals.

Features distinctive aluminum extrusions on all leading corners allowing for a continuous connection of chassis panels from top to bottom providing enhanced performance and durability. The aluminum extrusions offer increased protection from the impact of mobile equipment and furniture used in demanding healthcare environments.

Products have ventilation and drainage features built into the unique design providing air circulation and drainage where required. Products are freestanding allowing access underneath for cleaning.

Features decorative fascia options for enhancing the decor of any environment with the additional benefit of providing a safety guard to prevent items from falling behind units.

Wardrobe cabinets offer a safety garment hook with a safety feature to support a maximum of 75 lbs. The J-style safety clothing rail ensures maximum wellbeing and peace of mind from accidents.

Multiple needs and requirements are met with the several styles and variety of interior configurations.

**Features and benefits**

- Tops for units 37.5" or lower are constructed with 1" high pressure laminate
- Tops for units above 37.5" in height and structural fixed shelves are constructed of 1" thermally fused laminate
- Chassis, back panels, drawer fronts, adjustable shelves, doors and fascia profiles are constructed of 0.75" thermally fused laminate
- 3mm polymer edge with top over side panel design
- Constructed with NAUF (no added urea formaldehyde) particle board
- Laminate finishes are available in a variety of colors
- Thermofoil finishes are available on bedside cabinets. See notes for order requirements.
- All chassis panels and tops can be replaced if damaged
- Drawers are mounted on high quality precision steel full extension ball bearing slides
- Locks are optional on the top drawer position of all units
- Aluminum extrusions, legs and plastic parts are available in twelve paint finishes.
- Casters are available on bedside units
- Handles are offered in multiple styles
- For environmental certifications, please visit [globalfurnituregroup.com](http://globalfurnituregroup.com)

**ACCESSORIES**

- A complementary line of accessories is available to complete and enhance any room or setting.
- Bookcases offer the same superior construction utilizing aluminum extrusions on each corner and are available in several heights.

**TOPS**

- Units of 37.5" or lower are constructed with 1" high pressure laminate with coordinating 3mm polymer edge.
- Units above 37.5" in height are constructed with 1" thermally fused laminate with coordinating 3mm polymer edge.
- Thermofoil finishes are available on bedside cabinets only. See page 20 for finishes.

**CHASSIS**

- Constructed from 0.75" thermally fused laminate.
- Connected using aluminum extrusions allowing for a continuous connection top to bottom.
- Return on investment is enhanced through the ability to replace chassis panels or tops should they become damaged.

**BACK**

- Back panels are constructed from 0.75" thermally fused laminate.

**DRAWERS**

- Drawer fronts are constructed of ¾" thermally fused laminate with 3mm PVC edge.
- Thermofoil finishes are available on bedside cabinets only.
- Mounted on high quality precision steel full extension ball bearing slides.
- Drawer depth is determined by the individual product size:  
20"D cabinets feature 15.5" drawers.  
22"D products feature 17.25" drawers.
- Bottom drawer interior is fully wrapped in a White colored, durable vinyl covering. This vinyl wrap offers superior durability and performance in demanding environments.
- Soft close drawer is optional, specify **(SF)** at time of order. Add **\$50** per drawer.

**DRAWER INSERTS**

- The optional bedside cabinet drawer liner insert and personal organizer tray sets are constructed of high impact styrene plastic in a neutral color (French Vanilla). See page 32 for purchase information.
- High impact styrene plastic liners have been specially designed to saddle the drawer edges for a perfect fit while eliminating gaps and potential traps.
- High impact styrene plastic insert liner and organizer tray set can be removed for ease of room transfer and cleaning.

**SHELVING**

- Structural fixed shelves are constructed of 1" thermally fused laminate with coordinating self edge.
- Adjustable shelves are constructed of 0.75" thermally fused laminate with coordinating self edge.
- Shelf pins are offered for securing shelf with self-drilling screws to prevent accidental movement.

**DOORS**

- Constructed of 0.75" thermally fused laminate with 3mm PVC edge.
- Mounted utilizing commercial quality hinges that provide a 170° opening span for easy access to personal belongings.

**LOCKS**

- A lock is optional on the top drawer position of all units with drawers. Must be specified at time of order.
- Random keying will be provided as standard when locks are ordered.
- For key alike numbering sequence, please specify keys number 401-440.
- For specifying lock on top drawer, indicate **(LS)** (lock set) after model number. Add **\$66**.
- Electronic lock **(EL)** available on select models. Add **\$186**.

**ALUMINUM EXTRUSIONS/LEGS/PLASTIC PARTS**

- Aluminum extrusions form the structural integrity of the product, ensuring a continuous solid connection for the unit chassis as well as providing leg support.
- The aluminum extrusion connection/leg is extended to allow clearance under each unit for access during cleaning.
- The aluminum extrusion connection/leg is standard with Charcoal color plastic glide and a non-marking leveler.
- Levelers offer 0.5" adjustment for increased stability and leveling.
- Standard powder coated paint finishes are Black **(BLK)**, Blizzard **(BZD)**, Charcoal **(CHR)**, Kalua **(TKA)**, Latte **(TLA)**, Mocha **(TMO)**, Nevada **(NEV)**, Sierra **(SCA)**, Silver **(SIL)**, Taupe **(TPE)**, Toast **(TOA)**. Finish must be specified at time of order.
- Tungsten **(TUN)** finish is available at a **10% upcharge**.
- Custom powder coated paint finishes are available. Please contact customer care for further details.

**CASTERS**

- Available only on specific units.
- Products allowing use of casters are identified by the product code followed by a **(C)**.
- Casters must be specified at time of order.
- Casters cannot be retrofitted in the field.
- Casters are commercial quality, swivel dual wheel manual locking.
- When ordering two locking casters, the casters will be in the front of the unit for ease of access. Non-locking casters will be in the back.

**HANDLES**

- Handles require a 128mm center point if custom styles are desired.
- Handle style must be specified at time of order.



**A1**  
Arc - Sierra



**B1**  
Bow - Matte Chrome



**CM1**  
Contemporary Metal Pull -  
Matte Chrome



**CM2**  
Contemporary Metal Pull -  
Matte Black



**TM1**  
Transitional Metal Pull -  
Brushed Nickel



**TM2**  
Transitional Metal Pull -  
Matte Black



**RPH1** (add **\$62**/handle)  
Recessed - Silver

- Handles can be ordered separately (except for recessed handle). Add **\$32**.

Please specify:

**(GC-A1):** Arc - Sierra

**(GC-CM2):** Contemporary Metal Pull - Matte Black

**(GC-B1):** Bow - Matte Chrome

**(GC-TM1):** Transitional Metal Pull - Brushed Nickel

**(GC-CM1):** Contemporary Metal  
Pull - Matte Chrome

**(GC-TM2):** Transitional Metal Pull - Matte Black

- Recessed handle **(RPH1)** must be specified at time of order. Add **\$62**/handle.
- For additional finish options, please contact your Global sales representative.
- To view handle finish options, visit [globalfurnituregroup.com](http://globalfurnituregroup.com) and go to the Sonoma finishes section.



## OPTIONAL DECORATIVE TOP FASCIA FOR BEDSIDE CABINETS ONLY

- Top fascia keeps items from falling off the back of the unit. The top fascia profile is installed on site.
- Top fascia is available only in laminate, in two styles Linear (TPLN) or Arc (TPAR). **Add \$74.**
- Fascia profiles are constructed of 0.75" thermally fused laminate, with all leading edges offering a coordinating self edge finish.
- Top fascia is not available with Thermofoil or Solid Surface finishes.
- Bottom fascia is always linear.
- Fascia style must be specified at time of order.



Arc (TPAR)



Linear (TPLN)

- Custom designed fascia options are available. Please contact your Global sales representative.

## LAMINATE FINISHES - TOP AND CHASSIS

- All laminate finishes are available with coordinating 3mm polymer edge:

Absolute Acajou (ACJ)  
 Asian Night (ASN)  
 Avant Cherry (AWC)  
 Avant Honey (AWH)  
 Black (BLK)  
 Brushed Cobalt (BRC)  
 Clear Maple (CMB)  
 Dark Espresso (DES)  
 Designer White (DWT)  
 Fashionista (FAS)  
 First Class (FCL)

Noce Biondo (NBL)  
 Noce Grigio (NGL)  
 Noce Leggero (NEL)  
 Noce Medio (NML)  
 Quartered Mahogany (QTM)  
 Sheer Beauty (SBY)  
 Storm Grey (SOG)  
 Walnut Heights (WHE)  
 White Chocolate (WHC)  
 Winter Cherry (WCR)

## THERMOFOIL FINISHES - TOP AND FRONT (INCLUDING BOTTOM FASCIA)

- Thermofoil finishes are available on bedside cabinets only.

Absolute Acajou (ACJ)  
 Clear Maple (CMB)  
 Custom Grey (CGY)  
 Dark Espresso (DES)  
 Designer White (DWT)  
 Fashionista (FAS)  
 First Class (FCL)  
 Sheer Beauty (SBY)  
 Storm Grey (SOG)  
 White Chocolate (WHC)

## SOLID SURFACE FINISHES - TOP ONLY

- Solid surface finishes are available on bedside cabinets only. See models ending in "C1" or "C2".

### Grade 1 (C1)

Designer White (SWH)

### Grade 2 (C2)

Beige Tempest (SBT)

Hot Stone (SHS)

Northern Melange (SNM)

Black Onyx Mirage (SBX)

Frosty White Mirage (SFW)

Milk Glass Spectra (SMG)

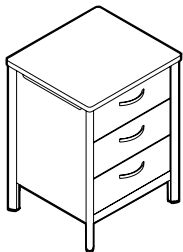

**Standard** - laminate top, front and case

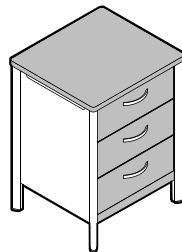

**TH** - thermofoil top and front, laminate case

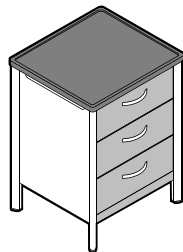

**THSC** - thermofoil top with spill guard and front, laminate case

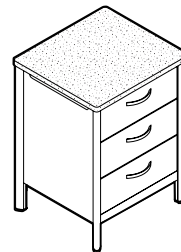

**C1/C2** - solid surface top, laminate front and case

- For detailed material information, please reference WilsonArt's Solid Surface collection.

## SPILL COLLECTOR

- Spill collector (SC) is optional on the edge of bedside cabinets with thermofoil finish only.



## CUSTOM

- Global invites the opportunity to provide quotation on special requests for project business.



## SHIPPING

- All products are shipped partially assembled, one per carton, unless otherwise noted.
- Fascia, shelves and accessories are to be installed on site.

## BEDSIDE CABINETS

**Notes:** Please specify all substitutions and options.

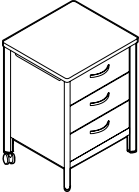
- Bedside cabinets incorporate the unique aluminum extrusion connection/leg construction.
- The aluminum extrusion offers superior strength and durability from impact with mobile equipment and furniture used in the space.
- Ventilation openings have been strategically incorporated into each unit where needed.
- See Sonoma™ - Notes pages for details on tops, chassis, finish and detail selections.
- Must specify detail information at time of order. See Sonoma™ - Notes pages.
  1. Laminate finish
  2. Aluminum extrusion/leg paint finish
  3. Handle style and finish
- An optional key lock is available for top drawer position only and must be specified at time of order.
- To specify lock on top drawer, indicate **(LS)** (lock set) after model number. Add **\$66**.
- Casters are available as specified on models and cannot be retrofitted in the field.

BEDSIDE CABINETS	MODEL#	DIMENSIONS	FREIGHT CLASS	WT/LBS.	CUBIC FT.	LIST PRICE
	<b>D x W x H</b>					
	<b>No casters</b>					
	GCSNBT01	20.5 x 22.5 x 30	100	97	11	<b>\$1414</b>
	GCSNBT01TH					<b>\$1688</b>
	w/Thermofoil top and front					
	GCSNBT01THSC					<b>\$1688</b>
	w/Thermofoil top with spillguard and front					
	GCSNBT01C1					<b>\$2614</b>
	w/solid surface top (grade 1)					
	GCSNBT01C2					<b>\$2820</b>
w/solid surface top (grade 2)						
	<b>Rear casters</b>					
	GCSNBT01C	20.5 x 22.5 x 30	100	100	11	<b>\$1414</b>
	GCSNBT01CTH					<b>\$1723</b>
	w/Thermofoil top and front					
	GCSNBT01CTHSC					<b>\$1723</b>
	w/Thermofoil top with spillguard and front					
	GCSNBT01CC1					<b>\$2656</b>
	w/solid surface top (grade 1)					
	GCSNBT01CC2					<b>\$2862</b>
	w/solid surface top (grade 2)					
	<b>Four casters</b>					
	GCSNBT014C	20.5 x 22.5 x 30	100	100	11	<b>\$1470</b>
	GCSNBT014CTH					<b>\$1738</b>
	w/Thermofoil top and front					
	GCSNBT014CTHSC					<b>\$1738</b>
	w/Thermofoil top with spillguard and front					
	GCSNBT014CC1					<b>\$2671</b>
	w/solid surface top (grade 1)					
	GCSNBT014CC2					<b>\$2876</b>
	w/solid surface top (grade 2)					
Three drawers. 1 per carton. <ul style="list-style-type: none"> <li>• Model GCSNBT01C has two manual locking swivel casters on back.</li> <li>• Model GCSNBT014C has four manual locking swivel casters.</li> </ul>						

**Bedside Cabinet**

BEDSIDE CABINETS



Bedside Cabinet\*

MODEL#	DIMENSIONS	FREIGHT CLASS	WT/LBS.	CUBIC FT.	LIST PRICE
--------	------------	---------------	---------	-----------	------------

**No casters** D x W x H

GCSNBT01S	20.5 x 22.5 x 34	100	104	11	\$1859
GCSNBT01STH	w/Thermofoil top and front				\$2131
GCSNBT01STHSC	w/Thermofoil top with spillguard and front				\$2131
GCSNBT01SC1	w/solid surface top (grade 1)				\$3058
GCSNBT01SC2	w/solid surface top (grade 2)				\$3265

**Rear casters**

GCSNBT01CS	20.5 x 22.5 x 34	100	107	11	\$1910
GCSNBT01CSTH	w/Thermofoil top and front				\$2145
GCSNBT01CSTHSC	w/Thermofoil top with spillguard and front				\$2145
GCSNBT01CSC1	w/solid surface top (grade 1)				\$3109
GCSNBT01CSC2	w/solid surface top (grade 2)				\$3316

**Four casters**

GCSNBT014CS	20.5 x 22.5 x 34	100	108	11	\$1939
GCSNBT014CSTH	w/Thermofoil top and front				\$2167
GCSNBT014CSTHSC	w/Thermofoil top with spillguard and front				\$2167
GCSNBT014CSC1	w/solid surface top (grade 1)				\$3138
GCSNBT014CSC2	w/solid surface top (grade 2)				\$3343

Three drawers and one pull-out shelf. 1 per carton.

- Model GCSNBT01CS has two manual locking swivel casters on back.
- Model GCSNBT014CS has four manual locking swivel casters.

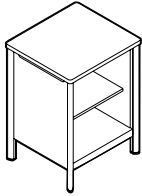
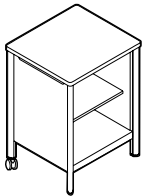
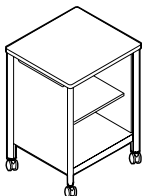
BEDSIDE CABINETS	MODEL#	DIMENSIONS D x W x H	FREIGHT CLASS	WT/LBS.	CUBIC FT.	LIST PRICE
	<b>No casters</b>					
	GCSNBT02	20.5 x 22.5 x 30	150	58	11	\$830
	GCSNBT02TH	w/Thermofoil top and front				\$1026
	GCSNBT02THSC	w/Thermofoil top with spillguard and front				\$1026
	GCSNBT02C1	w/solid surface top (grade 1)				\$2029
	GCSNBT02C2	w/solid surface top (grade 2)				\$2236
	<b>Rear casters</b>					
	GCSNBT02C	20.5 x 22.5 x 30	150	60	11	\$858
	GCSNBT02CTH	w/Thermofoil top and front				\$1034
	GCSNBT02CTHSC	w/Thermofoil top with spillguard and front				\$1034
	GCSNBT02CC1	w/solid surface top (grade 1)				\$2057
	GCSNBT02CC2	w/solid surface top (grade 2)				\$2264
	<b>Four casters</b>					
	GCSNBT024C	20.5 x 22.5 x 30	150	60	11	\$883
	GCSNBT024CTH	w/Thermofoil top and front				\$1048
	GCSNBT024CTHSC	w/Thermofoil top with spillguard and front				\$1048
	GCSNBT024CC1	w/solid surface top (grade 1)				\$2083
	GCSNBT024CC2	w/solid surface top (grade 2)				\$2287
<b>Bedside Cabinet</b>	One adjustable shelf. 1 per carton. • Model GCSNBT02C has two manual locking swivel casters on back. • Model GCSNBT024C has four manual locking swivel casters.					

BEDSIDE CABINETS

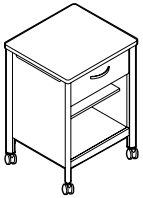
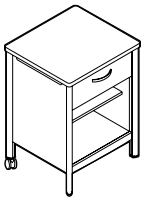
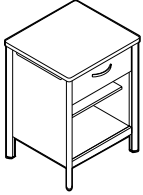

Bedside Cabinet

MODEL#	DIMENSIONS	FREIGHT CLASS	WT/LBS.	CUBIC FT.	LIST PRICE
--------	------------	---------------	---------	-----------	------------

**No casters** D x W x H

GCSNBT03	20.5 x 22.5 x 30	125	76	11	\$1196
GCSNBT03TH	w/Thermofoil top and front				\$1268
GCSNBT03THSC	w/Thermofoil top with spillguard and front				\$1268
GCSNBT03C1	w/solid surface top (grade 1)				\$2171
GCSNBT03C2	w/solid surface top (grade 2)				\$2378

**Rear casters**

GCSNBT03C	20.5 x 22.5 x 30	125	78	11	\$1214
GCSNBT03CTH	w/Thermofoil top and front				\$1285
GCSNBT03CTHSC	w/Thermofoil top with spillguard and front				\$1285
GCSNBT03CC1	w/solid surface top (grade 1)				\$2189
GCSNBT03CC2	w/solid surface top (grade 2)				\$2400

**Four casters**

GCSNBT034C	20.5 x 22.5 x 30	125	78	11	\$1237
GCSNBT034CTH	w/Thermofoil top and front				\$1307
GCSNBT034CTHSC	w/Thermofoil top with spillguard and front				\$1307
GCSNBT034CC1	w/solid surface top (grade 1)				\$2208
GCSNBT034CC2	w/solid surface top (grade 2)				\$2418

One drawer, one adjustable shelf. 1 per carton.

- Model GCSNBT03C has two manual locking swivel casters on back.
- Model GCSNBT034C has four manual locking swivel casters.

BEDSIDE CABINETS	MODEL#	DIMENSIONS	FREIGHT CLASS	WT/LBS.	CUBIC FT.	LIST PRICE
------------------	--------	------------	---------------	---------	-----------	------------

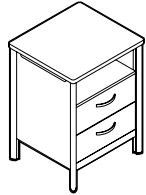

D x W x H						
<b>No casters</b>						
GCSNBT04	20.5 x 22.5 x 30	100	90	11		\$1249
GCSNBT04TH						\$1523
w/Thermofoil top and front						
GCSNBT04THSC						\$1523
w/Thermofoil top with spillguard and front						
GCSNBT04C1						\$2448
w/solid surface top (grade 1)						
GCSNBT04C2						\$2654
w/solid surface top (grade 2)						

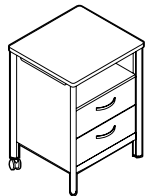

<b>Rear casters</b>						
GCSNBT04C	20.5 x 22.5 x 30	100	92	11		\$1278
GCSNBT04CTH						\$1540
w/Thermofoil top and front						
GCSNBT04CTHSC						\$1540
w/Thermofoil top with spillguard and front						
GCSNBT04CC1						\$2477
w/solid surface top (grade 1)						
GCSNBT04CC2						\$2681
w/solid surface top (grade 2)						

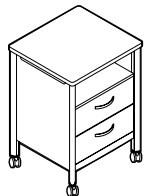

<b>Four casters</b>						
GCSNBT044C	20.5 x 22.5 x 30	100	92	11		\$1328
GCSNBT044CTH						\$1558
w/Thermofoil top and front						
GCSNBT044CTHSC						\$1558
w/Thermofoil top with spillguard and front						
GCSNBT044CC1						\$2527
w/solid surface top (grade 1)						
GCSNBT044CC2						\$2733
w/solid surface top (grade 2)						

Bedside Cabinet

- One fixed shelf, two drawers. 1 per carton.
- Model GCSNBT04C has two manual locking swivel casters on back.
  - Model GCSNBT044C has four manual locking swivel casters.

BEDSIDE CABINETS

MODEL# DIMENSIONS FREIGHT CLASS WT/LBS. CUBIC FT. LIST PRICE

D x W x H

**No casters**

GCSNBT06L	20.5 x 22.5 x 30	125	82	11	\$1265
GCSNBT06LTH	w/Thermofoil top and front				\$1720
GCSNBT06LTHSC	w/Thermofoil top with spillguard and front				\$1720
GCSNBT06LC1	w/solid surface top (grade 1)				\$2464
GCSNBT06LC2	w/solid surface top (grade 2)				\$2671

**Rear casters**

GCSNBT06CL	20.5 x 22.5 x 30	125	84	11	\$1300
GCSNBT06CLTH	w/Thermofoil top and front				\$1733
GCSNBT06CLTHSC	w/Thermofoil top with spillguard and front				\$1733
GCSNBT06CLC1	w/solid surface top (grade 1)				\$2499
GCSNBT06CLC2	w/solid surface top (grade 2)				\$2705

**Four casters**

GCSNBT06L4C	20.5 x 22.5 x 30	125	84	11	\$1328
GCSNBT06L4CTH	w/Thermofoil top and front				\$1746
GCSNBT06L4CTHSC	w/Thermofoil top with spillguard and front				\$1746
GCSNBT06L4CC1	w/solid surface top (grade 1)				\$2527
GCSNBT06L4CC2	w/solid surface top (grade 2)				\$2734

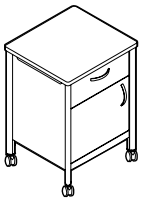
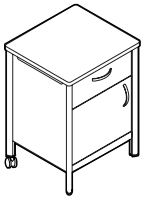
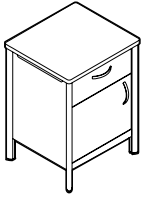

**Bedside Cabinet**

Top position drawer, one **left** opening door with adjustable shelf. 1 per carton.

- Model GCSNBT06CL has two manual locking swivel casters on back.
- Model GCSNBT06L4C has four manual locking swivel casters.

BEDSIDE CABINETS	MODEL#	DIMENSIONS	FREIGHT CLASS	WT/LBS.	CUBIC FT.	LIST PRICE
------------------	--------	------------	---------------	---------	-----------	------------

D x W x H

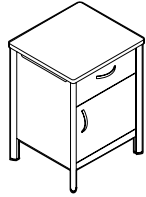

**No casters**

GCSNBT06R	20.5 x 22.5 x 30	125	82	11	\$1265
GCSNBT06LTH	w/Thermofoil top and front				\$1720
GCSNBT06RTHSC	w/Thermofoil top with spillguard and front				\$1720
GCSNBT06RC1	w/solid surface top (grade 1)				\$2464
GCSNBT06RC2	w/solid surface top (grade 2)				\$2671

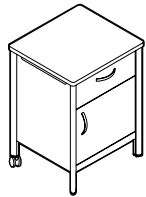

**Rear casters**

GCSNBT06CR	20.5 x 22.5 x 30	125	84	11	\$1300
GCSNBT06CRTH	w/Thermofoil top and front				\$1733
GCSNBT06CRTHSC	w/Thermofoil top with spillguard and front				\$1733
GCSNBT06CRC1	w/solid surface top (grade 1)				\$2499
GCSNBT06CRC2	w/solid surface top (grade 2)				\$2705

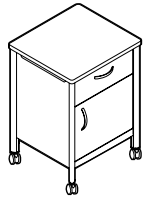

**Four casters**

GCSNBT06R4C	20.5 x 22.5 x 30	125	84	11	\$1328
GCSNBT06R4CTH	w/Thermofoil top and front				\$1746
GCSNBT06R4CTHSC	w/Thermofoil top with spillguard and front				\$1746
GCSNBT06R4CC1	w/solid surface top (grade 1)				\$2527
GCSNBT06R4CC2	w/solid surface top (grade 2)				\$2734

**Bedside Cabinet**

Top position drawer, one **left** opening door with adjustable shelf. 1 per carton.

- Model GCLBT06CRN has two manual locking swivel casters on back.
- Model GCLBT06R4CN has four manual locking swivel casters.



DRESSERS	MODEL#	DIMENSIONS	FREIGHT CLASS	WT/LBS.	CUBIC FT.	LIST PRICE
----------	--------	------------	---------------	---------	-----------	------------

D x W x H

**Notes:** Please specify all substitutions and options.

- Dresser units incorporate the unique aluminum extrusion connection/leg construction.
- The aluminum extrusion offers superior strength and durability from impact with mobile equipment and furniture used in the space.
- Ventilation openings have been strategically incorporated into each unit where needed.
- See Sonoma™ - Notes pages for details on tops, chassis, finish and detail selections.
- Must specify detail information at time of order. See Sonoma™ - Notes pages.
  1. Laminate finish
  2. Aluminum extrusion/leg paint finish
  3. Handle style and finish
- An optional key lock is available for top drawer position only and must be specified at time of order.
- To specify lock on top drawer, indicate **(LS)** (lock set) after model number. **Add \$66** list upcharge.

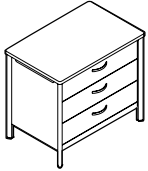

22.5" Deep Dresser

GCSNDR02	22.5 x 34.5 x 30	125	141	20	<b>\$1814</b>
----------	------------------	-----	-----	----	---------------

Three drawers. Shipped partially assembled, 1 per carton.



22.5" Deep Dresser

GCSNDR04	22.5 x 34.5 x 37.5	125	173	24	<b>\$2372</b>
----------	--------------------	-----	-----	----	---------------

Four drawers. Shipped partially assembled, 1 per carton.



22" Deep Dresser

GCSNDR06	22.5 x 34.5 x 37.5	125	165	24	<b>\$2200</b>
----------	--------------------	-----	-----	----	---------------

Three drawers with open storage space above. Cord access in back. Shipped partially assembled, 1 per carton.

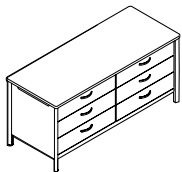

Double Dresser

GCSNDD01	22.5 x 66.75 x 30	125	281	40	<b>\$3106</b>
----------	-------------------	-----	-----	----	---------------

Double dresser with three drawers. 26" deep at each side. Shipped partially assembled, 1 per carton.

WARDROBE CABINETS	MODEL#	DIMENSIONS	FREIGHT CLASS	WT/LBS.	CUBIC FT.	LIST PRICE
-------------------	--------	------------	---------------	---------	-----------	------------

D x W x H

**Notes:** Please specify all substitutions and options.

- Wardrobe cabinets incorporate the unique aluminum extrusion connection/leg construction.
- The aluminum extrusion offers superior strength and durability from impact with mobile equipment and furniture used in the space.
- Doors are mounted utilizing commercial quality hinges that provide a 170° opening span for comfortable access to personal belongings.
- Ventilation and draining have been strategically incorporated into each unit where needed.
- Wardrobe cabinets offer a safety garment hook as standard and a J-style safety clothing rail to ensure maximum well being and peace of mind from accidents.
- See Sonoma™ - Notes pages for details on tops, chassis, finish and detail selections.
- Must specify detail information at time of order. See Sonoma™ - Notes pages.
  1. Laminate finish
  2. Aluminum extrusion/leg paint finish
  3. Handle style and finish
- Optional door lock is available on select models. Must be quoted on a project opportunity as a special.
- See accessories for additional options to enhance personal storage features.

GCSNWC01	26.5 x 50 x 72	125	442	71	<b>\$4772</b>
----------	----------------	-----	-----	----	---------------

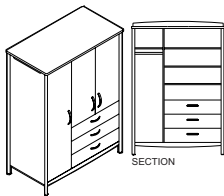

Wardrobe Cabinet

Inside dimensions:

- Left side top shelf: 14.75"W x 20.75"D x 8.625"H
- Left side clothing rail area: 14.75"W x 20.75"D x 55.6"H
- Right side top shelf: 30.75"W x 20.75"D x 8.625"H
- Right side middle section with adjustable shelf: 30.75"W x 20.75"D x 32"H
- Right side bottom section: 30.75"W x 20.75"D x 24"H
- Drawers: 28.5"W x 5.125"D x 17.25"H

Three doors. Interior **left** side offers an upper shelf with a J-style safety clothing rail below. The **right** side of the cabinet has two half length doors with two fixed and two adjustable shelves. Three drawers below. A safety garment hook is standard on the cabinet interior door. For greater security, the Anti-Tip Security Kit is recommended on units above 60" (see page 31). Shipped partially assembled, 1 per carton.

GCSNWC02	26.5 x 50 x 72	125	428	71	<b>\$3953</b>
----------	----------------	-----	-----	----	---------------

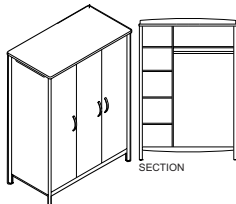

Wardrobe Cabinet

Inside dimensions:

- Left side top shelf: 14.75"W x 20.75"D x 8.625"H
- Left side middle section with adjustable shelf: 14.75"W x 20.75"D x 38.7"H
- Left side bottom section: 14.75"W x 20.75"D x 15.8"H
- Right side top shelf: 30.75"W x 20.75"D x 8.625"H
- Right side clothing rail area: 30.75"W x 22.75"D x 55.6"H

Three full length doors. Interior **left** side offers two adjustable and two fixed shelves. Interior **right** side offers an upper shelf with a J-style safety clothing rail below. A Safety Garment Hook is standard on the cabinet interior door. For greater security, the Anti-Tip Security Kit is recommended on units above 60" (see page 31). Lock not available on doors. Shipped partially assembled, 1 per carton.

GCSNWD01	26.5 x 38.5 x 72	150	261	55	<b>\$2694</b>
----------	------------------	-----	-----	----	---------------

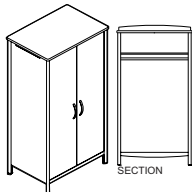

Wardrobe Cabinet

Inside dimensions:

- Top shelf: 34.75"W x 22.7"D x 8.625"H
- Bottom portion: 34.75"W x 22.7"D x 50.6"H

Two doors, full span J-style safety clothing rail below a fixed shelf. A safety garment hook is standard on the cabinet interior door. For greater security, the Anti-Tip Security Kit is recommended on units above 60" (see page 31). Lock not available on doors. Shipped partially assembled, 1 per carton.

**WARDROBE CABINETS**      **MODEL#**      **DIMENSIONS**      **FREIGHT CLASS**      **WT/LBS.**      **CUBIC FT.**      **LIST PRICE**

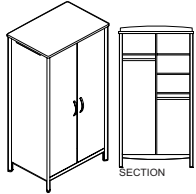

**Wardrobe Cabinet**

D x W x H						
GCSNWD02	26.5 x 38.5 x 72	150	282	55		<b>\$3362</b>

- Inside dimensions:
- Left side top shelf: 17"W x 20.7"D x 8.625"H
  - Left side clothing rail area: 17"W x 20.7"D x 55.6"H
  - Right side top shelf: 17"W x 20.7"D x 8.625"H
  - Right side clothing rail area: 17"W x 20.7"D x 36.6"H

Two doors. Interior is divided in two with an upper shelf and a J-style safety clothing rail on the **left** side. The **right** side has one adjustable and two fixed shelves with a J-style safety clothing rail below. A safety garment hook is standard on the cabinet interior door. For greater security, the Anti-Tip Security Kit is recommended on units above 60" (see page 31). Lock not available on doors. Shipped partially assembled, 1 per carton.

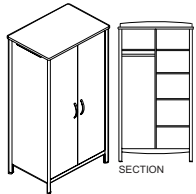

**Wardrobe Cabinet**

GCSNWD03	26.5 x 38.5 x 72	150	297	55		<b>\$3501</b>
----------	------------------	-----	-----	----	--	---------------

- Inside dimensions:
- Left side top shelf: 17"W x 20.7"D x 8.625"H
  - Left side clothing rail area: 17"W x 20.7"D x 55.6"H
  - Right side top shelf: 17"W x 20.7"D x 8.625"H
  - Right side middle section with adjustable shelf: 17"W x 20.7"D x 38.7"H
  - Right side bottom section: 17"W x 20.7"D x 15.8"H

Two doors. Interior is divided in two with an upper shelf and a J-style safety clothing rail on the **left** side. The **right** side has two adjustable and two fixed shelves. A safety garment hook is standard on the cabinet interior door. For greater security, the Anti-Tip Security Kit is recommended on units above 60" (see page 31). Lock not available on doors. Shipped partially assembled, 1 per carton.

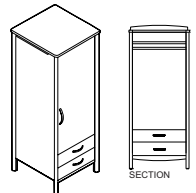

**Narrow Wardrobe Cabinet**

*right shown*

<b>Left:</b>						
GCSNWN01L		125	216	30		<b>\$2544</b>
<b>Right:</b>						
GCSNWN01R	24.5 x 22.5 x 72	125	216	30		<b>\$2544</b>

- Inside dimensions:
- Top shelf: 18.7"W x 20.7"D
  - Top drawer: 16.5"W x 5.125"D x 15.5"H
  - Clothing rail area: 18.7"W
  - Lower drawer: 16.5"W x 5.125"D x 15.5"H

One door covering upper shelf and J-style safety clothing rail. Two exposed drawers below. For greater security, the Anti-Tip Security Kit is recommended on units above 60" (see page 31). 1 per carton.

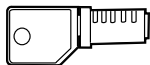

**Replacement Lock Set**

V00465FLOCK3/4	-- x -- x --	-	--	.01		<b>\$62</b>
----------------	--------------	---	----	-----	--	-------------

Replacement core and key.



**Replacement Key**

WL2EK	-- x -- x --	-	--	.01		<b>\$25</b>
-------	--------------	---	----	-----	--	-------------

Replacement key for all units with drawers. Specify key number 401-440.

ACCESSORIES	MODEL#	DIMENSIONS	FREIGHT CLASS	WT./LBS.	CUBIC FT.	LIST PRICE
-------------	--------	------------	---------------	----------	-----------	------------

**D x W x H**

**Notes:** Please specify all substitutions and options.

- Bookcase units incorporate the unique aluminum extrusion connection/leg construction.
- The aluminum extrusion offers superior strength and durability from impact with mobile equipment and furniture used in the space.
- See Sonoma™ - Notes pages for details on tops, chassis, finish and detail selections.
- Must specify detail information at time of order. See Sonoma™ - Notes pages.
  1. Laminate finish
  2. Aluminum extrusion/leg paint finish

ACCESSORIES	MODEL#	DIMENSIONS	FREIGHT CLASS	WT./LBS.	CUBIC FT.	LIST PRICE
-------------	--------	------------	---------------	----------	-----------	------------

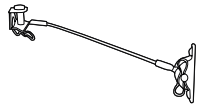

**Anti-Tip Security Kit**

GCAT400	--	70	0.24	0.1	<b>\$50</b>
---------	----	----	------	-----	-------------

Helps to prevent furniture from tipping over. This cabinet stabilization hardware is made from steel and galvanized steel aircraft cable. Full installation instructions are included. Recommended for all 72" high units.

- Two kits are required for LWA, LWC, LWD, LWG and LWN units.

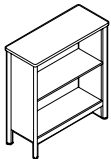

**Bookcase**

GCSNBC02	14.5 x 34.5 x 37.5	150	76	16	<b>\$1114</b>
----------	--------------------	-----	----	----	---------------

37.5" High. 1 adjustable shelf. Shipped partially assembled, 1 per carton.

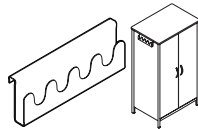

**Multiple Hook**

GCSNHA01	2 x 13 x 4.25	70	1	0.2	<b>\$86</b>
----------	---------------	----	---	-----	-------------

Fits into ventilation opening of wardrobes providing additional hanging of frequently worn or accessed items.

- Standard Powder Coated Paint Finish Color: Sierra (**SC**).

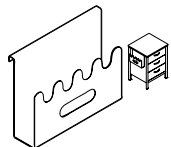

**Magazine/Tissue Holder**

GCSNHA02	3.75 x 13 x 10	70	1.5	0.6	<b>\$124</b>
----------	----------------	----	-----	-----	--------------

Fits into ventilation opening of bedside cabinet or dresser providing additional storage for frequently worn or accessed items.

- Standard Powder Coated Paint Finish Color: Sierra (**SC**).



**Safety Garment Hook**

GCSNHA03	1 x 1.5 x 3.25	70	1.5	0.2	<b>\$26</b>
----------	----------------	----	-----	-----	-------------

Garment hook provides additional hanging storage on the inside **right** and **center** wardrobe doors as standard. Engineered with the safety feature to support a maximum weight of 75 lbs.

- Standard Powder Coated Paint Finish Color: Sierra (**SC**).

ACCESSORIES	MODEL#	DIMENSIONS	FREIGHT CLASS	WT/LBS.	CUBIC FT.	LIST PRICE
-------------	--------	------------	---------------	---------	-----------	------------

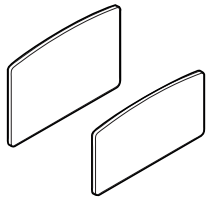

**Headboard and Footboard Fascia Profile: Arc (TPAR)**

	D x W x H				
GCSNHF01 Set	1 x 37 x 25	65	47	1.9	<b>\$1044</b>
GCSNHB01 Headboard	1 x 37 x 25	85	26	1.9	<b>\$714</b>
GCSNFB01 Footboard	1 x 37 x 20	85	21	1.7	<b>\$330</b>

Headboard and footboard are provided as a set or can be ordered individually. 1" thick high pressure laminate with 3mm edge.

- No predrilled holes.
- No mounting brackets or hardware included.
- Verify board application and dimensions before ordering.

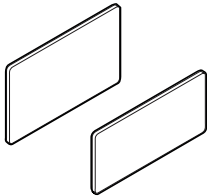

**Headboard and Footboard Fascia Profile: Linear (TPLN)**

GCSNHF04 Set	1 x 37 x 25	65	47	1.9	<b>\$1036</b>
GCSNHB04 Headboard	1 x 37 x 25	85	26	1.9	<b>\$641</b>
GCSNFB04 Footboard	1 x 37 x 20	85	21	1.7	<b>\$400</b>

Headboard and footboard are provided as a set or can be ordered individually. 1" thick high pressure laminate with 3mm edge.

- No predrilled holes.
- No mounting brackets or hardware included.
- Verify board application and dimensions before ordering.

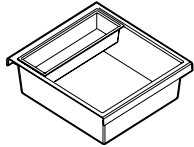

**Bedside Drawer Liner and Personal Organizer**

GCSNLP01	16.5 x 18 x 5.25	300	2	1.3	<b>\$164</b>
----------	------------------	-----	---	-----	--------------

Constructed from high impact styrene plastic. Plastic liners have been specially designed to saddle the drawer edges for a perfect fit while eliminating gaps and potential traps. Removable.

- Neutral color (French Vanilla) coordinates with drawer interiors.



**Wardrobe Mirror**

GCSNWM01	.25 x 11 x 29	65	40	1.5	<b>\$176</b>
----------	---------------	----	----	-----	--------------

Installed on the **left** inside of the door. Backed with shatterproof safety tape, tested for shatter resistance. Double mounted with both rubber lined mirror clips and heavy duty foam tape. Edges are polished. 1 per carton.

cafeteria + dining + occasional + reception

# tables

DRIFT



**model 8041R2616C**  
26"W x 16"H Round Table,  
Laminate Surface, Flat Edge,  
Chrome Base



**model 8042SQ2816I**  
28"W x 16"H Square Table,  
Laminate Surface, Flat Edge,  
Sled Base



**Model 8042SQ2816W**  
28"W x 16"H Square Table,  
Laminate Surface, Flat Edge  
Wood Base



For Drift seating, see page

EXAMPLE OF TABLE ORDER CODE:

8041R2616I	TFL	ACJ	TBL	CG
Model Number	Surface Type	Top HPL Finish	Base Finish (Sled Base)	Glide Type (Sled Base)

STANDARD FEATURES

- Tables are available in three shapes, multiple sizes, two edge styles, three top materials and three base types including: sled, wood and polished Chrome bases.
- Table bases are fixed and do not swivel.
- Wood bases are made from beechwood and are available in all standard wood finishes.
- Sled bases are standard in painted metal.
- Chrome base tables are available in polished Chrome only.
- All table tops are available with flat edge. High pressure laminate (HPL) and solid surface top tables are also available with knife edge.
- Laminate flat edge tops are available in either (TFL) 1" thick thermally fused laminate with 2mm edgeband or (HPL) 1-1/16" thick high pressure laminate with 2mm edgeband, with upcharge.
- Laminate knife edge tops are 1-3/16" thick with 2.5mm edgeband, available in high pressure laminate (HPL) only.
- Solid surface tablestops are 1.25" thick, available on models with flat or knife edge. For detailed material information, please reference WilsonArt's Solid Surface collection.
- Wood and Chrome bases are equipped with White non-marking polycarbonate glides suitable for most hard and carpeted floor surfaces.
- Sled bases are available with clear polycarbonate glides, standard.
- Wood and sled bases may be specified with a variety of optional glide types to suit various flooring materials. (See Glide Types for additional glide options and upcharges.)
- Tables are shipped fully assembled.

Add option codes in the following order:

- **Model Number**  
Specify model number
- **Surface Type** (Laminate, Flat Edge Tables)  
(TFL) Thermally fused laminate  
(HPL) High pressure laminate
- **Top Finish** (TFL or HPL laminate, flat edge tables and HPL laminate knife edge tables only)  
HPL upcharges apply -see model  
(ACJ) Absolute Acajou (ASN) Asian Night  
(AWC) Avant Cherry (AWH) Avant Honey  
(BLK) Black (BZD) Blizzard  
(BRC) Brushed Cobalt (CMB) Clear Maple  
(CGY) Custom Grey (DES) Dark Espresso  
(DWT) Designer White (FAS) Fashionista  
(FCL) First Class (NBL) Noce Biondo  
(NGL) Noce Grigio (NEL) Noce Leggero  
(NML) Noce Medio (QTM) Quartered Mahogany  
(SBY) Sheer Beauty (SDT) Stonedust  
(SOG) Storm Grey (WHE) Walnut Heights  
(WHC) White Chocolate (WCR) Winter Cherry
- **Top Finish** (solid surface, flat and knife edge tables)  
Grade 1  
(SWH) Designer White  
Grade 2, Upcharge applicable, see models.  
(SBT) Beige Tempest  
(SBX) Black Onyx Mirage  
(SMG) Milk Glass Spectra  
(SFW) Frosty White Mirage  
(SHS) Hot Stone  
(SNM) Northern Melange
- **Base finish** (sled base models only)  
Paint finishes:  
(TBL) Black (TTU) Tungsten  
(TSH) Shadow (TDW) Designer White  
(TNE) Nevada (TLA) Latte  
(TKA) Kalua (TMO) Mocha  
(TOA) Toast (TFO) Fog  
(TIV) Cloud (TSN) Sand  
(TFR) Frost (TDJ) Dijon  
(TCR) Carrot (TSR) Scarlet  
(TCC) Cactus (TBZ) Buzz Blue  
(TEG) Eggplant (TIN) Ink  
  
Metallic finish:  
(CHM) Chrome. Add \$42
- **Base Finish** (Chrome base only)  
(CHM) Chrome
- **Glide Type** (sled base)  
(CG) Clear, polycarbonate glide for most floor surfaces (standard)  
(XG) No glide for carpeted surfaces, no charge  
(SG) Steel cushioned glide for carpeted surface. Add \$34  
(RG) Rubber, non-slip glide for most hard floor surfaces. Add \$34  
(FG) Felt glide for most hard floor surfaces. Add \$34
- **Glide Type** (wood base)  
(NM) White non-marking nylon glide for most surfaces (standard)  
(SG) Steel cushioned glides for carpeted surfaces. Add \$34.  
(RG) Non-slip rubber glides for most hard floor surfaces. Add \$34.  
(FG) Felt glides for most hard floor surfaces. Add \$34.

**TABLES WITH SLED BASE**      **MODEL#**      **DIMENSIONS**      **FREIGHT CLASS**      **WT./LBS.**      **CUBIC FT.**      **LIST PRICE**      **HP ADD**      **GR. 2 ADD**



**Round Table with Sled Base**

D x W x H								
<b>Laminate, flat edge (TFL laminate)</b>								
8041R2616I	26 x 26 x 16	250	35	10.25	<b>\$561</b>	<b>\$98</b>	n/a	
8041R3016I	30 x 30 x 16	250	44	13	<b>\$591</b>	<b>\$115</b>	n/a	
8041R2120I	21 x 21 x 20	250	29	8.75	<b>\$587</b>	<b>\$97</b>	n/a	
<b>Laminate, knife edge (HPL laminate)</b>								
8041R2616IK	26 x 26 x 16	250	35	10.25	<b>\$1199</b>	n/a	n/a	
8041R3016IK	30 x 30 x 16	250	44	13	<b>\$1284</b>	n/a	n/a	
8041R2120IK	21 x 21 x 20	250	29	8.75	<b>\$996</b>	n/a	n/a	
<b>Solid surface, flat edge</b>								
8041R2616ISF	26 x 26 x 16	150	48	10.25	<b>\$2343</b>	n/a	<b>\$158</b>	
8041R3016ISF	30 x 30 x 16	150	61	13	<b>\$2522</b>	n/a	<b>\$218</b>	
8041R2120ISF	21 x 21 x 20	150	37.5	8.75	<b>\$2204</b>	n/a	<b>\$109</b>	
<b>Solid surface, knife edge</b>								
8041R2616ISK	26 x 26 x 16	150	48	10.25	<b>\$2397</b>	n/a	<b>\$169</b>	
8041R3016ISK	30 x 30 x 16	150	61	13	<b>\$2603</b>	n/a	<b>\$234</b>	
8041R2120ISK	21 x 21 x 20	150	37.5	8.75	<b>\$2302</b>	n/a	<b>\$115</b>	

Finished height will vary depending on material top. Shipped fully assembled in 1 carton.



**Square Table with Sled Base**

<b>Laminate, flat edge (TFL laminate)</b>								
8042SQ2216I	22 x 22 x 16	150	34	8	<b>\$561</b>	<b>\$98</b>	n/a	
8042SQ2816I	28 x 28 x 16	250	44	11.75	<b>\$591</b>	<b>\$115</b>	n/a	
8042SQ1920I	19 x 19 x 20	250	29	7.75	<b>\$568</b>	<b>\$88</b>	n/a	
<b>Laminate, knife edge (HPL laminate)</b>								
8042SQ2216IK	22 x 22 x 16	150	34	8	<b>\$996</b>	n/a	n/a	
8042SQ2816IK	28 x 28 x 16	250	44	11.75	<b>\$1248</b>	n/a	n/a	
8042SQ1920IK	19 x 19 x 20	250	29	7.75	<b>\$955</b>	n/a	n/a	
<b>Solid surface, flat edge</b>								
8042SQ2216ISF	22 x 22 x 16	150	39.5	8	<b>\$2065</b>	n/a	<b>\$136</b>	
8042SQ2816ISF	28 x 28 x 16	150	62.5	11.75	<b>\$2365</b>	n/a	<b>\$218</b>	
8042SQ1920ISF	19 x 19 x 20	150	38	7.75	<b>\$1976</b>	n/a	<b>\$164</b>	
<b>Solid surface, knife edge</b>								
8042SQ2216ISK	22 x 22 x 16	150	39.5	8	<b>\$2397</b>	n/a	<b>\$164</b>	
8042SQ2816ISK	28 x 28 x 16	150	62.5	11.75	<b>\$2819</b>	n/a	<b>\$245</b>	
8042SQ1920ISK	19 x 19 x 20	150	38	7.75	<b>\$2302</b>	n/a	<b>\$120</b>	

Finished height will vary depending on material top. Shipped fully assembled in 1 carton.



**Oval Table with Sled Base**

<b>Laminate, flat edge (TFL laminate)</b>								
8043OV2616I	26 x 22 x 16	150	36.5	8.75	<b>\$561</b>	<b>\$98</b>	n/a	
8043OV3116I	31 x 26 x 16	250	46	11.75	<b>\$591</b>	<b>\$115</b>	n/a	
8043OV2220I	22 x 18 x 20	250	34	10.75	<b>\$587</b>	<b>\$97</b>	n/a	
<b>Laminate, knife edge (HPL laminate)</b>								
8043OV2616IK	26 x 22 x 16	150	36.5	8.75	<b>\$1199</b>	n/a	n/a	
8043OV3116IK	31 x 26 x 16	250	46	11.75	<b>\$1365</b>	n/a	n/a	
8043OV2220IK	22 x 18 x 20	250	34	10.75	<b>\$1113</b>	n/a	n/a	
<b>Solid surface, flat edge</b>								
8043OV2616ISF	26 x 22 x 16	150	42	8.75	<b>\$2343</b>	n/a	<b>\$158</b>	
8043OV3116ISF	31 x 26 x 16	150	60	11.75	<b>\$2522</b>	n/a	<b>\$218</b>	
8043OV2220ISF	22 x 18 x 20	250	38	10.75	<b>\$2204</b>	n/a	<b>\$109</b>	
<b>Solid surface, knife edge</b>								
8043OV2616ISK	26 x 22 x 16	150	42	8.75	<b>\$2397</b>	n/a	<b>\$169</b>	
8043OV3116ISK	31 x 26 x 16	150	60	11.75	<b>\$2603</b>	n/a	<b>\$234</b>	
8043OV2220ISK	22 x 18 x 20	250	38	10.75	<b>\$2302</b>	n/a	<b>\$115</b>	

Finished height will vary depending on material top. Shipped fully assembled in 1 carton.



TABLES	MODEL#	DIMENSIONS	FREIGHT CLASS	WT./LBS.	CUBIC FT.	LIST PRICE	HP ADD	GR. 2 ADD
--------	--------	------------	---------------	----------	-----------	------------	--------	-----------

D x W x H



Round Table with Polished Chrome Base

**Laminate, flat edge (TFL laminate)**

8041R2616C	26 x 26 x 16	250	38	10.75	<b>\$1058</b>	<b>\$98</b>	n/a
8041R3016C	30 x 30 x 16	250	45	13	<b>\$1088</b>	<b>\$115</b>	n/a

**Laminate, knife edge (HPL laminate)**

8041R2616CK	26 x 26 x 16	250	38	10.75	<b>\$1696</b>	n/a	n/a
8041R3016CK	30 x 30 x 16	250	45	13	<b>\$1782</b>	n/a	n/a

**Solid surface, flat edge**

8041R2616CSF	26 x 26 x 16	150	51	10.75	<b>\$2840</b>	n/a	<b>\$158</b>
8041R3016CSF	30 x 30 x 16	150	62.5	13	<b>\$3019</b>	n/a	<b>\$218</b>

**Solid surface, knife edge**

8041R2616CSK	26 x 26 x 16	150	51	10.75	<b>\$2894</b>	n/a	<b>\$169</b>
8041R3016CSK	30 x 30 x 16	250	31.25	13	<b>\$3101</b>	n/a	<b>\$234</b>

Finished height will vary depending on material top. Shipped fully assembled in 1 carton.



Round Table with Wood Base

**Laminate, flat edge (TFL laminate)**

8041R2616W	26 x 26 x 16	250	32	10.75	<b>\$1204</b>	<b>\$98</b>	n/a
8041R3016W	30 x 30 x 16	250	40	13	<b>\$1234</b>	<b>\$115</b>	n/a

**Laminate, knife edge (HPL laminate)**

8041R2616WK	26 x 26 x 16	250	32	10.75	<b>\$1842</b>	n/a	n/a
8041R3016WK	30 x 30 x 16	250	40	13	<b>\$1927</b>	n/a	n/a

**Solid surface, flat edge**

8041R2616WSF	26 x 26 x 16	150	45.5	10.75	<b>\$2985</b>	n/a	<b>\$158</b>
8041R3016WSF	30 x 30 x 16	150	57.5	13	<b>\$3165</b>	n/a	<b>\$218</b>

**Solid surface, knife edge**

8041R2616WSK	26 x 26 x 16	150	45.5	10.75	<b>\$3040</b>	n/a	<b>\$169</b>
8041R3016WSK	30 x 30 x 16	150	57.5	13	<b>\$3246</b>	n/a	<b>\$234</b>

Finished height will vary depending on material top. Shipped fully assembled in 1 carton.



Square Table with Polished Chrome Base

**Laminate, flat edge (TFL laminate)**

8042SQ2216C	22.75 x 22.75 x 16	150	36	7.75	<b>\$1058</b>	<b>\$98</b>	n/a
8042SQ2816C	28.5 x 28.5 x 16	250	45	11.5	<b>\$1088</b>	<b>\$115</b>	n/a

**Laminate, knife edge (HPL laminate)**

8042SQ2216CK	22.75 x 22.75 x 16	150	36	7.75	<b>\$1493</b>	n/a	n/a
8042SQ2816CK	28.5 x 28.5 x 16	250	45	11.5	<b>\$1588</b>	n/a	n/a

**Solid surface, flat edge**

8042SQ2216CSF	22.75 x 22.75 x 16	150	41	7.75	<b>\$2563</b>	n/a	<b>\$136</b>
8042SQ2816CSF	28.5 x 28.5 x 16	150	57.5	11.5	<b>\$2862</b>	n/a	<b>\$218</b>

**Solid surface, knife edge**

8042SQ2216CSK	22.75 x 22.75 x 16	150	41	7.75	<b>\$2894</b>	n/a	<b>\$164</b>
8042SQ2816CSK	28.5 x 28.5 x 16	150	57.5	11.5	<b>\$3316</b>	n/a	<b>\$245</b>

Finished height will vary depending on material top. Shipped fully assembled in 1 carton.

TABLES	MODEL#	DIMENSIONS	FREIGHT CLASS	WT./LBS.	CUBIC FT.	LIST PRICE	HP ADD	GR. 2 ADD
--------	--------	------------	---------------	----------	-----------	------------	--------	-----------

D x W x H

**Laminate, flat edge (HPL laminate)**

8042SQ2216W	22.75 x 22.75 x 16	250	30	7.75	<b>\$1204</b>	<b>\$98</b>	n/a
8042SQ2816W	28.5 x 28.5 x 16	250	39	11.5	<b>\$1234</b>	<b>\$115</b>	n/a

**Laminate, knife edge (HPL laminate)**

8042SQ2216WK	22.75 x 22.75 x 16	250	30	7.75	<b>\$1639</b>	n/a	n/a
8042SQ2816WK	28.5 x 28.5 x 16	250	39	11.5	<b>\$1734</b>	n/a	n/a

**Solid surface, flat edge**

8042SQ2216WSF	22.75 x 22.75 x 16	150	36	7.75	<b>\$2708</b>	n/a	<b>\$136</b>
8042SQ2816WSF	28.5 x 28.5 x 16	150	59	11.5	<b>\$3008</b>	n/a	<b>\$218</b>

**Solid surface, knife edge**

8042SQ2216WSK	22.75 x 22.75 x 16	150	36	7.75	<b>\$3040</b>	n/a	<b>\$164</b>
8042SQ2816WSK	28.5 x 28.5 x 16	150	59	11.5	<b>\$3462</b>	n/a	<b>\$245</b>

Finished height will vary depending on material top. Shipped fully assembled in 1 carton.



**Square Table with Wood Base**



**Oval Table with Polished Chrome Base**

**Laminate, flat edge**

8043OV2616C	26 x 22 x 16	150	38	9.25	<b>\$1058</b>	<b>\$98</b>	n/a
8043OV3116C	31 x 26 x 16	250	44	11.75	<b>\$1088</b>	<b>\$115</b>	n/a

**Laminate, knife edge**

8043OV2616CK	26 x 22 x 16	150	38	9.25	<b>\$1696</b>	n/a	n/a
8043OV3116CK	31 x 26 x 16	250	44	11.75	<b>\$1862</b>	n/a	n/a

**Solid surface, flat edge**

8043OV2616CSF	26 x 22 x 16	150	49.5	9.25	<b>\$2840</b>	n/a	<b>\$158</b>
8043OV3116CSF	31 x 26 x 16	150	61.5	11.75	<b>\$3019</b>	n/a	<b>\$218</b>

**Solid surface, knife edge**

8043OV2616CSK	26 x 22 x 16	150	49.5	9.25	<b>\$2894</b>	n/a	<b>\$169</b>
8043OV3116CSK	31 x 26 x 16	150	61.5	11.75	<b>\$3101</b>	n/a	<b>\$234</b>

Finished height will vary depending on material top. Shipped fully assembled in 1 carton.



**Oval Table with Wood Base**

**Laminate, flat edge**

8043OV2616W	26 x 22 x 16	250	32	9.25	<b>\$1204</b>	<b>\$98</b>	n/a
8043OV3116W	31 x 26 x 16	250	39	11.75	<b>\$1234</b>	<b>\$115</b>	n/a

**Laminate, knife edge**

8043OV2616WK	26 x 22 x 16	250	32	9.25	<b>\$1842</b>	n/a	n/a
8043OV3116WK	31 x 26 x 16	250	39	11.75	<b>\$2008</b>	n/a	n/a

**Solid surface, flat edge**

8043OV2616WSF	26 x 22 x 16	150	44.5	9.25	<b>\$2985</b>	n/a	<b>\$158</b>
8043OV3116WSF	31 x 26 x 16	150	56.5	11.75	<b>\$3165</b>	n/a	<b>\$218</b>

**Solid surface, knife edge**

8043OV2616WSK	26 x 22 x 16	150	44.5	9.25	<b>\$3040</b>	n/a	<b>\$169</b>
8043OV3116WSK	31 x 26 x 16	150	56.5	11.75	<b>\$3246</b>	n/a	<b>\$234</b>

Finished height will vary depending on material top. Shipped fully assembled in 1 carton.

MODEL#	DIMENSIONS	FREIGHT CLASS	WT/LBS.	CUBIC FT.	LIST PRICE
--------	------------	---------------	---------	-----------	------------

D x W x H

**Notes:** Please specify all substitutions and options.

- Offers a solution to users with limited mobility.
- The Enable table top allows for two fixed tablets and two height adjustable tablets to be installed on opposite side into pre-drilled holes with metal inserts on the underside of the top
- The fixed and/or height adjustable tablets can be added to the table surface as needed to accommodate change in a person's physical abilities for continued enjoyment during mealtime and activities.
- Height adjustable tablet surface has a 13.5" range of motion (supporting heights from 22.5" to 36") for addressing mobility issues and devices (wheelchairs, geriatric chairs, walkers).
- Heavy duty tapered steel leg finish must be specified at time of order (see below).
- Legs are available with Black plastic glides offering 1.25" adjustment as standard.
- Shipped easy to assemble.
- 2mm edging color coordinated with laminate finish is standard for all tops. Finish must be specified at time of order.
- Tops are 1" thick and available in thermally fused laminate (**LP**) and high pressure laminate (**HP**). Please select the appropriate model number for the finish you prefer.
- Additional weight is available for added safety. Specify (**NC**) for no additional weight, (**13**) for 13 lbs. or (**26**) for 26 lbs. weights. For (**13**), add \$404. For (**26**), add \$634.
- Refer to the following lists when selecting a finish color. Must specify both a top color and leg finish at time of order.
- For custom laminate or contrasting edge, please contact your Global sales representative for special quotation.

**Thermally Fused Laminate (LP) Tops**

- Absolute Acajou (ACJ)
- Asian Night (ASN)
- Avant Cherry (AWC)
- Avant Honey (AWH)
- Blizzard (BZD)
- Brushed Cobalt (BRC)
- Clear Maple (CMB)
- Custom Grey (CGY)
- Dark Espresso (DES)
- Designer White (DWT)
- Fashionista (FAS)
- First Class (FCL)
- Noce Biondo (NBL)
- Noce Grigio (NGL)
- Noce Leggero (NEL)
- Noce Medio (NML)
- Quartered Mahogany (QTM)
- Sheer Beauty (SBL)
- Stonedust (SDT)
- Walnut Heights (WHE)
- White Chocolate (WHC)
- Winter Cherry (WCR)

**High Pressure Laminate (HP) Tops**

- Absolute Acajou (ACJ)
- Asian Night (ASN)
- Avant Cherry (W357)
- Avant Honey (W356)
- Blizzard (BZD)
- Brushed Cobalt (BRC)
- Clear Maple (CMB)
- Custom Grey (CGY)
- Dark Espresso (W142)
- Designer White (DWT)
- Fashionista (FAS)
- First Class (FCL)
- Noce Biondo (NBL)
- Noce Grigio (NGL)
- Noce Leggero (NEL)
- Noce Medio (NML)
- Quartered Mahogany (QTM)
- Sheer Beauty (SBL)
- Stonedust (SDT)
- Walnut Heights (WHE)
- White Chocolate (WHC)
- Winter Cherry (WCR)

**Leg Finish**

- Black (TBL)
- Cloud (TIV)
- Designer White (TDW)
- Fog (TFO)
- Frost (TFR)
- Kalua (TKA)
- Latte (TLA)
- Mocha (TMO)
- Nevada (TNE)
- Sand (TSN)
- Shadow (TSH)
- Toast (TOA)
- Tungsten (TTU)



TABLES	MODEL#	DIMENSIONS	FREIGHT CLASS	WT/LBS.	CUBIC FT.	LIST PRICE
--------	--------	------------	---------------	---------	-----------	------------

D x W x H

Thermally fused:

GCEN3642L	42 x 36 x 28.25	70	89	5.7	<b>\$2059</b>
GCEN4242L	42 x 42 x 28.25	70	102	6	<b>\$2237</b>
GCEN4848L	48 x 48 x 28.25	70	121	6.6	<b>\$2574</b>

High pressure:

GCEN3642H	42 x 36 x 28.25	70	89	5.7	<b>\$2595</b>
GCEN4242H	42 x 42 x 28.25	70	102	6	<b>\$2776</b>
GCEN4848H	48 x 48 x 28.25	70	121	6.6	<b>\$3115</b>

Allows for two EZ-lift arm tablets to be installed on the 42" or 48" wide ends and two fixed arm tablets on the 36" sides.  
2 cartons

Thermally fused:

GC3-DALN	13 x 36 x 7	125	31	4.9	<b>\$1771</b>
----------	-------------	-----	----	-----	---------------

High pressure:

GC3-DAHN	13 x 36 x 7	125	31	4.9	<b>\$2168</b>
----------	-------------	-----	----	-----	---------------

Adjusts up or down by the use of a single paddle actuator. Tablet remains level during adjustment and has a positive locking, smooth counterbalanced operation through the use of a gas cylinder. Tablet range of adjustment is 22.5"H to 36"H from the floor. Guard at the back prevents items from falling. 2 cartons.

- Allowance between arms is 21" for use with wheelchairs.
- Each tablet adds 15" to the depth of the table.
- Fits pre-drilled inserts on 42" or 48" table sides only. Hardware for attaching to table top is included.

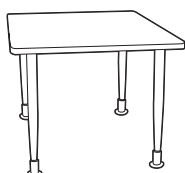

**Table Top with Legs**



**E-Z Lift Dual Arm Tablet**

• Mechanism and tablet bracket are available in Black only

MODEL#	DIMENSIONS	FREIGHT CLASS	WT/LBS.	CUBIC FT.	LIST PRICE
<b>D x W x H</b>					
Thermally fused:					
GC3-1336L	13 x 36 x 1	70	15	0.9	<b>\$759</b>
High pressure:					
GC3-1336H	13 x 36 x 1	70	15	0.9	<b>\$1120</b>



Fixed Height Tablet

Attachable fixed height tablet for Enable tables. Adds 10.5" per tablet to the depth of the table. Heavy duty Black mounting bracket slips onto the table top. Thumbscrews are included and attach into predrilled metal inserts for metal-to-metal fastening and security. 2 cartons.



Tapered Leg with Glide

LLL291	5.25 x 5.25 x 27.25	100	4.8	0.52	<b>\$169</b>
LLL294	5.25 x 5.25 x 27.25	100	18.4	2.1	<b>\$647</b>

• Hardware for assembly is included.

Support leg with glide offers 1.25" glide range adjustment.

- LLL291: 1 per carton
- LLL294: 4 per carton
- Available in Black (TBL), Tungsten (TTU), Shadow (TSH), Designer White (TDW), Nevada (TNE), Latte (TLA), Kalua (TKA), Mocha (TMO), Toast (TOA), Fog (TFO), Cloud (TIV), Sand (TSN) and Frost (TFR). Finish must be specified at time of order.



Tapered Leg with Caster

LCL291	5.25 x 5.25 x 27.75	100	4.8	0.52	<b>\$169</b>
LCL294	5.25 x 5.25 x 27.75	100	18.4	2.1	<b>\$647</b>

• Hardware for assembly is included.

Support leg with lockable caster.

- LCL291: 1 per carton
- LCL294: 4 per carton
- Available in Black (TBL), Tungsten (TTU), Shadow (TSH), Designer White (TDW), Nevada (TNE), Latte (TLA), Kalua (TKA), Mocha (TMO), Toast (TOA), Fog (TFO), Cloud (TIV), Sand (TSN) and Frost (TFR). Finish must be specified at time of order.

PACKAGES

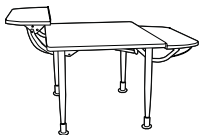

Package A

GCHATAL	64 x 42 x 28.25	100	120.5	13.83	<b>\$5501</b>
Thermally fused					
GCHATAH	64 x 42 x 28.25	100	120.5	13.83	<b>\$6815</b>
High pressure					

- Table top
- Metal inserts pre-drilled for tablets
- Two EZ-lift dual arm tablets
- 4 cartons.
- Four tapered Legs on glides
- All hardware

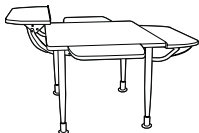

Package B

GCHATBL	68 x 64 x 28.25	100	135.5	14.4	<b>\$6868</b>
Thermally fused					
GCHATBH	68 x 64 x 28.25	100	135.5	14.4	<b>\$8899</b>
High pressure					

- Table top
- Metal inserts pre-drilled for tablets
- Two EZ-lift dual arm tablets
- 6 cartons.
- 2 fixed tablets
- Four tapered Legs on glides
- All hardware

NOTES

D x W x H

- Attractive top design offers an inward curve at each corner allowing comfortable access if assistance with eating is required.
- Adjustable 1.25" range Black plastic glides are standard.
- Heavy duty tapered steel leg finish must be specified at time of order (see below).
- Optional leg on caster available if required.
- Shipped easy to assemble.
- 2mm edging color coordinated with laminate finish is standard for all tops. Finish must be specified at the time of order.
- Tops are 1" thick and available in thermally fused laminate (LP) and high pressure laminate (HP). Please select the appropriate model number for the finish you prefer.
- Refer to the following lists when selecting a finish color. Must specify both a top color and leg finish at time of order.
- For custom laminate or contrasting edge, please contact your Global sales representative for special quotation.

**Thermally Fused Laminate (LP) Tops**



- Absolute Acajou (ACJ)
- Asian Night (ASN)
- Avant Cherry (AWC)
- Avant Honey (AWH)
- Blizzard (BZD)
- Brushed Cobalt (BRC)
- Clear Maple (CMB)
- Custom Grey (CGY)
- Dark Espresso (DES)
- Designer White (DWT)
- Fashionista (FAS)
- First Class (FCL)
- Noce Biondo (NBL)
- Noce Grigio (NGL)
- Noce Leggero (NEL)
- Noce Medio (NML)
- Quartered Mahogany (QTM)
- Sheer Beauty (SBL)
- Stonedust (SDT)
- Walnut Heights (WHE)
- White Chocolate (WHC)
- Winter Cherry (WCR)

**High Pressure Laminate (HP) Tops**

- Absolute Acajou (ACJ)
- Asian Night (ASN)
- Avant Cherry (W357)
- Avant Honey (W356)
- Blizzard (BZD)
- Brushed Cobalt (BRC)
- Clear Maple (CMB)
- Custom Grey (CGY)
- Dark Espresso (W142)
- Designer White (DWT)
- Fashionista (FAS)
- First Class (FCL)
- Noce Biondo (NBL)
- Noce Grigio (NGL)
- Noce Leggero (NEL)
- Noce Medio (NML)
- Quartered Mahogany (QTM)
- Sheer Beauty (SBL)
- Stonedust (SDT)
- Walnut Heights (WHE)
- White Chocolate (WHC)
- Winter Cherry (WCR)

**Leg Finish**

- Black (TBL)
- Cloud (TIV)
- Designer White (TDW)
- Fog (TFO)
- Frost (TFR)
- Kalua (TKA)
- Latte (TLA)
- Mocha (TMO)
- Nevada (TNE)
- Sand (TSN)
- Shadow (TSH)
- Toast (TOA)
- Tungsten (TTU)

	MODEL#	DIMENSIONS	FREIGHT CLASS	WT/LBS.	CUBIC FT.	LIST PRICE
	GCF-42L	42 x 42 x 28.25	70	79	4.14	<b>\$1916</b>
	GCF-42H	42 x 42 x 28.25	70	79	4.14	<b>\$2405</b>
<ul style="list-style-type: none"> <li>• For a thermally fused top (L), specify model GCF-42L.</li> <li>• For a high pressure laminate top (H), specify model GCF-42H.</li> </ul>						
	GCF-48L	48 x 48 x 28.25	70	98	4.7	<b>\$2001</b>
	GCF-48H	48 x 48 x 28.25	70	98	4.7	<b>\$2657</b>
<ul style="list-style-type: none"> <li>• For a thermally fused top (L), specify model GCF-48L.</li> <li>• For a high pressure laminate top (H), specify model GCF-48H.</li> </ul>						
<p>42" x 42" thermally fused laminate top. Four legs.</p> <ul style="list-style-type: none"> <li>• Additional leg heights are available. Special quote is required.</li> <li>• 2 cartons</li> </ul>						
<p>48" x 48" thermally fused laminate top. Four legs.</p> <ul style="list-style-type: none"> <li>• Additional leg heights are available. Special quote is required.</li> <li>• 2 cartons</li> </ul>						

Floral Dining Room Table - 42"

Floral Dining Room Table - 48"

NOTES

D x W x H

- Elliptical metal tube frame finish must be specified at time of order (see below).
- Freestanding tables coordinate with GC-Belong and Strand seating series. Table bridges can be mounted only to GC-Belong ganging seating or bench units. Table bridges do not have legs. All bridge models can be ganged to seat units with link. Please refer to the seating section for more information on ganging tables.
- Tables are 16" high
- Shipped easy to assemble.
- 1" thick tops are available in thermally fused laminate (LP) and high pressure laminate (HP). Please select the appropriate model number for the finish you prefer.
- 2mm edging color coordinated with laminate finish is standard for all tops. Finish must be specified at the time of order.
- Refer to the following lists when selecting a finish color. Must specify both a top color and leg finish when ordering.
- For custom laminate or contrasting edge, please contact your Global sales representative for special quotation.

**Thermally Fused Laminate (LP) Tops**



- Absolute Acajou (ACJ)
- Asian Night (ASN)
- Avant Cherry (AWC)
- Avant Honey (AWH)
- Blizzard (BZD)
- Brushed Cobalt (BRC)
- Clear Maple (CMB)
- Custom Grey (CGY)
- Dark Espresso (DES)
- Designer White (DWT)
- Fashionista (FAS)
- First Class (FCL)
- Noce Biondo (NBL)
- Noce Grigio (NGL)
- Noce Leggero (NEL)
- Noce Medio (NML)
- Quartered Mahogany (QTM)
- Sheer Beauty (SBL)
- Stonedust (SDT)
- Walnut Heights (WHE)
- White Chocolate (WHC)
- Winter Cherry (WCR)

**High Pressure Laminate (HP) Tops**

- Absolute Acajou (ACJ)
- Asian Night (ASN)
- Avant Cherry (W357)
- Avant Honey (W356)
- Blizzard (BZD)
- Brushed Cobalt (BRC)
- Clear Maple (CMB)
- Custom Grey (CGY)
- Dark Espresso (W142)
- Designer White (DWT)
- Fashionista (FAS)
- First Class (FCL)
- Noce Biondo (NBL)
- Noce Grigio (NGL)
- Noce Leggero (NEL)
- Noce Medio (NML)
- Quartered Mahogany (QTM)
- Sheer Beauty (SBL)
- Stonedust (SDT)
- Walnut Heights (WHE)
- White Chocolate (WHC)
- Winter Cherry (WCR)

**Leg Finish**

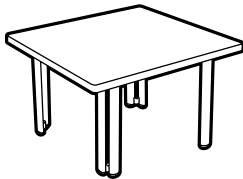
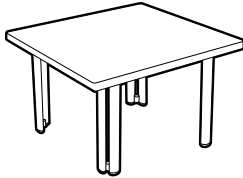
- Black (TBL)
- Cloud (TIV)
- Designer White (TDW)
- Fog (TFO)
- Frost (TFR)
- Kalua (TKA)
- Latte (TLA)
- Mocha (TMO)
- Nevada (TNE)
- Sand (TSN)
- Shadow (TSH)
- Toast (TOA)
- Tungsten (TTU)

	MODEL#	DIMENSIONS	FREIGHT CLASS	WT/LBS.	CUBIC FT.	LIST PRICE
 <p><b>Rectangular End Table</b></p>	GC4281-LP	22 x 18 x 16	100	30	3.4	<b>\$967</b>
	GC4281-HP	22 x 18 x 16	100	30	3.4	<b>\$1093</b>
<ul style="list-style-type: none"> <li>• For a thermally fused laminate top (LP), specify model GC4281-LP.</li> <li>• For a high pressure laminate top (HP), specify model GC4281-HP.</li> </ul> <p>Coordinating 2mm edge. Oval steel tube legs</p>						
 <p><b>Square End Table</b></p>	GC4288-LP	23 x 23 x 16	100	31	3.4	<b>\$1104</b>
	GC4288-HP	23 x 23 x 16	100	31	3.4	<b>\$1227</b>
<ul style="list-style-type: none"> <li>• For a thermally fused laminate top (LP), specify model GC4288-LP.</li> <li>• For a high pressure laminate top (HP), specify model GC4288-HP.</li> </ul> <p>Coordinating 2mm edge. Oval steel tube legs.</p>						
 <p><b>Square End Table</b></p>	GC4282-LP	30 x 30 x 16	150	34	6	<b>\$1239</b>
	GC4282-HP	30 x 30 x 16	150	34	6	<b>\$1383</b>
<ul style="list-style-type: none"> <li>• For a thermally fused laminate top (LP), specify model GC4282-LP.</li> <li>• For a high pressure laminate top (HP), specify model GC4282-HP.</li> </ul> <p>Coordinating 2mm edge. Oval steel tube legs.</p>						

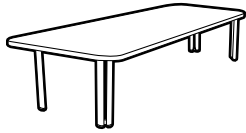

**Rectangular Coffee Table**



**Square Coffee Table**

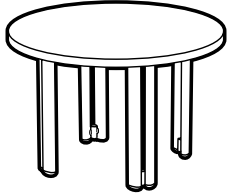

**Round Coffee Table - 24" Diameter**

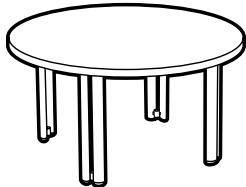

**Round Coffee Table - 30" Diameter**

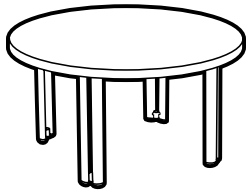

**Round Coffee Table 36" Diameter**

MODEL#	DIMENSIONS	FREIGHT CLASS	WT/LBS.	CUBIC FT.	LIST PRICE
--------	------------	---------------	---------	-----------	------------

**D x W x H**

GC4283-LP	54 x 22 x 16	125	37	6	<b>\$1248</b>
GC4283-HP	54 x 22 x 16	125	37	6	<b>\$1455</b>

- For a thermally fused laminate top (LP), specify model GC4283-LP.
- For a high pressure laminate top (HP), specify model GC4283-HP.

Coordinating 2mm edge. Oval steel tube legs

GC4284-LP	36 x 36 x 16	125	37	6	<b>\$1302</b>
GC4284-HP	36 x 36 x 16	125	37	6	<b>\$1455</b>

- For a thermally fused laminate top (LP), specify model GC4284-LP.
- For a high pressure laminate top (HP), specify model GC4284-HP.

Coordinating 2mm edge. Oval steel tube legs

GC4285-LP	24 x 24 x 16	100	33	3.4	<b>\$1213</b>
GC4285-HP	24 x 24 x 16	100	33	3.4	<b>\$1311</b>

- For a thermally fused laminate top (LP), specify model GC4285-LP.
- For a high pressure laminate top (HP), specify model GC4285-HP.

Coordinating 2mm edge. Oval steel tube legs

GC4286-LP	30 x 30 x 16	150	34	6	<b>\$1218</b>
GC4286-HP	30 x 30 x 16	150	34	6	<b>\$1311</b>

- For a thermally fused laminate top (LP), specify model GC4286-LP.
- For a high pressure laminate top (HP), specify model GC4286-HP.

Coordinating 2mm edge. Oval steel tube legs

GC4287-LP	36 x 36 x 16	125	37	6	<b>\$1379</b>
GC4287-HP	36 x 36 x 16	125	37	6	<b>\$1530</b>

- For a thermally fused laminate top (LP), specify model GC4287-LP.
- For a high pressure laminate top (HP), specify model GC4287-HP.

Coordinating 2mm edge. Oval steel tube legs

TABLE BRIDGES	MODEL#	DIMENSIONS	FREIGHT CLASS	WT/LBS.	CUBIC FT.	LIST PRICE
---------------	--------	------------	---------------	---------	-----------	------------

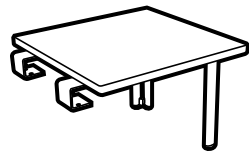

**End Table Bridge, Not Freestanding**

	D x W x H					
GC4274-LP	23 x 23 x 16	125	25	3.4		<b>\$795</b>
GC4274-HP	23 x 23 x 16	125	25	3.4		<b>\$850</b>

- For a thermally fused laminate top (LP), specify model GC4274-LP.
- For a high pressure laminate top (HP), specify model GC4274-HP.

**1 end suspends to a seating unit via linking brackets.** Coordinating 2mm edge. Oval steel tube legs Reversible.

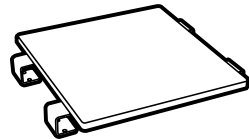

**Square Table Top, Not Freestanding**

GC4275-LP	23 x 23 x 1	150	18	3.4		<b>\$556</b>
GC4275-HP	23 x 23 x 1	150	18	3.4		<b>\$626</b>

- For a thermally fused laminate top (LP), specify model GC4275-LP.
- For a high pressure laminate top (HP), specify model GC4275-HP.

**Suspends between two seating units via linking brackets.** Coordinating 2mm edge No legs. Reversible.



**End Corner Table Bridge Not Freestanding**

GC4277-LP	35 x 35 x 16	125	45	6		<b>\$886</b>
GC4277-HP	35 x 35 x 16	125	45	6		<b>\$1011</b>

- For a thermally fused laminate top (LP), specify model GC4277-LP.
- For a high pressure laminate top (HP), specify model GC4277-HP.

**Suspends between two seating units via linking brackets.** Coordinating 2mm edge. Oval steel tube legs Can be used for right or left corner.



**End Corner Curve Table Bridge Not Freestanding**

GC4278-LP	35 x 35 x 16	125	45	6		<b>\$886</b>
GC4278-HP	35 x 35 x 16	125	45	6		<b>\$1011</b>

- For a thermally fused laminate top (LP), specify model GC4278-LP.
- For a high pressure laminate top (HP), specify model GC4278-HP.

**Suspends between two seating units via linking brackets.** Coordinating 2mm edge. Oval steel tube legs Can be used for right or left corner.



NOTES	MODEL#	DIMENSIONS D x W x H	FREIGHT CLASS	WT/LBS.	CUBIC FT.	LIST PRICE
-------	--------	-------------------------	---------------	---------	-----------	------------

- Select from Chippendale (C), Post (P) or Tapered (T) leg options to coordinate with traditional or contemporary decor.
- Solid wood legs and aprons are standard.
- Shipped RTA (ready to assemble).
- 1" thick tops are available in thermally fused laminate (LP), high pressure laminate (HP) or solid hardwood (W). Please select the appropriate model number for the finish you prefer.
- Thermally fused laminate (LP) and high pressure laminate (HP) tops come with 2mm edging color coordinated with laminate finish. Finish must be specified at time of order.
- Solid hardwood tops come with decorative edge detail to coordinate with the leg selected. Chippendale legs come with beveled edge. Post legs comes with bullnose edge. Tapered leg comes with reverse knife cut edge. See pictures below.
- Refer to the following lists when selecting a finish color. Must specify both a top color and base color when ordering all tables.
- Thermally fused and HP laminate tops cannot be manufactured with the exact finish color on the base.
- For custom laminate, custom wood stain or contrasting edge, please contact your Global sales representative for a special quotation.

**Thermally Fused Laminate (LP) Tops**

**Suggested coordinating wood finish**

**High Pressure Laminate (HP) Tops**

**Suggested coordinating wood finish**

Absolute Acajou (ACJ)	Absolute (AAM)	Absolute Acajou (ACJ)	Absolute (AAM)
Asian Night (ASN)	Night (ASM)	Asian Night (ASN)	Night (ASM)
Avant Cherry (AWC)	Cherry (ACM)	Avant Cherry (W357)	Cherry (ACM)
Avant Honey (AWH)	Honey (AHM)	Avant Honey (W356)	Honey (AHM)
Blizzard (BZD)		Blizzard (BZD)	
Brushed Cobalt (BRC)		Brushed Cobalt (BRC)	
Clear Maple (CMB)	Maple (AVM)	Clear Maple (CMB)	Maple (AVM)
Custom Grey (CGY)		Custom Grey (CGY)	
Dark Espresso (DES)	Espresso Cafe (ECM)	Dark Espresso (W142)	Espresso Cafe (ECM)
Designer White (DWT)	White (WHM)	Designer White (DWT)	White (WHM)
Fashionista (FAS)		Fashionista (FAS)	
First Class (FCL)		First Class (FCL)	
Noce Biondo (NBL)	Noce Biondo (NBM)	Noce Biondo (NBL)	Noce Biondo (NBM)
Noce Grigio (NGL)	Noce Grigio (NGM)	Noce Grigio (NGL)	Noce Grigio (NGM)
Noce Leggero (NEL)	Noce Leggero (NEM)	Noce Leggero (NEL)	Noce Leggero (NEM)
Noce Medio (NML)	Noce Medio (NMM)	Noce Medio (NML)	Noce Medio (NMM)
Quartered Mahogany (QTM)	Mahogany (TMM)	Quartered Mahogany (QTM)	Mahogany (TMM)
Sheer Beauty (SBL)		Sheer Beauty (SBL)	
Stonedust (SDT)		Stonedust (SDT)	
Walnut Heights (WHE)	Natural Walnut (NLW)	Walnut Heights (WHE)	Natural Walnut (NLW)
White Chocolate (WHC)	WC Cream (WTM)	White Chocolate (WHC)	WC Cream (WTM)
Winter Cherry (WCR)	Winter Cherry (WCM)	Winter Cherry (WCR)	Winter Cherry (WCM)

**Wood Finishes (W) - top, base, legs and apron:**

Absolute (AAM)	Medium Walnut (MWM)
Charcoal Java (CJM)	Natural Walnut (NLW)
Cherry (ACM)	Night (ASM)
Empire Mahogany (EMM)	Noce Biondo (NBM)
English Oak (EOM)	Noce Grigio (NGM)
Espresso Cafe (ECM)	Noce Leggero (NEM)
Fruitwood (TFM)	Noce Medio (NMM)
Gray (HGM)	Sandy Beach (SBM)
Harvest Oak (HOM)	Shaker Cherry (SKM)
Honey (AHM)	Silver Oak (SOM)
Jet Onyx (JOM)	Walnut (TWM)
Light Honey (LHM)	White (WHM)
Mahogany (TMM)	WC Cream (WTM)
Maple (AVM)	Winter Cherry (WCM)

**Table edges - wood tops**

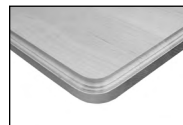

Beveled edge



Bullnose edge

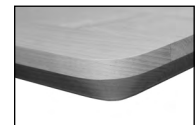

Reverse knife cut edge

**OCCASIONAL TABLES**

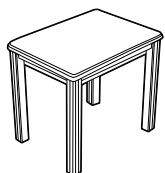

**Rectangular End Table**

**MODEL# DIMENSIONS FREIGHT CLASS WT/LBS. CUBIC FT. LIST PRICE**

GC3760-LC	24 x 18 x 21	150	26.26	5.25	<b>\$960</b>
GC3760-HC	24 x 18 x 21	150	26.26	5.25	<b>\$1099</b>
GC3760-WC	24 x 18 x 21.25	150	27.12	5.25	<b>\$1150</b>

- For a thermally fused top (L), specify model GC3760-LC.
- For a high pressure laminate top (H), specify model GC3760-HC.
- For a wood top (W), specify model GC3760-WC.

Features **Chippendale** legs. 21" high. Standard with solid wood legs and apron.

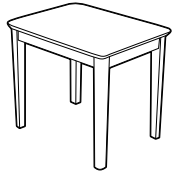

Rectangular End Table

MODEL#	DIMENSIONS D x W x H	FREIGHT CLASS	WT./LBS.	CUBIC FT.	LIST PRICE
GC3760-LT	24 x 18 x 21	150	24.69	5.25	<b>\$960</b>
GC3760-HT	24 x 18 x 21	150	24.69	5.25	<b>\$1099</b>
GC3760-WT	24 x 18 x 21.25	150	25.55	5.5	<b>\$1150</b>

- For a thermally fused top (L), specify model GC3760-LT.
- For a high pressure laminate top (H), specify model GC3760-HT.
- For a wood top (W), specify model GC3760-WT.

Features **Tapered** legs. 21" high. Standard with solid wood legs and apron.

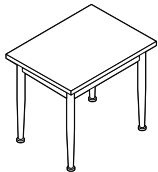

Rectangular End Table

GC3760-LP	24 x 18 x 21	150	26.3	5.25	<b>\$1716</b>
GC3760-HP	24 x 18 x 21	150	26.3	5.25	<b>\$1815</b>
GC3760-WP	24 x 18 x 21	150	27.1	5.25	<b>\$1784</b>

- For a thermally fused top (L), specify model GC3760-LP
- For a high pressure laminate top (H), specify model GC3760-HP
- For a wood top (W), specify model GC3760-WP

Features **Post** legs. 21" high. Standard with solid wood legs and apron. Post legs are 1 1/3" in diameter.

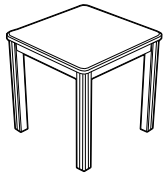

Square End Table

GC3761-LC	21 x 21 x 21	150	26.48	5.5	<b>\$960</b>
GC3761-HC	21 x 21 x 21	150	26.48	5.5	<b>\$1099</b>
GC3761-WC	21 x 21 x 21.25	150	27.36	5.5	<b>\$1150</b>

- For a thermally fused top (L), specify model GC3761-LC.
- For a high pressure laminate top (H), specify model GC3761-HC.
- For a wood top (W), specify model GC3761-WC.

Features **Chippendale** legs. 21" high. Standard with solid wood legs and apron.

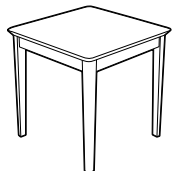

Square End Table

GC3761-LT	21 x 21 x 21	150	24.91	5.5	<b>\$960</b>
GC3761-HT	21 x 21 x 21	150	24.91	5.5	<b>\$1099</b>
GC3761-WT	21 x 21 x 21.25	150	25.79	5.5	<b>\$1150</b>

- For a thermally fused top (L), specify model GC3761-LT.
- For a high pressure laminate top (H), specify model GC3761-HT.
- For a wood top (W), specify model GC3761-WT.

Features **Tapered** legs. 21" high. Standard with solid wood legs and apron.

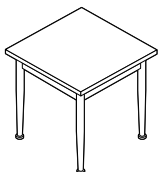

Square End Table

GC3761-LP	21 x 21 x 21	150	26.5	5.5	<b>\$1793</b>
GC3761-HP	21 x 21 x 21	150	26.5	5.5	<b>\$1874</b>
GC3761-WP	21 x 21 x 21	150	27.4	5.5	<b>\$1784</b>

- For a thermally fused top (L), specify model GC3761-LP
- For a high pressure laminate top (H), specify model GC3761-HP
- For a wood top (W), specify model GC3761-WP

Features **Post** legs. 21" high. Standard with solid wood legs and apron. Post legs are 1 1/3" in diameter.

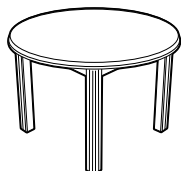

Round End Table

GC3762-LC	24 x 24 x 21	250	26.12	7	<b>\$990</b>
GC3762-HC	24 x 24 x 21	250	26.12	7	<b>\$1181</b>
GC3762-WC	24 x 24 x 21.25	250	27.02	7	<b>\$1232</b>

- For a thermally fused top (L), specify model GC3762-LC.
- For a high pressure laminate top (H), specify model GC3762-HC.
- For a wood top (W), specify model GC3762-WC.

Features **Chippendale** legs. 21" high. Standard with solid wood legs and apron.



Round End Table

MODEL#	DIMENSIONS D x W x H	FREIGHT CLASS	WT/LBS.	CUBIC FT.	LIST PRICE
GC3762-LT	24 x 24 x 21	250	24	8.5	\$990
GC3762-HT	24 x 24 x 21	250	24.55	8.5	\$1181
GC3762-WT	24 x 24 x 21.25	250	25.45	8.5	\$1232

- For a thermally fused top (L), specify model GC3762-LT.
- For a high pressure laminate top (H), specify model GC3762-HT.
- For a wood top (W), specify model GC3762-WT.

Features **Tapered** legs. 21" high. Standard with solid wood legs and apron.

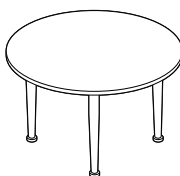

Round End Table

GC3762-LP	24 x 24 x 21	250	26.1	7	\$1779
GC3762-HP	24 x 24 x 21	250	26.1	7	\$1930
GC3762-WP	24 x 24 x 21	250	27	7	\$1903

- For a thermally fused top (L), specify model GC3762-LP.
- For a high pressure laminate top (H), specify model GC3762-HP.
- For a wood top (W), specify model GC3762-WP.

Features **Post** legs. 22" high. Post legs are 1 1/3" in diameter.

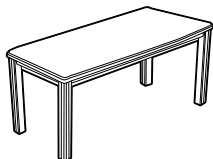

Rectangular Coffee Table

GC3763-LC	48 x 22 x 19	250	43.73	11.75	\$1154
GC3763-HC	48 x 22 x 19	250	43.73	11.75	\$1473
GC3763-WC	48 x 22 x 19.25	250	45.83	11.75	\$1557

- For a thermally fused top (L), specify model GC3763-LC.
- For a high pressure laminate top (H), specify model GC3763-HC.
- For a wood top (W), specify model GC3763-WC.

Features **Chippendale** legs. 19" high. Standard with solid wood legs and apron.

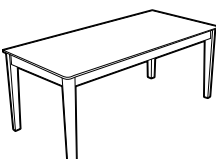

Rectangular Coffee Table

GC3763-LT	48 x 22 x 19	250	42.27	11.75	\$1154
GC3763-HT	48 x 22 x 19	250	42.27	11.75	\$1473
GC3763-WT	48 x 22 x 19.25	250	44.38	11.75	\$1557

- For a thermally fused top (L), specify model GC3763-LT.
- For a high pressure laminate top (H), specify model GC3763-HT.
- For a wood top (W), specify model GC3763-WT.

Features **Tapered** legs. 19" high. Standard with solid wood legs and apron.

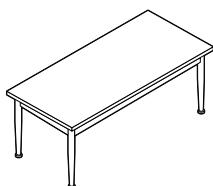

Rectangular Coffee Table

GC3763-LP	48 x 22 x 19	250	43.7	11.75	\$1926
GC3763-HP	48 x 22 x 19	250	43.7	11.75	\$2226
GC3763-WP	48 x 22 x 19	250	45.8	11.75	\$2279

- For a thermally fused top (L), specify model GC3763-LP.
- For a high pressure laminate top (H), specify model GC3763-HP.
- For a wood top (W), specify model GC3763-WP.

Features **Post** legs. 19" high. Standard with solid wood legs and apron. Post legs are 1 1/3" in diameter.

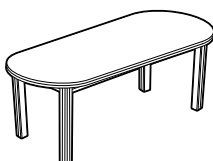

Oval Coffee Table

GC3764-LC	46 x 22 x 19	250	38.58	11.5	\$1110
GC3764-HC	46 x 22 x 19	250	38.58	11.5	\$1426
GC3764-WC	46 x 22 x 19.25	250	38.4	11.5	\$1514

- For a thermally fused top (L), specify model GC3764-LC.
- For a high pressure laminate top (H), specify model GC3764-HC.
- For a wood top (W), specify model GC3764-WC.

Features **Chippendale** legs. 19" high. Standard with solid wood legs and apron.

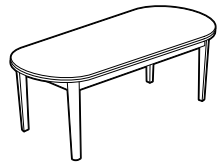

Oval Coffee Table

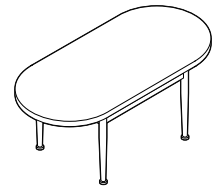

Oval Coffee Table

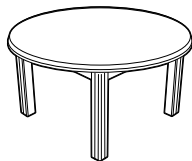

Round Coffee Table



Round Coffee Table

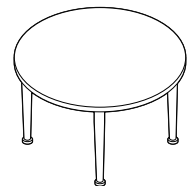

Round Coffee Table

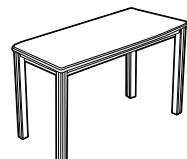

Rectangular Sofa Table

MODEL#	DIMENSIONS D x W x H	FREIGHT CLASS	WT/LBS.	CUBIC FT.	LIST PRICE
--------	-------------------------	---------------	---------	-----------	------------

GC3764-LT	46 x 22 x 19	250	37.13	11.5	<b>\$1110</b>
GC3764-HT	46 x 22 x 19	250	37.13	11.5	<b>\$1426</b>
GC3764-WT	46 x 22 x 19.25	250	36.94	11.5	<b>\$1514</b>

- For a thermally fused top (L), specify model GC3764-LT.
- For a high pressure laminate top (H), specify model GC3764-HT.
- For a wood top (W), specify model GC3764-WT.

Features **Tapered** legs. 19" high. Standard with solid wood legs and apron.

GC3764-LP	46 x 22 x 19	250	38.6	11.5	<b>\$1888</b>
GC3764-HP	46 x 22 x 19	250	38.6	11.5	<b>\$2197</b>
GC3764-WP	46 x 22 x 19	250	38.4	11.5	<b>\$2238</b>

- For a thermally fused top (L), specify model GC3763-LP.
- For a high pressure laminate top (H), specify model GC3763-HP.
- For a wood top (W), specify model GC3763-WP.

Features **Post** legs. 19" high. Standard with solid wood legs and apron. Post legs are 1 1/3" in diameter.

GC3765-LC	32 x 32 x 19	250	35.15	11.5	<b>\$1137</b>
GC3765-HC	32 x 32 x 19	250	35.15	11.5	<b>\$1454</b>
GC3765-WC	32 x 32 x 19.25	250	36.76	11.5	<b>\$1545</b>

- For a thermally fused top (L), specify model GC3765-LC.
- For a high pressure laminate top (H), specify model GC3765-HC.
- For a wood top (W), specify model GC3765-WC.

Features **Chippendale** legs. 19" high. Standard with solid wood legs and apron.

GC3765-LT	32 x 32 x 19	250	33.69	11.5	<b>\$1137</b>
GC3765-HT	32 x 32 x 19	250	33.69	11.5	<b>\$1454</b>
GC3765-WT	32 x 32 x 19.25	250	35.3	11.5	<b>\$1545</b>

- For a thermally fused top (L), specify model GC3765-LT.
- For a high pressure laminate top (H), specify model GC3765-HT.
- For a wood top (W), specify model GC3765-WT.

Features **Tapered** legs. 19" high. Standard with solid wood legs and apron.

GC3765-LP	32 x 32 x 19	250	35.2	11.5	<b>\$1917</b>
GC3765-HP	32 x 32 x 19	250	35.2	11.5	<b>\$2257</b>
GC3765-WP	32 x 32 x 19	250	36.8	11.5	<b>\$2248</b>

- For a thermally fused top (L), specify model GC3765-LP.
- For a high pressure laminate top (H), specify model GC3765-HP.
- For a wood top (W), specify model GC3765-WP.

Features **Post** legs. 19" high. Standard with solid wood legs and apron. Post legs are 1 1/3" in diameter.

GC3766-LC	42 x 16 x 29	250	37.62	11.5	<b>\$1073</b>
GC3766-HC	42 x 16 x 29	250	37.62	11.5	<b>\$1288</b>
GC3766-WC	42 x 16 x 29.25	250	38.07	11.5	<b>\$1330</b>

- For a thermally fused top (L), specify model GC3766-LC.
- For a high pressure laminate top (H), specify model GC3766-HC.
- For a wood top (W), specify model GC3766-WC.

Features **Chippendale** legs. 29" high. Standard with solid wood legs and apron.

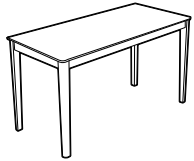

Rectangular Sofa Table

MODEL#	DIMENSIONS D x W x H	FREIGHT CLASS	WT/LBS.	CUBIC FT.	LIST PRICE
GC3766-LT	42 x 16 x 29	250	34.58	11.5	<b>\$1073</b>
GC3766-HT	42 x 16 x 29	250	34.58	11.5	<b>\$1288</b>
GC3766-WT	42 x 16 x 29.25	250	35.92	11.5	<b>\$1330</b>

- For a thermally fused top (L), specify model GC3766-LT.
- For a high pressure laminate top (H), specify model GC3766-HT.
- For a wood top (W), specify model GC3766-WT.

Features **Tapered** legs. 29" high. Standard with solid wood legs and apron.

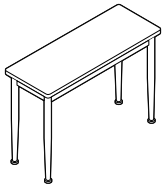

Rectangular Sofa Table

GC3766-LP	42 x 16 x 29	250	37.6	11.5	<b>\$1851</b>
GC3766-HP	42 x 16 x 29	250	37.6	11.5	<b>\$2027</b>
GC3766-WP	42 x 16 x 29	250	38.1	11.5	<b>\$2483</b>

- For a thermally fused top (L), specify model GC3766-LP.
- For a high pressure laminate top (H), specify model GC3766-HP.
- For a wood top (W), specify model GC3766-WP.

Features **Post** legs. 29" high. Standard with solid wood legs and apron. Post legs are 1 1/3" in diameter.

DINING TABLES

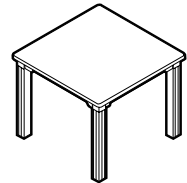

Square Dining Table

MODEL#	DIMENSIONS	FREIGHT CLASS	WT/LBS.	CUBIC FT.	LIST PRICE
GC3772-LC	36 x 36 x 29	85	50	3.9	<b>\$2063</b>
GC3772-HC	36 x 36 x 29	85	50	3.9	<b>\$2301</b>
GC3772-WC	36 x 36 x 29	85	50	3.9	<b>\$3276</b>

- For a thermally fused top (L), specify model GC3772-LC.
- For a high pressure laminate top (H), specify model GC3772-HC.
- For a wood top (W), specify model GC3772-WC.

Features **Chippendale** legs. 29" high. Standard with solid wood legs and apron.

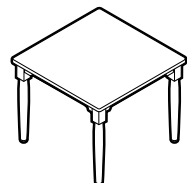

Square Dining Table

GC3772-LP	36 x 36 x 29	85	50	3.9	<b>\$2063</b>
GC3772-HP	36 x 36 x 29	85	50	3.9	<b>\$2301</b>
GC3772-WP	36 x 36 x 29	85	50	3.9	<b>\$3276</b>

- For a thermally fused top (L), specify model GC3772-LP.
- For a high pressure laminate top (H), specify model GC3772-HP.
- For a wood top (W), specify model GC3772-WP.

Features **Post** legs. 29" high. Standard with solid wood legs and apron. Post legs are 1 1/3" in diameter.

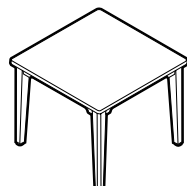

Square Dining Table

GC3772-LT	36 x 36 x 29	85	50	3.9	<b>\$2063</b>
GC3772-HT	36 x 36 x 29	85	50	3.9	<b>\$2301</b>
GC3772-WT	36 x 36 x 29	85	50	3.9	<b>\$3276</b>

- For a thermally fused top (L), specify model GC3772-LT.
- For a high pressure laminate top (H), specify model GC3772-HT.
- For a wood top (W), specify model GC3772-WT.

Features **Tapered** legs. 29" high. Standard with solid wood legs and apron.

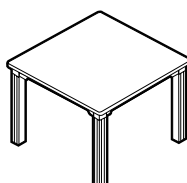

Square Dining Table

GC3773-LC	42 x 42 x 29	85	68	5.5	<b>\$2219</b>
GC3773-HC	42 x 42 x 29	85	68	5.5	<b>\$2543</b>
GC3773-WC	42 x 42 x 29	85	68	5.5	<b>\$3963</b>

- For a thermally fused top (L), specify model GC3773-LC.
- For a high pressure laminate top (H), specify model GC3773-HC.
- For a wood top (W), specify model GC3773-WC.

Features **Chippendale** legs. 29" high. Standard with solid wood legs and apron.

# TABLES

# OCCASIONAL

0

DINING TABLES	MODEL#	DIMENSIONS	FREIGHT CLASS	WT/LBS.	CUBIC FT.	LIST PRICE
---------------	--------	------------	---------------	---------	-----------	------------

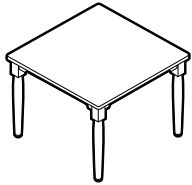

**Square Dining Table**

	D x W x H					
GC3773-LP	42 x 42 x 29	85	68	5.5		<b>\$2219</b>
GC3773-HP	42 x 42 x 29	85	68	5.5		<b>\$2543</b>
GC3773-WP	42 x 42 x 29	85	68	5.5		<b>\$3963</b>

- For a thermally fused top (L), specify model GC3773-LP.
- For a high pressure laminate top (H), specify model GC3773-HP.
- For a wood top (W), specify model GC3773-WP.

Features **Post** legs. 29" high. Standard with solid wood legs and apron. Post legs are 1 1/3" in diameter.

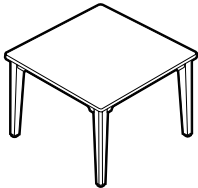

**Square Dining Table**

GC3773-LT	42 x 42 x 29	85	68	5.5		<b>\$2219</b>
GC3773-HT	42 x 42 x 29	85	68	5.5		<b>\$2543</b>
GC3773-WT	42 x 42 x 29	85	68	5.5		<b>\$3963</b>

- For a thermally fused top (L), specify model GC3773-LT.
- For a high pressure laminate top (H), specify model GC3773-HT.
- For a wood top (W), specify model GC3773-WT.

Features **Tapered** legs. 29" high. Standard with solid wood legs and apron.

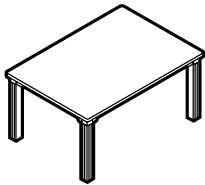

**Rectangular Dining Table**

GC3774-LC	60 x 42 x 29	85	97	7.5		<b>\$2527</b>
GC3774-HC	60 x 42 x 29	85	97	7.5		<b>\$2989</b>
GC3774-WC	60 x 42 x 29	85	97	7.5		<b>\$4958</b>

- For a thermally fused top (L), specify model GC3774-LC.
- For a high pressure laminate top (H), specify model GC3774-HC.
- For a wood top (W), specify model GC3774-WC.

Features **Chippendale** legs. 29" high. Standard with solid wood legs and apron.

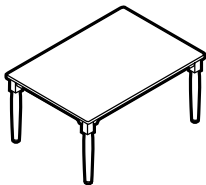

**Rectangular Dining Table**

GC3774-LP	60 x 42 x 29	85	97	7.5		<b>\$2527</b>
GC3774-HP	60 x 42 x 29	85	97	7.5		<b>\$2989</b>
GC3774-WP	60 x 42 x 29	85	97	7.5		<b>\$4958</b>

- For a thermally fused top (L), specify model GC3774-LP.
- For a high pressure laminate top (H), specify model GC3774-HP.
- For a wood top (W), specify model GC3774-WP.

Features **Post** legs. 29" high. Standard with solid wood legs and apron. Post legs are 1 1/3" in diameter.

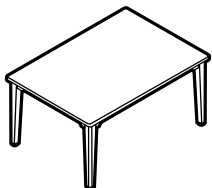

**Rectangular Dining Table**

GC3774-LT	60 x 42 x 29	85	97	7.5		<b>\$2527</b>
GC3774-HT	60 x 42 x 29	85	97	7.5		<b>\$2989</b>
GC3774-WT	60 x 42 x 29	85	97	7.5		<b>\$4958</b>

- For a thermally fused top (L), specify model GC3774-LT.
- For a high pressure laminate top (H), specify model GC3774-HT.
- For a wood top (W), specify model GC3774-WT.

Features **Tapered** legs. 29" high. Standard with solid wood legs and apron.

NOTES	MODEL#	DIMENSIONS D x W x H	FREIGHT CLASS	WT/LBS.	CUBIC FT.	LIST PRICE
-------	--------	-------------------------	---------------	---------	-----------	------------

**Notes:** Please specify all substitutions and options.

- Tops are available in various shapes: rectangular, kidney, peanut and jellybean shapes.
- Bases are available in three styles: H-base, U-base and C-base.
- Bases feature a shock-absorbent gas spring cylinder for easy height adjustment and exposed steel with no plastic cover for easy cleaning of base and casters.
- Manufactured with the lowest base (less than 2"H) in the industry, overbed tables can easily be moved under any patient bed or seating.
- Thermofoil top comes standard with seamless spillguard edge that holds up to 36 oz of liquid. For no spillguard, specify **(NSP)**. Add **\$94**.
- Overbed tables come standard with four non-locking casters.
- For two locking and two non-locking casters, please specify **2L** when ordering the overbed table. Add **\$42** each.
- For four locking casters, please specify **LC** when ordering the overbed table. Add **\$42** each.
- Refer to the following lists when selecting a finish color. Must specify both a top color and base color at time of order all tables.

**Thermofoil Tops**

- Candlelight (TCL)
- Chocolate Pear (TCP)
- Hard Rock Maple (THM)
- Medium Cherry (TMC)
- Medium Oak (TMO)
- Snow White (SNW)

**Bases**

- Almond (AL)
- Graphite Grey (GG)
- Nevada (NV)

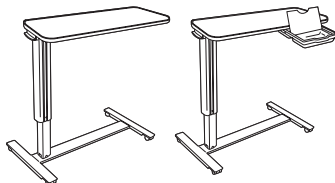
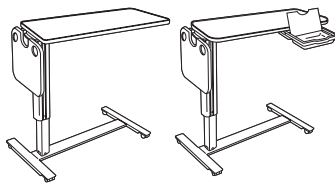
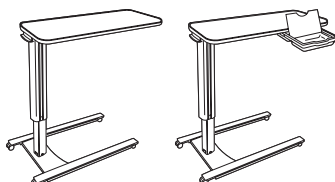
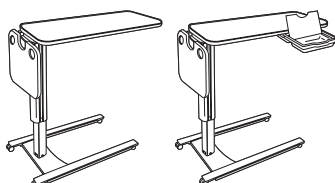
OVERBED TABLES	MODEL #	DIMENSIONS D x W x H	FREIGHT CLASS	WT/LBS.	CUBIC FT.	LIST PRICE
 <p><b>Rectangular Thermofoil Spillguard Top w/H Base</b></p>	GC3554	18 x 34 x 28-42	250	35	13.4	<b>\$1790</b>
	GC3554V w/Vanity drawer	18 x 34 x 28-42	250	37	13.4	<b>\$2063</b>
 <p><b>Rectangular Thermofoil Spillguard Top w/Flip-Top Surface and H Base</b></p>	GC3554F	18 x 48 x 28-42	250	40	13.4	<b>\$2587</b>
	GC3554VF w/Vanity drawer	18 x 48 x 28-42	250	42	13.4	<b>\$2860</b>
 <p><b>Rectangular Thermofoil Spillguard Top w/U Base</b></p>	GC3555	19 x 34 x 28-42	250	35	13.4	<b>\$1698</b>
	GC3555V w/Vanity drawer	19 x 34 x 28-42	250	37	13.4	<b>\$1973</b>
 <p><b>Rectangular Thermofoil Spillguard Top w/Flip-Top Surface and U Base</b></p>	GC3555F	19 x 46 x 28-42	250	40	13.4	<b>\$2495</b>
	GC3555VF w/Vanity drawer	19 x 46 x 28-42	250	42	13.37	<b>\$2769</b>

- Dual vanity drawer with mirror slides out from either side of the table.

Thermofoil top with seamless spillguard edge. Height adjustable steel base. 1 per carton.

- Dual vanity drawer with mirror slides out from either side of the table.

Thermofoil top with seamless spillguard edge. One-hand activation flip-top provides a secondary surface with two cupholders, can hold up to 10 lbs. Height adjustable steel base. 1 per carton.

- Dual vanity drawer with mirror slides out from either side of the table.

Thermofoil top with seamless spillguard edge. Height adjustable steel base. 1 per carton.

- Dual vanity drawer with mirror slides out from either side of the table.

Thermofoil top with seamless spillguard edge. One-hand activation flip-top provides a secondary surface with two cupholders, can hold up to 10 lbs. Height adjustable steel base. 1 per carton.

OVERBED TABLES	MODEL#	DIMENSIONS	FREIGHT CLASS	WT/LBS.	CUBIC FT.	LIST PRICE
----------------	--------	------------	---------------	---------	-----------	------------

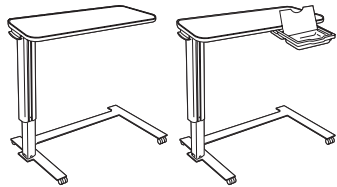

**Rectangular Thermofoil Spillguard Top w/C Base**

	D x W x H					
GC3556	21 x 32 x 28-42	300	35	19		<b>\$1912</b>
GC3556V w/Vanity drawer	21 x 32 x 28-42	300	37	19		<b>\$2185</b>

- Dual vanity drawer with mirror slides out from either side of the table.

Thermofoil top with seamless spillguard edge. Height adjustable steel base. 1 per carton.

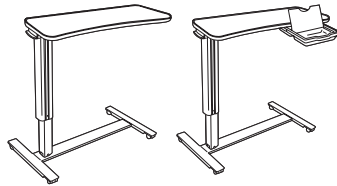

**Kidney Shaped Thermofoil Spillguard Top w/H Base - LEFT**

GC3557L	19 x 34 x 28-42	250	35	13.4		<b>\$1874</b>
GC3557LV w/Vanity drawer	19 x 34 x 28-42	250	37	13.4		<b>\$2150</b>

- Dual vanity drawer with mirror slides out from either side of the table.

**Left** hand side table. Thermofoil top with seamless spillguard edge. Height adjustable steel base. 1 per carton.

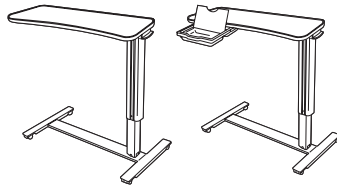

**Kidney Shaped Thermofoil Spillguard Top w/H Base - RIGHT**

GC3557R	19 x 34 x 28-42	250	35	13.4		<b>\$1874</b>
GC3557RV w/Vanity drawer	19 x 34 x 28-42	250	37	13.4		<b>\$2150</b>

- Dual vanity drawer with mirror slides out from either side of the table.

**Right** hand side table. Thermofoil top with seamless spillguard edge. Height adjustable steel base. 1 per carton.

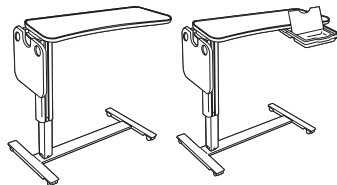

**Kidney Shaped Thermofoil Spillguard Top w/Flip-Top Surface and H-Base, LEFT**

GC3557LF	19 x 46 x 28-42	250	40	13.4		<b>\$2764</b>
GC3557LVF w/Vanity drawer	19 x 46 x 28-42	250	42	13.4		<b>\$3036</b>

- Dual vanity drawer with mirror slides out from either side of the table.

**Left** hand side table. Thermofoil top with seamless spillguard edge. One-hand activation flip-top provides a secondary surface with two cupholders, can hold up to 10 lbs. Height adjustable steel base. 1 per carton.

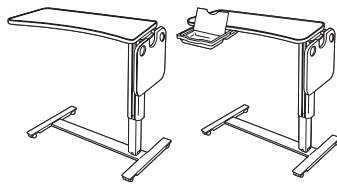

**Kidney Shaped Thermofoil Spillguard Top w/Flip-Top Surface and H-Base, RIGHT**

GC3557RF	19 x 46 x 28-42	250	40	13.4		<b>\$2764</b>
GC3557RVF w/Vanity drawer	19 x 46 x 28-42	250	42	13.4		<b>\$3036</b>

- Dual vanity drawer with mirror slides out from either side of the table.

**Right** hand side table. Thermofoil top with seamless spillguard edge. One-hand activation flip-top provides a secondary surface with two cupholders, can hold up to 10 lbs. Height adjustable steel base. 1 per carton.

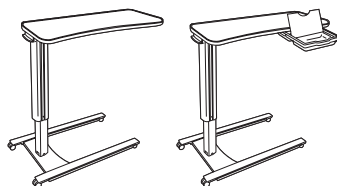

**Kidney Shaped Thermofoil Spillguard Top w/U Base - LEFT**

GC3558L	19 x 34 x 28-42	250	35	13.4		<b>\$1785</b>
GC3558LV w/Vanity drawer	19 x 34 x 28-42	250	37	13.4		<b>\$2058</b>

- Dual vanity drawer with mirror slides out from either side of the table.

**Left** hand side table. Thermofoil top with seamless spillguard edge. Height adjustable steel base. 1 per carton.

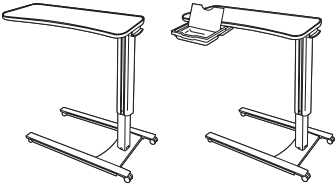
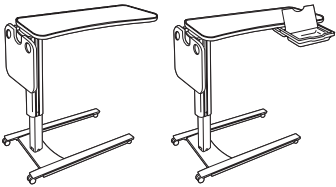
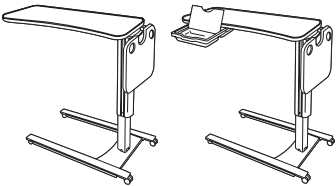
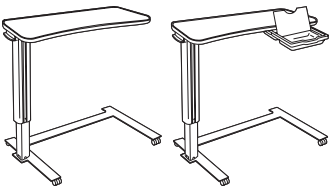
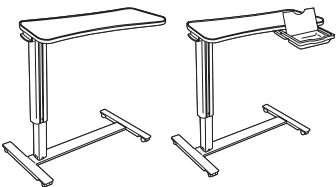
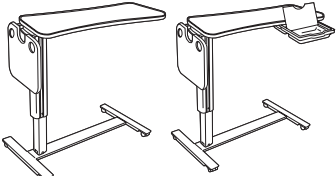

# 0 OVERBED TABLES

OVERBED TABLES	MODEL#	DIMENSIONS D x W x H	FREIGHT CLASS	WT/LBS.	CUBIC FT.	LIST PRICE
 <p><b>Kidney Shaped Thermofoil Spillguard Top w/U Base - RIGHT</b></p>	GC3558R	19 x 34 x 28-42	250	35	13.4	<b>\$1785</b>
	GC3558RV w/Vanity drawer	19 x 34 x 28-42	250	37	13.4	<b>\$2058</b>
<ul style="list-style-type: none"> <li>• Dual vanity drawer with mirror slides out from either side of the table.</li> </ul> <p><b>Right</b> hand side table. Thermofoil top with seamless spillguard edge. Height adjustable steel base. 1 per carton.</p>						
 <p><b>Kidney Shaped Thermofoil Spillguard Top w/Flip-Top Surface and U-Base, LEFT</b></p>	GC3558LF	19 x 48 x 28-42	250	40	13.4	<b>\$2672</b>
	GC3558LVF w/Vanity drawer	19 x 48 x 28-42	250	42	13.4	<b>\$2946</b>
<ul style="list-style-type: none"> <li>• Dual vanity drawer with mirror slides out from either side of the table.</li> </ul> <p><b>Left</b> hand side table. Thermofoil top with seamless spillguard edge. One-hand activation flip-top provides a secondary surface with two cupholders, can hold up to 10 lbs. Height adjustable steel base. 1 per carton.</p>						
 <p><b>Kidney Shaped Thermofoil Spillguard Top w/Flip-Top Surface and U-Base, RIGHT</b></p>	GC3558RF	19 x 48 x 28-42	250	40	13.4	<b>\$2672</b>
	GC3558RVF w/Vanity drawer	19 x 48 x 28-42	250	42	13.4	<b>\$2946</b>
<ul style="list-style-type: none"> <li>• Dual vanity drawer with mirror slides out from either side of the table.</li> </ul> <p><b>Right</b> hand side table. Thermofoil top with seamless spillguard edge. One-hand activation flip-top provides a secondary surface with two cupholders, can hold up to 10 lbs. Height adjustable steel base. 1 per carton.</p>						
 <p><b>Kidney Shaped Thermofoil Spillguard Top w/C Base - LEFT</b></p>	GC3559L	22 x 33 x 28-42	300	35	19	<b>\$1997</b>
	GC3559LV w/Vanity drawer	22 x 33 x 28-42	300	37	19	<b>\$2271</b>
<ul style="list-style-type: none"> <li>• Dual vanity drawer with mirror slides out from either side of the table.</li> </ul> <p><b>Left</b> hand side table. Thermofoil top with seamless spillguard edge. Height adjustable steel base. 1 per carton.</p>						
 <p><b>Peanut Shaped Thermofoil Spillguard Top w/H Base</b></p>	GC3560	19 x 34 x 28-42	250	35	13.4	<b>\$1874</b>
	GC3560V w/Vanity drawer	19 x 34 x 28-42	250	37	13.4	<b>\$2150</b>
<ul style="list-style-type: none"> <li>• Dual vanity drawer with mirror slides out from either side of the table.</li> </ul> <p>Thermofoil top with seamless spillguard edge. Height adjustable steel base. 1 per carton.</p>						
 <p><b>Peanut Shaped Thermofoil Spillguard Top w/Flip-Top Surface and H Base</b></p>	GC3560F	48 x 19 x 28-42	250	40	13.4	<b>\$2764</b>
	GC3560VF w/Vanity drawer	48 x 19 x 28-42	250	42	13.4	<b>\$3036</b>
<ul style="list-style-type: none"> <li>• Dual vanity drawer with mirror slides out from either side of the table.</li> </ul> <p>Thermofoil top with seamless spillguard edge. One-hand activation flip-top provides a secondary surface with two cupholders, can hold up to 10 lbs. Height adjustable steel base. 1 per carton.</p>						

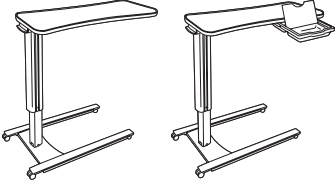
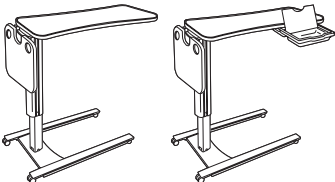
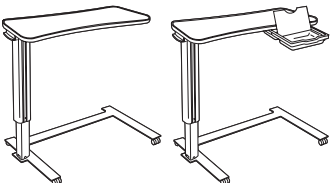
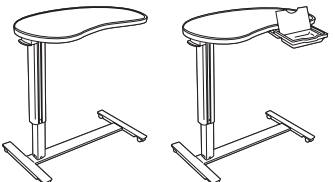
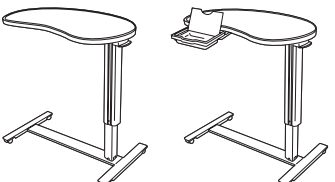
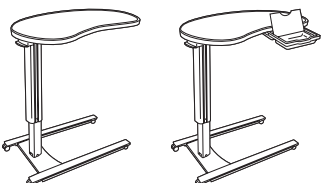
OVERBED TABLES	MODEL#	DIMENSIONS	FREIGHT CLASS	WT/LBS.	CUBIC FT.	LIST PRICE
 <p><b>Peanut Shaped Thermofoil Spillguard Top w/U Base</b></p>	GC3561	D x W x H 19 x 34 x 28-42	250	35	13.4	<b>\$1785</b>
	GC3561V w/Vanity drawer	19 x 34 x 28-42	250	37	13.4	<b>\$2058</b>
<p>• Dual vanity drawer with mirror slides out from either side of the table.</p> <p>Thermofoil top with seamless spillguard edge. Height adjustable steel base. 1 per carton.</p>						
 <p><b>Peanut Shaped Thermofoil Spillguard Top w/Flip-Top Surface and U Base</b></p>	GC3561F	19 x 48 x 28-42	250	40	13.4	<b>\$2672</b>
	GC3561VF w/Vanity drawer	19 x 48 x 28-42	250	42	13.4	<b>\$2946</b>
<p>• Dual vanity drawer with mirror slides out from either side of the table.</p> <p>Thermofoil top with seamless spillguard edge. One-hand activation flip-top provides a secondary surface with two cupholders, can hold up to 10 lbs. Height adjustable steel base. 1 per carton.</p>						
 <p><b>Peanut Shaped Thermofoil Spillguard Top w/C Base</b></p>	GC3562	22 x 33 x 28-42	300	35	19	<b>\$1997</b>
	GC3562V w/Vanity drawer	22 x 33 x 28-42	300	37	19	<b>\$2271</b>
<p>• Dual vanity drawer with mirror slides out from either side of the table.</p> <p>Thermofoil top with seamless spillguard edge. Height adjustable steel base. 1 per carton.</p>						
 <p><b>Jellybean Shaped Thermofoil Spillguard Top w/H Base - LEFT</b></p>	GC3563L	22 x 35 x 28-42.5	250	35	13.4	<b>\$2124</b>
	GC3563LV w/Vanity drawer	22 x 35 x 28-42.5	250	37	13.4	<b>\$2397</b>
<p>• Dual vanity drawer with mirror slides out from either side of the table.</p> <p><b>Left</b> hand side table. Thermofoil top with seamless spillguard edge. Height adjustable steel base. 1 per carton.</p>						
 <p><b>Jellybean Shaped Thermofoil Spillguard Top w/H Base - RIGHT</b></p>	GC3563R	22 x 35 x 28-42.5	250	35	13.4	<b>\$2124</b>
	GC3563RV w/Vanity drawer	22 x 35 x 28-42.5	250	37	13.4	<b>\$2397</b>
<p>• Dual vanity drawer with mirror slides out from either side of the table.</p> <p><b>Right</b> hand side table. Thermofoil top with seamless spillguard edge. Height adjustable steel base. 1 per carton.</p>						
 <p><b>Jellybean Shaped Thermofoil Spillguard Top w/U Base - LEFT</b></p>	GC3564L	22 x 36 x 28-42.5	250	35	13.4	<b>\$2033</b>
	GC3564LV w/Vanity drawer	22 x 36 x 28-42.5	250	37	13.4	<b>\$2306</b>
<p>• Dual vanity drawer with mirror slides out from either side of the table.</p> <p><b>Left</b> hand side table. Thermofoil top with seamless spillguard edge. Height adjustable steel base. 1 per carton.</p>						

# 0 OVERBED TABLES

OVERBED TABLES	MODEL#	DIMENSIONS	FREIGHT CLASS	WT/LBS.	CUBIC FT.	LIST PRICE
----------------	--------	------------	---------------	---------	-----------	------------

D x W x H

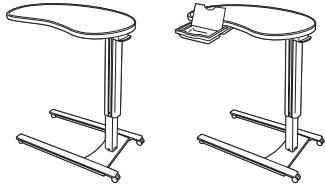

**Jellybean Shaped Thermofoil Spillguard Top w/U Base - RIGHT**

GC3564R	22 x 36 x 28-42.5	250	35	13.4	<b>\$2033</b>
GC3564RV w/Vanity drawer	22 x 36 x 28-42.5	250	37	13.4	<b>\$2306</b>

- Dual vanity drawer with mirror slides out from either side of the table.

**Right** hand side table. Thermofoil top with seamless spillguard edge. Height adjustable steel base. 1 per carton.

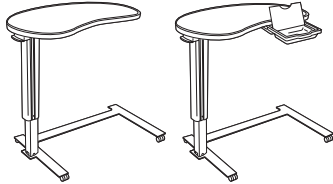

**Jellybean Shaped Thermofoil Spillguard Top w/C Base - LEFT**

GC3565L	22 x 36 x 28-42.5	300	35	19	<b>\$2245</b>
GC3565LV w/Vanity drawer	22 x 36 x 28-42.5	300	37	19	<b>\$2520</b>

- Dual vanity drawer with mirror slides out from either side of the table.

**Left** hand side table. Thermofoil top with seamless spillguard edge. Height adjustable steel base. 1 per carton.

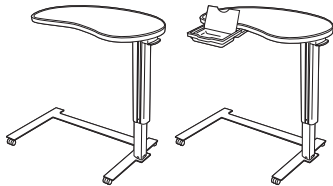



**Jellybean Shaped Thermofoil Spillguard Top w/C Base - RIGHT**

GC3565R	22 x 36 x 28-42.5	300	35	19	<b>\$2245</b>
GC3565RV w/Vanity drawer	22 x 36 x 28-42.5	300	37	19	<b>\$2520</b>

- Dual vanity drawer with mirror slides out from either side of the table.

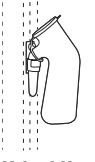
**Right** hand side table. Thermofoil top with seamless spillguard edge. Height adjustable steel base. 1 per carton.

ACCESSORIES	MODEL#	DIMENSIONS D x W x H	FREIGHT CLASS	WT/LBS.	CUBIC FT.	LIST PRICE
 <p><b>Storage Basket</b></p>	GC3566	6 x 10 x 9	150	2	0.4	<b>\$277</b>
	Storage basket hooks on either side of the integrated accessory rail of the overbed table. 1 per carton.					
 <p><b>Urinal Hook</b></p>	GC3567	--	70	1	0.01	<b>\$94</b>
	Hooks on either side of the integrated accessory rail of the overbed table. Bottle not included. 1 per carton.					
 <p><b>Locking Casters</b></p>	GC3568-UPCH	--	250	2	1	<b>\$46</b>
	Price is for 1.					

Notes: Please specify all substitutions and options.

- Primacare table legs complement and work seamlessly with Primacare seating.
- Solid wood legs and apron.
- All connections are metal-to-metal inserts and fasteners.
- Shipped easy to assemble.
- 2mm edging color coordinated with laminate finish is standard for all tops. Finish must specified at time of order.
- Tops are 1" thick and available thermally fused laminate (LP) and high pressure laminate (HP). Please select the appropriate model number for the finish you prefer.
- Refer to the following lists when selecting a finish color. Must specify both a top color and leg finish at time of order.

**Wood Legs**

- Absolute (AAM)
- Charcoal Java (CJM)
- Cherry (ACM)
- Empire Mahogany (EMM)
- English Oak (EOM)
- Espresso Cafe (ECM)
- Fruitwood (TFM)
- Gray (HGM)
- Harvest Oak (HOM)
- Honey (AHM)
- Jet Onyx (JOM)
- Light Honey (LHM)
- Mahogany (TMM)
- Maple (AVM)
- Medium Walnut (MWM)
- Natural Walnut (NLW)
- Night (ASM)
- Noce Biondo (NBM)
- Noce Grigio (NGM)
- Noce Leggero (NEM)
- Noce Medio (NMM)
- Sandy Beach (SBM)
- Shaker Cherry (SKM)
- Silver Oak (SOM)
- Walnut (TWM)
- White (WHM)
- WC Cream (WTM)
- Winter Cherry (WCM)

**Thermally Fused Laminate (LP) Tops**

- Absolute Acajou (ACJ)
- Asian Night (ASN)
- Avant Cherry (AWC)
- Avant Honey (AWH)
- Blizzard (BZD)
- Brushed Cobalt (BRC)
- Clear Maple (CMB)
- Custom Grey (CGY)
- Dark Espresso (DES)
- Designer White (DWT)
- Fashionista (FAS)
- First Class (FCL)
- Noce Biondo (NBL)
- Noce Grigio (NGL)
- Noce Leggero (NEL)
- Noce Medio (NML)
- Quartered Mahogany (QTM)
- Sheer Beauty (SBY)
- Stonedust (SDT)
- Walnut Heights (WHE)
- White Chocolate (WHC)
- Winter Cherry (WCR)

**High Pressure Laminate (HP) Tops**

- Absolute Acajou (ACJ)
- Asian Night (ASN)
- Avant Cherry (W357)
- Avant Honey (W356)
- Blizzard (BZD)
- Brushed Cobalt (BRC)
- Clear Maple (CMB)
- Custom Grey (CGY)
- Dark Espresso (W142)
- Designer White (DWT)
- Fashionista (FAS)
- First Class (FCL)
- Noce Biondo (NBL)
- Noce Grigio (NGL)
- Noce Leggero (NEL)
- Noce Medio (NML)
- Quartered Mahogany (QTM)
- Sheer Beauty (SBL)
- Stonedust (SDT)
- Walnut Heights (WHE)
- White Chocolate (WHC)
- Winter Cherry (WCR)

PRIMACARE TABLES	MODEL#	DIMENSIONS	FREIGHT CLASS	WT/LBS.	CUBIC FT.	LIST PRICE
------------------	--------	------------	---------------	---------	-----------	------------

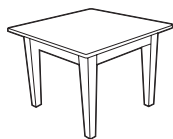

**Square End Table**

GC3664-LP	22 x 22 x 17	250	22	6.75	<b>\$1290</b>
GC3664-HP	22 x 22 x 17	250	22	6.75	<b>\$1389</b>

- For a thermally fused top (LP), specify model GC3664-LP.
- For a high pressure laminate top, specify model GC3664-HP.
- Power and data can be added on the surface of the table. Order power/data module GC36410, see page 205.

Coordinating edge and solid wood frame. 1 per carton.

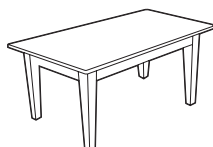

**Rectangular Coffee Table**

GC3665-LP	42 x 21 x 15	250	35	11	<b>\$1656</b>
GC3665-HP	42 x 21 x 15	250	35	11	<b>\$1789</b>

- For a thermally fused top (LP), specify model GC3665-LP.
- For a high pressure laminate top, specify model GC3665-HP.
- Power and data can be added on the surface of the table. Order power/data module GC36410, see page 205.

Coordinating edge and solid wood frame.

Notes: Please specify all substitutions and options.

- Primacare table legs complement the lines of design to work seamlessly with Primacare seating.
- Legs are metal with laminate skirt.
- All connections are metal-to-metal inserts and fasteners.
- Thermofoil and solid surface material options are available on request, please contact your Global sales representative for a special quotation.
- Shipped easy to assemble.
- 2mm edging color coordinated with laminate finish is standard for all tops. Finish must specified at time of order.
- Tops are 1" thick and available in thermally fused laminate (LP) and high pressure laminate (HP). Please select the appropriate model number for the finish you prefer.
- Refer to the following lists when selecting a finish color. Must specify both a top color and leg finish at time of order.

**Metal Legs**

TBL	Black
TTU	Tungsten
TDW	Designer White
TSH	Shadow
TNE	Nevada
TLA	Latte
TKA	Kalua
TMO	Mocha
TOA	Toast
TFO	Fog
TIV	Cloud
TSN	Sand
TFR	Frost

**Thermally Fused Laminate (LP) Tops**

Absolute Acajou (ACJ)
Asian Night (ASN)
Avant Cherry (AWC)
Avant Honey (AWH)
Blizzard (BZD)
Brushed Cobalt (BRC)
Clear Maple (CMB)
Custom Grey (CGY)
Dark Espresso (DES)
Designer White (DWT)
Fashionista (FAS)
First Class (FCL)
Noce Biondo (NBL)

**High Pressure Laminate (HP) Tops**

Absolute Acajou (ACJ)	Noce Grigio (NGL)
Asian Night (ASN)	Noce Leggero (NEL)
Avant Cherry (W357)	Noce Medio (NML)
Avant Honey (W356)	Quartered Mahogany (QTM)
Blizzard (BZD)	Sheer Beauty (SBY)
Brushed Cobalt (BRC)	Stonedust (SDT)
Clear Maple (CMB)	Walnut Heights (WHE)
Custom Grey (CGY)	White Chocolate (WHC)
Dark Espresso (W142)	Winter Cherry (WCR)
Designer White (DWT)	
Fashionista (FAS)	
First Class (FCL)	
Noce Biondo (NBL)	

PRIMACARE HT TABLES	MODEL#	DIMENSIONS	FREIGHT CLASS	WT/LBS.	CUBIC FT.	LIST PRICE
---------------------	--------	------------	---------------	---------	-----------	------------

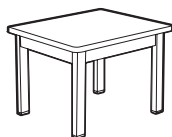

**Rectangular End Table**

GC3661-LP	20 x 24 x 17	250	35	10.5	<b>\$1253</b>
GC3661-HP	20 x 24 x 17	250	35	10.5	<b>\$1386</b>

- For a thermally fused top (LP), specify model GC3661-LP.
- For a high pressure laminate top, specify model GC3661-HP.
- Power and data can be added on the surface of the table. Order power/data module GC36410, see page 205.

Coordinating edge. 1.25" x 2" rectangular metal frame.

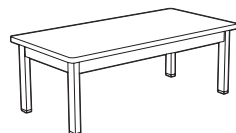

**Rectangular Coffee Table**

GC3662-LP	21 x 42 x 15	250	52	14	<b>\$1590</b>
GC3662-HP	21 x 42 x 15	250	52	14	<b>\$1762</b>

- For a thermally fused top (LP), specify model GC3662-LP.
- For a high pressure laminate top, specify model GC3662-HP.
- Power and data can be added on the surface of the table. Order power/data module GC36410, see page 205.

Coordinating edge. 1.25" x 2" rectangular metal frame.

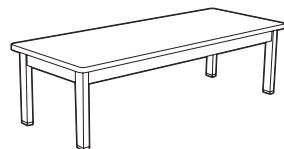

**Rectangular Coffee Table**

GC3663-LP	54 x 21 x 15	250	58	17.5	<b>\$1948</b>
GC3663-HP	54 x 21 x 15	250	58	17.5	<b>\$2141</b>

- For a thermally fused top (LP), specify model GC3662-LP.
- For a high pressure laminate top, specify model GC3662-HP.
- Power and data can be added on the surface of the table. Order power/data module GC36410, see page 205.

Coordinating edge. 1.25" x 2" rectangular metal frame.

**NOTES**

D x W x H

- Four on the floor stability. Heavy duty steel legs are available in Black (**TBL**), Shadow (**TSH**), Toast (**TOA**) and Tungsten (**TTU**). Please specify leg finish color when placing order.
- Shipped RTA (ready to assemble).
- Adjustable 1.25" range Black plastic glides are standard.
- 2mm edging color coordinated with laminate finish is standard for all tops. Optional Black (BLK) edging is also available. Finish must be specified at time of order.
- Tablet tables are designed to accept the fixed tablet on all sides.
- Please specify all substitutions and options.
- 1" thick tops are available in thermally fused laminate (**LP**) and high pressure laminate (**HP**). Please select the appropriate model number for the finish you prefer.
- Refer to the following lists when selecting a finish color. Must specify both a top color and leg finish at time of order.
- For custom laminate or contrasting edge, please contact your Global sales representative for special quotation.

**Thermally Fused Laminate (LP) Tops**

- Absolute Acajou (ACJ)
- Asian Night (ASN)
- Avant Cherry (AWC)
- Avant Honey (AWH)
- Blizzard (BZD)
- Brushed Cobalt (BRC)
- Clear Maple (CMB)
- Custom Grey (CGY)
- Dark Espresso (DES)
- Designer White (DWT)
- Fashionista (FAS)
- First Class (FCL)
- Noce Biondo (NBL)
- Noce Grigio (NGL)
- Noce Leggero (NEL)
- Noce Medio (NML)
- Quartered Mahogany (QTM)
- Sheer Beauty (SBL)
- Stonedust (SDT)
- Walnut Heights (WHE)
- White Chocolate (WHC)
- Winter Cherry (WCR)

**High Pressure Laminate (HP) Tops**

- Absolute Acajou (ACJ)
- Asian Night (ASN)
- Avant Cherry (W357)
- Avant Honey (W356)
- Blizzard (BZD)
- Brushed Cobalt (BRC)
- Clear Maple (CMB)
- Custom Grey (CGY)
- Dark Espresso (W142)
- Designer White (DWT)
- Fashionista (FAS)
- First Class (FCL)
- Noce Biondo (NBL)
- Noce Grigio (NGL)
- Noce Leggero (NEL)
- Noce Medio (NML)
- Quartered Mahogany (QTM)
- Sheer Beauty (SBL)
- Stonedust (SDT)
- Walnut Heights (WHE)
- White Chocolate (WHC)
- Winter Cherry (WCR)

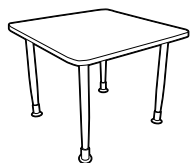

**Dining Table - 36"**



**Dining Table - 42"**



**Tablet**

MODEL#	DIMENSIONS	FREIGHT CLASS	WT/LBS.	CUBIC FT.	LIST PRICE
GC3-36L	36 x 36 x 28.25	70	63.4	3.68	<b>\$1173</b>
GC3-36LH	36 x 36 x 28.25	70	63.4	3.68	<b>\$1377</b>
<ul style="list-style-type: none"> <li>• For a thermally fused top (L), specify model GC3-36L.</li> <li>• For a high pressure laminate top (H), specify model GC3-36LH.</li> </ul> <p>Standard Black edge. 36" x 36" top accepts a tablet on all sides. Heavy duty steel legs are standard in Black Gloss (BLK). A variety of optional finishes are also available. Please Specify.</p> <ul style="list-style-type: none"> <li>• Additional leg heights are available. Special quote is required.</li> <li>• 2 cartons</li> </ul>					
GC3-42L	42 x 42 x 28.25	70	79.65	4.2	<b>\$1517</b>
GC3-42LH	42 x 42 x 28.25	70	79.65	4.2	<b>\$1753</b>
<ul style="list-style-type: none"> <li>• For a thermally fused top (L), specify model GC3-42L.</li> <li>• For a high pressure laminate top (H), specify model GC3-42LH.</li> </ul> <p>Standard Black edge. 42" x 42" top accepts a tablet on all sides. Heavy duty steel legs are standard in Black Gloss (BLK). A variety of optional finishes are also available. Please Specify.</p> <ul style="list-style-type: none"> <li>• Additional leg heights are available. Special quote is required.</li> <li>• 2 cartons</li> </ul>					
GC3-NUG	10 x 24 x 1	70	15	0.8	<b>\$491</b>
GC3-NUGH	10 x 24 x 1	70	15	0.8	<b>\$534</b>
<ul style="list-style-type: none"> <li>• For a thermally fused top (L), specify model GC3-NUG.</li> <li>• For a high pressure laminate top (H), specify model GC3-NUGH.</li> </ul> <p>Attachable tablet for above Tablet Tables. Attaches on any side to extend table by 24". Heavy duty steel mounting bracket is standard in Black.</p>					

NOTES

D x W x H

- Organic shaped tops available in three sizes: 48" x 48", 59" x 59" or 59" x 90".
- Tops supported by 3" diameter fixed height post legs.
- Tops are available in 1" thick thermally fused laminate or 1-1/16" thick high pressure laminate
- Worksurface core is made of 45 lb. density particleboard
- Global's preferred (2mm flat edge) matching edge is standard
- Surfaces include factory-installed metal inserts for solid and secure leg connections
- Optional ergo-friendly edge is available at an upcharge (varies by item; see product for details).

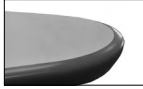

Ergo friendly edge

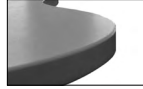

2mm flat edge

- Writeable surface option available. High gloss White, non-magnetic dry-erase surface. Complementary or contrasting edge to be specified, darker edge finish recommended. Specify **(WRW)** for top finish. For upcharge, refer to finish option per product.

**Thermally Fused and High Pressure Laminate Finishes:**

ACJ Absolute Acajou	NBL Noce Biondo
ASN Asian Night	NGL Noce Grigio
AWC Avant Cherry	NEL Noce Leggero
AWH Avant Honey	NML Noce Medio
BLK Black	QTM Quartered Mahogany
BZD Blizzard	SBY Sheer Beauty
BRC Brushed Cobalt	SDT Stonedust
CMB Clear Maple	SOG Storm Grey
CGY Custom Grey	WHE Walnut Heights
DES Dark Espresso	WHC White Chocolate
DWT Designer White	WCR Winter Cherry
FAS Fashionista	WRW Writeable Surface*
FCL First Class	<i>*Upcharge applies</i>

**2mm Thick Edgebanding:**

AAE Absolute Acajou	FCL First Class
ASE Asian Night	FOG Fog
ACE Avant Cherry	LAB Latte
AHE Avant Honey	NBL Noce Biondo
BLK Black	NGL Noce Grigio
BZD Blizzard	NEL Noce Leggero
BRC Brushed Cobalt	NML Noce Medio
BZB Buzz Blue	QTM Quartered Mahogany
CCT Cactus	SAR Scarlet
CRO Carrot	SHW Shadow
CME Clear Maple	SBY Sheer Beauty
CGY Custom Grey	SDT Stonedust
DEE Dark Espresso	SOG Storm Grey
DWE Designer White	WHE Walnut Heights
DJN Dijon	CBE White Chocolate
FAS Fashionista	WCE Winter Cherry

**Ergo Friendly Edge Finishes (optional - upcharge applies)**

EBL Black
ECP Latte
ECG Charcoal Grey
EDW Designer White
EGR Grey

**Leg Finishes:**

TBL Black	TEG Eggplant	TNE Nevada
TBZ Buzz Blue	TFO Fog	TSN Sand
TCC Cactus	TFR Frost	TSR Scarlet
TCR Carrot	TIN Ink	TSH Shadow
TIV Cloud	TKA Kalua	TOA Toast
TDW Designer White	TLA Latte	TTU Tungsten
TDJ Dijon	TMO Mocha	

**4-6 PERSON GROUP TABLES**

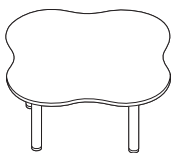

**4-Person Table, 20"H**

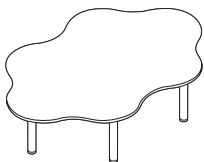

**6-Person Table, 20"H**

MODEL#	DIMENSIONS	FREIGHT CLASS	WT/LBS.	CUBIC FT.	LIST PRICE	HP ADD	ERGO EDGE	WRW
--------	------------	---------------	---------	-----------	------------	--------	-----------	-----

ZK4484820	48 x 48 x 20	60	92	7.10	<b>\$1089</b>	<b>\$317</b>	<b>\$91</b>	<b>\$341</b>
ZK4595920	59 x 59 x 20	65	123	9	<b>\$1119</b>	<b>\$375</b>	<b>\$193</b>	<b>\$510</b>

4-person table includes top and four steel post legs. Top includes factory installed metal inserts for solid and secure leg connections. Legs are 3" in diameter x 19" high each with an adjustable 3" diameter plastic glide and a 6" x 6" metal top plate. Shipped easy to assemble in 5 cartons.

ZK6599020	59 x 90 x 20	70	247.50	14	<b>\$1731</b>	<b>\$657</b>	<b>\$285</b>	<b>\$845</b>
-----------	--------------	----	--------	----	---------------	--------------	--------------	--------------

6-person table includes top and seven steel post legs. Top includes factory installed metal inserts for solid and secure leg connections. Legs are 3" in diameter x 19" high each with an adjustable 3" diameter plastic glide and a 6" x 6" metal top plate. Shipped easy to assemble in 8 cartons.



# seating

## Private + Public + Individual + Group Applications

Application guidelines.....	61	GC Comet.....	124
Bishop.....	62	GC Islands.....	125
Calidon.....	63	GC Sidero.....	126
Chap.....	70	GC Sirena.....	136
Coast.....	72	GC Vitrola.....	142
Collingwood.....	73	GC Vion.....	138
Desmond.....	75	GC Wind.....	140
Desmond HT.....	76	Janna.....	145
Doctor Buddy.....	78	Nourish.....	147
Dreme.....	79	Oakville.....	151
Drift.....	82	Primacare.....	152
Erin.....	83	River+.....	218
Flap.....	85	Senator.....	219
Foot Activated Stools.....	87	Sleep-Eez.....	220
Frolick.....	88	Splash.....	88
Gala II.....	93	Strand.....	221
GC Beach.....	94	Willow.....	227
GC Belong.....	95	Wingback.....	241
GC Citi.....	123		

SERIES	WOOD	METAL	BARIATRIC SEATING	DINING / CAFETERIA	GUEST SEATING	LOBBIES	LOUNGE / WAITING	OFFICE / MEETING	PATIENT ROOMS	RESIDENT ROOMS	STACKING	TREATMENT / EXAM ROOMS
BISHOP	•					•	•			•		
CALIDON	•		•		•	•	•		•	•		•
CHAP	•			•	•	•	•	•	•	•		
COAST	•						•		•	•		
COLLINGWOOD	•			•	•	•	•		•	•		
DESMOND	•			•	•	•	•	•	•	•		
DESMOND HT		•	•	•	•	•	•	•	•	•		
DOCTOR BUDDY		•		•				•	•	•		•
DREME									•	•		
ERIN	•	•		•	•	•	•		•	•		
FLAP				•	•						•	•
FOOT ACTIVATED STOOLS				•				•	•	•		•
FROLICK		•	•	•	•	•	•	•	•	•	•	•
GALA II		•						•				•
GC BEACH	•			•	•	•	•	•	•	•		
GC BELONG		•	•		•	•	•		•	•		•
GC CITI		•			•	•	•					
GC COMET	•	•	•	•	•	•	•	•	•	•	•	•
GC ISLANDS	•			•	•	•	•	•	•	•		
GC SIDERO		•	•	•	•	•	•	•	•	•	•	•
GC SIRENA	•			•	•	•	•	•	•	•		
GC VION								•				
GC VITROLA	•		•		•	•	•		•	•		
GC WIND		•				•	•	•	•	•		
JANNA	•			•	•		•	•	•	•		•
NOURISH		•	•				•		•	•		•
OAKVILLE	•				•	•	•		•	•		
OTTOMANS	•	•			•	•	•		•	•		•
PRIMACARE	•		•	•	•	•	•		•	•		•
PRIMACARE HT		•	•	•	•	•	•		•	•		•
PRIMACARE MODULAR	•		•	•	•	•	•					
PRIMACARE WINGBACK	•	•	•		•	•	•		•	•		
SENATOR	•	•				•	•		•	•		
SLEEP-EEZ					•				•	•		
SPLASH		•		•	•	•	•	•	•	•	•	•
STRAND	•	•	•		•	•	•		•	•		•
THROW PILLOWS						•	•			•		
WILLOW		•	•	•	•	•	•	•	•	•	•	•
WINGBACK	•				•	•	•		•	•		

**BISHOP**



model GC3751

**STANDARD FEATURES**

- Bishop offers a classic, traditional, rolled arm style design.
- Features removable and replaceable seat cushions
- Wood frame and hardwood block legs are available in a variety of finishes: erry (ACM), English Oak (EOM), Espresso Cafe (ECM), Fruitwood (TFM), Honey (AHM), Mahogany (TMM), Maple (AVM), Natural Walnut (NLW), Noce Biondo (NBM), Noce Grigio (NGM), Noce Leggero (NEM), Noce Medio (NMM), Sandy Beach (SKM), and Walnut (TWM). Please specify.
- For added comfort, seat and back are standard with high density Ultracell foam.
- Opaque non-marking glides are standard
- For healthcare textiles and finish options, visit the website at [globalfurnituregroup.com](http://globalfurnituregroup.com)
- Can be upholstered in standard Global textiles if healthcare compliance is not required.
- Shipped fully assembled.
- Standard glide is plastic.

**OPTIONAL FEATURES**

- For non-slip glides, specify **(NS)**. Add \$35
- For moisture barrier on seat, please specify **(MB)**. Add \$193 per seat.

**SUGGESTED APPLICATIONS**

- Lobbies
- Lounge/Waiting
- Resident rooms

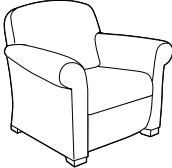
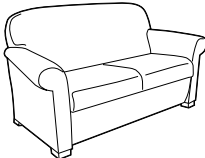
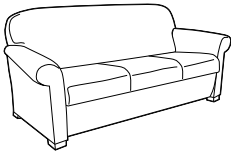
DESCRIPTION	MODEL#	STANDARD FABRIC GRADES											
		COM	2	3	4	5	6	7	8	9	10	11	12
  <b>Lounge Chair</b> COM Yardage: 7.25 Freight Class: 250 Product Weight (lbs.): 75 Cubic Feet Per Carton: 30.25	GC3751	\$2593	\$2843	\$3050	\$3350	\$3777	\$3941	\$4316	\$5016	\$5371	\$6025	\$6933	\$8056
		<b>OVERALL DIMENSIONS</b>			<b>SEAT DIMENSIONS</b>			<b>BACK DIMENSIONS</b>					
		W	D	H	W	D	H	W	H				
			37	32	34.5	21	18.5	17	28	17.5			
Active weight 300 lbs. Loose seat cushion.													
  <b>Two Seat Sofa</b> COM Yardage: 8.75 Freight Class: 250 Product Weight (lbs.): 112 Cubic Feet Per Carton: 55.75	GC3752	\$3663	\$3964	\$4212	\$4577	\$5093	\$5287	\$5738	\$6589	\$7014	\$7804	\$8899	\$10255
		<b>OVERALL DIMENSIONS</b>			<b>SEAT DIMENSIONS</b>			<b>BACK DIMENSIONS</b>					
		W	D	H	W	D	H	W	H				
			63.5	32	34.5	47.5	18.5	17	55	17.5			
Active weight 300 lbs./seat. Loose seat cushions.													
  <b>Three Seat Sofa</b> COM Yardage: 12 Freight Class: 250 Product Weight (lbs.): 155 Cubic Feet Per Carton: 74.75	GC3753	\$5416	\$5784	\$6391	\$6883	\$7574	\$7833	\$8443	\$9584	\$10152	\$11214	\$12688	\$14507
		<b>OVERALL DIMENSIONS</b>			<b>SEAT DIMENSIONS</b>			<b>BACK DIMENSIONS</b>					
		W	D	H	W	D	H	W	H				
			90	32	34.5	74	18.5	17	82	17.5			
Active weight 300 lbs./seat. Loose seat cushions.													

CALIDON



**GC36305**  
Wood Lounge Single Seat,



**GC36301**  
Wood Guest Single Seat



**GC36308**  
Fully Upholstered Lounge Single Seat



For Calidon tables, see 67.

EXAMPLE CALIDON ORDER CODE:

GC36308	PU75	PU75	AAM	NBS
Model #	Back/Arm textile	Seat textile	Frame Finish	Sealed Back Seams

NSS	NB	NM	SRT
Sealed Seat Seams	Moisture Barrier	Glides	Power

STANDARD FEATURES

- Calidon series consists of wood frame guest, lounge, bariatric and bench seating in addition to fully upholstered lounge seating. Freestanding and tandem/bridge tables also available to complement the line.
- Calidon is designed for the rigors of high use environments. Lounge units include metal frame supports.
- The seating in this series is available to specify with two textiles, one for the seat cushion and one for the back and arms (see model image).
- For pricing, start with the base price and add both back/arms graded textile upcharge and the seat graded textile upcharge.
- Frame design features a wall saver leg to prevent back contact and damage to walls.
- All guest and lounge chairs feature a clean out between seat and back, replaceable seat cushions and tall legs for ease of cleaning.
- For added comfort, seats are standard with high density Ultracell foam.
- Active weight capacity up to 400 lbs/seat for standard seating; up to 600 lbs for bariatric seating .
- For healthcare textiles, visit the website at globalfurnituregroup.com.
- Textiles with a minimum of 100,000 double rubs must be specified to meet Global's 24/7 warranty coverage.
- Can be upholstered in standard Global textiles if Healthcare 24/7 warranty compliance is not required.
- For alternate textile applications, contact Global specials. The Blended Textile matrix does not apply to this series.
- Tandem table models connect to guest seating only. See Calidon tables.
- No seating or bench models gang together.
- Shipped fully assembled.

OPTIONAL FEATURES

- All guest and lounge models can be specified with or without armcaps. Urethane armcaps are available on Wood arm guest and lounge chairs. Solid surface armcaps are available on all chair models. Armcaps are field replaceable, securely fastened with metal-to-metal connectors. Armcaps cannot be retrofitted in the field on units with no existing armcaps.
- Fully upholstered lounge chairs can be specified with a tamperproof Black power/USB unit, which includes one AC outlet, two 10 watt USB ports, and a 10 ft long power cord. Power is factory installed and must be specified at time of order. Add **\$237** each. Power locations vary by model. See power location diagram.
- For moisture barrier on seat, specify **(MB)**. Upcharges vary, see model.
- To add sealed seams, specify **(SBS)** for seat back and arms and/or **(SSS)** for seat. Upcharges vary, see model.
- A tamperproof power unit is available to specify in various locations on closed arm lounge models only. See diagrams.

SUGGESTED APPLICATIONS



- Guest seating
- Lobby/Lounge
- Treatment/Exam rooms



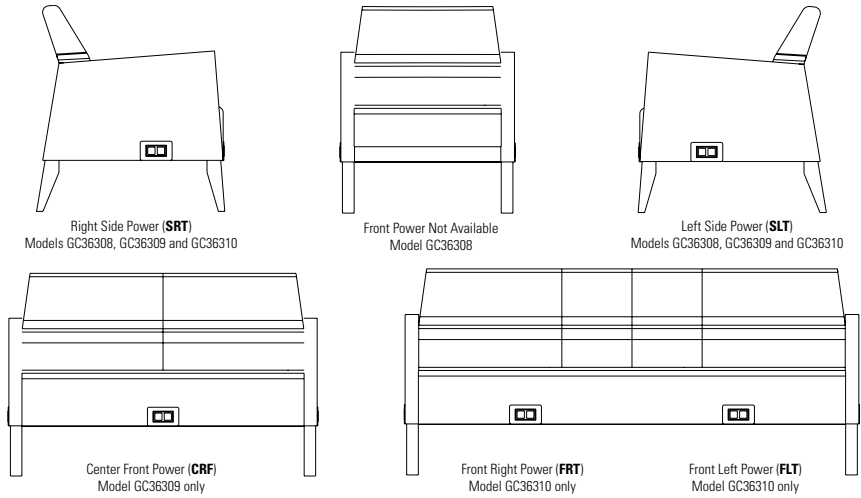

Please add option codes in the following order:





- **Model number**  
See models.  
For Calidon tables, refer to 67
- **Back/Arm Textile**  
Specify textile code. See model grade upcharges.
- **Seat Textile**  
Specify textile code. See model grade upcharges.
- **Armcap option (FNA)** No armcaps  
**(FAC)** With armcaps. Upcharges vary, see model.
- **Frame finish**  
**(AAM)** Absolute  
**(CJM)** Charcoal Java  
**(ACM)** Cherry  
**(EMM)** Empire Mahogany  
**(EOM)** English Oak  
**(ECM)** Espresso Cafe  
**(TFM)** Fruitwood  
**(HGM)** Grey  
**(HOM)** Harvest Oak  
**(AHM)** Honey  
**(JOM)** Jet Onyx  
**(LHM)** Light Honey  
**(TMM)** Mahogany  
**(AMV)** Maple  
**(MWM)** Medium Walnut  
**(ASM)** Night  
**(NBM)** Noce Biondo  
**(NGM)** Noce Grigio  
**(NEM)** Noce Leggero  
**(NMM)** Noce Medio  
**(SBM)** Sandy Beach  
**(SKM)** Shaker Cherry  
**(SOM)** Silver Oak  
**(TWM)** Walnut  
**(WTM)** WC Cream  
**(WHM)** White  
**(WCM)** Winter Cherry
- **Armcap finish (SSU)** Urethane (for wood arm models of guest and lounge seating with FAC specified). Urethane finishes (upcharges vary, see model):  
**(BLK)** Black  
**(KAL)** Kalua  
**(LAB)** Latte  
**(J52)** Mocha  
**(SHW)** Shadow  
**(TOA)** Toast  
**(CO)** Solid Surface (for all wood and fully upholstered arm models with FAC specified).  
Solid Surface Finishes:  
Grade 1: (Upcharges vary, see model)  
**(SWH)** Designer White  
Grade 2: (Upcharges vary, see model)  
**(SBT)** Beige Tempest  
**(SBX)** Black Onyx Mirage  
**(SMG)** Milk Glass Spectra  
**(SFW)** Frosty White Mirage  
**(SHS)** Hot Stone  
**(SNM)** Northern Melange
- **Sealed Back Seams** (Contact Customer Care for approved textiles.)  
**(NBS)** No sealed back seams  
**(SBS)** Sealed back seams. Upcharges vary, see model.
- **Sealed Seat Seams** (Contact Customer Care for approved textiles.)  
**(NSS)** No sealed seat seams  
**(SSS)** Sealed seat seams. Upcharges vary, see model.
- **Glides**  
**(NM)** Non-marking  
**(NS)** Non-slip  
Guest single seat, bariatric and lounge chairs, add \$29.  
Guest two seater, Add \$44.  
Guest three seater, add \$56.
- **Moisture Barrier** (seat only) (Not available with Sealed Seams)  
**(NB)** No moisture barrier  
**(MB)** Moisture barrier. Upcharges vary, see model.
- **Power/USB unit position** (lounge models only). Add **\$237**.  
**(NPM)** No power  
**(TPM)** Tamperproof power unit  
**(J)** Black  
**(SRT)** Side right  
**(SLT)** Side left  
**(FLT)** Front left (three seater only)  
**(FRT)** Front right (three seater only)  
**(CRF)** Center front (two seater only)  
**(SLR)** Side left and right. Add **\$472**.  
**(FLR)** Front left and right. Add **\$472**.

POWER LOCATION DIAGRAM



DESCRIPTION	MODEL#/ FEATURES	STANDARD TEXTILE GRADES											
		1/COM	2	3	4	5	6	7	8	9	10	11	12
 <p><b>Wood Guest Single Seat</b> COM Yardage: Back: 0.9; Seat: 1 Freight Class: 250 Product Weight (lbs.): 38 Cubic Feet Per Carton: 16.5</p>	GC36301	Base Price:	<b>\$1195</b>										
	Back upcharge:	<b>+0</b>	<b>+\$29</b>	<b>+\$52</b>	<b>+\$85</b>	<b>+\$132</b>	<b>+\$152</b>	<b>+\$192</b>	<b>+\$256</b>	<b>+\$304</b>	<b>+\$356</b>	<b>+\$465</b>	<b>+\$579</b>
	Seat upcharge:	<b>+0</b>	<b>+\$32</b>	<b>+\$57</b>	<b>+\$94</b>	<b>+\$146</b>	<b>+\$168</b>	<b>+\$213</b>	<b>+\$284</b>	<b>+\$337</b>	<b>+\$395</b>	<b>+\$516</b>	<b>+\$643</b>
	Active weight 400 lbs.	<b>OVERALL DIMENSIONS</b>			<b>SEAT DIMENSIONS</b>			<b>BACK DIMENSIONS</b>					
		<b>W</b>	<b>D</b>	<b>H</b>	<b>W</b>	<b>D</b>	<b>H</b>	<b>W</b>	<b>H</b>				
	23.5	26.5	34.5	21.5	18	18	21.5	16.5					
 <p><b>Wood Guest Two Seater, Full Center Arm</b> COM Yardage: Back: 1.8; Seat: 2 Freight Class: 250 Product Weight (lbs.): 68 Cubic Feet Per Carton: 31.75</p>	GC36302	Base Price:	<b>\$2211</b>										
	Back upcharge:	<b>+0</b>	<b>+\$58</b>	<b>+\$103</b>	<b>+\$170</b>	<b>+\$263</b>	<b>+\$303</b>	<b>+\$384</b>	<b>+\$512</b>	<b>+\$607</b>	<b>+\$711</b>	<b>+\$929</b>	<b>+\$1158</b>
	Seat upcharge:	<b>+0</b>	<b>+\$64</b>	<b>+\$114</b>	<b>+\$188</b>	<b>+\$292</b>	<b>+\$336</b>	<b>+\$426</b>	<b>+\$568</b>	<b>+\$674</b>	<b>+\$790</b>	<b>+\$1032</b>	<b>+\$1286</b>
	Active weight 400 lbs./seat	<b>OVERALL DIMENSIONS</b>			<b>SEAT DIMENSIONS</b>			<b>BACK DIMENSIONS</b>					
		<b>W</b>	<b>D</b>	<b>H</b>	<b>W</b>	<b>D</b>	<b>H</b>	<b>W</b>	<b>H</b>				
	46	26.5	34.5	21.5	18	18	21.5	16.5					
 <p><b>Wood Guest Three Seater, Full Center Arms</b> COM Yardage: Back: 2.7; Seat: 3 Freight Class: 250 Product Weight (lbs.): 101 Cubic Feet Per Carton: 47.5</p>	GC36303	Base Price:	<b>\$3255</b>										
	Back upcharge:	<b>+0</b>	<b>+\$87</b>	<b>+\$154</b>	<b>+\$254</b>	<b>+\$395</b>	<b>+\$454</b>	<b>+\$576</b>	<b>+\$767</b>	<b>+\$910</b>	<b>+\$1067</b>	<b>+\$1394</b>	<b>+\$1737</b>
	Seat upcharge:	<b>+0</b>	<b>+\$96</b>	<b>+\$171</b>	<b>+\$282</b>	<b>+\$438</b>	<b>+\$504</b>	<b>+\$639</b>	<b>+\$852</b>	<b>+\$1011</b>	<b>+\$1185</b>	<b>+\$1548</b>	<b>+\$1929</b>
	Active weight 400 lbs./seat	<b>OVERALL DIMENSIONS</b>			<b>SEAT DIMENSIONS</b>			<b>BACK DIMENSIONS</b>					
		<b>W</b>	<b>D</b>	<b>H</b>	<b>W</b>	<b>D</b>	<b>H</b>	<b>W</b>	<b>H</b>				
	68	26.5	34.5	21.5	18	18	21.5	16.5					

DESCRIPTION	MODEL#/ FEATURES	STANDARD TEXTILE GRADES											
		1/COM	2	3	4	5	6	7	8	9	10	11	12
 <p><b>Wood Guest Bariatric Chair</b> COM Yardage: Back: 1.25; Seat: 1.25 Freight Class: 250 Product Weight (lbs.): 55 Cubic Feet Per Carton: 22.25</p>	<b>GC36304</b> Base Price:	<b>\$1827</b>											
	Back upcharge:	<b>+0</b>	<b>+\$40</b>	<b>+\$72</b>	<b>+\$118</b>	<b>+\$183</b>	<b>+\$210</b>	<b>+\$267</b>	<b>+\$355</b>	<b>+\$422</b>	<b>+\$494</b>	<b>+\$645</b>	<b>+\$804</b>
	Seat upcharge:	<b>+0</b>	<b>+\$40</b>	<b>+\$72</b>	<b>+\$118</b>	<b>+\$183</b>	<b>+\$210</b>	<b>+\$267</b>	<b>+\$355</b>	<b>+\$422</b>	<b>+\$494</b>	<b>+\$645</b>	<b>+\$804</b>
	Active weight 600 lbs.	<b>OVERALL DIMENSIONS</b>			<b>SEAT DIMENSIONS</b>			<b>BACK DIMENSIONS</b>					
		<b>W</b>	<b>D</b>	<b>H</b>	<b>W</b>	<b>D</b>	<b>H</b>	<b>W</b>	<b>H</b>				
	32.75	26.5	34.5	31	18	18	30.5	16.5					
	Add \$111 for Urethane armcaps Add \$390 for <b>(CO)</b> Grade 1 armcaps Add \$414 for <b>(CO)</b> Grade 2 armcaps Add \$187 for <b>(MB)</b> Add \$27 for <b>(SSS)</b> , \$44 for <b>(SBS)</b>												
 <p><b>Wood Lounge Single Seat</b> COM Yardage: Back: 1.25; Seat: 1.25 Freight Class: 250 Product Weight (lbs.): 49 Cubic Feet Per Carton: 18.25</p>	<b>GC36305</b> Base Price:	<b>\$1670</b>											
	Back upcharge:	<b>+0</b>	<b>+\$40</b>	<b>+\$72</b>	<b>+\$118</b>	<b>+\$183</b>	<b>+\$210</b>	<b>+\$267</b>	<b>+\$355</b>	<b>+\$422</b>	<b>+\$494</b>	<b>+\$645</b>	<b>+\$804</b>
	Seat upcharge:	<b>+0</b>	<b>+\$40</b>	<b>+\$72</b>	<b>+\$118</b>	<b>+\$183</b>	<b>+\$210</b>	<b>+\$267</b>	<b>+\$355</b>	<b>+\$422</b>	<b>+\$494</b>	<b>+\$645</b>	<b>+\$804</b>
	Active weight 400 lbs.	<b>OVERALL DIMENSIONS</b>			<b>SEAT DIMENSIONS</b>			<b>BACK DIMENSIONS</b>					
		<b>W</b>	<b>D</b>	<b>H</b>	<b>W</b>	<b>D</b>	<b>H</b>	<b>W</b>	<b>H</b>				
	25.75	29.5	32.5	24	21	16	23.5	16.5					
	Add \$167 for Urethane armcaps Add \$409 for <b>(CO)</b> Grade 1 armcaps Add \$433 for <b>(CO)</b> Grade 2 armcaps Add \$126 for <b>(MB)</b> Add \$33 for <b>(SSS)</b> , \$45 for <b>(SBS)</b>												
 <p><b>Wood Lounge Two Seater</b> COM Yardage: Back: 1.75; Seat: 2.25 Freight Class: 250 Product Weight (lbs.): 77 Cubic Feet Per Carton: 32.75</p>	<b>GC36306</b> Base Price:	<b>\$2348</b>											
	Back upcharge:	<b>+0</b>	<b>+\$56</b>	<b>+\$100</b>	<b>+\$165</b>	<b>+\$256</b>	<b>+\$294</b>	<b>+\$373</b>	<b>+\$497</b>	<b>+\$590</b>	<b>+\$692</b>	<b>+\$903</b>	<b>+\$1126</b>
	Seat upcharge:	<b>+0</b>	<b>+\$72</b>	<b>+\$129</b>	<b>+\$212</b>	<b>+\$329</b>	<b>+\$378</b>	<b>+\$480</b>	<b>+\$639</b>	<b>+\$759</b>	<b>+\$889</b>	<b>+\$1161</b>	<b>+\$1447</b>
	Active weight 400 lbs./seat	<b>OVERALL DIMENSIONS</b>			<b>SEAT DIMENSIONS</b>			<b>BACK DIMENSIONS</b>					
		<b>W</b>	<b>D</b>	<b>H</b>	<b>W</b>	<b>D</b>	<b>H</b>	<b>W</b>	<b>H</b>				
	47.5	29.5	32.5	45	21	16	44.5	16.5					
	Add \$167 for Urethane armcaps Add \$409 for <b>(CO)</b> Grade 1 armcaps Add \$433 for <b>(CO)</b> Grade 2 armcaps Add \$250 for <b>(MB)</b> Add \$48 for <b>(SSS)</b> , \$63 for <b>(SBS)</b>												
 <p><b>Wood Lounge Three Seater</b> COM Yardage: Back: 2.5; Seat: 2.75 Freight Class: 250 Product Weight (lbs.): 109 Cubic Feet Per Carton: 50.75</p>	<b>GC36307</b> Base Price:	<b>\$2936</b>											
	Back upcharge:	<b>+0</b>	<b>+\$80</b>	<b>+\$143</b>	<b>+\$235</b>	<b>+\$365</b>	<b>+\$420</b>	<b>+\$533</b>	<b>+\$710</b>	<b>+\$843</b>	<b>+\$988</b>	<b>+\$1290</b>	<b>+\$1608</b>
	Seat upcharge:	<b>+0</b>	<b>+\$88</b>	<b>+\$157</b>	<b>+\$259</b>	<b>+\$402</b>	<b>+\$462</b>	<b>+\$586</b>	<b>+\$781</b>	<b>+\$927</b>	<b>+\$1087</b>	<b>+\$1419</b>	<b>+\$1769</b>
	Active weight 400 lbs./seat	<b>OVERALL DIMENSIONS</b>			<b>SEAT DIMENSIONS</b>			<b>BACK DIMENSIONS</b>					
		<b>W</b>	<b>D</b>	<b>H</b>	<b>W</b>	<b>D</b>	<b>H</b>	<b>W</b>	<b>H</b>				
	70.5	29.5	32.5	68	21	16	67.5	16.5					
	Add \$167 for Urethane armcaps Add \$409 for <b>(CO)</b> Grade 1 armcaps Add \$433 for <b>(CO)</b> Grade 2 armcaps Add \$373 for <b>(MB)</b> Add \$63 for <b>(SSS)</b> , \$80 for <b>(SBS)</b>												
 <p><b>Fully Upholstered Lounge Single Seat</b> COM Yardage: Back/Arm: 2.75; Seat: 1.25 Freight Class: 250 Product Weight (lbs.): 58 Cubic Feet Per Carton: 18.75</p>	<b>GC36308</b> Base Price:	<b>\$1893</b>											
	Back/Arm upcharge:	<b>+0</b>	<b>+\$88</b>	<b>+\$157</b>	<b>+\$259</b>	<b>+\$402</b>	<b>+\$462</b>	<b>+\$586</b>	<b>+\$781</b>	<b>+\$927</b>	<b>+\$1087</b>	<b>+\$1419</b>	<b>+\$1769</b>
	Seat upcharge:	<b>+0</b>	<b>+\$40</b>	<b>+\$72</b>	<b>+\$118</b>	<b>+\$183</b>	<b>+\$210</b>	<b>+\$267</b>	<b>+\$355</b>	<b>+\$422</b>	<b>+\$494</b>	<b>+\$645</b>	<b>+\$804</b>
	Active weight 400 lbs.	<b>OVERALL DIMENSIONS</b>			<b>SEAT DIMENSIONS</b>			<b>BACK DIMENSIONS</b>					
		<b>W</b>	<b>D</b>	<b>H</b>	<b>W</b>	<b>D</b>	<b>H</b>	<b>W</b>	<b>H</b>				
	27.5	29.5	33.5	24	21	16	23.5	17.5					
	Add \$403 for <b>(CO)</b> Grade 1 armcaps Add \$431 for <b>(CO)</b> Grade 2 armcaps Add \$126 for <b>(MB)</b> Add \$36 for <b>(SSS)</b> , \$143 for <b>(SBS)</b> Power/USB unit available.												

DESCRIPTION	MODEL#/ FEATURES	STANDARD TEXTILE GRADES											
		1/COM	2	3	4	5	6	7	8	9	10	11	12
 <p><b>Fully Upholstered Lounge Two Seater</b> COM Yardage: Back/Arm: 3.5; Seat: 2.25 Freight Class: 250 Product Weight (lbs.): 89 Cubic Feet Per Carton: 33.75</p>	GC36309	Base Price: <b>\$2545</b>											
		Back/Arm upcharge: <b>+0 +\$112 +\$200 +\$329 +\$511 +\$588 +\$746 +\$994 +\$1180 +\$1383 +\$1806 +\$2251</b>											
		Seat upcharge: <b>+0 +\$72 +\$129 +\$212 +\$329 +\$378 +\$480 +\$639 +\$759 +\$889 +\$1161 +\$1447</b>											
		Active weight 400 lbs./seat											
		OVERALL DIMENSIONS			SEAT DIMENSIONS			BACK DIMENSIONS					
	W	D	H	W	D	H	W	H					
	49.5	29.5	33.5	44.5	18	16	45.5	17.5					
	Add \$403 for (CO) Grade 1 armcaps Add \$431 for (CO) Grade 2 armcaps Add \$250 for (MB) Add \$52 for (SSS), \$160 for (SBS) Power/USB unit available.												
 <p><b>Fully Upholstered Lounge Three Seater</b> COM Yardage: Back/Arm: 4.25; Seat: 2.75 Freight Class: 250 Product Weight (lbs.): 123 Cubic Feet Per Carton: 52</p>	GC36310	Base Price: <b>\$3196</b>											
		Back/Arm upcharge: <b>+0 +\$136 +\$243 +\$400 +\$621 +\$714 +\$906 +\$1207 +\$1433 +\$1679 +\$2193 +\$2733</b>											
		Seat upcharge: <b>+0 +\$88 +\$157 +\$259 +\$402 +\$462 +\$586 +\$781 +\$927 +\$1087 +\$1419 +\$1769</b>											
		Active weight 400 lbs./seat											
		OVERALL DIMENSIONS			SEAT DIMENSIONS			BACK DIMENSIONS					
	W	D	H	W	D	H	W	H					
	71.5	29.5	33.5	66.5	18	16	67.5	17.5					
	Add \$403 for (CO) Grade 1 armcaps Add \$431 for (CO) Grade 2 armcaps Add \$373 for (MB) Add \$66 for (SSS), \$179 for (SBS) Power/USB unit available.												
 <p><b>Single Seat Bench</b> COM Yardage: 1 Freight Class: 150 Product Weight (lbs.): 41 Cubic Feet Per Carton: 10</p>	GC36311	Base Price: <b>\$1279</b>											
		Seat upcharge: <b>+0 +\$32 +\$57 +\$94 +\$146 +\$168 +\$213 +\$284 +\$337 +\$395 +\$516 +\$643</b>											
		Active weight 400 lbs.											
		OVERALL DIMENSIONS			SEAT DIMENSIONS			BACK DIMENSIONS					
		W	D	H	W	D	H	W	H				
	24	28	18	24	26.75	18							
	Add \$126 for (MB) Add \$31 for (SSS)												
 <p><b>Two Seat Bench</b> COM Yardage: 2 Freight Class: 250 Product Weight (lbs.): 61 Cubic Feet Per Carton: 18.75</p>	GC36312	Base Price: <b>\$2023</b>											
		Seat upcharge: <b>+0 +\$64 +\$114 +\$188 +\$292 +\$336 +\$426 +\$568 +\$674 +\$790 +\$1032 +\$1286</b>											
		Active weight 400 lbs./seat											
		OVERALL DIMENSIONS			SEAT DIMENSIONS			BACK DIMENSIONS					
		W	D	H	W	D	H	W	H				
	48	28	18	48	26.75	18							
	Add \$250 for (MB) Add \$61 for (SSS)												
 <p><b>Three Seat Bench</b> COM Yardage: 3 Freight Class: 250 Product Weight (lbs.): 97 Cubic Feet Per Carton: 27.75</p>	GC36313	Base Price: <b>\$2414</b>											
		Seat upcharge: <b>+0 +\$96 +\$171 +\$282 +\$438 +\$504 +\$639 +\$852 +\$1011 +\$1185 +\$1548 +\$1929</b>											
		Active weight 400 lbs./seat											
		OVERALL DIMENSIONS			SEAT DIMENSIONS			BACK DIMENSIONS					
		W	D	H	W	D	H	W	H				
	72	28	18	72	26.75	18							
	Add \$373 for (MB) Add \$89 for (SSS)												

## CALIDON TABLES



Square end table - 22"  
GC36314



Rectangular Coffee Table  
GC36317



Tandem Side Table, Right  
GC36319R



For Calidon seating, refer to page 63.

### EXAMPLE CALIDON TABLE ORDER CODE:

GC36319R	-HP	-ACJ	-CNT
Model #	Top material	Laminate finish	Power

### TABLE TOP FINISHES:

See finishes section on page 245 for solid wood/laminate coordination chart.

#### Thermally fused laminate (LP):

Absolute Acajou (ACJ)	First Class (FCL)
Asian Night (ASN)	Noce Biondo (NBL)
Avant Cherry (AWC)	Noce Grigio (NGL)
Avant Honey (AWH)	Noce Leggero (NEL)
Black (BLK)	Noce Medio (NML)
Blizzard (BZD)	Quartered Mahogany (QTM)
Brushed Cobalt (BRC)	Sheer Beauty (SBY)
Clear Maple (CMB)	Stonedust (SDT)
Custom Grey (CGY)	Walnut Heights (WHE)
Dark Espresso (DES)	White Chocolate (WHC)
Designer White (DWT)	Winter Cherry (WCR)
Fashionista (FAS)	

#### High pressure laminate (HP):

Absolute Acajou (ACJ)	First Class (FCL)
Asian Night (ASN)	Noce Biondo (NBL)
Avant Cherry (AWC)	Noce Grigio (NGL)
Avant Honey (AWH)	Noce Leggero (NEL)
Black (BLK)	Noce Medio (NML)
Blizzard (BZD)	Quartered Mahogany (QTM)
Brushed Cobalt (BRC)	Sheer Beauty (SBY)
Clear Maple (CMB)	Stonedust (SDT)
Custom Grey (CGY)	Walnut Heights (WHE)
Dark Espresso (DES)	White Chocolate (WHC)
Designer White (DWT)	Winter Cherry (WCR)
Fashionista (FAS)	

#### Solid Surface\* (CO):

<b>Grade 1:</b>
(SWH) Designer White
<b>Grade 2:</b>
(SBT) Beige Tempest
(SBX) Black Onyx Mirage
(SMG) Milk Glass Spectra
(SFW) Frosty White Mirage
(SHS) Hot Stone
(SNM) Northern Melange

\*For detailed material information, please reference WilsonArt's Solid Surface collection.

### TABLE STANDARD FEATURES

- Designed as part of the Calidon seating series, Calidon tables coordinate with a range of lounge and guest seating.
- A variety of wood leg tables are available, including various height end tables, coffee tables and tandem tables.
- Wood legs/frames are specifiable Global solid wood seating finishes.
- Table tops are 1" thick, available in thermally fused laminate (LP), high pressure laminate (HP), and solid surface (CO). Upcharges vary, see model for pricing.
- Laminate top tables include color coordinating vinyl edge band.
- Tandem/bridge table models (GC36318 to GC36321) connect to Calidon guest seating only and include ganging brackets.
- Tandem tables are specified left or right, as seated.

### TABLE OPTIONAL FEATURES

- A tamperproof tabletop power unit may be specified on laminate top, tandem and square end tables only. Specify **CNT**. Add **\$358**. The power unit is located centered 1.5" from the edge of the surface. See power location diagrams for reference.

### SUGGESTED APPLICATIONS

- Lounge/Lobby
- Patient rooms
- Resident rooms
- Private office





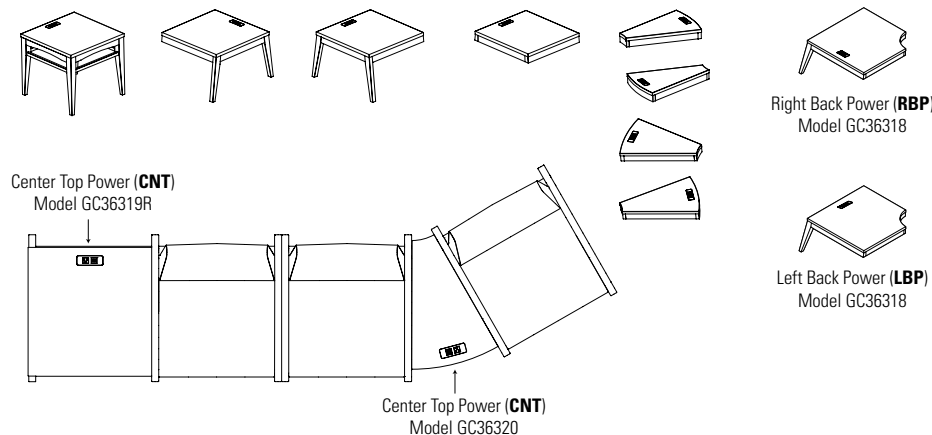

Please add option codes in the following order:





- **Table model number**  
GC36314 to GC36317 Freestanding tables  
GC36318 to GC36321 Tandem/bridge tables  
GC36324 to GC36326 23"H Freestanding tables  
For Calidon seating, refer to page 63.
- **Top Material (tables)**  
(LP) Thermally fused laminate. Specify finish - See LP finishes.  
(HP) High pressure laminate. Upcharges vary - see model. Specify finish - see HP finishes.  
(CO) Solid surface. Upcharges vary - see model. Specify finish - see CO finishes and grades.
- **Leg finish**  
(AAM) Absolute (MWM) Medium Walnut  
(CJM) Charcoal Java (ASM) Night  
(ACM) Cherry (NBM) Noce Biondo  
(EMM) Empire Mahogany (NGM) Noce Grigio  
(EOM) English Oak (NEM) Noce Leggero  
(ECM) Espresso Cafe (NMM) Noce Medio  
(TFM) Fruitwood (SBM) Sandy Beach  
(HGM) Grey (SKM) Shaker Cherry  
(HOM) Harvest Oak (SOM) Silver Oak  
(AHM) Honey (TWM) Walnut  
(JOM) Jet Onyx (WTM) WC Cream  
(LHM) Light Honey (WHM) White  
(TMM) Mahogany (WCM) Winter Cherry  
(AVM) Maple
- **Power/USB unit position** (laminate tandem and end tables with laminate tops only).  
(NPM) No power  
(CNT) Center top power. Jet Black. Add **\$358**.  
(RBP) Right back top power. Jet Black. Add **\$358**.  
(LBP) Left back top power. Jet Black. Add **\$358**.

### POWER LOCATION DIAGRAM



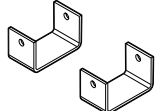

TABLES	MODEL#	DIMENSIONS	FREIGHT CLASS	WT/LBS.	CUBIC FT.	LIST PRICE
	GC36314	22 x 22 x 20.25	150	36	7.75	<b>\$826</b>
<b>Square End Table, 22" x 22" x 20.25" H</b>			<ul style="list-style-type: none"> <li>• Pricing shown for a thermally fused laminate top (LP).</li> <li>• For a high pressure laminate top (HP), add <b>\$65</b>.</li> <li>• For a solid surface top (CO), add <b>\$1071</b> for Grade 1 and add <b>\$1315</b> for Grade 2.</li> </ul>			
			Coordinating edge on laminate surfaces with solid wood frame and legs. 1 per carton. Power/USB unit can be specified in the surface of laminate top tables (CNT). Add <b>\$358</b> .			
	GC36324	22 x 22 x 23	150	23.5	6.75	<b>\$977</b>
<b>Square End Table, 22" x 22" x 23" H</b>			<ul style="list-style-type: none"> <li>• Pricing shown for a thermally fused laminate top (LP).</li> <li>• For a high pressure laminate top (HP), add <b>\$65</b>.</li> <li>• For a solid surface top (CO), add <b>\$1071</b> for Grade 1 and add <b>\$1315</b> for Grade 2.</li> </ul>			
			Coordinating edge on laminate surfaces with solid wood frame and legs. 1 per carton. Power/USB unit can be specified in the surface of laminate top tables (CNT). Add <b>\$358</b> .			
	GC36325	22 x 12 x 23	125	34	10.75	<b>\$841</b>
<b>Rectangular End Table, 23" H</b>			<ul style="list-style-type: none"> <li>• Pricing shown for a thermally fused laminate top (LP).</li> <li>• For a high pressure laminate top (HP), add <b>\$54</b>.</li> <li>• For a solid surface top (CO), add <b>\$884</b> for Grade 1 and add <b>\$1061</b> for Grade 2.</li> </ul>			
			Coordinating edge on laminate surfaces with solid wood frame and legs. 1 per carton. Power/USB unit can be specified in the surface of laminate top tables (CNT). Add <b>\$358</b> .			
	GC36326	24 x 25 x 23	150	34	12.75	<b>\$1082</b>
<b>Corner 30° End Table, 23" H</b>			<ul style="list-style-type: none"> <li>• Pricing shown for a thermally fused laminate top (LP).</li> <li>• For a high pressure laminate top (HP), add <b>\$70</b>.</li> <li>• For a solid surface top (CO), add <b>\$1215</b> for Grade 1 and add <b>\$1464</b> for Grade 2.</li> </ul>			
			Coordinating edge on laminate surfaces with solid wood frame and legs. 1 per carton. Power/USB unit can be specified in the surface of laminate top tables (CNT). Add <b>\$358</b> .			
	GC36315	24 x 24 x 17.25	250	37	9.5	<b>\$857</b>
<b>Square Coffee Table, 24"</b>			<ul style="list-style-type: none"> <li>• Pricing shown for a thermally fused laminate top (LP).</li> <li>• For a high pressure laminate top (HP), add <b>\$65</b>.</li> <li>• For a solid surface top (CO), add <b>\$1300</b> for Grade 1 and add <b>\$1605</b> for Grade 2.</li> </ul>			
			Coordinating edge on laminate surfaces with solid wood frame and legs. 1 per carton.			
	GC36316	36 x 36 x 17.25	250	65	18.25	<b>\$1025</b>
<b>Square Coffee Table, 36"</b>			<ul style="list-style-type: none"> <li>• Pricing shown for a thermally fused laminate top (LP).</li> <li>• For a high pressure laminate top (HP), add <b>\$140</b>.</li> <li>• For a solid surface top (CO), add <b>\$2979</b> for Grade 1 and add <b>\$3589</b> for Grade 2.</li> </ul>			
			Coordinating edge on laminate surfaces with solid wood frame and legs. 1 per carton.			
	GC36317	24 x 48 x 17.25	250	56	16.5	<b>\$1123</b>
<b>Rectangular Coffee Table</b>			<ul style="list-style-type: none"> <li>• Pricing shown for a thermally fused laminate top (LP).</li> <li>• For a high pressure laminate top (HP), add <b>\$127</b>.</li> <li>• For a solid surface top (CO), add <b>\$2481</b> for Grade 1 and add <b>\$2894</b> for Grade 2.</li> </ul>			
			Coordinating edge on laminate surfaces with solid wood frame and legs. 1 per carton.			

TABLES	MODEL#	DIMENSIONS	FREIGHT CLASS	WT/LBS.	CUBIC FT.	LIST PRICE
 <p><b>Corner Table, 90°</b></p>	GC36318	31.25 x 31.25 x 15.75	250	46	14.5	<b>\$1025</b>
		<ul style="list-style-type: none"> <li>• Pricing shown for a thermally fused laminate top (LP).</li> <li>• For a high pressure laminate top (HP), add <b>\$104</b>.</li> <li>• For a solid surface top (CO), add <b>\$2576</b> for Grade 1 and add <b>\$3079</b> for Grade 2.</li> </ul> <p>Coordinating edge on laminate surfaces with solid wood frame and legs. Must be connected between two guest chairs. Includes two sets of U-channel connectors and hardware. 1 per carton. Power/USB unit can be specified in the surface of laminate top tables (RBP) or (LBP). Add <b>\$358</b>. See power location diagram for placement.</p>				
 <p><b>Tandem Side Table, Left</b></p>	GC36319L	26.5 x 22.25 x 15.75	250	20	6.75	<b>\$715</b>
		<ul style="list-style-type: none"> <li>• Pricing shown for a thermally fused laminate top (LP).</li> <li>• For a high pressure laminate top (HP), add <b>\$65</b>.</li> <li>• For a solid surface top (CO), add <b>\$1089</b> for Grade 1 and add <b>\$1311</b> for Grade 2.</li> </ul> <p>Coordinating edge on laminate surfaces with solid wood frame and legs. Must be connected to a guest chair. Includes one set of U-channel connectors and hardware. 1 per carton. Power/USB unit can be specified in the surface of laminate top tables (CNT). Add <b>\$358</b>.</p>				
 <p><b>Tandem Side Table, Right</b></p>	GC36319R	26.5 x 22.25 x 15.75	250	20	6.75	<b>\$715</b>
		<ul style="list-style-type: none"> <li>• Pricing shown for a thermally fused laminate top (LP).</li> <li>• For a high pressure laminate top (HP), add <b>\$65</b>.</li> <li>• For a solid surface top (CO), add <b>\$1089</b> for Grade 1 and add <b>\$1311</b> for Grade 2.</li> </ul> <p>Coordinating edge on laminate surfaces with solid wood frame and legs. Must be connected to a guest chair. Includes one set of U-channel connectors and hardware. 1 per carton. Power/USB unit can be specified in the surface of laminate top tables (CNT). Add <b>\$358</b>.</p>				
 <p><b>Corner Table, 30 Degree</b></p>	GC36320	22.5 x 15.75 x 3	92.5	16	1.5	<b>\$563</b>
		<ul style="list-style-type: none"> <li>• Pricing shown for a thermally fused laminate top (LP).</li> <li>• For a high pressure laminate top (HP), add <b>\$65</b>.</li> <li>• For a solid surface top (CO), add <b>\$910</b> for Grade 1 and add <b>\$1093</b> for Grade 2.</li> </ul> <p>Coordinating edge on laminate surfaces with solid wood frame and legs. Must be connected between two guest chairs. Includes two sets of U-channel connectors and hardware. 1 per carton. Power/USB unit can be specified in the surface of laminate top tables (CNT). Add <b>\$358</b>.</p>				
 <p><b>In-Line Table, Square</b></p>	GC36321	21 x 23.5 x 3	92.5	20	1.9	<b>\$597</b>
		<ul style="list-style-type: none"> <li>• Pricing shown for a thermally fused laminate top (LP).</li> <li>• For a high pressure laminate top (HP), add <b>\$65</b>.</li> <li>• For a solid surface top (CO), add <b>\$942</b> for Grade 1 and add <b>\$1161</b> for Grade 2.</li> </ul> <p>Coordinating edge on laminate surfaces with solid wood frame and legs. Must be connected between two guest chairs. Includes two sets of U-channel connectors and hardware. 1 per carton. Power/USB unit can be specified in the surface of laminate top tables (CNT). Add <b>\$358</b>.</p>				
 <p><b>U-Channel (set of 2)</b></p>	GC36322	2.87 x 1.5 x 1.62	70	0.75	0.03	<b>\$48</b>
		Includes hardware. 4 sets per carton.				

CHAP™



Wood Back Armchair model 1010



Upholstered Back Armchair model 1015



Upholstered Round Back Armchair model 1004



Wood Round Back Armchair model 1005

STANDARD FEATURES





- Chap offers mid-century modern styling in a finely crafted beechwood armchair series.
- Straight and round back models have upholstered seats with upholstered or open wood frame backs.
- Straight back models are available with exposed wood or upholstered front seat rails.
- For reorders of discontinued models 1002 and 1003, use models 1004 and 1005 with 18" reduced seat depth.
- Custom stain matching is not available on models 1004 and 1005.
- Chairs are standard with a black liner under seat cushion. An underseat panel (USP) is available which conceals seat structure. It is covered with a coated textile and secured with tamperproof fasteners.
- For graded pricing, select model base price. Add graded textile upcharges for seat or for upholstered back models, both seat and back.
- The Blended Textile matrix does not apply to this series.
- Upholstery options include fabric, coated textiles and leather.
- Chap series is covered under Global's Limited Lifetime warranty, for single shift use.
- For multi-shift environments, and coverage under Globalcare's 24/7 warranty, Ultracell foam - 24/7 warranty (UC) must be selected.
- Textiles with a minimum of 100,000 double rubs must be specified to meet Global's 24/7 warranty coverage. For healthcare textiles, visit the website at globalfurnituregroup.com.
- Does not stack.
- Custom stain matching is not available on round back models.

Please add option codes in the following order:

- **Model number**  
Specify model number
- **Back textile**  
Specify textile code
- **Seat textile**  
Specify textile code
- **Frame finish** (Round back models)  
1004 and 1005 available in select finishes (\*).  
(AAM) Absolute\*  
(BKM) Black\*  
(ACM) Cherry\*  
(EOM) English Oak  
(ECM) Espresso Cafe\*  
(TFM) Fruitwood  
(HGM) Gray  
(AHM) Honey  
(TMM) Mahogany\*  
(AVM) Maple  
(MWM) Medium Walnut\*  
(NLW) Natural Walnut  
(ASM) Night\*  
(NBM) Noce Biondo  
(NGM) Noce Grigio  
(NEM) Noce Leggero  
(NMM) Noce Medio\*  
(SKM) Shaker Cherry\*  
(TWM) Walnut\*  
(WTM) WC Cream\*  
(WHM) White\*  
(WCM) Winter Cherry
- **Glides**  
(XG) No Glide for Carpeted Surfaces.  
(NM) White Non-marking Nylon Glide for most floor surfaces. Add \$34  
(SG) Steel Cushioned Glide for carpeted surfaces. Add \$34  
(FG) Felt Glide for most hard floor surfaces. Add \$34  
(RG) Rubber Non-slip Glide for most hard floor surfaces. Add \$34
- **Sealed Seams** (on approved coated textiles)  
(NS) No sealed seams  
(SSS) Sealed seat seams. Add \$63
- **Moisture barrier** (seat only, not available with sealed seams)  
(NB) No moisture barrier. No upcharge  
(MB) Moisture barrier. Add \$107.
- **Seat foam**  
(SF) Standard foam  
(UC) Ultracell foam - 24/7 warranty
- **Seat underside**  
(USL) Under seat liner  
(USP) Under seat panel. Add \$79

DESCRIPTION	FEATURES	MODEL#												STANDARD TEXTILE GRADES												
		1/COM	2	3	4	5	6	7	8	9	10	11	12	1	2	3	4	5	6	7	8	9	10	11	12	
 <p><b>Wood Back Armchair w/ Upholstered Seat Front</b> COM Yardage: 1 Freight Class: 250 Product Weight (lbs.): 33 Cubic Feet Per Carton: 15.75</p>	<p>Does not stack. Active weight 350 lbs. Ergonomic Features M, N</p>	1010	\$1307	\$1339	\$1364	\$1401	\$1453	\$1475	\$1520	\$1591	\$1644	\$1702	\$1823	\$1950												
					<p><b>OVERALL DIMENSIONS</b></p> <p>W D H</p>			<p><b>SEAT DIMENSIONS</b></p> <p>W D H</p>			<p><b>BACK DIMENSIONS</b></p> <p>W H</p>															
			25.5	25	31	21	20	18	20.5	13.5																

RTA 00

DESCRIPTION	FEATURES	MODEL#													
		1/COM	2	3	4	5	6	7	8	9	10	11	12		
 <p><b>Upholstered Back Armchair w/ Upholstered Seat Front</b> COM Yardage: Back: .75; Seat: .75 Freight Class: 250 Product Weight (lbs.): 33 Cubic Feet Per Carton: 15.75</p>	<p>Does not stack. Active weight 350 lbs. Ergonomic Features M, N</p>	1011	Base Price:	\$1315											
		Seat upcharge:	+0	\$24	\$43	\$71	\$110	\$126	\$160	\$213	\$253	\$297	\$387	\$483	
		Back upcharge:	+0	\$24	\$43	\$71	\$110	\$126	\$160	\$213	\$253	\$297	\$387	\$483	
		<b>OVERALL DIMENSIONS</b>			<b>SEAT DIMENSIONS</b>			<b>BACK DIMENSIONS</b>							
			W	D	H	W	D	H	W	H					
			25.5	25	31.5	21	20	18	20.5	13.5					
			<b>RTA 00</b>												
 <p><b>Wood Back Armchair w/ Wood Front Rail</b> COM Yardage: 1 Freight Class: 250 Product Weight (lbs.): 33 Cubic Feet Per Carton: 15.75</p>	<p>Does not stack. Active weight 350 lbs. Ergonomic Features M, N</p>	1014		\$1307	\$1339	\$1364	\$1401	\$1453	\$1475	\$1520	\$1591	\$1644	\$1702	\$1823	\$1950
		<b>OVERALL DIMENSIONS</b>			<b>SEAT DIMENSIONS</b>			<b>BACK DIMENSIONS</b>							
					W	D	H	W	D	H	W	H			
					25.5	25	31	21	20	18	20.5	13.5			
			<b>RTA 00</b>												
 <p><b>Upholstered Back Armchair w/ Wood Front Rail</b> COM Yardage: Back: .75; Seat: .75 Freight Class: 250 Product Weight (lbs.): 33 Cubic Feet Per Carton: 15.75</p>	<p>Does not stack. Active weight 350 lbs. Ergonomic Features M, N</p>	1015	Base Price:	\$1315											
		Seat upcharge:	+0	\$24	\$43	\$71	\$110	\$126	\$160	\$213	\$253	\$297	\$387	\$483	
		Back upcharge:	+0	\$24	\$43	\$71	\$110	\$126	\$160	\$213	\$253	\$297	\$387	\$483	
		<b>OVERALL DIMENSIONS</b>			<b>SEAT DIMENSIONS</b>			<b>BACK DIMENSIONS</b>							
			W	D	H	W	D	H	W	H					
			25.5	25	31.5	21	20	18	20.5	13.5					
			<b>RTA 00</b>												
 <p><b>Upholstered Roundback Armchair w/ Upholstered Seat Front</b> COM Yardage: Back: .75 ; Seat: .75 Freight Class: 300 Product Weight (lbs.): 26 Cubic Feet Per Carton: 13.25</p>	<p>Does not stack. Active weight 350 lbs. Ergonomic Features M, N</p>	1004	Base Price:	\$1488											
		Seat upcharge:	+0	\$24	\$43	\$71	\$110	\$126	\$160	\$213	\$253	\$297	\$387	\$483	
		Back upcharge:	+0	\$24	\$43	\$71	\$110	\$126	\$160	\$213	\$253	\$297	\$387	\$483	
		<b>OVERALL DIMENSIONS</b>			<b>SEAT DIMENSIONS</b>			<b>BACK DIMENSIONS</b>							
			W	D	H	W	D	H	W	H					
			24.5	22.5	30	22	18	18	20	12.5					
			<b>RTA 00</b>												
 <p><b>Round Wood Back Armchair w/ Upholstered Seat Front</b> COM Yardage: 1 Freight Class: 300 Product Weight (lbs.): 25 Cubic Feet Per Carton: 13.25</p>	<p>Does not stack. Active weight 350 lbs. Ergonomic Features M, N</p>	1005		\$1310	\$1342	\$1367	\$1404	\$1456	\$1478	\$213	\$1594	\$1647	\$1705	\$1826	\$1953
		<b>OVERALL DIMENSIONS</b>			<b>SEAT DIMENSIONS</b>			<b>BACK DIMENSIONS</b>							
					W	D	H	W	D	H	W	H			
					24.5	22.5	30	22	18	18	20	12.5			
			<b>RTA 00</b>												

COAST



Clean out space around seat cushions for easy housekeeping

model GC4172

EXAMPLE COAST ORDER CODE:

GC4172	-LX21	-SS	-ST	-	-
Model #	Textile	Armcaps	Glides	Moisture Barrier	Sealed Seams

STANDARD FEATURES

- The smooth low range glide adds relaxing motion while you sink back and coast in this ultra-comfortable chair.
- Adjustable non-marking glides are standard
- For added comfort, seats are standard with high density Ultracell foam.
- Cleanout space is provided between the seat and back cushions for easy housekeeping.
- Arms on the glider are fixed with a grip allowing the user to easily enter and exit from the chair. Combined with a smooth low-range motion mechanism, this eliminates the need for a locking mechanism
- Standard with Black Urethane fully extended arms with a grip for ease of entry and exit from chair.
- Seamless front upholstery method on the seat cushion prevents eventual breakdown of seams causing liquid penetration into the foam.
- For healthcare textiles and finish options, visit the website at [www.globalfurnituregroup.com](http://www.globalfurnituregroup.com)
- Can be upholstered in standard Global textiles only if healthcare compliance is not required.
- Shipped fully assembled.

OPTIONAL FEATURES

- For non-slip glides, please specify **(NS)**. Add **\$35**.
- To add sealed seams to your product, contact Customer Care. Upcharges vary
- For moisture barrier **(MB)** (Seat Only) - Add \$129 list upcharge.
- Tablet arm with spill collector on the edge is available, offered in Black Phenolic material. Tablet rotates so it can be positioned for any user activity and can fold down to store beside the chair when not being used. From seated position, specify **(LT)** for left hand tablet or **(RT)** for right hand tablet. Add **\$1014**. For tablet on both sides, specify **(TB)**. Add **\$2024**.

SUGGESTED APPLICATIONS

- Patient rooms
- Resident rooms
- Lounge/Waiting

Please add option codes in the following order:

- **Model number**  
**GC4172** Glider/motion chair
- **Textile**  
Specify fabric code.
- **Armcap finish**  
**(SS)** Black Urethane armcap  
**(LT)** Latte Urethane armcap  
**(KL)** Kalua Urethane armcap  
**(MA)** Mocha Urethane armcap  
**(SW)** Shadow Urethane armcap  
**(TO)** Toast Urethane armcap  
**(AB)** Absolute wood armcap  
**(CJ)** Charcoal Java wood armcap  
**(AC)** Cherry wood armcap  
**(EP)** Empire Mahogany wood armcap  
**(EM)** English Oak wood armcap  
**(EC)** Espresso Cafe wood armcap  
**(HG)** Gray wood armcap  
**(HA)** Harvest Oak wood armcap  
**(AH)** Honey wood armcap  
**(JO)** Jet Onyx wood armcap  
**(LH)** Light Honey wood armcap  
**(AV)** Maple wood armcap  
**(MW)** Medium Walnut wood armcap  
**(NL)** Natural Walnut wood armcap  
**(AT)** Night wood armcap  
**(BI)** Noce Biondo wood armcap  
**(GI)** Noce Grigio wood armcap  
**(EI)** Noce Leggero wood armcap  
**(MI)** Noce Medio wood armcap  
**(SB)** Sandy Beach wood armcap  
**(SK)** Shaker Cherry wood armcap  
**(SM)** Silver Oak wood armcap  
**(TF)** Tiger Fruitwood wood armcap  
**(TM)** Tiger Mahogany wood armcap  
**(TL)** Tiger Walnut wood armcap  
**(WR)** WC Cream wood armcap  
**(WE)** White wood armcap  
**(WC)** Winter Cherry wood armcap
- **Glides**  
**(ST)** Adjustable non-marking glides  
**(NS)** Adjustable non-slip glides
- **Moisture Barrier**  
**(MB)** Seat only
- **Sealed seams**  
**(SS)** All sealed seams

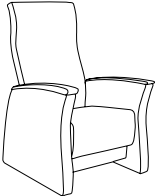
DESCRIPTION	MODEL#/ FEATURES	STANDARD TEXTILE GRADES												
		COM	2	3	4	5	6	7	8	9	10	11	12	
 <p><b>Glider / Motion Chair</b> COM Yardage: 5.5 Freight Class: 250 Product Weight (lbs.): 115 Cubic Feet Per Carton: 29.5</p>	<p>Active weight 350 lbs.</p> <p>Specify armcap: wood or Urethane.</p>	<b>GC4172</b>	\$2499	\$2672	\$2817	\$3027	\$3326	\$3468	\$3740	\$4174	\$4507	\$4878	\$5641	\$6457
		OVERALL DIMENSIONS			SEAT DIMENSIONS			BACK DIMENSIONS						
			W	D	H	W	D	H	W	H				
			30	31.5	43.5	21.5	19.5	18	22	28				

COLLINGWOOD



model GC36511  
High back lounge chair

STANDARD FEATURES

- Collingwood offers a cozy, streamlined design with classic curves.
- The series is available to specify with two textiles, one for the seat cushion and one for the back, arms and front rail (see model image).
- For pricing, start with the base price and add both back/arms graded textile upcharge and the seat graded textile upcharge.
- A clean through design is provided around the seat cushion for easy housekeeping.
- Seat cushion is mechanically removable, if required.
- For added comfort, the seat cushions are standard with high density Ultracell foam.
- The seat underside is sealed with a non-porous material to support housekeeping and infection control protocols.
- Legs are standard in wood or urethane (see upcharge).
- Choose from standard non-marking glides, steel cushioned glides, rubber non-slip glides, or felt glides (upcharges apply).
- The Globalcare warranty (for healthcare and 24/7 environments) applies for all Collingwood models when performance textiles are selected. Visit the website at [globalfurnituregroup.com/healthcare](http://globalfurnituregroup.com/healthcare).
- Global's standard lifetime warranty applies when approved standard Global textiles are selected.
- For alternate textile applications, contact Global specials. The Blended Textile matrix does not apply to this series.
- Shipped fully assembled.

SUGGESTED APPLICATIONS



- Dining/Cafeteria
- Guest seating
- Lobbies
- Lounge/Waiting
- Patient rooms
- Resident rooms

Add option codes in the following order:

- **Model number**  
**GC36510** Low back lounge chair  
**GC36511** High back lounge chair
- **Back/Arm Textile**  
Specify textile code. See model grade upcharges.
- **Seat Textile**  
Specify textile code. See model grade upcharges.
- **Leg Finish (Wood)**  
**(AAM)** Absolute **(MWM)** Medium Walnut  
**(BKM)** Black **(NLW)** Natural Walnut  
**(CJM)** Charcoal Java **(ASM)** Night  
**(ACM)** Cherry **(NBM)** Noce Biondo  
**(EMM)** Empire Mahogany **(NGM)** Noce Grigio  
**(EOM)** English Oak **(NEM)** Noce Leggero  
**(ECM)** Espresso Cafe **(NMM)** Noce Medio  
**(TFM)** Fruitwood **(SBM)** Sandy Beach  
**(HGM)** Grey **(SKM)** Shaker Cherry  
**(HOM)** Harvest Oak **(SOM)** Silver Oak  
**(AHM)** Honey **(TWM)** Walnut  
**(JOM)** Jet Onyx **(WTM)** WC Cream  
**(LHM)** Light Honey **(WHM)** White  
**(TMM)** Mahogany **(WCM)** Winter Cherry  
**(AVM)** Maple
- **Leg Finish (Urethane)** Add \$182  
**(BLK)** Black **(KAL)** Kalua  
**(LAB)** Latte **(J52)** Mocha  
**(SHW)** Shadow **(TOA)** Toast
- **Glides**  
**(NM)** Non-marking glide. No upcharge.  
**(RG)** Rubber, non-slip glide. Add \$34.  
**(SG)** Steel cushion glide. Add \$34.  
**(FG)** Felt glide. Add \$34.
- **Sealed Back Seams** (Contact Customer Care for approved textiles)  
**(NBS)** No sealed back seams  
**(SBS)** Sealed back seams. See model for upcharge.
- **Sealed Seat Seams** (Contact Customer Care for approved textiles)  
**(NSS)** No sealed seat seams  
**(SSS)** Sealed seat seams. Add \$33.
- **Moisture Barrier** (Not available with Sealed Seams.)  
**(NB)** No moisture barrier.  
**(MB)** Moisture barrier (seat only). Add \$110.

EXAMPLE COLLINGWOOD ORDER CODE:

GC36510	CE90	CE90	AVM	NM	NBS	NSS	NB
Model #	Back/arm textile	Seat textile	Leg finish	Glide	Sealed Back Seams	Sealed Seat Seams	Moisture Barrier

DESCRIPTION	MODEL#/ FEATURES	STANDARD TEXTILE GRADES											
		1/COM	2	3	4	5	6	7	8	9	10	11	12
 <p><b>Low Back Lounge Chair</b> COM Yardage: Back/Arm: 3.25; Seat: 1.25 Freight Class: 250 Product Weight (lbs.): 55 Cubic Feet Per Carton: 19.25</p>	<b>GC36510</b> Base Price:	<b>\$2155</b>											
	Back/Arm upcharge:	<b>+0</b>	<b>+\$104</b>	<b>+\$186</b>	<b>+\$303</b>	<b>+\$465</b>	<b>+\$540</b>	<b>+\$680</b>	<b>+\$907</b>	<b>+\$1076</b>	<b>+\$1258</b>	<b>+\$1645</b>	<b>+\$2048</b>
	Seat upcharge:	<b>+0</b>	<b>+\$40</b>	<b>+\$72</b>	<b>+\$117</b>	<b>+\$179</b>	<b>+\$208</b>	<b>+\$262</b>	<b>+\$349</b>	<b>+\$414</b>	<b>+\$484</b>	<b>+\$633</b>	<b>+\$788</b>
	<b>OVERALL DIMENSIONS</b>	<b>SEAT DIMENSIONS</b>			<b>BACK DIMENSIONS</b>								
	<b>W D H</b>	<b>W D H</b>	<b>W H</b>										
	28	27.25	28	21	19	18	21.5	12.5					
<p>Active weight 350 lbs. Replaceable seat cushion. Add \$65 for (SBS), \$33 for (SSS)</p>													
 <p><b>High Back Lounge Chair</b> COM Yardage: Back/Arm: 3.75; Seat: 1.25 Freight Class: 250 Product Weight (lbs.): 56 Cubic Feet Per Carton: 22.5</p>	<b>GC36511</b> Base Price:	<b>\$2212</b>											
	Back/Arm upcharge:	<b>+0</b>	<b>+\$120</b>	<b>+\$214</b>	<b>+\$349</b>	<b>+\$537</b>	<b>+\$623</b>	<b>+\$784</b>	<b>+\$1047</b>	<b>+\$1242</b>	<b>+\$1452</b>	<b>+\$1898</b>	<b>+\$2363</b>
	Seat upcharge:	<b>+0</b>	<b>+\$40</b>	<b>+\$72</b>	<b>+\$117</b>	<b>+\$179</b>	<b>+\$208</b>	<b>+\$262</b>	<b>+\$349</b>	<b>+\$414</b>	<b>+\$484</b>	<b>+\$633</b>	<b>+\$788</b>
	<b>OVERALL DIMENSIONS</b>	<b>SEAT DIMENSIONS</b>			<b>BACK DIMENSIONS</b>								
	<b>W D H</b>	<b>W D H</b>	<b>W H</b>										
	28	28.5	35.5	21	19	18	21.5	17					
<p>Active weight 350 lbs. Replaceable seat cushion. Add \$74 for (SBS), \$33 for (SSS)</p>													

DESMOND

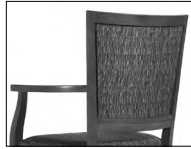

model GC4162

STANDARD FEATURES





- Clean lines and a contoured picture frame style back coordinate with any decor.
- Arms incorporate a firm grip extension to assist users in the entry and exit from the chair.
- Additional support rails on the legs ensure strength and durability.
- For added comfort, seats are standard with high density Ultracell bio foam
- Opaque non-marking glides are standard
- For Globalcare textiles and wood finish options, visit the website at [globalfurnituregroup.com](http://globalfurnituregroup.com)
- Models ending in FC have front casters
- Shipped fully assembled

OPTIONAL FEATURES

- For non-slip glides specify **(NS)**. Add \$35
- To add sealed seams to your product's back only contact Customer Care. Upcharges vary
- For moisture barrier **(MB)** (seat only) - Add \$129.

SUGGESTED APPLICATIONS

- Dining/Cafeteria
- Guest seating
- Lobbies
- Lounge/Waiting
- Office/Meeting
- Patient rooms
- Resident rooms

DESCRIPTION	MODEL#/ FEATURES	STANDARD TEXTILE GRADES											
		COM	2	3	4	5	6	7	8	9	10	11	12
 <b>Armchair</b> COM Yardage: 1.25 Freight Class: 300 Product Weight (lbs.): 24 Cubic Feet Per Carton: 14.5	GC4162	\$1397	\$1428	\$1465	\$1515	\$1585	\$1615	\$1681	\$1781	\$1859	\$1946	\$2123	\$2312
		OVERALL DIMENSIONS			SEAT DIMENSIONS			BACK DIMENSIONS					
		W	D	H	W	D	H	W	H				
	Active weight 300 lbs.	24	22.5	36	22.5	18	17.5	17.5	18.5				
 <b>Armchair w/Front Casters</b> COM Yardage: 1.25 Freight Class: 300 Product Weight (lbs.): 24 Cubic Feet Per Carton: 14.5	GC4162FC	\$1491	\$1522	\$1559	\$1609	\$1679	\$1709	\$1775	\$1875	\$1952	\$2038	\$2216	\$2405
		OVERALL DIMENSIONS			SEAT DIMENSIONS			BACK DIMENSIONS					
		W	D	H	W	D	H	W	H				
	Active weight 300 lbs.	24	22.5	36	22.5	18	17.5	17.5	18.5				
 <b>Side Chair</b> COM Yardage: 1.25 Freight Class: 300 Product Weight (lbs.): 22 Cubic Feet Per Carton: 14.5	GC4165	\$1280	\$1316	\$1350	\$1399	\$1466	\$1499	\$1559	\$1659	\$1734	\$1819	\$1991	\$2178
		OVERALL DIMENSIONS			SEAT DIMENSIONS			BACK DIMENSIONS					
		W	D	H	W	D	H	W	H				
	Active weight 300 lbs.	22.5	22.5	36	22.5	18	17.5	17.5	18.5				
 <b>Side Chair w/Front Casters</b> COM Yardage: 1.25 Freight Class: 300 Product Weight (lbs.): 22 Cubic Feet Per Carton: 14.5	GC4165FC	\$1374	\$1410	\$1444	\$1493	\$1560	\$1593	\$1653	\$1753	\$1828	\$1913	\$2085	\$2271
		OVERALL DIMENSIONS			SEAT DIMENSIONS			BACK DIMENSIONS					
		W	D	H	W	D	H	W	H				
	Active weight 300 lbs.	22.5	22.5	36	22.5	18	17.5	17.5	18.5				



**DESMOND HT**



model GC4290

**EXAMPLE DESMOND HT ORDER CODE:**

GC4290	-LX21	-TBL	-PT	-BK	-MB
Model #	Textile	Frame	Armcaps	Glides	Moisture Barrier

**STANDARD FEATURES**

- Desmond HT is a metal framed chair with residential design while ensuring maximum strength and durability within very challenging applications.
- Available with four-legged metal welded frame with or without arms; with rear casters that allow the caregiver to tip and move chair without lifting. Model GC4292 has a lift-assist mechanism and rear casters. The caregiver steps on the lift-assist in turning the chair and moving the occupant to and from a table.
- Models with rear casters also allow the caregiver to turn the chair with occupant seated for better access to wheelchair or walker.
- The welded metal frame, welded cross rails on lower frame, metal-to-metal fasteners on seat pan, back insert and urethane armcaps enhance strength and durability, ensuring its performance in the most rigorous environments.
- Urethane armcaps are comfortable, durable, cleanable and replaceable. Designed to offer proper support while seated and the forward extension allows the occupant to use with confidence when getting in or out of the chair.
- For added comfort and long term performance the seat cushion is standard with high density Ultracell bio foam
- The underside of the seat pan is moisture resistant, and the cushions have no exposed seams to support improved housekeeping and infection prevention practices
- For Globalcare textiles and finish options, visit the website at [globalfurnituregroup.com](http://globalfurnituregroup.com).
- Can be upholstered in standard Global textiles if Healthcare compliance is not required.
- Shipped fully assembled.

**SUGGESTED APPLICATIONS**

- Dining/Cafeteria
- Guest seating
- Lobbies
- Lounge/Waiting
- Office/Meeting
- Patient rooms
- Resident rooms
- Bariatric seating (model GC4293)

**OPTIONAL FEATURES**

- To add additional weight to your product, contact Customer Care for more information.
- Moisture Barrier (**MB**) (Seat Only) - Add \$129 list upcharge.

Please add option codes in the following order:

- **Model number**  
**GC4290** Metal armchair  
**GC4291** Metal armchair w/two rear swivel casters  
**GC4292** Metal armchair w/two rear swivel casters and lift mechanism  
**GC4293** Metal bariatric armchair  
**GC4294** Metal side chair, armless  
 - Add **(33)** to model # if CAL TB 133 is required.
- **Textile**  
Specify fabric code.
- **Frame finish**  
**(TBL)** Black  
**(TIV)** Cloud  
**(TDW)** Designer White  
**(TFO)** Fog  
**(TFR)** Frost  
**(TKA)** Kalua  
**(TLA)** Latte  
**(TMO)** Mocha  
**(TNE)** Nevada  
**(TSN)** Sand  
**(TSH)** Shadow  
**(TOA)** Toast  
**(TTU)** Tungsten
- **Armcap finish**  
**(SS)** Black  
**(KL)** Kalua  
**(LT)** Latte  
**(MC)** Mocha  
**(SW)** Shadow  
**(TO)** Toast
- **Glides**  
**(BK)** Black plastic glides
- **Moisture Barrier**  
**(MB)** Seat only

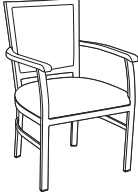
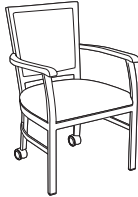
DESCRIPTION	MODEL#/ FEATURES	STANDARD TEXTILE GRADES											
		COM	2	3	4	5	6	7	8	9	10	11	12
 <b>Metal Armchair</b> COM Yardage: 1.25 Freight Class: 250 Product Weight (lbs.): 41 Cubic Feet Per Carton: 13.75	<b>GC4290</b>	\$1388	\$1424	\$1459	\$1508	\$1576	\$1607	\$1669	\$1768	\$1842	\$1928	\$2101	\$2286
		<b>OVERALL DIMENSIONS</b>			<b>SEAT DIMENSIONS</b>			<b>BACK DIMENSIONS</b>					
		W	D	H	W	D	H	W	H				
		24.5	23.5	35.75	23	19	18.5	18	17.5				
 <b>Metal Armchair w/Two Rear Swivel Casters</b> COM Yardage: 1.25 Freight Class: 250 Product Weight (lbs.): 41 Cubic Feet Per Carton: 13.75	<b>GC4291</b>	\$1530	\$1566	\$1601	\$1650	\$1718	\$1749	\$1811	\$1910	\$1984	\$2070	\$2243	\$2428
		<b>OVERALL DIMENSIONS</b>			<b>SEAT DIMENSIONS</b>			<b>BACK DIMENSIONS</b>					
		W	D	H	W	D	H	W	H				
		24.5	23.5	35.75	23	19	18.5	18	17.5				

# SEATING

# DESMOND HT D

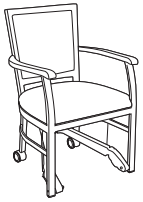
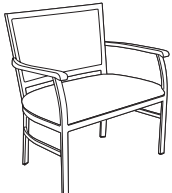
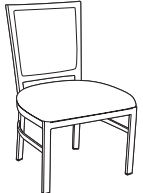
DESCRIPTION	MODEL#/ FEATURES	STANDARD TEXTILE GRADES											
		COM	2	3	4	5	6	7	8	9	10	11	12
 <p><b>Metal Armchair w/Two Rear Swivel Casters &amp; Lift Mech.</b> Active weight 350 lbs.                      COM Yardage: 1.25                      Freight Class: 250                      Product Weight (lbs.): 44                      Cubic Feet Per Carton: 13.75</p>	<b>GC4292</b>	\$2020	\$2056	\$2090	\$2139	\$2206	\$2238	\$2299	\$2399	\$2473	\$2559	\$2731	\$2917
	<b>OVERALL DIMENSIONS</b>			<b>SEAT DIMENSIONS</b>			<b>BACK DIMENSIONS</b>						
	<b>W</b>	<b>D</b>	<b>H</b>	<b>W</b>	<b>D</b>	<b>H</b>	<b>W</b>	<b>H</b>					
	24.5	23.5	35.75	23	19	18.5	18	17.5					
 <p><b>Metal Bariatric Armchair</b>                      COM Yardage: 2.25                      Freight Class: 250                      Product Weight (lbs.): 48                      Cubic Feet Per Carton: 20</p>	<b>GC4293</b>	\$1844	\$1913	\$1973	\$2057	\$2182	\$2240	\$2354	\$2529	\$2666	\$2817	\$3130	\$3463
	<b>OVERALL DIMENSIONS</b>			<b>SEAT DIMENSIONS</b>			<b>BACK DIMENSIONS</b>						
	<b>W</b>	<b>D</b>	<b>H</b>	<b>W</b>	<b>D</b>	<b>H</b>	<b>W</b>	<b>H</b>					
	35.5	23.5	35.75	34	19	18.5	29	17.5					
 <p><b>Metal Side Chair, Armless</b>                      COM Yardage: 1.25                      Freight Class: 250                      Product Weight (lbs.): 36                      Cubic Feet Per Carton: 13.75</p>	<b>GC4294</b>	\$1252	\$1288	\$1323	\$1372	\$1440	\$1471	\$1533	\$1632	\$1706	\$1792	\$1965	\$2150
	<b>OVERALL DIMENSIONS</b>			<b>SEAT DIMENSIONS</b>			<b>BACK DIMENSIONS</b>						
	<b>W</b>	<b>D</b>	<b>H</b>	<b>W</b>	<b>D</b>	<b>H</b>	<b>W</b>	<b>H</b>					
	23	23.5	35.75	23	19	18.5	18	17.5					

DOCTOR BUDDY



model GC1104

model GC1111

STANDARD FEATURES

- Doctor Buddy is the perfect stool to provide comfort when performing office tasks or as an examination or feeding stool when caring for others.
- For the right comfort and support when performing tasks, select Doctor Buddy with or without a back.
- Seat and back can be upholstered in vinyl or fabric. Seat is standard with high density Ultracell foam cushion.
- Models available with backrests: GC1111 & GC1113
- Moisture resistant protection on the underside of seat pan.
- GC1104, GC1109, GC1111 & GC1113: 16" seat diameter
- Black five-legged injection-molded base standard
- (C65) casters are standard
- For healthcare textiles, visit the website at [globalfurnituregroup.com/healthcare](http://globalfurnituregroup.com/healthcare).
- Can be upholstered in standard Global textiles if healthcare compliance is not required.

STANDARD FEATURES

- **Casters/Glides**  
**(C65)** Dual wheel carpet casters. No upcharge  
**(C65R)** Dual wheel hard floor casters. Add \$67.  
**(C7)** Set of 5 large Black slipper glides (for all surfaces). Can replace any Global casters. Glide is same height as casters. No upcharge.
- Moisture barrier on seat, specify **(MB)**. Add \$102.
- Sealed seat seams (and back), specify **(SS)**. Upcharges vary, see model.
- Height adjustable footrest, specify **(R2)**. Add \$93.

SUGGESTED APPLICATIONS

- Dining/Cafeteria
- Office/Meeting
- Patient rooms
- Resident rooms
- Treatment/Exam rooms

DESCRIPTION	MODEL#/ FEATURES	STANDARD TEXTILE GRADES											
		1	2	3	4	5	6	7	8	9	10	11	12
	<b>GC1104</b>  Active weight 300 lbs. Add \$17 for <b>(SS)</b> .	\$476	\$503	\$526	\$555	\$601	\$621	\$654	\$729	\$762	\$831	\$925	\$1040
		OVERALL DIMENSIONS			SEAT DIMENSIONS			BACK DIMENSIONS					
		W	D	H	W	D	H	W	H				
		16	16	18.5	16	--	16.5 - 21.5	--	--				
	<b>GC1109</b>  Active weight 300 lbs. Add \$17 for <b>(SS)</b> .	\$506	\$535	\$555	\$586	\$632	\$652	\$685	\$760	\$792	\$863	\$957	\$1070
		OVERALL DIMENSIONS			SEAT DIMENSIONS			BACK DIMENSIONS					
		W	D	H	W	D	H	W	H				
		16	16	27.5	16	--	22.5 - 32.5	--	--				
	<b>GC1111</b>  Active weight 300 lbs. Add \$33 for <b>(SS)</b> .	\$759	\$795	\$822	\$862	\$918	\$942	\$991	\$1067	\$1125	\$1187	\$1318	\$1455
		OVERALL DIMENSIONS			SEAT DIMENSIONS			BACK DIMENSIONS					
		W	D	H	W	D	H	W	H				
		16.5	20.5	29.75	16.5	15.5	16 - 21	14	11.25				
	<b>GC1113</b>  Active weight 300 lbs. Add \$33 for <b>(SS)</b> .	\$790	\$826	\$853	\$893	\$949	\$973	\$1022	\$1098	\$1156	\$1218	\$1349	\$1486
		OVERALL DIMENSIONS			SEAT DIMENSIONS			BACK DIMENSIONS					
		W	D	H	W	D	H	W	H				
		16.5	20.5	38.75	16.5	15.5	22.5 - 32.5	14	11.25				

## DREME



**Sleeper with back and arms**  
model GC35042

### EXAMPLE DREME ORDER CODE:

GC35042	-LE50	-	-BM21	-LPN	-AWH
---------	-------	---	-------	------	------

Model #	Textile	Arm/tablet location	Sleep surface textile	Front panel type (LPN, UPN, LPP, UPP)	Laminate panel finish
---------	---------	---------------------	-----------------------	---------------------------------------	-----------------------

-SRL	-TOA	-MB
------	------	-----

Storage	Leg finish/caster option	Moisture barrier
---------	--------------------------	------------------



Drawer box surface

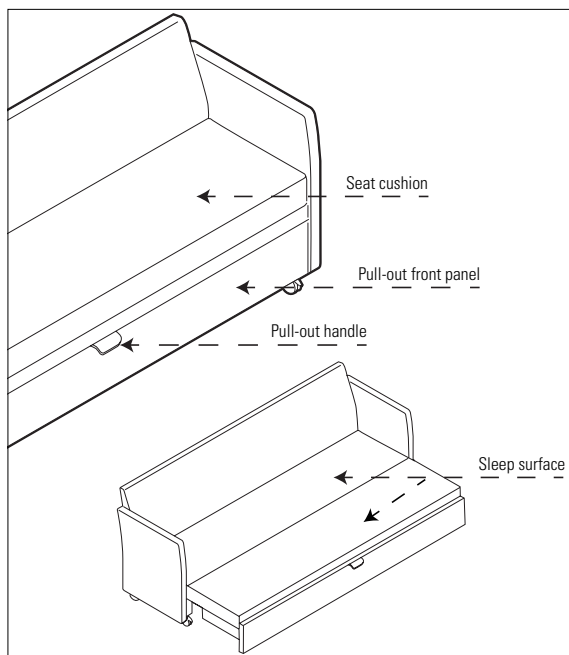

### STANDARD FEATURES

- Dreme has a compact, comfortable design that offers a place to sit and converts into a generous sleep surface with a simple pull and flip. A variety of models include backless/armless benches and 3-seater sofa models with or without arms and tablets.
- The seat deck is a clean through metal platform for superior strength.
- The seat/sleep cushion is attached to the unit with straps held in place by metal-to-metal fasteners allowing sheets to be tucked in place.
- Straps can be unfastened for field replacement of the cushion, if required for any reason.
- A clean through is located at the back of the seat cushion, extending to the floor supporting ease of cleaning.
- The seat cushion folds open to create a 36" deep sleep surface area. Foam is standard high density Ultracell, for enhanced comfort and long-term performance.
- A pull-out section below the seat deck slides forward to support the sleep surface.
- The sleep surface cushion and drawer box covering are upholstered in Bantam vinyl to ensure moisture barrier protection. These surfaces are 9:1 (water to bleach) cleanable. Please select **(BM)** color. See Morbern Bantam textile card for color samples. All other surfaces can be specified in your textile of choice.
- A curved, chrome pull handle is standard on the pull-out front panel of all Dreme models.
- The pull-out is supported by four heavy duty non-locking, swivel casters when in sleep position and is standard without storage.
- Dreme requires zero wall clearance to open into sleep position.
- Standard configuration for all models: two metal legs in front position, two non-locking swivel casters in back position (to assist with moving the unit). Optional front, locking, swivel casters **(FC)** are available. Add **\$80**.
- Legs are available in all Globalcare metal paint finishes.
- Models with a tablet are available with left, right or both sofa arms. On models with both arms, specify left **(LT)**, right **(RT)** or **(TB)** for tablets on both arms (add **\$324** for **TB**). Tablet and arms are designated based on seated position. The tablet surfaces attach to the outside of the arm. The tablet rotates up and can be swiveled over the arm into place for use by the occupant. The strong, oval tablet is a soft black colored, non-porous, phenolic material with a no-spill edge.
- Interior sleep surface: 79" L x 37" W
- All textiles are railroaded across all Dreme components.
- For healthcare textiles, visit the website at [globalfurnituregroup.com/healthcare](http://globalfurnituregroup.com/healthcare).
- Can be upholstered in standard Global textiles if healthcare compliance is not required.

### OPTIONAL FEATURES

- The pull-out is available with a storage compartment option. The storage compartment is divided into two sides, both with clean through spaces, and is finished in Storm Grey (SOG) laminate. The storage compartment must be ordered at time of original order and cannot be retrofitted, specify **(SRB)**. Add **\$447**.
- Storage compartment lids have a pneumatic lift support, allowing the lid to stay open when accessing the interior storage area.
- An optional seamless drawer liner is available for the storage compartments, as a set of two. Liners can be removed for ease of maintenance, specify **(SRL)**. Add **\$890**.
- Pull-out front panel is available with or without power units, and either upholstered or laminate. Specify one of the following: **(LPN)** laminate panel **(UPN)** high-density panel **(LPP)** laminate panel with power. Add **\$238**. **(UPP)** upholstered panel with power. Add **\$238**. Select from all standard laminate finishes.
- The optional power unit is located on the front panel, center front position. The tamper-resistant unit includes one power and two, USB-A, 10 watt charging ports with an 8 ft. long power cord. When the pull-out is in the open position, the remaining power cord length is 6 ft. The power module is Black with Black face plate and must be specified at time of order.
- **Leg finish/caster option:** **(TBL)** Black **(TKA)** Kalua **(TLA)** Latte **(TMO)** Mocha **(TSH)** Shadow **(TOA)** Toast **(TTU)** Tungsten **(FC)** Front, locking, swivel casters. Add **\$80**. (Casters are Black with Taupe center)
- **Sleep Surface Finish:** **(BM21)** Apple **(BM25)** Cosmic **(BM23)** Dove **(BM26)** Firelight **(BM22)** Ghost **(BM27)** Ginger **(BM24)** Iron **(BM20)** Rabbit **(BM28)** Tropical  
See finishes at [globalfurnituregroup.com/workplace/resources/textiles](http://globalfurnituregroup.com/workplace/resources/textiles) - Global Carded Textiles
- For moisture barrier on full seat and sleeping surface, specify **(MB)**. Add **\$518**.
- To add sealed seams to your product, specify **(SS)**. Add **\$485**.

### SUGGESTED APPLICATIONS

- Lounge
- Patient rooms
- Resident rooms
- Treatment/Exam rooms

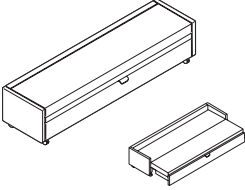
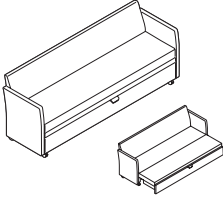
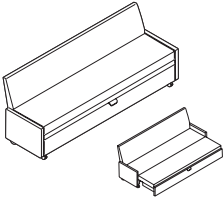
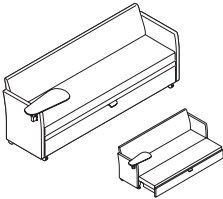
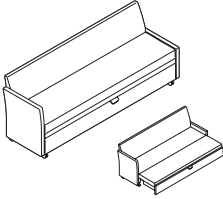
DESCRIPTION	MODEL#/ FEATURES	STANDARD TEXTILE GRADES											
		COM	2	3	4	5	6	7	8	9	10	11	12
 <p><b>Armless Sleeper</b> COM Yardage: 9.5 Freight Class: 125 Product Weight (lbs.): 158 Cubic Feet Per Carton: 22.75</p>	<b>GC35041NA</b>	\$5176	\$5507	\$5774	\$6177	\$6743	\$7009	\$7523	\$8341	\$8972	\$9674	\$11117	\$12658
	Active weight 450 lbs.	<b>OVERALL DIMENSIONS</b> W D H			<b>SEAT DIMENSIONS</b> W D H			<b>BACK DIMENSIONS</b> W H					
		82	23	18.5	78	--	18.5						
 <p><b>Sleeper w/Back and Arms</b> COM Yardage: 11.75 Freight Class: 150 Product Weight (lbs.): 210 Cubic Feet Per Carton: 46.25</p>	<b>GC35042</b>	\$5870	\$6267	\$6589	\$7069	\$7749	\$8069	\$8686	\$9671	\$10430	\$11271	\$13005	\$14856
	Active weight 450 lbs.	<b>OVERALL DIMENSIONS</b> W D H			<b>SEAT DIMENSIONS</b> W D H			<b>BACK DIMENSIONS</b> W H					
		82	25	32.5	78	18	18.5	78	14				
 <p><b>Armless Sleeper w/Back</b> COM Yardage: 11.45 Freight Class: 150 Product Weight (lbs.): 190 Cubic Feet Per Carton: 46.25</p>	<b>GC35042NA</b>	\$5708	\$6088	\$6397	\$6859	\$7510	\$7815	\$8407	\$9348	\$10075	\$10883	\$12545	\$14317
	Active weight 450 lbs.	<b>OVERALL DIMENSIONS</b> W D H			<b>SEAT DIMENSIONS</b> W D H			<b>BACK DIMENSIONS</b> W H					
		82	25	32.5	78	18	18.5	78	14				
 <p><b>Sleeper w/Back, Arms and Tablet</b> COM Yardage: 11.75 Freight Class: 150 Product Weight (lbs.): 210 Cubic Feet Per Carton: 48.5</p>	<b>GC35042T</b>	\$6214	\$6604	\$6921	\$7393	\$8062	\$8376	\$8983	\$9951	\$10697	\$11523	\$13229	\$15048
	Active weight 450 lbs.	<b>OVERALL DIMENSIONS</b> W D H			<b>SEAT DIMENSIONS</b> W D H			<b>BACK DIMENSIONS</b> W H					
		86	25	32.5	78	18	18.5	78	14				
 <p><b>Sleeper w/Back and one Arm</b> COM Yardage: 11.95 Freight Class: 150 Product Weight (lbs.): 200 Cubic Feet Per Carton: 46.25</p>	<b>GC35043</b>	\$5870	\$6267	\$6589	\$7069	\$7749	\$8069	\$8686	\$9671	\$10430	\$11271	\$13005	\$14856
	Active weight 450 lbs.	<b>OVERALL DIMENSIONS</b> W D H			<b>SEAT DIMENSIONS</b> W D H			<b>BACK DIMENSIONS</b> W H					
		82	25	32.5	78	18	18.5	78	14				

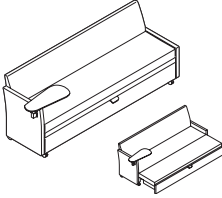
DESCRIPTION	MODEL#/ FEATURES	STANDARD TEXTILE GRADES											
		COM	2	3	4	5	6	7	8	9	10	11	12
 <p><b>Sleeper w/Back, Single Arm and Tablet</b>                      COM Yardage: 11.25                      Freight Class: 150                      Product Weight (lbs.): 205                      Cubic Feet Per Carton: 47.5</p>	<b>GC35043T</b>	<b>\$6231</b>	<b>\$6604</b>	<b>\$6908</b>	<b>\$7359</b>	<b>\$8001</b>	<b>\$8301</b>	<b>\$8882</b>	<b>\$9807</b>	<b>\$10523</b>	<b>\$11314</b>	<b>\$12948</b>	<b>\$14689</b>
	Specify (RT) for right arm or (LT) for left arm.												
		OVERALL DIMENSIONS			SEAT DIMENSIONS			BACK DIMENSIONS					
		W	D	H	W	D	H	W	H				
	Active weight 450 lbs.	86	25	32.5	78	18	18.5	78	14				



Change is the constant that each new generation brings to the table. Drift™ seating encourages people to come together with new ideas, new priorities and new ways of thinking. The welcoming look is ideal for collaborative spaces in the workplace to community spaces in healthcare.

The series includes lounge and side chairs, bar and counter stools, and task swivel models, connecting people and places wherever the day takes us. The wood base four-leg and swivel models, available in a wide range of popular finishes, bring added warmth to this contemporary seating series.

To see the full Drift series, please refer to the Seating price list at: [globalfurnituregroup.com/workplace/resources/price-lists](https://globalfurnituregroup.com/workplace/resources/price-lists)

#### Features and Benefits

- Soft seat and contoured back and arms provide the perfect balance of style and comfort
- Side chairs available in six base types: sled, wood 4-leg, wood 4-prong swivel, chrome 4-prong swivel, high 4-star swivel and 5-star base on casters
- Lounge chairs available in four base types: sled, wood 4-leg, wood 4-star swivel and Chrome 4-prong swivel
- Counter and bar height stools available with three base types: sled, wood 4-leg, and Chrome 4-star swivel.
- Lounge seating available with 17" seat height with a classic lounge angle or 18" seat height with a reduced back angle for ease of sitting and standing.
- Ottomans have a weighted bottom to maintain upright position.
- P and PH suffix models available with arm and head patches for increased durability
- For ease of cleaning, side and lounge chair models with "F" suffix have flip-forward seats.
- All Drift seating is assembled using tamper proof screws.
- Drift seating is designed for 300 lb. capacity.
- Available to specify with two textiles, one for the seat cushion and one for the back and arms.
- For environmental certifications, please visit [globalfurnituregroup.com](https://globalfurnituregroup.com).

#### Options

- Sealed back seams and sealed seat seams
- Moisture barrier (seat only)
- Variety of glide options (wood base and sled base models)



ERIN



**model GC36531**  
Armless Guest Chair,  
Metal Legs



**model GC36532**  
Guest Armchair,  
Wood Legs

STANDARD FEATURES

- Erin offers a streamlined silhouette brimming with mid-century modern style.
- A rounded arch gently curves around and under the seat to give extra support to a user's upper back and sides, while creating an open clean-out space at the back of the cushion.
- The series is available to specify with two textiles, one for the seat cushion and one for the back, arms and front rail (see model image).
- For pricing, start with the base price and add both back/arms graded textile upcharge and the seat graded textile upcharge.
- Tapered legs add style and elegance.
- Legs are available in wood or metal painted/plated finishes (noted).
- The seat underside is sealed with a non-porous material to support housekeeping and infection control protocols.
- Additional improved cleaning options include sealed seams (back and/or seat) and moisture barrier (seat). Upcharges apply.
- Assembled with tamper-resistant fasteners for greater security.
- For added comfort, the seat cushions are standard with high density Ultracell foam.
- Glides are self-leveling. Choose from standard non-marking glides, rubber non-slip glides or felt glides (upcharges apply).
- The Globalcare warranty (for healthcare and 24/7 environments) applies for all Erin GC models when performance textiles are selected. Visit the website at [globalfurnituregroup.com/healthcare](http://globalfurnituregroup.com/healthcare).
- Global's standard lifetime warranty applies when approved standard Global textiles are selected.
- For alternate textile applications, contact Global specials. The Blended Textile matrix does not apply to this series.
- Shipped fully assembled.

SUGGESTED APPLICATIONS

- Dining/Cafeteria
- Guest seating
- Lobbies
- Lounge/Waiting
- Patient rooms
- Resident rooms

OPTIONAL FEATURES





Please add option codes in the following order:

- **Model number**  
**GC36530** Guest armless chair, wood legs  
**GC36531** Guest armless chair, metal legs  
**GC36532** Guest armchair, wood legs  
**GC36533** Guest armchair, metal legs
- **Back/Arm Textile**  
Specify textile code. See model grade upcharges.
- **Seat Textile**  
Specify textile code. See model grade upcharges.
- **Wood leg finish** (models GC36530 and GC36532)  
**(AAM)** Absolute      **(MWM)** Medium Walnut  
**(BKM)** Black      **(NLW)** Natural Walnut  
**(CJM)** Charcoal Java      **(ASM)** Night  
**(ACM)** Cherry      **(NBM)** Noce Biondo  
**(EMM)** Empire Mahogany      **(NGM)** Noce Grigio  
**(EOM)** English Oak      **(NEM)** Noce Leggero  
**(ECM)** Espresso Cafe      **(NMM)** Noce Medio  
**(TFM)** Fruitwood      **(SBM)** Sandy Beach  
**(HGM)** Grey      **(SKM)** Shaker Cherry  
**(HOM)** Harvest Oak      **(SOM)** Silver Oak  
**(AHM)** Honey      **(TWM)** Walnut  
**(JOM)** Jet Onyx      **(WTM)** WC Cream  
**(LHM)** Light Honey      **(WHM)** White  
**(TMM)** Mahogany      **(WCM)** Winter Cherry  
**(AVM)** Maple
- **Metal leg finish** (models GC36531 and GC36533)  
**(CHM)** Chrome      **(TTU)** Tungsten  
**(TBL)** Black      **(TKA)** Kalua  
**(TLA)** Latte      **(TMO)** Mocha  
**(TSH)** Shadow      **(TOA)** Toast
- **Glides**  
**(NM)** Non-marking glide. No upcharge  
**(RG)** Rubber, non-slip glide. Add \$60.  
**(FG)** Felt glide. Add \$60.
- **Sealed Back Seams** (Contact Customer Care for approved textiles)  
**(NBS)** No sealed back seams  
**(SBS)** Sealed back seams. Upcharges vary, see model.
- **Sealed Seat Seams** (Contact Customer Care for approved textiles)  
**(NSS)** No sealed seat seams  
**(SSS)** Sealed seat seams. Add \$20.
- **Moisture Barrier** (Not available with Sealed Seams)  
**(NB)** No moisture barrier.  
**(MB)** Moisture barrier (seat only). Add \$110.

EXAMPLE ERIN ORDER CODE:

GC36530	CE90	CE90	AAM	NM	NBS	NSS	NB
Model #	Seat/Arm textile	Seat textile	Leg finish	Glide	Sealed Back Seams	Sealed Seat Seams	Moisture Barrier



DESCRIPTION	MODEL#/ FEATURES	STANDARD TEXTILE GRADES											
		1/COM	2	3	4	5	6	7	8	9	10	11	12
 <p><b>Armless Guest Chair, Wood Legs</b> COM Yardage: Back/Arm: 1.75; Seat: 1 Freight Class: 250 Product Weight (lbs.): 32.5 Cubic Feet Per Carton: 13.25</p>	<b>GC36530</b> Base Price:	<b>\$1892</b>											
	Back/Arm upcharge:	<b>+0</b>	<b>+\$56</b>	<b>+\$100</b>	<b>+\$165</b>	<b>+\$256</b>	<b>+\$294</b>	<b>+\$373</b>	<b>+\$497</b>	<b>+\$590</b>	<b>+\$692</b>	<b>+\$903</b>	<b>+\$1126</b>
	Seat upcharge:	<b>+0</b>	<b>+\$32</b>	<b>+\$57</b>	<b>+\$94</b>	<b>+\$146</b>	<b>+\$168</b>	<b>+\$213</b>	<b>+\$284</b>	<b>+\$337</b>	<b>+\$395</b>	<b>+\$516</b>	<b>+\$643</b>
	<b>OVERALL DIMENSIONS</b>			<b>SEAT DIMENSIONS</b>			<b>BACK DIMENSIONS</b>						
	<b>W D H</b>			<b>W D H</b>			<b>W H</b>						
	24 22.25 34			19 18 19			15 15.5						
		Active weight 350 lbs.	Add \$49 for (SBS), \$20 for (SSS)										
 <p><b>Armless Guest Chair, Metal Legs</b> COM Yardage: Back/Arm: 1.75; Seat: 1 Freight Class: 250 Product Weight (lbs.): 34.5 Cubic Feet Per Carton: 13.25</p>	<b>GC36531</b> Base Price:	<b>\$1801</b>											
	Back/Arm upcharge:	<b>+0</b>	<b>+\$56</b>	<b>+\$100</b>	<b>+\$165</b>	<b>+\$256</b>	<b>+\$294</b>	<b>+\$373</b>	<b>+\$497</b>	<b>+\$590</b>	<b>+\$692</b>	<b>+\$903</b>	<b>+\$1126</b>
	Seat upcharge:	<b>+0</b>	<b>+\$32</b>	<b>+\$57</b>	<b>+\$94</b>	<b>+\$146</b>	<b>+\$168</b>	<b>+\$213</b>	<b>+\$284</b>	<b>+\$337</b>	<b>+\$395</b>	<b>+\$516</b>	<b>+\$643</b>
	<b>OVERALL DIMENSIONS</b>			<b>SEAT DIMENSIONS</b>			<b>BACK DIMENSIONS</b>						
	<b>W D H</b>			<b>W D H</b>			<b>W H</b>						
	24 22.25 34			19 18 19			15 15.5						
		Active weight 350 lbs.	Add \$49 for (SBS), \$20 for (SSS)										
 <p><b>Guest Armchair, Wood Legs</b> COM Yardage: Back/Arm: 1.75; Seat: 1 Freight Class: 250 Product Weight (lbs.): 33 Cubic Feet Per Carton: 13.25</p>	<b>GC36532</b> Base Price:	<b>\$1892</b>											
	Back/Arm upcharge:	<b>+0</b>	<b>+\$56</b>	<b>+\$100</b>	<b>+\$165</b>	<b>+\$256</b>	<b>+\$294</b>	<b>+\$373</b>	<b>+\$497</b>	<b>+\$590</b>	<b>+\$692</b>	<b>+\$903</b>	<b>+\$1126</b>
	Seat upcharge:	<b>+0</b>	<b>+\$32</b>	<b>+\$57</b>	<b>+\$94</b>	<b>+\$146</b>	<b>+\$168</b>	<b>+\$213</b>	<b>+\$284</b>	<b>+\$337</b>	<b>+\$395</b>	<b>+\$516</b>	<b>+\$643</b>
	<b>OVERALL DIMENSIONS</b>			<b>SEAT DIMENSIONS</b>			<b>BACK DIMENSIONS</b>						
	<b>W D H</b>			<b>W D H</b>			<b>W H</b>						
	24 22 34.25			19 18.5 18.5			17 15.75						
		Active weight 350 lbs.	Add \$52 for (SBS), \$20 for (SSS)										
 <p><b>Guest Armchair, Metal Legs</b> COM Yardage: Back/Arm: 1.75; Seat: 1 Freight Class: 250 Product Weight (lbs.): 35 Cubic Feet Per Carton: 13.25</p>	<b>GC36533</b> Base Price:	<b>\$1801</b>											
	Back/Arm upcharge:	<b>+0</b>	<b>+\$56</b>	<b>+\$100</b>	<b>+\$165</b>	<b>+\$256</b>	<b>+\$294</b>	<b>+\$373</b>	<b>+\$497</b>	<b>+\$590</b>	<b>+\$692</b>	<b>+\$903</b>	<b>+\$1126</b>
	Seat upcharge:	<b>+0</b>	<b>+\$32</b>	<b>+\$57</b>	<b>+\$94</b>	<b>+\$146</b>	<b>+\$168</b>	<b>+\$213</b>	<b>+\$284</b>	<b>+\$337</b>	<b>+\$395</b>	<b>+\$516</b>	<b>+\$643</b>
	<b>OVERALL DIMENSIONS</b>			<b>SEAT DIMENSIONS</b>			<b>BACK DIMENSIONS</b>						
	<b>W D H</b>			<b>W D H</b>			<b>W H</b>						
	24 22 34.25			19 18.5 18.5			17 15.75						
		Active weight 350 lbs.	Add \$52 for (SBS), \$20 for (SSS)										

FLAP™



Folding Chair  
model 6775

STANDARD FEATURES

- A modern design, high quality, lightweight, all polymer folding chair intended for use indoors or outdoors. Products must be stored inside during extreme and inclement weather. See Global's Outdoor Furniture warranty for additional information.
- Weather resistant, UV resistant, stain resistant, 100% non-ferrous, and recyclable design that is 1:10 bleach solution cleanable.
- Chair legs are equipped with clear non-marking glides as standard. Suitable for outdoor environments, carpet and hard surface flooring
- Chairs are stocked in 2 colors:  
Alloy (ALY)  
Milk (MLK)
- No upholstery options available
- Rated to 275 lbs.
- Single chair folds flat to 2.2" (55 mm).
- Flap achieves its strength and durability using glass filled polymer. Evidence of this material may be visible on the surface and is often more evident in darker colors.
- The Flap Wall Hook (6776), sold individually, supports up to two folded Flap chairs. This Milk (MLK) colored plastic hook mounts on walls or inside closets and wardrobe cabinets providing easy access to extra seating. Two chairs on Wall Hook measure 7.3" (185 mm) deep off wall. Mounting hardware not included. Recommended mounting into stud.
- Flap Ganging Brackets (6778) are sold 12 to a box. These translucent, frosted plastic brackets attach across two adjacent chairs, just above or below the seat to provide temporary ganging for organized events.
- The Flap Dolly (6777), ordered separately, supports up to 24 chairs folded and stacked flat. Includes strap to secure chairs for storage and transport.





Please add option codes in the following order

- **Model number**  
6775 Folding Chair  
6776 Wall Hook  
6777 Dolly  
6778 Ganging Brackets
- **Chair Color**  
(ALY) Alloy  
(MLK) Milk

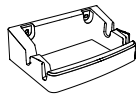
EXAMPLE OF FLAP ORDER CODE:

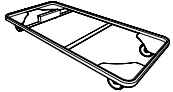
6775	ALY
Model Number	Finish

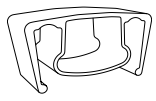
DESCRIPTION	MODEL#/ FEATURES	STANDARD TEXTILE GRADES											
		1	2	3	4	5	6	7	8	9	10	11	12
 <p><b>Folding Chair</b> COM Yardage: N/A Freight Class: 100 Product Weight (lbs.): 13.5 Cubic Feet Per Carton: 1.6</p>	6775	\$214											
	<p>Shipped 2 per box. Ordered as eaches.</p>	<b>OVERALL DIMENSIONS</b>			<b>SEAT DIMENSIONS</b>			<b>BACK DIMENSIONS</b>					
		W	D	H	W	D	H	W	H				
			19	21.5	33.5	16	16.5	18.5	18.5	16			
		RTA 00		ups		2 per carton (pricing and specifications are for one chair)							
 <p><b>Flap Wall Hook</b> COM Yardage: N/A Freight Class: 70 Product Weight (lbs.): 0.75 Cubic Feet Per Carton: 0.2</p>	6776	\$48											
		<b>OVERALL DIMENSIONS</b>			<b>SEAT DIMENSIONS</b>			<b>BACK DIMENSIONS</b>					
	W	D	H	W	D	H	W	H					
		9	6	2.75									
		RTA 00		ups		1 per carton							

DESCRIPTION	MODEL#/ FEATURES	STANDARD TEXTILE GRADES											
		1	2	3	4	5	6	7	8	9	10	11	12
 <p><b>Dolly for Flap Folding Chairs</b>                      COM Yardage: N/A                      Freight Class: 150                      Product Weight (lbs.): 23                      Cubic Feet Per Carton: 4.5</p>	<b>6777</b> \$614 Holds up to 24 Flap folded chairs. Includes tether strap.	<b>OVERALL DIMENSIONS</b> W    D    H			<b>SEAT DIMENSIONS</b> W    D    H			<b>BACK DIMENSIONS</b> W    H					
		20.75	44	5.25									
					RTA 00		1 per carton						
 <p><b>Flap Ganging Bracket (box of 12)</b>                      COM Yardage: N/A                      Freight Class: 70                      Product Weight (lbs.): 0.29                      Cubic Feet Per Carton: 0.03</p>	<b>6778</b> \$188	<b>OVERALL DIMENSIONS</b> W    D    H			<b>SEAT DIMENSIONS</b> W    D    H			<b>BACK DIMENSIONS</b> W    H					
		0	0	0									
					RTA 00		12 per carton (pricing and specifications are for box of 12)						

FOOT ACTIVATED STOOLS



STANDARD FEATURES

- Foot activated stools allow the occupant to adjust the gas cylinder by pressing on the ring below the base with their foot, which frees up hands to manage other tasks while working in a lab.
- Raise the seat by pressing on the ring before sitting; or lower the seat by pressing on the ring while seated.
- Swivel stool with 8" gas cylinder provides seat height range of 21.5" to 29.5".
- Seamless upholstered seat cushion is constructed from high density Ultracell foam.
- Underside of seat cushion is finished with polyurethane.
- 14" seat diameter with 25" diameter Black five prong injection molded base.
- Standard with dual wheel hard floor casters (C10R).
- For Globalcare textiles and finish options, visit the website at [globalfurnituregroup.com](http://globalfurnituregroup.com).
- Can be upholstered in standard Global textiles only if Healthcare compliance is not required.

OPTIONAL FEATURES

- To respond to higher expectations for housekeeping and infection prevention, seat underside can be completely sealed. Contact Customer Care for upcharge.

SUGGESTED APPLICATIONS

- Dining/Cafeteria
- Office/Meeting
- Patient rooms
- Resident rooms
- Treatment/Exam rooms

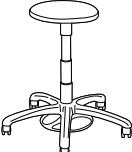
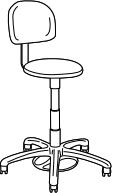
DESCRIPTION	MODEL#/ FEATURES	STANDARD TEXTILE GRADES											
		COM	2	3	4	5	6	7	8	9	10	11	12
 <p><b>Lab Swivel Stool</b> COM Yardage: 0.75 Freight Class: 250 Product weight (lbs.): 25 Cubic Feet per Carton: 9.75</p>	GC9604FG	\$782	\$804	\$827	\$856	\$900	\$921	\$959	\$1020	\$1068	\$1121	\$1230	\$1346
		OVERALL DIMENSIONS			SEAT DIMENSIONS			BACK DIMENSIONS					
		W	D	H	W	D	H	W	H				
		14	14	25.5	14	--	21.5-29.5						
 <p><b>Lab Swivel Stool w/Small Upholstered Back</b> COM Yardage: 1 Freight Class: 250 Product weight (lbs.): 32 Cubic Feet per Carton: 13</p>	GC9668FG	\$923	\$954	\$983	\$1024	\$1081	\$1107	\$1159	\$1241	\$1305	\$1377	\$1519	\$1675
		OVERALL DIMENSIONS			SEAT DIMENSIONS			BACK DIMENSIONS					
		W	D	H	W	D	H	W	H				
		14	14	38	14	--	21.5-29.5	14	12.5				

**FROLICK & SPLASH**



model GC3001

model GC3011

**Three different back constructions**



Separate panel piece closes the lower back to conceal the support bracket. Offered in **Frolick** series on select models.



Single piece back with a pullover style upholstery cover and support bracket fastened on the outer back. Offered on select **Frolick** models.



Two piece back covering the back support brackets when fastened in place. Offered in **Splash** series.

**STANDARD FEATURES**



- Frolick and Splash are multi-purpose stacking chairs that share generous width between the arms, great comfort, and a frame built for greater strength and stability. Each series offers a different back design with special features to best address the application and infection control practices.
- Standard size models offer 19" seat width with 21.5" clearance between the armrests. Bariatric size models offer 31.5" seat width with 33.5" clearance between the armrests.
- For a smaller scale bariatric chair, refer to GC Comet #GC2180 which offers 18.5" seat width with 28" clearance between armrests
- Heavy duty round, tubular gusseted frames.
- Active weight capacity is up to 300 lbs. for standard models, and 500 lbs. for Bariatric models.
- Protective Shadow finished seat shroud is standard on the underside of all models (except bariatric models GC3003 and GC3023).
- To respond to higher expectations for housekeeping and infection control practices, select models with a one-piece back. Description of back is noted with each model
- Wallsaver rear legs eliminate accidental damage to walls.
- Armrests are fiberglass reinforced Nylon and have a flat profile. Fully extended to front of seat edge to assist in entry and exit from the chair.
- Armrests are standard in Black.
- For added comfort, seats are standard with high density Ultracell bio foam
- Four legged standard size models stack 5 high without dolly and 8 high on GC3010 dolly.
- **Four legged Bariatric models stack 2 high only** - No dolly available.
- Sled base models do not stack
- For ganging brackets, see Model 2180 in the Global Seating List Price Book.
- On armless models, Black frames are standard with Black glides and front leg caps. All other frame colors are standard with Shadow glides and front leg caps.
- For textiles and finish options, visit the website at [globalfurnituregroup.com/healthcare](http://globalfurnituregroup.com/healthcare)
- Can be upholstered in standard Global textiles only if Healthcare compliance is not required.

**OPTIONAL FEATURES**

- A selection of glide options is available. Glides must be chosen to best suit flooring type and site conditions.
- For hard surface floors, please specify opaque non-marking glides (**WH**). No upcharge.
- Glides with felt pads (**FG**) are available for vinyl sheet, cork or laminate flooring. Please specify. Add **\$60**.
- Glides with rubber pads (**RG**) are available for vinyl, hardwood, laminate, stone or ceramic flooring. Please specify. Add **\$60**.
- Armrests available in Shadow (**SHW**) and Toast (**TOA**). Please Specify. Add **\$35**.
- To add sealed seams to your product contact Customer Care. Upcharges vary
- For moisture barrier on seat, add \$129 per seat. For bariatric models - Add \$198 per seat.
- **Frame finish**  
Painted finishes - no upcharge:  
(**TBL**) Black  
(**TBZ**) Buzz Blue  
(**TCC**) Cactus  
(**TCR**) Carrot  
(**TIV**) Cloud  
(**TDW**) Designer White  
(**TDJ**) Dijon  
(**TEG**) Eggplant  
(**TFO**) Fog  
(**TFR**) Frost  
(**TIN**) Ink  
(**TKA**) Kalua  
(**TLA**) Latte  
(**TMO**) Mocha  
(**TNE**) Nevada  
(**TSN**) Sand  
(**TSR**) Scarlet  
(**TSH**) Shadow  
(**TOA**) Toast  
(**TTU**) Tungsten  
Plated finish - see models for upcharge:  
(**CHM**) Chrome

**SUGGESTED APPLICATIONS**

- Bariatric seating (Frolick)
- Dining/Cafeteria
- Guest seating
- Lobbies
- Lounge/Waiting
- Office/Meeting
- Patient rooms
- Resident rooms
- Stacking
- Treatment/Exam Rooms

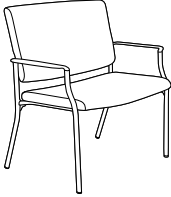
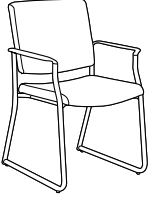
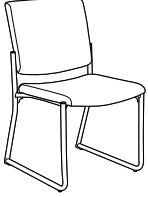
DESCRIPTION	MODEL#/ FEATURES	STANDARD TEXTILE GRADES											
		COM	2	3	4	5	6	7	8	9	10	11	12
 <p><b>Frolick Stacking Armchair</b> 4 Leg Base, Rectangular back with concealed attachment                      COM Yardage: 1.25                      Freight Class: 250                      Product Weight (lbs.): 24                      Cubic Feet Per Carton: 6.67</p>	<b>GC3001</b>	<b>\$818</b>	<b>\$854</b>	<b>\$891</b>	<b>\$942</b>	<b>\$1012</b>	<b>\$1038</b>	<b>\$1100</b>	<b>\$1216</b>	<b>\$1272</b>	<b>\$1382</b>	<b>\$1531</b>	<b>\$1716</b>
	<b>OVERALL DIMENSIONS</b>			<b>SEAT DIMENSIONS</b>			<b>BACK DIMENSIONS</b>						
	<b>W</b>	<b>D</b>	<b>H</b>	<b>W</b>	<b>D</b>	<b>H</b>	<b>W</b>	<b>H</b>					
	25	24.5	36	19	18	18.5	19.5	17					
 <p><b>Frolick Stacking Chair</b> Armless, 4 Leg Base, Rectangular back with concealed attachment                      COM Yardage: 1.25                      Freight Class: 250                      Product Weight (lbs.): 22                      Cubic Feet Per Carton: 6.67</p>	<b>GC3002</b>	<b>\$780</b>	<b>\$819</b>	<b>\$855</b>	<b>\$907</b>	<b>\$977</b>	<b>\$1003</b>	<b>\$1065</b>	<b>\$1181</b>	<b>\$1237</b>	<b>\$1345</b>	<b>\$1496</b>	<b>\$1682</b>
	<b>OVERALL DIMENSIONS</b>			<b>SEAT DIMENSIONS</b>			<b>BACK DIMENSIONS</b>						
	<b>W</b>	<b>D</b>	<b>H</b>	<b>W</b>	<b>D</b>	<b>H</b>	<b>W</b>	<b>H</b>					
	21	24.5	36	19	18	18.5	19.5	17					
 <p><b>Frolick Bariatric Stacking Armchair</b> 4 Leg Base, Rectangular back with concealed attachment                      COM Yardage: 2.25                      Freight Class: 300                      Product Weight (lbs.): 42                      Cubic Feet Per Carton: 26.5</p>	<b>GC3003</b>	<b>\$1491</b>	<b>\$1562</b>	<b>\$1627</b>	<b>\$1717</b>	<b>\$1843</b>	<b>\$1890</b>	<b>\$2003</b>	<b>\$2209</b>	<b>\$2316</b>	<b>\$2510</b>	<b>\$2779</b>	<b>\$3112</b>
	<b>OVERALL DIMENSIONS</b>			<b>SEAT DIMENSIONS</b>			<b>BACK DIMENSIONS</b>						
	<b>W</b>	<b>D</b>	<b>H</b>	<b>W</b>	<b>D</b>	<b>H</b>	<b>W</b>	<b>H</b>					
	37	24.5	36.5	31.5	18	18.5	32	18.5					
 <p><b>Frolick Armchair</b> Sled Base, Rectangular back with concealed attachment                      COM Yardage: 1.25                      Freight Class: 250                      Product Weight (lbs.): 32                      Cubic Feet Per Carton: 13.75</p>	<b>GC3021</b>	<b>\$847</b>	<b>\$886</b>	<b>\$923</b>	<b>\$974</b>	<b>\$1044</b>	<b>\$1070</b>	<b>\$1132</b>	<b>\$1248</b>	<b>\$1304</b>	<b>\$1414</b>	<b>\$1561</b>	<b>\$1747</b>
	<b>OVERALL DIMENSIONS</b>			<b>SEAT DIMENSIONS</b>			<b>BACK DIMENSIONS</b>						
	<b>W</b>	<b>D</b>	<b>H</b>	<b>W</b>	<b>D</b>	<b>H</b>	<b>W</b>	<b>H</b>					
	25	24.5	36	18	17	18.5	18.75	18					
 <p><b>Frolick Armless Chair</b> Sled Base, Rectangular back with concealed attachment                      COM Yardage: 1.25                      Freight Class: 250                      Product Weight (lbs.): 30                      Cubic Feet Per Carton: 13.75</p>	<b>GC3022</b>	<b>\$812</b>	<b>\$848</b>	<b>\$885</b>	<b>\$936</b>	<b>\$1006</b>	<b>\$1032</b>	<b>\$1094</b>	<b>\$1210</b>	<b>\$1266</b>	<b>\$1376</b>	<b>\$1523</b>	<b>\$1710</b>
	<b>OVERALL DIMENSIONS</b>			<b>SEAT DIMENSIONS</b>			<b>BACK DIMENSIONS</b>						
	<b>W</b>	<b>D</b>	<b>H</b>	<b>W</b>	<b>D</b>	<b>H</b>	<b>W</b>	<b>H</b>					
	21	24.5	36	19	18	18.5	19.5	17					

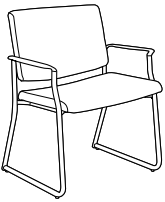
DESCRIPTION	MODEL#/ FEATURES	STANDARD TEXTILE GRADES											
		COM	2	3	4	5	6	7	8	9	10	11	12
 <p><b>Frolick Bariatric Armchair</b> Sled Base, Rectangular back with concealed attachment COM Yardage: 2.25 Freight Class: 300 Product Weight (lbs.): 47 Cubic Feet Per Carton: 26.5</p>	<b>GC3023</b>	\$1585	\$1656	\$1721	\$1811	\$1937	\$1984	\$2097	\$2303	\$2410	\$2605	\$2874	\$3208
	<b>OVERALL DIMENSIONS</b>			<b>SEAT DIMENSIONS</b>			<b>BACK DIMENSIONS</b>						
	<b>W</b>	<b>D</b>	<b>H</b>	<b>W</b>	<b>D</b>	<b>H</b>	<b>W</b>	<b>H</b>					
	37	24.5	36.5	31.5	18	18.5	32	18.5					

 <p><b>Frolick Stacking Armchair</b> 4 Leg Base, Rectangular back COM Yardage: 1.25 Freight Class: 250 Product Weight (lbs.): 24 Cubic Feet Per Carton: 6.67</p>	<b>GC3031</b>	\$818	\$854	\$891	\$942	\$1012	\$1038	\$1100	\$1216	\$1272	\$1382	\$1531	\$1716
	<b>OVERALL DIMENSIONS</b>			<b>SEAT DIMENSIONS</b>			<b>BACK DIMENSIONS</b>						
	<b>W</b>	<b>D</b>	<b>H</b>	<b>W</b>	<b>D</b>	<b>H</b>	<b>W</b>	<b>H</b>					
	25	24.5	36	19	18	18.5	19.5	17					

 <p><b>Frolick Stacking Chair</b> Armless, 4 Leg Base, Rectangular back COM Yardage: 1.25 Freight Class: 250 Product Weight (lbs.): 21 Cubic Feet Per Carton: 6.67</p>	<b>GC3032</b>	\$780	\$819	\$856	\$907	\$977	\$1003	\$1065	\$1181	\$1237	\$1347	\$1496	\$1682
	<b>OVERALL DIMENSIONS</b>			<b>SEAT DIMENSIONS</b>			<b>BACK DIMENSIONS</b>						
	<b>W</b>	<b>D</b>	<b>H</b>	<b>W</b>	<b>D</b>	<b>H</b>	<b>W</b>	<b>H</b>					
	21	24.5	36	19	18	18.5	19.5	17					

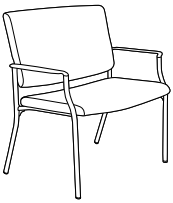

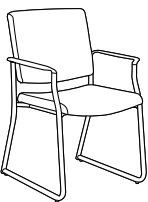
 <p><b>Frolick Bariatric Stacking Armchair</b> 4 Leg Base, Rectangular back COM Yardage: 2.25 Freight Class: 300 Product Weight (lbs.): 42 Cubic Feet Per Carton: 26.5</p>	<b>GC3033</b>	\$1491	\$1562	\$1627	\$1717	\$1843	\$1890	\$2003	\$2209	\$2316	\$2510	\$2779	\$3112
	<b>OVERALL DIMENSIONS</b>			<b>SEAT DIMENSIONS</b>			<b>BACK DIMENSIONS</b>						
	<b>W</b>	<b>D</b>	<b>H</b>	<b>W</b>	<b>D</b>	<b>H</b>	<b>W</b>	<b>H</b>					
	37	24.5	36.5	31.5	18	18.5	32	18.5					

 <p><b>Frolick Armchair</b> Sled Base, Rectangular back COM Yardage: 1.25 Freight Class: 250 Product Weight (lbs.): 32 Cubic Feet Per Carton: 13.75</p>	<b>GC3034</b>	\$847	\$886	\$923	\$974	\$1044	\$1070	\$1132	\$1248	\$1304	\$1414	\$1561	\$1747
	<b>OVERALL DIMENSIONS</b>			<b>SEAT DIMENSIONS</b>			<b>BACK DIMENSIONS</b>						
	<b>W</b>	<b>D</b>	<b>H</b>	<b>W</b>	<b>D</b>	<b>H</b>	<b>W</b>	<b>H</b>					
	25	24.5	36	18	17	18.5	18.75	18					

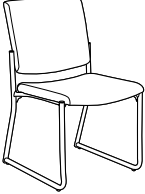
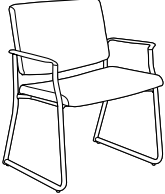

# SEATING

# FROLICK™ & SPLASH™

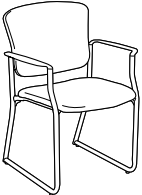
F

DESCRIPTION	MODEL#/ FEATURES	STANDARD TEXTILE GRADES											
		COM	2	3	4	5	6	7	8	9	10	11	12
 <p><b>Frolick</b>  <b>Armless Chair</b> Sled Base, Rectangular back                      COM Yardage: 1.25                      Freight Class: 250                      Product Weight (lbs.): 30                      Cubic Feet Per Carton: 13.75</p>	GC3035	\$812	\$848	\$885	\$936	\$1006	\$1032	\$1094	\$1210	\$1266	\$1376	\$1523	\$1710
	<b>OVERALL DIMENSIONS</b>			<b>SEAT DIMENSIONS</b>			<b>BACK DIMENSIONS</b>						
	<b>W</b>	<b>D</b>	<b>H</b>	<b>W</b>	<b>D</b>	<b>H</b>	<b>W</b>	<b>H</b>					
	21	24.5	36	19	18	18.5	19.5	17					
		Active weight 300 lbs. Single piece back with pullover style upholstery cover with <b>exposed support brackets</b> on the outer back. <b>Does not stack.</b> Chrome (CHM) frame finish, add \$193.											
 <p><b>Frolick</b>  <b>Bariatric Armchair</b> Sled Base, Rectangular back                      COM Yardage: 2.25                      Freight Class: 300                      Product Weight (lbs.): 47                      Cubic Feet Per Carton: 26.5</p>	GC3036	\$1585	\$1656	\$1721	\$1811	\$1937	\$1984	\$2097	\$2303	\$2410	\$2605	\$2874	\$3208
	<b>OVERALL DIMENSIONS</b>			<b>SEAT DIMENSIONS</b>			<b>BACK DIMENSIONS</b>						
	<b>W</b>	<b>D</b>	<b>H</b>	<b>W</b>	<b>D</b>	<b>H</b>	<b>W</b>	<b>H</b>					
	37	24.5	36.5	31.5	18	18.5	32	18.5					
		Active weight 500 lbs. Single piece back with pullover style upholstery cover with <b>exposed support brackets</b> on the outer back. Chrome (CHM) frame finish, add \$301. <b>Does not stack.</b>											
 <p><b>Splash</b>  <b>Stacking Armchair</b> 4 Leg Base, Fan back with concealed attachment                      COM Yardage: 1.25                      Freight Class: 250                      Product Weight (lbs.): 25.33                      Cubic Feet Per Carton: 6.67</p>	GC3011	\$818	\$854	\$891	\$942	\$1011	\$1038	\$1099	\$1216	\$1272	\$1382	\$1531	\$1716
	<b>OVERALL DIMENSIONS</b>			<b>SEAT DIMENSIONS</b>			<b>BACK DIMENSIONS</b>						
	<b>W</b>	<b>D</b>	<b>H</b>	<b>W</b>	<b>D</b>	<b>H</b>	<b>W</b>	<b>H</b>					
	25	24.25	35.5	19.5	18.5	18.5	20	17.5					
		Active weight 300 lbs. Stacks 5 high on floor. Chrome (CHM) frame finish, add \$180.											
 <p><b>Splash</b>  <b>Stacking Chair</b> Armless, 4 Leg Base, Fan back with concealed attachment                      COM Yardage: 1.25                      Freight Class: 250                      Product Weight (lbs.): 22.33                      Cubic Feet Per Carton: 6.67</p>	GC3012	\$780	\$819	\$855	\$907	\$977	\$1003	\$1065	\$1181	\$1237	\$1345	\$1496	\$1682
	<b>OVERALL DIMENSIONS</b>			<b>SEAT DIMENSIONS</b>			<b>BACK DIMENSIONS</b>						
	<b>W</b>	<b>D</b>	<b>H</b>	<b>W</b>	<b>D</b>	<b>H</b>	<b>W</b>	<b>H</b>					
	21	24.25	35.5	19.5	18.5	18.5	20	17.5					
		Active weight 300 lbs. Stacks 5 high on floor. Chrome (CHM) frame finish, add \$161.											
 <p><b>Splash</b>  <b>Armchair</b> Sled Base, Fan back with concealed attachment                      COM Yardage: 1.25                      Freight Class: 250                      Product Weight (lbs.): 34                      Cubic Feet Per Carton: 17</p>	GC3013	\$847	\$886	\$923	\$974	\$1043	\$1070	\$1131	\$1248	\$1304	\$1414	\$1563	\$1748
	<b>OVERALL DIMENSIONS</b>			<b>SEAT DIMENSIONS</b>			<b>BACK DIMENSIONS</b>						
	<b>W</b>	<b>D</b>	<b>H</b>	<b>W</b>	<b>D</b>	<b>H</b>	<b>W</b>	<b>H</b>					
	25	24.25	35.5	19.5	18.5	18.5	20	17.5					
		Active weight 300 lbs. <b>Does not stack.</b> Chrome (CHM) frame finish, add \$214.											

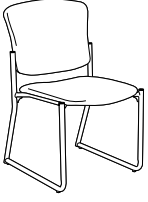

DESCRIPTION	MODEL#/ FEATURES	STANDARD TEXTILE GRADES											
		COM	2	3	4	5	6	7	8	9	10	11	12
 <p><b>Splash Side Chair</b> Sled Base, Fan back with concealed attachment                      COM Yardage: 1.25                      Freight Class: 250                      Product Weight (lbs.): 32                      Cubic Feet Per Carton: 13.75</p>	<b>GC3014</b>	<b>\$812</b>	<b>\$848</b>	<b>\$885</b>	<b>\$936</b>	<b>\$1006</b>	<b>\$1032</b>	<b>\$1094</b>	<b>\$1210</b>	<b>\$1266</b>	<b>\$1374</b>	<b>\$1523</b>	<b>\$1710</b>
		<b>OVERALL DIMENSIONS</b>			<b>SEAT DIMENSIONS</b>			<b>BACK DIMENSIONS</b>					
		<b>W</b>	<b>D</b>	<b>H</b>	<b>W</b>	<b>D</b>	<b>H</b>	<b>W</b>	<b>H</b>				
		21	24.25	35.5	19.5	18.5	18.5	20	17.5				
		<b>LIST PRICE</b>											
	<b>GC3010</b>	<b>\$364</b>											
 <p><b>Dolly for Frolick and Splash standard size, four leg chairs</b>                      COM Yardage: --                      Freight Class: 150                      Product Weight (lbs.): 16                      Cubic Feet Per Carton: 3.8</p>		<b>OVERALL DIMENSIONS</b>			<b>SEAT DIMENSIONS</b>			<b>BACK DIMENSIONS</b>					
		<b>W</b>	<b>D</b>	<b>H</b>	<b>W</b>	<b>D</b>	<b>H</b>	<b>W</b>	<b>H</b>				
		0	0	0									
			<b>Allows chairs to stack up to 8 high.</b>										

GALA II

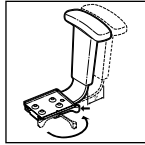

Vari-Width (WA) width adjustable arm extensions are standard.

model GC13012, medium back

Synchro-tilter mechanism (-0)

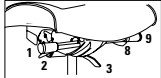

ADJUSTMENTS

- (1) Tilt tension
- (2) Pneumatic seat height
- (3) Back angle
- Back/lumbar height
- (8) Sliding seat depth
- (9) Multi position tilt lock
- Synchro tilt action
- Anti kick back

Ergonomic features:

A, B, C, D, E, G, H, L, M, N, Q, R, U

STANDARD FEATURES

- Gala II is designed to provide exceptional support and comfort throughout the work day.
- Vertical back height ratchet adjustment of 5.25" is standard.
- Back support upright is 3" wide for extra strength.
- One-piece curved back features a pull over style upholstery cover for easy housekeeping and infection prevention practices.
- Standard with Global's high quality Soft Descent™ pneumatic lift which slowly and gently lowers the seat height of the chair making it easy to obtain the exact seat height you desire.
- Standard with height adjustable arms (3B) with self-skinned urethane (SSU) armcaps.
- Vari-Width (WA) width adjustable arm extensions are standard. Allows the arms to move away from the seat by 2" on each side to accommodate various users.
- Waterfall seamless seat front design with high density Ultracell foam for superior comfort and longevity
- Underside of seat pan is completely sealed for ease of cleaning.
- Side activated sliding seat depth adjustment (MD) is standard on synchro-tilter.
- Five prong, injection molded, fiberglass reinforced nylon Black base with dual wheel carpet casters (C65).
- For Globalcare textiles and finish options, visit the website at [globalfurnituregroup.com](http://globalfurnituregroup.com).
- Can be upholstered in standard Global textiles if Healthcare compliance is not required.
- To meet higher standards for housekeeping and infection control, Gala II has a seamless seat and one stitch pull over back upholstery, while still offering soft curves to the design. Note: Vinyl and woven treated textiles are thicker in nature and will experience wrinkles on some curves or corners as a result.

OPTIONAL FEATURES

- Optional hard floor casters (C65R) are available. Add \$72.

SUGGESTED APPLICATIONS

- Office/Meeting
- Caregiver Workstations

DESCRIPTION	MODEL#/ FEATURES	STANDARD TEXTILE GRADES											
		COM	2	3	4	5	6	7	8	9	10	11	12
 <p><b>Medium Back Synchro-Tilter</b>                      COM Yardage: 1.9                      Freight Class: 150                      Product Weight (lbs.): 53                      Cubic Feet Per Carton: 10.5</p>	GC13012	\$1031	\$1100	\$1164	\$1250	\$1376	\$1434	\$1545	\$1725	\$1865	\$2018	\$2334	\$2672
		OVERALL DIMENSIONS			SEAT DIMENSIONS			BACK DIMENSIONS					
		W	D	H	W	D	H	W	H				
		24.5	23.5	39	20.5	17-18	16.5-21.5	20	20.5				

GC BEACH



model GC4077



model GC4078

STANDARD FEATURES

- Elegant wood seating with a choice of an upholstered or vertical wood slat back.
- Frame construction is beech hardwood.
- Legs are equipped with White non-marking polypropylene glides. Suitable for both carpet and hard surface flooring.
- All cushions are fixed and non-removable.
- Cushions are made with highly resilient foam and seats are equipped with a synthetic rubberized webbing suspension system for extra comfort
- Seat cushion underside is finished with Black polyurethane
- Does not stack
- For Globalcare textiles and finish options, visit the website at [globalfurnituregroup.com](http://globalfurnituregroup.com).
- Can be upholstered in standard Global textiles if Healthcare compliance is not required.

OPTIONAL FEATURES

- Wood frame available in Absolute (AAM), Black (BKM), Cherry (ACM), English Oak (EOM), Espresso Cafe (ECM), Fruitwood (TFM), Gray (HGM), Honey (AHM), Mahogany (TMM), Maple (AVM), Medium Walnut (MWM), Natural Walnut (NLW), Night (ASM), Noce Biondo (NBM), Noce Grigio (NGM), Noce Leggero (NEM), Noce Medio (NMM), Sandy Beach (SKM), Shaker Cherry (SKM), Silver Oak (SOM), Walnut (TWM), WC Cream (WTM), White (WHM) and Winter Cherry (WCM). Please specify.
- For moisture barrier on seat, please specify **(MB)**. - Add \$129 per seat.

SUGGESTED APPLICATIONS

- Dining/Cafeteria
- Guest seating
- Lobbies
- Lounge/Waiting
- Office/Meeting
- Patient rooms
- Resident rooms

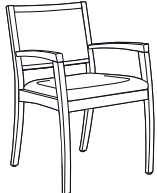
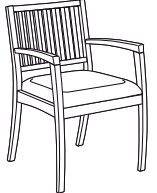
DESCRIPTION	MODEL#/ FEATURES	STANDARD TEXTILE GRADES											
		COM	2	3	4	5	6	7	8	9	10	11	12
 <p><b>Armchair w/Upholstered Back</b> COM Yardage: 1 Freight Class: 300 Product Weight (lbs.): 20 Cubic Feet Per Carton: 13.25</p>	<b>GC4077</b>	\$956	\$988	\$1017	\$1058	\$1118	\$1146	\$1201	\$1282	\$1350	\$1424	\$1568	\$1730
		<b>OVERALL DIMENSIONS</b>			<b>SEAT DIMENSIONS</b>			<b>BACK DIMENSIONS</b>					
		<b>W</b>	<b>D</b>	<b>H</b>	<b>W</b>	<b>D</b>	<b>H</b>	<b>W</b>	<b>H</b>	<b>W</b>	<b>H</b>		
		22	22.25	33.5	19.5	18.5	18.75	19.5	15.5				
 <p><b>Armchair w/Vertical Wood Slat Back</b> COM Yardage: 1 Freight Class: 300 Product Weight (lbs.): 20 Cubic Feet Per Carton: 13.25</p>	<b>GC4078</b>	\$983	\$1015	\$1044	\$1085	\$1145	\$1173	\$1228	\$1316	\$1377	\$1451	\$1608	\$1770
		<b>OVERALL DIMENSIONS</b>			<b>SEAT DIMENSIONS</b>			<b>BACK DIMENSIONS</b>					
		<b>W</b>	<b>D</b>	<b>H</b>	<b>W</b>	<b>D</b>	<b>H</b>	<b>W</b>	<b>H</b>	<b>W</b>	<b>H</b>		
		22	22.25	33.5	19.5	19	18.75	19.5	15.5				

## GC-BELONG



model GC4231HB

model GC4231HB

## STANDARD FEATURES

- The GC Belong series was developed for active and transient spaces and environments with rigorous demands.
- Elliptical metal tube frame is available in Black (**TBL**), Cloud (**TIIV**), Designer White (**TDW**), Fog (**TFO**), Frost (**TFR**), Kalua (**TKA**), Latte (**TLA**), Mocha (**TMO**), Nevada (**TNE**), Sand (**TSN**), Shadow (**TSH**), Toast (**TOA**) and Tungsten (**TTU**). Specify finish.
- Urethane armcaps are available in Black (**BLK**), Kalua (**KAL**), Latte (**LAB**), Mocha (**J52**), Shadow (**SHW**), and Toast (**TOA**).
- Wood armcaps are also available in Absolute (AAM), Black (BKM), Cherry (ACM), English Oak (EOM), Espresso Cafe (ECM), Fruitwood (TFM), Gray (HGM), Honey (AHM), Mahogany (TMM), Maple (AVM), Medium Walnut (MWM), Natural Walnut (NLW), Night (ASM), Noce Biondo (NBM), Noce Grigio (NGM), Noce Leggero (NEM), Noce Medio (NMM), Sandy Beach (SKM), Shaker Cherry (SKM), Silver Oak (SOM), Walnut (TWM), WC Cream (WTM), White (WHM) and Winter Cherry (WCM). Refer to individual models for upcharge.
- The frame can be weighted and made with tamperproof fasteners for greater security in more challenging mental health spaces or correctional facilities.
- Active weight capacity is 500 lbs. per seat position; 750 lbs. for bariatric seating.
- The seat and back are removable and field replaceable.
- For added comfort, seats are standard with high density Ultracell foam.
- All seat frames feature a wallsaver design to prevent back contact with wall. **Note:** In order to allow full flex of the back on models GC4242, GC4242HB, GC4243 and GC4243HB, a 10.5" wall clearance is required.
- Ottomans and Benches do not have wallsaver legs.
- Standard seat height on all models is 18.5"
- Seat height on GC4231-24 and GC4241-24 is 24"
- Standard with Black glides
- Select models are offered with casters on the rear legs. These casters allow for ease of movement in support of housekeeping efforts or repositioning seating within a space. **They are not intended for patient transfer.**

- Clean out space is provided between the seat and back cushions for easier housekeeping.
- **Left and Right position reference** is determined from the seated position.
- Flex back models feature a torsion control mechanism which allows the back to move 14° in a soothing rocking motion.
- For healthcare textiles and wood finish options, visit the website at [globalfurnituregroup.com](http://globalfurnituregroup.com)
- Can be upholstered in standard Global textiles if healthcare compliance is not required.

## OPTIONAL FEATURES

- For hardsurface floors, specify opaque, non-marking glides (**NM**). No upcharge.
- For moisture barrier on seat, specify (**MB**). Add \$129 per seat. For bariatric models, Add \$198 per seat.
- As an option, seams can be sealed to prevent penetration of fluids through the stitching. Contact Customer Care for approved textiles.  
Low Back Models - **Add \$113** list upcharge per seat  
Low Back Bariatric Models - **Add \$120** list upcharge per seat  
High Back Models - **Add \$123** list upcharge per seat  
High Back Bariatric Models - **Add \$130** list upcharge per seat  
Split-Back Models - **Add \$180** list upcharge per seat  
Ottoman - **Add \$40** list upcharge  
Benches: **Add \$49** list upcharge for one seat, **Add \$106** for two seat models, and **Add \$158** for three seat models.
- Complementary tables are offered as part of this series in either high pressure or thermally fused laminate tops.

## SUGGESTED APPLICATIONS

- Bariatric seating
- Guest seating
- Lobbies
- Lounge/Waiting
- Patient/Resident rooms
- Treatment/Exam rooms

## GC BELONG BENCHES &amp; BRIDGES

- Units with links can only gang with a bridge. They CANNOT gang directly with another link unit. (Link units have side brackets.)
- Available in one, two or three seat models.
- A bridge unit suspends between 2 other units using their links. A bridge is NOT freestanding. (A bridge does not have legs.)
- Benches have no front or back facing distinction so models with links can be reversed.
- All bridge models can be ganged to seat units with link.

## GC BELONG TABLES

- Table heights are 16"
- 1" thick tops are available in thermally fused laminate (LP) and high pressure laminate (HP). Please select the appropriate model number for the finish you prefer.
- 2mm edging color coordinated with laminate finish is standard for all tops. Finish must be specified at the time of order.
- Refer to the following lists when selecting a finish color. Must specify both a top color and leg finish when ordering.

## Thermally Fused Laminate (LP) Tops

Absolute Acajou (ACJ)  
Asian Night (ASN)  
Avant Cherry (AWC)  
Avant Honey (AWH)  
Blizzard (BZD)  
Brushed Cobalt (BRC)  
Clear Maple (CMB)  
Custom Grey (CGY)  
Dark Espresso (DES)  
Designer White (DWT)  
Fashionista (FAS)  
First Class (FCL)  
Noce Biondo (NBL)  
Noce Grigio (NGL)  
Noce Leggero (NEL)  
Noce Medio (NML)  
Quartered Mahogany (QTM)  
Sheer Beauty (SBY)  
Stonedust (SDT)  
Walnut Heights (WHE)  
White Chocolate (WHC)  
Winter Cherry (WCR)

## High Pressure Laminate (HP) Tops

Absolute Acajou (ACJ)  
Asian Night (ASN)  
Avant Cherry (W357)  
Avant Honey (W356)  
Blizzard (BZD)  
Brushed Cobalt (BRC)  
Clear Maple (CMB)  
Custom Grey (CGY)  
Dark Espresso (W142)  
Designer White (DWT)  
Fashionista (FAS)  
First Class (FCL)  
Noce Biondo (NBL)  
Noce Grigio (NGL)  
Noce Leggero (NEL)  
Noce Medio (NML)  
Quartered Mahogany (QTM)  
Sheer Beauty (SBY)  
Stonedust (SDT)  
Walnut Heights (WHE)  
White Chocolate (WHC)  
Winter Cherry (WCR)

**LOW BACK**

	GC4230	GC4231	GC4232	GC4234	GC4233	GC4235	GC4236
Freestanding units							
Ganging units with link on Left side	GC4230L 	GC4231L 	GC4232L 	GC4234L 	GC4233L 	GC4235L 	GC4236L 
Ganging units with link on Right side	GC4230R 	GC4231R 	GC4232R 	GC4234R 	GC4233R 	GC4235R 	GC4236R 
Ganging units with links on Both sides	GC4230B 	GC4231B 	GC4232B 	GC4234B 	GC4233B 	GC4235B 	GC4236B 

**HIGH BACK**

Freestanding units	GC4230HB 	GC4231HB 	GC4232HB 	GC4234HB 	GC4233HB 	GC4235HB 	GC4236HB 
Ganging units with link on Left side	GC4230HBL 	GC4231HBL 	GC4232HBL 	GC4234HBL 	GC4233HBL 	GC4235HBL 	GC4236HBL 
Ganging units with link on Right side	GC4230HBR 	GC4231HBR 	GC4232HBR 	GC4234HBR 	GC4233HBR 	GC4235HBR 	GC4236HBR 
Ganging units with links on Both sides	GC4230HBB 	GC4231HBB 	GC4232HBB 	GC4234HBB 	GC4233HBB 	GC4235HBB 	GC4236HBB 

Non ganging units with casters



Ganging Bariatric units with link on Both side



Non ganging Bariatric units



Non ganging Flexback units



Non ganging Split Back units



Ganging Bariatric units with link on Left side



Non ganging Flexback units with casters



Non ganging Split Back units with casters



Ganging Bariatric units with link on Right side



Hip Height Chair with wedged cushion, 24" Seat Height



**BENCHES & BRIDGES**

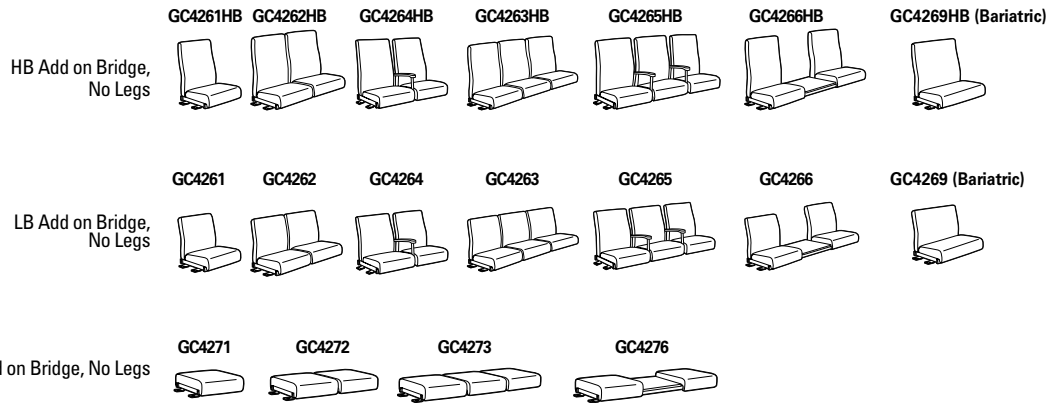
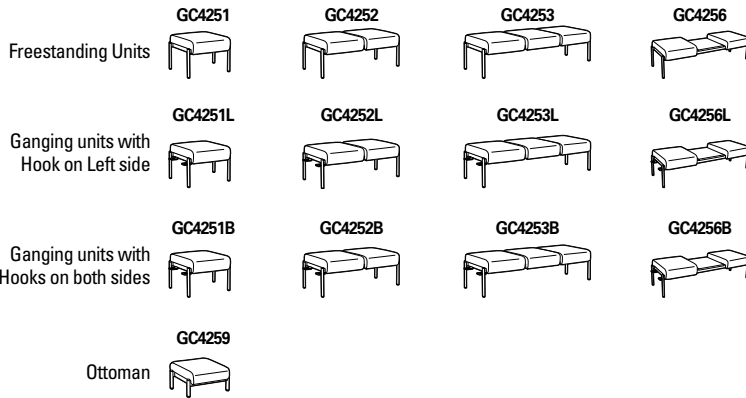

**TABLES**

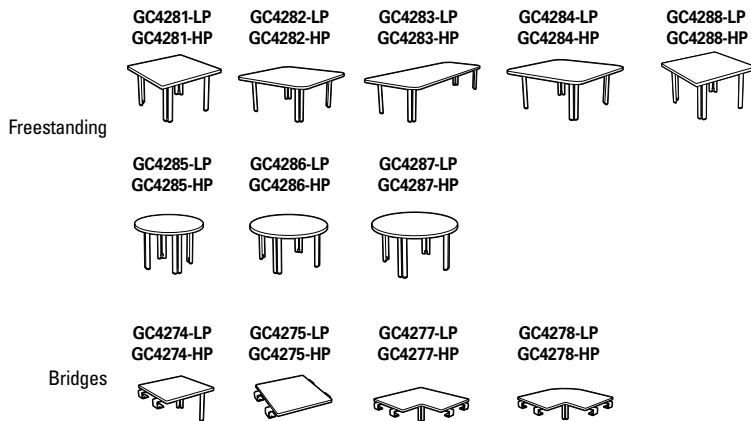

- A bridge unit suspends between 2 other units with legs and is supported by their linking brackets
- A bridge unit is **not** freestanding and cannot be made freestanding
- Units with legs and links can only gang with a bridge. They **cannot** gang directly with another link unit with legs
- Bridges **cannot** gang directly with another bridge

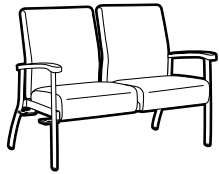

1, 2 or 3 seat chair with integrated ganging bracket

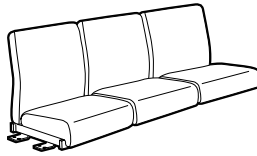

Any seating bridge unit connects to:



1, 2 or 3 seat bench with integrated ganging bracket



1, 2 or 3 seat chair with integrated ganging bracket



Any table bridge unit connects to:

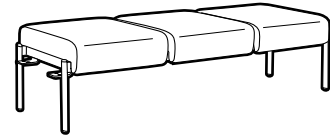

1, 2 or 3 seat bench with integrated ganging bracket

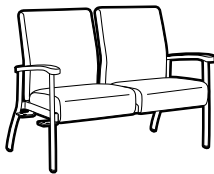

1, 2 or 3 seat chair with integrated ganging bracket



**CANNOT connect to**



1, 2 or 3 seat chair with integrated ganging bracket



Any table bridge unit



**CANNOT connect to**

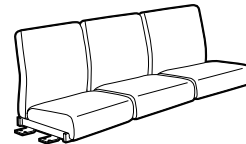

Any seating bridge unit



Any seating bridge unit



**CANNOT connect to**

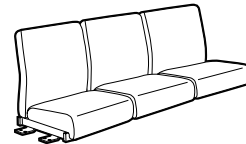

Any seating bridge unit



Any table bridge unit



**CANNOT connect to**

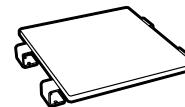

Any table bridge unit

PACKAGE 1



Description  
Low Back Three Seat Chair

Qty	Model Number	Dimensions	Ydg.	Freight Class	Wt./Lbs.	Cu. Ft.	List Price
4	GC4235	26 x 74.5 x 37.5	5	250	142	65.25	\$4548

**PACKAGE TOTAL** **\$18,192**  
 (\* Please Note: List Prices shown are for the standard Grade 2 vinyl/standard finishes.)

PACKAGE 2



Description  
Low Back Three Seat Chair  
Low Back Armchair, Left  
Low Back Armchair, Right  
End Corner Table Bridge

Qty	Model Number	Dimensions	Ydg.	Freight Class	Wt./Lbs.	Cu. Ft.	List Price
1	GC4233B	26 x 72.75 x 37.5	5	250	134	65.25	\$4023
1	GC4231L	28 x 26.5 x 37.5	1.75	250	53.5	20.25	\$1851
1	GC4231R	28 x 26.5 x 37.5	1.75	250	53.5	20.25	\$1851
2	GC4277-HP	35 x 35 x 16	--	125	45	6	\$1011

**PACKAGE TOTAL** **\$9747**  
 (\* Please Note: List Prices shown are for the standard Grade 2 vinyl/standard laminate.)

PACKAGE 3



Description  
Low Back Armless Chair  
Low Back Armless Chair, Right  
Low Back Armless Chair, Left  
End Corner Table Bridge

Qty	Model Number	Dimensions	Ydg.	Freight Class	Wt./Lbs.	Cu. Ft.	List Price
2	GC4230B	28 x 26.75 x 37.5	1.75	250	45.5	20.25	\$1535
1	GC4230R	28 x 25.75 x 37.5	1.75	250	45.5	20.25	\$1489
1	GC4230L	28 x 25.75 x 37.5	1.75	250	45.5	20.25	\$1489
3	GC4277-HP	35 x 35 x 16	--	125	45	6	\$1011

**PACKAGE TOTAL** **\$9081**  
 (\* Please Note: List Prices shown are for the standard Grade 2 vinyl/standard laminate.)

PACKAGE 4





Description  
Low Back Three Seat Chair  
Bariatric Low Back Armchair, Left  
Low Back Armchair, Left  
Low Back Armchair, Right  
End Corner Table Bridge  
Rectangular Coffee Table  
Square Table Top

Qty	Model Number	Dimensions	Ydg.	Freight Class	Wt./Lbs.	Cu. Ft.	List Price
1	GC4235R	26 x 74.5 x 37.5	5	250	143	65.25	\$4595
1	GC4241L	28 x 37.5 x 37.5	3	250	71	30.5	\$2413
1	GC4231L	28 x 26.5 x 37.5	1.75	250	53.5	20.25	\$1851
1	GC4231R	28 x 26.5 x 37.5	1.75	250	53.5	20.25	\$1851
1	GC4277-HP	35 x 35 x 16	--	125	45	6	\$1011
1	GC4283-HP	54 x 22 x 16	--	125	37	6	\$1455
1	GC4275-HP	23 x 23 x 1	--	150	18	3.4	\$626

**PACKAGE TOTAL** **\$13,802**  
 (\* Please Note: List Prices shown are for the standard Grade 2 vinyl/standard laminate.)

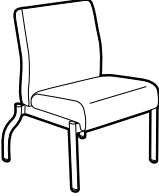
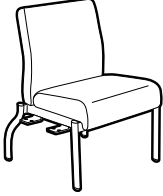
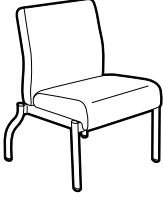
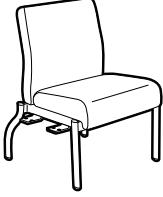

DESCRIPTION	MODEL#	STANDARD FABRIC GRADES											
		COM	2	3	4	5	6	7	8	9	10	11	12
 <p><b>Low Back Chair</b> Armless COM Yardage: 1.75 Freight Class: 250 Product Weight (lbs.): 45.5 Cubic Feet Per Carton: 20.25</p>	<b>GC4230</b>	\$1384	\$1441	\$1495	\$1567	\$1669	\$1708	\$1801	\$1972	\$2055	\$2214	\$2432	\$2703
		OVERALL DIMENSIONS			SEAT DIMENSIONS			BACK DIMENSIONS					
		W	D	H	W	D	H	W	H	W	H		
	Active weight 500 lbs.	24.75	28	37.5	22	18	18	21.5	19.5				
 <p><b>Low Back Chair</b> Armless, Right COM Yardage: 1.75 Freight Class: 250 Product Weight (lbs.): 45.5 Cubic Feet Per Carton: 20.25</p>	<b>GC4230R</b>	\$1429	\$1489	\$1541	\$1614	\$1716	\$1755	\$1847	\$2019	\$2103	\$2261	\$2479	\$2749
		OVERALL DIMENSIONS			SEAT DIMENSIONS			BACK DIMENSIONS					
		W	D	H	W	D	H	W	H	W	H		
	Active weight 500 lbs.	25.75	28	37.5	22	18	18	21.5	19.5				
 <p><b>Low Back Chair</b> Armless, Left COM Yardage: 1.75 Freight Class: 250 Product Weight (lbs.): 45.5 Cubic Feet Per Carton: 20.25</p>	<b>GC4230L</b>	\$1429	\$1489	\$1541	\$1614	\$1716	\$1755	\$1847	\$2019	\$2103	\$2261	\$2479	\$2749
		OVERALL DIMENSIONS			SEAT DIMENSIONS			BACK DIMENSIONS					
		W	D	H	W	D	H	W	H	W	H		
	Active weight 500 lbs.	25.75	28	37.5	22	18	18	21.5	19.5				
 <p><b>Low Back Chair</b> Armless, Left &amp; Right COM Yardage: 1.75 Freight Class: 250 Product Weight (lbs.): 45.5 Cubic Feet Per Carton: 20.25</p>	<b>GC4230B</b>	\$1475	\$1535	\$1587	\$1660	\$1762	\$1802	\$1893	\$2065	\$2149	\$2307	\$2526	\$2795
		OVERALL DIMENSIONS			SEAT DIMENSIONS			BACK DIMENSIONS					
		W	D	H	W	D	H	W	H	W	H		
	Active weight 500 lbs.	26.75	28	37.5	22	18	18	21.5	19.5				
 <p><b>High Back Chair</b> Armless COM Yardage: 2 Freight Class: 250 Product Weight (lbs.): 49.5 Cubic Feet Per Carton: 20.25</p>	<b>GC4230HB</b>	\$1456	\$1522	\$1582	\$1665	\$1782	\$1827	\$1930	\$2125	\$2222	\$2403	\$2653	\$2962
		OVERALL DIMENSIONS			SEAT DIMENSIONS			BACK DIMENSIONS					
		W	D	H	W	D	H	W	H	W	H		
	Active weight 500 lbs.	24.75	28	42.5	22	18	18	21.5	24.5				

# SEATING

# GC-BELONG

G

DESCRIPTION	MODEL#	STANDARD FABRIC GRADES											
-------------	--------	------------------------	--	--	--	--	--	--	--	--	--	--	--



MODEL#	COM	2	3	4	5	6	7	8	9	10	11	12
<b>GC4230HBR</b>	<b>\$1504</b>	<b>\$1570</b>	<b>\$1630</b>	<b>\$1713</b>	<b>\$1830</b>	<b>\$1877</b>	<b>\$1979</b>	<b>\$2173</b>	<b>\$2270</b>	<b>\$2451</b>	<b>\$2702</b>	<b>\$3011</b>

OVERALL DIMENSIONS			SEAT DIMENSIONS			BACK DIMENSIONS	
W	D	H	W	D	H	W	H
25.75	28	42.5	22	18	18	21.5	24.5

**High Back Chair** Armless, Right  
COM Yardage: 2  
Freight Class: 250  
Product Weight (lbs.): 49.5  
Cubic Feet Per Carton: 20.25

Active weight 500 lbs.



MODEL#	COM	2	3	4	5	6	7	8	9	10	11	12
<b>GC4230HBL</b>	<b>\$1504</b>	<b>\$1570</b>	<b>\$1630</b>	<b>\$1713</b>	<b>\$1830</b>	<b>\$1877</b>	<b>\$1979</b>	<b>\$2173</b>	<b>\$2270</b>	<b>\$2451</b>	<b>\$2702</b>	<b>\$3011</b>

OVERALL DIMENSIONS			SEAT DIMENSIONS			BACK DIMENSIONS	
W	D	H	W	D	H	W	H
25.75	28	42.5	22	18	18	21.5	24.5

**High Back Chair** Armless, Left  
COM Yardage: 2  
Freight Class: 250  
Product Weight (lbs.): 49.5  
Cubic Feet Per Carton: 20.25

Active weight 500 lbs.



MODEL#	COM	2	3	4	5	6	7	8	9	10	11	12
<b>GC4230HBB</b>	<b>\$1550</b>	<b>\$1616</b>	<b>\$1677</b>	<b>\$1759</b>	<b>\$1878</b>	<b>\$1923</b>	<b>\$2025</b>	<b>\$2220</b>	<b>\$2316</b>	<b>\$2498</b>	<b>\$2748</b>	<b>\$3057</b>

OVERALL DIMENSIONS			SEAT DIMENSIONS			BACK DIMENSIONS	
W	D	H	W	D	H	W	H
26.75	28	42.5	22	18	18	21.5	24.5

**High Back Chair** Armless, Left & Right  
COM Yardage: 2  
Freight Class: 250  
Product Weight (lbs.): 51.5  
Cubic Feet Per Carton: 20.25

Active weight 500 lbs.

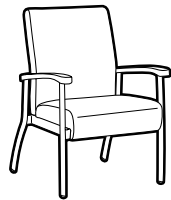

MODEL#	COM	2	3	4	5	6	7	8	9	10	11	12
<b>GC4231</b>	<b>\$1686</b>	<b>\$1744</b>	<b>\$1796</b>	<b>\$1869</b>	<b>\$1972</b>	<b>\$2010</b>	<b>\$2102</b>	<b>\$2274</b>	<b>\$2358</b>	<b>\$2517</b>	<b>\$2735</b>	<b>\$3004</b>

OVERALL DIMENSIONS			SEAT DIMENSIONS			BACK DIMENSIONS	
W	D	H	W	D	H	W	H
26.5	28	37.5	22	18	18	21.5	19.5

**Low Back Armchair**  
COM Yardage: 1.75  
Freight Class: 250  
Product Weight (lbs.): 53.5  
Cubic Feet Per Carton: 20.25

Active weight 500 lbs.  
Wood armcap option - **Add \$179**

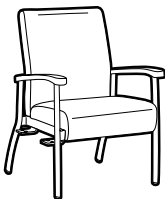

MODEL#	COM	2	3	4	5	6	7	8	9	10	11	12
<b>GC4231R</b>	<b>\$1791</b>	<b>\$1851</b>	<b>\$1903</b>	<b>\$1976</b>	<b>\$2078</b>	<b>\$2117</b>	<b>\$2209</b>	<b>\$2381</b>	<b>\$2465</b>	<b>\$2623</b>	<b>\$2841</b>	<b>\$3111</b>

OVERALL DIMENSIONS			SEAT DIMENSIONS			BACK DIMENSIONS	
W	D	H	W	D	H	W	H
26.5	28	37.5	22	18	18	21.5	19.5

**Low Back Armchair** Right  
COM Yardage: 1.75  
Freight Class: 250  
Product Weight (lbs.): 53.5  
Cubic Feet Per Carton: 20.25

Active weight 500 lbs.  
Wood armcap option - **Add \$179**

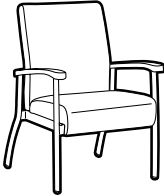
DESCRIPTION	MODEL#	STANDARD FABRIC GRADES											
		COM	2	3	4	5	6	7	8	9	10	11	12
 <p><b>Low Back Armchair Left</b> COM Yardage: 1.75 Freight Class: 250 Product Weight (lbs.): 53.5 Cubic Feet Per Carton: 20.25</p>	<b>GC4231L</b>	\$1791	\$1851	\$1903	\$1976	\$2078	\$2117	\$2209	\$2381	\$2465	\$2623	\$2841	\$3111
		OVERALL DIMENSIONS			SEAT DIMENSIONS			BACK DIMENSIONS					
		W	D	H	W	D	H	W	H				
		26.5	28	37.5	22	18	18	21.5	19.5				

Active weight 500 lbs.  
Wood armcap option - **Add \$179**

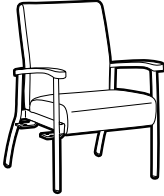
DESCRIPTION	MODEL#	STANDARD FABRIC GRADES											
		COM	2	3	4	5	6	7	8	9	10	11	12
 <p><b>Low Back Armchair Left &amp; Right</b> COM Yardage: 1.75 Freight Class: 250 Product Weight (lbs.): 53.5 Cubic Feet Per Carton: 20.25</p>	<b>GC4231B</b>	\$1836	\$1896	\$1948	\$2022	\$2123	\$2163	\$2254	\$2426	\$2510	\$2668	\$2887	\$3158
		OVERALL DIMENSIONS			SEAT DIMENSIONS			BACK DIMENSIONS					
		W	D	H	W	D	H	W	H				
		26.5	28	37.5	22	18	18	21.5	19.5				

Active weight 500 lbs.  
Wood armcap option - **Add \$179**

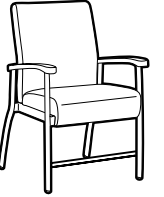
DESCRIPTION	MODEL#	STANDARD FABRIC GRADES											
		COM	2	3	4	5	6	7	8	9	10	11	12
 <p><b>Low Back Armchair Post Surgery.</b> Designed to immobilize the pelvis and hip joints after surgery. COM Yardage: 1.75 Freight Class: 250 Product Weight (lbs.): 57.5 Cubic Feet Per Carton: 24.25</p>	<b>GC4231-24</b>	\$2011	\$2069	\$2121	\$2194	\$2297	\$2335	\$2427	\$2599	\$2683	\$2842	\$3059	\$3329
		OVERALL DIMENSIONS			SEAT DIMENSIONS			BACK DIMENSIONS					
		W	D	H	W	D	H	W	H				
		26.5	28.75	43.5	22	18	24	21.5	19.5				

Active weight 500 lbs.  
Wood armcap option - **Add \$179**

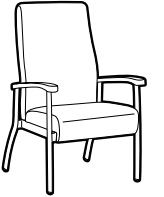

DESCRIPTION	MODEL#	STANDARD FABRIC GRADES											
		COM	2	3	4	5	6	7	8	9	10	11	12
 <p><b>High Back Armchair</b> COM Yardage: 2 Freight Class: 250 Product Weight (lbs.): 58.5 Cubic Feet Per Carton: 20.25</p>	<b>GC4231HB</b>	\$1799	\$1863	\$1926	\$2008	\$2126	\$2171	\$2272	\$2468	\$2564	\$2746	\$2996	\$3306
		OVERALL DIMENSIONS			SEAT DIMENSIONS			BACK DIMENSIONS					
		W	D	H	W	D	H	W	H				
		26.5	28	42.5	22	18	18	21.5	24.5				

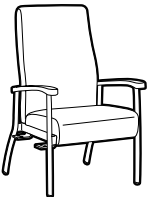
Active weight 500 lbs.  
Wood armcap option - **Add \$179**

DESCRIPTION	MODEL#	STANDARD FABRIC GRADES											
		COM	2	3	4	5	6	7	8	9	10	11	12
 <p><b>High Back Armchair Right</b> COM Yardage: 2 Freight Class: 250 Product Weight (lbs.): 58.5 Cubic Feet Per Carton: 20.25</p>	<b>GC4231HBR</b>	\$1845	\$1911	\$1972	\$2054	\$2173	\$2218	\$2320	\$2515	\$2612	\$2793	\$3043	\$3352
		OVERALL DIMENSIONS			SEAT DIMENSIONS			BACK DIMENSIONS					
		W	D	H	W	D	H	W	H				
		26.5	28	42.5	22	18	18	21.5	24.5				

Active weight 500 lbs.  
Wood armcap option - **Add \$179**

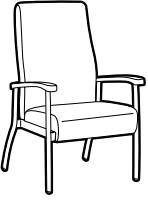
# SEATING

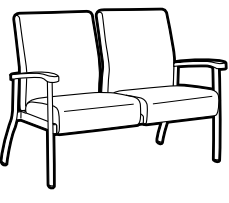
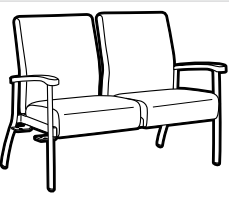
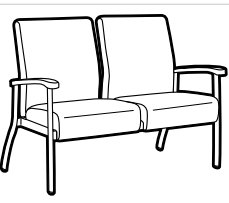
DESCRIPTION	MODEL#	STANDARD FABRIC GRADES											
		COM	2	3	4	5	6	7	8	9	10	11	12
 <p><b>High Back Armchair Left</b> COM Yardage: 2 Freight Class: 250 Product Weight (lbs.): 58.5 Cubic Feet Per Carton: 20.25</p>	<b>GC4231HBL</b>	\$1845	\$1911	\$1972	\$2054	\$2173	\$2218	\$2320	\$2515	\$2612	\$2793	\$3043	\$3352
	<b>OVERALL DIMENSIONS</b>			<b>SEAT DIMENSIONS</b>			<b>BACK DIMENSIONS</b>						
	<b>W</b>	<b>D</b>	<b>H</b>	<b>W</b>	<b>D</b>	<b>H</b>	<b>W</b>	<b>H</b>					
	26.5	28	42.5	22	18	18	21.5	24.5					
<p>Active weight 500 lbs. Wood armcap option - <b>Add \$179</b></p>													
 <p><b>High Back Armchair Left &amp; Right</b> COM Yardage: 2 Freight Class: 250 Product Weight (lbs.): 60.5 Cubic Feet Per Carton: 20.25</p>	<b>GC4231HBB</b>	\$1890	\$1955	\$2015	\$2098	\$2215	\$2260	\$2363	\$2558	\$2655	\$2836	\$3086	\$3395
	<b>OVERALL DIMENSIONS</b>			<b>SEAT DIMENSIONS</b>			<b>BACK DIMENSIONS</b>						
	<b>W</b>	<b>D</b>	<b>H</b>	<b>W</b>	<b>D</b>	<b>H</b>	<b>W</b>	<b>H</b>					
	26.5	28	42.5	22	18	18	21.5	24.5					
<p>Active weight 500 lbs. Wood armcap option - <b>Add \$179</b></p>													
 <p><b>Low Back Two Seat Chair No Center Arm</b> COM Yardage: 3.5 Freight Class: 250 Product Weight (lbs.): 94 Cubic Feet Per Carton: 43</p>	<b>GC4232</b>	\$2724	\$2841	\$2945	\$3089	\$3295	\$3375	\$3556	\$3896	\$4068	\$4380	\$4820	\$5359
	<b>OVERALL DIMENSIONS</b>			<b>SEAT DIMENSIONS</b>			<b>BACK DIMENSIONS</b>						
	<b>W</b>	<b>D</b>	<b>H</b>	<b>W</b>	<b>D</b>	<b>H</b>	<b>W</b>	<b>H</b>					
	49.75	26	37.5	44	18	18	44	19.5					
<p>Active weight 500 lbs./seat. Wood armcap option - <b>Add \$179</b></p>													
 <p><b>Low Back Two Seat Chair No Center Arm, Right</b> COM Yardage: 3.5 Freight Class: 250 Product Weight (lbs.): 95 Cubic Feet Per Carton: 43</p>	<b>GC4232R</b>	\$2767	\$2886	\$2988	\$3132	\$3339	\$3419	\$3600	\$3939	\$4110	\$4424	\$4864	\$5403
	<b>OVERALL DIMENSIONS</b>			<b>SEAT DIMENSIONS</b>			<b>BACK DIMENSIONS</b>						
	<b>W</b>	<b>D</b>	<b>H</b>	<b>W</b>	<b>D</b>	<b>H</b>	<b>W</b>	<b>H</b>					
	49.75	26	37.5	44	18	18	44	19.5					
<p>Active weight 500 lbs./seat. Wood armcap option - <b>Add \$179</b></p>													
 <p><b>Low Back Two Seat Chair No Center Arm, Left</b> COM Yardage: 3.5 Freight Class: 250 Product Weight (lbs.): 95 Cubic Feet Per Carton: 43</p>	<b>GC4232L</b>	\$2767	\$2886	\$2988	\$3132	\$3339	\$3419	\$3600	\$3939	\$4110	\$4424	\$4864	\$5403
	<b>OVERALL DIMENSIONS</b>			<b>SEAT DIMENSIONS</b>			<b>BACK DIMENSIONS</b>						
	<b>W</b>	<b>D</b>	<b>H</b>	<b>W</b>	<b>D</b>	<b>H</b>	<b>W</b>	<b>H</b>					
	49.75	26	37.5	44	18	18	44	19.5					
<p>Active weight 500 lbs./seat. Wood armcap option - <b>Add \$179</b></p>													

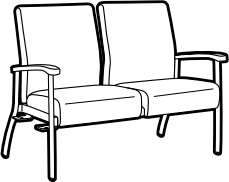
DESCRIPTION	MODEL#	STANDARD FABRIC GRADES											
		COM	2	3	4	5	6	7	8	9	10	11	12
 <p><b>Low Back Two Seat Chair</b> No Center Arm, Left &amp; Right COM Yardage: 3.5 Freight Class: 250 Product Weight (lbs.): 96 Cubic Feet Per Carton: 43</p>	<b>GC4232B</b>	\$2812	\$2931	\$3031	\$3177	\$3384	\$3463	\$3643	\$3983	\$4152	\$4468	\$4907	\$5448
	<p><b>OVERALL DIMENSIONS</b></p> <p>W D H</p> <p>49.75 26 37.5</p> <p><b>SEAT DIMENSIONS</b></p> <p>W D H</p> <p>44 18 18</p> <p><b>BACK DIMENSIONS</b></p> <p>W H</p> <p>44 19.5</p>												

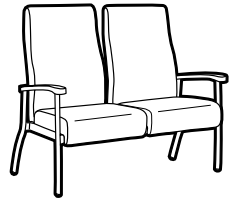
DESCRIPTION	MODEL#	STANDARD FABRIC GRADES											
		COM	2	3	4	5	6	7	8	9	10	11	12
 <p><b>High Back Two Seat Chair</b> No Center Arm COM Yardage: 4 Freight Class: 300 Product Weight (lbs.): 95 Cubic Feet Per Carton: 56.5</p>	<b>GC4232HB</b>	\$2920	\$3056	\$3171	\$3338	\$3574	\$3662	\$3870	\$4257	\$4454	\$4814	\$5316	\$5935
	<p><b>OVERALL DIMENSIONS</b></p> <p>W D H</p> <p>49.75 26 42.5</p> <p><b>SEAT DIMENSIONS</b></p> <p>W D H</p> <p>44 18 18</p> <p><b>BACK DIMENSIONS</b></p> <p>W H</p> <p>44 24.5</p>												

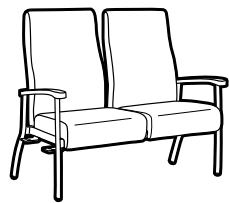
DESCRIPTION	MODEL#	STANDARD FABRIC GRADES											
		COM	2	3	4	5	6	7	8	9	10	11	12
 <p><b>High Back Two Seat Chair</b> No Center Arm, Right COM Yardage: 4 Freight Class: 300 Product Weight (lbs.): 96 Cubic Feet Per Carton: 56.5</p>	<b>GC4232HBR</b>	\$2962	\$3099	\$3216	\$3381	\$3617	\$3705	\$3913	\$4300	\$4497	\$4857	\$5359	\$5978
	<p><b>OVERALL DIMENSIONS</b></p> <p>W D H</p> <p>49.75 26 42.5</p> <p><b>SEAT DIMENSIONS</b></p> <p>W D H</p> <p>44 18 18</p> <p><b>BACK DIMENSIONS</b></p> <p>W H</p> <p>44 24.5</p>												

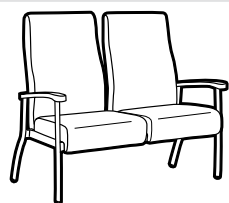
DESCRIPTION	MODEL#	STANDARD FABRIC GRADES											
		COM	2	3	4	5	6	7	8	9	10	11	12
 <p><b>High Back Two Seat Chair</b> No Center Arm, Left COM Yardage: 4 Freight Class: 300 Product Weight (lbs.): 96 Cubic Feet Per Carton: 56.5</p>	<b>GC4232HBL</b>	\$2962	\$3099	\$3216	\$3381	\$3617	\$3705	\$3913	\$4300	\$4497	\$4857	\$5359	\$5978
	<p><b>OVERALL DIMENSIONS</b></p> <p>W D H</p> <p>49.75 26 42.5</p> <p><b>SEAT DIMENSIONS</b></p> <p>W D H</p> <p>44 18 18</p> <p><b>BACK DIMENSIONS</b></p> <p>W H</p> <p>44 24.5</p>												

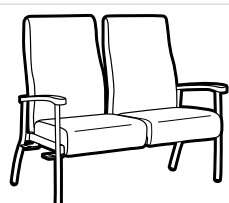
DESCRIPTION	MODEL#	STANDARD FABRIC GRADES											
		COM	2	3	4	5	6	7	8	9	10	11	12
 <p><b>High Back Two Seat Chair</b> No Center Arm, Left &amp; Right COM Yardage: 4 Freight Class: 300 Product Weight (lbs.): 98 Cubic Feet Per Carton: 56.5</p>	<b>GC4232HBB</b>	\$3007	\$3144	\$3259	\$3426	\$3660	\$3749	\$3957	\$4344	\$4541	\$4899	\$5403	\$6021
	<p><b>OVERALL DIMENSIONS</b></p> <p>W D H</p> <p>49.75 26 42.5</p> <p><b>SEAT DIMENSIONS</b></p> <p>W D H</p> <p>44 18 18</p> <p><b>BACK DIMENSIONS</b></p> <p>W H</p> <p>44 24.5</p>												

# SEATING

# GC-BELONG

G

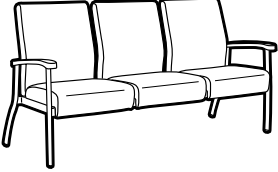
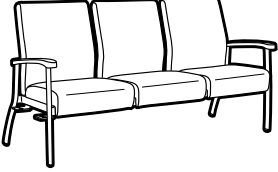
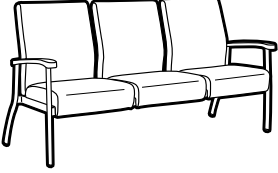
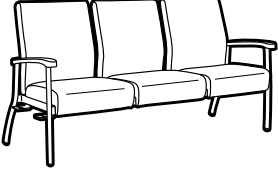
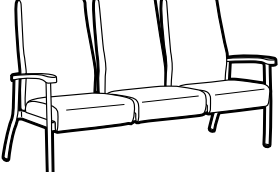
DESCRIPTION	MODEL#	STANDARD FABRIC GRADES											
		COM	2	3	4	5	6	7	8	9	10	11	12
 <p><b>Low Back Three Seat Chair</b> No Center Arm COM Yardage: 5 Freight Class: 250 Product Weight (lbs.): 132 Cubic Feet Per Carton: 65.25</p>	GC4233	\$3763	\$3934	\$4076	\$4282	\$4576	\$4689	\$4948	\$5432	\$5674	\$6126	\$6753	\$7530
		OVERALL DIMENSIONS			SEAT DIMENSIONS			BACK DIMENSIONS					
		W	D	H	W	D	H	W	H				
			72.75	26	37.5	70	18	18		70	19.5		
Active weight 500 lbs./seat. Wood armcap option - <b>Add \$179</b>													
 <p><b>Low Back Three Seat Chair</b> No Center Arm, Right COM Yardage: 5 Freight Class: 250 Product Weight (lbs.): 134 Cubic Feet Per Carton: 65.25</p>	GC4233R	\$3807	\$3978	\$4121	\$4329	\$4621	\$4734	\$4992	\$5479	\$5721	\$6172	\$6799	\$7575
		OVERALL DIMENSIONS			SEAT DIMENSIONS			BACK DIMENSIONS					
		W	D	H	W	D	H	W	H				
			72.75	26	37.5	70	18	18		70	19.5		
Active weight 500 lbs./seat. Wood armcap option - <b>Add \$179</b>													
 <p><b>Low Back Three Seat Chair</b> No Center Arm, Left COM Yardage: 5 Freight Class: 250 Product Weight (lbs.): 134 Cubic Feet Per Carton: 65.25</p>	GC4233L	\$3807	\$3978	\$4121	\$4329	\$4621	\$4734	\$4992	\$5479	\$5721	\$6172	\$6799	\$7575
		OVERALL DIMENSIONS			SEAT DIMENSIONS			BACK DIMENSIONS					
		W	D	H	W	D	H	W	H				
			72.75	26	37.5	70	18	18		70	19.5		
Active weight 500 lbs./seat. Wood armcap option - <b>Add \$179</b>													
 <p><b>Low Back Three Seat Chair</b> No Center Arm, Left &amp; Right COM Yardage: 5 Freight Class: 250 Product Weight (lbs.): 134 Cubic Feet Per Carton: 65.25</p>	GC4233B	\$3854	\$4023	\$4166	\$4372	\$4667	\$4782	\$5038	\$5523	\$5769	\$6217	\$6844	\$7619
		OVERALL DIMENSIONS			SEAT DIMENSIONS			BACK DIMENSIONS					
		W	D	H	W	D	H	W	H				
			72.75	26	37.5	70	18	18		70	19.5		
Active weight 500 lbs./seat. Wood armcap option - <b>Add \$179</b>													
 <p><b>High Back Three Seat Chair</b> No Center Arm COM Yardage: 5.75 Freight Class: 300 Product Weight (lbs.): 138 Cubic Feet Per Carton: 80.75</p>	GC4233HB	\$3987	\$4182	\$4347	\$4586	\$4924	\$5055	\$5350	\$5907	\$6189	\$6709	\$7430	\$8318
		OVERALL DIMENSIONS			SEAT DIMENSIONS			BACK DIMENSIONS					
		W	D	H	W	D	H	W	H				
			72.75	26	42.5	70	18	18		70	24.5		
Active weight 500 lbs./seat. Wood armcap option - <b>Add \$179</b>													

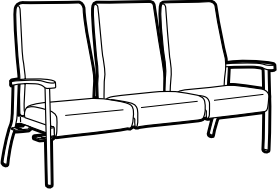
DESCRIPTION	MODEL#	STANDARD FABRIC GRADES											
		COM	2	3	4	5	6	7	8	9	10	11	12
 <p><b>High Back Three Seat Chair</b> No Center Arm, Right COM Yardage: 5.75 Freight Class: 300 Product Weight (lbs.): 140 Cubic Feet Per Carton: 80.75</p>	GC4233HBR	\$4032	\$4228	\$4392	\$4631	\$4969	\$5099	\$5394	\$5954	\$6232	\$6752	\$7475	\$8364
		OVERALL DIMENSIONS			SEAT DIMENSIONS			BACK DIMENSIONS					
		W	D	H	W	D	H	W	H				
			72.75	26	42.5	70	18	18	70	24.5			

Active weight 500 lbs./seat.  
Wood armcap option - **Add \$179**

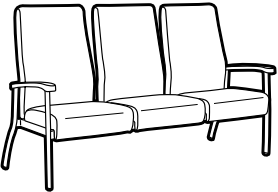
 <p><b>High Back Three Seat Chair</b> No Center Arm, Left COM Yardage: 5.75 Freight Class: 300 Product Weight (lbs.): 140 Cubic Feet Per Carton: 80.75</p>	GC4233HBL	\$4032	\$4228	\$4392	\$4631	\$4969	\$5099	\$5394	\$5954	\$6232	\$6752	\$7475	\$8364
		OVERALL DIMENSIONS			SEAT DIMENSIONS			BACK DIMENSIONS					
		W	D	H	W	D	H	W	H				
			72.75	26	42.5	70	18	18	70	24.5			

Active weight 500 lbs./seat.  
Wood armcap option - **Add \$179**

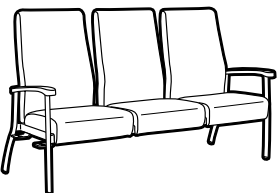
 <p><b>High Back Three Seat Chair</b> No Center Arm, Left &amp; Right COM Yardage: 5.75 Freight Class: 300 Product Weight (lbs.): 140 Cubic Feet Per Carton: 80.75</p>	GC4233HBB	\$4075	\$4271	\$4435	\$4674	\$5012	\$5142	\$5439	\$5996	\$6275	\$6795	\$7518	\$8407
		OVERALL DIMENSIONS			SEAT DIMENSIONS			BACK DIMENSIONS					
		W	D	H	W	D	H	W	H				
			72.75	26	42.5	70	18	18	70	24.5			

Active weight 500 lbs./seat.  
Wood armcap option - **Add \$179**

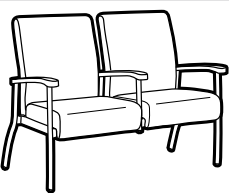
 <p><b>Low Back Two Seat Chair</b> Half Center Arm COM Yardage: 3.5 Freight Class: 250 Product Weight (lbs.): 100 Cubic Feet Per Carton: 43</p>	GC4234	\$3075	\$3195	\$3297	\$3441	\$3648	\$3727	\$3907	\$4247	\$4416	\$4732	\$5171	\$5712
		OVERALL DIMENSIONS			SEAT DIMENSIONS			BACK DIMENSIONS					
		W	D	H	W	D	H	W	H				
			50.75	26	37.5	22	18	18	21.5	19.5			

Active weight 500 lbs./seat.  
Wood armcap option - **Add \$264**

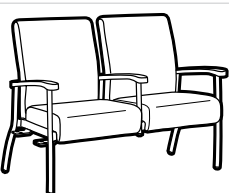
 <p><b>Low Back Two Seat Chair</b> Half Center Arm, Right COM Yardage: 3.5 Freight Class: 250 Product Weight (lbs.): 101 Cubic Feet Per Carton: 43</p>	GC4234R	\$3120	\$3237	\$3339	\$3483	\$3690	\$3770	\$3950	\$4290	\$4461	\$4775	\$5215	\$5754
		OVERALL DIMENSIONS			SEAT DIMENSIONS			BACK DIMENSIONS					
		W	D	H	W	D	H	W	H				
			50.75	26	37.5	22	18	18	21.5	19.5			

Active weight 500 lbs./seat.  
Wood armcap option - **Add \$264**

# SEATING

# GC-BELONG

G

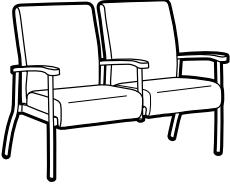
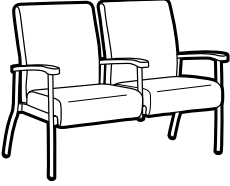
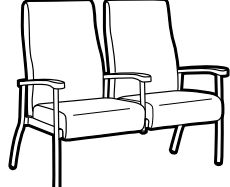
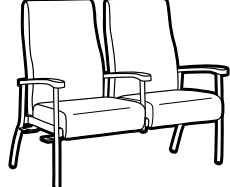
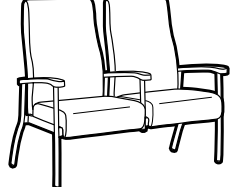
DESCRIPTION	MODEL#	STANDARD FABRIC GRADES											
		COM	2	3	4	5	6	7	8	9	10	11	12
 <p><b>Low Back Two Seat Chair</b> Half Center Arm, Left COM Yardage: 3.5 Freight Class: 250 Product Weight (lbs.): 101 Cubic Feet Per Carton: 43</p>	<b>GC4234L</b>	\$3120	\$3237	\$3339	\$3483	\$3690	\$3770	\$3950	\$4290	\$4461	\$4775	\$5215	\$5754
		<b>OVERALL DIMENSIONS</b>			<b>SEAT DIMENSIONS</b>			<b>BACK DIMENSIONS</b>					
		W	D	H	W	D	H	W	H				
			50.75	26	37.5	22	18	18	21.5	19.5			
 <p><b>Low Back Two Seat Chair</b> Half Center Arm, Left &amp; Right COM Yardage: 3.5 Freight Class: 250 Product Weight (lbs.): 102 Cubic Feet Per Carton: 43</p>	<b>GC4234B</b>	\$3165	\$3284	\$3386	\$3532	\$3737	\$3817	\$3997	\$4337	\$4507	\$4822	\$5261	\$5801
		<b>OVERALL DIMENSIONS</b>			<b>SEAT DIMENSIONS</b>			<b>BACK DIMENSIONS</b>					
		W	D	H	W	D	H	W	H				
			50.75	26	37.5	22	18	18	21.5	19.5			
 <p><b>High Back Two Seat Chair</b> Half Center Arm COM Yardage: 4 Freight Class: 300 Product Weight (lbs.): 104 Cubic Feet Per Carton: 56.5</p>	<b>GC4234HB</b>	\$3349	\$3486	\$3601	\$3767	\$4004	\$4092	\$4300	\$4687	\$4883	\$5244	\$5745	\$6363
		<b>OVERALL DIMENSIONS</b>			<b>SEAT DIMENSIONS</b>			<b>BACK DIMENSIONS</b>					
		W	D	H	W	D	H	W	H				
			50.75	26	42.5	22	18	18	21.5	24.5			
 <p><b>High Back Two Seat Chair</b> Half Center Arm, Right COM Yardage: 4 Freight Class: 300 Product Weight (lbs.): 104 Cubic Feet Per Carton: 56.5</p>	<b>GC4234HBR</b>	\$3396	\$3533	\$3650	\$3815	\$4051	\$4140	\$4347	\$4734	\$4931	\$5291	\$5793	\$6412
		<b>OVERALL DIMENSIONS</b>			<b>SEAT DIMENSIONS</b>			<b>BACK DIMENSIONS</b>					
		W	D	H	W	D	H	W	H				
			50.75	26	42.5	22	18	18	21.5	24.5			
 <p><b>High Back Two Seat Chair</b> Half Center Arm, Left COM Yardage: 4 Freight Class: 300 Product Weight (lbs.): 104 Cubic Feet Per Carton: 56.5</p>	<b>GC4234HBL</b>	\$3396	\$3533	\$3650	\$3815	\$4051	\$4140	\$4347	\$4734	\$4931	\$5291	\$5793	\$6412
		<b>OVERALL DIMENSIONS</b>			<b>SEAT DIMENSIONS</b>			<b>BACK DIMENSIONS</b>					
		W	D	H	W	D	H	W	H				
			50.75	26	42.5	22	18	18	21.5	24.5			

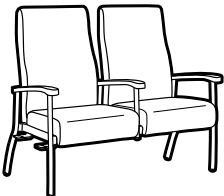
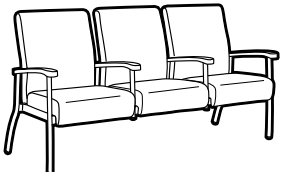
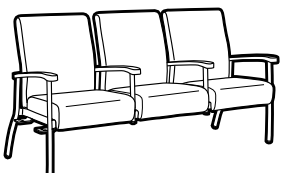
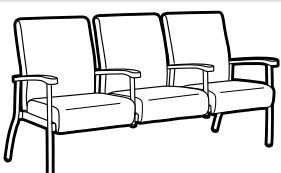
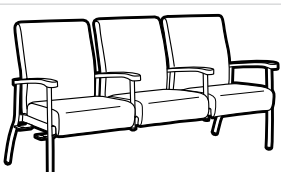

DESCRIPTION	MODEL#	STANDARD FABRIC GRADES											
		COM	2	3	4	5	6	7	8	9	10	11	12
 <p><b>High Back Two Seat Chair</b> Half Center Arm, Left &amp; Right COM Yardage: 4 Freight Class: 300 Product Weight (lbs.): 108 Cubic Feet Per Carton: 56.5</p>	GC4234HBB	\$3443	\$3580	\$3695	\$3862	\$4098	\$4186	\$4393	\$4780	\$4977	\$5338	\$5839	\$6457
		<b>OVERALL DIMENSIONS</b>		<b>SEAT DIMENSIONS</b>			<b>BACK DIMENSIONS</b>						
		W	D	H	W	D	H	W	H				
Active weight 500 lbs./seat. Wood armcap option - <b>Add \$264</b>		50.75	26	42.5	22	18	18	21.5	24.5				
 <p><b>Low Back Three Seat Chair</b> Half Center Arms COM Yardage: 5 Freight Class: 250 Product Weight (lbs.): 142 Cubic Feet Per Carton: 65.25</p>	GC4235	\$4379	\$4548	\$4693	\$4901	\$5192	\$5307	\$5564	\$6050	\$6294	\$6744	\$7371	\$8147
		<b>OVERALL DIMENSIONS</b>		<b>SEAT DIMENSIONS</b>			<b>BACK DIMENSIONS</b>						
		W	D	H	W	D	H	W	H				
Active weight 500 lbs./seat. Wood armcap option - <b>Add \$353</b>		74.5	26	37.5	22	18	18	21.5	19.5				
 <p><b>Low Back Three Seat Chair</b> Half Center Arms, Right COM Yardage: 5 Freight Class: 250 Product Weight (lbs.): 143 Cubic Feet Per Carton: 65.25</p>	GC4235R	\$4424	\$4595	\$4738	\$4946	\$5239	\$5354	\$5610	\$6097	\$6340	\$6791	\$7418	\$8193
		<b>OVERALL DIMENSIONS</b>		<b>SEAT DIMENSIONS</b>			<b>BACK DIMENSIONS</b>						
		W	D	H	W	D	H	W	H				
Active weight 500 lbs./seat. Wood armcap option - <b>Add \$353</b>		74.5	26	37.5	22	18	18	21.5	19.5				
 <p><b>Low Back Three Seat Chair</b> Half Center Arms, Left COM Yardage: 5 Freight Class: 250 Product Weight (lbs.): 143 Cubic Feet Per Carton: 65.25</p>	GC4235L	\$4424	\$4595	\$4738	\$4946	\$5239	\$5354	\$5610	\$6097	\$6340	\$6791	\$7418	\$8193
		<b>OVERALL DIMENSIONS</b>		<b>SEAT DIMENSIONS</b>			<b>BACK DIMENSIONS</b>						
		W	D	H	W	D	H	W	H				
Active weight 500 lbs./seat. Wood armcap option - <b>Add \$353</b>		74.5	26	37.5	22	18	18	21.5	19.5				
 <p><b>Low Back Three Seat Chair</b> Half Center Arms, Left &amp; Right COM Yardage: 5 Freight Class: 250 Product Weight (lbs.): 144 Cubic Feet Per Carton: 65.25</p>	GC4235B	\$4468	\$4637	\$4780	\$4988	\$5281	\$5396	\$5652	\$6138	\$6383	\$6833	\$7460	\$8235
		<b>OVERALL DIMENSIONS</b>		<b>SEAT DIMENSIONS</b>			<b>BACK DIMENSIONS</b>						
		W	D	H	W	D	H	W	H				
Active weight 500 lbs./seat. Wood armcap option - <b>Add \$353</b>		74.5	26	37.5	22	18	18	21.5	19.5				

# SEATING

# GC-BELONG

G

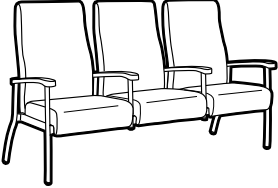
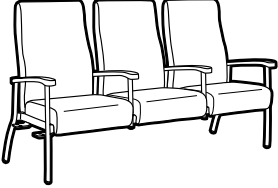
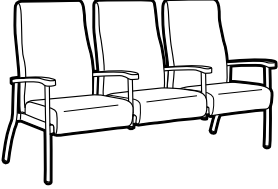
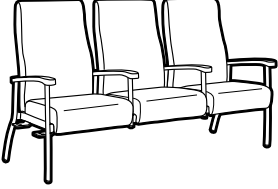
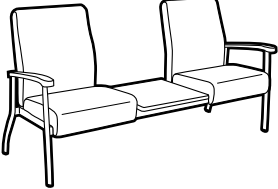
DESCRIPTION	MODEL#	STANDARD FABRIC GRADES											
		COM	2	3	4	5	6	7	8	9	10	11	12
 <p><b>High Back Three Seat Chair</b> Half Center Arms COM Yardage: 5.75 Freight Class: 300 Product Weight (lbs.): 148 Cubic Feet Per Carton: 80.75</p>	GC4235HB	\$4637	\$4831	\$4998	\$5236	\$5575	\$5705	\$6001	\$6558	\$6840	\$7359	\$8080	\$8968
		<b>OVERALL DIMENSIONS</b>			<b>SEAT DIMENSIONS</b>			<b>BACK DIMENSIONS</b>					
		W	D	H	W	D	H	W	H				
			74.5	26	42.5	22	18	18	21.5	24.5			
 <p><b>High Back Three Seat Chair</b> Half Center Arms, Right COM Yardage: 5.75 Freight Class: 300 Product Weight (lbs.): 159 Cubic Feet Per Carton: 80.75</p>	GC4235HBR	\$4682	\$4878	\$5040	\$5281	\$5618	\$5749	\$6044	\$6603	\$6882	\$7401	\$8125	\$9014
		<b>OVERALL DIMENSIONS</b>			<b>SEAT DIMENSIONS</b>			<b>BACK DIMENSIONS</b>					
		W	D	H	W	D	H	W	H				
			74.5	26	42.5	22	18	18	21.5	24.5			
 <p><b>High Back Three Seat Chair</b> Half Center Arms, Left COM Yardage: 5.75 Freight Class: 300 Product Weight (lbs.): 159 Cubic Feet Per Carton: 80.75</p>	GC4235HBL	\$4682	\$4878	\$5040	\$5281	\$5618	\$5749	\$6044	\$6603	\$6882	\$7401	\$8125	\$9014
		<b>OVERALL DIMENSIONS</b>			<b>SEAT DIMENSIONS</b>			<b>BACK DIMENSIONS</b>					
		W	D	H	W	D	H	W	H				
			74.5	26	42.5	22	18	18	21.5	24.5			
 <p><b>High Back Three Seat Chair</b> Half Center Arms, Left &amp; Right COM Yardage: 5.75 Freight Class: 300 Product Weight (lbs.): 160 Cubic Feet Per Carton: 80.75</p>	GC4235HBB	\$4727	\$4923	\$5088	\$5327	\$5664	\$5794	\$6091	\$6648	\$6927	\$7447	\$8170	\$9059
		<b>OVERALL DIMENSIONS</b>			<b>SEAT DIMENSIONS</b>			<b>BACK DIMENSIONS</b>					
		W	D	H	W	D	H	W	H				
			74.5	26	42.5	22	18	18	21.5	24.5			
 <p><b>Low Back Two Seat Chair with Table</b> Center Table Top, No Center Arms COM Yardage: 3.5 Freight Class: 300 Product Weight (lbs.): 106 Cubic Feet Per Carton: 65.25</p>	GC4236	\$3546	\$3665	\$3765	\$3911	\$4117	\$4196	\$4377	\$4716	\$4885	\$5201	\$5641	\$6182
		<b>OVERALL DIMENSIONS</b>			<b>SEAT DIMENSIONS</b>			<b>BACK DIMENSIONS</b>					
		W	D	H	W	D	H	W	H				
			72.75	26	37.5	44	18	18	44	19.5			

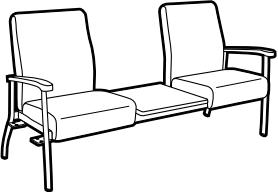
DESCRIPTION	MODEL#	STANDARD FABRIC GRADES											
		COM	2	3	4	5	6	7	8	9	10	11	12
	GC4236R	\$3590	\$3709	\$3809	\$3955	\$4161	\$4240	\$4421	\$4760	\$4930	\$5245	\$5686	\$6225
		<b>OVERALL DIMENSIONS</b>			<b>SEAT DIMENSIONS</b>			<b>BACK DIMENSIONS</b>					
			W	D	H	W	D	H	W	H			
<b>Low Back Two Seat Chair with Table</b> Center Table Top, No Center Arms, Right COM Yardage: 3.5 Freight Class: 300 Product Weight (lbs.): 107 Cubic Feet Per Carton: 65.25			72.75	26	37.5	44	18	18	44	19.5			
			Wood armcap option - <b>Add \$179</b>			Active weight 500 lbs./seat.			• Table top only offered in High Pressure Laminate				

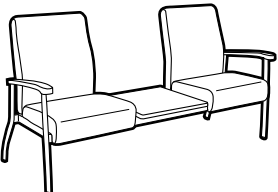
DESCRIPTION	MODEL#	STANDARD FABRIC GRADES											
		COM	2	3	4	5	6	7	8	9	10	11	12
	GC4236L	\$3590	\$3709	\$3809	\$3955	\$4161	\$4240	\$4421	\$4760	\$4930	\$5245	\$5686	\$6225
		<b>OVERALL DIMENSIONS</b>			<b>SEAT DIMENSIONS</b>			<b>BACK DIMENSIONS</b>					
			W	D	H	W	D	H	W	H			
<b>Low Back Two Seat Chair with Table</b> Center Table Top, No Center Arms, Left COM Yardage: 3.5 Freight Class: 300 Product Weight (lbs.): 107 Cubic Feet Per Carton: 65.25			72.75	26	37.5	44	18	18	44	19.5			
			Wood armcap option - <b>Add \$179</b>			Active weight 500 lbs./seat.			• Table top only offered in High Pressure Laminate				

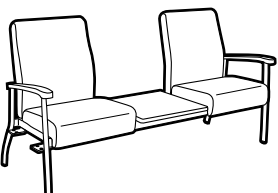
DESCRIPTION	MODEL#	STANDARD FABRIC GRADES											
		COM	2	3	4	5	6	7	8	9	10	11	12
	GC4236B	\$3636	\$3755	\$3855	\$4000	\$4207	\$4287	\$4467	\$4807	\$4975	\$5292	\$5730	\$6272
		<b>OVERALL DIMENSIONS</b>			<b>SEAT DIMENSIONS</b>			<b>BACK DIMENSIONS</b>					
			W	D	H	W	D	H	W	H			
<b>Low Back Two Seat Chair with Table</b> Center Table Top, No Center Arms, Left & Right COM Yardage: 3.5 Freight Class: 300 Product Weight (lbs.): 108 Cubic Feet Per Carton: 65.25			72.75	26	37.5	44	18	18	44	19.5			
			Wood armcap option - <b>Add \$179</b>			Active weight 500 lbs./seat.			• Table top only offered in High Pressure Laminate				

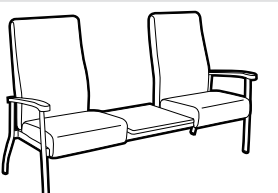

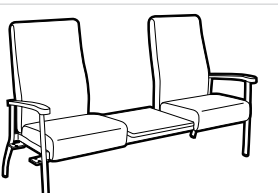
DESCRIPTION	MODEL#	STANDARD FABRIC GRADES											
		COM	2	3	4	5	6	7	8	9	10	11	12
	GC4236HB	\$3796	\$3932	\$4049	\$4214	\$4450	\$4539	\$4746	\$5135	\$5330	\$5690	\$6192	\$6811
		<b>OVERALL DIMENSIONS</b>			<b>SEAT DIMENSIONS</b>			<b>BACK DIMENSIONS</b>					
			W	D	H	W	D	H	W	H			
<b>High Back Two Seat Chair with Table</b> Center Table Top, No Center Arms COM Yardage: 4 Freight Class: 300 Product Weight (lbs.): 110 Cubic Feet Per Carton: 80.75			72.75	26	42.5	44	18	18	44	24.5			
			Wood armcap option - <b>Add \$179</b>			Active weight 500 lbs./seat.			• Table top only offered in High Pressure Laminate				

DESCRIPTION	MODEL#	STANDARD FABRIC GRADES											
		COM	2	3	4	5	6	7	8	9	10	11	12
	GC4236HBR	\$3838	\$3975	\$4090	\$4257	\$4493	\$4581	\$4788	\$5175	\$5372	\$5733	\$6234	\$6852
		<b>OVERALL DIMENSIONS</b>			<b>SEAT DIMENSIONS</b>			<b>BACK DIMENSIONS</b>					
			W	D	H	W	D	H	W	H			
<b>High Back Two Seat Chair with Table</b> Center Table Top, No Center Arms, Right COM Yardage: 4 Freight Class: 300 Product Weight (lbs.): 111 Cubic Feet Per Carton: 80.75			72.75	26	42.5	44	18	18	44	24.5			
			Wood armcap option - <b>Add \$179</b>			Active weight 500 lbs./seat.			• Table top only offered in High Pressure Laminate				

# SEATING

# GC-BELONG

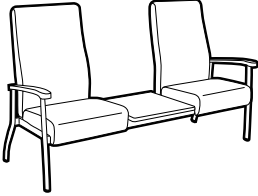
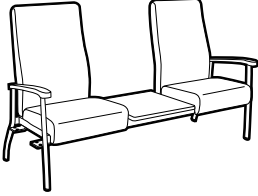
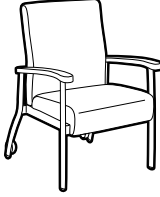
G

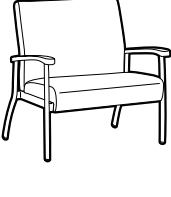
DESCRIPTION	MODEL#	STANDARD FABRIC GRADES											
		COM	2	3	4	5	6	7	8	9	10	11	12
 <p><b>High Back Two Seat Chair with Table</b> Center Table Top, No Center Arms, Left                      COM Yardage: 4                      Freight Class: 300                      Product Weight (lbs.): 111                      Cubic Feet Per Carton: 80.75</p>	GC4236HBL	\$3838	\$3975	\$4090	\$4257	\$4493	\$4581	\$4788	\$5175	\$5372	\$5733	\$6234	\$6852
		<b>OVERALL DIMENSIONS</b>			<b>SEAT DIMENSIONS</b>			<b>BACK DIMENSIONS</b>					
		W	D	H	W	D	H	W	H				
			72.75	26	42.5	44	18	18	44	24.5			
		Wood armcap option - <b>Add \$179</b> Active weight 500 lbs./seat. • Table top only offered in High Pressure Laminate											
 <p><b>High Back Two Seat Chair with Table</b> Center Table Top, No Center Arms, Left &amp; Right                      COM Yardage: 4                      Freight Class: 300                      Product Weight (lbs.): 114                      Cubic Feet Per Carton: 80.75</p>	GC4236HBB	\$3882	\$4019	\$4134	\$4301	\$4537	\$4624	\$4832	\$5220	\$5416	\$5777	\$6278	\$6896
		<b>OVERALL DIMENSIONS</b>			<b>SEAT DIMENSIONS</b>			<b>BACK DIMENSIONS</b>					
		W	D	H	W	D	H	W	H				
			72.75	26	42.5	44	18	18	44	24.5			
		Wood armcap option - <b>Add \$179</b> Active weight 500 lbs./seat. • Table top only offered in High Pressure Laminate											
 <p><b>Low Back Armchair</b> Casters                      COM Yardage: 1.75                      Freight Class: 250                      Product Weight (lbs.): 49                      Cubic Feet Per Carton: 20.25</p>	GC4240	\$1963	\$2020	\$2074	\$2146	\$2248	\$2287	\$2380	\$2551	\$2634	\$2793	\$3011	\$3282
		<b>OVERALL DIMENSIONS</b>			<b>SEAT DIMENSIONS</b>			<b>BACK DIMENSIONS</b>					
		W	D	H	W	D	H	W	H				
			26.75	27.5	37.5	22	18	18	21.5	19.5			
		Active weight 500 lbs. Wood armcap option - <b>Add \$179</b>											
 <p><b>High Back Armchair</b> Casters                      COM Yardage: 2                      Freight Class: 250                      Product Weight (lbs.): 54                      Cubic Feet Per Carton: 22.25</p>	GC4240HB	\$2037	\$2103	\$2163	\$2246	\$2363	\$2408	\$2511	\$2706	\$2803	\$2984	\$3234	\$3543
		<b>OVERALL DIMENSIONS</b>			<b>SEAT DIMENSIONS</b>			<b>BACK DIMENSIONS</b>					
		W	D	H	W	D	H	W	H				
			26.75	27.5	42.5	22	18	18	21.5	24.5			
		Active weight 500 lbs. Wood armcap option - <b>Add \$179</b>											
 <p><b>Bariatric Low Back Armchair</b>                      COM Yardage: 3                      Freight Class: 250                      Product Weight (lbs.): 70                      Cubic Feet Per Carton: 30.5</p>	GC4241	\$2269	\$2370	\$2457	\$2583	\$2759	\$2825	\$2983	\$3273	\$3418	\$3690	\$4065	\$4530
		<b>OVERALL DIMENSIONS</b>			<b>SEAT DIMENSIONS</b>			<b>BACK DIMENSIONS</b>					
		W	D	H	W	D	H	W	H				
			37.5	28	37.5	32.5	18	18	32.5	19.5			
		Active weight 750 lbs. Wood armcap option - <b>Add \$179</b> Armless Bariatric models are <u>not</u> available.											

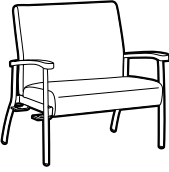
DESCRIPTION	MODEL#	STANDARD FABRIC GRADES											
		COM	2	3	4	5	6	7	8	9	10	11	12
 <p><b>Bariatric Low Back Armchair Right</b> COM Yardage: 3 Freight Class: 250 Product Weight (lbs.): 71 Cubic Feet Per Carton: 30.5</p>	<b>GC4241R</b>	\$2311	\$2413	\$2501	\$2626	\$2802	\$2868	\$3026	\$3316	\$3462	\$3733	\$4109	\$4573
		OVERALL DIMENSIONS			SEAT DIMENSIONS			BACK DIMENSIONS					
		W	D	H	W	D	H	W	H				
		37.5	28	37.5	32.5	18	18	32.5	19.5				
		Active weight 750 lbs. Wood armcap option - <b>Add \$179</b> <i>Armless Bariatric models are <u>not</u> available.</i>											

DESCRIPTION	MODEL#	STANDARD FABRIC GRADES											
		COM	2	3	4	5	6	7	8	9	10	11	12
 <p><b>Bariatric Low Back Armchair Left</b> COM Yardage: 3 Freight Class: 250 Product Weight (lbs.): 71 Cubic Feet Per Carton: 30.5</p>	<b>GC4241L</b>	\$2311	\$2413	\$2501	\$2626	\$2802	\$2868	\$3026	\$3316	\$3462	\$3733	\$4109	\$4573
		OVERALL DIMENSIONS			SEAT DIMENSIONS			BACK DIMENSIONS					
		W	D	H	W	D	H	W	H				
		37.5	28	37.5	32.5	18	18	32.5	19.5				
		Active weight 750 lbs. Wood armcap option - <b>Add \$179</b> <i>Armless Bariatric models are <u>not</u> available.</i>											

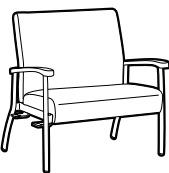
DESCRIPTION	MODEL#	STANDARD FABRIC GRADES											
		COM	2	3	4	5	6	7	8	9	10	11	12
 <p><b>Bariatric Low Back Armchair Left &amp; Right</b> COM Yardage: 3 Freight Class: 250 Product Weight (lbs.): 71 Cubic Feet Per Carton: 30.5</p>	<b>GC4241B</b>	\$2354	\$2456	\$2544	\$2670	\$2847	\$2912	\$3069	\$3360	\$3505	\$3777	\$4153	\$4616
		OVERALL DIMENSIONS			SEAT DIMENSIONS			BACK DIMENSIONS					
		W	D	H	W	D	H	W	H				
		37.5	28	37.5	32.5	18	18	32.5	19.5				
		Active weight 750 lbs. Wood armcap option - <b>Add \$179</b> <i>Armless Bariatric models are <u>not</u> available.</i>											

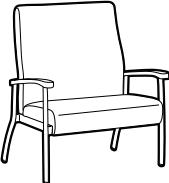
DESCRIPTION	MODEL#	STANDARD FABRIC GRADES											
		COM	2	3	4	5	6	7	8	9	10	11	12
 <p><b>Bariatric High Back Armchair</b> COM Yardage: 3.25 Freight Class: 250 Product Weight (lbs.): 73 Cubic Feet Per Carton: 30.5</p>	<b>GC4241HB</b>	\$2577	\$2686	\$2780	\$2914	\$3108	\$3180	\$3349	\$3662	\$3820	\$4114	\$4522	\$5027
		OVERALL DIMENSIONS			SEAT DIMENSIONS			BACK DIMENSIONS					
		W	D	H	W	D	H	W	H				
		37.5	28	43	32.5	18	18	32.5	24.5				
		Active weight 750 lbs. Wood armcap option - <b>Add \$179</b> <i>Armless Bariatric models are <u>not</u> available.</i>											

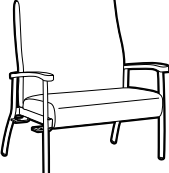
DESCRIPTION	MODEL#	STANDARD FABRIC GRADES											
		COM	2	3	4	5	6	7	8	9	10	11	12
 <p><b>Bariatric High Back Armchair Right</b> COM Yardage: 3.25 Freight Class: 250 Product Weight (lbs.): 74 Cubic Feet Per Carton: 30.5</p>	<b>GC4241HBR</b>	\$2623	\$2733	\$2827	\$2965	\$3155	\$3227	\$3396	\$3709	\$3867	\$4162	\$4569	\$5074
		OVERALL DIMENSIONS			SEAT DIMENSIONS			BACK DIMENSIONS					
		W	D	H	W	D	H	W	H				
		37.5	28	43	32.5	18	18	32.5	24.5				
		Active weight 750 lbs. Wood armcap option - <b>Add \$179</b> <i>Armless Bariatric models are <u>not</u> available.</i>											



# SEATING

# GC-BELONG

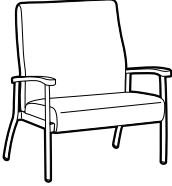
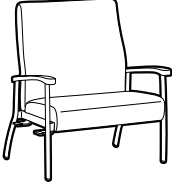
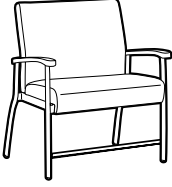
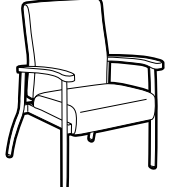
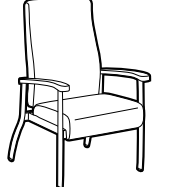
G

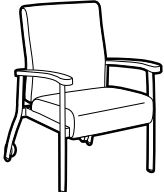
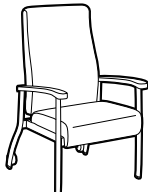
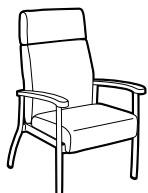
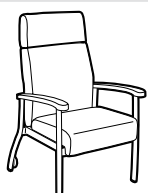
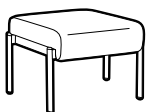
DESCRIPTION	MODEL#	STANDARD FABRIC GRADES											
		COM	2	3	4	5	6	7	8	9	10	11	12
 <p><b>Bariatric High Back Armchair Left</b> COM Yardage: 3.25 Freight Class: 250 Product Weight (lbs.): 74 Cubic Feet Per Carton: 30.5</p>	<b>GC4241HBL</b>	\$2623	\$2733	\$2827	\$2965	\$3155	\$3227	\$3396	\$3709	\$3867	\$4162	\$4569	\$5074
		<b>OVERALL DIMENSIONS</b>			<b>SEAT DIMENSIONS</b>			<b>BACK DIMENSIONS</b>					
		W	D	H	W	D	H	W	H				
Active weight 750 lbs. Wood armcap option - <b>Add \$179</b> <i>Armless Bariatric models are <u>not</u> available.</i>	37.5	28	43	32.5	18	18	32.5	24.5					
 <p><b>Bariatric High Back Armchair Left &amp; Right</b> COM Yardage: 3.25 Freight Class: 250 Product Weight (lbs.): 74 Cubic Feet Per Carton: 30.50</p>	<b>GC4241HBB</b>	\$2669	\$2779	\$2873	\$3011	\$3202	\$3274	\$3443	\$3757	\$3913	\$4208	\$4618	\$5120
		<b>OVERALL DIMENSIONS</b>			<b>SEAT DIMENSIONS</b>			<b>BACK DIMENSIONS</b>					
		W	D	H	W	D	H	W	H				
Active weight 750 lbs. Wood armcap option - <b>Add \$179</b> <i>Armless Bariatric models are <u>not</u> available.</i>	37.5	28	43	32.5	18	18	32.5	24.5					
 <p><b>Bariatric Low Back Armchair Post Surgery.</b> Designed to immobilize the pelvis and hip joints after surgery. COM Yardage: 3 Freight Class: 250 Product Weight (lbs.): 76 Cubic Feet Per Carton: 33.5</p>	<b>GC4241-24</b> 24" Seat Height	\$2646	\$2749	\$2836	\$2962	\$3138	\$3204	\$3360	\$3652	\$3797	\$4069	\$4445	\$4908
		<b>OVERALL DIMENSIONS</b>			<b>SEAT DIMENSIONS</b>			<b>BACK DIMENSIONS</b>					
		W	D	H	W	D	H	W	H				
Active weight 750 lbs. Wood armcap option - <b>Add \$179</b> <i>Armless Bariatric models are <u>not</u> available.</i>	37.5	28.75	43.5	32.5	18	24	32.5	19.5					
 <p><b>Low Back Armchair Flex Back</b> COM Yardage: 1.75 Freight Class: 250 Product Weight (lbs.): 53 Cubic Feet Per Carton: 20.25</p>	<b>GC4242</b>	\$2340	\$2400	\$2452	\$2525	\$2627	\$2667	\$2758	\$2930	\$3014	\$3172	\$3391	\$3660
		<b>OVERALL DIMENSIONS</b>			<b>SEAT DIMENSIONS</b>			<b>BACK DIMENSIONS</b>					
		W	D	H	W	D	H	W	H				
Active weight 500 lbs. Wood armcap option - <b>Add \$179</b>	26.5	28	37.5	22	18	18	21.5	19.5					
 <p><b>High Back Armchair Flex Back</b> COM Yardage: 2 Freight Class: 250 Product Weight (lbs.): 61 Cubic Feet Per Carton: 22.25</p>	<b>GC4242HB</b>	\$2416	\$2480	\$2543	\$2625	\$2743	\$2788	\$2892	\$3085	\$3181	\$3363	\$3613	\$3923
		<b>OVERALL DIMENSIONS</b>			<b>SEAT DIMENSIONS</b>			<b>BACK DIMENSIONS</b>					
		W	D	H	W	D	H	W	H				
Active weight 500 lbs. Wood armcap option - <b>Add \$179</b>	26.5	28	43	22	18	18	21.5	24.5					

DESCRIPTION	MODEL#	STANDARD FABRIC GRADES											
		COM	2	3	4	5	6	7	8	9	10	11	12
 <p><b>Low Back Armchair</b> Flex Back, Casters COM Yardage: 1.75 Freight Class: 250 Product Weight (lbs.): 49 Cubic Feet Per Carton: 20.25</p>	GC4243	\$2480	\$2538	\$2590	\$2663	\$2766	\$2804	\$2896	\$3068	\$3153	\$3311	\$3528	\$3798
		OVERALL DIMENSIONS			SEAT DIMENSIONS			BACK DIMENSIONS					
		W	D	H	W	D	H	W	H				
			26.75	27.5	37.5	22	18	18	21.5	19.5			
<p>Active weight 500 lbs. Wood armcap option - <b>Add \$179</b></p>													
 <p><b>High Back Armchair</b> Flex Back, Casters COM Yardage: 2 Freight Class: 250 Product Weight (lbs.): 51 Cubic Feet Per Carton: 22.25</p>	GC4243HB	\$2558	\$2623	\$2684	\$2766	\$2885	\$2930	\$3032	\$3226	\$3323	\$3505	\$3755	\$4064
		OVERALL DIMENSIONS			SEAT DIMENSIONS			BACK DIMENSIONS					
		W	D	H	W	D	H	W	H				
			26.75	27.5	42.5	22	18	18	21.5	24.5			
<p>Active weight 500 lbs. Wood armcap option - <b>Add \$179</b></p>													
 <p><b>High Back Armchair</b> Split Back COM Yardage: 2.25 Freight Class: 250 Product Weight (lbs.): 54 Cubic Feet Per Carton: 20.25</p>	GC4244HB	\$2275	\$2351	\$2417	\$2510	\$2644	\$2693	\$2808	\$3028	\$3137	\$3341	\$3623	\$3971
		OVERALL DIMENSIONS			SEAT DIMENSIONS			BACK DIMENSIONS					
		W	D	H	W	D	H	W	H				
			26.75	26	42.5	22	18	18	21.5	24.5			
<p>Active weight 500 lbs. Wood armcap option - <b>Add \$179</b></p>													
 <p><b>High Back Armchair</b> Split Back, Casters COM Yardage: 2.25 Freight Class: 250 Product Weight (lbs.): 54 Cubic Feet Per Carton: 20.25</p>	GC4245HB	\$2416	\$2490	\$2557	\$2650	\$2784	\$2833	\$2951	\$3168	\$3277	\$3481	\$3763	\$4110
		OVERALL DIMENSIONS			SEAT DIMENSIONS			BACK DIMENSIONS					
		W	D	H	W	D	H	W	H				
			26.75	26	42.5	22	18	18	21.5	24.5			
<p>Active weight 500 lbs. Wood armcap option - <b>Add \$179</b></p>													
 <p><b>Single Seat Bench</b> COM Yardage: 1.5 Freight Class: 250 Product Weight (lbs.): 30 Cubic Feet Per Carton: 13</p>	GC4251	\$1154	\$1203	\$1248	\$1311	\$1400	\$1431	\$1510	\$1656	\$1729	\$1866	\$2053	\$2285
		OVERALL DIMENSIONS			SEAT DIMENSIONS			BACK DIMENSIONS					
		W	D	H	W	D	H	W	H				
			24.75	26.5	18								
<p>Active weight 500 lbs.</p>													

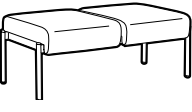
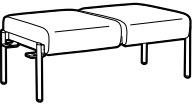
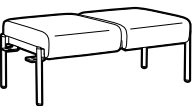
DESCRIPTION	MODEL#	STANDARD FABRIC GRADES											
		COM	2	3	4	5	6	7	8	9	10	11	12
 <p><b>Single Seat Bench Left</b> COM Yardage: 1.5 Freight Class: 250 Product Weight (lbs.): 31 Cubic Feet Per Carton: 13</p>	<b>GC4251L</b>	\$1198	\$1248	\$1293	\$1356	\$1446	\$1480	\$1556	\$1701	\$1774	\$1911	\$2100	\$2330
	Active weight 500 lbs.	<b>OVERALL DIMENSIONS</b> W D H			<b>SEAT DIMENSIONS</b> W D H			<b>BACK DIMENSIONS</b> W H					
		25.75	26.5	18									
 <p><b>Single Seat Bench Left &amp; Right</b> COM Yardage: 1.5 Freight Class: 250 Product Weight (lbs.): 32 Cubic Feet Per Carton: 13</p>	<b>GC4251B</b>	\$1247	\$1294	\$1339	\$1402	\$1492	\$1526	\$1602	\$1747	\$1820	\$1957	\$2146	\$2377
	Active weight 500 lbs.	<b>OVERALL DIMENSIONS</b> W D H			<b>SEAT DIMENSIONS</b> W D H			<b>BACK DIMENSIONS</b> W H					
		26.75	26.5	18									
 <p><b>Two Seat Bench</b> COM Yardage: 2.25 Freight Class: 250 Product Weight (lbs.): 53 Cubic Feet Per Carton: 23</p>	<b>GC4252</b>	\$2096	\$2172	\$2238	\$2331	\$2465	\$2514	\$2629	\$2849	\$2958	\$3162	\$3444	\$3792
	Active weight 500 lbs./seat.	<b>OVERALL DIMENSIONS</b> W D H			<b>SEAT DIMENSIONS</b> W D H			<b>BACK DIMENSIONS</b> W H					
		47.75	26.5	18									
 <p><b>Two Seat Bench Left</b> COM Yardage: 2.25 Freight Class: 250 Product Weight (lbs.): 54 Cubic Feet Per Carton: 23</p>	<b>GC4252L</b>	\$2144	\$2218	\$2285	\$2377	\$2511	\$2561	\$2675	\$2895	\$3005	\$3209	\$3491	\$3838
	Active weight 500 lbs./seat.	<b>OVERALL DIMENSIONS</b> W D H			<b>SEAT DIMENSIONS</b> W D H			<b>BACK DIMENSIONS</b> W H					
		48.75	26.5	18									
 <p><b>Two Seat Bench Left &amp; Right</b> COM Yardage: 2.25 Freight Class: 250 Product Weight (lbs.): 55 Cubic Feet Per Carton: 23</p>	<b>GC4252B</b>	\$2191	\$2265	\$2332	\$2425	\$2559	\$2608	\$2722	\$2943	\$3052	\$3256	\$3538	\$3885
	Active weight 500 lbs./seat.	<b>OVERALL DIMENSIONS</b> W D H			<b>SEAT DIMENSIONS</b> W D H			<b>BACK DIMENSIONS</b> W H					
		49.75	26.5	18									



DESCRIPTION	MODEL#	STANDARD FABRIC GRADES											
		COM	2	3	4	5	6	7	8	9	10	11	12

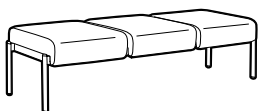

**Three Seat Bench**  
 COM Yardage: 3  
 Freight Class: 250  
 Product Weight (lbs.): 73  
 Cubic Feet Per Carton: 33.25

Active weight 500 lbs./seat.

OVERALL DIMENSIONS			SEAT DIMENSIONS			BACK DIMENSIONS	
W	D	H	W	D	H	W	H

70.75 26.5 18

COM	2	3	4	5	6	7	8	9	10	11	12
-----	---	---	---	---	---	---	---	---	----	----	----

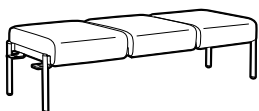

**Three Seat Bench Left**  
 COM Yardage: 3  
 Freight Class: 250  
 Product Weight (lbs.): 74  
 Cubic Feet Per Carton: 33.25

Active weight 500 lbs./seat.

OVERALL DIMENSIONS			SEAT DIMENSIONS			BACK DIMENSIONS	
W	D	H	W	D	H	W	H

71.75 26.5 18

COM	2	3	4	5	6	7	8	9	10	11	12
-----	---	---	---	---	---	---	---	---	----	----	----

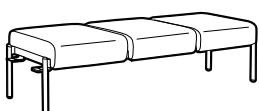

**Three Seat Bench Left & Right**  
 COM Yardage: 3  
 Freight Class: 250  
 Product Weight (lbs.): 75  
 Cubic Feet Per Carton: 33.25

Active weight 500 lbs./seat.

OVERALL DIMENSIONS			SEAT DIMENSIONS			BACK DIMENSIONS	
W	D	H	W	D	H	W	H

72.75 26.5 18

COM	2	3	4	5	6	7	8	9	10	11	12
-----	---	---	---	---	---	---	---	---	----	----	----

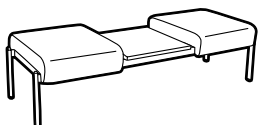

**Two Seat Bench with Table Center Table Top**  
 COM Yardage: 2.25  
 Freight Class: 250  
 Product Weight (lbs.): 68  
 Cubic Feet Per Carton: 33.25

Active weight 500 lbs./seat.

• Table top only offered in High Pressure Laminate

OVERALL DIMENSIONS			SEAT DIMENSIONS			BACK DIMENSIONS	
W	D	H	W	D	H	W	H

70.75 26.5 18

COM	2	3	4	5	6	7	8	9	10	11	12
-----	---	---	---	---	---	---	---	---	----	----	----

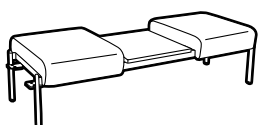

**Two Seat Bench with Table Center Table Top, Left**  
 COM Yardage: 2.25  
 Freight Class: 250  
 Product Weight (lbs.): 72  
 Cubic Feet Per Carton: 33.25

Active weight 500 lbs./seat.

• Table top only offered in High Pressure Laminate

OVERALL DIMENSIONS			SEAT DIMENSIONS			BACK DIMENSIONS	
W	D	H	W	D	H	W	H

71.75 26.5 18

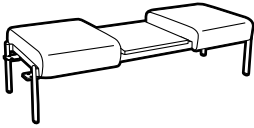
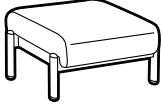
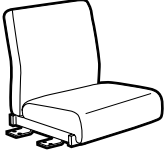
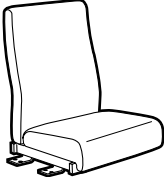
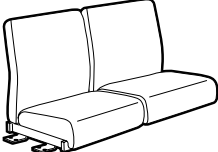

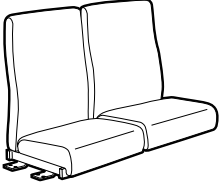
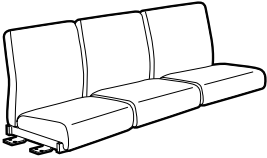
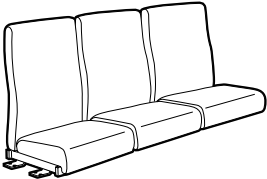
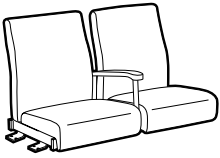
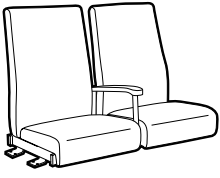
DESCRIPTION	MODEL#	STANDARD FABRIC GRADES											
		COM	2	3	4	5	6	7	8	9	10	11	12
 <b>Two Seat Bench with Table</b> Center Table Top, Left & Right COM Yardage: 2.25 Freight Class: 250 Product Weight (lbs.): 70 Cubic Feet Per Carton: 33.25	<b>GC4256B</b>	\$3083	\$3157	\$3224	\$3317	\$3450	\$3500	\$3614	\$3835	\$3944	\$4148	\$4430	\$4777
		OVERALL DIMENSIONS			SEAT DIMENSIONS			BACK DIMENSIONS					
		W	D	H	W	D	H	W	H				
		72.75	26.5	18									
		• Table top only offered in High Pressure Laminate											
 <b>Ottoman</b> Angled cushion top. COM Yardage: 1 Freight Class: 150 Product Weight (lbs.): 16 Cubic Feet Per Carton: 3.6	<b>GC4259</b>	\$858	\$891	\$924	\$964	\$1023	\$1047	\$1098	\$1196	\$1244	\$1334	\$1457	\$1614
		OVERALL DIMENSIONS			SEAT DIMENSIONS			BACK DIMENSIONS					
		W	D	H	W	D	H	W	H				
		17.75	19	10.5									
 <b>Low Back Single Seat Armless Bridge</b> Left & Right COM Yardage: 1.75 Freight Class: 250 Product Weight (lbs.): 36 Cubic Feet Per Carton: 13	<b>GC4261</b>	\$1202	\$1259	\$1313	\$1385	\$1487	\$1526	\$1619	\$1790	\$1873	\$2032	\$2250	\$2521
		OVERALL DIMENSIONS			SEAT DIMENSIONS			BACK DIMENSIONS					
		W	D	H	W	D	H	W	H				
		26.75	24	25.5	22	18	--	21.5	19.5				
		Active weight 500 lbs. <b>Not freestanding.</b> Suspends between 2 units via linking brackets.											
 <b>High Back Single Seat Armless Bridge</b> Left & Right COM Yardage: 2 Freight Class: 250 Product Weight (lbs.): 41 Cubic Feet Per Carton: 14.5	<b>GC4261HB</b>	\$1268	\$1334	\$1395	\$1477	\$1596	\$1641	\$1743	\$1938	\$2035	\$2216	\$2466	\$2775
		OVERALL DIMENSIONS			SEAT DIMENSIONS			BACK DIMENSIONS					
		W	D	H	W	D	H	W	H				
		26.75	24	30.5	22	18	--	21.5	24.5				
		Active weight 500 lbs. <b>Not freestanding.</b> Suspends between 2 units via linking brackets.											
 <b>Low Back Two Seat Armless Bridge</b> Left & Right COM Yardage: 3.5 Freight Class: 250 Product Weight (lbs.): 66 Cubic Feet Per Carton: 23	<b>GC4262</b>	\$2296	\$2415	\$2517	\$2661	\$2868	\$2948	\$3128	\$3468	\$3639	\$3953	\$4392	\$4932
		OVERALL DIMENSIONS			SEAT DIMENSIONS			BACK DIMENSIONS					
		W	D	H	W	D	H	W	H				
		49.75	24	25.5	44	18	--	44	19.5				
		Active weight 500 lbs./seat. <b>Not freestanding.</b> Suspends between 2 units via linking brackets.											

DESCRIPTION	MODEL#	STANDARD FABRIC GRADES											
		COM	2	3	4	5	6	7	8	9	10	11	12
 <p><b>High Back Two Seat Armless Bridge</b> Left &amp; Right COM Yardage: 4 Freight Class: 250 Product Weight (lbs.): 72 Cubic Feet Per Carton: 24</p>	<b>GC4262HB</b>	\$2434	\$2571	\$2686	\$2853	\$3089	\$3177	\$3384	\$3771	\$3968	\$4329	\$4830	\$5448
		OVERALL DIMENSIONS			SEAT DIMENSIONS			BACK DIMENSIONS					
		W	D	H	W	D	H	W	H				
		49.75	24	30.5	44	18	--	44	24.5				
		Active weight 500 lbs./seat. <b>Not freestanding.</b> Suspends between 2 units via linking brackets.											
 <p><b>Low Back Three Seat Armless Bridge</b> Left &amp; Right COM Yardage: 5 Freight Class: 300 Product Weight (lbs.): 74 Cubic Feet Per Carton: 38.75</p>	<b>GC4263</b>	\$3343	\$3512	\$3655	\$3865	\$4156	\$4271	\$4527	\$5014	\$5257	\$5708	\$6335	\$7110
		OVERALL DIMENSIONS			SEAT DIMENSIONS			BACK DIMENSIONS					
		W	D	H	W	D	H	W	H				
		72.75	24	25.5	70	18	--	70	19.5				
		Active weight 500 lbs./seat. <b>Not freestanding.</b> Suspends between 2 units via linking brackets.											
 <p><b>High Back Three Seat Armless Bridge</b> Left &amp; Right COM Yardage: 5.75 Freight Class: 250 Product Weight (lbs.): 80 Cubic Feet Per Carton: 38.75</p>	<b>GC4263HB</b>	\$3566	\$3762	\$3926	\$4165	\$4503	\$4633	\$4928	\$5487	\$5766	\$6286	\$7009	\$7898
		OVERALL DIMENSIONS			SEAT DIMENSIONS			BACK DIMENSIONS					
		W	D	H	W	D	H	W	H				
		72.75	24	30.5	70	18	--	70	24.5				
		Active weight 500 lbs./seat. <b>Not freestanding.</b> Suspends between 2 units via linking brackets.											
 <p><b>Low Back Two Seat Bridge</b> Half Center Arm, Left &amp; Right COM Yardage: 3.5 Freight Class: 250 Product Weight (lbs.): 58 Cubic Feet Per Carton: 27.25</p>	<b>GC4264</b>	\$2763	\$2880	\$2982	\$3126	\$3333	\$3413	\$3593	\$3933	\$4103	\$4418	\$4856	\$5397
		OVERALL DIMENSIONS			SEAT DIMENSIONS			BACK DIMENSIONS					
		W	D	H	W	D	H	W	H				
		50.75	24	25.5	22	18	--	21.5	19.5				
		Active weight 500 lbs./seat. <b>Not freestanding.</b> Suspends between 2 units via linking brackets. Wood armcap option - <b>Add \$47</b>											
 <p><b>High Back Two Seat Bridge</b> Half Center Arm, Left &amp; Right COM Yardage: 4 Freight Class: 250 Product Weight (lbs.): 68 Cubic Feet Per Carton: 27.25</p>	<b>GC4264HB</b>	\$2907	\$3044	\$3159	\$3326	\$3562	\$3650	\$3857	\$4245	\$4441	\$4802	\$5303	\$5921
		OVERALL DIMENSIONS			SEAT DIMENSIONS			BACK DIMENSIONS					
		W	D	H	W	D	H	W	H				
		50.75	24	30.5	22	18	--	21.5	24.5				
		Active weight 500 lbs./seat. <b>Not freestanding.</b> Suspends between 2 units via linking brackets. Wood armcap option - <b>Add \$47</b>											

# SEATING

# GC-BELONG

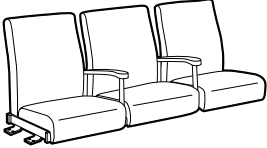
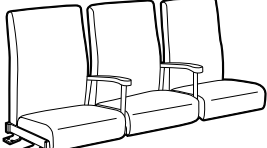
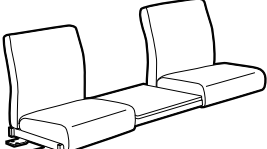
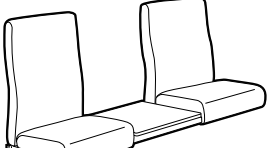
G

DESCRIPTION	MODEL#	STANDARD FABRIC GRADES											
		COM	2	3	4	5	6	7	8	9	10	11	12
 <p><b>Low Back Three Seat Bridge</b> Half Center Arms, Left &amp; Right                      COM Yardage: 5                      Freight Class: 250                      Product Weight (lbs.): 78                      Cubic Feet Per Carton: 38.75</p>	<b>GC4265</b>	\$4155	\$4324	\$4467	\$4675	\$4970	\$5083	\$5340	\$5827	\$6070	\$6521	\$7147	\$7923
	Active weight 500 lbs./seat. <b>Not freestanding.</b> Suspends between 2 units via linking brackets. Wood armcap option - <b>Add \$90</b>	<b>OVERALL DIMENSIONS</b> W D H			<b>SEAT DIMENSIONS</b> W D H			<b>BACK DIMENSIONS</b> W H					
	74.25	24	25.5	22	18	--	21.5	19.5					
 <p><b>High Back Three Seat Bridge</b> Half Center Arms, Left &amp; Right                      COM Yardage: 5.75                      Freight Class: 250                      Product Weight (lbs.): 86                      Cubic Feet Per Carton: 38.75</p>	<b>GC4265HB</b>	\$4377	\$4573	\$4738	\$4977	\$5315	\$5444	\$5741	\$6298	\$6577	\$7097	\$7820	\$8709
	Active weight 500 lbs./seat. <b>Not freestanding.</b> Suspends between 2 units via linking brackets. Wood armcap option - <b>Add \$90</b>	<b>OVERALL DIMENSIONS</b> W D H			<b>SEAT DIMENSIONS</b> W D H			<b>BACK DIMENSIONS</b> W H					
	74.25	24	30.5	22	18	--	21.5	24.5					
 <p><b>Low Back Two Seat Armless Bridge</b> Center Table Top, Left &amp; Right                      COM Yardage: 3.5                      Freight Class: 300                      Product Weight (lbs.): 60                      Cubic Feet Per Carton: 38.75</p>	<b>GC4266</b>	\$3386	\$3505	\$3605	\$3751	\$3958	\$4037	\$4217	\$4557	\$4726	\$5042	\$5481	\$6022
	Active weight 500 lbs./seat. <b>Not freestanding.</b> Suspends between 2 units via linking brackets. • Table top only offered in High Pressure Laminate	<b>OVERALL DIMENSIONS</b> W D H			<b>SEAT DIMENSIONS</b> W D H			<b>BACK DIMENSIONS</b> W H					
	72.75	24	25.5	22	18	--	21.5	19.5					
 <p><b>High Back Two Seat Armless Bridge</b> Center Table Top, Left &amp; Right                      COM Yardage: 4                      Freight Class: 300                      Product Weight (lbs.): 66                      Cubic Feet Per Carton: 38.75</p>	<b>GC4266HB</b>	\$3532	\$3668	\$3783	\$3950	\$4186	\$4274	\$4482	\$4869	\$5066	\$5426	\$5928	\$6547
	Active weight 500 lbs./seat. <b>Not freestanding.</b> Suspends between 2 units via linking brackets. • Table top only offered in High Pressure Laminate	<b>OVERALL DIMENSIONS</b> W D H			<b>SEAT DIMENSIONS</b> W D H			<b>BACK DIMENSIONS</b> W H					
	72.75	24	30.5	22	18	--	21.5	24.5					
 <p><b>Bariatric Low Back Armless Bridge</b> Left &amp; Right                      COM Yardage: 3                      Freight Class: 300                      Product Weight (lbs.): 44                      Cubic Feet Per Carton: 26.5</p>	<b>GC4269</b>	\$1761	\$1863	\$1950	\$2076	\$2252	\$2318	\$2476	\$2766	\$2911	\$3183	\$3559	\$4023
	Active weight 750 lbs. <b>Not freestanding.</b> Suspends between 2 units via linking brackets.	<b>OVERALL DIMENSIONS</b> W D H			<b>SEAT DIMENSIONS</b> W D H			<b>BACK DIMENSIONS</b> W H					
	37.5	24	25.5	32.5	18	--	32.5	19.5					

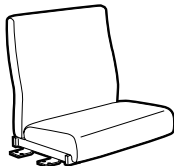
DESCRIPTION	MODEL#	STANDARD FABRIC GRADES											
		COM	2	3	4	5	6	7	8	9	10	11	12
 <p><b>Bariatric High Back Armless Bridge</b> Left &amp; Right COM Yardage: 3.25 Freight Class: 300 Product Weight (lbs.): 50 Cubic Feet Per Carton: 26.5</p>	<b>GC4269HB</b>	\$1873	\$1983	\$2077	\$2211	\$2406	\$2478	\$2647	\$2959	\$3117	\$3412	\$3821	\$4321
	<p><b>OVERALL DIMENSIONS</b></p> <p>W D H</p> <p>37.5 24 30.5</p> <p><b>SEAT DIMENSIONS</b></p> <p>W D H</p> <p>32.5 18 --</p> <p><b>BACK DIMENSIONS</b></p> <p>W H</p> <p>32.5 24.5</p> <p>Active weight 750 lbs. <b>Not freestanding.</b> Suspends between 2 units via linking brackets.</p>												

DESCRIPTION	MODEL#	STANDARD FABRIC GRADES											
		COM	2	3	4	5	6	7	8	9	10	11	12
 <p><b>Single Seat Bench Bridge</b> Left &amp; Right COM Yardage: 1.5 Freight Class: 100 Product Weight (lbs.): 24 Cubic Feet Per Carton: 2.9</p>	<b>GC4271</b>	\$1111	\$1160	\$1205	\$1268	\$1357	\$1388	\$1467	\$1613	\$1686	\$1823	\$2010	\$2242
	<p><b>OVERALL DIMENSIONS</b></p> <p>W D H</p> <p>24.75 26.5 6</p> <p><b>SEAT DIMENSIONS</b></p> <p>W D H</p> <p>24.75 26.5 6</p> <p><b>BACK DIMENSIONS</b></p> <p>W H</p> <p>24.75 6</p> <p>Active weight 500 lbs. <b>Not freestanding.</b> Suspends between 2 units via linking brackets.</p>												

DESCRIPTION	MODEL#	STANDARD FABRIC GRADES											
		COM	2	3	4	5	6	7	8	9	10	11	12
 <p><b>Two Seat Bench Bridge</b> Left &amp; Right COM Yardage: 2.25 Freight Class: 125 Product Weight (lbs.): 64 Cubic Feet Per Carton: 9.25</p>	<b>GC4272</b>	\$2024	\$2098	\$2164	\$2257	\$2391	\$2440	\$2555	\$2775	\$2884	\$3088	\$3370	\$3718
	<p><b>OVERALL DIMENSIONS</b></p> <p>W D H</p> <p>49.75 26.5 6</p> <p><b>SEAT DIMENSIONS</b></p> <p>W D H</p> <p>49.75 26.5 6</p> <p><b>BACK DIMENSIONS</b></p> <p>W H</p> <p>49.75 6</p> <p>Active weight 500 lbs./seat. <b>Not freestanding.</b> Suspends between 2 units via linking brackets.</p>												

DESCRIPTION	MODEL#	STANDARD FABRIC GRADES											
		COM	2	3	4	5	6	7	8	9	10	11	12
 <p><b>Three Seat Bench Bridge</b> Left &amp; Right COM Yardage: 3 Freight Class: 125 Product Weight (lbs.): 68 Cubic Feet Per Carton: 9.25</p>	<b>GC4273</b>	\$2998	\$3099	\$3187	\$3312	\$3490	\$3554	\$3712	\$4002	\$4148	\$4420	\$4795	\$5259
	<p><b>OVERALL DIMENSIONS</b></p> <p>W D H</p> <p>72.75 26.5 6</p> <p><b>SEAT DIMENSIONS</b></p> <p>W D H</p> <p>72.75 26.5 6</p> <p><b>BACK DIMENSIONS</b></p> <p>W H</p> <p>72.75 6</p> <p>Active weight 500 lbs./seat. <b>Not freestanding.</b> Suspends between 2 units via linking brackets.</p>												

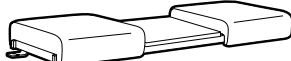
DESCRIPTION	MODEL#	STANDARD FABRIC GRADES											
		COM	2	3	4	5	6	7	8	9	10	11	12
 <p><b>Two Seat Bench Bridge</b> Center Table Top, Left &amp; Right COM Yardage: 2.25 Freight Class: 250 Product Weight (lbs.): 32 Cubic Feet Per Carton: 9.25</p>	<b>GC4276</b>	\$2821	\$2897	\$2964	\$3056	\$3190	\$3240	\$3354	\$3574	\$3684	\$3887	\$4170	\$4517
	<p><b>OVERALL DIMENSIONS</b></p> <p>W D H</p> <p>72.75 26 6</p> <p><b>SEAT DIMENSIONS</b></p> <p>W D H</p> <p>72.75 26 6</p> <p><b>BACK DIMENSIONS</b></p> <p>W H</p> <p>72.75 6</p> <p>Active weight 500 lbs./seat. <b>Not freestanding.</b> Suspends between 2 units via linking brackets. • Table top only offered in High Pressure Laminate</p>												

DESCRIPTION	MODEL#	STANDARD FABRIC GRADES				
-------------	--------	------------------------	--	--	--	--

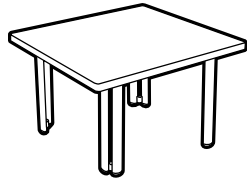

**Rectangular End Table**

GC4281-LP	22 x 18 x 16	100	30	3.4	<b>\$967</b>
GC4281-HP	22 x 18 x 16	100	30	3.4	<b>\$1093</b>

- For a thermally fused laminate top (LP), specify model GC4281-LP.
- For a high pressure laminate top (HP), specify model GC4281-HP.

1" thick top with coordinating 3mm edge. Oval steel tube legs

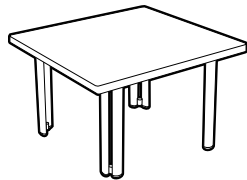

**Square End Table**

GC4288-LP	23 x 23 x 16	100	31	3.4	<b>\$1104</b>
GC4288-HP	23 x 23 x 16	100	31	3.4	<b>\$1227</b>

- For a thermally fused laminate top (LP), specify model GC4288-LP.
- For a high pressure laminate top (HP), specify model GC4288-HP.

1" thick top with coordinating 3mm edge. Oval steel tube legs.



**Square End Table**

GC4282-LP	30 x 30 x 16	150	34	6	<b>\$1239</b>
GC4282-HP	30 x 30 x 16	150	34	6	<b>\$1383</b>

- For a thermally fused laminate top (LP), specify model GC4282-LP.
- For a high pressure laminate top (HP), specify model GC4282-HP.

1" thick top with coordinating 3mm edge. Oval steel tube legs.

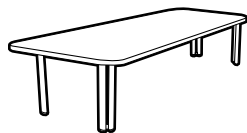

**Rectangular Coffee Table**

GC4283-LP	54 x 22 x 16	125	37	6	<b>\$1248</b>
GC4283-HP	54 x 22 x 16	125	37	6	<b>\$1455</b>

- For a thermally fused laminate top (LP), specify model GC4283-LP.
- For a high pressure laminate top (HP), specify model GC4283-HP.

1" thick top with coordinating 3mm edge. Oval steel tube legs



**Square Coffee Table**

GC4284-LP	36 x 36 x 16	125	37	6	<b>\$1302</b>
GC4284-HP	36 x 36 x 16	125	37	6	<b>\$1455</b>

- For a thermally fused laminate top (LP), specify model GC4284-LP.
- For a high pressure laminate top (HP), specify model GC4284-HP.

1" thick top with coordinating 3mm edge. Oval steel tube legs

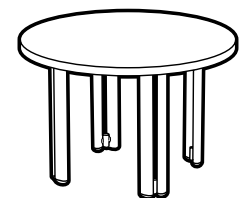

**Round Coffee Table - 24" Diameter**

GC4285-LP	24 x 24 x 16	100	33	3.4	<b>\$1213</b>
GC4285-HP	24 x 24 x 16	100	33	3.4	<b>\$1311</b>

- For a thermally fused laminate top (LP), specify model GC4285-LP.
- For a high pressure laminate top (HP), specify model GC4285-HP.

1" thick top with coordinating 3mm edge. Oval steel tube legs

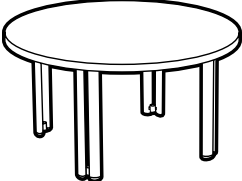
DESCRIPTION	MODEL#	STANDARD FABRIC GRADES				
	GC4286-LP	30 x 30 x 16	150	34	6	<b>\$1218</b>
	GC4286-HP	30 x 30 x 16	150	34	6	<b>\$1311</b>

Round Coffee Table - 30" Diameter

- For a thermally fused laminate top (LP), specify model GC4286-LP.
- For a high pressure laminate top (HP), specify model GC4286-HP.

1" thick top with coordinating 3mm edge. Oval steel tube legs

	GC4287-LP	36 x 36 x 16	125	37	6	<b>\$1379</b>
	GC4287-HP	36 x 36 x 16	125	37	6	<b>\$1530</b>

Round Coffee Table 36" Diameter

- For a thermally fused laminate top (LP), specify model GC4287-LP.
- For a high pressure laminate top (HP), specify model GC4287-HP.

1" thick top with coordinating 3mm edge. Oval steel tube legs

TABLE BRIDGES	MODEL#	DIMENSIONS	FREIGHT CLASS	WT/LBS.	CUBIC FT.	LIST PRICE
---------------	--------	------------	---------------	---------	-----------	------------

	GC4274-LP	23 x 23 x 16	125	25	3.4	<b>\$795</b>
	GC4274-HP	23 x 23 x 16	125	25	3.4	<b>\$850</b>

End Table Bridge, Not Freestanding

- For a thermally fused laminate top (LP), specify model GC4274-LP.
- For a high pressure laminate top (HP), specify model GC4274-HP.

**1 end suspends to a seating unit via linking brackets.** 1" thick top with coordinating 3mm edge. Oval steel tube legs Reversible.

	GC4275-LP	23 x 23 x 1	150	18	3.4	<b>\$556</b>
	GC4275-HP	23 x 23 x 1	150	18	3.4	<b>\$626</b>

Square Table Top, Not Freestanding

- For a thermally fused laminate top (LP), specify model GC4275-LP.
- For a high pressure laminate top (HP), specify model GC4275-HP.

**Suspends between two seating units via linking brackets.** 1" thick top with coordinating 3mm edge. No legs. Reversible.

	GC4277-LP	35 x 35 x 16	125	45	6	<b>\$886</b>
	GC4277-HP	35 x 35 x 16	125	45	6	<b>\$1011</b>

End Corner Table Bridge Not Freestanding

- For a thermally fused laminate top (LP), specify model GC4277-LP.
- For a high pressure laminate top (HP), specify model GC4277-HP.

**Suspends between two seating units via linking brackets.** 1" thick top with coordinating 3mm edge. Oval steel tube legs. Can be used for right or left corner.

	GC4278-LP	35 x 35 x 16	125	45	6	<b>\$886</b>
	GC4278-HP	35 x 35 x 16	125	45	6	<b>\$1011</b>

End Corner Curve Table Bridge Not Freestanding

- For a thermally fused laminate top (LP), specify model GC4278-LP.
- For a high pressure laminate top (HP), specify model GC4278-HP.

**Suspends between two seating units via linking brackets.** 1" thick top with coordinating 3mm edge. Oval steel tube legs. Can be used for right or left corner.

**DESCRIPTION** **MODEL#** **STANDARD FABRIC GRADES**

**GC-CITI**



model GC7875



5" tubular metal leg (shown in Tungsten)



5" tapered wood leg (shown in Maple)

**STANDARD FEATURES**

- Fully upholstered contemporary design, complements timeless decor. Proportions are compact, 31" deep, works well in public spaces, lounges and lobbies.
- The steel leg brings a lightness of scale, while satisfying the need for accessibility
- GC Citi seat legs are 5" high tubular metal, standard in a Tungsten finish.
- The seat is fastened into place and removable over an open frame structure eliminating all barriers and traps below the surface.
- The seat cushion is fully encased by the upholstery with a nylon zippered opening for access if replacement is required. This method of upholstery when using Crypton or vinyl textiles prevents the interior construction from contact with spills and body fluids that could affect the products long-term performance
- Models have removable cushions. Cushions feature removable covers
- The interior wood frame has an interlocking construction providing superior strength and long-term durability
- Arm height on all models is 25".
- Casters are not available on this series
- For added comfort, seats are standard with high density Ultracell foam
- For healthcare textiles and finish options, visit the website at [www.globalfurnituregroup.com](http://www.globalfurnituregroup.com)
- Can be upholstered in standard Global textiles only if Healthcare compliance is not required.
- Shipped fully assembled

**OPTIONAL FEATURES**

- To add sealed seams to your product, contact customer care. Upcharges vary.
- For moisture barrier on seat, specify **(MB)**. Add \$188.
- Leg Type**  
**(MTL)** Metal legs  
**(WDL)** Wood legs. Add \$315.
- Leg Finish**  
**(TBL)** Black  
**(TTU)** Tungsten  
**(CHM)** Chrome. Add \$110. Please specify.
- Wood leg finish:**  
**(AAM)** Absolute **(MWM)** Medium Walnut  
**(BKM)** Black **(NLW)** Natural Walnut  
**(CJM)** Charcoal Java **(ASM)** Night  
**(ACM)** Cherry **(NBM)** Noce Biondo  
**(EMM)** Empire Mahogany **(NGM)** Noce Grigio  
**(EOM)** English Oak **(NEM)** Noce Leggero  
**(ECM)** Espresso Cafe **(NMM)** Noce Medio  
**(TFM)** Fruitwood **(SBM)** Sandy Beach  
**(HGM)** Grey **(SKM)** Shaker Cherry  
**(HOM)** Harvest Oak **(SOM)** Silver Oak  
**(AHM)** Honey **(TWM)** Walnut  
**(JOM)** Jet Onyx **(WTM)** WC Cream  
**(LHM)** Light Honey **(WHM)** White  
**(TMM)** Mahogany **(WCM)** Winter Cherry  
**(AVM)** Maple
- Glide Type** (wood legs)  
**(NM)** White, non-marking nylon glide for most surfaces. No upcharge.  
**(SG)** Steel cushioned glide for carpeted surfaces. Add \$34.  
**(RG)** Rubber, non-slip glide for most hard floor surfaces. Add \$34.  
**(FG)** Felt glide for most hard floor surfaces. Add \$34.

**SUGGESTED APPLICATIONS**

- Guest seating
- Lobbies
- Lounge/Waiting
- Resident rooms

**DESCRIPTION** **MODEL#** **STANDARD FABRIC GRADES**



**Lounge Chair**  
COM Yardage: 4.75  
Freight Class: 250  
Product Weight (lbs.): 67  
Cubic Feet Per Carton: 21

Active weight 300 lbs.

	COM	2	3	4	5	6	7	8	9	10	11	12
--	-----	---	---	---	---	---	---	---	---	----	----	----

<b>GC7875</b>	<b>\$1966</b>	<b>\$2142</b>	<b>\$2288</b>	<b>\$2504</b>	<b>\$2808</b>	<b>\$2952</b>	<b>\$3227</b>	<b>\$3669</b>	<b>\$4007</b>	<b>\$4385</b>	<b>\$5162</b>	<b>\$5991</b>
---------------	---------------	---------------	---------------	---------------	---------------	---------------	---------------	---------------	---------------	---------------	---------------	---------------

OVERALL DIMENSIONS			SEAT DIMENSIONS			BACK DIMENSIONS	
W	D	H	W	D	H	W	H

30	31	30	22	19.5	17.5	22	12.5
----	----	----	----	------	------	----	------



GC-COMET



model GC2180 (TUN)



Black Plastic Arms

Wallsaver Leg

STANDARD FEATURES

- The rounded steel frame and durable seat cushion will ensure years of use.
- Black plastic arms are standard.
- This bariatric model has been specially designed in consultation with healthcare specialists to meet the needs of larger individuals.
- Reinforced steel seat frame accommodates users up to 500 pounds.
- For added comfort, seats are standard with high density Ultracell bio foam.
- The steel frame is available in Black (TBL), Buzz Blue (TBZ), Cactus (TCC), Carrot (TCR), Cloud (TIV), Designer White (TDW), Dijon (TDJ), Eggplant (TEG), Fog (TFO), Frost (TFR), Ink (TIN), Kalua (TKA), Latte (TLA), Mocha (TMO), Nevada (TNE), Sand (TSN), Scarlet (TSR), Shadow (TSH), Toast (TOA) and Tungsten (TTU). Please specify.
- Standard glide is a plastic dome shape on back legs, flat glide on front legs.
- Bariatric models stack 2 high on floor. No dolly available.
- For Globalcare textiles and finish options, visit the website at globalfurnituregroup.com
- Can be upholstered in standard Global textiles only if Healthcare compliance is not required.
- Shipped fully assembled

OPTIONAL FEATURES

- Plastic arms available in Shadow (SHW) and Toast (TOA). Please specify. Add \$44.
- A selection of glide options is available. Glides must be chosen to best suit flooring type and site conditions.
- Steel cushioned glides (B) are available - Add \$31.
- Glides with felt pads (FG) are available for vinyl sheet, cork or laminate flooring. Please specify. Add \$60.
- Glides with rubber pads (RG) are available for vinyl, hardwood, laminate, stone or ceramic flooring. Please specify. Add \$60.
- For moisture barrier on seat, specify (MB). Add \$193.
- **Frame finish**  
Painted finishes - no upcharge:  
(TBL) Black  
(TBZ) Buzz Blue  
(TCC) Cactus  
(TCR) Carrot  
(TIV) Cloud  
(TDW) Designer White  
(TDJ) Dijon  
(TEG) Eggplant  
(TFO) Fog  
(TFR) Frost  
(TIN) Ink  
(TKA) Kalua  
(TLA) Latte  
(TMO) Mocha  
(TNE) Nevada  
(TSN) Sand  
(TSR) Scarlet  
(TSH) Shadow  
(TOA) Toast  
(TTU) Tungsten  
Plated finish - Add \$34:  
(CHM) Chrome

SUGGESTED APPLICATIONS

- Bariatric seating
- Patient Rooms
- Waiting Areas
- Exam Rooms
- Guest Seating
- Dining Rooms

DESCRIPTION	MODEL#	STANDARD FABRIC GRADES											
		COM	2	3	4	5	6	7	8	9	10	11	12
 <p><b>Bariatric Lounge Chair</b> COM Yardage: 1.75 Freight Class: 300 Product Weight (lbs.): 44 Cubic Feet Per Carton: 23</p>	GC2180	\$1242	\$1300	\$1352	\$1425	\$1528	\$1566	\$1658	\$1830	\$1914	\$2073	\$2291	\$2560
		Active weight 500 lbs.											
		OVERALL DIMENSIONS			SEAT DIMENSIONS			BACK DIMENSIONS					
		W	D	H	W	D	H	W	H				
		31.5	27	38	26.5	18.5	18	26.5	20				

## GC ISLANDS



model GC4075



model GC4076

### STANDARD FEATURES



- GC Islands offers wood guest seating with contemporary styling.
- Two back styles: Upholstered back pad or horizontal wood slat back.
- Legs are equipped with White non-marking polypropylene glides. Suitable for both carpet and hard surface flooring.
- All cushions are fixed and non-removable.
- Cushions are made with highly resilient foam and seats are equipped with a synthetic rubberized webbing suspension system for extra comfort
- Seat cushion underside is finished with a Black impermeable surface material
- Does not stack
- For Globalcare textiles and finish options, visit the website at [globalfurnituregroup.com](http://globalfurnituregroup.com).
- Can be upholstered in standard Global textiles if Healthcare compliance is not required.

### OPTIONAL FEATURES

- Wood frame available in Absolute (AAM), Black (BKM), Cherry (ACM), English Oak (EOM), Espresso Cafe (ECM), Fruitwood (TFM), Gray (HGM), Honey (AHM), Mahogany (TMM), Maple (AVM), Medium Walnut (MWM), Natural Walnut (NLW), Night (ASM), Noce Biondo (NBM), Noce Grigio (NGM), Noce Leggero (NEM), Noce Medio (NMM), Sandy Beach (SKM), Shaker Cherry (SKM), Silver Oak (SOM), Walnut (TWM), WC Cream (WTM), White (WHM) and Winter Cherry (WCM). Please specify.
- For moisture barrier on seat, specify **(MB)**. Add **\$129** per seat.
- Back sealed seam available, please specify **(S2)**. Add **\$38**.

### SUGGESTED APPLICATIONS

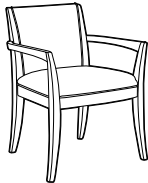
- Dining/Cafeteria
- Guest seating
- Lobbies
- Lounge/Waiting
- Office/Meeting
- Patient rooms
- Resident rooms

DESCRIPTION	MODEL#	STANDARD FABRIC GRADES											
		COM	2	3	4	5	6	7	8	9	10	11	12
 <p><b>Armchair w/Upholstered Back</b> COM Yardage: 1.5 Freight Class: 300 Product Weight (lbs.): 25 Cubic Feet Per Carton: 13.25</p>	GC4075	\$1016	\$1061	\$1105	\$1171	\$1260	\$1300	\$1376	\$1505	\$1606	\$1715	\$1941	\$2176
		<b>OVERALL DIMENSIONS</b>			<b>SEAT DIMENSIONS</b>			<b>BACK DIMENSIONS</b>					
		W	D	H	W	D	H	W	H				
			24.5	23.5	32	20.5	18	18.5	19	13			
 <p><b>Armchair w/Horizontal Wood Slat Back</b> COM Yardage: 1 Freight Class: 300 Product Weight (lbs.): 25 Cubic Feet Per Carton: 13.25</p>	GC4076	\$1098	\$1130	\$1159	\$1206	\$1268	\$1292	\$1349	\$1431	\$1499	\$1566	\$1723	\$1880
		<b>OVERALL DIMENSIONS</b>			<b>SEAT DIMENSIONS</b>			<b>BACK DIMENSIONS</b>					
		W	D	H	W	D	H	W	H				
			24.5	23.5	32	20.5	18	18.5	19	13			

GC SIDERO™



model GC6923

STANDARD FEATURES

- GC Sidero is a collection of contemporary multi-purpose stacking chairs with a sculptured look, featuring wide, curved arms and a round tubular wallsaver steel frame.
- Available in arm and armless models (except on bariatric models) with three seat widths, two back heights, and a four-legged and sled base frame.
- Offers options that allow the chair to meet rigorous infection prevention control requirements.
- Compound curved back provides comfort and support in multiple seating positions
- Rugged steel frame made from round welded steel tubing 7/8" dia.
- Frames feature a wall saver design to prevent back contact with wall
- Standard glide is durable Black polypropylene
- For added comfort, seats are standard with high density Ultracell bio foam
- Three seat widths: 19.5" (standard size), 24" (mid size) and 30" (bariatric).
- Two different back constructions are offered:
  1. Concealed back attachment: two piece back covering the back support brackets when fastened in place.
  2. Single piece back with a pullover style upholstery cover and support bracket fastened on the outer back.
- Low back and high back models are available:
  1. Low back version is available on all three seat widths: 15.5" high.
  2. High back version on 19" and 24" seat widths: 21" high.
  3. High back version on bariatric 30" seat width: 21.75" high.
- Fiberglass nylon reinforced arms have a generous width and extend to the front of the seat. They offer additional support and help to stabilize users as they sit or exit the chair. Available in Black only.
- Select GC Sidero models are equipped with a polypropylene seat shroud that helps avoid frame imprints on upholstered seats when chairs are stacked. Protective seat shroud is standard on all 19.5" seat width models.
- 30" Bariatric and 24" seat width models do not have a seat shroud and are standard with a vinyl covered seat underside.
- Active weight capacity for 19.5" seat width models is up to 300 lbs., and up to 500 lbs for 24" seat width and Bariatric models.
- For healthcare textiles and finish options, visit the website at [globalfurnituregroup.com](http://globalfurnituregroup.com).
- Can be upholstered in standard Global textiles if healthcare compliance is not required.





OPTIONAL FEATURES



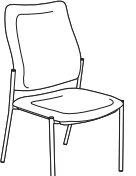

- To respond to higher expectations for housekeeping and infection prevention, single piece back underside and all seat pan undersides can be completely sealed and seat shroud (if standard on the model) would be removed.
  - For standard models with single piece back, please specify **(BSS)**. Add **\$72**.
  - For standard models with concealed attachment back, please specify **(STS)**. Add **\$47**.
  - For 24" width models with single piece back, please specify **(BSS)**. Add **\$84**.
  - For 24" width models with concealed attachment back, please specify **(STS)**. Add **\$65**.
  - For bariatric models with single piece back, please specify **(BSS)**. Add **\$102**.
  - For bariatric models with concealed attachment back, please specify **(STS)**. Add **\$66**.
- Chrome frame available, please specify **(CHM)**. Add **\$44** list upcharge.
- A selection of glide options is available. Glides must be chosen to best suit flooring type and site conditions.
- For hard surface floors, please specify opaque non-marking glides **(NM)**. No upcharge.
- Steel cushioned glides **(B)** are available on four legged models. Add **\$31** list upcharge.
- Glides with felt pads **(FG)** are available for vinyl sheet, cork or laminate flooring. Please specify. Add **\$60**.
- Glides with rubber pads **(RG)** are available for vinyl, hardwood, laminate, stone or ceramic flooring. Please specify. Add **\$60**.
- Seams can be sealed to prevent penetration of fluids through the stitching. Sealed seams are only available with select textiles. Please contact CustomerCare for more information.
- Moisture Barrier for 19.5" seat width - Add \$129 list upcharge per seat. For 24" seat width models - Add \$129 list upcharge per seat.. For Bariatric models - Add \$198 list upcharge per seat.
- **Frame finish**  
Painted finishes - no upcharge:
  - (TBL)** Black
  - (TIV)** Cloud
  - (TDW)** Designer White
  - (TFO)** Fog
  - (TFR)** Frost
  - (TKA)** Kalua
  - (TLA)** Latte
  - (TMO)** Mocha
  - (TNE)** Nevada
  - (TSN)** Sand
  - (TSH)** Shadow
  - (TOA)** Toast
  - (TTU)** Tungsten
  - Plated finish - Add \$44:
  - (CHM)** Chrome

SEAT WIDTH	STACKING CAPABILITIES
19.5"	Four-legged armchairs and side chairs can stack up to 5 high on the floor or 8 high on dolly #2125WS. Sled base armchairs and side chairs do not stack.
24" midsize	Four-legged armchairs and side chairs can stack up to 5 high on the floor. No dolly is available. Sled base armchairs and side chairs do not stack.
30" bariatric	Four-legged armchairs can stack up to 2 high on the floor. No dolly is available. Sled base models do not stack.





SUGGESTED APPLICATIONS





- Bariatric seating (some models)
- Dining/Cafeteria
- Guest seating
- Lobbies
- Lounge/Waiting
- Office/Meeting
- Patient rooms
- Resident rooms
- Stacking
- Treatment/Exam rooms



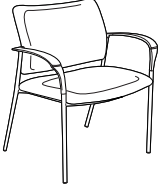

DESCRIPTION	MODEL#	STANDARD FABRIC GRADES											
		COM	2	3	4	5	6	7	8	9	10	11	12
 <p><b>LB Stacking Armchair, 4 Leg Base</b> with concealed attachment                      COM Yardage: 1.25                      Freight Class: 250                      Product Weight (lbs.): 29                      Cubic Feet Per Carton: 13.5</p>	GC6900	\$675	\$739	\$793	\$871	\$985	\$1038	\$1139	\$1303	\$1429	\$1566	\$1852	\$2159
		OVERALL DIMENSIONS			SEAT DIMENSIONS			BACK DIMENSIONS					
		W	D	H	W	D	H	W	H				
			25.5	24	33	19.5	18	17.5	19	15.5			
 <p><b>HB Stacking Armchair, 4 Leg Base</b> with concealed attachment                      COM Yardage: 1.75                      Freight Class: 250                      Product Weight (lbs.): 33                      Cubic Feet Per Carton: 15.25</p>	GC6900HB	\$821	\$893	\$956	\$1046	\$1175	\$1235	\$1349	\$1536	\$1680	\$1837	\$2165	\$2512
		OVERALL DIMENSIONS			SEAT DIMENSIONS			BACK DIMENSIONS					
		W	D	H	W	D	H	W	H				
			25.5	24	38.5	19.5	18	17.5	19	21			
 <p><b>LB Stacking Chair, 4 Leg Base</b> with concealed attachment                      COM Yardage: 1.25                      Freight Class: 250                      Product Weight (lbs.): 26                      Cubic Feet Per Carton: 11.25</p>	GC6901	\$634	\$697	\$755	\$832	\$945	\$1000	\$1100	\$1262	\$1388	\$1526	\$1811	\$2119
		OVERALL DIMENSIONS			SEAT DIMENSIONS			BACK DIMENSIONS					
		W	D	H	W	D	H	W	H				
			21	24	33	19.5	18	17.5	19	15.5			
 <p><b>HB Stacking Chair, 4 Leg Base</b> with concealed attachment                      COM Yardage: 1.75                      Freight Class: 250                      Product Weight (lbs.): 30                      Cubic Feet Per Carton: 14.5</p>	GC6901HB	\$778	\$850	\$913	\$1003	\$1132	\$1192	\$1306	\$1493	\$1637	\$1794	\$2122	\$2469
		OVERALL DIMENSIONS			SEAT DIMENSIONS			BACK DIMENSIONS					
		W	D	H	W	D	H	W	H				
			21	24	38.5	19.5	18	17.5	19	21			
 <p><b>LB Armchair, Sled Base</b> with concealed attachment                      COM Yardage: 1.25                      Freight Class: 250                      Product Weight (lbs.): 32                      Cubic Feet Per Carton: 13.5</p>	GC6902	\$888	\$952	\$1006	\$1085	\$1198	\$1251	\$1352	\$1516	\$1643	\$1782	\$2066	\$2372
		OVERALL DIMENSIONS			SEAT DIMENSIONS			BACK DIMENSIONS					
		W	D	H	W	D	H	W	H				
			25.5	24	33	19.5	18	17.5	19	15.5			

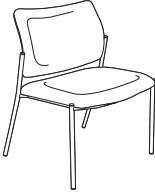
DESCRIPTION	MODEL#	STANDARD FABRIC GRADES											
		COM	2	3	4	5	6	7	8	9	10	11	12
 <p><b>HB Armchair, Sled Base</b> with concealed attachment COM Yardage: 1.75 Freight Class: 250 Product Weight (lbs.): 36 Cubic Feet Per Carton: 15.25</p> <p>Active weight 300 lbs. <b>Does not stack.</b></p>	<b>GC6902HB</b>	\$959	\$1031	\$1094	\$1184	\$1313	\$1373	\$1487	\$1674	\$1818	\$1975	\$2303	\$2650
		OVERALL DIMENSIONS			SEAT DIMENSIONS			BACK DIMENSIONS					
		W	D	H	W	D	H	W	H				
		25.5	24	38.5	19.5	18	17.5	19	21				
 <p><b>LB Side Chair, Sled Base</b> with concealed attachment COM Yardage: 1.25 Freight Class: 250 Product Weight (lbs.): 30 Cubic Feet Per Carton: 11.25</p> <p>Active weight 300 lbs. <b>Does not stack.</b></p>	<b>GC6903</b>	\$842	\$904	\$958	\$1037	\$1150	\$1203	\$1304	\$1468	\$1595	\$1734	\$2018	\$2324
		OVERALL DIMENSIONS			SEAT DIMENSIONS			BACK DIMENSIONS					
		W	D	H	W	D	H	W	H				
		21	24	33	19.5	18	17.5	19	15.5				
 <p><b>HB Side Chair, Sled Base</b> with concealed attachment COM Yardage: 1.75 Freight Class: 250 Product Weight (lbs.): 34 Cubic Feet Per Carton: 14.5</p> <p>Active weight 300 lbs. <b>Does not stack.</b></p>	<b>GC6903HB</b>	\$1000	\$1071	\$1136	\$1227	\$1356	\$1414	\$1532	\$1715	\$1858	\$2016	\$2345	\$2693
		OVERALL DIMENSIONS			SEAT DIMENSIONS			BACK DIMENSIONS					
		W	D	H	W	D	H	W	H				
		21	24	38.5	19.5	18	17.5	19	21				
 <p><b>Low Back Stacking Chair</b> 4 Leg Base COM Yardage: 1.25 Freight Class: 250 Product Weight (lbs.): 26 Cubic Feet Per Carton: 11.25</p> <p>Active weight 300 lbs. Single piece back with pullover style upholstery cover with <b>exposed support brackets</b> on the outer back.</p>	<b>GC6912</b>	\$653	\$697	\$740	\$795	\$874	\$912	\$986	\$1101	\$1190	\$1288	\$1493	\$1712
		OVERALL DIMENSIONS			SEAT DIMENSIONS			BACK DIMENSIONS					
		W	D	H	W	D	H	W	H				
		21	24	33	19.5	18	17.5	19	15.5				
 <p><b>High Back Stacking Chair</b> 4 Leg Base COM Yardage: 1.75 Freight Class: 250 Product Weight (lbs.): 30 Cubic Feet Per Carton: 14.5</p> <p>Active weight 300 lbs. Single piece back with pullover style upholstery cover with <b>exposed support brackets</b> on the outer back.</p>	<b>GC6912HB</b>	\$787	\$850	\$904	\$983	\$1096	\$1149	\$1250	\$1414	\$1541	\$1680	\$1964	\$2270
		OVERALL DIMENSIONS			SEAT DIMENSIONS			BACK DIMENSIONS					
		W	D	H	W	D	H	W	H				
		21	24	38.5	19.5	18	17.5	19	21				

# SEATING

DESCRIPTION	MODEL#	STANDARD FABRIC GRADES											
		COM	2	3	4	5	6	7	8	9	10	11	12
 <p><b>LB Stacking Armchair, 4 Leg Base</b> COM Yardage: 1.25 Freight Class: 250 Product Weight (lbs.): 29 Cubic Feet Per Carton: 13.5</p>	GC6913	\$695	\$739	\$782	\$837	\$916	\$954	\$1028	\$1143	\$1232	\$1330	\$1535	\$1754
	<b>OVERALL DIMENSIONS</b>			<b>SEAT DIMENSIONS</b>			<b>BACK DIMENSIONS</b>						
	W	D	H	W	D	H	W	H					
	25.5	24	33	19.5	18	17.5	19	15.5					
<p>Active weight 300 lbs. Single piece back with pullover style upholstery cover with <b>exposed support brackets</b> on the outer back.</p>													
 <p><b>HB Stacking Armchair, 4 Leg Base</b> COM Yardage: 1.75 Freight Class: 250 Product Weight (lbs.): 33 Cubic Feet Per Carton: 15.25</p>	GC6913HB	\$829	\$893	\$947	\$1025	\$1139	\$1192	\$1293	\$1457	\$1583	\$1720	\$2006	\$2313
	<b>OVERALL DIMENSIONS</b>			<b>SEAT DIMENSIONS</b>			<b>BACK DIMENSIONS</b>						
	W	D	H	W	D	H	W	H					
	25.5	24	38.5	19.5	18	17.5	19	21					
<p>Active weight 300 lbs. Single piece back with pullover style upholstery cover with <b>exposed support brackets</b> on the outer back.</p>													
 <p><b>LB Armchair, Sled Base</b> COM Yardage: 1.25 Freight Class: 250 Product Weight (lbs.): 32 Cubic Feet Per Carton: 13.5</p>	GC6914	\$908	\$952	\$995	\$1051	\$1131	\$1168	\$1242	\$1357	\$1446	\$1545	\$1752	\$1968
	<b>OVERALL DIMENSIONS</b>			<b>SEAT DIMENSIONS</b>			<b>BACK DIMENSIONS</b>						
	W	D	H	W	D	H	W	H					
	25.5	24	33	19.5	18	17.5	19	15.5					
<p>Active weight 300 lbs. Single piece back with pullover style upholstery cover with <b>exposed support brackets</b> on the outer back.</p>													
 <p><b>LB Armchair, Sled Base</b> COM Yardage: 1.75 Freight Class: 250 Product Weight (lbs.): 36 Cubic Feet Per Carton: 15.25</p>	GC6914HB	\$1053	\$1115	\$1169	\$1248	\$1361	\$1414	\$1515	\$1679	\$1806	\$1945	\$2229	\$2535
	<b>OVERALL DIMENSIONS</b>			<b>SEAT DIMENSIONS</b>			<b>BACK DIMENSIONS</b>						
	W	D	H	W	D	H	W	H					
	25.5	24	38.5	19.5	18	17.5	19	21					
<p>Active weight 300 lbs. Single piece back with pullover style upholstery cover with <b>exposed support brackets</b> on the outer back. <b>Does not stack.</b></p>													
 <p><b>Low Back Side Chair, Sled Base</b> COM Yardage: 1.25 Freight Class: 250 Product Weight (lbs.): 30 Cubic Feet Per Carton: 11.25</p>	GC6915	\$860	\$904	\$947	\$1003	\$1083	\$1120	\$1194	\$1309	\$1398	\$1497	\$1704	\$1920
	<b>OVERALL DIMENSIONS</b>			<b>SEAT DIMENSIONS</b>			<b>BACK DIMENSIONS</b>						
	W	D	H	W	D	H	W	H					
	21	24	33	19.5	18	17.5	19	15.5					
<p>Active weight 300 lbs. Single piece back with pullover style upholstery cover with <b>exposed support brackets</b> on the outer back. <b>Does not stack.</b></p>													

DESCRIPTION	MODEL#	STANDARD FABRIC GRADES											
		COM	2	3	4	5	6	7	8	9	10	11	12
 <p><b>HB Side Chair, Sled Base</b> COM Yardage: 1.75 Freight Class: 250 Product Weight (lbs.): 34 Cubic Feet Per Carton: 14.5</p>	<b>GC6915HB</b>	\$1008	\$1071	\$1129	\$1206	\$1319	\$1374	\$1474	\$1636	\$1762	\$1900	\$2185	\$2493
		OVERALL DIMENSIONS			SEAT DIMENSIONS			BACK DIMENSIONS					
		W	D	H	W	D	H	W	H				
		21	24	38.5	19.5	18	17.5	19	21				
		Active weight 300 lbs. Single piece back with pullover style upholstery cover with <b>exposed support brackets</b> on the outer back.											
 <p><b>LB Midsize Stacking Armchair, 4 Leg Base</b> COM Yardage: 1.75 Freight Class: 250 Product Weight (lbs.): 34 Cubic Feet Per Carton: 16.</p>	<b>GC6916</b>	\$1010	\$1073	\$1131	\$1208	\$1321	\$1376	\$1476	\$1638	\$1764	\$1902	\$2187	\$2495
		OVERALL DIMENSIONS			SEAT DIMENSIONS			BACK DIMENSIONS					
		W	D	H	W	D	H	W	H				
		30.5	24	33	24	18	17.5	24	15.5				
		Active weight 500 lbs. Single piece back with pullover style upholstery cover with <b>exposed support brackets</b> on the outer back.											
 <p><b>HB Midsize Stacking Armchair, 4 Leg Base</b> COM Yardage: 2 Freight Class: 250 Product Weight (lbs.): 37 Cubic Feet Per Carton: 18.25</p>	<b>GC6916HB</b>	\$1155	\$1227	\$1290	\$1380	\$1509	\$1569	\$1683	\$1870	\$2014	\$2171	\$2499	\$2846
		OVERALL DIMENSIONS			SEAT DIMENSIONS			BACK DIMENSIONS					
		W	D	H	W	D	H	W	H				
		30.5	24	38.5	24	18	17.5	24	21				
		Active weight 500 lbs. Single piece back with pullover style upholstery cover with <b>exposed support brackets</b> on the outer back.											
 <p><b>LB Midsize Stacking Chair, 4 Leg Base</b> COM Yardage: 1.75 Freight Class: 250 Product Weight (lbs.): 30 Cubic Feet Per Carton: 14.5</p>	<b>GC6917</b>	\$969	\$1032	\$1090	\$1167	\$1280	\$1335	\$1435	\$1597	\$1723	\$1861	\$2146	\$2454
		OVERALL DIMENSIONS			SEAT DIMENSIONS			BACK DIMENSIONS					
		W	D	H	W	D	H	W	H				
		26	24	33	24	18	17.5	24	15.5				
		Active weight 500 lbs. Single piece back with pullover style upholstery cover with <b>exposed support brackets</b> on the outer back.											
 <p><b>HB Midsize Stacking Chair, 4 Leg Base</b> COM Yardage: 2 Freight Class: 300 Product Weight (lbs.): 33 Cubic Feet Per Carton: 17.75</p>	<b>GC6917HB</b>	\$1112	\$1184	\$1247	\$1337	\$1466	\$1526	\$1640	\$1827	\$1971	\$2128	\$2456	\$2803
		OVERALL DIMENSIONS			SEAT DIMENSIONS			BACK DIMENSIONS					
		W	D	H	W	D	H	W	H				
		26	24	38.5	24	18	17.5	24	21				
		Active weight 500 lbs. Single piece back with pullover style upholstery cover with <b>exposed support brackets</b> on the outer back.											

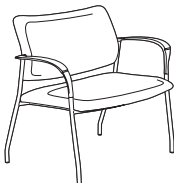
DESCRIPTION	MODEL#	STANDARD FABRIC GRADES											
		COM	2	3	4	5	6	7	8	9	10	11	12
 <b>LB Midsize Armchair, Sled Base</b> COM Yardage: 1.75 Freight Class: 250 Product Weight (lbs.): 36 Cubic Feet Per Carton: 16	<b>GC6918</b>	\$1248	\$1311	\$1369	\$1448	\$1559	\$1614	\$1714	\$1876	\$2002	\$2140	\$2425	\$2733
	<b>OVERALL DIMENSIONS</b>			<b>SEAT DIMENSIONS</b>			<b>BACK DIMENSIONS</b>						
	W	D	H	W	D	H	W	H					
	30.5	24	33	24	18	17.5	24	15.5					
Active weight 500 lbs. Single piece back with pullover style upholstery cover with <b>exposed support brackets</b> on the outer back.													
 <b>HB Midsize Armchair, Sled Base</b> COM Yardage: 2 Freight Class: 250 Product Weight (lbs.): 39 Cubic Feet Per Carton: 18.25	<b>GC6918HB</b>	\$1404	\$1476	\$1541	\$1632	\$1761	\$1819	\$1937	\$2120	\$2263	\$2421	\$2750	\$3098
	<b>OVERALL DIMENSIONS</b>			<b>SEAT DIMENSIONS</b>			<b>BACK DIMENSIONS</b>						
	W	D	H	W	D	H	W	H					
	30.5	24	38.5	24	18	17.5	24	21					
Active weight 500 lbs. Single piece back with pullover style upholstery cover with <b>exposed support brackets</b> on the outer back.													
 <b>LB Midsize Side Chair, Sled Base</b> COM Yardage: 1.75 Freight Class: 250 Product Weight (lbs.): 34 Cubic Feet Per Carton: 14.5	<b>GC6919</b>	\$1204	\$1266	\$1324	\$1403	\$1514	\$1569	\$1669	\$1831	\$1957	\$2095	\$2380	\$2688
	<b>OVERALL DIMENSIONS</b>			<b>SEAT DIMENSIONS</b>			<b>BACK DIMENSIONS</b>						
	W	D	H	W	D	H	W	H					
	26	24	33	24	18	17.5	24	15.5					
Active weight 500 lbs. Single piece back with pullover style upholstery cover with <b>exposed support brackets</b> on the outer back.													
 <b>HB Midsize Side Chair, Sled Base</b> COM Yardage: 2 Freight Class: 250 Product Weight (lbs.): 37 Cubic Feet Per Carton: 17.75	<b>GC6919HB</b>	\$1362	\$1434	\$1497	\$1587	\$1716	\$1776	\$1890	\$2077	\$2221	\$2378	\$2706	\$3053
	<b>OVERALL DIMENSIONS</b>			<b>SEAT DIMENSIONS</b>			<b>BACK DIMENSIONS</b>						
	W	D	H	W	D	H	W	H					
	26	24	38.5	24	18	17.5	24	21					
Active weight 500 lbs. Single piece back with pullover style upholstery cover with <b>exposed support brackets</b> on the outer back.													
 <b>LB Bariatric Stacking Armchair, 4 Leg Base</b> COM Yardage: 2.5 Freight Class: 250 Product Weight (lbs.): 46 Cubic Feet Per Carton: 20.5	<b>GC6920</b>	\$1342	\$1433	\$1512	\$1622	\$1787	\$1863	\$2009	\$2239	\$2417	\$2613	\$3025	\$3461
	<b>OVERALL DIMENSIONS</b>			<b>SEAT DIMENSIONS</b>			<b>BACK DIMENSIONS</b>						
	W	D	H	W	D	H	W	H					
	36.5	26	33	30	18	17.5	30	15.5					
Active weight 500 lbs. Single piece back with pullover style upholstery cover with <b>exposed support brackets</b> on the outer back.													

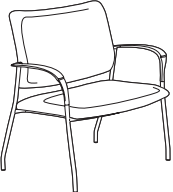

DESCRIPTION	MODEL#	STANDARD FABRIC GRADES											
		COM	2	3	4	5	6	7	8	9	10	11	12
	GC6920HB	\$1407	\$1508	\$1595	\$1721	\$1899	\$1982	\$2144	\$2399	\$2599	\$2819	\$3272	\$3755
		<b>OVERALL DIMENSIONS</b>		<b>SEAT DIMENSIONS</b>			<b>BACK DIMENSIONS</b>						
		W	D	H	W	D	H	W	H				
<b>HB Bariatric Stacking Armchair, 4 Leg Base</b> COM Yardage: 2.75 Freight Class: 300 Product Weight (lbs.): 47 Cubic Feet Per Carton: 22.5	Active weight 500 lbs. Single piece back with pullover style upholstery cover with <b>exposed support brackets</b> on the outer back.	36.5	26	38.5	30	18	17.5	30	21				



DESCRIPTION	MODEL#	STANDARD FABRIC GRADES											
		COM	2	3	4	5	6	7	8	9	10	11	12
	GC6921	\$1607	\$1698	\$1777	\$1893	\$2052	\$2128	\$2274	\$2504	\$2682	\$2880	\$3290	\$3726
		<b>OVERALL DIMENSIONS</b>		<b>SEAT DIMENSIONS</b>			<b>BACK DIMENSIONS</b>						
		W	D	H	W	D	H	W	H				
<b>LB Bariatric Armchair, Sled Base</b> COM Yardage: 2.5 Freight Class: 250 Product Weight (lbs.): 48 Cubic Feet Per Carton: 20.5	Active weight 500 lbs. Single piece back with pullover style upholstery cover with <b>exposed support brackets</b> on the outer back. <b>Does not stack.</b>	36.5	26	33	30	18	17.5	30	15.5				



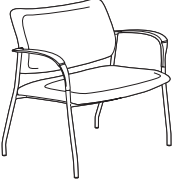
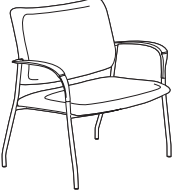
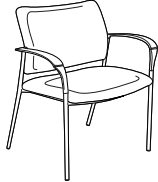

DESCRIPTION	MODEL#	STANDARD FABRIC GRADES											
		COM	2	3	4	5	6	7	8	9	10	11	12
	GC6921HB	\$1591	\$1696	\$1789	\$1914	\$2097	\$2184	\$2350	\$2616	\$2819	\$3046	\$3514	\$4013
		<b>OVERALL DIMENSIONS</b>		<b>SEAT DIMENSIONS</b>			<b>BACK DIMENSIONS</b>						
		W	D	H	W	D	H	W	H				
<b>HB Bariatric Armchair, Sled Base</b> COM Yardage: 3 Freight Class: 300 Product Weight (lbs.): 51 Cubic Feet Per Carton: 22.5	Active weight 500 lbs. Single piece back with pullover style upholstery cover with <b>exposed support brackets</b> on the outer back. <b>Does not stack.</b>	36.5	26	38.5	30	18	17.5	30	21				

DESCRIPTION	MODEL#	STANDARD FABRIC GRADES											
		COM	2	3	4	5	6	7	8	9	10	11	12
	GC6922	\$1607	\$1698	\$1777	\$1893	\$2052	\$2128	\$2274	\$2504	\$2682	\$2880	\$3290	\$3726
		<b>OVERALL DIMENSIONS</b>		<b>SEAT DIMENSIONS</b>			<b>BACK DIMENSIONS</b>						
		W	D	H	W	D	H	W	H				
<b>LB Bariatric Stacking Armchair, Sled Base with concealed attachment</b> COM Yardage: 2.5 Freight Class: 250 Product Weight (lbs.): 48 Cubic Feet Per Carton: 20.5	Active weight 500 lbs.	36.5	26	33	30	18	17.5	30	15.5				

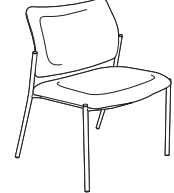
DESCRIPTION	MODEL#	STANDARD FABRIC GRADES											
		COM	2	3	4	5	6	7	8	9	10	11	12
	GC6922HB	\$1591	\$1696	\$1789	\$1914	\$2097	\$2184	\$2350	\$2616	\$2819	\$3046	\$3514	\$4013
		<b>OVERALL DIMENSIONS</b>		<b>SEAT DIMENSIONS</b>			<b>BACK DIMENSIONS</b>						
		W	D	H	W	D	H	W	H				
<b>HB Bariatric Stacking Armchair, Sled Base with concealed attachment</b> COM Yardage: 3 Freight Class: 300 Product Weight (lbs.): 51 Cubic Feet Per Carton: 22.5	Active weight 500 lbs.	36.5	26	38.5	30	18	17.5	30	21				

# SEATING

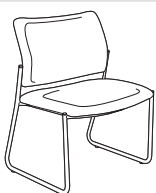
DESCRIPTION	MODEL#	STANDARD FABRIC GRADES											
		COM	2	3	4	5	6	7	8	9	10	11	12
 <p><b>LB Bariatric Stacking Armchair, 4 Leg Base</b> with concealed attachment            COM Yardage: 2.5            Freight Class: 250            Product Weight (lbs.): 46            Cubic Feet Per Carton: 20.5</p>	GC6923	\$1342	\$1433	\$1512	\$1622	\$1787	\$1863	\$2009	\$2239	\$2417	\$2613	\$3025	\$3461
		OVERALL DIMENSIONS			SEAT DIMENSIONS			BACK DIMENSIONS					
		W	D	H	W	D	H	W	H				
			36.5	26	33	30	18	17.5		30	15.5		
 <p><b>HB Bariatric Stacking Armchair, 4 Leg Base</b> with concealed attachment            COM Yardage: 3            Freight Class: 250            Product Weight (lbs.): 47            Cubic Feet Per Carton: 22.5</p>	GC6923HB	\$1407	\$1508	\$1595	\$1721	\$1899	\$1982	\$2144	\$2399	\$2599	\$2819	\$3272	\$3755
		OVERALL DIMENSIONS			SEAT DIMENSIONS			BACK DIMENSIONS					
		W	D	H	W	D	H	W	H				
			36.5	26	38.5	30	18	17.5		30	21		
 <p><b>LB Midsize Stacking Armchair, 4 Leg Base</b> with concealed attachment            COM Yardage: 2.5            Freight Class: 250            Product Weight (lbs.): 34            Cubic Feet Per Carton: 16</p>	GC6924	\$982	\$1073	\$1152	\$1268	\$1427	\$1503	\$1649	\$1879	\$2057	\$2255	\$2665	\$3101
		OVERALL DIMENSIONS			SEAT DIMENSIONS			BACK DIMENSIONS					
		W	D	H	W	D	H	W	H				
			30.5	24	33	24	18	17.5		24	15.5		
 <p><b>HB Midsize Stacking Armchair, 4 Leg Base</b> with concealed attachment            COM Yardage: 2.75            Freight Class: 250            Product Weight (lbs.): 38            Cubic Feet Per Carton: 18.25</p>	GC6924HB	\$1127	\$1227	\$1314	\$1439	\$1615	\$1698	\$1859	\$2112	\$2310	\$2528	\$2977	\$3456
		OVERALL DIMENSIONS			SEAT DIMENSIONS			BACK DIMENSIONS					
		W	D	H	W	D	H	W	H				
			30.5	24	38.5	24	18	17.5		24	21		
 <p><b>LB Midsize Stacking Chair, 4 Leg Base</b> with concealed attachment            COM Yardage: 2.5            Freight Class: 250            Product Weight (lbs.): 30            Cubic Feet Per Carton: 14.5</p>	GC6925	\$941	\$1032	\$1111	\$1227	\$1386	\$1462	\$1608	\$1838	\$2016	\$2214	\$2624	\$3060
		OVERALL DIMENSIONS			SEAT DIMENSIONS			BACK DIMENSIONS					
		W	D	H	W	D	H	W	H				
			26	24	33	24	18	17.5		24	15.5		

DESCRIPTION	MODEL#	STANDARD FABRIC GRADES											
		COM	2	3	4	5	6	7	8	9	10	11	12
 <p><b>HB Midsize Stacking Chair, 4 Leg Base</b> with concealed attachment COM Yardage: 2.75 Freight Class: 300 Product Weight (lbs.): 33 Cubic Feet Per Carton: 17.75</p>	<b>GC6925HB</b>	<b>\$1085</b>	<b>\$1184</b>	<b>\$1271</b>	<b>\$1396</b>	<b>\$1572</b>	<b>\$1655</b>	<b>\$1816</b>	<b>\$2069</b>	<b>\$2267</b>	<b>\$2485</b>	<b>\$2934</b>	<b>\$3413</b>
		<b>OVERALL DIMENSIONS</b>			<b>SEAT DIMENSIONS</b>			<b>BACK DIMENSIONS</b>					
		<b>W</b>	<b>D</b>	<b>H</b>	<b>W</b>	<b>D</b>	<b>H</b>	<b>W</b>	<b>H</b>				
		26	24	38.5	24	18	17.5	24	21				
 <p><b>LB Midsize Armchair, Sled Base</b> with concealed attachment COM Yardage: 2.5 Freight Class: 250 Product Weight (lbs.): 36 Cubic Feet Per Carton: 16</p>	<b>GC6926</b>	<b>\$1220</b>	<b>\$1311</b>	<b>\$1390</b>	<b>\$1506</b>	<b>\$1665</b>	<b>\$1741</b>	<b>\$1887</b>	<b>\$2117</b>	<b>\$2295</b>	<b>\$2493</b>	<b>\$2903</b>	<b>\$3339</b>
		<b>OVERALL DIMENSIONS</b>			<b>SEAT DIMENSIONS</b>			<b>BACK DIMENSIONS</b>					
		<b>W</b>	<b>D</b>	<b>H</b>	<b>W</b>	<b>D</b>	<b>H</b>	<b>W</b>	<b>H</b>				
		30.5	24	33	24	18	17.5	24	15.5				
 <p><b>HB Midsize Armchair, Sled Base</b> with concealed attachment COM Yardage: 2.75 Freight Class: 250 Product Weight (lbs.): 39 Cubic Feet Per Carton: 18.25</p>	<b>GC6926HB</b>	<b>\$1375</b>	<b>\$1476</b>	<b>\$1563</b>	<b>\$1688</b>	<b>\$1864</b>	<b>\$1947</b>	<b>\$2108</b>	<b>\$2361</b>	<b>\$2558</b>	<b>\$2777</b>	<b>\$3226</b>	<b>\$3705</b>
		<b>OVERALL DIMENSIONS</b>			<b>SEAT DIMENSIONS</b>			<b>BACK DIMENSIONS</b>					
		<b>W</b>	<b>D</b>	<b>H</b>	<b>W</b>	<b>D</b>	<b>H</b>	<b>W</b>	<b>H</b>				
		30.5	24	38.5	24	18	17.5	24	21				
 <p><b>LB Midsize Side Chair, Sled Base</b> with concealed attachment COM Yardage: 2.5 Freight Class: 250 Product Weight (lbs.): 34 Cubic Feet Per Carton: 14.5</p>	<b>GC6927</b>	<b>\$1175</b>	<b>\$1266</b>	<b>\$1345</b>	<b>\$1461</b>	<b>\$1620</b>	<b>\$1696</b>	<b>\$1842</b>	<b>\$2072</b>	<b>\$2250</b>	<b>\$2448</b>	<b>\$2858</b>	<b>\$3294</b>
		<b>OVERALL DIMENSIONS</b>			<b>SEAT DIMENSIONS</b>			<b>BACK DIMENSIONS</b>					
		<b>W</b>	<b>D</b>	<b>H</b>	<b>W</b>	<b>D</b>	<b>H</b>	<b>W</b>	<b>H</b>				
		26	24	33	24	18	17.5	24	15.5				
 <p><b>HB Midsize Side Chair, Sled Base</b> with concealed attachment COM Yardage: 2.75 Freight Class: 250 Product Weight (lbs.): 37 Cubic Feet Per Carton: 17.75</p>	<b>GC6927HB</b>	<b>\$1334</b>	<b>\$1434</b>	<b>\$1521</b>	<b>\$1646</b>	<b>\$1822</b>	<b>\$1905</b>	<b>\$2066</b>	<b>\$2319</b>	<b>\$2517</b>	<b>\$2735</b>	<b>\$3184</b>	<b>\$3663</b>
		<b>OVERALL DIMENSIONS</b>			<b>SEAT DIMENSIONS</b>			<b>BACK DIMENSIONS</b>					
		<b>W</b>	<b>D</b>	<b>H</b>	<b>W</b>	<b>D</b>	<b>H</b>	<b>W</b>	<b>H</b>				
		26	24	38.5	24	18	17.5	24	21				

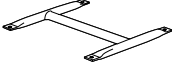
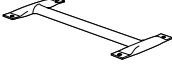
DESCRIPTION	MODEL#	STANDARD FABRIC GRADES						
	GC6928	LIST PRICE						
		\$113						
		OVERALL DIMENSIONS			SEAT DIMENSIONS			BACK DIMENSIONS
		W	D	H	W	D	H	W
<b>Metal Ganging Connector for Armchairs</b> Freight Class: 92.5 Product Weight (lbs.): 4 Cubic Feet Per Carton: 0.4		12	13.75	1				
	GC6929	LIST PRICE						
		\$113						
		OVERALL DIMENSIONS			SEAT DIMENSIONS			BACK DIMENSIONS
		W	D	H	W	D	H	W
<b>Metal Ganging Connector for Armless Chairs</b> Freight Class: 100 Product Weight (lbs.): 3.5 Cubic Feet Per Carton: 0.4		7.87	13.75	1				

DESCRIPTION	MODEL#	STANDARD FABRIC GRADES
<p><b>GC SIRENA™</b></p>  <p>model GC3380                      model GC3380RTL/M</p>		<p><b>STANDARD FEATURES</b></p> <ul style="list-style-type: none"> <li>The size and scale of this chair permits it to be used in smaller areas, where space is a consideration and style cannot be compromised. The soft curves and comfortable fit make this the right solution for creating group seating areas or in confined spaces.</li> <li>Complementary round foot design is available in Black only.</li> <li>For tablet models, please specify left hand or right hand tablet at time of order (determined from the seated position). See models below.</li> <li>Tablets rotate and are non-removable. Overall tablet size is 17"W by 14"D.</li> <li>Laminate tablet surfaces are 1.5" thick.</li> <li>(C1M) dual wheel carpet casters are standard on select models.</li> <li>The interior wood frame is an interlocking construction providing superior strength and long-term durability.</li> <li>Clean out space is provided around the seat pan for easy housekeeping and infection prevention practices</li> <li>Seat cushion can be removed if replacement is required</li> <li>For added comfort, seats are standard with high density Ultracell foam.</li> <li>For textile options, visit the website at <a href="http://globalfurnituregroup.com/healthcare">globalfurnituregroup.com/healthcare</a></li> <li>Can be upholstered in standard Global textiles if healthcare compliance is not required.</li> </ul> <p><b>OPTIONAL FEATURES</b></p> <ul style="list-style-type: none"> <li>Laminate finishes are offered in the following laminate finishes: Absolute Acajou (ACJ), Asian Night (ASN), Avant Cherry (AWC), Avant Honey (AWH), Black (BLK), Blizzard (BZD), Brushed Cobalt (BRC), Clear Maple (CMB), Custom Grey (CGY), Dark Espresso (DES), Designer White (DWT), Fashionista (FAS), First Class (FCL), Noce Biondo (NBM), Noce Leggero (NEM), Noce Grigio (NGM), Noce Medio (NMM), Quartered Mahogany (QTM), Sheer Beauty (SBY), Stonedust (SDT), Walnut Heights (WHE), White Chocolate (WHC) and Winter Cherry (WCR). Please specify</li> <li>To add sealed seams to your product, contact CustomerCare for more information.</li> <li>For moisture barrier on seat, please specify (MB). Add \$169.</li> </ul> <p><b>SUGGESTED APPLICATIONS</b></p> <ul style="list-style-type: none"> <li>Dining/Cafeteria</li> <li>Guest seating</li> <li>Lobbies</li> <li>Lounge/Waiting</li> <li>Office/Meeting</li> <li>Patient rooms</li> <li>Resident rooms</li> </ul>

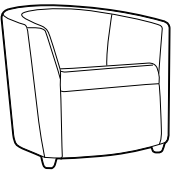
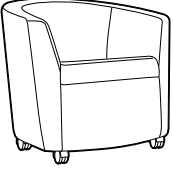
DESCRIPTION	MODEL# / FEATURES	STANDARD TEXTILE GRADES											
 <p><b>Club Chair w/Seat Clean Out</b> COM Yardage: 4.25 Freight Class: 250 Product Weight (lbs.): 52 Cubic Feet Per Carton: 19.25</p>	GC3380	COM	2	3	4	5	6	7	8	9	10	11	12
		\$1707	\$1851	\$1974	\$2150	\$2402	\$2521	\$2747	\$3111	\$3392	\$3706	\$4345	\$5028
		<b>OVERALL DIMENSIONS</b>			<b>SEAT DIMENSIONS</b>			<b>BACK DIMENSIONS</b>					
		W	D	H	W	D	H	W	H				
		30.5	29.5	28.5	20	20	17.5	19	11.5				
 <p><b>Club Chair on Casters w/Seat Clean Out</b> COM Yardage: 4.25 Freight Class: 250 Product Weight (lbs.): 52 Cubic Feet Per Carton: 19.25</p>	GC3380C	COM	2	3	4	5	6	7	8	9	10	11	12
		\$1718	\$1862	\$1981	\$2157	\$2406	\$2525	\$2750	\$3110	\$3387	\$3697	\$4330	\$5009
		<b>OVERALL DIMENSIONS</b>			<b>SEAT DIMENSIONS</b>			<b>BACK DIMENSIONS</b>					
		W	D	H	W	D	H	W	H				
		30.5	29.5	29.5	20	20	18	19	12.5				

# SEATING

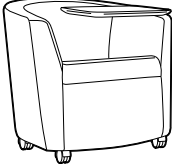
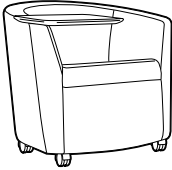
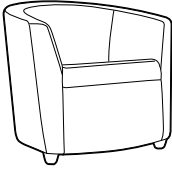
DESCRIPTION	MODEL#	STANDARD FABRIC GRADES											
		COM	2	3	4	5	6	7	8	9	10	11	12
 <p><b>Club Chair on Casters w/Seat Clean Out and LP Tablet - Left</b>                      COM Yardage: 4.25                      Freight Class: 250                      Product Weight (lbs.): 62                      Cubic Feet Per Carton: 19.25</p>	GC3380CLTL	\$2253	\$2397	\$2517	\$2693	\$2942	\$3061	\$3287	\$3646	\$3922	\$4233	\$4867	\$5546
		OVERALL DIMENSIONS			SEAT DIMENSIONS			BACK DIMENSIONS					
		W	D	H	W	D	H	W	H				
			32	29.5	29.5	20	20	18	19	12.5			
 <p><b>Club Chair on Casters w/Seat Clean Out and LP Tablet - Right</b>                      COM Yardage: 4.25                      Freight Class: 250                      Product Weight (lbs.): 62                      Cubic Feet Per Carton: 19.25</p>	GC3380CRTL	\$2253	\$2397	\$2517	\$2693	\$2942	\$3061	\$3287	\$3646	\$3922	\$4233	\$4867	\$5546
		OVERALL DIMENSIONS			SEAT DIMENSIONS			BACK DIMENSIONS					
		W	D	H	W	D	H	W	H				
			32	29.5	29.5	20	20	18	19	12.5			
 <p><b>Weighted Club Chair w/Seat Clean Out</b>                      COM Yardage: 4.25                      Freight Class: 150                      Product Weight (lbs.): 108                      Cubic Feet Per Carton: 19.25</p>	GC3380-CW	\$1906	\$2049	\$2168	\$2344	\$2593	\$2712	\$2937	\$3297	\$3574	\$3884	\$4517	\$5196
		OVERALL DIMENSIONS			SEAT DIMENSIONS			BACK DIMENSIONS					
		W	D	H	W	D	H	W	H				
			30.5	29.5	28.5	20	20	17.5	19	11.5			

## GC VION



model GC6322-4 (BLK-C)

## STANDARD FEATURES

- GC Vion is a comprehensive seating series offering a family of models to address multiple applications: task, management and conference.
- Series offers mid and high back models with either a mesh or upholstered back.
- Mechanism options available: synchro tilter (-0) and tilter (-4).
- All models are standard with height and width adjustable arms (**AS**) that feature a front to back sliding armcap.
- Standard with Global's high quality Soft Descent™ pneumatic lift which slowly and gently lowers the seat height of the chair, making it easy to obtain the desired position.
- Side activated sliding seat depth adjustment (**MD**) is standard on synchro-tilter with back angle adjustment.
- Standard with Black five prong, injection molded, fiberglass reinforced nylon Governor base (**B7**) with dual wheel carpet casters (**C1**).
- Mesh back models are available in 10 standard Vion colors: Aqua (**MS75**), Black (**MS69**), Black Cherry (**MS76**), Blue (**MS72**), Dust (**MS77**), Ivory (**MS78**), Natural (**MS74**), Paprika (**MS79**), Rope (**MS73**) and Stone (**MS71**).
- Underside of the seat is upholstered in a coated textile. The joining of the textiles on the underside of the seat pan is sealed on all models.
- Upholstered back models feature black fabric Jenny (**JN02**) on the back side as standard.
- Check textile availability prior to specifying upholstery material. Materials must meet or exceed 100,000 double rubs to comply with Globalcare's 24/7 seating textile warranty.

## OPTIONAL FEATURES

- Vion back frames, arms and bases are available in three colors: Black, Shadow and Fog. See Vion finishes chart for options and upcharges. Armcaps are always Black.
- Mesh back models are also available in 10 Dimension Mesh colors: Black (**DBK**), Fog (**DST**), Chalk (**DCL**), Shadow (**DGM**), Charcoal (**DCH**), Sand (**DSD**), Cobalt (**DCO**), Pool Blue (**DPB**), Citrus (**DCT**) and Berry (**DBE**). Add \$27
- Petite seat models (2" shorter and 2" narrower than the standard size seat) are available. Specify (**ST**) for standard seat or (**P**) for petite seat. No upcharge.
- An optional moisture barrier is available for the seat cushion. Specify (**NB**) for no moisture barrier, no upcharge, or (**MB**) for Moisture Barrier. Add \$117.
- Sealed seams are available on the seat of GC Vion models when specified with approved coated textile. Contact Customer Care for availability. Specify (**NS**) for no sealed seams, no upcharge, or (**SE**) for sealed seat seams. Add \$26.
- For hard surface flooring casters, please specify (**C9R**). Add \$72.
- Two featured "T" arm options that include height and width adjusting arms, one with sliding arm caps (**AS**) and one without sliding arm caps (**AF**). Also, available is a stylish fixed urethane arm (**C**) for conference/management environments.
- For additional arm/caster options, please refer to the Arm and Caster section of the Seating List Price Book. *Optional casters for your chair and the difference will be charged. Lower priced optional casters will not be credited.*

VION FINISHES - TASK SEATING				
Back Frame	Base	Specify Code	Arm Option	Specify Code
Black	Black	BLK no upcharge	Adj. "T" arm ( <b>Black</b> ) Adj. "T" arm, fixed armcap ( <b>Black</b> )	AS AF AC
Black	Polished Aluminum	BAU Add \$167	Adj. "T" arm ( <b>Black</b> , Chrome accent) Adj. "T" arm, fixed armcap ( <b>Black</b> , Chrome accent) Fixed "C" arm ( <b>Black</b> ) Fixed "C" arm ( <b>Polished Aluminum</b> )	A C CA - Add \$202
Shadow	Shadow	SHW Add \$76	Adj. "T" arm ( <b>Shadow</b> ) Adj. "T" arm, fixed armcap ( <b>Shadow</b> )	SHA SHF SHR
Shadow	Polished Aluminum	SAU Add \$241	Adj. "T" arm ( <b>Shadow</b> , Chrome accent) Adj. "T" arm, fixed armcap ( <b>Shadow</b> , Chrome accent) Fixed "C" arm ( <b>Shadow</b> ) Fixed "C" arm ( <b>Polished Aluminum</b> )	SHD SHC CA - Add \$202
Fog	Fog	FOG Add \$76	Adj. "T" arm ( <b>Fog</b> ) Adj. "T" arm, fixed armcap ( <b>Fog</b> )	FA FF
Fog	Polished Aluminum	FAU Add \$241	Adj. "T" arm ( <b>Fog</b> , Chrome accent) Adj. "T" arm, fixed armcap ( <b>Fog</b> , Chrome accent) Fixed "C" arm ( <b>Fog</b> ) Fixed "C" arm ( <b>Polished Aluminum</b> )	FC CF CC CA - Add \$202

\* All arms have Black Urethane Armcaps.

## MECHANISMS:

## Synchro-tilter mechanism (-0)

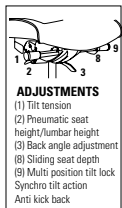

## Ergonomic features:

A, B, C, E, G, H, L, M, N, Q, U

## Tilter (-4)

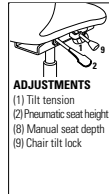

## Ergonomic features:

A, B, C, E, H, M, N, Q, S, U





## EXAMPLE GC VION ORDER CODE:

GC3622-0	-BAU	-MS76	-ST	-ST	-AF15
----------	------	-------	-----	-----	-------

Model #      Finish      Mesh      Seat size      Seat foam      Seat upholstery

-AF	-EE	-MB	-NS	-5L
Arms	Casters	Moisture barrier	Sealed seams	Pneumatic lift

# SEATING

DESCRIPTION	MODEL#	STANDARD FABRIC GRADES											
		COM	2	3	4	5	6	7	8	9	10	11	12
 <p><b>MB Synchro-Tilter w/Back Angle Adj.</b>, mesh back COM Yardage: 1 Freight Class: 150 Product Weight (lbs.): 58 Cubic Feet Per Carton: 10.5</p>	<b>GC6322-0</b>	\$1304	\$1332	1358	1396	1447	1471	\$1518	\$1594	\$1650	1716	1847	1988
		OVERALL DIMENSIONS			SEAT DIMENSIONS			BACK DIMENSIONS					
		W	D	H	W	D	H	W	H				
		25.5	24	39.5	20	17-20	17.5-22.5	18.5	21				
		RTA 2		ups									
 <p><b>MB Tilter</b>, mesh back COM Yardage: 1 Freight Class: 150 Product Weight (lbs.): 52 Cubic Feet Per Carton: 10.5</p>	<b>GC6322-4</b>	\$1160	\$1188	1218	1257	1312	1336	\$1387	\$1467	\$1529	\$1597	\$1736	\$1887
		OVERALL DIMENSIONS			SEAT DIMENSIONS			BACK DIMENSIONS					
		W	D	H	W	D	H	W	H				
		25.5	24	37.5	20	17.5	16-21	18.5	21				
		RTA 2		ups									
 <p><b>HB Synchro-Tilter w/Back Angle Adj.</b>, upholstered back, standard seat COM Yardage: 1.25 Freight Class: 150 Product Weight (lbs.): 61 Cubic Feet Per Carton: 10.5</p>	<b>GC6331-0</b>	\$1353	\$1388	\$1421	\$1466	\$1531	\$1562	\$1621	\$1715	\$1786	\$1867	\$2032	\$2208
		OVERALL DIMENSIONS			SEAT DIMENSIONS			BACK DIMENSIONS					
		W	D	H	W	D	H	W	H				
		25.5	24	41.5	20	17-20	17.5-22.5	18.5	23				
		RTA 2		ups									
 <p><b>HB Tilter</b>, upholstered back, standard seat COM Yardage: 1.25 Freight Class: 150 Product Weight (lbs.): 55 Cubic Feet Per Carton: 10.5</p>	<b>GC6331-4</b>	\$1177	\$1213	\$1247	\$1293	\$1360	\$1392	\$1452	\$1548	\$1624	\$1706	\$1876	\$2058
		OVERALL DIMENSIONS			SEAT DIMENSIONS			BACK DIMENSIONS					
		W	D	H	W	D	H	W	H				
		25.5	24	39.25	20	17.5	16-21	18.5	23				
		RTA 2		ups									



GC-WIND



Removable Seat Cushion



Tubular Steel Leg

model 3361HB



model 3363HB

STANDARD FEATURES

- An attractive, sleek and modern lounge series on Chrome tubular legs.
- Seat cushions are easily removable for cleaning and the open frame is great for housekeeping access. Cushion covers are removable.
- For added comfort, seats are standard with high density Ultracell bio foam.
- Frame available in Black (TBL), Buzz Blue (TBZ), Cactus (TCC), Carrot (TCR), Chrome (CHM), Cloud (TIV), Designer White (TDW), Dijon (TDJ), Eggplant (TEG), Fog (TFO), Frost (TFR), Ink (TIN), Kalua (TKA), Latte (TLA), Mocha (TMO), Nevada (TNE), Sand (TSN), Scarlet (TSR), Shadow (TSH), Toast (TOA) and Tungsten (TTU).
- Standard glide is plastic.
- For Globalcare textiles and finish options, visit the website at www.globalfurnituregroup.com
- This product can be upholstered in standard Global textiles only if Healthcare compliance is not required.
- Shipped fully assembled

OPTIONAL FEATURES

- For hard surface floors, please specify opaque non-marking glides (NM). No upcharge.
- To add sealed seams to your product contact Customer Care. Upcharges vary
- Moisture Barrier (seat only) - **Add \$193** list upcharge for Lounge Chair. For 2 seat sofa - **Add \$382** list upcharge and for 3 seat sofa - **Add \$566**.
- **Frame finish**  
Painted finishes. No upcharge.  
(TBL) Black (TIN) Ink  
(TBZ) Buzz Blue (TKA) Kalua  
(TCC) Cactus (TLA) Latte  
(TCR) Carrot (TMO) Mocha  
(TIV) Cloud (TNE) Nevada  
(TDW) Designer White (TSA) Sand  
(TDJ) Dijon (TSR) Scarlet  
(TEG) Eggplant (TSH) Shadow  
(TFO) Fog (TOA) Toast  
(TFR) Frost (TTU) Tungsten  
Plated finish. See models for upcharges.  
(CHM) Chrome (SBR) Satin Brass  
(BCH) Brushed Chrome (ACO) Antique Copper

SUGGESTED APPLICATIONS

- Lobbies
- Lounge / Waiting
- Office / Meeting
- Patient rooms
- Resident rooms

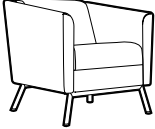
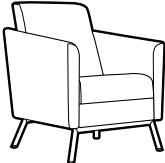
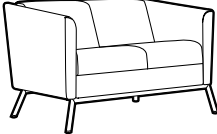
DESCRIPTION	MODEL#	STANDARD FABRIC GRADES											
		COM	2	3	4	5	6	7	8	9	10	11	12
 <b>Lounge Chair</b> COM Yardage: 4.25 Freight Class: 250 Product Weight (lbs.): 62 Cubic Feet Per Carton: 16.5  Removable seat cushion. Active weight 300 lbs.  Frame finish upcharges: Chrome (CHM), no upcharge. Brushed Chrome (BCH), add \$156. Satin Brass (SBR) or Antique Copper (ACO), add \$331	<b>GC3361</b>	\$2526	\$2702	\$2849	\$3064	\$3368	\$3512	\$3787	\$4229	\$4568	\$4946	\$5723	\$6551
				<b>OVERALL DIMENSIONS</b> W D H			<b>SEAT DIMENSIONS</b> W D H			<b>BACK DIMENSIONS</b> W H			
				27.5	29	28.5	19.5	19	17	19	12		
 <b>High Back Lounge Chair</b> COM Yardage: 4.75 Freight Class: 250 Product Weight (lbs.): 69 Cubic Feet Per Carton: 23  Removable seat cushion. Active weight 300 lbs.  Frame finish upcharges: Chrome (CHM), no upcharge. Brushed Chrome (BCH), add \$156.sw Satin Brass (SBR) or Antique Copper (ACO), add \$331.	<b>GC3361HB</b>	\$2293	\$2469	\$2615	\$2830	\$3134	\$3276	\$3553	\$3994	\$4334	\$4710	\$5489	\$6315
				<b>OVERALL DIMENSIONS</b> W D H			<b>SEAT DIMENSIONS</b> W D H			<b>BACK DIMENSIONS</b> W H			
				27.5	29	36	19.5	19	17	19	19.5		
 <b>Two Seat Sofa</b> COM Yardage: 7.25 Freight Class: 250 Product Weight (lbs.): 102 Cubic Feet Per Carton: 30  Removable seat cushion. Active weight 300 lbs./seat  Frame finish upcharges: Chrome (CHM), no upcharge. Brushed Chrome (BCH), add \$189. Satin Brass (SBR) or Antique Copper (ACO), add \$414.	<b>GC3362</b>	\$3100	\$3365	\$3584	\$3909	\$4368	\$4585	\$5003	\$5666	\$6178	\$6747	\$7919	\$9169
				<b>OVERALL DIMENSIONS</b> W D H			<b>SEAT DIMENSIONS</b> W D H			<b>BACK DIMENSIONS</b> W H			
				54.5	29	28.5	46.5	19	17	46.5	12		

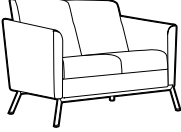
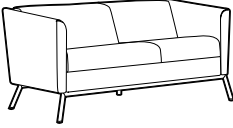
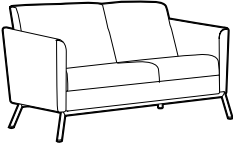
DESCRIPTION	MODEL#	STANDARD FABRIC GRADES											
		COM	2	3	4	5	6	7	8	9	10	11	12
 <p><b>High Back Two Seat Sofa</b> COM Yardage: 8 Freight Class: 250 Product Weight (lbs.): 107 Cubic Feet Per Carton: 44.75</p>	<p><b>GC3362HB</b></p> <p>Removable seat cushion Active weight 300 lbs./seat</p>	\$3200	\$3460	\$3853	\$4184	\$4653	\$4833	\$5246	\$6021	\$6409	\$7127	\$8129	\$9365
		OVERALL DIMENSIONS			SEAT DIMENSIONS			BACK DIMENSIONS					
		W	D	H	W	D	H	W	H				
		54.5	29	36	46.5	19	17	46.5	19.5				
<p>Frame finish upcharges: Chrome (CHM), no upcharge. Brushed Chrome (BCH), add \$189. Satin Brass (SBR) or Antique Copper (ACO), add \$414.</p>													
 <p><b>Three Seat Sofa</b> COM Yardage: 10.5 Freight Class: 250 Product Weight (lbs.): 135 Cubic Feet Per Carton: 42.5</p>	<p><b>GC3363</b></p> <p>Removable seat cushion. Active weight 300 lbs./seat</p>	\$3882	\$4269	\$4585	\$5055	\$5722	\$6034	\$6638	\$7600	\$8340	\$9164	\$10862	\$12673
		OVERALL DIMENSIONS			SEAT DIMENSIONS			BACK DIMENSIONS					
		W	D	H	W	D	H	W	H				
		78	29	28.5	70.5	19	17	70.5	12				
<p>Frame finish upcharges: Chrome (CHM), no upcharge. Brushed Chrome (BCH), add \$212. Satin Brass (SBR) or Antique Copper (ACO), add \$485.</p>													
 <p><b>High Back Three Seat Sofa</b> COM Yardage: 12.25 Freight Class: 250 Product Weight (lbs.): 140 Cubic Feet Per Carton: 62.25</p>	<p><b>GC3363HB</b></p> <p>Removable seat cushion. Active weight 300 lbs./seat</p>	\$3987	\$4387	\$4943	\$5450	\$6173	\$6444	\$7071	\$8258	\$8855	\$9957	\$11491	\$13381
		OVERALL DIMENSIONS			SEAT DIMENSIONS			BACK DIMENSIONS					
		W	D	H	W	D	H	W	H				
		78	29	36	70.5	19	17	70.5	19.5				
<p>Frame finish upcharges: Chrome (CHM), no upcharge. Brushed Chrome (BCH), add \$212. Satin Brass (SBR) or Antique Copper (ACO), add \$485.</p>													

GC VITROLA



model GC8271LB  
Low Back Lounge Chair



model GC8271HB  
High Back Lounge Chair

Two Textile Application



STANDARD FEATURES

- Classic soft seating upholstery design with swooping arms.
- Available in two back heights.
- Features a cleanout at back of seat cushion.
- Arms are standard fully upholstered. Arm caps are available in Urethane or Solid Surface. See upcharges.
- Durable, steel seat structure.
- The seat underside is covered with non-porous material for ease of cleaning.
- The seat cushion is mechanically removable for replacement.
- Back spring structure provides comfort and durability.
- For added comfort, seats are standard with high density Ultracell foam.
- Tapered legs are standard in maple wood or optional Urethane, see upcharge.
- Models are standard with White non-marking nylon glides. See Glide Type for additional glide options.
- Sealed seams are available on chair backs and arms and/or seats (see model upcharges).
- A moisture barrier may be added to seat cushions only (see model upcharges). Not available with sealed seams.
- GC Vitrola is covered under Global Healthcare 12 year, 24/7 warranty when upholstered with minimum 100,000 DR textile. For healthcare textiles, visit the website at globalfurnituregroup.com.
- Can be upholstered in standard Global textiles if healthcare compliance is not required. Global's Limited Lifetime warranty applies.
- The series is available with contrasting fabrics. Specify arms, back and front rail separate from seat cushion (see model image).
- For pricing, start with the base price and add both back/arms graded textile upcharge and the seat graded textile upcharge.
- For alternate textile applications, contact Global specials. The Blended Textile matrix does not apply to this series.
- Shipped fully assembled
- GC Vitrola standard seating has 350 lb. capacity per seat; 600 lbs. for bariatric chairs.

SUGGESTED APPLICATIONS

- Lobbies
- Lounge/Waiting
- Patient rooms
- Resident rooms

OPTIONAL FEATURES

Add option codes in the following order:

- **Model number**  
Specify model number.
- **Back and arm textile**  
Specify textile code. See model grade upcharges.
- **Seat textile**  
Specify textile code. See model grade upcharges.
- **Armcap type**  
**(NC)** No armcap  
**(SSU)** Urethane armcap. Add \$162.  
**(CO)** Solid surface armcap. See color grade upcharge.
- **Armcap finish (urethane)**  
**(BLK)** Black **(J52)** Mocha  
**(KAL)** Kalua **(SHW)** Shadow  
**(LAB)** Latte **(TOA)** Toast
- **Armcap finish (solid surface)**  
Grade 1 - Add \$395:  
**(SWH)** Designer White  
Grade 2 - Add \$417:  
**(SBT)** Beige Tempest  
**(SBX)** Black Onyx Mirage  
**(SMG)** Milk Glass Spectra  
**(SFW)** Frosty White Mirage  
**(SHS)** Hot Stone  
**(SNM)** Northern Melange
- **Leg type**  
**(WOD)** Wood. No upcharge.  
**(SSU)** Urethane. Add \$194.
- **Leg finish (wood)**  
**(AAM)** Absolute **(AVM)** Maple  
**(BKM)** Black **(MWM)** Medium Walnut  
**(CJM)** Charcoal Java **(ASM)** Night  
**(ACM)** Cherry **(NBM)** Noce Biondo  
**(EMM)** Empire Mahogany **(NGM)** Noce Grigio  
**(EOM)** English Oak **(NEM)** Noce Leggero  
**(ECM)** Espresso Cafe **(NMM)** Noce Medio  
**(TFM)** Fruitwood **(SBM)** Sandy Beach  
**(HGM)** Grey **(SKM)** Shaker Cherry  
**(HOM)** Harvest Oak **(SOM)** Silver Oak  
**(AHM)** Honey **(TWM)** Walnut  
**(JOM)** Jet Onyx **(WTM)** WC Cream  
**(LHM)** Light Honey **(WHM)** White  
**(TMM)** Mahogany **(WCM)** Winter Cherry
- **Leg finish (urethane)**  
**(BLK)** Black **(J52)** Mocha  
**(KAL)** Kalua **(SHW)** Shadow  
**(LAB)** Latte **(TOA)** Toast
- **Fastener type**  
**(RS)** Standard fasteners.  
**(TP)** Tamperproof fasteners. Add \$89.
- **Glide type**  
**(NM)** Non-marking glide. Standard.  
**(SG)** Steel cushion glide. Add \$34.  
**(RG)** Rubber, non-slip glide. Add \$34.  
**(FG)** Felt glide. Add \$34.
- **Back and arm seams** (Contact Customer Care for approved textiles.)  
**(NS)** No sealed seams.  
**(SBS)** Sealed back and arm seams. See model upcharge.
- **Seat seams** (Contact Customer Care for approved textiles.)  
**(NS)** No sealed seams.  
**(SSS)** Sealed seat seams. See model upcharge.
- **Moisture Barrier** (seat only, not available with sealed seams)  
**(NB)** No moisture barrier. No upcharge.  
**(MB)** Moisture barrier. See model upcharge.

EXAMPLE OAKVILLE ORDER CODE:

GC8271HB	-WA50	-WA50	NC	-
----------	-------	-------	----	---





Model #      Back/arms textile      Seat textile      Armcap type      Armcap finish





-WOD	-BKM	-NBS	-NSS	-NB
------	------	------	------	-----

Leg type      Leg finish      Back seams      Seat seams      Moisture barrier

# SEATING

# GC-VITROLA G

DESCRIPTION	FEATURES	MODEL#	STANDARD TEXTILE GRADES											
			1/COM	2	3	4	5	6	7	8	9	10	11	12
 <p><b>Lounge Chair</b> COM Yardage: Back/Arms: 4.5; Seat: 1.25 Freight Class: 250 Product Weight (lbs.): 74.5 Cubic Feet Per Carton: 20.25</p>	<b>GC8271LB</b> Base Price:	<b>\$2094</b>												
	Back/Arm upcharge:	<b>+0</b>	<b>+\$144</b>	<b>+\$257</b>	<b>+\$423</b>	<b>+\$657</b>	<b>+\$756</b>	<b>+\$959</b>	<b>+\$1278</b>	<b>+\$1517</b>	<b>+\$1778</b>	<b>+\$2322</b>	<b>+\$2894</b>	
	Seat upcharge:	<b>+0</b>	<b>+\$40</b>	<b>+\$72</b>	<b>+\$118</b>	<b>+\$183</b>	<b>+\$210</b>	<b>+\$267</b>	<b>+\$355</b>	<b>+\$422</b>	<b>+\$494</b>	<b>+\$645</b>	<b>+\$804</b>	
		<b>OVERALL DIMENSIONS</b>	<b>SEAT DIMENSIONS</b>			<b>BACK DIMENSIONS</b>								
		<b>W D H</b>	<b>W D H</b>	<b>W H</b>										
	Active weight 350 lbs.	28.25	32.25	34.25	21.5	19.25	18.5		22.5	15.75				
	Moisture barrier (MB), add \$107 Sealed seams (SBS), add \$20 Sealed seat seams (SSS), add \$147	<b>RTA 00</b>	1 per carton											
 <p><b>High Back Lounge Chair</b> COM Yardage: Back/Arms: 5; Seat: 1.25 Freight Class: 250 Product Weight (lbs.): 83.5 Cubic Feet Per Carton: 28.25</p>	<b>GC8271HB</b> Base Price:	<b>\$2210</b>												
	Back/Arm upcharge:	<b>+0</b>	<b>+\$160</b>	<b>+\$285</b>	<b>+\$470</b>	<b>+\$730</b>	<b>+\$840</b>	<b>+\$1065</b>	<b>+\$1420</b>	<b>+\$1685</b>	<b>+\$1975</b>	<b>+\$2580</b>	<b>+\$3215</b>	
	Seat upcharge:	<b>+0</b>	<b>+\$40</b>	<b>+\$72</b>	<b>+\$118</b>	<b>+\$183</b>	<b>+\$210</b>	<b>+\$267</b>	<b>+\$355</b>	<b>+\$422</b>	<b>+\$494</b>	<b>+\$645</b>	<b>+\$804</b>	
		<b>OVERALL DIMENSIONS</b>	<b>SEAT DIMENSIONS</b>			<b>BACK DIMENSIONS</b>								
		<b>W D H</b>	<b>W D H</b>	<b>W H</b>										
	Active weight 350 lbs.	28.25	33.75	42	21.5	19.25	18.5		22.5	23.5				
	Moisture barrier (MB), add \$107 Sealed seams (SBS), add \$20 Sealed seat seams (SSS), add \$173	<b>RTA 00</b>	1 per carton											
 <p><b>Bariatric Lounge Chair</b> COM Yardage: Back/Arms: 5; Seat: 1.25 Freight Class: 250 Product Weight (lbs.): 79 Cubic Feet Per Carton: 30</p>	<b>GC8271BLB</b> Base Price:	<b>\$2893</b>												
	Back/Arm upcharge:	<b>+0</b>	<b>+\$160</b>	<b>+\$285</b>	<b>+\$470</b>	<b>+\$730</b>	<b>+\$840</b>	<b>+\$1065</b>	<b>+\$1420</b>	<b>+\$1685</b>	<b>+\$1975</b>	<b>+\$2580</b>	<b>+\$3215</b>	
	Seat upcharge:	<b>+0</b>	<b>+\$40</b>	<b>+\$72</b>	<b>+\$118</b>	<b>+\$183</b>	<b>+\$210</b>	<b>+\$267</b>	<b>+\$355</b>	<b>+\$422</b>	<b>+\$494</b>	<b>+\$645</b>	<b>+\$804</b>	
		<b>OVERALL DIMENSIONS</b>	<b>SEAT DIMENSIONS</b>			<b>BACK DIMENSIONS</b>								
		<b>W D H</b>	<b>W D H</b>	<b>W H</b>										
	Active weight 600 lbs.	39	32.25	34.25	39	19.25	18.5		33	15.75				
	Moisture barrier (MB), add \$160 Sealed seams (SBS), add \$20 Sealed seat seams (SSS), add \$151	<b>RTA 00</b>	1 per carton											
 <p><b>High Back Bariatric Lounge Chair</b> COM Yardage: Back/Arms: 5.75; Seat: 1.25 Freight Class: 250 Product Weight (lbs.): 88.5 Cubic Feet Per Carton: 36.5</p>	<b>GC8271BHB</b> Base Price:	<b>\$3020</b>												
	Back/Arm upcharge:	<b>+0</b>	<b>+\$184</b>	<b>+\$328</b>	<b>+\$541</b>	<b>+\$840</b>	<b>+\$966</b>	<b>+\$1225</b>	<b>+\$1633</b>	<b>+\$1938</b>	<b>+\$2272</b>	<b>+\$2967</b>	<b>+\$3698</b>	
	Seat upcharge:	<b>+0</b>	<b>+\$40</b>	<b>+\$72</b>	<b>+\$118</b>	<b>+\$183</b>	<b>+\$210</b>	<b>+\$267</b>	<b>+\$355</b>	<b>+\$422</b>	<b>+\$494</b>	<b>+\$645</b>	<b>+\$804</b>	
		<b>OVERALL DIMENSIONS</b>	<b>SEAT DIMENSIONS</b>			<b>BACK DIMENSIONS</b>								
		<b>W D H</b>	<b>W D H</b>	<b>W H</b>										
	Active weight 600 lbs.	39	33.75	42	39	19.25	18.5		33	23.5				
	Moisture barrier (MB), add \$160 Sealed seams (SBS), add \$20 Sealed seat seams (SSS), add \$178	<b>RTA 00</b>	1 per carton											
 <p><b>Two Seat Sofa</b> COM Yardage: Back/Arms: 5; Seat: 1.5 Freight Class: 250 Product Weight (lbs.): 100 Cubic Feet Per Carton: 39.75</p>	<b>GC8272LB</b> Base Price:	<b>\$3147</b>												
	Back/Arm upcharge:	<b>+0</b>	<b>+\$160</b>	<b>+\$285</b>	<b>+\$470</b>	<b>+\$730</b>	<b>+\$840</b>	<b>+\$1065</b>	<b>+\$1420</b>	<b>+\$1685</b>	<b>+\$1975</b>	<b>+\$2580</b>	<b>+\$3215</b>	
	Seat upcharge:	<b>+0</b>	<b>+\$48</b>	<b>+\$86</b>	<b>+\$141</b>	<b>+\$219</b>	<b>+\$252</b>	<b>+\$320</b>	<b>+\$426</b>	<b>+\$506</b>	<b>+\$593</b>	<b>+\$774</b>	<b>+\$965</b>	
		<b>OVERALL DIMENSIONS</b>	<b>SEAT DIMENSIONS</b>			<b>BACK DIMENSIONS</b>								
		<b>W D H</b>	<b>W D H</b>	<b>W H</b>										
	Active weight 350 lbs./seat	50.5	32.25	34.25	43.5	19.25	18.5		43.5	15.75				
	Moisture barrier (MB), add \$213 Sealed seams (SBS), add \$42 Sealed seat seams (SSS), add \$176	<b>RTA 00</b>	1 per carton											

DESCRIPTION	FEATURES	MODEL#	STANDARD TEXTILE GRADES														
			1/COM	2	3	4	5	6	7	8	9	10	11	12			
 <p><b>High Back Two Seat Sofa</b> COM Yardage: Back/Arms: 6; Seat: 1.5 Freight Class: 250 Product Weight (lbs.): 116.5 Cubic Feet Per Carton: 48.25</p>	GC8272HB	Base Price:	\$3323														
		Back/Arm upcharge:	+0	+\$192	+\$342	+\$564	+\$876	+\$1008	+\$1278	+\$1704	+\$2022	+\$2370	+\$3096	+\$3858			
		Seat upcharge:	+0	+\$48	+\$86	+\$141	+\$219	+\$252	+\$320	+\$426	+\$506	+\$593	+\$774	+\$965			
		<b>OVERALL DIMENSIONS</b>															
			Active weight 350 lbs./seat	50.5	33.75	42		43.5	19.25	18.5		43.5	23.5				
		Add \$213 for (MB) Add \$42 for (SSS) \$203 for (SBS)	RTA 00													1 per carton	
 <p><b>Three Seat Sofa</b> COM Yardage: Back/Arms: 6.25; Seat: 2 Freight Class: 250 Product Weight (lbs.): 133 Cubic Feet Per Carton: 56.75</p>	GC8273LB	Base Price:	\$4203														
		Back/Arm upcharge:	+0	+\$160	+\$285	+\$470	+\$730	+\$840	+\$1065	+\$1420	+\$1685	+\$1975	+\$2580	+\$3215			
		Seat upcharge:	+0	+\$48	+\$86	+\$141	+\$219	+\$252	+\$320	+\$426	+\$506	+\$593	+\$774	+\$965			
		<b>OVERALL DIMENSIONS</b>															
			Active weight 350 lbs./seat	71.5	32.25	34.25		65	19.25	18.5		65	15.75				
		Moisture barrier (MB), add \$319 Sealed seams (SBS), add \$65 Sealed seat seams (SSS), add \$206	RTA 00													1 per carton	
 <p><b>High Back Three Seat Sofa</b> COM Yardage: Back/Arms: 7.25; Seat: 2 Freight Class: 250 Product Weight (lbs.): 153.5 Cubic Feet Per Carton: 68.75</p>	GC8273HB	Base Price:	\$4458														
		Back/Arm upcharge:	+0	+\$232	+\$414	+\$682	+\$1059	+\$1218	+\$1545	+\$2059	+\$2444	+\$2864	+\$3741	+\$4662			
		Seat upcharge:	+0	+\$64	+\$114	+\$188	+\$292	+\$336	+\$426	+\$568	+\$674	+\$790	+\$1032	+\$1286			
		<b>OVERALL DIMENSIONS</b>															
			Active weight 350 lbs./seat	71.5	33.75	42		65	19.25	18.5		65	23.5				
		Moisture barrier (MB), add \$319 Sealed seams (SBS), add \$65 Sealed seat seams (SSS), add \$233	RTA 00													1 per carton	
 <p><b>Bench</b> COM Yardage: 1.5 Freight Class: 250 Product Weight (lbs.): 30.5 Cubic Feet Per Carton: 8</p>	GC8275	List Price:	\$940	\$988	\$1026	\$1081	\$1159	\$1192	\$1260	\$1366	\$1446	\$1533	\$1714	\$1905			
		<b>OVERALL DIMENSIONS</b>															
			Active weight 350 lbs.	24	24	18		0	0	18							
		<b>SEAT DIMENSIONS</b>															
			Moisture barrier (MB), add \$107 Sealed seat seams (SSS), add \$21	RTA 00													1 per carton
 <p><b>Bariatric Width Bench</b> COM Yardage: 2 Freight Class: 150 Product Weight (lbs.): 39 Cubic Feet Per Carton: 8</p>	GC8275B	List Price:	\$1117	\$1181	\$1231	\$1305	\$1409	\$1453	\$1543	\$1685	\$1791	\$1907	\$2149	\$2403			
		<b>OVERALL DIMENSIONS</b>															
			Active weight 350 lbs.	34	24	18		0	0	18							
		<b>SEAT DIMENSIONS</b>															
			Moisture barrier (MB), add \$160 Sealed seat seams (SSS), add \$21	RTA 00													1 per carton

## JANNA



model GC7609

## STANDARD FEATURES

- Very often tight spaces create a challenge when additional seating is required for guests. Janna's unique folding frame is the perfect solution for temporary seating, especially where space is at a premium.
- Molded wood veneer frame.
- Concealed folding mechanism uses metal-to-metal construction details with lock tight fasteners.
- For added comfort, seats are standard with high density foam.
- Non-marking nylon glides are standard.
- For healthcare textiles, visit the website at [globalfurnituregroup.com](http://globalfurnituregroup.com).
- Can be upholstered in standard Global textiles if Healthcare compliance is not required
- Shipped fully assembled.

## OPTIONAL FEATURES

- **Wood frame finish.** Please specify.
 

(AAM) Absolute	(AVM) Maple
(CJM) Charcoal Java	(MWM) Medium Walnut
(ACM) Cherry	(NLW) Natural Walnut
(ASM) Night	(NBM) Noce Biondo
(EMM) Empire Mahogany	(NGM) Noce Grigio
(EOM) English Oak	(NEM) Noce Leggero
(ECM) Espresso Cafe	(NMM) Noce Medio
(TFM) Fruitwood	(SBM) Sandy Beach
(HGM) Grey	(SKM) Shaker Cherry
(HOM) Harvest Oak	(SOM) Silver Oak
(AHM) Honey	(TWM) Walnut
(JOM) Jet Onyx	(WTM) WC Cream
(LHM) Light Honey	(WHM) White
(TMM) Mahogany	(WCM) Winter Cherry
- Optional cushion glide is available - **Add \$17** list upcharge.
- Optional wall bracket (model GC7607) allows chairs to be conveniently stored while not in use. (Underside of chair seat is predrilled to accept wall bracket.)
- For moisture barrier (seat only), **Add \$129** list upcharge.

## SUGGESTED APPLICATIONS

- Dining/Cafeteria
- Guest seating
- Lounge/Waiting
- Office/Meeting
- Patient rooms
- Resident rooms
- Treatment/Exam

DESCRIPTION MODEL# STANDARD FABRIC GRADES



MODEL#	COM	2	3	4	5	6	7	8	9	10	11	12
GC7609	\$699	\$731	\$762	\$804	\$861	\$886	\$937	\$1034	\$1082	\$1174	\$1298	\$1453

OVERALL DIMENSIONS			SEAT DIMENSIONS			BACK DIMENSIONS	
W	D	H	W	D	H	W	H

**Folding Chair** Upholstered Back  
 COM Yardage: 1  
 Freight Class: 150  
 Product Weight (lbs.): 19  
 Cubic Feet Per Carton: 3.5

Active weight 300 lbs.

19	22.5	32.5	16	17.5	18.5	16	13.5
----	------	------	----	------	------	----	------



MODEL#	COM	2	3	4	5	6	7	8	9	10	11	12
GC7611	\$794	\$827	\$860	\$900	\$959	\$983	\$1034	\$1131	\$1180	\$1270	\$1394	\$1550

OVERALL DIMENSIONS			SEAT DIMENSIONS			BACK DIMENSIONS	
W	D	H	W	D	H	W	H

**Folding Chair** Wood Back  
 COM Yardage: 1  
 Freight Class: 150  
 Product Weight (lbs.): 19  
 Cubic Feet Per Carton: 3.5

Active weight 300 lbs.

19	22.5	32.5	16	17.5	18.5	16	13.5
----	------	------	----	------	------	----	------

List Price

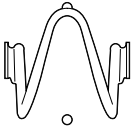

GC7607	\$65
--------	------

OVERALL DIMENSIONS			SEAT DIMENSIONS			BACK DIMENSIONS	
W	D	H	W	D	H	W	H

**Wall Mounting Bracket.**

For Janna series only. Allows for hanging a chair on the wall or behind a door.

COM Yardage: --  
 Freight Class: 70  
 Product Weight (lbs.): 1.5  
 Cubic Feet Per Carton: 0.1

**If ordering after the original purchase, specify GC7607.**  
**For complete set at time of order - specify WLHK. Add \$66.**  
 Two (one pair) per package in chrome finish. One bracket connects to the underside of the chair seat. The second bracket connects to the wall or door.

3	1.5	3.5
---	-----	-----

NOURISH



GC3681FXH



GC3683F



GC3685



Headrest adjustment handle



Casters and height adjustable legs



Transfer arm

STANDARD FEATURES

- Nourish is an innovative, state-of-the-art patient chair, developed in consultation with leading healthcare professionals. It embraces the body, cultivating comfort during periods of recovery.
- All chair models have left and right, easy to operate transfer arms. Transfer arms allow users to easily transfer in and out of the chair and provide easy access to assist the user.
- Models with fixed legs have a standard seat height of 18.5".
- Models with adjustable legs have adjustment pins to conveniently adapt seat heights from 17" to 20". 20" seat height models (-20) have a seat height adjustment range of 20" to 23". Front and back legs can be adjusted separately allowing modification of seat pitch, forward or rearward.
- Models with rear casters allow for "tip and move" so the chair can be conveniently relocated while unoccupied. The optional push bar aids staff in moving the chair (see upcharge). Push bar matches frame finish.
- Select models have a unique Schukra depth adjustable headrest solution integrated inside the back near the user's neck area. The depth is controlled by a handle on the lower outer back cushion.
- Schukra depth adjustable lumbar support for additional comfort is standard on select models.
- Standard models have minimal flex to the back. Flex back models (F model suffix) have additional back movement.
- For added comfort, seats are standard with high density Ultracell foam.
- Metal frame is available in several paint finishes.
- The arm structure finish is Tungsten with a urethane armcap, available in five finishes.
- Available to specify with two textiles, one for the seat cushion and one for the back (see model image). For pricing, start with the base price and add both back graded textile upcharge and seat graded textile upcharge.
- The Blended Textile matrix does not apply to this series.
- Nourish is covered under Globalcare's 12-yr, 24/7 warranty. Textiles with a minimum of 100,000 double rubs must be specified.
- For healthcare textile and finish options, visit the website at [globalfurnituregroup.com](http://globalfurnituregroup.com).
- Can be upholstered in standard Global textiles if high traffic, heavy duty or multi-shift compliance is not required. Globalcare's limited lifetime warranty applies.
- Shipped fully assembled.
- Active weight capacity for standard single seat is 350 lbs. and 750 lbs for bariatric seating.

Add option codes in the following order:

- **Model number**  
Specify model number
- **Back Textile**  
Specify textile code.
- **Seat Textile**  
Specify textile code.
- **Frame Finish**  
(TBL) Black  
(TIV) Cloud  
(TDW) Designer White  
(TFO) Fog  
(TFR) Frost  
(TKA) Kalua  
(TLA) Latte  
(TMO) Mocha  
(TNE) Nevada  
(TSN) Sand  
(TSH) Shadow  
(TOA) Toast  
(TTU) Tungsten
- **Back Push Bar** (matches frame finish)  
(NBR) No push bar  
(PBR) Back push bar. Add \$150.
- **Armcap Finish**  
(BLK) Black  
(LAB) Latte  
(J52) Mocha  
(SHW) Shadow  
(TOA) Toast
- **Sealed Seat Underside**  
(ST) None  
(SU) Sealed seat underside. Add \$50.  
For bariatric, add \$60.  
For ottoman, add \$33.
- **Moisture Barrier** (seat only, not available with sealed seams)  
(NB) No moisture barrier.  
(MB) Moisture barrier. Add \$129. For bariatric, add \$184.
- **Back Seams**  
(NS) No sealed seams  
(SBS) Sealed back seams. Add \$60; bariatric add \$97.
- **Seat Seams**  
(NS) No sealed seat seams  
(SSS) Sealed seat seams. Add \$23; bariatric add \$26.







SUGGESTED APPLICATIONS



- Bariatric seating (model GC3685)
- Lounge/Waiting
- Patient rooms
- Resident rooms
- Treatment/Exam rooms



EXAMPLE NOURISH ORDER CODE:



GC3681	FU75	FU75	TMO	NBR	J52	ST	NB	NS	NS
Model #	Back textile	Seat textile	Frame finish	Push Bar	Armcap Finish	Seat Underside	Moisture Barrier	Back Seams	Seat Seams







DESCRIPTION		MODEL# / FEATURES	STANDARD TEXTILE GRADES												
			COM	2	3	4	5	6	7	8	9	10	11	12	
		<b>GC3681</b> Base Price:		<b>\$2850</b>											
		Adjustable height													
		<b>GC3681-20</b> Base Price:		<b>\$2914</b>											
		Adjustable height, 20"													
		<b>GC3681XH</b> Base Price:		<b>\$2533</b>											
		Fixed 18.5" height													
		Back upcharge:	<b>\$-40</b>	<b>+0</b>	<b>+\$32</b>	<b>+\$78</b>	<b>+\$143</b>	<b>+\$170</b>	<b>+\$227</b>	<b>+\$315</b>	<b>+\$382</b>	<b>+\$454</b>	<b>+\$605</b>	<b>+\$764</b>	
		Seat upcharge:	<b>\$-24</b>	<b>+0</b>	<b>+\$19</b>	<b>+\$47</b>	<b>+\$86</b>	<b>+\$102</b>	<b>+\$136</b>	<b>+\$189</b>	<b>+\$229</b>	<b>+\$273</b>	<b>+\$363</b>	<b>+\$459</b>	
			<b>OVERALL DIMENSIONS</b>			<b>SEAT DIMENSIONS</b>			<b>BACK DIMENSIONS</b>						
			<b>W</b>	<b>D</b>	<b>H</b>	<b>W</b>	<b>D</b>	<b>H</b>	<b>W</b>	<b>H</b>					
			28.5	29	45.5	20	18.5	17-20	20	29					
			28.5	29	48.5	20	18.5	20-23	20	29					
<b>High Back Patient Chair</b>		Active weight 350 lbs.													
COM Yardage: Back: 1.25; Seat: .75															
Freight Class: 300															
Product Weight (lbs.): 56															
Cubic Feet Per Carton: 33.5															
		<b>GC3681F</b> Base Price:		<b>\$3204</b>											
		Adjustable height													
		<b>GC3681-20F</b> Base Price:		<b>\$3269</b>											
		Adjustable height, 20"													
		<b>GC3681FXH</b> Base Price:		<b>\$2881</b>											
		Fixed 18.5" height													
		Back upcharge:	<b>\$-40</b>	<b>+0</b>	<b>+\$32</b>	<b>+\$78</b>	<b>+\$143</b>	<b>+\$170</b>	<b>+\$227</b>	<b>+\$315</b>	<b>+\$382</b>	<b>+\$454</b>	<b>+\$605</b>	<b>+\$764</b>	
		Seat upcharge:	<b>\$-24</b>	<b>+0</b>	<b>+\$19</b>	<b>+\$47</b>	<b>+\$86</b>	<b>+\$102</b>	<b>+\$136</b>	<b>+\$189</b>	<b>+\$229</b>	<b>+\$273</b>	<b>+\$363</b>	<b>+\$459</b>	
			<b>OVERALL DIMENSIONS</b>			<b>SEAT DIMENSIONS</b>			<b>BACK DIMENSIONS</b>						
			<b>W</b>	<b>D</b>	<b>H</b>	<b>W</b>	<b>D</b>	<b>H</b>	<b>W</b>	<b>H</b>					
			28.5	29	45.5	20	18.5	17-20	20	29					
			28.5	29	48.5	20	18.5	20-23	20	29					
<b>High Back Patient Chair, Flex Back</b>		Active weight 350 lbs.													
COM Yardage: Back: 1.25; Seat: .75															
Freight Class: 300															
Product Weight (lbs.): 56															
Cubic Feet Per Carton: 33.5															
		<b>GC3682</b> Base Price:		<b>\$3015</b>											
		Adjustable height													
		<b>GC3682-20</b> Base Price:		<b>\$3080</b>											
		Adjustable height, 20"													
		<b>GC3682XH</b> Base Price:		<b>\$2874</b>											
		Fixed 18.5" height													
		Back upcharge:	<b>\$-40</b>	<b>+0</b>	<b>+\$32</b>	<b>+\$78</b>	<b>+\$143</b>	<b>+\$170</b>	<b>+\$227</b>	<b>+\$315</b>	<b>+\$382</b>	<b>+\$454</b>	<b>+\$605</b>	<b>+\$764</b>	
		Seat upcharge:	<b>\$-24</b>	<b>+0</b>	<b>+\$19</b>	<b>+\$47</b>	<b>+\$86</b>	<b>+\$102</b>	<b>+\$136</b>	<b>+\$189</b>	<b>+\$229</b>	<b>+\$273</b>	<b>+\$363</b>	<b>+\$459</b>	
			<b>OVERALL DIMENSIONS</b>			<b>SEAT DIMENSIONS</b>			<b>BACK DIMENSIONS</b>						
			<b>W</b>	<b>D</b>	<b>H</b>	<b>W</b>	<b>D</b>	<b>H</b>	<b>W</b>	<b>H</b>					
			28.5	29	45.5	20	18.5	17-20	20	29					
			28.5	29	48.5	20	18.5	20-23	20	29					
<b>High Back Patient Chair, Schukra depth adjustable lumbar</b>		Active weight 350 lbs.													
COM Yardage: Back: 1.25; Seat: .75															
Freight Class: 300															
Product Weight (lbs.): 56															
Cubic Feet Per Carton: 33.5															

DESCRIPTION	MODEL#/FEATURES	STANDARD FABRIC GRADES												
		COM	2	3	4	5	6	7	8	9	10	11	12	
 Adjustable height	<b>GC3682F</b> Base Price: Adjustable height	<b>\$3371</b>												
	<b>GC3682-20F</b> Base Price: Adjustable height, 20"	<b>\$3436</b>												
 Fixed 18.5" height	<b>GC3682FXH</b> Base Price: Fixed 18.5" height	<b>\$3230</b>												
	Back upcharge:	<b>-\$40</b>	<b>+0</b>	<b>+\$32</b>	<b>+\$78</b>	<b>+\$143</b>	<b>+\$170</b>	<b>+\$227</b>	<b>+\$315</b>	<b>+\$382</b>	<b>+\$454</b>	<b>+\$605</b>	<b>+\$764</b>	
	Seat upcharge:	<b>-\$24</b>	<b>+0</b>	<b>+\$19</b>	<b>+\$47</b>	<b>+\$86</b>	<b>+\$102</b>	<b>+\$136</b>	<b>+\$189</b>	<b>+\$229</b>	<b>+\$273</b>	<b>+\$363</b>	<b>+\$459</b>	
<b>OVERALL DIMENSIONS</b>			<b>SEAT DIMENSIONS</b>			<b>BACK DIMENSIONS</b>								
			<b>W</b>	<b>D</b>	<b>H</b>	<b>W</b>	<b>D</b>	<b>H</b>	<b>W</b>	<b>H</b>				
			28.5	29	45.5	20	18.5	17-20	20	29				
			28.5	29	48.5	20	18.5	20-23	20	29				
<b>High Back Patient Chair with Schukra depth adjustable lumbar, Flex Back</b> COM Yardage: Back: 1.25; Seat: .75      Active weight 350 lbs. Freight Class: 300 Product Weight (lbs.): 56 Cubic Feet Per Carton: 33.5														

DESCRIPTION	MODEL#/FEATURES	STANDARD FABRIC GRADES												
		COM	2	3	4	5	6	7	8	9	10	11	12	
 Adjustable height	<b>GC3683</b> Base Price: Adjustable height	<b>\$3181</b>												
	<b>GC3683-20</b> Base Price: Adjustable height, 20"	<b>\$3245</b>												
 Fixed 18.5" height	<b>GC3683XH</b> Base Price: Fixed 18.5" height	<b>\$3047</b>												
	Back upcharge:	<b>-\$40</b>	<b>+0</b>	<b>+\$32</b>	<b>+\$78</b>	<b>+\$143</b>	<b>+\$170</b>	<b>+\$227</b>	<b>+\$315</b>	<b>+\$382</b>	<b>+\$454</b>	<b>+\$605</b>	<b>+\$764</b>	
	Seat upcharge:	<b>-\$24</b>	<b>+0</b>	<b>+\$19</b>	<b>+\$47</b>	<b>+\$86</b>	<b>+\$102</b>	<b>+\$136</b>	<b>+\$189</b>	<b>+\$229</b>	<b>+\$273</b>	<b>+\$363</b>	<b>+\$459</b>	
<b>OVERALL DIMENSIONS</b>			<b>SEAT DIMENSIONS</b>			<b>BACK DIMENSIONS</b>								
			<b>W</b>	<b>D</b>	<b>H</b>	<b>W</b>	<b>D</b>	<b>H</b>	<b>W</b>	<b>H</b>				
			28.5	29	45.5	20	18.5	17-20	20	29				
			28.5	29	48.5	20	18.5	20-23	20	29				
<b>High Back Patient Chair, Schukra depth adjustable headrest</b> COM Yardage: Back: 1.25; Seat: .75      Active weight 350 lbs. Freight Class: 300 Product Weight (lbs.): 56 Cubic Feet Per Carton: 33.5														

DESCRIPTION	MODEL#/FEATURES	STANDARD FABRIC GRADES												
		COM	2	3	4	5	6	7	8	9	10	11	12	
 Adjustable height	<b>GC3683F</b> Base Price: Adjustable height	<b>\$3536</b>												
	<b>GC3683-20F</b> Base Price: Adjustable height, 20"	<b>\$3600</b>												
 Fixed 18.5" height	<b>GC3683FXH</b> Base Price: Fixed 18.5" height	<b>\$3402</b>												
	Back upcharge:	<b>-\$40</b>	<b>+0</b>	<b>+\$32</b>	<b>+\$78</b>	<b>+\$143</b>	<b>+\$170</b>	<b>+\$227</b>	<b>+\$315</b>	<b>+\$382</b>	<b>+\$454</b>	<b>+\$605</b>	<b>+\$764</b>	
	Seat upcharge:	<b>-\$24</b>	<b>+0</b>	<b>+\$19</b>	<b>+\$47</b>	<b>+\$86</b>	<b>+\$102</b>	<b>+\$136</b>	<b>+\$189</b>	<b>+\$229</b>	<b>+\$273</b>	<b>+\$363</b>	<b>+\$459</b>	
<b>OVERALL DIMENSIONS</b>			<b>SEAT DIMENSIONS</b>			<b>BACK DIMENSIONS</b>								
			<b>W</b>	<b>D</b>	<b>H</b>	<b>W</b>	<b>D</b>	<b>H</b>	<b>W</b>	<b>H</b>				
			28.5	29	45.5	20	18.5	17-20	20	29				
			28.5	29	48.5	20	18.5	20-23	20	29				
<b>High Back Patient Chair, Schukra depth adjustable headrest, Flex Back</b> COM Yardage: Back: 1.25; Seat: .75      Active weight 350 lbs. Freight Class: 300 Product Weight (lbs.): 56 Cubic Feet Per Carton: 33.5														

DESCRIPTION	MODEL# / FEATURES	STANDARD TEXTILE GRADES											
		COM	2	3	4	5	6	7	8	9	10	11	12
 <p>Adjustable height      Fixed 18.5" height</p>	<b>GC3684</b> Base Price: <b>\$3512</b> Adjustable height												
	<b>GC3684-20</b> Base Price: <b>\$3573</b> Adjustable height, 20"												
	<b>GC3684XH</b> Base Price: <b>\$3378</b> Fixed 18.5" height												
	Back upcharge:	<b>\$-40</b>	<b>+0</b>	<b>+\$32</b>	<b>+\$78</b>	<b>+\$143</b>	<b>+\$170</b>	<b>+\$227</b>	<b>+\$315</b>	<b>+\$382</b>	<b>+\$454</b>	<b>+\$605</b>	<b>+\$764</b>
	Seat upcharge:	<b>\$-24</b>	<b>+0</b>	<b>+\$19</b>	<b>+\$47</b>	<b>+\$86</b>	<b>+\$102</b>	<b>+\$136</b>	<b>+\$189</b>	<b>+\$229</b>	<b>+\$273</b>	<b>+\$363</b>	<b>+\$459</b>
	<b>OVERALL DIMENSIONS</b>	<b>SEAT DIMENSIONS</b>			<b>BACK DIMENSIONS</b>								
	W D H	W	D	H	W	D	H	W	H				
	28.5 29 45.5	20	18.5	17-20	20	18.5	20-23	20	29				
	28.5 29 48.5	20	18.5	20-23	20	18.5	20-23	20	29				
<b>High Back Patient Chair, Schukra depth adjustable lumbar &amp; headrest</b> COM Yardage: Back: 1.25; Seat: .75      Active weight 350 lbs. Freight Class: 300 Product Weight (lbs.): 56 Cubic Feet Per Carton: 33.5													
 <p>Adjustable height      Fixed 18.5" height</p>	<b>GC3684F</b> Base Price: <b>\$3868</b> Adjustable height												
	<b>GC3684-20F</b> Base Price: <b>\$3930</b> Adjustable height, 20"												
	<b>GC3684FXH</b> Base Price: <b>\$3735</b> Fixed 18.5" height												
	Back upcharge:	<b>\$-40</b>	<b>+0</b>	<b>+\$32</b>	<b>+\$78</b>	<b>+\$143</b>	<b>+\$170</b>	<b>+\$227</b>	<b>+\$315</b>	<b>+\$382</b>	<b>+\$454</b>	<b>+\$605</b>	<b>+\$764</b>
	Seat upcharge:	<b>\$-24</b>	<b>+0</b>	<b>+\$19</b>	<b>+\$47</b>	<b>+\$86</b>	<b>+\$102</b>	<b>+\$136</b>	<b>+\$189</b>	<b>+\$229</b>	<b>+\$273</b>	<b>+\$363</b>	<b>+\$459</b>
	<b>OVERALL DIMENSIONS</b>	<b>SEAT DIMENSIONS</b>			<b>BACK DIMENSIONS</b>								
	W D H	W	D	H	W	D	H	W	H				
	28.5 29 45.5	20	18.5	17-20	20	18.5	20-23	20	29				
	28.5 29 48.5	20	18.5	20-23	20	18.5	20-23	20	29				
<b>High Back Patient Chair with Schukra depth adjustable lumbar &amp; headrest, Flex Back</b> COM Yardage: Back: 1.25; Seat: .75      Active weight 350 lbs. Freight Class: 300 Product Weight (lbs.): 56 Cubic Feet Per Carton: 33.5													
	<b>GC3685</b> Base Price: <b>\$3529</b>												
	Back upcharge:	<b>\$-72</b>	<b>+0</b>	<b>+\$57</b>	<b>+\$140</b>	<b>+\$257</b>	<b>+\$306</b>	<b>+\$408</b>	<b>+\$567</b>	<b>+\$687</b>	<b>+\$817</b>	<b>+\$1089</b>	<b>+\$1375</b>
	Seat upcharge:	<b>\$-32</b>	<b>+0</b>	<b>+\$25</b>	<b>+\$62</b>	<b>+\$114</b>	<b>+\$136</b>	<b>+\$181</b>	<b>+\$252</b>	<b>+\$305</b>	<b>+\$363</b>	<b>+\$484</b>	<b>+\$611</b>
	<b>OVERALL DIMENSIONS</b>	<b>SEAT DIMENSIONS</b>			<b>BACK DIMENSIONS</b>								
	W D H	W	D	H	W	D	H	W	H				
	40 29 47	35	18.5	18.5	35	18.5	18.5	35	29				
<b>Bariatric High Back Patient Chair</b> COM Yardage: Back: 2.25; Seat: 1      Active weight 750 lbs. Fixed height legs. Freight Class: 300 Product Weight (lbs.): 70 Cubic Feet Per Carton: 45													
	<b>GC3686</b>												
	Active weight 350 lbs.	<b>\$859</b>	<b>\$891</b>	<b>\$916</b>	<b>\$953</b>	<b>\$1005</b>	<b>\$1027</b>	<b>\$1072</b>	<b>\$1143</b>	<b>\$1196</b>	<b>\$1254</b>	<b>\$1375</b>	<b>\$1502</b>
	<b>OVERALL DIMENSIONS</b>	<b>SEAT DIMENSIONS</b>			<b>BACK DIMENSIONS</b>								
	W D H	W	D	H	W	D	H	W	H				
	17 17.5 12.5												
<b>Ottoman</b> COM Yardage: 1 Freight Class: 150 Product Weight (lbs.): 18 Cubic Feet Per Carton: 3.6	Can be stored beneath any Nourish chair when not in use.												

OAKVILLE



model GC36500  
High back lounge chair

STANDARD FEATURES

- Oakville offers a modern take on wingback seating for social settings, resident rooms and lounge areas.
- The seating in this series is available to specify with two textiles, one for the seat cushion and one for the back, arms and front rail (see model image).
- For pricing, start with the base price and add both back/arms graded textile upcharge and the seat graded textile upcharge.
- A clean through design is provided around the seat cushion for easy housekeeping.
- Legs are available in wood or urethane (see upcharge).
- Choose from standard non-marking glides, steel cushioned glides, rubber non-slip glides, or felt glides (upcharges apply).
- The seat underside is sealed with a non-porous material to support housekeeping and infection control protocols.
- For added comfort, seat cushions are standard with high density Ultracell foam.
- The Globalcare warranty (for healthcare and 24/7 environments) applies for all Oakville models when performance textiles are selected. Visit the website at [globalfurnituregroup.com/healthcare](http://globalfurnituregroup.com/healthcare).
- Global's standard lifetime warranty applies when approved standard Global textiles are selected.
- For alternate textile applications, contact Global specials. The Blended Textile matrix does not apply to this series.
- Shipped fully assembled.

SUGGESTED APPLICATIONS

- Guest seating
- Lobbies
- Lounge/Waiting
- Patient rooms
- Resident rooms

Add option codes in the following order:

- **Model number**  
**GC36500** High back lounge chair
- **Back/Arm Textile**  
Specify textile code. See model grade upcharges.
- **Seat Textile**  
Specify textile code. See model grade upcharges.
- **Leg Finish (Wood)**

<b>(AAM)</b> Absolute	<b>(MWM)</b> Medium Walnut
<b>(BKM)</b> Black	<b>(NLW)</b> Natural Walnut
<b>(CJM)</b> Charcoal Java	<b>(ASM)</b> Night
<b>(ACM)</b> Cherry	<b>(NBM)</b> Noce Biondo
<b>(EMM)</b> Empire Mahogany	<b>(NGM)</b> Noce Grigio
<b>(EOM)</b> English Oak	<b>(NEM)</b> Noce Leggero
<b>(ECM)</b> Espresso Cafe	<b>(NMM)</b> Noce Medio
<b>(TFM)</b> Fruitwood	<b>(SBM)</b> Sandy Beach
<b>(HGM)</b> Grey	<b>(SKM)</b> Shaker Cherry
<b>(HOM)</b> Harvest Oak	<b>(SOM)</b> Silver Oak
<b>(AHM)</b> Honey	<b>(TWM)</b> Walnut
<b>(JOM)</b> Jet Onyx	<b>(WTM)</b> WC Cream
<b>(LHM)</b> Light Honey	<b>(WHM)</b> White
<b>(TMM)</b> Mahogany	<b>(WCM)</b> Winter Cherry
<b>(AVM)</b> Maple	
- **Leg Finish (Urethane)** Add \$86.
 

<b>(BLK)</b> Black	<b>(KAL)</b> Kalua
<b>(LAB)</b> Latte	<b>(J52)</b> Mocha
<b>(SHW)</b> Shadow	<b>(TOA)</b> Toast
- **Glides**
  - (NM)** Non-marking glide. Standard.
  - (RG)** Rubber, non-slip glide. Add \$34.
  - (SG)** Steel cushion glide. Add \$34.
  - (FG)** Felt glide. Add \$34.
- **Sealed Back Seams** (Contact Customer Care for approved textiles)
  - (NBS)** No sealed back seams
  - (SBS)** Sealed back seams. Add \$166.
- **Sealed Seat Seams** (Contact Customer Care for approved textiles)
  - (NSS)** No sealed seat seams
  - (SSS)** Sealed seat seams. Add \$32.
- **Moisture Barrier** (Not available with Sealed Seams)
  - (NB)** No moisture barrier.
  - (MB)** Moisture barrier (seat only). Add \$110.

EXAMPLE OAKVILLE ORDER CODE:

GC36500	CE90	CE90	AVM	NM	NBS	NSS	NB
Model #	Back/Arm textile	Seat textile	Leg finish	Glide	Sealed Back Seams	Sealed Seat Seams	Moisture Barrier

DESCRIPTION	MODEL#/ FEATURES	STANDARD TEXTILE GRADES											
		1/COM	2	3	4	5	6	7	8	9	10	11	12
	GC36500 Base Price:	\$2801											
	Back/Arm upcharge:	+0	+\$136	+\$243	+\$400	+\$621	+\$714	+\$906	+\$1207	+\$1433	+\$1679	+\$2193	+\$2733
	Seat upcharge:	+0	+\$40	+\$72	+\$118	+\$183	+\$210	+\$267	+\$355	+\$422	+\$494	+\$645	+\$804
	<b>OVERALL DIMENSIONS</b>	<b>SEAT DIMENSIONS</b>			<b>BACK DIMENSIONS</b>								
	<b>W D H</b>	<b>W</b>	<b>D</b>	<b>H</b>	<b>W</b>	<b>D</b>	<b>H</b>	<b>W</b>	<b>H</b>				
		30	30	41.25	20.5	21	18.5	21.75	23.75				
<b>High Back Lounge Chair</b> COM Yardage: Back/Arm: 4.25; Seat: 1.25 Freight Class: 250 Product Weight (lbs.): 75.5 Cubic Feet Per Carton: 19.25	Active weight 350 lbs. Replaceable seat cushion.												



GC3616W Dining armchair with open arms

Primacare™ set a benchmark for healthcare seating. All the features, all the looks and quite possibly the most extensive offering of its kind for both acute care and long-term care applications.

Under the skin of every Primacare chair is a heart of solid steel waiting to meet the rigorous demands of any environment.

The Primacare series includes more than 40 models that extend from patient rooms to waiting areas, dining rooms to treatment centers including bariatric hip chair solutions.

**FEATURES**



Open arms



Closed arms - fully upholstered side panels

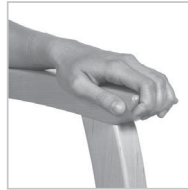

Arm grip extension - to assist getting in and out of the chair safely

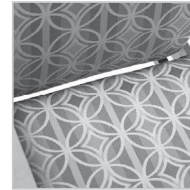

Separate seat and back - provides clean out for housekeeping staff



Fold down headrest - to provide access for caregiver assistance



Removable upholstery - for ease of cleaning and replacement

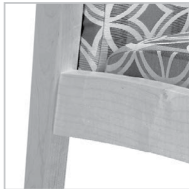

Solid wood frame - in hardwood for long life and a warm look



Metal-to-metal connector - provides unparalleled strength and durability

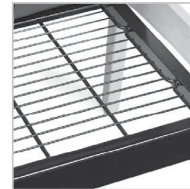

Metal mesh pan - superior comfort and hygiene for patient incontinence



Wall safe legs - offer first contact to protect walls and chair backs on most models

**AVAILABLE TEXTILES AND FINISHES**

Please see the Globalcare Textile and Finishes section at [www.globalfurnituregroup.com](http://www.globalfurnituregroup.com) for all details including wood finishes.

**SUGGESTED APPLICATIONS**

- Bariatric seating (some models)
- Dining/Cafeteria
- Guest seating
- Lobbies
- Lounge/Waiting
- Patient rooms
- Resident rooms
- Treatment/Exam rooms

**DINING** - available with wood or metal frames



**GUEST** - available with wood or metal frames



**PATIENT** - available with wood or metal frames



**HIP CHAIRS** - available with wood or metal frames



**LOUNGE** - available with wood or metal legs



**FULLY UPHOLSTERED LOUNGE** - available with wood or metal legs

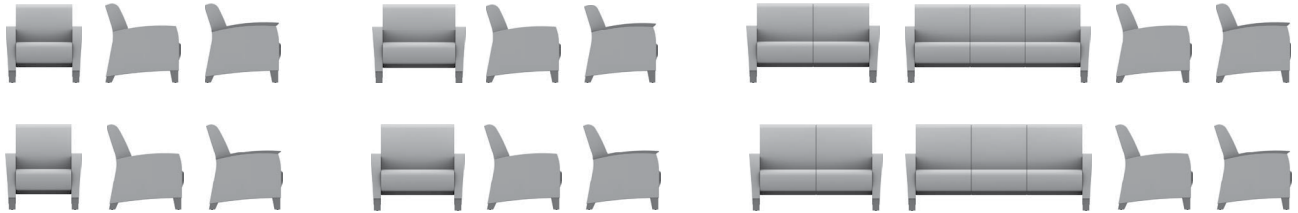

**WINGBACK ARMCHAIR** - available with wood or metal armcaps and legs



**RECLINERS** - available with wood or metal armcaps



**SLEEPERS** - available with wood or metal armcaps



**BENCHES** - available with wood or metal legs



(SSU or wood legs only)

**MODULAR GUEST/PATIENT** - see page 154.



## PRIMACARE DINING



model GC3616CA (HT)



model GC3616W (Wood)

## STANDARD FEATURES

- Primacare is a family of products offering the most significant return on investment approach in the industry since every component can be repaired or replaced on site.
- High traffic (HT) models:** Metal frame with die cast zinc connectors and metal-to-metal fasteners. Available in the following finishes: Black (TBL), Cloud (TIV), Designer White (TDW), Fog (TFO), Frost (TFR), Kalua (TKA), Latte (TLA), Mocha (TMO), Nevada (TNE), Sand (TSN), Shadow (TSH), Toast (TOA) and Tungsten (TTU).
- Wood models:** Solid hardwood frame with die cast zinc connectors and metal-to-metal fastening. Available in the following finishes: Absolute (AAM), Charcoal Java (CJM), Cherry (ACM), Empire Mahogany (EMM), English Oak (EOM), Espresso Cafe (ECM), Fruitwood (TFM), Gray (HGM), Harvest Oak (HOM), Honey (AHM), Jet Onyx (JOM), Light Honey (LHM), Mahogany (TMM), Maple (AVM), Medium Walnut (MWM), Natural Walnut (NLW), Night (ASM), Noce Biondo (NBM), Noce Grigio (NGM), Noce Leggero (NEM), Noce Medio (NMM), Sandy Beach (SBM), Shaker Cherry (SKM), Silver Oak (SOM), Walnut (TWM), White (WHM), WC Cream (WTM) and Winter Cherry (WCM).
- Armchairs are securely fastened with metal-to-metal connectors which allow for field replacement if required.
- Easy grip forward extending armcap on models with arms.
- Wood armchairs are standard.
- Replaceable seat covers and replaceable and/or removable seat cushions are standard.
- Waterfall cleanout between the seat and back cushions.
- Models are standard with metal mesh seat deck. For behavioral health applications, the metal mesh seat deck can be covered with a solid moisture resistant surface, held in place with tamperproof fasteners. Contact your Global sales rep for a special quotation.
- All seat frames feature a wall saver design to prevent back contact with wall.
- GC3616WCA** and **GC3616CA** have upholstered panel arm inserts closing the arm. (Closed arm panels are designed to be replaceable. Request a special quote to have them secured with tamperproof fasteners.)
- Model **GC3616RCEZ** has a lift-assist mechanism and rear casters. The caregiver steps on the lift-assist foot lever to assist in turning the chair and moving the occupant to and from a table.
- For healthcare textile options, visit the website at [www.globalfurnituregroup.com](http://www.globalfurnituregroup.com).
- Can be upholstered in standard Global textiles if healthcare compliance is not required.

- It is recommended that High Traffic (HT) models be specified in textiles that meet or exceed 100,000 double rubs for added abrasion performance.
- Shipped fully assembled.
- HIGH TRAFFIC (HT) MODELS ARE LISTED FIRST, FOLLOWED BY WOOD MODELS.**

## OPTIONAL FEATURES

- Urethane armchairs are available. See far left column "High traffic (HT) models" for finishes. Please specify. *Refer to individual models for availability and pricing.*
- For moisture barrier on seat, specify (MB). Add \$129 per seat.
- To add sealed seams to your product contact Customer Care. Upcharges vary.
- For Primacare tables, see page 56.

## SUGGESTED APPLICATIONS

- Dining/Cafeteria
- Guest seating
- Lobbies
- Lounge/Waiting
- Patient rooms
- Resident rooms

DESCRIPTION	MODEL# / FEATURES	STANDARD TEXTILE GRADES											
		COM	2	3	4	5	6	7	8	9	10	11	12



**Dining Chair, Open Arms (HT)**  
COM Yardage: 1.5  
Freight Class: 150  
Product Weight (lbs.): 58  
Cubic Feet Per Carton: 13.25

<b>GC3616</b> Metal	\$1654	\$1703	\$1748	\$1809	\$1899	\$1930	\$2008	\$2154	\$2227	\$2364	\$2551	\$2783
	<b>OVERALL DIMENSIONS</b>			<b>SEAT DIMENSIONS</b>			<b>BACK DIMENSIONS</b>					
	<b>W</b>	<b>D</b>	<b>H</b>	<b>W</b>	<b>D</b>	<b>H</b>	<b>W</b>	<b>H</b>				
	23	23	34.5	19	17.5	18	19	16.5				

Active weight 500 lbs.  
Urethane armcap option - **Add \$104 list upcharge**



**Dining Chair, Closed Arms (HT)**  
COM Yardage: 2  
Freight Class: 150  
Product Weight (lbs.): 66  
Cubic Feet Per Carton: 13.25

<b>GC3616CA</b> Metal	\$1899	\$1965	\$2021	\$2107	\$2223	\$2268	\$2370	\$2567	\$2664	\$2845	\$3094	\$3404
	<b>OVERALL DIMENSIONS</b>			<b>SEAT DIMENSIONS</b>			<b>BACK DIMENSIONS</b>					
	<b>W</b>	<b>D</b>	<b>H</b>	<b>W</b>	<b>D</b>	<b>H</b>	<b>W</b>	<b>H</b>				
	23	23	34.5	19	17.5	18	19	16.5				

Active weight 500 lbs.  
Urethane armcap option - **Add \$104 list upcharge**

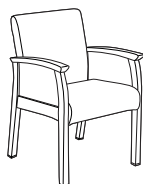



**Dining Chair, Closed Arms, Laminate Panels (HT)**  
COM Yardage: 1.5  
Freight Class: 150  
Product Weight (lbs.): 66  
Cubic Feet Per Carton: 13.25

<b>GC3616CAL</b> Metal	\$2237	\$2281	\$2321	\$2377	\$2458	\$2494	\$2566	\$2679	\$2767	\$2867	\$3070	\$3284
	<b>OVERALL DIMENSIONS</b>			<b>SEAT DIMENSIONS</b>			<b>BACK DIMENSIONS</b>					
	<b>W</b>	<b>D</b>	<b>H</b>	<b>W</b>	<b>D</b>	<b>H</b>	<b>W</b>	<b>H</b>				
	23	23	34.5	19	17.5	18	19	16.5				

Active weight 500 lbs.  
Urethane armcap option - **Add \$104 list upcharge**

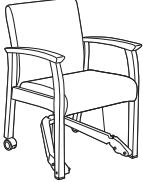
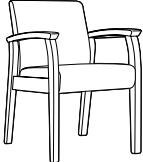
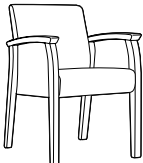

DESCRIPTION	MODEL#	STANDARD FABRIC GRADES											
		COM	2	3	4	5	6	7	8	9	10	11	12
 <p>Allows caregiver to gently move a seated person to and from a table.</p> <p><b>Dining Chair, Open Arms, Rear Swivel Casters &amp; Lift Mech (HT)</b>                      COM Yardage: 1.5                      Freight Class: 150                      Product Weight (lbs.): 59                      Cubic Feet Per Carton: 13.25</p>	GC3616RCEZ Metal	\$2594	\$2643	\$2687	\$2749	\$2838	\$2879	\$2957	\$3084	\$3180	\$3288	\$3512	\$3749
		OVERALL DIMENSIONS			SEAT DIMENSIONS			BACK DIMENSIONS					
		W	D	H	W	D	H	W	H				
		23	23	34.5	19	17.5	18	19	16.5				
		Active weight 500 lbs. Urethane armcap option - Add \$104 list upcharge											
 <p><b>Dining Chair, Open Arms (Wood)</b>                      COM Yardage: 1.5                      Freight Class: 250                      Product Weight (lbs.): 50                      Cubic Feet Per Carton: 13.25</p>	GC3616W Wood	\$1364	\$1411	\$1456	\$1518	\$1608	\$1639	\$1719	\$1863	\$1935	\$2072	\$2261	\$2491
		OVERALL DIMENSIONS			SEAT DIMENSIONS			BACK DIMENSIONS					
		W	D	H	W	D	H	W	H				
		23	23	34.5	19	17.5	18	19	16.5				
		Active weight 350 lbs. Urethane armcap option - Add \$104 list upcharge											
 <p><b>Dining Chair, Closed Arms (Wood)</b>                      COM Yardage: 2                      Freight Class: 150                      Product Weight (lbs.): 58                      Cubic Feet Per Carton: 13.25</p>	GC3616WCA Wood	\$1563	\$1627	\$1685	\$1770	\$1887	\$1934	\$2036	\$2230	\$2326	\$2508	\$2758	\$3067
		OVERALL DIMENSIONS			SEAT DIMENSIONS			BACK DIMENSIONS					
		W	D	H	W	D	H	W	H				
		23	23	34.5	19	17.5	18	19	16.5				
		Active weight 350 lbs. Urethane armcap option - Add \$104 list upcharge											
 <p><b>Dining Chair, Open Arms, Front Casters (Wood)</b>                      COM Yardage: 1.5                      Freight Class: 250                      Product Weight (lbs.): 50                      Cubic Feet Per Carton: 13.25</p>	GC3616WFC Wood	\$1522	\$1569	\$1614	\$1675	\$1766	\$1797	\$1876	\$2021	\$2093	\$2230	\$2418	\$2651
		OVERALL DIMENSIONS			SEAT DIMENSIONS			BACK DIMENSIONS					
		W	D	H	W	D	H	W	H				
		23	23	34.5	19	17.5	18	19	16.5				
		Active weight 350 lbs. Urethane armcap option - Add \$104 list upcharge											

PRIMACARE GUEST



model GC3620CA (HT)



model GC3625W (Wood)

STANDARD FEATURES

- Primacare is a family of products offering the most significant return on investment approach in the industry since every component can be repaired or replaced on site.
- **High traffic (HT) models:** Metal frame with die cast zinc connectors and metal-to-metal fasteners. Available in the following finishes: Black (TBL), Cloud (TIV), Designer White (TDW), Fog (TFO), Frost (TFR), Kalua (TKA), Latte (TLA), Mocha (TMO), Nevada (TNE), Sand (TSN), Shadow (TSH), Toast (TOA) and Tungsten (TTU).
- **Wood models:** Solid hardwood frame with die cast zinc connectors and metal-to-metal fastening. Available in the following finishes: Absolute (AAM), Charcoal Java (CJM), Cherry (ACM), Empire Mahogany (EMM), English Oak (EOM), Espresso Cafe (ECM), Fruitwood (TFM), Gray (HGM), Harvest Oak (HOM), Honey (AHM), Jet Onyx (JOM), Light Honey (LHM), Mahogany (TMM), Maple (AVM), Medium Walnut (MWM), Natural Walnut (NLW), Night (ASM), Noce Biondo (NBM), Noce Grigio (NGM), Noce Leggero (NEM), Noce Medio (NMM), Sandy Beach (SBM), Shaker Cherry (SKM), Silver Oak (SOM), Walnut (TWM), White (WHM), WC Cream (WTM) and Winter Cherry (WCM).
- Armcaps are securely fastened with metal-to-metal connectors which allow for field replacement if required.
- Easy grip forward extending armcap on models with arms.

- Wood armcaps are standard.
- Replaceable seat covers and replaceable and/or removable seat cushions are standard.
- Waterfall cleanout between the seat and back cushions.
- Models are standard with metal mesh seat deck. For behavioral health applications, the metal mesh seat deck can be covered with a solid moisture resistant surface, held in place with tamperproof fasteners. Contact your sales rep for a special quotation.
- All seat frames feature a wall saver design to prevent back contact with wall.
- Models ending in **CA / ARC**, have upholstered panel arm inserts closing the arm. (Closed arm panels are designed to be replaceable. Request a special quote to have them secured with tamperproof fasteners.)
- For Globalcare textile options, visit the website at [www.globalfurnituregroup.com](http://www.globalfurnituregroup.com).
- Can be upholstered in standard Global textiles if healthcare compliance is not required.
- It is recommended that High Traffic (HT) models be specified in textiles that meet or exceed 100,000 double rubs for added abrasion performance.
- Shipped fully assembled.
- **High traffic (HT) models are listed first, followed by wood models.**

OPTIONAL FEATURES

- Urethane armcaps are available. Please specify. Refer to individual models for availability and pricing.
- For moisture barrier (seat only), add \$129 list upcharge per seat. For Bariatric Models: GC3637, GC3637W, GC3637CA and GC3637WCA - **Add \$198** list upcharge per seat.
- To add sealed seams to your product contact Customer Care. Upcharges vary.
- For Primacare tables, see page 56.

SUGGESTED APPLICATIONS

- Bariatric seating
- Guest seating
- Lobbies
- Lounge/Waiting
- Patient rooms
- Resident rooms

DESCRIPTION MODEL# / FEATURES STANDARD TEXTILE GRADES



**LB Armchair, Open Arms (HT)**  
COM Yardage: 1.75  
Freight Class: 250  
Product Weight (lbs.): 62  
Cubic Feet Per Carton: 17.5

COM	2	3	4	5	6	7	8	9	10	11	12	
<b>GC3620</b> Metal	\$1974	\$2031	\$2083	\$2157	\$2258	\$2298	\$2389	\$2559	\$2644	\$2803	\$3021	\$3293
<b>GC3620F</b> Metal flex back	\$2468	\$2529	\$2579	\$2653	\$2755	\$2793	\$2884	\$3055	\$3140	\$3300	\$3519	\$3788
OVERALL DIMENSIONS			SEAT DIMENSIONS			BACK DIMENSIONS						
W	D	H	W	D	H	W	H					
25	27	33	20.5	17.5	18	20.5	15					

Active weight 500 lbs.  
Urethane armcap option - **Add \$104 list upcharge**

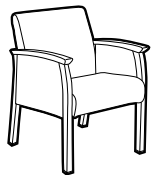

**LB Armchair, Closed Arms (HT)**  
COM Yardage: 2.75  
Freight Class: 150  
Product Weight (lbs.): 72  
Cubic Feet Per Carton: 17.5

COM	2	3	4	5	6	7	8	9	10	11	12	
<b>GC3620CA</b> Metal	\$2239	\$2331	\$2410	\$2526	\$2688	\$2748	\$2892	\$3158	\$3292	\$3540	\$3885	\$4309
<b>GC3620FCA</b> Metal flex back	\$2737	\$2829	\$2908	\$3022	\$3184	\$3246	\$3389	\$3656	\$3790	\$4038	\$4383	\$4808
OVERALL DIMENSIONS			SEAT DIMENSIONS			BACK DIMENSIONS						
W	D	H	W	D	H	W	H					
25	27	33	20.5	17.5	18	20.5	15					

Active weight 500 lbs.  
Urethane armcap option - **Add \$104 list upcharge**

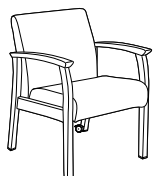

**LB Armchair, Open Arms, Rear Tip & Move Wheels (HT)**  
COM Yardage: 1.75  
Freight Class: 250  
Product Weight (lbs.): 62  
Cubic Feet Per Carton: 23

COM	2	3	4	5	6	7	8	9	10	11	12	
<b>GC3620RC</b> Metal	\$2125	\$2183	\$2235	\$2308	\$2411	\$2449	\$2541	\$2713	\$2797	\$2956	\$3174	\$3443
OVERALL DIMENSIONS			SEAT DIMENSIONS			BACK DIMENSIONS						
W	D	H	W	D	H	W	H					
25	29.5	33	20.5	17.5	18	20.5	15					

Active weight 500 lbs.  
Urethane armcap option - **Add \$104 list upcharge**

DESCRIPTION MODEL# STANDARD FABRIC GRADES

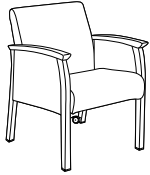

COM	2	3	4	5	6	7	8	9	10	11	12	
<b>GC3620CARC</b>	<b>\$2398</b>	<b>\$2490</b>	<b>\$2569</b>	<b>\$2683</b>	<b>\$2844</b>	<b>\$2906</b>	<b>\$3050</b>	<b>\$3317</b>	<b>\$3450</b>	<b>\$3698</b>	<b>\$4042</b>	<b>\$4468</b>

Metal

OVERALL DIMENSIONS			SEAT DIMENSIONS			BACK DIMENSIONS	
W	D	H	W	D	H	W	H
25	29.5	33	20.5	17.5	18	20.5	15

**LB Armchair, Closed Arms, Rear Tip & Move Wheels (HT)**  
 COM Yardage: 2.75  
 Freight Class: 250  
 Product Weight (lbs.): 72  
 Cubic Feet Per Carton: 23

Active weight 500 lbs.  
 Urethane armcap option - **Add \$104 list upcharge**

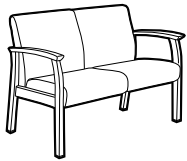

COM	2	3	4	5	6	7	8	9	10	11	12	
<b>GC3621</b>	<b>\$3193</b>	<b>\$3304</b>	<b>\$3396</b>	<b>\$3531</b>	<b>\$3722</b>	<b>\$3797</b>	<b>\$3964</b>	<b>\$4278</b>	<b>\$4435</b>	<b>\$4731</b>	<b>\$5140</b>	<b>\$5639</b>

Metal

OVERALL DIMENSIONS			SEAT DIMENSIONS			BACK DIMENSIONS	
W	D	H	W	D	H	W	H
45	27	33	40	17.5	18	40	15

**LB Two Seat Chair, No Center Arm, Open Arms (HT)**  
 COM Yardage: 3.25  
 Freight Class: 250  
 Product Weight (lbs.): 92  
 Cubic Feet Per Carton: 43

Active weight 500 lbs./seat  
 Urethane armcap option - **Add \$104 list upcharge**

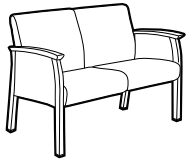

COM	2	3	4	5	6	7	8	9	10	11	12	
<b>GC3621CA</b>	<b>\$3478</b>	<b>\$3603</b>	<b>\$3710</b>	<b>\$3867</b>	<b>\$4087</b>	<b>\$4170</b>	<b>\$4364</b>	<b>\$4731</b>	<b>\$4912</b>	<b>\$5250</b>	<b>\$5719</b>	<b>\$6302</b>

Metal

OVERALL DIMENSIONS			SEAT DIMENSIONS			BACK DIMENSIONS	
W	D	H	W	D	H	W	H
45	27	33	40	17.5	18	40	15

**LB Two Seat Chair, No Center Arm, Closed Arms (HT)**  
 COM Yardage: 3.75  
 Freight Class: 250  
 Product Weight (lbs.): 100  
 Cubic Feet Per Carton: 43

Active weight 500 lbs./seat  
 Urethane armcap option - **Add \$104 list upcharge**

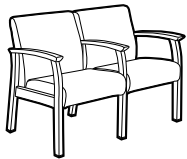

COM	2	3	4	5	6	7	8	9	10	11	12	
<b>GC3622</b>	<b>\$3604</b>	<b>\$3716</b>	<b>\$3808</b>	<b>\$3943</b>	<b>\$4138</b>	<b>\$4207</b>	<b>\$4376</b>	<b>\$4690</b>	<b>\$4849</b>	<b>\$5142</b>	<b>\$5550</b>	<b>\$6051</b>

Metal

OVERALL DIMENSIONS			SEAT DIMENSIONS			BACK DIMENSIONS	
W	D	H	W	D	H	W	H
46	27	33	20.5	17.5	18	20.5	15

**LB Two Seat Chair, Full Center Arm, Open Arms (HT)**  
 COM Yardage: 3.25  
 Freight Class: 250  
 Product Weight (lbs.): 98  
 Cubic Feet Per Carton: 43

Active weight 500 lbs./seat  
 Urethane armcap option - **Add \$155 list upcharge**

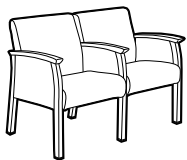

COM	2	3	4	5	6	7	8	9	10	11	12	
<b>GC3622CA</b>	<b>\$4012</b>	<b>\$4166</b>	<b>\$4292</b>	<b>\$4481</b>	<b>\$4746</b>	<b>\$4846</b>	<b>\$5078</b>	<b>\$5515</b>	<b>\$5735</b>	<b>\$6141</b>	<b>\$6703</b>	<b>\$7400</b>

Metal

OVERALL DIMENSIONS			SEAT DIMENSIONS			BACK DIMENSIONS	
W	D	H	W	D	H	W	H
46	27	33	20.5	17.5	18	20.5	15

**LB Two Seat Chair, Full Center Arm, Closed Arms (HT)**  
 COM Yardage: 4.5  
 Freight Class: 250  
 Product Weight (lbs.): 118  
 Cubic Feet Per Carton: 43

Active weight 500 lbs./seat  
 Urethane armcap option - **Add \$155 list upcharge**

# SEATING

# PRIMACARE™ GUEST P

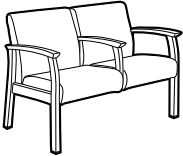
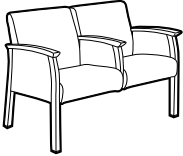
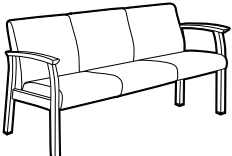
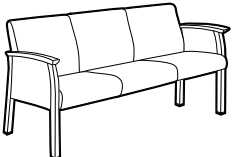
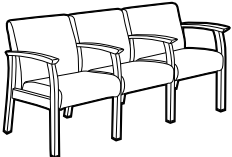
DESCRIPTION	MODEL#	STANDARD FABRIC GRADES											
		COM	2	3	4	5	6	7	8	9	10	11	12
 <p><b>LB Two Seat Chair, Half Center Arm, Open Arms (HT)</b>                      COM Yardage: 3.25                      Freight Class: 250                      Product Weight (lbs.): 94                      Cubic Feet Per Carton: 43</p>	<b>GC3623</b> Metal	\$3539	\$3648	\$3742	\$3875	\$4070	\$4142	\$4311	\$4624	\$4782	\$5076	\$5483	\$5989
		<b>OVERALL DIMENSIONS</b>			<b>SEAT DIMENSIONS</b>			<b>BACK DIMENSIONS</b>					
		W	D	H	W	D	H	W	H				
			46	27	33	20.5	17.5	18	20.5	15			
			Active weight 500 lbs./seat Urethane armcap option - <b>Add \$155 list upcharge</b>										
 <p><b>LB Two Seat Chair, Half Center Arm, Closed Arms (HT)</b>                      COM Yardage: 4.5                      Freight Class: 250                      Product Weight (lbs.): 106                      Cubic Feet Per Carton: 43</p>	<b>GC3623CA</b> Metal	\$3944	\$4098	\$4225	\$4413	\$4678	\$4778	\$5011	\$5447	\$5667	\$6073	\$6635	\$7336
		<b>OVERALL DIMENSIONS</b>			<b>SEAT DIMENSIONS</b>			<b>BACK DIMENSIONS</b>					
		W	D	H	W	D	H	W	H				
			46	27	33	20.5	17.5	18	20.5	15			
			Active weight 500 lbs./seat Urethane armcap option - <b>Add \$155 list upcharge</b>										
 <p><b>LB Three Seat Chair, No Center Arms, Open Arms (HT)</b>                      COM Yardage: 4.25                      Freight Class: 250                      Product Weight (lbs.): 137                      Cubic Feet Per Carton: 65.25</p>	<b>GC3624</b> Metal	\$4335	\$4465	\$4575	\$4734	\$4960	\$5068	\$5274	\$5599	\$5853	\$6134	\$6711	\$7326
		<b>OVERALL DIMENSIONS</b>			<b>SEAT DIMENSIONS</b>			<b>BACK DIMENSIONS</b>					
		W	D	H	W	D	H	W	H				
			65	27	33	60	17.5	18	60	15			
			Active weight 500 lbs./seat Urethane armcap option - <b>Add \$104 list upcharge</b>										
 <p><b>LB Three Seat Chair, No Center Arms, Closed Arms (HT)</b>                      COM Yardage: 5.25                      Freight Class: 250                      Product Weight (lbs.): 147                      Cubic Feet Per Carton: 65.25</p>	<b>GC3624CA</b> Metal	\$4586	\$4765	\$4915	\$5133	\$5440	\$5559	\$5830	\$6340	\$6596	\$7068	\$7728	\$8540
		<b>OVERALL DIMENSIONS</b>			<b>SEAT DIMENSIONS</b>			<b>BACK DIMENSIONS</b>					
		W	D	H	W	D	H	W	H				
			65	27	33	60	17.5	18	60	15			
			Active weight 500 lbs./seat Urethane armcap option - <b>Add \$104 list upcharge</b>										
 <p><b>LB Three Seat Chair, Full Center Arms, Open Arms (HT)</b>                      COM Yardage: 4.75                      Freight Class: 250                      Product Weight (lbs.): 162                      Cubic Feet Per Carton: 65.25</p>	<b>GC3625</b> Metal	\$5126	\$5289	\$5426	\$5621	\$5903	\$6009	\$6253	\$6715	\$6945	\$7374	\$7971	\$8704
		<b>OVERALL DIMENSIONS</b>			<b>SEAT DIMENSIONS</b>			<b>BACK DIMENSIONS</b>					
		W	D	H	W	D	H	W	H				
			69	27	33	20.5	17.5	18	20.5	15			
			Active weight 500 lbs./seat Urethane armcap option - <b>Add \$204 list upcharge</b>										

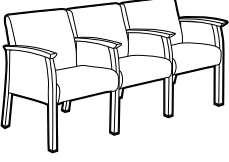
DESCRIPTION	MODEL#	STANDARD FABRIC GRADES											
		COM	2	3	4	5	6	7	8	9	10	11	12
 <p><b>GC3625CA</b> Metal</p>		\$5672	\$5888	\$6066	\$6323	\$6693	\$6831	\$7154	\$7762	\$8067	\$8630	\$9411	\$10381
	<b>OVERALL DIMENSIONS</b>			<b>SEAT DIMENSIONS</b>			<b>BACK DIMENSIONS</b>						
		W	D	H	W	D	H	W	H				
		69	27	33	20.5	17.5	18	20.5	15				
<p><b>LB Three Seat Chair, Full Center Arms, Closed Arms (HT)</b> COM Yardage: 6.25 Freight Class: 250 Product Weight (lbs.): 172 Cubic Feet Per Carton: 65.25</p>		<p>Active weight 500 lbs./seat Urethane armcap option - <b>Add \$204 list upcharge</b></p>											

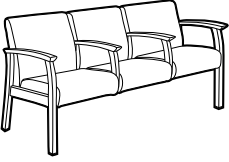
DESCRIPTION	MODEL#	STANDARD FABRIC GRADES											
		COM	2	3	4	5	6	7	8	9	10	11	12
 <p><b>GC3626</b> Metal</p>		\$4991	\$5153	\$5288	\$5487	\$5767	\$5872	\$6116	\$6579	\$6808	\$7238	\$7834	\$8568
	<b>OVERALL DIMENSIONS</b>			<b>SEAT DIMENSIONS</b>			<b>BACK DIMENSIONS</b>						
		W	D	H	W	D	H	W	H				
		69	27	33	20.5	17.5	18	20.5	15				
<p><b>LB Three Seat Chair, Half Center Arms, Open Arms (HT)</b> COM Yardage: 4.75 Freight Class: 250 Product Weight (lbs.): 147 Cubic Feet Per Carton: 65.25</p>		<p>Active weight 500 lbs./seat Urethane armcap option - <b>Add \$204 list upcharge</b></p>											

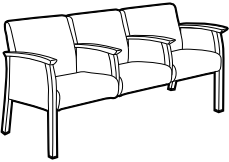
DESCRIPTION	MODEL#	STANDARD FABRIC GRADES											
		COM	2	3	4	5	6	7	8	9	10	11	12
 <p><b>GC3626CA</b> Metal</p>		\$5541	\$5753	\$5931	\$6194	\$6558	\$6698	\$7021	\$7627	\$7932	\$8496	\$9280	\$10248
	<b>OVERALL DIMENSIONS</b>			<b>SEAT DIMENSIONS</b>			<b>BACK DIMENSIONS</b>						
		W	D	H	W	D	H	W	H				
		69	27	33	20.5	17.5	18	20.5	15				
<p><b>LB Three Seat Chair, Half Center Arms, Closed Arms (HT)</b> COM Yardage: 6.25 Freight Class: 250 Product Weight (lbs.): 157 Cubic Feet Per Carton: 65.25</p>		<p>Active weight 500 lbs./seat Urethane armcap option - <b>Add \$204 list upcharge</b></p>											

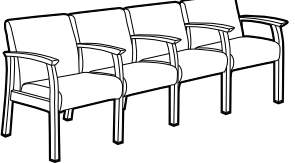
DESCRIPTION	MODEL#	STANDARD FABRIC GRADES											
		COM	2	3	4	5	6	7	8	9	10	11	12
 <p><b>GC3628</b> Metal</p>		\$7406	\$7610	\$7781	\$8028	\$8384	\$8520	\$8827	\$9410	\$9700	\$10241	\$10996	\$11925
	<b>OVERALL DIMENSIONS</b>			<b>SEAT DIMENSIONS</b>			<b>BACK DIMENSIONS</b>						
		W	D	H	W	D	H	W	H				
		93	27	33	20.5	17.5	18	20.5	15				
<p><b>LB Four Seat Chair, Full Center Arms, Open Arms (HT)</b> COM Yardage: 6 Freight Class: 150 Product Weight (lbs.): 197 Cubic Feet Per Carton: 43</p>		<p>Active weight 500 lbs./seat Urethane armcap option - <b>Add \$254 list upcharge</b></p> <ul style="list-style-type: none"> <li>• Shipped RTA (Ready to Assemble) in 2 cartons</li> </ul>											

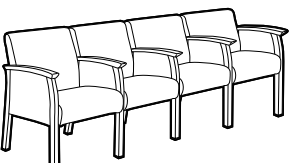
DESCRIPTION	MODEL#	STANDARD FABRIC GRADES											
		COM	2	3	4	5	6	7	8	9	10	11	12
 <p><b>GC3628CA</b> Metal</p>		\$8084	\$8358	\$8583	\$8918	\$9388	\$9568	\$9978	\$10756	\$11144	\$11867	\$12870	\$14109
	<b>OVERALL DIMENSIONS</b>			<b>SEAT DIMENSIONS</b>			<b>BACK DIMENSIONS</b>						
		W	D	H	W	D	H	W	H				
		93	27	33	20.5	17.5	18	20.5	15				
<p><b>LB Four Seat Chair, Full Center Arms, Closed Arms (HT)</b> COM Yardage: 8 Freight Class: 150 Product Weight (lbs.): 207 Cubic Feet Per Carton: 43</p>		<p>Active weight 500 lbs./seat Urethane armcap option - <b>Add \$254 list upcharge</b></p> <ul style="list-style-type: none"> <li>• Shipped RTA (Ready to Assemble) in 2 cartons</li> </ul>											

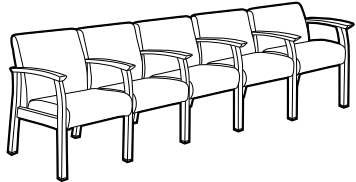
DESCRIPTION	MODEL#	STANDARD FABRIC GRADES													
		COM	2	3	4	5	6	7	8	9	10	11	12		
 <p><b>GC3630</b> Metal</p> <p><b>LB Five Seat Chair, Full Center Arms, Open Arms (HT)</b> COM Yardage: 7.5 Freight Class: 150 Product Weight (lbs.): 249 Cubic Feet Per Carton: 43</p> <p>Active weight 500 lbs./seat Urethane armcap option - <b>Add \$303 list upcharge</b></p> <p>• Shipped RTA (Ready to Assemble) in 2 cartons</p>															
	\$8130	\$8388	\$8600	\$8912	\$9354	\$9521	\$9908	\$10635	\$11001	\$11679	\$12620	\$13780			
	OVERALL DIMENSIONS			SEAT DIMENSIONS			BACK DIMENSIONS								
	W	D	H	W	D	H	W	H	115	27	33	20.5	17.5	18	20.5

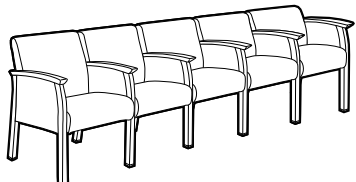
DESCRIPTION	MODEL#	STANDARD FABRIC GRADES													
		COM	2	3	4	5	6	7	8	9	10	11	12		
 <p><b>GC3630CA</b> Metal</p> <p><b>LB Five Seat Chair, Full Center Arms, Closed Arms (HT)</b> COM Yardage: 10 Freight Class: 125 Product Weight (lbs.): 261 Cubic Feet Per Carton: 43</p> <p>Active weight 500 lbs./seat Urethane armcap option - <b>Add \$303 list upcharge</b></p> <p>• Shipped RTA (Ready to Assemble) in 2 cartons</p>															
	\$8944	\$9288	\$9571	\$9987	\$10576	\$10798	\$11315	\$12288	\$12771	\$13675	\$14929	\$16477			
	OVERALL DIMENSIONS			SEAT DIMENSIONS			BACK DIMENSIONS								
	W	D	H	W	D	H	W	H	115	27	33	20.5	17.5	18	20.5

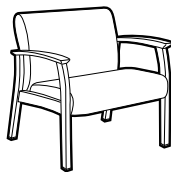
DESCRIPTION	MODEL#	STANDARD FABRIC GRADES													
		COM	2	3	4	5	6	7	8	9	10	11	12		
 <p><b>GC3637</b> Metal</p> <p><b>Bariatric LB Armchair, Open Arms (HT)</b> COM Yardage: 2.5 Freight Class: 250 Product Weight (lbs.): 78 Cubic Feet Per Carton: 26.5</p> <p>Active weight 500 lbs. Urethane armcap option - <b>Add \$104 list upcharge</b></p>															
	\$2576	\$2662	\$2735	\$2839	\$2984	\$3040	\$3170	\$3413	\$3535	\$3761	\$4073	\$4462			
	OVERALL DIMENSIONS			SEAT DIMENSIONS			BACK DIMENSIONS								
	W	D	H	W	D	H	W	H	35	27	33	30	17.5	18	30

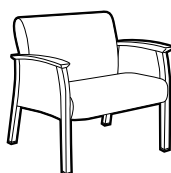
DESCRIPTION	MODEL#	STANDARD FABRIC GRADES													
		COM	2	3	4	5	6	7	8	9	10	11	12		
 <p><b>GC3637CA</b> Metal</p> <p><b>Bariatric LB Armchair, Closed Arms (HT)</b> COM Yardage: 3.5 Freight Class: 250 Product Weight (lbs.): 88 Cubic Feet Per Carton: 26.5</p> <p>Active weight 500 lbs. Urethane armcap option - <b>Add \$104 list upcharge</b></p>															
	\$2840	\$2960	\$3060	\$3205	\$3412	\$3490	\$3671	\$4011	\$4179	\$4496	\$4935	\$5477			
	OVERALL DIMENSIONS			SEAT DIMENSIONS			BACK DIMENSIONS								
	W	D	H	W	D	H	W	H	35	27	33	30	17.5	18	30

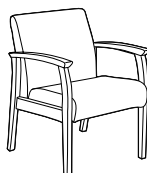
DESCRIPTION	MODEL#	STANDARD FABRIC GRADES													
		COM	2	3	4	5	6	7	8	9	10	11	12		
 <p><b>GC3620W</b> Wood</p> <p><b>GC3620WF</b> Wood flex back</p> <p><b>LB Single Seat Armchair, Open Arms (Wood)</b> COM Yardage: 1.75 Freight Class: 250 Product Weight (lbs.): 50 Cubic Feet Per Carton: 17.5</p> <p>Active weight 350 lbs. Urethane armcap option - <b>Add \$104 list upcharge</b></p>															
	\$1626	\$1683	\$1735	\$1809	\$1910	\$1950	\$2043	\$2214	\$2296	\$2455	\$2673	\$2945			
	\$2122	\$2180	\$2230	\$2304	\$2407	\$2445	\$2535	\$2706	\$2793	\$2951	\$3170	\$3440			
	OVERALL DIMENSIONS			SEAT DIMENSIONS			BACK DIMENSIONS								
W	D	H	W	D	H	W	H	25	27	33	20.5	17.5	18	20.5	15

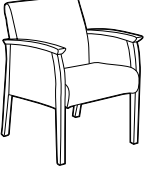
DESCRIPTION	MODEL#	STANDARD FABRIC GRADES											
		COM	2	3	4	5	6	7	8	9	10	11	12
	<b>GC3620WCA</b>	<b>\$1841</b>	<b>\$1932</b>	<b>\$2012</b>	<b>\$2127</b>	<b>\$2289</b>	<b>\$2349</b>	<b>\$2492</b>	<b>\$2761</b>	<b>\$2894</b>	<b>\$3141</b>	<b>\$3486</b>	<b>\$3909</b>
	Wood												
	<b>GC3620WFCA</b>	<b>\$2335</b>	<b>\$2427</b>	<b>\$2505</b>	<b>\$2622</b>	<b>\$2781</b>	<b>\$2843</b>	<b>\$2988</b>	<b>\$3254</b>	<b>\$3388</b>	<b>\$3635</b>	<b>\$3981</b>	<b>\$4405</b>
	Wood flex back												
		<b>OVERALL DIMENSIONS</b>			<b>SEAT DIMENSIONS</b>			<b>BACK DIMENSIONS</b>					
		<b>W</b>	<b>D</b>	<b>H</b>	<b>W</b>	<b>D</b>	<b>H</b>	<b>W</b>	<b>H</b>				
		25	27	33	20.5	17.5	18	20.5	15				
<b>LB Single Seat Armchair, Closed Arms (Wood)</b>		Active weight 350 lbs. Urethane armcap option - <b>Add \$104 list upcharge</b>											
COM Yardage: 2.75													
Freight Class: 250													
Product Weight (lbs.): 60													
Cubic Feet Per Carton: 17.5													

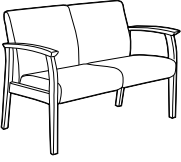
DESCRIPTION	MODEL#	STANDARD FABRIC GRADES											
		COM	2	3	4	5	6	7	8	9	10	11	12
	<b>GC3621W</b>	<b>\$2627</b>	<b>\$2737</b>	<b>\$2830</b>	<b>\$2964</b>	<b>\$3159</b>	<b>\$3230</b>	<b>\$3398</b>	<b>\$3711</b>	<b>\$3869</b>	<b>\$4165</b>	<b>\$4571</b>	<b>\$5074</b>
	Wood												
		<b>OVERALL DIMENSIONS</b>			<b>SEAT DIMENSIONS</b>			<b>BACK DIMENSIONS</b>					
		<b>W</b>	<b>D</b>	<b>H</b>	<b>W</b>	<b>D</b>	<b>H</b>	<b>W</b>	<b>H</b>				
		45	27	33	40	17.5	18	40	15				
<b>LB Two Seat Chair, No Center Arm, Open Arms (Wood)</b>		Active weight 350 lbs./seat Urethane armcap option - <b>Add \$104 list upcharge</b>											
COM Yardage: 3.25													
Freight Class: 300													
Product Weight (lbs.): 80													
Cubic Feet Per Carton: 43													

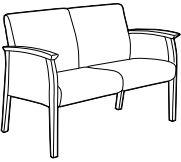
DESCRIPTION	MODEL#	STANDARD FABRIC GRADES											
		COM	2	3	4	5	6	7	8	9	10	11	12
	<b>GC3621WCA</b>	<b>\$2857</b>	<b>\$2985</b>	<b>\$3091</b>	<b>\$3248</b>	<b>\$3469</b>	<b>\$3551</b>	<b>\$3746</b>	<b>\$4113</b>	<b>\$4294</b>	<b>\$4632</b>	<b>\$5100</b>	<b>\$5682</b>
	Wood												
		<b>OVERALL DIMENSIONS</b>			<b>SEAT DIMENSIONS</b>			<b>BACK DIMENSIONS</b>					
		<b>W</b>	<b>D</b>	<b>H</b>	<b>W</b>	<b>D</b>	<b>H</b>	<b>W</b>	<b>H</b>				
		45	27	33	40	17.5	18	40	15				
<b>LB Two Seat Chair, No Center Arm, Closed Arms (Wood)</b>		Active weight 350 lbs./seat Urethane armcap option - <b>Add \$104 list upcharge</b>											
COM Yardage: 3.75													
Freight Class: 250													
Product Weight (lbs.): 90													
Cubic Feet Per Carton: 43													

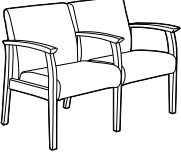
DESCRIPTION	MODEL#	STANDARD FABRIC GRADES											
		COM	2	3	4	5	6	7	8	9	10	11	12
	<b>GC3622W</b>	<b>\$2966</b>	<b>\$3078</b>	<b>\$3170</b>	<b>\$3305</b>	<b>\$3500</b>	<b>\$3569</b>	<b>\$3738</b>	<b>\$4052</b>	<b>\$4210</b>	<b>\$4504</b>	<b>\$4913</b>	<b>\$5415</b>
	Wood												
		<b>OVERALL DIMENSIONS</b>			<b>SEAT DIMENSIONS</b>			<b>BACK DIMENSIONS</b>					
		<b>W</b>	<b>D</b>	<b>H</b>	<b>W</b>	<b>D</b>	<b>H</b>	<b>W</b>	<b>H</b>				
		46	27	33	20.5	17.5	18	20.5	15				
<b>LB Two Seat Chair, Full Center Arm, Open Arms (Wood)</b>		Active weight 350 lbs./seat Urethane armcap option - <b>Add \$155 list upcharge</b>											
COM Yardage: 3.25													
Freight Class: 250													
Product Weight (lbs.): 86													
Cubic Feet Per Carton: 43													

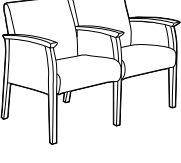
DESCRIPTION	MODEL#	STANDARD FABRIC GRADES											
		COM	2	3	4	5	6	7	8	9	10	11	12
	<b>GC3622WCA</b>	<b>\$3297</b>	<b>\$3450</b>	<b>\$3577</b>	<b>\$3766</b>	<b>\$4032</b>	<b>\$4131</b>	<b>\$4363</b>	<b>\$4800</b>	<b>\$5020</b>	<b>\$5426</b>	<b>\$5991</b>	<b>\$6688</b>
	Wood												
		<b>OVERALL DIMENSIONS</b>			<b>SEAT DIMENSIONS</b>			<b>BACK DIMENSIONS</b>					
		<b>W</b>	<b>D</b>	<b>H</b>	<b>W</b>	<b>D</b>	<b>H</b>	<b>W</b>	<b>H</b>				
		46	27	33	20.5	17.5	18	20.5	15				
<b>LB Two Seat Chair, Full Center Arm, Closed Arms (Wood)</b>		Active weight 350 lbs./seat Urethane armcap option - <b>Add \$155 list upcharge</b>											
COM Yardage: 4.5													
Freight Class: 250													
Product Weight (lbs.): 106													
Cubic Feet Per Carton: 43													

# SEATING

# PRIMACARE™ GUEST P

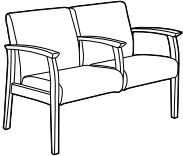
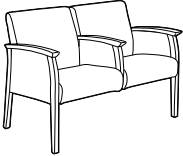
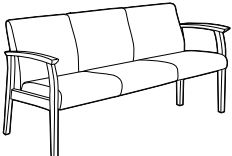
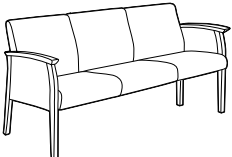
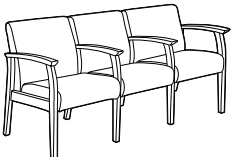
DESCRIPTION	MODEL#	STANDARD FABRIC GRADES											
		COM	2	3	4	5	6	7	8	9	10	11	12
 <p><b>LB Two Seat Chair, Half Center Arm, Open Arms (Wood)</b>            COM Yardage: 3.25            Freight Class: 300            Product Weight (lbs.): 82            Cubic Feet Per Carton: 43</p>	<b>GC3623W</b> Wood	\$2912	\$3022	\$3114	\$3250	\$3440	\$3515	\$3683	\$3998	\$4155	\$4449	\$4858	\$5360
		<b>OVERALL DIMENSIONS</b>			<b>SEAT DIMENSIONS</b>			<b>BACK DIMENSIONS</b>					
		W	D	H	W	D	H	W	H				
			46	27	33	20.5	17.5	18		20.5	15		
<p>Active weight 350 lbs./seat            Urethane armcap option - <b>Add \$155 list upcharge</b></p>													
 <p><b>LB Two Seat Chair, Half Center Arm, Closed Arms (Wood)</b>            COM Yardage: 4.5            Freight Class: 250            Product Weight (lbs.): 92            Cubic Feet Per Carton: 43</p>	<b>GC3623WCA</b> Wood	\$3240	\$3394	\$3520	\$3709	\$3976	\$4075	\$4306	\$4744	\$4963	\$5369	\$5935	\$6631
		<b>OVERALL DIMENSIONS</b>			<b>SEAT DIMENSIONS</b>			<b>BACK DIMENSIONS</b>					
		W	D	H	W	D	H	W	H				
			46	27	33	20.5	17.5	18		20.5	15		
<p>Active weight 350 lbs./seat            Urethane armcap option - <b>Add \$155 list upcharge</b></p>													
 <p><b>LB Three Seat Chair, No Center Arm, Open Arms (Wood)</b>            COM Yardage: 4.25            Freight Class: 300            Product Weight (lbs.): 125            Cubic Feet Per Carton: 65.25</p>	<b>GC3624W</b> Wood	\$3553	\$3698	\$3818	\$3994	\$4245	\$4340	\$4560	\$4974	\$5179	\$5563	\$6096	\$6756
		<b>OVERALL DIMENSIONS</b>			<b>SEAT DIMENSIONS</b>			<b>BACK DIMENSIONS</b>					
		W	D	H	W	D	H	W	H				
			65	27	33	60	17.5	18		60	15		
<p>Active weight 350 lbs./seat            Urethane armcap option - <b>Add \$104 list upcharge</b></p>													
 <p><b>LB Three Seat Chair, No Center Arm, Closed Arms (Wood)</b>            COM Yardage: 5.25            Freight Class: 250            Product Weight (lbs.): 135            Cubic Feet Per Carton: 65.25</p>	<b>GC3624WCA</b> Wood	\$3770	\$3947	\$4097	\$4315	\$4625	\$4741	\$5012	\$5522	\$5778	\$6252	\$6910	\$7722
		<b>OVERALL DIMENSIONS</b>			<b>SEAT DIMENSIONS</b>			<b>BACK DIMENSIONS</b>					
		W	D	H	W	D	H	W	H				
			65	27	33	60	17.5	18		60	15		
<p>Active weight 350 lbs./seat            Urethane armcap option - <b>Add \$104 list upcharge</b></p>													
 <p><b>LB Three Seat Chair, Full Center Arms, Open Arms (Wood)</b>            COM Yardage: 4.75            Freight Class: 250            Product Weight (lbs.): 150            Cubic Feet Per Carton: 65.25</p>	<b>GC3625W</b> Wood	\$4218	\$4380	\$4517	\$4714	\$4994	\$5099	\$5345	\$5807	\$6035	\$6467	\$7061	\$7798
		<b>OVERALL DIMENSIONS</b>			<b>SEAT DIMENSIONS</b>			<b>BACK DIMENSIONS</b>					
		W	D	H	W	D	H	W	H				
			69	27	33	20.5	17.5	18		20.5	15		
<p>Active weight 350 lbs./seat            Urethane armcap option - <b>Add \$204 list upcharge</b></p>													

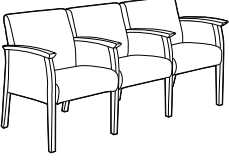
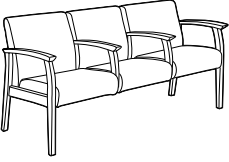
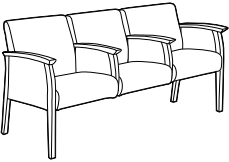
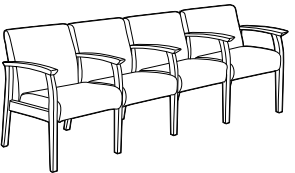
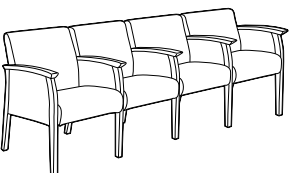

DESCRIPTION	MODEL#	STANDARD FABRIC GRADES											
		COM	2	3	4	5	6	7	8	9	10	11	12
 <p><b>LB Three Seat Chair, Full Center Arms, Closed Arms (Wood)</b>                      COM Yardage: 6.25                      Freight Class: 250                      Product Weight (lbs.): 160                      Cubic Feet Per Carton: 65.25</p>	<b>GC3625WCA</b> Wood	\$4663	\$4876	\$5053	\$5311	\$5681	\$5820	\$6143	\$6750	\$7055	\$7618	\$8402	\$9369
		<b>OVERALL DIMENSIONS</b> W D H			<b>SEAT DIMENSIONS</b> W D H			<b>BACK DIMENSIONS</b> W H					
		69	27	33	20.5	17.5	18	20.5	15				
Active weight 350 lbs./seat Urethane armcap option - <b>Add \$204 list upcharge</b>													
 <p><b>LB Three Seat Chair, Half Center Arms, Open Arms (Wood)</b>                      COM Yardage: 4.75                      Freight Class: 250                      Product Weight (lbs.): 135                      Cubic Feet Per Carton: 65.25</p>	<b>GC3626W</b> Wood	\$4107	\$4269	\$4406	\$4603	\$4883	\$4988	\$5233	\$5695	\$5924	\$6356	\$6950	\$7684
		<b>OVERALL DIMENSIONS</b> W D H			<b>SEAT DIMENSIONS</b> W D H			<b>BACK DIMENSIONS</b> W H					
		69	27	33	20.5	17.5	18	20.5	15				
Active weight 350 lbs./seat Urethane armcap option - <b>Add \$204 list upcharge</b>													
 <p><b>LB Three Seat Chair, Half Center Arms, Closed Arms (Wood)</b>                      COM Yardage: 6.25                      Freight Class: 250                      Product Weight (lbs.): 145                      Cubic Feet Per Carton: 65.25</p>	<b>GC3626WCA</b> Wood	\$4553	\$4765	\$4943	\$5203	\$5571	\$5713	\$6034	\$6640	\$6945	\$7507	\$8292	\$9259
		<b>OVERALL DIMENSIONS</b> W D H			<b>SEAT DIMENSIONS</b> W D H			<b>BACK DIMENSIONS</b> W H					
		69	27	33	20.5	17.5	18	20.5	15				
Active weight 350 lbs./seat Urethane armcap option - <b>Add \$204 list upcharge</b>													
 <p><b>LB Four Seat Chair, Full Center Arms, Open Arms (Wood)</b>                      COM Yardage: 6                      Freight Class: 150                      Product Weight (lbs.): 185                      Cubic Feet Per Carton: 43</p>	<b>GC3628W</b> Wood	\$6098	\$6302	\$6473	\$6724	\$7076	\$7212	\$7520	\$8104	\$8392	\$8934	\$9689	\$10617
		<b>OVERALL DIMENSIONS</b> W D H			<b>SEAT DIMENSIONS</b> W D H			<b>BACK DIMENSIONS</b> W H					
		93	27	33	20.5	17.5	18	20.5	15				
Active weight 350 lbs./seat Urethane armcap option - <b>Add \$254 list upcharge</b> • Shipped RTA (Ready to Assemble) in 2 cartons													
 <p><b>LB Four Seat Chair, Full Center Arms, Closed Arms (Wood)</b>                      COM Yardage: 8                      Freight Class: 150                      Product Weight (lbs.): 195                      Cubic Feet Per Carton: 43</p>	<b>GC3628WCA</b> Wood	\$6648	\$6923	\$7149	\$7481	\$7952	\$8133	\$8543	\$9323	\$9709	\$10433	\$11435	\$12673
		<b>OVERALL DIMENSIONS</b> W D H			<b>SEAT DIMENSIONS</b> W D H			<b>BACK DIMENSIONS</b> W H					
		93	27	33	20.5	17.5	18	20.5	15				
Active weight 350 lbs./seat Urethane armcap option - <b>Add \$254 list upcharge</b> • Shipped RTA (Ready to Assemble) in 2 cartons													

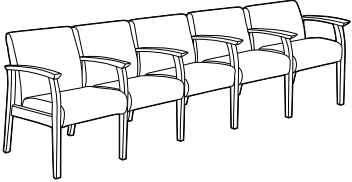
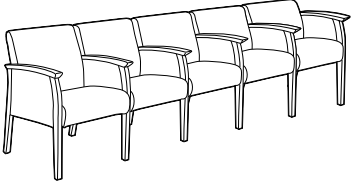
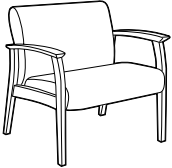
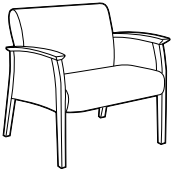
DESCRIPTION	MODEL#	STANDARD FABRIC GRADES											
		COM	2	3	4	5	6	7	8	9	10	11	12
 <p><b>LB Five Seat Chair, Full Center Arms, Open Arms (Wood)</b>                      COM Yardage: 7.5                      Freight Class: 150                      Product Weight (lbs.): 227                      Cubic Feet Per Carton: 43</p>	<b>GC3630W</b> Wood	\$6689	\$6947	\$7159	\$7471	\$7912	\$8079	\$8466	\$9195	\$9560	\$10236	\$11177	\$12339
		<b>OVERALL DIMENSIONS</b>			<b>SEAT DIMENSIONS</b>			<b>BACK DIMENSIONS</b>					
		<b>W</b>	<b>D</b>	<b>H</b>	<b>W</b>	<b>D</b>	<b>H</b>	<b>W</b>	<b>H</b>				
		115	27	33	20.5	17.5	18	20.5	15				
<p>Active weight 350 lbs./seat                      Urethane armcap option - <b>Add \$303 list upcharge</b></p> <p>• Shipped RTA (Ready to Assemble) in 2 cartons</p>													
 <p><b>LB Five Seat Chair, Full Center Arms, Closed Arms (Wood)</b>                      COM Yardage: 10                      Freight Class: 250                      Product Weight (lbs.): 237                      Cubic Feet Per Carton: 43</p>	<b>GC3630WCA</b> Wood	\$7349	\$7692	\$7973	\$8389	\$8980	\$9203	\$9720	\$10692	\$11175	\$12077	\$13331	\$14880
		<b>OVERALL DIMENSIONS</b>			<b>SEAT DIMENSIONS</b>			<b>BACK DIMENSIONS</b>					
		<b>W</b>	<b>D</b>	<b>H</b>	<b>W</b>	<b>D</b>	<b>H</b>	<b>W</b>	<b>H</b>				
		115	27	33	20.5	17.5	18	20.5	15				
<p>Active weight 350 lbs./seat                      Urethane armcap option - <b>Add \$303 list upcharge</b></p> <p>• Shipped RTA (Ready to Assemble) in 2 cartons</p>													
 <p><b>Bariatric LB Armchair, Open Arms (Wood)</b>                      COM Yardage: 2.5                      Freight Class: 250                      Product Weight (lbs.): 66                      Cubic Feet Per Carton: 26.5</p>	<b>GC3637W</b> Wood	\$2121	\$2204	\$2277	\$2383	\$2531	\$2586	\$2714	\$2958	\$3079	\$3305	\$3618	\$4006
		<b>OVERALL DIMENSIONS</b>			<b>SEAT DIMENSIONS</b>			<b>BACK DIMENSIONS</b>					
		<b>W</b>	<b>D</b>	<b>H</b>	<b>W</b>	<b>D</b>	<b>H</b>	<b>W</b>	<b>H</b>				
		35	27	33	30	17.5	18	30	15				
<p>Active weight 500 lbs.                      Urethane armcap option - <b>Add \$104 list upcharge</b></p>													
 <p><b>Bariatric LB Armchair, Closed Arms (Wood)</b>                      COM Yardage: 3.5                      Freight Class: 250                      Product Weight (lbs.): 76                      Cubic Feet Per Carton: 26.5</p>	<b>GC3637WCA</b> Wood	\$2319	\$2438	\$2540	\$2684	\$2891	\$2970	\$3151	\$3490	\$3661	\$3976	\$4415	\$4955
		<b>OVERALL DIMENSIONS</b>			<b>SEAT DIMENSIONS</b>			<b>BACK DIMENSIONS</b>					
		<b>W</b>	<b>D</b>	<b>H</b>	<b>W</b>	<b>D</b>	<b>H</b>	<b>W</b>	<b>H</b>				
		35	27	33	30	17.5	18	30	15				
<p>Active weight 500 lbs.                      Urethane armcap option - <b>Add \$104 list upcharge</b></p>													

PRIMACARE PATIENT



model GC3631 (HT)



model GC3632WCA (Wood)

STANDARD FEATURES

- Primacare is a family of products offering the most significant return on investment approach in the industry since every component can be repaired or replaced on site.
- **High traffic (HT) models:** Metal frame with die cast zinc connectors and metal-to-metal fasteners. Available in the following finishes: Black (TBL), Cloud (TIV), Designer White (TDW), Fog (TFO), Frost (TFR), Kalua (TKA), Latte (TLA), Mocha (TMO), Nevada (TNE), Sand (TSN), Shadow (TSH), Toast (TOA) and Tungsten (TTU).
- **Wood models:** Solid hardwood frame with die cast zinc connectors and metal-to-metal fastening. Available in the following finishes: Absolute (AAM), Charcoal Java (CJM), Cherry (ACM), Empire Mahogany (EMM), English Oak (EOM), Espresso Cafe (ECM), Fruitwood (TFM), Gray (HGM), Harvest Oak (HOM), Honey (AHM), Jet Onyx (JOM), Light Honey (LHM), Mahogany (TMM), Maple (AVM), Medium Walnut (MWM), Natural Walnut (NLW), Night (ASM), Noce Biondo (NBM), Noce Grigio (NGM), Noce Leggero (NEM), Noce Medio (NMM), Sandy Beach (SBM), Shaker Cherry (SKM), Silver Oak (SOM), Walnut (TWM), White (WHM), WC Cream (WTM) and Winter Cherry (WCM).
- Armcaps are securely fastened with metal-to-metal connectors which allow for field replacement if required.
- Easy grip forward extending armcap on models with arms.

- Replaceable seat covers and replaceable and/or removable seat cushions are standard.
- Wood armcaps are standard.
- Waterfall cleanout between the seat and back cushions.
- Models are standard with metal mesh seat deck. For behavioral health applications, the metal mesh seat deck can be covered with a solid moisture resistant surface, held in place with tamperproof fasteners. Contact your sales rep for a special quotation.
- All seat frames feature a wall saver design to prevent back contact with wall.
- Models ending in **CA / ARC**, have upholstered panel arm inserts closing the arm. (Closed arm panels are designed to be replaceable. Request a special quote to have them secured with tamperproof fasteners.)
- For Globalcare textile options, visit the website at [www.globalfurnituregroup.com](http://www.globalfurnituregroup.com).
- Can be upholstered in standard Global textiles if healthcare compliance is not required.
- It is recommended that High Traffic (HT) models be specified in textiles that meet or exceed 100,000 double rubs for added abrasion performance.
- Shipped fully assembled.
- **High traffic (HT) models are listed first, followed by wood models.**

OPTIONAL FEATURES

- Urethane armcaps are available. Please specify. Refer to individual models for availability and pricing.
- For moisture barrier (seat only), add **\$129** list upcharge per seat. For Bariatric Models: GC3638W, GC3638WCA, GC3639W, GC3639WCA, GC3640W, GC3640WCA, GC3656W and GC3656WCA - **Add \$198** list upcharge per seat.
- To add sealed seams to your product contact Customer Care. Upcharges vary.
- For Primacare tables, see page 56.

SUGGESTED APPLICATIONS

- Bariatric seating
- Guest seating
- Lobbies
- Lounge/Waiting
- Patient rooms
- Resident rooms
- Treatment/Exam rooms

DESCRIPTION MODEL# / FEATURES STANDARD TEXTILE GRADES



**MB Armchair Open Arms (HT)**  
COM Yardage: 1.75  
Freight Class: 250  
Product Weight (lbs.): 64  
Cubic Feet Per Carton: 17.5

MODEL# / FEATURES	COM	STANDARD TEXTILE GRADES											
		2	3	4	5	6	7	8	9	10	11	12	
<b>GC3631</b> Metal	\$2083	\$2143	\$2195	\$2269	\$2370	\$2410	\$2500	\$2669	\$2756	\$2914	\$3133	\$3405	
<b>GC3631F</b> Metal flex back	\$2586	\$2641	\$2695	\$2767	\$2873	\$2908	\$3001	\$3172	\$3256	\$3415	\$3633	\$3903	
		OVERALL DIMENSIONS			SEAT DIMENSIONS			BACK DIMENSIONS					
		W	D	H	W	D	H	W	H				
		25	27	36.5	20.5	17.5	18	20.5	18				

Active weight 500 lbs.  
Urethane armcap option - **Add \$104 list upcharge**



**MB Armchair Closed Arms (HT)**  
COM Yardage: 2.75  
Freight Class: 150  
Product Weight (lbs.): 76  
Cubic Feet Per Carton: 17.5

MODEL# / FEATURES	COM	STANDARD TEXTILE GRADES											
		2	3	4	5	6	7	8	9	10	11	12	
<b>GC3631CA</b> Metal	\$2388	\$2480	\$2558	\$2676	\$2835	\$2897	\$3040	\$3307	\$3441	\$3689	\$4034	\$4457	
<b>GC3631FCA</b> Metal flex back	\$2887	\$2978	\$3056	\$3173	\$3333	\$3395	\$3539	\$3805	\$3939	\$4187	\$4532	\$4956	
		OVERALL DIMENSIONS			SEAT DIMENSIONS			BACK DIMENSIONS					
		W	D	H	W	D	H	W	H				
		25	27	36.5	20.5	17.5	18	20.5	18				

Active weight 500 lbs.  
Urethane armcap option - **Add \$104 list upcharge**

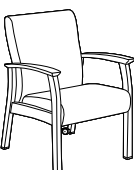

**MB Armchair Open Arms, Rear Tip & Move Wheels (HT)**  
COM Yardage: 1.75  
Freight Class: 250  
Product Weight (lbs.): 64  
Cubic Feet Per Carton: 23

MODEL# / FEATURES	COM	STANDARD TEXTILE GRADES											
		2	3	4	5	6	7	8	9	10	11	12	
<b>GC3631RC</b> Metal	\$2228	\$2288	\$2340	\$2413	\$2516	\$2554	\$2646	\$2818	\$2902	\$3061	\$3279	\$3548	
		OVERALL DIMENSIONS			SEAT DIMENSIONS			BACK DIMENSIONS					
		W	D	H	W	D	H	W	H				
		25	29.5	36.5	20.5	17.5	18	20.5	18				

Active weight 500 lbs.  
Urethane armcap option - **Add \$104 list upcharge**

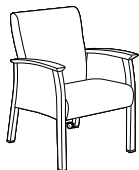
DESCRIPTION	MODEL#	STANDARD FABRIC GRADES											
		COM	2	3	4	5	6	7	8	9	10	11	12
 <p><b>GC3631CARC</b> Metal</p>		\$2548	\$2640	\$2718	\$2835	\$2994	\$3057	\$3201	\$3466	\$3601	\$3849	\$4194	\$4618
	<b>OVERALL DIMENSIONS</b>			<b>SEAT DIMENSIONS</b>			<b>BACK DIMENSIONS</b>						
		W	D	H	W	D	H	W	H				
		25	29.5	36.5	20.5	17.5	18	20.5	18				

**MB Armchair, Closed Arms, Rear Tip & Move Wheels (HT)**  
 COM Yardage: 2.75      Active weight 500 lbs.  
 Freight Class: 250      Urethane armcap option - **Add \$104 list upcharge**  
 Product Weight (lbs.): 76  
 Cubic Feet Per Carton: 23

 <p><b>GC3632</b> Metal</p> <p><b>GC3632F</b> Metal flex back</p>		\$2332	\$2406	\$2472	\$2565	\$2698	\$2748	\$2862	\$3083	\$3192	\$3396	\$3677	\$4025
		\$2831	\$2904	\$2970	\$3063	\$3196	\$3246	\$3360	\$3581	\$3689	\$3893	\$4176	\$4523
	<b>OVERALL DIMENSIONS</b>			<b>SEAT DIMENSIONS</b>			<b>BACK DIMENSIONS</b>						
		W	D	H	W	D	H	W	H				

**HB Armchair, Open Arms, Split Back (HT)**  
 COM Yardage: 2.25      Active weight 500 lbs. Fold away headrest.  
 Freight Class: 250      Urethane armcap option - **Add \$104 list upcharge**  
 Product Weight (lbs.): 72  
 Cubic Feet Per Carton: 27.5

 <p><b>GC3632CA</b> Metal</p> <p><b>GC3632FCA</b> Metal flex back</p>		\$2643	\$2744	\$2830	\$2953	\$3132	\$3198	\$3355	\$3645	\$3789	\$4061	\$4438	\$4902
		\$3138	\$3240	\$3327	\$3452	\$3628	\$3694	\$3851	\$4142	\$4287	\$4559	\$4935	\$5399
	<b>OVERALL DIMENSIONS</b>			<b>SEAT DIMENSIONS</b>			<b>BACK DIMENSIONS</b>						
		W	D	H	W	D	H	W	H				

**HB Armchair, Closed Arms, Split Back (HT)**  
 COM Yardage: 3      Active weight 500 lbs. Fold away headrest.  
 Freight Class: 250      Urethane armcap option - **Add \$104 list upcharge**  
 Product Weight (lbs.): 84  
 Cubic Feet Per Carton: 27.5

 <p><b>GC3632RC</b> Metal</p>		\$2491	\$2564	\$2631	\$2724	\$2857	\$2907	\$3021	\$3242	\$3350	\$3554	\$3837	\$4184
	<b>OVERALL DIMENSIONS</b>			<b>SEAT DIMENSIONS</b>			<b>BACK DIMENSIONS</b>						
		W	D	H	W	D	H	W	H				
		25	29.5	48.5	20.5	17.5	18	20.5	30				

**HB Armchair, Open Arms, Split Back, Rear Tip & Move Wheels (HT)**  
 COM Yardage: 2.25      Active weight 500 lbs. Fold away headrest.  
 Freight Class: 250      Urethane armcap option - **Add \$104 list upcharge**  
 Product Weight (lbs.): 72  
 Cubic Feet Per Carton: 27.5

 <p><b>GC3632CARC</b> Metal</p>		\$2800	\$2902	\$2989	\$3111	\$3289	\$3356	\$3512	\$3803	\$3949	\$4219	\$4596	\$5060
	<b>OVERALL DIMENSIONS</b>			<b>SEAT DIMENSIONS</b>			<b>BACK DIMENSIONS</b>						
		W	D	H	W	D	H	W	H				
		25	29.5	48.5	20.5	17.5	18	20.5	30				

**HB Armchair, Closed Arms, Split Back, Rear Tip & Move Wheels (HT)**  
 COM Yardage: 3      Active weight 500 lbs. Fold away headrest.  
 Freight Class: 250      Urethane armcap option - **Add \$104 list upcharge**  
 Product Weight (lbs.): 84  
 Cubic Feet Per Carton: 27.5

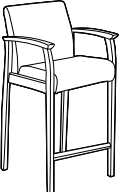
DESCRIPTION	MODEL#	STANDARD FABRIC GRADES											
		COM	2	3	4	5	6	7	8	9	10	11	12
 <p>Designed to immobilize the pelvis and hip joints after surgery.</p> <p><b>LB Hip Armchair, Open Arms - Post Surgery (HT)</b>                      COM Yardage: 1.5                      Freight Class: 250                      Product Weight (lbs.): 67                      Cubic Feet Per Carton: 20</p>	<b>GC3636</b>	\$2697	\$2746	\$2792	\$2853	\$2942	\$2978	\$3053	\$3198	\$3271	\$3407	\$3596	\$3826
	Metal												
		<b>OVERALL DIMENSIONS</b> W D H			<b>SEAT DIMENSIONS</b> W D H			<b>BACK DIMENSIONS</b> W H					
		23	26	40.5	19	17.5	25.5	19	15.5				

Active weight 500 lbs.  
 Urethane armcap option - **Add \$104 list upcharge**

DESCRIPTION	MODEL#	STANDARD FABRIC GRADES											
		COM	2	3	4	5	6	7	8	9	10	11	12
 <p><b>Bariatric MB Armchair, Open Arms (HT)</b>                      COM Yardage: 2.75                      Freight Class: 250                      Product Weight (lbs.): 94                      Cubic Feet Per Carton: 30.5</p>	<b>GC3638</b>	\$2681	\$2773	\$2852	\$2969	\$3128	\$3190	\$3334	\$3600	\$3735	\$3982	\$4329	\$4752
	Metal												
		<b>OVERALL DIMENSIONS</b> W D H			<b>SEAT DIMENSIONS</b> W D H			<b>BACK DIMENSIONS</b> W H					
		35	27	36.5	30	17.5	18	30	18				

Active weight 500 lbs.  
 Urethane armcap option - **Add \$104 list upcharge**

DESCRIPTION	MODEL#	STANDARD FABRIC GRADES											
		COM	2	3	4	5	6	7	8	9	10	11	12
 <p><b>Bariatric MB Armchair, Closed Arms (HT)</b>                      COM Yardage: 3.75                      Freight Class: 250                      Product Weight (lbs.): 104                      Cubic Feet Per Carton: 30.5</p>	<b>GC3638CA</b>	\$2984	\$3110	\$3217	\$3374	\$3594	\$3676	\$3871	\$4235	\$4419	\$4756	\$5225	\$5807
	Metal												
		<b>OVERALL DIMENSIONS</b> W D H			<b>SEAT DIMENSIONS</b> W D H			<b>BACK DIMENSIONS</b> W H					
		35	27	36.5	30	17.5	18	30	18				

Active weight 500 lbs.  
 Urethane armcap option - **Add \$104 list upcharge**

DESCRIPTION	MODEL#	STANDARD FABRIC GRADES											
		COM	2	3	4	5	6	7	8	9	10	11	12
 <p><b>Bariatric HB Armchair, Open Arms, Split Back (HT)</b>                      COM Yardage: 3.75                      Freight Class: 250                      Product Weight (lbs.): 77                      Cubic Feet Per Carton: 33</p>	<b>GC3639</b>	\$2984	\$3110	\$3217	\$3374	\$3594	\$3676	\$3871	\$4235	\$4419	\$4756	\$5225	\$5807
	Metal												
		<b>OVERALL DIMENSIONS</b> W D H			<b>SEAT DIMENSIONS</b> W D H			<b>BACK DIMENSIONS</b> W H					
		35	27	48.5	30	17.5	18	30	30				

Active weight 500 lbs. Fold away headrest.  
 Urethane armcap option - **Add \$104 list upcharge**

DESCRIPTION	MODEL#	STANDARD FABRIC GRADES											
		COM	2	3	4	5	6	7	8	9	10	11	12
 <p><b>Bariatric HB Armchair, Closed Arms, Split Back (HT)</b>                      COM Yardage: 4.75                      Freight Class: 250                      Product Weight (lbs.): 108                      Cubic Feet Per Carton: 33</p>	<b>GC3639CA</b>	\$3283	\$3447	\$3579	\$3779	\$4058	\$4164	\$4411	\$4870	\$5102	\$5531	\$6125	\$6862
	Metal												
		<b>OVERALL DIMENSIONS</b> W D H			<b>SEAT DIMENSIONS</b> W D H			<b>BACK DIMENSIONS</b> W H					
		35	27	48.5	30	17.5	18	30	30				

Active weight 500 lbs. Fold away headrest.  
 Urethane armcap option - **Add \$104 list upcharge**

# SEATING

# PRIMACARE™ PATIENT P

DESCRIPTION	MODEL#	STANDARD FABRIC GRADES											
		COM	2	3	4	5	6	7	8	9	10	11	12
 <p><b>HB Armchair, Open Arms (HT)</b> COM Yardage: 2.5 Freight Class: 250 Product Weight (lbs.): 72 Cubic Feet Per Carton: 27.5</p>		COM	2	3	4	5	6	7	8	9	10	11	12
	<b>GC3655</b>	\$2173	\$2256	\$2329	\$2433	\$2579	\$2634	\$2766	\$3007	\$3129	\$3355	\$3668	\$4056
	Metal												
	<b>GC3655F</b>	\$2670	\$2753	\$2826	\$2932	\$3080	\$3135	\$3263	\$3506	\$3627	\$3853	\$4167	\$4554
	Metal flex back												
		OVERALL DIMENSIONS			SEAT DIMENSIONS			BACK DIMENSIONS					
		W	D	H	W	D	H	W	H				
		25	27	48.5	20.5	17.5	18	20.5	30				

Active weight 500 lbs.  
Urethane armcap option - **Add \$104 list upcharge**

 <p><b>HB Armchair, Closed Arms (HT)</b> COM Yardage: 3.25 Freight Class: 250 Product Weight (lbs.): 84 Cubic Feet Per Carton: 27.5</p>		COM	2	3	4	5	6	7	8	9	10	11	12
	<b>GC3655CA</b>	\$2483	\$2592	\$2686	\$2824	\$3014	\$3085	\$3253	\$3570	\$3725	\$4019	\$4428	\$4930
	Metal												
	<b>GC3655FCA</b>	\$2978	\$3090	\$3182	\$3317	\$3508	\$3581	\$3750	\$4066	\$4222	\$4516	\$4924	\$5427
	Metal flex back												
		OVERALL DIMENSIONS			SEAT DIMENSIONS			BACK DIMENSIONS					
		W	D	H	W	D	H	W	H				
		25	27	48.5	20.5	17.5	18	20.5	30				

Active weight 500 lbs.  
Urethane armcap option - **Add \$104 list upcharge**

 <p><b>HB Armchair, Open Arms, Rear Tip &amp; Move Wheels (HT)</b> COM Yardage: 2.5 Freight Class: 250 Product Weight (lbs.): 72 Cubic Feet Per Carton: 27.5</p>		COM	2	3	4	5	6	7	8	9	10	11	12
	<b>GC3655RC</b>	\$2331	\$2415	\$2488	\$2593	\$2738	\$2796	\$2923	\$3167	\$3288	\$3514	\$3827	\$4216
	Metal												
		OVERALL DIMENSIONS			SEAT DIMENSIONS			BACK DIMENSIONS					
		W	D	H	W	D	H	W	H				
		25	29.5	48.5	20.5	17.5	18	20.5	30				

Active weight 500 lbs.  
Urethane armcap option - **Add \$104 list upcharge**

 <p><b>HB Armchair, Open Arms, Rear Tip &amp; Move Wheels (HT)</b> COM Yardage: 3.25 Freight Class: 250 Product Weight (lbs.): 84 Cubic Feet Per Carton: 27.5</p>		COM	2	3	4	5	6	7	8	9	10	11	12
	<b>GC3655CARC</b>	\$2641	\$2751	\$2844	\$2979	\$3173	\$3244	\$3412	\$3729	\$3884	\$4179	\$4586	\$5089
	Metal												
		OVERALL DIMENSIONS			SEAT DIMENSIONS			BACK DIMENSIONS					
		W	D	H	W	D	H	W	H				
		25	29.5	48.5	20.5	17.5	18	20.5	30				

Active weight 500 lbs.  
Urethane armcap option - **Add \$104 list upcharge**

 <p><b>Bariatric HB Armchair, Open Arms (HT)</b> COM Yardage: 3.5 Freight Class: 250 Product Weight (lbs.): 79 Cubic Feet Per Carton: 33</p>		COM	2	3	4	5	6	7	8	9	10	11	12
	<b>GC3656</b>	\$2765	\$2885	\$2985	\$3130	\$3336	\$3416	\$3596	\$3936	\$4106	\$4420	\$4860	\$5402
	Metal												
		OVERALL DIMENSIONS			SEAT DIMENSIONS			BACK DIMENSIONS					
		W	D	H	W	D	H	W	H				
		35	27	48.5	30	17.5	18	30	30				

Active weight 500 lbs.  
Urethane armcap option - **Add \$104 list upcharge**

DESCRIPTION	MODEL#	STANDARD FABRIC GRADES											
		COM	2	3	4	5	6	7	8	9	10	11	12
 <p><b>Bariatric HB Armchair, Closed Arms (HT)</b>                      COM Yardage: 4.5                      Freight Class: 250                      Product Weight (lbs.): 108                      Cubic Feet Per Carton: 33</p>	<b>GC3656CA</b>	\$3068	\$3222	\$3349	\$3537	\$3802	\$3902	\$4134	\$4571	\$4791	\$5196	\$5759	\$6456
	Metal												
		OVERALL DIMENSIONS			SEAT DIMENSIONS			BACK DIMENSIONS					
		W	D	H	W	D	H	W	H				
		35	27	48.5	30	17.5	18	30	30				
<p>Active weight 500 lbs.                      Urethane armcap option - <b>Add \$104 list upcharge</b></p>													

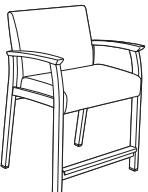
DESCRIPTION	MODEL#	STANDARD FABRIC GRADES											
		COM	2	3	4	5	6	7	8	9	10	11	12
 <p>Designed to immobilize the pelvis and hip joints after surgery.</p> <p><b>Wide Hip Armchair, Open Arms - Post Surgery (HT)</b>                      COM Yardage: 1.5                      Freight Class: 250                      Product Weight (lbs.): 78                      Cubic Feet Per Carton: 20</p>	<b>GC3657</b>	\$3320	\$3370	\$3416	\$3478	\$3567	\$3602	\$3678	\$3823	\$3896	\$4033	\$4222	\$4452
	Metal												
		OVERALL DIMENSIONS			SEAT DIMENSIONS			BACK DIMENSIONS					
		W	D	H	W	D	H	W	H				
		28	25	41	24	17.5	26	24	15.5				
<p>Active weight 500 lbs.                      Urethane armcap option - <b>Add \$104 list upcharge</b></p>													

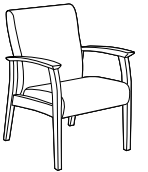
DESCRIPTION	MODEL#	STANDARD FABRIC GRADES											
		COM	2	3	4	5	6	7	8	9	10	11	12
 <p><b>MB Armchair, Open Arms (Wood)</b>                      COM Yardage: 1.75                      Freight Class: 250                      Product Weight (lbs.): 52                      Cubic Feet Per Carton: 20</p>	<b>GC3631W</b>	\$1737	\$1797	\$1851	\$1923	\$2025	\$2064	\$2155	\$2327	\$2411	\$2569	\$2788	\$3059
	Wood												
		OVERALL DIMENSIONS			SEAT DIMENSIONS			BACK DIMENSIONS					
		W	D	H	W	D	H	W	H				
		25	27	36.5	20.5	17.5	18	20.5	18				
<p>Active weight 350 lbs.                      Urethane armcap option - <b>Add \$104 list upcharge</b></p>													

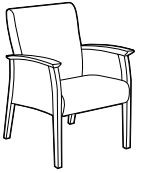
DESCRIPTION	MODEL#	STANDARD FABRIC GRADES											
		COM	2	3	4	5	6	7	8	9	10	11	12
 <p><b>MB Armchair, Closed Arms (Wood)</b>                      COM Yardage: 2.75                      Freight Class: 250                      Product Weight (lbs.): 62                      Cubic Feet Per Carton: 17.5</p>	<b>GC3631WCA</b>	\$1971	\$2063	\$2143	\$2259	\$2420	\$2480	\$2624	\$2892	\$3025	\$3272	\$3619	\$4042
	Wood												
		OVERALL DIMENSIONS			SEAT DIMENSIONS			BACK DIMENSIONS					
		W	D	H	W	D	H	W	H				
		25	27	36.5	20.5	17.5	18	20.5	18				
<p>Active weight 350 lbs.                      Urethane armcap option - <b>Add \$104 list upcharge</b></p>													

DESCRIPTION	MODEL#	STANDARD FABRIC GRADES											
		COM	2	3	4	5	6	7	8	9	10	11	12
 <p><b>HB Armchair, Open Arms, Split Back (Wood)</b>                      COM Yardage: 2.25                      Freight Class: 250                      Product Weight (lbs.): 60                      Cubic Feet Per Carton: 27.5</p>	<b>GC3632W</b>	\$1930	\$2003	\$2070	\$2162	\$2296	\$2346	\$2460	\$2680	\$2790	\$2994	\$3276	\$3623
	Wood												
		OVERALL DIMENSIONS			SEAT DIMENSIONS			BACK DIMENSIONS					
		W	D	H	W	D	H	W	H				
		25	27	48.5	20.5	17.5	18	20.5	30				
<p>Active weight 350 lbs. Fold away headrest.                      Urethane armcap option - <b>Add \$104 list upcharge</b></p>													

DESCRIPTION	MODEL#	STANDARD FABRIC GRADES											
		COM	2	3	4	5	6	7	8	9	10	11	12
 <p><b>HB Armchair, Closed Arms, Split Back (Wood)</b> COM Yardage: 3 Freight Class: 250 Product Weight (lbs.): 68 Cubic Feet Per Carton: 27.5</p>	<b>GC3632WCA</b>	\$2167	\$2268	\$2356	\$2481	\$2657	\$2723	\$2881	\$3171	\$3317	\$3588	\$3964	\$4428
	Wood												
	<b>GC3632WFCA</b>	\$2668	\$2769	\$2856	\$2981	\$3157	\$3223	\$3379	\$3671	\$3816	\$4088	\$4464	\$4928
	Wood flex back												
		<b>OVERALL DIMENSIONS</b>			<b>SEAT DIMENSIONS</b>			<b>BACK DIMENSIONS</b>					
		<b>W</b>	<b>D</b>	<b>H</b>	<b>W</b>	<b>D</b>	<b>H</b>	<b>W</b>	<b>H</b>				
		25	27	48.5	20.5	17.5	18	20.5	30				

Active weight 350 lbs. Fold away headrest.  
Urethane armcap option - **Add \$104 list upcharge**

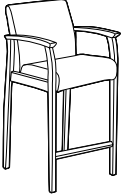
 <p>Designed to immobilize the pelvis and hip joints after surgery.</p> <p><b>LB Hip Armchair, Open Arms - Post Surgery (Wood)</b> COM Yardage: 1.5 Freight Class: 250 Product Weight (lbs.): 57 Cubic Feet Per Carton: 20</p>		COM	2	3	4	5	6	7	8	9	10	11	12
	<b>GC3636W</b>	\$2398	\$2448	\$2494	\$2556	\$2645	\$2680	\$2756	\$2901	\$2974	\$3111	\$3300	\$3530
	Wood												
		<b>OVERALL DIMENSIONS</b>			<b>SEAT DIMENSIONS</b>			<b>BACK DIMENSIONS</b>					
		<b>W</b>	<b>D</b>	<b>H</b>	<b>W</b>	<b>D</b>	<b>H</b>	<b>W</b>	<b>H</b>				
		23	26	40.5	19	17.5	25.5	19	15.5				

Active weight 350 lbs.  
Urethane armcap option - **Add \$104 list upcharge**

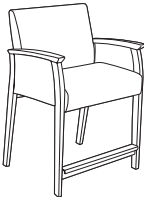
 <p>Designed to immobilize the pelvis and hip joints after surgery.</p> <p><b>LB Hip Armchair, Closed Arms - Post Surgery (Wood)</b> COM Yardage: 2 Freight Class: 250 Product Weight (lbs.): 62 Cubic Feet Per Carton: 20</p>		COM	2	3	4	5	6	7	8	9	10	11	12
	<b>GC3636WCA</b>	\$2644	\$2716	\$2781	\$2872	\$3001	\$3059	\$3177	\$3360	\$3503	\$3664	\$3990	\$4338
	Wood												
		<b>OVERALL DIMENSIONS</b>			<b>SEAT DIMENSIONS</b>			<b>BACK DIMENSIONS</b>					
		<b>W</b>	<b>D</b>	<b>H</b>	<b>W</b>	<b>D</b>	<b>H</b>	<b>W</b>	<b>H</b>				
		23	26	40.5	19	17.5	25.5	19	15.5				

Active weight 350 lbs.  
Urethane armcap option - **Add \$104 list upcharge**

 <p><b>Bariatric MB Armchair, Open Arms (Wood)</b> COM Yardage: 2.75 Freight Class: 250 Product Weight (lbs.): 82 Cubic Feet Per Carton: 30.5</p>		COM	2	3	4	5	6	7	8	9	10	11	12
	<b>GC3638W</b>	\$2202	\$2291	\$2480	\$2598	\$2757	\$2821	\$2961	\$3230	\$3363	\$3611	\$3957	\$4381
	Wood												
		<b>OVERALL DIMENSIONS</b>			<b>SEAT DIMENSIONS</b>			<b>BACK DIMENSIONS</b>					
		<b>W</b>	<b>D</b>	<b>H</b>	<b>W</b>	<b>D</b>	<b>H</b>	<b>W</b>	<b>H</b>				
		35	27	36.5	30	17.5	18	30	18				

Active weight 500 lbs.  
Urethane armcap option - **Add \$104 list upcharge**

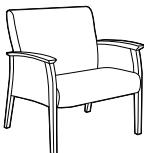
 <p><b>Bariatric MB Armchair, Closed Arms (Wood)</b> COM Yardage: 3.75 Freight Class: 250 Product Weight (lbs.): 92 Cubic Feet Per Carton: 30.5</p>		COM	2	3	4	5	6	7	8	9	10	11	12
	<b>GC3638WCA</b>	\$2432	\$2557	\$2665	\$2821	\$3042	\$3127	\$3319	\$3686	\$3868	\$4206	\$4674	\$5257
	Wood												
		<b>OVERALL DIMENSIONS</b>			<b>SEAT DIMENSIONS</b>			<b>BACK DIMENSIONS</b>					
		<b>W</b>	<b>D</b>	<b>H</b>	<b>W</b>	<b>D</b>	<b>H</b>	<b>W</b>	<b>H</b>				
		35	27	36.5	30	17.5	18	30	18				

Active weight 500 lbs.  
Urethane armcap option - **Add \$104 list upcharge**

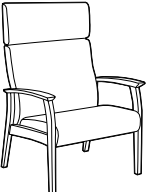

DESCRIPTION	MODEL#	STANDARD FABRIC GRADES											
		COM	2	3	4	5	6	7	8	9	10	11	12
 <p><b>GC3639W</b> Wood</p>		COM	2	3	4	5	6	7	8	9	10	11	12
		\$2431	\$2557	\$2665	\$2821	\$3042	\$3127	\$3319	\$3686	\$3865	\$4206	\$4674	\$5256
		OVERALL DIMENSIONS			SEAT DIMENSIONS			BACK DIMENSIONS					
		W	D	H	W	D	H	W	H				
		35	27	48.5	30	17.5	18	30	30				

**Bariatric HB Armchair, Open Arms, Split Back (Wood)**  
 COM Yardage: 3.75  
 Freight Class: 300  
 Product Weight (lbs.): 65  
 Cubic Feet Per Carton: 33

Active weight 500 lbs. Fold away headrest.  
 Urethane armcap option - **Add \$104 list upcharge**

 <p><b>GC3639WCA</b> Wood</p>		COM	2	3	4	5	6	7	8	9	10	11	12
		\$2692	\$2854	\$2991	\$3188	\$3468	\$3574	\$3819	\$4281	\$4510	\$4940	\$5536	\$6272
		OVERALL DIMENSIONS			SEAT DIMENSIONS			BACK DIMENSIONS					
		W	D	H	W	D	H	W	H				
		35	27	48.5	30	17.5	18	30	30				

**Bariatric HB Armchair, Closed Arms, Split Back (Wood)**  
 COM Yardage: 4.75  
 Freight Class: 250  
 Product Weight (lbs.): 75  
 Cubic Feet Per Carton: 33

Active weight 500 lbs. Fold away headrest.  
 Urethane armcap option - **Add \$104 list upcharge**

 <p><b>GC3655W</b> Wood</p> <p><b>GC3655WF</b> Wood flex back</p>		COM	2	3	4	5	6	7	8	9	10	11	12
		\$1801	\$1885	\$1958	\$2063	\$2209	\$2267	\$2393	\$2638	\$2759	\$2986	\$3299	\$3686
		\$2265	\$2349	\$2422	\$2528	\$2673	\$2731	\$2859	\$3102	\$3223	\$3449	\$3763	\$4150
		OVERALL DIMENSIONS			SEAT DIMENSIONS			BACK DIMENSIONS					
		W	D	H	W	D	H	W	H				
		25	27	48.5	20.5	17.5	18	20.5	30				

**HB Armchair, Open Arms (Wood)**  
 COM Yardage: 2.5  
 Freight Class: 250  
 Product Weight (lbs.): 60  
 Cubic Feet Per Carton: 27.5

Active weight 350 lbs.  
 Urethane armcap option - **Add \$104 list upcharge**

 <p><b>GC3655WCA</b> Wood</p> <p><b>GC3655WFCA</b> Wood flex back</p>		COM	2	3	4	5	6	7	8	9	10	11	12
		\$2041	\$2150	\$2244	\$2382	\$2572	\$2643	\$2813	\$3126	\$3284	\$3578	\$3986	\$4491
		\$2533	\$2644	\$2737	\$2872	\$3066	\$3137	\$3305	\$3622	\$3777	\$4071	\$4479	\$4982
		OVERALL DIMENSIONS			SEAT DIMENSIONS			BACK DIMENSIONS					
		W	D	H	W	D	H	W	H				
		25	27	48.5	20.5	17.5	18	20.5	30				

**HB Armchair, Closed Arms (Wood)**  
 COM Yardage: 3.25  
 Freight Class: 250  
 Product Weight (lbs.): 68  
 Cubic Feet Per Carton: 27.5

Active weight 350 lbs.  
 Urethane armcap option - **Add \$104 list upcharge**

 <p><b>GC3656W</b> Wood</p>		COM	2	3	4	5	6	7	8	9	10	11	12
		\$2263	\$2380	\$2482	\$2626	\$2833	\$2913	\$3093	\$3433	\$3603	\$3918	\$4357	\$4897
		OVERALL DIMENSIONS			SEAT DIMENSIONS			BACK DIMENSIONS					
		W	D	H	W	D	H	W	H				
		35	27	48.5	30	17.5	18	30	30				

**Bariatric HB Armchair, Open Arms (Wood)**  
 COM Yardage: 3.5  
 Freight Class: 250  
 Product Weight (lbs.): 65  
 Cubic Feet Per Carton: 30.75

Active weight 500 lbs.  
 Urethane armcap option - **Add \$104 list upcharge**

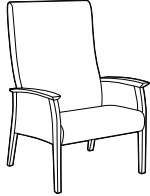
DESCRIPTION	MODEL#	STANDARD FABRIC GRADES												
		COM	2	3	4	5	6	7	8	9	10	11	12	
 <p><b>Bariatric HB Armchair, Closed Arms (Wood)</b>                      COM Yardage: 4.5                      Freight Class: 250                      Product Weight (lbs.): 75                      Cubic Feet Per Carton: 33</p>	<b>GC3656WCA</b>	<b>\$2513</b>	<b>\$2668</b>	<b>\$2794</b>	<b>\$2982</b>	<b>\$3246</b>	<b>\$3346</b>	<b>\$3579</b>	<b>\$4017</b>	<b>\$4236</b>	<b>\$4642</b>	<b>\$5204</b>	<b>\$5902</b>	
	Wood													
		OVERALL DIMENSIONS			SEAT DIMENSIONS			BACK DIMENSIONS						
		W	D	H	W	D	H	W	H					
		35	27	48.5	30	17.5	18	30	30					
		Active weight 500 lbs. Urethane armcap option - <b>Add \$104 list upcharge</b>												

PRIMACARE LOUNGE



model GC3641 (HT)



model GC3641W (Wood)

STANDARD FEATURES

- Primacare is a family of products offering the most significant return on investment approach in the industry since every component can be repaired or replaced on site.
- **High traffic (HT) models:** Metal frame and urethane armcaps with die cast zinc connectors and metal-to-metal fasteners. Available in the following finishes: Black (TBL), Cloud (TIV), Designer White (TDW), Fog (TFO), Frost (TFR), Kalua (TKA), Latte (TLA), Mocha (TMO), Nevada (TNE), Sand (TSN), Shadow (TSH), Toast (TOA) and Tungsten (TTU).
- **Wood models:** Solid hardwood frame and armcaps with die cast zinc connectors and metal-to-metal fastening. Available in the following finishes: Absolute (AAM), Charcoal Java (CJM), Cherry (ACM), Empire Mahogany (EMM), English Oak (EOM), Espresso Cafe (ECM), Fruitwood (TFM), Gray (HGM), Harvest Oak (HOM), Honey (AHM), Jet Onyx (JOM), Light Honey (LHM), Mahogany (TMM), Maple (AVM), Medium Walnut (MWM), Night (ASM), Natural Walnut (NLW), Noce Biondo (NBM), Noce Grigio (NGM), Noce Leggero (NEM), Noce Medio (NMM), Sandy Beach (SBM), Shaker Cherry (SKM), Silver Oak (SOM), Walnut (TWM), White (WHM), WC Cream (WTM) and Winter Cherry (WCM).
- Armcaps are securely fastened with metal-to-metal connectors which allow for field replacement if required.
- Easy grip forward extending armcap on models with arms.
- Replaceable seat covers and replaceable and/or removable seat cushions are standard.
- Waterfall cleanout between the seat and back cushions.
- Models are standard with metal mesh seat deck. For behavioral health applications, the metal mesh seat deck can be covered with a solid moisture resistant surface, held in place with tamperproof fasteners. Contact your sales rep for a special quotation.
- All seat frames feature a wall saver design to prevent back contact with wall.
- Models ending in **CA** have upholstered panel arm inserts closing the arm. (Closed arm panels are designed to be replaceable. Request a special quote to have them secured with tamperproof fasteners.)
- For Globalcare textile options, visit the website at globalfurnituregroup.com.
- Can be upholstered in standard Global textiles if healthcare compliance is not required.
- It is recommended that High Traffic (HT) models be specified in textiles that meet or exceed 100,000 double rubs for added abrasion performance.
- Shipped fully assembled.

- **High traffic (HT) models are listed first, followed by wood models.**

OPTIONAL FEATURES

- **High traffic (HT) models:** Wood armcaps are available. See far left column "Wood models" for finishes. Please specify. No upcharge.
- **High traffic (HT) and wood models:** Urethane armcaps are available. Please specify. Refer to individual models for availability and pricing.
- For moisture barrier (seat only), add **\$193** list upcharge per seat. For bariatric models: GC3640, GC3640CA, GC3640W, and GC3640WCA - Add **\$198** list upcharge per seat.
- To add sealed seams to your product contact Customer Care. Upcharges vary.
- For Primacare tables, see page page 56.

SUGGESTED APPLICATIONS

- Bariatric seating
- Guest seating
- Lobbies
- Lounge/Waiting
- Patient rooms
- Resident rooms

DESCRIPTION MODEL# / FEATURES STANDARD TEXTILE GRADES

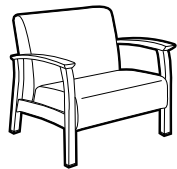

Bariatric Lounge Chair, Open Arms (HT)

COM Yardage: 3.25  
Freight Class: 250  
Product Weight (lbs.): 109  
Cubic Feet Per Carton: 49.5

Active weight 500 lbs.  
Urethane armcap option - **Add \$123 list upcharge**

COM	2	3	4	5	6	7	8	9	10	11	12	
<b>GC3640</b>	<b>\$3335</b>	<b>\$3447</b>	<b>\$3537</b>	<b>\$3673</b>	<b>\$3869</b>	<b>\$3940</b>	<b>\$4107</b>	<b>\$4419</b>	<b>\$4579</b>	<b>\$4873</b>	<b>\$5282</b>	<b>\$5782</b>
Metal												
OVERALL DIMENSIONS			SEAT DIMENSIONS			BACK DIMENSIONS						
W	D	H	W	D	H	W	H					
40	32	33	36	20	17.25	36	16					

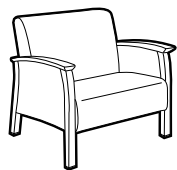

Bariatric Lounge Chair, Closed Arms (HT)

COM Yardage: 5.75  
Freight Class: 250  
Product Weight (lbs.): 119  
Cubic Feet Per Carton: 49.5

Active weight 500 lbs.  
Urethane armcap option - **Add \$123 list upcharge**

- For users up to 500 lbs.

COM	2	3	4	5	6	7	8	9	10	11	12	
<b>GC3640CA</b>	<b>\$3589</b>	<b>\$3784</b>	<b>\$3949</b>	<b>\$4187</b>	<b>\$4526</b>	<b>\$4655</b>	<b>\$4950</b>	<b>\$5509</b>	<b>\$5790</b>	<b>\$6308</b>	<b>\$7031</b>	<b>\$7919</b>
Metal												
OVERALL DIMENSIONS			SEAT DIMENSIONS			BACK DIMENSIONS						
W	D	H	W	D	H	W	H					
40	32	33	36	20	17.25	36	16					

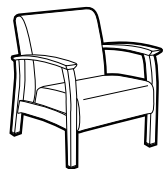

Lounge Chair, Open Arms (HT)

COM Yardage: 2.5  
Freight Class: 250  
Product Weight (lbs.): 78  
Cubic Feet Per Carton: 29.5

Active weight 500 lbs.  
Urethane armcap option - **Add \$123 list upcharge**

COM	2	3	4	5	6	7	8	9	10	11	12	
<b>GC3641</b>	<b>\$2680</b>	<b>\$2765</b>	<b>\$2838</b>	<b>\$2942</b>	<b>\$3087</b>	<b>\$3143</b>	<b>\$3272</b>	<b>\$3515</b>	<b>\$3638</b>	<b>\$3863</b>	<b>\$4177</b>	<b>\$4566</b>
Metal												
OVERALL DIMENSIONS			SEAT DIMENSIONS			BACK DIMENSIONS						
W	D	H	W	D	H	W	H					
29	32	33	23	20	17.25	22.5	16					

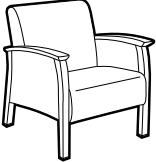
DESCRIPTION	MODEL#	STANDARD FABRIC GRADES											
		COM	2	3	4	5	6	7	8	9	10	11	12
 <p><b>Lounge Chair, Closed Arms (HT)</b> COM Yardage: 3.75 Freight Class: 250 Product Weight (lbs.): 91 Cubic Feet Per Carton: 29.5</p>	<b>GC3641CA</b>	\$2977	\$3102	\$3209	\$3365	\$3586	\$3669	\$3864	\$4230	\$4411	\$4749	\$5218	\$5801
	Metal												
		OVERALL DIMENSIONS			SEAT DIMENSIONS			BACK DIMENSIONS					
		W	D	H	W	D	H	W	H				
		29	32	33	23	20	17.25	22.5	16				
		Active weight 500 lbs. Urethane armcap option - <b>Add \$123 list upcharge</b>											

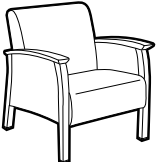
DESCRIPTION	MODEL#	STANDARD FABRIC GRADES											
		COM	2	3	4	5	6	7	8	9	10	11	12
 <p><b>Lounge Chair, Closed Arms, Laminate Panels (HT)</b> COM Yardage: 2.5 Freight Class: 250 Product Weight (lbs.): 91 Cubic Feet Per Carton: 29.5</p>	<b>GC3641CAL</b>	\$3336	\$3410	\$3475	\$3568	\$3700	\$3763	\$3882	\$4074	\$4220	\$4384	\$4722	\$5081
	Metal												
		OVERALL DIMENSIONS			SEAT DIMENSIONS			BACK DIMENSIONS					
		W	D	H	W	D	H	W	H				
		29	32	33	23	20	17.25	22.5	16				
		Active weight 500 lbs. Urethane armcap option - <b>Add \$123 list upcharge</b>											

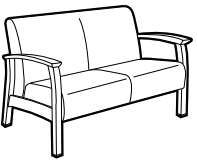
DESCRIPTION	MODEL#	STANDARD FABRIC GRADES											
		COM	2	3	4	5	6	7	8	9	10	11	12
 <p><b>Two Seat Sofa, Open Arms (HT)</b> COM Yardage: 4 Freight Class: 250 Product Weight (lbs.): 122 Cubic Feet Per Carton: 49.5</p>	<b>GC3642</b>	\$3864	\$4000	\$4114	\$4282	\$4516	\$4607	\$4813	\$5201	\$5398	\$5755	\$6259	\$6879
	Metal												
		OVERALL DIMENSIONS			SEAT DIMENSIONS			BACK DIMENSIONS					
		W	D	H	W	D	H	W	H				
		52	32	33	48	20	17.25	48	16				
		Active weight 500 lbs./seat Urethane armcap option - <b>Add \$123 list upcharge</b>											

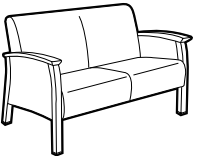
DESCRIPTION	MODEL#	STANDARD FABRIC GRADES											
		COM	2	3	4	5	6	7	8	9	10	11	12
 <p><b>Two Seat Sofa, Closed Arms (HT)</b> COM Yardage: 5.5 Freight Class: 250 Product Weight (lbs.): 132 Cubic Feet Per Carton: 49.5</p>	<b>GC3642CA</b>	\$4149	\$4338	\$4494	\$4724	\$5049	\$5170	\$5456	\$5988	\$6257	\$6752	\$7441	\$8293
	Metal												
		OVERALL DIMENSIONS			SEAT DIMENSIONS			BACK DIMENSIONS					
		W	D	H	W	D	H	W	H				
		52	32	33	48	20	17.25	48	16				
		Active weight 500 lbs./seat Urethane armcap option - <b>Add \$123 list upcharge</b>											

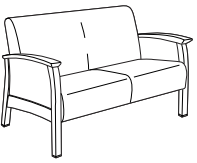
DESCRIPTION	MODEL#	STANDARD FABRIC GRADES											
		COM	2	3	4	5	6	7	8	9	10	11	12
 <p><b>Two Seat Sofa, Closed Arms, Laminate Panels (HT)</b> COM Yardage: 4 Freight Class: 250 Product Weight (lbs.): 132 Cubic Feet Per Carton: 49.5</p>	<b>GC3642CAL</b>	\$4514	\$4636	\$4739	\$4889	\$5099	\$5198	\$5390	\$5696	\$5930	\$6194	\$6733	\$7307
	Metal												
		OVERALL DIMENSIONS			SEAT DIMENSIONS			BACK DIMENSIONS					
		W	D	H	W	D	H	W	H				
		52	32	33	48	20	17.25	48	16				
		Active weight 500 lbs./seat Urethane armcap option - <b>Add \$123 list upcharge</b>											

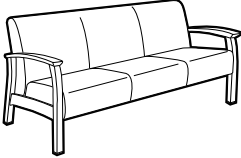
DESCRIPTION	MODEL# / FEATURES	STANDARD TEXTILE GRADES											
		COM	2	3	4	5	6	7	8	9	10	11	12
 <p><b>Three Seat Sofa, Open Arms (HT)</b> COM Yardage: 6.25 Freight Class: 250 Product Weight (lbs.): 173 Cubic Feet Per Carton: 69.5</p>	<b>GC3643</b> Metal	\$5473	\$5686	\$5863	\$6121	\$6491	\$6629	\$6952	\$7560	\$7864	\$8426	\$9212	\$10179
		OVERALL DIMENSIONS			SEAT DIMENSIONS			BACK DIMENSIONS					
		W	D	H	W	D	H	W	H				
		75	32	33	71	20	17.25	71	16				

Active weight 500 lbs./seat  
Urethane armcap option - **Add \$123 list upcharge**

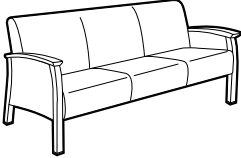
DESCRIPTION	MODEL# / FEATURES	STANDARD TEXTILE GRADES											
		COM	2	3	4	5	6	7	8	9	10	11	12
 <p><b>Three Seat Sofa, Closed Arms (HT)</b> COM Yardage: 7.5 Freight Class: 250 Product Weight (lbs.): 183 Cubic Feet Per Carton: 69.5</p>	<b>GC3643CA</b> Metal	\$5768	\$6023	\$6236	\$6547	\$6988	\$7155	\$7543	\$8271	\$8636	\$9314	\$10253	\$11416
		OVERALL DIMENSIONS			SEAT DIMENSIONS			BACK DIMENSIONS					
		W	D	H	W	D	H	W	H				
		75	32	33	71	20	17.25	71	16				

Active weight 500 lbs./seat  
Urethane armcap option - **Add \$123 list upcharge**

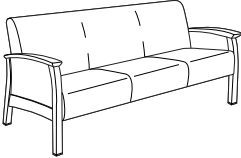
DESCRIPTION	MODEL# / FEATURES	STANDARD TEXTILE GRADES											
		COM	2	3	4	5	6	7	8	9	10	11	12
 <p><b>Three Seat Sofa, Closed Arms, Laminate Panels (HT)</b> COM Yardage: 6.25 Freight Class: 250 Product Weight (lbs.): 183 Cubic Feet Per Carton: 69.5</p>	<b>GC3643CAL</b> Metal	\$6115	\$6308	\$6466	\$6699	\$7030	\$7185	\$7486	\$7962	\$8330	\$8740	\$9581	\$10481
		OVERALL DIMENSIONS			SEAT DIMENSIONS			BACK DIMENSIONS					
		W	D	H	W	D	H	W	H				
		75	32	33	71	20	17.25	71	16				

Active weight 500 lbs./seat  
Urethane armcap option - **Add \$123 list upcharge**

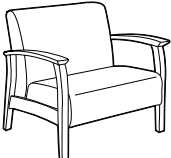
DESCRIPTION	MODEL# / FEATURES	STANDARD TEXTILE GRADES											
		COM	2	3	4	5	6	7	8	9	10	11	12
 <p><b>Bariatric Lounge Chair, Open Arms (Wood)</b> COM Yardage: 3.25 Freight Class: 300 Product Weight (lbs.): 97 Cubic Feet Per Carton: 49.5</p>	<b>GC3640W</b> Wood	\$2744	\$2854	\$2947	\$3082	\$3276	\$3347	\$3515	\$3830	\$3986	\$4282	\$4688	\$5191
		OVERALL DIMENSIONS			SEAT DIMENSIONS			BACK DIMENSIONS					
		W	D	H	W	D	H	W	H				
		40	32	33	36	20	17.25	36	16				

Active weight 500 lbs.  
Urethane armcap option - **Add \$123 list upcharge**

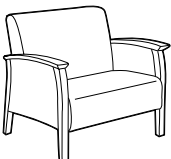
DESCRIPTION	MODEL# / FEATURES	STANDARD TEXTILE GRADES											
		COM	2	3	4	5	6	7	8	9	10	11	12
 <p><b>Bariatric Lounge Chair, Closed Arms (Wood)</b> COM Yardage: 5.75 Freight Class: 250 Product Weight (lbs.): 107 Cubic Feet Per Carton: 49.5</p>	<b>GC3640WCA</b> Wood	\$2936	\$3134	\$3296	\$3535	\$3875	\$4003	\$4300	\$4858	\$5138	\$5657	\$6377	\$7268
		OVERALL DIMENSIONS			SEAT DIMENSIONS			BACK DIMENSIONS					
		W	D	H	W	D	H	W	H				
		40	32	33	36	20	17.25	36	16				

Active weight 500 lbs.  
Urethane armcap option - **Add \$123 list upcharge**

DESCRIPTION

MODEL#

STANDARD FABRIC GRADES

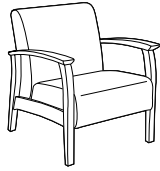

**Lounge Chair, Open Arms (Wood)**  
 COM Yardage: 2.5  
 Freight Class: 250  
 Product Weight (lbs.): 66  
 Cubic Feet Per Carton: 29.5

Active weight 350 lbs.  
 Urethane armcap option - **Add \$123 list upcharge**

COM	2	3	4	5	6	7	8	9	10	11	12	
<b>GC3641W</b>	<b>\$2202</b>	<b>\$2287</b>	<b>\$2360</b>	<b>\$2466</b>	<b>\$2611</b>	<b>\$2669</b>	<b>\$2797</b>	<b>\$3040</b>	<b>\$3161</b>	<b>\$3387</b>	<b>\$3701</b>	<b>\$4088</b>

OVERALL DIMENSIONS			SEAT DIMENSIONS			BACK DIMENSIONS	
W	D	H	W	D	H	W	H
29	32	33	23	20	17.25	22.5	16

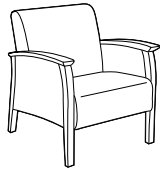

**Lounge Chair, Closed Arms (Wood)**  
 COM Yardage: 3.75  
 Freight Class: 250  
 Product Weight (lbs.): 79  
 Cubic Feet Per Carton: 29.5

Active weight 350 lbs.  
 Urethane armcap option - **Add \$123 list upcharge**

COM	2	3	4	5	6	7	8	9	10	11	12	
<b>GC3641WCA</b>	<b>\$2424</b>	<b>\$2550</b>	<b>\$2658</b>	<b>\$2815</b>	<b>\$3035</b>	<b>\$3120</b>	<b>\$3312</b>	<b>\$3679</b>	<b>\$3861</b>	<b>\$4199</b>	<b>\$4666</b>	<b>\$5249</b>

OVERALL DIMENSIONS			SEAT DIMENSIONS			BACK DIMENSIONS	
W	D	H	W	D	H	W	H
29	32	33	23	20	17.25	22.5	16

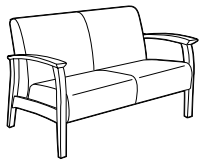

**Two Seat Sofa, Open Arms (Wood)**  
 COM Yardage: 4  
 Freight Class: 250  
 Product Weight (lbs.): 110  
 Cubic Feet Per Carton: 49.5

Active weight 350 lbs./seat  
 Urethane armcap option - **Add \$123 list upcharge**

COM	2	3	4	5	6	7	8	9	10	11	12	
<b>GC3642W</b>	<b>\$3177</b>	<b>\$3313</b>	<b>\$3428</b>	<b>\$3595</b>	<b>\$3829</b>	<b>\$3918</b>	<b>\$4126</b>	<b>\$4514</b>	<b>\$4710</b>	<b>\$5071</b>	<b>\$5569</b>	<b>\$6190</b>

OVERALL DIMENSIONS			SEAT DIMENSIONS			BACK DIMENSIONS	
W	D	H	W	D	H	W	H
52	32	33	48	20	17.25	48	16

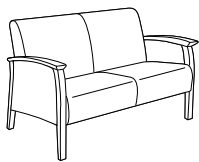

**Two Seat Sofa, Closed Arms (Wood)**  
 COM Yardage: 5.5  
 Freight Class: 250  
 Product Weight (lbs.): 120  
 Cubic Feet Per Carton: 49.5

Active weight 350 lbs./seat  
 Urethane armcap option - **Add \$123 list upcharge**

COM	2	3	4	5	6	7	8	9	10	11	12	
<b>GC3642WCA</b>	<b>\$3408</b>	<b>\$3593</b>	<b>\$3750</b>	<b>\$3979</b>	<b>\$4301</b>	<b>\$4424</b>	<b>\$4708</b>	<b>\$5243</b>	<b>\$5510</b>	<b>\$6006</b>	<b>\$6696</b>	<b>\$7547</b>

OVERALL DIMENSIONS			SEAT DIMENSIONS			BACK DIMENSIONS	
W	D	H	W	D	H	W	H
52	32	33	48	20	17.25	48	16

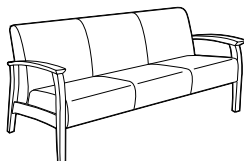

**Three Seat Sofa, Open Arms (Wood)**  
 COM Yardage: 6.25  
 Freight Class: 250  
 Product Weight (lbs.): 161  
 Cubic Feet Per Carton: 69.5

Active weight 350 lbs./seat  
 Urethane armcap option - **Add \$123 list upcharge**

COM	2	3	4	5	6	7	8	9	10	11	12	
<b>GC3643W</b>	<b>\$4497</b>	<b>\$4708</b>	<b>\$4888</b>	<b>\$5149</b>	<b>\$5515</b>	<b>\$5657</b>	<b>\$5977</b>	<b>\$6583</b>	<b>\$6890</b>	<b>\$7451</b>	<b>\$8236</b>	<b>\$9203</b>

OVERALL DIMENSIONS			SEAT DIMENSIONS			BACK DIMENSIONS	
W	D	H	W	D	H	W	H
75	32	33	71	20	17.25	71	16

**DESCRIPTION**

**MODEL#**

**STANDARD FABRIC GRADES**

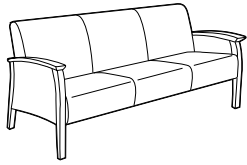

	COM	2	3	4	5	6	7	8	9	10	11	12
<b>GC3643WCA</b>	<b>\$4729</b>	<b>\$4988</b>	<b>\$5197</b>	<b>\$5512</b>	<b>\$5953</b>	<b>\$6120</b>	<b>\$6507</b>	<b>\$7236</b>	<b>\$7601</b>	<b>\$8277</b>	<b>\$9217</b>	<b>\$10379</b>
Wood												

OVERALL DIMENSIONS			SEAT DIMENSIONS			BACK DIMENSIONS	
W	D	H	W	D	H	W	H
75	32	33	71	20	17.25	71	16

**Three Seat Sofa, Closed Arms (Wood)**  
 COM Yardage: 7.5  
 Freight Class: 250  
 Product Weight (lbs.): 171  
 Cubic Feet Per Carton: 69.5

Active weight 350 lbs./seat  
 Urethane armcap option - **Add \$123 list upcharge**

# SEATING

# PRIMACARE™ FULLY UPHOLSTERED LOUNGE

## PRIMACARE FULLY UPHOLSTERED LOUNGE



model GC3676HB



model GC3677

### STANDARD FEATURES

- Primacare is a family of products offering the most significant return on investment approach in the industry since every component can be repaired or replaced on site.
- Standard with fully upholstered arms and Black urethane legs.
- Solid hardwood frame with die cast zinc connectors and metal-to-metal fastening.
- Replaceable seat covers and replaceable and/or removable seat cushions are standard.
- Waterfall cleanout between the seat and back cushions.
- Models are standard with metal mesh seat deck. For behavioral health applications, the metal mesh seat deck can be covered with a solid moisture resistant surface, held in place with tamperproof fasteners. Contact your sales rep for a special quotation.
- All seat frames feature a wall saver design to prevent back contact with wall.
- For Globalcare textile options, visit the website at [www.globalfurnituregroup.com](http://www.globalfurnituregroup.com).
- Can be upholstered in standard Global textiles if healthcare compliance is not required.
- Shipped fully assembled.

### OPTIONAL FEATURES

- Optional urethane armcaps available in the following finishes: Black (**BLK**), Latte (**LAB**), Kalua (**KAL**), Mocha (**J52**), Shadow (**SHW**), and Toast (**TOA**). Add \$443.
- Optional wood legs and armcaps available in the following finishes: Absolute (AAM), Charcoal Java (CJM), Cherry (ACM), Empire Mahogany (EMM), English Oak (EOM), Espresso Cafe (ECM), Fruitwood (TFM), Gray (HGM), Harvest Oak (HOM), Honey (AHM), Jet Onyx (JOM), Light Honey (LHM), Mahogany (TMM), Maple (AVM), Medium Walnut (MWM), Neutral Walnut (NLW), Night (ASM), Noce Biondo (NBM), Noce Grigio (NGM), Noce Leggero (NEM), Noce Medio (NMM), Sandy Beach (SBM), Silver Oak (SOM), Walnut (TWM), White (WHM), WC Cream (WTM) and Winter Cherry (WCM). See features column for upcharges.
- When specified with armcaps are securely fastened with metal-to-metal connectors which allow for field replacement if required.
- For moisture barrier on seat, please specify (**MB**). Add \$193 list upcharge per seat.
- To add sealed seams to your product contact Customer Care. Upcharges vary.
- For Primacare tables, see page 56

### SUGGESTED APPLICATIONS

- Guest seating
- Patient rooms
- Lobbies
- Resident rooms
- Lounge/Waiting

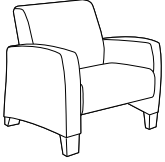
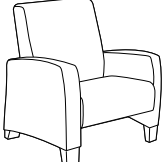
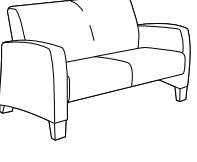
DESCRIPTION	MODEL# / FEATURES	STANDARD TEXTILE GRADES											
		COM	2	3	4	5	6	7	8	9	10	11	12
 <p><b>Lounge Chair, Fully Upholstered Arms, Urethane legs</b> COM Yardage: 6.25 Freight Class: 250 Product Weight (lbs.): 95 Cubic Feet Per Carton: 29.5</p>	<b>GC3676</b>	\$2322	\$2538	\$2715	\$2974	\$3342	\$3482	\$3805	\$4412	\$4716	\$5280	\$6064	\$7032
	Active weight 350 lbs.	<b>OVERALL DIMENSIONS</b>			<b>SEAT DIMENSIONS</b>			<b>BACK DIMENSIONS</b>					
		<b>W</b>	<b>D</b>	<b>H</b>	<b>W</b>	<b>D</b>	<b>H</b>	<b>W</b>	<b>H</b>				
		32.5	29	33	23	20	17.25	23	16				
		Optional wood legs - no charge. Urethane or wood armcap option - Add \$443 list upcharge											
 <p><b>HB Lounge Chair, Fully Upholstered Arms, Urethane legs</b> COM Yardage: 6.5 Freight Class: 250 Product Weight (lbs.): 114 Cubic Feet Per Carton: 29.5</p>	<b>GC3676HB</b>	\$2383	\$2634	\$2842	\$3145	\$3575	\$3740	\$4116	\$4827	\$5181	\$5844	\$6760	\$7892
	Active weight 350 lbs.	<b>OVERALL DIMENSIONS</b>			<b>SEAT DIMENSIONS</b>			<b>BACK DIMENSIONS</b>					
		<b>W</b>	<b>D</b>	<b>H</b>	<b>W</b>	<b>D</b>	<b>H</b>	<b>W</b>	<b>H</b>				
		32.5	29	36	23	20	17.25	23	19				
		Optional wood legs - no charge. Urethane or wood armcap option - Add \$443 list upcharge											
 <p><b>Two Seat Sofa, Fully Upholstered Arms, Urethane legs</b> COM Yardage: 7.5 Freight Class: 250 Product Weight (lbs.): 135 Cubic Feet Per Carton: 56.25</p>	<b>GC3677</b>	\$3406	\$3661	\$3874	\$4184	\$4626	\$4795	\$5180	\$5908	\$6275	\$6950	\$7891	\$9053
	Active weight 350 lbs.	<b>OVERALL DIMENSIONS</b>			<b>SEAT DIMENSIONS</b>			<b>BACK DIMENSIONS</b>					
		<b>W</b>	<b>D</b>	<b>H</b>	<b>W</b>	<b>D</b>	<b>H</b>	<b>W</b>	<b>H</b>				
		55.5	29	33	45.5	20	17.25	45.5	16				
		Optional wood legs - no charge. Urethane or wood armcap option - Add \$443 list upcharge											



DESCRIPTION	MODEL#	STANDARD FABRIC GRADES											
-------------	--------	------------------------	--	--	--	--	--	--	--	--	--	--	--

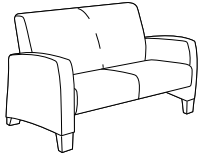

	COM	2	3	4	5	6	7	8	9	10	11	12
<b>GC3677HB</b>	<b>\$3551</b>	<b>\$3852</b>	<b>\$4097</b>	<b>\$4462</b>	<b>\$4974</b>	<b>\$5168</b>	<b>\$5618</b>	<b>\$6466</b>	<b>\$6888</b>	<b>\$7677</b>	<b>\$8768</b>	<b>\$10120</b>

Active weight 350 lbs.

OVERALL DIMENSIONS			SEAT DIMENSIONS			BACK DIMENSIONS	
W	D	H	W	D	H	W	H
55.5	29	36	45.5	20	17.25	45.5	19

**HB Two Seat Sofa, Fully Upholstered Arms, Urethane legs**  
 COM Yardage: 7.75  
 Freight Class: 250  
 Product Weight (lbs.): 142  
 Cubic Feet Per Carton: 56.25

Optional wood legs - no charge.  
 Urethane or wood armcap option - **Add \$443 list upcharge**

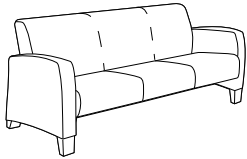

	COM	2	3	4	5	6	7	8	9	10	11	12
<b>GC3678</b>	<b>\$4717</b>	<b>\$5026</b>	<b>\$5280</b>	<b>\$5655</b>	<b>\$6184</b>	<b>\$6386</b>	<b>\$6851</b>	<b>\$7723</b>	<b>\$8161</b>	<b>\$8974</b>	<b>\$10100</b>	<b>\$11495</b>

Active weight 350 lbs.

OVERALL DIMENSIONS			SEAT DIMENSIONS			BACK DIMENSIONS	
W	D	H	W	D	H	W	H
78.5	29	33	68.5	20	17.25	68.5	16

**Three Seat Sofa, Fully Upholstered Arms, Urethane legs**  
 COM Yardage: 9  
 Freight Class: 250  
 Product Weight (lbs.): 181  
 Cubic Feet Per Carton: 69.5

Optional wood legs - no charge.  
 Urethane or wood armcap option - **Add \$443 list upcharge**

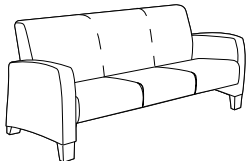

	COM	2	3	4	5	6	7	8	9	10	11	12
<b>GC3678HB</b>	<b>\$4954</b>	<b>\$5312</b>	<b>\$5605</b>	<b>\$6037</b>	<b>\$6652</b>	<b>\$6884</b>	<b>\$7420</b>	<b>\$8430</b>	<b>\$8937</b>	<b>\$9877</b>	<b>\$11180</b>	<b>\$12791</b>

Active weight 350 lbs.

OVERALL DIMENSIONS			SEAT DIMENSIONS			BACK DIMENSIONS	
W	D	H	W	D	H	W	H
78.5	29	36	68.5	20	17.25	68.5	19

**HB Three Seat Sofa, Fully Upholstered Arms, Urethane legs**  
 COM Yardage: 9.25  
 Freight Class: 250  
 Product Weight (lbs.): 188  
 Cubic Feet Per Carton: 69.5

Optional wood legs - no charge.  
 Urethane or wood armcap option - **Add \$443 list upcharge**

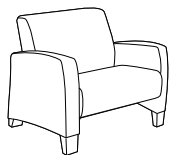

	COM	2	3	4	5	6	7	8	9	10	11	12
<b>GC3679</b>	<b>\$3202</b>	<b>\$3425</b>	<b>\$3609</b>	<b>\$3880</b>	<b>\$4261</b>	<b>\$4408</b>	<b>\$4745</b>	<b>\$5374</b>	<b>\$5690</b>	<b>\$6277</b>	<b>\$7093</b>	<b>\$8096</b>

Active weight 500 lbs.

OVERALL DIMENSIONS			SEAT DIMENSIONS			BACK DIMENSIONS	
W	D	H	W	D	H	W	H
42	29	33	32	20	17.25	32	16

**Bariatric Lounge Chair, Fully Upholstered Arms, Urethane legs**  
 COM Yardage: 6.5  
 Freight Class: 250  
 Product Weight (lbs.): 107  
 Cubic Feet Per Carton: 37.75

Optional wood legs - no charge.  
 Urethane or wood armcap option - **Add \$443 list upcharge**

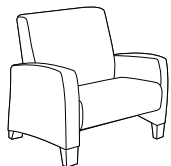

	COM	2	3	4	5	6	7	8	9	10	11	12
<b>GC3679HB</b>	<b>\$3308</b>	<b>\$3569</b>	<b>\$3783</b>	<b>\$4099</b>	<b>\$4547</b>	<b>\$4718</b>	<b>\$5107</b>	<b>\$5846</b>	<b>\$6214</b>	<b>\$6900</b>	<b>\$7853</b>	<b>\$9026</b>

Active weight 500 lbs.

OVERALL DIMENSIONS			SEAT DIMENSIONS			BACK DIMENSIONS	
W	D	H	W	D	H	W	H
42	29	36	32	20	17.25	32	19

**HB Bariatric Lounge Chair, Fully Upholstered Arms, Urethane legs**  
 COM Yardage: 6.75  
 Freight Class: 250  
 Product Weight (lbs.): 121  
 Cubic Feet Per Carton: 37.75

Optional wood legs - no charge.  
 Urethane or wood armcap option - **Add \$443 list upcharge**

## PRIMACARE WINGBACK



model GC3694HB



model GC3692HB

### STANDARD FEATURES



- Primacare is a family of products offering the most significant return on investment approach in the industry since every component can be repaired or replaced on site.
- Legs and armcaps are available in urethane (6 colors) or wood, with upcharge.
- Legs are standard with white nylon glides (1"OD, 0.5" thick)
- Easy grip forward extending armcaps are securely fastened with metal-to-metal connectors which allow for field replacement if required.
- For added comfort, seat and back are standard with high density foam.
- Replaceable seat covers and replaceable and/or removable seat cushions are standard.
- Seat cushion has a seamless waterfall front and clean out between and around the seat and back cushions.
- Models are standard with metal mesh seat deck. For mental health applications, the metal mesh seat deck can be covered with a solid moisture resistant surface, held in place with tamperproof fasteners. Contact your sales rep for a special quotation.
- For healthcare textile options, visit the website at [globalfurnituregroup.com](http://globalfurnituregroup.com)
- Can be upholstered in standard Global textiles if healthcare compliance is not required.



### OPTIONAL FEATURES

- Optional urethane legs and armcaps available in the following finishes: Black (**BLK**), Latte (**LAB**), Kalua (**KAL**), Mocha (**J52**), Shadow (**SHW**) and Toast (**TOA**). No upcharge.
- For optional wood legs and armcaps, refer to the Seating wood finishes in the Textiles + Finishes section.  
For wood armcaps: Add \$135  
For wood legs: Add \$160
- For moisture barrier on seat, please specify (**MB**).  
For single seat model, add \$152.  
For two seat model, add \$303.  
For bariatric model, add \$202.  
For standard ottoman, add \$129.  
For bariatric ottoman, add \$198.
- To add sealed seams to your product, contact Customer Care. Upcharges vary.
- For Primacare tables, see page 56

### SUGGESTED APPLICATIONS

- Bariatric seating
- Lobbies
- Lounge/Waiting
- Guest seating
- Patient rooms
- Resident rooms

DESCRIPTION	MODEL# / FEATURES	STANDARD TEXTILE GRADES											
		COM	2	3	4	5	6	7	8	9	10	11	12
 <p><b>Single Seat Wingback Armchair</b> COM Yardage: 6.25 Freight Class: 250 Product weight (lbs.): 94 Cubic Feet Per Carton: 29</p>	<b>GC3691HB</b>	\$3259	\$3459	\$3616	\$3847	\$4172	\$4309	\$4591	\$5034	\$5366	\$5729	\$6484	\$7279
	Active weight 350 lbs.	<b>OVERALL DIMENSIONS</b>			<b>SEAT DIMENSIONS</b>			<b>BACK DIMENSIONS</b>					
		<b>W</b>	<b>D</b>	<b>H</b>	<b>W</b>	<b>D</b>	<b>H</b>	<b>W</b>	<b>H</b>				
		30.5	28.5	45.5	22.5	18	19	19	26				
 <p><b>Two Seat Wingback Armchair</b> COM Yardage: 9.5 Freight Class: 250 Product weight (lbs.): 163 Cubic Feet Per Carton: 52.5</p>	<b>GC3692HB</b>	\$4495	\$4799	\$5037	\$5388	\$5882	\$6091	\$6519	\$7193	\$7697	\$8248	\$9397	\$10604
	Active weight 350 lbs/seat.	<b>OVERALL DIMENSIONS</b>			<b>SEAT DIMENSIONS</b>			<b>BACK DIMENSIONS</b>					
		<b>W</b>	<b>D</b>	<b>H</b>	<b>W</b>	<b>D</b>	<b>H</b>	<b>W</b>	<b>H</b>				
		57.5	28.5	45.5	50	18	19	45	26				
 <p><b>Bariatric Single Seat Wingback Armchair</b> COM Yardage: 8.25 Freight Class: 250 Product weight (lbs.): 130 Cubic Feet Per Carton: 35.5</p>	<b>GC3694HB</b>	\$3692	\$3956	\$4163	\$4468	\$4897	\$5078	\$5450	\$6035	\$6473	\$6952	\$7949	\$8998
	Active weight 600 lbs.	<b>OVERALL DIMENSIONS</b>			<b>SEAT DIMENSIONS</b>			<b>BACK DIMENSIONS</b>					
		<b>W</b>	<b>D</b>	<b>H</b>	<b>W</b>	<b>D</b>	<b>H</b>	<b>W</b>	<b>H</b>				
		38	28.5	45.5	31	18	19	26.5	26				

DESCRIPTION	MODEL#	STANDARD FABRIC GRADES											
		COM	2	3	4	5	6	7	8	9	10	11	12
 <p><b>Standard Size Ottoman</b> COM Yardage: 1.25 Freight Class: 250 Product weight (lbs.): 17 Cubic Feet Per Carton: 4.7</p>	GC3695	\$878	\$917	\$955	\$1007	\$1082	\$1116	\$1182	\$1288	\$1370	\$1461	\$1648	\$1847
	Active weight 350 lbs.	OVERALL DIMENSIONS			SEAT DIMENSIONS			BACK DIMENSIONS					
		W	D	H	W	D	H	W	H				
		23	18	15.75	-	-	-	-	-				
 <p><b>Bariatric Ottoman</b> COM Yardage: 1.75 Freight Class: 250 Product Weight (lbs.): 20 Cubic Feet Per Carton: 9</p>	GC3696	\$1108	\$1166	\$1218	\$1291	\$1392	\$1442	\$1534	\$1682	\$1798	\$1925	\$2186	\$2464
	Active weight 500 lbs.	OVERALL DIMENSIONS			SEAT DIMENSIONS			BACK DIMENSIONS					
		W	D	H	W	D	H	W	H				
		31.25	18	15.75	-	-	-	-	-				

PRIMACARE RECLINERS



model GC3608



model GC3609

STANDARD FEATURES

- Primacare is a family of products offering the most significant return on investment approach in the industry since every component can be repaired or replaced on site.
- Solid hardwood frame with die cast zinc connectors and metal-to-metal fastening. Available in the following finishes: Absolute (AAM), Charcoal Java (CJM), Cherry (ACM), Empire Mahogany (EMM), English Oak (EOM), Espresso Cafe (ECM), Fruitwood (TFM), Gray (HGM), Harvest Oak (HOM), Honey (AHM), Jet Onyx (JOM), Light Honey (LHM), Mahogany (TMM), Maple (AVM), Medium Walnut (MWM), Natural Walnut (NLW), Night (ASM), Noce Biondo (NBM), Noce Grigio (NGM), Noce Leggero (NEM), Noce Medio (NMM), Sandy Beach (SBM), Shaker Cherry (SKM), Silver Oak (SOM), Walnut (TWM), White (WHM), WC Cream (WTM) and Winter Cherry (WCM).
- Armcaps are securely fastened with metal-to-metal connectors which allow for field replacement if required.
- Easy grip forward extending armcap on models with arms.
- For healthcare textile options, visit the website at [globalfurnituregroup.com](http://globalfurnituregroup.com).
- Can be upholstered in standard Global textiles if healthcare compliance is not required.
- Shipped easy to assemble.

OPTIONAL FEATURES

- Urethane armcaps are available in the following finishes: Black (BLK), Latte (LAB), Kalua (KAL), Mocha (J52), Shadow (SHW) and Toast (TOA). Please specify. Add \$259 list upcharge.
- Urethane armcaps are not available on models GC3606 and GC3609.
- For moisture barrier on seat, please specify (MB). Add \$193 list upcharge per seat.
- For Primacare tables, see page 56

GC3608 AND GC3609 ONLY

- Tablet arm with spill collector on the edge is available, offered in Black Phenolic material. Tablet rotates so it can be positioned for any user activity and can fold down to store beside the chair when not in use. From seated position, specify (LT) for left hand tablet or (RT) for right hand tablet. Add \$1042.
- Footrest in Grey thermally fused laminate with a Black edge is available. Specify (FT). Add \$360.

SUGGESTED APPLICATIONS

- Guest seating
- Lobbies
- Lounge/Waiting
- Patient rooms
- Resident rooms
- Treatment/Exam rooms

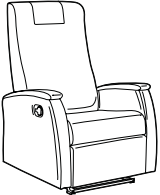
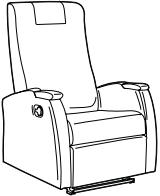
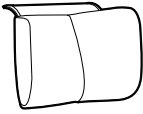
DESCRIPTION	MODEL# / FEATURES	STANDARD TEXTILE GRADES												
		COM	2	3	4	5	6	7	8	9	10	11	12	
 <p><b>Recliner, Solid Wood Armcaps, Full Span</b> COM Yardage: 6.5 Freight Class: 150 Product Weight (lbs.): 110 Cubic Feet Per Carton: 22.75</p>	GC3605	\$3242	\$3453	\$3804	\$4076	\$4456	\$4604	\$4936	\$5570	\$5887	\$6471	\$7284	\$8294	
			OVERALL DIMENSIONS			SEAT DIMENSIONS			BACK DIMENSIONS					
			W	D	H	W	D	H	W	H				
			29.5	34.5	45.5	21.5	20	17	21.5	28				
		<p>Head mat &amp; loose seat cushion. Active weight 350 lbs. Urethane armcap option - <b>Add \$259 list upcharge</b></p> <p>• Not available with casters</p>												
 <p><b>Recliner, Solid Wood Armcaps, Front Only</b> COM Yardage: 6.5 Freight Class: 150 Product Weight (lbs.): 110 Cubic Feet Per Carton: 22.75</p>	GC3606	\$3075	\$3286	\$3628	\$3900	\$4282	\$4428	\$4763	\$5395	\$5711	\$6296	\$7111	\$8119	
			OVERALL DIMENSIONS			SEAT DIMENSIONS			BACK DIMENSIONS					
			W	D	H	W	D	H	W	H				
			29.5	34.5	45.5	21.5	20	17	21.5	28				
		<p>Head mat &amp; loose seat cushion. Active weight 350 lbs.</p> <p>• Not available with casters</p>												
 <p><b>Headrest for Primacare Recliners</b> COM Yardage: 1.25 Freight Class: 250 Product Weight (lbs.): 3 Cubic Feet Per Carton: 1</p>	GC3607	\$135	\$174	\$222	\$274	\$348	\$378	\$440	\$561	\$622	\$735	\$891	\$1085	
			OVERALL DIMENSIONS			SEAT DIMENSIONS			BACK DIMENSIONS					
			W	D	H	W	D	H	W	H				
			14	4	9.5									

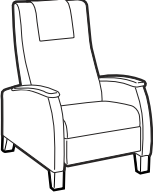
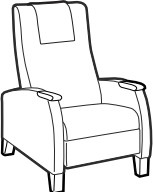
DESCRIPTION	MODEL#	STANDARD FABRIC GRADES												
		COM	2	3	4	5	6	7	8	9	10	11	12	
 <p><b>Motion Recliner, Solid Wood Armcaps, Full Span</b>                      COM Yardage: 6.5                      Freight Class: 150                      Product Weight (lbs.): 120                      Cubic Feet Per Carton: 27.75</p>	GC3608	\$3682	\$3893	\$4264	\$4535	\$4917	\$5063	\$5399	\$6029	\$6347	\$6933	\$7747	\$8753	
		OVERALL DIMENSIONS			SEAT DIMENSIONS			BACK DIMENSIONS						
		W	D	H	W	D	H	W	H					
			30	39	46.5	23.5	20	19	22.5	29				
		Active weight 400 lbs. Urethane armcap option - <b>Add \$259 list upcharge</b> Optional 4 manual locking casters w/push bar. Specify <b>(MRC)</b> - no upcharge.												
 <p><b>Motion Recliner, Solid Wood Armcaps, Front Only</b>                      COM Yardage: 6.5                      Freight Class: 150                      Product Weight (lbs.): 120                      Cubic Feet Per Carton: 27.75</p>	GC3609	\$3515	\$3726	\$4088	\$4360	\$4742	\$4885	\$5224	\$5853	\$6172	\$6757	\$7572	\$8581	
		OVERALL DIMENSIONS			SEAT DIMENSIONS			BACK DIMENSIONS						
		W	D	H	W	D	H	W	H					
			30	39	46.5	23.5	20	19	22.5	29				
		Active weight 400 lbs. Optional 4 manual locking casters w/push bar. Specify <b>(MRC)</b> - no upcharge.												

PRIMACARE SLEEPERS



model GC3611



model GC3611 (pulled out)

STANDARD FEATURES

- Primacare is a family of products offering the most significant return on investment approach in the industry since every component can be repaired or replaced on site.
- Solid hardwood frame with die cast zinc connectors and metal-to-metal fastening. Available in the following finishes: Absolute (AAM), Charcoal Java (CJM), Cherry (ACM), Empire Mahogany (EMM), English Oak (EOM), Espresso Cafe (ECM), Fruitwood (TFM), Gray (HGM), Harvest Oak (HOM), Honey (AHM), Jet Onyx (JOM), Light Honey (LHM), Mahogany (TMM), Maple (AVM), Medium Walnut (MWM), Natural Walnut (NLW), Night (ASM), Noce Biondo (NBM), Noce Grigio (NGM), Noce Leggero (NEM), Noce Medio (NMM), Sandy Beach (SBM), Shaker Cherry (SKM), Silver Oak (SOM), Walnut (TWM), White (WHM), WC Cream (WTM) and



OPTIONAL FEATURES

- Urethane armcaps are available in the following finishes: Black (BLK), Latte (LAB), Kalua (KAL), Mocha (J52), Shadow (SHW) and Toast (TOA). Please specify. Add \$259 list upcharge.
- For moisture barrier on seat, please specify (MB). Add \$193 list upcharge per seat.
- For Primacare tables, see page 56

SUGGESTED APPLICATIONS

- Guest seating
- Lounge/Waiting
- Patient rooms
- Resident rooms
- Treatment/Exam rooms

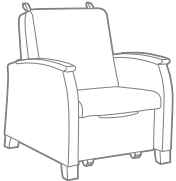
**SUSPENDED UNTIL FURTHER NOTICE**

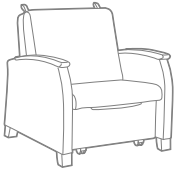
DESCRIPTION	MODEL# / FEATURES	STANDARD TEXTILE GRADES												
		COM	2	3	4	5	6	7	8	9	10	11	12	
 <p><b>Single Sleeper Chair, Wood Legs</b> COM Yardage: 7.5 Freight Class: 250 Product Weight (lbs.): 116 Cubic Feet Per Carton: 32.25</p>	<b>GC3610</b>	\$3333	\$3591	\$3986	\$4315	\$4776	\$4951	\$5358	\$6125	\$6509	\$7219	\$8204	\$9425	
		<b>OVERALL DIMENSIONS</b>			<b>SEAT DIMENSIONS</b>			<b>BACK DIMENSIONS</b>						
		W	D	H	W	D	H	W	H					
		31.5	37.5	38	24	20	18	24	21					
		Sleep surface is 24.5"W x 77"L Active weight 350 lbs. Urethane armcap option - <b>Add \$259 list upcharge</b>												
 <p><b>Single Sleeper Chair, Casters</b> COM Yardage: 7.5 Freight Class: 250 Product Weight (lbs.): 116 Cubic Feet Per Carton: 32.25</p>	<b>GC3610C</b>	\$3333	\$3591	\$3986	\$4315	\$4776	\$4951	\$5358	\$6125	\$6509	\$7219	\$8204	\$9425	
		<b>OVERALL DIMENSIONS</b>			<b>SEAT DIMENSIONS</b>			<b>BACK DIMENSIONS</b>						
		W	D	H	W	D	H	W	H					
		31.5	37.5	38	24	20	18	24	21					
		Sleep surface is 24.5"W x 77"L Active weight 350 lbs. Urethane armcap option - <b>Add \$259 list upcharge</b>												
 <p><b>Single Sleeper Chair, Wide, Wood Legs</b> COM Yardage: 9 Freight Class: 250 Product Weight (lbs.): 140 Cubic Feet Per Carton: 36.75</p>	<b>GC3611</b>	\$4058	\$4352	\$4814	\$5188	\$5721	\$5922	\$6385	\$7259	\$7698	\$8512	\$9636	\$11033	
		<b>OVERALL DIMENSIONS</b>			<b>SEAT DIMENSIONS</b>			<b>BACK DIMENSIONS</b>						
		W	D	H	W	D	H	W	H					
		37	37.5	38	30	20	18	30	21					
		Sleep surface is 30"W x 77"L Active weight 350 lbs. Urethane armcap option - <b>Add \$259 list upcharge</b>												

DESCRIPTION	MODEL#	STANDARD FABRIC GRADES											
		COM	2	3	4	5	6	7	8	9	10	11	12
 <p><b>Single Sleeper Chair, Wide, Casters</b>                      COM Yardage: 9                      Freight Class: 250                      Product Weight (lbs.): 140                      Cubic Feet Per Carton: 36.75</p>	GC3611C	\$4058	\$4352	\$4814	\$5188	\$5721	\$5922	\$6385	\$7259	\$7698	\$8512	\$9636	\$11033
		<p>Sleep surface is 30"W x 77"L                      Active weight 350 lbs.                      Urethane armcap option - <b>Add \$259 list upcharge</b>                      For users up to 350 lbs.</p>			<p><b>OVERALL DIMENSIONS</b></p> <p>W D H</p>			<p><b>SEAT DIMENSIONS</b></p> <p>W D H</p>			<p><b>BACK DIMENSIONS</b></p> <p>W H</p>		
		37	37.5	38		30	20	18		30	21		

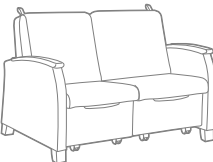
DESCRIPTION	MODEL#	STANDARD FABRIC GRADES											
		COM	2	3	4	5	6	7	8	9	10	11	12
 <p><b>Double Sleeper Chair, Wood Legs</b>                      COM Yardage: 11.75                      Freight Class: 250                      Product Weight (lbs.): 215                      Cubic Feet Per Carton: 60</p>	GC3612	\$5268	\$5653	\$6256	\$6746	\$7437	\$7699	\$8305	\$9446	\$10017	\$11079	\$12549	\$14369
		<p>Sleep surface is 49"W x 77"L                      Active weight 350 lbs./seat                      Urethane armcap option - <b>Add \$259 list upcharge</b>                      For users up to 350 lbs.</p>			<p><b>OVERALL DIMENSIONS</b></p> <p>W D H</p>			<p><b>SEAT DIMENSIONS</b></p> <p>W D H</p>			<p><b>BACK DIMENSIONS</b></p> <p>W H</p>		
		56	36	38		48	19.5	18		48	21		

**SUSPENDED UNTIL FURTHER NOTICE**

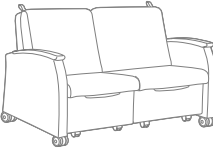
DESCRIPTION	MODEL#	STANDARD FABRIC GRADES											
		COM	2	3	4	5	6	7	8	9	10	11	12
 <p><b>Double Sleeper Chair, Casters</b>                      COM Yardage: 11.75                      Freight Class: 250                      Product Weight (lbs.): 215                      Cubic Feet Per Carton: 60</p>	GC3612C	\$5268	\$5653	\$6256	\$6746	\$7437	\$7699	\$8305	\$9446	\$10017	\$11079	\$12549	\$14369
		<p>Sleep surface is 49"W x 77"L                      Active weight 350 lbs./seat                      Urethane armcap option - <b>Add \$259 list upcharge</b>                      For users up to 350 lbs.</p>			<p><b>OVERALL DIMENSIONS</b></p> <p>W D H</p>			<p><b>SEAT DIMENSIONS</b></p> <p>W D H</p>			<p><b>BACK DIMENSIONS</b></p> <p>W H</p>		
		56	36	38		48	19.5	18		48	21		

## PRIMACARE BENCHES



model GC3651 (HT)



model GC3652W (Wood)

### STANDARD FEATURES

- Primacare is a family of products offering the most significant return on investment approach in the industry since every component can be repaired or replaced on site.
- High traffic (HT) models:** Metal frame with die cast zinc connectors and metal-to-metal fasteners. Available in the following finishes: Black (TBL), Cloud (TIV), Designer White (TDW), Fog (TFO), Frost (TFR), Kalua (TKA), Latte (TLA), Mocha (TMO), Nevada (TNE), Sand (TSN), Shadow (TSH), Toast (TOA) and Tungsten (TTU).
- Wood models:** Solid hardwood frame with die cast zinc connectors and metal-to-metal fastening. Available in the following finishes: Absolute (AAM), Charcoal Java (CJM), Cherry (ACM), Empire Mahogany (EMM), English Oak (EOM), Espresso Cafe (ECM), Fruitwood (TFM), Gray (HGM), Harvest Oak (HOM), Honey (AHM), Jet Onyx (JOM), Light Honey (LHM), Mahogany (TMM), Maple (AVM), Medium Walnut (MWM), Natural Walnut (NLW), Night (ASM), Noce Biondo (NBM), Noce Grigio (NGM), Noce Leggero (NEM), Noce Medio (NMM), Sandy Beach (SBM), Shaker Cherry (SKM), Silver Oak (SOM), Walnut (TWM), White (WHM), WC Cream (WTM) and Winter Cherry (WCM).
- Replaceable and/or removable cushions are standard.
- For healthcare textile options, visit the website at [www.globalfurnituregroup.com/healthcare](http://www.globalfurnituregroup.com/healthcare).
- Can be upholstered in standard Global textiles if healthcare compliance is not required.
- It is recommended that High Traffic (HT) models be specified in textiles that meet or exceed 100,000 double rubs for added abrasion performance.
- Shipped fully assembled.
- HIGH TRAFFIC (HT) MODELS ARE LISTED FIRST, FOLLOWED BY WOOD MODELS.**

### OPTIONAL FEATURES

- For moisture barrier on seat, please specify **(MB)**. Add \$129 per seat.
- To add sealed seams to your product contact Customer Care. Upcharges vary.
- For Primacare tables, see page 56

### SUGGESTED APPLICATIONS

- Guest seating
- Patient rooms
- Lounge/Waiting
- Resident rooms

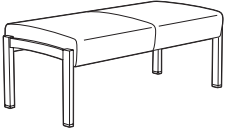
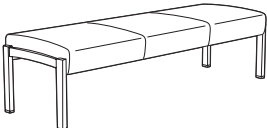
DESCRIPTION	MODEL# / FEATURES	STANDARD TEXTILE GRADES											
		COM	2	3	4	5	6	7	8	9	10	11	12
 <b>Single Seat Bench (HT)</b> COM Yardage: 1.25 Freight Class: 250 Product Weight (lbs.): 31 Cubic Feet Per Carton: 9.75	GC3651 Metal	\$1758	\$1802	\$1845	\$1901	\$1981	\$2018	\$2092	\$2207	\$2296	\$2395	\$2602	\$2818
	Active weight 350 lbs.	<b>OVERALL DIMENSIONS</b>			<b>SEAT DIMENSIONS</b>			<b>BACK DIMENSIONS</b>					
		W	D	H	W	D	H	W	H				
		26.5	22.5	19									
 <b>Two Seat Bench</b> COM Yardage: 2 Freight Class: 250 Product Weight (lbs.): 48 Cubic Feet Per Carton: 20.25	GC3652 Metal	\$2771	\$2843	\$2908	\$2999	\$3128	\$3186	\$3304	\$3487	\$3630	\$3791	\$4117	\$4465
	Active weight 350 lbs./seat	<b>OVERALL DIMENSIONS</b>			<b>SEAT DIMENSIONS</b>			<b>BACK DIMENSIONS</b>					
		W	D	H	W	D	H	W	H				
		49.5	22.5	19									
 <b>Three Seat Bench</b> COM Yardage: 2.75 Freight Class: 250 Product Weight (lbs.): 66 Cubic Feet Per Carton: 28.75	GC3653 Metal	\$3785	\$3885	\$3972	\$4097	\$4273	\$4356	\$4517	\$4770	\$4967	\$5186	\$5635	\$6114
	Active weight 350 lbs./seat	<b>OVERALL DIMENSIONS</b>			<b>SEAT DIMENSIONS</b>			<b>BACK DIMENSIONS</b>					
		W	D	H	W	D	H	W	H				
		72.5	22.5	19									

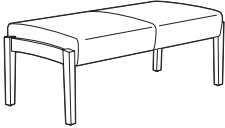
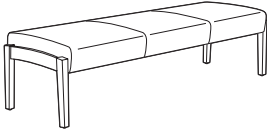
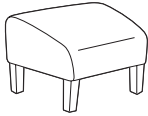
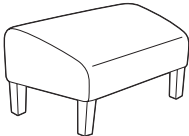

DESCRIPTION	MODEL#	STANDARD FABRIC GRADES											
		COM	2	3	4	5	6	7	8	9	10	11	12
 <p><b>Single Seat Bench (Wood)</b> COM Yardage: 1.25 Freight Class: 250 Product Weight (lbs.): 26 Cubic Feet Per Carton: 9.75</p>	<b>GC3651W</b> Wood  Active weight 350 lbs./seat	\$1512	\$1554	\$1597	\$1653	\$1733	\$1770	\$1844	\$1959	\$2048	\$2147	\$2354	\$2570
		OVERALL DIMENSIONS			SEAT DIMENSIONS			BACK DIMENSIONS					
		W	D	H	W	D	H	W	H				
			26.5	22.5	19								
 <p><b>Two Seat Bench (Wood)</b> COM Yardage: 2 Freight Class: 250 Product Weight (lbs.): 41 Cubic Feet Per Carton: 20.25</p>	<b>GC3652W</b> Wood  Active weight 350 lbs./seat	\$2417	\$2487	\$2552	\$2643	\$2772	\$2830	\$2948	\$3131	\$3274	\$3435	\$3761	\$4109
		OVERALL DIMENSIONS			SEAT DIMENSIONS			BACK DIMENSIONS					
		W	D	H	W	D	H	W	H				
			49.5	22.5	19								
 <p><b>Three Seat Bench (Wood)</b> COM Yardage: 2.75 Freight Class: 250 Product Weight (lbs.): 61 Cubic Feet Per Carton: 28.75</p>	<b>GC3653W</b> Wood  Active weight 350 lbs./seat	\$3317	\$3418	\$3505	\$3630	\$3806	\$3889	\$4050	\$4303	\$4500	\$4719	\$5168	\$5647
		OVERALL DIMENSIONS			SEAT DIMENSIONS			BACK DIMENSIONS					
		W	D	H	W	D	H	W	H				
			72.5	22.5	19								
 <p><b>Standard Size Ottoman</b> COM Yardage: 1.25 Freight Class: 250 Product weight (lbs.): 17 Cubic Feet Per Carton: 4.7</p>	<b>GC3695</b>  Active weight 350 lbs.  Standard leg is Black Urethane.  Optional Urethane colors or wood legs. No upcharge.	\$878	\$917	\$955	\$1007	\$1082	\$1116	\$1182	\$1288	\$1370	\$1461	\$1648	\$1847
		OVERALL DIMENSIONS			SEAT DIMENSIONS			BACK DIMENSIONS					
		W	D	H	W	D	H	W	H				
			23	18	15.75	-	-	-	-	-	-	-	-
 <p><b>Bariatric Ottoman</b> COM Yardage: 1.75 Freight Class: 250 Product Weight (lbs.): 20 Cubic Feet Per Carton: 9</p>	<b>GC3696</b>  Active weight 500 lbs.  Standard leg is Black Urethane.  Optional Urethane colors or wood legs. No upcharge.	\$1108	\$1166	\$1218	\$1291	\$1392	\$1442	\$1534	\$1682	\$1798	\$1925	\$2186	\$2464
		OVERALL DIMENSIONS			SEAT DIMENSIONS			BACK DIMENSIONS					
		W	D	H	W	D	H	W	H				
			31.25	18	15.75	-	-	-	-	-	-	-	-

## PRIMACARE MODULAR



## STANDARD FEATURES

- Modular seating tops: Linking applications are available for medium and high back patient top units, low back guest top units and lounge top units.
- All modular seating top units are complete with frame and cushions. Leg/arm frames are ordered separately according to the desired specification.
- Frame design features a wall saver leg to prevent damage to walls. Frame construction ensures metal-to-metal fastening.
- For leg/arm frames and modular tables with power/USB module, refer to models ending in "M". Module includes two power outlets, four USB charging ports and a 6 foot long power cord. Available in Black or White (must be specified at time of order).
- Replaceable and/or removable seat and back cushions with replaceable cushion covers are standard.
- Seat cushion has a seamless waterfall front and clean out between and around the seat and back cushions.
- All (CA) models have closed upholstered arm panel inserts at each arm position.
- For added comfort, seats are standard with high density foam.
- Active weight capacity up to 500 lbs/seat when using metal frame, fully upholstered frame or on bariatric models; up to 350 lbs/seat when using wood frame.
- For textile options, visit the website at [www.globalfurnituregroup.com](http://www.globalfurnituregroup.com).
- Can be upholstered in standard Global textiles if healthcare compliance is not required.
- Left and right position reference is determined from the seated position.

## SUGGESTED APPLICATIONS

- Bariatric seating
- Guest seating
- Lobbies
- Lounge/Waiting

## OPTIONAL FEATURES

- Urethane finishes are available on armcaps and on models with urethane legs in the following: Black (BLK), Latte (LAB), Kalua (KAL), Mocha (J52), Shadow (SHW) and Toast (TOA). Refer to individual models for availability and pricing.
- Metal leg/arm frames are available in the following finishes: Black (TBL), Cloud (TIV), Designer White (TDW), Fog (TFO), Frost (TFR), Kalua (TKA), Latte (TLA), Mocha (TMO), Nevada (TNE), Sand (TSN), Shadow (TSH), Toast (TOA) and Tungsten (TTU).
- Wood legs and armcaps available in the following finishes: Absolute (AAM), Charcoal Java (CJM), Cherry (ACM), Empire Mahogany (EMM), English Oak (EOM), Espresso Cafe (ECM), Fruitwood (TFM), Gray (HGM), Harvest Oak (HOM), Honey (AHM), Jet Onyx (JOM), Light Honey (LHM), Mahogany (TMM), Maple (AVM), Medium Walnut (MWM), Natural Walnut (NLW), Night (ASM), Noce Biondo (NBM), Noce Grigio (NGM), Noce Leggero (NEM), Noce Medio (NMM), Sandy Beach (SBM), Shaker Cherry (SKM), Silver Oak (SOM), Walnut (TWM), White (WHM), WC Cream (WTM) and Winter Cherry (WCM). Refer to individual models for availability and pricing.
- Armcaps are securely fastened with metal-to-metal connectors which allows for field replacement if required. *Armcaps cannot be retrofitted in the field on units with no existing armcaps.*
- For moisture barrier on seat, please specify (MB). Add \$129 per seat. For bariatric/lounge models, - Add \$198 per seat.
- To add sealed seams to your product contact Customer Care. Upcharges vary.

For Primacare freestanding tables, see page 56  
 For Primacare Modular tables, see page 202  
 For Primacare Modular lounge tables, see page 213

## MODULAR TABLES

Modular tables are offered with wood or metal legs. 1" thick table tops are available in thermally fused laminate (LP) and high pressure laminate (HP). Please select the appropriate model number for the finish you prefer.

**Note:** Modular tables are shipped KD (knock down) as per the published cube and weight. For Primacare freestanding tables, see page 56.

## Thermally Fused Laminate (LP)

Absolute Acajou (ACJ)	First Class (FCL)
Asian Night (ASN)	Noce Biondo (NBL)
Avant Cherry (AWC)	Noce Grigio (NGL)
Avant Honey (AWH)	Noce Leggero (NEL)
Blizzard (BZD)	Noce Medio (NML)
Brushed Cobalt (BRC)	Quartered Mahogany (QTM)
Clear Maple (CMB)	Sheer Beauty (SBY)
Custom Grey (CGY)	Stonedust (SDT)
Dark Espresso (DES)	Walnut Heights (WHE)
Designer White (DWT)	White Chocolate (WHC)
Fashionista (FAS)	Winter Cherry (WCR)

## High Pressure Laminate (HP)

Absolute Acajou (ACJ)	First Class (FCL)
Asian Night (ASN)	Noce Biondo (NBL)
Avant Cherry (W357)	Noce Grigio (NGL)
Avant Honey (W356)	Noce Leggero (NEL)
Blizzard (BZD)	Noce Medio (NML)
Brushed Cobalt (BRC)	Quartered Mahogany (QTM)
Clear Maple (CMB)	Sheer Beauty (SBY)
Custom Grey (CGY)	Stonedust (SDT)
Dark Espresso (W142)	Walnut Heights (WHE)
Designer White (DWT)	White Chocolate (WHC)
Fashionista (FAS)	Winter Cherry (WCR)

## Metal leg and frame finishes:

Available in Black (TBL), Cloud (TIV), Designer White (TDW), Fog (TFO), Frost (TFR), Kalua (TKA), Latte (TLA), Mocha (TMO), Nevada (TNE), Sand (TSN), Shadow (TSH), Toast (TOA) and Tungsten (TTU).

## SHIPPING INFORMATION:

Product components and parts will be shipped knocked down (KD). Weight and volume are indicated with each item KD. They will not be shipped assembled.

## Assembled with drawing:

Product orders that are part of a linked application may require a combination of complete units and components for build up to achieve the limitless configurations that are possible. CAD drawing must be submitted with order when requesting units ship assembled.

Global will provide assembled units under the following conditions:

1. Detailed drawing clearly indicating:
  - The layout and location of each model number being ordered (see sample following).
  - If multiple textiles are used - textile color codes must be clearly identified on drawing.
2. Global will carton assemble orders to a maximum of 3 regular seat positions, which is the largest carton available.
3. Global reserves the right to determine the best method of assembly based on the information provided with the order.

PACKAGE 1 - Primacare HT

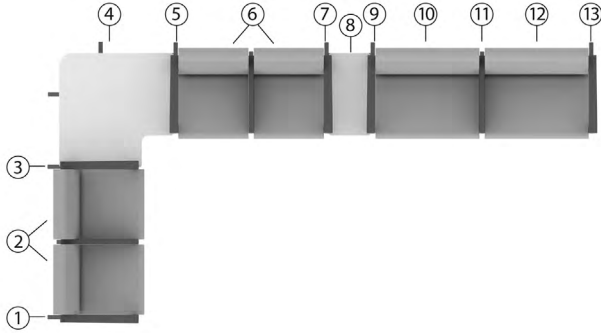

Always call out components as if seated in the chairs.

Item	Description	Qty.	Model #	Dimensions (D x W x H)	Ydg.	Frts. Class	Wt. Lbs.	Cu. Ft.	List Price	Ext. Price
1	Right End Frame with Right Armcap	1	GC3620RA	27 x 2.5 x 26.5	--	125	10	1.4	\$588	\$588
2, 6	Guest Low Back Two Seat Top w/Half Center Arm	2	GC3623TOP	25 x 42 x 19	3.25	300	68	43	\$2745	\$5490
3, 7	Seat to Table Center Linking Frame w/Left Armcap	2	GC3622TLA	27 x 2.5 x 26.5	--	125	10	1.4	\$641	\$1282
4	Right Corner Table	1	GC3671R-HP	33 x 33 x 17	--	125	45	6	\$1503	\$1503
5, 9	Seat to Table Center Linking Frame w/Right Armcap	2	GC3622TRA	27 x 2.5 x 26.5	--	125	10	1.4	\$641	\$1282
8	Narrow Center Table	1	GC3673-HP	23.87 x 12 x 5.5	--	100	18	2.1	\$821	\$821
10, 12	Bariatric Top, Guest Low Back	2	GC3637TOP	25 x 30 x 19	2.5	250	53	26.5	\$1730	\$3460
11	Seat to Seat Center Linking Frame w/Narrow Armcap	1	GC3622LA	27 x 2.5 x 26.5	--	125	10	1.4	\$656	\$656
13	Left End Frame with Left Armcap	1	GC3620LA	27 x 2.5 x 26.5	--	125	10	1.4	\$588	\$588

PACKAGE TOTAL

\$15,670

(\*Please Note: List Prices shown are for the standard Grade 2 vinyl/standard finishes.)

PACKAGE 2 - Primacare HT

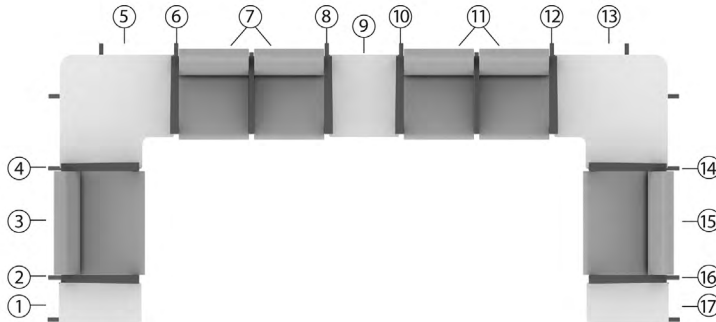

Always call out components as if seated in the chairs.

Item	Description	Qty.	Model #	Dimensions (D x W x H)	Ydg.	Frts. Class	Wt. Lbs.	Cu. Ft.	List Price	Ext. Price
1	Narrow Right End Table	1	GC3675R-HP	23.87 x 12 x 17	--	100	18	2.1	\$1227	\$1227
2, 6, 10, 14	Seat to Table Center Linking Frame w/Right Armcap	4	GC3622TRA	27 x 2.5 x 26.5	--	125	10	1.4	\$641	\$2564
3, 15	Guest Low Back Bariatric Top	2	GC3637TOP	25 x 30 x 19	2.5	250	53	26.5	\$1730	\$3460
4, 8, 12, 16	Seat to Table Center Linking Frame w/Left Armcap	4	GC3622TLA	27 x 2.5 x 26.5	--	125	10	1.4	\$641	\$2564
5	Right Corner Table	1	GC3671R-HP	33 x 33 x 17	--	125	45	6	\$1503	\$1503
7, 11	Guest Low Back Two Seat Top w/Half Center Arm	2	GC3623TOP	25 x 42 x 19	3.25	300	68	43	\$2745	\$5490
9	Regular Center Table	1	GC3672-HP	23.87 x 20.25 x 5.5	--	150	20	3.4	\$845	\$845
13	Left Corner Table	1	GC3671L-HP	33 x 33 x 17	--	100	54	6	\$1503	\$1503
17	Narrow Left End Table	1	GC3675L-HP	23.87 x 12 x 17	--	100	18	2.1	\$1227	\$1227

PACKAGE TOTAL

\$20,383

(\*Please Note: List Prices shown are for the standard Grade 2 vinyl/standard finishes.)

PACKAGE 3 - Primacare Wood

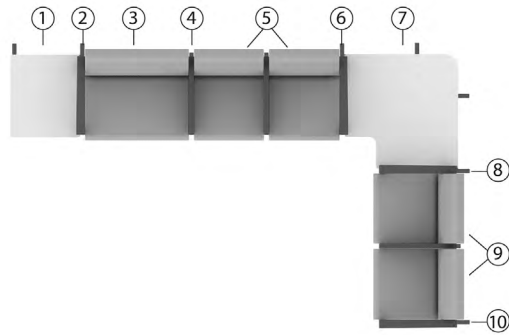

Always call out components as if seated in the chairs.

Item	Description	Qty.	Model #	Dimensions (D x W x H)	Ydg.	Frts. Class	Wt. Lbs.	Cu. Ft.	List Price	Ext. Price
1	Right End Run Table	1	GC3674WR-LP	23.87 x 20.25 x 17	--	150	19	3.4	\$1126	\$1126
2, 8	Seat to Table Center Linking Frame w/Right Armcap	2	GC3622WTRA	27 x 2.5 x 26.5	--	150	8	1.4	\$472	\$944
3	Guest Low Back Bariatric Top	1	GC3637TOP	25 x 30 x 19	2.5	250	53	26.5	\$1730	\$1730
4	Seat to Seat Center Linking Frame w/Narrow Armcap	1	GC3622WLA	27 x 2.5 x 26.5	--	150	8	1.4	\$436	\$436
5, 9	Guest Low Back Two Seat Top w/Half Center Arm	2	GC3623WTOP	25 x 42 x 19	3.25	300	68	43	\$2441	\$4882
6	Seat to Table Center Linking Frame w/Left Armcap	1	GC3622WTLA	27 x 2.5 x 26.5	--	150	8	1.4	\$472	\$472
7	Left Corner Table	1	GC3671WL-HP	33 x 33 x 17	--	100	54	6	\$1423	\$1423
10	Left End Frame w/Left Armcap	1	GC3620WLA	23 x 2 x 26	--	125	10	1.4	\$421	\$421

**PACKAGE TOTAL**

**\$11,434**

(\*Please Note: List Prices shown are for the standard Grade 2 vinyl/standard finishes.)

MODULAR TOP UNITS	SINGLE SEAT BARIATRIC		SINGLE SEAT BARIATRIC		TWO SEATER, NO CENTER ARM	TWO SEATER, CENTER ARM	THREE SEATER, NO CENTER ARMS	THREE SEATER, TWO ARMS		
	medium back	high back	medium back	high back	medium back	medium back	high back	medium back	high back	
<b>Guest seating</b>	GC3620TOP 	GC3637TOP 	GC3655TOP 	GC3656TOP 	GC3621TOP 	GC3623TOP GC3623WVTOP 	GC3623HB-TOP GC3623WHB-TOP 	GC3624TOP 	GC3626TOP GC3626WVTOP 	GC3626HB-TOP GC3626WHB-TOP 
<b>Patient seating</b>	GC3631TOP 	GC3638TOP 	GC3655TOP 	GC3656TOP 		GC3623CATOP GC3623WCATOP 	GC3623HBCA-TOP GC3623WHBCA-TOP 		GC3626CATOP GC3626WCATOP 	GC3626HBCA-TOP GC3626WHBCA-TOP 

LEG / ARM FRAMES	Wood frame: Must select armcap Metal frame: Standard with Black SSU armcap (see notes for wood and SSU finish options)										
	LEFT, OPEN		RIGHT, OPEN		LEFT, CLOSED		RIGHT, CLOSED		LEFT, CLOSED LAMINATE PANEL	RIGHT, CLOSED LAMINATE PANEL	
<b>Metal (HT) End</b>	GC3620LA 	GC3620LAM 	GC3620RA 	GC3620RAM 	GC3620LCA 	GC3620LCAM 	GC3620RCA 	GC3620RCAM 	GC3620LCAL 	GC3620RCAL 	
<b>Wood End</b>	GC3620WLA 	GC3620WLAM 	GC3620WRA 	GC3620WRAM 	GC3620WLCA 	GC3620WLCAM 	GC3620WRCA 	GC3620WRCAM 			
<b>Metal (HT) Center</b>	GC3622LA 				GC3622LCA 				GC3622LCAL 		
<b>Wood Center</b>	GC3622WLA 				GC3622WLCA 						
<b>Metal (HT) Center table linking</b>	GC3622TLA 		GC3622TRA 		GC3622TLCA 		GC3622TRCA 		GC3622TLCAL 		GC3622TRCAL 
<b>Wood Center table linking</b>	GC3622WTLA 		GC3622WTRA 		GC3622WTLCA 		GC3622WTRCA 				

For frame with power/USB module\*, refer to models ending in "M"

End Frame: Armless

Metal End	LEFT	RIGHT
	GC3620LNA 	GC3620RNA 
Wood End	GC3620WLNA 	GC3620WRNA 

Central Linking Frame: Armless

Metal	CENTER
GC3622LNA 	
Wood	GC3622WLNA 

(Center = link both sides)

\*Power module includes two power outlets, four USB charging ports and a 6 foot long power cord. Available in Black or White (must be specified at time of order). Power module is mounted on the frame below seat support rail.

MODULAR TABLES

Tables include legs to support table top (except for center tables). All tables have a metal frame.

**Corner**  
(laminated top with metal legs)

LEFT

GC3671L-HP  
GC3671L-LP



GC3671LM-HP  
GC3671LM-LP



RIGHT

GC3671R-HP  
GC3671R-LP



GC3671RM-HP  
GC3671RM-LP



**Corner**  
(laminated top with wood legs)

GC3671WL-HP  
GC3671WL-LP



GC3671WLM-HP  
GC3671WLM-LP



GC3671WR-HP  
GC3671WR-LP



GC3671WRM-HP  
GC3671WRM-LP



**Center**  
(laminated top, connects to metal or wood frame)

GC3672-HP  
GC3672-LP



GC3672M-HP  
GC3672M-LP



**Narrow Center**  
(laminated top, connects to metal or wood frame)

GC3673-HP  
GC3673-LP



GC3673M-HP  
GC3673M-LP



For table with power/USB module\*, refer to models ending in "M"

**End**  
(laminated top with metal legs)

GC3674L-HP  
GC3674L-LP



GC3674LM-HP  
GC3674LM-LP



GC3674R-HP  
GC3674R-LP



GC3674RM-HP  
GC3674RM-LP



**End**  
(laminated top with wood legs)

GC3674WL-HP  
GC3674WL-LP



GC3674WLM-HP  
GC3674WLM-LP



GC3674WR-HP  
GC3674WR-LP



GC3674WRM-HP  
GC3674WRM-LP



**Narrow End**  
(laminated top with metal legs)

GC3675L-HP  
GC3675L-LP

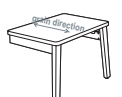

GC3675LM-HP  
GC3675LM-LP



GC3675R-HP  
GC3675R-LP



GC3675RM-HP  
GC3675RM-LP



**Narrow End**  
(laminated top with wood legs)

GC3675WL-HP  
GC3675WL-LP

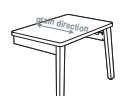

GC3675WLM-HP  
GC3675WLM-LP



GC3675WR-HP  
GC3675WR-LP



GC3675WRM-HP  
GC3675WRM-LP



\*Power module includes two power outlets, four USB charging ports and a 6 foot long power cord. Available in Black or White (must be specified at time of order). Power module is mounted on surface on narrow tables; mounted in surface on larger tables (as shown above).

DESCRIPTION	MODEL#	STANDARD FABRIC GRADES																						
		COM	2	3	4	5	6	7	8	9	10	11	12											
 <b>LB Guest Single Seat Top</b> COM Yardage: 1.75 Freight Class: 250 Product Weight (lbs.): 36 Cubic Feet Per Carton: 10	<b>GC3620TOP</b>	\$1029	\$1087	\$1139	\$1212	\$1315	\$1353	\$1445	\$1617	\$1701	\$1860	\$2078	\$2347											
	<table border="1"> <thead> <tr> <th colspan="3">OVERALL DIMENSIONS</th> <th colspan="3">SEAT DIMENSIONS</th> <th colspan="2">BACK DIMENSIONS</th> </tr> <tr> <th>W</th> <th>D</th> <th>H</th> <th>W</th> <th>D</th> <th>H</th> <th>W</th> <th>H</th> </tr> </thead> <tbody> <tr> <td>20.5</td> <td>25</td> <td>19</td> <td>20.5</td> <td>17.5</td> <td>--</td> <td>20.5</td> <td>15</td> </tr> </tbody> </table> <p>Single frame guest top unit with 1 low back cushion and 1 seat cushion.  <b>Must be connected to a full arm/leg frame.</b></p>	OVERALL DIMENSIONS			SEAT DIMENSIONS			BACK DIMENSIONS		W	D	H	W	D	H	W	H	20.5	25	19	20.5	17.5	--	20.5
OVERALL DIMENSIONS			SEAT DIMENSIONS			BACK DIMENSIONS																		
W	D	H	W	D	H	W	H																	
20.5	25	19	20.5	17.5	--	20.5	15																	

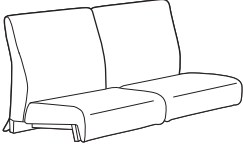
 <b>LB Guest Two Seat Top, No Center Arm</b> COM Yardage: 3.25 Freight Class: 300 Product Weight (lbs.): 72 Cubic Feet Per Carton: 43	<b>GC3621TOP</b>	\$2281	\$2391	\$2485	\$2623	\$2813	\$2885	\$3054	\$3369	\$3525	\$3819	\$4229	\$4732											
	<table border="1"> <thead> <tr> <th colspan="3">OVERALL DIMENSIONS</th> <th colspan="3">SEAT DIMENSIONS</th> <th colspan="2">BACK DIMENSIONS</th> </tr> <tr> <th>W</th> <th>D</th> <th>H</th> <th>W</th> <th>D</th> <th>H</th> <th>W</th> <th>H</th> </tr> </thead> <tbody> <tr> <td>40</td> <td>25</td> <td>19</td> <td>40</td> <td>17.5</td> <td>--</td> <td>40</td> <td>15</td> </tr> </tbody> </table> <p>Double frame guest top unit with 2 low back cushions and 2 seat cushions.  <b>Must be connected to a full arm/leg frame.</b></p>	OVERALL DIMENSIONS			SEAT DIMENSIONS			BACK DIMENSIONS		W	D	H	W	D	H	W	H	40	25	19	40	17.5	--	40
OVERALL DIMENSIONS			SEAT DIMENSIONS			BACK DIMENSIONS																		
W	D	H	W	D	H	W	H																	
40	25	19	40	17.5	--	40	15																	

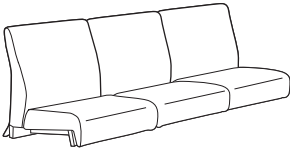
 <b>LB Guest Three Seat Top, No Center Arm</b> COM Yardage: 4.25 Freight Class: 300 Product Weight (lbs.): 82 Cubic Feet Per Carton: 65.25	<b>GC3624TOP</b>	\$3471	\$3615	\$3734	\$3911	\$4162	\$4257	\$4476	\$4888	\$5096	\$5480	\$6013	\$6670											
	<table border="1"> <thead> <tr> <th colspan="3">OVERALL DIMENSIONS</th> <th colspan="3">SEAT DIMENSIONS</th> <th colspan="2">BACK DIMENSIONS</th> </tr> <tr> <th>W</th> <th>D</th> <th>H</th> <th>W</th> <th>D</th> <th>H</th> <th>W</th> <th>H</th> </tr> </thead> <tbody> <tr> <td>60</td> <td>25</td> <td>19</td> <td>60</td> <td>17.5</td> <td>--</td> <td>60</td> <td>15</td> </tr> </tbody> </table> <p>Triple frame guest top unit with 3 low back cushions and 3 seat cushions.  <b>Must be connected to a full arm/leg frame.</b></p>	OVERALL DIMENSIONS			SEAT DIMENSIONS			BACK DIMENSIONS		W	D	H	W	D	H	W	H	60	25	19	60	17.5	--	60
OVERALL DIMENSIONS			SEAT DIMENSIONS			BACK DIMENSIONS																		
W	D	H	W	D	H	W	H																	
60	25	19	60	17.5	--	60	15																	

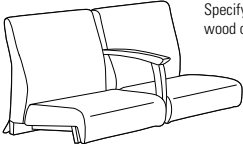

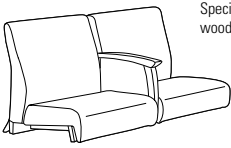
 Specify armcap: wood or Urethane.	<b>GC3623TOP</b>	\$2634	\$2745	\$2838	\$2977	\$3167	\$3239	\$3408	\$3723	\$3879	\$4173	\$4583	\$5086											
	<b>GC3623WTOP</b>	\$2330	\$2441	\$2533	\$2673	\$2863	\$2935	\$3104	\$3419	\$3575	\$3868	\$4277	\$4779											
	<table border="1"> <thead> <tr> <th colspan="3">OVERALL DIMENSIONS</th> <th colspan="3">SEAT DIMENSIONS</th> <th colspan="2">BACK DIMENSIONS</th> </tr> <tr> <th>W</th> <th>D</th> <th>H</th> <th>W</th> <th>D</th> <th>H</th> <th>W</th> <th>H</th> </tr> </thead> <tbody> <tr> <td>42</td> <td>25</td> <td>19</td> <td>20.5</td> <td>17.5</td> <td>--</td> <td>20.5</td> <td>15</td> </tr> </tbody> </table> <p>Double low back frame guest top, 2 back and 2 seat cushions.                      Urethane armcap option - <b>Add \$53 list upcharge</b>  <b>Must be connected to a full arm/leg frame.</b></p>	OVERALL DIMENSIONS			SEAT DIMENSIONS			BACK DIMENSIONS		W	D	H	W	D	H	W	H	42	25	19	20.5	17.5	--	20.5
OVERALL DIMENSIONS			SEAT DIMENSIONS			BACK DIMENSIONS																		
W	D	H	W	D	H	W	H																	
42	25	19	20.5	17.5	--	20.5	15																	

 Specify armcap: wood or Urethane.	<b>GC3623CATOP</b>	\$2777	\$2896	\$2998	\$3142	\$3349	\$3428	\$3609	\$3948	\$4119	\$4434	\$4873	\$5413											
	<b>GC3623WCATOP</b>	\$2451	\$2570	\$2670	\$2816	\$3023	\$3102	\$3283	\$3622	\$3793	\$4107	\$4545	\$5086											
	<table border="1"> <thead> <tr> <th colspan="3">OVERALL DIMENSIONS</th> <th colspan="3">SEAT DIMENSIONS</th> <th colspan="2">BACK DIMENSIONS</th> </tr> <tr> <th>W</th> <th>D</th> <th>H</th> <th>W</th> <th>D</th> <th>H</th> <th>W</th> <th>H</th> </tr> </thead> <tbody> <tr> <td>42</td> <td>25</td> <td>19</td> <td>20.5</td> <td>17.5</td> <td>--</td> <td>20.5</td> <td>15</td> </tr> </tbody> </table> <p>Double low back frame guest top, 2 back and 2 seat cushions.                      Urethane armcap option - <b>Add \$53 list upcharge</b>  <b>Must be connected to a full arm/leg frame.</b></p>	OVERALL DIMENSIONS			SEAT DIMENSIONS			BACK DIMENSIONS		W	D	H	W	D	H	W	H	42	25	19	20.5	17.5	--	20.5
OVERALL DIMENSIONS			SEAT DIMENSIONS			BACK DIMENSIONS																		
W	D	H	W	D	H	W	H																	
42	25	19	20.5	17.5	--	20.5	15																	

# SEATING

# PRIMACARE™ MODULAR - GUEST/PATIENT

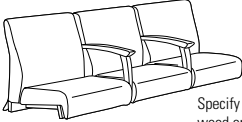
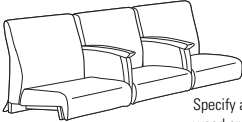
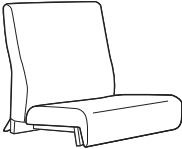
P

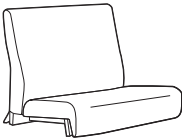
DESCRIPTION	MODEL#	STANDARD FABRIC GRADES												
		COM	2	3	4	5	6	7	8	9	10	11	12	
 <p>Specify armcap: wood or Urethane.</p> <p><b>LB Guest Three Seat Top, Open Center Arms</b> COM Yardage: 4.75 Freight Class: 300 Product Weight (lbs.): 77 Cubic Feet Per Carton: 65.25</p>		COM	2	3	4	5	6	7	8	9	10	11	12	
	<p><b>GC3626TOP</b> Metal</p> <p><b>GC3626WTOP</b> Wood</p>	\$4181	\$4343	\$4478	\$4678	\$4957	\$5063	\$5307	\$5769	\$5999	\$6429	\$7025	\$7762	\$7192
		OVERALL DIMENSIONS			SEAT DIMENSIONS			BACK DIMENSIONS						
		W	D	H	W	D	H	W	H					
		64	25	19	20.5	17.5	--	20.5	15					
		Triple low back frame guest top, 3 back and 3 seat cushions. Due to the size and weight, this top requires at least 3 installers. Urethane armcap option - <b>Add \$104 list upcharge</b> <b>Must be connected to a full arm/leg frame.</b>												
 <p>Specify armcap: wood or Urethane.</p> <p><b>LB Guest Three Seat Top, Closed Center Arms</b> COM Yardage: 5.5 Freight Class: 300 Product Weight (lbs.): 83 Cubic Feet Per Carton: 65.25</p>		COM	2	3	4	5	6	7	8	9	10	11	12	
	<p><b>GC3626CATOP</b> Metal</p> <p><b>GC3626WCATOP</b> Wood</p>	\$4463	\$4652	\$4810	\$5039	\$5363	\$5484	\$5770	\$6303	\$6571	\$7066	\$7756	\$8607	\$7986
		OVERALL DIMENSIONS			SEAT DIMENSIONS			BACK DIMENSIONS						
		W	D	H	W	D	H	W	H					
		64	25	19	20.5	17.5	--	20.5	15					
		Triple low back frame guest top, 3 back and 3 seat cushions. Due to the size and weight, this top requires at least 3 installers. Urethane armcap option - <b>Add \$104 list upcharge</b> <b>Must be connected to a full arm/leg frame.</b>												
 <p><b>MB Patient Top</b> COM Yardage: 1.75 Freight Class: 150 Product Weight (lbs.): 42 Cubic Feet Per Carton: 10</p>		COM	2	3	4	5	6	7	8	9	10	11	12	
	<p><b>GC3631TOP</b></p>	\$1086	\$1144	\$1196	\$1269	\$1372	\$1410	\$1502	\$1674	\$1758	\$1917	\$2135	\$2404	
		OVERALL DIMENSIONS			SEAT DIMENSIONS			BACK DIMENSIONS						
		W	D	H	W	D	H	W	H					
		20.5	25	22	20.5	17.5	--	20.5	18					
		Single mid back frame patient top, with 1 back and 1 seat cushion. <b>Must be connected to a full arm/leg frame.</b>												
 <p><b>LB Bariatric Guest Top</b> COM Yardage: 2.5 Freight Class: 250 Product Weight (lbs.): 53 Cubic Feet Per Carton: 26.5</p>		COM	2	3	4	5	6	7	8	9	10	11	12	
	<p><b>GC3637TOP</b></p>	\$1646	\$1730	\$1803	\$1909	\$2054	\$2112	\$2240	\$2483	\$2604	\$2830	\$3144	\$3531	
		OVERALL DIMENSIONS			SEAT DIMENSIONS			BACK DIMENSIONS						
		W	D	H	W	D	H	W	H					
		30	25	19	30	17.5	--	30	15					
		Single low back frame bariatric guest top, with 1 back and 1 seat cushion. <b>Must be connected to a full arm/leg frame.</b>												
 <p><b>MB Bariatric Patient Top</b> COM Yardage: 2.75 Freight Class: 250 Product Weight (lbs.): 62 Cubic Feet Per Carton: 30.5</p>		COM	2	3	4	5	6	7	8	9	10	11	12	
	<p><b>GC3638TOP</b></p>	\$1755	\$1847	\$1927	\$2043	\$2204	\$2264	\$2408	\$2676	\$2809	\$3056	\$3403	\$3826	
		OVERALL DIMENSIONS			SEAT DIMENSIONS			BACK DIMENSIONS						
		W	D	H	W	D	H	W	H					
		30	25	22	30	17.5	--	30	18					
		Single mid back frame bariatric patient top, with 1 back and 1 seat cushion. <b>Must be connected to a full arm/leg frame.</b>												



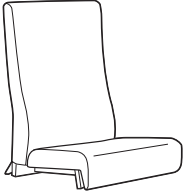

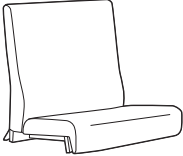
DESCRIPTION	MODEL#	STANDARD FABRIC GRADES											
		COM	2	3	4	5	6	7	8	9	10	11	12
 <p><b>HB Patient Top</b> COM Yardage: 2.5 Freight Class: 250 Product Weight (lbs.): 52 Cubic Feet Per Carton: 13.25</p>	<b>GC3655TOP</b>	\$1174	\$1259	\$1332	\$1437	\$1583	\$1641	\$1769	\$2012	\$2133	\$2359	\$2673	\$3060
	<b>OVERALL DIMENSIONS</b>			<b>SEAT DIMENSIONS</b>			<b>BACK DIMENSIONS</b>						
	<b>W</b>	<b>D</b>	<b>H</b>	<b>W</b>	<b>D</b>	<b>H</b>	<b>W</b>	<b>H</b>					
	20.5	25	34	20.5	17.5	--	20.5	30					
<p>Single high back frame patient top with 1 back and 1 seat cushion.</p> <p><b>Must be connected to a full arm/leg frame.</b></p>													

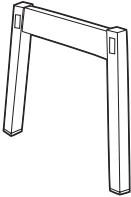
DESCRIPTION	MODEL#	STANDARD FABRIC GRADES											
		COM	2	3	4	5	6	7	8	9	10	11	12
 <p><b>HB Bariatric Patient Top</b> COM Yardage: 3.5 Freight Class: 300 Product Weight (lbs.): 62 Cubic Feet Per Carton: 33</p>	<b>GC3656TOP</b>	\$1841	\$1960	\$2062	\$2206	\$2413	\$2492	\$2673	\$3012	\$3183	\$3498	\$3937	\$4477
	<b>OVERALL DIMENSIONS</b>			<b>SEAT DIMENSIONS</b>			<b>BACK DIMENSIONS</b>						
	<b>W</b>	<b>D</b>	<b>H</b>	<b>W</b>	<b>D</b>	<b>H</b>	<b>W</b>	<b>H</b>					
	30	25	34	30	17.5	--	30	30					
<p>Single high back frame bariatric patient top with 1 back and 1 seat cushion.</p> <p><b>Must be connected to a full arm/leg frame.</b></p>													

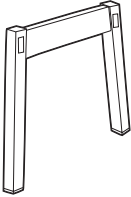
DESCRIPTION	MODEL#	STANDARD FABRIC GRADES											
		COM	2	3	4	5	6	7	8	9	10	11	12
 <p><b>Left End Frame, Armless</b> COM Yardage: -- Freight Class: 150 Product Weight (lbs.): 5 Cubic Feet Per Carton: 1.2</p>		List Price											
	<b>GC3620LNA</b>		\$489										
	Metal												
	<b>GC3620WLN</b>		\$261										
Wood													
<b>OVERALL DIMENSIONS</b>			<b>SEAT DIMENSIONS</b>			<b>BACK DIMENSIONS</b>							
<b>W</b>	<b>D</b>	<b>H</b>	<b>W</b>	<b>D</b>	<b>H</b>	<b>W</b>	<b>H</b>						
	1.25	24.25	16										
<p>For use in <b>left</b> side finished position of guest and/or patient seating units.</p> <p><b>Does not allow linking to other units or tables.</b></p>													

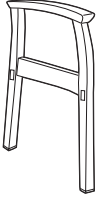
DESCRIPTION	MODEL#	STANDARD FABRIC GRADES											
		COM	2	3	4	5	6	7	8	9	10	11	12
 <p><b>Right End Frame, Armless</b> COM Yardage: -- Freight Class: 150 Product Weight (lbs.): 5 Cubic Feet Per Carton: 1.2</p>		List Price											
	<b>GC3620RNA</b>		\$489										
	Metal												
	<b>GC3620WRNA</b>		\$261										
Wood													
<b>OVERALL DIMENSIONS</b>			<b>SEAT DIMENSIONS</b>			<b>BACK DIMENSIONS</b>							
<b>W</b>	<b>D</b>	<b>H</b>	<b>W</b>	<b>D</b>	<b>H</b>	<b>W</b>	<b>H</b>						
	1.25	24.25	16										
<p>For use in <b>right</b> side finished position of guest and/or patient seating units.</p> <p><b>Does not allow linking to other units or tables.</b></p>													

DESCRIPTION	MODEL#	STANDARD FABRIC GRADES												
		COM	2	3	4	5	6	7	8	9	10	11	12	
 <p><b>Left End Frame, Open Arm</b> COM Yardage: -- Freight Class: 125 Product Weight (lbs.): 10 Cubic Feet Per Carton: 1.4</p>		List Price												
	<b>GC3620LA</b>		\$588											
	<b>GC3620LAM</b> (w/power)		\$1903											
	<b>GC3620WLA</b>		\$421											
<b>GC3620WLAM</b> (w/power)		\$1706												
Specify armcap: wood or Urethane.			<b>OVERALL DIMENSIONS</b>			<b>SEAT DIMENSIONS</b>			<b>BACK DIMENSIONS</b>					
<b>W</b>	<b>D</b>	<b>H</b>	<b>W</b>	<b>D</b>	<b>H</b>	<b>W</b>	<b>H</b>							
	2.5	27	26.5											
<p>For use in <b>left</b> side finished position of guest and/or patient seating units.</p> <p>• Models GC3620LAM and GC3620WLAM have <b>power/USB</b> module (not shown).</p> <p><b>Does not allow linking to other units or tables.</b></p> <p>Urethane armcap option - <b>Add \$53 list upcharge</b></p>														

DESCRIPTION	MODEL#	STANDARD FABRIC GRADES								
 <p><b>Right End Frame, Open Arm</b> COM Yardage: -- Freight Class: 125 Product Weight (lbs.): 10 Cubic Feet Per Carton: 1.4</p>		List Price								
	GC3620RA (Metal)	\$588								
	GC3620RAM (w/power)	\$1903								
	GC3620WRA (Wood)	\$421								
	GC3620WRAM (w/power)	\$1706								
Specify armcap: wood or Urethane.		OVERALL DIMENSIONS			SEAT DIMENSIONS			BACK DIMENSIONS		
		W	D	H	W	D	H	W	H	
		2.5	27	26.5						
		For use in <b>right</b> side finished position of guest and/or patient seating units.								
		• Models GC3620RAM and GC3620WRAM have <b>power/USB</b> module (not shown).								
		<b>Does not allow linking to other units or tables.</b>								
		Urethane armcap option - <b>Add \$53 list upcharge</b>								

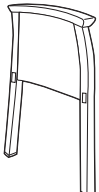
 <p><b>Left End Frame, Closed Arm</b> COM Yardage: 0.65 Freight Class: 92.5 Product Weight (lbs.): 15 Cubic Feet Per Carton: 1.4</p>	COM	2	3	4	5	6	7	8	9	10	11	12	
	GC3620LCA (Metal)	\$724	\$745	\$766	\$793	\$831	\$847	\$877	\$943	\$973	\$1034	\$1116	\$1116
	GC3620LCAM (w/power)	\$2062	\$2082	\$2103	\$2130	\$2169	\$2186	\$2222	\$2278	\$2319	\$2367	\$2464	\$2568
	GC3620WLCA (Wood)	\$528	\$548	\$571	\$596	\$636	\$652	\$683	\$747	\$780	\$838	\$919	\$1019
	GC3620WLCAM (w/power)	\$1835	\$1855	\$1878	\$1903	\$1942	\$1960	\$1997	\$2052	\$2093	\$2140	\$2240	\$2345
Specify armcap: wood or Urethane.		OVERALL DIMENSIONS			SEAT DIMENSIONS			BACK DIMENSIONS					
		W	D	H	W	D	H	W	H				
		2.5	27	26.5									
		For use in <b>left</b> side finished position of guest and/or patient seating units.											
		• Models GC3620LCAM and GC3620WLCAM have <b>power/USB</b> module (not shown).											
		<b>Does not allow linking to other units or tables.</b>											
		Urethane armcap option - <b>Add \$53 list upcharge</b>											

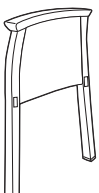
 <p><b>Right End Frame, Closed Arm</b> COM Yardage: 0.65 Freight Class: 92.5 Product Weight (lbs.): 15 Cubic Feet Per Carton: 1.4</p>	COM	2	3	4	5	6	7	8	9	10	11	12	
	GC3620RCA (metal)	\$724	\$745	\$768	\$793	\$832	\$848	\$878	\$944	\$973	\$1035	\$1116	\$1216
	GC3620RCAM (w/power)	\$2062	\$2082	\$2103	\$2130	\$2169	\$2186	\$2222	\$2278	\$2319	\$2367	\$2464	\$2568
	GC3620WRCA (wood)	\$528	\$548	\$571	\$596	\$636	\$652	\$683	\$747	\$780	\$838	\$919	\$1019
	GC3620WRCAM (w/power)	\$1835	\$1855	\$1878	\$1903	\$1942	\$1960	\$1997	\$2052	\$2093	\$2140	\$2240	\$2345
Specify armcap: wood or Urethane.		OVERALL DIMENSIONS			SEAT DIMENSIONS			BACK DIMENSIONS					
		W	D	H	W	D	H	W	H				
		2.5	27	26.5									
		For use in <b>right</b> side finished position of guest and/or patient seating units.											
		• Models GC3620RCAM and GC3620WRCAM have <b>power/USB</b> module (not shown).											
		<b>Does not allow linking to other units or tables.</b>											
		Urethane armcap option - <b>Add \$53 list upcharge</b>											

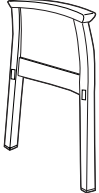
 <p><b>Left End Frame, Closed Arm, Laminate Panel</b> COM Yardage: -- Freight Class: 85 Product Weight (lbs.): 18 Cubic Feet Per Carton: 1.4</p>		List Price									
	GC3620LCAL	\$956									
	Metal										
	Specify armcap: wood or Urethane.		OVERALL DIMENSIONS			SEAT DIMENSIONS			BACK DIMENSIONS		
			W	D	H	W	D	H	W	H	
		2.5	27	26.5							
		For use in <b>left</b> side finished position of guest and/or patient seating units.									
		<b>Does not allow linking to other units or tables.</b>									
		Urethane armcap option - <b>Add \$53 list upcharge</b>									

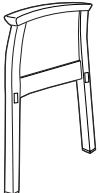
 <p><b>Right End Frame, Closed Arm, Laminate Panel</b> COM Yardage: -- Freight Class: 85 Product Weight (lbs.): 18 Cubic Feet Per Carton: 1.4</p>		List Price									
	GC3620RCAL	\$956									
	Metal										
	Specify armcap: wood or Urethane.		OVERALL DIMENSIONS			SEAT DIMENSIONS			BACK DIMENSIONS		
			W	D	H	W	D	H	W	H	
		2.5	27	26.5							
		For use in <b>right</b> side finished position of guest and/or patient seating units.									
		<b>Does not allow linking to other units or tables.</b>									
		Urethane armcap option - <b>Add \$53 list upcharge</b>									

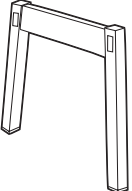
DESCRIPTION	MODEL#	STANDARD FABRIC GRADES									
		List Price									
	<b>GC3622LNA</b>	<b>\$507</b>									
	Metal										
	<b>GC3622WLNA</b>	<b>\$279</b>									
	Wood										
		OVERALL DIMENSIONS			SEAT DIMENSIONS			BACK DIMENSIONS			
		W	D	H	W	D	H	W	H		
		1.25	24.25	16							

**Seat to Seat Central Linking Frame, Armless**  
 COM Yardage: --  
 Freight Class: 150  
 Product Weight (lbs.): Metal: 5 / Wood: 4  
 Cubic Feet Per Carton: 1.2

For **linking** guest and/or patient top seating units.

**Does not allow linking to other units or tables.**

DESCRIPTION	MODEL#	STANDARD FABRIC GRADES									
		List Price									
	<b>GC3622LA</b>	<b>\$656</b>									
	Metal										
	<b>GC3622WLA</b>	<b>\$436</b>									
	Wood										
		OVERALL DIMENSIONS			SEAT DIMENSIONS			BACK DIMENSIONS			
		W	D	H	W	D	H	W	H		
		2.5	27	26.5							

**Center Frame, Open Arm**  
 COM Yardage: --  
 Freight Class: 125  
 Product Weight (lbs.) Metal: 10 / Wood: 8  
 Cubic Feet Per Carton: 1.4

For **linking** guest and/or patient top seating units.

Urethane armcap option - **Add \$53 list upcharge**

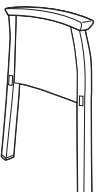
DESCRIPTION	MODEL#	STANDARD FABRIC GRADES											
		COM	2	3	4	5	6	7	8	9	10	11	12
	<b>GC3622LCA</b>	<b>\$740</b>	<b>\$760</b>	<b>\$781</b>	<b>\$808</b>	<b>\$847</b>	<b>\$863</b>	<b>\$893</b>	<b>\$959</b>	<b>\$988</b>	<b>\$1049</b>	<b>\$1129</b>	<b>\$1230</b>
	Metal												
	<b>GC3622WLCA</b>	<b>\$543</b>	<b>\$563</b>	<b>\$586</b>	<b>\$611</b>	<b>\$651</b>	<b>\$666</b>	<b>\$696</b>	<b>\$762</b>	<b>\$791</b>	<b>\$853</b>	<b>\$932</b>	<b>\$1034</b>
	Wood												
		OVERALL DIMENSIONS			SEAT DIMENSIONS			BACK DIMENSIONS					
		W	D	H	W	D	H	W	H				
		2.5	27	26.5									

**Center Frame, Closed Arm**  
 COM Yardage: 0.65  
 Freight Class: 92.5  
 Product Weight (lbs.) Metal: 15 / Wood: 10  
 Cubic Feet Per Carton: 1.4

For **linking** guest and/or patient top seating units.

Urethane armcap option - **Add \$53 list upcharge**

DESCRIPTION	MODEL#	STANDARD FABRIC GRADES									
		List Price									
	<b>GC3622TLA</b>	<b>\$641</b>									
	Metal										
	<b>GC3622WTLA</b>	<b>\$472</b>									
	Wood										
		OVERALL DIMENSIONS			SEAT DIMENSIONS			BACK DIMENSIONS			
		W	D	H	W	D	H	W	H		
		2.5	27	26.5							

**Center Frame, Open Arm**  
 COM Yardage: --  
 Freight Class: 125  
 Product Weight (lbs.) Metal: 10 / Wood: 8  
 Cubic Feet Per Carton: 1.4

For **linking** guest and/or patient top seating units to modular table on the **left** side of the frame.

Urethane armcap option - **Add \$53 list upcharge**

DESCRIPTION	MODEL#	STANDARD FABRIC GRADES									
		List Price									
	<b>GC3622TRA</b>	<b>\$641</b>									
	Metal										
	<b>GC3622WTRA</b>	<b>\$472</b>									
	Wood										
		OVERALL DIMENSIONS			SEAT DIMENSIONS			BACK DIMENSIONS			
		W	D	H	W	D	H	W	H		
		2.5	27	26.5							

**Center Frame, Open Arm**  
 COM Yardage: --  
 Freight Class: 125  
 Product Weight (lbs.) Metal: 10 / Wood: 8  
 Cubic Feet Per Carton: 1.4





For **linking** guest and/or patient top seating units to modular table on the **right** side of the frame.

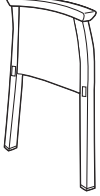
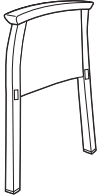

Urethane armcap option - **Add \$53 list upcharge**

# SEATING

# PRIMACARE™ MODULAR - GUEST/PATIENT

DESCRIPTION	MODEL#	STANDARD FABRIC GRADES											
		COM	2	3	4	5	6	7	8	9	10	11	12
 <p><b>GC3622TLCA</b> Metal</p> <p><b>GC3622WTLCA</b> Wood</p> <p>Specify armcap: wood or Urethane.</p>	<b>\$773</b>	<b>\$794</b>	<b>\$817</b>	<b>\$842</b>	<b>\$881</b>	<b>\$897</b>	<b>\$927</b>	<b>\$993</b>	<b>\$1022</b>	<b>\$1084</b>	<b>\$1165</b>	<b>\$1265</b>	
	<b>\$578</b>	<b>\$598</b>	<b>\$621</b>	<b>\$646</b>	<b>\$685</b>	<b>\$701</b>	<b>\$733</b>	<b>\$797</b>	<b>\$830</b>	<b>\$888</b>	<b>\$969</b>	<b>\$1069</b>	
		<b>OVERALL DIMENSIONS</b>			<b>SEAT DIMENSIONS</b>			<b>BACK DIMENSIONS</b>					
		<b>W</b>	<b>D</b>	<b>H</b>	<b>W</b>	<b>D</b>	<b>H</b>	<b>W</b>	<b>H</b>				
		2.5	27	26.5									
<p><b>Center Frame, Closed Arm</b> COM Yardage: 0.65 Freight Class: 92.5 Product Weight (lbs.) Metal: 15 / Wood: 10 Cubic Feet Per Carton: 1.4</p>		<p>For <b>linking</b> guest and/or patient top seating units to modular table on the <b>left</b> side of the frame.</p> <p>Urethane armcap option - <b>Add \$53 list upcharge</b></p>											
 <p><b>GC3622TRCA</b> Metal</p> <p><b>GC3622WTRCA</b> Wood</p> <p>Specify armcap: wood or Urethane.</p>	<b>\$773</b>	<b>\$794</b>	<b>\$817</b>	<b>\$842</b>	<b>\$881</b>	<b>\$897</b>	<b>\$927</b>	<b>\$993</b>	<b>\$1022</b>	<b>\$1084</b>	<b>\$1165</b>	<b>\$1265</b>	
	<b>\$578</b>	<b>\$598</b>	<b>\$621</b>	<b>\$646</b>	<b>\$685</b>	<b>\$701</b>	<b>\$733</b>	<b>\$797</b>	<b>\$830</b>	<b>\$888</b>	<b>\$969</b>	<b>\$1069</b>	
		<b>OVERALL DIMENSIONS</b>			<b>SEAT DIMENSIONS</b>			<b>BACK DIMENSIONS</b>					
		<b>W</b>	<b>D</b>	<b>H</b>	<b>W</b>	<b>D</b>	<b>H</b>	<b>W</b>	<b>H</b>				
		2.5	27	26.5									
<p><b>Center Frame, Closed Arm</b> COM Yardage: 0.65 Freight Class: 92.5 Product Weight (lbs.) Metal: 15 / Wood: 10 Cubic Feet Per Carton: 1.4</p>		<p>For <b>linking</b> guest and/or patient top seating units to modular table on the <b>right</b> side of the frame.</p> <p>Urethane armcap option - <b>Add \$53 list upcharge</b></p>											

DESCRIPTION	MODEL#	STANDARD FABRIC GRADES							
		List Price							
	<b>GC3616SSULACAP</b>	<b>\$177</b>							
	Urethane								
	<b>GC3616WLACAP</b>	<b>\$211</b>							
	Wood								
		OVERALL DIMENSIONS			SEAT DIMENSIONS			BACK DIMENSIONS	
		W	D	H	W	D	H	W	H
		0	0	0					
<b>Dining Armcap, Left</b> COM Yardage: -- Freight Class: 250 Product Weight (lbs.) Urethane: 2 / Wood: 1.5 Cubic Feet Per Carton: 0.6		Armcap with hardware for dining top seating units. <i>For field replacement only.</i>							
		List Price							
	<b>GC3616SSURACAP</b>	<b>\$177</b>							
	Urethane								
	<b>GC3616WRACAP</b>	<b>\$211</b>							
	Wood								
		OVERALL DIMENSIONS			SEAT DIMENSIONS			BACK DIMENSIONS	
		W	D	H	W	D	H	W	H
		0	0	0					
<b>Dining Armcap, Right</b> COM Yardage: -- Freight Class: 250 Product Weight (lbs.) Urethane: 2 / Wood: 1.5 Cubic Feet Per Carton: 0.6		Armcap with hardware dining top seating units. <i>For field replacement only.</i>							
		List Price							
	<b>GC3620SSULACAP</b>	<b>\$177</b>							
	Urethane								
	<b>GC3620WLACAP</b>	<b>\$211</b>							
	Wood								
		OVERALL DIMENSIONS			SEAT DIMENSIONS			BACK DIMENSIONS	
		W	D	H	W	D	H	W	H
		0	0	0					
<b>Guest/Patient Armcap, Left</b> COM Yardage: -- Freight Class: 150 Product Weight (lbs.) Urethane: 2.5 / Wood: 2 Cubic Feet Per Carton: 0.6		Armcap with hardware for guest/patient top seating units. <i>For field replacement only.</i>							
		List Price							
	<b>GC3620SSURACAP</b>	<b>\$177</b>							
	Urethane								
	<b>GC3620WRACAP</b>	<b>\$211</b>							
	Wood								
		OVERALL DIMENSIONS			SEAT DIMENSIONS			BACK DIMENSIONS	
		W	D	H	W	D	H	W	H
		0	0	0					
<b>Guest/Patient Armcap, Right</b> COM Yardage: -- Freight Class: 150 Product Weight (lbs.) Urethane: 2.5 / Wood: 2 Cubic Feet Per Carton: 0.6		Armcap with hardware for guest/patient top seating units. <i>For field replacement only.</i>							
		List Price							
	<b>GC3622SSULACAP</b>	<b>\$177</b>							
	(Urethane)								
	<b>GC3622WLACAP</b>	<b>\$211</b>							
	(wood)								
		OVERALL DIMENSIONS			SEAT DIMENSIONS			BACK DIMENSIONS	
		W	D	H	W	D	H	W	H
		0	0	0					
<b>Narrow Center Armcap</b> COM Yardage: -- Freight Class: 70 Product Weight (lbs.) Urethane: 1.5 / Wood: 1.5 Cubic Feet Per Carton: 0.6		Armcap with hardware for guest/patient top seating units. <i>For field replacement only.</i>							

DESCRIPTION	MODEL#	STANDARD FABRIC GRADES							
		List Price							
	<b>GC3641SSULACAP</b>	<b>\$199</b>							
	Urethane								
	<b>GC3641WLACAP</b>	<b>\$250</b>							
	Wood								
		OVERALL DIMENSIONS			SEAT DIMENSIONS			BACK DIMENSIONS	
		W	D	H	W	D	H	W	H
		3	26.75	1.5					
<b>Lounge Armcap, Left</b> COM Yardage: -- Freight Class: 150 Product Weight (lbs.) Urethane: 2.5 / Wood: 2 Cubic Feet Per Carton: 0.6		Armcap with hardware <b>for Lounge chair</b> <i>For field replacement only.</i>							
		List Price							
	<b>GC3641SSURACAP</b>	<b>\$199</b>							
	Urethane								
	<b>GC3641WRACAP</b>	<b>\$250</b>							
	Wood								
		OVERALL DIMENSIONS			SEAT DIMENSIONS			BACK DIMENSIONS	
		W	D	H	W	D	H	W	H
		3	26.75	1.5					
<b>Lounge Armcap, Right</b> COM Yardage: -- Freight Class: 150 Product Weight (lbs.) Urethane: 2.5 / Wood: 2 Cubic Feet Per Carton: 0.6		Armcap with hardware <b>for Lounge chair</b> <i>For field replacement only.</i>							

**Modular tables:**

Tops are 1" thick.

**Wooden leg tables:**

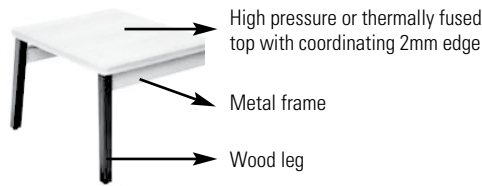

**Metal leg tables:**

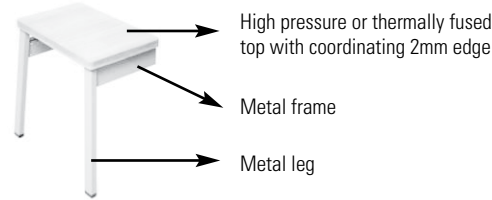

**Table top finishes:**

**Wood Legs**

- Absolute (AAM)
- Charcoal Java (CJM)
- Cherry (ACM)
- Empire Mahogany (EMM)
- English Oak (EOM)
- Espresso Cafe (ECM)
- Fruitwood (TFM)
- Gray (HGM)
- Harvest Oak (HOM)
- Honey (AHM)
- Jet Onyx (JOM)
- Light Honey (LHM)
- Mahogany (TMM)
- Maple (AVM)
- Medium Walnut (MWM)
- Natural Walnut (NLW)
- Night (ASM)
- Noce Biondo (NBM)
- Noce Grigio (NGM)
- Noce Leggero (NEM)
- Noce Medio (NMM)
- Sandy Beach (SBM)
- Shaker Cherry (SKM)
- Silver Oak (SOM)
- Walnut (TWM)
- White (WHM)
- WC Cream (WTM)
- Winter Cherry (WCM)

**Thermally Fused Laminate (LP) Tops**

- Absolute Acajou (ACJ)
- Asian Night (ASN)
- Avant Cherry (AWC)
- Avant Honey (AWH)
- Blizzard (BZD)
- Brushed Cobalt (BRC)
- Clear Maple (CMB)
- Custom Grey (CGY)
- Dark Espresso (DES)
- Designer White (DWT)
- Fashionista (FAS)
- First Class (FCL)
- Noce Biondo (NBL)
- Noce Grigio (NGL)
- Noce Leggero (NEL)
- Noce Medio (NML)
- Quartered Mahogany (QTM)
- Sheer Beauty (SBY)
- Stonedust (SDT)
- Walnut Heights (WHE)
- White Chocolate (WHC)
- Winter Cherry (WCR)

**High Pressure Laminate (HP) Tops**

- Absolute Acajou (ACJ)
- Asian Night (ASN)
- Avant Cherry (W357)
- Avant Honey (W356)
- Blizzard (BZD)
- Brushed Cobalt (BRC)
- Clear Maple (CMB)
- Custom Grey (CGY)
- Dark Espresso (W142)
- Designer White (DWT)
- Fashionista (FAS)
- First Class (FCL)
- Noce Biondo (NBL)
- Noce Grigio (NGL)
- Noce Leggero (NEL)
- Noce Medio (NML)
- Quartered Mahogany (QTM)
- Sheer Beauty (SBL)
- Stonedust (SDT)
- Walnut Heights (WHE)
- White Chocolate (WHC)
- Winter Cherry (WCR)

**Metal leg finishes:**

Black (TBL), Cloud (TIV), Designer White (TDW), Fog (TFO), Frost (TFR), Kalua (TKA), Latte (TLA), Mocha (TMO), Nevada (TNE), Sand (TSN), Shadow (TSH), Toast (TOA) and Tungsten (TTU).

**Metal frame finishes:**

Black (TBL), Cloud (TIV), Designer White (TDW), Fog (TFO), Frost (TFR), Kalua (TKA), Latte (TLA), Mocha (TMO), Nevada (TNE), Sand (TSN), Shadow (TSH), Toast (TOA) and Tungsten (TTU).

**Power/USB modules:**

For modular tables with power/USB module, refer to models ending in "M". Power module includes two power outlets, four USB charging ports and a 6 foot long power cord. Available in Black or White (must be specified at time of order). Power module is mounted **on surface** on narrow tables; mounted **in surface** on larger tables.



On surface power module on narrow tables

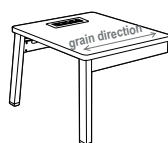

In surface power module on larger tables

DESCRIPTION	MODEL#	STANDARD FABRIC GRADES				
-------------	--------	------------------------	--	--	--	--

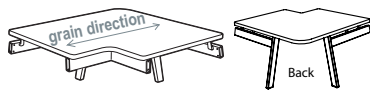

GC3671WL-LP	33 x 33 x 17	100	54	6	<b>\$1332</b>
GC3671WLM-LP					<b>\$2659</b>
GC3671WL-HP	33 x 33 x 17	100	54	6	<b>\$1423</b>
GC3671WLM-HP					<b>\$2765</b>

- For a thermally fused laminate top (LP), specify model GC3671WL-LP.
- For a high pressure laminate top (HP), specify model GC3671WL-HP.
- Models GC3671WLM-LP and GC3671WLM-HP have a **power/USB** module mounted in surface.

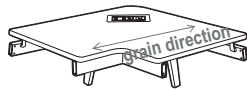

Left Corner Table, for Wood Frame

Coordinating 2mm edge. Must be connected to full arm and leg with **wood** frames. (GC3622WTLA/WTRA, GC3622WTLCA/WTRCA). This table allows for kneespace when specifying chairs in a corner position. 1 per carton.

- Includes 2 rear wood legs (not shown)

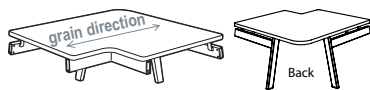

GC3671L-LP	33 x 33 x 17	100	53	6	<b>\$1412</b>
GC3671LM-LP					<b>\$2753</b>
GC3671L-HP	33 x 33 x 17	100	54	6	<b>\$1503</b>
GC3671LM-HP					<b>\$2859</b>

- For a thermally fused laminate top (LP), specify model GC3671L-LP.
- For a high pressure laminate top (HP), specify model GC3671L-HP.
- Models GC3671LM-LP and GC3671LM-HP have a **power/USB** module mounted in surface.

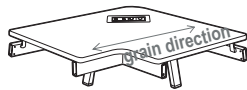

Left Corner Table, for Metal Frame

Coordinating 2mm edge. Must be connected to full arm and leg with **metal** frames. (GC3622TLA/TRA, GC3622TLCA/TRCA). This table allows for kneespace when specifying chairs in a corner position. 1 per carton.

- Includes 2 rear metal legs (not shown)

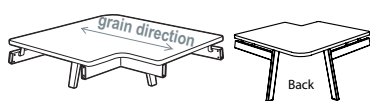

GC3671WR-LP	33 x 33 x 17	100	54	6	<b>\$1332</b>
GC3671WRM-LP					<b>\$2659</b>
GC3671WR-HP	33 x 33 x 17	100	54	6	<b>\$1423</b>
GC3671WRM-HP					<b>\$2765</b>

- For a thermally fused laminate top (LP), specify model GC3671WR-LP.
- For a high pressure laminate top (HP), specify model GC3671WR-HP.
- Models GC3671WRM-LP and GC3671WRM-HP have a **power/USB** module mounted in surface.



Right Corner Table, for Wood Frame

Coordinating 2mm edge. Must be connected to full arm and leg with **wood** frames. (GC3622WTLA/WTRA, GC3622WTLCA/WTRCA). This table allows for kneespace when specifying chairs in a corner position. 1 per carton.

- Includes 2 rear wood legs (not shown)

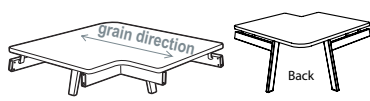

GC3671R-LP	33 x 33 x 17	100	54	6	<b>\$1412</b>
GC3671RM-LP					<b>\$2753</b>
GC3671R-HP	33 x 33 x 17	125	45	6	<b>\$1503</b>
GC3671RM-HP					<b>\$2859</b>

- For a thermally fused laminate top (LP), specify model GC3671R-LP.
- For a high pressure laminate top (HP), specify model GC3671R-HP.
- Models GC3671RM-LP and GC3671RM-HP have a **power/USB** module mounted in surface.

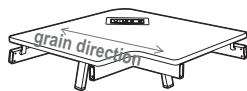

Right Corner Table, for Metal Frame

Coordinating 2mm edge. Must be connected to full arm and leg with **metal** frames (GC3622TLA/TRA, GC3622TLCA/TRCA). This table allows for kneespace when specifying chairs in a corner position. 1 per carton.

- Includes 2 rear metal legs (not shown).



GC3672-LP	23.87 x 20.25 x 5.5	150	20	3.4	<b>\$805</b>
GC3672M-LP					<b>\$2082</b>
GC3672-HP	23.87 x 20.25 x 5.5	150	20	3.4	<b>\$845</b>
GC3672M-HP					<b>\$2129</b>

- For a thermally fused laminate top (LP), specify model GC3672-LP.
- For a high pressure laminate top (HP), specify model GC3672-HP.
- Models GC3672M-LP and GC3672M-HP have a **power/USB** module mounted in surface.



Center Table

Coordinating 2mm edge. Regular center table for **wood** or **metal** (HT) frame. Must be connected to full arm and leg with **metal** or **wood** frames (GC3622TLA/TRA, GC3622TLCA/TRCA, GC3622WTLA/WTRA, GC3622WTLCA/WTRCA). 1 per carton.



DESCRIPTION	MODEL#	STANDARD FABRIC GRADES				
-------------	--------	------------------------	--	--	--	--



GC3673-LP	23.87 x 12 x 5.5	100	18	2.1	<b>\$783</b>
GC3673M-LP					<b>\$2226</b>
GC3673-HP	23.87 x 12 x 5.5	100	18	2.1	<b>\$821</b>
GC3673M-HP					<b>\$2275</b>



- For a thermally fused laminate top (LP), specify model GC3673-LP.
- For a high pressure laminate top (HP), specify model GC3673-HP.
- Models GC3673M-LP and GC3673M-HP have a **power/USB** module mounted on surface.

**Narrow Center Table**

Coordinating 2mm edge. Narrow center table for **wood or metal** (HT) frame. Must be connected to full arm and leg with **metal** or **wood** frames (GC3622TLA/TRA, GC3622TLCA/TRCA, GC3622WTLA/WTRA, GC3622WTLCA/WTRCA).  
1 per carton

GC3674WL-LP	23.87 x 20.25 x 17	150	19	3.4	<b>\$1126</b>
GC3674WLM-LP					<b>\$2434</b>
GC3674WL-HP	23.87 x 20.25 x 17	150	20	3.4	<b>\$1166</b>
GC3674WLM-HP					<b>\$2480</b>

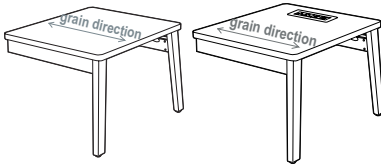

- For a thermally fused laminate top (LP), specify model GC3674WL-LP.
- For a high pressure laminate top (HP), specify model GC3674WL-HP.
- Models GC3674WLM-LP and GC3674WLM-HP have a **power/USB** module mounted in surface.

**Left End Table, for Wood Frame**

Coordinating 2mm edge. Must be connected to full arm and leg with **wood** frames (GC3622WTLA or GC3622WTLCA).  
1 per carton.

GC3674L-LP	23.87 x 20.25 x 17	150	19	3.4	<b>\$1208</b>
GC3674LM-LP					<b>\$2526</b>
GC3674L-HP	23.87 x 20.25 x 17	150	20	3.4	<b>\$1250</b>
GC3674LM-HP					<b>\$2572</b>

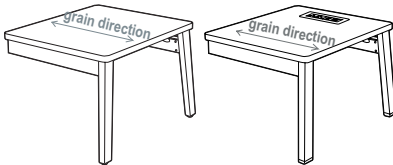

- For a thermally fused laminate top (LP), specify model GC3674L-LP.
- For a high pressure laminate top (HP), specify model GC3674L-HP.
- Models GC3674LM-LP and GC3674LM-HP have a **power/USB** module mounted in surface.

**Left End Table, for Metal Frame**

Coordinating 2mm edge. Must be connected to full arm and leg with **metal** frames. (GC3622TLA or GC3622TLCA).  
1 per carton.

GC3674WR-LP	23.87 x 20.25 x 17	150	19	3.4	<b>\$1126</b>
GC3674WRM-LP					<b>\$2434</b>
GC3674WR-HP	23.87 x 20.25 x 17	150	20	3.4	<b>\$1166</b>
GC3674WRM-HP					<b>\$2480</b>

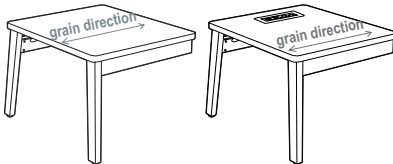

- For a thermally fused laminate top (LP), specify model GC3674WR-LP.
- For a high pressure laminate top (HP), specify model GC3674WR-HP.
- Models GC3674WRM-LP and GC3674WRM-HP have a **power/USB** module mounted in surface.

**Right End Table, for Wood Frame**

Coordinating 2mm edge. Must be connected to full arm and leg with **wood** frames. (GC3622WTRA or GC3622WTRCA).  
1 per carton.

GC3674R-LP	23.87 x 20.25 x 17	150	19	3.4	<b>\$1208</b>
GC3674RM-LP					<b>\$2526</b>
GC3674R-HP	23.87 x 20.25 x 17	150	20	3.4	<b>\$1250</b>
GC3674RM-HP					<b>\$2572</b>

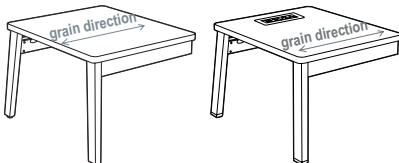

- For a thermally fused laminate top (LP), specify model GC3674R-LP.
- For a high pressure laminate top (HP), specify model GC3674R-HP.
- Models GC3674RM-LP and GC3674RM-HP have a **power/USB** module mounted in surface.

**Right End Table, for Metal Frame**

Coordinating 2mm edge. Must be connected to full arm and leg with **metal** frames. (GC3622TRA or GC3622TRCA).  
1 per carton.

DESCRIPTION	MODEL#	STANDARD FABRIC GRADES				
-------------	--------	------------------------	--	--	--	--

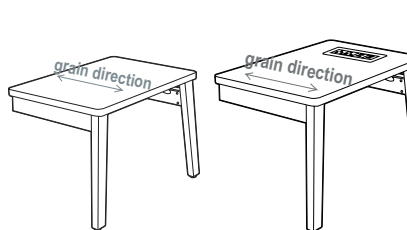

**Narrow Left End Table, for Wood Frame**

GC3675WL-LP	23.87 x 12 x 17	100	18	2.1	<b>\$1101</b>
GC3675WLM-LP					<b>\$2607</b>
GC3675WL-HP	23.87 x 12 x 17	100	18	2.1	<b>\$1143</b>
GC3675WLM-HP					<b>\$2657</b>

- For a thermally fused laminate top (LP), specify model GC3675WL-LP.
- For a high pressure laminate top (HP), specify model GC3675WL-HP.
- Models GC3675WLM-LP and GC3675WLM-HP have a **power/USB** module mounted on surface.

Coordinating 2mm edge. Must be connected to full arm and leg with **wood** frames. (GC3622WTLA or GC3622WTLCA). 1 per carton.

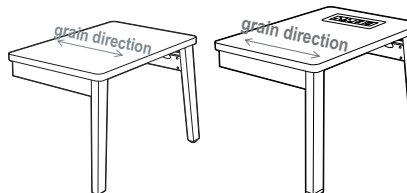

**Narrow Left End Table, for Metal Frame**

GC3675L-LP	23.87 x 12 x 17	100	18	2.1	<b>\$1185</b>
GC3675LM-LP					<b>\$2708</b>
GC3675L-HP	23.87 x 12 x 17	100	18	2.1	<b>\$1227</b>
GC3675LM-HP					<b>\$2758</b>

- For a thermally fused laminate top (LP), specify model GC3675L-LP.
- For a high pressure laminate top (HP), specify model GC3675L-HP.
- Models GC3675LM-LP and GC3675LM-HP have a **power/USB** module mounted on surface.

Coordinating 2mm edge. Must be connected to full arm and leg with **metal** frames. (GC3622TLA or GC3622TLCA). 1 per carton.

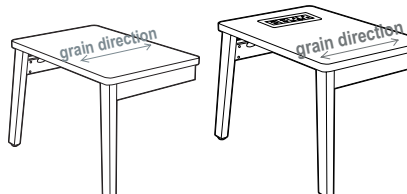

**Narrow Right End Table, for Wood Frame**

GC3675WR-LP	23.87 x 12 x 17	100	18	2.1	<b>\$1101</b>
GC3675WRM-LP					<b>\$2607</b>
GC3675WR-HP	23.87 x 12 x 17	100	18	2.1	<b>\$1143</b>
GC3675WRM-HP					<b>\$2657</b>

- For a thermally fused laminate top (LP), specify model GC3675WR-LP.
- For a high pressure laminate top (HP), specify model GC3675WR-HP.
- Models GC3675WRM-LP and GC3675WRM-HP have a **power/USB** module mounted on surface.

Coordinating 2mm edge. Must be connected to full arm and leg with **wood** frames. (GC3622WTLA or GC3622WTLCA). 1 per carton.

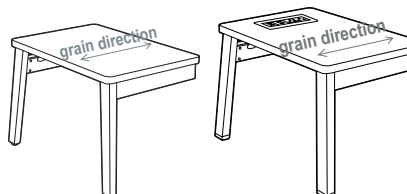

**Narrow Right End Table, for Metal Frame**

GC3675R-LP	23.87 x 12 x 17	100	18	2.1	<b>\$1185</b>
GC3675RM-LP					<b>\$2708</b>
GC3675R-HP	23.87 x 12 x 17	100	18	2.1	<b>\$1227</b>
GC3675RM-HP					<b>\$2758</b>

- For a thermally fused laminate top (LP), specify model GC3675R-LP.
- For a high pressure laminate top (HP), specify model GC3675R-HP.
- Models GC3675RM-LP and GC3675RM-HP have a **power/USB** module mounted on surface.

Coordinating 2mm edge. Must be connected to full arm and leg with **metal** frames. (GC3622TLA or GC3622TLCA). 1 per carton.

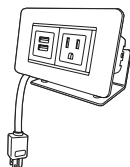







**On Surface Power/Data Module**

GC36410	-- x -- x --	250	2	1	<b>\$735</b>
---------	--------------	-----	---	---	--------------

Surface top mount power/data module with one power outlet, two USB charging ports. 6 foot cord. White. Can be mounted to all freestanding and modular tables.

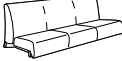

























MODULAR TABLES	MODEL#	DIMENSIONS D x W x H	FREIGHT CLASS	WT/LBS.	CUBIC FT.	LIST PRICE
----------------	--------	-------------------------	---------------	---------	-----------	------------

**MODULAR TOP UNITS** **FOR MODULAR LOUNGE AND FULLY UPHOLSTERED LOUNGE**

	SINGLE SEAT	BARIATRIC	TWO SEATER	THREE SEATER
	GC3641TOP	GC3640TOP	GC3642TOP	GC3643TOP
<b>Lounge Seating</b>				
<b>High Back Lounge Seating</b>	GC3676HBTOP	GC3679HBTOP	GC3677HBTOP	GC3678HBTOP
				

**LEG / ARM FRAMES** **FOR MODULAR LOUNGE**

**Metal frame: Standard with Black Urethane armcap (see notes for wood and urethane finish options) | Wood frame: Must select armcap**

	LEFT, OPEN	RIGHT, OPEN	LEFT, CLOSED	RIGHT, CLOSED	LEFT, CLOSED LAMINATE PANEL	RIGHT, CLOSED LAMINATE PANEL
<b>Metal (HT) End</b>	GC3641LA	GC3641LAM	GC3641RA	GC3641RAM	GC3641LCA	GC3641LCAM
						
<b>Wood End</b>	GC3641WLA	GC3641WLAM	GC3641WRA	GC3641WRAM	GC3641WLCA	GC3641WLCAM
						
<b>Metal (HT) Center</b>	GC36406LA		GC36406LCA		GC36406LCAL	
						
<b>Wood, Center</b>	GC36406WLA		GC36406WLCA			
						
<b>Metal (HT) Center table linking</b>	GC36406TLA	GC3622TRA	GC36406TLCA	GC36406TRCA	GC36406TLCAL	GC36406TRCAL
						
<b>Wood Center table linking</b>	GC36406WTLA	GC3622WTRA	GC36406WTLCA	GC36406WTRCA		
						

For frame with power/USB module\*, add "M" after model number

**LEG / ARM FRAMES** **FOR FULLY UPHOLSTERED MODULAR LOUNGE**

**Standard with Black Urethane legs (see notes for wood and urethane finish options)**  
**Optional armcap in wood or urethane (cannot be retrofitted in the field if the frame is ordered without armcap)**

	LEFT	RIGHT
<b>Fully Upholstered End</b>	GC3676LA	GC3676RA
		
<b>Fully Upholstered Center</b>	GC3676CFA	
		

(Center = link both sides)

\*Power module includes two power outlets, four USB charging ports and a 6 foot long power cord. Available in Black or White (must be specified at time of order). Power module is mounted on the frame below seat support rail.

DESCRIPTION

MODEL# / FEATURES

STANDARD TEXTILE GRADES

**MODULAR TABLES FOR MODULAR LOUNGE AND FULLY UPHOLSTERED LOUNGE**

Tables include legs to support table top (except for center tables). All tables have a metal frame.

	LEFT		RIGHT	
<b>Corner</b> (laminated top with metal legs)	GC36403L-HP	GC36403LM-HP	GC36403R-HP	GC36403RM-HP
	GC36403L-LP	GC36403LM-LP	GC36403R-LP	GC36403RM-LP
<b>Corner</b> (laminated top with wood legs)	GC36403WL-HP	GC36403WLM-HP	GC36403WR-HP	GC36403WRM-HP
	GC36403WL-LP	GC36403WLM-LP	GC36403WR-LP	GC36403WRM-LP
<b>Center</b> (laminated top, connects to metal or wood frame)	GC36401-HP	GC36401M-HP		
	GC36401-LP	GC36401M-LP		
<b>Narrow Center</b> (laminated top, connects to metal or wood frame)	GC36402-HP	GC36402M-HP		
	GC36402-LP	GC36402M-LP		
<b>End</b> (laminated top with metal legs)	GC36404L-HP	GC36404LM-HP	GC36404R-HP	GC36404RM-HP
	GC36404L-LP	GC36404LM-LP	GC36404R-LP	GC36404RM-LP
<b>End</b> (laminated top with wood legs)	GC36404WL-HP	GC36404WLM-HP	GC36404WR-HP	GC36404WRM-HP
	GC36404WL-LP	GC36404WLM-LP	GC36404WR-LP	GC36404WRM-LP
<b>Narrow End</b> (laminated top with metal legs)	GC36405L-HP	GC36405LM-HP	GC36405R-HP	GC36405RM-HP
	GC36405L-LP	GC36405LM-LP	GC36405R-LP	GC36405RM-LP
<b>Narrow End</b> (laminated top with wood legs)	GC36405WL-HP	GC36405WLM-HP	GC36405WR-HP	GC36405WRM-HP
	GC36405WL-LP	GC36405WLM-LP	GC36405WR-LP	GC36405WRM-LP

For table with power/USB module\*, refer to models ending in "M"

\* Power module includes two power outlets, four USB charging ports and a 6 foot long power cord. Available in Black or White (must be specified at time of order). Power module is mounted on surface on narrow tables; mounted in surface on larger tables (as shown above).

DESCRIPTION MODEL# / FEATURES STANDARD TEXTILE GRADES

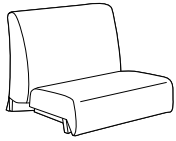

**Lounge Bariatric Top**  
 COM Yardage: 3.25  
 Freight Class: 300  
 Product Weight (lbs.): 97  
 Cubic Feet Per Carton: 49.5

	COM	2	3	4	5	6	7	8	9	10	11	12
<b>GC3640TOP</b>	<b>\$2275</b>	<b>\$2386</b>	<b>\$2478</b>	<b>\$2614</b>	<b>\$2809</b>	<b>\$2897</b>	<b>\$3071</b>	<b>\$3351</b>	<b>\$3565</b>	<b>\$3805</b>	<b>\$4294</b>	<b>\$4819</b>

Active weight: see notes.

Single frame lounge top unit with 1 back and 1 seat cushion.

**Must be connected to a full arm/leg frame.**

OVERALL DIMENSIONS			SEAT DIMENSIONS			BACK DIMENSIONS	
W	D	H	W	D	H	W	H
36	32	25	36	20	-	36	16

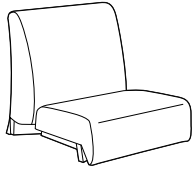

**Lounge Single Seater Top**  
 COM Yardage: 2.5  
 Freight Class: 250  
 Product Weight (lbs.): 66  
 Cubic Feet Per Carton: 29.5

	COM	2	3	4	5	6	7	8	9	10	11	12
<b>GC3641TOP</b>	<b>\$1633</b>	<b>\$1718</b>	<b>\$1790</b>	<b>\$1896</b>	<b>\$2042</b>	<b>\$2114</b>	<b>\$2248</b>	<b>\$2460</b>	<b>\$2627</b>	<b>\$2810</b>	<b>\$3185</b>	<b>\$3588</b>

Active weight: see notes.

Single frame lounge top unit with 1 back and 1 seat cushion.

**Must be connected to a full arm/leg frame.**

OVERALL DIMENSIONS			SEAT DIMENSIONS			BACK DIMENSIONS	
W	D	H	W	D	H	W	H
25	32	25	23	20	-	22.5	16

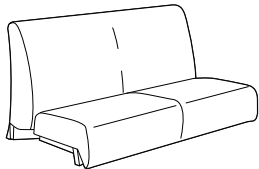

**Lounge Two Seater Top**  
 COM Yardage: 4  
 Freight Class: 250  
 Product Weight (lbs.): 110  
 Cubic Feet Per Carton: 49.5

	COM	2	3	4	5	6	7	8	9	10	11	12
<b>GC3642TOP</b>	<b>\$2894</b>	<b>\$3029</b>	<b>\$3146</b>	<b>\$3311</b>	<b>\$3550</b>	<b>\$3661</b>	<b>\$3877</b>	<b>\$4217</b>	<b>\$4482</b>	<b>\$4775</b>	<b>\$5376</b>	<b>\$6022</b>

Active weight: see notes.

Double frame lounge top unit with 2 back and 2 seat cushions.

**Must be connected to a full arm/leg frame.**

OVERALL DIMENSIONS			SEAT DIMENSIONS			BACK DIMENSIONS	
W	D	H	W	D	H	W	H
48	32	25	48	20	-	48	16

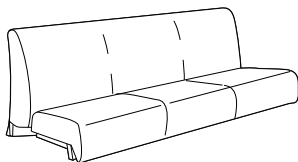

**Lounge Three Seater Top**  
 COM Yardage: 6.25  
 Freight Class: 250  
 Product Weight (lbs.): 161  
 Cubic Feet Per Carton: 69.5

	COM	2	3	4	5	6	7	8	9	10	11	12
<b>GC3643TOP</b>	<b>\$4773</b>	<b>\$4989</b>	<b>\$5167</b>	<b>\$5430</b>	<b>\$5798</b>	<b>\$5973</b>	<b>\$6308</b>	<b>\$6843</b>	<b>\$7255</b>	<b>\$7712</b>	<b>\$8655</b>	<b>\$9662</b>

**Due to the size and weight, this top requires at least 3 installers.**

Active weight: see notes.

Triple frame lounge top unit with 3 back and 3 seat cushions.

**Must be connected to a full arm/leg frame.**

OVERALL DIMENSIONS			SEAT DIMENSIONS			BACK DIMENSIONS	
W	D	H	W	D	H	W	H
71	32	25	71	20	-	71	16

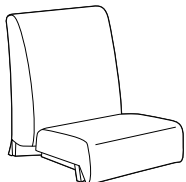

**HB Lounge Single Seater Top**  
 COM Yardage: 6.5  
 Freight Class: 250  
 Product Weight (lbs.): 92  
 Cubic Feet Per Carton: 29.5

	COM	2	3	4	5	6	7	8	9	10	11	12
<b>GC3676HB-TOP</b>	<b>\$1585</b>	<b>\$1805</b>	<b>\$1988</b>	<b>\$2257</b>	<b>\$2637</b>	<b>\$2816</b>	<b>\$3164</b>	<b>\$3713</b>	<b>\$4138</b>	<b>\$4610</b>	<b>\$5581</b>	<b>\$6620</b>

Active weight: see notes.

Single high back frame lounge top, 1 back and 1 seat cushion.

**Must be connected to a full arm/leg frame.**

OVERALL DIMENSIONS			SEAT DIMENSIONS			BACK DIMENSIONS	
W	D	H	W	D	H	W	H
23	29	36	23	20	-	23	19

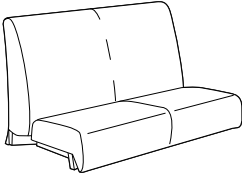
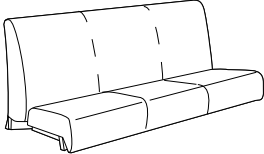
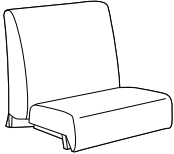
DESCRIPTION	MODEL# / FEATURES	STANDARD TEXTILE GRADES											
		COM	2	3	4	5	6	7	8	9	10	11	12
 <p><b>HB Lounge Two Seater Top</b> COM Yardage: 7.75 Freight Class: 250 Product Weight (lbs.): 117 Cubic Feet Per Carton: 56.25</p>	<b>GC3677HB-TOP</b>	\$2947	\$3210	\$3426	\$3747	\$4202	\$4417	\$4828	\$5485	\$5991	\$6553	\$7712	\$8949
	Active weight: see notes.	<b>OVERALL DIMENSIONS</b>			<b>SEAT DIMENSIONS</b>			<b>BACK DIMENSIONS</b>					
		<b>W</b>	<b>D</b>	<b>H</b>	<b>W</b>	<b>D</b>	<b>H</b>	<b>W</b>	<b>H</b>				
	Double high back frame lounge top unit with 2 back and 2 seat cushions.	45.5	29	36	45.5	20	-	45.5	19				
<b>Must be connected to a full arm/leg frame.</b>													
 <p><b>HB Lounge Three Seater Top</b> COM Yardage: 9.25 Freight Class: 250 Product Weight (lbs.): 158 Cubic Feet Per Carton: 69.5</p>	<b>GC3678HB-TOP</b>	\$4942	\$5257	\$5515	\$5898	\$6440	\$6695	\$7187	\$7972	\$8576	\$9247	\$10630	\$12104
	Active weight: see notes.	<b>OVERALL DIMENSIONS</b>			<b>SEAT DIMENSIONS</b>			<b>BACK DIMENSIONS</b>					
		<b>W</b>	<b>D</b>	<b>H</b>	<b>W</b>	<b>D</b>	<b>H</b>	<b>W</b>	<b>H</b>				
	Triple high back frame lounge top unit with 3 back and 3 seat cushions.	68.5	29	36	68.5	20	--	71	19				
<b>Must be connected to a full arm/leg frame.</b>													
 <p><b>HB Lounge Bariatric Top</b> COM Yardage: 6.75 Freight Class: 250 Product Weight (lbs.): 96 Cubic Feet Per Carton: 37.75</p>	<b>GC3679HB-TOP</b>	\$2478	\$2709	\$2898	\$3177	\$3573	\$3760	\$4119	\$4691	\$5132	\$5622	\$6632	\$7708
	Active weight: see notes.	<b>OVERALL DIMENSIONS</b>			<b>SEAT DIMENSIONS</b>			<b>BACK DIMENSIONS</b>					
		<b>W</b>	<b>D</b>	<b>H</b>	<b>W</b>	<b>D</b>	<b>H</b>	<b>W</b>	<b>H</b>				
	Single high back frame bariatric lounge top, 1 back and 1 seat cushion.	32	29	36	32	20	--	32	19				
<b>Must be connected to a full arm/leg frame.</b>													

DESCRIPTION MODEL# / FEATURES STANDARD TEXTILE GRADES

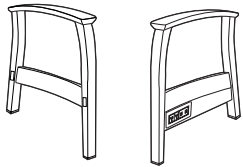

**Lounge Left End Frame, Open Arm**  
 COM Yardage: --  
 Freight Class: 150  
 Product Weight (lbs.): metal: 9.67 | wood: 11  
 Cubic Feet Per Carton: 2.1

List price	
GC3641LA (metal)	\$767
GC3641LAM (w/power)	\$2021
GC3641WLA (wood)	\$517
GC3641WLAM (wood)	\$1771

Specify armcap: wood or Urethane.	OVERALL DIMENSIONS			SEAT DIMENSIONS			BACK DIMENSIONS	
	W	D	H	W	D	H	W	H

For use in **left** side finished position of lounge seating units.  
 • Models GC3641LAM and GC3641WLAM have **power/USB module**  
**Does not allow linking to other units or tables.**  
 Urethane armcap option - **Add \$53 list upcharge**

3.5	29	25.25	-	-	-	-	-
-----	----	-------	---	---	---	---	---

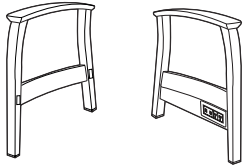

**Lounge Right End Frame, Open Arm**  
 COM Yardage: --  
 Freight Class: 150  
 Product Weight (lbs.): metal: 9.67 | wood: 11  
 Cubic Feet Per Carton: 2.1

List price	
GC3641RA (metal)	\$767
GC3641RAM (w/power)	\$2021
GC3641WRA (wood)	\$517
GC3641WRAM (w/power)	\$1771

Specify armcap: wood or Urethane.	OVERALL DIMENSIONS			SEAT DIMENSIONS			BACK DIMENSIONS	
	W	D	H	W	D	H	W	H

For use in **right** side finished position of lounge seating units.  
 • Models GC3641RAM and GC3641WRAM have **power/USB module**  
**Does not allow linking to other units or tables.**  
 Urethane armcap option - **Add \$53 list upcharge**

3.5	29	25.25	-	-	-	-	-
-----	----	-------	---	---	---	---	---

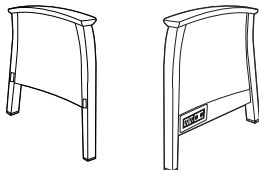

**Lounge Left End Frame, Closed Arm**  
 COM Yardage: 0.75  
 Freight Class: 150  
 Product Weight (lbs.): metal: 10.17 | wood: 11  
 Cubic Feet Per Carton: 2.1

	COM	2	3	4	5	6	7	8	9	10	11	12
GC3641LCA (metal)	\$967	\$990	\$1013	\$1043	\$1089	\$1109	\$1148	\$1213	\$1263	\$1317	\$1428	\$1548
GC3641LCAM (w/power)	\$2231	\$2254	\$2277	\$2310	\$2354	\$2374	\$2414	\$2478	\$2527	\$2585	\$2697	\$2817
GC3641WLCA (wood)	\$669	\$701	\$732	\$773	\$833	\$860	\$914	\$998	\$1068	\$1139	\$1290	\$1452
GC3641WLCAM (w/power)	\$1924	\$1955	\$1986	\$2028	\$2085	\$2114	\$2168	\$2254	\$2322	\$2396	\$2545	\$2706

Specify armcap: wood or Urethane.	OVERALL DIMENSIONS			SEAT DIMENSIONS			BACK DIMENSIONS	
	W	D	H	W	D	H	W	H

For use in **left** side finished position of lounge seating units.  
 • Models GC3641LCAM and GC3641WLCAM have **power/USB module**  
**Does not allow linking to other units or tables.**  
 Urethane armcap option - **Add \$53 list upcharge**

3.5	29	25.25	-	-	-	-	-
-----	----	-------	---	---	---	---	---

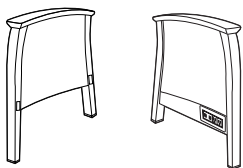

**Lounge Right End Frame, Closed Arm**  
 COM Yardage: 0.75  
 Freight Class: 150  
 Product Weight (lbs.): metal: 10.17 | wood: 11  
 Cubic Feet Per Carton: 2.1

	COM	2	3	4	5	6	7	8	9	10	11	12
GC3641RCA (metal)	\$967	\$990	\$1013	\$1043	\$1089	\$1109	\$1148	\$1213	\$1263	\$1317	\$1428	\$1548
GC3641RCAM (w/power)	\$2231	\$2254	\$2277	\$2310	\$2354	\$2374	\$2414	\$2478	\$2527	\$2585	\$2697	\$2817
GC3641WRCA (wood)	\$669	\$701	\$732	\$773	\$833	\$860	\$914	\$998	\$1068	\$1139	\$1290	\$1452
GC3641WRCAM (w/power)	\$1924	\$1955	\$1986	\$2028	\$2085	\$2114	\$2168	\$2254	\$2322	\$2396	\$2545	\$2706

Specify armcap: wood or Urethane.	OVERALL DIMENSIONS			SEAT DIMENSIONS			BACK DIMENSIONS	
	W	D	H	W	D	H	W	H

For use in **right** side finished position of lounge seating units.  
 • Models GC3641RCAM and GC3641WRCAM have **power/USB module**  
**Does not allow linking to other units or tables.**  
 Urethane armcap option - **Add \$53 list upcharge**

3.5	29	25.25	-	-	-	-	-
-----	----	-------	---	---	---	---	---

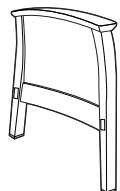

**Lounge Left End Frame, Closed Arm, Laminate Panel**  
 COM Yardage: --  
 Freight Class: 100  
 Product Weight (lbs.): 18  
 Cubic Feet Per Carton: 2.1

List Price	
GC3641LCAL	\$1090

Metal

Specify armcap: wood or Urethane.	OVERALL DIMENSIONS			SEAT DIMENSIONS			BACK DIMENSIONS	
	W	D	H	W	D	H	W	H

For use in **left** side finished position of lounge seating units.

**Does not allow linking to other units or tables.**  
 Urethane armcap option - **Add \$53 list upcharge**

3.5	29	25.25	-	-	-	-	-
-----	----	-------	---	---	---	---	---

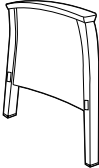
DESCRIPTION	MODEL# / FEATURES	STANDARD TEXTILE GRADES											
		List Price											
	<b>GC3641RCAL</b> Metal	<b>\$1090</b>											
	Specify armcap: wood or Urethane.	<b>OVERALL DIMENSIONS</b>			<b>SEAT DIMENSIONS</b>			<b>BACK DIMENSIONS</b>					
		<b>W</b>	<b>D</b>	<b>H</b>	<b>W</b>	<b>D</b>	<b>H</b>	<b>W</b>	<b>H</b>				
<b>Lounge Right End Frame, Closed Arm, Laminate Panel</b> COM Yardage: -- Freight Class: 100 Product Weight (lbs.): 18 Cubic Feet Per Carton: 2.1	For use in <b>right</b> side finished position of lounge seating units.  <b>Does not allow linking to other units or tables.</b> Urethane armcap option - <b>Add \$53 list upcharge</b>	3.5	29	25.25									
		List price											
	<b>GC36406LA</b> (metal)	<b>\$767</b>											
	<b>GC36406WLA</b> (wood)	<b>\$517</b>											
	Specify armcap: wood or Urethane.	<b>OVERALL DIMENSIONS</b>			<b>SEAT DIMENSIONS</b>			<b>BACK DIMENSIONS</b>					
		<b>W</b>	<b>D</b>	<b>H</b>	<b>W</b>	<b>D</b>	<b>H</b>	<b>W</b>	<b>H</b>				
<b>Lounge Center Frame, Open Arm</b> COM Yardage: -- Freight Class: 300 Product Weight (lbs.): metal: 2.24   wood: 11 Cubic Feet Per Carton: 2.1	For linking lounge top seating units together only.  Urethane armcap option - <b>Add \$53 list upcharge</b>	3.5	29	25.25	-	-	-	-	-				
		COM	2	3	4	5	6	7	8	9	10	11	12
	<b>GC36406LCA</b> (metal)	<b>\$978</b>	<b>\$1001</b>	<b>\$1026</b>	<b>\$1057</b>	<b>\$1103</b>	<b>\$1124</b>	<b>\$1161</b>	<b>\$1226</b>	<b>\$1277</b>	<b>\$1333</b>	<b>\$1445</b>	<b>\$1565</b>
	<b>GC36406WLCA</b> (wood)	<b>\$669</b>	<b>\$701</b>	<b>\$734</b>	<b>\$774</b>	<b>\$833</b>	<b>\$861</b>	<b>\$915</b>	<b>\$1000</b>	<b>\$1068</b>	<b>\$1142</b>	<b>\$1291</b>	<b>\$1453</b>
	Specify armcap: wood or Urethane.	<b>OVERALL DIMENSIONS</b>			<b>SEAT DIMENSIONS</b>			<b>BACK DIMENSIONS</b>					
		<b>W</b>	<b>D</b>	<b>H</b>	<b>W</b>	<b>D</b>	<b>H</b>	<b>W</b>	<b>H</b>				
<b>Lounge Center Frame, Closed Arm</b> COM Yardage: 0.75 Freight Class: 150 Product Weight (lbs.): metal: 8.87   wood: 11 Cubic Feet Per Carton: 2.1	For linking lounge top seating units together only.  Urethane armcap option - <b>Add \$53 list upcharge</b>	3.5	29	25.25	-	-	-	-	-				
		List price											
	<b>GC36406TLA</b> (metal)	<b>\$767</b>											
	<b>GC36406WTLA</b> (wood)	<b>\$517</b>											
	Specify armcap: wood or Urethane.	<b>OVERALL DIMENSIONS</b>			<b>SEAT DIMENSIONS</b>			<b>BACK DIMENSIONS</b>					
		<b>W</b>	<b>D</b>	<b>H</b>	<b>W</b>	<b>D</b>	<b>H</b>	<b>W</b>	<b>H</b>				
<b>Lounge Center Frame, Open Arm</b> COM Yardage: -- Freight Class: 300 Product Weight (lbs.): metal: 11   wood: 11 Cubic Feet Per Carton: 2.1	For linking lounge top seating units to modular table on the <b>left</b> side of the frame.  Urethane armcap option - <b>Add \$53 list upcharge</b>	3.5	29	25.25	-	-	-	-	-				
		List price											
	<b>GC36406TRA</b> (metal)	<b>\$767</b>											
	<b>GC36406WTRA</b> (wood)	<b>\$517</b>											
	Specify armcap: wood or Urethane.	<b>OVERALL DIMENSIONS</b>			<b>SEAT DIMENSIONS</b>			<b>BACK DIMENSIONS</b>					
		<b>W</b>	<b>D</b>	<b>H</b>	<b>W</b>	<b>D</b>	<b>H</b>	<b>W</b>	<b>H</b>				
<b>Lounge Center Frame, Open Arm</b> COM Yardage: -- Freight Class: 300 Product Weight (lbs.): metal: 11   wood: 11 Cubic Feet Per Carton: 2.1	For linking lounge top seating units to modular table on the <b>right</b> side of the frame.  Urethane armcap option - <b>Add \$53 list upcharge</b>	3.5	29	25.25	-	-	-	-	-				



DESCRIPTION	MODEL# / FEATURES	STANDARD TEXTILE GRADES											
		COM	2	3	4	5	6	7	8	9	10	11	12
 <p><b>Lounge Center Frame, Closed Arm</b> COM Yardage: 0.75 Freight Class: 150 Product Weight (lbs.): metal: 8.87   wood: 11 Cubic Feet Per Carton: 2.1</p>	GC36406TLCA (metal)	\$978	\$1001	\$1026	\$1057	\$1103	\$1124	\$1161	\$1226	\$1277	\$1333	\$1445	\$1565
	GC36406WTLCA (wood)	\$669	\$701	\$734	\$774	\$833	\$861	\$915	\$1000	\$1068	\$1142	\$1291	\$1453
	Specify armcap: wood or Urethane.	<b>OVERALL DIMENSIONS</b>			<b>SEAT DIMENSIONS</b>			<b>BACK DIMENSIONS</b>					
		<b>W</b>	<b>D</b>	<b>H</b>	<b>W</b>	<b>D</b>	<b>H</b>	<b>W</b>	<b>H</b>				
	3.5	29	25.25	-	-	-	-	-					
	Urethane armcap option - <b>Add \$53 list upcharge</b>												
 <p><b>Lounge Center Frame, Closed Arm</b> COM Yardage: 0.75 Freight Class: 150 Product Weight (lbs.): metal: 8.87   wood: 11 Cubic Feet Per Carton: 2.1</p>	GC36406TRCA (metal)	\$978	\$1001	\$1026	\$1057	\$1103	\$1124	\$1161	\$1226	\$1277	\$1333	\$1445	\$1565
	GC36406WTRCA (wood)	\$669	\$701	\$734	\$774	\$833	\$861	\$915	\$1000	\$1068	\$1142	\$1291	\$1453
	Specify armcap: wood or SSU.	<b>OVERALL DIMENSIONS</b>			<b>SEAT DIMENSIONS</b>			<b>BACK DIMENSIONS</b>					
		<b>W</b>	<b>D</b>	<b>H</b>	<b>W</b>	<b>D</b>	<b>H</b>	<b>W</b>	<b>H</b>				
	3.5	29	25.25	-	-	-	-	-					
	Urethane armcap option - <b>Add \$53 list upcharge</b>												
 <p><b>Center Frame, Fully Upholstered Arm</b> COM Yardage: 1.75 Freight Class: 150 Product Weight (lbs.): 35 Cubic Feet Per Carton: 6</p>	GC3676CFA	\$617	\$675	\$727	\$800	\$901	\$951	\$1043	\$1191	\$1307	\$1434	\$1695	\$1973
	Specify leg finish: wood or SSU.	<b>OVERALL DIMENSIONS</b>			<b>SEAT DIMENSIONS</b>			<b>BACK DIMENSIONS</b>					
	Optional wood or Urethane armcap. Please specify. Add \$206.	<b>W</b>	<b>D</b>	<b>H</b>	<b>W</b>	<b>D</b>	<b>H</b>	<b>W</b>	<b>H</b>				
		5	29	25.25	-	-	-	-	-				
	For <b>linking</b> lounge top seating units together or to modular table.												
 <p><b>Left End Frame, Fully Upholstered Arm</b> COM Yardage: 1.75 Freight Class: 250 Product Weight (lbs.): 20 Cubic Feet Per Carton: 6</p>	GC3676LA	\$617	\$675	\$727	\$800	\$901	\$951	\$1043	\$1191	\$1307	\$1434	\$1695	\$1973
	Specify leg finish: wood or Urethane.	<b>OVERALL DIMENSIONS</b>			<b>SEAT DIMENSIONS</b>			<b>BACK DIMENSIONS</b>					
	Optional wood or Urethane armcap. Please specify. Add \$206.	<b>W</b>	<b>D</b>	<b>H</b>	<b>W</b>	<b>D</b>	<b>H</b>	<b>W</b>	<b>H</b>				
		5	29	25.25	-	-	-	-	-				
	For use in <b>left</b> side finished position of lounge seating units. <b>Does not allow linking to other units or tables.</b>												
 <p><b>Right End Frame, Fully Upholstered Arm</b> COM Yardage: 1.75 Freight Class: 250 Product Weight (lbs.): 20 Cubic Feet Per Carton: 6</p>	GC3676RA	\$617	\$675	\$727	\$800	\$901	\$951	\$1043	\$1191	\$1307	\$1434	\$1695	\$1973
	Specify leg finish: wood or Urethane.	<b>OVERALL DIMENSIONS</b>			<b>SEAT DIMENSIONS</b>			<b>BACK DIMENSIONS</b>					
	Optional wood or Urethane armcap. Please specify. Add \$206.	<b>W</b>	<b>D</b>	<b>H</b>	<b>W</b>	<b>D</b>	<b>H</b>	<b>W</b>	<b>H</b>				
		5	29	25.25	-	-	-	-	-				
	For use in <b>right</b> side finished position of lounge seating units. <b>Does not allow linking to other units or tables.</b>												

**Modular tables for use with modular lounge and fully upholstered lounge units:**

Tops are 1" thick.

**Wooden leg tables:**

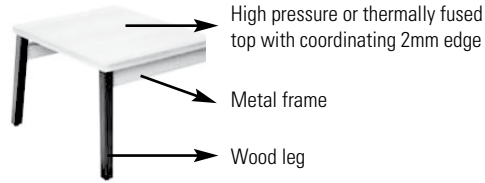

**Metal leg tables:**

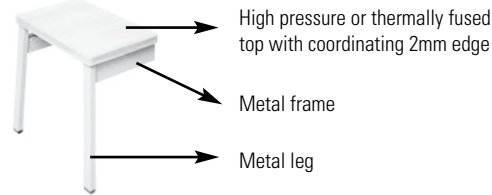

**Table top finishes:**

**Thermally Fused Laminate (LP)**

- Absolute Acajou (ACJ)
- Asian Night (ASN)
- Avant Cherry (AWC)
- Avant Honey (AWH)
- Blizzard (BZD)
- Brushed Cobalt (BRC)
- Clear Maple (CMB)
- Custom Grey (CGY)
- Dark Espresso (DES)
- Designer White (DWT)
- Fashionista (FAS)
- First Class (FCL)
- Noce Biondo (NBL)
- Noce Grigio (NGL)
- Noce Leggero (NEL)
- Noce Medio (NML)
- Quartered Mahogany (QTM)
- Sheer Beauty (SBY)
- Stonedust (SDT)
- Walnut Heights (WHE)
- White Chocolate (WHC)
- Winter Cherry (WCR)

**High Pressure Laminate (HP)**

- Absolute Acajou (ACJ)
- Asian Night (ASN)
- Avant Cherry (W357)
- Avant Honey (W356)
- Blizzard (BZD)
- Brushed Cobalt (BRC)
- Clear Maple (CMB)
- Custom Grey (CGY)
- Dark Espresso (W142)
- Designer White (DWT)
- Fashionista (FAS)
- First Class (FCL)
- Noce Biondo (NBL)
- Noce Grigio (NGL)
- Noce Leggero (NEL)
- Noce Medio (NML)
- Quartered Mahogany (QTM)
- Sheer Beauty (SBY)
- Stonedust (SDT)
- Walnut Heights (WHE)
- White Chocolate (WHC)
- Winter Cherry (WCR)

**Wood leg finishes (top, base, legs & apron):**

- Absolute (AAM)
- Charcoal Java (CJM)
- Cherry (ACM)
- Empire Mahogany (EMM)
- English Oak (EOM)
- Espresso Cafe (ECM)
- Fruitwood (TFM)
- Gray (HGM)
- Harvest Oak (HOM)
- Honey (AHM)
- Jet Onyx (JOM)
- Light Honey (LHM)
- Mahogany (TMM)
- Maple (AVM)
- Medium Walnut (MWM)
- Natural Walnut (NLW)
- Night (ASM)
- Noce Biondo (NBM)
- Noce Grigio (NGM)
- Noce Leggero (NEM)
- Noce Medio (NMM)
- Sandy Beach (SBM)
- Shaker Cherry (SKM)
- Silver Oak (SOM)
- Walnut (TWM)
- White (WHM)
- WC Cream (WTM)
- Winter Cherry (WCM)

**Metal leg finishes:**

Black (TBL), Cloud (TIV), Designer White (TDW), Fog (TFO), Frost (TFR), Kalua (TKA), Latte (TLA), Mocha (TMO), Nevada (TNE), Sand (TSN), Shadow (TSH), Toast (TOA) and Tungsten (TTU).

**Metal frame finishes:**

Black (TBL), Cloud (TIV), Designer White (TDW), Fog (TFO), Frost (TFR), Kalua (TKA), Latte (TLA), Mocha (TMO), Nevada (TNE), Sand (TSN), Shadow (TSH), Toast (TOA) and Tungsten (TTU).

**Power/USB modules:**



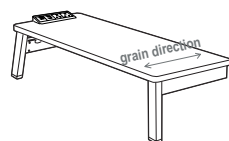

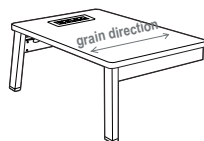

For modular tables with power/USB module, refer to models ending in "M". Module includes two power outlets, four USB charging ports and a 6 foot long power cord. Available in Black or White (must be specified at time of order). Power module is mounted **on surface** on narrow tables; mounted **in surface** on larger tables.



On surface power module on narrow tables





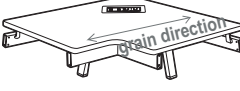

In surface power module on larger tables

DESCRIPTION	MODEL# / FEATURES	STANDARD TEXTILE GRADES				
	GC36401-LP	28 x 20.25 x 13	125	23	3.5	<b>\$1060</b>
	GC36401M-LP With power					<b>\$2240</b>
	GC36401-HP	28 x 20.25 x 13	125	23	3.5	<b>\$1105</b>
	GC36401M-HP With power					<b>\$2288</b>
<b>Center Table</b>	<ul style="list-style-type: none"> <li>• For a thermally fused laminate top (LP), specify model GC36401-LP.</li> <li>• For a high pressure laminate top (HP), specify model GC36401-HP.</li> <li>• Models GC36401M-LP and GC36401M-HP have <b>power/USB</b> module mounted in surface.</li> </ul> <p>Coordinating 2mm edge. Regular center table for <b>wood or metal lounge</b> frame. Must be connected to full arm and leg with <b>lounge</b> frames (GC36406TLA/TRA, GC36406TLCA/TRCA, GC36406WTLA/TRA, GC36406WTLCA/TRCA). 1 per carton.</p>					
	GC36402-LP	28 x 12 x 13	100	20	2.1	<b>\$1011</b>
	GC36402M-LP With power					<b>\$2195</b>
	GC36402-HP	28 x 12 x 13	100	20	2.1	<b>\$1060</b>
	GC36402M-HP With power					<b>\$2240</b>
<b>Narrow Center Table</b>	<ul style="list-style-type: none"> <li>• For a thermally fused laminate top (LP), specify model GC36402-LP.</li> <li>• For a high pressure laminate top (HP), specify model GC36402-HP.</li> <li>• Models GC36402M-LP and GC36402M-HP have <b>power/USB</b> module mounted in surface.</li> </ul> <p>Coordinating 2mm edge. Narrow center table for <b>wood or metal lounge</b> frame. Must be connected to full arm and leg with <b>lounge</b> frames (GC36406TLA/TRA, GC36406TLCA/TRCA, GC36406WTLA/TRA, GC36406WTLCA/TRCA). 1 per carton.</p>					
	GC36403WL-LP	37.12 x 37.12 x 13	125	46	6	<b>\$1808</b>
	GC36403WLM-LP With power					<b>\$2993</b>
	GC36403WL-HP	37.12 x 37.12 x 13	125	46	6	<b>\$1915</b>
	GC36403WLM-HP With power					<b>\$3098</b>
<b>Left Corner Table, Wood Legs</b>	<ul style="list-style-type: none"> <li>• For a thermally fused laminate top (LP), specify model GC36403WL-LP.</li> <li>• For a high pressure laminate top (HP), specify model GC36403WL-HP.</li> <li>• Models GC36403WLM-LP and GC36403WLM-HP have <b>power/USB</b> module mounted in surface.</li> </ul> <p>Coordinating 2mm edge. Must be connected to full arm and leg with <b>wood lounge</b> frames (GC36406WTLA/TRA, GC36406WTLCA/TRCA). This table allows for kneespace when specifying chairs in a corner position. 1 per carton.</p> <ul style="list-style-type: none"> <li>• Includes 2 rear wood legs (not shown).</li> </ul>					
	GC36403L-LP	37.12 x 37.12 x 13	125	46	6	<b>\$1902</b>
	GC36403LM-LP With power					<b>\$3083</b>
	GC36403L-HP	37.12 x 37.12 x 13	125	46	6	<b>\$2009</b>
	GC36403LM-HP With power					<b>\$3192</b>
<b>Left Corner Table, Metal Legs</b>	<ul style="list-style-type: none"> <li>• For a thermally fused laminate top (LP), specify model GC36403L-LP.</li> <li>• For a high pressure laminate top (HP), specify model GC36403L-HP.</li> <li>• Models GC36403LM-LP and GC36403LM-HP have <b>power/USB</b> module mounted in surface.</li> </ul> <p>Coordinating 2mm edge. Must be connected to full arm and leg with <b>metal lounge</b> frames (GC36406TLA/TRA, GC36406TLCA/TRCA). This table allows for kneespace when specifying chairs in a corner position. 1 per carton.</p> <ul style="list-style-type: none"> <li>• Includes 2 rear metal legs (not shown).</li> </ul>					

# SEATING

# PRIMACARE™ MODULAR - LOUNGE P

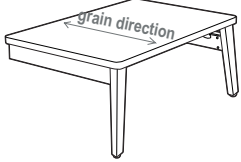
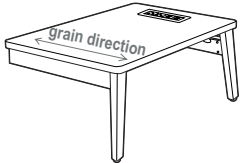
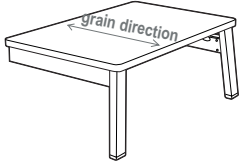
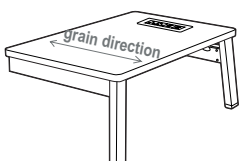
DESCRIPTION	MODEL# / FEATURES	STANDARD TEXTILE GRADES				
	GC36403WR-LP	37.12 x 37.12 x 13	125	46	6	<b>\$1808</b>
	GC36403WRM-LP With power					<b>\$2993</b>
	GC36403WR-HP	37.12 x 37.12 x 13	125	46	6	<b>\$1915</b>
	GC36403WRM-HP With power					<b>\$3098</b>
<b>Right Corner Table, Wood Legs</b>	<p>Coordinating 2mm edge. Must be connected to full arm and leg with <b>wood lounge</b> frames (GC36406WTLA/TRA, GC36406WTLCA/TRCA). This table allows for kneespace when specifying chairs in a corner position. 1 per carton.</p> <ul style="list-style-type: none"> <li>For a thermally fused laminate top (LP), specify model GC36403WR-LP.</li> <li>For a high pressure laminate top (HP), specify model GC36403WR-HP.</li> <li>Models GC36403WRM-LP and GC36403WRM-HP have <b>power/USB</b> module mounted in surface.</li> </ul>					
	GC36403R-LP	37.12 x 37.12 x 13	125	46	6	<b>\$1902</b>
	GC36403RM-LP With power					<b>\$3083</b>
	GC36403R-HP	37.12 x 37.12 x 13	125	46	6	<b>\$2009</b>
	GC36403RM-HP With power					<b>\$3192</b>
<b>Right Corner Table, Metal Legs</b>	<p>Coordinating 2mm edge. Must be connected to full arm and leg with <b>metal lounge</b> frames (GC36406TLA/TRA, GC36406TLCA/TRCA). This table allows for kneespace when specifying chairs in a corner position. 1 per carton.</p> <ul style="list-style-type: none"> <li>For a thermally fused laminate top (LP), specify model GC36403R-LP.</li> <li>For a high pressure laminate top (HP), specify model GC36403R-HP.</li> <li>Models GC36403RM-LP and GC36403RM-HP have <b>power/USB</b> module mounted in surface.</li> </ul>					
	GC36404WL-LP	28 x 20.25 x 13	125	23	3.5	<b>\$1416</b>
	GC36404WLM-LP With power					<b>\$2600</b>
	GC36404WL-HP	28 x 20.25 x 13	125	23	3.5	<b>\$1471</b>
	GC36404WLM-HP With power					<b>\$2654</b>
<b>Left End Table, Wood Legs</b>	<p>Coordinating 2mm edge. Must be connected to full arm and leg with <b>wood lounge</b> frames (GC36406WTLA or GC36406WTLCA). 1 per carton.</p> <ul style="list-style-type: none"> <li>For a thermally fused laminate top (LP), specify model GC36404WL-LP.</li> <li>For a high pressure laminate top (HP), specify model GC36404WL-HP.</li> <li>Models GC36404WLM-LP and GC36404WLM-HP have <b>power/USB</b> module mounted in surface.</li> </ul>					
	GC36404L-LP	28 x 20.25 x 13	125	23	3.5	<b>\$1511</b>
	GC36404LM-LP With power					<b>\$2692</b>
	GC36404L-HP	28 x 20.25 x 13	125	23	3.5	<b>\$1563</b>
	GC36404LM-HP With power					<b>\$2745</b>
<b>Left End Table, Metal Legs</b>	<p>Coordinating 2mm edge. Must be connected to full arm and leg with <b>metal lounge</b> frames (GC36406TLA or GC36406TLCA). 1 per carton.</p> <ul style="list-style-type: none"> <li>For a thermally fused laminate top (LP), specify model GC36404L-LP.</li> <li>For a high pressure laminate top (HP), specify model GC36404L-HP.</li> <li>Models GC36404LM-LP and GC36404LM-HP have <b>power/USB</b> module mounted in surface.</li> </ul>					

MODULAR TABLES

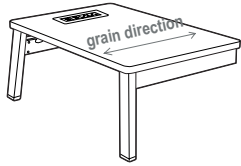
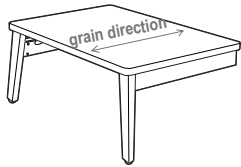

Right End Table, Wood Legs

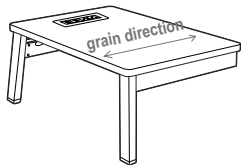
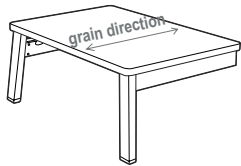

Right End Table, Metal Legs

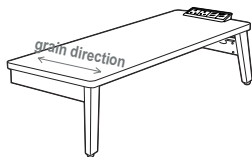
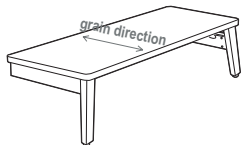

Narrow Left End Table, Wood Legs

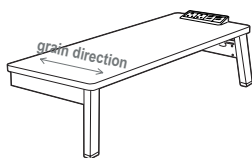
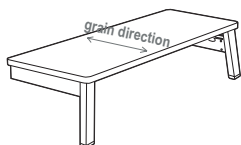

Narrow Left End Table, Metal Legs

MODEL# DIMENSIONS FREIGHT CLASS WT/LBS. CUBIC FT. LIST PRICE

D x W x H

GC36404WR-LP	28 x 20.25 x 13	125	23	3.5	<b>\$1416</b>
GC36404WRM-LP					<b>\$2600</b>
With power					

GC36404WR-HP	28 x 20.25 x 13	125	23	3.5	<b>\$1471</b>
GC36404WRM-HP					<b>\$2654</b>
With power					

- For a thermally fused laminate top (LP), specify model GC36404WR-LP.
- For a high pressure laminate top (HP), specify model GC36404WR-HP.

- Models GC36404WRM-LP and GC36404WRM-HP have **power/USB** module mounted in surface.

Coordinating 2mm edge. Must be connected to full arm and leg with **wood lounge** frames (GC36406WTRA or GC36406WTRCA). 1 per carton.

GC36404R-LP	28 x 20.25 x 13	125	23	3.5	<b>\$1511</b>
GC36404RM-LP					<b>\$2692</b>
With power					

GC36404R-HP	28 x 20.25 x 13	125	23	3.5	<b>\$1563</b>
GC36404RM-HP					<b>\$2745</b>
With power					

- For a thermally fused laminate top (LP), specify model GC36404R-LP.
- For a high pressure laminate top (HP), specify model GC36404R-HP.

- Models GC36404RM-LP and GC36404RM-HP have **power/USB** module mounted in surface.

Coordinating 2mm edge. Must be connected to full arm and leg with **metal lounge** frames (GC36406TRA or GC36406TRCA). 1 per carton.

GC36405WL-LP	28 x 12 x 13	100	20	2.1	<b>\$1358</b>
GC36405WLM-LP					<b>\$2538</b>
With power					

GC36405WL-HP	28 x 12 x 13	100	20	2.1	<b>\$1404</b>
GC36405WLM-HP					<b>\$2585</b>
With power					

- For a thermally fused laminate top (LP), specify model GC36405WL-LP.
- For a high pressure laminate top (HP), specify model GC36405WL-HP.

- Models GC36405WLM-LP and GC36405WLM-HP have **power/USB** module mounted on surface.

Coordinating 2mm edge. Must be connected to full arm and leg with **wood lounge** frames (GC36406WTLA or GC36406WTLCA). 1 per carton.

GC36405L-LP	28 x 12 x 13	100	20	2.1	<b>\$1449</b>
GC36405LM-LP					<b>\$2632</b>
With power					

GC36405L-HP	28 x 12 x 13	100	20	2.1	<b>\$1497</b>
GC36405LM-HP					<b>\$2680</b>
With power					

- For a thermally fused laminate top (LP), specify model GC36405L-LP.
- For a high pressure laminate top (HP), specify model GC36405L-HP.

- Models GC36405LM-LP and GC36405LM-HP have **power/USB** module mounted on surface.

Coordinating 2mm edge. Must be connected to full arm and leg with **metal lounge** frames (GC36406TLA or GC36406TLCA). 1 per carton.

MODULAR TABLES

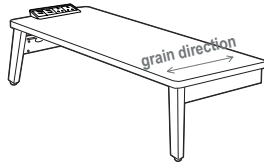
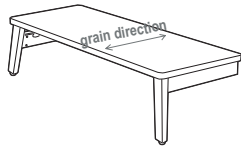

**Narrow Right End Table, Wood Legs**

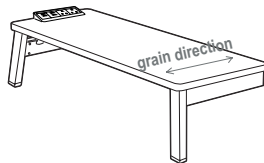
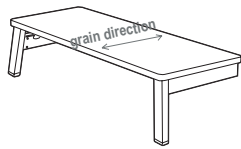

**Narrow Right End Table, Metal Legs**

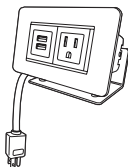

**On Surface Power/Data Module**

MODEL# DIMENSIONS FREIGHT CLASS WT/LBS. CUBIC FT. LIST PRICE

D x W x H

GC36405WR-LP	28 x 12 x 13	100	20	2.1	<b>\$1358</b>
GC36405WRM-LP					<b>\$2538</b>
With power					

GC36405WR-HP	28 x 12 x 13	100	20	2.1	<b>\$1404</b>
GC36405WRM-HP					<b>\$2585</b>
With power					

- For a thermally fused laminate top (LP), specify model GC36405WR-LP.
- For a high pressure laminate top (HP), specify model GC36405WR-HP.

- Models GC36405WRM-LP and GC36405WRM-HP have **power/USB** module mounted on surface.

Coordinating 2mm edge. Must be connected to full arm and leg with **wood lounge** frames (GC36406WTRA or GC36406WTRCA). 1 per carton.

GC36405R-LP	28 x 12 x 13	100	20	2.1	<b>\$1449</b>
GC36405RM-LP					<b>\$2632</b>
With power					

GC36405R-HP	28 x 12 x 13	100	20	2.1	<b>\$1497</b>
GC36405RM-HP					<b>\$2680</b>
With power					

- For a thermally fused laminate top (LP), specify model GC36405R-LP.
- For a high pressure laminate top (HP), specify model GC36405R-HP.

- Models GC36405RM-LP and GC36405RM-HP have **power/USB** module mounted on surface.

Coordinating 2mm edge. Must be connected to full arm and leg with **metal lounge** frames (GC36406TRA or GC36406TRCA). 1 per carton.

GC36410	-- x -- x --	250	2	1	<b>\$735</b>
---------	--------------	-----	---	---	--------------

Surface top mount power/data module with one power outlet, two USB charging ports. 6 foot cord. White. Can be mounted to all freestanding and modular tables.





Meet River+™, the next generation of our highly popular River lounge series. Now with industry-leading support for workplace, education and healthcare, River+ performs at three times the BIFMA standard for true 24/7 applications in demanding environments. All models have been active weight tested to 600 lbs. including bariatric use. Multiple back and seat heights, 120-degree configurations and modular Aluminum arms are just a few of the many options that will make it yours.

To see the full River+ series, please refer to the Seating price list at: [globalfurnituregroup.com/workplace/resources/price-lists](http://globalfurnituregroup.com/workplace/resources/price-lists)

#### Features and Benefits

- A modular series that is composed of straight, curved and corner lounge sections, a wide assortment of benches and tables, and media hearths.
- Lounge and linking tables can be linked together in any combination to create a wide variety of layouts. Ganging hardware is standard and is factory installed. Ganging hardware swivels out of the way when not in use.
- Seating frames are constructed of heavy duty plywood, and are made for active environments. Seats are high density with highly resilient foam.
- River+ seating is rated for an active weight up to 600 lbs. per seat and 24/7 use.
- For 24/7 use and/or heavy duty application use, Global's Heavy Duty warranty is only on models specified with performance textiles, rated for 150,000 double rubs or more.
- A clean-out gap is created by seat-to-back connector brackets available in three finishes.
- The tapered legs are made of welded steel. The standard leg height is 6.5" with optional 3" and 8" legs available on select models. The leg height makes it easy to clean under the product.
- Modular, polished Aluminum loop arms can be relocated and retrofit to support changing layouts.
- A back shelf is available on most units in many laminate finishes.
- For improved safety, housekeeping and infection control, optional features include: sealed seams, sealed seat underside, and tamperproof bottom enclosures.
- For easy user access, optional power units are available for specification in a variety of locations across most River+ lounges, benches, and tables.
- For environmental certifications, please visit [globalfurnituregroup.com](http://globalfurnituregroup.com).

## SENATOR



model GC3392

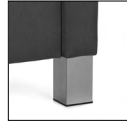

### STANDARD FEATURES

- The flared back design and creative curves enhance any healthcare environment without sacrificing comfort.
- Waterfall seamless front upholstered design with removable seat cushions for easy cleaning and protecting against bacteria.
- For added comfort, seats are standard with high density foam.
- Standard with wood legs.
- For healthcare textiles and wood finish options, visit the website at [globalfurnituregroup.com](http://globalfurnituregroup.com).
- Can be upholstered in standard Global textiles if healthcare compliance is not required.
- Shipped fully assembled.

### OPTIONAL FEATURES

- Optional metal legs are available in Black (TBL), Kalua (TKA), Latte (TLA), Mocha (TMO), Shadow (TSH), Toast (TOA) and Tungsten (TTU). Please specify. No upcharge.
- For non-slip glides, specify (NS) - Add \$35.
- For moisture barrier on seat, please specify (MB). Add \$193 per seat.

### SUGGESTED APPLICATIONS

- Lobbies
- Lounge/Waiting
- Patient rooms
- Resident rooms

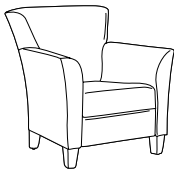
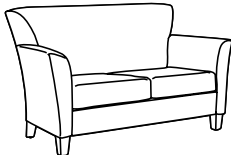
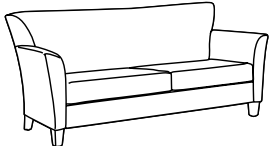
DESCRIPTION	MODEL# / FEATURES	STANDARD TEXTILE GRADES											
		COM	2	3	4	5	6	7	8	9	10	11	12
 <p><b>Armchair</b> COM Yardage: 5.25 Freight Class: 250 Product Weight (lbs.): 66 Cubic Feet Per Carton: 28.5</p>	GC3391	\$2716	\$2873	\$3155	\$3368	\$3674	\$3787	\$4054	\$4551	\$4802	\$5266	\$5912	\$6704
	Active weight 300lbs.	OVERALL DIMENSIONS			SEAT DIMENSIONS			BACK DIMENSIONS					
		W	D	H	W	D	H	W	H				
		34	32.25	36	19.5	19	17.5	28	18.5				
 <p><b>Two Seat Sofa</b> COM Yardage: 8.25 Freight Class: 300 Product Weight (lbs.): 100 Cubic Feet Per Carton: 55.75</p>	GC3392	\$3820	\$4073	\$4495	\$4832	\$5309	\$5490	\$5908	\$6690	\$7082	\$7812	\$8827	\$10073
	Active weight 300lbs./seat.	OVERALL DIMENSIONS			SEAT DIMENSIONS			BACK DIMENSIONS					
		W	D	H	W	D	H	W	H				
		61	32.25	36	46	19	17.5	56	18.5				
 <p><b>Three Seat Sofa</b> COM Yardage: 9.5 Freight Class: 250 Product Weight (lbs.): 125 Cubic Feet Per Carton: 62.25</p>	GC3393	\$4932	\$5218	\$5730	\$6120	\$6668	\$6875	\$7355	\$8259	\$8710	\$9551	\$10717	\$12156
	Active weight 300lbs./seat.	OVERALL DIMENSIONS			SEAT DIMENSIONS			BACK DIMENSIONS					
		W	D	H	W	D	H	W	H				
		76	32.25	36	61	19	17.5	71	18.5				



SLEEP-EEZ



model GC3614

STANDARD FEATURES

- Sleep-Eez provides incredible comfort, requires zero wall clearance and can be easily opened and closed by one person.
- It can be adjusted to create three functional positions: a chair, a chaise lounge and a sleep surface.
- The heavy duty steel mechanism will provide long-term performance.
- Commercial grade casters are standard. Front casters are non-swivel manual locking. Back casters are non-locking and swivel for better steering when moving the chair.
- Clean out space is provided between the seat and back cushions for housekeeping and infection prevention control.
- Sleep-Eez's construction allows for on-site replacement of all components, eliminating down time and enhancing the product's life.
- Standard with Black urethane fully extended arms with a grip for ease of entry and exit from chair.
- For healthcare textile options, visit the website at [www.globalfurnituregroup.com](http://www.globalfurnituregroup.com).
- Can be upholstered in standard Global textiles if healthcare compliance is not required.
- Ships fully assembled.
- Measurements:  
Chair: 34.5"W x 37"D x 34.25"H  
Chaise lounge: 34.5"W x 64"D x 34.25"H  
Sleep surface: 24"W x 77"D

OPTIONAL FEATURES

- For moisture barrier on seat, please specify **(MB)**. Add \$193.
- To add sealed seams to your product, please specify **(SS)**. Add \$343.

SUGGESTED APPLICATIONS

- Lobbies
- Lounge/Waiting
- Office/Meeting
- Patient rooms
- Resident rooms
- Treatment/Exam rooms

Please add option codes in the following order:

- **Model number**  
**GC3614** Single sleeper chair
- **Textile**  
Specify fabric code.
- **Armcap finish**  
**(SS)** Black Urethane armcap  
**(KL)** Kalua Urethane armcap  
**(LT)** Latte Urethane armcap  
**(MC)** Mocha Urethane armcap  
**(SW)** Shadow Urethane armcap  
**(TO)** Toast Urethane armcap  
**(AB)** Absolute wood armcap  
**(CJ)** Charcoal Java wood armcap  
**(AC)** Cherry wood armcap  
**(EP)** Empire Mahogany wood armcap  
**(EM)** English Oak wood armcap  
**(EC)** Espresso Cafe wood armcap  
**(HG)** Gray wood armcap  
**(HA)** Harvest Oak wood armcap  
**(AH)** Honey wood armcap  
**(JO)** Jet Onyx wood armcap  
**(LH)** Light Honey wood armcap  
**(AV)** Maple wood armcap  
**(MW)** Medium Walnut wood armcap  
**(NL)** Natural Walnut wood armcap  
**(AT)** Night wood armcap  
**(BI)** Noce Biondo wood armcap  
**(GI)** Noce Grigio wood armcap  
**(EI)** Noce Leggero wood armcap  
**(MI)** Noce Medio wood armcap  
**(SB)** Sandy Beach wood armcap  
**(SK)** Shaker Cherry wood armcap  
**(SM)** Silver Oak wood armcap  
**(TF)** Tiger Fruitwood wood armcap  
**(TM)** Tiger Mahogany wood armcap  
**(TL)** Tiger Walnut wood armcap  
**(WR)** WC Cream wood armcap  
**(WH)** White wood armcap  
**(WC)** Winter Cherry wood armcap
- **Moisture Barrier**  
**(MB)** Seat only
- **Sealed Seams**  
**(SS)** All sealed seams

EXAMPLE SLEEP-EEZ ORDER CODE:

GC3614	-LX21	-PT	-MB	-SS
Model #	Textile	Armcaps	Moisture Barrier	Sealed Seams

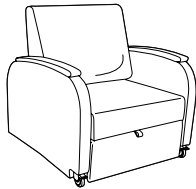
DESCRIPTION	MODEL#	STANDARD TEXTILE GRADES											
		COM	2	3	4	5	6	7	8	9	10	11	12
 <b>Single Sleeper Chair</b> COM Yardage: 8.5 Freight Class: 150 Product weight (lbs.): 160 Cubic Feet per Carton: 38	GC3614	\$4988	\$5281	\$5522	\$5875	\$6381	\$6616	\$7072	\$7798	\$8362	\$8986	\$10266	\$11634
	Active weight 350 lbs.												
		OVERALL DIMENSIONS			SEAT DIMENSIONS			BACK DIMENSIONS					
		W	D	H	W	D	H	W	H				
		35	37	35	27.5	21	17.5	27.5	18.5				

STRAND



model GC3707HB



model GC3702

FEATURES



- Strand is the perfect synthesis of versatility, comfort, durability and value pricing. Strand offers a pleasing look in a diverse range of solutions from single patient room chairs to waiting areas and public spaces.
- All models are standard in oval metal tube frame.
- Frame available in Black (**TBL**), Cloud (**TIV**), Designer White (**TDW**), Fog (**TFO**), Frost (**TFR**), Kalua (**TKA**), Latte (**TLA**), Mocha (**TMO**), Nevada (**TNE**), Sand (**TSN**), Shadow (**TSH**), Toast (**TOA**) and Tungsten (**TTU**).
- The frame can be weighted and made with tamper proof fasteners for greater security in more challenging mental health spaces or correctional facilities.
- Armcaps are standard in Black urethane.
- **Left and Right Position Reference** is determined based on being seated in the chair.
- The seat and back are removable and field replaceable.
- For added comfort, seats are standard with high density foam.
- All seat frames feature a wall saver design to prevent back contact with wall. Footstool and benches do not have wall saver legs.
- Standard seat height on all models is 18".
- Cleanout space is provided between the seat and back cushions for easy housekeeping.
- Standard with Black plastic glides.
- Select models are offered with rear tip and move wheels. To activate wheels, tilt the chair back so the casters are in contact with the floor. This feature makes it easy to relocate the chair while unoccupied.
- Flex back models allow the back to move in a soothing rocking motion.
- Active weight capacity for standard single seat is 350 lbs. and 750 lbs for bariatric seating.
- For healthcare textiles and finish options, visit the website at [www.globalfurnituregroup.com](http://www.globalfurnituregroup.com)
- Can be upholstered in standard Global textiles if healthcare compliance is not required.

OPTIONAL FEATURES

- Wood armcaps are also available in all healthcare wood seating finishes.  
Single Seat - Add \$179  
Two Seater - Add \$264.  
Three Seater - Add \$353.
- Non-marking White glides are available. Please specify (**WH**). No upcharge.
- For moisture barrier on seat, add **\$129** per seat. For bariatric models - Add **\$198** per seat.
- As an option, seams can be sealed to prevent penetration of fluids through the stitching. Contact Customer Care for approved textiles.  
For Low Back Models - Add \$75 per seat.  
For Low Back Bariatric Models - Add \$80 per seat.  
For High Back Models - Add \$87 per seat.  
For High Back Bariatric Models - Add \$90 per seat.  
For Split-Back models - Add \$131  
For Ottoman - Add \$23  
For Single Seat Bench - Add \$30  
For Two Seat Bench - Add \$59  
For Three Seat Bench - Add \$87
- For complementary tables, please refer to the GC-Belong **freestanding** tables, page 41 (*Not for use with GC-Belong table bridges.*)

SUGGESTED APPLICATIONS

- Bariatric seating (some models)
- Guest seating
- Lobbies
- Lounge/Waiting
- Patient rooms
- Resident rooms
- Treatment/Exam rooms

DESCRIPTION	MODEL#	STANDARD FABRIC GRADES											
		COM	2	3	4	5	6	7	8	9	10	11	12
 <b>Low Back Single Seat Armless Chair</b> COM Yardage: 1.75 Freight Class: 250 Product Weight (lbs.): 43 Cubic Feet Per Carton: 17.5	GC3700	\$1256	\$1314	\$1366	\$1439	\$1541	\$1581	\$1672	\$1844	\$1927	\$2086	\$2304	\$2574
		OVERALL DIMENSIONS			SEAT DIMENSIONS			BACK DIMENSIONS					
		W	D	H	W	D	H	W	H				
		24.5	27.5	34.5	22	18.5	18	21.5	17				
 <b>LB Single Seat Armchair</b> COM Yardage: 1.75 Freight Class: 250 Product Weight (lbs.): 48 Cubic Feet Per Carton: 17.5	GC3701	\$1498	\$1558	\$1610	\$1683	\$1785	\$1824	\$1916	\$2088	\$2171	\$2330	\$2548	\$2818
		OVERALL DIMENSIONS			SEAT DIMENSIONS			BACK DIMENSIONS					
		W	D	H	W	D	H	W	H				
		25.5	27.5	34.5	22	18.5	18	21.5	17				

Active weight 350 lbs.

Active weight 350 lbs.  
Wood armcap option - Add \$179

DESCRIPTION	MODEL#	STANDARD FABRIC GRADES											
		COM	2	3	4	5	6	7	8	9	10	11	12
 <p><b>LB Hip Armchair, Post Surgery</b>                      COM Yardage: 1.75                      Freight Class: 250                      Product Weight (lbs.): 53                      Cubic Feet Per Carton: 17.5</p> <p>Designed to immobilize the pelvis and hip joints after surgery.</p>	<b>GC3701-24</b>	<b>\$1836</b>	<b>\$1896</b>	<b>\$1948</b>	<b>\$2022</b>	<b>\$2123</b>	<b>\$2163</b>	<b>\$2254</b>	<b>\$2426</b>	<b>\$2511</b>	<b>\$2668</b>	<b>\$2887</b>	<b>\$3158</b>
	24" seat height												
	<b>OVERALL DIMENSIONS</b>	<b>SEAT DIMENSIONS</b>			<b>BACK DIMENSIONS</b>								
	<b>W D H</b>	<b>W</b>	<b>D</b>	<b>H</b>	<b>W</b>	<b>D</b>	<b>H</b>	<b>W</b>	<b>H</b>				
	25.5	27.5	40.5	22	18.5	24	21.5	17					
 <p><b>HB Single Seat Armchair</b>                      COM Yardage: 2                      Freight Class: 250                      Product Weight (lbs.): 53                      Cubic Feet Per Carton: 20</p> <p>Active weight 350 lbs.                      Wood armcap option - <b>Add \$179</b></p>	<b>GC3701HB</b>	<b>\$1727</b>	<b>\$1792</b>	<b>\$1853</b>	<b>\$1935</b>	<b>\$2054</b>	<b>\$2099</b>	<b>\$2201</b>	<b>\$2396</b>	<b>\$2492</b>	<b>\$2674</b>	<b>\$2924</b>	<b>\$3233</b>
	<b>OVERALL DIMENSIONS</b>	<b>SEAT DIMENSIONS</b>			<b>BACK DIMENSIONS</b>								
	<b>W D H</b>	<b>W</b>	<b>D</b>	<b>H</b>	<b>W</b>	<b>D</b>	<b>H</b>	<b>W</b>	<b>H</b>				
	25.5	27.5	42.5	22	18	18	21.5	25					
 <p><b>LB Two Seat Chair, No Center Arm</b>                      COM Yardage: 3.25                      Freight Class: 300                      Product Weight (lbs.): 68                      Cubic Feet Per Carton: 43</p> <p>Active weight 350 lbs./seat                      Wood armcap option - <b>Add \$179</b></p>	<b>GC3702</b>	<b>\$2363</b>	<b>\$2473</b>	<b>\$2567</b>	<b>\$2705</b>	<b>\$2895</b>	<b>\$2967</b>	<b>\$3136</b>	<b>\$3449</b>	<b>\$3607</b>	<b>\$3901</b>	<b>\$4311</b>	<b>\$4814</b>
	<b>OVERALL DIMENSIONS</b>	<b>SEAT DIMENSIONS</b>			<b>BACK DIMENSIONS</b>								
	<b>W D H</b>	<b>W</b>	<b>D</b>	<b>H</b>	<b>W</b>	<b>D</b>	<b>H</b>	<b>W</b>	<b>H</b>				
	49.75	27.5	34.5	44	18.5	18	43	17					
 <p><b>HB Two Seat Chair, No Center Arm</b>                      COM Yardage: 3.75                      Freight Class: 300                      Product Weight (lbs.): 75                      Cubic Feet Per Carton: 56.5</p> <p>Active weight 350 lbs./seat                      Wood armcap option - <b>Add \$179</b></p>	<b>GC3702HB</b>	<b>\$2722</b>	<b>\$2846</b>	<b>\$2956</b>	<b>\$3111</b>	<b>\$3332</b>	<b>\$3417</b>	<b>\$3611</b>	<b>\$3976</b>	<b>\$4158</b>	<b>\$4496</b>	<b>\$4964</b>	<b>\$5548</b>
	<b>OVERALL DIMENSIONS</b>	<b>SEAT DIMENSIONS</b>			<b>BACK DIMENSIONS</b>								
	<b>W D H</b>	<b>W</b>	<b>D</b>	<b>H</b>	<b>W</b>	<b>D</b>	<b>H</b>	<b>W</b>	<b>H</b>				
	49.75	27.5	42.5	44	18.5	18	43	25					
 <p><b>LB Three Seat Chair, No Center Arms</b>                      COM Yardage: 4.5                      Freight Class: 300                      Product Weight (lbs.): 90                      Cubic Feet Per Carton: 65.25</p> <p>Active weight 350 lbs./seat                      Wood armcap option - <b>Add \$179</b></p>	<b>GC3703</b>	<b>\$3303</b>	<b>\$3454</b>	<b>\$3583</b>	<b>\$3770</b>	<b>\$4037</b>	<b>\$4137</b>	<b>\$4368</b>	<b>\$4804</b>	<b>\$5025</b>	<b>\$5430</b>	<b>\$5996</b>	<b>\$6692</b>
	<b>OVERALL DIMENSIONS</b>	<b>SEAT DIMENSIONS</b>			<b>BACK DIMENSIONS</b>								
	<b>W D H</b>	<b>W</b>	<b>D</b>	<b>H</b>	<b>W</b>	<b>D</b>	<b>H</b>	<b>W</b>	<b>H</b>				
	71.25	27.5	34.5	66	18.5	18	64.5	17					

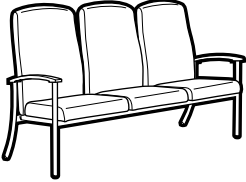
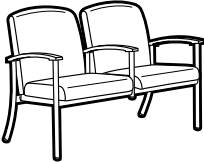
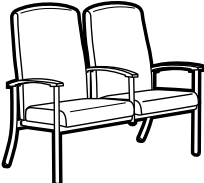
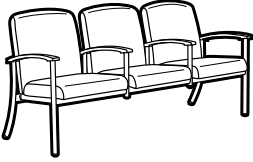
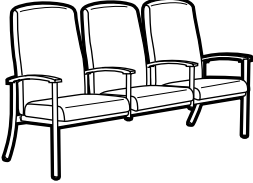
DESCRIPTION	MODEL#	STANDARD FABRIC GRADES											
		COM	2	3	4	5	6	7	8	9	10	11	12
 <p><b>HB Three Seat Chair, No Center Arms</b>                      COM Yardage: 5.25                      Freight Class: 300                      Product Weight (lbs.): 96                      Cubic Feet Per Carton: 80.75</p>	GC3703HB	\$3702	\$3879	\$4031	\$4250	\$4559	\$4678	\$4948	\$5456	\$5714	\$6185	\$6844	\$7656
		<b>OVERALL DIMENSIONS</b>			<b>SEAT DIMENSIONS</b>			<b>BACK DIMENSIONS</b>					
		W	D	H	W	D	H	W	H				
			71.25	27.5	42.5	66	18.5	18	64.5	25			
<p>Active weight 350 lbs./seat                      Wood armcap option - <b>Add \$179</b></p>													
 <p><b>LB Two Seat Chair, Half Center Arm</b>                      COM Yardage: 3.25                      Freight Class: 300                      Product Weight (lbs.): 73                      Cubic Feet Per Carton: 43</p>	GC3704	\$2613	\$2723	\$2816	\$2955	\$3145	\$3217	\$3386	\$3701	\$3857	\$4151	\$4561	\$5064
		<b>OVERALL DIMENSIONS</b>			<b>SEAT DIMENSIONS</b>			<b>BACK DIMENSIONS</b>					
		W	D	H	W	D	H	W	H				
			49.75	27.5	34.5	22	18.5	18	21.5	17			
<p>Active weight 350 lbs./seat                      Wood armcap option - <b>Add \$264</b></p>													
 <p><b>HB Two Seat Chair, Half Center Arm</b>                      COM Yardage: 3.75                      Freight Class: 300                      Product Weight (lbs.): 79                      Cubic Feet Per Carton: 56.5</p>	GC3704HB	\$2975	\$3099	\$3209	\$3364	\$3585	\$3670	\$3864	\$4229	\$4411	\$4749	\$5217	\$5801
		<b>OVERALL DIMENSIONS</b>			<b>SEAT DIMENSIONS</b>			<b>BACK DIMENSIONS</b>					
		W	D	H	W	D	H	W	H				
			49.75	27.5	42.5	44	18.5	18	43	25			
<p>Active weight 350 lbs./seat                      Wood armcap option - <b>Add \$264</b></p>													
 <p><b>LB Three Seat Chair, Half Center Arms</b>                      COM Yardage: 4.5                      Freight Class: 300                      Product Weight (lbs.): 100                      Cubic Feet Per Carton: 65.25</p>	GC3705	\$3801	\$3954	\$4083	\$4270	\$4537	\$4637	\$4867	\$5304	\$5525	\$5930	\$6496	\$7192
		<b>OVERALL DIMENSIONS</b>			<b>SEAT DIMENSIONS</b>			<b>BACK DIMENSIONS</b>					
		W	D	H	W	D	H	W	H				
			71.25	27.5	34.5	22	18.5	18	21.5	17			
<p>Active weight 350 lbs./seat                      Wood armcap option - <b>Add \$353</b></p>													
 <p><b>HB Three Seat Chair, Half Center Arms</b>                      COM Yardage: 5.25                      Freight Class: 300                      Product Weight (lbs.): 100                      Cubic Feet Per Carton: 80.75</p>	GC3705HB	\$4201	\$4380	\$4532	\$4749	\$5058	\$5179	\$5449	\$5957	\$6211	\$6686	\$7345	\$8155
		<b>OVERALL DIMENSIONS</b>			<b>SEAT DIMENSIONS</b>			<b>BACK DIMENSIONS</b>					
		W	D	H	W	D	H	W	H				
			71.25	27.5	42.5	66	18.5	18	64.5	25			
<p>Active weight 350 lbs./seat                      Wood armcap option - <b>Add \$353</b></p>													

DESCRIPTION	MODEL#	STANDARD FABRIC GRADES											
		COM	2	3	4	5	6	7	8	9	10	11	12
 <p><b>LB Armchair, Rear Tip &amp; Move Wheels</b>                      COM Yardage: 1.75                      Freight Class: 250                      Product Weight (lbs.): 48                      Cubic Feet Per Carton: 17.5</p>	<b>GC3707</b>	\$1653	\$1711	\$1763	\$1836	\$1938	\$1978	\$2069	\$2241	\$2325	\$2483	\$2702	\$2971
		<b>OVERALL DIMENSIONS</b> W D H			<b>SEAT DIMENSIONS</b> W D H			<b>BACK DIMENSIONS</b> W H					
		25.5	27.5	34.5	22	18.5	18	21.5	17				

Active weight 350 lbs.  
 Wood armcap option - **Add \$179**

DESCRIPTION	MODEL#	STANDARD FABRIC GRADES											
		COM	2	3	4	5	6	7	8	9	10	11	12
 <p><b>HB Armchair, Rear Tip &amp; Move Wheels</b>                      COM Yardage: 2                      Freight Class: 250                      Product Weight (lbs.): 50                      Cubic Feet Per Carton: 20</p>	<b>GC3707HB</b>	\$1881	\$1944	\$2007	\$2089	\$2207	\$2252	\$2356	\$2549	\$2648	\$2827	\$3077	\$3387
		<b>OVERALL DIMENSIONS</b> W D H			<b>SEAT DIMENSIONS</b> W D H			<b>BACK DIMENSIONS</b> W H					
		25.5	27.5	42.5	22	18	18	21	25				

Active weight 350 lbs.  
 Wood armcap option - **Add \$179**

DESCRIPTION	MODEL#	STANDARD FABRIC GRADES											
		COM	2	3	4	5	6	7	8	9	10	11	12
 <p><b>Bariatric LB Armchair</b>                      COM Yardage: 2.75                      Freight Class: 250                      Product Weight (lbs.): 60                      Cubic Feet Per Carton: 26.5</p>	<b>GC3711</b>	\$1891	\$1983	\$2063	\$2179	\$2341	\$2400	\$2544	\$2812	\$2945	\$3192	\$3539	\$3962
		<b>OVERALL DIMENSIONS</b> W D H			<b>SEAT DIMENSIONS</b> W D H			<b>BACK DIMENSIONS</b> W H					
		36	27.5	34.5	32.5	18	18	31	17				



Active weight 750 lbs.  
 Wood armcap option - **Add \$179**  
 Armless Bariatric models are not available.

DESCRIPTION	MODEL#	STANDARD FABRIC GRADES											
		COM	2	3	4	5	6	7	8	9	10	11	12
 <p><b>Bariatric LB Hip Armchair, Post Surgery</b>                      COM Yardage: 2.75                      Freight Class: 250                      Product Weight (lbs.): 63                      Cubic Feet Per Carton: 30.5</p> <p>Designed to immobilize the pelvis and hip joints after surgery.</p>	<b>GC3711-24</b>	\$2203	\$2295	\$2375	\$2492	\$2652	\$2712	\$2856	\$3124	\$3257	\$3504	\$3851	\$4274
		<b>OVERALL DIMENSIONS</b> W D H			<b>SEAT DIMENSIONS</b> W D H			<b>BACK DIMENSIONS</b> W H					
		36	27.5	40.5	32.5	18	24	31	17				

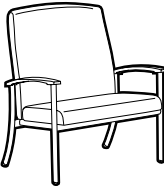
Active weight 750 lbs.  
 Wood armcap option - **Add \$179**  
 Armless Bariatric models are not available.

DESCRIPTION	MODEL#	STANDARD FABRIC GRADES											
		COM	2	3	4	5	6	7	8	9	10	11	12
 <p><b>Bariatric HB Armchair</b>                      COM Yardage: 3.25                      Freight Class: 250                      Product Weight (lbs.): 66                      Cubic Feet Per Carton: 30.5</p>	<b>GC3711HB</b>	\$2095	\$2207	\$2300	\$2435	\$2629	\$2700	\$2870	\$3183	\$3340	\$3635	\$4043	\$4545
		<b>OVERALL DIMENSIONS</b> W D H			<b>SEAT DIMENSIONS</b> W D H			<b>BACK DIMENSIONS</b> W H					
		36	27.5	42.5	32.5	18	18	31	25				

Active weight 750 lbs.  
 Wood armcap option - **Add \$179**  
 Armless Bariatric models are not available.

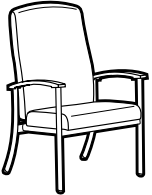
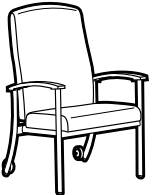
DESCRIPTION	MODEL#	STANDARD FABRIC GRADES											
		COM	2	3	4	5	6	7	8	9	10	11	12
 <p><b>Bariatric LB Armchair, Rear Tip &amp; Move Wheels</b>                      COM Yardage: 2.75                      Freight Class: 250                      Product Weight (lbs.): 60                      Cubic Feet Per Carton: 26.5</p>	<b>GC3712</b>	\$2048	\$2139	\$2222	\$2336	\$2497	\$2557	\$2700	\$2969	\$3101	\$3349	\$3696	\$4118
		OVERALL DIMENSIONS			SEAT DIMENSIONS			BACK DIMENSIONS					
		W	D	H	W	D	H	W	H				
		36	27.5	34.5	32.5	18	18	31	17				
		Active weight 750 lbs. Wood armcap option - <b>Add \$179</b>  <i>Armless Bariatric models are <u>not</u> available.</i>											
 <p><b>Bariatric HB Armchair, Rear Tip &amp; Move Wheels</b>                      COM Yardage: 3.25                      Freight Class: 250                      Product Weight (lbs.): 66                      Cubic Feet Per Carton: 30.5</p>	<b>GC3712HB</b>	\$2248	\$2358	\$2451	\$2586	\$2780	\$2852	\$3021	\$3334	\$3492	\$3786	\$4196	\$4699
		OVERALL DIMENSIONS			SEAT DIMENSIONS			BACK DIMENSIONS					
		W	D	H	W	D	H	W	H				
		36	27.5	42.5	31	18	18	30	25				
		Active weight 750 lbs. Wood armcap option - <b>Add \$179</b>  <i>Armless Bariatric models are <u>not</u> available.</i>											
 <p><b>LB Armchair, Flex Back</b>                      COM Yardage: 1.75                      Freight Class: 250                      Product Weight (lbs.): 49                      Cubic Feet Per Carton: 17.5</p>	<b>GC3715</b>	\$1782	\$1839	\$1893	\$1965	\$2067	\$2106	\$2199	\$2370	\$2453	\$2612	\$2830	\$3101
		OVERALL DIMENSIONS			SEAT DIMENSIONS			BACK DIMENSIONS					
		W	D	H	W	D	H	W	H				
		25.5	27.5	34.5	22	18	18	21	17				
		Active weight 350 lbs. Wood armcap option - <b>Add \$179</b>											
 <p><b>HB Armchair, Flex Back</b>                      COM Yardage: 2                      Freight Class: 250                      Product Weight (lbs.): 50                      Cubic Feet Per Carton: 20</p>	<b>GC3715HB</b>	\$2012	\$2076	\$2139	\$2221	\$2338	\$2384	\$2488	\$2680	\$2777	\$2958	\$3209	\$3519
		OVERALL DIMENSIONS			SEAT DIMENSIONS			BACK DIMENSIONS					
		W	D	H	W	D	H	W	H				
		25.5	27.5	42.5	22	18	18	21	25				
		Active weight 350 lbs. Wood armcap option - <b>Add \$179</b>											
 <p><b>HB Armchair, Flex Back, Rear Tip &amp; Move Wheels</b>                      COM Yardage: 2                      Freight Class: 250                      Product Weight (lbs.): 50                      Cubic Feet Per Carton: 20</p>	<b>GC3716HB</b>	\$2164	\$2227	\$2290	\$2372	\$2490	\$2535	\$2639	\$2832	\$2928	\$3110	\$3360	\$3670
		OVERALL DIMENSIONS			SEAT DIMENSIONS			BACK DIMENSIONS					
		W	D	H	W	D	H	W	H				
		25.5	27.5	42.5	22	18	18	21	25				
		Active weight 350 lbs. Wood armcap option - <b>Add \$179</b>											

DESCRIPTION MODEL# STANDARD FABRIC GRADES

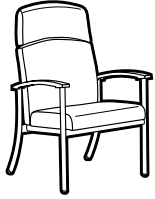

**HB Armchair, Split Back**  
 COM Yardage: 2  
 Freight Class: 250  
 Product Weight (lbs.): 53  
 Cubic Feet Per Carton: 20

MODEL#	COM	2	3	4	5	6	7	8	9	10	11	12
GC3717HB	\$2024	\$2089	\$2150	\$2232	\$2351	\$2396	\$2497	\$2693	\$2790	\$2971	\$3221	\$3530

Fold away headrest.  
 Active weight 350 lbs.  
 Wood armcap option - Add \$179

OVERALL DIMENSIONS			SEAT DIMENSIONS			BACK DIMENSIONS	
W	D	H	W	D	H	W	H
25.5	27.5	42.5	22	18	18	21.5	25

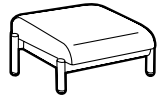

**Footstool, Angled Top**  
 COM Yardage: 1  
 Freight Class: 150  
 Product Weight (lbs.): 16  
 Cubic Feet Per Carton: 3.5

Stores beneath any standard seating unit.  
 Active weight 350 lbs.

MODEL#	COM	2	3	4	5	6	7	8	9	10	11	12
GC3708	\$951	\$983	\$1014	\$1056	\$1113	\$1139	\$1189	\$1287	\$1336	\$1425	\$1549	\$1705

OVERALL DIMENSIONS			SEAT DIMENSIONS			BACK DIMENSIONS	
W	D	H	W	D	H	W	H
16.5	18.5	10.5					

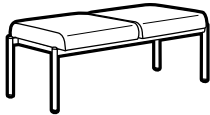

**Two Seat Bench**  
 COM Yardage: 1.75  
 Freight Class: 250  
 Product Weight (lbs.): 48  
 Cubic Feet Per Carton: 23

Active weight 350 lbs./seat

MODEL#	COM	2	3	4	5	6	7	8	9	10	11	12
GC3722	\$1593	\$1651	\$1705	\$1777	\$1879	\$1918	\$2009	\$2181	\$2265	\$2423	\$2642	\$2913

OVERALL DIMENSIONS			SEAT DIMENSIONS			BACK DIMENSIONS	
W	D	H	W	D	H	W	H
47.5	23.5	18					

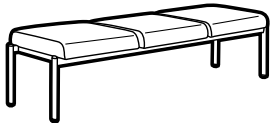

**Three Seat Bench**  
 COM Yardage: 2  
 Freight Class: 250  
 Product Weight (lbs.): 68  
 Cubic Feet Per Carton: 33.25

Active weight 350 lbs./seat

MODEL#	COM	2	3	4	5	6	7	8	9	10	11	12
GC3723	\$2076	\$2141	\$2201	\$2284	\$2401	\$2446	\$2550	\$2744	\$2841	\$3022	\$3272	\$3581

OVERALL DIMENSIONS			SEAT DIMENSIONS			BACK DIMENSIONS	
W	D	H	W	D	H	W	H
70	23.5	18					

WILLOW



**model W5AUUG**  
Armchair, Upholstered Seat & Back



Wipeable shroud edge does not collect debris



No visible brackets or upholstery staples

Arm Options



Waterfall Arm (WFA)



Forward Grip Assist (GAA)

	Willow Chair Stacking Capability	
	Stacks on floor	Stacks on dolly
<b>Four leg arm and armless chairs with glides only</b>		
Poly/poly chairs	up to 6 high	up to 10 high
Upholstered chairs	up to 4 high	up to 8 high
Bariatric Models	up to 4 high	up to 8 high
<b>Four leg bar and counter stools</b>		
Stools with arms	Does not stack	N/A
Armless stools	up to 4 high	N/A

Plastic Component Finish Matching Chart		
Chair Types	Seat Shroud	Arms and Back Shroud
Poly back and seat	Matches seat/back	Matches seat/back
Upholstered back and seat	Specify	Specify
Poly back/upholstered seat	Specify	Specify
Upholstered back/poly seat	Matches seat	Specify



For linking tables, see page 238.

EXAMPLE WILLOW ORDER CODE:

W5AUU	PU75	NS	PU75	WFA	BLK
Model #	Back Textile	Seat	Seat Textile	Arm Style	Seat Shroud Finish
CHM	ST	BLK	NS	NB	
Frame Finish	Glide Type	Glide Finish	Back seams	Moisture Barrier	

STANDARD FEATURES

- Willow's durable design and open, welcoming form will ensure years of use. Freestanding chairs are available with four legs or sled base, in seated standard or bariatric widths. Additional models include hip, counter and bar height stools. Freestanding and corner, in-line and end tables are also available to complement the line.
- Seated height chairs may be ganged with ganging brackets or with in-line and corner tables.
- Plastic seats and backs, reinforced nylon arms, back shrouds and seat shrouds are available in a wide range of colors. See finish chart for matching color components.
- Tubular steel frame is available in 20 paint finishes and 4 plated finishes (upcharge applies).
- Frame design features a wall saver leg to prevent contact with walls.
- Active weight capacity is 300 lbs. for four-leg seating with casters, 400 lbs. for seating on glides and 600 lbs. for 30" wide bariatric and parent/child models.
- Plastic seat shrouds are standard on all models.
- Upholstered seats have no seams for ease of cleaning.
- Four-leg chairs with glides are stackable, see matrix. Stacking of caster models is not recommended due to damage to plastic and upholstery.
- Armless counter and bar height stools are stackable on the floor only. See chart for details.
- Four-leg and stool models are available with a variety of glide types. Glides must be chosen to best suit flooring type and site conditions. For more information, refer to glide selection chart.
- Tables used with Willow armchairs require 28" clearance under the surface top; counter height stools require 34.25" clearance; bar height stools require 40.25" clearance.
- Sled base models have nylon colored glides, non-marking natural glides for use on most floor surfaces, or no glides for use on carpeted floors.
- For healthcare textiles, visit the website at [globalfurnituregroup.com](http://globalfurnituregroup.com).
- Check textile availability prior to specifying upholstery material.
- The series is available to specify with two textiles on upholstered seat and back models. For pricing, start with the base price and add applicable graded textile upcharges for the back and the seat.
- The blended textile matrix does not apply to this series.
- The series is designed for use across a range of facilities and is covered under Global's limited lifetime warranty for single-shift use. Specify for approved textiles.
- Shipped fully assembled.

OPTIONAL FEATURES

- Additional weight (CW) of 24 lbs. is available. Weighted four-leg chairs are not stackable.
- Power/USB units are available, ordered separately, for use with in-line, corner and end tables. See model for details.
- Tables are pre-drilled for field installation of undermount power. Clamp mount units are available. Order power units separately for field installation.
- Moisture barrier may be specified on seats.
- Sled base models offer a floor mount (FM) option. See upcharges. Mounting hardware not included.

Add option codes in the following order:

- Model number**  
Enter model number.
- Back, Seat and Seat Shroud Finish** (plastic back and seat models)  
Plastic finishes:  





<b>(BZB)</b> Buzz Blue	<b>(KAL)</b> Kalua
<b>(CCT)</b> Cactus	<b>(LAB)</b> Latte
<b>(CRO)</b> Carrot	<b>(J52)</b> Mocha
<b>(IVC)</b> Cloud	<b>(BLK)</b> Night
<b>(DJN)</b> Dijon	<b>(SND)</b> Sand
<b>(EGP)</b> Eggplant	<b>(SAR)</b> Scarlet
<b>(FOG)</b> Fog	<b>(SHW)</b> Shadow
<b>(FRO)</b> Frost	<b>(TOA)</b> Toast
<b>(INK)</b> Ink	
- Back Finish** (plastic back and upholstered seat models)  
See Plastic finishes.
- Back Textile** (for upholstered back models)  
Specify back textile.
- Seat Textile** (for upholstered seat models)  
Specify seat textile.
- Arm Style** (for chairs with arms)  
**(WFA)** Waterfall arm  
**(GAA)** Grip assist arm. Add \$33.
- Arm and Back Shroud Finish**  
See Plastic finishes.
- Seat and Seat Shroud Finish** (for upholstered back and plastic seat models).  
See Plastic finishes.
- Leg Type** (for sled base models)  
**(NF)** No floor mount  
**(FM)** Floor mounted. Add \$12.
- Frame finish**  
Paint finishes:  
Black **(TBL)**, Buzz Blue **(TBZ)**, Cactus **(TCC)**, Carrot **(TCR)**, Cloud **(TIV)**, Designer White **(TDW)**, Dijon **(TDJ)**, Eggplant **(TEG)**, Fog **(TFO)**, Frost **(TFR)**, Ink **(TIN)**, Kalua **(TKA)**, Latte **(TLA)**, Mocha **(TMO)**, Nevada **(TNE)**, Sand **(TSN)**, Scarlet **(TSR)**, Shadow **(TSH)**, Toast **(TOA)** and Tungsten **(TTU)**.  
Plated finishes - see chart on page 228 for upcharges:  
**(CHM)** Chrome                      **(SBR)** Satin Brass  
**(BCH)** Brushed Chrome            **(ACO)** Antique Copper
- Glide type** (four leg glides)  
**(ST)** Nylon, colored glide for most surfaces  
**(NM)** White, non-marking Nylon glide for most surfaces  
**(SG)** Steel cushion glide for carpeted surfaces. Add \$34.  
**(FG)** Felt glide for most hard floor surfaces. Add \$34.  
**(RG)** Rubber, non-slip glide for most hard floor surfaces. Add \$34.
- Glide type** (sled bases)  
**(ST)** Nylon, colored glide for most surfaces  
**(NM)** White, non-marking Nylon glide for most surfaces  
**(XG)** No glide for carpeted surfaces
- Glide Finish** (ST glides)  
**(BLK)** Black  
**(SND)** Sand
- Caster Type** (caster models)  
**(DC)** 2" caster for carpeted surface  
**(RC)** 2" caster for most hard floor surfaces. Add \$50.
- Back Seams**  
**(NS)** No sealed back seams  
**(SBS)** Sealed back seams
- Moisture Barrier** (on seat)  
**(NB)** No moisture barrier.  
**(MB)** Moisture barrier. Add \$101. For bariatric, add \$152.











DESCRIPTION MODEL# STANDARD FABRIC GRADES





	GLIDES							
	Standard colored (ST) + non-marking (NM) glides - standard height		Steel cushion (SG) glides - 0.313" higher than standard		Felt pad (FG) glides - 0.375" higher than standard		Rubber non-slip (RG) glides - 0.563" higher than standard	
	SEAT HEIGHT (in)	ARM HEIGHT (in)	SEAT HEIGHT (in)	ARM HEIGHT (in)	SEAT HEIGHT (in)	ARM HEIGHT (in)	SEAT HEIGHT (in)	ARM HEIGHT (in)
<b>ARMCHAIRS</b>								
Plastic seat, standard arms	17	26.75	17.31	27.06	17.38	27.13	17.56	27.31
Plastic seat, grip assist arms	17	27	17.31	27.31	17.38	27.38	17.56	27.56
Upholstered seat, standard arms	18.25	26.75	18.56	27.06	18.63	27.13	18.81	27.31
Upholstered seat, grip assist arms	18.25	27	18.56	27.31	18.63	27.38	18.81	27.56
<b>COUNTER STOOLS WITH ARMS</b>								
Plastic seat, standard arms	23.25	33	23.56	33.31	23.63	33.38	23.81	33.56
Plastic seat, grip assist arms	23.25	33.25	23.56	33.56	23.63	33.63	23.81	33.81
Upholstered seat, standard arms	24.25	33	24.56	33.31	24.63	33.38	24.81	33.56
Upholstered seat, grip assist arms	24.25	33.25	24.56	33.56	24.63	33.63	24.81	33.81
<b>BAR STOOLS WITH ARMS</b>								
Plastic seat, standard arms	29.25	39	29.56	39.31	29.63	39.38	29.81	39.56
Plastic seat, grip assist arms	29.25	39.25	29.56	39.56	29.63	39.63	29.81	39.81
Upholstered seat, standard arms	30.25	39	30.56	39.31	30.63	39.38	30.81	39.56
Upholstered seat, grip assist arms	30.25	39.25	30.56	39.56	30.63	39.63	30.81	39.81

PLATED FRAME FINISH UPCHARGES				
	Chrome (CHM)	Brushed Chrome (BCH)	Antique Copper (ACO)	Satin Brass (SBR)
<b>FOUR LEG BASE</b>				
Standard, arm and armless	\$39	\$139	\$206	\$206
Bariatric	\$67	\$217	\$317	\$317
Hip chairs, standard and bariatric	\$67	\$217	\$317	\$317
Counter stools, arm and armless	\$71	\$231	\$338	\$338
Bar stools, arm and armless	\$71	\$231	\$338	\$338
<b>SLED BASE</b>				
Standard, arm and armless	\$50	\$170	\$250	\$250
Bariatric	\$67	\$217	\$317	\$317

DESCRIPTION	MODEL#	STANDARD FABRIC GRADES											
 <p><b>Armchair, Polypropylene Back and Seat</b> COM Yardage: n/a Freight Class: 250 Product Weight (lbs.): 20.88 Cubic Feet Per Carton: 5.56</p>		List Price											
	<p><b>W5APPG</b> with glides</p> <p><b>W5APPC</b> with casters</p>	<p><b>\$533</b></p> <p><b>\$670</b></p>											
		OVERALL DIMENSIONS			SEAT DIMENSIONS			BACK DIMENSIONS					
		W	D	H	W	D	H	W	H				
		24.25	23.5	32	17.75	17.5	17	16	16				
		Active weight with casters 300 lbs.; does not stack. Active weight with glides 400 lbs.; stacks 6 high on floor. 2 per carton (pricing and specifications are for one seat unit)											
 <p><b>Armchair, Upholstered Back and Polypropylene Seat</b> COM Yardage: 0.5 Freight Class: 250 Product Weight (lbs.): 21.88 Cubic Feet Per Carton: 5.56</p>		1/COM											
	<p><b>W5AUPG</b> with glides</p> <p><b>W5AUPC</b> with casters</p>	\$627	\$643	\$656	\$674	\$700	\$711	\$734	\$769	\$796	\$825	\$885	\$949
		\$739	\$755	\$768	\$786	\$812	\$823	\$846	\$881	\$908	\$937	\$997	\$1061
		OVERALL DIMENSIONS			SEAT DIMENSIONS			BACK DIMENSIONS					
		W	D	H	W	D	H	W	H				
		24.25	21.75	32.25	17.75	16.75	17	16.5	16				
		Active weight with casters 300 lbs.; does not stack. Active weight with glides 400 lbs.; stacks 4 high on floor. Add \$15 for (SBS) 2 per carton (pricing and specifications are for one seat unit)											
 <p><b>Armchair, Polypropylene Back and Upholstered Seat</b> COM Yardage: 0.75 Freight Class: 250 Product Weight (lbs.): 21.38 Cubic Feet Per Carton: 5.56</p>		1/COM											
	<p><b>W5APUG</b> with glides</p> <p><b>W5APUC</b> with casters</p>	\$627	\$643	\$656	\$674	\$700	\$711	\$734	\$769	\$796	\$825	\$885	\$949
		\$739	\$755	\$768	\$786	\$812	\$823	\$846	\$881	\$908	\$937	\$997	\$1061
		OVERALL DIMENSIONS			SEAT DIMENSIONS			BACK DIMENSIONS					
		W	D	H	W	D	H	W	H				
		24.25	23.5	32	18.25	17.75	18.25	16	15.25				
		Active weight with casters 300 lbs.; does not stack. Active weight with glides 400 lbs.; stacks 4 high on floor. 2 per carton (pricing and specifications are for one seat unit)											
 <p><b>Armchair, Upholstered Back and Seat</b> COM Yardage: Back: 0.5; Seat: 0.75 Freight Class: 250 Product Weight (lbs.): 21.88 Cubic Feet Per Carton: 5.56</p>		1/COM											
	<p><b>W5AUUG</b> Base Price: <b>\$659</b> with glides Seat upcharge: <b>+0</b> Back upcharge: <b>+0</b></p> <p><b>W5AUUC</b> Base Price: <b>\$802</b> with casters Seat upcharge: <b>+0</b> Back upcharge: <b>+0</b></p>	<b>+0</b>	<b>+\$24</b>	<b>+\$43</b>	<b>+\$71</b>	<b>+\$110</b>	<b>+\$126</b>	<b>+\$160</b>	<b>+\$213</b>	<b>+\$253</b>	<b>+\$297</b>	<b>+\$387</b>	<b>+\$483</b>
		<b>+0</b>	<b>+\$16</b>	<b>+\$29</b>	<b>+\$47</b>	<b>+\$73</b>	<b>+\$84</b>	<b>+\$107</b>	<b>+\$142</b>	<b>+\$169</b>	<b>+\$198</b>	<b>+\$258</b>	<b>+\$322</b>
		<b>+0</b>	<b>+\$24</b>	<b>+\$43</b>	<b>+\$71</b>	<b>+\$110</b>	<b>+\$126</b>	<b>+\$160</b>	<b>+\$213</b>	<b>+\$253</b>	<b>+\$297</b>	<b>+\$387</b>	<b>+\$483</b>
		<b>+0</b>	<b>+\$16</b>	<b>+\$29</b>	<b>+\$47</b>	<b>+\$73</b>	<b>+\$84</b>	<b>+\$107</b>	<b>+\$142</b>	<b>+\$169</b>	<b>+\$198</b>	<b>+\$258</b>	<b>+\$322</b>
		OVERALL DIMENSIONS			SEAT DIMENSIONS			BACK DIMENSIONS					
		W	D	H	W	D	H	W	H				
		24.25	22	32.25	18.25	17	18.25	16.5	15.25				
		Active weight with casters 300 lbs.; does not stack. Active weight with glides 400 lbs.; stacks 4 high on floor. Add \$15 for (SBS) 2 per carton (pricing and specifications are for one seat unit)											

DESCRIPTION	MODEL#	STANDARD FABRIC GRADES											
 <p><b>Armless Chair, Polypropylene Back and Seat</b> COM Yardage: n/a Freight Class: 250 Product Weight (lbs.): 18 Cubic Feet Per Carton: 4.63</p>		List Price											
	<b>W5NPPG</b> with glides	<b>\$486</b>											
	<b>W5NPPC</b> with casters	<b>\$621</b>											
		<b>OVERALL DIMENSIONS</b>			<b>SEAT DIMENSIONS</b>			<b>BACK DIMENSIONS</b>					
	<b>W</b>	<b>D</b>	<b>H</b>	<b>W</b>	<b>D</b>	<b>H</b>	<b>W</b>	<b>H</b>	<b>W</b>	<b>H</b>	<b>W</b>	<b>H</b>	
	20.75	23.5	32	17.75	17.5	17	16	16					
Active weight with casters 300 lbs.; does not stack. Active weight with glides 400 lbs.; stacks 6 high on floor. 2 per carton (pricing and specifications are for one seat unit)													
 <p><b>Armless Chair, Upholstered Back and Polypropylene Seat</b> COM Yardage: 0.5 Freight Class: 250 Product Weight (lbs.): 18.5 Cubic Feet Per Carton: 4.63</p>		1/COM	2	3	4	5	6	7	8	9	10	11	12
	<b>W5NUPG</b> with glides	<b>\$578</b>	<b>\$594</b>	<b>\$607</b>	<b>\$625</b>	<b>\$651</b>	<b>\$662</b>	<b>\$685</b>	<b>\$720</b>	<b>\$747</b>	<b>\$776</b>	<b>\$836</b>	<b>\$900</b>
	<b>W5NUPC</b> with casters	<b>\$689</b>	<b>\$705</b>	<b>\$718</b>	<b>\$736</b>	<b>\$762</b>	<b>\$773</b>	<b>\$796</b>	<b>\$831</b>	<b>\$858</b>	<b>\$887</b>	<b>\$947</b>	<b>\$1011</b>
		<b>OVERALL DIMENSIONS</b>			<b>SEAT DIMENSIONS</b>			<b>BACK DIMENSIONS</b>					
	<b>W</b>	<b>D</b>	<b>H</b>	<b>W</b>	<b>D</b>	<b>H</b>	<b>W</b>	<b>H</b>	<b>W</b>	<b>H</b>	<b>W</b>	<b>H</b>	
	20.75	23.5	32.25	17.75	16.75	17	16.5	16					
Active weight with casters 300 lbs.; does not stack. Active weight with glides 400 lbs.; stacks 4 high on floor. Add \$15 for (SBS) 2 per carton (pricing and specifications are for one seat unit)													
 <p><b>Armless Chair, Polypropylene Back and Upholstered Seat</b> COM Yardage: 0.75 Freight Class: 250 Product Weight (lbs.): 18.5 Cubic Feet Per Carton: 4.63</p>		1/COM	2	3	4	5	6	7	8	9	10	11	12
	<b>W5NPUG</b> with glides	<b>\$578</b>	<b>\$602</b>	<b>\$621</b>	<b>\$649</b>	<b>\$688</b>	<b>\$704</b>	<b>\$738</b>	<b>\$791</b>	<b>\$831</b>	<b>\$875</b>	<b>\$965</b>	<b>\$1061</b>
	<b>W5NPUC</b> with casters	<b>\$689</b>	<b>\$713</b>	<b>\$732</b>	<b>\$760</b>	<b>\$799</b>	<b>\$815</b>	<b>\$849</b>	<b>\$902</b>	<b>\$942</b>	<b>\$986</b>	<b>\$1076</b>	<b>\$1172</b>
		<b>OVERALL DIMENSIONS</b>			<b>SEAT DIMENSIONS</b>			<b>BACK DIMENSIONS</b>					
	<b>W</b>	<b>D</b>	<b>H</b>	<b>W</b>	<b>D</b>	<b>H</b>	<b>W</b>	<b>H</b>	<b>W</b>	<b>H</b>	<b>W</b>	<b>H</b>	
	20.75	23.5	32	18.25	17.75	18.25	16	15.25					
Active weight with casters 300 lbs.; does not stack. Active weight with glides 400 lbs.; stacks 4 high on floor. 2 per carton (pricing and specifications are for one seat unit)													
 <p><b>Armless Chair, Upholstered Back and Seat</b> COM Yardage: Back: 0.5; Seat: 0.75 Freight Class: 150 Product Weight (lbs.): 19 Cubic Feet Per Carton: 4.63</p>		1/COM	2	3	4	5	6	7	8	9	10	11	12
	<b>W5NUUG</b> with glides	Base Price: <b>\$612</b> Seat upcharge: <b>+0</b> Back upcharge: <b>+0</b>	<b>+\$24</b>	<b>+\$43</b>	<b>+\$71</b>	<b>+\$110</b>	<b>+\$126</b>	<b>+\$160</b>	<b>+\$213</b>	<b>+\$253</b>	<b>+\$297</b>	<b>+\$387</b>	<b>+\$483</b>
	<b>W5NUUC</b> with casters	Base Price: <b>\$752</b> Seat upcharge: <b>+0</b> Back upcharge: <b>+0</b>	<b>+\$16</b>	<b>+\$29</b>	<b>+\$47</b>	<b>+\$73</b>	<b>+\$84</b>	<b>+\$107</b>	<b>+\$142</b>	<b>+\$169</b>	<b>+\$198</b>	<b>+\$258</b>	<b>+\$322</b>
		<b>OVERALL DIMENSIONS</b>			<b>SEAT DIMENSIONS</b>			<b>BACK DIMENSIONS</b>					
	<b>W</b>	<b>D</b>	<b>H</b>	<b>W</b>	<b>D</b>	<b>H</b>	<b>W</b>	<b>H</b>	<b>W</b>	<b>H</b>	<b>W</b>	<b>H</b>	
	20.75	23.5	32.25	18.25	17	18.25	16.5	15.25					
Active weight with casters 300 lbs.; does not stack. Active weight with glides 400 lbs.; stacks 4 high on floor. Add \$15 for (SBS). 2 per carton (pricing and specifications are for one seat unit)													

DESCRIPTION	MODEL#	STANDARD FABRIC GRADES												
		1/COM	2	3	4	5	6	7	8	9	10	11	12	
 <p><b>Bariatric Armchair, Upholstered Back and Seat</b> COM Yardage: Back: 0.75; Seat: 1 Freight Class: 250 Product Weight (lbs.): 41 Cubic Feet Per Carton: 20.5</p>	<b>W530AUU</b> Base Price: <b>\$1034</b> Seat upcharge: <b>+0</b> Back upcharge: <b>+0</b>	<b>+0</b>	<b>+\$32</b>	<b>+\$57</b>	<b>+\$94</b>	<b>+\$146</b>	<b>+\$168</b>	<b>+\$213</b>	<b>+\$284</b>	<b>+\$337</b>	<b>+\$395</b>	<b>+\$516</b>	<b>+\$643</b>	
		<b>+0</b>	<b>+\$24</b>	<b>+\$43</b>	<b>+\$71</b>	<b>+\$110</b>	<b>+\$126</b>	<b>+\$160</b>	<b>+\$213</b>	<b>+\$253</b>	<b>+\$297</b>	<b>+\$387</b>	<b>+\$483</b>	
		<b>OVERALL DIMENSIONS</b>			<b>SEAT DIMENSIONS</b>			<b>BACK DIMENSIONS</b>						
		<b>W</b>	<b>D</b>	<b>H</b>	<b>W</b>	<b>D</b>	<b>H</b>	<b>W</b>	<b>H</b>					
			35.25	23.5	32.25	29	17	18.25	26.75	15.25				
<p>Active weight 600 lbs. Stacks 4 high on floor. Caster model not available. Add \$23 for <b>(SBS)</b>. One per carton (pricing and specifications are for one seat unit)</p>														
	 <p><b>Bariatric Armless Chair, Upholstered Back and Seat</b> COM Yardage: Back: 0.75; Seat: 1 Freight Class: 250 Product Weight (lbs.): 37.5 Cubic Feet Per Carton: 16.75</p>	<b>W530NUU</b> Base Price: <b>\$985</b> Seat upcharge: <b>+0</b> Back upcharge: <b>+0</b>	<b>+0</b>	<b>+\$32</b>	<b>+\$57</b>	<b>+\$94</b>	<b>+\$146</b>	<b>+\$168</b>	<b>+\$213</b>	<b>+\$284</b>	<b>+\$337</b>	<b>+\$395</b>	<b>+\$516</b>	<b>+\$643</b>
			<b>+0</b>	<b>+\$24</b>	<b>+\$43</b>	<b>+\$71</b>	<b>+\$110</b>	<b>+\$126</b>	<b>+\$160</b>	<b>+\$213</b>	<b>+\$253</b>	<b>+\$297</b>	<b>+\$387</b>	<b>+\$483</b>
			<b>OVERALL DIMENSIONS</b>			<b>SEAT DIMENSIONS</b>			<b>BACK DIMENSIONS</b>					
<b>W</b>			<b>D</b>	<b>H</b>	<b>W</b>	<b>D</b>	<b>H</b>	<b>W</b>	<b>H</b>					
			31.75	23.5	32.25	29	17	0	26.75	15.25				
<p>Active weight 600 lbs. Stacks 4 high on floor. Caster model not available. Add \$23 for <b>(SBS)</b>. One per carton (pricing and specifications are for one seat unit)</p>														
	 <p><b>Armchair, Sled Base, Polypropylene Back and Seat</b> COM Yardage: n/a Freight Class: 250 Product Weight (lbs.): 29.5 Cubic Feet Per Carton: 13.25</p>	<b>W6APP</b> List Price <b>\$684</b>												
			<b>OVERALL DIMENSIONS</b>			<b>SEAT DIMENSIONS</b>			<b>BACK DIMENSIONS</b>					
			<b>W</b>	<b>D</b>	<b>H</b>	<b>W</b>	<b>D</b>	<b>H</b>	<b>W</b>	<b>H</b>				
					24.25	23.75	32	17.75	17.75	17.75	16	16		
<p>Active weight 400 lbs. Does not stack.</p>														
	 <p><b>Armchair, Sled Base, Upholstered Back and Polypropylene Seat</b> COM Yardage: 0.5 Freight Class: 250 Product Weight (lbs.): 30 Cubic Feet Per Carton: 13.25</p>	<b>W6AUP</b> <b>\$752</b> <b>\$768</b> <b>\$781</b> <b>\$799</b> <b>\$825</b> <b>\$836</b> <b>\$859</b> <b>\$894</b> <b>\$921</b> <b>\$950</b> <b>\$1010</b> <b>\$1074</b>	<b>1/COM</b>	<b>2</b>	<b>3</b>	<b>4</b>	<b>5</b>	<b>6</b>	<b>7</b>	<b>8</b>	<b>9</b>	<b>10</b>	<b>11</b>	<b>12</b>
			<b>OVERALL DIMENSIONS</b>			<b>SEAT DIMENSIONS</b>			<b>BACK DIMENSIONS</b>					
			<b>W</b>	<b>D</b>	<b>H</b>	<b>W</b>	<b>D</b>	<b>H</b>	<b>W</b>	<b>H</b>				
					24.25	23.75	32.25	17.75	17.75	17.75	16.5	16		
<p>Active weight 400 lbs. Does not stack. Add \$15 for <b>(SBS)</b>.</p>														
	 <p><b>Armchair, Sled Base, Polypropylene Back and Upholstered Seat</b> COM Yardage: 0.75 Freight Class: 250 Product Weight (lbs.): 30 Cubic Feet Per Carton: 13.25</p>	<b>W6APU</b> <b>\$752</b> <b>\$776</b> <b>\$795</b> <b>\$823</b> <b>\$862</b> <b>\$878</b> <b>\$912</b> <b>\$965</b> <b>\$1005</b> <b>\$1049</b> <b>\$1139</b> <b>\$1235</b>	<b>1/COM</b>	<b>2</b>	<b>3</b>	<b>4</b>	<b>5</b>	<b>6</b>	<b>7</b>	<b>8</b>	<b>9</b>	<b>10</b>	<b>11</b>	<b>12</b>
			<b>OVERALL DIMENSIONS</b>			<b>SEAT DIMENSIONS</b>			<b>BACK DIMENSIONS</b>					
			<b>W</b>	<b>D</b>	<b>H</b>	<b>W</b>	<b>D</b>	<b>H</b>	<b>W</b>	<b>H</b>				
					24.25	23.75	32	18.25	17.75	18.25	16	15.25		
<p>Active weight 400 lbs. Does not stack.</p>														

DESCRIPTION	MODEL#	STANDARD FABRIC GRADES											
		1/COM	2	3	4	5	6	7	8	9	10	11	12
 <p><b>Armchair, Sled Base, Upholstered Back and Seat</b>                      COM Yardage: Back: 0.5; Seat: 0.75                      Freight Class: 250                      Product Weight (lbs.): 30.5                      Cubic Feet Per Carton: 13.25</p>	<b>W6AUU</b> Base Price: Seat upcharge: Back upcharge:	<b>\$815</b>											
		<b>+0</b>	<b>+\$24</b>	<b>+\$43</b>	<b>+\$71</b>	<b>+\$110</b>	<b>+\$126</b>	<b>+\$160</b>	<b>+\$213</b>	<b>+\$253</b>	<b>+\$297</b>	<b>+\$387</b>	<b>+\$483</b>
		<b>+0</b>	<b>+\$32</b>	<b>+\$57</b>	<b>+\$94</b>	<b>+\$146</b>	<b>+\$168</b>	<b>+\$213</b>	<b>+\$284</b>	<b>+\$337</b>	<b>+\$395</b>	<b>+\$516</b>	<b>+\$643</b>
		<b>OVERALL DIMENSIONS</b>			<b>SEAT DIMENSIONS</b>			<b>BACK DIMENSIONS</b>					
		<b>W</b>	<b>D</b>	<b>H</b>	<b>W</b>	<b>D</b>	<b>H</b>	<b>W</b>	<b>H</b>				
		24.25	23.75	32.25	18.25	16.5	18.25	16.5	15.25				
	Active weight 400 lbs. Does not stack.  Add \$15 for (SBS).												
 <p><b>Armless Chair, Sled Base, Polypropylene Back and Seat</b>                      COM Yardage: n/a                      Freight Class: 250                      Product Weight (lbs.): 26.5                      Cubic Feet Per Carton: 11.75</p>	<b>W6NPP</b>	List Price											
		<b>\$634</b>											
		<b>OVERALL DIMENSIONS</b>			<b>SEAT DIMENSIONS</b>			<b>BACK DIMENSIONS</b>					
				<b>W</b>	<b>D</b>	<b>H</b>	<b>W</b>	<b>D</b>	<b>H</b>	<b>W</b>	<b>H</b>		
		20.75	23.5	32	17.75	17.75	17.75	16	16				
	Active weight 400 lbs. Does not stack.												
 <p><b>Armless Chair, Sled Base, Upholstered Back and Polypropylene Seat</b>                      COM Yardage: n/a                      Freight Class: 250                      Product Weight (lbs.): 27                      Cubic Feet Per Carton: 11.75</p>	<b>W6NUP</b>	1/COM	2	3	4	5	6	7	8	9	10	11	12
		<b>\$703</b>	<b>\$719</b>	<b>\$732</b>	<b>\$750</b>	<b>\$776</b>	<b>\$787</b>	<b>\$810</b>	<b>\$845</b>	<b>\$872</b>	<b>\$901</b>	<b>\$961</b>	<b>\$1025</b>
		<b>OVERALL DIMENSIONS</b>			<b>SEAT DIMENSIONS</b>			<b>BACK DIMENSIONS</b>					
				<b>W</b>	<b>D</b>	<b>H</b>	<b>W</b>	<b>D</b>	<b>H</b>	<b>W</b>	<b>H</b>		
		20.75	23.5	32.25	17.75	17.75	17.75	16.5	16				
	Active weight 400 lbs. Does not stack. Add \$15 for (SBS)												
 <p><b>Armless Chair, Sled Base, Polypropylene Back and Upholstered Seat</b>                      COM Yardage: 0.75                      Freight Class: 250                      Product Weight (lbs.): 27                      Cubic Feet Per Carton: 11.75</p>	<b>W6NPU</b>	List Price											
		<b>\$703</b>	<b>\$727</b>	<b>\$746</b>	<b>\$774</b>	<b>\$813</b>	<b>\$829</b>	<b>\$863</b>	<b>\$916</b>	<b>\$956</b>	<b>\$1000</b>	<b>\$1090</b>	<b>\$1186</b>
		<b>OVERALL DIMENSIONS</b>			<b>SEAT DIMENSIONS</b>			<b>BACK DIMENSIONS</b>					
				<b>W</b>	<b>D</b>	<b>H</b>	<b>W</b>	<b>D</b>	<b>H</b>	<b>W</b>	<b>H</b>		
		20.75	23.5	32	18.25	17.75	18.25	16	15.25				
	Active weight 400 lbs. Does not stack.												
 <p><b>Armless Chair, Sled Base, Upholstered Back and Seat</b>                      COM Yardage: Back: 0.5; Seat: 0.75                      Freight Class: 250                      Product Weight (lbs.): 27.5                      Cubic Feet Per Carton: 11.75</p>	<b>W6NUU</b> Base Price: Seat upcharge: Back upcharge:	<b>\$766</b>											
		<b>+0</b>	<b>+\$24</b>	<b>+\$43</b>	<b>+\$71</b>	<b>+\$110</b>	<b>+\$126</b>	<b>+\$160</b>	<b>+\$213</b>	<b>+\$253</b>	<b>+\$297</b>	<b>+\$387</b>	<b>+\$483</b>
		<b>+0</b>	<b>+\$16</b>	<b>+\$29</b>	<b>+\$47</b>	<b>+\$73</b>	<b>+\$84</b>	<b>+\$107</b>	<b>+\$142</b>	<b>+\$169</b>	<b>+\$198</b>	<b>+\$258</b>	<b>+\$322</b>
		<b>OVERALL DIMENSIONS</b>			<b>SEAT DIMENSIONS</b>			<b>BACK DIMENSIONS</b>					
		<b>W</b>	<b>D</b>	<b>H</b>	<b>W</b>	<b>D</b>	<b>H</b>	<b>W</b>	<b>H</b>				
		20.75	23.5	32.25	18.25	16.5	18.25	16.5	15.25				
	Active weight 400 lbs. Does not stack.  Add \$15 for (SBS).												





DESCRIPTION	MODEL#	STANDARD FABRIC GRADES												
		1/COM	2	3	4	5	6	7	8	9	10	11	12	
	<b>W630AUU</b>	Base Price:	<b>\$1159</b>											
		Seat upcharge:	<b>+0</b>	<b>+\$32</b>	<b>+\$57</b>	<b>+\$94</b>	<b>+\$146</b>	<b>+\$168</b>	<b>+\$213</b>	<b>+\$284</b>	<b>+\$337</b>	<b>+\$395</b>	<b>+\$516</b>	<b>+\$643</b>
		Back upcharge:	<b>+0</b>	<b>+\$24</b>	<b>+\$43</b>	<b>+\$71</b>	<b>+\$110</b>	<b>+\$126</b>	<b>+\$160</b>	<b>+\$213</b>	<b>+\$253</b>	<b>+\$297</b>	<b>+\$387</b>	<b>+\$483</b>
		<b>OVERALL DIMENSIONS</b>			<b>SEAT DIMENSIONS</b>			<b>BACK DIMENSIONS</b>						
		<b>W</b>	<b>D</b>	<b>H</b>	<b>W</b>	<b>D</b>	<b>H</b>	<b>W</b>	<b>H</b>					
		35.25	23.5	32.25	29	17	18.25	26.75	15.25					
<b>Bariatric Armchair, Sled Base, Upholstered Back and Seat</b> COM Yardage: Back: 0.75; Seat: 1 Freight Class: 250 Product Weight (lbs.): 45 Cubic Feet Per Carton: 20.5		Active weight 600 lbs. Does not stack. Add \$23 for (SBS).												





DESCRIPTION	MODEL#	STANDARD FABRIC GRADES												
		1/COM	2	3	4	5	6	7	8	9	10	11	12	
	<b>W630NUU</b>	Base Price:	<b>\$1110</b>											
		Seat upcharge:	<b>+0</b>	<b>+\$32</b>	<b>+\$57</b>	<b>+\$94</b>	<b>+\$146</b>	<b>+\$168</b>	<b>+\$213</b>	<b>+\$284</b>	<b>+\$337</b>	<b>+\$395</b>	<b>+\$516</b>	<b>+\$643</b>
		Back upcharge:	<b>+0</b>	<b>+\$24</b>	<b>+\$43</b>	<b>+\$71</b>	<b>+\$110</b>	<b>+\$126</b>	<b>+\$160</b>	<b>+\$213</b>	<b>+\$253</b>	<b>+\$297</b>	<b>+\$387</b>	<b>+\$483</b>
		<b>OVERALL DIMENSIONS</b>			<b>SEAT DIMENSIONS</b>			<b>BACK DIMENSIONS</b>						
		<b>W</b>	<b>D</b>	<b>H</b>	<b>W</b>	<b>D</b>	<b>H</b>	<b>W</b>	<b>H</b>					
		31.75	23.5	32.25	29	17	18.25	26.75	15.25					
<b>Bariatric Armless Chair, Sled Base, Upholstered Back and Seat</b> COM Yardage: Back: 0.75; Seat: 1 Freight Class: 250 Product Weight (lbs.): 41.5 Cubic Feet Per Carton: 16.75		Active weight 600 lbs. Does not stack. Add \$23 for (SBS).												

DESCRIPTION	MODEL#	STANDARD FABRIC GRADES											
		1/COM	2	3	4	5	6	7	8	9	10	11	12
	<b>W5CSAPP</b>	List Price											
		<b>\$748</b>											
			<b>OVERALL DIMENSIONS</b>			<b>SEAT DIMENSIONS</b>			<b>BACK DIMENSIONS</b>				
		<b>W</b>	<b>D</b>	<b>H</b>	<b>W</b>	<b>D</b>	<b>H</b>	<b>W</b>	<b>H</b>				
		24.25	23.5	38.25	17.75	17.15	23.25	16	16				
<b>Counter Stool with Arms, Polypropylene Back and Seat</b> COM Yardage: n/a Freight Class: 250 Product Weight (lbs.): 32.5 Cubic Feet Per Carton: 15		Active weight 400 lbs. Does not stack.											





DESCRIPTION	MODEL#	STANDARD FABRIC GRADES												
		1/COM	2	3	4	5	6	7	8	9	10	11	12	
	<b>W5CSAUP</b>	<b>\$816</b>	<b>\$832</b>	<b>\$845</b>	<b>\$863</b>	<b>\$889</b>	<b>\$900</b>	<b>\$923</b>	<b>\$958</b>	<b>\$985</b>	<b>\$1014</b>	<b>\$1074</b>	<b>\$1138</b>	
			<b>OVERALL DIMENSIONS</b>			<b>SEAT DIMENSIONS</b>			<b>BACK DIMENSIONS</b>					
			<b>W</b>	<b>D</b>	<b>H</b>	<b>W</b>	<b>D</b>	<b>H</b>	<b>W</b>	<b>H</b>				
		24.25	23.5	38.25	17.75	16.5	23.25	16.5	16					
<b>Counter Stool with Arms, Upholstered Back and Polypropylene Seat</b> COM Yardage: 0.5 Freight Class: 250 Product Weight (lbs.): 33 Cubic Feet Per Carton: 15		Active weight 400 lbs. Does not stack. Add \$15 for (SBS).												





DESCRIPTION	MODEL#	STANDARD FABRIC GRADES												
		1/COM	2	3	4	5	6	7	8	9	10	11	12	
	<b>W5CSAPU</b>	<b>\$816</b>	<b>\$840</b>	<b>\$859</b>	<b>\$887</b>	<b>\$926</b>	<b>\$942</b>	<b>\$976</b>	<b>\$1029</b>	<b>\$1069</b>	<b>\$1113</b>	<b>\$1203</b>	<b>\$1299</b>	
			<b>OVERALL DIMENSIONS</b>			<b>SEAT DIMENSIONS</b>			<b>BACK DIMENSIONS</b>					
			<b>W</b>	<b>D</b>	<b>H</b>	<b>W</b>	<b>D</b>	<b>H</b>	<b>W</b>	<b>H</b>				
		24.25	23.5	38.25	18.25	17.75	24.25	16	15.25					
<b>Counter Stool with Arms, Polypropylene Back and Upholstered Seat</b> COM Yardage: 0.75 Freight Class: 250 Product Weight (lbs.): 33 Cubic Feet Per Carton: 15		Active weight 400 lbs. Does not stack.												

DESCRIPTION	MODEL#	STANDARD FABRIC GRADES											
		1/COM	2	3	4	5	6	7	8	9	10	11	12
 <p><b>Counter Stool with Arms, Upholstered Back and Seat</b> COM Yardage: Back: 0.5; Seat: 0.75 Freight Class: 250 Product Weight (lbs.): 33.5 Cubic Feet Per Carton: 15</p>	<b>W5CSAAU</b> Base Price: Seat upcharge: Back upcharge:	<b>\$880</b>											
		<b>+0</b>	<b>+\$24</b>	<b>+\$43</b>	<b>+\$71</b>	<b>+\$110</b>	<b>+\$126</b>	<b>+\$160</b>	<b>+\$213</b>	<b>+\$253</b>	<b>+\$297</b>	<b>+\$387</b>	<b>+\$483</b>
		<b>+0</b>	<b>+\$16</b>	<b>+\$29</b>	<b>+\$47</b>	<b>+\$73</b>	<b>+\$84</b>	<b>+\$107</b>	<b>+\$142</b>	<b>+\$169</b>	<b>+\$198</b>	<b>+\$258</b>	<b>+\$322</b>
		<b>OVERALL DIMENSIONS</b>			<b>SEAT DIMENSIONS</b>			<b>BACK DIMENSIONS</b>					
		<b>W</b>	<b>D</b>	<b>H</b>	<b>W</b>	<b>D</b>	<b>H</b>	<b>W</b>	<b>H</b>				
		24.25	23.5	38.25	18.25	17	24.25	16.5	15.25				
<p>Active weight 400 lbs. Does not stack. Add \$15 for (SBS).</p>													
 <p><b>Armless Counter Stool, Polypropylene Back and Seat</b> COM Yardage: n/a Freight Class: 250 Product Weight (lbs.): 29.5 Cubic Feet Per Carton: 13.75</p>	<b>W5CSNPP</b>	List Price											
		<b>\$698</b>											
		<b>OVERALL DIMENSIONS</b>			<b>SEAT DIMENSIONS</b>			<b>BACK DIMENSIONS</b>					
				<b>W</b>	<b>D</b>	<b>H</b>	<b>W</b>	<b>D</b>	<b>H</b>	<b>W</b>	<b>H</b>		
		21.75	23.5	38.25	17.75	17.15	23.25	16	16				
<p>Active weight 400 lbs. Stacks 4 high on floor.</p>													
 <p><b>Armless Counter Stool, Upholstered Back and Polypropylene Seat</b> COM Yardage: 0.5 Freight Class: 250 Product Weight (lbs.): 30 Cubic Feet Per Carton: 13.75</p>	<b>W5CSNUP</b>	1/COM	2	3	4	5	6	7	8	9	10	11	12
		<b>\$767</b>	<b>\$783</b>	<b>\$796</b>	<b>\$814</b>	<b>\$840</b>	<b>\$851</b>	<b>\$874</b>	<b>\$909</b>	<b>\$936</b>	<b>\$965</b>	<b>\$1025</b>	<b>\$1089</b>
		<b>OVERALL DIMENSIONS</b>			<b>SEAT DIMENSIONS</b>			<b>BACK DIMENSIONS</b>					
				<b>W</b>	<b>D</b>	<b>H</b>	<b>W</b>	<b>D</b>	<b>H</b>	<b>W</b>	<b>H</b>		
		21.75	23.5	38.25	17.75	16.5	23.25	16.5	16				
<p>Active weight 400 lbs. Stacks 4 high on floor. Add \$15 for (SBS).</p>													
 <p><b>Armless Counter Stool, Polypropylene Back and Upholstered Seat</b> COM Yardage: 0.75 Freight Class: 250 Product Weight (lbs.): 30 Cubic Feet Per Carton: 13.75</p>	<b>W5CSNPU</b>	1/COM	2	3	4	5	6	7	8	9	10	11	12
		<b>\$767</b>	<b>\$791</b>	<b>\$810</b>	<b>\$838</b>	<b>\$877</b>	<b>\$893</b>	<b>\$927</b>	<b>\$980</b>	<b>\$1020</b>	<b>\$1064</b>	<b>\$1154</b>	<b>\$1250</b>
		<b>OVERALL DIMENSIONS</b>			<b>SEAT DIMENSIONS</b>			<b>BACK DIMENSIONS</b>					
				<b>W</b>	<b>D</b>	<b>H</b>	<b>W</b>	<b>D</b>	<b>H</b>	<b>W</b>	<b>H</b>		
		21.75	23.5	38.25	18.25	17.75	24.25	16	15.25				
<p>Active weight 400 lbs. Stacks 4 high on floor.</p>													
 <p><b>Armless Counter Stool, Upholstered Back and Seat</b> COM Yardage: Back: 0.5; Seat: 0.75 Freight Class: 250 Product Weight (lbs.): 30.5 Cubic Feet Per Carton: 13.75</p>	<b>W5CSNUU</b> Base Price: Seat upcharge: Back upcharge:	<b>\$830</b>											
		<b>+0</b>	<b>+\$24</b>	<b>+\$43</b>	<b>+\$71</b>	<b>+\$110</b>	<b>+\$126</b>	<b>+\$160</b>	<b>+\$213</b>	<b>+\$253</b>	<b>+\$297</b>	<b>+\$387</b>	<b>+\$483</b>
		<b>+0</b>	<b>+\$16</b>	<b>+\$29</b>	<b>+\$47</b>	<b>+\$73</b>	<b>+\$84</b>	<b>+\$107</b>	<b>+\$142</b>	<b>+\$169</b>	<b>+\$198</b>	<b>+\$258</b>	<b>+\$322</b>
		<b>OVERALL DIMENSIONS</b>			<b>SEAT DIMENSIONS</b>			<b>BACK DIMENSIONS</b>					
		<b>W</b>	<b>D</b>	<b>H</b>	<b>W</b>	<b>D</b>	<b>H</b>	<b>W</b>	<b>H</b>				
		21.75	23.5	38.25	18.25	17	24.25	16.5	15.25				
<p>Active weight 400 lbs. Stacks 4 high on floor. Add \$15 for (SBS).</p>													

DESCRIPTION	MODEL#	STANDARD FABRIC GRADES													
 <p><b>Bar Stool with Arms, Polypropylene Back and Seat</b> COM Yardage: n/a Freight Class: 250 Product Weight (lbs.): 34.5 Cubic Feet Per Carton: 17</p>		List Price													
	<b>W5BSAPP</b>	<b>\$759</b>													
		OVERALL DIMENSIONS			SEAT DIMENSIONS			BACK DIMENSIONS							
		W	D	H	W	D	H	W	H						
		24.25	23.5	44	17.75	17.5	29.25	16	16						
 <p><b>Bar Stool with Arms, Upholstered Back and Polypropylene Seat</b> COM Yardage: 0.5 Freight Class: 250 Product Weight (lbs.): 35 Cubic Feet Per Carton: 17</p>		1/COM 2 3 4 5 6 7 8 9 10 11 12													
	<b>W5BSAUP</b>	<b>\$828</b>	<b>\$844</b>	<b>\$857</b>	<b>\$875</b>	<b>\$901</b>	<b>\$912</b>	<b>\$935</b>	<b>\$970</b>	<b>\$997</b>	<b>\$1026</b>	<b>\$1086</b>	<b>\$1150</b>		
		OVERALL DIMENSIONS			SEAT DIMENSIONS			BACK DIMENSIONS							
		W	D	H	W	D	H	W	H						
		24.25	23.5	44.5	17.75	16.5	29.25	16.5	16						
 <p><b>Bar Stool with Arms, Polypropylene Back and Upholstered Seat</b> COM Yardage: 0.75 Freight Class: 250 Product Weight (lbs.): 35 Cubic Feet Per Carton: 17</p>		1/COM 2 3 4 5 6 7 8 9 10 11 12													
	<b>W5BSAPU</b>	<b>\$828</b>	<b>\$844</b>	<b>\$857</b>	<b>\$875</b>	<b>\$901</b>	<b>\$912</b>	<b>\$935</b>	<b>\$970</b>	<b>\$997</b>	<b>\$1026</b>	<b>\$1086</b>	<b>\$1150</b>		
		OVERALL DIMENSIONS			SEAT DIMENSIONS			BACK DIMENSIONS							
		W	D	H	W	D	H	W	H						
		24.25	23.5	44	18.25	17.5	30.25	16	15.25						
 <p><b>Bar Stool with Arms, Upholstered Back and Seat</b> COM Yardage: Back: 0.5; Seat: 0.75 Freight Class: 250 Product Weight (lbs.): 35.5 Cubic Feet Per Carton: 17</p>		1/COM 2 3 4 5 6 7 8 9 10 11 12													
	<b>W5BSAAU</b>	Base Price: <b>\$891</b>	Seat upcharge: <b>+\$0</b>	Back upcharge: <b>+\$0</b>	<b>+\$24</b>	<b>+\$43</b>	<b>+\$71</b>	<b>+\$110</b>	<b>+\$126</b>	<b>+\$160</b>	<b>+\$213</b>	<b>+\$253</b>	<b>+\$297</b>	<b>+\$387</b>	<b>+\$483</b>
		OVERALL DIMENSIONS			SEAT DIMENSIONS			BACK DIMENSIONS							
		W	D	H	W	D	H	W	H						
		24.25	23.5	44.5	18.25	16.75	30.25	16.5	15.25						
 <p><b>Armless Bar Stool, Polypropylene Back and Seat</b> COM Yardage: n/a Freight Class: 250 Product Weight (lbs.): 31.5 Cubic Feet Per Carton: 15.75</p>		List Price													
	<b>W5BSNPP</b>	<b>\$710</b>													
		OVERALL DIMENSIONS			SEAT DIMENSIONS			BACK DIMENSIONS							
		W	D	H	W	D	H	W	H						
		20.75	23.5	44	17.75	17.5	29.25	16	16						



DESCRIPTION	MODEL#	STANDARD FABRIC GRADES												
		1/COM	2	3	4	5	6	7	8	9	10	11	12	
 <p><b>Armless Bar Stool, Upholstered Back and Polypropylene Seat</b>                      COM Yardage: 0.5                      Freight Class: 250                      Product Weight (lbs.): 32                      Cubic Feet Per Carton: 15.75</p>	<b>W5BSNUP</b>	\$779	\$795	\$808	\$826	\$852	\$863	\$886	\$921	\$948	\$977	\$1037	\$1101	
	<b>OVERALL DIMENSIONS</b>			<b>SEAT DIMENSIONS</b>			<b>BACK DIMENSIONS</b>							
	<b>W</b>	<b>D</b>	<b>H</b>	<b>W</b>	<b>D</b>	<b>H</b>	<b>W</b>	<b>H</b>						
	20.75	23.5	44.5	17.75	16.5	29.25	16.5	16						
 <p><b>Armless Bar Stool, Polypropylene Back and Upholstered Seat</b>                      COM Yardage: 0.75                      Freight Class: 250                      Product Weight (lbs.): 32                      Cubic Feet Per Carton: 15.75</p>	<b>W5BSNPU</b>	\$779	\$803	\$822	\$850	\$889	\$905	\$939	\$992	\$1032	\$1076	\$1166	\$1262	
	<b>OVERALL DIMENSIONS</b>			<b>SEAT DIMENSIONS</b>			<b>BACK DIMENSIONS</b>							
	<b>W</b>	<b>D</b>	<b>H</b>	<b>W</b>	<b>D</b>	<b>H</b>	<b>W</b>	<b>H</b>						
	20.75	23.5	44	18.25	17.5	30.25	16	15.25						
 <p><b>Armless Bar Stool, Upholstered Back and Seat</b>                      COM Yardage: Back: 0.5; Seat: 0.75                      Freight Class: 250                      Product Weight (lbs.): 32.5                      Cubic Feet Per Carton: 15.75</p>	<b>W5BSNUU</b>	Base Price: <b>\$842</b>												
		Seat upcharge:	<b>+0</b>	<b>+\$24</b>	<b>+\$43</b>	<b>+\$71</b>	<b>+\$110</b>	<b>+\$126</b>	<b>+\$160</b>	<b>+\$213</b>	<b>+\$253</b>	<b>+\$297</b>	<b>+\$387</b>	<b>+\$483</b>
		Back upcharge:	<b>+0</b>	<b>+\$16</b>	<b>+\$29</b>	<b>+\$47</b>	<b>+\$73</b>	<b>+\$84</b>	<b>+\$107</b>	<b>+\$142</b>	<b>+\$169</b>	<b>+\$198</b>	<b>+\$258</b>	<b>+\$322</b>
	<b>OVERALL DIMENSIONS</b>			<b>SEAT DIMENSIONS</b>			<b>BACK DIMENSIONS</b>							
<b>W</b>	<b>D</b>	<b>H</b>	<b>W</b>	<b>D</b>	<b>H</b>	<b>W</b>	<b>H</b>							
20.75	23.5	44.5	18.25	16.75	30.25	16.5	15.25							
 <p><b>Hip Chair, Polypropylene Back and Seat</b>                      COM Yardage: n/a                      Freight Class: 250                      Product Weight (lbs.): 35.5                      Cubic Feet Per Carton: 17.75</p>	<b>W524APP</b>	List Price												
		<b>\$771</b>												
	<b>OVERALL DIMENSIONS</b>			<b>SEAT DIMENSIONS</b>			<b>BACK DIMENSIONS</b>							
	<b>W</b>	<b>D</b>	<b>H</b>	<b>W</b>	<b>D</b>	<b>H</b>	<b>W</b>	<b>H</b>						
24.25	24.25	38	17.75	17.5	22.25	16	16							
 <p><b>Hip Chair, Upholstered Back and Polypropylene Seat</b>                      COM Yardage: 0.5                      Freight Class: 250                      Product Weight (lbs.): 36                      Cubic Feet Per Carton: 17.75</p>	<b>W524AUP</b>	\$839	\$855	\$868	\$886	\$912	\$923	\$946	\$981	\$1008	\$1037	\$1097	\$1161	
	<b>OVERALL DIMENSIONS</b>			<b>SEAT DIMENSIONS</b>			<b>BACK DIMENSIONS</b>							
	<b>W</b>	<b>D</b>	<b>H</b>	<b>W</b>	<b>D</b>	<b>H</b>	<b>W</b>	<b>H</b>						
	24.25	24.25	38.25	17.75	16.5	22.25	16.5	16.25						

DESCRIPTION	MODEL#	STANDARD FABRIC GRADES												
		1/COM	2	3	4	5	6	7	8	9	10	11	12	
 <p><b>Hip Chair, Polypropylene Back and Upholstered Seat</b> COM Yardage: 0.75 Freight Class: 250 Product Weight (lbs.): 36 Cubic Feet Per Carton: 17.75</p>	<b>W524APU</b>	\$839	\$855	\$868	\$886	\$912	\$923	\$946	\$981	\$1008	\$1037	\$1097	\$1161	
		<b>OVERALL DIMENSIONS</b>			<b>SEAT DIMENSIONS</b>			<b>BACK DIMENSIONS</b>						
		<b>W</b>	<b>D</b>	<b>H</b>	<b>W</b>	<b>D</b>	<b>H</b>	<b>W</b>	<b>H</b>					
		24.25	24.25	38	18.25	17.5	23.25	16	15.25					
<p>Active weight 400 lbs. Does not stack.</p>														
 <p><b>Hip Chair, Upholstered Back and Seat</b> COM Yardage: Back: 0.5; Seat: 0.75 Freight Class: 250 Product Weight (lbs.): 36.5 Cubic Feet Per Carton: 17.75</p>	<b>W524AUU</b>	Base Price: \$902												
		Seat upcharge:	+0	+\$24	+\$43	+\$71	+\$110	+\$126	+\$160	+\$213	+\$253	+\$297	+\$387	+\$483
		Back upcharge:	+0	+\$16	+\$29	+\$47	+\$73	+\$84	+\$107	+\$142	+\$169	+\$198	+\$258	+\$322
			<b>OVERALL DIMENSIONS</b>			<b>SEAT DIMENSIONS</b>			<b>BACK DIMENSIONS</b>					
		<b>W</b>	<b>D</b>	<b>H</b>	<b>W</b>	<b>D</b>	<b>H</b>	<b>W</b>	<b>H</b>					
		24.25	24.25	38.25	18.25	16.5	23.25	16.5	15.25					
<p>Active weight 400 lbs. Does not stack.</p> <p>Add \$15 for (SBS).</p>														
 <p><b>Bariatric Hip Chair, Upholstered Back and Seat</b> COM Yardage: Back: 0.75; Seat: 1 Freight Class: 250 Product Weight (lbs.): 50 Cubic Feet Per Carton: 23.75</p>	<b>W324AUU</b>	Base Price: \$1188												
		Seat upcharge:	+0	+\$32	+\$57	+\$94	+\$146	+\$168	+\$213	+\$284	+\$337	+\$395	+\$516	+\$643
		Back upcharge:	+0	+\$24	+\$43	+\$71	+\$110	+\$126	+\$160	+\$213	+\$253	+\$297	+\$387	+\$483
			<b>OVERALL DIMENSIONS</b>			<b>SEAT DIMENSIONS</b>			<b>BACK DIMENSIONS</b>					
		<b>W</b>	<b>D</b>	<b>H</b>	<b>W</b>	<b>D</b>	<b>H</b>	<b>W</b>	<b>H</b>					
		35.25	24.25	38.5	29	17.5	23.25	26.75	15.25					
<p>Active weight 600 lbs. Does not stack.</p> <p>Add \$23 for (SBS).</p>														
 <p><b>Dolly</b> COM Yardage: n/a Freight Class: 150 Product Weight (lbs.): 16 Cubic Feet Per Carton: 3.5</p>	<b>WDOL</b>	List Price												
		\$348												
			<b>OVERALL DIMENSIONS</b>			<b>SEAT DIMENSIONS</b>			<b>BACK DIMENSIONS</b>					
			<b>W</b>	<b>D</b>	<b>H</b>	<b>W</b>	<b>D</b>	<b>H</b>	<b>W</b>	<b>H</b>				
		22	23.75	9.25										
<p>Accommodates 10 standard 4-legged chairs.</p>														
 <p><b>Bariatric Dolly</b> COM Yardage: n/a Freight Class: 250 Product Weight (lbs.): 19 Cubic Feet Per Carton: 5</p>	<b>WDOL30</b>	List Price												
		\$386												
			<b>OVERALL DIMENSIONS</b>			<b>SEAT DIMENSIONS</b>			<b>BACK DIMENSIONS</b>					
			<b>W</b>	<b>D</b>	<b>H</b>	<b>W</b>	<b>D</b>	<b>H</b>	<b>W</b>	<b>H</b>				
		32.12	23.75	9.25										
<p>Accommodates 4 bariatric 4-legged chairs.</p>														

WILLOW LINKING TABLES



**WPT12G**  
120 degree corner linking table



**WPT9GL**  
End linking table, left



For Willow seating, see page 227.

STANDARD FEATURES







- Linking tables can be used together in any combination with Willow four-leg or sled chairs to create a wide variety of layouts.
- Connecting hardware is included.
- Legs and ganging brackets are available in 20 paint finishes and 4 plated finishes.
- All tables are laminate, choose thermally fused or high pressure, and feature a flat edge with edgeband.
- Tables are available with a variety of glide types. Glides must be chosen to best suit flooring type and site conditions. See Glide Type.
- All tables (except 9" In-line Linking) are pre-drilled for center front, field installed, undermount power. Specified separately.
- Undermount power unit (SU2P10U) includes 1 AC and 2 USB-A charging ports with a 10' power cord and 3-prong plug, specify Jet Black or White. Power units do not link.
- Clamp mount (SU2P10C) power, with 1 AC and 2 USB-A charging ports with a 10' power cord, available Jet Black or White. These units can be mounted on the back edge of all linking tables. Specified separately for field installation. Power units do not link.



Add option codes in the following order:

- **Model number**  
Enter model number.
- **Surface Type**  
**(TFL)** Thermally fused laminate  
**(HPL)** High pressure laminate
- **Top finish**  
**(ACJ)** Absolute Acajou  
**(ASN)** Asian Night  
**(AWC)** Avant Cherry  
**(AWH)** Avant Honey  
**(BLK)** Black  
**(BZD)** Blizzard  
**(BRC)** Brushed Cobalt  
**(CMB)** Clear Maple  
**(CGY)** Custom Grey  
**(DES)** Dark Espresso  
**(DWT)** Designer White  
**(FAS)** Fashionista  
**(FCL)** First Class  
**(NBL)** Noce Biondo  
**(NGL)** Noce Grigio  
**(NEL)** Noce Leggero  
**(NML)** Noce Medio  
**(QTM)** Quartered Mahogany  
**(SBY)** Sheer Beauty  
**(SDT)** Stonedust  
**(SOG)** Storm Grey  
**(WCR)** Winter Cherry  
**(WHC)** White Chocolate  
**(WHE)** Walnut Heights
- **Leg Finish** (for tables with legs)  
Paint finishes:  
Black **(TBL)**, Buzz Blue **(TBZ)**, Cactus **(TCC)**, Carrot **(TCR)**, Cloud **(TIV)**, Designer White **(TDW)**, Dijon **(TDJ)**, Eggplant **(TEG)**, Fog **(TFO)**, Frost **(TFR)**, Ink **(TIN)**, Kalua **(TKA)**, Latte **(TLA)**, Mocha **(TMO)**, Nevada **(TNE)**, Sand **(TSN)**, Scarlet **(TSR)**, Shadow **(TSH)**, Toast **(TOA)** and Tungsten **(TTU)**.  
Plated finishes:  
**(CHM)** Chrome. Add \$42.  
**(BCH)** Brushed Chrome. Add \$147.  
**(SBR)** Satin Brass. Add \$217.  
**(ACO)** Antique Copper. Add \$217.
- **Bracket Finish** (for linking tables and ganging bracket)  
Paint finishes:  
Black **(TBL)**, Cloud **(TIV)**, Designer White **(TDW)**, Fog **(TFO)**, Frost **(TFR)**, Kalua **(TKA)**, Latte **(TLA)**, Mocha **(TMO)**, Nevada **(TNE)**, Sand **(TSN)**, Shadow **(TSH)**, Toast **(TOA)** and Tungsten **(TTU)**.
- **Glide type** (for models with legs)  
**(ST)** Nylon colored glide for most surfaces  
**(NM)** White, non-marking Nylon glide for most surfaces  
**(SG)** Steel cushion glide for carpeted surfaces. Add \$8 for models with one leg. Add \$15 for models with two legs.  
**(FG)** Felt glide for most hard floor surfaces. Add \$8 for models with one leg. Add \$15 for models with two legs.  
**(RG)** Rubber, non-slip glide for most hard floor surfaces. Add \$8 for models with one leg. Add \$15 for models with two legs.
- **Glide Finish** (for ST glides only)  
**(BLK)** Black  
**(SND)** Sand

EXAMPLE WILLOW TABLE ORDER CODE:

WPT90G	HPL	ACJ	-CHM	-ST	-SND
Model #	Surface type	Top finish	Leg finish	Glide type	Glide finish

LINKING TABLES	MODEL#	DIMENSIONS	FREIGHT CLASS	WT/LBS.	CUBIC FT.	LIST PRICE
 <p><b>90° Corner Linking Table</b></p>	WPT90G	26.12 x 26.12 x 17.62	100	24	2.6	<b>\$561</b>
						<ul style="list-style-type: none"> <li>• Pricing shown for a thermally fused laminate top (LP).</li> <li>• For a high pressure laminate top (HP), add <b>\$144</b>.</li> </ul>
Coordinating edge on laminate surfaces with metal frame and legs. Must be connected to a four-leg or sled base chair. Includes one set of U-channel connectors and hardware. 1 per carton. Shipped KD for assembly on site.						
 <p><b>120° Corner Linking Table</b></p>	WPT12G	31 x 12.62 x 17.5	92.5	16.5	1.5	<b>\$482</b>
						<ul style="list-style-type: none"> <li>• Pricing shown for a thermally fused laminate top (LP).</li> <li>• For a high pressure laminate top (HP), add <b>\$92</b>.</li> </ul>
Coordinating edge on laminate surfaces with metal frame and legs. Must be connected to a four-leg or sled base chair. Includes one set of U-channel connectors and hardware. 1 per carton. Shipped KD for assembly on site.						
 <p><b>16" In-Line Linking Table</b></p>	WPT16G	15 x 16 x 2.75	85	12	0.9	<b>\$315</b>
						<ul style="list-style-type: none"> <li>• Pricing shown for a thermally fused laminate top (LP).</li> <li>• For a high pressure laminate top (HP), add <b>\$58</b>.</li> </ul>
Coordinating edge on laminate surfaces with metal frame and legs. Must be connected to a four-leg or sled base chair. Includes one set of U-channel connectors and hardware. 1 per carton. Shipped KD for assembly on site.						
 <p><b>9" In-Line Linking Table</b></p>	WPT09G		85	8.5	0.7	<b>\$245</b>
						<ul style="list-style-type: none"> <li>• Pricing shown for a thermally fused laminate top (LP).</li> <li>• For a high pressure laminate top (HP), add <b>\$41</b>.</li> </ul>
Coordinating edge on laminate surfaces with metal frame and legs. Must be connected to a four-leg or sled base chair. Includes one set of U-channel connectors and hardware. 1 per carton. Shipped KD for assembly on site.						
 <p><b>End Linking Table</b></p>	WPTEGL (Left)	15 x 14 x 17.62	85	13	1	<b>\$489</b>
	WPTEGR (Right)	15 x 14 x 17.62	85	13	1	<b>\$489</b>
						<ul style="list-style-type: none"> <li>• Pricing shown for a thermally fused laminate top (LP).</li> <li>• For a high pressure laminate top (HP), add <b>\$55</b>.</li> </ul>
Coordinating edge on laminate surfaces with metal frame and legs. Must be connected to a four-leg or sled base chair. Includes one set of U-channel connectors and hardware. 1 per carton. Shipped KD for assembly on site.						
 <p><b>Ganging Bracket</b></p>	WPGBRK	9 x 15 x 1.25	300	2	2	<b>\$108</b>
For use between two seated height arm or armless chairs where table top is not desired. Not for use with stools. Does not accept power units. 1 per carton.						

POWER	MODEL#	DIMENSIONS	FREIGHT CLASS	WT/LBS.	CUBIC FT.	LIST PRICE
 <p><b>Power Unit, Clamp Attachment</b></p>	SU2P10C		70	0.01	0.5	<b>\$557</b>
<p>Tamper-resistant clamp mount power, with 1 AC and 2 USB-A charging ports with a 10' power cord and 3-prong plug. Available in Jet Black or White. Can be mounted on the back edge of all linking tables. Must be specified separately for field installation. Power units do not link.</p>						
 <p><b>Power Unit, Under Mount Attachment</b></p>	SU2P10U		70	0.01	2	<b>\$527</b>
<p>Tamper-resistant undermount power, with 1 AC and 2 USB-A charging ports with a 10' power cord and 3-prong plug. Available in Jet Black or White. Must be specified separately for field installation. Power units do not link.</p>						

WINGBACK



model GC3787C

STANDARD FEATURES

- Traditional styling, easy to exit and features removable and replaceable seats.
- For added comfort, seats are standard with high density foam.
- Standard glide is plastic.
- Wood legs are available in a variety of finishes. Available in Maple wood only species.
- For textile and finish options, visit the website at [globalfurnituregroup.com](http://globalfurnituregroup.com)
- Can be upholstered in standard Global textiles if Healthcare compliance is not required.
- Shipped fully assembled.

OPTIONAL FEATURES

- For non-slip glides specify (NS) - Add **\$35**
- For moisture barrier (seat only) - Add **\$193** per seat.

SUGGESTED APPLICATIONS

- Guest seating
- Lobbies
- Lounge/Waiting
- Patient rooms
- Resident rooms

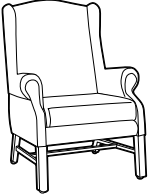
DESCRIPTION	MODEL#	STANDARD TEXTILE GRADES											
		COM	2	3	4	5	6	7	8	9	10	11	12
 <p><b>HB Armchair, Chippendale Legs</b>                      COM Yardage: 4.75                      Freight Class: 250                      Product Weight (lbs.): 50                      Cubic Feet Per Carton: 22.25</p>	GC3787C	\$1847	\$1991	\$2219	\$2413	\$2687	\$2792	\$3032	\$3484	\$3708	\$4124	\$4708	\$5431
		OVERALL DIMENSIONS			SEAT DIMENSIONS			BACK DIMENSIONS					
		W	D	H	W	D	H	W	H				
		29	30	39	19.5	18	17.5	19.5	22				

Active weight 300 lbs.  
Removable seat cushion.

OTTOMANS



model GC3346

STANDARD FEATURES

- Designed to coordinate with healthcare seating.
- Standard glide is plastic.
- Wood legs are available in a variety of finishes.
- For textiles and finish options, visit the website at [www.globalfurnituregroup.com](http://www.globalfurnituregroup.com)
- Can be upholstered in standard Global textiles only if Healthcare compliance is not required.
- Shipped fully assembled.

OPTIONAL FEATURES

- For hard surface floors, please specify opaque non-marking glides (**NM**). No upcharge.
- For non-slip glides, please specify (**NS**). Add **\$35**.
- Optional metal leg is available. Offered in Black (**TBL**), Latte (**TLA**), Toast (**TOA**), Tungsten (**TTU**), Shadow (**TSH**), Mocha (**TMO**), and Kalua (**TKA**). Please specify. No upcharge.

SUGGESTED APPLICATIONS

- Guest seating
- Lobbies
- Lounge/Waiting
- Patient rooms
- Resident rooms
- Treatment/Exam

DESCRIPTION	MODEL#	STANDARD TEXTILE GRADES											
		COM	2	3	4	5	6	7	8	9	10	11	12
<p><b>Ottoman</b> Block Legs COM Yardage: 1.25 Freight Class: 150 Product Weight (lbs.): 20 Cubic Feet Per Carton: 4.6</p>	GC3346	\$1455	\$1497	\$1535	\$1587	\$1662	\$1692	\$1755	\$1875	\$1938	\$2049	\$2208	\$2400
			<b>OVERALL DIMENSIONS</b> W D H			<b>SEAT DIMENSIONS</b> W D H			<b>BACK DIMENSIONS</b> W H				
		17.5	19.5	15	--	--	15						

THROW PILLOWS



model GCTP1515

STANDARD FEATURES

- Throw pillows complement decor by adding a personal touch.
- Colors and patterns enhance and add to the overall design
- Velcro closure allows for covers to be changed
- Can be upholstered in standard Global textiles only if Healthcare compliance is not required.
- For a complete list of healthcare textile, visit the website at [globalfurnituregroup.com](http://globalfurnituregroup.com)

SUGGESTED APPLICATIONS

- Lobbies
- Lounge/Waiting
- Resident rooms

DESCRIPTION	MODEL#	STANDARD TEXTILE GRADES											
		COM	2	3	4	5	6	7	8	9	10	11	12
<p><b>15" x 15" Square Throw Pillow</b> COM Yardage: 0.75 Freight Class: 70 Product Weight (lbs.): 1 Cubic Feet Per Carton: 1.3</p>	GCTP1515	\$203	\$223	\$257	\$287	\$330	\$348	\$382	\$457	\$492	\$558	\$650	\$763
			<b>OVERALL DIMENSIONS</b> W D H			<b>SEAT DIMENSIONS</b> W D H			<b>BACK DIMENSIONS</b> W H				
		15	15	6									
<p><b>20" x 20" Square Throw Pillow</b> COM Yardage: 0.75 Freight Class: 70 Product Weight (lbs.): 1.5 Cubic Feet Per Carton: 1.3</p>	GCTP2020	\$245	\$267	\$290	\$319	\$363	\$384	\$426	\$483	\$536	\$584	\$694	\$807
			<b>OVERALL DIMENSIONS</b> W D H			<b>SEAT DIMENSIONS</b> W D H			<b>BACK DIMENSIONS</b> W H				
		20	20	6									

# textiles + finishes



# TEXTILES & FINISHES

## TEXTILES

For a complete listing of healthcare carded textiles, please refer to our website at [www.globalfurnituregroup.com](http://www.globalfurnituregroup.com).

## SEATING FINISHES

### METAL

#### Paint:

Black (TBL)	Tungsten (TTU)	Shadow (TSH)	Designer White (TDW)	Nevada (TNE)	Kalua (TKA)
Latte (TLA)	Mocha (TMO)	Toast (TOA)	Fog (TFO)	Cloud (TIV)	Sand (TSN)
Frost (TFR)	Dijon (TDJ)	Carrot (TCR)	Scarlet (TSR)	Cactus (TCC)	Buzz Blue (TBZ)
Eggplant (TEG)	Ink (TIN)				

#### Plated:

Chrome (CHM)	Brushed Chrome (BCH)	Satin Brass (SBR)	Antique Copper (ACO)
--------------	----------------------	-------------------	----------------------

### WOOD

Absolute (AAM)	Cherry (ACM)	Charcoal Java (CJM)	Empire Mahogany (EMM)	English Oak (EOM)	Espresso Cafe (ECM)
Fruitwood (TFM)	Gray (HGM)	Harvest Oak (HOM)	Honey (AHM)	Jet Onyx (JOM)	Light Honey (LHM)
Mahogany (TMM)	Maple (AVM)	Medium Walnut (MWM)	Natural Walnut (NLW)	Night (ASM)	Noce Biondo (NBM)
Noce Grigio (NGM)	Noce Leggero (NEM)	Noce Medio (NMM)	Sandy Beach (SBM)	Shaker Cherry (SKM)	Silver Oak (SOM)
Walnut (TWM)	WC Cream (WTM)	White (WHM)	Winter Cherry (WCM)		

Finishes ending with an "M" use Maple wood.

### URETHANE ARMCAPS

Black (BLK)	Kalua (KAL)	Latte (LAB)	Mocha (J52)	Shadow (SHW)	Toast (TOA)
-------------	-------------	-------------	-------------	--------------	-------------

### POLYPROPYLENE ARMCAPS

Black (BLK)	Shadow (SW)	Toast (TOA)
-------------	-------------	-------------

## TABLE FINISHES

### THERMALLY FUSED LAMINATES (AUBRA, GC-BELONG, PRIMACARE, TABLET, FLORAL, ENABLE & OCCASIONAL)

Absolute Acajou (ACJ)	Asian Night (ASN)	Avant Cherry (AWC)	Avant Honey (AWH)	Black (BLK)	Blizzard (BZD)
Brushed Cobalt (BRC)	Clear Maple (CMB)	Custom Grey (CGY)	Dark Espresso (DES)	Designer White (DWT)	Fashionista (FAS)
First Class (FCL)	Noce Biondo (NBL)	Noce Grigio (NGL)	Noce Leggero (NEL)	Noce Medio (NML)	Quartered Mahogany (QTM)
Sheer Beauty (SBY)	Stonedust (SDT)	Storm Grey (SOG)	Walnut Heights (WHE)	White Chocolate (WHC)	Winter Cherry (WCR)

### HIGH PRESSURE LAMINATES (AUBRA, GC-BELONG, PRIMACARE, TABLET, FLORAL, ENABLE & OCCASIONAL)

Absolute Acajou (ACJ)	Asian Night (ASN)	Avant Cherry (W357)	Avant Honey (W356)	Black (BLK)	Blizzard (BZD)
Brushed Cobalt (BRC)	Clear Maple (CMB)	Custom Grey (CGY)	Dark Espresso (W142)	Designer White (DWT)	Fashionista (FAS)
First Class (FCL)	Noce Biondo (NBL)	Noce Grigio (NGL)	Noce Leggero (NEL)	Noce Medio (NML)	Quartered Mahogany (QTM)
Sheer Beauty (SBY)	Stonedust (SDT)	Storm Grey (SOG)	Walnut Heights (WHE)	White Chocolate (WHC)	Winter Cherry (WCR)

### WOOD OCCASIONAL TABLES Please refer to the Tables section for availability and coordinating Wood Base & Leg Finishes.

Absolute (AAM)	Charcoal Java (CJM)	Cherry (ACM)	Empire Mahogany (EMM)	English Oak (EOM)	Espresso Cafe (ECM)
Fruitwood (TFM)	Gray (HGM)	Harvest Oak (HOM)	Honey (AHM)	Jet Onyx (JOM)	Light Honey (LHM)
Mahogany (TMM)	Maple (AVM)	Medium Walnut (MWM)	Natural Walnut (NLW)	Night (ASM)	Noce Biondo (NBM)
Noce Grigio (NGM)	Noce Leggero (NEM)	Noce Medio (NMM)	Sandy Beach (SBM)	Shaker Cherry (SKM)	Silver Oak (SOM)
Walnut (TWM)	WC Cream (WTM)	White (WHM)	Winter Cherry (WCM)		

### METAL TABLE LEGS

#### Painted:

Black (TBL)	Tungsten (TTU)	Shadow (TSH)	Designer White (TDW)	Nevada (TNE)	Kalua (TKA)
Latte (TLA)	Mocha (TMO)	Toast (TOA)	Fog (TFO)	Cloud (TIV)	Sand (TSN)
Frost (TFR)	Dijon (TDJ)	Carrot (TCR)	Scarlet (TSR)	Cactus (TCC)	Buzz Blue (TBZ)
Eggplant (TEG)	Ink (TIN)				

#### Plated:

Chrome (CHM)	Brushed Chrome (BCH)	Satin Brass (SBR)	Antique Copper (ACO)
--------------	----------------------	-------------------	----------------------

## OVERBED TABLE FINISHES

### THERMOFOIL TOPS

Candlelight (TCL)	Chocolate Pear (TCP)	Hard Rock Maple (THM)	Medium Cherry (TMC)	Medium Oak (TMO)	Snow White (SNW)
-------------------	----------------------	-----------------------	---------------------	------------------	------------------

### STEEL BASES

Almond (AL)	Graphite Grey (GG)	Nevada (NV)
-------------	--------------------	-------------

## PERSONAL ROOM FURNITURE FINISHES

### ALDON AND SONOMA- LAMINATES

Absolute Acajou (ACJ)	Asian Night (ASN)	Avant Cherry (AWC)	Avant Honey (AWH)	Black (BLK)	Brushed Cobalt (BRC)
Clear Maple (CMB)	Dark Espresso (DES)	Designer White (DWT)	Fashionista (FAS)	First Class (FCL)	Noce Biondo (NBL)
Noce Grigio (NGL)	Noce Leggero (NEL)	Noce Medio (NML)	Quartered Mahogany (QTM)	Sheer Beauty (SBY)	Storm Grey (SOG)
Walnut Heights (WHE)	White Chocolate (WHC)	Winter Cherry (WCR)			

### ALDON AND SONOMA- THERMOFOIL FINISHES - TOP AND FRONT (INCLUDING BOTTOM FASCIA) (BEDSIDE CABINETS ONLY)

Absolute Acajou (ACJ)	Clear Maple (CMB)	Custom Grey (CGY)	Dark Espresso (DES)	Designer White (DWT)	Fashionista (FAS)
First Class (FCL)	Sheer Beauty (SBY)	Storm Grey (SOG)	White Chocolate (WHC)		

### ALDON AND SONOMA- SOLID SURFACE FINISHES - TOP ONLY (BEDSIDE CABINETS ONLY)

#### Grade 1 (C1):

Designer White (SWH)

#### Grade 2 (C2):

Beige Tempest (SBT)	Hot Stone (SHS)	Northern Melange (SNM)	Black Onyx Mirage (SBX)	Frosty White Mirage (SFW)	Milk Glass Spectra (SMG)
---------------------	-----------------	------------------------	-------------------------	---------------------------	--------------------------

### ALDON AND SONOMA - ALUMINUM EXTRUSIONS

Black (BLK)	Blizzard (BZD)	Charcoal (CHR)	Kalua (TKA)	Latte (TLA)	Mocha (TMO)
Nevada (NEV)	Sierra (SCA)	Silver (SIL)	Taupe (TPE)	Toast (TOA)	Tungsten (TUN)*

\*10% upcharge applies.

For a complete listing of healthcare textiles and finishes, please refer to our website at [www.globalfurnituregroup.com](http://www.globalfurnituregroup.com).

LAMINATE FINISHES COORDINATION CHART			
LAMINATE FINISH		COORDINATING WOOD FINISH	
ACJ	Absolute Acajou	AAM	Absolute
ASN	Asian Night	ASM	Night
AWC	Avant Cherry	ACM	Cherry
AWH	Avant Honey	AHM	Honey
BLK	Black	BKM	Black
CMB	Clear Maple	AVM	Maple
DES	Dark Espresso	ECM	Espresso Cafe
DWT	Designer White	WHM	White
NBL	Noce Biondo	NBM	Noce Biondo
NEL	Noce Leggero	NEM	Noce Leggero
NGL	Noce Grigio	NGM	Noce Grigio
NML	Noce Medio	NMM	Noce Medio
QTM	Quartered Mahogany	TMM	Mahogany
WCR	Winter Cherry	WCM	Winter Cherry
WHC	White Chocolate	WTM	WC Cream
WHE	Walnut Heights	MWM	Medium Walnut
LAMINATE FINISHES WITH NO COORDINATING WOOD FINISHES		WOOD FINISHES WITH NO COORDINATING LAMINATE FINISHES	
BRC	Brushed Cobalt	EOM	English Oak
BZD	Blizzard	HGM	Grey
CGY	Custom Grey	NLW	Natural Walnut
FAS	Fashionista	SKM	Shaker Cherry
FCL	First Class	TFM	Fruitwood
SBY	Sheer Beauty	TWM	Walnut
SOG	Storm Grey		
SDT	Stonedust		

# TEXTILES & FINISHES

## Blended Seating Textiles

The grid below outlines the grade structure for using multiple textiles on select seating series. Blended textiles occur when one textile is chosen for one part of the chair and a different textile is selected for another part of the chair, resulting in a revised "blended grade".

**NOT FOR USE with Calidon, Collingwood, Erin, Nourish, or Oakville. See series price list pages for pricing.**

For specification and pricing for more than two different textiles, please contact Global Customer Care for approval and pricing.

### FIRST TEXTILE SELECTED

		1	2	3	4	5	6	7	8	9	10	11	12	13	14	15	16	17	18		
SECOND TEXTILE SELECTED	1	1																			
	2	2	2																		
	3	3	3	3																	
	4	3	4	4	4																
	5	4	4	5	5	5															
	6	5	5	5	6	6	6														
	7	5	6	6	6	7	7	7													
	8	6	6	7	7	7	8	8	8												
	9	7	7	7	8	8	8	9	9	9											
	10	8	8	8	8	9	9	9	10	10	10										
	11	9	9	9	9	9	10	10	10	11	11	11									
	12	10	10	10	10	10	10	11	11	11	12	12	12								
	13	11	11	11	11	11	11	12	12	12	12	13	13	13							
	14	11	12	12	12	12	12	12	13	13	13	13	14	14	14						
	15	12	12	13	13	13	13	13	13	14	14	14	14	15	15	15					
	16	13	13	13	14	14	14	14	14	14	15	15	15	15	16	16	16				
	17	14	14	14	14	15	15	15	15	15	15	16	16	16	16	17	17	17			
	18	15	15	15	15	15	16	16	16	16	16	16	17	17	17	17	18	18	18		

## ALTERNATIVE TEXTILE OPTIONS

### GPM - Global Purchased (customer specified) Material

For a greater selection of upholstery options, please visit the following websites. Global will be happy to provide as a G.P.M.

Supplier's Name	Website	Phone number to call for Memo Samples
Architex	<a href="http://www.architex-ljh.com">www.architex-ljh.com</a>	800.220.0827
CF Stinson	<a href="http://www.cfstinson.com">www.cfstinson.com</a>	800.841.6279
Maharam Textiles	<a href="http://www.maharam.com">www.maharam.com</a>	800.645.3943
Mayer Fabrics	<a href="http://www.mayerfabrics.com">www.mayerfabrics.com</a>	800.428.4415
Momentum Textiles	<a href="http://www.themomgroup.com">www.themomgroup.com</a>	800.366.6839
Morbern	<a href="http://www.morbern.com">www.morbern.com</a>	336.883.4332

To access any of the selected suppliers' textiles for use on healthcare products as a G.P.M. (Global Purchases [customer specified] Material), please contact your Global Territory Manager or Global Customer Care Department.

**NOTE: Please contact Global Customer Care for inquiries regarding grading as a G.P.M. on any selected for use from the above mentioned suppliers.**

# GLOBALCARE C.O.M. AUTHORIZATION FORM

## CUSTOMER INFORMATION

To be completed by the dealer/design firm. Use one form per textile. Incomplete information may delay or prevent approval.

A+D/Dealer/Company Name:			Contact:		
Billing Address:			Phone:		
City:	State:	Zip:	Fax:		
End-User/Project Name:			End-User/Project Registered? YES NO If YES, The Global Quote#:		
Local Global Distribution Center:			Date:		

## TEXTILE APPLICATION INFORMATION

SEATING MODEL NUMBER	QUANTITY	SPECIAL INSTRUCTIONS

Textile Name (Series/Style #):

Textile Color Name and Description:

Country of Origin:

Mill or Manufacturer's Name:

Textile Content (% Cotton, % Poly, % Wool, etc.):

Textile Width: Pattern Repeat: VERTICAL HORIZONTAL Rail Routed? YES NO

### TEXTILE DIRECTION



**STAPLE FABRIC TO THIS FORM IN THE DIRECTION IN WHICH THE FABRIC IS TO BE UPHOLSTERED WITH THE TOP OF THIS PAGE BEING THE SAME AS THE TOP OF THE CHAIR.**

### NEW TEXTILE

Attached textile sample  
(Minimum 5"x 5", Max 12"x 12")  
In correct DIRECTION and SIDE.

### PREVIOUSLY APPROVED TEXTILE

Please e-mail completed form to:  
ComRequest@globalfurnituregroup.com

### MAIL FORM AND TEXTILE SAMPLE ONLY TO:

GLOBAL - COM Department  
17 West Stow Road  
Marlton, NJ 08053 | 856.596.3390

Please contact your local GLOBAL Distribution Center for status of all COM requests. When textile is approved and an authorization number issued, a set of shipping instructions will be faxed or e-mailed to you.

Approved textiles are to be shipped to the address that will be included with instructions. Do not ship textiles to the address on this form. Dealer is responsible for the shipping expenses. Brokerage fees will be paid for by Global. However, duties imposed by North American Governments related to textile materials, content and Country of Origin, additional fees may apply and will be billed separately.

Please Note: C.O.M Textiles may not be shipped without shipping documents. GLOBAL is not responsible for any material shipped without the authorization number.

**Please be advised that Global has phased out the use of textiles that contain certain Phthalates, including but not limited to: DEHP ( di (2-ethylhexyl) phthalate), DBP (di-n-butyl phthalate), BBP (butyl benzyl phthalate) and DINP (di-isononyl phthalate) (collectively the "Listed Chemicals"). The Listed Chemicals are used in certain types of vinyls. Global cannot accept orders for textiles that contain the Listed Chemicals, if such orders are to be shipped to the U.S.A. or are intended for customers in the U.S.A. If you are not sure if the C.O.M you have selected contains the Listed Chemicals, please contact the manufacturer or supplier of the fabric to verify.**

## GLOBAL AUTHORIZATION FORM (TO BE COMPLETED BY GLOBAL)

CAN#:

TEXTILE YARDAGE (REQUIRED FOR THE ORDER):

GU CODE:



**LEVEL CERTIFIED**  
Many products in various categories



**LEED PARTNERSHIP PROGRAM**  
Products can help you earn credits



**GREENGUARD CERTIFIED**  
Children & Schools Certified

**THE ENVIRONMENT** We believe now more than ever, that it is our responsibility to protect the environment and our precious natural resources for future generations. The growing importance of energy and environmental concerns continues to challenge us in this ever changing marketplace.

As an industry leader, Global continues to take proactive steps towards reducing the negative impacts on the environment. We are building "healthier" offices; investing in Research & Development and new technologies; reducing waste and the consumption of energy; and improving the quality of the air we breathe, all which can have a significant impact on our quality of life.



Epoxy Powder coating process is solvent free. No harmful VOC's or lead. No toxins are released into the atmosphere.

Global's recycled fabrics offer affordable, environmentally responsible alternatives to commercial textiles. We recycle 35,000 lbs of fabric offcuts weekly.



Global has the products and resources to help your projects achieve LEED certification.

New technology allows us to reduce glue usage by 50%. In addition, our polyurethane glue reduces emissions and requires less energy to apply.

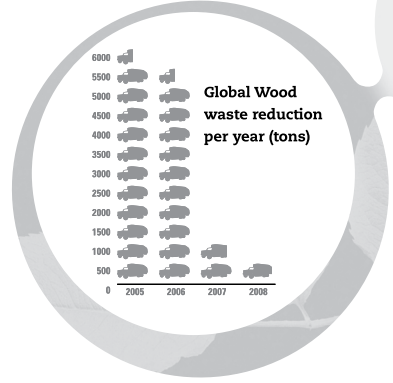

powder paint process:  
**98% paint recovery and reuse**

more recycled fabric  
**less to the landfill**

talk to us about our  
**leed partnership program**

we've diverted  
**90% of our wood waste from landfill in four years**

For further information on Global's environmental initiatives, please visit <http://www.globaltotaloffice.com/enviro/>

Global is focused on providing furniture products for use in healthcare environments. This illustrated price list book has been designed to facilitate fast reference and easy use. Products are categorized into "personal room furniture", "tables" or "seating" and are listed numerically within their categories. The line drawings match actual photographs (where possible) to aid in instant recognition of the total range within a series.

Sales of healthcare products are made only on Global's standard Terms and Conditions of sale which are contained in this price book. The "Purchaser" in these Terms, Conditions and General Information shall refer to dealers and those who originally purchase directly from Global for use or resale. These standard terms and conditions may be modified or supplemented only by a separately written document signed by Global's authorized personnel at its head office in Marlton, NJ. Any term or condition contained in any purchase order or other form used by the Purchaser to order goods (including standard, printed language) which is different from, in addition to, or in any way inconsistent with Global's standard terms and conditions shall be of no force or effect whatsoever.

All illustrations, specifications and prices in this list price book are based on the latest product information available at the time of publication. Global reserves the right to make changes, at any time and without prior notice to prices, colors, materials, specifications and models offered.

## DESCRIPTION

Each product shown or described in this price list is standard healthcare product. Available options are noted at the beginning of each series. Available options may require additional delivery time and cost, and may affect the warranty given. Sizes and weights shown are approximate and are subject to slight changes from time to time.

## PRICES AND PAYMENT

The prices shown in this book, as well as those quoted by Global, are in United States dollars for orders shipped to destinations in the U.S., Mexico and Puerto Rico.

If shipping date requested is more than 90 days from date of order, Global shall reserve the right to use published list prices effective at the time of shipment.

Orders are invoiced at the time of shipment. **Terms of payment are net 30 days from date of invoice (1% 15 days) unless otherwise stated.** The Purchaser agrees that Global shall reserve the right to enforce a charge amounting to 1.5% per month (18% per year) on invoices outstanding more than 30 days.

If the Purchaser's most recent annual net volume is less than \$5,000, payment must be made in advance.

All orders are subject to the Purchaser complying with Global's prevailing credit policy.

Any products sold by Global shall remain the property of Global until fully paid.

Prices are suggested list prices only and are subject to change without notice. Global will, however, attempt to keep the Purchaser up-to-date on all developments including price changes.

## TAXES

All prices shown in this list price book are exclusive of sales, use, excise and other applicable taxes and are the Purchaser's responsibility as per the invoice issued by Global. If the Purchaser claims an exemption from such taxes, it shall be the Purchaser's responsibility to furnish Global with an appropriate exemption certificate at time of order.

## ORDERING INFORMATION

Global requires that all orders be submitted in writing and will be acknowledged on Global's acknowledgment forms governing the transaction.

The details appearing on this acknowledgement will describe the items to be shipped and the approximate shipping date. It is the Purchaser's responsibility to determine that the information in the acknowledgement is correct. In the event of an error, the Purchaser must notify Global immediately by telephone followed by written confirmation. Shipping dates are assigned to orders based on the item having the longest manufacturing lead time (unless instructed to partial ship).

At the time of order, please provide the following information:

1. Account number (if possible)
2. PO number
3. "Bill to" and/or "Ship to" name and address
4. Complete model number and selected options, including textiles/finishes
5. Special instructions and tag information
6. Shipping instructions
7. Special quote (SQ) # or MTM # (if applicable)
8. Customer's Own Material (COM), Global Purchased Material (GPM), Customer's Own Leather (COL), see below.
9. For specials and custom quoted product, please indicate the custom quote # on your PO. If changes are made to the quote, a new quote must be issued prior to submitting the order. It is the Purchaser's responsibility to determine that the information on the quote is correct. Global will not be responsible for wrong product due to errors in the quote.

The above points will be checked by Global for accuracy. Global will process orders using the codes provided by the Purchaser. Price discrepancy is the responsibility of the Purchaser. The Purchaser must notify Global prior to invoicing.

The Purchaser is responsible for providing correct information when placing an order. Orders with incorrect information (finish, etc.) will be scheduled for manufacturing upon receipt of complete information.

To prevent a delay in processing orders, please specify delivery routing.

## CHANGES AND CANCELLATIONS

After the date of Global's acknowledgment of a Purchaser's order, the order may not be changed or canceled by Purchaser without the written consent of Global. Special order items, C.O.M. and fabric-covered items already in production are not subject to change or cancellation under any circumstances. Fabric-covered items are considered to be in production once the fabric is scheduled for cutting.

## ERRORS AND OMISSIONS

All quotations, acknowledgements and invoices are subject to corrections for any errors and omissions.

## FINISHES

### Seating Finishes - Painted

Where painted frames are not a standard color, there is a one time charge of \$613 list price per order for custom wood staining/color matching. Restrictions may apply. The customer must provide a 3" x 3" color chip/sample for review and approval. Non-standard finishes must be approved by Global prior to acceptance of order.

### Seating Finishes - Wood Stained

Because the distinctive characteristics and the nature of wood products cause variations, exact matches are not always possible.

Global coordinates its finishes program between marketing divisions within the Global Group to match products as best as possible when same finishes are specified. However, Global will not be held responsible if the finishes cannot be matched.

## Customers Own Material (COM)

Use of COM must be approved by Global prior to acceptance of order. Please submit the Authorization Request Form.

Photocopy and use this form as often as necessary. The customer must provide a 12" x 12" fabric sample and advise how the fabric is to be applied and quantity of fabric being sent.

**Textile yardage requirement will be advised if factory, and additional yardage may be required if pattern requires matching.** Upon approval from Global, send textile to your Customer Care Representative. If COM is difficult to apply or if product is required to be modified, extra charges will apply.

Global reserves the right to cancel an order at any time if COM is inadequate for any reason. COM must be shipped freight and duties paid (if applicable) to our factory. Such shipment must be fully identified with the Purchaser's order number, RGA # provided by Global, and the item for which material is intended. Performance of COM when applied to product is the sole responsibility of the Purchaser. Global's standard product warranty shall not apply to COM. Use of COM will not reduce the published list price.

## C.S.M. (Customer Specified Material)

Use of Customer Specified Material must be approved by Global prior to acceptance of order. If C.S.M. is difficult to apply or if product is required to be modified, extra charges shall apply.

Global reserves the right to cancel an order at any time if C.S.M. is inadequate for any reason. Performance of C.S.M. when applied to product is the sole responsibility of the Purchaser. Global's standard product warranty shall not apply to C.S.M.

## VINYL AND FABRIC GRADING

All products are priced according to their standard vinyl and fabric grade. Lower grade vinyls and fabrics are available (unless otherwise specified) at same price as standard. The listing of prices for each model indicates a price for each of the upholstery grades. Prices are based on yardage in imperial measurements. Please refer to the Textiles & Finishes section of the Global website for the most up to date listing.

## UPHOLSTERY COVERINGS

Slight variations in color may occur between dye lots. Although Global attempts to minimize these variances, they do occur and must be accepted as normal and will not be considered defects.

## YARDAGE

Required yardage (ydg) is based on unmatched materials with widths of 54" for seating. Yardage calculations are based on imperial measurements.

## WEIGHT

This figure indicates the weight of one part and its packaging, regardless of the number of parts shipped in a single carton. In order to estimate the approximate shipping weight for an order, you have to multiply the indicated weight by the number of parts per carton. (e.g. if a part weight is 10 lbs. and is shipped 4 per carton, shipment weight should be calculated as: 4 x 10 = 40 lbs.)

## CUBIC MEASURE

The stated cubage is an approximate cubic foot measure to calculate freight costs. The figure shown is the volume for the total shipment of a part (e.g. if a part is sent in 2 cartons the volume indicated reflects the cubage of both cartons together) and is subject to change without notice. It is most economical to purchase the specified number per carton.

**DELAYS**

Global's shipping confirmation will state a shipping date which is Global's best estimate at the time the order is acknowledged. However, Global shall not incur any obligation or liability to Purchaser for failure to ship by specified date unless Global has agreed to an unequivocal shipping date in a separately signed written document executed by its authorized personnel at its head office. In addition, Global shall not be liable for any loss or damage resulting from any delay or failure in shipment or other failure to perform all or any part of the agreement between the parties with respect to the goods shown on the face of the order acknowledgement where such delay, failure, loss or damage is the proximate result of any act of any governmental authority or political subdivision thereof, revolution, riot, civil disorder or disturbance, delay or default in transportation, electrical power failure, strike disputes among or between labor unions or other labor disputes, delay or inability in obtaining materials and facilities, fire, flood, act of God or any cause not within the reasonable control of Global, whether of the class of causes enumerated or otherwise.

**SUSPENSION**

In the event that the Purchaser defaults in the payment of any sum due to Global, or in the event the Purchaser's financial condition becomes unsatisfactory to Global, Global shall have the right to defer or discontinue shipment of any goods until such time as the default is cured or the Purchaser provides assurance of payment to Global.

**F.O.B.**

F.O.B. point is Global's Factory, Downsview, Ontario, Canada, or any Global Regional Distribution Center.

**SERVICE**

Service requests are normally the responsibility of Global's authorized dealers. Where this cannot be accomplished on a local level, service problems should be referred to Global's Customer Service Department at the nearest distribution center.

**RETURNS**

No returns of goods will be accepted without written consent and shipping instruction of Global. A minimum re-stocking charge of 35% is made on all authorized returns for credit or refund, provided goods are received by Global in the condition in which they left the factory. This may increase depending on the type of product. Global's Return Goods Authorization (R.G.A.) numbers must appear prominently on all authorized returns. Global will not be responsible for freight costs. No credit will be given if goods cannot be reused as new. Special order items and C.O.M. products are in no event subject to return. All returns must be approved and authorized in writing by Global Customer Care. Global reserves the right to refuse delivery of any unauthorized returns.

**STORAGE CHARGE**

Global reserves the right to assess storage charges if a customer does not accept shipment of an order within a week of shipment or requested ship date.

**CLAIMS**

All goods are sold F.O.B. plant or Global Distribution Center. Global is not responsible for damage which occurs in transit (or in storage). The carrier signs for all goods received in apparently good order. It is the Purchaser's responsibility to examine goods upon receipt and to file any claims with the carrier for losses or damage to the product occurring during transit, including concealed damage.

Any claims made against Global for apparent defects, errors or shortages must be made by the Purchaser, in writing, within 15 working days after any delivery. Failure by the Purchaser to make any claim against Global within 15 days shall constitute acceptance of the goods and a waiver of any apparent defects, errors or shortages.

**COMBINED SHIPMENTS**

Global will make every effort to combine shipments and orders on written request. However, Global cannot be held responsible where such request is not complied with.

**UPS SHIPMENTS**

Seating products marked with a UPS symbol next to the CARTON COUNT are packaged for UPS-able shipments.

**OFFER OF SALE**

Possession of this price list or any other literature shall not imply Global's willingness to sell to the holder and shall not be construed as a direct offer of sale.

*If a conflict arises between: (i) prices found in software support packages furnished to the customer by Global or by any other source on behalf of Global; and (ii) Global's current printed price lists, then the printed price list shall prevail.*

**TESTING QUALIFICATIONS**

Many Global products pass or exceed the most stringent testing procedures. Where tests are significant, they are marked as C.G.S.B. (Canadian General Standards Board) qualified and as passing ANSI/BIFMA (American National Standards Institute/Business Institutional Furniture Manufacturer's Association).

**DISCLAIMER**

All dimensions are in inches. Prices shown are current manufacturer's suggested list prices at the time of printing. All applicable taxes are extra. Descriptions, specifications and prices are subject to change without notice. Errors and omissions are subject to correction.

**COPYRIGHT**

All catalogs, photographs, drawings, price lists and other printed material are protected by copyright. All rights reserved.

**TRADEMARKS**

All trademarks are owned by Global other than OBUSFORME™ which is owned by OBUSFORME LTD. and are used under license and MOR-CARE™ which is owned by MORBERN INC. OBUSFORME® and the distinctive backrest design are registered trademarks of OBUSFORME LTD.

**DESIGNS**

Many of the products produced by Global are protected by Industrial Design Registrations, Design Patents and/or Patents. Designs and specifications are subject to change, discontinuance or additions without notice.

**FLAMMABILITY**

The foam used in Global chairs meets the requirements of California TB117:2013. In addition to the foam, upholstery materials must also meet the California TB117 smolder resistant requirements. Please contact Customer Care to determine if a selected textile meets the California TB117 requirement.

**This list price book is effective as of January 1, 2023.**

*For periodic updates, please check the PDF at [www.globalfurnituregroup.com](http://www.globalfurnituregroup.com). Global warrants that all commercial products are free from defects in material and workmanship, for the life of the product, to the original purchaser.*



Global warrants that all commercial products are free from defects in material and workmanship, for the life of the product, to the original purchaser.

Global will repair or replace, at Global's option, as the sole remedy for any defect covered by the warranty. The warranty applies to products manufactured after March 22, 2016.

Global makes no warranty that any of its products are suitable for any particular purpose and makes no other warranties, express or implied, other than those set out here. As codes and standards vary from one jurisdiction to another, references to compliance are solely for convenience and without any representation as to accuracy or suitability. Users must verify the suitability of such information or product for their specific application. In no event shall Global be liable in either tort or contract for any loss or direct, special, incidental, consequential, or exemplary damages.

### General Healthcare Seating

Global's healthcare warranty for general seating covers all chair components including pneumatic cylinders, bases, casters, glides, frames, arms, plastic seats, backs and other structural components.

The warranty applies to single shift, standard usage, defined as a standard eight (8) hour day, forty (40) hour week as noted with each model number.

Exceptions to the warranty for general seating are as follows:

- Foam, upholstery, textiles (as sampled on Global branded and textile program cards), mesh material and electrical devices are warranted for five (5) years
- Control mechanisms are warranted for twelve (12) years
- Heavy Duty Seating is not defined as General Healthcare Seating (see below for warranty exceptions)

### Heavy Duty / Bariatric Seating

Global offers products designed for multiple shift applications (24 hours a day / 7 days a week) and larger individuals weighing up to 350 and/or 500 lbs or 750 lbs (depending on series and/or model). Global warrants these products for twelve (12) years to the original Purchaser. All components (including control mechanisms, pneumatic cylinders, bases, casters, glides, frames, arms, plastic seats/backs, etc.) are covered for 24/7 applications under the warranty. The exceptions are foam and textiles, which are covered for five (5) years. Fabric or upholstery material on these products must exceed 100,000 double rubs for the textile portion of the warranty to apply. Please refer to [www.globalfurnituregroup.com](http://www.globalfurnituregroup.com) for an up to date list of series and/or applicable models.

### Files, Desks, Modular Furniture, Tables, Panels & Accessories

Global warrants all components of metal storage and filing, laminate and wood veneer desks, laminate and wood veneer tables, metal leg components and panels for the lifetime of the product to the original Purchaser.

### Seating Warranty Summary

Seating Type	Components Warranty For Original Purchaser	Use Time For Warranty Coverage	Exceptions
General healthcare seating	lifetime	8 hours/5 days per week	foam/upholstery/textiles/mesh/electrical devices - 5 Years control mechanisms - 12 years
Heavy duty / bariatric seating	12 years	24 hours/7 days per week	foam/upholstery/textiles - 5 years

### Files, Desks, Modular Furniture, Tables & Accessories Warranty Summary

Product Type	Components Warranty For Original Purchaser	Exceptions
Metal storage and filing	lifetime	none
Laminate/wood veneer desks and modular furniture	lifetime	tackboard textiles, electrical devices, task lights - 5 years
Boardroom, conference and training tables	lifetime	electrical devices - 5 years moving parts - 5 years

### Global's healthcare warranty does not apply (for any product category) to the following:

- Nominal or normal amount of wear and tear that can occur over time
- Failures which result from negligence, abuse, accident or misuse
- Failure to apply, install or maintain products according to Global's written instructions and warnings
- Modifications, attachments or repair methods not approved by Global
- Damage caused by a carrier in transit, or delivery/installation contractors
- The matching of colors, grains or textures (wood, leather, etc.) of natural materials
- Products exposed to extreme hot or cold temperatures or excessively dry or humid environments
- Colorfastness or the matching of color of textiles; dye lots of textile can vary
- Damage by markings or staining; damage by sharp objects or imprinting from instruments
- Damage to textiles or laminate and wood surfaces/edges from exposure to sunlight (including UV rays)
- Products used for rental purposes
- Purchased parts are warranted for one (1) year
- Failure to follow specific cleaning and disinfecting instructions by the textile supplier

Warranty does not cover the costs of transportation or labor. Repair or replacement will be at Global's discretion.

### Textiles and Finishes

Global warrants Global branded textiles and Global carded textile programs inclusive of fabrics, vinyls and leather products for five (5) years. Global does not warrant COM (Customer's Own Material) or GPM (Global Purchased Materials) that are customer specified materials, or graded-in and purchased by Global for a customer. For GPM or COM products, please contact the textile supplier for performance information and warranty details. Please refer to our website at [www.globalfurnituregroup.com](http://www.globalfurnituregroup.com) for a link to the supplier's recommendation for cleaning and disinfecting procedures. Improper usage of disinfecting/cleaning products may void the warranty.

Global textiles and finishes are updated periodically to meet the demand and trends of the market. As a result, some textiles and finishes may be discontinued by Global or the manufacturer. In the event that a textile or finish is discontinued, Global will make every reasonable effort to provide an alternative product(s) of comparable function.

## Global US Headquarters/Distribution Center

17 West Stow Road, P.O. Box 562  
Marlton, New Jersey U.S.A. 08053  
T (856) 596-3390  
T (800) 220-1900

---

### Showrooms

#### Atlanta

10 10th Street  
Suite 150  
Atlanta, GA 30309  
T (404) 879-0998

#### Boston

One Harbor Street  
Suite 104  
Boston, MA 02210  
T (617) 406-5435

#### Chicago

222 Merchandise  
Mart Plaza  
10th Floor, Suite 1035  
Chicago, IL 60654  
T (312) 755-0843

#### Irvine

18400 Von Karman Ave.  
Suite 100  
Irvine, CA 92618

#### Miami

112 NE 41st Street  
6th floor  
Miami, FL 33137

#### New York City

386 Park Avenue South  
7th floor  
New York, NY 10016  
T (212) 545-9900

#### Philadelphia

1735 Market Street  
38th Floor  
Philadelphia PA, 19103  
T (215) 861-0963

#### New Jersey (Southern)

119 West Greentree Road  
Marlton, NJ 08053  
T (856) 596-3390

#### Phoenix

4675 E Cotton Center Blvd.  
Suite 165  
Phoenix, AZ 85040  
T (602) 426-0666  
T (602) 426-0777

#### Washington, DC

1130 Connecticut Avenue  
10th Floor, Suite 1000  
Washington, DC 20036  
T (202) 659-0230  
T (202) 659-0236

### Distribution Centers

#### Atlanta Area

6715 Maple Ave.  
Suite 100  
Buford, GA 30518  
T (678) 602-4130

#### Baltimore Area

Troy Hill  
Corporate Center  
7030 Troy Hill Drive  
Elkridge, MD 21075  
T (410) 379-8021

#### Chicago Area

27W501 North Ave.  
Suite 300  
West Chicago, IL 60185  
T (630) 681-2818

#### Cincinnati Area

8712 LeSaint Drive  
Fairfield, OH 45014  
T (513) 777-0009

#### Dallas Area

2025 West Beltline Road  
#100  
Carrollton, TX 75006  
T (972) 236-1366

#### Denver Area

16401 East 33rd Drive  
Suite 50  
Aurora, CO 80011  
T (303) 340-1617

#### Ft. Lauderdale Area

560 Sawgrass  
Corporate Pkwy  
Sunrise, FL 33325  
T (954) 846-8888

#### Houston Area

7865 Northcourt Road  
Suite 200  
Houston, TX 77040  
T (713) 695-5777

#### Los Angeles Area

3629 Workman Mill Road  
Whittier, CA 90601  
T (562) 484-9686

#### Seattle Area

Oakesdale Commerce Ctr.  
820 Southwest 34th Street  
Building W7, Suite A  
Renton, WA 98057  
T (425) 291-9282

#### Kansas City Area

11617 West 81st Street  
Lenexa, KS 66214  
T (913) 310-9963

#### Tampa Area

10351 Windhorst Road  
Tampa, FL 33619  
T (813) 621-6272



globalfurnituregroup.com

