

CALIDON TABLES



Square End Table - 22" model GC36314



Rectangular Coffee Table model GC36317

Calidon seating



For Calidon seating, refer to page 69.

EXAMPLE CALIDON TABLE ORDER CODE:

GC36314	-HP	-ACJ	-CNT
Model #	Top material	Laminate finish	Power

STANDARD FEATURES

- A variety of wood leg tables are available. The wood legs/aprons are specifiable in the same wood seating finishes.
- Table tops are 1" thick, available in thermally fused laminate (LP), high pressure laminate (HP), and solid surface (CO). Upcharges vary, see model for pricing.
- Laminate top tables include color coordinating 2 mm PVC edgeband.
- Tandem/bridge table models (GC36318 to GC36321) connect to guest seating only.
- Tandem tables are specified left or right, as seated.

OPTIONAL FEATURES

- A tamper resistant power/USB unit is optional for laminate top, tandem in-line, 30 degree, 90 degree and freestanding square end tables only. Unit is black; includes one AC outlet, two 10-watt USB-A ports, matching faceplate and a 10 ft long 3-prong power cord. The power unit is centered 1.5" from the edge of the surface. See power location diagrams for reference.

SUGGESTED APPLICATIONS

- Lounge rooms
- Patient rooms
- Resident rooms
- Treatment/Exam room

Please add option codes in the following order:

- Model number**  
**GC36314** Freestanding end table, 20.25"H  
**GC36324 to GC36326** Freestanding end tables, 23"H  
**GC36315 to GC36317** Freestanding coffee tables, 17,25"H  
**GC36318 to GC36321** Tandem/bridge tables (refer to page 73)
- Top material**  
**(LP)** Thermally fused laminate. Specify finish - see LP finishes.  
**(HP)** High pressure laminate. Upcharges vary - see model. Specify finish - see HP finishes.  
**(CO)** Solid surface. Upcharges vary - see model. Specify finish - see Solid Surface finishes.
- Leg finish**  
**(AAM)** Absolute **(MWM)** Medium Walnut  
**(CJM)** Charcoal Java **(ASM)** Night  
**(ACM)** Cherry **(NBM)** Noce Biondo  
**(EMM)** Empire Mahogany **(NGM)** Noce Grigio  
**(EOM)** English Oak **(NEM)** Noce Leggero  
**(ECM)** Espresso Cafe **(NMM)** Noce Medio  
**(TFM)** Fruitwood **(SBM)** Sandy Beach  
**(HGM)** Grey **(SKM)** Shaker Cherry  
**(HOM)** Harvest Oak **(SOM)** Silver Oak  
**(AHM)** Honey **(TWM)** Walnut  
**(JOM)** Jet Onyx **(WTM)** WC Cream  
**(LHM)** Light Honey **(WHM)** White  
**(TMM)** Mahogany **(WCM)** Winter Cherry  
**(AVM)** Maple
- Power/USB unit position** (laminate tandem and end tables only).  
**(NPM)** No power  
**(CNT)** Center top power. Add \$232.
- Power/USB unit position** (laminate corner tables only).  
**(NPM)** No power  
**(LBP)** Left back power. Add \$232.  
**(RBP)** Right back power. Add \$232.

TABLE TOP FINISHES:

Thermally fused laminate (LP):

- (ACJ)** Absolute Acajou
- (ASN)** Asian Night
- (AWC)** Avant Cherry
- (AWH)** Avant Honey
- (BLK)** Black
- (BZD)** Blizzard
- (BRC)** Brushed Cobalt
- (CMB)** Clear Maple
- (CGY)** Custom Grey
- (DES)** Dark Espresso
- (DWT)** Designer White
- (FAS)** Fashionista

- (FCL)** First Class
- (NBL)** Noce Biondo
- (NGL)** Noce Grigio
- (NEL)** Noce Leggero
- (NML)** Noce Medio
- (QTM)** Quartered Mahogany
- (SBY)** Sheer Beauty
- (SDT)** Stonedust
- (WHE)** Walnut Heights
- (WHC)** White Chocolate
- (WCR)** Winter Cherry

High pressure laminate (HP):

- (ACJ)** Absolute Acajou
- (ASN)** Asian Night
- (W357)** Avant Cherry
- (W356)** Avant Honey
- (BLK)** Black
- (BZD)** Blizzard
- (BRC)** Brushed Cobalt
- (CMB)** Clear Maple
- (CGY)** Custom Grey
- (DES)** Dark Espresso
- (DWT)** Designer White
- (FAS)** Fashionista





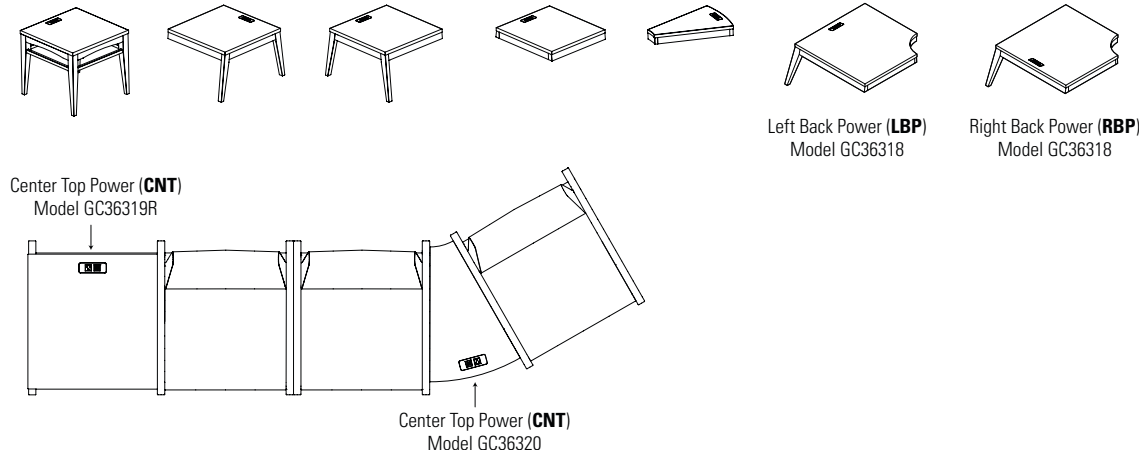

- (FCL)** First Class
- (NBL)** Noce Biondo
- (NGL)** Noce Grigio
- (NEL)** Noce Leggero
- (NML)** Noce Medio
- (QTM)** Quartered Mahogany
- (SBY)** Sheer Beauty
- (SDT)** Stonedust
- (WHE)** Walnut Heights
- (WHC)** White Chocolate
- (WCR)** Winter Cherry

Solid surface (CO)

- Grade 1**  
**(SWH)** Designer White
- Grade 2**  
**(SBT)** Beige Tempest  
**(SBX)** Black Onyx Mirage  
**(SFW)** Frosty White Mirage  
**(SHS)** Hot Stone  
**(SMG)** Milk Glass Spectra  
**(SNM)** Northern Melange

POWER LOCATION DIAGRAM



TABLES	MODEL #	DIMENSIONS <sup>IN</sup> <sub>MM</sub>	WEIGHT <sup>LB</sup> <sub>KG</sub>	VOLUME <sup>FT<sup>3</sup></sup> <sub>MT<sup>3</sup></sub>	LIST PRICE
 <b>Square 22" End Table - 20.25"H</b>	GC36314	22 x 22 x 20.25	29	7.75	<b>\$595</b>
		559 x 559 x 514	13.2	0.21	
		<ul style="list-style-type: none"> <li>• For a thermally fused laminate top (<b>LP</b>), specify model GC36314-LP.</li> <li>• For a high pressure laminate top (<b>HP</b>), specify model GC36314-HP. Add \$42.</li> <li>• For a solid surface top (<b>CO</b>), specify model GC36314-CO. For grade 1, add \$810. For grade 2, add \$1010.</li> </ul>			
		Coordinating edge and solid wood frame. 1 per carton. Power and data can be added on the surface of the table ( <b>CNT</b> ). Add \$232.			
 <b>Square 22" End Table - 23"H</b>	GC36324	22 x 22 x 23	34	10.75	<b>\$772</b>
		559 x 559 x 584	15.45	0.3	
		<ul style="list-style-type: none"> <li>• For a thermally fused laminate top (<b>LP</b>), specify model GC36324-LP.</li> <li>• For a high pressure laminate top (<b>HP</b>), specify model GC36324-HP. Add \$42.</li> <li>• For a solid surface top (<b>CO</b>), specify model GC36324-CO. For grade 1, add \$810. For grade 2, add \$1010.</li> </ul>			
		Coordinating edge and solid wood frame. 1 per carton. Power and data can be added on the surface of the table ( <b>CNT</b> ). Add \$232.			
 <b>Rectangular End Table - 23"H</b>	GC36325	12 x 22 x 23	23.5	6.75	<b>\$665</b>
		305 x 559 x 584	10.68	0.19	
		<ul style="list-style-type: none"> <li>• For a thermally fused laminate top (<b>LP</b>), specify model GC36325-LP.</li> <li>• For a high pressure laminate top (<b>HP</b>), specify model GC36325-HP. Add \$42.</li> <li>• For a solid surface top (<b>CO</b>), specify model GC36325-CO. For grade 1, add \$690. For grade 2, add \$840.</li> </ul>			
		Coordinating edge and solid wood frame. 1 per carton. Power and data can be added on the surface of the table ( <b>CNT</b> ). Add \$232.			
 <b>Corner 30° End Table - 23"H</b>	GC36326	25 x 24 x 23	34	12.75	<b>\$840</b>
		635 x 610 x 584	15.45	0.36	
		<ul style="list-style-type: none"> <li>• For a thermally fused laminate top (<b>LP</b>), specify model GC36326-LP.</li> <li>• For a high pressure laminate top (<b>HP</b>), specify model GC36326-HP. Add \$55.</li> <li>• For a solid surface top (<b>CO</b>), specify model GC36326-CO. For grade 1, add \$869. For grade 2, add \$1159.</li> </ul>			
		Coordinating edge and solid wood frame. 1 per carton. Power and data can be added on the surface of the table ( <b>CNT</b> ). Add \$232.			
 <b>Square 24" Coffee Table</b>	GC36315	24 x 24 x 17.25	37	9.5	<b>\$591</b>
		610 x 610 x 438	16.78	0.26	
		<ul style="list-style-type: none"> <li>• For a thermally fused laminate top (<b>LP</b>), specify model GC36315-LP.</li> <li>• For a high pressure laminate top (<b>HP</b>), specify model GC36315-HP. Add \$42.</li> <li>• For a solid surface top (<b>CO</b>), specify model GC36315-CO. For grade 1, add \$917. For grade 2, add \$1237.</li> </ul>			
		Coordinating edge and solid wood frame. 1 per carton.			
 <b>Square 36" Coffee Table</b>	GC36316	36 x 36 x 17.25	65	18.25	<b>\$806</b>
		914 x 914 x 438	29.48	0.51	
		<ul style="list-style-type: none"> <li>• For a thermally fused laminate top (<b>LP</b>), specify model GC36316-LP.</li> <li>• For a high pressure laminate top (<b>HP</b>), specify model GC36316-HP. Add \$89.</li> <li>• For a solid surface top (<b>CO</b>), specify model GC36316-CO. For grade 1, add \$2071. For grade 2, add \$2771.</li> </ul>			
		Coordinating edge and solid wood frame. 1 per carton.			

TABLES	MODEL #	DIMENSIONS <sup>IN</sup> <sub>MM</sub>	WEIGHT <sup>LB</sup> <sub>KG</sub>	VOLUME <sup>FT<sup>3</sup></sup> <sub>MT<sup>3</sup></sub>	LIST PRICE
--------	---------	-------------------------------------------	---------------------------------------	---------------------------------------------------------------	------------

W x D x H

GC36317	48 x 24 x 17.25	56	16.5	<b>\$774</b>
	1219 x 610 x 438	25.4	0.46	



Rectangular Coffee Table

- For a thermally fused laminate top (**LP**), specify model GC36317-LP.
- For a high pressure laminate top (**HP**), specify model GC36317-HP. Add \$83.
- For a solid surface top (**CO**), specify model GC36317-CO. For grade 1, add \$1857. For grade 2, add \$2487.

Coordinating edge and solid wood frame. 1 per carton.