

tables

Cafeteria + Dining + Occasional + Reception

Calidon Tables.....	36	Overbed tables.....	53
Enable	40	Primacare.....	59
Floral Dining	41	Primacare HT.....	60
GC Belong	42	River+ tables.....	61
Occasional.....	44	Tablet.....	62

CALIDON TABLES



Square End Table - 22" model GC36314



Rectangular Coffee Table model GC36317

Calidon seating



For Calidon seating, refer to page 70.

EXAMPLE CALIDON TABLE ORDER CODE:

GC36314	-HP	-ACJ	-CNT
Model #	Top material	Laminate finish	Power

STANDARD FEATURES

- A variety of wood leg tables are available. The wood legs/aprons are specifiable in the same wood seating finishes.
- Table tops are 1" thick, available in thermally fused laminate (LP), high pressure laminate (HP), and solid surface (CO). Upcharges vary, see model for pricing.
- Laminate top tables include color coordinating 2 mm PVC edgeband.
- Tandem/bridge table models (GC36318 to GC36321) connect to guest seating only.
- Tandem tables are specified left or right, as seated.

OPTIONAL FEATURES

- A tamper resistant power/USB unit is optional for laminate top, tandem in-line, 30 degree, 90 degree and freestanding square end tables only. Unit is black; includes one AC outlet, two 10-watt USB-A ports, matching faceplate and a 10 ft long 3-prong power cord. The power unit is centered 1.5" from the edge of the surface. See power location diagrams for reference.

SUGGESTED APPLICATIONS

- Lounge rooms
- Patient rooms
- Resident rooms
- Treatment/Exam room

Please add option codes in the following order:

- Model number**
GC36314 Freestanding end table, 20.25"H
GC36324 to GC36326 Freestanding end tables, 23"H
GC36315 to GC36317 Freestanding coffee tables, 17,25"H
GC36318 to GC36321 Tandem/bridge tables (refer to page 74)
- Top material**
(LP) Thermally fused laminate. Specify finish - see LP finishes.
(HP) High pressure laminate. Upcharges vary - see model. Specify finish - see HP finishes.
(CO) Solid surface. Upcharges vary - see model. Specify finish - see Solid Surface finishes.
- Leg finish**
(AAM) Absolute **(MWM)** Medium Walnut
(CJM) Charcoal Java **(ASM)** Night
(ACM) Cherry **(NBM)** Noce Biondo
(EMM) Empire Mahogany **(NGM)** Noce Grigio
(EOM) English Oak **(NEM)** Noce Leggero
(ECM) Espresso Cafe **(NMM)** Noce Medio
(TFM) Fruitwood **(SBM)** Sandy Beach
(HGM) Grey **(SKM)** Shaker Cherry
(HOM) Harvest Oak **(SOM)** Silver Oak
(AHM) Honey **(TWM)** Walnut
(JOM) Jet Onyx **(WTM)** WC Cream
(LHM) Light Honey **(WHM)** White
(TMM) Mahogany **(WCM)** Winter Cherry
(AVM) Maple
- Power/USB unit position** (laminate tandem and end tables only).
(NPM) No power
(CNT) Center top power. Add \$232.
- Power/USB unit position** (laminate corner tables only).
(NPM) No power
(LBP) Left back power. Add \$232.
(RBP) Right back power. Add \$232.

TABLE TOP FINISHES:

Thermally fused laminate (LP):

- (ACJ)** Absolute Acajou
- (ASN)** Asian Night
- (AWC)** Avant Cherry
- (AWH)** Avant Honey
- (BLK)** Black
- (BZD)** Blizzard
- (BRC)** Brushed Cobalt
- (CMB)** Clear Maple
- (CGY)** Custom Grey
- (DES)** Dark Espresso
- (DWT)** Designer White
- (FAS)** Fashionista

- (FCL)** First Class
- (NBL)** Noce Biondo
- (NGL)** Noce Grigio
- (NEL)** Noce Leggero
- (NML)** Noce Medio
- (QTM)** Quartered Mahogany
- (SBY)** Sheer Beauty
- (SDT)** Stonedust
- (WHE)** Walnut Heights
- (WHC)** White Chocolate
- (WCR)** Winter Cherry

High pressure laminate (HP):

- (ACJ)** Absolute Acajou
- (ASN)** Asian Night
- (W357)** Avant Cherry
- (W356)** Avant Honey
- (BLK)** Black
- (BZD)** Blizzard
- (BRC)** Brushed Cobalt
- (CMB)** Clear Maple
- (CGY)** Custom Grey
- (DES)** Dark Espresso
- (DWT)** Designer White
- (FAS)** Fashionista





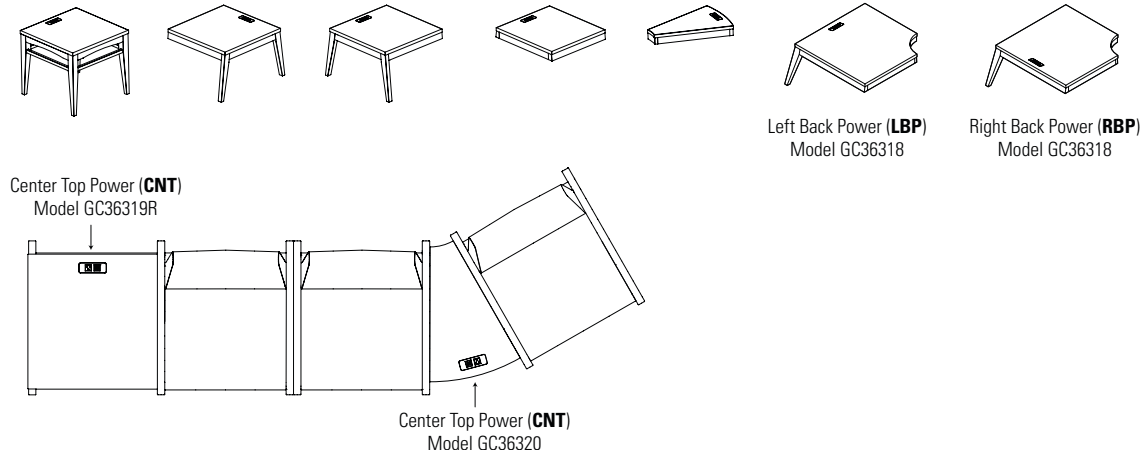

- (FCL)** First Class
- (NBL)** Noce Biondo
- (NGL)** Noce Grigio
- (NEL)** Noce Leggero
- (NML)** Noce Medio
- (QTM)** Quartered Mahogany
- (SBY)** Sheer Beauty
- (SDT)** Stonedust
- (WHE)** Walnut Heights
- (WHC)** White Chocolate
- (WCR)** Winter Cherry

Solid surface (CO)

- Grade 1**
(SWH) Designer White
- Grade 2**
(SBT) Beige Tempest
(SBX) Black Onyx Mirage
(SFW) Frosty White Mirage
(SHS) Hot Stone
(SMG) Milk Glass Spectra
(SNM) Northern Melange

POWER LOCATION DIAGRAM



TABLES	MODEL #	DIMENSIONS ^{IN} _{MM}	WEIGHT ^{LB} _{KG}	VOLUME ^{FT³} _{MT³}	LIST PRICE
 <p>Square 22" End Table - 20.25"H</p>	GC36314	22 x 22 x 20.25	29	7.75	\$625
		559 x 559 x 514	13.2	0.21	
<ul style="list-style-type: none"> • For a thermally fused laminate top (LP), specify model GC36314-LP. • For a high pressure laminate top (HP), specify model GC36314-HP. Add \$42. • For a solid surface top (CO), specify model GC36314-CO. For grade 1, add \$810. For grade 2, add \$1010. <p>Coordinating edge and solid wood frame. 1 per carton. Power and data can be added on the surface of the table (CNT). Add \$232.</p>					
 <p>Square 22" End Table - 23"H</p>	GC36324	22 x 22 x 23	25	10.75	\$811
		559 x 559 x 584	13.2	0.3	
<ul style="list-style-type: none"> • For a thermally fused laminate top (LP), specify model GC36324-LP. • For a high pressure laminate top (HP), specify model GC36324-HP. Add \$42. • For a solid surface top (CO), specify model GC36324-CO. For grade 1, add \$810. For grade 2, add \$1010. <p>Coordinating edge and solid wood frame. 1 per carton. Power and data can be added on the surface of the table (CNT). Add \$232.</p>					
 <p>Rectangular End Table - 23"H</p>	GC36325	12 x 22 x 23	17.5	6.75	\$698
		305 x 559 x 584	16.78	0.19	
<ul style="list-style-type: none"> • For a thermally fused laminate top (LP), specify model GC36325-LP. • For a high pressure laminate top (HP), specify model GC36325-HP. Add \$42. • For a solid surface top (CO), specify model GC36325-CO. For grade 1, add \$690. For grade 2, add \$840. <p>Coordinating edge and solid wood frame. 1 per carton. Power and data can be added on the surface of the table (CNT). Add \$232.</p>					
 <p>Corner 30° End Table - 23"H</p>	GC36326	25 x 24 x 23	23.5	12.75	\$882
		635 x 610 x 584	29.48	0.36	
<ul style="list-style-type: none"> • For a thermally fused laminate top (LP), specify model GC36326-LP. • For a high pressure laminate top (HP), specify model GC36326-HP. Add \$55. • For a solid surface top (CO), specify model GC36326-CO. For grade 1, add \$869. For grade 2, add \$1159. <p>Coordinating edge and solid wood frame. 1 per carton. Power and data can be added on the surface of the table (CNT). Add \$232.</p>					
 <p>Square 24" Coffee Table</p>	GC36315	24 x 24 x 17.25	37	9.5	\$621
		610 x 610 x 438	16.78	0.26	
<ul style="list-style-type: none"> • For a thermally fused laminate top (LP), specify model GC36315-LP. • For a high pressure laminate top (HP), specify model GC36315-HP. Add \$42. • For a solid surface top (CO), specify model GC36315-CO. For grade 1, add \$917. For grade 2, add \$1237. <p>Coordinating edge and solid wood frame. 1 per carton.</p>					
 <p>Square 36" Coffee Table</p>	GC36316	36 x 36 x 17.25	65	18.25	\$846
		914 x 914 x 438	29.48	0.51	
<ul style="list-style-type: none"> • For a thermally fused laminate top (LP), specify model GC36316-LP. • For a high pressure laminate top (HP), specify model GC36316-HP. Add \$89. • For a solid surface top (CO), specify model GC36316-CO. For grade 1, add \$2071. For grade 2, add \$2771. <p>Coordinating edge and solid wood frame. 1 per carton.</p>					

TABLES	MODEL #	DIMENSIONS ^{IN} _{MM}	WEIGHT ^{LB} _{KG}	VOLUME ^{FT³} _{MT³}	LIST PRICE
--------	---------	---	---------------------------------------	---	------------

W x D x H

GC36317	48 x 24 x 17.25	56	16.5	\$813
	1219 x 610 x 438	25.4	0.46	



Rectangular Coffee Table

- For a thermally fused laminate top (**LP**), specify model GC36317-LP.
- For a high pressure laminate top (**HP**), specify model GC36317-HP. Add \$83.
- For a solid surface top (**CO**), specify model GC36317-CO. For grade 1, add \$1857. For grade 2, add \$2487.

Coordinating edge and solid wood frame. 1 per carton.

Notes: Please specify all substitutions and options.

- Offers a solution to users with limited mobility.
- The Enable table top allows for two fixed tablets and two height adjustable tablets to be installed on opposite sides into the predrilled holes with metal inserts on the underside of the top.
- The fixed and or height adjustable tablets can be added to the table surface as needed to accommodate change in a persons physical abilities for continued enjoyment during mealtime and activities.
- Height adjustable tablet surface has a 13.5" range of motion. When attached to the underside of the table top to motion range is 22.5" to 36" for accommodating a larger range of mobility issues and devices (wheelchairs, geriatric chairs, walkers).
- Heavy duty tapered steel leg finish must be specified at time of order (see below).
- Legs are available with Black (BLK) plastic glides offering 1.5" adjustment as standard except Tungsten (TTU) which has Tungsten glides.
- Legs with Black manual locking casters are available and can be specified as needed in the "Build It" tool.
- To support the need to move tables for cleaning, repositioning or placing in storage, tables can be ordered with two standard legs and two legs with casters. Add (LF) to model #.
- This allows for specifying the top with four legs on glides or two legs on casters, two leg with glides or four legs with manual locking casters.
- Shipped easy to assemble.
- 2mm edging color coordinated with laminate finish is standard for all tops. Finish must be specified at time of order.
- Tops are 1" thick and available in thermally fused laminate (LP) and high pressure laminate (HP). Please select the appropriate model number for the finish you prefer.
- Counterweights are available as an option when additional weight is required for increased safety. For a 13 lb. counterweight, specify (CW13) - add \$286. For 26 lb. counterweight, specify (CW26) - add \$484.
- Refer to the following lists when selecting a finish color. Must specify both a top color and leg finish at time of order.
- For custom laminate or contrasting edge, please contact your Global sales representative for a special quotation.

Thermally Fused Laminate (LP)

- (ACJ) Absolute Acajou
- (ASN) Asian Night
- (AWC) Avant Cherry
- (AWH) Avant Honey
- (BLK) Black
- (BZD) Blizzard
- (BRC) Brushed Cobalt
- (CMB) Clear Maple
- (CGY) Custom Grey
- (DES) Dark Espresso
- (DWT) Designer White
- (FAS) Fashionista
- (FCL) First Class
- (NBL) Noce Biondo
- (NGL) Noce Grigio
- (NEL) Noce Leggero
- (NML) Noce Medio
- (QTM) Quartered Mahogany
- (SDT) Stonedust
- (SBY) Sheer Beauty
- (SOG) Storm Grey
- (WHE) Walnut Heights
- (WHC) White Chocolate
- (WCR) Winter Cherry

High Pressure Laminate (HP)

- (ACJ) Absolute Acajou
- (ASN) Asian Night
- (W357) Avant Cherry
- (W356) Avant Honey
- (BLK) Black
- (BZD) Blizzard
- (BRC) Brushed Cobalt
- (CMB) Clear Maple
- (CGY) Custom Grey
- (DES) Dark Espresso
- (DWT) Designer White
- (FAS) Fashionista
- (FCL) First Class
- (NBL) Noce Biondo
- (NGL) Noce Grigio
- (NEL) Noce Leggero
- (NML) Noce Medio
- (QTM) Quartered Mahogany
- (SDT) Stonedust
- (SBY) Sheer Beauty
- (SOG) Storm Grey
- (WHE) Walnut Heights
- (WHC) White Chocolate
- (WCR) Winter Cherry

Leg Finish

- (TBL) Black
- (TIV) Cloud
- (TDW) Designer White
- (TFO) Fog
- (TFR) Frost
- (TKA) Kalua
- (TLA) Latte
- (TMO) Mocha
- (TNE) Nevada
- (TSN) Sand
- (TSH) Shadow
- (TOA) Toast
- (TTU) Tungsten



TABLETS	MODEL #	DIMENSIONS IN MM	WEIGHT LB KG	VOLUME FT ³ MT ³	LIST PRICE
---------	---------	------------------	--------------	--	------------



E-Z Lift Dual Arm Tablet

W x D x H					
GC3-DAHN	36 x 13 x 7-13	31	4.9	\$1438	
	914 x 330 x 178-330	14.06	0.13		
GC3-DALN	36 x 13 x 7-13	31	4.9	\$1210	
	914 x 330 x 178-330	14.06	0.13		

- For a high pressure laminate top (HP), specify model GC3-DAHN.
- For a thermally fused top (LP), specify model GC3-DALN.

Adjust up or down by the use of a single paddle actuator. Tablet remains level during adjustment and has a positive locking, smooth counterbalanced operation through the use of a gas cylinder. Tablet range when attached to the underside of the table top to motion range is 22.5" to 36". Guard at the back prevents items from falling. 2 cartons.

- Allowance between arms is 22.5" for use with wheelchairs.
- Adds 15" per tablet to the depth of the table.
- Fits predrilled inserts on 42" table sides only. Thumbscrew hardware for attaching to table top is included.
- Mechanism and tablet bracket are available in Black only.



Tablet

GC3-NUGH	24 x 10 x 1	15	0.8	\$398	
	610 x 254 x 25	6.8	0.02		
GC3-NUG	24 x 10 x 1	15	0.8	\$361	
	610 x 254 x 25	6.8	0.02		

- For a high pressure laminate top (HP), specify model GC3-NUGH.
- For a thermally fused top (LP), specify model GC3-NUG.

Attachable fixed height tablet for Enable tables. Adds 10.5" per tablet to the depth of the table. Heavy duty Black mounting bracket slips onto the table top on the 36" sides. Thumbscrews are included and attach into predrilled metal inserts for metal to-metal fastening and security. 2 cartons.

TABLE TOPS WITH LEGS

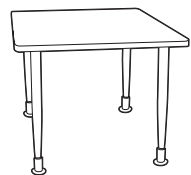

Table Top with Legs - 36"

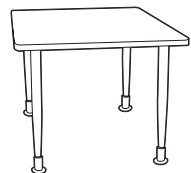

Table Top with Legs - 42"

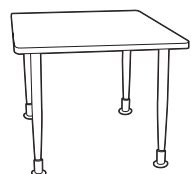

Table Top with Legs - 48"

MODEL #	DIMENSIONS ^{IN} _{MM}	WEIGHT ^{LB} _{KG}	VOLUME ^{FT³} _{MT³}	LIST PRICE
GCEN3642H	36 x 42 x 28.25	89	5.7	\$1516
	914 x 1067 x 718	40.36	0.16	
GCEN3642L	36 x 42 x 28.25	89	5.7	\$1261
	914 x 1067 x 718	40.36	0.16	

- For a high pressure laminate top (HP), specify model GCEN3642H.
- For a thermally fused top (LP), specify model GCEN3642L.

Allows for EZ-lift arm tablets to be installed on the 42" wide ends and fixed arm tablets on the 36" sides. 2 cartons.

GCEN4242H	42 x 42 x 28.25	102	6	\$1649
	1067 x 1067 x 718	46.26	0.16	
GCEN4242L	42 x 42 x 28.25	102	6	\$1389
	1067 x 1067 x 718	46.26	0.16	

- For a high pressure laminate top (HP), specify model GCEN4242H.
- For a thermally fused top (LP), specify model GCEN4242L.

GCEN4848H	48 x 48 x 28.25	121	6.6	\$1900
	1219 x 1219 x 718	54.88	0.18	
GCEN4848L	48 x 48 x 28.25	121	6.6	\$1639
	1219 x 1219 x 718	54.88	0.18	

- For a high pressure laminate top (HP), specify model GCEN4848H.
- For a thermally fused top (LP), specify model GCEN4848L.

TAPERED LEGS



Tapered Leg with Caster



Tapered Leg with Glide

LCL291	5.25 x 5.25 x 27.75	4.8	0.52	\$106
	133 x 133 x 692	2.17	0.01	
LCL294	5.25 x 5.25 x 27.75	18.4	2.1	\$419
	133 x 133 x 705	8.34	0.05	

Tapered leg with locking caster. Hardware for assembly is included

- LCL291: 1 per carton.
- LCL294: 4 per carton.
- Finish must be specified at time of order.

LLL291	5.25 x 5.25 x 27.25	4.8	0.52	\$106
	133 x 133 x 692	2.17	0.01	
LLL294	5.25 x 5.25 x 27.25	18.4	2.1	\$419
	133 x 133 x 692	8.34	0.05	

Tapered leg with glide offers 1.5" glide range adjustment. Legs are available and can be ordered separately from the top. Hardware for assembly is included.

- LLL291: 1 per carton.
- LLL294: 4 per carton.
- Finish must be specified at time of order.

Notes: Please specify all substitutions and options.

- Attractive top design offers an inward curve at each corner allowing comfortable access if assistance with eating is required.
- Adjustable 1.5" range Black plastic glides are standard except Tungsten (TTU) which has Tungsten glides.
- Heavy duty tapered steel leg finish must be specified at time of order (see below).
- Optional leg on caster available if required.
- Shipped easy to assemble.
- 2mm edging color coordinated with laminate finish is standard for all tops. Finish must be specified at time of order.
- Tops are 1" thick and available in thermally fused laminate (LP) and high pressure laminate (HP). Please select the appropriate model number for the finish you prefer.
- Refer to the following lists when selecting a finish color. Must specify both a top color and leg finish at time of order.
- For custom laminate or contrasting edge, please contact your Global sales representative for a special quotation.

Thermally Fused Laminate (LP)

- (ACJ) Absolute Acajou
- (ASN) Asian Night
- (AWC) Avant Cherry
- (AWH) Avant Honey
- (BLK) Black
- (BZD) Blizzard
- (BRC) Brushed Cobalt
- (CMB) Clear Maple
- (CGY) Custom Grey
- (DES) Dark Espresso
- (DWT) Designer White
- (FAS) Fashionista
- (FCL) First Class
- (NBL) Noce Biondo
- (NGL) Noce Grigio
- (NEL) Noce Leggero
- (NML) Noce Medio
- (QTM) Quartered Mahogany
- (SBY) Sheer Beauty
- (SDT) Stonedust
- (SOG) Storm Grey
- (WHE) Walnut Heights
- (WHC) White Chocolate
- (WCR) Winter Cherry

High Pressure Laminate (HP)

- (ACJ) Absolute Acajou
- (ASN) Asian Night
- (AWC) Avant Cherry
- (AWH) Avant Honey
- (BLK) Black
- (BZD) Blizzard
- (BRC) Brushed Cobalt
- (CMB) Clear Maple
- (CGY) Custom Grey
- (DES) Dark Espresso
- (DWT) Designer White
- (FAS) Fashionista
- (FCL) First Class
- (NBL) Noce Biondo
- (NGL) Noce Grigio
- (NEL) Noce Leggero
- (NML) Noce Medio
- (QTM) Quartered Mahogany
- (SBY) Sheer Beauty
- (SDT) Stonedust
- (SOG) Storm Grey
- (WHE) Walnut Heights
- (WHC) White Chocolate
- (WCR) Winter Cherry

Leg Finish

- (TBL) Black
- (TIV) Cloud
- (TDW) Designer White
- (TFO) Fog
- (TFR) Frost
- (TKA) Kalua
- (TLA) Latte
- (TMO) Mocha
- (TNE) Nevada
- (TSN) Sand
- (TSH) Shadow
- (TOA) Toast
- (TTU) Tungsten

DINING ROOM TABLES



Floral Dining Room Table - 42"



Floral Dining Room Table - 48"

MODEL #	DIMENSIONS IN MM	WEIGHT LB KG	VOLUME FT ³ MT ³	LIST PRICE
---------	------------------------	--------------------	--	------------

W x D x H				
GCF-42H	42 x 42 x 28.25	79	4.15	\$1416
	1067 x 1067 x 718	35.83	0.11	
GCF-42L	42 x 42 x 28.25	79	4.15	\$1216
	1067 x 1067 x 718	35.83	0.11	

- For a high pressure laminate top (HP), specify model GCF-42H.
- For a thermally fused top (LP), specify model GCF-42L.

- 42" x 42" thermally fused laminate top. Four legs.
- Additional leg heights are available. Special quote is required.
 - 2 cartons.

GCF-48H	48 x 48 x 28.25	98	4.7	\$1795
	1219 x 1219 x 718	44.45	0.13	
GCF-48L	48 x 48 x 28.25	98	4.7	\$1335
	1219 x 1219 x 718	44.45	0.13	

- For a high pressure laminate top (HP), specify model GCF-48H.
- For a thermally fused top (LP), specify model GCF-48L.

- 48" x 48" thermally fused laminate top. Four legs.
- Additional leg heights are available. Special quote is required.
 - 2 cartons.

Notes: Please specify all substitutions and options.

- Elliptical metal tube frame finish must be specified at time of order (see below).
- Freestanding tables coordinate with GC Belong and Strand seating series. Please refer to the seating section for information on ganging tables.
- Tables are 16" high.
- Shipped easy to assemble.
- 2mm edging color coordinated with laminate finish is standard for all tops. Finish must be specified at time of order.
- Tops are 1" thick and available in thermally fused laminate (**LP**) and high pressure laminate (**HP**). Please select the appropriate model number for the finish you prefer.
- Refer to the following lists when selecting a finish color. Must specify both a top color and leg finish at time of order.
- For custom laminate or contrasting edge, please contact your Global sales representative for a special quotation.

Thermally Fused Laminate (LP)



- (ACJ)** Absolute Acajou
- (ASN)** Asian Night
- (AWC)** Avant Cherry
- (AWH)** Avant Honey
- (BLK)** Black
- (BZD)** Blizzard
- (BRC)** Brushed Cobalt
- (CMB)** Clear Maple
- (CGY)** Custom Grey
- (DES)** Dark Espresso
- (DWT)** Designer White
- (FAS)** Fashionista
- (FCL)** First Class
- (NBL)** Noce Biondo
- (NGL)** Noce Grigio
- (NEL)** Noce Leggero
- (NML)** Noce Medio
- (QTM)** Quartered Mahogany
- (SBY)** Sheer Beauty
- (SDT)** Stonedust
- (SOG)** Storm Grey
- (WHE)** Walnut Heights
- (WHC)** White Chocolate
- (WCR)** Winter Cherry

High Pressure Laminate (HP)

- (ACJ)** Absolute Acajou
- (ASN)** Asian Night
- (AWC)** Avant Cherry
- (AWH)** Avant Honey
- (BLK)** Black
- (BZD)** Blizzard
- (BRC)** Brushed Cobalt
- (CMB)** Clear Maple
- (CGY)** Custom Grey
- (DES)** Dark Espresso
- (DWT)** Designer White
- (FAS)** Fashionista
- (FCL)** First Class
- (NBL)** Noce Biondo
- (NGL)** Noce Grigio
- (NEL)** Noce Leggero
- (NML)** Noce Medio
- (QTM)** Quartered Mahogany
- (SBY)** Sheer Beauty
- (SDT)** Stonedust
- (SOG)** Storm Grey
- (WHE)** Walnut Heights
- (WHC)** White Chocolate
- (WCR)** Winter Cherry

Leg Finish

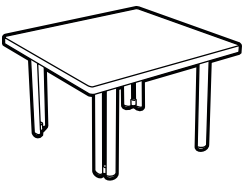
- (TBL)** Black
- (TIV)** Cloud
- (TDW)** Designer White
- (TFO)** Fog
- (TFR)** Frost
- (TKA)** Kalua
- (TLA)** Latte
- (TMO)** Mocha
- (TNE)** Nevada
- (TSN)** Sand
- (TSH)** Shadow
- (TOA)** Toast
- (TTU)** Tungsten

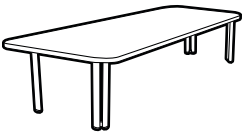
TABLES	MODEL #	DIMENSIONS IN MM	WEIGHT LB KG	VOLUME FT ³ MT ³	LIST PRICE	
 <p>Rectangular End Table</p>	W x D x H					
	GC4281-HP	18 x 22 x 16	25	3.4	\$750	
	GC4281-LP	457 x 559 x 406	11.4	0.09	\$662	
		18 x 22 x 16	25	3.4		
		457 x 559 x 406	11.4	0.09		
						<ul style="list-style-type: none"> • For a high pressure laminate top (HP), specify model GC4281-HP. • For a thermally fused laminate top (LP), specify model GC4281-LP. <p>Coordinating 2mm edge. Oval steel tube legs. 1 per carton.</p>
 <p>Square End Table</p>	GC4282-HP	30 x 30 x 16	28	6	\$931	
	GC4282-LP	762 x 762 x 406	12.7	0.16	\$831	
		30 x 30 x 16	28	6		
		762 x 762 x 406	12.7	0.16		
						<ul style="list-style-type: none"> • For a high pressure laminate top (HP), specify model GC4282-HP. • For a thermally fused laminate top (LP), specify model GC4282-LP. <p>Coordinating 2mm edge. Oval steel tube legs. 1 per carton.</p>
 <p>Rectangular Coffee Table</p>	GC4283-HP	22 x 54 x 16	30	6	\$1077	
	GC4283-LP	559 x 1372 x 406	13.6	0.16	\$899	
		22 x 54 x 16	30	6		
		559 x 1372 x 406	13.6	0.16		
						<ul style="list-style-type: none"> • For a high pressure laminate top (HP), specify model GC4283-HP. • For a thermally fused laminate top (LP), specify model GC4283-LP. <p>Coordinating 2mm edge. Oval steel tube legs. 1 per carton.</p>

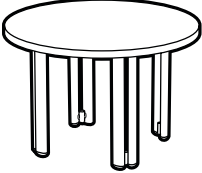
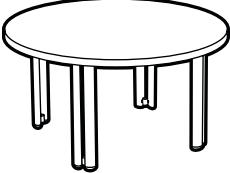
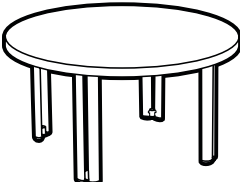
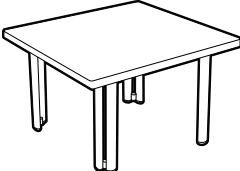
TABLES	MODEL #	DIMENSIONS ^{IN} _{MM}	WEIGHT ^{LB} _{KG}	VOLUME ^{FT³} _{MT³}	LIST PRICE
	GC4284-HP	36 x 36 x 16	30	6	\$997
		914 x 914 x 406	13.6	0.16	
	GC4284-LP	36 x 36 x 16	30	6	\$855
		914 x 914 x 406	13.6	0.16	
<p>• For a high pressure laminate top (HP), specify model GC4284-HP. • For a thermally fused laminate top (LP), specify model GC4284-LP.</p> <p>Coordinating 2mm edge. Oval steel tube legs. 1 per carton.</p>					
	GC4285-HP	24 x 24 x 16	27	3.4	\$903
		610 x 610 x 406	12.3	0.09	
	GC4285-LP	24 x 24 x 16	27	3.4	\$836
		610 x 610 x 406	12.3	0.09	
<p>• For a high pressure laminate top (HP), specify model GC4285-HP. • For a thermally fused laminate top (LP), specify model GC4285-LP.</p> <p>Coordinating 2mm edge. Oval steel tube legs. 1 per carton.</p>					
	GC4286-HP	30 x 30 x 16	29	6	\$950
		762 x 762 x 406	13.2	0.16	
	GC4286-LP	30 x 30 x 16	29	6	\$885
		762 x 762 x 406	13.2	0.16	
<p>• For a high pressure laminate top (HP), specify model GC4286-HP. • For a thermally fused laminate top (LP), specify model GC4286-LP.</p> <p>Coordinating 2mm edge. Oval steel tube legs. 1 per carton.</p>					
	GC4287-HP	36 x 36 x 16	30	6	\$999
		914 x 914 x 406	13.6	0.16	
	GC4287-LP	36 x 36 x 16	30	6	\$937
		914 x 914 x 406	13.6	0.16	
<p>• For a high pressure laminate top (HP), specify model GC4287-HP. • For a thermally fused laminate top (LP), specify model GC4287-LP.</p> <p>Coordinating 2mm edge. Oval steel tube legs. 1 per carton.</p>					
	GC4288-HP	23 x 23 x 16	25	3.4	\$790
		584 x 584 x 406	11.4	0.09	
	GC4288-LP	23 x 23 x 16	25	3.4	\$756
		584 x 584 x 406	11.4	0.09	
<p>• For a high pressure laminate top (HP), specify model GC4288-HP. • For a thermally fused laminate top (LP), specify model GC4288-LP.</p> <p>Coordinating 2mm edge. Oval steel tube legs. 1 per carton.</p>					

Notes: Please specify all substitutions and options.

- Select from chippendale (**C**), post (**P**), or tapered (**T**) leg options to coordinate with traditional or contemporary decor.
- Solid wood legs and aprons are standard.
- Shipped easy to assemble.
- 2mm edging color coordinated with laminate finish is standard for all tops. Finish must be specified at time of order.
- Tops are 1" thick and available in thermally fused laminate (**LP**), high pressure laminate (**HP**) or solid hardwood (**W**). Please select the appropriate model number for the finish you prefer.
- Thermally fused laminate (**LP**) and high pressure laminate (**HP**) tops come with a 2mm edging color coordinated with laminate finish. Top finish must be specified at time of order.
- Solid hardwood tops come with decorative edge detail to coordinate with leg selected. Chippendale legs come with beveled edge. Post leg comes with bullnose edge. Tapered leg comes with knife cut edge. See pictures below.
- Refer to the following lists when selecting a finish color. Must specify both a top color and base color at time of order all tables.
- Thermally fused and high pressure laminate tops cannot be manufactured with the exact finish color on the base.
- For custom laminate, custom wood stain or contrasting edge, please contact your Global sales representative for a special quotation.

Thermally Fused Laminate (LP)

- (ACJ) Absolute Acajou
- (ASN) Asian Night
- (AWC) Avant Cherry
- (AWH) Avant Honey
- (BLK) Black
- (BZD) Blizzard
- (BRC) Brushed Cobalt
- (CMB) Clear Maple
- (CGY) Custom Grey
- (DES) Dark Espresso
- (DWT) Designer White
- (FAS) Fashionista
- (FCL) First Class
- (NBL) Noce Biondo
- (NGL) Noce Grigio
- (NEL) Noce Leggero
- (NML) Noce Medio
- (QTM) Quartered Mahogany
- (SBY) Sheer Beauty
- (SDT) Stonedust
- (SOG) Storm Grey
- (WHE) Walnut Heights
- (WHC) White Chocolate
- (WCR) Winter Cherry

Suggested coordinating wood finish

- (AAM) Absolute
- (ASM) Night
- (ACM) Cherry on Maple
- (AHM) Honey on Maple
- (JOM) Jet Onyx
-
- (LHM) Light Honey on Maple
- (AVM) Maple on Maple
-
- (ECM) Espresso Cafe on Maple
- (WHM) White
-
- (NBM) Noce Biondo
- (NGM) Noce Grigio
- (NEM) Noce Leggero
- (NMM) Noce Medio
- (TMM) Tiger Mahogany on Maple
-
-
- (NLW) Natural Walnut
- (WTM) WC Cream
- (WCM) Winter Cherry on Maple

High Pressure Laminate (HP)

- (ACJ) Absolute Acajou
- (ASN) Asian Night
- (W357) Avant Cherry
- (W356) Avant Honey
- (BLK) Black
- (BZD) Blizzard
- (BRC) Brushed Cobalt
- (CMB) Clear Maple
- (CGY) Custom Grey
- (DES) Dark Espresso
- (DWT) Designer White
- (FAS) Fashionista
- (FCL) First Class
- (NBL) Noce Biondo
- (NGL) Noce Grigio
- (NEL) Noce Leggero
- (NML) Noce Medio
- (QTM) Quartered Mahogany
- (SBY) Sheer Beauty
- (SDT) Stonedust
- (SOG) Storm Grey
- (WHE) Walnut Heights
- (WHC) White Chocolate
- (WCR) Winter Cherry

Suggested coordinating wood finish

- (AAM) Absolute
- (ASM) Night
- (ACM) Cherry on Maple
- (AHM) Honey on Maple
- (JOM) Jet Onyx
-
- (LHM) Light Honey on Maple
- (AVM) Maple on Maple
-
- (ECM) Espresso Cafe on Maple
- (WHM) White
-
- (NBM) Noce Biondo
- (NGM) Noce Grigio
- (NEM) Noce Leggero
- (NMM) Noce Medio
- (TMM) Tiger Mahogany on Maple
-
-
- (NLW) Natural Walnut
- (WTM) WC Cream
- (WCM) Winter Cherry on Maple

Wood finishes (W) - top, base, legs & apron

- Absolute (AAM) Natural Walnut (NLW)
- Charcoal Java on Maple (CJM) Night (ASM)
- Cherry on Maple (ACM) Noce Biondo (NBM)
- Empire Mahogany on Maple (EMM) Noce Grigio (NGM)
- English Oak on Maple (EOM) Noce Leggero (NEM)
- Espresso Cafe on Maple (ECM) Noce Medio (NMM)
- Grey (HGM) Sandy Beach on Maple (SBM)
- Harvest Oak on Maple (HOM) Shaker Cherry on Maple (SKM)
- Honey on Maple (AHM) Silver Oak on Maple (SOM)
- Jet Onyx on Maple (JOM) Tiger Fruitwood on Maple (TFM)
- Light Honey on Maple (LHM) Tiger Walnut on Maple (TWM)
- Mahogany on Maple (TMM) WC Cream (WTM)
- Maple on Maple (AVM) White on Maple (WHM)
- Medium Walnut on Maple (MWM) Winter Cherry on Maple (WCM)

Table edges - wood tops

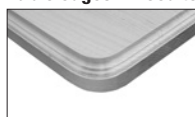

Beveled edge

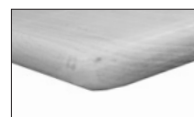

Bullnose edge

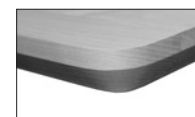

Reverse knife cut edge

RECTANGULAR END TABLES	MODEL #	DIMENSIONS ^{IN} _{MM}	WEIGHT ^{LB} _{KG}	VOLUME ^{FT³} _{MT³}	LIST PRICE
		W x D x H			
	GC3760-HC	18 x 24 x 21 457 x 610 x 533	26.26 11.91	5.25 0.14	\$801
	GC3760-LC	18 x 24 x 21 457 x 610 x 533	26.26 11.91	5.25 0.14	\$692
	GC3760-WC	18 x 24 x 21.25 457 x 610 x 540	27.12 12.3	5.25 0.14	\$836

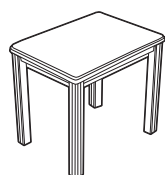

Rectangular End Table

- For a high pressure laminate top (HP), specify model GC3760-HC.
- For a thermally fused top (LP), specify model GC3760-LC.
- For a wood top (W), specify model GC3760-WC.

Features **chippendale** legs. 21" high. Standard with solid wood legs and apron. 1 per carton.

RECTANGULAR END TABLES

MODEL #	DIMENSIONS ^{IN} ^{MM}	WEIGHT ^{LB} ^{KG}	VOLUME ^{FT³} ^{MT³}	LIST PRICE
GC3760-HP	18 x 24 x 21	26.3	5.25	\$1187
	457 x 610 x 533	11.92	0.14	
GC3760-LP	18 x 24 x 21	26.3	5.25	\$1075
	457 x 610 x 533	11.92	0.14	
GC3760-WP	18 x 24 x 21	27.1	5.25	\$1224
	457 x 610 x 533	12.29	0.14	

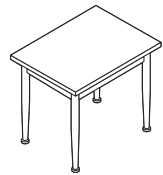

Rectangular End Table

- For a high pressure laminate top (HP), specify model GC3760-HP.
- For a thermally fused top (LP), specify model GC3760-LP.
- For a wood top (W), specify model GC3760-WP.

Features **post** legs. 21" high. Standard with solid wood legs and apron. Post legs are 1.33" in diameter. 1 per carton.

GC3760-HT	18 x 24 x 21 457 x 610 x 533	24.69 11.19	5.25 0.14	\$801
GC3760-LT	18 x 24 x 21 457 x 610 x 533	24.69 11.19	5.25 0.14	\$692
GC3760-WT	18 x 24 x 21.25 457 x 610 x 540	25.55 11.58	5.5 0.15	\$836

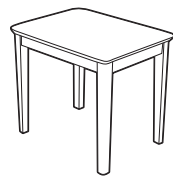

Rectangular End Table

- For a high pressure laminate top (HP), specify model GC3760-HT.
- For a thermally fused top (LP), specify model GC3760-LT.
- For a wood top (W), specify model GC3760-WT.

Features **tapered** legs. 21" high. Standard with solid wood legs and apron. 1 per carton.

SQUARE END TABLES

GC3761-HC	21 x 21 x 21 533 x 533 x 533	26.48 12.01	5.5 0.15	\$801
GC3761-LC	21 x 21 x 21 533 x 533 x 533	26.48 12.01	5.5 0.15	\$692
GC3761-WC	21 x 21 x 21.25 533 x 533 x 540	27.36 12.41	5.5 0.15	\$836

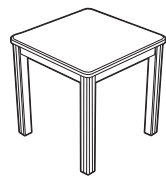

Square End Table

- For a high pressure laminate top (HP), specify model GC3761-HC.
- For a thermally fused top (LP), specify model GC3761-LC.
- For a wood top (W), specify model GC3761-WC.

Features **chippendale** legs. 21" high. Standard with solid wood legs and apron. 1 per carton.

GC3761-HP	21 x 21 x 21 533 x 533 x 533	26.5 12.02	5.5 0.15	\$1187
GC3761-LP	21 x 21 x 21 533 x 533 x 533	26.5 12.02	5.5 0.15	\$1075
GC3761-WP	21 x 21 x 21 533 x 533 x 533	27.4 12.42	5.5 0.15	\$1224

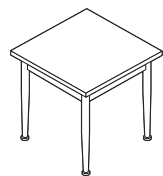

Square End Table

- For a high pressure laminate top (HP), specify model GC3761-HP.
- For a thermally fused top (LP), specify model GC3761-LP.
- For a wood top (W), specify model GC3761-WP.

Features **post** legs. 21" high. Standard with solid wood legs and apron. Post legs are 1.33" in diameter. 1 per carton.

SQUARE END TABLES

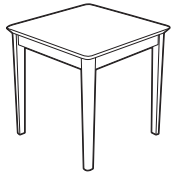

Square End Table

MODEL #	DIMENSIONS ^{IN} _{MM}	WEIGHT ^{LB} _{KG}	VOLUME ^{FT³} _{MT³}	LIST PRICE
GC3761-HT	21 x 21 x 21	24.91	5.5	\$801
	533 x 533 x 533	11.29	0.15	
GC3761-LT	21 x 21 x 21	24.91	5.5	\$692
	533 x 533 x 533	11.29	0.15	
GC3761-WT	21 x 21 x 21.25	25.79	5.5	\$836
	533 x 533 x 540	11.69	0.15	

- For a high pressure laminate top (HP), specify model GC3761-HT.
- For a thermally fused top (LP), specify model GC3761-LT.
- For a wood top (W), specify model GC3761-WT.

Features **tapered** legs. 21" high. Standard with solid wood legs and apron. 1 per carton.

ROUND END TABLES



Round End Table

GC3762-HC	24 x 24 x 21	26.12	7	\$858
	610 x 610 x 533	11.84	0.19	
GC3762-LC	24 x 24 x 21	26.12	7	\$712
	610 x 610 x 533	11.84	0.19	
GC3762-WC	24 x 24 x 21.25	27.02	7	\$902
	610 x 610 x 540	12.25	0.19	

- For a high pressure laminate top (HP), specify model GC3762-HC.
- For a thermally fused top (LP), specify model GC3762-LC.
- For a wood top (W), specify model GC3762-WC.

Features **chippendale** legs. 21" high. Standard with solid wood legs and apron. 1 per carton.

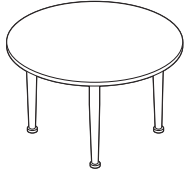

Round End Table

GC3762-HP	24 x 24 x 21	26.1	7	\$1249
	610 x 610 x 533	11.83	0.19	
GC3762-LP	24 x 24 x 21	20	7	\$1097
	610 x 610 x 533	9	0.19	
GC3762-WP	24 x 24 x 21	27	7	\$1294
	610 x 610 x 533	12.24	0.19	

- For a high pressure laminate top (HP), specify model GC3762-HP.
- For a thermally fused top (LP), specify model GC3762-LP.
- For a wood top (W), specify model GC3762-WP.

Features **post** legs. 21" high. Post legs are 1.33" in diameter. 1 per carton.



Round End Table

GC3762-HT	24 x 24 x 21	24.55	8.5	\$858
	610 x 610 x 533	11.13	0.24	
GC3762-LT	24 x 24 x 21	20	8.5	\$712
	610 x 610 x 533	9.1	0.24	
GC3762-WT	24 x 24 x 21.25	25.45	8.5	\$902
	610 x 610 x 540	11.54	0.24	

- For a high pressure laminate top (HP), specify model GC3762-HT.
- For a thermally fused top (LP), specify model GC3762-LT.
- For a wood top (W), specify model GC3762-WT.

Features **tapered** legs. 21" high. Standard with solid wood legs and apron. 1 per carton.

RECTANGULAR COFFEE TABLES

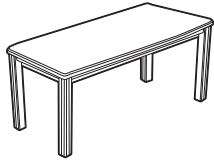

Rectangular Coffee Table

MODEL #	DIMENSIONS ^{IN} ^{MM} W x D x H	WEIGHT ^{LB} ^{KG}	VOLUME ^{FT³} ^{MT³}	LIST PRICE
GC3763-HC	22 x 48 x 19	43.73	11.75	\$1084
	559 x 1219 x 483	19.83	0.33	
GC3763-LC	22 x 48 x 19	43.73	11.75	\$840
	559 x 1219 x 483	19.83	0.33	
GC3763-WC	22 x 48 x 19.25	45.83	11.75	\$1150
	559 x 1219 x 489	20.78	0.33	

- For a high pressure laminate top (HP), specify model GC3763-HC.
- For a thermally fused top (LP), specify model GC3763-LC.
- For a wood top (W), specify model GC3763-WC.

Features **chippendale** legs. 19" high. Standard with solid wood legs and apron. 1 per carton.

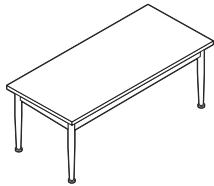

Rectangular Coffee Table

GC3763-HP	22 x 48 x 19	43.7	11.75	\$1483
	559 x 1219 x 483	19.82	0.33	
GC3763-LP	22 x 48 x 19	43.7	11.75	\$1230
	559 x 1219 x 483	19.82	0.33	
GC3763-WP	22 x 48 x 19	45.8	11.75	\$1554
	559 x 1219 x 483	20.77	0.33	

- For a high pressure laminate top (HP), specify model GC3763-HP.
- For a thermally fused top (LP), specify model GC3763-LP.
- For a wood top (W), specify model GC3763-WP.

Features **post** legs. 19" high. Standard with solid wood legs and apron. Post legs are 1.33" in diameter. 1 per carton.



Rectangular Coffee Table

GC3763-HT	22 x 48 x 19	42.27	11.75	\$1084
	559 x 1219 x 483	19.17	0.33	
GC3763-LT	22 x 48 x 19	42.27	11.75	\$840
	559 x 1219 x 483	19.17	0.33	
GC3763-WT	22 x 48 x 19.25	44.38	11.75	\$1150
	559 x 1219 x 489	20.13	0.33	

- For a high pressure laminate top (HP), specify model GC3763-HT.
- For a thermally fused top (LP), specify model GC3763-LT.
- For a wood top (W), specify model GC3763-WT.

Features **tapered** legs. 19" high. Standard with solid wood legs and apron. 1 per carton.

OVAL COFFEE TABLES

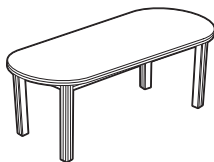

Oval Coffee Table

GC3764-HC	22 x 46 x 19	38.58	11.5	\$1048
	559 x 1168 x 483	17.49	0.32	
GC3764-LC	22 x 46 x 19	38.58	11.5	\$805
	559 x 1168 x 483	17.49	0.32	
GC3764-WC	22 x 46 x 19.25	38.4	11.5	\$1118
	559 x 1168 x 489	17.41	0.32	

- For a high pressure laminate top (HP), specify model GC3764-HC.
- For a thermally fused top (LP), specify model GC3764-LC.
- For a wood top (W), specify model GC3764-WC.

Features **chippendale** legs. 19" high. Standard with solid wood legs and apron. 1 per carton.

OVAL COFFEE TABLES

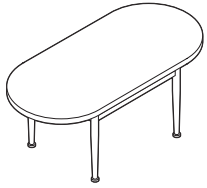

Oval Coffee Table

MODEL #	DIMENSIONS ^{IN} ^{MM}	WEIGHT ^{LB} ^{KG}	VOLUME ^{FT³} ^{MT³}	LIST PRICE
GC3764-HP	22 x 46 x 19	38.6	11.5	\$1447
	559 x 1168 x 483	17.5	0.32	
GC3764-LP	22 x 46 x 19	38.6	11.5	\$1192
	559 x 1168 x 483	17.5	0.32	
GC3764-WP	22 x 46 x 19	38.4	11.5	\$1516
	559 x 1168 x 483	17.41	0.32	

- For a high pressure laminate top (HP), specify model GC3763-HP.
- For a thermally fused top (LP), specify model GC3763-LP.
- For a wood top (W), specify model GC3763-WP.

Features **post** legs. 19" high. Standard with solid wood legs and apron. Post legs are 1.33" in diameter. 1 per carton.

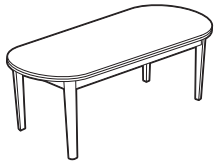

Oval Coffee Table

GC3764-HT	22 x 46 x 19	37.13	11.5	\$1048
	559 x 1168 x 483	16.84	0.32	
GC3764-LT	22 x 46 x 19	37.13	11.5	\$805
	559 x 1168 x 483	16.84	0.32	
GC3764-WT	22 x 46 x 19.25	36.94	11.5	\$1118
	559 x 1168 x 489	16.75	0.32	

- For a high pressure laminate top (HP), specify model GC3764-HT.
- For a thermally fused top (LP), specify model GC3764-LT.
- For a wood top (W), specify model GC3764-WT.

Features **tapered** legs. 19" high. Standard with solid wood legs and apron. 1 per carton.

ROUND COFFEE TABLES

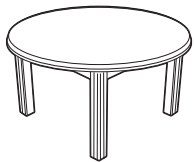

Round Coffee Table

GC3765-HC	32 x 32 x 19	35.15	11.5	\$1070
	813 x 813 x 483	15.94	0.32	
GC3765-LC	32 x 32 x 19	35.15	11.5	\$828
	813 x 813 x 483	15.94	0.32	
GC3765-WC	32 x 32 x 19.25	36.76	11.5	\$1140
	813 x 813 x 489	16.67	0.32	

- For a high pressure laminate top (HP), specify model GC3765-HC.
- For a thermally fused top (LP), specify model GC3765-LC.
- For a wood top (W), specify model GC3765-WC.

Features **chippendale** legs. 19" high. Standard with solid wood legs and apron. 1 per carton.

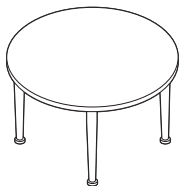

Round Coffee Table

GC3765-HP	32 x 32 x 19	35.2	11.5	\$1471
	813 x 813 x 483	15.96	0.32	
GC3765-LP	32 x 32 x 19	35.2	11.5	\$1216
	813 x 813 x 483	15.96	0.32	
GC3765-WP	32 x 32 x 19	36.8	11.5	\$1542
	813 x 813 x 483	16.69	0.32	

- For a high pressure laminate top (HP), specify model GC3765-HP.
- For a thermally fused top (LP), specify model GC3765-LP.
- For a wood top (W), specify model GC3765-WP.

Features **post** legs. 19" high. Standard with solid wood legs and apron. Post legs are 1.33" in diameter. 1 per carton.

ROUND COFFEE TABLES

MODEL #	DIMENSIONS	WEIGHT	VOLUME	LIST PRICE
	IN MM	LB KG	FT ³ MT ³	
GC3765-HT	32 x 32 x 19	33.69	11.5	\$1070
	813 x 813 x 483	15.28	0.32	
GC3765-LT	32 x 32 x 19	33.69	11.5	\$828
	813 x 813 x 483	15.28	0.32	
GC3765-WT	32 x 32 x 19.25	35.3	11.5	\$1140
	813 x 813 x 489	16.01	0.32	

- For a high pressure laminate top (HP), specify model GC3765-HT.
- For a thermally fused top (LP), specify model GC3765-LT.
- For a wood top (W), specify model GC3765-WT.

Features **tapered** legs. 19" high. Standard with solid wood legs and apron. 1 per carton.



Round Coffee Table

RECTANGULAR SOFA TABLES

MODEL #	DIMENSIONS	WEIGHT	VOLUME	LIST PRICE
	IN MM	LB KG	FT ³ MT ³	
GC3766-HC	16 x 42 x 29	37.62	11.5	\$942
	406 x 1067 x 737	17.06	0.32	
GC3766-LC	16 x 42 x 29	37.62	11.5	\$774
	406 x 1067 x 737	17.06	0.32	
GC3766-WC	16 x 42 x 29.25	38.07	11.5	\$978
	406 x 1067 x 743	17.26	0.32	

- For a high pressure laminate top (HP), specify model GC3766-HC.
- For a thermally fused top (LP), specify model GC3766-LC.
- For a wood top (W), specify model GC3766-WC.

Features **chippendale** legs. 29" high. Standard with solid wood legs and apron. 1 per carton.

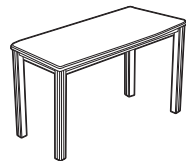

Rectangular Sofa Table

MODEL #	DIMENSIONS	WEIGHT	VOLUME	LIST PRICE
	IN MM	LB KG	FT ³ MT ³	
GC3766-HP	16 x 42 x 29	37.6	11.5	\$1481
	406 x 1067 x 737	17.05	0.32	
GC3766-LP	16 x 42 x 29	37.6	11.5	\$1306
	406 x 1067 x 737	17.05	0.32	
GC3766-WP	16 x 42 x 29	38.1	11.5	\$1514
	406 x 1067 x 737	17.28	0.32	

- For a high pressure laminate top (HP), specify model GC3766-HP.
- For a thermally fused top (LP), specify model GC3766-LP.
- For a wood top (W), specify model GC3766-WP.

Features **post** legs. 29" high. Standard with solid wood legs and apron. Post legs are 1.33" in diameter. 1 per carton.

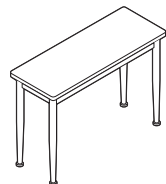

Rectangular Sofa Table

MODEL #	DIMENSIONS	WEIGHT	VOLUME	LIST PRICE
	IN MM	LB KG	FT ³ MT ³	
GC3766-HT	16 x 42 x 29	34.58	11.5	\$942
	406 x 1067 x 737	15.68	0.32	
GC3766-LT	16 x 42 x 29	34.58	11.5	\$774
	406 x 1067 x 737	15.68	0.32	
GC3766-WT	16 x 42 x 29.25	35.92	11.5	\$978
	406 x 1067 x 743	16.29	0.32	

- For a high pressure laminate top (HP), specify model GC3766-HT.
- For a thermally fused top (LP), specify model GC3766-LT.
- For a wood top (W), specify model GC3766-WT.

Features **tapered** legs. 29" high. Standard with solid wood legs and apron. 1 per carton.

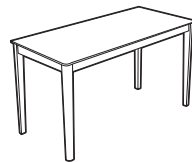

Rectangular Sofa Table

SQUARE DINING TABLES

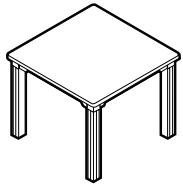

Square Dining Table

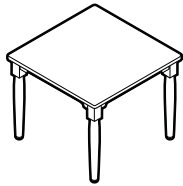

Square Dining Table

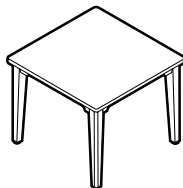

Square Dining Table

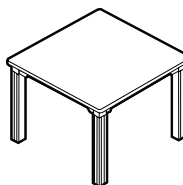

Square Dining Table

MODEL #	DIMENSIONS ^{IN} _{MM}	WEIGHT ^{LB} _{KG}	VOLUME ^{FT³} _{MT³}	LIST PRICE
GC3772-HC	36 x 36 x 29	50	3.9	\$1672
	914 x 914 x 737	22.67	0.11	
GC3772-LC	36 x 36 x 29	50	3.9	\$1496
	914 x 914 x 737	22.67	0.11	
GC3772-WC	36 x 36 x 29	50	3.9	\$2391
	914 x 914 x 737	22.67	0.11	

- For a high pressure laminate top (HP), specify model GC3772-HC.
- For a thermally fused top (LP), specify model GC3772-LC.
- For a wood top (W), specify model GC3772-WC.

Features **chippendale** legs. 29" high. Standard with solid wood legs and apron. 1 per carton.

GC3772-HP	36 x 36 x 29	50	3.9	\$1672
	914 x 914 x 737	22.67	0.11	
GC3772-LP	36 x 36 x 29	50	3.9	\$1496
	914 x 914 x 737	22.67	0.11	
GC3772-WP	36 x 36 x 29	50	3.9	\$2391
	914 x 914 x 737	22.67	0.11	

- For a high pressure laminate top (HP), specify model GC3772-HP.
- For a thermally fused top (LP), specify model GC3772-LP.
- For a wood top (W), specify model GC3772-WP.

Features **post** legs. 29" high. Standard with solid wood legs and apron. Post legs are 1.33" in diameter. 1 per carton.

GC3772-HT	36 x 36 x 29	50	3.9	\$1672
	914 x 914 x 737	22.67	0.11	
GC3772-LT	36 x 36 x 29	50	3.9	\$1496
	914 x 914 x 737	22.67	0.11	
GC3772-WT	36 x 36 x 29	50	3.9	\$2391
	914 x 914 x 737	22.67	0.11	

- For a high pressure laminate top (HP), specify model GC3772-HT.
- For a thermally fused top (LP), specify model GC3772-LT.
- For a wood top (W), specify model GC3772-WT.

Features **tapered** legs. 29" high. Standard with solid wood legs and apron. 1 per carton.

GC3773-HC	42 x 42 x 29	68	5.5	\$1852
	1067 x 1067 x 737	30.84	0.15	
GC3773-LC	42 x 42 x 29	68	5.5	\$1610
	1067 x 1067 x 737	30.84	0.15	
GC3773-WC	42 x 42 x 29	68	5.5	\$2900
	1067 x 1067 x 737	30.84	0.15	

- For a high pressure laminate top (HP), specify model GC3773-HC.
- For a thermally fused top (LP), specify model GC3773-LC.
- For a wood top (W), specify model GC3773-WC.

Features **chippendale** legs. 29" high. Standard with solid wood legs and apron. 1 per carton.

SQUARE DINING TABLES **MODEL #** **DIMENSIONS** ^{IN} / ^{MM} **WEIGHT** ^{LB} / ^{KG} **VOLUME** ^{FT³} / ^{MT³} **LIST PRICE**

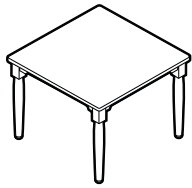

Square Dining Table

	W x D x H			
GC3773-HP	42 x 42 x 29 1067 x 1067 x 737	68	5.5	\$1852
GC3773-LP	42 x 42 x 29 1067 x 1067 x 737	68	5.5	\$1610
GC3773-WP	42 x 42 x 29 1067 x 1067 x 737	68	5.5	\$2900

- For a high pressure laminate top (HP), specify model GC3773-HP.
- For a thermally fused top (LP), specify model GC3773-LP.
- For a wood top (W), specify model GC3773-WP.

Features **post** legs. 29" high. Standard with solid wood legs and apron. Post legs are 1.33" in diameter. 1 per carton.

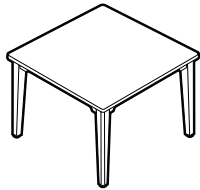

Square Dining Table

GC3773-HT	42 x 42 x 29 1067 x 1067 x 737	68	5.5	\$1852
GC3773-LT	42 x 42 x 29 1067 x 1067 x 737	68	5.5	\$1610
GC3773-WT	42 x 42 x 29 1067 x 1067 x 737	68	5.5	\$2900

- For a high pressure laminate top (HP), specify model GC3773-HT.
- For a thermally fused top (LP), specify model GC3773-LT.
- For a wood top (W), specify model GC3773-WT.

Features **tapered** legs. 29" high. Standard with solid wood legs and apron. 1 per carton.

RECTANGULAR DINING TABLES

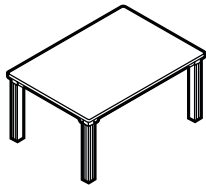

Rectangular Dining Table

GC3774-HC	42 x 60 x 29 1067 x 1524 x 737	97	7.5	\$2182
GC3774-LC	42 x 60 x 29 1067 x 1524 x 737	97	7.5	\$1839
GC3774-WC	42 x 60 x 29 1067 x 1524 x 737	97	7.5	\$3634

- For a high pressure laminate top (HP), specify model GC3774-HC.
- For a thermally fused top (LP), specify model GC3774-LC.
- For a wood top (W), specify model GC3774-WC.

Features **chippendale** legs. 29" high. Standard with solid wood legs and apron. 1 per carton.

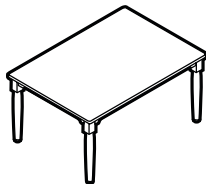

Rectangular Dining Table

GC3774-HP	42 x 60 x 29 1067 x 1524 x 737	97	7.5	\$2182
GC3774-LP	42 x 60 x 29 1067 x 1524 x 737	97	7.5	\$1839
GC3774-WP	42 x 60 x 29 1067 x 1524 x 737	97	7.5	\$3634

- For a high pressure laminate top (HP), specify model GC3774-HP.
- For a thermally fused top (LP), specify model GC3774-LP.
- For a wood top (W), specify model GC3774-WP.

Features **post** legs. 29" high. Standard with solid wood legs and apron. Post legs are 1.33" in diameter. 1 per carton.

RECTANGULAR DINING TABLES

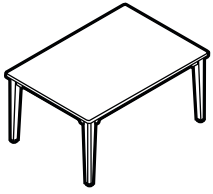

Rectangular Dining Table

MODEL #	DIMENSIONS ^{IN} _{MM}	WEIGHT ^{LB} _{KG}	VOLUME ^{FT³} _{MT³}	LIST PRICE
	W x D x H			
GC3774-HT	42 x 60 x 29 1067 x 1524 x 737	97 43.99	7.5 0.21	\$2182
GC3774-LT	42 x 60 x 29 1067 x 1524 x 737	97 43.99	7.5 0.21	\$1839
GC3774-WT	42 x 60 x 29 1067 x 1524 x 737	97 43.99	7.5 0.21	\$3634

- For a high pressure laminate top (HP), specify model GC3774-HT.
- For a thermally fused top (LP), specify model GC3774-LT.
- For a wood top (W), specify model GC3774-WT.

Features **tapered** legs. 29" high. Standard with solid wood legs and apron. 1 per carton.

Notes: Please specify all substitutions and options.

- Tops are available in various shapes: rectangular, kidney, peanut and jellybean shapes.
- Bases are available in three styles: H-base, U-base and C-base.
- Bases feature a shock-absorbent gas spring cylinder for easy height adjustment and exposed steel with no plastic cover for easy cleaning of base and casters.
- Manufactured with the lowest base (less than 2”H) in the industry, overbed tables can easily be moved under any patient bed or seating.
- Thermofoil top comes standard with seamless spillguard edge that holds up to 36 oz of liquid. For no spillguard, specify **(NS)**. **Add \$62.**
- Overbed tables come standard with four non-locking casters.
- For two locking and two non-locking casters, specify **(2L)** when ordering the overbed table. **Add \$148.**
- For four locking casters, specify **(LC)** when ordering the overbed table. **Add \$295.**
- Refer to the following lists when selecting a finish color. Must specify both a top color and base color at time of order all tables.

Thermofoil Tops

- Candlelight (TCL)
- Chocolate Pear (TCP)
- Dolce Vita (TDV)
- Hard Rock Maple (THM)
- Medium Oak (TMO)

Bases

- Almond (AL)
- Graphite Grey (GG)
- Nevada (NV)

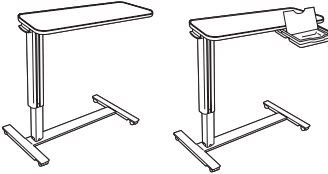
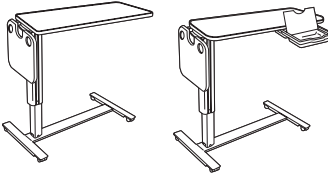
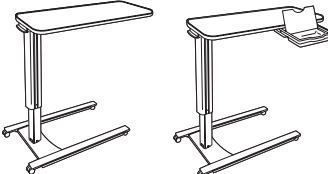
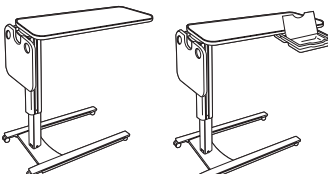
OVERBED TABLES W/THERMOFOIL TOP	MODEL #	DIMENSIONS	WEIGHT	VOLUME	LIST PRICE
 <p>Rectangular Thermofoil Spillguard Top w/H-Base</p>		W x D x H			
	GC3554	34 x 18 x 28-42	35	13.4	\$1468
		864 x 457 x 711-1067	15.87	0.37	
	GC3554V w/Vanity drawer	34 x 18 x 28-42 864 x 457 x 711-1067	37 16.78	13.4 0.37	\$1718
					<ul style="list-style-type: none"> • Dual vanity drawer with mirror slides out from either side of the table. <p>Thermofoil top with seamless spillguard edge. Height adjustable steel base. 1 per carton.</p>
 <p>Rectangular Thermofoil Spillguard Top w/Flip-Top Surface and H-Base</p>					
	GC3554F	48 x 18 x 28-42	40	13.4	\$2114
		1219 x 457 x 711-1067	18.14	0.37	
	GC3554VF w/Vanity drawer	48 x 18 x 28-42 1219 x 457 x 711-1067	42 19.05	13.4 0.37	\$2365
					<ul style="list-style-type: none"> • Dual vanity drawer with mirror slides out from either side of the table. <p>Thermofoil top with seamless spillguard edge. One-hand activation flip-top provides a secondary surface with two cupholders, can hold up to 10 lbs. Height adjustable steel base. 1 per carton.</p>
 <p>Rectangular Thermofoil Spillguard Top w/U-Base</p>					
	GC3555	34 x 19 x 28-42	35	13.4	\$1385
		864 x 483 x 711-1067	11.91	0.37	
	GC3555V w/Vanity drawer	34 x 19 x 28-42 864 x 483 x 711-1067	37 16.78	13.4 0.37	\$1635
					<ul style="list-style-type: none"> • Dual vanity drawer with mirror slides out from either side of the table. <p>Thermofoil top with seamless spillguard edge. Height adjustable steel base. 1 per carton.</p>
 <p>Rectangular Thermofoil Spillguard Top w/Flip-Top Surface and U-Base</p>					
	GC3555F	46 x 19 x 28-42	40	13.4	\$2031
		1168 x 483 x 711-1067	18.14	0.37	
	GC3555VF w/Vanity drawer	46 x 19 x 28-42 1168 x 483 x 711-1067	42 19.05	13.37 0.37	\$2281
					<ul style="list-style-type: none"> • Dual vanity drawer with mirror slides out from either side of the table. <p>Thermofoil top with seamless spillguard edge. One-hand activation flip-top provides a secondary surface with two cupholders, can hold up to 10 lbs. Height adjustable steel base. 1 per carton.</p>

OVERBED TABLES W/THERMOFOIL TOP

MODEL #	DIMENSIONS ^{IN} _{MM}	WEIGHT ^{LB} _{KG}	VOLUME ^{FT³} _{MT³}	LIST PRICE
GC3556	33 x 21 x 28-42	35	19	\$1579
	838 x 533 x 711-1067	15.87	0.53	
GC3556V w/Vanity drawer	33 x 21 x 28-42	37	19	\$1831
	838 x 533 x 711-1067	16.78	0.53	

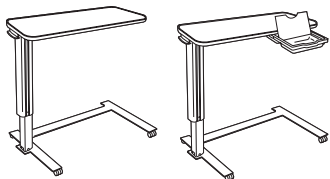

Rectangular Thermofoil Spillguard Top w/C-Base

- Dual vanity drawer with mirror slides out from either side of the table.

Thermofoil top with seamless spillguard edge. Height adjustable steel base. 1 per carton.

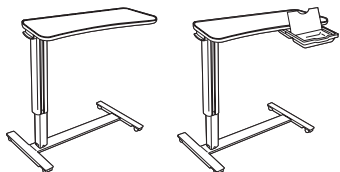

Kidney Shaped Thermofoil Spillguard Top w/H-Base - LEFT

GC3557L	34 x 19 x 42	35	13.4	\$1553
	864 x 483 x 1067	15.87	0.37	
GC3557LV w/Vanity drawer	34 x 19 x 42	37	13.4	\$1802
	864 x 483 x 1067	16.78	0.37	

- Dual vanity drawer with mirror slides out from either side of the table.

Left hand side table. Thermofoil top with seamless spillguard edge. Height adjustable steel base. 1 per carton.

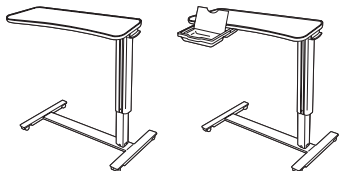

Kidney Shaped Thermofoil Spillguard Top w/H-Base - RIGHT

GC3557R	34 x 19 x 28-42	35	13.4	\$1553
	864 x 483 x 711-1067	15.87	0.37	
GC3557RV w/Vanity drawer	34 x 19 x 28-42	37	13.4	\$1802
	864 x 483 x 711-1067	16.78	0.37	

- Dual vanity drawer with mirror slides out from either side of the table.

Right hand side table. Thermofoil top with seamless spillguard edge. Height adjustable steel base. 1 per carton.

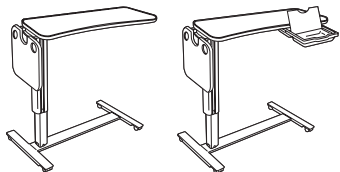

Kidney Shaped Thermofoil Spillguard Top w/Flip-Top Surface and H-Base - LEFT

GC3557LF	48 x 19 x 28-42	40	13.4	\$2365
	1219 x 483 x 711-1067	18.14	0.37	
GC3557LVF w/Vanity drawer	48 x 19 x 28-42	42	13.4	\$2616
	1219 x 483 x 711-1067	19.05	0.37	

- Dual vanity drawer with mirror slides out from either side of the table.

Left hand side table. Thermofoil top with seamless spillguard edge. One-hand activation flip-top provides a secondary surface with two cupholders, can hold up to 10 lbs. Height adjustable steel base. 1 per carton.

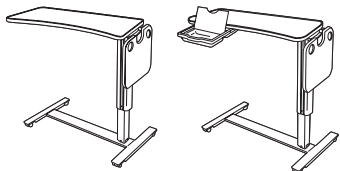

Kidney Shaped Thermofoil Spillguard Top w/Flip-Top Surface and H-Base - RIGHT

GC3557RF	48 x 19 x 28-42	42	13.4	\$2365
	1219 x 483 x 711-1067	19.05	0.37	
GC3557RVF w/Vanity drawer	48 x 19 x 28-42	42	24.75	\$2616
	1219 x 483 x 711-1067	19.05	0.7	

- Dual vanity drawer with mirror slides out from either side of the table.

Right hand side table. Thermofoil top with seamless spillguard edge. One-hand activation flip-top provides a secondary surface with two cupholders, can hold up to 10 lbs. Height adjustable steel base. 1 per carton.

OVERBED TABLES W/THERMOFOIL TOP	MODEL #	DIMENSIONS ^{IN} ^{MM}	WEIGHT ^{LB} ^{KG}	VOLUME ^{FT³} ^{MT³}	LIST PRICE
---------------------------------	---------	---	---------------------------------------	---	------------

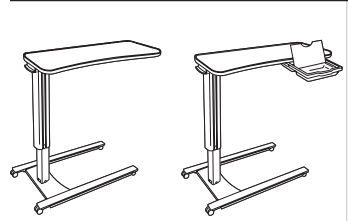

Kidney Shaped Thermofoil Spillguard Top w/U-Base - LEFT

	W x D x H			
GC3558L	34 x 19 x 28-42	35	13.4	\$1468
	864 x 483 x 711-1067	15.87	0.37	
GC3558LV	34 x 19 x 28-42	37	13.4	\$1718
w/Vanity drawer	864 x 483 x 711-1067	16.78	0.37	

- Dual vanity drawer with mirror slides out from either side of the table.

Left hand side table. Thermofoil top with seamless spillguard edge. Height adjustable steel base. 1 per carton.

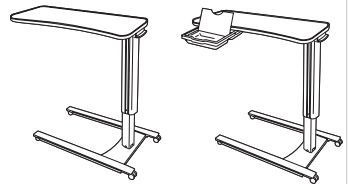

Kidney Shaped Thermofoil Spillguard Top w/U-Base - RIGHT

GC3558R	34 x 19 x 28-42	35	13.4	\$1468
	864 x 483 x 711-1067	15.87	0.37	
GC3558RV	34 x 19 x 28-42	37	13.4	\$1718
w/Vanity drawer	864 x 483 x 711-1067	16.78	0.37	

- Dual vanity drawer with mirror slides out from either side of the table.

Right hand side table. Thermofoil top with seamless spillguard edge. Height adjustable steel base. 1 per carton.

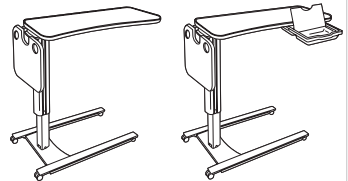

Kidney Shaped Thermofoil Spillguard Top w/Flip-Top Surface and U-Base - LEFT

GC3558LF	48 x 19 x 28-42	40	13.4	\$2281
	1219 x 483 x 711-1067	18.14	0.37	
GC3558LVF	48 x 19 x 28-42	42	13.4	\$2532
w/Vanity drawer	1219 x 483 x 711-1067	19.05	0.37	

- Dual vanity drawer with mirror slides out from either side of the table.

Left hand side table. Thermofoil top with seamless spillguard edge. One-hand activation flip-top provides a secondary surface with two cupholders, can hold up to 10 lbs. Height adjustable steel base. 1 per carton.

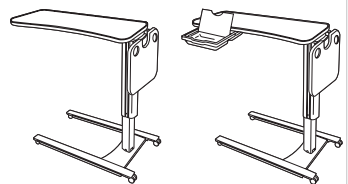

Kidney Shaped Thermofoil Spillguard Top w/Flip-Top Surface and U-Base - RIGHT

GC3558RF	48 x 19 x 28-42	40	13.4	\$2281
	1219 x 483 x 711-1067	18.14	0.37	
GC3558RVF	48 x 19 x 28-42	42	13.4	\$2532
w/Vanity drawer	1219 x 483 x 711-1067	19.05	0.37	

- Dual vanity drawer with mirror slides out from either side of the table.

Right hand side table. Thermofoil top with seamless spillguard edge. One-hand activation flip-top provides a secondary surface with two cupholders, can hold up to 10 lbs. Height adjustable steel base. 1 per carton.

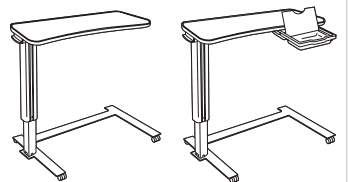

Kidney Shaped Thermofoil Spillguard Top w/C-Base - LEFT

GC3559L	33 x 22 x 28-42	35	19	\$1663
	838 x 559 x 711-1067	15.87	0.53	
GC3559LV	33 x 22 x 28-42	37	19	\$1914
w/Vanity drawer	838 x 559 x 711-1067	16.78	0.53	

- Dual vanity drawer with mirror slides out from either side of the table.

Left hand side table. Thermofoil top with seamless spillguard edge. Height adjustable steel base. 1 per carton.

OVERBED TABLES W/THERMOFOIL TOP

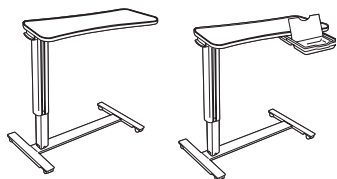

Peanut Shaped Thermofoil Spillguard Top w/H-Base

MODEL #	DIMENSIONS ^{IN} _{MM}	WEIGHT ^{LB} _{KG}	VOLUME ^{FT³} _{MT³}	LIST PRICE
GC3560	34 x 19 x 42	35	13.4	\$1553
	864 x 483 x 1067	15.87	0.37	
GC3560V w/Vanity drawer	34 x 19 x 42	37	13.4	\$1802
	864 x 483 x 1067	16.78	0.37	

- Dual vanity drawer with mirror slides out from either side of the table.

Thermofoil top with seamless spillguard edge. Height adjustable steel base. 1 per carton.

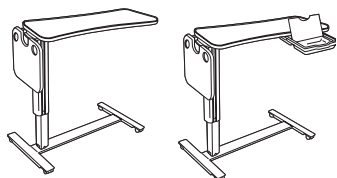

Peanut Shaped Thermofoil Spillguard Top w/Flip-Top Surface and H-Base

GC3560F	48 x 19 x 28-42	40	13.4	\$2365
	1219 x 483 x 711-1067	18.14	0.37	
GC3560VF w/Vanity drawer	48 x 19 x 28-42	42	13.4	\$2616
	1219 x 483 x 711-1067	19.05	0.37	

- Dual vanity drawer with mirror slides out from either side of the table.

Thermofoil top with seamless spillguard edge. One-hand activation flip-top provides a secondary surface with two cupholders, can hold up to 10 lbs. Height adjustable steel base. 1 per carton.

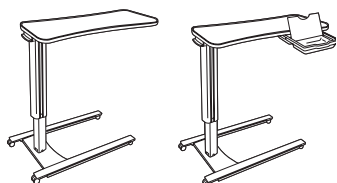

Peanut Shaped Thermofoil Spillguard Top w/U-Base

GC3561	34 x 19 x 28-42	35	13.4	\$1468
	864 x 483 x 711-1067	15.87	0.37	
GC3561V w/Vanity drawer	34 x 19 x 28-42	37	13.4	\$1718
	864 x 483 x 711-1067	16.78	0.37	

- Dual vanity drawer with mirror slides out from either side of the table.

Thermofoil top with seamless spillguard edge. Height adjustable steel base. 1 per carton.

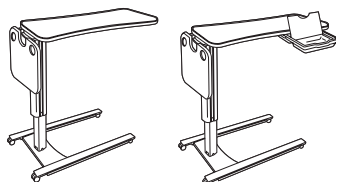

Peanut Shaped Thermofoil Spillguard Top w/Flip-Top Surface and U-Base

GC3561F	48 x 19 x 28-42	40	13.4	\$2281
	1219 x 483 x 711-1067	18.14	0.37	
GC3561VF w/Vanity drawer	48 x 19 x 28-42	42	13.4	\$2532
	1219 x 483 x 711-1067	19.05	0.37	

- Dual vanity drawer with mirror slides out from either side of the table.

Thermofoil top with seamless spillguard edge. One-hand activation flip-top provides a secondary surface with two cupholders, can hold up to 10 lbs. Height adjustable steel base. 1 per carton.

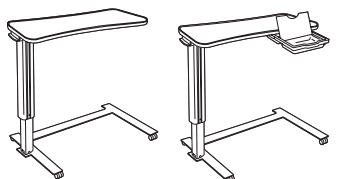

Peanut Shaped Thermofoil Spillguard Top w/C-Base - LEFT

GC3562	33 x 22 x 28-42	35	19	\$1663
	838 x 559 x 711-1067	15.87	0.53	
GC3562V w/Vanity drawer	33 x 22 x 28-42	37	19	\$1914
	838 x 559 x 711-1067	16.78	0.53	

- Dual vanity drawer with mirror slides out from either side of the table.

Left hand side table. Thermofoil top with seamless spillguard edge. Height adjustable steel base. 1 per carton.

OVERBED TABLES W/THERMOFOIL TOP	MODEL #	DIMENSIONS ^{IN} _{MM}	WEIGHT ^{LB} _{KG}	VOLUME ^{FT³} _{MT³}	LIST PRICE
---------------------------------	---------	---	---------------------------------------	---	------------

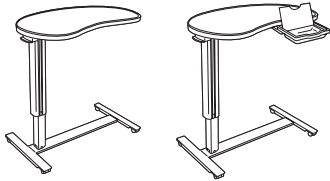

Jellybean Shaped Thermofoil Spillguard Top w/H-Base - LEFT

	W x D x H			
GC3563L	35 x 22 x 42.5	35	13.4	\$1779
	889 x 559 x 1080	15.87	0.37	
GC3563LV	35 x 22 x 42.5	37	13.4	\$2032
w/Vanity drawer	889 x 559 x 1080	16.78	0.37	

- Dual vanity drawer with mirror slides out from either side of the table.

Left hand side table. Thermofoil top with seamless spillguard edge. Height adjustable steel base. 1 per carton.

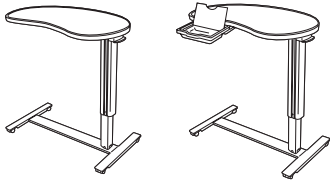

Jellybean Shaped Thermofoil Spillguard Top w/H-Base - RIGHT

GC3563R	35 x 22 x 28.5-42.5	35	13.4	\$1779
	889 x 559 x 724-1080	15.87	0.37	
GC3563RV	35 x 22 x 28.5-42.5	37	13.4	\$2032
w/Vanity drawer	889 x 559 x 724-1080	16.78	0.37	

Dual vanity drawer with mirror slides out from either side of the table.

Right hand side table. Thermofoil top with seamless spillguard edge. Height adjustable steel base. 1 per carton.

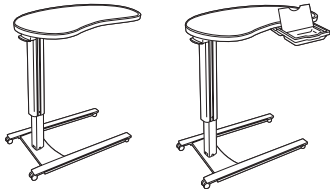

Jellybean Shaped Thermofoil Spillguard Top w/U-Base - LEFT

GC3564L	35 x 22 x 28.5-42.5	35	13.4	\$1696
	889 x 559 x 724-1080	15.87	0.37	
GC3564LV	35 x 22 x 28.5-42.5	37	13.4	\$1948
w/Vanity drawer	889 x 559 x 724-1080	16.78	0.37	

- Dual vanity drawer with mirror slides out from either side of the table.

Left hand side table. Thermofoil top with seamless spillguard edge. Height adjustable steel base. 1 per carton.

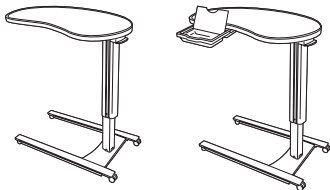

Jellybean Shaped Thermofoil Spillguard Top w/U-Base - RIGHT

GC3564R	36 x 22 x 28.5-42.5	35	13.4	\$1696
	914 x 559 x 724-1080	15.87	0.37	
GC3564RV	36 x 22 x 28.5-42.5	37	13.4	\$1948
w/Vanity drawer	914 x 559 x 724-1080	16.78	0.37	

- Dual vanity drawer with mirror slides out from either side of the table.

Right hand side table. Thermofoil top with seamless spillguard edge. Height adjustable steel base. 1 per carton.

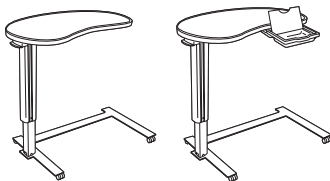

Jellybean Shaped Thermofoil Spillguard Top w/C-Base - LEFT

GC3565L	35 x 22 x 28.5-42.5	35	19	\$1892
	889 x 559 x 724-1080	15.87	0.53	
GC3565LV	35 x 22 x 28.5-42.5	37	19	\$2143
w/Vanity drawer	889 x 559 x 724-1080	16.78	0.53	

- Dual vanity drawer with mirror slides out from either side of the table.

Left hand side table. Thermofoil top with seamless spillguard edge. Height adjustable steel base. 1 per carton.

ACCESSORIES AND PARTS

MODEL #	DIMENSIONS ^{IN} _{MM}	WEIGHT ^{LB} _{KG}	VOLUME ^{FT³} _{MT³}	LIST PRICE
GC3566	10 x 6 x 9	2	0.4	\$251
	254 x 152 x 229	0.9	0.01	



Storage Basket

Storage basket hooks on either side of the integrated accessory rail of the overbed table. 1 per carton.

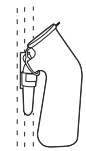

Urinal Hook

GC3567	1.5 x 2 x 3	1	0.01	\$83
	38 x 51 x 76	0.45	-	

Hooks on either side of the integrated accessory rail of the overbed table. Bottle not included. 1 per carton.

Notes: Please specify all substitutions and options.

- Primacare table legs complement and work seamlessly with Primacare seating.
- Solid wood legs and apron.
- All connections are metal-to-metal inserts and fasteners.
- Thermofoil and solid surface material options are available on request, please contact your Global sales representative for a special quotation.
- Shipped easy to assemble.
- 2mm edging color coordinated with laminate finish is standard for all tops. Finish must specified at time of order.
- Tops are 1" thick and available in high pressure laminate (HP).
- Refer to the following lists when selecting a finish color. Must specify both a top color and leg finish at time of order.
- For custom laminate or contrasting edge, contact your Global sales representative or visit the Dealer Center and click on "Specials" on the left sidebar to submit your request.

Wood Legs/Apron

- (AAM) Absolute
- (CJM) Charcoal Java
- (ACM) Cherry
- (EMM) Empire Mahogany
- (EOM) English Oak
- (ECM) Espresso Cafe
- (TFM) Fruitwood
- (HGM) Grey
- (HOM) Harvest Oak
- (AHM) Honey
- (JOM) Jet Onyx
- (LHM) Light Honey
- (AVM) Maple
- (TMM) Mahogany
- (MWM) Medium Walnut
- (NLW) Natural Walnut
- (ASM) Night
- (NBM) Noce Biondo
- (NGM) Noce Grigio
- (NEM) Noce Leggero
- (NMM) Noce Medio
- (SBM) Sandy Beach
- (SKM) Shaker Cherry
- (SOM) Silver Oak
- (TWM) Walnut
- (WTM) WC Cream
- (WHM) White
- (WCM) Winter Cherry

High Pressure Laminate (HP) Tops

- (ACJ) Absolute Acajou
- (ASN) Asian Night
- (AWC) Avant Cherry
- (AWH) Avant Honey
- (BLK) Black
- (BZD) Blizzard
- (BRC) Brushed Cobalt
- (CMB) Clear Maple
- (CGY) Custom Grey
- (DES) Dark Espresso
- (DWT) Designer White
- (FAS) Fashionista
- (FCL) First Class
- (NBL) Noce Biondo
- (NGL) Noce Grigio
- (NEL) Noce Leggero
- (NML) Noce Medio
- (QTM) Quartered Mahogany
- (SBY) Sheer Beauty
- (SDT) Stonedust
- (SOG) Storm Grey
- (WHE) Walnut Heights
- (WHC) White Chocolate
- (WCR) Winter Cherry

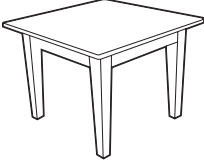
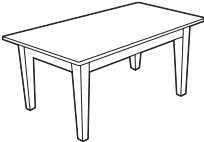
TABLES	MODEL #	DIMENSIONS ^{IN} _{MM}	WEIGHT ^{LB} _{KG}	VOLUME ^{FT³} _{MT³}	LIST PRICE
 <p>Square End Table, High Pressure</p>	GC3664-HP	22 x 22 x 17	22	6.75	\$1011
		559 x 559 x 432	9.97	0.19	
 <p>Rectangular Coffee Table, High Pressure.</p>	GC3665-HP	21 x 42 x 15	35	11	\$1314
		533 x 1067 x 381	15.87	0.31	

- Power and data can be added on surface of the table. Order power/data module GC36410, see page 201 list price.

Coordinating edge and solid wood frame. 1 per carton.

- Power and data can be added on surface of the table. Order power/data module GC36410, see page 201 for list price.

Coordinating edge and solid wood frame. 1 per carton

Notes: Please specify all substitutions and options.

- Primacare table legs complement the lines of design to work seamlessly with Primacare seating.
- Legs are metal with laminate skirt.
- All connections are metal-to-metal inserts and fasteners.
- Thermofoil and solid surface material options are available on request, please contact your Global sales representative for a special quotation.
- Shipped easy to assemble.
- 2mm edging color coordinated with laminate finish is standard for all tops. Finish must specified at time of order.
- Tops are 1" thick and available in high pressure laminate (**HP**).
- Refer to the following lists when selecting a finish color. Must specify both a top color and leg finish at time of order.
- For custom laminate or contrasting edge, contact your Global sales representative or visit the Dealer Center and click on "Specials" on the left sidebar to submit your request.

High Pressure Laminate (HP)

- (ACJ) Absolute Acajou
- (ASN) Asian Night
- (AWC) Avant Cherry
- (AWH) Avant Honey
- (BLK) Black
- (BZD) Blizzard
- (BRC) Brushed Cobalt
- (CMB) Clear Maple
- (CGY) Custom Grey
- (DES) Dark Espresso
- (DWT) Designer White
- (FAS) Fashionista
- (FCL) First Class
- (NBL) Noce Biondo
- (NGL) Noce Grigio
- (NEL) Noce Leggero
- (NML) Noce Medio
- (QTM) Quartered Mahogany
- (SBY) Sheer Beauty
- (SDT) Stonedust
- (SOG) Storm Grey
- (WHE) Walnut Heights
- (WHC) White Chocolate
- (WCR) Winter Cherry

Metal Legs

- (TBL) Black
- (TIV) Cloud
- (TDW) Designer White
- (TFO) Fog
- (TFR) Frost
- (TKA) Kalua
- (TLA) Latte
- (TMO) Mocha
- (TNE) Nevada
- (TSN) Sand
- (TSH) Shadow
- (TOA) Toast
- (TTU) Tungsten

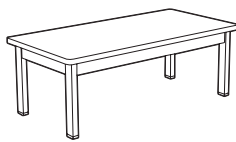
TABLES	MODEL #	DIMENSIONS ^{IN} _{MM}	WEIGHT ^{LB} _{KG}	VOLUME ^{FT³} _{MT³}	LIST PRICE
 <p>Square End Table, High Pressure</p>	GC3661-HP	W x D x H			
		24 x 20 x 17	29	9.75	\$920
		610 x 508 x 432	13.2	0.27	
					<ul style="list-style-type: none"> • Power and data can be added on surface of the table. Order power/data module GC36410, see page 201 for list price. Coordinating edge. 1.25" x 2" rectangular metal frame. 1 per carton.
 <p>Rectangular Coffee Table, High Pressure</p>	GC3662-HP	42 x 21 x 15	44	14.5	\$1183
		1067 x 533 x 381	20	0.41	
					<ul style="list-style-type: none"> • Power and data can be added on surface of the table. Order power/data module GC36410, see page 201 for list price. Coordinating edge. 1.25" x 2" rectangular metal frame. 1 per carton.
 <p>Rectangular Coffee Table High Pressure</p>	GC3663-HP	21 x 54 x 15	50	18.5	\$1444
		533 x 1372 x 381	22.7	0.52	
					<ul style="list-style-type: none"> • Power and data can be added on surface of the table. Order power/data module GC36410, see page 201 for list price. Coordinating edge. 1.25" x 2" rectangular metal frame. 1 per carton.



Meet River+™, the next generation of our highly popular lounge series. Now with industry-leading support for workplace, education and healthcare, River+ performs at three times the BIFMA standard for true 24/7 applications in demanding environments. All models have been active weight tested to 600 lbs. including bariatric use. Multiple back and seat heights, 120-degree configurations and modular Aluminum arms are just a few of the many options that will make it yours.

To see the River+ tables, please refer to the Seating price list at globalfurnituregroup.com/ca/resources/pricelists.

Features and Benefits

- A modular series that is composed of straight, curved and corner sections.
- Units can be linked together to create a wide variety of layouts. Ganging hardware is standard and is factory installed. Ganging hardware swivels out of the way when not in use.
- Front and back faces of end (linking) tables angles slightly inwards. This inward slant matches the inward angles of River seating so all units coordinate in visual appearance.
- The tapered legs are made of welded steel, with each leg bolted directly to the unit frame. Standard leg height is 6.5" with an optional 8" height. The leg height makes it easy to clean under the product.
- Tables are made with high pressure laminate.
- Legs of coffee and end (linking) tables are available in 3" and 8" heights. All heights are available with fixed-to-floor option.
- All tables (except freestanding units) can be specified with power/USB modules, which include one power outlets, one double USB terminals and a Black 120" 3-prong power cord..

Notes: Please specify all substitutions and options.

- Metal legs with adjustable glides. Heavy duty steel legs are available in Black (**TBL**), Shadow (**TSH**), Toast (**TOA**) and Tungsten (**TTU**). Please specify leg finish color at time of order.
- To support the need to move tables for cleaning, repositioning or placing in storage, tables can be ordered with two standard legs and two legs with casters. Add (**LF**) to model #.
- Adjustable 1.5" range Black plastic glides are standard. Except Tungsten (**TTU**) which has Tungsten glides.
- Tablet tables are designed to accept the fixed tablet on all sides.
- Shipped easy to assemble.
- 2mm edging color coordinated with laminate finish is standard for all tops. Optional Black (**BLK**) edging is also available. Finish must be specified at time of order.
- Tops are 1" thick and available in thermally fused laminate (**LP**) and high pressure laminate (**HP**). Please select the appropriate model number for the finish you prefer.
- Refer to the following lists when selecting a finish color. Must specify both a top color and leg finish at time of order.
- For custom laminate or contrasting edge, please contact your Global sales representative for a special quotation.

Thermally Fused Laminate (LP)

- (**ACJ**) Absolute Acajou
- (**ASN**) Asian Night
- (**AWC**) Avant Cherry
- (**AWH**) Avant Honey
- (**BLK**) Black
- (**BZD**) Blizzard
- (**BRC**) Brushed Cobalt
- (**CMB**) Clear Maple
- (**CGY**) Custom Grey
- (**DES**) Dark Espresso
- (**DWT**) Designer White
- (**FAS**) Fashionista
- (**FCL**) First Class
- (**NBL**) Noce Biondo
- (**NGL**) Noce Grigio
- (**NEL**) Noce Leggero
- (**NML**) Noce Medio
- (**QTM**) Quartered Mahogany
- (**SBY**) Sheer Beauty
- (**SDT**) Stonedust
- (**SOG**) Storm Grey
- (**WHE**) Walnut Heights
- (**WHC**) White Chocolate
- (**WCR**) Winter Cherry

High Pressure Laminate (HP)

- (**ACJ**) Absolute Acajou
- (**ASN**) Asian Night
- (**AWC**) Avant Cherry
- (**AWH**) Avant Honey
- (**BLK**) Black
- (**BZD**) Blizzard
- (**BRC**) Brushed Cobalt
- (**CMB**) Clear Maple
- (**CGY**) Custom Grey
- (**DES**) Dark Espresso
- (**DWT**) Designer White
- (**FAS**) Fashionista
- (**FCL**) First Class
- (**NBL**) Noce Biondo
- (**NGL**) Noce Grigio
- (**NEL**) Noce Leggero
- (**NML**) Noce Medio
- (**QTM**) Quartered Mahogany
- (**SBY**) Sheer Beauty
- (**SDT**) Stonedust
- (**SOG**) Storm Grey
- (**WHE**) Walnut Heights
- (**WHC**) White Chocolate
- (**WCR**) Winter Cherry

SQUARE DINING TABLES



Dining Table - 36"



Dining Table - 42"

MODEL #	DIMENSIONS ^{IN} _{MM}	WEIGHT ^{LB} _{KG}	VOLUME ^{FT³} _{MT³}	LIST PRICE
W x D x H				
GC3-36LH	36 x 36 x 28.25	63.4	3.68	\$1100
	914 x 914 x 718	28.75	0.1	
GC3-36L	36 x 36 x 28.25	63.4	3.68	\$932
	914 x 914 x 718	28.75	0.1	
<ul style="list-style-type: none"> • For a high pressure laminate top (HP), specify model GC3-36LH. • For a thermally fused top (LP), specify model GC3-36L. <p>Standard Black edge. 36" x 36" top accepts a tablet on all sides. Heavy duty steel legs are standard in Black Gloss (TBL). A variety of optional finishes are also available. Please specify.</p> <ul style="list-style-type: none"> • Additional leg heights are available. Special quote is required. • 2 cartons. 				
GC3-42LH	42 x 42 x 28.25	79.65	4.2	\$1416
	1067 x 1067 x 718	36.12	0.11	
GC3-42L	42 x 42 x 28.25	79.65	4.2	\$1216
	1067 x 1067 x 718	36.12	0.11	
<ul style="list-style-type: none"> • For a high pressure laminate top (HP), specify model GC3-42LH. • For a thermally fused top (LP), specify model GC3-42L. <p>Standard Black edge. 42" x 42" top accepts a tablet on all sides. Heavy duty steel legs are standard in Black Gloss (TBL). A variety of optional finishes are also available. Please specify.</p> <ul style="list-style-type: none"> • Additional leg heights are available. Special quote is required. • 2 cartons. 				

SQUARE DINING TABLES	MODEL #	DIMENSIONS ^{IN} _{MM}	WEIGHT ^{LB} _{KG}	VOLUME ^{FT³} _{MT³}	LIST PRICE
 <p>Dining Table - 48"</p>	GC3-48LH	48 x 48 x 28.25	99	4.9	\$1795
		1219 x 1219 x 718	44.9	0.13	
	GC3-48L	48 x 48 x 28.25	99	4.9	\$1335
		1219 x 1219 x 718	44.9	0.13	

- For a high pressure laminate top (HP), specify model GC3-48LH.
- For a thermally fused top (LP), specify model GC3-48L.

Standard Black edge. 48" x 48" top accepts a tablet on all sides. Heavy duty steel legs are standard in Black Gloss (TBL). A variety of optional finishes are also available. Please specify.

- Additional leg heights are available. Special quote is required.
- 2 cartons.

TABLETS	MODEL #	DIMENSIONS ^{IN} _{MM}	WEIGHT ^{LB} _{KG}	VOLUME ^{FT³} _{MT³}	LIST PRICE
 <p>Tablet</p>	GC3-NUGH	24 x 10 x 1	15	0.8	\$398
		610 x 254 x 25	6.8	0.02	
	GC3-NUG	24 x 10 x 1	15	0.8	\$361
		610 x 254 x 25	6.8	0.02	

- For a high pressure laminate top (HP), specify model GC3-NUGH.
- For a thermally fused top (LP), specify model GC3-NUG.

Attachable tablet for above tablet tables. Attaches on any side, adding 10" per tablet. Heavy duty steel mounting bracket is standard in Black. 2 cartons.

TAPERED LEGS	MODEL #	DIMENSIONS ^{IN} _{MM}	WEIGHT ^{LB} _{KG}	VOLUME ^{FT³} _{MT³}	LIST PRICE
 <p>Tapered Leg with Caster</p>	LCL291	5.25 x 5.25 x 27.75	4.8	0.52	\$106
		133 x 133 x 692	2.17	0.01	
	LCL294	5.25 x 5.25 x 27.75	18.4	2.1	\$419
		133 x 133 x 705	8.34	0.05	

Tapered leg with locking caster. Hardware for assembly is included

- LCL291: 1 per carton.
- LCL294: 4 per carton.
- Available in Black (TBL), Shadow (TSH), Toast (TOA) and Tungsten (TTU). Finish must be specified at time of order.

 <p>Tapered Leg with Glide</p>	LLL291	5.25 x 5.25 x 27.25	4.8	0.52	\$106
		133 x 133 x 692	2.17	0.01	
	LLL294	5.25 x 5.25 x 27.25	18.4	2.1	\$419
		133 x 133 x 692	8.34	0.05	

Tapered leg with glide offers 1.5" glide range adjustment. Legs are available and can be ordered separately from the top. Hardware for assembly is included.

- LLL291: 1 per carton.
- LLL294: 4 per carton.
- Available in Black (TBL), Shadow (TSH), Toast (TOA) and Tungsten (TTU). Finish must be specified at time of order.

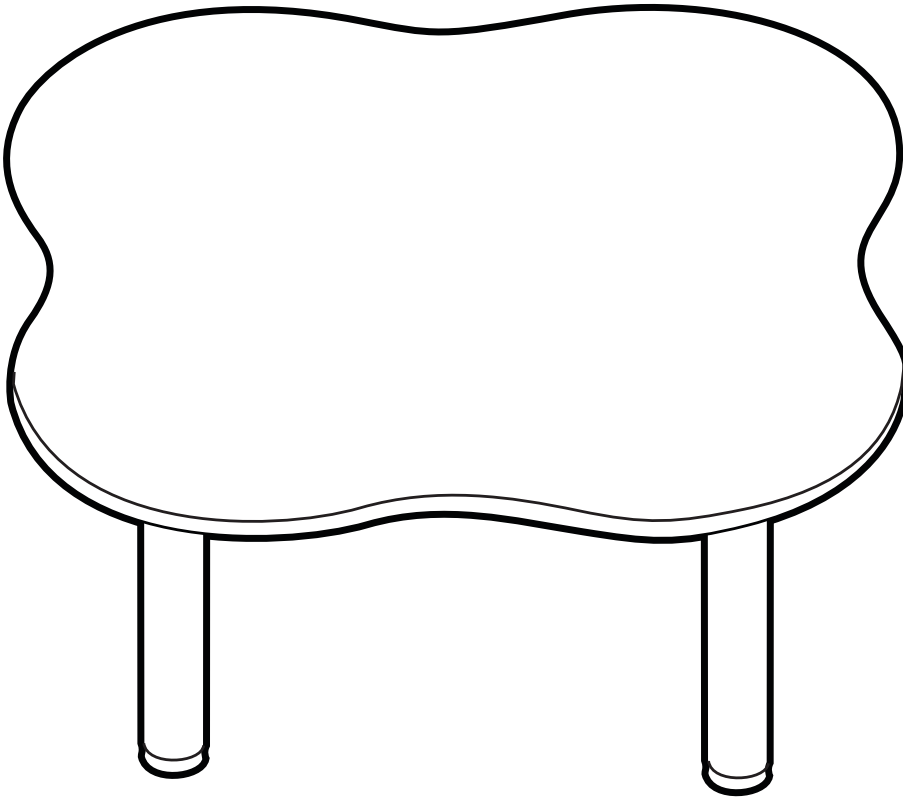

Zook™ children's tables designed for waiting rooms and playroom settings make children's areas more playful and supportive. With gentle curves and 20"H overall, creating inviting and safe environments is easy.

Choose from a variety of durable finishes in thermally fused laminate or high pressure laminate options with matching or complementary edge band and an array of painted finishes for metal legs.

Tops are available in 1" thick thermally fused laminate or 1 1/16" high pressure laminate with 2mm PVC edgebanding or optional ergo friendly edge. 3" diameter metal legs provide support and stability.

To see the Zook children's tables, please refer to the Desking + Tables price list at globalfurnituregroup.com/ca/resources/pricelists.

Features and Benefits

- 20"h, the perfect height for children.
- Choose tables for groups of 4 to 6 people.
- Tops are 1" thick thermally fused laminate or 1 1/16" high pressure laminate.
- Top core construction is 45 lb. density particle board.
- 2mm PVC edgebanding or optional ergo friendly edge.
- Organic shaped tops with gentle curves around perimeter.
- Surfaces include factory installed metal inserts for solid and secure leg connections.
- 3" diameter tubular steel legs.
- Easy to assemble.