

seating

Private + Public + Individual + Group Applications

Application guidelines	66	GC Sidero.....	126
Adeline.....	67	GC Sirena.....	136
Bishop.....	69	GC Sonic.....	138
Calidon.....	70	GC Vitrola.....	142
Coast.....	75	GC Wind.....	143
Collingwood.....	76	Heather.....	145
Desmond.....	77	Janna.....	146
Desmond HT.....	78	Nourish.....	147
Dreme.....	80	Oakville.....	150
Erin.....	83	Primacare.....	151
Frolick.....	85	River+.....	223
GC Beach.....	90	Senator.....	224
GC Belong.....	91	Sleep-Eez.....	225
GC Citi.....	118	Splash.....	88
GC Comet.....	121	Strand.....	226
GC Islands.....	124	Willow.....	232
GC Prairie.....	125	Wingback.....	245

Work + Task

Doctor Buddy.....	249	GC Trittek.....	256
Ergonomic features.....	247	GC Trittek TS.....	258
Foot activated stools.....	251	GC Vion.....	260
Gala II.....	252	Harmony.....	262
Gala II TS.....	254	Mechanism adjustments....	248

SERIES	WOOD	METAL	BARIATRIC SEATING	DINING / CAFETERIA	GUEST SEATING	LOBBIES	LOUNGE / WAITING	OFFICE / MEETING	PATIENT ROOMS	RESIDENT ROOMS	STACKING	TASK	TREATMENT / EXAM ROOMS
ADELINE		•	•		•	•	•		•	•			•
BISHOP	•					•	•			•			
CALIDON	•		•		•	•	•		•	•			•
COAST	•						•		•	•			
COLLINGWOOD	•			•	•	•	•		•	•			
DESMOND	•			•	•	•	•	•	•	•			
DESMOND HT		•		•	•	•	•	•	•	•			
DOCTOR BUDDY		•		•				•	•	•		•	•
DREME									•	•			
ERIN	•	•		•	•	•	•		•	•			
FOOT ACTIVATED STOOLS		•		•				•	•	•		•	•
FROLICK		•	•	•	•	•	•	•	•	•	•		•
GALA II		•						•				•	•
GALA II TS		•						•				•	•
GC BEACH	•			•	•	•	•	•	•	•			
GC BELONG		•	•		•	•	•		•	•			•
GC CITI		•			•	•	•			•			
GC COMET		•	•	•	•	•	•	•	•	•	•		•
GC ISLANDS	•			•	•	•	•	•	•	•			
GC PRAIRIE	•					•	•			•			
GC SIDERO		•	•	•	•	•	•	•	•	•	•		•
GC SIRENA	•			•	•	•	•	•	•	•			
GC SONIC		•		•	•	•	•	•	•	•	•		•
GC TRITEK		•						•				•	•
GC TRITEK TS		•						•				•	•
GC VION		•						•				•	•
GC VITROLA	•				•	•	•		•	•			
GC WIND		•				•	•	•	•	•			
HARMONY		•	•					•				•	•
HARMONY TS		•						•				•	•
HEATHER	•			•	•	•	•		•	•			
JANNA	•			•	•		•	•	•	•			•
NOURISH		•	•				•		•	•			•
OAKVILLE	•				•	•	•		•	•			
OTTOMANS	•	•			•	•	•		•	•			•
PRIMACARE	•		•	•	•	•	•		•	•			•
PRIMACARE HT		•	•	•	•	•	•		•	•			•
PRIMACARE MODULAR	•		•	•	•	•	•						
PRIMACARE WINGBACK	•	•	•		•	•	•		•	•			
RIVER+		•			•	•	•						
SENATOR	•	•				•	•		•	•			
SLEEP-EEZ		•				•	•	•	•	•			•
SPLASH		•		•	•	•	•	•	•	•	•		•
STRAND		•	•		•	•	•		•	•			•
THROW PILLOWS						•	•			•			
WILLOW		•	•	•	•	•	•	•	•	•	•		•
WINGBACK	•				•	•	•		•	•			

HEAVY DUTY + 24/7 MODELS

The following series feature specific models for Heavy Duty + 24/7 use:

GC Belong, Nourish, Primacare, Sleep-Eez, Strand, GC ritek, Bariatric models of GC Comet, Frolick and Harmony, and heavy duty 24 hour (TS) models of Gala II, Harmony and GC Tritek.

ADELINE



model GC7680

STANDARD FEATURES



- Flex back moves with the user, providing comfort and support while seated.
- Sleek oval tube steel frame is available in Black (TBL), Kalua (TKA), Latte (TLA), Mocha (TMO), Nevada (TNE), Shadow (TSH), Toast (TOA) and Tungsten (TTU). Please specify.
- Urethane armcaps are available in Black (BLK), Kalua (KAL), Latte (LAB), Mocha (J52), Shadow (SHW) and Toast (TOA). Please specify.
- Standard seat height on all models is 18".
- For healthcare textiles and finish options, visit the website at globalfurnituregroup.com.
- For added comfort, seats are standard with high density Ultracell foam.
- The textile covered side panel on bariatric model GC7694 is covered in a coated textile in a choice of Ink Black (A16F), Warm Smoke (A08F), Chocolate Sundae (A23F), Gibraltar (A12F) or Illusion (A01F). Please specify.
- Standard glide is plastic.
- Shipped fully assembled.



OPTIONAL FEATURES

- For hard surface floors, please specify opaque non-marking glides **(NM)**. No upcharge.
- To add sealed seams to your product contact Customer Service. Upcharges vary.
- For moisture barrier on seat, please specify **(MB)**. Add \$81. For bariatric models add \$122.
- For improved housekeeping and infection control practices, please add **(SU)** to model number. The underside of the seat will be finished with vinyl and sealed to prevent penetration of liquids. For standard models: Add \$39. For bariatric models: Add \$59.

SUGGESTED APPLICATIONS

- Bariatric seating
- Guest seating
- Lobbies
- Lounge/Waiting
- Patient rooms
- Resident rooms
- Treatment/Exam rooms

DESCRIPTION	MODEL# / FEATURES	STANDARD TEXTILE GRADES											
		COM	2	3	4	5	6	7	8	9	10	11	12
 <p>Curved High Flex Back Armchair COM: 2 YD 1.83 M Unit weight: 35 LB 15.9 KG Carton weight: 40 LB 18.14 KG Carton volume: 20 FT³ 0.56 MT³</p>	GC7680	1012	1076	1130	1192	1294	1388	1482	1564	1666	1762	1892	2076
	Active weight 350 lbs.	IN 25.5 MM 648	28 711	45 1143	19.5 495	18 457	18 457	18 457	18 457	27 686			
		RTA 00	1 per carton										
 <p>Curved High Fixed Back Armchair COM: 2 YD 1.83 M Unit weight: 40 LB 18.2 KG Carton weight: 46 LB 20.87 KG Carton volume: 20 FT³ 0.56 MT³</p>	GC7681	1064	1128	1182	1244	1346	1440	1534	1616	1718	1814	1944	2128
	Active weight 350 lbs.	IN 25.5 MM 648	28 711	45 1143	19.5 495	18 457	18 457	18 457	18 457	27 686			
		RTA 00	1 per carton										
 <p>High Fixed Straight Top, Armchair COM: 2 YD 1.83 M Unit weight: 38 LB 17.3 KG Carton weight: 45 LB 20.41 KG Carton volume: 20 FT³ 0.56 MT³</p>	GC7692	1012	1076	1130	1192	1294	1388	1482	1564	1666	1762	1892	2076
	Active weight 350 lbs.	IN 25.5 MM 648	26.5 673	45 1143	19.5 495	18.5 470	18 457	20 508	27 686				
		RTA 00	1 per carton										

DESCRIPTION	MODEL# / FEATURES	STANDARD TEXTILE GRADES											
		COM	2	3	4	5	6	7	8	9	10	11	12
 <p>Low Fixed Straight Top Armchair, Bariatric COM: 3.25 YD 2.97 M Unit weight: 61 LB 27.7 KG Carton weight: 71 LB 32.21 KG Carton volume: 23 FT³ 0.65 MT³</p>	GC7694 Active weight 750 lbs.	1696	1800	1888	1989	2154	2307	2460	2593	2759	2915	3126	3425
		OVERALL DIMENSIONS W D H			SEAT DIMENSIONS W D H			BACK DIMENSIONS W H					
		IN	32.5	26.5	40.5	28	18.5	18	27	23.5			
		MM	826	673	1029	711	470	457	686	597			
		RTA 00		1 per carton									
 <p>High Flex Back Straight Top, Armchair COM: 2 YD 1.83 M Unit weight: 36 LB 16.4 KG Carton weight: 43 LB 19.5 KG Carton volume: 20 FT³ 0.56 MT³</p>	GC7696 Active weight 350 lbs.	1012	1076	1130	1192	1294	1388	1482	1564	1666	1762	1892	2076
		OVERALL DIMENSIONS W D H			SEAT DIMENSIONS W D H			BACK DIMENSIONS W H					
		IN	25.5	26.5	45	19.5	18.5	18	20	27			
		MM	648	673	1143	495	470	457	508	686			
		RTA 00		1 per carton									
 <p>High Fixed Straight Top Armchair, Sled Base COM: 2 YD 1.83 M Unit weight: 40 LB 18.2 KG Carton weight: 47 LB 21.32 KG Carton volume: 20 FT³ 0.56 MT³</p>	GC7693 Active weight 350 lbs.	1077	1141	1195	1257	1359	1453	1547	1629	1731	1827	1957	2141
		OVERALL DIMENSIONS W D H			SEAT DIMENSIONS W D H			BACK DIMENSIONS W H					
		IN	25.5	26.5	45	19.5	18.5	18	20	27			
		MM	648	673	1143	495	470	457	508	686			
		RTA 00		1 per carton									

BISHOP



model GC3751

STANDARD FEATURES

- Bishop offers a classic, traditional, rolled arm style design.
- Features removable and replaceable seat cushions.
- Wood frame and hardwood block legs are available in a variety of finishes. Available in Maple wood species only (refer to finishes ending in "M").
- For added comfort, seat and back are standard with high density Ultracell foam.
- Opaque non-marking glides are standard.
- For healthcare textiles and wood finish options, visit the website at globalfurnituregroup.com.
- Can be upholstered in standard Global textiles if Healthcare compliance is not required.
- Shipped fully assembled.

OPTIONAL FEATURES

- For non-slip glides, please specify **(NS)**. Add \$22.
- To add sealed seams to your product contact Customer Service. Upcharges vary.
- For moisture barrier on seat, please specify **(MB)**. See upcharges below.

SUGGESTED APPLICATIONS

- Lobbies
- Lounge/Waiting
- Resident rooms

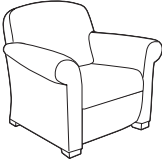
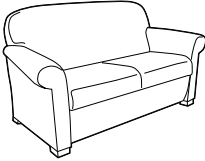
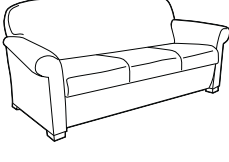
DESCRIPTION	MODEL# / FEATURES	STANDARD TEXTILE GRADES											
		COM	2	3	4	5	6	7	8	9	10	11	12
 <p>Lounge Chair COM: 7.25 YD 6.63 M Unit weight: 69 LB 31.4 KG Carton weight: 75 LB 34.02 KG Carton volume: 30.25 FT³ 0.85 MT³</p>	GC3751	1977	2209	2405	2630	2999	3340	3681	3978	4348	4696	5167	5834
		OVERALL DIMENSIONS			SEAT DIMENSIONS			BACK DIMENSIONS					
		W	D	H	W	D	H	W	H				
	Active weight 300 lbs.	IN 37	32	34.5	21	18.5	17	28	17.5				
	Removable seat cushion.	MM 940	813	876	533	470	432	711	445				
Add \$122 for (MB) .	RTA 00	1 per carton											
 <p>Two Seat Sofa COM: 8.75 YD 8 M Unit weight: 107 LB 48.6 KG Carton weight: 112 LB 50.8 KG Carton volume: 55.75 FT³ 1.57 MT³</p>	GC3752	2793	3073	3309	3581	4027	4438	4849	5208	5654	6074	6643	7448
		OVERALL DIMENSIONS			SEAT DIMENSIONS			BACK DIMENSIONS					
		W	D	H	W	D	H	W	H				
	Active weight 300 lbs/seat.	IN 63.5	32	34.5	47.5	18.5	17	55	17.5				
	Removable seat cushions.	MM 1613	813	876	1207	470	432	1397	445				
Add \$245 for (MB) .	RTA 00	1 per carton											
 <p>Three Seat Sofa COM: 12 YD 10.97 M Unit weight: 145 LB 65.9 KG Carton weight: 155 LB 70.31 KG Carton volume: 74.75 FT³ 2.11 MT³</p>	GC3753	3554	3938	4262	4634	5246	5810	6374	6866	7478	8054	8834	9938
		OVERALL DIMENSIONS			SEAT DIMENSIONS			BACK DIMENSIONS					
		W	D	H	W	D	H	W	H				
	Active weight 300 lbs/seat.	IN 90	32	34.5	74	18.5	17	82	17.5				
	Removable seat cushions.	MM 2286	813	876	1880	470	432	2083	445				
Add \$366 for (MB) .	RTA 00	1 per carton											

CALIDON



model GC36301



Tandem Side Table
model GC36319R

Calidon freestanding tables



For Calidon freestanding tables, please see page 76 .

EXAMPLE CALIDON ORDER CODE:

GC36308	-NS	-PU75	-NS
---------	-----	-------	-----

Model # Sealed back seams Back/arm textile Sealed seat seams

-PU75	-AAM	-TPM-J-SLT	-NM	-NB
-------	------	------------	-----	-----

Seat textile Frame finish Power Glides Moisture barrier

CONTRASTING TEXTILES APPLICATION

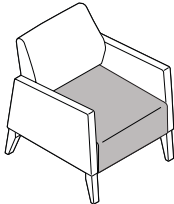

Back and arms are separate from seat.

POWER LOCATION DIAGRAM

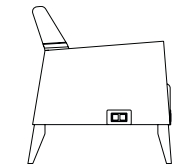

Right Side Power (SRT)
Models GC36308, GC36309 and GC36310

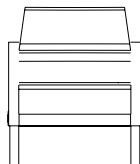

Front Power Not Available
Model GC36308

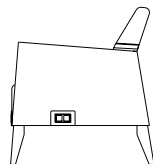

Left Side Power (SLT)
Models GC36308, GC36309 and GC36310

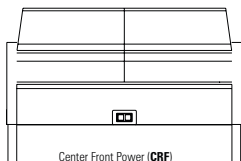

Center Front Power (CRF)
Model GC36309 only

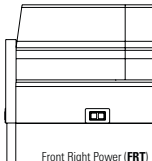

Front Right Power (FRT)
Model GC36310 only

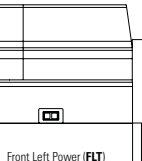

Front Left Power (FLT)
Model GC36310 only

STANDARD FEATURES

- Calidon series consists of wood frame guest, lounge, bariatric and bench seating, in addition to fully upholstered lounge seating. Calidon freestanding and tandem/bridge tables complement the line.
- Calidon is designed for the rigors of high use environments. Lounge units include metal frame supports.
- Frame design features a wall saver leg to prevent back contact and damage to walls.
- All guest and lounge chairs feature a clean out between seat and back, and tall legs for ease of cleaning.
- For added comfort, seats are standard with high density Ultracell foam.
- Active weight capacity up to 400 lbs./seat for standard seating; up to 600 lbs. for bariatric seating.
- For healthcare textiles, visit the website at globalfurnituregroup.com.
- Textiles with a minimum of 100,000 double rubs must be specified to meet Global 24/7 warranty coverage.
- Can be upholstered in standard Global textiles if Healthcare 24/7 application compliance is not required.
- Tandem table models (GC36319 to GC36321) connect to guest seating only. Tandem tables are specified left or right, as seated. Refer to page 76 for more details.
- No seating or bench models gang together.

OPTIONAL FEATURES

- All guest and lounge models can be specified with armcaps, securely fastened with metal-to-metal connectors, allowing for field replacement if required. Urethane armcaps are available on open (wood) arm models. Solid surface armcaps are available on open (wood) and fully upholstered arm models. Armcaps cannot be retrofitted in the field on units with no existing armcaps.
- Fully upholstered lounge seating can be specified with a tamper resistant power/USB unit, which includes one AC outlet, two 10-watt USB ports and a 10 ft long, 3-prong power cord. The power unit is Black with matching face plate and cord. Power is factory installed and must be specified at time of order. Add \$160. Power locations vary by model. See power location diagram.
- For contrasting textile specification, the back and arms are specified in one textile. The seat is specified separately. Use the Build-it tool on globalfurnituregroup.com for pricing.

SUGGESTED APPLICATIONS

- Bariatric seating
- Guest seating
- Lobbies
- Treatment/Exam rooms
- Patient rooms
- Resident rooms
- Lounge rooms

Please add option codes in the following order:

- **Model number**
GC36301 to GC36303 Guest chairs
GC36304 Bariatric guest chair
GC36305 to GC36307 Lounge chairs
GC36308 to GC36310 Fully upholstered lounge
GC36311 to GC36313 Benches
GC36318 to GC36320 Tandem/bridge tables
- **Sealed back seams**
(NS) No sealed back seams.
(SS) Sealed back seams. Upcharges vary, see model.
- **Back and arm textile**
Specify textile code.
- **Sealed seat seams**
(NS) No sealed seams.
(SS) Sealed seat seams. Upcharges vary, see model.
- **Seat textile**
Specify textile code.
- **Armcap option**
(FNA) No armcaps.
(FAC) With armcaps.
- **Frame finish**
(AAM) Absolute **(MWM)** Medium Walnut
(CJM) Charcoal Java **(ASM)** Night
(ACM) Cherry **(NBM)** Noce Biondo
(EMM) Empire Mahogany **(NGM)** Noce Grigio
(EOM) English Oak **(NEM)** Noce Leggero
(ECM) Espresso Cafe **(NMM)** Noce Medio
(TFM) Fruitwood **(SBM)** Sandy Beach
(HGM) Gray **(SKM)** Shaker Cherry
(HOM) Harvest Oak **(SOM)** Silver Oak
(AHM) Honey **(TWM)** Walnut
(JOM) Jet Onyx **(WTM)** WC Cream
(LHM) Light Honey **(WHM)** White
(TMM) Mahogany **(WCM)** Winter Cherry
(AVM) Maple
- **Armcap finish** (guest chairs only with **FAC** specified)
(SSU) Urethane armcaps (for wood arm guest and lounge with **FAC** specified). Upcharges vary, see model.
Urethane finishes
(BLK) Black **(J52)** Mocha
(KAL) Kalua **(SHW)** Shadow
(LAB) Latte **(TOA)** Toast
(CO) Solid surface. (for all wood and fully upholstered arm models with **FAC** specified). Upcharges vary, see model.
Solid surface finishes
Grade 1:
(SWH) Designer White
Grade 2:
(SBT) Beige Tempest
(SBX) Black Onyx Mirage
(SMG) Milk Glass Spectra
(SFW) Frosty White Mirage
(SHS) Hot Stone
(SNM) Northern Melange
- **Power/USB unit position** (fully upholstered, lounge models only, as specified below).
(NPM) No power.
(TPM) Tamper resistant power unit.
(J) Black
(SRT) Side right. Add \$160.
(SLT) Side left. Add \$160.
(FLT) Front left (three seater only). Add \$160.
(FRT) Front right (three seater only). Add \$160.
(CRF) Center front (two seater only). Add \$160.
(SLR) Side left and right. Add \$322.
(FLR) Front left and right. Add \$322.
- **Glides**
(NM) Non-marking
(NS) Non-slip. Guest single seat, bariatric and lounge chairs, add \$22. Guest two seater, add \$32. Guest three seater, add \$43.
- **Moisture Barrier** (seat only)
(NB) No moisture barrier.
(MB) Moisture barrier. Upcharges vary, see model.

DESCRIPTION	MODEL# / FEATURES	STANDARD TEXTILE GRADES											
		COM	2	3	4	5	6	7	8	9	10	11	12
 <p>Wood Guest Single Seat COM: 1.9 YD 1.74 M Unit weight: 26 LB 11.8 KG Carton weight: 38 LB 17.24 KG Carton volume: 16.5 FT³ 0.46 MT³</p>	GC36301	1109	1170	1221	1280	1377	1466	1556	1633	1730	1822	1945	2120
	Active weight 400 lbs.	OVERALL DIMENSIONS			SEAT DIMENSIONS			BACK DIMENSIONS					
		W	D	H	W	D	H	W	H				
	Solid surface GRD1 armcaps, add \$290. IN 23.5 26.5 34.5 21.5 18 18 21.5 16.5 Solid surface GRD2 armcaps, add \$310. MM 597 673 876 546 457 457 546 419 Urethane armcaps, add \$96. Moisture barrier (MB), add \$81. Sealed back seams (SS), add \$27. Sealed seat seams (SS), add \$19.	RTA 00	1 per carton										

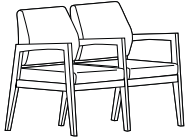
DESCRIPTION	MODEL# / FEATURES	STANDARD TEXTILE GRADES											
		COM	2	3	4	5	6	7	8	9	10	11	12
 <p>Wood Guest Two Seater, Full Center Arm COM: 3.8 YD 3.47 M Unit weight: 50 LB 22.7 KG Carton weight: 68 LB 30.84 KG Carton volume: 31.75 FT³ 0.89 MT³</p>	GC36302	2087	2209	2311	2429	2623	2801	2980	3136	3330	3512	3759	4109
	Active weight 400 lbs./seat	OVERALL DIMENSIONS			SEAT DIMENSIONS			BACK DIMENSIONS					
		W	D	H	H	W	D	H	H	WH			
	Solid surface GRD1 armcaps, add \$435. IN 46 26.5 34.5 21.5 18 18 21.5 16.5 Solid surface GRD2 armcaps, add \$465. MM 1168 673 876 546 457 457 546 419 Urethane armcaps, add \$144. Moisture barrier (MB), add \$161. Sealed back seams (SS), add \$55. Sealed seat seams (SS), add \$38.	RTA 00	1 per carton										

DESCRIPTION	MODEL# / FEATURES	STANDARD TEXTILE GRADES											
		COM	2	3	4	5	6	7	8	9	10	11	12
 <p>Wood Guest Three Seater, Full Center Arms COM: 5.7 YD 5.21 M Unit weight: 75 LB 34.1 KG Carton weight: 101 LB 45.81 KG Carton volume: 47.5 FT³ 1.34 MT³</p>	GC36303	3067	3249	3403	3580	3871	4139	4407	4640	4931	5205	5575	6099
	Active weight 400 lbs./seat	OVERALL DIMENSIONS			SEAT DIMENSIONS			BACK DIMENSIONS					
		W	D	H	W	D	H	W	H				
	Solid surface GRD1 armcaps, add \$580. IN 68 26.5 34.5 21.5 18 18 21.5 16.5 Solid surface GRD2 armcaps, add \$620. MM 1727 673 876 546 457 457 546 419 Urethane armcaps, add \$192. Moisture barrier (MB), add \$243. Sealed back seams (SS), add \$82. Sealed seat seams (SS), add \$57.	RTA 00	1 per carton										

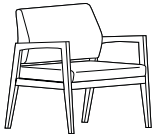
DESCRIPTION	MODEL# / FEATURES	STANDARD TEXTILE GRADES											
		COM	2	3	4	5	6	7	8	9	10	11	12
 <p>Wood Guest Bariatric Chair COM: 2.5 YD 2.29 M Unit weight: 41 LB 18.6 KG Carton weight: 55 LB 24.95 KG Carton volume: 22.25 FT³ 0.63 MT³</p>	GC36304	1617	1697	1765	1843	1969	2087	2205	2307	2435	2555	2717	2947
	Active weight 600 lbs.	OVERALL DIMENSIONS			SEAT DIMENSIONS			BACK DIMENSIONS					
		W	D	H	W	D	H	W	H				
	Solid surface GRD1 armcaps, add \$290. IN 32.75 26.5 34.5 31 18 18 30.5 16.5 Solid surface GRD2 armcaps, add \$310. MM 832 673 876 787 457 457 775 419 Urethane armcaps, add \$96. Moisture barrier (MB), add \$122. Sealed back seams (SS), add \$30. Sealed seat seams (SS), add \$19.	RTA 00	1 per carton										

DESCRIPTION	MODEL# / FEATURES	STANDARD TEXTILE GRADES											
		COM	2	3	4	5	6	7	8	9	10	11	12
 <p>Wood Lounge Single Seat COM: 2.5 YD 2.29 M Unit weight: 37 LB 16.8 KG Carton weight: 49 LB 22.23 KG Carton volume: 18.25 FT³ 0.51 MT³</p>	GC36305	1501	1581	1649	1727	1853	1971	2089	2191	2319	2439	2601	2831
	Active weight 400 lbs.	OVERALL DIMENSIONS			SEAT DIMENSIONS			BACK DIMENSIONS					
		W	D	H	W	D	H	W	H				
	Solid surface GRD1 armcaps, add \$305. IN 25.75 29.5 32.5 24 21 16 23.5 16.5 Solid surface GRD2 armcaps, add \$329. MM 654 749 826 610 533 406 597 419 Urethane armcaps, add \$144. Moisture barrier (MB), add \$81. Sealed back seams (SS), add \$31. Sealed seat seams (SS), add \$24.	RTA 00	1 per carton										

DESCRIPTION	MODEL# / FEATURES	STANDARD TEXTILE GRADES											
		COM	2	3	4	5	6	7	8	9	10	11	12

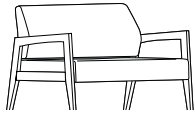

Wood Lounge Two Seater
 COM: 4 YD | 3.66 M
 Unit weight: 60 LB | 27.3 KG
 Carton weight: 77 LB | 34.93 KG
 Carton volume: 32.75 FT³ | 0.92 MT³

MODEL# / FEATURES	COM	2	3	4	5	6	7	8	9	10	11	12
GC36306	2086	2214	2322	2447	2650	2838	3026	3190	3394	3586	3846	4214

Active weight 400 lbs./seat	OVERALL DIMENSIONS			SEAT DIMENSIONS			BACK DIMENSIONS		
	W	D	H	W	D	H	W	H	
Solid surface GRD1 armcaps, add \$305. IN	47.5	29.5	32.5	45	21	16	44.5	16.5	
Solid surface GRD2 armcaps, add \$329. MM	1207	749	826	1143	533	406	1130	419	
Urethane armcaps, add \$144. Moisture barrier (MB), add \$161. Sealed back seams (SS), add \$45. Sealed seat seams (SS), add \$34.	RTA 00	1 per carton							

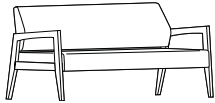

Wood Lounge Three Seater
 COM: 5.25 YD | 4.8 M
 Unit weight: 86 LB | 39.1 KG
 Carton weight: 109 LB | 49.44 KG
 Carton volume: 50.75 FT³ | 1.43 MT³

MODEL# / FEATURES	COM	2	3	4	5	6	7	8	9	10	11	12
GC36307	2608	2776	2918	3081	3349	3595	3842	4057	4325	4577	4918	5401

Active weight 400 lbs./seat	OVERALL DIMENSIONS			SEAT DIMENSIONS			BACK DIMENSIONS		
	W	D	H	W	D	H	W	H	
Solid surface GRD1 armcaps, add \$305. IN	70.5	29.5	32.5	68	21	16	67.5	16.5	
Solid surface GRD2 armcaps, add \$329. MM	1791	749	826	1727	533	406	1715	419	
Urethane armcaps, add \$144. Moisture barrier (MB), add \$243. Sealed back seams (SS), add \$58. Sealed seat seams (SS), add \$45.	RTA 00	1 per carton							

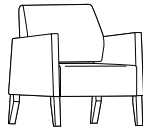

Fully Upholstered Lounge Single Seat
 COM: 4 YD | 3.66 M
 Unit weight: 46 LB | 20.9 KG
 Carton weight: 58 LB | 26.31 KG
 Carton volume: 18.75 FT³ | 0.53 MT³

MODEL# / FEATURES	COM	2	3	4	5	6	7	8	9	10	11	12
GC36308	1631	1759	1867	1992	2195	2383	2571	2735	2939	3131	3391	3759

Active weight 400 lbs.	OVERALL DIMENSIONS			SEAT DIMENSIONS			BACK DIMENSIONS		
	W	D	H	W	D	H	W	H	
Solid surface GRD1 armcaps, add \$335. IN	27.5	29.5	33.5	24	21	16	23.5	17.5	
Solid surface GRD2 armcaps, add \$355. MM	699	749	851	610	533	406	597	445	
Moisture barrier (MB), add \$81. Sealed back and arm seams (SS), add \$104. Sealed seat seams (SS), add \$26. Power/USB module available.	RTA 00	1 per carton							

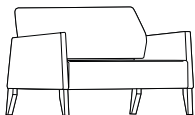

Fully Upholstered Lounge Two Seater
 COM: 5.75 YD | 5.26 M
 Unit weight: 72 LB | 32.7 KG
 Carton weight: 89 LB | 40.37 KG
 Carton volume: 33.75 FT³ | 0.95 MT³

MODEL# / FEATURES	COM	2	3	4	5	6	7	8	9	10	11	12
GC36309	2217	2401	2557	2735	3028	3298	3569	3804	4098	4374	4747	5276

Active weight 400 lbs./seat	OVERALL DIMENSIONS			SEAT DIMENSIONS			BACK DIMENSIONS		
	W	D	H	W	D	H	W	H	
Solid surface GRD1 armcaps, add \$335. IN	49.5	29.5	33.5	44.5	18	16	45.5	17.5	
Solid surface GRD2 armcaps, add \$355. MM	1257	749	851	1130	457	406	1156	445	
Moisture barrier (MB), add \$161. Sealed back and arm seams (SS), add \$118. Sealed seat seams (SS), add \$37. Power/USB module available.	RTA 00	1 per carton							

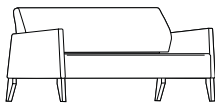

Fully Upholstered Lounge Three Seater
 COM: 7 YD | 6.4 M
 Unit weight: 99 LB | 45 KG
 Carton weight: 123 LB | 55.79 KG
 Carton volume: 52 FT³ | 1.47 MT³

MODEL# / FEATURES	COM	2	3	4	5	6	7	8	9	10	11	12
GC36310	2738	2962	3151	3369	3725	4054	4383	4670	5027	5363	5818	6462

Active weight 400 lbs./seat	OVERALL DIMENSIONS			SEAT DIMENSIONS			BACK DIMENSIONS		
	W	D	H	W	D	H	W	H	
Solid surface GRD1 armcaps, add \$335. IN	71.5	29.5	33.5	66.5	18	16	67.5	17.5	
Solid surface GRD2 armcaps, add \$355. MM	1816	749	851	1689	457	406	1715	445	
Moisture barrier (MB), add \$243. Sealed back and arm seams (SS), add \$132. Sealed seat seams (SS), add \$47. Power/USB module available.	RTA 00	1 per carton							

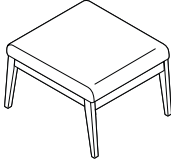
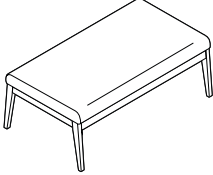
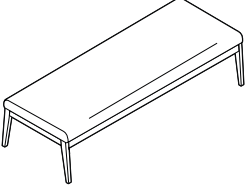
DESCRIPTION	MODEL# / FEATURES	STANDARD TEXTILE GRADES											
		COM	2	3	4	5	6	7	8	9	10	11	12
 <p>Single Seat Bench COM: 1 YD 0.91 M Unit weight: 31 LB 14.1 KG Carton weight: 41 LB 18.6 KG Carton volume: 10 FT³ 0.28 MT³</p>	GC36311	1275	1307	1334	1365	1416	1463	1510	1551	1602	1650	1715	1807
		OVERALL DIMENSIONS			SEAT DIMENSIONS			BACK DIMENSIONS					
		W	D	H	W	D	H	W	H				
	Active weight 400 lbs.	IN 24 MM 610	28 711	18 457	24 610	26.75 679	18 457	-	-				
	Moisture barrier (MB), add \$81. Sealed seat seams (SS), add \$22.	RTA 00	1 per carton										
 <p>Two Seat Bench COM: 2 YD 1.83 M Unit weight: 43 LB 19.5 KG Carton weight: 61 LB 27.67 KG Carton volume: 18.75 FT³ 0.53 MT³</p>	GC36312	1860	1924	1978	2040	2142	2236	2330	2412	2514	2610	2740	2924
		OVERALL DIMENSIONS			SEAT DIMENSIONS			BACK DIMENSIONS					
		W	D	H	W	D	H	W	H				
	Active weight 400 lbs./seat	IN 48 MM 1219	28 711	18 457	48 1219	26.75 679	18 457	-	-				
	Moisture barrier (MB), add \$161. Sealed seat seams (SS), add \$44.	RTA 00	1 per carton										
 <p>Three Seat Bench COM: 3 YD 2.74 M Unit weight: 75 LB 34.1 KG Carton weight: 97 LB 44 KG Carton volume: 27.75 FT³ 0.78 MT³</p>	GC36313	2167	2263	2344	2437	2590	2731	2872	2995	3148	3292	3487	3763
		OVERALL DIMENSIONS			SEAT DIMENSIONS			BACK DIMENSIONS					
		W	D	H	W	D	H	W	H				
	Active weight 400 lbs./seat	IN 72 MM 1829	28 711	18 457	72 1829	26.75 679	18 457	-	-				
	Moisture barrier (MB), add \$243. Sealed seat seams (SS), add \$65.	RTA 00	1 per carton										

TABLES	MODEL #	DIMENSIONS ^{IN} _{MM}	WEIGHT ^{LB} _{KG}	VOLUME ^{FT³} _{MT³}	LIST PRICE
--------	---------	---	---------------------------------------	---	------------

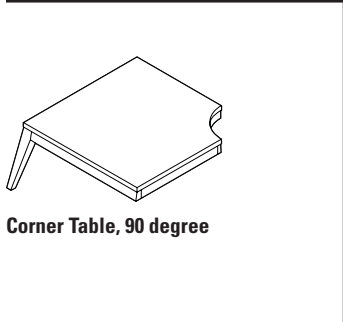

Corner Table, 90 degree

W x D x H					
GC36318	31.25 x 31.25 x 15.75	34	14.5		\$677
	794 x 794 x 400	15.5	0.41		

- For a thermally fused laminate top (**LP**), specify model GC36318-LP.
- For a high pressure laminate top (**HP**), specify model GC36318-HP. Add \$72.
- For a solid surface top (**CO**), specify model GC36318-CO. Add \$1970 for Grade 1. Add \$2250 for Grade 2.

Coordinating edge and solid wood frame. Must be connected to a guest chair. Includes one set of U-channel connectors and hardware. 1 per carton. Power and data can be added on the surface of the table (**LBT**) or (**RBT**). Add \$232. See power location diagram for placement on page 76.

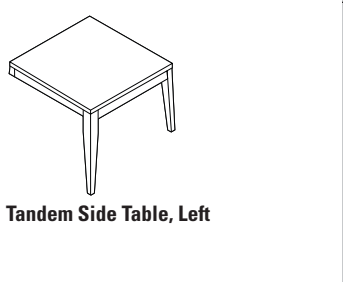

Tandem Side Table, Left

GC36319L	22.25 x 26.5 x 15.75	15	6.75		\$451
	565 x 673 x 400	6.8	0.19		

- For a thermally fused laminate top (**LP**), specify model GC36319L-LP.
- For a high pressure laminate top (**HP**), specify model GC36319L-HP. Add \$42.
- For a solid surface top (**CO**), specify model GC36319L-CO. Add \$869 for Grade 1. Add \$1159 for Grade 2.

Coordinating edge and solid wood frame. Must be connected to a guest chair. Includes one set of U-channel connectors and hardware. 1 per carton. Power and data can be added on the surface of the table (**CNT**). Add \$232.

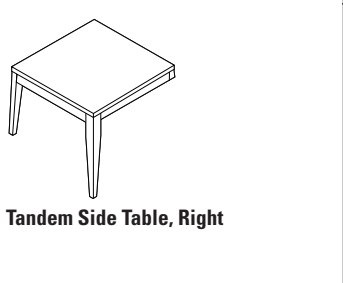

Tandem Side Table, Right

GC36319R	22.25 x 26.5 x 15.75	15	6.75		\$451
	565 x 673 x 400	6.8	0.19		

- For a thermally fused laminate top (**LP**), specify model GC36319R-LP.
- For a high pressure laminate top (**HP**), specify model GC36319R-HP. Add \$42.
- For a solid surface top (**CO**), specify model GC36319R-CO. Add \$869 for Grade 1. Add \$1159 for Grade 2.

Coordinating edge and solid wood frame. Must be connected to a guest chair. Includes one set of U-channel connectors and hardware. 1 per carton. Power and data can be added on the surface of the table (**CNT**). Add \$232.

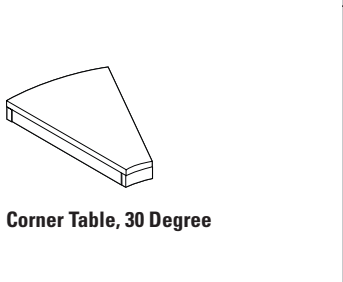

Corner Table, 30 Degree

GC36320	15.75 x 22.5 x 3	16	1.5		\$340
	400 x 572 x 76	7.25	0.04		

- For a thermally fused laminate top (**LP**), specify model GC36320-LP.
- For a high pressure laminate top (**HP**), specify model GC36320-HP. Add \$42.
- For a solid surface top (**CO**), specify model GC36320-CO. Add \$690 for Grade 1. Add \$840 for Grade 2.

Coordinating edge and solid wood frame. Must be connected between two guest chairs. Includes two sets of U-channel connectors and hardware. 1 per carton. Power and data can be added on the surface of the table (**CNT**). Add \$232.

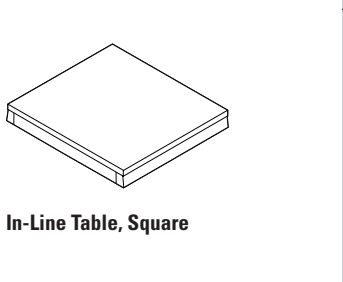

In-Line Table, Square

GC36321	23.5 x 21 x 3	16	1.9		\$368
	597 x 533 x 76	7.3	0.05		

- For a thermally fused laminate top (**LP**), specify model GC36321-LP.
- For a high pressure laminate top (**HP**), specify model GC36321-HP. Add \$42.
- For a solid surface top (**CO**), specify model GC36321-CO. Add \$822 for Grade 1. Add \$1032 for Grade 2.

Coordinating edge and solid wood frame. Must be connected between two guest chairs. Includes two sets of U-channel connectors and hardware. 1 per carton. Power and data can be added on the surface of the table (**CNT**). Add \$232.

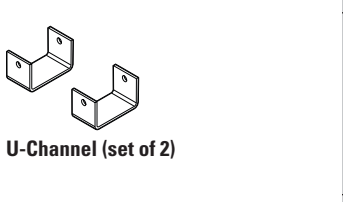

U-Channel (set of 2)

GC36322	1.5 x 2.87 x 1.62	0.5	0.1		\$40
	38 x 73 x 41	0.2	-		

Includes hardware. 4 sets per carton.

COAST



Clean out space around seat cushions for easy housekeeping

model GC4172

STANDARD FEATURES

- The smooth low range glide adds relaxing motion while you sink back and coast in this ultra-comfortable chair.
- Adjustable non-marking glides are standard.
- For added comfort, seats are standard with high density Ultracell foam.
- Clean out space is provided between the seat and back cushions for easy housekeeping.
- Arms on the glider are fixed with a grip allowing the user to easily enter and exit from the chair. Combined with a smooth low-range motion mechanism, this eliminates the need for a locking mechanism.
- Standard with Black urethane fully extended arms.
- Left and right position reference is determined from the seated position.
- Seamless front upholstery method on the seat cushion prevents eventual breakdown of seams causing liquid penetration into the foam.
- For healthcare textiles and finish options, visit the website at globalfurnituregroup.com.
- Can be upholstered in standard Global textiles if Healthcare compliance is not required.
- Shipped fully assembled.

OPTIONAL FEATURES

- For moisture barrier on seat, please specify **(MB)**. Add \$81.
- To add sealed seams to your product, please specify **(SS)**. Add \$153.
- For adjustable non-slip glides, please specify **(NS)**. Add \$22.
- Tablet arm with spill collector on the edge is available, offered in Black Phenolic material. From seated position, specify **(LT)** for left hand tablet or **(RT)** for right hand tablet. Add \$572. For left and right tablets, please specify **(TB)**. Add \$1143.

SUGGESTED APPLICATIONS

- Patient rooms
- Resident rooms
- Lounge/Waiting

Please add option codes in the following order:

- **Model number**
GC4172 Glider/motion chair
- **Textile**
Specify fabric code.
- **Armcap finish**
(SS) Black urethane armcap
(LA) Latte urethane armcap
(KL) Kalua urethane armcap
(MC) Mocha urethane armcap
(SH) Shadow urethane armcap
(TO) Toast urethane armcap
(AB) Absolute wood armcap
(CJ) Charcoal Java wood armcap
(AC) Cherry wood armcap
(EP) Empire Mahogany wood armcap
(EM) English Oak wood armcap
(EC) Espresso Cafe wood armcap
(HG) Gray wood armcap
(HA) Harvest Oak wood armcap
(AH) Honey wood armcap
(JO) Jet Onyx wood armcap
(LH) Light Honey wood armcap
(AV) Maple wood armcap
(MW) Medium Walnut wood armcap
(NT) Natural Walnut wood armcap
(AT) Night wood armcap
(BI) Noce Biondo wood armcap
(GI) Noce Grigio wood armcap
(EI) Noce Leggero wood armcap
(MI) Noce Medio wood armcap
(SB) Sandy Beach wood armcap
(SK) Shaker Cherry wood armcap
(SM) Silver Oak wood armcap
(TF) Tiger Fruitwood wood armcap
(TM) Tiger Mahogany wood armcap
(TL) Tiger Walnut wood armcap
(WR) WC Cream wood armcap
(WH) White wood armcap
(WC) Winter Cherry wood armcap
- **Glides**
(ST) Adjustable non-marking glides
(NS) Adjustable non-slip glides
- **Moisture barrier**
(MB) Seat only
- **Sealed seams**
(SS) All sealed seams

EXAMPLE COAST ORDER CODE:

GC4172	-LX21	-SS	-ST	-	-
Model #	Textile	Armcaps	Glides	Moisture barrier	Sealed seams

DESCRIPTION	MODEL# / FEATURES	STANDARD TEXTILE GRADES																																
		COM	2	3	4	5	6	7	8	9	10	11	12																					
 <p>Glider/Motion Chair COM: 5.5 YD 5.03 M Unit weight: 100 LB 45.5 KG Carton weight: 115 LB 52.16 KG Carton volume: 29.5 FT³ 0.83 MT³</p>	GC4172	2107	2283	2432	2602	2883	3141	3400	3625	3906	4170	4527	5033																					
	<p>Active weight 350 lbs.</p> <p>Specify armcap: wood or urethane.</p>	<table border="1"> <thead> <tr> <th colspan="3">OVERALL DIMENSIONS</th> <th colspan="3">SEAT DIMENSIONS</th> <th colspan="2">BACK DIMENSIONS</th> </tr> <tr> <th>W</th> <th>D</th> <th>H</th> <th>W</th> <th>D</th> <th>H</th> <th>W</th> <th>H</th> </tr> </thead> <tbody> <tr> <td>IN 30</td> <td>31.5</td> <td>43.5</td> <td>21.5</td> <td>19.5</td> <td>18</td> <td>22</td> <td>28</td> </tr> <tr> <td>MM 762</td> <td>800</td> <td>1105</td> <td>546</td> <td>495</td> <td>457</td> <td>559</td> <td>711</td> </tr> </tbody> </table>	OVERALL DIMENSIONS			SEAT DIMENSIONS			BACK DIMENSIONS		W	D	H	W	D	H	W	H	IN 30	31.5	43.5	21.5	19.5	18	22	28	MM 762	800	1105	546	495	457	559	711
OVERALL DIMENSIONS			SEAT DIMENSIONS			BACK DIMENSIONS																												
W	D	H	W	D	H	W	H																											
IN 30	31.5	43.5	21.5	19.5	18	22	28																											
MM 762	800	1105	546	495	457	559	711																											

COLLINGWOOD



model GC36510



STANDARD FEATURES

- Collingwood offers a cozy, streamlined design with classic curves.
- Features a clean out around the seat cushion for easy housekeeping.
- The seat underside is sealed with a non-porous material to support housekeeping and infection control protocols.
- Seat cushion is mechanically removable, if required.
- Legs are available in wood or urethane, in a variety of colors.
- For added comfort, seat cushions are standard with high density Ultracell foam.
- Opaque non-marking glides are standard.
- For healthcare textiles, visit the website at globalfurnituregroup.com.
- Can be upholstered in standard Global textiles if healthcare compliance is not required.
- Shipped fully assembled.

SUGGESTED APPLICATIONS

- Dining/Cafeteria
- Guest seating
- Lobbies
- Lounge/Waiting
- Patient rooms
- Resident rooms

OPTIONAL FEATURES

Please add option codes in the following order:

- **Model number**
GC36510 Low Back Lounge Chair
GC36511 High Back Lounge Chair
- **Sealed back/arms seams (NS)** No sealed back seams.
(SS) Sealed back seams. Upcharges vary, see model.
- **Back/arms textile**
Specify textile code.
- **Sealed seat seams (NS)** No sealed seat seams.
(SS) Sealed seat seams. Add \$27.
- **Seat textile**
Specify textile code.
- **Wood leg finish**
(AAM) Absolute **(MWM)** Medium Walnut
(BKM) Black **(NLW)** Natural Walnut
(CJM) Charcoal Java **(NSM)** Night
(ACM) Cherry **(NBM)** Noce Biondo
(EMM) Empire Mahogany **(NGM)** Noce Grigio
(EOM) English Oak **(NEM)** Noce Leggero
(ECM) Espresso Cafe **(NMM)** Noce Medio
(TFM) Fruitwood **(SBM)** Sandy Beach
(HGM) Gray **(SKM)** Shaker Cherry
(HOM) Harvest Oak **(SOM)** Silver Oak
(AHM) Honey **(TWM)** Walnut
(JOM) Jet Onyx **(WTM)** WC Cream
(LHM) Light Honey **(WHM)** White
(TMM) Mahogany **(WCM)** Winter Cherry
(AVM) Maple
- **Urethane leg finish**
Add \$150.
(BLK) Black **(J52)** Mocha
(KAL) Kalua **(SHW)** Shadow
(LAB) Latte **(TOA)** Toast
- **Glides**
(NM) Non-marking glides. No upcharge
(RG) Rubber, non-slip glides. Add \$21.
(SG) Steel cushion glides. Add \$17.
(FG) Felt glides. Add \$21.
- **Moisture barrier (seat only)**
(NB) No moisture barrier. No upcharge.
(MB) Moisture barrier. Add \$77.

EXAMPLE COLLINGWOOD ORDER CODE:

GC36510	NS	CE90	NS	CE90	AAM	NM	NB
Model #	Sealed back/arms seams	Back/arms textile	Sealed seat seams	Seat textile	Base	Glides	Moisture barrier

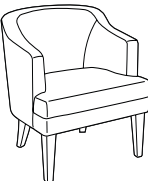
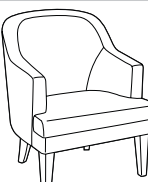
DESCRIPTION	MODEL# / FEATURES	STANDARD TEXTILE GRADES											
		COM	2	3	4	5	6	7	8	9	10	11	12
 <p>Low Back Lounge Chair COM: 4.5 YD 4.11 M Unit weight: 42 LB 19.1 KG Carton weight: 55 LB 24.95 KG Carton volume: 19.25 FT³ 0.54 MT³</p>	GC36510	1591	1735	1857	1997	2225	2437	2649	2833	3063	3279	3571	3985
		OVERALL DIMENSIONS W D H			SEAT DIMENSIONS W D H			BACK DIMENSIONS W H					
	Active weight 350 lbs. Replaceable seat cushion. Add \$54 for sealed back seams (SS)	IN 28	27.25	31	21	19	18	21.5	12.5				
	MM 711	692	787	533	483	457	546	318					
	RTA 00	1 per carton											
 <p>High Back Lounge Chair COM: 5 YD 4.57 M Unit weight: 43 LB 19.5 KG Carton weight: 56 LB 25.4 KG Carton volume: 22.5 FT³ 0.63 MT³</p>	GC36511	1632	1792	1927	2083	2337	2572	2807	3012	3267	3507	3832	4292
		OVERALL DIMENSIONS W D H			SEAT DIMENSIONS W D H			BACK DIMENSIONS W H					
	Active weight 350 lbs. Replaceable seat cushion. Add \$62 for sealed back seams (SS)	IN 28	28.5	35.5	21	19	18	21.5	17				
	MM 711	724	902	533	483	457	546	432					
	RTA 00	1 per carton											

DESMOND



model GC4162

STANDARD FEATURES





- Clean lines and a contoured picture frame style back coordinate with any decor.
- Arms incorporate a firm grip extension to assist users in the entry and exit from the chair.
- Additional support rails on the legs ensure strength and durability.
- For added comfort, seats are standard with high density Ultracell foam.
- Opaque non-marking glides are standard.
- For healthcare textiles and wood finish options, visit the website at globalfurnituregroup.com. Available in European beechwood species only (refer to finishes that end with an "M").
- Models ending in FC have front casters.
- Shipped fully assembled.

OPTIONAL FEATURES

- For non-slip glides, please specify **(NS)**. Add \$22. For models with front casters, add \$9.
- For moisture barrier on seat, please specify **(MB)**. Add \$81.

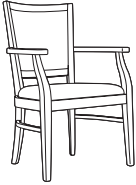
SUGGESTED APPLICATIONS

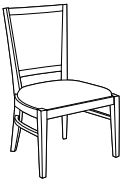
- Dining/Cafeteria
- Guest seating
- Lobbies
- Lounge/Waiting
- Office/Meeting
- Patient rooms
- Resident rooms

DESCRIPTION	MODEL# / FEATURES	STANDARD TEXTILE GRADES												
		COM	2	3	4	5	6	7	8	9	10	11	12	
 <p>Armchair COM: 1.25 YD 1.14 M Unit weight: 19 LB 8.6 KG Carton weight: 24 LB 10.89 KG Carton volume: 14.5 FT³ 0.41 MT³</p>	GC4162	1137	1177	1211	1250	1313	1372	1431	1482	1546	1606	1687	1802	
	Active weight 300 lbs.	OVERALL DIMENSIONS			SEAT DIMENSIONS			BACK DIMENSIONS						
		IN	24	22.5	36		22.5	18	17.5		17.5	18.5		
		MM	610	572	914		572	457	445		445	470		
		RTA 00		1 per carton										
 <p>Armchair Front Casters COM: 1.25 YD 1.14 M Unit weight: 19 LB 8.6 KG Carton weight: 24 LB 10.89 KG Carton volume: 14.5 FT³ 0.41 MT³</p>	GC4162FC	1218	1258	1292	1331	1394	1453	1512	1563	1627	1687	1768	1883	
	Active weight 300 lbs.	OVERALL DIMENSIONS			SEAT DIMENSIONS			BACK DIMENSIONS						
		IN	24	22.5	36		22.5	18	17.5		17.5	18.5		
		MM	610	572	914		572	457	445		445	470		
		RTA 00		1 per carton										
 <p>Side Chair COM: 1.25 YD 1.14 M Unit weight: 17 LB 7.7 KG Carton weight: 22 LB 9.98 KG Carton volume: 14.5 FT³ 0.41 MT³</p>	GC4165	1070	1110	1144	1183	1246	1305	1364	1415	1479	1539	1620	1735	
	Active weight 300 lbs.	OVERALL DIMENSIONS			SEAT DIMENSIONS			BACK DIMENSIONS						
		IN	22.5	22.5	36		22.5	18	17.5		17.5	18.5		
		MM	572	572	914		572	457	445		445	470		
		RTA 00		1 per carton										
 <p>Side Chair Front Casters COM: 1.25 YD 1.14 M Unit weight: 17 LB 7.7 KG Carton weight: 22 LB 9.98 KG Carton volume: 14.5 FT³ 0.41 MT³</p>	GC4165FC	1149	1189	1223	1262	1325	1384	1443	1494	1558	1618	1699	1814	
	Active weight 300 lbs.	OVERALL DIMENSIONS			SEAT DIMENSIONS			BACK DIMENSIONS						
		IN	22.5	22.5	36		22.5	18	17.5		17.5	18.5		
		MM	572	572	914		572	457	445		445	470		
		RTA 00		1 per carton										

DESMOND HT



model GC4290

EXAMPLE DESMOND HT ORDER CODE:

GC4290	-LX21	-TBL	-PT	-BK	-MB
Model #	Textile	Frame	Armcaps	Glides	Moisture barrier

STANDARD FEATURES

- Desmond HT is a metal framed chair with residential design while ensuring maximum strength and durability within very challenging applications.
- Available with four-legged metal welded frame with or without arms; with rear casters that allow the caregiver to tip and move chair without lifting; with lift mechanism and rear casters to assist the caregiver in turning the chair and moving the occupant to and from a table; or a bariatric model.
- Models with rear casters also allow the caregiver to turn the chair with occupant seated for better access to wheelchair or walker.
- The welded metal frame, welded cross rails on lower frame, metal-to-metal fasteners on seat pan, back insert and urethane armcaps enhance strength and durability, ensuring its performance in the most rigorous environments.
- Urethane armcaps are comfortable, durable, cleanable and replaceable. Designed to offer proper support while seated and the egress grip allows the occupant to use with confidence when getting in or out of the chair.
- For added comfort and long term performance the seat cushion is standard with high density Ultracell foam.
- The underside of the seat pan is moisture resistant, and the cushions have no exposed seams to support improved housekeeping and infection prevention practices.
- For healthcare textiles and finish options, visit the website at globalfurnituregroup.com.
- Can be upholstered in standard Global textiles if Healthcare compliance is not required.
- Shipped fully assembled.

OPTIONAL FEATURES



- To add additional weight to your product, contact Customer Service for more information.
- For moisture barrier on seat, please specify **(MB)**. Add \$81. For bariatric model, add \$122.



Please add option codes in the following order:

- **Model number**
GC4290 Metal armchair
GC4291 Metal armchair w/two rear swivel casters
GC4292 Metal armchair w/two rear swivel casters and lift mechanism
GC4293 Metal bariatric armchair
GC4294 Metal side chair, armless
- **Textile**
Specify fabric code.
- **Frame finish**
(TBL) Black
(TIV) Cloud
(TDW) Designer White
(TFO) Fog
(TFR) Frost
(TKA) Kalua
(TLA) Latte
(TMO) Mocha
(TNE) Nevada
(TSN) Sand
(TSH) Shadow
(TOA) Toast
(TTU) Tungsten
- **Armcap finish**
(SS) Black
(KL) Kalua
(LA) Latte
(MC) Mocha
(SH) Shadow
(TO) Toast
- **Glides**
(BK) Black plastic glides
- **Moisture barrier**
(MB) Seat only

SUGGESTED APPLICATIONS

- Bariatric seating (model GC4293)
- Dining/Cafeteria
- Guest seating
- Lobbies
- Lounge/Waiting
- Office/Meeting
- Patient rooms
- Resident room

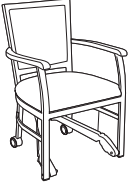
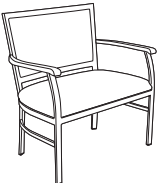
DESCRIPTION	MODEL# / FEATURES	STANDARD TEXTILE GRADES												
		COM	2	3	4	5	6	7	8	9	10	11	12	
 <p>Metal Armchair COM: 1.25 YD 1.14 M Unit weight: 34 LB 15.5 KG Carton weight: 41 LB 18.6 KG Carton volume: 13.75 FT³ 0.38 MT³</p>	GC4290	1262	1302	1336	1375	1438	1497	1556	1607	1671	1731	1812	1927	
	Active weight 500 lbs.													
			OVERALL DIMENSIONS			SEAT DIMENSIONS			BACK DIMENSIONS					
			IN	24.5	23.5	35.75	23	19	18.5	18	17.5			
		MM	622	597	908	584	483	470	457	445				
		RTA 00	1 per carton											
 <p>Metal Armchair w/Two Rear Swivel Casters COM: 1.25 YD 1.14 M Unit weight: 34 LB 15.5 KG Carton weight: 41 LB 18.6 KG Carton volume: 13.75 FT³ 0.38 MT³</p>	GC4291	1349	1389	1423	1462	1525	1584	1643	1694	1758	1818	1899	2014	
	Active weight 500 lbs.													
			OVERALL DIMENSIONS			SEAT DIMENSIONS			BACK DIMENSIONS					
			IN	24.5	23.5	35.75	23	19	18.5	18	17.5			
		MM	622	597	908	584	483	470	457	445				
		RTA 00	1 per carton											

DESCRIPTION	MODEL# / FEATURES	STANDARD TEXTILE GRADES											
		COM	2	3	4	5	6	7	8	9	10	11	12
 <p>Metal Armchair w/Two Rear Swivel Casters & Lift Mec. COM: 1.25 YD 1.14 M Unit weight: 37 LB 16.8 KG Carton weight: 44 LB 19.96 KG Carton volume: 13.75 FT³ 0.38 MT³</p>	<p>GC4292</p> <p>Active weight 500 lbs.</p>	1739	1779	1813	1852	1915	1974	2033	2084	2148	2208	2289	2404
		OVERALL DIMENSIONS			SEAT DIMENSIONS			BACK DIMENSIONS					
		W	D	H	W	D	H	W	H				
		IN 24.5	23.5	35.75	23	19	18.5	18	17.5				
		MM 622	597	908	584	483	470	457	445				
	RTA 00	1 per carton											
 <p>Metal Bariatric Armchair COM: 2.25 YD 2.06 M Unit weight: 40 LB 18.2 KG Carton weight: 48 LB 21.77 KG Carton volume: 20 FT³ 0.56 MT³</p>	<p>GC4293</p> <p>Active weight 750 lbs.</p>	1686	1758	1819	1889	2003	2109	2215	2307	2422	2530	2676	2883
		OVERALL DIMENSIONS			SEAT DIMENSIONS			BACK DIMENSIONS					
		W	D	H	W	D	H	W	H				
		IN 35.5	23.5	35.75	34	19	18.5	29	17.5				
		MM 902	597	908	864	483	470	737	445				
	RTA 00	1 per carton											
 <p>Metal Armless Side Chair COM: 1.25 YD 1.14 M Unit weight: 29 LB 13.2 KG Carton weight: 36 LB 16.33 KG Carton volume: 13.75 FT³ 0.38 MT³</p>	<p>GC4294</p> <p>Active weight 500 lbs.</p>	1158	1198	1232	1271	1334	1393	1452	1503	1567	1627	1708	1823
		OVERALL DIMENSIONS			SEAT DIMENSIONS			BACK DIMENSIONS					
		W	D	H	W	D	H	W	H				
		IN 23	23.5	35.75	23	19	18.5	18	17.5				
		MM 584	597	908	584	483	470	457	445				
	RTA 00	1 per carton											

DREME



model GC35042



Drawer box surface

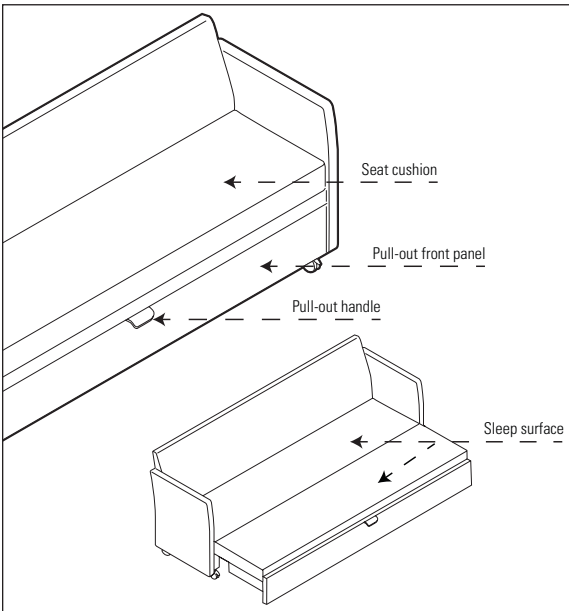

STANDARD FEATURES

- Dreme has a compact, comfortable design that offers a place to sit or easily converts into a generous sleep surface. The various configurations include a bench with or without back and with or without arms. All models are listed.
- The seat deck is a clean through metal platform for superior strength.
- The seat/sleep cushion is attached to the unit with straps that are held in place by metal-to-metal fasteners for unparalleled strength and durability. This allows sheets to be tucked in place.
- There is a clean out space to the floor at the back of the seat cushion in support of housekeeping and infection control practices.
- The seat cushion folds open to create a 36" deep sleep surface area. Foam is standard high density Ultracell, for enhanced comfort and long-term performance.
- Below the seat deck is a closed drawer box that pulls out, increasing the sleep area.
- The sleep surface cushion and drawer box covering are upholstered in Bantam Vinyl to ensure moisture barrier protection. These surfaces are 9:1 (water to bleach) cleanable. Please select **(BM)** color. See Morbern Bantam textile card for color samples.
- All other surfaces can be specified in your textile of choice.
- The drawer section of the unit has a Chrome handle to assist adjusting the unit from a bench to a sleep surface.
- The lower portion of the unit is supported by four heavy duty supporting non-locking casters when in sleep position and is standard without storage.
- Straps can be unfastened for field replacement of the cushion, if required for any reason.
- Dreme requires zero wall clearance to open into sleep position.
- Standard configuration for all models: two metal legs in front position, two non-locking swivel casters in back position (to assist with moving the unit). Optional front, locking, swivel casters **(BC)** are available. Add \$54.
- A tablet arm is available on units with arms only. The tablet surfaces attach to the outside of the arm (will add 4" to the length of the overall length per tablet). The tablet swivels up and can be moved over the arm and swiveled into place for use by the occupant. The oblong oval shaped tablet is a phenolic surface, strong, non-porous and extremely durable. It offers a no-spill edge and is standard in soft Black. Tablet designation is based on seated position. See models with tablet option for ordering.
- Interior sleep surface: 79"L x 37"W
- All textiles are railroaded across all Dreme components.
- For healthcare textiles, visit the website at globalfurnituregroup.com.
- Can be upholstered in standard Global textiles if Healthcare compliance is not required.

OPTIONAL FEATURES

- The pull-out is available with a storage compartment option below the sleep surface. The storage compartment is divided into two sides and is finished in Storm Grey **(SOG)** laminate. The storage compartment must be ordered at time of original order and cannot be retrofitted, specify **(SR)**. Add \$327.
- Storage compartment lids have a pneumatic lift support, allowing the lid to stay open when accessing the interior storage area.
- An optional seamless White drawer liner is available for the storage compartment, as a set of two. Liners can be removed for ease of maintenance, specify **(SL)**. Add \$655.
- Pull-out front panel is available in upholstered or laminate finish with or without power units. Specify the following:
(FL) laminate panel no power
(LP) laminate panel with power. Add \$160
(FU) upholstered panel
(UP) upholstered panel with power. Add \$160
 Select from all standard laminate finishes.
- Power module is available on the front panel, center front position. The unit includes one power and two USB-A, 10 watt charging ports and an 8 ft. long power cord. When the pull-out is in open position the remaining power cord length is 6 ft. The power module is Black with Black face plate and must be specified at time of order.
- **Leg finish/caster option:**
(TBL) Black
(TLA) Latte
(TKA) Kalua
(TMO) Mocha
(TSH) Shadow
(TOA) Toast
(TTU) Tungsten
(BC) Front, locking, swivel casters. Add \$54 (Casters are Black with Taupe center)
- **Sleep Surface Finish:**
(B21) BM21 Apple
(B25) BM25 Cosmic
(B23) BM23 Dove
(B26) BM26 Firelight
(B22) BM22 Ghost
(B27) BM27 Ginger
(B24) BM24 Iron
(B20) BM20 Rabbit
(B28) BM28 Tropical
- For moisture barrier on seat and sleeping surface, please specify **(MB)**. Upcharges vary by model.
- To add sealed seams to your product, please specify **(SS)**. Upcharges vary by model.

SUGGESTED APPLICATIONS

- Lounge rooms
- Patient rooms
- Resident rooms
- Treatment/Exam rooms

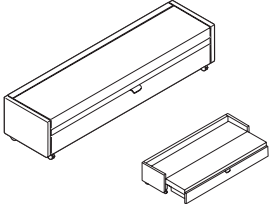
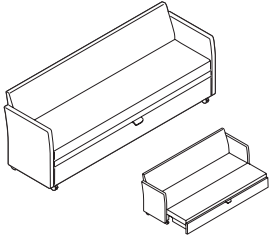
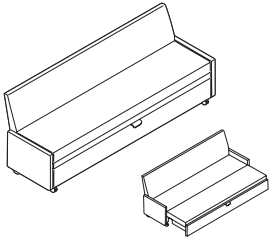
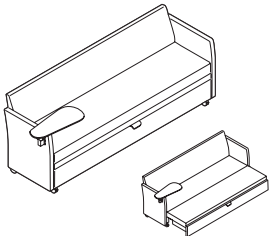
DESCRIPTION	MODEL# / FEATURES	STANDARD TEXTILE GRADES																															
		COM	2	3	4	5	6	7	8	9	10	11	12																				
 <p>Armless Sleeper COM: 9.5 YD 8.69 M Unit weight: 143 LB 65 KG Carton weight: 158 LB 71.67 KG Carton volume: 22.75 FT³ 0.64 MT³</p>	GC35041NA	4185	4489	4746	5040	5525	5971	6418	6807	7292	7748	8365	9239																				
	<p>Active weight 450 lbs.</p> <p>Add \$310 for (MB) Add \$299 for (SS)</p>	<table border="1"> <thead> <tr> <th colspan="3">OVERALL DIMENSIONS</th> <th colspan="3">SEAT DIMENSIONS</th> <th colspan="2">BACK DIMENSIONS</th> </tr> <tr> <th>W</th> <th>D</th> <th>H</th> <th>W</th> <th>D</th> <th>H</th> <th>W</th> <th>H</th> </tr> </thead> <tbody> <tr> <td>IN 82</td> <td>23</td> <td>18.5</td> <td>78</td> <td>-</td> <td>18.5</td> <td>-</td> <td>-</td> </tr> <tr> <td>MM 2083</td> <td>584</td> <td>470</td> <td>1981</td> <td>-</td> <td>470</td> <td>-</td> <td>-</td> </tr> </tbody> </table>	OVERALL DIMENSIONS			SEAT DIMENSIONS			BACK DIMENSIONS		W	D	H	W	D	H	W	H	IN 82	23	18.5	78	-	18.5	-	-	MM 2083	584	470	1981	-	470	-
OVERALL DIMENSIONS			SEAT DIMENSIONS			BACK DIMENSIONS																											
W	D	H	W	D	H	W	H																										
IN 82	23	18.5	78	-	18.5	-	-																										
MM 2083	584	470	1981	-	470	-	-																										
 <p>Sleeper w/Back and Arms COM: 11.75 YD 10.74 M Unit weight: 195 LB 88.6 KG Carton weight: 210 LB 95.25 KG Carton volume: 46.25 FT³ 1.3 MT³</p>	GC35042	4732	5108	5426	5790	6389	6941	7494	7975	8575	9139	9902	10983																				
	<p>Active weight 450 lbs.</p> <p>Add \$310 for (MB) Add \$371 for (SS)</p>	<table border="1"> <thead> <tr> <th colspan="3">OVERALL DIMENSIONS</th> <th colspan="3">SEAT DIMENSIONS</th> <th colspan="2">BACK DIMENSIONS</th> </tr> <tr> <th>W</th> <th>D</th> <th>H</th> <th>W</th> <th>D</th> <th>H</th> <th>W</th> <th>H</th> </tr> </thead> <tbody> <tr> <td>IN 82</td> <td>25</td> <td>32.5</td> <td>78</td> <td>18</td> <td>18.5</td> <td>78</td> <td>14</td> </tr> <tr> <td>MM 2083</td> <td>635</td> <td>826</td> <td>1981</td> <td>457</td> <td>470</td> <td>1981</td> <td>356</td> </tr> </tbody> </table>	OVERALL DIMENSIONS			SEAT DIMENSIONS			BACK DIMENSIONS		W	D	H	W	D	H	W	H	IN 82	25	32.5	78	18	18.5	78	14	MM 2083	635	826	1981	457	470	1981
OVERALL DIMENSIONS			SEAT DIMENSIONS			BACK DIMENSIONS																											
W	D	H	W	D	H	W	H																										
IN 82	25	32.5	78	18	18.5	78	14																										
MM 2083	635	826	1981	457	470	1981	356																										
 <p>Armless Sleeper w/Back COM: 10.5 YD 9.6 M Unit weight: 175 LB 79.5 KG Carton weight: 190 LB 86.18 KG Carton volume: 46.25 FT³ 1.3 MT³</p>	GC35042NA	4628	4964	5248	5573	6109	6602	7096	7526	8062	8566	9248	10214																				
	<p>Active weight 450 lbs.</p> <p>Add \$310 for (MB) Add \$299 for (SS)</p>	<table border="1"> <thead> <tr> <th colspan="3">OVERALL DIMENSIONS</th> <th colspan="3">SEAT DIMENSIONS</th> <th colspan="2">BACK DIMENSIONS</th> </tr> <tr> <th>W</th> <th>D</th> <th>H</th> <th>W</th> <th>D</th> <th>H</th> <th>W</th> <th>H</th> </tr> </thead> <tbody> <tr> <td>IN 82</td> <td>25</td> <td>32.5</td> <td>78</td> <td>18</td> <td>18.5</td> <td>78</td> <td>14</td> </tr> <tr> <td>MM 2083</td> <td>635</td> <td>826</td> <td>1981</td> <td>457</td> <td>470</td> <td>1981</td> <td>356</td> </tr> </tbody> </table>	OVERALL DIMENSIONS			SEAT DIMENSIONS			BACK DIMENSIONS		W	D	H	W	D	H	W	H	IN 82	25	32.5	78	18	18.5	78	14	MM 2083	635	826	1981	457	470	1981
OVERALL DIMENSIONS			SEAT DIMENSIONS			BACK DIMENSIONS																											
W	D	H	W	D	H	W	H																										
IN 82	25	32.5	78	18	18.5	78	14																										
MM 2083	635	826	1981	457	470	1981	356																										
 <p>Sleeper w/Back, Arms, Right Tablet COM: 11.75 YD 10.74 M Unit weight: 200 LB 90.9 KG Carton weight: 215 LB 97.52 KG Carton volume: 48.5 FT³ 1.37 MT³</p>	GC35042T	4981	5357	5675	6039	6638	7190	7743	8224	8824	9388	10151	11232																				
	<p>Active weight 450 lbs.</p> <p>Specify (LT) for left tablet. Specify (TB) for tablet on both arms. Add \$238.</p> <p>Add \$310 for (MB) Add \$371 for (SS)</p>	<table border="1"> <thead> <tr> <th colspan="3">OVERALL DIMENSIONS</th> <th colspan="3">SEAT DIMENSIONS</th> <th colspan="2">BACK DIMENSIONS</th> </tr> <tr> <th>W</th> <th>D</th> <th>H</th> <th>W</th> <th>D</th> <th>H</th> <th>W</th> <th>H</th> </tr> </thead> <tbody> <tr> <td>IN 86</td> <td>25</td> <td>32.5</td> <td>78</td> <td>18</td> <td>18.5</td> <td>78</td> <td>14</td> </tr> <tr> <td>MM 2184</td> <td>635</td> <td>826</td> <td>1981</td> <td>457</td> <td>470</td> <td>1981</td> <td>356</td> </tr> </tbody> </table>	OVERALL DIMENSIONS			SEAT DIMENSIONS			BACK DIMENSIONS		W	D	H	W	D	H	W	H	IN 86	25	32.5	78	18	18.5	78	14	MM 2184	635	826	1981	457	470	1981
OVERALL DIMENSIONS			SEAT DIMENSIONS			BACK DIMENSIONS																											
W	D	H	W	D	H	W	H																										
IN 86	25	32.5	78	18	18.5	78	14																										
MM 2184	635	826	1981	457	470	1981	356																										

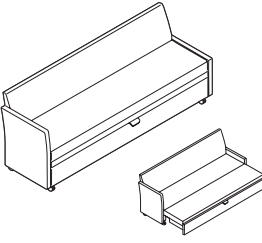
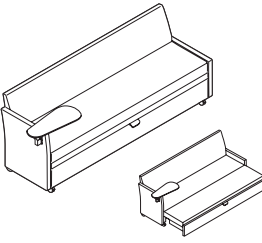
DESCRIPTION	MODEL# / FEATURES	STANDARD TEXTILE GRADES											
		COM	2	3	4	5	6	7	8	9	10	11	12
 <p>Sleeper w/Back, Right Arm COM: 11.25 YD 10.29 M Unit weight: 185 LB 84.1 KG Carton weight: 200 LB 90.72 KG Carton volume: 46.25 FT³ 1.3 MT³</p>	GC35043 Active weight 450 lbs. Add \$310! for (MB) Add \$335 for (SS)	4748	5108	5412	5761	6335	6863	7392	7853	8427	8967	9698	10733
		OVERALL DIMENSIONS W D H			SEAT DIMENSIONS W D H			BACK DIMENSIONS W H					
		IN 82	25	32.5		78	18	18.5		78	14		
		MM 2083	635	826		1981	457	470		1981	356		
						RTA 00	1 per carton						
 <p>Sleeper w/Back, Right Arm w/Tablet COM: 11.25 YD 10.29 M Unit weight: 190 LB 86.4 KG Carton weight: 205 LB 92.99 KG Carton volume: 47.5 FT³ 1.34 MT³</p>	GC35043T Specify (LT) for left tablet/arm. Active weight 450 lbs. Add \$310 for (MB) Add \$335 for (SS)	4997	5357	5661	6010	6584	7112	7641	8102	8676	9216	9947	10982
		OVERALL DIMENSIONS W D H			SEAT DIMENSIONS W D H			BACK DIMENSIONS W H					
		IN 86	25	32.5		78	18	18.5		78	14		
		MM 2184	635	826		1981	457	470		1981	356		
						RTA 00	1 per carton						

ERIN



model GC36530



model GC36533



back textile

seat textile

STANDARD FEATURES

- Erin offers a streamlined silhouette brimming with mid-century modern style.
- A rounded arch gently curves around and under the seat to give extra support to user's upper back and sides, while creating an open clean out space at the back of the cushion.
- Tapered legs add style and elegance.
- Legs are available in wood or metal paint/plated finishes (noted).
- The seat underside is sealed with a non-porous material to support housekeeping and infection control protocols.
- Additional improved cleaning options include sealed seams (back and/or seat) and moisture barrier (seat). Upcharges apply.
- Assembled with tamper-resistant fasteners for greater security.
- For added comfort, seat cushions are standard with high density Ultracell foam.
- Glides are self-leveling. Choose from standard non-marking glides, rubber non-slip glides or felt glides (upcharges apply).
- For healthcare textiles, visit the website at globalfurnituregroup.com.
- Can be upholstered in standard Global textiles if Healthcare 24/7 application compliance is not required.
- Shipped fully assembled.

SUGGESTED APPLICATIONS

- Dining/Cafeteria
- Guest seating
- Lobbies
- Lounge/Waiting
- Patient rooms
- Resident rooms

OPTIONAL FEATURES

Please add option codes in the following order:

- **Model number**
GC36530 Guest armless chair, wood legs
GC36531 Guest armless chair, metal legs
GC3632 Guest armchair, wood legs
GC3632 Guest armchair, metal legs
- **Sealed back seams**
(NS) No sealed back seams
(SS) Sealed back seams. Upcharges vary, see model. Add \$43.
- **Back textile**
Specify textile code.
- **Sealed seat seams**
(NS) No sealed seat seams
(SS) Sealed seat seams. Add \$17.
- **Seat textile**
Specify textile code.
- **Wood leg finish** (models GC36530 and GC36532)
(AAM) Absolute **(MWM)** Medium Walnut
(BKM) Black **(NLW)** Natural Walnut
(CJM) Charcoal Java **(ASM)** Night
(ACM) Cherry **(NBM)** Noce Biondo
(EMM) Empire Mahogany **(NGM)** Noce Grigio
(EOM) English Oak **(NEM)** Noce Leggero
(ECM) Espresso Cafe **(NMM)** Noce Medio
(TFM) Fruitwood **(SBM)** Sandy Beach
(HGM) Gray **(SKM)** Shaker Cherry
(HOM) Harvest Oak **(SOM)** Silver Oak
(AHM) Honey **(TWM)** Walnut
(JOM) Jet Onyx **(WTM)** WC Cream
(LHM) Light Honey **(WHM)** White
(TMM) Mahogany **(WCM)** Winter Cherry
(AVM) Maple
- **Metal leg finish** (models GC36531 and GC36533)
(CHM) Chrome **(TTU)** Tungsten
(TBL) Black **(TKA)** Kalua
(TLA) Latte **(TMO)** Mocha
(TSH) Shadow **(TOA)** Toast
- **Glides**
(NM) Non-marking glides. No upcharge
(RG) Rubber, non-slip glides. Add \$43.
(FG) Felt glides. Add \$43.
- **Moisture barrier**
(NB) No moisture barrier. No upcharge.
(MB) Moisture barrier (seat only). Add \$81.

EXAMPLE ERIN ORDER CODE:

GC36530	NS	CE90	NS	CE90	AAM	NM	NB
Model #	Sealed back seams	Back textile	Sealed seat seams	Seat textile	Leg finish	Glides	Moisture barrier

DESCRIPTION	MODEL# / FEATURES	STANDARD TEXTILE GRADES																																										
		COM	2	3	4	5	6	7	8	9	10	11	12																															
 Armless Guest Chair, Wood Legs COM: 2.75 YD 2.51 M Unit weight: 23.5 LB 10.7 KG Carton weight: 32.5 LB 14.74 KG Carton volume: 13.25 FT³ 0.37 MT³	GC36530	1410	1498	1572	1658	1798	1927	2056	2169	2309	2441	2620	2873																															
	Active weight 350 lbs.	<table border="1"> <thead> <tr> <th colspan="3">OVERALL DIMENSIONS</th> <th colspan="3">SEAT DIMENSIONS</th> <th colspan="2">BACK DIMENSIONS</th> </tr> <tr> <th>W</th> <th>D</th> <th>H</th> <th>W</th> <th>D</th> <th>H</th> <th>W</th> <th>H</th> </tr> </thead> <tbody> <tr> <td>IN 24</td> <td>22.25</td> <td>34</td> <td>19</td> <td>18</td> <td>19</td> <td>15</td> <td>15.5</td> </tr> <tr> <td>MM 610</td> <td>565</td> <td>864</td> <td>483</td> <td>457</td> <td>483</td> <td>381</td> <td>394</td> </tr> </tbody> </table>												OVERALL DIMENSIONS			SEAT DIMENSIONS			BACK DIMENSIONS		W	D	H	W	D	H	W	H	IN 24	22.25	34	19	18	19	15	15.5	MM 610	565	864	483	457	483	381
OVERALL DIMENSIONS			SEAT DIMENSIONS			BACK DIMENSIONS																																						
W	D	H	W	D	H	W	H																																					
IN 24	22.25	34	19	18	19	15	15.5																																					
MM 610	565	864	483	457	483	381	394																																					
	RTA 00	1 per carton																																										

DESCRIPTION MODEL# / FEATURES STANDARD TEXTILE GRADES



Armless Guest Chair, Metal Legs
 COM: 2.75 YD | 2.51 M
 Unit weight: 25.5 LB | 11.6 KG
 Carton weight: 34.5 LB | 15.65 KG
 Carton volume: 13.25 FT³ | 0.37 MT³

Active weight 350 lbs.

MODEL#	2	3	4	5	6	7	8	9	10	11	12	
GC36531	1335	1423	1497	1583	1723	1852	1981	2094	2234	2366	2545	2798

OVERALL DIMENSIONS			SEAT DIMENSIONS			BACK DIMENSIONS	
W	D	H	W	D	H	W	H

IN	24	22.25	34	19	18	19	15	15.5
MM	610	565	864	483	457	483	381	394

RTA 00 1 per carton



Guest Armchair, Wood Legs
 COM: 2.75 YD | 2.51 M
 Unit weight: 24 LB | 10.9 KG
 Carton weight: 33 LB | 14.97 KG
 Carton volume: 13.25 FT³ | 0.37 MT³

Active weight 350 lbs.

MODEL#	2	3	4	5	6	7	8	9	10	11	12	
GC36532	1410	1498	1572	1658	1798	1927	2056	2169	2309	2441	2620	2873

OVERALL DIMENSIONS			SEAT DIMENSIONS			BACK DIMENSIONS	
W	D	H	W	D	H	W	H

IN	24	22	34.25	19	18.5	18.5	17	15.75
MM	610	559	870	483	470	470	432	400

RTA 00 1 per carton



Guest Armchair, Metal Legs
 COM: 2.75 YD | 2.51 M
 Unit weight: 26 LB | 11.8 KG
 Carton weight: 35 LB | 15.88 KG
 Carton volume: 13.25 FT³ | 0.37 MT³

Active weight 350 lbs.

MODEL#	2	3	4	5	6	7	8	9	10	11	12	
GC36533	1335	1423	1497	1583	1723	1852	1981	2094	2234	2366	2545	2798

OVERALL DIMENSIONS			SEAT DIMENSIONS			BACK DIMENSIONS	
W	D	H	W	D	H	W	H

IN	24	22	34.25	19	18.5	18.5	17	15.75
MM	610	559	870	483	470	470	432	400

RTA 00 1 per carton

FROLICK & SPLASH



model GC3001

model GC3011

Three different back constructions



Separate panel piece closes the lower back to conceal the support bracket. Offered on select **Frolick** models.



Single piece back with a pullover style upholstery cover and exposed support brackets fastened on the outer back. Offered on select **Frolick** models.



Two-piece back covering the back support brackets when fastened in place. Offered on **Splash** models.

STANDARD FEATURES

- Frolick & Splash are multi-purpose stacking chairs that share generous widths between the arms, great comfort and a frame built for greater strength and stability. Each series offers a different back design with special features to best address the application and infection prevention practices.
- Four-legged standard size models stack 5 high on floor and 8 high on GC3010 dolly.
- Four-legged bariatric models stack 2 high only on floor. No dolly available.
- Sled base models do not stack.
- Standard size models offer 19" seat width with 21.5" clearance between the armrests. Bariatric size models (Frolick) offer 31.5" seat width with 33.5" clearance between the armrests.
- For a smaller scale bariatric chair, refer to GC Comet #GC2180 which offers 18.5" seat depth with 28" clearance between armrests.
- Heavy duty round, tubular gusseted frames available. Please specify finish.
- Active weight capacity is up to 300 lbs. for standard models; 500 lbs. for bariatric models.
- Protective Platinum color seat shroud is standard on all models (except bariatric models GC3003 and GC3023).
- To respond to higher expectations for housekeeping and infection control practices, select models with a one-piece back. Description of back is noted with each model.
- Wall saver rear legs eliminate accidental damage to walls.
- Armrests are fiberglass reinforced nylon and have a flat profile. Fully extended to front of seat edge to assist in entry and exit from the chair.
- Armrests are standard in Black.
- For added comfort, seats are standard with high density Ultracell foam.
- For ganging brackets, see model 2180 on page 123.
- Black frames are standard with Black glides and front leg caps on armless models. All other frame colors are standard with Platinum glides and front leg caps on armless models.
- For healthcare textile and finish options, visit the website at globalfurnituregroup.com.
- Can be upholstered in standard Global textiles if Healthcare compliance is not required.

OPTIONAL FEATURES

- A selection of glide options is available. Glides must be chosen to best suit flooring type and site conditions. For more information, please refer to the glide section (page 274).
- For hard surface floors, please specify opaque non-marking glides (**NM**). No upcharge.
- Glides with felt pads (**FG**) are available for vinyl sheet, cork or laminate flooring, please specify. Add \$43.
- Glides with rubber pads (**RG**) are available for vinyl, hardwood, laminate, stone or ceramic flooring, please specify. Add \$43.
- Armrests available in Shadow (**SHW**) and Toast (**TOA**). Please specify. Add \$25.
- To add sealed seams to your product contact Customer Service. Pricing is based on the model number, available on the website Build It tool.
- For moisture barrier on seat, please specify (**MB**). Add \$81. Bariatric models: Add \$122.
- For improved housekeeping and infection control practices sealed underside (**SU**) on the seat shroud can be removed and the underside of the seat can be finished with vinyl and sealed to prevent penetration of liquids. The back seam that closes upholstery on underside of the back will also be sealed.
- **Frame finish**
Paint finishes. No upcharge.
(**TBL**) Black (TIN) Ink
(**TBZ**) Buzz Blue (TKA) Kalua
(**TCC**) Cactus (TLA) Latte
(**TCR**) Carrot (TMO) Mocha
(**TIV**) Cloud (TNE) Nevada
(**TDW**) Designer White (TSN) Sand
(**TDJ**) Dijon (TSR) Scarlet
(**TEG**) Eggplant (TSH) Shadow
(**TFO**) Fog (TOA) Toast
(**TFR**) Frost (TTU) Tungsten
Plated finish. See models for upcharges.
(**CHM**) Chrome

SUGGESTED APPLICATIONS

- Bariatric seating (Frolick)
- Dining/Cafeteria
- Guest seating
- Lobbies
- Lounge/Waiting
- Office/Meeting
- Patient rooms
- Resident rooms
- Stacking
- Treatment/Exam rooms

DESCRIPTION	MODEL# / FEATURES	STANDARD TEXTILE GRADES																																				
		COM	2	3	4	5	6	7	8	9	10	11	12																									
 Frolick Stacking Armchair, Four-Legged COM: 1.25 YD 1.14 M Unit weight: 22 LB 10 KG Carton weight: 25.67 LB 11.64 KG Carton volume: 24 FT³ 0.67 MT³	GC3001 2-piece rectangular back	491	531	565	604	668	726	785	836	900	960	1041	1156																									
	Active weight 300 lbs. Stacks 5 high on floor. Chrome (CHM) frame finish, add \$147	<table border="1"> <thead> <tr> <th rowspan="2"></th> <th colspan="3">OVERALL DIMENSIONS</th> <th colspan="3">SEAT DIMENSIONS</th> <th colspan="2">BACK DIMENSIONS</th> </tr> <tr> <th>W</th> <th>D</th> <th>H</th> <th>W</th> <th>D</th> <th>H</th> <th>W</th> <th>H</th> </tr> </thead> <tbody> <tr> <td>IN</td> <td>25</td> <td>24.5</td> <td>36</td> <td>19</td> <td>18</td> <td>18.5</td> <td>19.5</td> <td>17</td> </tr> <tr> <td>MM</td> <td>635</td> <td>622</td> <td>914</td> <td>483</td> <td>457</td> <td>470</td> <td>495</td> <td>432</td> </tr> </tbody> </table>		OVERALL DIMENSIONS			SEAT DIMENSIONS			BACK DIMENSIONS		W	D	H	W	D	H	W	H	IN	25	24.5	36	19	18	18.5	19.5	17	MM	635	622	914	483	457	470	495	432	RTA 00
	OVERALL DIMENSIONS			SEAT DIMENSIONS			BACK DIMENSIONS																															
	W	D	H	W	D	H	W	H																														
IN	25	24.5	36	19	18	18.5	19.5	17																														
MM	635	622	914	483	457	470	495	432																														

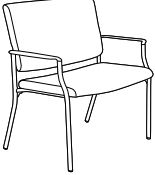

DESCRIPTION	MODEL# / FEATURES	STANDARD TEXTILE GRADES											
		COM	2	3	4	5	6	7	8	9	10	11	12
 <p>Frolick Stacking Armless Chair, Four-Legged COM: 1.25 YD 1.14 M Unit weight: 20 LB 9.1 KG Carton weight: 23.67 LB 10.74 KG Carton volume: 24 FT³ 0.67 MT³</p>	<p>GC3002 2-piece rectangular back</p>	452	492	526	565	629	687	746	797	861	921	1002	1117
		OVERALL DIMENSIONS			SEAT DIMENSIONS			BACK DIMENSIONS					
		W	D	H	W	D	H	W	H				
		IN 21 MM 533	24.5 622	36 914	19 483	18 457	18.5 470	19.5 495	17 432				
<p>Active weight 300 lbs. Stacks 5 high on floor. Chrome (CHM) frame finish, add \$132</p>		RTA 00	3 per carton (pricing and specifications are for one chair)										



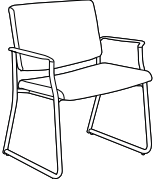

DESCRIPTION	MODEL# / FEATURES	STANDARD TEXTILE GRADES											
		COM	2	3	4	5	6	7	8	9	10	11	12
 <p>Frolick Bariatric Armchair, Four-Legged COM: 2.25 YD 2.06 M Unit weight: 35 LB 15.9 KG Carton weight: 46 LB 20.87 KG Carton volume: 28.25 FT³ 0.79 MT³</p>	<p>GC3003 2-piece rectangular back</p>	1133	1205	1266	1336	1450	1556	1662	1754	1869	1977	2123	2330
		OVERALL DIMENSIONS			SEAT DIMENSIONS			BACK DIMENSIONS					
		W	D	H	W	D	H	W	H				
		IN 37 MM 940	24.5 622	36.5 927	31.5 800	18 457	18.5 470	32 813	18.5 470				
<p>Active weight 500 lbs. Stacks 2 high. Chrome (CHM) frame finish, add \$206</p>		RTA 00	1 per carton										

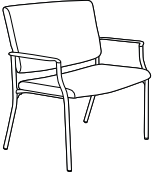
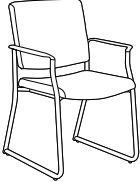
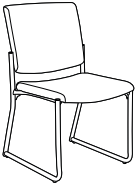

DESCRIPTION	MODEL# / FEATURES	STANDARD TEXTILE GRADES											
		COM	2	3	4	5	6	7	8	9	10	11	12
 <p>Frolick Armchair, Sled Base COM: 1.25 YD 1.14 M Unit weight: 26 LB 11.8 KG Carton weight: 36 LB 16.33 KG Carton volume: 15.5 FT³ 0.43 MT³</p>	<p>GC3021 2-piece rectangular back</p>	554	594	628	667	731	789	848	899	963	1023	1104	1219
		OVERALL DIMENSIONS			SEAT DIMENSIONS			BACK DIMENSIONS					
		W	D	H	W	D	H	W	H				
		IN 25 MM 635	24.5 622	36 914	18 457	17 432	18.5 470	18.75 476	18 457				
<p>Active weight 300 lbs. Does not stack. Chrome (CHM) frame finish, add \$176</p>		RTA 00	1 per carton										

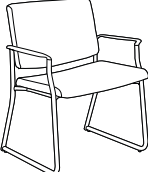
DESCRIPTION	MODEL# / FEATURES	STANDARD TEXTILE GRADES											
		COM	2	3	4	5	6	7	8	9	10	11	12
 <p>Frolick Armless Chair, Sled Base COM: 1.25 YD 1.14 M Unit weight: 25 LB 11.4 KG Carton weight: 35 LB 15.88 KG Carton volume: 15.5 FT³ 0.43 MT³</p>	<p>GC3022 2-piece rectangular back</p>	511	551	585	624	688	746	805	856	920	980	1061	1176
		OVERALL DIMENSIONS			SEAT DIMENSIONS			BACK DIMENSIONS					
		W	D	H	W	D	H	W	H				
		IN 21 MM 533	24.5 622	36 914	19 483	18 457	18.5 470	19.5 495	17 432				
<p>Active weight 300 lbs. Does not stack. Chrome (CHM) frame finish, add \$158</p>		RTA 00	1 per carton										

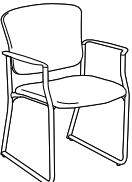
DESCRIPTION	MODEL# / FEATURES	STANDARD TEXTILE GRADES											
		COM	2	3	4	5	6	7	8	9	10	11	12
 <p>Frolick Bariatric Armchair, Sled Base COM: 2.25 YD 2.06 M Unit weight: 40 LB 18.2 KG Carton weight: 51 LB 23.13 KG Carton volume: 28.25 FT³ 0.79 MT³</p>	<p>GC3023 2-piece rectangular back</p>	1190	1262	1323	1393	1507	1613	1719	1811	1926	2034	2180	2387
		OVERALL DIMENSIONS			SEAT DIMENSIONS			BACK DIMENSIONS					
		W	D	H	W	D	H	W	H				
		IN 37 MM 940	24.5 622	36.5 927	31.5 800	18 457	18.5 470	32 813	18.5 470				
<p>Active weight 500 lbs. Does not stack. Chrome (CHM) frame finish, add \$247</p>		RTA 00	1 per carton										

DESCRIPTION	MODEL# / FEATURES	STANDARD TEXTILE GRADES											
		COM	2	3	4	5	6	7	8	9	10	11	12
 <p>Frolick Stacking Armchair, Four-Legged COM: 1.25 YD 1.14 M Unit weight: 22 LB 10 KG Carton weight: 25.67 LB 11.64 KG Carton volume: 24 FT³ 0.67 MT³</p>	<p>GC3031 1-piece rectangular back</p> <p>Active weight 300 lbs.</p> <p>Stacks 5 high on floor. Chrome (CHM) frame finish, add \$147</p>	491	531	565	604	668	726	785	836	900	960	1041	1156
		OVERALL DIMENSIONS			SEAT DIMENSIONS			BACK DIMENSIONS					
		W	D	H	W	D	H	W	H				
		IN 25 MM 635	24.5 622	36 914	19 483	18 457	18.5 470	19.5 495	17 432				
		RTA 00	3 per carton (pricing and specifications are for one chair)										
 <p>Frolick Stacking Armless Chair, Four-Legged COM: 1.25 YD 1.14 M Unit weight: 19 LB 8.6 KG Carton weight: 22.67 LB 10.28 KG Carton volume: 24 FT³ 0.67 MT³</p>	<p>GC3032 1-piece rectangular back</p> <p>Active weight 300 lbs.</p> <p>Stacks 5 high on floor. Chrome (CHM) frame finish, add \$132</p>	452	492	526	565	629	687	746	797	861	921	1002	1117
		OVERALL DIMENSIONS			SEAT DIMENSIONS			BACK DIMENSIONS					
		W	D	H	W	D	H	W	H				
		IN 21 MM 533	24.5 622	36 914	19 483	18 457	18.5 470	19.5 495	17 432				
		RTA 00	3 per carton (pricing and specifications are for one chair)										
 <p>Frolick Bariatric Stacking Armchair, Four-Legged COM: 2.25 YD 2.06 M Unit weight: 35 LB 15.9 KG Carton weight: 46 LB 20.87 KG Carton volume: 28.25 FT³ 0.79 MT³</p>	<p>GC3033 1-piece rectangular back</p> <p>Active weight 500 lbs.</p> <p>Stacks 2 high. Chrome (CHM) frame finish, add \$206</p>	1133	1205	1266	1336	1450	1556	1662	1754	1869	1977	2123	2330
		OVERALL DIMENSIONS			SEAT DIMENSIONS			BACK DIMENSIONS					
		W	D	H	W	D	H	W	H				
		IN 37 MM 940	24.5 622	36.5 927	31.5 800	18 457	18.5 470	32 813	18.5 470				
		RTA 00	1 per carton										
 <p>Frolick Armchair, Sled Base COM: 1.25 YD 1.14 M Unit weight: 26 LB 11.8 KG Carton weight: 36 LB 16.33 KG Carton volume: 15.5 FT³ 0.43 MT³</p>	<p>GC3034 1-piece rectangular back</p> <p>Active weight 300 lbs.</p> <p>Does not stack. Chrome (CHM) frame finish, add \$176</p>	554	594	628	667	731	789	848	899	963	1023	1104	1219
		OVERALL DIMENSIONS			SEAT DIMENSIONS			BACK DIMENSIONS					
		W	D	H	W	D	H	W	H				
		IN 25 MM 635	24.5 622	36 914	18 457	17 432	18.5 470	18.75 476	18 457				
		RTA 00	1 per carton										
 <p>Frolick Armless Chair, Sled Base COM: 1.25 YD 1.14 M Unit weight: 25 LB 11.4 KG Carton weight: 35 LB 15.88 KG Carton volume: 15.5 FT³ 0.43 MT³</p>	<p>GC3035 1-piece rectangular back</p> <p>Active weight 300 lbs.</p> <p>Does not stack. Chrome (CHM) frame finish, add \$158</p>	511	551	585	624	688	746	805	856	920	980	1061	1176
		OVERALL DIMENSIONS			SEAT DIMENSIONS			BACK DIMENSIONS					
		W	D	H	W	D	H	W	H				
		IN 21 MM 533	24.5 622	36 914	19 483	18 457	18.5 470	19.5 495	17 432				
		RTA 00	1 per carton										

DESCRIPTION	MODEL# / FEATURES	STANDARD TEXTILE GRADES											
		COM	2	3	4	5	6	7	8	9	10	11	12
 <p>Frolick Bariatric Armchair, Sled Base COM: 2.25 YD 2.06 M Unit weight: 40 LB 18.2 KG Carton weight: 51 LB 23.13 KG Carton volume: 28.25 FT³ 0.79 MT³</p>	GC3036 1-piece rectangular back	1190	1262	1323	1393	1507	1613	1719	1811	1926	2034	2180	2387
		OVERALL DIMENSIONS W D H			SEAT DIMENSIONS W D H			BACK DIMENSIONS W H					
	Active weight 500 lbs. Does not stack. Chrome (CHM) frame finish, add \$247	IN 37 24.5 36.5 MM 940 622 927	31.5 18 18.5 800 457 470	32 18.5 813 470	RTA 00 1 per carton								
 <p>Splash Stacking Armchair, Four-Legged COM: 1.25 YD 1.14 M Unit weight: 23 LB 10.5 KG Carton weight: 26.67 LB 12.1 KG Carton volume: 24 FT³ 0.67 MT³</p>	GC3011 2-piece fan back	491	531	565	604	668	726	785	836	900	960	1041	1156
		OVERALL DIMENSIONS W D H			SEAT DIMENSIONS W D H			BACK DIMENSIONS W H					
	Active weight 300 lbs. Stacks 5 high on floor. Chrome (CHM) frame finish, add \$147	IN 25 24.25 35.5 MM 635 616 902	19.5 18.5 18.5 495 470 470	20 17.5 508 445	RTA 00 3 per carton (pricing and specifications are for one chair)								
 <p>Splash Stacking Armless Chair, Four-Legged COM: 1.25 YD 1.14 M Unit weight: 21 LB 9.5 KG Carton weight: 24.67 LB 11.19 KG Carton volume: 24 FT³ 0.67 MT³</p>	GC3012 2-piece fan back	452	492	526	565	629	687	746	797	861	921	1002	1117
		OVERALL DIMENSIONS W D H			SEAT DIMENSIONS W D H			BACK DIMENSIONS W H					
	Active weight 300 lbs. Stacks 5 high on floor. Chrome (CHM) frame finish, add \$132	IN 21 24.25 35.5 MM 533 616 902	19.5 18.5 18.5 495 470 470	20 17.5 508 445	RTA 00 3 per carton (pricing and specifications are for one chair)								
 <p>Splash Armchair, Sled Base COM: 1.25 YD 1.14 M Unit weight: 28 LB 12.7 KG Carton weight: 36.5 LB 16.56 KG Carton volume: 15.5 FT³ 0.43 MT³</p>	GC3013 2-piece fan back	554	594	628	667	731	789	848	899	963	1023	1104	1219
		OVERALL DIMENSIONS W D H			SEAT DIMENSIONS W D H			BACK DIMENSIONS W H					
	Active weight 300 lbs. Does not stack. Chrome (CHM) frame finish, add \$176	IN 25 24.25 35.5 MM 635 616 902	19.5 18.5 18.5 495 470 470	20 17.5 508 445	RTA 00 1 per carton								
 <p>Splash Side Armless Chair, Sled Base COM: 1.25 YD 1.14 M Unit weight: 26 LB 11.8 KG Carton weight: 36 LB 16.33 KG Carton volume: 15.5 FT³ 0.43 MT³</p>	GC3014 2-piece fan back	511	551	585	624	688	746	805	856	920	980	1061	1176
		OVERALL DIMENSIONS W D H			SEAT DIMENSIONS W D H			BACK DIMENSIONS W H					
	Active weight 300 lbs. Does not stack. Chrome (CHM) frame finish, add \$158	IN 21 24.25 35.5 MM 533 616 902	19.5 18.5 18.5 495 470 470	20 17.5 508 445	RTA 00 1 per carton								

DESCRIPTION	MODEL# / FEATURES	STANDARD TEXTILE GRADES								
		List price								
		GC3010	293							
	Dolly for Frolick or Splash COM: - YD - M Unit weight: 13 LB 5.9 KG Carton weight: 16 LB 7.26 KG Carton volume: 3.8 FT³ 0.1 MT³	Standard size, four-legged models (only) stack 8 high.	OVERALL DIMENSIONS			SEAT DIMENSIONS			BACK DIMENSIONS	
			W	D	H	W	D	H	W	H
			IN 23.25	24.75	12.25	-	-	-	-	-
			MM 591	629	311	-	-	-	-	-
			RTA 1			1 per carton				

GC BEACH



model GC4077



model GC4078

STANDARD FEATURES



- Elegant wood seating with a choice of an upholstered or vertical wood slat back.
- Frame construction is beech hardwood.
- Legs are equipped with White non-marking polypropylene glides. Suitable for both carpet and hard surface flooring.
- All cushions are fixed and non-removable.
- Cushions are made with highly resilient foam and seats are equipped with a synthetic rubberized webbing suspension system for extra comfort.
- Seat cushion underside is finished with Black polyurethane.
- Does not stack.
- Can be upholstered in standard Global textiles if healthcare compliance is not required.

OPTIONAL FEATURES

- Wood frame available in Absolute (AAM), Black (BKM), Cherry (ACM), English Oak (EOM), Espresso Cafe (ECM), Fruitwood (TFM), Gray (HGM), Honey (AHM), Mahogany (TMM), Maple (AVM), Medium Walnut (MWM), Natural Walnut (NLW), Night (ASM), Noce Biondo (NBM), Noce Grigio (NGM), Noce Leggero (NEM), Noce Medio (NMM), Sandy Beach (SBM), Shaker Cherry (SKM), Silver Oak (SOM), Walnut (TWM), WC Cream (WTM), White (WHM) and Winter Cherry (WCM). Please specify.
- For moisture barrier on seat, please specify **(MB)**. Add \$81 per seat.

SUGGESTED APPLICATIONS

- Dining/Cafeteria
- Guest seating
- Lobbies
- Lounge/Waiting
- Office/Meeting
- Patient rooms
- Resident rooms

DESCRIPTION	MODEL# / FEATURES	STANDARD TEXTILE GRADES											
		COM	2	3	4	5	6	7	8	9	10	11	12
 <p>Armchair w/Upholstered Back COM: 1 YD 0.91 M Unit weight: 15 LB 6.8 KG Carton weight: 20 LB 9.07 KG Carton volume: 13.25 FT³ 0.37 MT³</p>	GC4077	781	813	840	871	922	969	1016	1057	1108	1156	1221	1313
		OVERALL DIMENSIONS			SEAT DIMENSIONS			BACK DIMENSIONS					
		W	D	H	W	D	H	W	H				
		IN 22	22.25	33.5	19.5	18.5	18.75	19.5	15.5				
		MM 559	565	851	495	470	476	495	394				
		RTA 00		1 per carton									
 <p>Armchair w/Vertical Wood Slat Back COM: 1 YD 0.91 M Unit weight: 15 LB 6.8 KG Carton weight: 20 LB 9.07 KG Carton volume: 13.25 FT³ 0.37 MT³</p>	GC4078	781	813	840	871	922	969	1016	1057	1108	1156	1221	1313
		OVERALL DIMENSIONS			SEAT DIMENSIONS			BACK DIMENSIONS					
		W	D	H	W	D	H	W	H				
		IN 22	22.25	33.5	19.5	19	18.75	19.5	15.5				
		MM 559	565	851	495	483	476	495	394				
		RTA 00		1 per carton									

GC BELONG



model GC4231

model GC4231HB

STANDARD FEATURES

- The GC Belong series was developed for active and transient environments with rigorous demands.
- Elliptical metal tube frame. Available in Black (TBL), Cloud (TIV), Designer White (TDW), Fog (TFO), Frost (TFR), Kalua (TKA), Latte (TLA), Mocha (TMO), Nevada (TNE), Sand (TSN), Shadow (TSH), Toast (TOA) and Tungsten (TTU). Please specify.
- Urethane armcaps are available in Black (BLK), Kalua (KAL), Latte (LAB), Mocha (J52), Shadow (SHW) and Toast (TOA). Please specify. Wood armcaps are also available in all healthcare wood finishes. Please specify. For upcharge refer to individual models.
- The frame can be weighted and made with tamperproof fasteners for greater security in more challenging mental health spaces or correctional facilities. Request a special quote.
- The seat and back are removable and field replaceable.
- For added comfort, seats are standard with high density Ultracell foam.
- All seat frames feature a wall saver design to prevent back contact with wall. **Note:** In order to allow full flex of the back on models GC4242, GC4242HB, GC4243 and GC4243HB, a 10.5" wall clearance is required.
- Ottomans and benches do not have wall saver legs.
- Seat height on standard models and benches is 18".
- Seat height on GC4231-24 and GC4241-24 is 24".
- Standard with Black glides.
- Select models are offered with **rear tip and move wheels**. To activate wheels, tilt the chair back so the wheels are in contact with the floor. This feature makes it easy to relocate the chair while unoccupied.
- Clean out space is provided between the seat and back cushions for easy housekeeping.
- Left and right position reference is determined from the seated position.
- Flex back models feature a torsion control mechanism which allows the back to move 14° in a soothing rocking motion.
- For healthcare textiles and wood finish options, visit the website at globalfurnituregroup.com.
- Can be upholstered in standard Global textiles if healthcare compliance is not required.

OPTIONAL FEATURES

- For hard surface floors, please specify opaque non-marking glides (**NM**). No upcharge.
- For moisture barrier on seat, please specify (**MB**). Add \$81 per seat. For bariatric models, add \$122 per seat.
- For improved housekeeping and infection control practices, please add (**SU**) to model number. The underside of the seat will be finished with vinyl and sealed to prevent penetration of liquids. For standard models: Add \$35. For bariatric models: Add \$47. Upcharges may vary.

SUGGESTED APPLICATIONS

- Bariatric seating
- Guest seating
- Lobbies
- Lounge/Waiting
- Patient rooms
- Resident rooms
- Treatment/Exam rooms

For freestanding GC Belong tables, see page 42

GC BELONG BENCHES & BRIDGES

- Units with links can only gang with a bridge. They cannot gang directly with another link unit. (Link units have side brackets.)
- Available in one, two or three seat models.
- A bridge unit suspends between two other units using their links. A bridge is not freestanding. (A bridge does not have legs.)
- Benches have no front or back facing distinction, so models with links can be reversed.
- All bridge models can be ganged to seat units with link.

GC BELONG MODULAR TABLES

- Table heights are 16".
- 1" thick tops are available in thermally fused laminate (LP) and high pressure laminate (HP). Please select the appropriate model number for the finish you prefer.
- 2mm edging color coordinated with laminate finish is standard for all tops. Finish must be specified at the time of order.
- Refer to the following lists when selecting a finish color. Must specify both a top color and leg finish at time of order.

Thermally Fused Laminate (LP)

Absolute Acajou (ACJ)
 Asian Night (ASN)
 Avant Cherry (AWC)
 Avant Honey (AWH)
 Brushed Cobalt (BRC)
 Clear Maple (CMB)
 Dark Espresso (DES)
 Designer White (DWT)
 Fashionista (FAS)
 First Class (FCL)
 Quartered Mahogany (QTM)
 Noce Biondo (NBL)
 Noce Grigio (NGL)
 Noce Leggero (NEL)
 Noce Medio (NML)
 Sheer Beauty (SBY)
 Walnut Heights (WHE)
 White Chocolate (WHC)
 Winter Cherry (WCR)













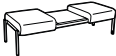



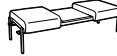







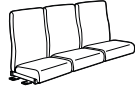



High Pressure Laminate (HP)

Absolute Acajou (ACJ)
 Asian Night (ASN)
 Avant Cherry (W357)
 Avant Honey (W356)
 Brushed Cobalt (BRC)
 Clear Maple (CMB)
 Dark Espresso (W142)
 Designer White (DWT)
 Fashionista (FAS)
 First Class (FCL)
 Quartered Mahogany (QTM)
 Noce Biondo (NBL)
 Noce Grigio (NGL)
 Noce Leggero (NEL)
 Noce Medio (NML)
 Sheer Beauty (SBY)
 Walnut Heights (WHE)
 White Chocolate (WHC)
 Winter Cherry (WCR)













	one seater armless	one seater two arms	two seater two arms	two seater three arms	three seater two arms	three seater four arms	two seater one table, two arms
LOW BACK							
Freestanding units	GC4230 	GC4231 	GC4232 	GC4234 	GC4233 	GC4235 	GC4236
Ganging units with link on left side	GC4230L 	GC4231L 	GC4232L 	GC4234L 	GC4233L 	GC4235L 	GC4236L
Ganging units with link on right side	GC4230R 	GC4231R 	GC4232R 	GC4234R 	GC4233R 	GC4235R 	GC4236R
Ganging units with links on both sides	GC4230B 	GC4231B 	GC4232B 	GC4234B 	GC4233B 	GC4235B 	GC4236B
HIGH BACK							
Freestanding units	GC4230HB 	GC4231HB 	GC4232HB 	GC4234HB 	GC4233HB 	GC4235HB 	GC4236HB
Ganging units with link on left side	GC4230HBL 	GC4231HBL 	GC4232HBL 	GC4234HBL 	GC4233HBL 	GC4235HBL 	GC4236HBL
Ganging units with link on right side	GC4230HBR 	GC4231HBR 	GC4232HBR 	GC4234HBR 	GC4233HBR 	GC4235HBR 	GC4236HBR
Ganging units with links on both sides	GC4230HBB 	GC4231HBB 	GC4232HBB 	GC4234HBB 	GC4233HBB 	GC4235HBB 	GC4236HBB

SPECIALTY							
Freestanding units with casters	GC4240 	GC4240HB 	Ganging bariatric units with link on left side	GC4241L 	GC4241HBL 		
Freestanding Bariatric units	GC4241 	GC4241HB 	Ganging bariatric units with link on right side	GC4241R 	GC4241HBR 	Freestanding split back units	GC4244HB
Freestanding flex back units	GC4242 	GC4242HB 	Ganging bariatric units with link on both sides	GC4241B 	GC4241HBB 	Freestanding split back units with casters	GC4245HB
Freestanding flex back units with casters	GC4243 	GC4243HB 	Hip height chair with wedged cushion 24" seat height	GC4231-24 	GC4241-24 (bariatric) 		

BENCHES & BRIDGES

	GC4251	GC4252	GC4253	GC4256			
Freestanding units							
	GC4251L	GC4252L	GC4253L	GC4256L			
Ganging units with reversible hook/link							
	GC4251B	GC4252B	GC4253B	GC4256B			
Ganging units with hooks on both sides							
	GC4259						
Ottoman							
	GC4261HB	GC4262HB	GC4264HB	GC4263HB	GC4265HB	GC4266HB	GC4269HB (bariatric)
HB add on bridge, no legs							
	GC4261	GC4262	GC4264	GC4263	GC4265	GC4266	GC4269 (bariatric)
LB add on bridge, no legs							
	GC4271	GC4272	GC4273	GC4276			
Bench add on bridge, no legs							

TABLES

	GC4281-LP GC4281-HP	GC4282-LP GC4282-HP	GC4283-LP GC4283-HP	GC4284-LP GC4284-HP	GC4288-LP GC4288-HP
Freestanding					
	GC4285-LP GC4285-HP	GC4286-LP GC4286-HP	GC4287-LP GC4287-HP		
					
	GC4274-LP GC4274-HP	GC4275-LP GC4275-HP	GC4277-LP GC4277-HP	GC4278-LP GC4278-HP	
Bridges					

- A bridge unit suspends between two other units with legs and is supported by their linking brackets.
- A bridge unit is **not** freestanding and cannot be made freestanding.
- Units with legs and links can only gang with a bridge. They **cannot** gang directly with another link unit with legs.
- Bridges **cannot** gang directly with another bridge.

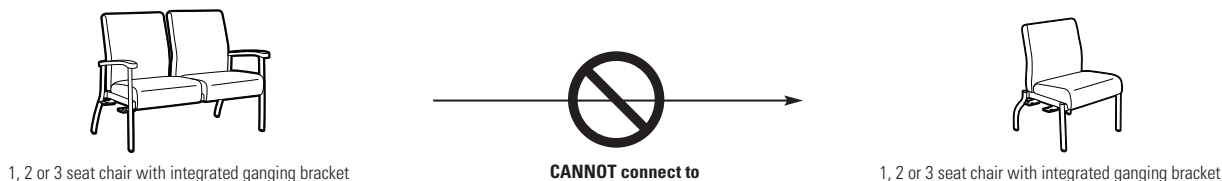
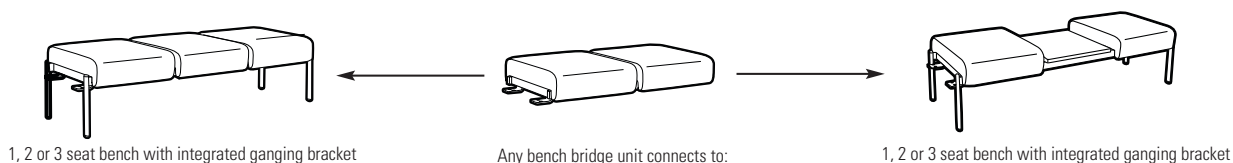
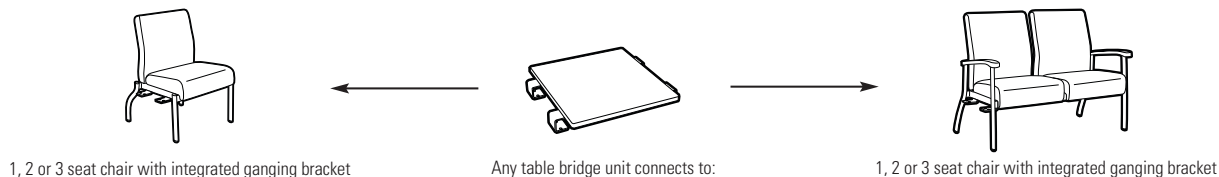
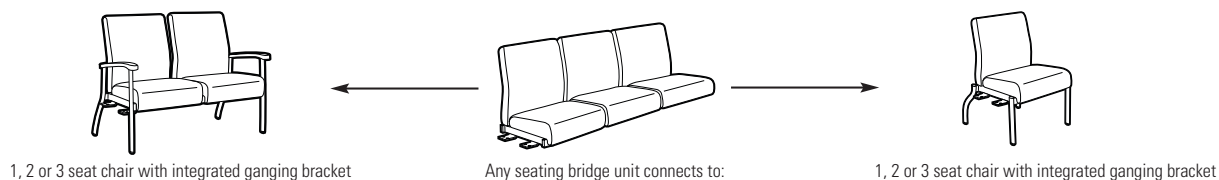

PACKAGE 1

Description
Low Back Three Seat Chair

Qty	Model #	W x D x H	Yardage	Unit Weight	Carton Volume
4	GC4235	74.5 x 26 x 37.5	5	130	65.25



PACKAGE 2

Description
Low Back Three Seat Chair
Low Back Armchair, Left
Low Back Armchair, Right
End Corner Table Bridge

Qty	Model #	W x D x H	Yardage	Unit Weight	Carton Volume
1	GC4233B	72.75 x 26 x 37.5	5	122	65.25
1	GC4231L	26.5 x 28 x 37.5	1.75	41	20.25
1	GC4231R	26.5 x 28 x 37.5	1.75	41	20.25
2	GC4277-HP	35 x 35 x 16	-	40	6



PACKAGE 3

Description
Low Back Armless Chair
Low Back Armless Chair, Right
Low Back Armless Chair, Left
End Corner Table Bridge

Qty	Model #	W x D x H	Yardage	Unit Weight	Carton Volume
2	GC4230B	26.75 x 28 x 37.5	1.75	33	20.25
1	GC4230R	25.75 x 28 x 37.5	1.75	33	20.25
1	GC4230L	25.75 x 28 x 37.5	1.75	33	20.25
3	GC4277-HP	35 x 35 x 16	-	40	6







PACKAGE 4

Description
Low Back Three Seat Chair
Bariatric Low Back Armchair, Left
Low Back Armchair, Left
Low Back Armchair, Right
End Corner Table Bridge
Rectangular Coffee Table
Square Table Top

Qty	Model #	W x D x H	Yardage	Unit Weight	Carton Volume
1	GC4235R	74.5 x 26 x 37.5	5	131	65.25
1	GC4241L	37.5 x 28 x 37.5	3	57	30.5
1	GC4231L	26.5 x 28 x 37.5	1.75	41	20.25
1	GC4231R	26.5 x 28 x 37.5	1.75	41	20.25
1	GC4277-HP	35 x 35 x 16	-	40	6
1	GC4283-HP	22 x 54 x 16	-	30	6
1	GC4275-HP	23 x 23 x 1	-	14	3.4



DESCRIPTION	MODEL# / FEATURES	STANDARD TEXTILE GRADES											
		COM	2	3	4	5	6	7	8	9	10	11	12
 <p>LB Chair Armless COM: 1.75 YD 1.6 M Unit weight: 33 LB 15 KG Carton weight: 45.5 LB 20.64 KG Carton volume: 20.25 FT³ 0.57 MT³</p>	GC4230	877	933	980	1035	1124	1206	1288	1360	1449	1533	1647	1808
	Active weight 500 lbs.	OVERALL DIMENSIONS W D H			SEAT DIMENSIONS W D H			BACK DIMENSIONS W H					
		IN 24.75	28	37.5	22	18	18	21.5	19.5				
		MM 629	711	953	559	457	457	546	495				
	RTA 00	1 per carton											
 <p>LB Chair Armless - Left COM: 1.75 YD 1.6 M Unit weight: 33 LB 15 KG Carton weight: 45.5 LB 20.64 KG Carton volume: 20.25 FT³ 0.57 MT³</p>	GC4230L	908	964	1011	1066	1155	1237	1319	1391	1480	1564	1678	1839
	Ganging.	OVERALL DIMENSIONS W D H			SEAT DIMENSIONS W D H			BACK DIMENSIONS W H					
	Active weight 500 lbs.	IN 25.75	28	37.5	22	18	18	21.5	19.5				
		MM 533	711	953	559	457	457	546	495				
	RTA 00	1 per carton											
 <p>LB Chair Armless - Right COM: 1.75 YD 1.6 M Unit weight: 33 LB 15 KG Carton weight: 45.5 LB 20.64 KG Carton volume: 20.25 FT³ 0.57 MT³</p>	GC4230R	908	964	1011	1066	1155	1237	1319	1391	1480	1564	1678	1839
	Ganging.	OVERALL DIMENSIONS W D H			SEAT DIMENSIONS W D H			BACK DIMENSIONS W H					
	Active weight 500 lbs.	IN 25.75	28	37.5	22	18	18	21.5	19.5				
		MM 654	711	953	559	457	457	546	495				
	RTA 00	1 per carton											
 <p>LB Chair Armless - Left & Right COM: 1.75 YD 1.6 M Unit weight: 33 LB 15 KG Carton weight: 45.5 LB 20.64 KG Carton volume: 20.25 FT³ 0.57 MT³</p>	GC4230B	938	994	1041	1096	1185	1267	1349	1421	1510	1594	1708	1869
	Ganging.	OVERALL DIMENSIONS W D H			SEAT DIMENSIONS W D H			BACK DIMENSIONS W H					
	Active weight 500 lbs.	IN 26.75	28	37.5	22	18	18	21.5	19.5				
		MM 679	711	953	559	457	457	546	495				
	RTA 00	1 per carton											
 <p>HB Chair Armless COM: 2 YD 1.83 M Unit weight: 37 LB 16.8 KG Carton weight: 49.5 LB 22.45 KG Carton volume: 20.25 FT³ 0.57 MT³</p>	GC4230HB	923	987	1041	1103	1205	1299	1393	1475	1577	1673	1803	1987
	Active weight 500 lbs.	OVERALL DIMENSIONS W D H			SEAT DIMENSIONS W D H			BACK DIMENSIONS W H					
		IN 24.75	28	42.5	22	18	18	21.5	24.5				
		MM 629	711	1080	559	457	457	546	622				
	RTA 00	1 per carton											

DESCRIPTION	MODEL# / FEATURES	STANDARD TEXTILE GRADES											
		COM	2	3	4	5	6	7	8	9	10	11	12
 HB Chair Armless - Left COM: 2 YD 1.83 M Unit weight: 37 LB 16.8 KG Carton weight: 49.5 LB 22.45 KG Carton volume: 20.25 FT³ 0.57 MT³	GC4230HBL	952	1016	1070	1132	1234	1328	1422	1504	1606	1702	1832	2016
	Ganging.	OVERALL DIMENSIONS			SEAT DIMENSIONS			BACK DIMENSIONS					
	Active weight 500 lbs.	IN 25.75	28	42.5	22	18	18	21.5	24.5				
		MM 654	711	1080	559	457	457	546	622				
		RTA 00	1 per carton										
 HB Chair Armless - Right COM: 2 YD 1.83 M Unit weight: 37 LB 16.8 KG Carton weight: 49.5 LB 22.45 KG Carton volume: 20.25 FT³ 0.57 MT³	GC4230HBR	952	1016	1070	1132	1234	1328	1422	1504	1606	1702	1832	2016
	Ganging.	OVERALL DIMENSIONS			SEAT DIMENSIONS			BACK DIMENSIONS					
	Active weight 500 lbs.	IN 25.75	28	42.5	22	18	18	21.5	24.5				
		MM 654	711	1080	559	457	457	546	622				
		RTA 00	1 per carton										
 HB Chair Armless - Left & Right COM: 2 YD 1.83 M Unit weight: 39 LB 17.7 KG Carton weight: 51.5 LB 23.36 KG Carton volume: 20.25 FT³ 0.57 MT³	GC4230HBB	982	1046	1100	1162	1264	1358	1452	1534	1636	1732	1862	2046
	Ganging.	OVERALL DIMENSIONS			SEAT DIMENSIONS			BACK DIMENSIONS					
	Active weight 500 lbs.	IN 26.75	28	42.5	22	18	18	21.5	24.5				
		MM 679	711	1080	559	457	457	546	622				
		RTA 00	1 per carton										
 LB Armchair COM: 1.75 YD 1.6 M Unit weight: 41 LB 18.6 KG Carton weight: 53.5 LB 24.27 KG Carton volume: 20.25 FT³ 0.57 MT³	GC4231	1146	1202	1249	1304	1393	1475	1557	1629	1718	1802	1916	2077
	Ganging.	OVERALL DIMENSIONS			SEAT DIMENSIONS			BACK DIMENSIONS					
	Active weight 500 lbs.	IN 26.5	28	37.5	22	18	18	21.5	19.5				
	Wood armcap option: Add \$49.	MM 673	711	953	559	457	457	546	495				
		RTA 00	1 per carton										
 LB Armchair - Left COM: 1.75 YD 1.6 M Unit weight: 41 LB 18.6 KG Carton weight: 53.5 LB 24.27 KG Carton volume: 20.25 FT³ 0.57 MT³	GC4231L	1175	1231	1278	1333	1422	1504	1586	1658	1747	1831	1945	2106
	Ganging.	OVERALL DIMENSIONS			SEAT DIMENSIONS			BACK DIMENSIONS					
	Active weight 500 lbs.	IN 26.5	28	37.5	22	18	18	21.5	19.5				
	Wood armcap option: Add \$49.	MM 673	711	953	559	457	457	546	495				
		RTA 00	1 per carton										

DESCRIPTION MODEL# / FEATURES STANDARD TEXTILE GRADES

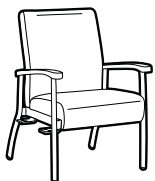

LB Armchair - Right
 COM: 1.75 YD | 1.6 M
 Unit weight: 41 LB | 18.6 KG
 Carton weight: 53.5 LB | 24.27 KG
 Carton volume: 20.25 FT³ | 0.57 MT³

MODEL#	COM	2	3	4	5	6	7	8	9	10	11	12
GC4231R	1175	1231	1278	1333	1422	1504	1586	1658	1747	1831	1945	2106

Ganging.

Active weight 500 lbs.

Wood armcap option:
 Add \$49.

OVERALL DIMENSIONS			SEAT DIMENSIONS			BACK DIMENSIONS	
W	D	H	W	D	H	W	H
IN 26.5	28	37.5	22	18	18	21.5	19.5
MM 673	711	953	559	457	457	546	495

RTA 00 1 per carton

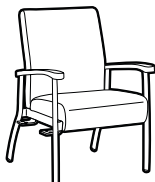

LB Armchair - Left & Right
 COM: 1.75 YD | 1.6 M
 Unit weight: 41 LB | 18.6 KG
 Carton weight: 53.5 LB | 24.27 KG
 Carton volume: 20.25 FT³ | 0.57 MT³

MODEL#	COM	2	3	4	5	6	7	8	9	10	11	12
GC4231B	1205	1261	1308	1363	1452	1534	1616	1688	1777	1861	1975	2136

Ganging.

Active weight 500 lbs.

Wood armcap option:
 Add \$49.

OVERALL DIMENSIONS			SEAT DIMENSIONS			BACK DIMENSIONS	
W	D	H	W	D	H	W	H
IN 26.5	28	37.5	22	18	18	21.5	19.5
MM 673	711	953	559	457	457	546	495

RTA 00 1 per carton

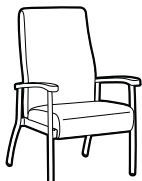

HB Armchair
 COM: 2 YD | 1.83 M
 Unit weight: 46 LB | 20.9 KG
 Carton weight: 58.5 LB | 26.54 KG
 Carton volume: 20.25 FT³ | 0.57 MT³

MODEL#	COM	2	3	4	5	6	7	8	9	10	11	12
GC4231HB	1189	1253	1307	1369	1471	1565	1659	1741	1843	1939	2069	2253

Active weight 500 lbs.

Wood armcap option:
 Add \$49.

OVERALL DIMENSIONS			SEAT DIMENSIONS			BACK DIMENSIONS	
W	D	H	W	D	H	W	H
IN 26.5	28	42.5	22	18	18	21.5	24.5
MM 673	711	1080	559	457	457	546	622

RTA 00 1 per carton



HB Armchair - Left
 COM: 2 YD | 1.83 M
 Unit weight: 46 LB | 20.9 KG
 Carton weight: 58.5 LB | 26.54 KG
 Carton volume: 20.25 FT³ | 0.57 MT³

MODEL#	COM	2	3	4	5	6	7	8	9	10	11	12
GC4231HBL	1222	1286	1340	1402	1504	1598	1692	1774	1876	1972	2102	2286

Ganging.

Active weight 500 lbs.

Wood armcap option:
 Add \$49.

OVERALL DIMENSIONS			SEAT DIMENSIONS			BACK DIMENSIONS	
W	D	H	W	D	H	W	H
IN 26.5	28	42.5	22	18	18	21.5	24.5
MM 673	711	1080	559	457	457	546	622

RTA 00 1 per carton



HB Armchair - Right
 COM: 2 YD | 1.83 M
 Unit weight: 46 LB | 20.9 KG
 Carton weight: 58.5 LB | 26.54 KG
 Carton volume: 20.25 FT³ | 0.57 MT³

MODEL#	COM	2	3	4	5	6	7	8	9	10	11	12
GC4231HBR	1222	1286	1340	1402	1504	1598	1692	1774	1876	1972	2102	2286



Ganging.

Active weight 500 lbs.

Wood armcap option:
 Add \$49.

OVERALL DIMENSIONS			SEAT DIMENSIONS			BACK DIMENSIONS	
W	D	H	W	D	H	W	H
IN 26.5	28	42.5	22	18	18	21.5	24.5
MM 673	711	1080	559	457	457	546	622

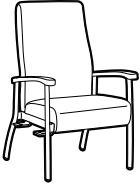
RTA 00 1 per carton

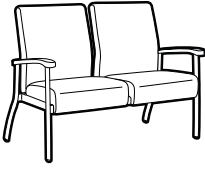
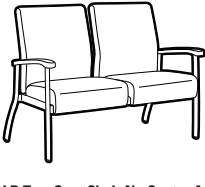
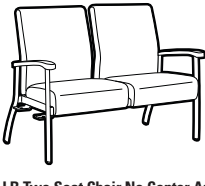
DESCRIPTION	MODEL# / FEATURES	STANDARD TEXTILE GRADES																
 <p>HB Armchair - Left & Right COM: 2 YD 1.83 M Unit weight: 48 LB 21.8 KG Carton weight: 60.5 LB 27.44 KG Carton volume: 20.25 FT³ 0.57 MT³</p>	GC4231HBB	COM	2	3	4	5	6	7	8	9	10	11	12					
		1254	1318	1372	1434	1536	1630	1724	1806	1908	2004	2134	2318					
	Ganging.	OVERALL DIMENSIONS			SEAT DIMENSIONS			BACK DIMENSIONS										
	Active weight 500 lbs.	IN	26.5	28	42.5	22	18	18	21.5	24.5	MM	673	711	1080	559	457	457	546
Wood armcap option: Add \$49.		RTA 00	1 per carton															
 <p>LB Armchair, Post Surgery COM: 1.75 YD 1.6 M Unit weight: 45 LB 20.5 KG Carton weight: 57.5 LB 26.08 KG Carton volume: 24.25 FT³ 0.68 MT³</p> <p>Designed to immobilize the pelvis and hip joints after surgery.</p>	GC4231-24	COM	2	3	4	5	6	7	8	9	10	11	12					
		1267	1323	1370	1425	1514	1596	1678	1750	1839	1923	2037	2198					
	Ganging.	OVERALL DIMENSIONS			SEAT DIMENSIONS			BACK DIMENSIONS										
	Active weight 500 lbs.	IN	26.5	28.75	43.5	22	18	24	21.5	19.5	MM	673	730	1105	559	457	610	546
Wood armcap option: Add \$49.		RTA 00	1 per carton															
 <p>LB Two Seat Chair No Center Arm COM: 3.5 YD 3.2 M Unit weight: 82 LB 37.3 KG Carton weight: 94 LB 42.64 KG Carton volume: 43 FT³ 1.21 MT³</p>	GC4232	COM	2	3	4	5	6	7	8	9	10	11	12					
		1946	2058	2153	2261	2440	2604	2769	2912	3091	3259	3486	3808					
	Ganging.	OVERALL DIMENSIONS			SEAT DIMENSIONS			BACK DIMENSIONS										
	Active weight 500 lbs/seat.	IN	49.75	26	37.5	44	18	18	44	19.5	MM	1264	660	953	1118	457	457	1118
Wood armcap option: Add \$49.		RTA 00	1 per carton															
 <p>LB Two Seat Chair No Center Arm - Left COM: 3.5 YD 3.2 M Unit weight: 83 LB 37.7 KG Carton weight: 95 LB 43.09 KG Carton volume: 43 FT³ 1.21 MT³</p>	GC4232L	COM	2	3	4	5	6	7	8	9	10	11	12					
		1977	2089	2184	2292	2471	2635	2800	2943	3122	3290	3517	3839					
	Ganging.	OVERALL DIMENSIONS			SEAT DIMENSIONS			BACK DIMENSIONS										
	Active weight 500 lbs/seat.	IN	49.75	26	37.5	44	18	18	44	19.5	MM	1264	660	953	1118	457	457	1118
Wood armcap option: Add \$49.		RTA 00	1 per carton															
 <p>LB Two Seat Chair No Center Arm - Right COM: 3.5 YD 3.2 M Unit weight: 83 LB 37.7 KG Carton weight: 95 LB 43.09 KG Carton volume: 43 FT³ 1.21 MT³</p>	GC4232R	COM	2	3	4	5	6	7	8	9	10	11	12					
		1977	2089	2184	2292	2471	2635	2800	2943	3122	3290	3517	3839					
	Ganging.	OVERALL DIMENSIONS			SEAT DIMENSIONS			BACK DIMENSIONS										
	Active weight 500 lbs/seat.	IN	49.75	26	37.5	44	18	18	44	19.5	MM	1264	660	953	1118	457	457	1118
Wood armcap option: Add \$49.		RTA 00	1 per carton															

DESCRIPTION MODEL# / FEATURES STANDARD TEXTILE GRADES

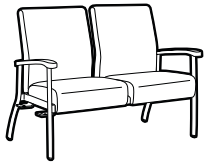

LB Two Seat Chair No Center Arm - Left & Right
 COM: 3.5 YD | 3.2 M
 Unit weight: 84 LB | 38.2 KG
 Carton weight: 96 LB | 43.54 KG
 Carton volume: 43 FT³ | 1.21 MT³

MODEL#	2	3	4	5	6	7	8	9	10	11	12	
GC4232B	2007	2119	2214	2322	2501	2665	2830	2973	3152	3320	3547	3869

Ganging.

Active weight 500 lbs.

Wood armcap option:
 Add \$49.

OVERALL DIMENSIONS			SEAT DIMENSIONS			BACK DIMENSIONS	
W	D	H	W	D	H	W	H
IN 49.75	26	37.5	44	18	18	44	19.5
MM 1264	660	953	1118	457	457	1118	495

RTA 00 1 per carton

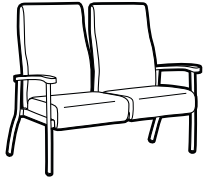

HB Two Seat Chair No Center Arm
 COM: 4 YD | 3.66 M
 Unit weight: 83 LB | 37.7 KG
 Carton weight: 95 LB | 43.09 KG
 Carton volume: 56.5 FT³ | 1.59 MT³

MODEL#	2	3	4	5	6	7	8	9	10	11	12	
GC4232HB	2036	2164	2272	2396	2600	2788	2976	3140	3344	3536	3796	4164

Active weight 500 lbs.

Wood armcap option:
 Add \$49.

OVERALL DIMENSIONS			SEAT DIMENSIONS			BACK DIMENSIONS	
W	D	H	W	D	H	W	H
IN 49.75	26	42.5	44	18	18	44	24.5
MM 1264	660	1080	1118	457	457	1118	622

RTA 00 1 per carton



HB Two Seat Chair No Center Arm - Left
 COM: 4 YD | 3.66 M
 Unit weight: 84 LB | 38.2 KG
 Carton weight: 96 LB | 43.54 KG
 Carton volume: 56.5 FT³ | 1.59 MT³

MODEL#	2	3	4	5	6	7	8	9	10	11	12	
GC4232HBL	2068	2196	2304	2428	2632	2820	3008	3172	3376	3568	3828	4196

Ganging.

Active weight 500 lbs/seat.

Wood armcap option:
 Add \$49.

OVERALL DIMENSIONS			SEAT DIMENSIONS			BACK DIMENSIONS	
W	D	H	W	D	H	W	H
IN 49.75	26	42.5	44	18	18	44	24.5
MM 1264	660	1080	1118	457	457	1118	622

RTA 00 1 per carton

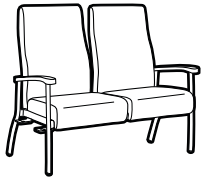

HB Two Seat Chair No Center Arm - Right
 COM: 4 YD | 3.66 M
 Unit weight: 84 LB | 38.2 KG
 Carton weight: 96 LB | 43.54 KG
 Carton volume: 56.5 FT³ | 1.59 MT³

MODEL#	2	3	4	5	6	7	8	9	10	11	12	
GC4232HBR	2068	2196	2304	2428	2632	2820	3008	3172	3376	3568	3828	4196

Ganging.

Active weight 500 lbs/seat.

Wood armcap option:
 Add \$49.

OVERALL DIMENSIONS			SEAT DIMENSIONS			BACK DIMENSIONS	
W	D	H	W	D	H	W	H
IN 49.75	26	42.5	44	18	18	44	24.5
MM 1264	660	1080	1118	457	457	1118	622

RTA 00 1 per carton

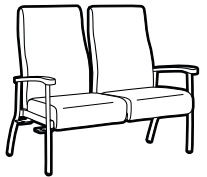

HB Two Seat Chair No Center Arm - Left & Right
 COM: 4 YD | 3.66 M
 Unit weight: 86 LB | 39.1 KG
 Carton weight: 98 LB | 44.45 KG
 Carton volume: 56.5 FT³ | 1.59 MT³

MODEL#	2	3	4	5	6	7	8	9	10	11	12	
GC4232HBB	2096	2224	2332	2456	2660	2848	3036	3200	3404	3596	3856	4224

Ganging.

Active weight 500 lbs/seat.

Wood armcap option:
 Add \$49.

OVERALL DIMENSIONS			SEAT DIMENSIONS			BACK DIMENSIONS	
W	D	H	W	D	H	W	H
IN 49.75	26	42.5	44	18	18	44	24.5
MM 1264	660	1080	1118	457	457	1118	622

RTA 00 1 per carton

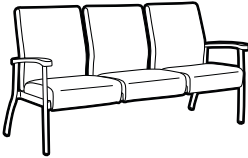
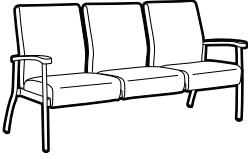
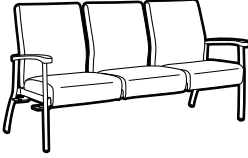
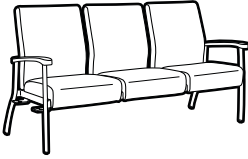
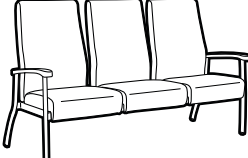
DESCRIPTION	MODEL# / FEATURES	STANDARD TEXTILE GRADES											
		COM	2	3	4	5	6	7	8	9	10	11	12
 <p>LB Three Seat Chair No Center Arms COM: 5 YD 4.57 M Unit weight: 120 LB 54.5 KG Carton weight: 132 LB 59.87 KG Carton volume: 65.25 FT³ 1.84 MT³</p>	GC4233	2753	2913	3048	3203	3458	3693	3928	4133	4388	4628	4953	5413
		OVERALL DIMENSIONS			SEAT DIMENSIONS			BACK DIMENSIONS					
		W	D	H	W	D	H	W	H				
		IN 72.75 MM 1848	26 660	37.5 953	70 1778	18 457	18 457	70 1778	19.5 495				
	Active weight 500 lbs/seat. Wood armcap option: Add \$49.	RTA 00		1 per carton									
 <p>LB Three Seat Chair No Center Arms - Left COM: 5 YD 4.57 M Unit weight: 122 LB 55.5 KG Carton weight: 134 LB 60.78 KG Carton volume: 65.25 FT³ 1.84 MT³</p>	GC4233L	2785	2945	3080	3235	3490	3725	3960	4165	4420	4660	4985	5445
	Ganging.	OVERALL DIMENSIONS			SEAT DIMENSIONS			BACK DIMENSIONS					
		W	D	H	W	D	H	W	H				
		IN 72.75 MM 1848	26 660	37.5 953	70 1778	18 457	18 457	70 1778	19.5 495				
	Active weight 500 lbs/seat. Wood armcap option: Add \$49.	RTA 00		1 per carton									
 <p>LB Three Seat Chair No Center Arms - Right COM: 5 YD 4.57 M Unit weight: 122 LB 55.5 KG Carton weight: 134 LB 60.78 KG Carton volume: 65.25 FT³ 1.84 MT³</p>	GC4233R	2785	2945	3080	3235	3490	3725	3960	4165	4420	4660	4985	5445
	Ganging.	OVERALL DIMENSIONS			SEAT DIMENSIONS			BACK DIMENSIONS					
		W	D	H	W	D	H	W	H				
		IN 72.75 MM 1848	26 660	37.5 953	70 1778	18 457	18 457	70 1778	19.5 495				
	Active weight 500 lbs/seat. Wood armcap option: Add \$49.	RTA 00		1 per carton									
 <p>LB Three Seat Chair No Center Arms - Left & Right COM: 5 YD 4.57 M Unit weight: 122 LB 55.5 KG Carton weight: 134 LB 60.78 KG Carton volume: 65.25 FT³ 1.84 MT³</p>	GC4233B	2816	2976	3111	3266	3521	3756	3991	4196	4451	4691	5016	5476
	Ganging.	OVERALL DIMENSIONS			SEAT DIMENSIONS			BACK DIMENSIONS					
		W	D	H	W	D	H	W	H				
		IN 72.75 MM 1848	26 660	37.5 953	70 1778	18 457	18 457	70 1778	19.5 495				
	Active weight 500 lbs/seat. Wood armcap option: Add \$49.	RTA 00		1 per carton									
 <p>HB Three Seat Chair No Center Arms COM: 5.75 YD 5.26 M Unit weight: 126 LB 57.3 KG Carton weight: 138 LB 62.6 KG Carton volume: 80.75 FT³ 2.28 MT³</p>	GC4233HB	2888	3072	3227	3406	3699	3969	4239	4475	4768	5044	5418	5947
		OVERALL DIMENSIONS			SEAT DIMENSIONS			BACK DIMENSIONS					
		W	D	H	W	D	H	W	H				
		IN 72.75 MM 1848	26 660	42.5 1080	70 1778	18 457	18 457	70 1778	24.5 622				
	Active weight 500 lbs/seat. Wood armcap option: Add \$49.	RTA 00		1 per carton									

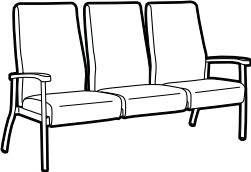
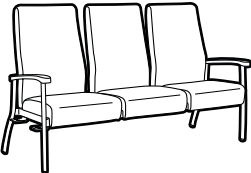
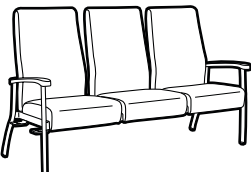
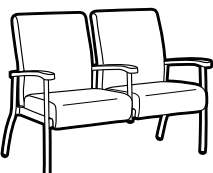
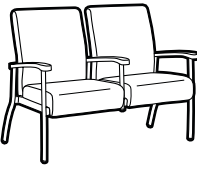
DESCRIPTION	MODEL# / FEATURES	STANDARD TEXTILE GRADES											
		COM	2	3	4	5	6	7	8	9	10	11	12
 <p>HB Three Seat Chair No Center Arms - Left COM: 5.75 YD 5.26 M Unit weight: 128 LB 58.2 KG Carton weight: 140 LB 63.5 KG Carton volume: 80.75 FT³ 2.28 MT³</p>	GC4233HBL	2920	3104	3259	3438	3731	4001	4271	4507	4800	5076	5450	5979
	Ganging.	OVERALL DIMENSIONS W D H			SEAT DIMENSIONS W D H			BACK DIMENSIONS W H					
	Active weight 500 lbs./seat.	IN 72.75	26	42.5	70	18	18	70	24.5				
	Wood armcap option: Add \$49.	MM 1848	660	1080	1778	457	457	1778	622				
		RTA 00		1 per carton									
 <p>HB Three Seat Chair No Center Arms - Right COM: 5.75 YD 5.26 M Unit weight: 128 LB 58.2 KG Carton weight: 140 LB 63.5 KG Carton volume: 80.75 FT³ 2.28 MT³</p>	GC4233HBR	2920	3104	3259	3438	3731	4001	4271	4507	4800	5076	5450	5979
	Ganging.	OVERALL DIMENSIONS W D H			SEAT DIMENSIONS W D H			BACK DIMENSIONS W H					
	Active weight 500 lbs./seat.	IN 72.75	26	42.5	70	18	18	70	24.5				
	Wood armcap option: Add \$49.	MM 1848	660	1080	1778	457	457	1778	622				
		RTA 00		1 per carton									
 <p>HB Three Seat Chair No Center Arms - Left & Right COM: 5.75 YD 5.26 M Unit weight: 128 LB 58.2 KG Carton weight: 140 LB 63.5 KG Carton volume: 80.75 FT³ 2.28 MT³</p>	GC4233HBB	2951	3135	3290	3469	3762	4032	4302	4538	4831	5107	5481	6010
	Ganging.	OVERALL DIMENSIONS W D H			SEAT DIMENSIONS W D H			BACK DIMENSIONS W H					
	Active weight 500 lbs./seat.	IN 72.75	26	42.5	70	18	18	70	24.5				
	Wood armcap option: Add \$49.	MM 1848	660	1080	1778	457	457	1778	622				
		RTA 00		1 per carton									
 <p>LB Two Seat Chair Half Center Arm COM: 3.5 YD 3.2 M Unit weight: 88 LB 40 KG Carton weight: 100 LB 45.36 KG Carton volume: 43 FT³ 1.21 MT³</p>	GC4234	2121	2233	2328	2436	2615	2779	2944	3087	3266	3434	3661	3983
	Ganging.	OVERALL DIMENSIONS W D H			SEAT DIMENSIONS W D H			BACK DIMENSIONS W H					
	Active weight 500 lbs./seat.	IN 50.75	26	37.5	22	18	18	21.5	19.5				
	Wood armcap option: Add \$74.	MM 1289	660	953	559	457	457	546	495				
		RTA 00		1 per carton									
 <p>LB Two Seat Chair Half Center Arm - Left COM: 3.5 YD 3.2 M Unit weight: 89 LB 40.5 KG Carton weight: 101 LB 45.81 KG Carton volume: 43 FT³ 1.21 MT³</p>	GC4234L	2151	2263	2358	2466	2645	2809	2974	3117	3296	3464	3691	4013
	Ganging.	OVERALL DIMENSIONS W D H			SEAT DIMENSIONS W D H			BACK DIMENSIONS W H					
	Active weight 500 lbs./seat.	IN 50.75	26	37.5	22	18	18	21.5	19.5				
	Wood armcap option: Add \$74.	MM 1289	660	953	559	457	457	546	495				
		RTA 00		1 per carton									

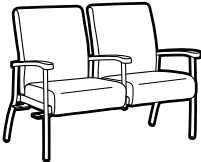
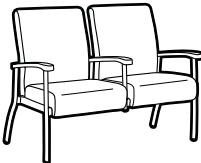
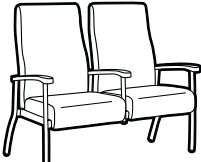
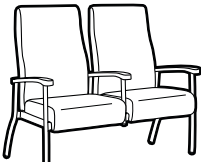
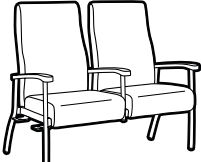
DESCRIPTION	MODEL# / FEATURES	STANDARD TEXTILE GRADES											
		COM	2	3	4	5	6	7	8	9	10	11	12
 <p>LB Two Seat Chair Half Center Arm - Right COM: 3.5 YD 3.2 M Unit weight: 89 LB 40.5 KG Carton weight: 101 LB 45.81 KG Carton volume: 43 FT³ 1.21 MT³</p>	GC4234R	2151	2263	2358	2466	2645	2809	2974	3117	3296	3464	3691	4013
	Ganging.	OVERALL DIMENSIONS			SEAT DIMENSIONS			BACK DIMENSIONS					
	Active weight 500 lbs/seat.	IN 50.75	26	37.5	22	18	18	21.5	19.5				
	Wood armcap option: Add \$74.	MM 1289	660	953	559	457	457	546	495				
		RTA 00	1 per carton										
 <p>LB Two Seat Chair Half Center Arm - Left & Right COM: 3.5 YD 3.2 M Unit weight: 90 LB 40.9 KG Carton weight: 102 LB 46.27 KG Carton volume: 43 FT³ 1.21 MT³</p>	GC4234B	2182	2294	2389	2497	2676	2840	3005	3148	3327	3495	3722	4044
	Ganging.	OVERALL DIMENSIONS			SEAT DIMENSIONS			BACK DIMENSIONS					
	Active weight 500 lbs/seat.	IN 50.75	26	37.5	22	18	18	21	19.5				
	Wood armcap option: Add \$74.	MM 1289	660	953	559	457	457	533	495				
		RTA 00	1 per carton										
 <p>HB Two Seat Chair Half Center Arm COM: 4 YD 3.66 M Unit weight: 92 LB 41.8 KG Carton weight: 104 LB 47.17 KG Carton volume: 56.5 FT³ 1.59 MT³</p>	GC4234HB	2214	2342	2450	2574	2778	2966	3154	3318	3522	3714	3974	4342
	Ganging.	OVERALL DIMENSIONS			SEAT DIMENSIONS			BACK DIMENSIONS					
	Active weight 500 lbs/seat.	IN 50.75	26	42.5	22	18	18	21.5	24.5				
	Wood armcap option: Add \$74.	MM 1289	660	1080	559	457	457	546	622				
		RTA 00	1 per carton										
 <p>HB Two Seat Chair Half Center Arm - Left COM: 4 YD 3.66 M Unit weight: 93 LB 42.3 KG Carton weight: 104 LB 47.17 KG Carton volume: 56.5 FT³ 1.59 MT³</p>	GC4234HBL	2244	2372	2480	2604	2808	2996	3184	3348	3552	3744	4004	4372
	Ganging.	OVERALL DIMENSIONS			SEAT DIMENSIONS			BACK DIMENSIONS					
	Active weight 500 lbs/seat.	IN 50.75	26	42.5	22	18	18	21.5	24.5				
	Wood armcap option: Add \$74.	MM 1289	660	1080	559	457	457	546	622				
		RTA 00	1 per carton										
 <p>HB Two Seat Chair Half Center Arm - Right COM: 4 YD 3.66 M Unit weight: 93 LB 42.3 KG Carton weight: 104 LB 47.17 KG Carton volume: 56.5 FT³ 1.59 MT³</p>	GC4234HBR	2244	2372	2480	2604	2808	2996	3184	3348	3552	3744	4004	4372
	Ganging.	OVERALL DIMENSIONS			SEAT DIMENSIONS			BACK DIMENSIONS					
	Active weight 500 lbs/seat.	IN 50.75	26	42.5	22	18	18	21.5	24.5				
	Wood armcap option: Add \$74.	MM 1289	660	1080	559	457	457	546	622				
		RTA 00	1 per carton										

DESCRIPTION MODEL# / FEATURES STANDARD TEXTILE GRADES

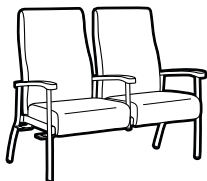

HB Two Seat Chair Half Center Arm - Left & Right
 COM: 1.25 YD | 3.66 M
 Unit weight: 96 LB | 43.6 KG
 Carton weight: 108 LB | 48.99 KG
 Carton volume: 56.5 FT³ | 1.59 MT³

COM	2	3	4	5	6	7	8	9	10	11	12	
GC4234HBB	2273	2401	2509	2633	2837	3025	3213	3377	3581	3773	4033	4401

Ganging.

Active weight 500 lbs/seat.

Wood armcap option:
 Add \$74.

OVERALL DIMENSIONS			SEAT DIMENSIONS			BACK DIMENSIONS	
W	D	H	W	D	H	W	H
IN 50.75	26	42.5	22	18	18	21	24.5
MM 1289	660	1080	559	457	457	533	622

RTA 00 1 per carton

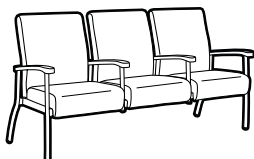

LB Three Seat Chair Half Center Arms
 COM: 5 YD | 4.57 M
 Unit weight: 130 LB | 59.1 KG
 Carton weight: 142 LB | 64.41 KG
 Carton volume: 65.25 FT³ | 1.84 MT³

COM	2	3	4	5	6	7	8	9	10	11	12	
GC4235	3105	3265	3400	3555	3810	4045	4280	4485	4740	4980	5305	5765

Active weight 500 lbs/seat.

Wood armcap option:
 Add \$99.

OVERALL DIMENSIONS			SEAT DIMENSIONS			BACK DIMENSIONS	
W	D	H	W	D	H	W	H
IN 74.5	26	37.5	22	18	18	21.5	19.5
MM 1892	660	953	559	457	457	546	495

RTA 00 1 per carton

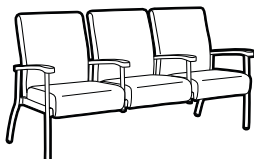

LB Three Seat Chair Half Center Arms - Left
 COM: 5 YD | 4.57 M
 Unit weight: 131 LB | 59.5 KG
 Carton weight: 143 LB | 64.86 KG
 Carton volume: 65.25 FT³ | 1.84 MT³

COM	2	3	4	5	6	7	8	9	10	11	12	
GC4235L	3133	3293	3428	3583	3838	4073	4308	4513	4768	5008	5333	5793

Ganging.

Active weight 500 lbs/seat.

Wood armcap option:
 Add \$99.

OVERALL DIMENSIONS			SEAT DIMENSIONS			BACK DIMENSIONS	
W	D	H	W	D	H	W	H
IN 74.5	26	37.5	22	18	18	21.5	19.5
MM 1892	660	953	559	457	457	546	495

RTA 00 1 per carton

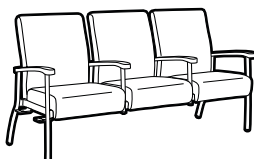

LB Three Seat Chair Half Center Arms - Right
 COM: 5 YD | 4.57 M
 Unit weight: 131 LB | 59.5 KG
 Carton weight: 143 LB | 64.86 KG
 Carton volume: 65.25 FT³ | 1.84 MT³

COM	2	3	4	5	6	7	8	9	10	11	12	
GC4235R	3133	3293	3428	3583	3838	4073	4308	4513	4768	5008	5333	5793

Ganging.

Active weight 500 lbs/seat.

Wood armcap option:
 Add \$99.

OVERALL DIMENSIONS			SEAT DIMENSIONS			BACK DIMENSIONS	
W	D	H	W	D	H	W	H
IN 74.5	26	37.5	22	18	18	21.5	19.5
MM 1892	660	953	559	457	457	546	495

RTA 00 1 per carton

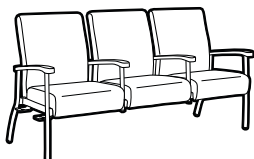

LB Three Seat Chair Half Center Arms - Left & Right
 COM: 5 YD | 4.57 M
 Unit weight: 132 LB | 60 KG
 Carton weight: 144 LB | 65.32 KG
 Carton volume: 65.25 FT³ | 1.84 MT³

COM	2	3	4	5	6	7	8	9	10	11	12	
GC4235B	3168	3328	3463	3618	3873	4108	4343	4548	4803	5043	5368	5828

Ganging.

Active weight 500 lbs/seat.

Wood armcap option:
 Add \$99.

OVERALL DIMENSIONS			SEAT DIMENSIONS			BACK DIMENSIONS	
W	D	H	W	D	H	W	H
IN 74.5	26	37.5	22	18	18	21.5	19.5
MM 1892	660	953	559	457	457	546	495

RTA 00 1 per carton

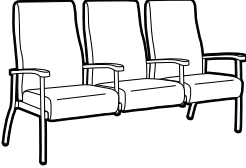
DESCRIPTION	MODEL# / FEATURES	STANDARD TEXTILE GRADES															
		COM	2	3	4	5	6	7	8	9	10	11	12				
 <p>HB Three Seat Chair Half Center Arms COM: 5.75 YD 5.26 M Unit weight: 136 LB 61.8 KG Carton weight: 148 LB 67.13 KG Carton volume: 80.75 FT³ 2.28 MT³</p>	GC4235HB	3241	3425	3580	3759	4052	4322	4592	4828	5121	5397	5771	6300				
	Active weight 500 lbs/seat.	OVERALL DIMENSIONS W D H			SEAT DIMENSIONS W D H			BACK DIMENSIONS W H									
	Wood armcap option: Add \$99.	IN 74.5	26	42.5	22	18	18	21.5	24.5	MM 1892	660	1080	559	457	457	546	622
		RTA 00	1 per carton														
 <p>HB Three Seat Chair Half Center Arms - Left COM: 5.75 YD 5.26 M Unit weight: 137 LB 62.3 KG Carton weight: 149 LB 67.59 KG Carton volume: 80.75 FT³ 2.28 MT³</p>	GC4235HBL	3272	3456	3611	3790	4083	4353	4623	4859	5152	5428	5802	6331				
	Ganging.	OVERALL DIMENSIONS W D H			SEAT DIMENSIONS W D H			BACK DIMENSIONS W H									
	Active weight 500 lbs/seat.	IN 74.5	26	42.5	22	18	18	21.5	24.5	MM 1892	660	1080	559	457	457	546	622
	Wood armcap option: Add \$99.	RTA 00	1 per carton														
 <p>HB Three Seat Chair Half Center Arms - Right COM: 5.75 YD 5.26 M Unit weight: 137 LB 62.3 KG Carton weight: 159 LB 72.12 KG Carton volume: 80.75 FT³ 2.28 MT³</p>	GC4235HBR	3272	3456	3611	3790	4083	4353	4623	4859	5152	5428	5802	6331				
	Ganging.	OVERALL DIMENSIONS W D H			SEAT DIMENSIONS W D H			BACK DIMENSIONS W H									
	Active weight 500 lbs/seat.	IN 74.5	26	42.5	22	18	18	21.5	24.5	MM 1892	660	1080	559	457	457	546	622
	Wood armcap option: Add \$99.	RTA 00	1 per carton														
 <p>HB Three Seat Chair Half Center Arms - Left & Right COM: 5.75 YD 5.26 M Unit weight: 138 LB 62.7 KG Carton weight: 160 LB 72.57 KG Carton volume: 80.75 FT³ 2.28 MT³</p>	GC4235HBB	3303	3487	3642	3821	4114	4384	4654	4890	5183	5459	5833	6362				
	Ganging.	OVERALL DIMENSIONS W D H			SEAT DIMENSIONS W D H			BACK DIMENSIONS W H									
	Active weight 500 lbs/seat.	IN 74.5	26	42.5	22	18	18	21.5	24.5	MM 1892	660	1080	559	457	457	546	622
	Wood armcap option: Add \$99.	RTA 00	1 per carton														
 <p>LB Two Seat Chair w/Center Table Top COM: 3.5 YD 3.2 M Unit weight: 94 LB 42.7 KG Carton weight: 106 LB 48.08 KG Carton volume: 65.25 FT³ 1.84 MT³</p>	GC4236	2527	2639	2734	2842	3021	3185	3350	3493	3672	3840	4067	4389				
	Active weight 500 lbs/seat.	OVERALL DIMENSIONS W D H			SEAT DIMENSIONS W D H			BACK DIMENSIONS W H									
	Wood armcap option: Add \$49.	IN 72.75	26	37.5	44	18	18	44	19.5	MM 1848	660	953	1118	457	457	1118	495
	Table top only offered in high pressure laminate.	RTA 00	1 per carton														

DESCRIPTION MODEL# / FEATURES STANDARD TEXTILE GRADES

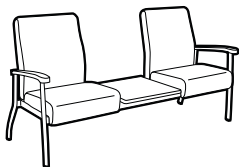

LB Two Seat Chair w/Center Table Top - Left
 COM: 3.5 YD | 3.2 M
 Unit weight: 95 LB | 43.2 KG
 Carton weight: 107 LB | 48.53 KG
 Carton volume: 65.25 FT³ | 1.84 MT³

MODEL# / FEATURES	STANDARD TEXTILE GRADES											
	COM	2	3	4	5	6	7	8	9	10	11	12
GC4236L	2556	2668	2763	2871	3050	3214	3379	3522	3701	3869	4096	4418
Ganging.												
Active weight 500 lbs/seat.												
Wood armcap option: Add \$49.	IN 72.75 MM 1848	26 660	37.5 953	44 1118	18 457	18 457	44 1118	19.5 495				
Table top only offered in high pressure laminate.	RTA 00 1 per carton											

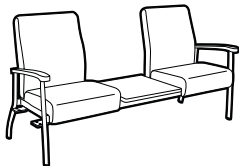

LB Two Seat Chair w/Center Table Top - Right
 COM: 3.5 YD | 3.2 M
 Unit weight: 95 LB | 43.2 KG
 Carton weight: 107 LB | 48.53 KG
 Carton volume: 65.25 FT³ | 1.84 MT³

MODEL# / FEATURES	STANDARD TEXTILE GRADES											
	COM	2	3	4	5	6	7	8	9	10	11	12
GC4236R	2556	2668	2763	2871	3050	3214	3379	3522	3701	3869	4096	4418
Ganging.												
Active weight 500 lbs/seat.												
Wood armcap option: Add \$49.	IN 72.75 MM 1848	26 660	37.5 953	44 1118	18 457	18 457	44 1118	19.5 495				
Table top only offered in high pressure laminate.	RTA 00 1 per carton											

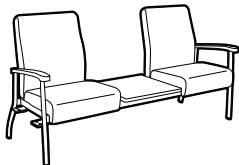

LB Two Seat Chair w/Center Table Top - Left & Right
 COM: 3.5 YD | 3.2 M
 Unit weight: 96 LB | 43.6 KG
 Carton weight: 108 LB | 48.99 KG
 Carton volume: 65.25 FT³ | 1.84 MT³

MODEL# / FEATURES	STANDARD TEXTILE GRADES											
	COM	2	3	4	5	6	7	8	9	10	11	12
GC4236B	2589	2701	2796	2904	3083	3247	3412	3555	3734	3902	4129	4451
Ganging.												
Active weight 500 lbs/seat.												
Wood armcap option: Add \$49.	IN 72.75 MM 1848	26 660	37.5 953	44 1118	18 457	18 457	44 1118	19.5 495				
Table top only offered in high pressure laminate.	RTA 00 1 per carton											

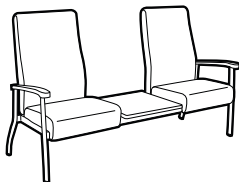

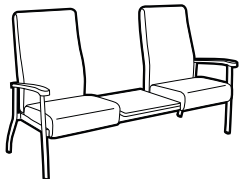

HB Two Seat Chair w/Center Table Top
 COM: 4 YD | 3.66 M
 Unit weight: 98 LB | 44.5 KG
 Carton weight: 110 LB | 49.9 KG
 Carton volume: 80.75 FT³ | 2.28 MT³

MODEL# / FEATURES	STANDARD TEXTILE GRADES											
	COM	2	3	4	5	6	7	8	9	10	11	12
GC4236HB	2617	2745	2853	2977	3181	3369	3557	3721	3925	4117	4377	4745
Ganging.												
Active weight 500 lbs/seat.												
Wood armcap option: Add \$49.	IN 72.75 MM 1848	26 660	42.5 1080	44 1118	18 457	18 457	44 1118	24.5 622				
Table top only offered in high pressure laminate.	RTA 00 1 per carton											



HB Two Seat Chair w/Center Table Top - Left
 COM: 4 YD | 3.66 M
 Unit weight: 99 LB | 45 KG
 Carton weight: 111 LB | 50.35 KG
 Carton volume: 80.75 FT³ | 2.28 MT³

MODEL# / FEATURES	STANDARD TEXTILE GRADES											
	COM	2	3	4	5	6	7	8	9	10	11	12
GC4236HBL	2647	2775	2883	3007	3211	3399	3587	3751	3955	4147	4407	4775
Ganging.												
Active weight 500 lbs/seat.												
Wood armcap option: Add \$49.	IN 72.75 MM 1848	26 660	42.5 1080	44 1118	18 457	18 457	44 1118	24.5 622				
Table top only offered in high pressure laminate.	RTA 00 1 per carton											

DESCRIPTION	MODEL# / FEATURES	STANDARD TEXTILE GRADES											
 <p>HB Two Seat Chair w/Center Table Top - Right COM: 4 YD 3.66 M Unit weight: 99 LB 45 KG Carton weight: 111 LB 50.35 KG Carton volume: 80.75 FT³ 2.28 MT³</p>	GC4236HBR	COM	2	3	4	5	6	7	8	9	10	11	12
	2647	2775	2883	3007	3211	3399	805	3751	3955	4147	4407	4775	
	Ganging.	OVERALL DIMENSIONS			SEAT DIMENSIONS			BACK DIMENSIONS					
	Active weight 500 lbs/seat.	W	D	H	W	D	H	W	H				
Wood armcap option: Add \$49.	IN 72.75	26	42.5	44	18	18	44	24.5					
Table top only offered in high pressure laminate.	MM 1848	660	1080	1118	457	457	1118	622					
	RTA 00	1 per carton											
 <p>HB Two Seat Chair w/Center Table Top - Left & Right COM: 4 YD 3.66 M Unit weight: 102 LB 46.4 KG Carton weight: 114 LB 51.71 KG Carton volume: 80.75 FT³ 2.28 MT³</p>	GC4236HBB	COM	2	3	4	5	6	7	8	9	10	11	12
	2679	2807	2915	3039	3243	3431	3619	3783	3987	4179	4439	4807	
	Ganging.	OVERALL DIMENSIONS			SEAT DIMENSIONS			BACK DIMENSIONS					
	Active weight 500 lbs/seat.	W	D	H	W	D	H	W	H				
Wood armcap option: Add \$49.	IN 72.75	26	42.5	44	18	18	44	24.5					
Table top only offered in high pressure laminate.	MM 1848	660	1080	1118	457	457	1118	622					
	RTA 00	1 per carton											
 <p>LB Armchair w/Rear Casters COM: 1.75 YD 1.6 M Unit weight: 41 LB 18.6 KG Carton weight: 49 LB 22.23 KG Carton volume: 20.25 FT³ 0.57 MT³</p>	GC4240	COM	2	3	4	5	6	7	8	9	10	11	12
	1237	1293	1340	1395	1484	1566	1648	1720	1809	1893	2007	2168	
	Active weight 500 lbs.	OVERALL DIMENSIONS			SEAT DIMENSIONS			BACK DIMENSIONS					
	Wood armcap option: Add \$49.	W	D	H	W	D	H	W	H				
	IN 26.75	27.5	37.5	22	18	18	21.5	19.5					
	MM 679	699	953	559	457	457	546	495					
	RTA 00	1 per carton											
 <p>HB Armchair w/Rear Casters COM: 2 YD 1.83 M Unit weight: 46 LB 20.9 KG Carton weight: 54 LB 24.49 KG Carton volume: 22.25 FT³ 0.63 MT³</p>	GC4240HB	COM	2	3	4	5	6	7	8	9	10	11	12
	1282	1346	1400	1462	1564	1658	1752	1834	1936	2032	2162	2346	
	Active weight 500 lbs.	OVERALL DIMENSIONS			SEAT DIMENSIONS			BACK DIMENSIONS					
	Wood armcap option: Add \$49.	W	D	H	W	D	H	W	H				
	IN 26.75	27.5	42.5	22	18	18	21.5	24.5					
	MM 679	699	1080	559	457	457	546	622					
	RTA 00	1 per carton											
 <p>Bariatric LB Armchair COM: 3 YD 2.74 M Unit weight: 56 LB 25.5 KG Carton weight: 70 LB 31.75 KG Carton volume: 30.5 FT³ 0.86 MT³</p>	GC4241	COM	2	3	4	5	6	7	8	9	10	11	12
	1524	1620	1701	1794	1947	2088	2229	2352	2505	2649	2844	3120	
	Active weight 750 lbs.	OVERALL DIMENSIONS			SEAT DIMENSIONS			BACK DIMENSIONS					
	Wood armcap option: Add \$49.	W	D	H	W	D	H	W	H				
	IN 37.5	28	37.5	32.5	18	18	32.5	19.5					
Armless bariatric models are not available.	MM 953	711	953	826	457	457	826	495					
	RTA 00	1 per carton											

DESCRIPTION MODEL# / FEATURES STANDARD TEXTILE GRADES

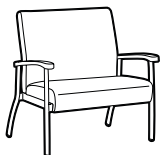

Bariatric LB Armchair - Left
 COM: 3 YD | 2.74 M
 Unit weight: 57 LB | 25.9 KG
 Carton weight: 71 LB | 32.21 KG
 Carton volume: 30.5 FT³ | 0.86 MT³

MODEL#	2	3	4	5	6	7	8	9	10	11	12	
GC4241L	1555	1651	1732	1825	1978	2119	2260	2383	2536	2680	2875	3151
Ganging.												
Active weight 750 lbs.												
Wood armcap option: Add \$49.												
Armless bariatric models are <u>not</u> available.												

OVERALL DIMENSIONS			SEAT DIMENSIONS			BACK DIMENSIONS		
W	D	H	W	D	H	W	H	
IN 37.5	28	37.5	32.5	18	18	32.5	19.5	
MM 953	711	953	826	457	457	826	495	

RTA 00	1 per carton
---------------	--------------



Bariatric LB Armchair - Right
 COM: 3 YD | 2.74 M
 Unit weight: 57 LB | 25.9 KG
 Carton weight: 71 LB | 32.21 KG
 Carton volume: 30.5 FT³ | 0.86 MT³

MODEL#	2	3	4	5	6	7	8	9	10	11	12	
GC4241R	1555	1651	1732	1825	1978	2119	2260	2383	2536	2680	2875	3151
Ganging.												
Active weight 750 lbs.												
Wood armcap option: Add \$49.												
Armless bariatric models are <u>not</u> available.												

OVERALL DIMENSIONS			SEAT DIMENSIONS			BACK DIMENSIONS		
W	D	H	W	D	H	W	H	
IN 37.5	28	37.5	32.5	18	18	32.5	19.5	
MM 953	711	953	826	457	457	826	495	

RTA 00	1 per carton
---------------	--------------



Bariatric LB Armchair - Left & Right
 COM: 3 YD | 2.74 M
 Unit weight: 57 LB | 25.9 KG
 Carton weight: 71 LB | 32.21 KG
 Carton volume: 30.5 FT³ | 0.86 MT³

MODEL#	2	3	4	5	6	7	8	9	10	11	12	
GC4241B	1588	1684	1765	1858	2011	2152	2293	2416	2569	2713	2908	3184
Ganging.												
Active weight 750 lbs.												
Wood armcap option: Add \$49.												
Armless bariatric models are <u>not</u> available.												

OVERALL DIMENSIONS			SEAT DIMENSIONS			BACK DIMENSIONS		
W	D	H	W	D	H	W	H	
IN 37.5	28	37.5	32.5	18	18	32.5	19.5	
MM 953	711	953	826	457	457	826	495	

RTA 00	1 per carton
---------------	--------------



Bariatric HB Armchair
 COM: 3.25 YD | 2.97 M
 Unit weight: 59 LB | 26.8 KG
 Carton weight: 73 LB | 33.11 KG
 Carton volume: 30.5 FT³ | 0.86 MT³

MODEL#	2	3	4	5	6	7	8	9	10	11	12	
GC4241HB	1600	1704	1792	1893	2058	2211	2364	2497	2663	2819	3030	3329
Active weight 750 lbs.												
Wood armcap option: Add \$49.												
Armless bariatric models are <u>not</u> available.												

OVERALL DIMENSIONS			SEAT DIMENSIONS			BACK DIMENSIONS		
W	D	H	W	D	H	W	H	
IN 37.5	28	43	32.5	18	18	32.5	24.5	
MM 953	711	1092	826	457	457	826	622	

RTA 00	1 per carton
---------------	--------------





Bariatric HB Armchair - Left
 COM: 3.25 YD | 2.97 M
 Unit weight: 60 LB | 27.3 KG
 Carton weight: 73 LB | 33.11 KG
 Carton volume: 15.5 FT³ | 0.86 MT³





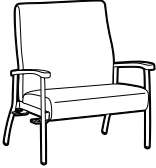
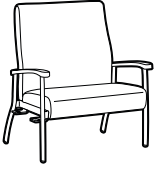

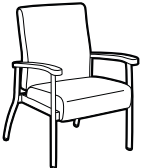
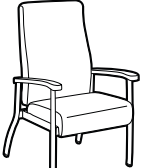



MODEL#	2	3	4	5	6	7	8	9	10	11	12	
GC4241HBL	1632	1736	1824	1925	2090	2243	2396	2529	2695	2851	3062	3361
Ganging.												
Active weight 750 lbs.												
Wood armcap option: Add \$49.												
Armless bariatric models are <u>not</u> available.												

OVERALL DIMENSIONS			SEAT DIMENSIONS			BACK DIMENSIONS		
W	D	H	W	D	H	W	H	
IN 37.5	28	43	32.5	18	18	32.5	24.5	
MM 953	711	1092	826	457	457	826	622	

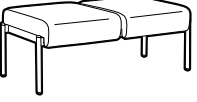
RTA 00	1 per carton
---------------	--------------

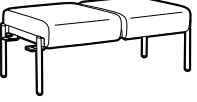
DESCRIPTION	MODEL# / FEATURES	STANDARD TEXTILE GRADES											
		COM	2	3	4	5	6	7	8	9	10	11	12
 <p>Bariatric HB Armchair - Right COM: 3.25 YD 2.97 M Unit weight: 60 LB 27.3 KG Carton weight: 74 LB 33.57 KG Carton volume: 30.5 FT³ 0.86 MT³</p>	GC4241HBR	1632	1736	1824	1925	2090	2243	2396	2529	2695	2851	3062	3361
	Ganging.												
	Active weight 750 lbs.	OVERALL DIMENSIONS			SEAT DIMENSIONS			BACK DIMENSIONS					
	Wood armcap option: Add \$49.	IN	37.5	28	43	32.5	18	18	32.5	24.5			
	Armless bariatric models are <u>not</u> available.	MM	953	711	1092	826	457	457	826	622			
	RTA 00	1 per carton											
 <p>Bariatric HB Armchair - Left & Right COM: 3.25 YD 2.97 M Unit weight: 60 LB 27.3 KG Carton weight: 74 LB 33.57 KG Carton volume: 30.5 FT³ 0.86 MT³</p>	GC4241HBB	1664	1768	1856	1957	2122	2275	2428	2561	2727	2883	3094	3393
	Ganging.												
	Active weight 750 lbs.	OVERALL DIMENSIONS			SEAT DIMENSIONS			BACK DIMENSIONS					
	Wood armcap option: Add \$49.	IN	37.5	28	43	32.5	18	18	32.5	24.5			
	Armless bariatric models are <u>not</u> available.	MM	953	711	1092	826	457	457	826	622			
	RTA 00	1 per carton											
 <p>Designed to immobilize the pelvis and hip joints after surgery.</p> <p>Bariatric LB Armchair Post Surgery COM: 3 YD 2.74 M Unit weight: 64 LB 29.1 KG Carton weight: 76 LB 34.47 KG Carton volume: 33.5 FT³ 0.94 MT³</p>	GC4241-24 24" seat height	1672	1768	1849	1942	2095	2236	2377	2500	2653	2797	2992	3268
	Active weight 750 lbs.	OVERALL DIMENSIONS			SEAT DIMENSIONS			BACK DIMENSIONS					
	Wood armcap option: Add \$49.	IN	37.5	28.75	43.5	32.5	18	24	32.5	19.5			
	Armless bariatric models are <u>not</u> available.	MM	953	730	1105	826	457	610	826	495			
		RTA 00	1 per carton										
 <p>LB Armchair Flex Back COM: 1.75 YD 1.6 M Unit weight: 41 LB 18.6 KG Carton weight: 53 LB 24.04 KG Carton volume: 20.25 FT³ 0.57 MT³</p>	GC4242	1482	1538	1585	1640	1729	1811	1893	1965	2054	2138	2252	2413
	Active weight 500 lbs.	OVERALL DIMENSIONS			SEAT DIMENSIONS			BACK DIMENSIONS					
	Wood armcap option: Add \$49.	IN	26.5	28	37.5	22	18	18	21.5	19.5			
		MM	673	711	953	559	457	457	546	495			
		RTA 00	1 per carton										
 <p>HB Armchair Flex Back COM: 2 YD 1.83 M Unit weight: 48 LB 21.8 KG Carton weight: 61 LB 27.67 KG Carton volume: 22.25 FT³ 0.63 MT³</p>	GC4242HB	1527	1591	1645	1707	1809	1903	1997	2079	2181	2277	2407	2591
	Active weight 500 lbs.	OVERALL DIMENSIONS			SEAT DIMENSIONS			BACK DIMENSIONS					
	Wood armcap option: Add \$49.	IN	26.5	28	43	22	18	18	21.5	24.5			
		MM	673	711	1092	559	457	457	546	622			
		RTA 00	1 per carton										

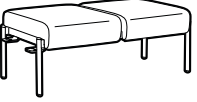
DESCRIPTION	MODEL# / FEATURES	STANDARD TEXTILE GRADES											
		COM	2	3	4	5	6	7	8	9	10	11	12
 <p>LB Armchair Flex Back w/Rear Casters COM: 1.75 YD 1.6 M Unit weight: 41 LB 18.6 KG Carton weight: 49 LB 22.23 KG Carton volume: 20.25 FT³ 0.57 MT³</p>	<p>GC4243</p>	1571	1627	1674	1729	1818	1900	1982	2054	2143	2227	2341	2502
		OVERALL DIMENSIONS			SEAT DIMENSIONS			BACK DIMENSIONS					
		W	D	H	W	D	H	W	H				
		IN 26.75 MM 679	27.5 699	37.5 953	22 559	18 457	18 457	21.5 546	19.5 495				
Active weight 500 lbs.		Wood armcap option: Add \$49.		RTA 00		1 per carton							
 <p>HB Armchair Flex Back w/Rear Casters COM: 2 YD 1.83 M Unit weight: 43 LB 19.5 KG Carton weight: 51 LB 23.13 KG Carton volume: 22.25 FT³ 0.63 MT³</p>	<p>GC4243HB</p>	1620	1684	1738	1800	1902	1996	2090	2172	2274	2370	2500	2684
		OVERALL DIMENSIONS			SEAT DIMENSIONS			BACK DIMENSIONS					
		W	D	H	W	D	H	W	H				
		IN 26.75 MM 679	27.5 699	42.5 1080	22 559	18 457	18 457	21.5 546	24.5 622				
Active weight 500 lbs.		Wood armcap option: Add \$49.		RTA 00		1 per carton							
 <p>HB Armchair Split Back COM: 2.25 YD 2.06 M Unit weight: 46 LB 20.9 KG Carton weight: 54 LB 24.49 KG Carton volume: 20.25 FT³ 0.57 MT³</p>	<p>GC4244HB</p>	1412	1484	1545	1615	1729	1835	1941	2033	2148	2256	2402	2609
		OVERALL DIMENSIONS			SEAT DIMENSIONS			BACK DIMENSIONS					
		W	D	H	W	D	H	W	H				
		IN 26.75 MM 679	26 660	42.5 1080	22 559	18 457	18 457	21.5 546	24.5 622				
Active weight 500 lbs.		Fold down headrest allows caregiver to assist occupant.		Wood armcap option: Add \$49.		RTA 00		1 per carton					
 <p>HB Armchair Split Back w/Rear Casters COM: 2.25 YD 2.06 M Unit weight: 46 LB 20.9 KG Carton weight: 54 LB 24.49 KG Carton volume: 20.25 FT³ 0.57 MT³</p>	<p>GC4245HB</p>	1503	1575	1636	1706	1820	1926	2032	2124	2239	2347	2493	2700
		OVERALL DIMENSIONS			SEAT DIMENSIONS			BACK DIMENSIONS					
		W	D	H	W	D	H	W	H				
		IN 26.75 MM 679	26 660	42.5 1080	22 559	18 457	18 457	21.5 546	24.5 622				
Active weight 500 lbs.		Fold down headrest allows caregiver to assist occupant.		Wood armcap option: Add \$49.		RTA 00		1 per carton					
 <p>Single Seat Bench COM: 1.5 YD 1.37 M Unit weight: 25 LB 11.4 KG Carton weight: 30 LB 13.61 KG Carton volume: 13 FT³ 0.36 MT³</p>	<p>GC4251</p>	740	788	829	875	952	1022	1093	1154	1231	1303	1400	1538
		OVERALL DIMENSIONS			SEAT DIMENSIONS			BACK DIMENSIONS					
		W	D	H	W	D	H	W	H				
		IN 24.75 MM 629	26.5 673	18 457	-	-	-	-	-				
Active weight 500 lbs.		RTA 00		courier		1 per carton							

DESCRIPTION	MODEL# / FEATURES	STANDARD TEXTILE GRADES												
		COM	2	3	4	5	6	7	8	9	10	11	12	
 <p>Single Seat Bench - Reversible (One Side) COM: 1.5 YD 1.37 M Unit weight: 26 LB 11.8 KG Carton weight: 31 LB 14.06 KG Carton volume: 13 FT³ 0.36 MT³</p>	GC4251L	769	817	858	904	981	1051	1122	1183	1260	1332	1429	1567	
	Ganging.	OVERALL DIMENSIONS			SEAT DIMENSIONS			BACK DIMENSIONS						
	Active weight 500 lbs.	IN 25.75	26.5	18	-	-	-	-	-	-	-	-	-	-
		MM 654	673	457	-	-	-	-	-	-	-	-	-	-
		RTA 00		1 per carton										
 <p>Single Seat Bench - Left & Right COM: 1.5 YD 1.37 M Unit weight: 27 LB 12.3 KG Carton weight: 32 LB 14.51 KG Carton volume: 13 FT³ 0.36 MT³</p>	GC4251B	801	849	890	936	1013	1083	1154	1215	1292	1364	1461	1599	
	Ganging.	OVERALL DIMENSIONS			SEAT DIMENSIONS			BACK DIMENSIONS						
	Active weight 500 lbs.	IN 26.75	26.5	18	-	-	-	-	-	-	-	-	-	-
		MM 679	673	457	-	-	-	-	-	-	-	-	-	-
		RTA 00		1 per carton										
 <p>Two Seat Bench COM: 2.25 YD 2.06 M Unit weight: 45 LB 20.5 KG Carton weight: 53 LB 24.04 KG Carton volume: 23 FT³ 0.65 MT³</p>	GC4252	1328	1400	1461	1531	1645	1751	1857	1949	2064	2172	2318	2525	
		OVERALL DIMENSIONS			SEAT DIMENSIONS			BACK DIMENSIONS						
	Active weight 500 lbs/seat.	IN 47.75	26.5	18	-	-	-	-	-	-	-	-	-	-
		MM 1213	673	457	-	-	-	-	-	-	-	-	-	-
		RTA 00		1 per carton										
 <p>Two Seat Bench - Reversible (One Side) COM: 2.25 YD 2.06 M Unit weight: 46 LB 20.9 KG Carton weight: 54 LB 24.49 KG Carton volume: 23 FT³ 0.65 MT³</p>	GC4252L	1358	1430	1491	1561	1675	1781	1887	1979	2094	2202	2348	2555	
	Ganging.	OVERALL DIMENSIONS			SEAT DIMENSIONS			BACK DIMENSIONS						
	Active weight 500 lbs/seat.	IN 48.75	26.5	18	-	-	-	-	-	-	-	-	-	-
		MM 1238	673	457	-	-	-	-	-	-	-	-	-	-
		RTA 00		1 per carton										
 <p>Two Seat Bench - Left & Right COM: 2.25 YD 2.06 M Unit weight: 47 LB 21.4 KG Carton weight: 55 LB 24.95 KG Carton volume: 23 FT³ 0.65 MT³</p>	GC4252B	1388	1460	1521	1591	1705	1811	1917	2009	2124	2232	2378	2585	
	Ganging.	OVERALL DIMENSIONS			SEAT DIMENSIONS			BACK DIMENSIONS						
	Active weight 500 lbs/seat.	IN 49.75	26.5	18	-	-	-	-	-	-	-	-	-	-
		MM 1264	673	457	-	-	-	-	-	-	-	-	-	-
		RTA 00		1 per carton										

DESCRIPTION MODEL# / FEATURES STANDARD TEXTILE GRADES

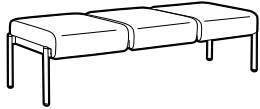

Three Seat Bench
 COM: 3 YD | 2.74 M
 Unit weight: 65 LB | 29.5 KG
 Carton weight: 73 LB | 33.11 KG
 Carton volume: 33.25 FT³ | 0.94 MT³

Active weight 500 lbs/seat.

COM	2	3	4	5	6	7	8	9	10	11	12
1954	2050	2131	2224	2377	2518	2659	2782	2935	3079	3274	3550

OVERALL DIMENSIONS			SEAT DIMENSIONS			BACK DIMENSIONS	
W	D	H	W	D	H	W	H

IN	70.75	26.5	18	-	-	-	-	-
MM	1797	673	457	-	-	-	-	-

RTA 00 1 per carton



Three Seat Bench - Reversible (One Side)
 COM: 3 YD | 2.74 M
 Unit weight: 66 LB | 30 KG
 Carton weight: 74 LB | 33.57 KG
 Carton volume: 33.25 FT³ | 0.94 MT³

Ganging.
 Active weight 500 lbs/seat.

COM	2	3	4	5	6	7	8	9	10	11	12
1983	2079	2160	2253	2406	2547	2688	2811	2964	3108	3303	3579

OVERALL DIMENSIONS			SEAT DIMENSIONS			BACK DIMENSIONS	
W	D	H	W	D	H	W	H

IN	71.75	26.5	18	-	-	-	-	-
MM	1822	673	457	-	-	-	-	-

RTA 00 1 per carton

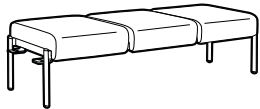

Three Seat Bench - Left & Right
 COM: 3 YD | 2.74 M
 Unit weight: 67 LB | 30.5 KG
 Carton weight: 75 LB | 34.02 KG
 Carton volume: 33.25 FT³ | 0.94 MT³

Ganging.
 Active weight 500 lbs/seat.

COM	2	3	4	5	6	7	8	9	10	11	12
2013	2109	2190	2283	2436	2577	2718	2841	2994	3138	3333	3609

OVERALL DIMENSIONS			SEAT DIMENSIONS			BACK DIMENSIONS	
W	D	H	W	D	H	W	H

IN	72.75	26.5	18	-	-	-	-	-
MM	1848	673	457	-	-	-	-	-

RTA 00 1 per carton

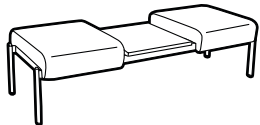

Two Seat Bench w/Center Table Top
 COM: 2.25 YD | 2.06 M
 Unit weight: 60 LB | 27.3 KG
 Carton weight: 68 LB | 30.84 KG
 Carton volume: 33.25 FT³ | 0.94 MT³

Active weight 500 lbs/seat.
 Table top only offered in high pressure laminate.

COM	2	3	4	5	6	7	8	9	10	11	12
1908	1980	2041	2111	2225	2331	2437	2529	2644	2752	2898	3105

OVERALL DIMENSIONS			SEAT DIMENSIONS			BACK DIMENSIONS	
W	D	H	W	D	H	W	H

IN	70.75	26.5	18	-	-	-	-	-
MM	1797	673	457	-	-	-	-	-

RTA 00  1 per carton

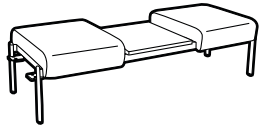

Two Seat Bench w/Center Table Top - Reversible (One Side)
 COM: 2.25 YD | 2.06 M
 Unit weight: 64 LB | 29.1 KG
 Carton weight: 72 LB | 32.66 KG
 Carton volume: 33.25 FT³ | 0.94 MT³









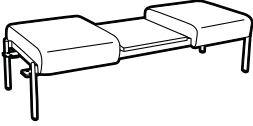

Ganging.
 Active weight 500 lbs/seat.
 Table top only offered in high pressure laminate.

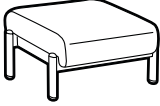
COM	2	3	4	5	6	7	8	9	10	11	12
1941	2013	2074	2144	2258	2364	2470	2562	2677	2785	2931	3138

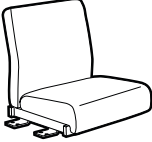
OVERALL DIMENSIONS			SEAT DIMENSIONS			BACK DIMENSIONS	
W	D	H	W	D	H	W	H

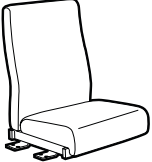
IN	71.75	26.5	18	-	-	-	-	-
MM	1822	673	457	-	-	-	-	-

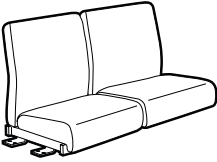
RTA 00  1 per carton

DESCRIPTION	MODEL# / FEATURES	STANDARD TEXTILE GRADES													
		COM	2	3	4	5	6	7	8	9	10	11	12		
 <p>Two Seat Bench w/Center Table Top - Left & Right COM: 2.25 YD 2.06 M Unit weight: 62 LB 28.2 KG Carton weight: 70 LB 31.75 KG Carton volume: 33.25 FT³ 0.94 MT³</p>	GC4256B	1969	2041	2102	2172	2286	2392	2498	2590	2705	2813	2959	3166		
	Ganging.	OVERALL DIMENSIONS			SEAT DIMENSIONS			BACK DIMENSIONS							
	Active weight 500 lbs/seat.	IN 72.75	26.5	18	-	-	-	-	-	-	-	-	-	-	
	Table top only offered in high pressure laminate.	MM 1848	673	457	-	-	-	-	-	-	-	-	-	-	
		RTA 00		1 per carton											
 <p>Ottoman Angled Cushion Top COM: 1 YD 0.91 M Unit weight: 14 LB 6.4 KG Carton weight: 16 LB 7.26 KG Carton volume: 3.6 FT³ 0.1 MT³</p>	GC4259	426	458	485	516	567	614	661	702	753	801	866	958		
		OVERALL DIMENSIONS			SEAT DIMENSIONS			BACK DIMENSIONS							
	Active weight 500 lbs.	IN 17.75	19	10.5	-	-	-	-	-	-	-	-	-	-	
		MM 451	483	267	-	-	-	-	-	-	-	-	-	-	
		RTA 00		1 per carton											
 <p>LB Single Seat Armless Bridge - Left & Right COM: 1.75 YD 1.6 M Unit weight: 31 LB 14.1 KG Carton weight: 36 LB 16.33 KG Carton volume: 13 FT³ 0.36 MT³</p>	GC4261	855	911	958	1013	1102	1184	1266	1338	1427	1511	1625	1786		
	Ganging/linking.	OVERALL DIMENSIONS			SEAT DIMENSIONS			BACK DIMENSIONS							
	Active weight 500 lbs.	IN 26.75	24	25.5	22	18	-	21.5	19.5	-	-	-	-	-	
	Not freestanding. Suspends between 2 units via linking brackets.	MM 679	610	648	559	457	-	546	495	-	-	-	-	-	
		RTA 00		1 per carton											
 <p>HB Single Seat Armless Bridge - Left & Right COM: 2 YD 1.83 M Unit weight: 36 LB 16.4 KG Carton weight: 41 LB 18.6 KG Carton volume: 14.5 FT³ 0.41 MT³</p>	GC4261HB	900	964	1018	1080	1182	1276	1370	1452	1554	1650	1780	1964		
	Ganging/linking.	OVERALL DIMENSIONS			SEAT DIMENSIONS			BACK DIMENSIONS							
	Active weight 500 lbs.	IN 26.75	24	30.5	22	18	-	21.5	24.5	-	-	-	-	-	
	Not freestanding. Suspends between 2 units via linking brackets.	MM 679	610	775	559	457	-	546	622	-	-	-	-	-	
		RTA 00		1 per carton											
 <p>LB Two Seat Armless Bridge - Left & Right COM: 3.5 YD 3.2 M Unit weight: 60 LB 27.3 KG Carton weight: 66 LB 29.94 KG Carton volume: 23 FT³ 0.65 MT³</p>	GC4262	1656	1768	1863	1971	2150	2314	2479	2622	2801	2969	3196	3518		
	Ganging/linking.	OVERALL DIMENSIONS			SEAT DIMENSIONS			BACK DIMENSIONS							
	Active weight 500 lbs/seat.	IN 49.75	24	25.5	44	18	-	44	19.5	-	-	-	-	-	
	Not freestanding. Suspends between 2 units via linking brackets.	MM 1264	610	648	1118	457	-	1118	495	-	-	-	-	-	
		RTA 00		1 per carton											

DESCRIPTION MODEL# / FEATURES STANDARD TEXTILE GRADES

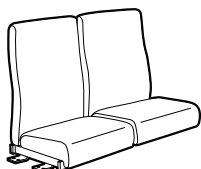

HB Two Seat Armless Bridge - Left & Right
 COM: 4 YD | 3.66 M
 Unit weight: 64 LB | 29.1 KG
 Carton weight: 72 LB | 32.66 KG
 Carton volume: 24 FT³ | 0.67 MT³

COM	2	3	4	5	6	7	8	9	10	11	12	
GC4262HB	1745	1873	1981	2105	2309	2497	2685	2849	3053	3245	3505	3873

Ganging/linking.

Active weight 500 lbs/seat.

Not freestanding.
 Suspends between 2 units via linking brackets.

OVERALL DIMENSIONS			SEAT DIMENSIONS			BACK DIMENSIONS	
W	D	H	W	D	H	W	H
IN 49.75	24	30.5	44	18	-	44	24.5
MM 1264	610	775	1118	457	-	1118	622

RTA 00  1 per carton

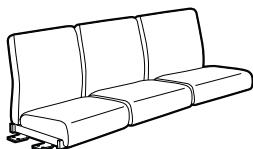

LB Three Seat Armless Bridge - Left & Right
 COM: 5 YD | 4.57 M
 Unit weight: 68 LB | 30.9 KG
 Carton weight: 74 LB | 33.57 KG
 Carton volume: 38.75 FT³ | 1.09 MT³

COM	2	3	4	5	6	7	8	9	10	11	12	
GC4263	2464	2624	2759	2914	3169	3404	3639	3844	4099	4339	4664	5124

Ganging/linking.

Active weight 500 lbs/seat.

Not freestanding.
 Suspends between 2 units via linking brackets.

OVERALL DIMENSIONS			SEAT DIMENSIONS			BACK DIMENSIONS	
W	D	H	W	D	H	W	H
IN 72.75	24	25.5	70	18	-	70	19.5
MM 1848	610	648	1778	457	-	1778	495

RTA 00  1 per carton

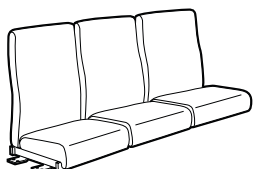

HB Three Seat Armless Bridge - Left & Right
 COM: 5.75 YD | 5.26 M
 Unit weight: 74 LB | 33.6 KG
 Carton weight: 80 LB | 36.29 KG
 Carton volume: 38.75 FT³ | 1.09 MT³

COM	2	3	4	5	6	7	8	9	10	11	12	
GC4263HB	2601	2785	2940	3119	3412	3682	3952	4188	4481	4757	5131	5660

Ganging/linking.

Active weight 500 lbs/seat.

Not freestanding.
 Suspends between 2 units via linking brackets.

OVERALL DIMENSIONS			SEAT DIMENSIONS			BACK DIMENSIONS	
W	D	H	W	D	H	W	H
IN 72.75	24	30.5	70	18	-	70	24.5
MM 1848	610	775	1778	457	-	1778	622

RTA 00  1 per carton

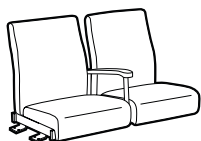

LB Two Seat Bridge Half Center Arm - Left & Right
 COM: 3.5 YD | 3.2 M
 Unit weight: 52 LB | 23.6 KG
 Carton weight: 58 LB | 26.31 KG
 Carton volume: 27.25 FT³ | 0.77 MT³

COM	2	3	4	5	6	7	8	9	10	11	12	
GC4264	1831	1943	2038	2146	2325	2489	2654	2797	2976	3144	3371	3693

Ganging/linking.

Active weight 500 lbs/seat.

Not freestanding.
 Suspends between 2 units via linking brackets.

Wood armcap option:
 Add \$25.

OVERALL DIMENSIONS			SEAT DIMENSIONS			BACK DIMENSIONS	
W	D	H	W	D	H	W	H
IN 50.75	24	25.5	22	18	-	21.5	19.5
MM 1289	610	648	559	457	-	546	4951

RTA 00 1 per carton

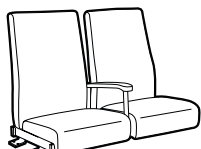

HB Two Seat Bridge Half Center Arm - Left & Right
 COM: 4 YD | 3.66 M
 Unit weight: 62 LB | 28.2 KG
 Carton weight: 68 LB | 30.84 KG
 Carton volume: 27.25 FT³ | 0.77 MT³

COM	2	3	4	5	6	7	8	9	10	11	12	
GC4264HB	1922	2050	2158	2282	2486	2674	2862	3026	3230	3422	3682	4050

Ganging/linking.









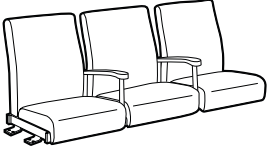

Active weight 500 lbs/seat.

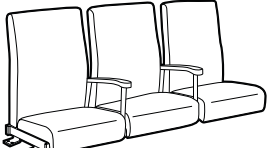

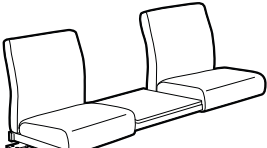
Not freestanding.
 Suspends between 2 units via linking brackets.

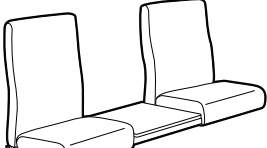

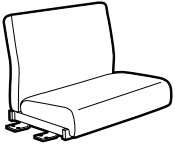
Wood armcap option:
 Add \$25.

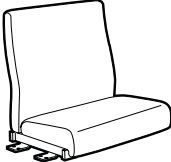

OVERALL DIMENSIONS			SEAT DIMENSIONS			BACK DIMENSIONS	
W	D	H	W	D	H	W	H
IN 50.75	24	30.5	22	18	-	21.5	24.5
MM 1289	610	775	559	457	-	546	622



RTA 00 1 per carton

DESCRIPTION	MODEL# / FEATURES	STANDARD TEXTILE GRADES											
		COM	2	3	4	5	6	7	8	9	10	11	12
 <p>LB Three Seat Bridge Half Center Arms - Left & Right COM: 5 YD 4.57 M Unit weight: 72 LB 32.7 KG Carton weight: 78 LB 35.38 KG Carton volume: 38.75 FT³ 1.09 MT³</p>	GC4265	2816	2976	3111	3266	3521	3756	3991	4196	4451	4691	5016	5476
	Ganging/linking.												
	Active weight 500 lbs/seat.	OVERALL DIMENSIONS			SEAT DIMENSIONS			BACK DIMENSIONS					
		W	D	H	W	D	H	W	H				
	IN 74.25	24	25.5	22	18	-	21.5	19.5					
	MM 1886	610	648	559	457	-	546	495					
Wood armcap option: Add \$49.	RTA 00		1 per carton										
 <p>HB Three Seat Bridge Half Center Arms - Left & Right COM: 5.75 YD 5.26 M Unit weight: 80 LB 36.4 KG Carton weight: 86 LB 39.01 KG Carton volume: 38.75 FT³ 1.09 MT³</p>	GC4265HB	2951	3135	3290	3469	3762	4032	4302	4538	4831	5107	5481	6010
	Ganging/linking.												
	Active weight 500 lbs/seat.	OVERALL DIMENSIONS			SEAT DIMENSIONS			BACK DIMENSIONS					
		W	D	H	W	D	H	W	H				
	IN 74.25	24	30.5	22	18	-	21.5	24.5					
	MM 1886	610	775	559	457	-	546	622					
Wood armcap option: Add \$49.	RTA 00		1 per carton										
 <p>LB Two Seat Armless Bridge Center Table Top - Left & Right COM: 3.5 YD 3.2 M Unit weight: 54 LB 24.5 KG Carton weight: 60 LB 27.22 KG Carton volume: 38.75 FT³ 1.09 MT³</p>	GC4266	2235	2347	2442	2550	2729	2893	3058	3201	3380	3548	3775	4097
	Ganging/linking.												
	Active weight 500 lbs/seat.	OVERALL DIMENSIONS			SEAT DIMENSIONS			BACK DIMENSIONS					
		W	D	H	W	D	H	W	H				
	IN 72.75	24	25.5	22	18	-	21.5	19.5					
	MM 1848	610	648	559	457	-	546	495					
Table top only offered in high pressure laminate.	RTA 00		1 per carton										
 <p>HB Two Seat Armless Bridge Center Table Top - Left & Right COM: 4 YD 3.66 M Unit weight: 60 LB 27.3 KG Carton weight: 66 LB 29.94 KG Carton volume: 38.75 FT³ 1.09 MT³</p>	GC4266HB	2327	2455	2563	2687	2891	3079	3267	3431	3635	3827	4087	4455
	Ganging/linking.												
	Active weight 500 lbs/seat.	OVERALL DIMENSIONS			SEAT DIMENSIONS			BACK DIMENSIONS					
		W	D	H	W	D	H	W	H				
	IN 72.75	24	30.5	22	18	-	21.5	24.5					
	MM 1848	610	775	559	457	-	546	622					
Table top only offered in high pressure laminate.	RTA 00		1 per carton										
 <p>Bariatric LB Armless Bridge - Left & Right COM: 3 YD 2.74 M Unit weight: 38 LB 17.3 KG Carton weight: 44 LB 19.96 KG Carton volume: 26.5 FT³ 0.75 MT³</p>	GC4269	1235	1331	1412	1505	1658	1799	1940	2063	2216	2360	2555	2831
	Ganging/linking.												
	Active weight 750 lbs.	OVERALL DIMENSIONS			SEAT DIMENSIONS			BACK DIMENSIONS					
		W	D	H	W	D	H	W	H				
	IN 37.5	24	25.5	32.5	18	-	32.5	19.5					
	MM 953	610	648	826	457	-	826	495					
Not freestanding. Suspends between 2 units via linking brackets.	RTA 00		1 per carton										

DESCRIPTION	MODEL# / FEATURES	STANDARD TEXTILE GRADES											
		COM	2	3	4	5	6	7	8	9	10	11	12
 <p>Bariatric HB Armless Bridge - Left & Right COM: 3.25 YD 2.97 M Unit weight: 44 LB 20 KG Carton weight: 50 LB 22.68 KG Carton volume: 26.5 FT³ 0.75 MT³</p>	GC4269HB	1310	1414	1502	1603	1768	1921	2074	2207	2373	2529	2740	3039
	Ganging/linking.	OVERALL DIMENSIONS W D H			SEAT DIMENSIONS W D H			BACK DIMENSIONS W H					
	Active weight 750 lbs.	IN 37.5 MM 953	24 610	30.5 775	32.5 826	18 457	- -	32.5 826	24.5 622				
<p>Not freestanding. Suspends between 2 units via linking brackets.</p> <p>RTA 00  1 per carton</p>													

DESCRIPTION	MODEL# / FEATURES	STANDARD TEXTILE GRADES											
		COM	2	3	4	5	6	7	8	9	10	11	12
 <p>Single Seat Bench Bridge - Left & Right COM: 1.5 YD 1.37 M Unit weight: 20 LB 9.1 KG Carton weight: 24 LB 10.89 KG Carton volume: 2.9 FT³ 0.08 MT³</p>	GC4271	718	766	807	853	930	1000	1071	1132	1209	1281	1378	1516
	Ganging/linking.	OVERALL DIMENSIONS W D H			SEAT DIMENSIONS W D H			BACK DIMENSIONS W H					
	Active weight 500 lbs.	IN 24.75 MM 629	26.5 673	6 152	- -	- -	- -	- -	- -				
<p>Not freestanding. Suspends between 2 units via linking brackets.</p> <p>RTA 00  1 per carton</p>													

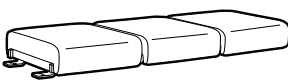
DESCRIPTION	MODEL# / FEATURES	STANDARD TEXTILE GRADES											
		COM	2	3	4	5	6	7	8	9	10	11	12
 <p>Two Seat Bench Bridge - Left & Right COM: 2.25 YD 2.06 M Unit weight: 58 LB 26.4 KG Carton weight: 64 LB 29.03 KG Carton volume: 9.25 FT³ 0.26 MT³</p>	GC4272	1304	1376	1437	1507	1621	1727	1833	1925	2040	2148	2294	2501
	Ganging/linking.	OVERALL DIMENSIONS W D H			SEAT DIMENSIONS W D H			BACK DIMENSIONS W H					
	Active weight 500 lbs/seat.	IN 49.75 MM 1264	26.5 673	6 152	- -	- -	- -	- -	- -				
<p>Not freestanding. Suspends between 2 units via linking brackets.</p> <p>RTA 00  1 per carton</p>													

DESCRIPTION	MODEL# / FEATURES	STANDARD TEXTILE GRADES											
		COM	2	3	4	5	6	7	8	9	10	11	12
 <p>Three Seat Bench Bridge - Left & Right COM: 3 YD 2.74 M Unit weight: 62 LB 28.2 KG Carton weight: 68 LB 30.84 KG Carton volume: 9.25 FT³ 0.26 MT³</p>	GC4273	1929	2025	2106	2199	2352	2493	2634	2757	2910	3054	3249	3525
	Ganging/linking.	OVERALL DIMENSIONS W D H			SEAT DIMENSIONS W D H			BACK DIMENSIONS W H					
	Active weight 500 lbs/seat.	IN 72.75 MM 1848	26.5 673	6 152	- -	- -	- -	- -	- -				
<p>Not freestanding. Suspends between 2 units via linking brackets.</p> <p>RTA 00  1 per carton</p>													





DESCRIPTION	MODEL# / FEATURES	STANDARD TEXTILE GRADES											
		COM	2	3	4	5	6	7	8	9	10	11	12
 <p>Two Seat Bench Bridge Center Table Top - Left & Right COM: 2.25 YD 2.06 M Unit weight: 28 LB 12.7 KG Carton weight: 32 LB 14.51 KG Carton volume: 9.25 FT³ 0.26 MT³</p>	GC4276	1886	1958	2019	2089	2203	2309	2415	2507	2622	2730	2876	3083
	Ganging/linking.	OVERALL DIMENSIONS W D H			SEAT DIMENSIONS W D H			BACK DIMENSIONS W H					
	Active weight 500 lbs/seat.	IN 72.75 MM 1848	26 660	6 152	- -	- -	- -	- -	- -				
<p>Not freestanding. Suspends between 2 units via linking brackets.</p> <p>Table top only offered in high pressure laminate.</p> <p>RTA 00  1 per carton</p>													

TABLE BRIDGES	MODEL #	DIMENSIONS ^{IN} _{MM}	WEIGHT ^{LB} _{KG}	VOLUME ^{FT³} _{MT³}	LIST PRICE
 <p>End Table Bridge, Not Freestanding</p>	W x D x H				
	GC4274-LP	23 x 23 x 16 584 x 584 x 406	20 9.1	3.4 0.09	\$523
	GC4274-HP	23 x 23 x 16 584 x 584 x 406	20 9.1	3.4 0.09	\$553
	<ul style="list-style-type: none"> • For a thermally fused laminate top (LP), specify model GC4274-LP. • For a high pressure laminate top (HP), specify model GC4274-HP. 				
	<p>1 end suspends to a seating unit via linking brackets. Coordinating 2mm edge. Oval steel tube legs. Reversible. 1 per carton.</p>				
	<hr/>				
 <p>Square Table Top, Not Freestanding</p>	GC4275-LP	23 x 23 x 1 584 x 584 x 25	14 6.4	3.4 0.09	\$347
	GC4275-HP	23 x 23 x 1 584 x 584 x 25	14 6.4	3.4 0.09	\$375
	<ul style="list-style-type: none"> • For a thermally fused laminate top (LP), specify model GC4275-LP. • For a high pressure laminate top (HP), specify model GC4275-HP. 				
	<p>Suspends between two seating units via linking brackets. Coordinating 2mm edge. No legs. Reversible. 1 per carton.</p>				
	<hr/>				
	 <p>End Corner Table Bridge, Not Freestanding</p>	GC4277-LP	35 x 35 x 16 889 x 889 x 406	40 18.2	6 0.16
GC4277-HP		35 x 35 x 16 889 x 889 x 406	40 18.2	6 0.16	\$611
<ul style="list-style-type: none"> • For a thermally fused laminate top (LP), specify model GC4277-LP. • For a high pressure laminate top (HP), specify model GC4277-HP. 					
<p>Suspends between two seating units via linking brackets. Coordinating 2mm edge. Oval steel tube legs. Can be used for right or left corner. 1 per carton.</p>					
<hr/>					
 <p>End Corner Curve Table Bridge, Not Freestanding</p>		GC4278-LP	35 x 35 x 16 889 x 889 x 406	40 18.2	6 0.16
	GC4278-HP	35 x 35 x 16 889 x 889 x 406	40 18.2	6 0.16	\$611
	<ul style="list-style-type: none"> • For a thermally fused laminate top (LP), specify model GC4278-LP. • For a high pressure laminate top (HP), specify model GC4278-HP. 				
	<p>Suspends between two seating units via linking brackets. Coordinating 2mm edge. Oval steel tube legs. Can be used for right or left corner. 1 per carton.</p>				
	<hr/>				

GC CITI

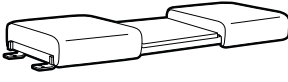

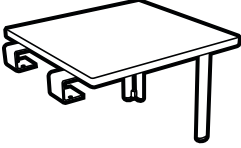
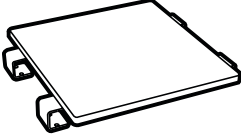
model GC7875LTL (TBL)

Leg options



5" tubular metal leg (shown in Tungsten finish)



5" tapered, softened edge, wood leg (shown in Maple finish)

STANDARD FEATURES

- Fully upholstered contemporary design, complements timeless decor. Proportions are compact, 31" deep, works well in public spaces, lounges and lobbies.
- The steel leg brings a lightness of scale, while satisfying the need for accessibility.
- GC Citi seat and table legs are 5" high tubular metal, standard in a Tungsten finish.
- The seat is fastened into place and removable over an open frame structure eliminating all barriers and traps below the surface.
- The seat cushion is fully encased by the upholstery with a nylon zippered opening for access if replacement is required. This method of upholstery when using Crypton or vinyl textiles prevents the interior construction from contact with spills and body fluids that could affect the products long-term performance.
- All models have removable cushions. Cushions feature removable covers.
- The interior wood frame has an interlocking construction providing superior strength and long-term durability.
- Arm height on all models is 25".
- Casters are not available on this series.
- Citi table tops are available in either tempered glass or laminate. See the Global Seating list price book for details.
- Tablets are made from thermally fused laminate.
- Tablet arms measure 12"D x 16.5"W. Available right hand seated (RT), left hand seated (LT) or both right and left hand (LRT).
- For added comfort, seats are standard with high density Ultracell foam.
- Laminate tables and tablets are offered in the following finishes: Absolute Acajou (ACJ), Asian Night (ASN), Avant Cherry (AWC), Avant Honey (AWH), Black (BLK), Blizzard (BZD), Brushed Cobalt (BRC), Clear Maple (CMB), Custom Grey (CGY), Dark Espresso (DES), Designer White (DWT), Fashionista (FAS), First Class (FCL), Quartered Mahogany (QTM), Noce Biondo (NBL), Noce Grigio (NGL), Noce Leggero (NEL), Noce Medio (NML), Sheer Beauty (SBY), Stonedust (SDT), Walnut Heights (WHE), White Chocolate (WHC) and Winter Cherry (WCR). Please specify.
- For healthcare textiles and wood finish options, visit the website at globalfurnituregroup.com.
- Can be upholstered in standard Global textiles if healthcare compliance is not required.
- Shipped fully assembled.

OPTIONAL FEATURES

- For two and three seat units with tablet arms, after the 6 digit model number:
 - Add (LTL) for left hand laminate tablet or (RTL) for right hand laminate tablet. Add \$412.
- To add sealed seams to your product contact Customer Service. Upcharges vary.
- For moisture barrier on seat, please specify (MB). Add \$122 per seat.
- Leg options:**
 - (MTL) Cylindrical metal legs
Paint finishes. No upcharge.
 - (TBL) Black
 - (TTU) Tungsten
Plated finish. Add \$68.
 - (CHM) Chrome
 - (WDL) Non-cylindrical wood legs
Wood finishes. Add \$300.
 - (AAM) Absolute
 - (BKM) Black
 - (CJM) Charcoal Java
 - (ACM) Cherry
 - (EMM) Empire Mahogany
 - (EOM) English Oak
 - (ECM) Espresso Cafe
 - (TFM) Fruitwood
 - (HGM) Gray
 - (HOM) Harvest Oak
 - (AHM) Honey
 - (JOM) Jet Onyx
 - (LHM) Light Honey
 - (TMM) Mahogany
 - (AVM) Maple
 - (MWM) Medium Walnut
 - (NLW) Natural Walnut
 - (ASM) Night
 - (NBM) Noce Biondo
 - (NGM) Noce Grigio
 - (NEM) Noce Leggero
 - (NMM) Noce Medio
 - (SBM) Sandy Beach
 - (SKM) Shaker Cherry
 - (SOM) Silver Oak
 - (TWM) Walnut
 - (WTM) WC Cream
 - (WHM) White
 - (WCM) Winter Cherry



SUGGESTED APPLICATIONS

- Guest seating
- Lobbies
- Lounge/Waiting
- Resident rooms

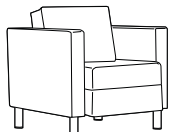
For matching tables, see Citi series in the Global Seating list price book.

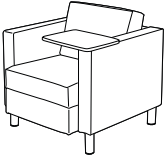
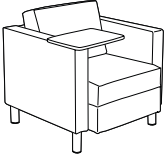
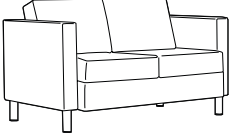
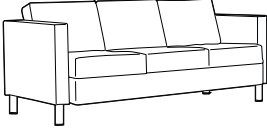
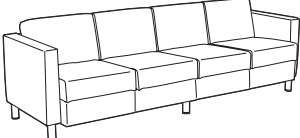
DESCRIPTION	MODEL# / FEATURES	STANDARD TEXTILE GRADES											
		COM	2	3	4	5	6	7	8	9	10	11	12
 <p>Lounge Chair COM: 4.75 YD 4.34 M Unit weight: 57 LB 25.9 KG Carton weight: 67 LB 30.39 KG Carton volume: 21 FT³ 0.59 MT³</p>	GC7875	1303	1455	1583	1731	1973	2196	2419	2614	2856	3084	3393	3830
	Active weight 300 lbs.	OVERALL DIMENSIONS W D H			SEAT DIMENSIONS W D H			BACK DIMENSIONS W H					
		IN 30	31	30	22	19.5	17.5	22	12.5				
		MM 762	787	762	559	495	445	559	318				
		RTA 00		1 per carton									

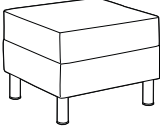
DESCRIPTION	MODEL# / FEATURES	STANDARD TEXTILE GRADES											
		COM	2	3	4	5	6	7	8	9	10	11	12
 <p>Lounge Chair w/Laminate Tablet - Left COM: 4.75 YD 4.34 M Unit weight: 65 LB 29.5 KG Carton weight: 78 LB 35.38 KG Carton volume: 22.5 FT³ 0.63 MT³</p>	GC7875LTL	1715	1867	1995	2143	2385	2608	2831	3026	3268	3496	3805	4242
		OVERALL DIMENSIONS			SEAT DIMENSIONS			BACK DIMENSIONS					
		W	D	H	W	D	H	W	H				
		IN 31.5 MM 800	33.5 851	30 762	22 559	19.5 495	17.5 445	22 559	12.5 318				
	RTA 2	1 per carton											
 <p>Lounge Chair w/Laminate Tablet - Right COM: 4.75 YD 4.34 M Unit weight: 65 LB 29.5 KG Carton weight: 75 LB 34.02 KG Carton volume: 22.5 FT³ 0.63 MT³</p>	GC7875RTL	1715	1867	1995	2143	2385	2608	2831	3026	3268	3496	3805	4242
		OVERALL DIMENSIONS			SEAT DIMENSIONS			BACK DIMENSIONS					
		W	D	H	W	D	H	W	H				
		IN 31.5 MM 800	33.5 851	30 762	22 559	19.5 495	17.5 445	22 559	12.5 318				
	RTA 00	1 per carton											
 <p>Two Seat Sofa COM: 7 YD 6.4 M Unit weight: 113 LB 51.4 KG Carton weight: 125 LB 56.7 KG Carton volume: 36 FT³ 1.01 MT³</p>	GC7876	1854	2078	2267	2485	2841	3170	3499	3786	4143	4479	4934	5578
		OVERALL DIMENSIONS			SEAT DIMENSIONS			BACK DIMENSIONS					
		W	D	H	W	D	H	W	H				
		IN 51.25 MM 1302	31 787	30 762	43.25 1099	19.5 495	17.5 445	43.25 1099	12.5 318				
	RTA 00	1 per carton											
 <p>Three Seat Sofa COM: 9 YD 8.23 M Unit weight: 149 LB 67.7 KG Carton weight: 163 LB 73.94 KG Carton volume: 50.25 FT³ 1.42 MT³</p>	GC7877	2417	2705	2948	3228	3686	4109	4532	4901	5360	5792	6377	7205
		OVERALL DIMENSIONS			SEAT DIMENSIONS			BACK DIMENSIONS					
		W	D	H	W	D	H	W	H				
		IN 72.5 MM 1842	31 787	30 762	64.5 1638	19.5 495	17.5 445	64.5 1638	12.5 318				
	RTA 00	1 per carton											
 <p>Four Seat Sofa COM: 11.5 YD 10.52 M Unit weight: 188 LB 85.5 KG Carton weight: 204 LB 92.53 KG Carton volume: 69 FT³ 1.95 MT³</p>	GC7878	3015	3383	3694	4050	4637	5177	5718	6189	6776	7328	8075	9133
		OVERALL DIMENSIONS			SEAT DIMENSIONS			BACK DIMENSIONS					
		W	D	H	W	D	H	W	H				
		IN 93.5 MM 2375	31 787	30 762	85.5 2172	19.5 495	17.5 445	85.5 2172	12.5 318				
	RTA 00	1 per carton											

DESCRIPTION	MODEL# / FEATURES	STANDARD TEXTILE GRADES											
		COM	2	3	4	5	6	7	8	9	10	11	12
 <p>Ottoman COM: 1.75 YD 1.6 M Unit weight: 23 LB 10.5 KG Carton weight: 27 LB 12.25 KG Carton volume: 7.5 FT³ 0.21 MT³</p>	GC7879	677	733	780	835	924	1006	1088	1160	1249	1333	1447	1608
	Active weight 300 lbs.	OVERALL DIMENSIONS W D H			SEAT DIMENSIONS W D H			BACK DIMENSIONS W H					
		IN	22	22	17	-	-	17	-	-			
	MM	559	559	432	-	-	432	-	-				
									1 per carton				

GC COMET



Black plastic arms



Wall saver leg

model GC2180 (TUN)

STANDARD FEATURES

- The rounded steel frame and durable seat cushion will ensure years of use.
- Black plastic arms are standard.
- Round tubular steel frame.
- Active weight capacity is up to 300 lbs. for standard models; 500 lbs. for bariatric models.
- For added comfort, seats are standard with high density Ultracell foam.
- Standard glide is a plastic dome shape on back legs, flat glide on front legs.
- Ganging hardware is available for standard models.
- Standard models stack 5 high on floor, 8 high on dolly.
- Bariatric models stack 2 high on floor. No dolly available.
- For healthcare textiles and finish options, visit the website at globalfurnituregroup.com.
- Can be upholstered in standard Global textiles if Healthcare compliance is not required.
- Shipped fully assembled.



OPTIONAL FEATURES

- Plastic arms available in Shadow (SHW) and Toast (TOA). Please specify. Add \$25.
- A selection of glide options is available. Glides must be chosen to best suit flooring type and site conditions. For more information, please refer to the glide section (page 274).
- For thick carpeted floors, request four dome/ball glides for ease of movement. No upcharge.
- Steel cushioned glides (B) are available on four-legged models. Add \$17.

- Glides with felt pads (FG) are available for vinyl sheet, cork or laminate flooring, please specify. Add \$43.
- Glides with rubber pads (RG) are available for vinyl, hardwood, laminate, stone or ceramic flooring, please specify. Add \$43.
- For improved housekeeping and infection control practices, please add (SU) to model number. The underside of the seat will be finished with vinyl and sealed to prevent penetration of liquids. For standard models: Add \$41. For bariatric models: Add \$59.
- For moisture barrier on seat, please specify (MB). Add \$81. Bariatric models: Add \$122.
- **Frame finish**
Paint finishes. No upcharge.
(TBL) Black (TIN) Ink
(TBZ) Buzz Blue (TKA) Kalua
(TCC) Cactus (TLA) Latte
(TCR) Carrot (TMO) Mocha
(TIV) Cloud (TNE) Nevada
(TDW) Designer White (TSN) Sand
(TDJ) Dijon (TSR) Scarlet
(TEG) Eggplant (TSH) Shadow
(TFO) Fog (TOA) Toast
(TFR) Frost (TTU) Tungsten
Plated finish. Add \$26.
(CHM) Chrome

SUGGESTED APPLICATIONS

- Bariatric seating
- Dining/Cafeteria
- Guest seating
- Lobbies
- Lounge/Waiting
- Office/Meeting
- Patient rooms
- Resident rooms
- Stacking
- Treatment/Exam

DESCRIPTION	MODEL# / FEATURES	STANDARD TEXTILE GRADES											
		COM	2	3	4	5	6	7	8	9	10	11	12
 <p>Medium Back Stacking Armchair COM: 1 YD 0.91 M Unit weight: 14 LB 6.4 KG Carton weight: 16.67 LB 7.56 KG Carton volume: 13.75 FT³ 0.38 MT³</p>	GC2173	377	409	436	467	518	565	612	653	704	752	817	909
	Active weight 300 lbs.												
	Stacks 5 high on floor. Stacks 8 high on dolly.												
	RTA 00	3 per carton (pricing and specifications are for one chair)											
 <p>High Back Stacking Armchair COM: 1.25 YD 1.14 M Unit weight: 15 LB 6.8 KG Carton weight: 18 LB 8.16 KG Carton volume: 17.75 FT³ 0.5 MT³</p>	GC2173HB	430	470	504	543	606	665	724	775	839	899	980	1095
	Active weight 300 lbs.												
	Stacks 5 high on floor. Stacks 8 high on dolly.												
	RTA 00	3 per carton (pricing and specifications are for one chair)											

DESCRIPTION MODEL# / FEATURES STANDARD TEXTILE GRADES



Medium Back Stacking Chair, Armless

COM: 1 YD | 0.91 M
 Unit weight: 13 LB | 5.9 KG
 Carton weight: 15.67 LB | 7.11 KG
 Carton volume: 14.25 FT³ | 0.4 MT³

Active weight 300 lbs.

Stacks 5 high on floor.
 Stacks 8 high on dolly.

COM	2	3	4	5	6	7	8	9	10	11	12
301	333	360	391	442	489	536	577	628	676	741	833

OVERALL DIMENSIONS			SEAT DIMENSIONS			BACK DIMENSIONS	
W	D	H	W	D	H	W	H

IN	20	24.5	32	18	17	18.5	17.5	13.5
MM	508	622	813	457	432	470	445	343

RTA 00 3 per carton (pricing and specifications are for one chair)



High Back Stacking Chair, Armless

COM: 1.25 YD | 1.14 M
 Unit weight: 14 LB | 6.4 KG
 Carton weight: 17 LB | 7.71 KG
 Carton volume: 17.75 FT³ | 0.5 MT³

Active weight 300 lbs.

Stacks 2 high on floor.
 Stacks 8 high on dolly.

COM	2	3	4	5	6	7	8	9	10	11	12
396	436	470	509	572	631	690	741	805	865	946	1061

OVERALL DIMENSIONS			SEAT DIMENSIONS			BACK DIMENSIONS	
W	D	H	W	D	H	W	H

IN	20	24.5	36.5	18	17.5	18	17.5	18
MM	508	622	927	457	445	457	445	457

RTA 00 3 per carton (pricing and specifications are for one chair)

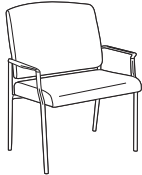

Bariatric Stacking Armchair

COM: 1.75 YD | 1.6 M
 Unit weight: 35 LB | 15.9 KG
 Carton weight: 46 LB | 20.87 KG
 Carton volume: 26.75 FT³ | 0.75 MT³

Active weight 500 lbs.

Stacks 2 high on floor.
 (no dolly available)

COM	2	3	4	5	6	7	8	9	10	11	12
1135	1191	1238	1293	1382	1464	1546	1618	1707	1791	1905	2066

OVERALL DIMENSIONS			SEAT DIMENSIONS			BACK DIMENSIONS	
W	D	H	W	D	H	W	H

IN	31.5	27	38	26.5	18.5	18	26.5	20
MM	800	686	965	673	470	457	673	508

RTA 00 1 per carton



Square Medium Back Stacking Armchair

COM: 1 YD | 0.91 M
 Unit weight: 14 LB | 6.4 KG
 Carton weight: 17.33 LB | 7.86 KG
 Carton volume: 15.5 FT³ | 0.43 MT³

Active weight 300 lbs.

Stacks 5 high on floor.
 Stacks 8 high on dolly.

COM	2	3	4	5	6	7	8	9	10	11	12
377	409	436	467	518	565	612	653	704	752	817	909

OVERALL DIMENSIONS			SEAT DIMENSIONS			BACK DIMENSIONS	
W	D	H	W	D	H	W	H

IN	23	22.5	32	18	17.5	18	17.5	13.5
MM	584	572	813	457	445	457	445	343

RTA 00 3 per carton (pricing and specifications are for one chair)



Square High Back Stacking Armchair

COM: 1 YD | 0.91 M
 Unit weight: 15 LB | 6.8 KG
 Carton weight: 18.33 LB | 8.31 KG
 Carton volume: 15.5 FT³ | 0.43 MT³

Active weight 300 lbs.







Stacks 5 high on floor.
 Stacks 8 high on dolly.

COM	2	3	4	5	6	7	8	9	10	11	12
438	470	497	528	579	626	673	714	765	813	878	970

OVERALL DIMENSIONS			SEAT DIMENSIONS			BACK DIMENSIONS	
W	D	H	W	D	H	W	H

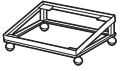
IN	23	22.5	35.5	18	17.5	18	17.5	17
MM	584	572	902	457	445	457	445	432

RTA 00 3 per carton (pricing and specifications are for one chair)

DESCRIPTION	MODEL# / FEATURES	STANDARD TEXTILE GRADES											
		COM	2	3	4	5	6	7	8	9	10	11	12
 <p>Square Medium Stacking Side Chair COM: 1 YD 0.91 M Unit weight: 13 LB 5.9 KG Carton weight: 16.33 LB 7.41 KG Carton volume: 15.5 FT³ 0.43 MT³</p>	GC2184	301	333	360	391	442	489	536	577	628	676	741	833
		OVERALL DIMENSIONS			SEAT DIMENSIONS			BACK DIMENSIONS					
		W	D	H	W	D	H	W	H				
		IN 20	22.5	32	18	17.5	18	17.5	13.5				
	MM 508	572	813	457	445	457	445	343					
		RTA 00 3 per carton (pricing and specifications are for one chair)											
 <p>Fan Back Stacking Armchair COM: 1.25 YD 1.14 M Unit weight: 19 LB 8.6 KG Carton weight: 24 LB 10.89 KG Carton volume: 15.5 FT³ 0.43 MT³</p>	GC2194	516	556	590	629	692	751	810	861	925	985	1066	1181
		OVERALL DIMENSIONS			SEAT DIMENSIONS			BACK DIMENSIONS					
		W	D	H	W	D	H	W	H				
		IN 23	24.5	35	18	16	18	18.5	16				
	MM 584	622	889	457	406	457	470	406					
		RTA 00 2 per carton (pricing and specifications are for one chair)											
 <p>Fan Back Stacking Side Chair COM: 1.25 YD 1.14 M Unit weight: 16 LB 7.3 KG Carton weight: 21 LB 9.53 KG Carton volume: 15.5 FT³ 0.43 MT³</p>	GC2195	445	485	519	558	621	680	739	790	854	914	995	1110
		OVERALL DIMENSIONS			SEAT DIMENSIONS			BACK DIMENSIONS					
		W	D	H	W	D	H	W	H				
		IN 20	24.5	35	18	16	18	18.5	16				
	MM 508	622	889	457	406	457	470	406					
		RTA 00 2 per carton (pricing and specifications are for one chair)											
 <p>Dolly COM: N/A Unit weight: 13 LB 5.9 KG Carton weight: 16 LB 7.26 KG Carton volume: 3.8 FT³ 0.1 MT³</p>	2125WS	List price											
		290											
		OVERALL DIMENSIONS			SEAT DIMENSIONS			BACK DIMENSIONS					
		W	D	H	W	D	H	W	H				
	IN 23.25	24.75	12.25	-	-	-	-	-					
	MM 591	629	311	-	-	-	-	-					
		RTA 00  1 per carton											
 <p>Snap On Ganging Brackets - Set of 2 COM: N/A Unit weight: 0.09 LB 0.04 KG Carton weight: 0.2 LB 0.09 KG Carton volume: 1 FT³ 0.02 MT³</p>	2180	List price											
		15											
		OVERALL DIMENSIONS			SEAT DIMENSIONS			BACK DIMENSIONS					
		W	D	H	W	D	H	W	H				
	IN 0.87	7.75	1.5	-	-	-	-	-					
	MM 22	197	38	-	-	-	-	-					
		RTA 00  1 per carton (pricing is for the set, specifications are for one bracket)											

GC ISLANDS



model GC4075



model GC4076

STANDARD FEATURES



- GC Islands offers wood guest seating with contemporary styling.
- Two back styles: Upholstered back pad or horizontal wood slat back.
- Legs are equipped with White non-marking polypropylene glides. Suitable for both carpet and hard surface flooring.
- All cushions are fixed and non-removable.
- Cushions are made with highly resilient foam and seats are equipped with a synthetic rubberized webbing suspension system for extra comfort.
- Seat cushion underside is finished with a Black impermeable surface material.
- Does not stack.
- Can be upholstered in standard Global textiles if healthcare compliance is not required.

OPTIONAL FEATURES

- Wood frame available in Absolute (AAM), Black (BKM), Cherry (ACM), English Oak (EOM), Espresso Cafe (ECM), Fruitwood (TFM), Gray (HGM), Honey (AHM), Mahogany (TMM), Maple (AVM), Medium Walnut (MWM), Natural Walnut (NLW), Night (ASM), Noce Biondo (NBM), Noce Grigio (NGM), Noce Leggero (NEM), Noce Medio (NMM), Sandy Beach (SGM), Shaker Cherry (SKM), Silver Oak (SOM), Walnut (TWM), WC Cream (WTM), White (WHM) and Winter Cherry (WCM).
- For moisture barrier on seat, please specify **(MB)**. Add \$81 per seat.
- Upholstered back sealed seam available, please specify **(S2)**. Add \$27.

SUGGESTED APPLICATIONS

- Dining/Cafeteria
- Guest seating
- Lobbies
- Lounge/Waiting
- Office/Meeting
- Patient rooms
- Resident rooms

DESCRIPTION	MODEL# / FEATURES	STANDARD TEXTILE GRADES												
		COM	2	3	4	5	6	7	8	9	10	11	12	
 <p>Armchair - Upholstered Back COM: 1.5 YD 1.37 M Unit weight: 19 LB 8.6 KG Carton weight: 25 LB 11.34 KG Carton volume: 13.25 FT³ 0.37 MT³</p>	GC4075	856	904	945	991	1068	1138	1209	1270	1347	1419	1516	1654	
	Active weight 300 lbs.													
	Does not stack.													
		OVERALL DIMENSIONS	SEAT DIMENSIONS			BACK DIMENSIONS								
		W D H	W	D	H	W	D	H	W	H				
	IN 24.5 23.5 32	20.5	18	18.5	19	13								
	MM 622 597 813	521	457	470	483	330								
	RTA 00	1 per carton												
 <p>Armchair - Horizontal Wood Slat Back COM: 1 YD 0.91 M Unit weight: 19 LB 8.6 KG Carton weight: 25 LB 11.34 KG Carton volume: 13.25 FT³ 0.37 MT³</p>	GC4076	923	955	982	1013	1064	1111	1158	1199	1250	1298	1363	1455	
	Active weight 300 lbs.													
	Does not stack.													
		OVERALL DIMENSIONS	SEAT DIMENSIONS			BACK DIMENSIONS								
		W D H	W	D	H	W	D	H	W	H				
	IN 24.5 23.5 32	20.5	18	18.5	19	13								
	MM 622 597 813	521	457	470	483	330								
	RTA 00	1 per carton												

GC PRAIRIE



model GC3481



model GC3482

STANDARD FEATURES







- Features barrel shaped arms that provide an attractive and enticing appearance.
- GC Prairie is fully upholstered.
- Tapered wood skirt and legs.
- Removable cushions and covers.
- Elasticized seat suspension system for extra comfort built into cushions.
- Seamless front upholstery on the seat cushion prevents eventual breakdown of seams causing liquid penetration into the foam.
- For added comfort, seats are standard with high density Ultracell foam.
- For healthcare textiles and wood finish options, visit the website at globalfurnituregroup.com. Available in Maple wood species only (refer to finishes ending in "M").
- Can be upholstered in standard Global textiles if Healthcare compliance is not required.
- Shipped fully assembled.

OPTIONAL FEATURES

- For non-slip glides, please specify **(NS)**. Add \$22.
- Tapered wood legs are available in Absolute (AAM), Charcoal Java (CJM), Cherry (ACM), Empire Mahogany (EMM), English Oak (EOM), Espresso Cafe (ECM), Fruitwood (TFM), Gray (HGM), Harvest Oak (HOM), Honey (AHM), Jet Onyx (JOM), Light Honey (LHM), Mahogany (TMM), Maple (AVM), Medium Walnut (MWM), Natural Walnut (NLW), Night (ASM), Noce Biondo (NBM), Noce Grigio (NGM), Noce Leggero (NEM), Noce Medio (NMM), Sandy Beach (SBM), Silver Oak (SOM), Walnut (TWM), WC Cream (WTM), White (WHM) and Winter Cherry (WCM). Please specify. Genuine Maple faced veneers and solids are used.
- To add sealed seams to your product contact Customer Service. Upcharges vary.
- For moisture barrier on seat, please specify **(MB)**. See upcharges below.

SUGGESTED APPLICATIONS

- Lobbies
- Lounge/Waiting
- Resident rooms

DESCRIPTION	MODEL# / FEATURES	STANDARD TEXTILE GRADES											
		COM	2	3	4	5	6	7	8	9	10	11	12
 Lounge Chair COM: 4.5 YD 4.11 M Unit weight: 70 LB 31.8 KG Carton weight: 80 LB 36.29 KG Carton volume: 19.25 FT³ 0.54 MT³	GC3481	1516	1660	1782	1921	2151	2362	2574	2758	2988	3204	3496	3910
		OVERALL DIMENSIONS			SEAT DIMENSIONS			BACK DIMENSIONS					
		W	D	H	W	D	H	W	H				
		IN 32	29	30.5	21	19	16	21	14.5				
	MM 813	737	775	533	483	406	533	368					
		RTA 00		1 per carton									
		Active weight 300 lbs.											
		Add \$122 for (MB) .											
 Two Seat Sofa COM: 6.75 YD 6.17 M Unit weight: 96 LB 43.6 KG Carton weight: 106 LB 48.08 KG Carton volume: 41.25 FT³ 1.16 MT³	GC3482	2068	2284	2466	2676	3020	3337	3654	3931	4275	4599	5038	5659
		OVERALL DIMENSIONS			SEAT DIMENSIONS			BACK DIMENSIONS					
		W	D	H	W	D	H	W	H				
		IN 52.5	29	30.5	42	19	16	42	14.5				
	MM 1334	737	775	1067	483	406	1067	368					
		RTA 00		1 per carton									
		Active weight 300 lbs/seat.											
		Add \$245 for (MB) .											
 Three Seat Sofa COM: 10.75 YD 9.83 M Unit weight: 135 LB 61.4 KG Carton weight: 150 LB 68.04 KG Carton volume: 55.5 FT³ 1.57 MT³	GC3483	2610	2954	3244	3578	4126	4631	5136	5577	6125	6641	7340	8329
		OVERALL DIMENSIONS			SEAT DIMENSIONS			BACK DIMENSIONS					
		W	D	H	W	D	H	W	H				
		IN 73.5	29	30.5	63.5	19	16	63.5	14.5				
	MM 1867	737	775	1613	483	406	1613	368					
		RTA 00		1 per carton									
		Active weight 300 lbs/seat.											
		Add \$366 for (MB) .											

GC SIDERO



model GC6900



model GC6900HB



model GC6924



model GC6926

SEAT WIDTH	STACKING CAPABILITIES
19.5"	Four-legged armchairs and side chairs can stack up to 5 high on the floor or 8 high on dolly #2125WS. Sled base armchairs and side chairs do not stack.
24"	Four-legged armchairs and side chairs can stack up to 5 high on the floor, no dolly is available. Sled base armchairs and side chairs do not stack.
30" bariatric	Four-legged armchairs can stack up to 2 high on the floor, no dolly is available. Sled base models do not stack.

STANDARD FEATURES

- GC Sidero is a collection of contemporary multi-purpose stacking chairs with a sculpted look, featuring wide, curved arms, and a round tubular wall saver steel frame.
- Available in arm and armless models (except on bariatric models) with three seat widths, two back heights, and a four-legged and sled base frame.
- Offers options that allow the chair to meet rigorous infection prevention control requirements.
- Compound curved back provides comfort and support in multiple seated positions.
- Rugged steel frame made from round welded steel tubing with a 7/8" steel dia.
- Frames feature a wall saver design to prevent back contact with wall.
- Standard glide is durable Black polypropylene.
- For added comfort, seats are standard with high density Ultracell foam.
- Three seat widths: 19.5" (standard size), 24" (mid size) and 30" (bariatric).
- Two different back constructions are offered:
 - Concealed back attachment: two-piece back covering the back support brackets when fastened in place.
 - Single piece back with a pullover style upholstery cover and exposed support bracket fastened on the outer back.
- Low back and high back models are available:
 - Low back version is available on all three seat widths: 15.5" (394mm) high.
 - High back version on 19" and 24" seat widths: 21" (533mm) high.
 - High back version on bariatric 30" seat width: 21.75" (552mm) high.
- Fiberglass nylon reinforced arms have a generous width and extend to the front of the seat. They offer additional support and help to stabilize users as they sit or exit the chair. Available in Black only.
- Select GC Sidero models are equipped with a polypropylene seat shroud that helps avoid frame imprints on upholstered seats when chairs are stacked. Protective seat shroud is standard on all 19.5" seat width models.
- 30" bariatric and 24" seat width models do not have a seat shroud and are standard with a vinyl covered seat underside.
- For healthcare textiles and finish options, visit the website at globalfurnituregroup.com.
- Can be upholstered in standard Global textiles if Healthcare compliance is not required.

OPTIONAL FEATURES

- A selection of glide options is available. Glides must be chosen to best suit flooring type and site conditions. For more information, please refer to the glide section (page 274).
- For hard surface floors, please specify opaque non-marking glides (NM). No upcharge.
- To respond to higher expectations for housekeeping and infection control practices, single piece back underside and all seat pan undersides can be completely sealed and seat shroud (if standard on the model) would be removed.
 - For standard models with single piece back, please specify (BSS). Add \$51.
 - For standard models with concealed attachment back, please specify (SU). Add \$32.
 - For 24" width models with single piece back, please specify (BSS). Add \$58.
 - For 24" width models with concealed attachment back, please specify (SU). Add \$41.
 - For bariatric models with single piece back, please specify (BSS). Add \$73.
 - For bariatric models with concealed attachment back, please specify (SU). Add \$59.
- Steel cushioned glides (B) are available on four-legged models. Add \$17.
- Glides with felt pads (FG) are available for vinyl sheet, cork or laminate flooring, please specify. Add \$43.
- Glides with rubber pads (RG) are available for vinyl, hardwood, laminate, stone or ceramic flooring, please specify. Add \$43.
- For moisture barrier on seat, please specify (MB). See below for upcharges:
 - 19.5" seat width units: Add \$81.
 - 24" seat width units: Add \$81.
 - 30" seat width bariatric units: Add \$122.
- Frame finish**
Paint finishes. No upcharge.





(TBL) Black	(TMO) Mocha
(TIV) Cloud	(TNE) Nevada
(TDW) Designer White	(TSN) Sand
(TFO) Fog	(TSH) Shadow
(TFR) Frost	(TOA) Toast
(TKA) Kalua	(TTU) Tungsten
(TLA) Latte	

 Plated finish. Add \$26.
(CHM) Chrome

SUGGESTED APPLICATIONS

- Bariatric seating (some models)
- Dining/Cafeteria
- Guest seating
- Lobbies
- Lounge/Waiting
- Office/Meeting
- Patient rooms
- Resident rooms
- Stacking
- Treatment/Exam rooms

DESCRIPTION	MODEL# / FEATURES	STANDARD TEXTILE GRADES																																					
		COM	2	3	4	5	6	7	8	9	10	11	12																										
 LB Concealed Attachment Armchair, Four-Legged COM: 1.25 YD 1.14 M Unit weight: 23 LB 10.5 KG Carton weight: 31.5 LB 14.29 KG Carton volume: 15.5 FT³ 0.43 MT³	GC6900	491	531	565	604	667	726	785	836	900	960	1041	1156																										
	<table border="0"> <tr> <th colspan="3">OVERALL DIMENSIONS</th> <th colspan="3">SEAT DIMENSIONS</th> <th colspan="3">BACK DIMENSIONS</th> </tr> <tr> <th>W</th> <th>D</th> <th>H</th> <th>W</th> <th>D</th> <th>H</th> <th>W</th> <th>H</th> <th></th> </tr> <tr> <td>IN 25.5</td> <td>24</td> <td>33</td> <td>19.5</td> <td>18</td> <td>17.5</td> <td>19</td> <td>15.5</td> <td></td> </tr> <tr> <td>MM 648</td> <td>610</td> <td>838</td> <td>495</td> <td>457</td> <td>445</td> <td>483</td> <td>394</td> <td></td> </tr> </table>	OVERALL DIMENSIONS			SEAT DIMENSIONS			BACK DIMENSIONS			W	D	H	W	D	H	W	H		IN 25.5	24	33	19.5	18	17.5	19	15.5		MM 648	610	838	495	457	445	483	394		Active weight 300 lbs.	RTA 00
OVERALL DIMENSIONS			SEAT DIMENSIONS			BACK DIMENSIONS																																	
W	D	H	W	D	H	W	H																																
IN 25.5	24	33	19.5	18	17.5	19	15.5																																
MM 648	610	838	495	457	445	483	394																																

DESCRIPTION	MODEL# / FEATURES	STANDARD TEXTILE GRADES											
 <p>HB Concealed Attachment Armchair, Four-Legged COM: 1.75 YD 1.6 M Unit weight: 25 LB 11.4 KG Carton weight: 34 LB 15.42 KG Carton volume: 17.75 FT³ 0.5 MT³</p>	COM	2	3	4	5	6	7	8	9	10	11	12	
	GC6900HB	596	652	699	754	843	925	1007	1079	1168	1252	1366	1527
	OVERALL DIMENSIONS			SEAT DIMENSIONS			BACK DIMENSIONS						
		W	D	H	W	D	H	W	H				
	IN 25.5	24	38.5	19.5	18	17.5	19	21					
	MM 648	610	978	495	457	445	483	533					
	RTA 00	1 per carton											
 <p>LB Concealed Attachment Side Chair, Four-Legged COM: 1.25 YD 1.14 M Unit weight: 20 LB 9.1 KG Carton weight: 28 LB 12.7 KG Carton volume: 13.75 FT³ 0.38 MT³</p>	COM	2	3	4	5	6	7	8	9	10	11	12	
	GC6901	462	502	536	575	638	697	756	807	871	931	1012	1127
	OVERALL DIMENSIONS			SEAT DIMENSIONS			BACK DIMENSIONS						
		W	D	H	W	D	H	W	H				
	IN 21	24	33	19.5	18	17.5	19	15.5					
	MM 533	610	838	495	457	445	483	394					
	RTA 00	1 per carton											
 <p>HB Concealed Attachment Side Chair, Four-Legged COM: 1.75 YD 1.6 M Unit weight: 22 LB 10 KG Carton weight: 31 LB 14.06 KG Carton volume: 17.75 FT³ 0.5 MT³</p>	COM	2	3	4	5	6	7	8	9	10	11	12	
	GC6901HB	566	622	669	724	813	895	977	1049	1138	1222	1336	1497
	OVERALL DIMENSIONS			SEAT DIMENSIONS			BACK DIMENSIONS						
		W	D	H	W	D	H	W	H				
	IN 21	24	38.5	19.5	18	17.5	19	21					
	MM 533	610	978	495	457	445	483	533					
	RTA 00	1 per carton											
 <p>LB Concealed Attachment Armchair, Sled Base COM: 1.25 YD 1.14 M Unit weight: 26 LB 11.8 KG Carton weight: 34.5 LB 15.65 KG Carton volume: 15.5 FT³ 0.43 MT³</p>	COM	2	3	4	5	6	7	8	9	10	11	12	
	GC6902	593	633	667	706	769	828	887	938	1002	1062	1143	1258
	OVERALL DIMENSIONS			SEAT DIMENSIONS			BACK DIMENSIONS						
		W	D	H	W	D	H	W	H				
	IN 25.5	24	33	19.5	18	17.5	19	15.5					
	MM 648	610	838	495	457	445	483	394					
	RTA 00	1 per carton											
 <p>HB Concealed Attachment Armchair, Sled Base COM: 1.75 YD 1.6 M Unit weight: 28 LB 12.7 KG Carton weight: 37 LB 16.78 KG Carton volume: 17.75 FT³ 0.5 MT³</p>	COM	2	3	4	5	6	7	8	9	10	11	12	
	GC6902HB	695	751	798	853	942	1024	1106	1178	1267	1351	1465	1626
	OVERALL DIMENSIONS			SEAT DIMENSIONS			BACK DIMENSIONS						
		W	D	H	W	D	H	W	H				
	IN 25.5	24	38.5	19.5	18	17.5	19	21					
	MM 648	610	978	495	457	445	483	533					
	RTA 00	1 per carton											

DESCRIPTION MODEL# / FEATURES STANDARD TEXTILE GRADES



MODEL#	COM	2	3	4	5	6	7	8	9	10	11	12
GC6903	561	601	635	674	737	796	855	906	970	1030	1111	1226

OVERALL DIMENSIONS			SEAT DIMENSIONS			BACK DIMENSIONS	
W	D	H	W	D	H	W	H

LB Concealed Attachment Std Side Chair, Sled Base
 COM: 1.25 YD | 1.14 M
 Unit weight: 24 LB | 10.9 KG
 Carton weight: 32 LB | 14.51 KG
 Carton volume: 13.75 FT³ | 0.38 MT³

Active weight 300 lbs.

IN	21	24	33	19.5	18	17.5	19	15.5
MM	533	610	838	495	457	445	483	394

RTA 00 1 per carton



MODEL#	COM	2	3	4	5	6	7	8	9	10	11	12
GC6903HB	663	719	766	821	910	992	1074	1146	1235	1319	1433	1594

OVERALL DIMENSIONS			SEAT DIMENSIONS			BACK DIMENSIONS	
W	D	H	W	D	H	W	H

HB Concealed Attachment Std Side Chair, Sled Base
 COM: 1.75 YD | 1.6 M
 Unit weight: 26 LB | 11.8 KG
 Carton weight: 35 LB | 15.88 KG
 Carton volume: 17.75 FT³ | 0.5 MT³

Active weight 300 lbs.

IN	21	24	38.5	19.5	18	17.5	19	21
MM	533	610	978	495	457	445	483	533

RTA 00 1 per carton



MODEL#	COM	2	3	4	5	6	7	8	9	10	11	12
GC6912	462	502	536	575	638	697	756	807	871	931	1012	1127

OVERALL DIMENSIONS			SEAT DIMENSIONS			BACK DIMENSIONS	
W	D	H	W	D	H	W	H

Low Single Piece Back Std Side Chair, Four-Legged
 COM: 1.25 YD | 1.14 M
 Unit weight: 20 LB | 9.1 KG
 Carton weight: 28 LB | 12.7 KG
 Carton volume: 13.75 FT³ | 0.38 MT³

Active weight 300 lbs.

IN	21	24	33	19.5	18	17.5	19	15.5
MM	533	610	838	495	457	445	483	394

RTA 00 1 per carton



MODEL#	COM	2	3	4	5	6	7	8	9	10	11	12
GC6912HB	566	622	669	724	813	895	977	1049	1138	1222	1336	1497

OVERALL DIMENSIONS			SEAT DIMENSIONS			BACK DIMENSIONS	
W	D	H	W	D	H	W	H

High Single Piece Back Std Side Chair, Four-Legged
 COM: 1.75 YD | 1.6 M
 Unit weight: 22 LB | 10 KG
 Carton weight: 31 LB | 14.06 KG
 Carton volume: 17.75 FT³ | 0.5 MT³

Active weight 300 lbs.

IN	21	24	38.5	19.5	18	17.5	19	21
MM	533	610	978	495	457	445	483	533

RTA 00 1 per carton



MODEL#	COM	2	3	4	5	6	7	8	9	10	11	12
GC6913	491	531	565	604	667	726	785	836	900	960	1041	1156





OVERALL DIMENSIONS			SEAT DIMENSIONS			BACK DIMENSIONS	
W	D	H	W	D	H	W	H

Low Single Piece Back Std Armchair, Four-Legged
 COM: 1.25 YD | 1.14 M
 Unit weight: 23 LB | 10.5 KG
 Carton weight: 31.5 LB | 14.29 KG
 Carton volume: 15.5 FT³ | 0.43 MT³

Active weight 300 lbs.

IN	25.5	24	33	19.5	18	17.5	19	15.5
MM	648	610	838	495	457	445	483	394

RTA 00 1 per carton

DESCRIPTION	MODEL# / FEATURES	STANDARD TEXTILE GRADES															
 <p>High Single Piece Back Std Armchair, Four-Legged COM: 1.75 YD 1.6 M Unit weight: 25 LB 11.4 KG Carton weight: 34 LB 15.42 KG Carton volume: 17.75 FT³ 0.5 MT³</p>	<p>GC6913HB</p> <p>Active weight 300 lbs.</p>	COM	2	3	4	5	6	7	8	9	10	11	12				
		596	652	699	754	843	925	1007	1079	1168	1252	1366	1527				
		OVERALL DIMENSIONS			SEAT DIMENSIONS			BACK DIMENSIONS									
		IN	25.5	24	38.5	19.5	18	17.5	19	21	MM	648	610	978	495	457	445
	RTA 00	1 per carton															
 <p>Low Single Piece Back Std Armchair, Sled Base COM: 1.25 YD 1.14 M Unit weight: 26 LB 11.8 KG Carton weight: 34.5 LB 15.65 KG Carton volume: 15.5 FT³ 0.43 MT³</p>	<p>GC6914</p> <p>Active weight 300 lbs.</p>	COM	2	3	4	5	6	7	8	9	10	11	12				
		593	633	667	706	769	828	887	938	1002	1062	1143	1258				
		OVERALL DIMENSIONS			SEAT DIMENSIONS			BACK DIMENSIONS									
		IN	25.5	24	33	19.5	18	17.5	19	15.5	MM	648	610	838	495	457	445
	RTA 00	1 per carton															
 <p>High Single Piece Back Std Armchair, Sled Base COM: 1.75 YD 1.6 M Unit weight: 28 LB 12.7 KG Carton weight: 37 LB 16.78 KG Carton volume: 17.75 FT³ 0.5 MT³</p>	<p>GC6914HB</p> <p>Active weight 300 lbs.</p>	COM	2	3	4	5	6	7	8	9	10	11	12				
		695	751	798	853	942	1024	1106	1178	1267	1351	1465	1626				
		OVERALL DIMENSIONS			SEAT DIMENSIONS			BACK DIMENSIONS									
		IN	25.5	24	38.5	19.5	18	17.5	19	21	MM	648	610	978	495	457	445
	RTA 00	1 per carton															
 <p>Low Single Piece Back Std Sidechair, Sled Base COM: 1.25 YD 1.14 M Unit weight: 24 LB 10.9 KG Carton weight: 32 LB 14.51 KG Carton volume: 13.75 FT³ 0.38 MT³</p>	<p>GC6915</p> <p>Active weight 300 lbs.</p>	COM	2	3	4	5	6	7	8	9	10	11	12				
		561	601	635	674	737	796	855	906	970	1030	1111	1226				
		OVERALL DIMENSIONS			SEAT DIMENSIONS			BACK DIMENSIONS									
		IN	21	24	33	19.5	18	17.5	19	15.5	MM	533	610	838	495	457	445
	RTA 00	1 per carton															
 <p>High Single Piece Back Std Sidechair, Sled Base COM: 1.75 YD 1.6 M Unit weight: 26 LB 11.8 KG Carton weight: 34 LB 15.42 KG Carton volume: 14.5 FT³ 0.41 MT³</p>	<p>GC6915HB</p> <p>Active weight 300 lbs.</p>	COM	2	3	4	5	6	7	8	9	10	11	12				
		663	719	766	821	910	992	1074	1146	1235	1319	1433	1594				
		OVERALL DIMENSIONS			SEAT DIMENSIONS			BACK DIMENSIONS									
		IN	21	24	38.5	19.5	18	17.5	19	21	MM	533	610	978	495	457	445
	RTA 00	1 per carton															

DESCRIPTION MODEL# / FEATURES STANDARD TEXTILE GRADES



GC6916	COM	2	3	4	5	6	7	8	9	10	11	12
---------------	-----	---	---	---	---	---	---	---	---	----	----	----

789	845	892	947	1036	1118	1200	1272	1361	1445	1559	1720
-----	-----	-----	-----	------	------	------	------	------	------	------	------

OVERALL DIMENSIONS			SEAT DIMENSIONS			BACK DIMENSIONS	
W	D	H	W	D	H	W	H

IN	30.5	24	33	24	18	17.5	24	15.5
MM	775	610	838	610	457	445	610	394

RTA 00 1 per carton

Low Single Piece Back Mid Size Armchair, Four-Legged
 COM: 1.75 YD | 1.6 M
 Unit weight: 26 LB | 11.8 KG
 Carton weight: 36 LB | 16.33 KG
 Carton volume: 23 FT³ | 0.65 MT³

Active weight 500 lbs.



GC6916HB	COM	2	3	4	5	6	7	8	9	10	11	12
-----------------	-----	---	---	---	---	---	---	---	---	----	----	----

878	942	996	1058	1160	1254	1348	1430	1532	1628	1758	1942
-----	-----	-----	------	------	------	------	------	------	------	------	------

OVERALL DIMENSIONS			SEAT DIMENSIONS			BACK DIMENSIONS	
W	D	H	W	D	H	W	H

IN	30.5	24	38.5	24	18	17.5	24	21
MM	775	610	978	610	457	445	610	533

RTA 00 1 per carton

High Single Piece Back Mid Size Armchair, Four-Legged
 COM: 2 YD | 1.83 M
 Unit weight: 29 LB | 13.2 KG
 Carton weight: 40 LB | 18.14 KG
 Carton volume: 26.75 FT³ | 0.75 MT³

Active weight 500 lbs.



GC6917	COM	2	3	4	5	6	7	8	9	10	11	12
---------------	-----	---	---	---	---	---	---	---	---	----	----	----

757	813	860	915	1004	1086	1168	1240	1329	1413	1527	1688
-----	-----	-----	-----	------	------	------	------	------	------	------	------

OVERALL DIMENSIONS			SEAT DIMENSIONS			BACK DIMENSIONS	
W	D	H	W	D	H	W	H

IN	26	24	33	24	18	17.5	24	15.5
MM	660	610	838	610	457	445	610	394

RTA 00 1 per carton

Low Single Piece Back Mid Size Side Chair, Four-Legged
 COM: 1.75 YD | 1.6 M
 Unit weight: 22 LB | 10 KG
 Carton weight: 30 LB | 13.61 KG
 Carton volume: 14.5 FT³ | 0.41 MT³

Active weight 500 lbs.

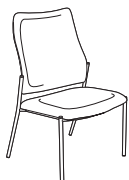

GC6917HB	COM	2	3	4	5	6	7	8	9	10	11	12
-----------------	-----	---	---	---	---	---	---	---	---	----	----	----

848	912	966	1028	1130	1224	1318	1400	1502	1598	1728	1912
-----	-----	-----	------	------	------	------	------	------	------	------	------

OVERALL DIMENSIONS			SEAT DIMENSIONS			BACK DIMENSIONS	
W	D	H	W	D	H	W	H

IN	26	24	38.5	24	18	17.5	24	21
MM	660	610	978	610	457	445	610	533

RTA 00 1 per carton

High Single Piece Back Mid Size Sidechair, Four-Legged
 COM: 2 YD | 1.83 M
 Unit weight: 25 LB | 11.4 KG
 Carton weight: 33 LB | 14.97 KG
 Carton volume: 17.75 FT³ | 0.5 MT³

Active weight 500 lbs.



GC6918	COM	2	3	4	5	6	7	8	9	10	11	12
---------------	-----	---	---	---	---	---	---	---	---	----	----	----

899	955	1002	1057	1146	1228	1310	1382	1471	1555	1669	1830
-----	-----	------	------	------	------	------	------	------	------	------	------





OVERALL DIMENSIONS			SEAT DIMENSIONS			BACK DIMENSIONS	
W	D	H	W	D	H	W	H





IN	30.5	24	33	24	18	17.5	24	15.5
MM	775	610	838	610	457	445	610	394





RTA 00 1 per carton

Low Single Piece Back Mid Size Armchair, Sled Base
 COM: 1.75 YD | 1.6 M
 Unit weight: 28 LB | 12.7 KG
 Carton weight: 38 LB | 17.24 KG
 Carton volume: 23 FT³ | 0.65 MT³

Active weight 500 lbs.

DESCRIPTION	MODEL# / FEATURES	STANDARD TEXTILE GRADES															
 <p>High Single Piece Back Mid Size Armchair, Sled Base COM: 2 YD 1.83 M Unit weight: 31 LB 14.1 KG Carton weight: 39 LB 17.69 KG Carton volume: 18.25 FT³ 0.51 MT³</p>	GC6918HB	COM	2	3	4	5	6	7	8	9	10	11	12				
	988	1052	1106	1168	1270	1364	1458	1540	1642	1738	1868	2052					
	OVERALL DIMENSIONS			SEAT DIMENSIONS			BACK DIMENSIONS										
	IN	30.5	24	38.5	24	18	17.5	24	21	MM	775	610	978	610	457	445	610
	RTA 00	1 per carton															
 <p>Low Single Piece Back Mid Size Sidechair, Sled Base COM: 1.75 YD 1.6 M Unit weight: 26 LB 11.8 KG Carton weight: 34 LB 15.42 KG Carton volume: 14.5 FT³ 0.41 MT³</p>	GC6919	COM	2	3	4	5	6	7	8	9	10	11	12				
	866	922	969	1024	1113	1195	1277	1349	1438	1522	1636	1797					
	OVERALL DIMENSIONS			SEAT DIMENSIONS			BACK DIMENSIONS										
	IN	26	24	33	24	18	17.5	24	15.5	MM	660	610	838	610	457	445	610
	RTA 00	1 per carton															
 <p>High Single Piece Back Mid Size Sidechair, Sled Base COM: 2 YD 1.83 M Unit weight: 28 LB 12.7 KG Carton weight: 37 LB 16.78 KG Carton volume: 17.75 FT³ 0.5 MT³</p>	GC6919HB	COM	2	3	4	5	6	7	8	9	10	11	12				
	957	1021	1075	1137	1239	1333	1427	1509	1611	1707	1837	2021					
	OVERALL DIMENSIONS			SEAT DIMENSIONS			BACK DIMENSIONS										
	IN	26	24	38.5	24	18	17.5	24	21	MM	660	610	978	610	457	445	610
	RTA 00	1 per carton															
 <p>Bariatric Low Single Piece Back Armchair, Four-Legged COM: 2.5 YD 2.29 M Unit weight: 36 LB 16.4 KG Carton weight: 46 LB 20.87 KG Carton volume: 20.5 FT³ 0.58 MT³</p>	GC6920	COM	2	3	4	5	6	7	8	9	10	11	12				
	1081	1161	1229	1306	1434	1551	1669	1771	1899	2019	2181	2411					
	OVERALL DIMENSIONS			SEAT DIMENSIONS			BACK DIMENSIONS										
	IN	36.5	26	33	30	18	17.5	30	15.5	MM	927	660	838	762	457	445	762
	RTA 00	1 per carton															
 <p>Bariatric High Single Piece Back Armchair, Four-Legged COM: 2.75 YD 2.51 M Unit weight: 37 LB 16.8 KG Carton weight: 49 LB 21.77 KG Carton volume: 28.25 FT³ 0.79 MT³</p>	GC6920HB	COM	2	3	4	5	6	7	8	9	10	11	12				
	1110	1198	1272	1358	1498	1627	1756	1869	2009	2141	2320	2573					
	OVERALL DIMENSIONS			SEAT DIMENSIONS			BACK DIMENSIONS										
	IN	36.5	26	38.5	30	18	17.5	30	21	MM	927	660	978	762	457	445	762
	RTA 00	1 per carton															

DESCRIPTION	MODEL# / FEATURES	STANDARD TEXTILE GRADES											
		COM	2	3	4	5	6	7	8	9	10	11	12
 <p>Bariatric Low Single Piece Back Armchair, Sled Base COM: 2.5 YD 2.29 M Unit weight: 38 LB 17.3 KG Carton weight: 48 LB 21.77 KG Carton volume: 20.5 FT³ 0.58 MT³</p>	GC6921 Active weight 500 lbs. RTA 00 1 per carton	1188	1268	1336	1413	1541	1658	1776	1878	2006	2126	2288	2518
		OVERALL DIMENSIONS W D H			SEAT DIMENSIONS W D H			BACK DIMENSIONS W H					
		IN	36.5	26	33	30	18	17.5	30	15.5			
		MM	927	660	838	762	457	445	762	394			
 <p>Bariatric High Single Piece Back Armchair, Sled Base COM: 2.75 YD 2.51 M Unit weight: 39 LB 17.7 KG Carton weight: 50 LB 22.68 KG Carton volume: 28.25 FT³ 0.79 MT³</p>	GC6921HB Active weight 500 lbs. RTA 00 1 per carton	1218	1306	1380	1466	1606	1735	1864	1977	2117	2249	2428	2681
		OVERALL DIMENSIONS W D H			SEAT DIMENSIONS W D H			BACK DIMENSIONS W H					
		IN	36.5	26	38.5	30	18	17.5	30	21			
		MM	927	660	978	762	457	445	762	533			
 <p>Bariatric LB Concealed Attachment Armchair, Sled Base COM: 2.5 YD 2.29 M Unit weight: 38 LB 17.3 KG Carton weight: 48 LB 21.77 KG Carton volume: 20.5 FT³ 0.58 MT³</p>	GC6922 Active weight 500 lbs. RTA 00 1 per carton	1188	1268	1336	1413	1541	1658	1776	1878	2006	2126	2288	2518
		OVERALL DIMENSIONS W D H			SEAT DIMENSIONS W D H			BACK DIMENSIONS W H					
		IN	36.5	26	33	30	18	17.5	30	15.5			
		MM	927	660	838	762	457	445	762	394			
 <p>Bariatric HB Concealed Attachment Armchair, Sled Base COM: 2.5 YD 2.29 M Unit weight: 38 LB 17.3 KG Carton weight: 48 LB 21.77 KG Carton volume: 20.5 FT³ 0.58 MT³</p>	GC6922HB Active weight 500 lbs. RTA 00 1 per carton	1210	1306	1387	1480	1633	1774	1915	2038	2191	2335	2530	2806
		OVERALL DIMENSIONS W D H			SEAT DIMENSIONS W D H			BACK DIMENSIONS W H					
		IN	36.5	26	38.5	30	18	17.5	30	21			
		MM	927	660	978	762	457	445	762	533			
 <p>Bariatric LB Concealed Attachment Armchair, Four-Legged COM: 2.5 YD 2.29 M Unit weight: 36 LB 16.4 KG Carton weight: 46 LB 20.87 KG Carton volume: 20.5 FT³ 0.58 MT³</p>	GC6923 Active weight 500 lbs. RTA 00 1 per carton	1127	1207	1275	1352	1490	1597	1715	1817	1945	2065	2227	2457
		OVERALL DIMENSIONS W D H			SEAT DIMENSIONS W D H			BACK DIMENSIONS W H					
		IN	36.5	26	33	30	18	17.5	30	15.5			
		MM	927	660	838	762	457	445	762	394			

DESCRIPTION	MODEL# / FEATURES	STANDARD TEXTILE GRADES											
		COM	2	3	4	5	6	7	8	9	10	11	12
 <p>Bariatric HB Concealed Attachment Armchair, Four-Legged COM: 3 YD 2.74 M Unit weight: 37 LB 16.8 KG Carton weight: 48 LB 21.77 KG Carton volume: 28.25 FT³ 0.79 MT³</p>	GC6923HB	1148	1244	1325	1418	1571	1712	1853	1976	2129	2273	2468	2744
		OVERALL DIMENSIONS			SEAT DIMENSIONS			BACK DIMENSIONS					
		IN	36.5	26	38.5	30	18	17.5	30	21			
		MM	927	660	978	762	457	445	762	533			
		RTA 00	1 per carton										
 <p>LB Concealed Attachment Mid Size Armchair, Four-Legged COM: 2.5 YD 2.29 M Unit weight: 26 LB 11.8 KG Carton weight: 36 LB 16.33 KG Carton volume: 23 FT³ 0.65 MT³</p>	GC6924	765	845	913	990	1118	1235	1353	1455	1583	1703	1865	2095
		OVERALL DIMENSIONS			SEAT DIMENSIONS			BACK DIMENSIONS					
		IN	30.5	24	33	24	18	17.5	24	15.5			
		MM	775	610	838	610	457	445	610	394			
		RTA 00	1 per carton										
 <p>HB Concealed Attachment Mid Size Armchair, Four-Legged COM: 2.5 YD 2.51 M Unit weight: 29 LB 13.2 KG Carton weight: 41 LB 18.6 KG Carton volume: 26.75 FT³ 0.75 MT³</p>	GC6924HB	854	942	1016	1102	1242	1371	1500	1613	1753	1885	2064	2317
		OVERALL DIMENSIONS			SEAT DIMENSIONS			BACK DIMENSIONS					
		IN	30.5	24	38.5	24	18	17.5	24	21			
		MM	775	610	978	610	457	445	610	533			
		RTA 00	1 per carton										
 <p>LB Concealed Attachment Mid Size Sidechair, Four-Legged COM: 2.5 YD 2.29 M Unit weight: 22 LB 10 KG Carton weight: 30 LB 13.61 KG Carton volume: 14.5 FT³ 0.41 MT³</p>	GC6925	733	813	881	958	1086	1203	1321	1423	1551	1671	1833	2063
		OVERALL DIMENSIONS			SEAT DIMENSIONS			BACK DIMENSIONS					
		IN	26	24	33	24	18	17.5	24	15.5			
		MM	660	610	838	610	457	445	610	394			
		RTA 00	1 per carton										
 <p>HB Concealed Attachment Mid Size Sidechair, Four-Legged COM: 2.5 YD 2.51 M Unit weight: 25 LB 11.4 KG Carton weight: 35.5 LB 16.1 KG Carton volume: 24 FT³ 0.67 MT³</p>	GC6925HB	824	912	986	1072	1212	1341	1470	1583	1723	1855	2034	2287
		OVERALL DIMENSIONS			SEAT DIMENSIONS			BACK DIMENSIONS					
		IN	26	24	38.5	24	18	17.5	24	21			
		MM	660	610	978	610	457	445	610	533			
		RTA 00	1 per carton										

DESCRIPTION	MODEL# / FEATURES	STANDARD TEXTILE GRADES											
		COM	2	3	4	5	6	7	8	9	10	11	12



GC6926	875	955	1023	1100	1228	1345	1463	1565	1693	1813	1975	2205
---------------	-----	-----	------	------	------	------	------	------	------	------	------	------

OVERALL DIMENSIONS			SEAT DIMENSIONS			BACK DIMENSIONS	
W	D	H	W	D	H	W	H

LB Concealed Attachment Mid Size Armchair, Sled Base
 COM: 2.5 YD | 2.29 M
 Unit weight: 28 LB | 12.7 KG
 Carton weight: 36 LB | 16.33 KG
 Carton volume: 16 FT³ | 0.45 MT³

Active weight 500 lbs.

IN	30.5	24	33	24	18	17.5	24	15.5
MM	775	610	838	610	457	445	610	394

RTA 00 1 per carton



GC6926HB	964	1052	1126	1212	1352	1481	1610	1723	1863	1995	2174	2427
-----------------	-----	------	------	------	------	------	------	------	------	------	------	------

OVERALL DIMENSIONS			SEAT DIMENSIONS			BACK DIMENSIONS	
W	D	H	W	D	H	W	H

HB Concealed Attachment Mid Size Armchair, Sled Base
 COM: 2.75 YD | 2.51 M
 Unit weight: 31 LB | 14.1 KG
 Carton weight: 42 LB | 19.05 KG
 Carton volume: 26.75 FT³ | 0.75 MT³

Active weight 500 lbs.

IN	30.5	24	38.5	24	18	17.5	24	21
MM	775	610	978	610	457	445	610	533

RTA 00 1 per carton



GC6927	842	922	990	1067	1195	1312	1430	1532	1660	1780	1942	2172
---------------	-----	-----	-----	------	------	------	------	------	------	------	------	------

OVERALL DIMENSIONS			SEAT DIMENSIONS			BACK DIMENSIONS	
W	D	H	W	D	H	W	H

LB Concealed Attachment Mid Size Sidechair, Sled Base
 COM: 2.5 YD | 2.29 M
 Unit weight: 26 LB | 11.8 KG
 Carton weight: 34 LB | 15.42 KG
 Carton volume: 14.5 FT³ | 0.41 MT³

Active weight 500 lbs.

IN	26	24	33	24	18	17.5	24	15.5
MM	660	610	838	610	457	445	610	394

RTA 00 1 per carton



GC6927HB	933	1021	1095	1181	1321	1450	1579	1692	1832	1964	2143	2396
-----------------	-----	------	------	------	------	------	------	------	------	------	------	------

OVERALL DIMENSIONS			SEAT DIMENSIONS			BACK DIMENSIONS	
W	D	H	W	D	H	W	H

HB Concealed Attachment Mid Size Sidechair, Sled Base
 COM: 2.75 YD | 2.51 M
 Unit weight: 28 LB | 12.7 KG
 Carton weight: 37 LB | 16.78 KG
 Carton volume: 17.75 FT³ | 0.5 MT³

Active weight 500 lbs.

IN	26	24	38.5	24	18	17.5	24	21
MM	660	610	978	610	457	445	610	533

RTA 00 1 per carton

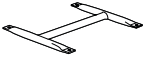
DESCRIPTION	MODEL# / FEATURES	STANDARD TEXTILE GRADES							
		List price							
	GC6928	84							
 <p>Metal Ganging Connector for Armchairs COM: N/A Unit weight: 2 LB 0.9 KG Carton weight: 4 LB 1.81 KG Carton volume: 0.4 FT³ 0.01 MT³</p>		OVERALL DIMENSIONS			SEAT DIMENSIONS			BACK DIMENSIONS	
		W	D		H	W	D	H	WH
	IN	12	13.75	1	-	-	-	-	-
	MM	305	349	25	-	-	-	-	-
		RTA 00	courier						

		List price							
	GC6929	84							
 <p>Metal Ganging Connector for Armless Chairs COM: N/A Unit weight: 1.5 LB 0.7 KG Carton weight: 3.5 LB 1.59 KG Carton volume: 0.4 FT³ 0.01 MT³</p>		OVERALL DIMENSIONS			SEAT DIMENSIONS			BACK DIMENSIONS	
		W	D	H	W	D	H	W	H
	IN	7.87	13.75	1	-	-	-	-	-
	MM	200	349	25	-	-	-	-	-
		RTA 00	courier						

GC SIRENA



model GC3380



model GC3380CTRL

STANDARD FEATURES

- A modern take on a classic design, GC Sirena remains relevant, charming and diverse offering simple, clean, flexible lines that will complement and create a sense of warmth in any room. The soft curves and comfortable fit make it the right solution for relaxation or meetings.
- Models are available with complementary round bun shaped foot design or swivel casters in Black only.
- For tablet models, please specify left hand or right hand tablet at time of order (determined from the seated position). See models below.
- Tablets rotate and are non-removable. Overall tablet size is 17"W by 14"D.
- Laminate tablet surfaces are 1.5" thick.
- **(C1M)** dual wheel carpet casters are standard on select models.
- The interior wood frame is an interlocking construction providing superior strength and long-term durability.
- Clean out space is provided around the seat pan for easy housekeeping and infection prevention practices.
- Seat cushion can be removed if replacement is required.
- For added comfort, seats are standard with high density Ultracell foam.
- For textile options, visit the Healthcare vertical section on globalfurnituregroup.com.
- Can be upholstered in standard Global textiles if Healthcare compliance is not required.

OPTIONAL FEATURES

- Laminate tablets are offered in the following laminate finishes: Absolute Acajou (ACJ), Asian Night (ASN), Avant Cherry (AWC), Avant Honey (AWH), Black (BLK), Blizzard (BZD) Brushed Cobalt (BRC), Clear Maple (CMB), Custom Grey (CGY), Dark Espresso (DES), Designer White (DWT), Fashionista (FAS), First Class (FCL), Quartered Mahogany (QTM), Noce Biondo (NBL), Noce Grigio (NGL), Noce Leggero (NEL), Noce Medio (NML), Sheer Beauty (SBY), Stonedust (SDT) Walnut Heights (WHE), White Chocolate (WHC) and Winter Cherry (WCR). Please specify.
- For less demanding areas, models are available with a tapered cylindrical 3 ¾ high wood leg to create a 19" seat height for models GC3380 and GC3380-CW. Add \$366.
- To add sealed seams to your product contact Customer Service. Upcharges vary.
- For moisture barrier on seat, please specify **(MB)**. Add \$122.

SUGGESTED APPLICATIONS

- Dining/Cafeteria
- Guest seating
- Lobbies
- Lounge/Waiting
- Office/Meeting
- Patient rooms
- Resident rooms

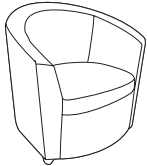
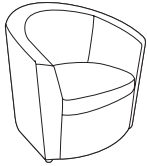
DESCRIPTION	MODEL# / FEATURES	STANDARD TEXTILE GRADES											
		COM	2	3	4	5	6	7	8	9	10	11	12
 <p>Club Chair w/Seat Clean Out COM: 4.25 YD 3.89 M Unit weight: 45 LB 20.5 KG Carton weight: 52 LB 23.59 KG Carton volume: 19.25 FT³ 0.54 MT³</p>	GC3380	1152	1288	1403	1535	1751	1951	2151	2325	2542	2746	3022	3413
		OVERALL DIMENSIONS			SEAT DIMENSIONS			BACK DIMENSIONS					
		W	D	H	W	D	H	W	H				
		IN 30.5	29.5	28.5	20	20	17.5	19	11.5				
	MM 775	749	724	508	508	445	483	292					
	RTA 00	1 per carton											
 <p>Club Chair on Casters w/Seat Clean Out COM: 4.25 YD 3.89 M Unit weight: 47 LB 21.4 KG Carton weight: 52 LB 23.59 KG Carton volume: 19.25 FT³ 0.54 MT³</p>	GC3380C	1242	1378	1493	1625	1841	2041	2241	2415	2632	2836	3112	3503
		OVERALL DIMENSIONS			SEAT DIMENSIONS			BACK DIMENSIONS					
		W	D	H	W	D	H	W	H				
		IN 30.5	29.5	29.5	20	20	18	19	12.5				
	MM 775	749	749	508	508	457	483	318					
	RTA 00	1 per carton											

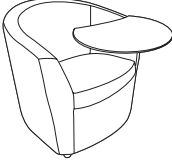
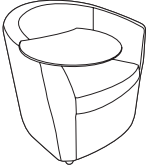
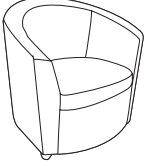
DESCRIPTION	MODEL# / FEATURES	STANDARD TEXTILE GRADES												
		COM	2	3	4	5	6	7	8	9	10	11	12	
 <p>Club Chair on Casters w/Seat Clean Out and LP Tablet - Left COM: 4.25 YD 3.89 M Unit weight: 57 LB 25.9 KG Carton weight: 62 LB 28.12 KG Carton volume: 19.25 FT³ 0.54 MT³</p>	<p>GC3380CLTL</p>	1652	1788	1903	2035	2251	2451	2651	2825	3042	3246	3522	3913	
		OVERALL DIMENSIONS			SEAT DIMENSIONS			BACK DIMENSIONS						
		W	D	H	W	D	H	W	H					
		IN	32	29.5	29.5	20	20	18	19	12.5				
		MM	813	749	749	508	508	457	483	318				
		RTA 00	1 per carton											
 <p>Club Chair on Casters w/Seat Clean Out and LP Tablet - Right COM: 4.25 YD 3.89 M Unit weight: 57 LB 25.9 KG Carton weight: 62 LB 28.12 KG Carton volume: 19.25 FT³ 0.54 MT³</p>	<p>GC3380CRTL</p>	1652	1788	1903	2035	2251	2451	2651	2825	3042	3246	3522	3913	
		OVERALL DIMENSIONS			SEAT DIMENSIONS			BACK DIMENSIONS						
		W	D	H	W	D	H	W	H					
		IN	32	29.5	29.5	20	20	18	19	12.5				
		MM	813	749	749	508	508	457	483	318				
		RTA 00	1 per carton											
 <p>Weighted Club Chair w/Seat Clean Out COM: 4.25 YD 3.89 M Unit weight: 98 LB 44.5 KG Carton weight: 108 LB 48.99 KG Carton volume: 19.25 FT³ 0.54 MT³</p>	<p>GC3380-CW</p>	1419	1555	1670	1802	2018	2218	2418	2592	2809	3013	3289	3680	
		OVERALL DIMENSIONS			SEAT DIMENSIONS			BACK DIMENSIONS						
		W	D	H	W	D	H	W	H					
		IN	30.5	29.5	28.5	20	20	17.5	19	11.5				
		MM	775	749	724	508	508	445	483	292				
		RTA 00	1 per carton											

GC SONIC



model GC6508WS



model GC6525WS

STANDARD FEATURES

- GC Sonic offers a large variety of solutions for patient rooms, public and reception areas and activity rooms, either as stand-alone or as a beam seating solution.
- The versatility continues with plastic or upholstered seat/back options. For convenience and additional space, the four-legged models stack.
- Four-legged/freestanding models are standard with a straight leg or with a “WS” wall saver frame in Chrome and durable polypropylene glides.
- “WS” models have a wall saver frame design; rear legs hit the baseboard first leaving clearance between the back of the chair and the wall, saving both the chair and the wall from damage.
- Four-legged/freestanding models are stackable up to 5 high on floor and 10 high on dolly 6517WS.
- Upholstered chairs have a polypropylene seat shroud to prevent imprints on the upholstery on the seat below when they are stacked.
- Units available with or without arms. Arms available in Black finish.
- For healthcare textiles, visit the website at globalfurnituregroup.com.
- Can be upholstered in standard Global textiles if Healthcare compliance is not required.
- Shipped fully assembled.

SUGGESTED APPLICATIONS

- Dining/Cafeteria
- Guest seating
- Lobbies
- Lounge/Waiting
- Office/Meeting
- Patient rooms
- Resident rooms
- Stacking
- Treatment/Exam rooms

OPTIONAL FEATURES

- Polypropylene seats and backs are available in 14 designer colors: Buzz Blue (B2B), Cactus (CCT), Carrot (CRO), Cloud (IVC), Dijon (DJN), Eggplant (EGP), Fog (FOG), Frost (FRO), Ink (INK), Latte (LAB), Night (BLK), Sand (SND), Scarlet (SAR) and Shadow (SHW). Please specify.
- A selection of glide options is available. Glides must be chosen to best suit flooring type and site conditions. For more information, please refer to the glide section (page 274).
- For hard surface floors, please specify opaque non-marking glides (NM). No upcharge.
- Steel cushioned glides (B) are available on four-legged chairs. Add \$17.
- Glides with felt pads (FG) are available for vinyl sheet, cork or laminate flooring, please specify. Add \$43.
- Glides with rubber pads (RG) are available for vinyl, hardwood, laminate, stone or ceramic flooring, please specify. Add \$43.
- For highly resilient, high density Ultracell foam seat, please specify (UC). Add \$15.
- For moisture barrier on seat, please specify (MB). Add \$81.
- **Frame finish**
Paint finishes. No upcharge.
(TBL) Black (TIN) Ink
(TBZ) Buzz Blue (TKA) Kalua
(TCC) Cactus (TLA) Latte
(TCR) Carrot (TMO) Mocha
(TIV) Cloud (TNE) Nevada
(TDW) Designer White (TSN) Sand
(TDJ) Dijon (TSR) Scarlet
(TEG) Eggplant (TSH) Shadow
(TFO) Fog (TOA) Toast
(TFR) Frost (TTU) Tungsten
Plated finish. No upcharge.
(CHM) Chrome

DESCRIPTION MODEL# / FEATURES STANDARD TEXTILE GRADES



GC6508



GC6508WS

Armless Chair
COM: N/A
Unit weight: 7.5 LB | 3.4 KG
Carton weight: 11.5 LB | 5.22 KG
Carton volume: 13.75 FT³ | 0.38 MT³

List price	
GC6508	213
GC6508WS	241

Active weight 300 lbs.
Polypropylene seat & back.

	OVERALL DIMENSIONS			SEAT DIMENSIONS			BACK DIMENSIONS	
	W	D	H	W	D	H	W	H
IN	21.5	22	33	17	16	18	17	15
MM	546	559	838	432	406	457	432	381

RTA 00 2 per carton (pricing and specifications are for one chair)



GC6509



GC6509WS









Armless Chair
COM: 0.75 YD | 0.69 M
Unit weight: 10 LB | 4.5 KG
Carton weight: 12.5 LB | 5.67 KG
Carton volume: 11.75 FT³ | 0.33 MT³

COM	2	3	4	5	6	7	8	9	10	11	12	
GC6509	272	296	316	340	378	413	448	479	517	553	602	671
GC6509WS	301	325	345	369	407	442	477	508	546	582	631	700

Active weight 300 lbs.
Upholstered seat/poly back.

	OVERALL DIMENSIONS			SEAT DIMENSIONS			BACK DIMENSIONS	
	W	D	H	W	D	H	W	H
IN	21.5	22	33	17	16	18.5	17	14.5
MM	546	559	838	432	406	470	432	368

RTA 00 2 per carton (pricing and specifications are for one chair)

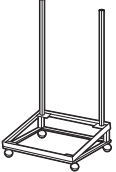
DESCRIPTION	MODEL# / FEATURES	STANDARD TEXTILE GRADES											
		COM	2	3	4	5	6	7	8	9	10	11	12
 GC6511 Armless Chair COM: 0.75 YD 0.69 M Unit weight: 11 LB 5 KG Carton weight: 13.5 LB 6.12 KG Carton volume: 11.75 FT³ 0.33 MT³	 GC6511WS Wall saver	309	333	353	377	415	450	485	516	554	590	639	708
		338	362	382	406	444	479	514	545	583	619	668	737
		OVERALL DIMENSIONS			SEAT DIMENSIONS			BACK DIMENSIONS					
		W	D	H	W	D	H	W	H				
		IN 21.5	22	33.5	17	15.5	18.5	17	15				
		MM 546	559	851	432	394	470	432	381				
		RTA 00		2 per carton (pricing and specifications are for one chair)									
		List price											
		GC6511 271 GC6511WS 297											
 GC6513 Armchair COM: N/A Unit weight: 9.5 LB 4.3 KG Carton weight: 12 LB 5.44 KG Carton volume: 11.75 FT³ 0.33 MT³	 GC6513WS Wall saver	271											
		297											
		OVERALL DIMENSIONS			SEAT DIMENSIONS			BACK DIMENSIONS					
		W	D	H	W	D	H	W	H				
		IN 23	22	33	17	16	18	17	15				
		MM 584	559	838	432	406	457	432	381				
		RTA 00		2 per carton (pricing and specifications are for one chair)									
		List price											
		GC6513 271 GC6513WS 297											
 GC6514 Armchair COM: 0.75 YD 0.69 M Unit weight: 12 LB 5.5 KG Carton weight: 14.5 LB 6.58 KG Carton volume: 11.75 FT³ 0.33 MT³	 GC6514WS Wall saver	331	355	375	399	437	472	507	538	576	612	661	730
		358	382	402	426	464	499	534	565	603	639	688	757
		OVERALL DIMENSIONS			SEAT DIMENSIONS			BACK DIMENSIONS					
		W	D	H	W	D	H	W	H				
		IN 23	22	33	17	16	18.5	17	14.5				
		MM 584	559	838	432	406	470	432	368				
		RTA 00		2 per carton (pricing and specifications are for one chair)									
		List price											
		GC6514 331 GC6514WS 358											
 GC6515 Armchair COM: 0.75 YD 0.69 M Unit weight: 13 LB 5.9 KG Carton weight: 15.5 LB 7.03 KG Carton volume: 11.75 FT³ 0.33 MT³	 GC6515WS Wall saver	368	392	412	436	474	509	544	575	613	649	698	767
		381	405	425	449	487	522	557	588	626	662	711	780
		OVERALL DIMENSIONS			SEAT DIMENSIONS			BACK DIMENSIONS					
		W	D	H	W	D	H	W	H				
		IN 23	22	33.5	17	15.5	18.5	17	15				
		MM 584	559	851	432	394	470	432	381				
		RTA 00		2 per carton (pricing and specifications are for one chair)									
		List price											
		GC6515 368 GC6515WS 381											
 GC6517WS Dolly COM: N/A Unit weight: 17 LB 7.7 KG Carton weight: 20 LB 9.07 KG Carton volume: 4 FT³ 0.11 MT³	GC6517WS Accommodates 10 chairs.	383											
		OVERALL DIMENSIONS			SEAT DIMENSIONS			BACK DIMENSIONS					
		W	D	H	W	D	H	W	H				
		IN 23.25	24.75	12.25	-	-	-	-	-				
		MM 591	629	311	-	-	-	-	-				
		RTA 1		courier 2 cartons									

DESCRIPTION MODEL# / FEATURES STANDARD TEXTILE GRADES



GC6518



GC6518WS

Armless Chair, Sled Base
 COM: N/A
 Unit weight: 9 LB | 4.1 KG
 Carton weight: 11.5 LB | 5.22 KG
 Carton volume: 11.75 FT³ | 0.33 MT³

Active weight 300 lbs.
 Polypropylene seat & back.

List price

GC6518 271
GC6518WS 297
 Wall saver

OVERALL DIMENSIONS			SEAT DIMENSIONS			BACK DIMENSIONS	
W	D	H	W	D	H	W	H

IN	21.5	22	33	17	16	18	17	15
MM	546	559	838	432	406	457	432	381

RTA 00 2 per carton (pricing and specifications are for one chair)



GC6519



GC6519WS

Armless Chair, Sled Base
 COM: 0.75 YD | 0.69 M
 Unit weight: 11.5 LB | 5.2 KG
 Carton weight: 14 LB | 6.35 KG
 Carton volume: 11.75 FT³ | 0.33 MT³

Active weight 300 lbs.
 Upholstered seat/poly back.

COM	2	3	4	5	6	7	8	9	10	11	12	
GC6519	331	355	375	399	437	472	507	538	576	612	661	730
GC6519WS	358	382	402	426	464	499	534	565	603	639	688	757

OVERALL DIMENSIONS			SEAT DIMENSIONS			BACK DIMENSIONS	
W	D	H	W	D	H	W	H

IN	21.5	22	33	17	16	18.5	17	14.5
MM	546	559	838	432	406	470	432	368

RTA 00 2 per carton (pricing and specifications are for one chair)



GC6521



GC6521WS

Armless Chair, Sled Base
 COM: 0.75 YD | 0.69 M
 Unit weight: 12.5 LB | 5.7 KG
 Carton weight: 15 LB | 6.8 KG
 Carton volume: 11.75 FT³ | 0.33 MT³

Active weight 300 lbs.
 Upholstered seat & back.

COM	2	3	4	5	6	7	8	9	10	11	12	
GC6521	368	392	412	436	474	509	544	575	613	649	698	767
GC6521WS	393	417	437	461	499	534	569	600	638	674	723	792

OVERALL DIMENSIONS			SEAT DIMENSIONS			BACK DIMENSIONS	
W	D	H	W	D	H	W	H

IN	21.5	22	33.5	17	16	18.5	17	15
MM	546	559	851	432	406	470	432	381

RTA 00 2 per carton (pricing and specifications are for one chair)



GC6523



GC6523WS

Armchair, Sled Base
 COM: N/A
 Unit weight: 11 LB | 5 KG
 Carton weight: 15 LB | 6.8 KG
 Carton volume: 13.75 FT³ | 0.38 MT³

Active weight 300 lbs.
 Polypropylene seat & back.

List price

GC6523 327
GC6523WS 354
 Wall saver

OVERALL DIMENSIONS			SEAT DIMENSIONS			BACK DIMENSIONS	
W	D	H	W	D	H	W	H

IN	23	22	33	17	16	18	17	15
MM	584	559	838	432	406	457	432	381

RTA 00 2 per carton (pricing and specifications are for one chair)



GC6524



GC6524WS

Armchair, Sled Base
 COM: 0.75 YD | 0.69 M
 Unit weight: 13.5 LB | 6.1 KG
 Carton weight: 16 LB | 7.26 KG
 Carton volume: 11.75 FT³ | 0.33 MT³





Active weight 300 lbs.
 Upholstered seat/poly back.

COM	2	3	4	5	6	7	8	9	10	11	12	
GC6524	386	410	430	454	492	527	562	593	631	667	716	785
GC6524WS	413	437	457	481	519	554	589	620	658	694	743	812

OVERALL DIMENSIONS			SEAT DIMENSIONS			BACK DIMENSIONS	
W	D	H	W	D	H	W	H

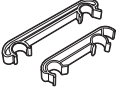
IN	23	22	33	17	16	18.5	17	14.5
MM	584	559	838	432	406	470	432	368

RTA 00  2 per carton (pricing and specifications are for one chair)

DESCRIPTION	MODEL# / FEATURES	STANDARD TEXTILE GRADES																																			
		COM	2	3	4	5	6	7	8	9	10	11	12																								
 <p>GC6525 GC6525WS</p> <p>Armchair, Sled Base COM: 0.75 YD 0.69 M Unit weight: 14.5 LB 6.6 KG Carton weight: 17 LB 7.71 KG Carton volume: 11.75 FT³ 0.33 MT³</p>	<p>GC6525 GC6525WS Wall saver</p>	422	446	466	490	528	563	598	629	667	703	752	821																								
	<p>Active weight 300 lbs. Upholstered seat & back.</p>	<table border="1"> <thead> <tr> <th rowspan="2"></th> <th colspan="3">OVERALL DIMENSIONS</th> <th colspan="3">SEAT DIMENSIONS</th> <th colspan="2">BACK DIMENSIONS</th> </tr> <tr> <th>W</th> <th>D</th> <th>H</th> <th>W</th> <th>D</th> <th>H</th> <th>W</th> <th>H</th> </tr> </thead> <tbody> <tr> <td>IN</td> <td>23</td> <td>22</td> <td>33.5</td> <td>17</td> <td>16</td> <td>18.5</td> <td>17</td> <td>15</td> </tr> <tr> <td>MM</td> <td>584</td> <td>559</td> <td>851</td> <td>432</td> <td>406</td> <td>470</td> <td>432</td> <td>381</td> </tr> </tbody> </table>		OVERALL DIMENSIONS			SEAT DIMENSIONS			BACK DIMENSIONS		W	D	H	W	D	H	W	H	IN	23	22	33.5	17	16	18.5	17	15	MM	584	559	851	432	406	470	432	381
	OVERALL DIMENSIONS			SEAT DIMENSIONS			BACK DIMENSIONS																														
	W	D	H	W	D	H	W	H																													
IN	23	22	33.5	17	16	18.5	17	15																													
MM	584	559	851	432	406	470	432	381																													
		RTA 00	2 per carton (pricing and specifications are for one chair)																																		
		List price																																			
	GC6522	15																																			
 <p>Ganging Brackets - Set of 2 COM: N/A Unit weight: 0.07 LB 0.03 KG Carton weight: 0.16 LB 0.07 KG Carton volume: 1 FT³ 0.02 MT³</p>	<p>For four-legged models only.</p>	<table border="1"> <thead> <tr> <th rowspan="2"></th> <th colspan="3">OVERALL DIMENSIONS</th> <th colspan="3">SEAT DIMENSIONS</th> <th colspan="2">BACK DIMENSIONS</th> </tr> <tr> <th>W</th> <th>D</th> <th>H</th> <th>W</th> <th>D</th> <th>H</th> <th>W</th> <th>H</th> </tr> </thead> <tbody> <tr> <td>IN</td> <td>0.87</td> <td>7.75</td> <td>1.5</td> <td>-</td> <td>-</td> <td>-</td> <td>-</td> <td>-</td> </tr> <tr> <td>MM</td> <td>22</td> <td>197</td> <td>38</td> <td>-</td> <td>-</td> <td>-</td> <td>-</td> <td>-</td> </tr> </tbody> </table>		OVERALL DIMENSIONS			SEAT DIMENSIONS			BACK DIMENSIONS		W	D	H	W	D	H	W	H	IN	0.87	7.75	1.5	-	-	-	-	-	MM	22	197	38	-	-	-	-	-
		OVERALL DIMENSIONS			SEAT DIMENSIONS			BACK DIMENSIONS																													
W		D	H	W	D	H	W	H																													
IN	0.87	7.75	1.5	-	-	-	-	-																													
MM	22	197	38	-	-	-	-	-																													
		RTA 00		Pricing is for the set, specifications are for one bracket																																	
		List price																																			
	GC6526	15																																			
 <p>Ganging Brackets - Set of 2 COM: N/A Unit weight: 0.25 LB 0.1 KG Carton weight: 0.28 LB 0.13 KG Carton volume: 0.5 FT³ 0.01 MT³</p>	<p>For sled base models only.</p>	<table border="1"> <thead> <tr> <th rowspan="2"></th> <th colspan="3">OVERALL DIMENSIONS</th> <th colspan="3">SEAT DIMENSIONS</th> <th colspan="2">BACK DIMENSIONS</th> </tr> <tr> <th>W</th> <th>D</th> <th>H</th> <th>W</th> <th>D</th> <th>H</th> <th>W</th> <th>H</th> </tr> </thead> <tbody> <tr> <td>IN</td> <td>0.75</td> <td>5.75</td> <td>1.25</td> <td>-</td> <td>-</td> <td>-</td> <td>-</td> <td>-</td> </tr> <tr> <td>MM</td> <td>19</td> <td>146</td> <td>32</td> <td>-</td> <td>-</td> <td>-</td> <td>-</td> <td>-</td> </tr> </tbody> </table>		OVERALL DIMENSIONS			SEAT DIMENSIONS			BACK DIMENSIONS		W	D	H	W	D	H	W	H	IN	0.75	5.75	1.25	-	-	-	-	-	MM	19	146	32	-	-	-	-	-
		OVERALL DIMENSIONS			SEAT DIMENSIONS			BACK DIMENSIONS																													
W		D	H	W	D	H	W	H																													
IN	0.75	5.75	1.25	-	-	-	-	-																													
MM	19	146	32	-	-	-	-	-																													
		RTA 00		Pricing is for the set, specifications are for one bracket																																	

GC VITROLA



model GC8271LB

model GC8271HB



EXAMPLE GC VITROLA ORDER CODE:

GC8271HB	-NS	-WA50	-NS	-WA50
Model #	Sealed back/arms seams	Back/arms textile	Sealed seat seams	Seat textile
-WOD	-AAM	-RS	-NB	-NM
Leg type	Leg finish	Fastener type	Moisture barrier	Glide

STANDARD FEATURES

- Classic soft seating upholstery design with swooping arms.
- Available in two back heights.
- Clean out space is provided between the seat and back cushions for easy housekeeping.
- The seat underside is sealed with a non-porous material to support housekeeping and infection control protocols.
- Seat cushion is mechanically removable for replacement.
- For added comfort, seats are standard with high density Ultracell foam.
- Tapered legs are available in Maple wood in a variety of finishes.
- White non-marking nylon glides are standard.
- Textiles with a minimum of 100,000 double rubs must be specified to meet Global 24/7 warranty coverage.
- For healthcare textiles and finish options, visit the website at globalfurnituregroup.com.
- Can be upholstered in standard Global textiles if Healthcare 24/7 application compliance is not required. Global's Limited Lifetime warranty applies.
- Shipped fully assembled.
- Active weight capacity is up to 350 lbs.

OPTIONAL FEATURES



- A selection of glide options is available, see Glide types. Glides must be chosen to best suit flooring type and site conditions.
- Sealed seams are available on chair's back and arms and/or seat (upcharges apply).
- Moisture barrier may be added to seat cushions only (upcharge applies).

SUGGESTED APPLICATIONS

- Lobbies
- Lounge/Waiting
- Patient rooms
- Resident rooms

Please add option codes in the following order:

- **Model number**
GC8271LB Lounge chair
GC8271HB High back lounge chair
- **Back and arm seams**
(NS) No sealed seams.
(S2) Sealed back and arm seams. Add \$93. For high back, add \$109.
- **Back and arm textile**
Specify back and arm textile.
- **Seat seams**
(NS) No sealed seams.
(SE) Sealed seat seams. Add \$18.
- **Seat textile**
Specify seat textile.
- **Leg type**
(WOD) Wood
- **Leg finish**
(AAM) Absolute
(BKM) Black
(ACM) Cherry
(CJM) Charcoal Java
(EMM) Empire Mahogany
(EOM) English Oak
(ECM) Espresso Cafe
(TFM) Fruitwood
(HGM) Gray
(HOM) Harvest Oak
(AHM) Honey
(JOM) Jet Onyx
(LHM) Light Honey
(TMM) Mahogany
(AVM) Maple
(MWM) Medium Walnut
(ASM) Night
(NBM) Noce Biondo
(NGM) Noce Grigio
(NEM) Noce Leggero
(NMM) Noce Medio
(SBM) Sandy Beach
(SKM) Shaker Cherry
(SOM) Silver Oak
(TWM) Walnut
(WTM) WC Cream
(WHM) White
(WCM) Winter Cherry
- **Fastener type**
(RS) Standard fasteners.
(TP) Tamperproof fasteners. Add \$70.
- **Moisture barrier** (seat only, not available with sealed seams option)
(NB) No moisture barrier.
(MB) Moisture barrier. Add \$81.
- **Glides**
(NM) Non-marking glides for most surfaces.
(SG) Steel cushioned glides for carpeted surfaces. Add \$17.
(RG) Rubber non-slip glides for most hard floor surfaces. Add \$22.
(FG) Felt glides for most hard floor surfaces. Add \$22.

DESCRIPTION	MODEL# / FEATURES	STANDARD TEXTILE GRADES												
		COM	2	3	4	5	6	7	8	9	10	11	12	
 <p>Lounge Chair COM: 5.75 YD 5.26 M Unit weight: 59.5 LB 27 KG Carton weight: 74.5 LB 33.79 KG Carton volume: 20.25 FT³ 0.57 MT³</p>	GC8271LB	1946	2130	2286	2464	2757	3027	3298	3533	3827	4103	4476	5005	
		OVERALL DIMENSIONS W D H			SEAT DIMENSIONS W D H			BACK DIMENSIONS W H						
	IN	28.25	32.25	34.25	21.5	19.25	18.5	22.5	15.75					
MM	718	819	870	546	489	470	572	400						
	RTA 00	1 per carton												
 <p>High Back Lounge Chair COM: 6.25 YD 5.72 M Unit weight: 67.5 LB 30.7 KG Carton weight: 83.5 LB 37.87 KG Carton volume: 28.25 FT³ 0.79 MT³</p>	GC8271HB	2099	2299	2468	2662	2980	3274	3568	3824	4143	4443	4849	5424	
		OVERALL DIMENSIONS W D H			SEAT DIMENSIONS W D H			BACK DIMENSIONS W H						
	IN	28.25	33.75	42	21.5	19.25	18.5	22.5	23.5					
MM	718	857	1067	546	489	470	572	597						
	RTA 00	1 per carton												

GC WIND



model GC3361HB

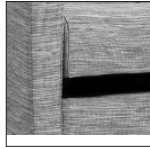

Removable Seat Cushion



Tubular Steel Leg



model GC3363HB

STANDARD FEATURES

- An attractive, sleek and modern lounge series with tubular legs.
- Seat cushions are easily removable for cleaning and the open frame is great for housekeeping access. Cushion covers are removable.
- For added comfort, seats are standard with high density Ultracell foam.
- Standard glide is Black plastic.
- For healthcare textiles and finish options, visit the website at globalfurnituregroup.com.
- Can be upholstered in standard Global textiles if Healthcare compliance is not required.
- Shipped fully assembled.

SUGGESTED APPLICATIONS

- Lobbies
- Lounge/Waiting
- Office/Meeting
- Patient rooms
- Resident rooms

OPTIONAL FEATURES

- For hard surface floors, please specify opaque non-marking glides (**NM**). No upcharge.
- To add sealed seams to your product contact Customer Service. Upcharges vary.
- For moisture barrier on seat, please specify (**MB**). See below for upcharges:
Lounge chair: Add \$122.
Two seat sofa: Add \$245.
Three seat sofa: Add \$366.
- **Frame finish**
Paint finishes. No upcharge.
(**TBL**) Black (**TIN**) Ink
(**TBZ**) Buzz Blue (**TKA**) Kalua
(**TCC**) Cactus (**TLA**) Latte
(**TCR**) Carrot (**TMO**) Mocha
(**TIV**) Cloud (**TNE**) Nevada
(**TDW**) Designer White (**TSN**) Sand
(**TDJ**) Dijon (**TSR**) Scarlet
(**TEG**) Eggplant (**TSH**) Shadow
(**TFO**) Fog (**TOA**) Toast
(**TFR**) Frost (**TTU**) Tungsten
Plated finish. See below for upcharges.
(**CHM**) Chrome (**SBR**) Satin Brass
(**BCH**) Brushed Chrome (**ACO**) Antique Copper
- Upcharges apply for plated finishes:
(**CHM**) Chrome. No upcharge.
(**BCH**) Brushed Chrome. Add \$49 for lounge chair. Add \$84 for two seat sofa. Add \$174 for three seat sofa.
(**SBR**) Satin Brass. Add \$132 for lounge chair. Add \$204 for two seat sofa. Add \$399 for three seat sofa.
(**ACO**) Antique Copper. Add \$132 for lounge chair. Add \$204 for two seat sofa. Add \$399 for three seat sofa.

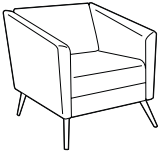
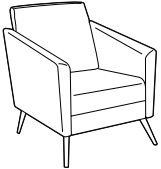
DESCRIPTION	MODEL# / FEATURES	STANDARD TEXTILE GRADES											
		COM	2	3	4	5	6	7	8	9	10	11	12
 Lounge Chair COM: 4.25 YD 3.89 M Unit weight: 55 LB 25 KG Carton weight: 62 LB 28.12 KG Carton volume: 16.5 FT³ 0.46 MT³	GC3361	1781	1917	2032	2164	2380	2580	2780	2954	3171	3375	3651	4042
	Active weight 300 lbs. Removable seat cushion.	OVERALL DIMENSIONS			SEAT DIMENSIONS			BACK DIMENSIONS					
		W	D	H	W	D	H	W	H				
		IN 27.5 MM 699	29 737	28.5 724	19.5 495	19 483	17 432	19 483	12 305				
	RTA 00	1 per carton											
 High Back Lounge Chair COM: 4.75 YD 4.34 M Unit weight: 62 LB 28.2 KG Carton weight: 69 LB 31.3 KG Carton volume: 23 FT³ 0.65 MT³	GC3361HB	2040	2192	2320	2468	2710	2933	3156	3351	3593	3821	4130	4567
	Active weight 300 lbs. Removable seat cushions.	OVERALL DIMENSIONS			SEAT DIMENSIONS			BACK DIMENSIONS					
		W	D	H	W	D	H	W	H				
		IN 27.5 MM 699	29 737	36 914	19.5 495	19 483	17 432	19 483	19.5 495				
	RTA 00	1 per carton											

DESCRIPTION MODEL# / FEATURES STANDARD TEXTILE GRADES

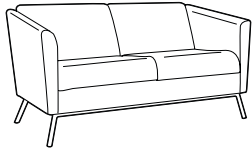

GC3362	COM	2	3	4	5	6	7	8	9	10	11	12
---------------	-----	---	---	---	---	---	---	---	---	----	----	----

2332	2564	2760	2985	3354	3695	4036	4333	4703	5051	5522	6189
------	------	------	------	------	------	------	------	------	------	------	------

Active weight 300 lbs/seat.

Removable seat cushions.

OVERALL DIMENSIONS			SEAT DIMENSIONS			BACK DIMENSIONS	
W	D	H	W	D	H	W	H

IN	54.5	29	28.5	46.5	19	17	46.5	12
MM	1384	737	724	1181	483	432	1181	305

RTA 00 1 per carton

Two Seat Sofa
 COM: 7.25 YD | 6.63 M
 Unit weight: 95 LB | 43.2 KG
 Carton weight: 102 LB | 46.27 KG
 Carton volume: 30 FT³ | 0.84 MT³

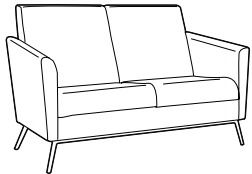

GC3362HB	COM	2	3	4	5	6	7	8	9	10	11	12
-----------------	-----	---	---	---	---	---	---	---	---	----	----	----

2834	3090	3306	3554	3962	4338	4714	5042	5450	5834	6354	7090
------	------	------	------	------	------	------	------	------	------	------	------

Active weight 300 lbs/seat.

Removable seat cushions.

OVERALL DIMENSIONS			SEAT DIMENSIONS			BACK DIMENSIONS	
W	D	H	W	D	H	W	H

IN	54.5	29	36	46.5	19	17	46.5	19.5
MM	1384	737	914	1181	483	432	1181	495

RTA 00 1 per carton

High Back Two Seat Sofa
 COM: 8 YD | 7.32 M
 Unit weight: 100 LB | 45.5 KG
 Carton weight: 107 LB | 48.53 KG
 Carton volume: 44.75 FT³ | 1.26 MT³

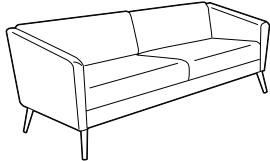

GC3363	COM	2	3	4	5	6	7	8	9	10	11	12
---------------	-----	---	---	---	---	---	---	---	---	----	----	----

2872	3208	3492	3817	4353	4846	5340	5770	6306	6810	7492	8458
------	------	------	------	------	------	------	------	------	------	------	------

Active weight 300 lbs/seat.

Removable seat cushions.

OVERALL DIMENSIONS			SEAT DIMENSIONS			BACK DIMENSIONS	
W	D	H	W	D	H	W	H

IN	78	29	28.5	70.5	19	17	70.5	12
MM	1981	737	724	1791	483	432	1791	305

RTA 00 1 per carton

Three Seat Sofa
 COM: 10.5 YD | 9.6 M
 Unit weight: 125 LB | 56.8 KG
 Carton weight: 135 LB | 61.23 KG
 Carton volume: 42.5 FT³ | 1.2 MT³

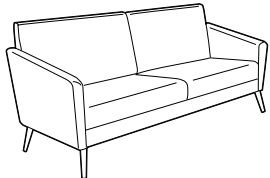

GC3363HB	COM	2	3	4	5	6	7	8	9	10	11	12
-----------------	-----	---	---	---	---	---	---	---	---	----	----	----

3597	3989	4320	4700	5324	5900	6476	6978	7603	8191	8987	10114
------	------	------	------	------	------	------	------	------	------	------	-------

Active weight 300 lbs/seat.

Removable seat cushions.

OVERALL DIMENSIONS			SEAT DIMENSIONS			BACK DIMENSIONS	
W	D	H	W	D	H	W	H

IN	78	29	36	70.5	19	17	70.5	19.5
MM	1981	737	914	1791	483	432	1791	495

RTA 00 1 per carton

High Back Three Seat Sofa
 COM: 12.25 YD | 11.2 M
 Unit weight: 130 LB | 59.1 KG
 Carton weight: 140 LB | 63.5 KG
 Carton volume: 62.25 FT³ | 1.76 MT³

HEATHER



model GC3770

STANDARD FEATURES



- Contemporary slim line design is compact and stylish for a variety of different environments.
- Seat cushions are easily removable for cleaning and the open frame below the cushion eliminates traps.
- Wood legs are available in a variety of finishes. Available in Maple wood species only (refer to finishes ending in "M").
- Matching tapered leg tables are also available, see Tables section.
- For added comfort, seats are standard with high density Ultracell foam.
- Opaque non-marking glides are standard.
- For healthcare textiles and wood finish options, visit the website at globalfurnituregroup.com.
- This product can be upholstered in standard Global textiles only if Healthcare compliance is not required.
- Shipped fully assembled.

OPTIONAL FEATURES

- For non-slip glides, please specify **(NS)**. Add \$22.
- For steel cushion glide, please specify **(GI)**. Add \$5.
- To add sealed seams to your product contact Customer Service. Upcharges vary.
- For moisture barrier on seat, please specify **(MB)**. Add \$81.

SUGGESTED APPLICATIONS

- Dining/Cafeteria
- Guest seating
- Lobbies
- Lounge/Waiting
- Patient rooms
- Resident rooms

DESCRIPTION	MODEL# / FEATURES	STANDARD TEXTILE GRADES												
		COM	2	3	4	5	6	7	8	9	10	11	12	
 <p>High Back Lounge Chair COM: 3.25 YD 2.97 M Unit weight: 35 LB 15.9 KG Carton weight: 40 LB 18.14 KG Carton volume: 17 FT³ 0.48 MT³</p>	GC3770	1327	1431	1519	1620	1785	1938	2091	2224	2390	2546	2757	3056	
		OVERALL DIMENSIONS			SEAT DIMENSIONS			BACK DIMENSIONS						
		W	D	H	W	D	H	W	H					
	Active weight 300 lbs. Removable seat cushion.	IN 24 MM 610	24.5 622	36.5 927	18.5 470	17 432	18 457	19.5 495	18.5 470					
		RTA 00		1 per carton										
 <p>Low Back Lounge Chair COM: 3 YD 2.74 M Unit weight: 32 LB 14.5 KG Carton weight: 36 LB 16.33 KG Carton volume: 13.25 FT³ 0.37 MT³</p>	GC3771	1241	1337	1418	1511	1664	1805	1946	2069	2222	2366	2561	2837	
		OVERALL DIMENSIONS			SEAT DIMENSIONS			BACK DIMENSIONS						
		W	D	H	W	D	H	W	H					
	Active weight 300 lbs. Removable seat cushion.	IN 24 MM 610	24.5 622	31.5 800	18.5 470	17 432	18 457	19.5 495	13.5 343					
		RTA 00		1 per carton										

JANNA



model GC7609

STANDARD FEATURES







- Very often tight spaces create a challenge when additional seating is required for guests. Janna's unique folding frame is the perfect solution for temporary seating, especially where space is at a premium.
- Molded wood veneer frame.
- Concealed folding mechanism uses metal-to-metal construction details with lock tight fasteners.
- For added comfort, seats are standard with high density Ultracell foam.
- Non-marking nylon glides are standard.
- For healthcare textiles and wood finish options, visit the website at globalfurnituregroup.com. Available in Maple wood species only.
- Can be upholstered in standard Global textiles if Healthcare compliance is not required.
- Shipped fully assembled.

OPTIONAL FEATURES

- White cushioned glides (B) are available. Add \$5.
- For wall mounting bracket, please specify (WH). Add \$38.
- For moisture barrier on seat, please specify (MB). Add \$81.

SUGGESTED APPLICATIONS

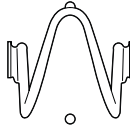
- Dining/Cafeteria
- Guest seating
- Lounge/Waiting
- Office/Meeting
- Patient rooms
- Resident rooms
- Treatment/Exam

DESCRIPTION	MODEL# / FEATURES	STANDARD TEXTILE GRADES												
		COM	2	3	4	5	6	7	8	9	10	11	12	
 <p>Folding Chair Upholstered Seat and Back COM: 1 YD 0.91 M Unit weight: 17 LB 7.7 KG Carton weight: 19 LB 8.62 KG Carton volume: 7 FT³ 0.19 MT³</p>	GC7609	602	634	661	692	743	790	837	878	929	977	1042	1134	
	Active weight 300 lbs.	OVERALL DIMENSIONS			SEAT DIMENSIONS			BACK DIMENSIONS						
		IN	19	22.5	32.5	16	17.5	18.5	16	13.5				
		MM	483	572	826	406	445	470	406	343				
		RTA 00		2 per carton (pricing and specifications are for one chair)										
 <p>Folding Chair Wood Back Upholstered Seat COM: 1 YD 0.91 M Unit weight: 17 LB 7.7 KG Carton weight: 19 LB 8.62 KG Carton volume: 7 FT³ 0.19 MT³</p>	GC7611	568	600	627	658	709	756	803	844	895	943	1008	1100	
	Active weight 300 lbs.	OVERALL DIMENSIONS			SEAT DIMENSIONS			BACK DIMENSIONS						
		IN	19	22.5	32.5	16	17.5	18.5	16	13.5				
		MM	483	572	826	406	445	470	406	343				
		RTA 00		2 per carton (pricing and specifications are for one chair)										
 <p>Wall Mounting Bracket COM: N/A Unit weight: 0.5 LB 0.2 KG Carton weight: 1.5 LB 0.68 KG Carton volume: 0.1 FT³ 0.003 MT³</p>	GC7607	List price												
	48													
	For Janna series only.	OVERALL DIMENSIONS			SEAT DIMENSIONS			BACK DIMENSIONS						
	Allows for hanging of one chair on a wall or a door.	IN	3	1.5	3.5	-	-	-	-	-				
	MM	76	38	89	-	-	-	-	-					
		RTA 00		1 per carton										
		Two (one pair) per package in Chrome finish. One bracket connects to the underside of the chair seat. The other bracket connects to the wall or door.												

NOURISH



model GC3683



model GC3685



Headrest adjustment handle



Tip and Move (T&M) wheels, height adjustable legs



Transfer arm

STANDARD FEATURES

- Nourish is an innovative state of the art patient chair, developed in consultation with leading healthcare professionals. It curves around the body, providing additional comfort during periods of recovery.
- All chair models have left and right, easy to operate transfer arms. Transfer arms allow for ease of movement in and out of the chair and provide easy caregiver access to assist the user.
- Models with fixed legs have a standard seat height of 18.5".
- Models with adjustable legs have adjustment pins to conveniently adapt seat heights from 17" to 20". The 20" seat height models (-20) have a seat height adjustment range of 20"-23". Front and back legs can be adjusted separately, allowing modification of seat pitch, forward or backward.
- Models with rear casters allow for 'tip and move' so that the chair can be conveniently relocated while unoccupied. The optional push bar aids staff in moving the chair (see upcharge). Push bar matches frame finish.
- Select models have a unique Schukra depth adjustable headrest solution integrated inside the back near the user's neck area. The depth is controlled by a handle on the lower outer back cushion.
- Schukra depth adjustable lumbar support for additional comfort is standard on select models.
- For added comfort, seats are standard with high density Ultracell foam.
- Metal frame is available in several paint finishes.
- The arm structure finish is Tungsten, with a urethane armcap, available in five finishes.
- Active weight capacity for standard single seat is 350 lbs. and 750 lbs. for bariatric seating.
- For healthcare textile and finish options, visit our website at globalfurnituregroup.com.
- Can be upholstered in standard Global textiles if Healthcare compliance is not required.

Please add option codes in the following order

- **Model number**
Specify model number.
- **Back seams and textile**
(NS) No sealed seams.
(S2) Sealed back seams. Add \$55.
For bariatric model, add \$89.
Back textile
Specify textile code.
- **Seat seams and textile**
(NS) No sealed seat seams.
(SE) Sealed seat seams. Add \$20.
For bariatric model, add \$23.
Seat textile
Specify textile code.
- **Sealed seat underside**
(ST) No sealed seat underside.
(SU) Sealed seat underside. Add \$39.
For bariatric model, add \$47.
- **Frame finish**
(TBL) Black **(TMO)** Mocha
(TIV) Cloud **(TNE)** Nevada
(TDW) Designer White **(TSN)** Sand
(TFO) Fog **(TSH)** Shadow
(TFR) Frost **(TOA)** Toast
(TKA) Kalua **(TTU)** Tungsten
(TLA) Latte
- **Back push bar** (matches frame finish)
(NBR) No push bar.
(PBR) Back push bar. Add \$81.
- **Armcap finish**
(BLK) Black
(KAL) Kalua
(LAB) Latte
(J52) Mocha
(SHW) Shadow
(TOA) Toast
- **Moisture barrier** (seat only, not available with sealed seams option)
(NB) No moisture barrier.
(MB) Moisture barrier. Add \$81.
For bariatric model, add \$124.

SUGGESTED APPLICATIONS

- Bariatric seating (model GC3685)
- Lounge/Waiting
- Patient rooms
- Resident rooms
- Treatment/Exam rooms

EXAMPLE NOURISH ORDER CODE:

GC3681	NS	FU75	NS	FU75	ST	TMO	NBR	J52	NB
Model #	Back seams	Back textile	Seat seams	Seat textile	Seat underside	Frame finish	Push bar	Armcap finish	Moisture barrier

DESCRIPTION	MODEL# / FEATURES	STANDARD TEXTILE GRADES											
		COM	2	3	4	5	6	7	8	9	10	11	12
 <p>High Back Patient Chair COM: 2 YD 1.83 M Unit weight: 42 LB 19.1 KG Carton weight: 52 LB 23.59 KG Carton volume: 33.5 FT³ 0.94 MT³</p>	GC3681 Adjustable 17"-20" seat height	1916	1980	2034	2096	2198	2292	2386	2468	2570	2666	2796	2980
	GC3681-20 Adjustable 20"-23" seat height	1962	2026	2080	2142	2244	2338	2432	2514	2616	2712	2842	3026
	GC3681XH Fixed 18.5" seat height	1871	1935	1989	2052	2153	2247	2341	2423	2525	2621	2751	2935
		OVERALL DIMENSIONS			SEAT DIMENSIONS			BACK DIMENSIONS					
		W	D	H	W	D	H	W	H				
Active weight 350 lbs.		IN 28.5	29	45.5	20	18.5	17	20	29				
Optional push bar, add \$81.		MM 724	737	1156	508	470	432	508	737				
		RTA 00	1 per carton (specifications are for model GC3681)										

DESCRIPTION MODEL# / FEATURES STANDARD TEXTILE GRADES



High Back Patient Chair w/Schukra Lumbar
 COM: 2 YD | 1.83 M
 Unit weight: 42 LB | 19.1 KG
 Carton weight: 52 LB | 23.59 KG
 Carton volume: 33.5 FT³ | 0.94 MT³

MODEL# / FEATURES	COM	2	3	4	5	6	7	8	9	10	11	12
GC3682 Adjustable 17"-20" seat height	2040	2104	2158	2220	2322	2416	2510	2592	2694	2790	2920	3104
GC3682-20 Adjustable 20"-23" seat height	2088	2152	2206	2268	2370	2464	2558	2640	2742	2838	2968	3152
GC3682XH Fixed 18.5" seat height	1995	2059	2113	2176	2277	2371	2465	2547	2649	2745	2875	3059

OVERALL DIMENSIONS			SEAT DIMENSIONS			BACK DIMENSIONS	
W	D	H	W	D	H	W	H

Active weight 350 lbs.	IN 28.5	29	45.5	20	18.5	17	20	29
	MM 724	737	1156	508	470	432	508	737
Optional push bar: Add \$81.	RTA 00 1 per carton (specifications are for model GC3682)							



High Back Patient Chair w/Schukra Headrest
 COM: 2 YD | 1.83 M
 Unit weight: 42 LB | 19.1 KG
 Carton weight: 52 LB | 23.59 KG
 Carton volume: 33.5 FT³ | 0.94 MT³

MODEL# / FEATURES	COM	2	3	4	5	6	7	8	9	10	11	12
GC3683 Adjustable 17"-20" seat height	2040	2104	2158	2220	2322	2416	2510	2592	2694	2790	2920	3104
GC3683-20 Adjustable 20"-23" seat height	2088	2152	2206	2268	2370	2464	2558	2640	2742	2838	2968	3152
GC3683XH Fixed 18.5" seat height	1995	2059	2113	2176	2277	2371	2465	2547	2649	2745	2875	3059

OVERALL DIMENSIONS			SEAT DIMENSIONS			BACK DIMENSIONS	
W	D	H	W	D	H	W	H

Active weight 350 lbs.	IN 28.5	29	45.5	20	18.5	17	20	29
	MM 724	737	1156	508	470	432	508	737
Optional push bar, add \$81.	RTA 00 1 per carton (specifications are for model GC3683)							



High Back Patient Chair w/Schukra Lumbar & Headrest
 COM: 2 YD | 1.83 M
 Unit weight: 42 LB | 19.1 KG
 Carton weight: 52 LB | 23.59 KG
 Carton volume: 33.5 FT³ | 0.94 MT³

MODEL# / FEATURES	COM	2	3	4	5	6	7	8	9	10	11	12
GC3684 Adjustable 17"-20" seat height	2162	2226	2280	2342	2444	2538	2632	2714	2816	2912	3042	3226
GC3684-20 Adjustable 20"-23" seat height	2209	2273	2327	2389	2491	2585	2679	2761	2863	2959	3089	3273
GC3684XH Fixed 18.5" seat height	2117	2181	2235	2298	2399	2493	2587	2669	2771	2867	2997	3181

OVERALL DIMENSIONS			SEAT DIMENSIONS			BACK DIMENSIONS	
W	D	H	W	D	H	W	H

Active weight 350 lbs.	IN 28.5	29	45.5	20	18.5	17	20	29
	MM 724	737	1156	508	470	432	508	737
Optional push bar, add \$81.	RTA 00 1 per carton (specifications are for model GC3684)							







Bariatric High Back Patient Chair (no height adjustment)
 COM: 3.25 YD | 2.97 M
 Unit weight: 60 LB | 27.3 KG
 Carton weight: 70 LB | 31.75 KG
 Carton volume: 45 FT³ | 1.27 MT³

MODEL# / FEATURES	COM	2	3	4	5	6	7	8	9	10	11	12
GC3685 Fixed 18.5" seat height	2372	2476	2564	2665	2830	2983	3136	3269	3435	3591	3802	4101

OVERALL DIMENSIONS			SEAT DIMENSIONS			BACK DIMENSIONS	
W	D	H	W	D	H	W	H

Active weight 750 lbs.	IN 40	29	47	35	18.5	18.5	35	29
	MM 1016	737	1194	889	470	470	889	737
Optional push bar, add \$81.	RTA 00 1 per carton							

DESCRIPTION	MODEL# / FEATURES	STANDARD TEXTILE GRADES											
		COM	2	3	4	5	6	7	8	9	10	11	12
 <p>Footstool COM: 1 YD 0.91 M Unit weight: 15 LB 6.8 KG Carton weight: 18 LB 8.16 KG Carton volume: 3.6 FT³ 0.1 MT³</p>	GC3686	463	495	522	553	604	651	698	739	790	838	903	995
	Active weight 350 lbs.	IN 17	17.5	12.5	-	-	-	-	-	-	-	-	-
	MM 432	445	318	-	-	-	-	-	-	-	-	-	-
	Can be stored beneath any Nourish chair when not in use.	  1 per carton											
 <p>High Back Patient Chair w/Four Manual Locking Casters (no height adjustment) COM: 2 YD 1.83 M Unit weight: 42 LB 19.1 KG Carton weight: 52 LB 23.59 KG Carton volume: 33.5 FT³ 0.94 MT³</p>	GC3698	2447	2511	2565	2627	2729	2823	2917	2999	3101	3197	3327	3511
	Fixed 17" seat height	IN 28.5	29	45.5	20	18.5	17	20	29				
	MM 724	737	1156	508	470	432	508	737					
	Active weight 500 lbs. Optional push bar, add \$81.	 1 per carton											

OAKVILLE



model GC36500



STANDARD FEATURES

- Oakville offers a modern take on wingback seating for social settings, resident rooms and lounge areas.
- Features a clean out space at the back of the seat cushion for easy housekeeping.
- The seat underside is sealed with a non-porous material to support housekeeping and infection control protocols.
- For added comfort, seat cushions are standard with high density Ultracell foam.
- Legs are available in wood or urethane, in a variety of colors.
- Choose from standard non-marking glides, steel cushioned glides, rubber non-slip glides or felt glides (upcharges apply).
- Assembled with tamper-resistant fasteners for greater security.
- For healthcare textiles, visit the website at globalfurnituregroup.com.
- The Lifetime Warranty (for healthcare and 24/7 environments) applies for all Oakville models when performance textiles are selected.
- Can be upholstered in standard Global textiles if Healthcare compliance is not required.

SUGGESTED APPLICATIONS

- Guest seating
- Lobbies
- Lounge/Waiting
- Patient rooms
- Resident rooms

OPTIONAL FEATURES

Please add option codes in the following order:

- **Model number**
GC36500 High Back Lounge Chair
- **Sealed back/arms seams**
(NS) No sealed back seams.
(SS) Sealed back seams. Add \$148.
- **Back/arms textile**
Specify textile code.
- **Sealed seat seams**
(NS) No sealed seat seams.
(SS) Sealed seat seams. Add \$27.
- **Seat textile**
Specify textile code.
- **Wood leg finish**
(AAM) Absolute
(BKM) Black
(CJM) Charcoal Java
(ACM) Cherry
(EMM) Empire Mahogany
(EOM) English Oak
(ECM) Espresso Cafe
(TFM) Fruitwood
(HGM) Grey
(HOM) Harvest Oak
(AHM) Honey
(JOM) Jet Onyx
(LHM) Light Honey
(TMM) Mahogany
(AVM) Maple
(MWM) Medium Walnut
(NLW) Natural Walnut
(ASM) Night
(NBM) Noce Biondo
(NGM) Noce Grigio
(NEM) Noce Leggero
(NMM) Noce Medio
(SBM) Sandy Beach
(SKM) Shaker Cherry
(SOM) Silver Oak
(TWM) Walnut
(WTM) WC Cream
(WHM) White
(WCM) Winter Cherry
- **Urethane leg finish**
Add \$63.
(BLK) Black
(KAL) Kalua
(LAB) Latte
(J52) Mocha
(SHW) Shadow
(TOA) Toast
- **Glides**
(NM) Non-marking glides. No upcharge
(RG) Rubber, non-slip glides. Add \$22.
(SG) Steel cushion glides. Add \$17.
(FG) Felt glides. Add \$22.
- **Moisture barrier** (seat only)
(NB) No moisture barrier. No upcharge.
(MB) Moisture barrier. Add \$81.

EXAMPLE OAKVILLE ORDER CODE:

GC36500	NS	CE90	NS	CE90	BLK	NM	NB
Model #	Sealed back/arms seams	Back/arms textile	Sealed seat seams	Seat textile	Leg finish	Glides	Moisture barrier

DESCRIPTION	MODEL# / FEATURES	STANDARD TEXTILE GRADES													
		COM	2	3	4	5	6	7	8	9	10	11	12		
 High Back Lounge Chair COM: 5.5 YD 5.03 M Unit weight: 59.5 LB 27 KG Carton weight: 75.5 LB 34.25 KG Carton volume: 19.25 FT³ 0.54 MT³	GC36500	2280	2456	2605	2776	3055	3314	3573	3798	4079	4343	4700	5206		
	Overall Dimensions: W D H Seat Dimensions: W D H Back Dimensions: W H	IN 30 30 41.25 MM 762 762 1048	IN 20.5 21 18.5 MM 521 533 470	IN 21.75 23.75 MM 552 603											
	Active weight 350 lbs.	<table border="1"> <tr> <td>RTA 00</td> <td>1 per carton</td> </tr> </table>												RTA 00	1 per carton
RTA 00	1 per carton														



GC3616W Dining armchair with open arms

Primacare™ set a benchmark for healthcare seating. All the features, all the looks and quite possibly the most extensive offering of its kind for both acute care and long-term care applications.

Under the skin of every Primacare chair is a heart of solid steel waiting to meet the rigorous demands of any environment.

The Primacare series includes more than 40 models that extend from patient rooms to waiting areas, dining rooms to treatment centers including bariatric hip chair solutions.

FEATURES



Open arms



Closed arms - fully upholstered side panels



Arm grip extension - to assist getting in and out of the chair safely

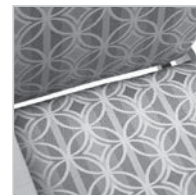

Separate seat and back - provides clean out for housekeeping staff



Fold down headrest - to provide access for caregiver assistance



Removable upholstery - for ease of cleaning and replacement

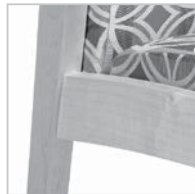

Solid wood frame - in hardwood for long life and a warm look



Metal-to-metal connector - provides unparalleled strength and durability

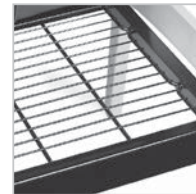

Metal mesh pan - superior comfort and hygiene for patient incontinence



Wall saver legs - offer first contact to protect walls and chair backs on most models

AVAILABLE TEXTILES AND FINISHES

Please see the healthcare Textile and Finishes section at globalfurnituregroup.com for all details including wood finishes.

SUGGESTED APPLICATIONS

- Bariatric seating (some models)
- Dining/Cafeteria
- Guest seating
- Lobbies
- Lounge/Waiting
- Patient rooms
- Resident rooms
- Treatment/Exam rooms

DINING - available with wood or metal frames



GUEST - available with wood or metal frames



PATIENT - available with wood or metal frames



HIP CHAIRS - available with wood or metal frames



LOUNGE - available with wood or metal legs



FULLY UPHOLSTERED LOUNGE - available with wood or urethane legs

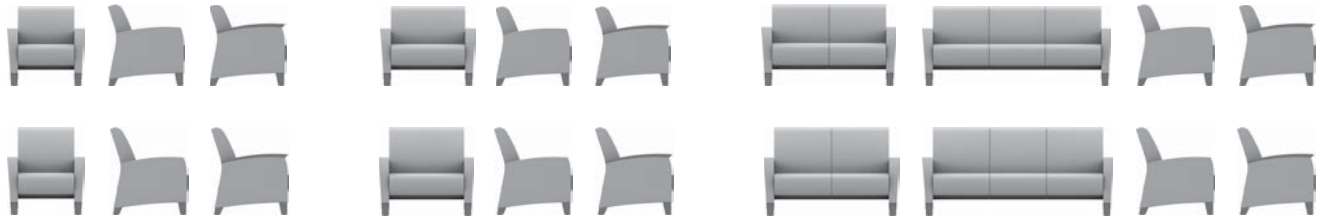

WINGBACK ARMCHAIR - available with wood or urethane armcaps and legs



RECLINERS - available with wood or urethane armcaps



SLEEPERS - available with wood or urethane armcaps



BENCHES - available with wood or metal legs



(urethane or wood legs only)

MODULAR GUEST/PATIENT - see page 193.

MODULAR LOUNGE - see page 208.

PRIMACARE DINING



model GC3616CA (HT)



model GC3616W (Wood)

STANDARD FEATURES

- Primacare is a family of products offering the most significant return on investment approach in the industry since every component can be repaired or replaced on site.
- **High traffic (HT) models:** Metal frame with die cast zinc connectors and metal-to-metal fasteners. Available in the following finishes: Black (TBL), Cloud (TIV), Designer White (TDW), Fog (TFO), Frost (TFR), Kalua (TKA), Latte (TLA), Mocha (TMO), Nevada (TNE), Sand (TSN), Shadow (TSH), Toast (TOA) and Tungsten (TTU).
- **Wood models:** Solid hardwood frame with die cast zinc connectors and metal-to-metal fastening. Available in the following finishes: Absolute (AAM), Charcoal Java (CJM), Cherry (ACM), Empire Mahogany (EMM), English Oak (EOM), Espresso Cafe (ECM), Fruitwood (TFM), Gray (HGM), Harvest Oak (HOM), Honey (AHM), Jet Onyx (JOM), Light Honey (LHM), Mahogany (TMM), Maple (AVM), Medium Walnut (MWM), Natural Walnut (NLW), Night (ASM), Noce Biondo (NBM), Noce Grigio (NGM), Noce Leggero (NEM), Noce Medio (NMM), Sandy Beach (SBM), Shaker Cherry (SKM), Silver Oak (SOM), Walnut (TWM), White (WHM), WC Cream (WTM) and Winter Cherry (WCM).
- Armcaps are securely fastened with metal-to-metal connectors which allow for field replacement if required.
- Easy grip forward extending armcap on models with arms.
- Replaceable seat covers and replaceable and/or removable seat cushions are standard.

- Seat cushion has a seamless waterfall front and clean out between and around the seat and back cushions.
- Models are standard with metal mesh seat deck. For mental health applications, the metal mesh seat deck can be covered with a solid moisture resistant surface, held in place with tamperproof fasteners. Contact your Global sales rep for a special quotation.
- All seat frames feature a wall saver design to prevent back contact with wall.
- **GC3616WCA** and **GC3616CA** have upholstered panel arm inserts closing the arm. (Closed arm panels are designed to be replaceable. Request a special quote to have them secured with tamperproof fasteners.)
- For healthcare textile options, visit the website at globalfurnituregroup.com.
- Can be upholstered in standard Global textiles if healthcare compliance is not required.
- Shipped fully assembled.



OPTIONAL FEATURES



- **High traffic (HT) models:** Wood armcaps are available. See far left column "Wood models" for finishes. Please specify. No upcharge.
- **High traffic (HT) and wood models:** Urethane armcaps are available in the following finishes: Black (BLK), Kalua (KAL), Latte (LAB), Mocha (J52), Shadow (SHW) and Toast (TOA). Please specify. No upcharge.
- For moisture barrier on seat, please specify **(MB)**. Add \$81 per seat.
- To add sealed seams to your product contact Customer Service. Upcharges vary.
- For Primacare tables, see page 59.



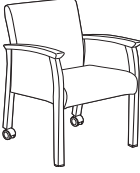

SUGGESTED APPLICATIONS

- Dining/Cafeteria
- Guest seating
- Lobbies
- Lounge/Waiting
- Patient rooms
- Resident rooms

HIGH TRAFFIC (HT) MODELS ARE LISTED FIRST, FOLLOWED BY WOOD MODELS.

DESCRIPTION	MODEL# / FEATURES	STANDARD TEXTILE GRADES											
		COM	2	3	4	5	6	7	8	9	10	11	12
 <p>Dining Chair, Open Arms (HT) COM: 1.5 YD 1.37 M Unit weight: 50 LB 22.7 KG Carton weight: 58 LB 26.31 KG Carton volume: 13.25 FT³ 0.37 MT³</p>	GC3616 Metal	1433	1481	1522	1568	1645	1715	1786	1847	1924	1996	2093	2231
		OVERALL DIMENSIONS			SEAT DIMENSIONS			BACK DIMENSIONS					
		IN	23	23	34.5	19	17.5	18	19	16.5			
		MM	584	584	876	483	445	457	483	419			
		RTA 00	1 per carton										
 <p>Dining Chair, Closed Arms (HT) COM: 2 YD 1.83 M Unit weight: 58 LB 26.4 KG Carton weight: 66 LB 29.94 KG Carton volume: 13.25 FT³ 0.37 MT³</p>	GC3616CA Metal	1649	1713	1767	1829	1931	2025	2119	2201	2303	2399	2529	2713
		OVERALL DIMENSIONS			SEAT DIMENSIONS			BACK DIMENSIONS					
		IN	23	23	34.5	19	17.5	18	19	16.5			
		MM	584	584	876	483	445	457	483	419			
		RTA 00	1 per carton										
 <p>Dining Chair, Closed Arms, Laminate Panels (HT) COM: 1.5 YD 1.37 M Unit weight: 58 LB 26.4 KG Carton weight: 66 LB 29.94 KG Carton volume: 13.25 FT³ 0.37 MT³</p>	GC3616CAL Metal	1950	1998	2039	2085	2162	2232	2303	2364	2441	2513	2610	2748
		OVERALL DIMENSIONS			SEAT DIMENSIONS			BACK DIMENSIONS					
		IN	23	23	34.5	19	17.5	18	19	16.5			
		MM	584	584	876	483	445	457	483	419			
		RTA 00	1 per carton										

DESCRIPTION	MODEL# / FEATURES	STANDARD TEXTILE GRADES											
 <p>Dining Chair, Open Arms, Rear Swivel Casters (HT) COM: 1.5 YD 1.37 M Unit weight: 50 LB 22.7 KG Carton weight: 58 LB 26.31 KG Carton volume: 13.25 FT³ 0.37 MT³</p>	GC3616RC Metal	COM	2	3	4	5	6	7	8	9	10	11	12
		1522	1570	1611	1657	1734	1804	1875	1936	2013	2085	2182	2320
		OVERALL DIMENSIONS W D H			SEAT DIMENSIONS W D H			BACK DIMENSIONS W H					
Active weight 500 lbs. Optional wood armcaps. Please specify. No upcharge.	IN 23 MM 584	23 584	34.5 876	19 483	17.5 445	18 457	19 483	16.5 419	RTA 00 1 per carton				
 <p>Dining Chair, Closed Arms, Rear Swivel Casters (HT) COM: 2 YD 1.83 M Unit weight: 58 LB 26.4 KG Carton weight: 66 LB 29.94 KG Carton volume: 13.25 FT³ 0.37 MT³</p>	GC3616CARC Metal	COM	2	3	4	5	6	7	8	9	10	11	12
		1737	1801	1855	1917	2019	2113	2207	2289	2391	2487	2617	2801
		OVERALL DIMENSIONS W D H			SEAT DIMENSIONS W D H			BACK DIMENSIONS W H					
Active weight 500 lbs. Optional urethane armcaps. Please specify. No upcharge.	IN 23 MM 584	23 584	34.5 876	19 483	17.5 445	18 457	19 483	16.5 419	RTA 00 1 per carton				
 <p>Allows caregiver to gently move a seated person to and from a table.</p> <p>Dining Chair, Open Arms, Rear Swivel Casters & Lift Mec. (HT) COM: 1.5 YD 1.37 M Unit weight: 51 LB 23.2 KG Carton weight: 59 LB 26.76 KG Carton volume: 13.25 FT³ 0.37 MT³</p>	GC3616RCEZ Metal	COM	2	3	4	5	6	7	8	9	10	11	12
		1983	2031	2072	2118	2195	2265	2336	2397	2474	2546	2643	2781
		OVERALL DIMENSIONS W D H			SEAT DIMENSIONS W D H			BACK DIMENSIONS W H					
Active weight 500 lbs. Optional wood armcaps. Please specify. No upcharge.	IN 23 MM 584	23 584	34.5 876	19 483	17.5 445	18 457	19 483	16.5 419	RTA 00 1 per carton				
 <p>Dining Chair Open Arms (Wood) COM: 1.5 YD 1.37 M Unit weight: 40 LB 18.2 KG Carton weight: 50 LB 22.68 KG Carton volume: 13.25 FT³ 0.37 MT³</p>	GC3616W Wood	COM	2	3	4	5	6	7	8	9	10	11	12
		1122	1170	1211	1257	1334	1404	1475	1536	1613	1685	1782	1920
		OVERALL DIMENSIONS W D H			SEAT DIMENSIONS W D H			BACK DIMENSIONS W H					
Active weight 350 lbs. Optional urethane armcaps. Please specify. No upcharge.	IN 23 MM 584	23 584	34.5 876	19 483	17.5 445	18 457	19 483	16.5 419	RTA 00 1 per carton				
 <p>Dining Chair Closed Arms (Wood) COM: 2 YD 1.83 M Unit weight: 48 LB 21.8 KG Carton weight: 58 LB 26.31 KG Carton volume: 13.25 FT³ 0.37 MT³</p>	GC3616WCA Wood	COM	2	3	4	5	6	7	8	9	10	11	12
		1289	1353	1407	1469	1571	1665	1759	1841	1943	2039	2169	2353
		OVERALL DIMENSIONS W D H			SEAT DIMENSIONS W D H			BACK DIMENSIONS W H					
Active weight 350 lbs. Optional urethane armcaps. Please specify. No upcharge.	IN 23 MM 584	23 584	34.5 876	19 483	17.5 445	18 457	19 483	16.5 419	RTA 00 1 per carton				

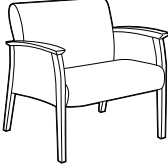
DESCRIPTION	MODEL# / FEATURES	STANDARD TEXTILE GRADES											
		COM	2	3	4	5	6	7	8	9	10	11	12
 <p>Dining Chair Open Arms, Front Casters (Wood) COM: 1.5 YD 1.37 M Unit weight: 40 LB 18.2 KG Carton weight: 50 LB 22.68 KG Carton volume: 13.25 FT³ 0.37 MT³</p>	GC3616WFC Wood	1203	1251	1292	1338	1415	1485	1556	1617	1694	1766	1863	2001
		OVERALL DIMENSIONS			SEAT DIMENSIONS			BACK DIMENSIONS					
		W	D	H	W	D	H	W	H				
	Active weight 350 lbs. Optional urethane armcaps. Please specify. No upcharge.	IN 23 MM 584	23 584	34.5 876	19 483	17.5 445	18 457	19 483	16.5 419				
	RTA 00	1 per carton											
 <p>Bariatric LB Single Seat Armchair Open Arms (HT) COM: 2.5 YD 2.29 M Unit weight: 66 LB 30 KG Carton weight: 78 LB 35.38 KG Carton volume: 26.5 FT³ 0.75 MT³</p>	GC3637 Metal	2009	2089	2157	2234	2362	2479	2597	2699	2827	2947	3109	3339
		OVERALL DIMENSIONS			SEAT DIMENSIONS			BACK DIMENSIONS					
		W	D	H	W	D	H	W	H				
	Active weight 500 lbs. Optional wood armcaps. Please specify. No upcharge.	IN 35 MM 889	27 686	33 838	30 762	17.5 445	18 457	30 762	15 381				
	RTA 00	1 per carton											
 <p>Bariatric LB Single Seat Armchair Closed Arms (HT) COM: 3.5 YD 3.2 M Unit weight: 76 LB 34.5 KG Carton weight: 88 LB 39.92 KG Carton volume: 26.5 FT³ 0.75 MT³</p>	GC3637CA Metal	2257	2369	2464	2572	2751	2915	3080	3223	3402	3570	3797	4119
		OVERALL DIMENSIONS			SEAT DIMENSIONS			BACK DIMENSIONS					
		W	D	H	W	D	H	W	H				
	Active weight 500 lbs. Optional wood armcaps. Please specify. No upcharge.	IN 35 MM 889	27 686	33 838	30 762	17.5 445	18 457	30 762	15 381				
	RTA 00	1 per carton											
 <p>Bariatric LB Single Seat Armchair, Open Arms (Wood) COM: 2.5 YD 2.29 M Unit weight: 54 LB 24.5 KG Carton weight: 66 LB 29.94 KG Carton volume: 26.5 FT³ 0.75 MT³</p>	GC3637W Wood	1570	1650	1718	1795	1923	2040	2158	2260	2388	2508	2670	2900
		OVERALL DIMENSIONS			SEAT DIMENSIONS			BACK DIMENSIONS					
		W	D	H	W	D	H	W	H				
	Active weight 500 lbs. Optional urethane armcaps. Please specify. No upcharge.	IN 35 MM 889	27 686	33 838	30 762	17.5 445	18 457	30 762	15 381				
	RTA 00	1 per carton											
 <p>Bariatric LB Single Seat Armchair, Closed Arms (Wood) COM: 3.5 YD 3.2 M Unit weight: 64 LB 29.1 KG Carton weight: 76 LB 34.47 KG Carton volume: 26.5 FT³ 0.75 MT³</p>	GC3637WCA Wood	1760	1872	1967	2075	2254	2418	2583	2726	2905	3073	3300	3622
		OVERALL DIMENSIONS			SEAT DIMENSIONS			BACK DIMENSIONS					
		W	D	H	W	D	H	W	H				
	Active weight 500 lbs. Optional urethane armcaps. Please specify. No upcharge.	IN 35 MM 889	27 686	33 838	30 762	17.5 445	18 457	30 762	15 381				
	RTA 00	1 per carton											

PRIMACARE GUEST



model GC3620CA (HT)



model GC3625W (Wood)

STANDARD FEATURES

- Primacare is a family of products offering the most significant return on investment approach in the industry since every component can be repaired or replaced on site.
- **High traffic (HT) models:** Metal frame with die cast zinc connectors and metal-to-metal fasteners. Available in the following finishes: Black (TBL), Cloud (TIV), Designer White (TDW), Fog (TFO), Frost (TFR), Kalua (TKA), Latte (TLA), Mocha (TMO), Nevada (TNE), Sand (TSN), Shadow (TSH), Toast (TOA) and Tungsten (TTU).
- **Wood models:** Solid hardwood frame with die cast zinc connectors and metal-to-metal fastening. Available in the following finishes: Absolute (AAM), Charcoal Java (CJM), Cherry (ACM), Empire Mahogany (EMM), English Oak (EOM), Espresso Cafe (ECM), Fruitwood (TFM), Gray (HGM), Harvest Oak (HOM), Honey (AHM), Jet Onyx (JOM), Light Honey (LHM), Mahogany (TMM), Maple (AVM), Medium Walnut (MWM), Natural Walnut (NLW), Night (ASM), Noce Biondo (NBM), Noce Grigio (NGM), Noce Leggero (NEM), Noce Medio (NMM), Sandy Beach (SBM), Shaker Cherry (SKM), Silver Oak (SOM), Walnut (TWM), White (WHM), WC Cream (WTM) and Winter Cherry (WCM).
- Armcaps are securely fastened with metal-to-metal connectors which allow for field replacement if required.
- Easy grip forward extending armcap on models with arms.
- Replaceable seat covers and replaceable and/or removable seat cushions are standard.

- Seat cushion has a seamless waterfall front and clean out between and around the seat and back cushions.
- Models are standard with metal mesh seat deck. For mental health applications, the metal mesh seat deck can be covered with a solid moisture resistant surface, held in place with tamperproof fasteners. Contact your sales rep for a special quotation.
- All seat frames feature a wall saver design to prevent back contact with wall.
- Models ending in **CA / ARC**, have upholstered panel arm inserts closing the arm. (Closed arm panels are designed to be replaceable. Request a special quote to have them secured with tamperproof fasteners.)
- For healthcare textile options, visit the website at globalfurnituregroup.com.
- Can be upholstered in standard Global textiles if healthcare compliance is not required.
- Shipped fully assembled.

OPTIONAL FEATURES

- **High traffic (HT) models:** Wood armcaps are available. See far left column "Wood models" for finishes. Please specify. No upcharge.
- **High traffic (HT) and wood models:** Urethane armcaps are available in the following finishes: Black (BLK), Kalua (KAL), Latte (LAB), Mocha (J52), Shadow (SHW) and Toast (TOA). Please specify. No upcharge.
- For moisture barrier on seat, please specify **(MB)**. Add \$81 per seat.
- To add sealed seams to your product contact Customer Service. Upcharges vary.
- For Primacare tables, see page 59.

SUGGESTED APPLICATIONS

- Bariatric seating
- Guest seating
- Lobbies
- Lounge/Waiting
- Patient rooms
- Resident rooms

HIGH TRAFFIC (HT) MODELS ARE LISTED FIRST, FOLLOWED BY WOOD MODELS.

DESCRIPTION	MODEL# / FEATURES	STANDARD TEXTILE GRADES												
		COM	2	3	4	5	6	7	8	9	10	11	12	
<p>LB Armchair Open Arms (HT) COM: 1.75 YD 1.6 M Unit weight: 54 LB 24.5 KG Carton weight: 62 LB 28.12 KG Carton volume: 17.5 FT³ 0.49 MT³</p>	<p>Active weight 500 lbs.</p> <p>Optional wood armcaps. Please specify. No upcharge.</p> <p>RTA 00 1 per carton</p>	1558	1614	1661	1716	1805	1887	1969	2041	2130	2214	2328	2489	
	<p>GC3620 Metal</p> <p>GC3620F Metal flex back</p>	1930	1986	2033	2088	2177	2259	2341	2413	2502	2586	2700	2861	
		OVERALL DIMENSIONS			SEAT DIMENSIONS			BACK DIMENSIONS						
		W	D	H	W	D	H	W	H					
		IN 25	27	33	20.5	17.5	18	20.5	15					
		MM 635	686	838	521	445	457	521	381					
<p>LB Armchair Closed Arms (HT) COM: 2.75 YD 2.51 M Unit weight: 64 LB 29.1 KG Carton weight: 72 LB 32.66 KG Carton volume: 17.5 FT³ 0.49 MT³</p>	<p>Active weight 500 lbs.</p> <p>Optional wood armcaps. Please specify. No upcharge.</p> <p>RTA 00 1 per carton</p>	1810	1898	1972	2058	2198	2327	2456	2569	2709	2841	3020	3273	
	<p>GC3620CA Metal</p> <p>GC3620FCA Metal flex back</p>	2178	2266	2340	2426	2566	2695	2824	2937	3077	3209	3388	3641	
		OVERALL DIMENSIONS			SEAT DIMENSIONS			BACK DIMENSIONS						
		W	D	H	W	D	H	W	H					
		IN 25	27	33	20.5	17.5	18	20.5	15					
		MM 635	686	838	521	445	457	521	381					
<p>LB Armchair Closed Arms, Rear Tip and Move Wheels (HT) COM: 2.75 YD 2.51 M Unit weight: 64 LB 29.1 KG Carton weight: 72 LB 32.66 KG Carton volume: 23 FT³ 0.65 MT³</p>	<p>Active weight 500 lbs.</p> <p>Optional wood armcaps. Please specify. No upcharge.</p> <p>RTA 00 1 per carton</p>	1909	1997	2071	2157	2297	2426	2555	2668	2808	2940	3119	3372	
	<p>GC3620CARC Metal</p>													
		OVERALL DIMENSIONS			SEAT DIMENSIONS			BACK DIMENSIONS						
		W	D	H	W	D	H	W	H					
		IN 25	29.5	33	20.5	17.5	18	20.5	15					
		MM 635	749	838	521	445	457	521	381					

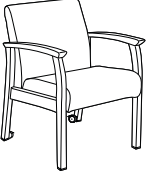
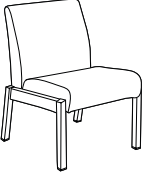
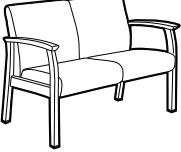
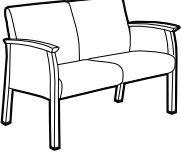
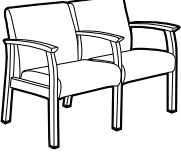
DESCRIPTION	MODEL# / FEATURES	STANDARD TEXTILE GRADES											
		COM	2	3	4	5	6	7	8	9	10	11	12
 <p>LB Armchair Open Arms, Rear Tip and Move Wheels (HT) COM: 1.75 YD 1.6 M Unit weight: 54 LB 24.5 KG Carton weight: 62 LB 28.12 KG Carton volume: 23 FT³ 0.65 MT³</p>	GC3620RC Metal	1661	1717	1764	1819	1908	1990	2072	2144	2233	2317	2431	2592
		OVERALL DIMENSIONS			SEAT DIMENSIONS			BACK DIMENSIONS					
			W	D	H	W	D	H	W	H			
		IN	25	29.5	33	20.5	17.5	18	20.5	15			
		MM	635	749	838	521	445	457	521	381			
		RTA 00	1 per carton										
		Optional wood armcaps. Please specify. No upcharge.											
 <p>LB Single Seat Chair, Armless (HT) COM: 1.75 YD 1.6 M Unit weight: 52 LB 23.6 KG Carton weight: 60 LB 27.22 KG Carton volume: 17.5 FT³ 0.49 MT³</p>	GC3620NA Metal	1270	1326	1373	1428	1517	1599	1681	1753	1842	1926	2040	2201
		OVERALL DIMENSIONS			SEAT DIMENSIONS			BACK DIMENSIONS					
			W	D	H	W	D	H	W	H			
		IN	23.5	27	33	20.5	17.5	18	20.5	15			
		MM	597	686	838	521	445	457	521	381			
		RTA 00	1 per carton										
		Optional wood armcaps. Please specify. No upcharge.											
 <p>LB Two Seat Chair No Center Arm, Open Arms (HT) COM: 3.25 YD 2.97 M Unit weight: 80 LB 36.4 KG Carton weight: 92 LB 41.73 KG Carton volume: 43 FT³ 1.21 MT³</p>	GC3621 Metal	2373	2477	2565	2666	2831	2984	3137	3270	3436	3592	3803	4102
		OVERALL DIMENSIONS			SEAT DIMENSIONS			BACK DIMENSIONS					
			W	D	H	W	D	H	W	H			
		IN	45	27	33	40	17.5	18	40	15			
		MM	1143	686	838	1016	445	457	1016	381			
		RTA 00	1 per carton										
		Optional wood armcaps. Please specify. No upcharge.											
 <p>LB Two Seat Chair No Center Arm, Closed Arms (HT) COM: 3.25 YD 3.43 M Unit weight: 88 LB 40 KG Carton weight: 100 LB 45.36 KG Carton volume: 43 FT³ 1.21 MT³</p>	GC3621CA Metal	2638	2758	2859	2976	3167	3343	3519	3673	3864	4044	4288	4633
		OVERALL DIMENSIONS			SEAT DIMENSIONS			BACK DIMENSIONS					
			W	D	H	W	D	H	W	H			
		IN	45	27	33	40	17.5	18	40	15			
		MM	1143	686	838	1016	445	457	1016	381			
		RTA 00	1 per carton										
		Optional wood armcaps. Please specify. No upcharge.											
 <p>LB Two Seat Chair Full Center Arm, Open Arms (HT) COM: 3.25 YD 2.97 M Unit weight: 86 LB 39.1 KG Carton weight: 98 LB 44.45 KG Carton volume: 43 FT³ 1.21 MT³</p>	GC3622 Metal	2867	2971	3059	3160	3325	3478	3631	3764	3930	4086	4297	4596
		OVERALL DIMENSIONS			SEAT DIMENSIONS			BACK DIMENSIONS					
			W	D	H	W	D	H	W	H			
		IN	46	27	33	20.5	17.5	18	20.5	15			
		MM	1168	686	838	521	445	457	521	381			
		RTA 00	1 per carton										
		Optional wood armcaps. Please specify. No upcharge.											

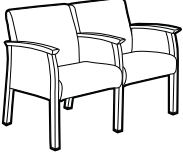
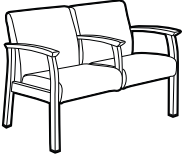
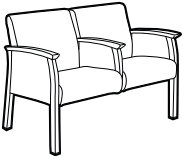
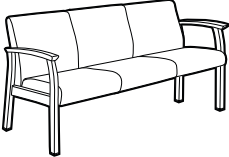
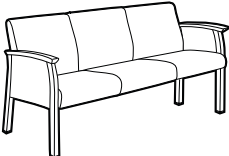
DESCRIPTION	MODEL# / FEATURES	STANDARD TEXTILE GRADES											
		COM	2	3	4	5	6	7	8	9	10	11	12
 <p>LB Two Seat Chair Full Center Arm, Closed Arms (HT) COM: 4.5 YD 4.11 M Unit weight: 106 LB 48.2 KG Carton weight: 118 LB 53.52 KG Carton volume: 43 FT³ 1.21 MT³</p>	<p>GC3622CA Metal</p>	3248	3392	3514	3653	3883	4094	4306	4490	4720	4936	5228	5642
		OVERALL DIMENSIONS			SEAT DIMENSIONS			BACK DIMENSIONS					
		W	D	H	W	D	H	W	H				
		IN 46 MM 1168	27 686	33 838	20.5 521	17.5 445	18 457	20.5 521	15 381				
			RTA 00	1 per carton									
 <p>LB Two Seat Chair Half Center Arm, Open Arms (HT) COM: 3.25 YD 2.97 M Unit weight: 82 LB 37.3 KG Carton weight: 94 LB 42.64 KG Carton volume: 43 FT³ 1.21 MT³</p>	<p>GC3623 Metal</p>	2731	2835	2923	3024	3189	3342	3495	3628	3794	3950	4161	4460
		OVERALL DIMENSIONS			SEAT DIMENSIONS			BACK DIMENSIONS					
		W	D	H	W	D	H	W	H				
		IN 46 MM 1168	27 686	33 838	20.5 521	17.5 445	18 457	20.5 521	15 381				
			RTA 00	1 per carton									
 <p>LB Two Seat Chair Half Center Arm, Closed Arms (HT) COM: 4.5 YD 4.11 M Unit weight: 94 LB 42.7 KG Carton weight: 106 LB 48.08 KG Carton volume: 43 FT³ 1.21 MT³</p>	<p>GC3623CA Metal</p>	3193	3337	3459	3598	3828	4039	4251	4435	4665	4881	5173	5587
		OVERALL DIMENSIONS			SEAT DIMENSIONS			BACK DIMENSIONS					
		W	D	H	W	D	H	W	H				
		IN 46 MM 1168	27 686	33 838	20.5 521	17.5 445	18 457	20.5 483	15 381				
			RTA 00	1 per carton									
 <p>LB Three Seat Chair No Center Arms, Open Arms (HT) COM: 4.25 YD 3.89 M Unit weight: 114 LB 51.8 KG Carton weight: 137 LB 62.14 KG Carton volume: 65.25 FT³ 1.84 MT³</p>	<p>GC3624 Metal</p>	3230	3366	3481	3613	3829	4029	4229	4403	4620	4824	5100	5491
		OVERALL DIMENSIONS			SEAT DIMENSIONS			BACK DIMENSIONS					
		W	D	H	W	D	H	W	H				
		IN 65 MM 1651	27 686	33 838	60 1524	17.5 445	18 457	60 1524	15 381				
			RTA 00	1 per carton									
 <p>LB Three Seat Chair No Center Arms, Closed Arms (HT) COM: 5.25 YD 4.8 M Unit weight: 124 LB 56.4 KG Carton weight: 147 LB 66.68 KG Carton volume: 65.25 FT³ 1.84 MT³</p>	<p>GC3624CA Metal</p>	3477	3645	3787	3950	4217	4464	4711	4926	5194	5446	5787	6270
		OVERALL DIMENSIONS			SEAT DIMENSIONS			BACK DIMENSIONS					
		W	D	H	W	D	H	W	H				
		IN 65 MM 1651	27 686	33 838	60 1524	17.5 445	18 457	60 1524	15 381				
			RTA 00	1 per carton									

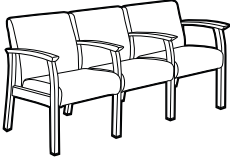
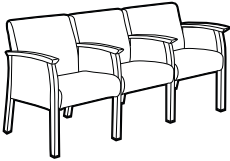
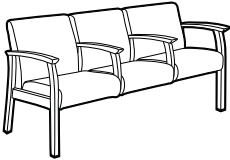
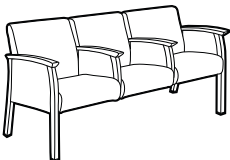
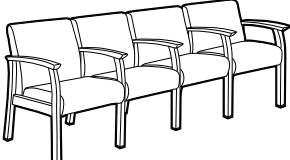

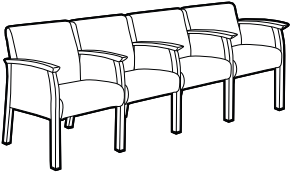
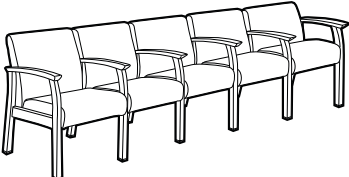
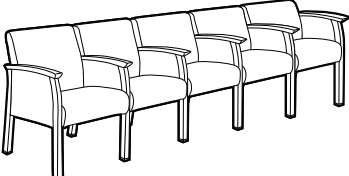
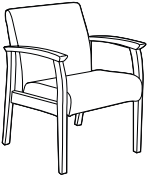
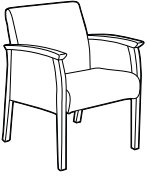

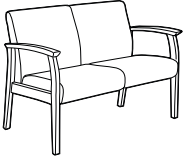
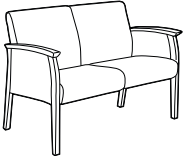
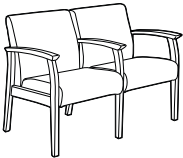
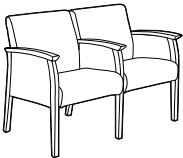
DESCRIPTION	MODEL# / FEATURES	STANDARD TEXTILE GRADES											
		COM	2	3	4	5	6	7	8	9	10	11	12
 <p>LB Three Seat Chair Full Center Arms, Open Arms (HT) COM: 4.75 YD 4.34 M Unit weight: 137 LB 62.3 KG Carton weight: 162 LB 73.48 KG Carton volume: 65.25 FT³ 1.84 MT³</p>	<p>GC3625 Metal</p>	4201	4353	4481	4629	4871	5094	5317	5512	5754	5982	6291	6728
		OVERALL DIMENSIONS			SEAT DIMENSIONS			BACK DIMENSIONS					
		W D H			W D H			W H					
		IN 69	27	33	20.5	17.5	18	20.5	15				
MM 1753	686	838	521	445	457	521	381						
Active weight 500 lbs/seat.	Optional wood armcaps. Please specify. No upcharge.	<p>RTA 00 1 per carton</p>											
 <p>LB Three Seat Chair Full Center Arms, Closed Arms (HT) COM: 6.25 YD 5.72 M Unit weight: 147 LB 66.8 KG Carton weight: 172 LB 78.02 KG Carton volume: 65.25 FT³ 1.84 MT³</p>	<p>GC3625CA Metal</p>	4713	4913	5082	5276	5594	5888	6182	6438	6757	7057	7463	8038
		OVERALL DIMENSIONS			SEAT DIMENSIONS			BACK DIMENSIONS					
		W D H			W D H			W H					
		IN 69	27	33	20.5	17.5	18	20.5	15				
MM 1753	686	838	521	445	457	521	381						
Active weight 500 lbs/seat.	Optional wood armcaps. Please specify. No upcharge.	<p>RTA 00 1 per carton</p>											
 <p>LB Three Seat Chair Half Center Arms, Open Arms (HT) COM: 4.75 YD 4.34 M Unit weight: 124 LB 56.4 KG Carton weight: 147 LB 66.68 KG Carton volume: 65.25 FT³ 1.84 MT³</p>	<p>GC3626 Metal</p>	3872	4024	4152	4300	4542	4765	4988	5183	5425	5653	5962	6399
		OVERALL DIMENSIONS			SEAT DIMENSIONS			BACK DIMENSIONS					
		W D H			W D H			W H					
		IN 69	27	33	20.5	17.5	18	20.5	15				
MM 1753	686	838	521	445	457	521	381						
Active weight 500 lbs/seat.	Optional wood armcaps. Please specify. No upcharge.	<p>RTA 00 1 per carton</p>											
 <p>LB Three Seat Chair Half Center Arms, Closed Arms (HT) COM: 6.25 YD 5.72 M Unit weight: 134 LB 60.9 KG Carton weight: 157 LB 71.21 KG Carton volume: 65.25 FT³ 1.84 MT³</p>	<p>GC3626CA Metal</p>	4386	4586	4755	4949	5267	5561	5855	6111	6430	6730	7136	7711
		OVERALL DIMENSIONS			SEAT DIMENSIONS			BACK DIMENSIONS					
		W D H			W D H			W H					
		IN 69	27	33	20.5	17.5	18	20.5	15				
MM 1753	686	838	521	445	457	521	381						
Active weight 500 lbs/seat.	Optional wood armcaps. Please specify. No upcharge.	<p>RTA 00 1 per carton</p>											
 <p>LB Four Seat Chair Full Center Arms, Open Arms (HT) COM: 6 YD 5.49 M Unit weight: 172 LB 78.2 KG Carton weight: 197 LB 89.36 KG Carton volume: 43 FT³ 1.21 MT³</p>	<p>GC3628 Metal</p>	5546	5738	5900	6086	6392	6674	6956	7202	7508	7796	8186	8738
		OVERALL DIMENSIONS			SEAT DIMENSIONS			BACK DIMENSIONS					
		W D H			W D H			W H					
		IN 93	27	33	20.5	17.5	18	20.5	15				
MM 2362	686	838	521	445	457	521	381						
Active weight 500 lbs/seat.	Optional wood armcaps. Please specify. No upcharge.	<p>RTA 2 2 cartons</p>											

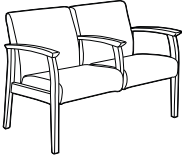
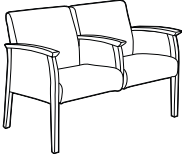
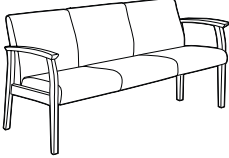
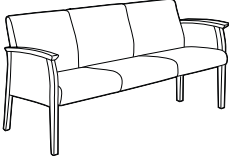
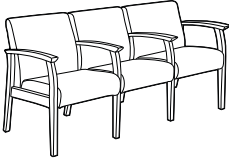
DESCRIPTION	MODEL# / FEATURES	STANDARD TEXTILE GRADES											
		COM	2	3	4	5	6	7	8	9	10	11	12
 <p>LB Four Seat Chair Full Center Arms, Closed Arms (HT) COM: 8 YD 7.32 M Unit weight: 182 LB 82.7 KG Carton weight: 207 LB 93.89 KG Carton volume: 43 FT³ 1.21 MT³</p>	<p>GC3628CA Metal</p>	6182	6438	6654	6902	7310	7686	8062	8390	8798	9182	9702	10438
		OVERALL DIMENSIONS			SEAT DIMENSIONS			BACK DIMENSIONS					
		W	D	H	W	D	H	W	H				
		IN 93	27	33	20.5	17.5	18	20.5	15				
	MM 2362	686	838	521	445	457	521	381					
		RTA 2	2 cartons										
 <p>LB Five Seat Chair Full Center Arms, Open Arms (HT) COM: 7.5 YD 6.86 M Unit weight: 224 LB 101.8 KG Carton weight: 249 LB 112.94 KG Carton volume: 43 FT³ 1.21 MT³</p>	<p>GC3630 Metal</p>	6879	7119	7322	7554	7937	8289	8642	8949	9332	9692	10179	10869
		OVERALL DIMENSIONS			SEAT DIMENSIONS			BACK DIMENSIONS					
		W	D	H	W	D	H	W	H				
		IN 115	27	33	20.5	17.5	18	20.5	15				
	MM 2921	686	838	521	445	457	521	381					
		RTA 2	2 cartons										
 <p>LB Five Seat Chair Full Center Arms, Closed Arms (HT) COM: 10 YD 9.14 M Unit weight: 236 LB 107.3 KG Carton weight: 261 LB 118.39 KG Carton volume: 43 FT³ 1.21 MT³</p>	<p>GC3630CA Metal</p>	7640	7960	8230	8540	9050	9520	9990	10400	10910	11390	12040	12960
		OVERALL DIMENSIONS			SEAT DIMENSIONS			BACK DIMENSIONS					
		W	D	H	W	D	H	W	H				
		IN 115	27	33	20.5	17.5	18	20.5	15				
	MM 2921	686	838	521	445	457	521	381					
		RTA 2	2 cartons										
 <p>LB Single Seat Armchair Open Arms (Wood) COM: 1.75 YD 1.6 M Unit weight: 42 LB 19.1 KG Carton weight: 50 LB 22.68 KG Carton volume: 17.5 FT³ 0.49 MT³</p>	<p>GC3620W Wood GC3620WF Wood flex back</p>	1222	1278	1325	1380	1469	1551	1633	1705	1794	1878	1992	2153
		OVERALL DIMENSIONS			SEAT DIMENSIONS			BACK DIMENSIONS					
		W	D	H	W	D	H	W	H				
		IN 25	27	33	20.5	17.5	18	20.5	15				
	MM 635	686	838	521	445	457	521	381					
		RTA 00	1 per carton										
 <p>LB Single Seat Armchair Closed Arms (Wood) COM: 2.75 YD 2.51 M Unit weight: 52 LB 23.6 KG Carton weight: 60 LB 27.22 KG Carton volume: 17.5 FT³ 0.49 MT³</p>	<p>GC3620WCA Wood GC3620WFCA Wood flex back</p>	1411	1499	1573	1659	1799	1928	2057	2170	2310	2442	2621	2874
		OVERALL DIMENSIONS			SEAT DIMENSIONS			BACK DIMENSIONS					
		W	D	H	W	D	H	W	H				
		IN 25	27	33	20.5	17.5	18	20.5	15				
	MM 635	686	838	521	445	457	521	381					
		RTA 00	1 per carton										

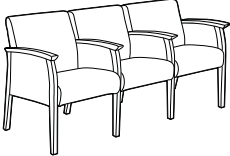
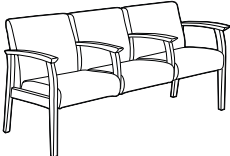
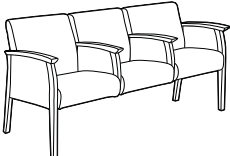
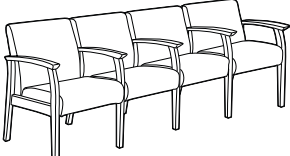
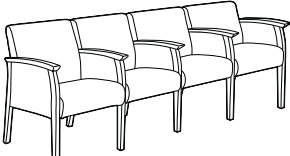
DESCRIPTION	MODEL# / FEATURES	STANDARD TEXTILE GRADES											
		COM	2	3	4	5	6	7	8	9	10	11	12
 <p>LB Single Seat Chair, Armless (Wood) COM: 1.75 YD 1.6 M Unit weight: 40 LB 18.2 KG Carton weight: 48 LB 21.77 KG Carton volume: 17.5 FT³ 0.49 MT³</p>	GC3620WNA Wood	1094	1150	1197	1252	1341	1423	1505	1577	1666	1750	1864	2025
		OVERALL DIMENSIONS			SEAT DIMENSIONS			BACK DIMENSIONS					
		W	D	H	W	D	H	W	H				
		IN 23.5 MM 597	27 686	33 838	20.5 521	17.5 445	18 457	20.5 521	15 381				
		RTA 00	1 per carton										
 <p>LB Two Seat Chair No Center Arm, Open Arms (Wood) COM: 3.25 YD 2.97 M Unit weight: 68 LB 30.9 KG Carton weight: 80 LB 36.29 KG Carton volume: 43 FT³ 1.21 MT³</p>	GC3621W Wood	1854	1958	2046	2147	2312	2465	2618	2751	2917	3073	3284	3583
		OVERALL DIMENSIONS			SEAT DIMENSIONS			BACK DIMENSIONS					
		W	D	H	W	D	H	W	H				
		IN 45 MM 1143	27 686	33 838	40 1016	17.5 445	18 457	40 1016	15 381				
		RTA 00	1 per carton										
 <p>LB Two Seat Chair No Center Arm, Closed Arms (Wood) COM: 3.75 YD 3.43 M Unit weight: 78 LB 35.5 KG Carton weight: 90 LB 40.82 KG Carton volume: 43 FT³ 1.21 MT³</p>	GC3621WCA Wood	2060	2180	2281	2398	2589	2765	2941	3095	3286	3466	3710	4055
		OVERALL DIMENSIONS			SEAT DIMENSIONS			BACK DIMENSIONS					
		W	D	H	W	D	H	W	H				
		IN 45 MM 1143	27 686	33 838	40 1016	17.5 445	18 457	40 1016	15 381				
		RTA 00	1 per carton										
 <p>LB Two Seat Chair Full Center Arm, Open Arms (Wood) COM: 3.25 YD 2.97 M Unit weight: 74 LB 33.6 KG Carton weight: 86 LB 39.01 KG Carton volume: 43 FT³ 1.21 MT³</p>	GC3622W Wood	2243	2347	2435	2536	2701	2854	3007	3140	3306	3462	3673	3972
		OVERALL DIMENSIONS			SEAT DIMENSIONS			BACK DIMENSIONS					
		W	D	H	W	D	H	W	H				
		IN 46 MM 1168	27 686	33 838	20.5 521	17.5 445	18 457	20.5 521	15 381				
		RTA 00	1 per carton										
 <p>LB Two Seat Chair Full Center Arm, Closed Arms (Wood) COM: 4.5 YD 4.11 M Unit weight: 94 LB 42.7 KG Carton weight: 106 LB 48.08 KG Carton volume: 43 FT³ 1.21 MT³</p>	GC3622WCA Wood	2538	2682	2804	2943	3173	3384	3596	3780	4010	4226	4518	4932
		OVERALL DIMENSIONS			SEAT DIMENSIONS			BACK DIMENSIONS					
		W	D	H	W	D	H	W	H				
		IN 46 MM 1168	27 686	33 838	20.5 521	17.5 445	18 457	20.5 521	15 381				
		RTA 00	1 per carton										

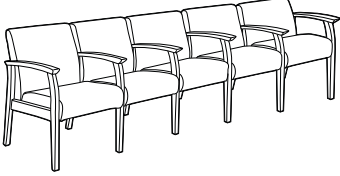
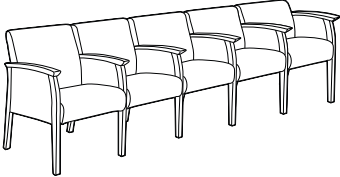
DESCRIPTION	MODEL# / FEATURES	STANDARD TEXTILE GRADES											
		COM	2	3	4	5	6	7	8	9	10	11	12
 <p>GC3623W Wood</p> <p>LB Two Seat Chair Half Center Arm, Open Arms (Wood) COM: 3.25 YD 2.97 M Unit weight: 70 LB 31.8 KG Carton weight: 82 LB 37.19 KG Carton volume: 43 FT³ 1.21 MT³</p>	<p>Active weight 350 lbs/seat.</p> <p>Optional urethane armcaps. Please specify. No upcharge.</p>	2137	2241	2329	2430	2595	2748	2901	3034	3200	3356	3567	3866
		OVERALL DIMENSIONS			SEAT DIMENSIONS			BACK DIMENSIONS					
		W	D	H	W	D	H	W	H				
		IN 46	27	33	20.5	17.5	18	20.5	15				
		MM 1168	686	838	521	445	457	521	381				
		RTA 00	1 per carton										
 <p>GC3623WCA Wood</p> <p>LB Two Seat Chair Half Center Arm, Closed Arms (Wood) COM: 4.5 YD 4.11 M Unit weight: 80 LB 36.4 KG Carton weight: 92 LB 41.73 KG Carton volume: 43 FT³ 1.21 MT³</p>	<p>Active weight 350 lbs/seat.</p> <p>Optional urethane armcaps. Please specify. No upcharge.</p>	2430	2574	2696	2835	3065	3276	3488	3672	3902	4118	4410	4824
		OVERALL DIMENSIONS			SEAT DIMENSIONS			BACK DIMENSIONS					
		W	D	H	W	D	H	W	H				
		IN 46	27	36.5	20.5	17.5	18	20.5	18				
		MM 1168	686	927	521	445	457	521	457				
		RTA 00	1 per carton										
 <p>GC3624W Wood</p> <p>LB Three Seat Chair No Center Arm, Open Arms (Wood) COM: 4.25 YD 3.89 M Unit weight: 102 LB 46.4 KG Carton weight: 125 LB 56.7 KG Carton volume: 65.25 FT³ 1.84 MT³</p>	<p>Active weight 350 lbs/seat.</p> <p>Optional urethane armcaps. Please specify. No upcharge.</p>	2524	2660	2775	2907	3123	3323	3523	3697	3914	4118	4394	4785
		OVERALL DIMENSIONS			SEAT DIMENSIONS			BACK DIMENSIONS					
		W	D	H	W	D	H	W	H				
		IN 65	27	33	60	17.5	18	60	15				
		MM 1651	686	838	1524	445	457	1524	381				
		RTA 00	1 per carton										
 <p>GC3624WCA Wood</p> <p>LB Three Seat Chair No Center Arm, Closed Arms (Wood) COM: 5.25 YD 4.8 M Unit weight: 112 LB 50.9 KG Carton weight: 135 LB 61.23 KG Carton volume: 65.25 FT³ 1.84 MT³</p>	<p>Active weight 350 lbs/seat.</p> <p>Optional urethane armcaps. Please specify. No upcharge.</p>	2714	2882	3024	3187	3454	3701	3948	4163	4431	4683	5024	5507
		OVERALL DIMENSIONS			SEAT DIMENSIONS			BACK DIMENSIONS					
		W	D	H	W	D	H	W	H				
		IN 65	27	33	60	17.5	18	60	15				
		MM 1651	686	838	1524	445	457	1524	381				
		RTA 00	1 per carton										
 <p>GC3625W Wood</p> <p>LB Three Seat Chair Full Center Arms, Open Arms (Wood) COM: 4.75 YD 4.34 M Unit weight: 125 LB 56.8 KG Carton weight: 150 LB 68.04 KG Carton volume: 65.25 FT³ 1.84 MT³</p>	<p>Active weight 350 lbs/seat.</p> <p>Optional urethane armcaps. Please specify. No upcharge.</p>	3290	3442	3570	3718	3960	4183	4406	4601	4843	5071	5380	5817
		OVERALL DIMENSIONS			SEAT DIMENSIONS			BACK DIMENSIONS					
		W	D	H	W	D	H	W	H				
		IN 69	27	33	20.5	17.5	18	20.5	15				
		MM 1753	686	876	521	445	457	521	381				
		RTA 00	1 per carton										

DESCRIPTION	MODEL# / FEATURES	STANDARD TEXTILE GRADES											
		COM	2	3	4	5	6	7	8	9	10	11	12
 <p>LB Three Seat Chair Full Center Arms, Closed Arms (Wood) COM: 6.25 YD 5.72 M Unit weight: 135 LB 61.4 KG Carton weight: 160 LB 72.57 KG Carton volume: 65.25 FT³ 1.84 MT³</p>	<p>GC3625WCA Wood</p>	3685	3885	4054	4248	4566	4860	5154	5410	5729	6029	6435	7010
		OVERALL DIMENSIONS			SEAT DIMENSIONS			BACK DIMENSIONS					
		W D H			W D H			W H					
		IN 69	27	33	20.5	17.5	18	20.5	15				
MM 1753	686	838	521	445	457	521	381						
Active weight 350 lbs/seat.		1 per carton											
Optional urethane armcaps. Please specify. No upcharge.		RTA 00											
 <p>LB Three Seat Chair Half Center Arms, Open Arms (Wood) COM: 4.75 YD 4.34 M Unit weight: 112 LB 50.9 KG Carton weight: 135 LB 61.23 KG Carton volume: 65.25 FT³ 1.84 MT³</p>	<p>GC3626W Wood</p>	3028	3180	3308	3456	3698	3921	4144	4339	4581	4809	5118	5555
		OVERALL DIMENSIONS			SEAT DIMENSIONS			BACK DIMENSIONS					
		W D H			W D H			W H					
		IN 69	27	33	20.5	17.5	18	20.5	15				
MM 1753	686	838	521	445	457	521	381						
Active weight 350 lbs/seat.		1 per carton											
Optional urethane armcaps. Please specify. No upcharge.		RTA 00											
 <p>LB Three Seat Chair Half Center Arms, Closed Arms (Wood) COM: 6.25 YD 5.72 M Unit weight: 122 LB 55.5 KG Carton weight: 145 LB 65.77 KG Carton volume: 65.25 FT³ 1.84 MT³</p>	<p>GC3626WCA Wood</p>	3423	3623	3792	3986	4304	4598	4892	5148	5467	5767	6173	6748
		OVERALL DIMENSIONS			SEAT DIMENSIONS			BACK DIMENSIONS					
		W D H			W D H			W H					
		IN 69	27	33	20.5	17.5	18	20.5	15				
MM 1753	686	838	521	445	457	521	381						
Active weight 350 lbs/seat.		1 per carton											
Optional urethane armcaps. Please specify. No upcharge.		RTA 00											
 <p>LB Four Seat Chair Full Center Arms, Open Arms (Wood) COM: 8 YD 5.49 M Unit weight: 160 LB 72.7 KG Carton weight: 185 LB 83.91 KG Carton volume: 43 FT³ 1.21 MT³</p>	<p>GC3628W Wood</p>	4342	4534	4696	4882	5188	5470	5752	5998	6304	6592	6982	7534
		OVERALL DIMENSIONS			SEAT DIMENSIONS			BACK DIMENSIONS					
		W D H			W D H			W H					
		IN 93	27	33	20.5	17.5	18	20.5	15				
MM 2362	686	838	521	445	457	521	381						
Active weight 350 lbs/seat.		2 cartons											
Optional urethane armcaps. Please specify. No upcharge.		RTA 4											
 <p>LB Four Seat Chair Full Center Arms, Closed Arms (Wood) COM: 8 YD 7.32 M Unit weight: 170 LB 77.3 KG Carton weight: 195 LB 88.45 KG Carton volume: 43 FT³ 1.21 MT³</p>	<p>GC3628WCA Wood</p>	4833	5089	5305	5553	5961	6337	6713	7041	7449	7833	8353	9089
		OVERALL DIMENSIONS			SEAT DIMENSIONS			BACK DIMENSIONS					
		W D H			W D H			W H					
		IN 93	27	33	20.5	17.5	18	20.5	15				
MM 2362	686	838	521	445	457	521	381						
Active weight 350 lbs/seat.		2 cartons											
Optional urethane armcaps. Please specify. No upcharge.		RTA 4											

DESCRIPTION	MODEL# / FEATURES	STANDARD TEXTILE GRADES											
		COM	2	3	4	5	6	7	8	9	10	11	12
 LB Five Seat Chair Full Center Arms, Open Arms (Wood) COM: 7.5 YD 6.86 M Unit weight: 202 LB 91.8 KG Carton weight: 227 LB 102.97 KG Carton volume: 43 FT³ 1.21 MT³	GC3630W Wood Active weight 350 lbs/seat. Optional urethane armcaps. Please specify. No upcharge.	5389	5629	5832	6064	6447	6799	7152	7459	7842	8202	8689	9379
		OVERALL DIMENSIONS			SEAT DIMENSIONS			BACK DIMENSIONS					
		W	D	H	W	D	H	W	H				
		IN 115	27	33	20.5	17.5	18	20.5	15				
		MM 2921	686	838	521	445	457	521	381				
	RTA 4	2 cartons											
 LB Five Seat Chair Full Center Arms, Closed Arms (Wood) COM: 10 YD 9.14 M Unit weight: 212 LB 96.4 KG Carton weight: 237 LB 107.5 KG Carton volume: 43 FT³ 1.21 MT³	GC3630WCA Wood Active weight 350 lbs/seat. Optional urethane armcaps. Please specify. No upcharge.	5972	6292	6562	6872	7382	7852	8322	8732	9242	9722	10372	11292
		OVERALL DIMENSIONS			SEAT DIMENSIONS			BACK DIMENSIONS					
		W	D	H	W	D	H	W	H				
		IN 115	27	33	20.5	17.5	18	20.5	15				
		MM 2921	686	838	521	445	457	521	381				
	RTA 4	2 cartons											
 Bariatric LB Single Seat Armchair Open Arms (HT) COM: 2.5 YD 2.29 M Unit weight: 66 LB 30 KG Carton weight: 78 LB 35.38 KG Carton volume: 26.5 FT³ 0.75 MT³	GC3637 Metal Active weight 500 lbs. Optional wood armcaps. Please specify. No upcharge.	2009	2089	2157	2234	2362	2479	2597	2699	2827	2947	3109	3339
		OVERALL DIMENSIONS			SEAT DIMENSIONS			BACK DIMENSIONS					
		W	D	H	W	D	H	W	H				
		IN 35	27	33	30	17.5	18	30	15				
		MM 889	686	838	762	445	457	762	381				
	RTA 00	1 per carton											
 Bariatric LB Single Seat Armchair Closed Arms (HT) COM: 3.5 YD 3.2 M Unit weight: 76 LB 34.5 KG Carton weight: 88 LB 39.92 KG Carton volume: 26.5 FT³ 0.75 MT³	GC3637CA Metal Active weight 500 lbs. Optional wood armcaps. Please specify. No upcharge.	2257	2369	2464	2572	2751	2915	3080	3223	3402	3570	3797	4119
		OVERALL DIMENSIONS			SEAT DIMENSIONS			BACK DIMENSIONS					
		W	D	H	W	D	H	W	H				
		IN 35	27	33	30	17.5	18	30	15				
		MM 889	686	838	762	445	457	762	381				
	RTA 00	1 per carton											
 Bariatric LB Single Seat Armchair, Open Arms (Wood) COM: 2.5 YD 2.29 M Unit weight: 54 LB 24.5 KG Carton weight: 66 LB 29.94 KG Carton volume: 26.5 FT³ 0.75 MT³	GC3637W Wood Active weight 500 lbs. Optional urethane armcaps. Please specify. No upcharge.	1570	1650	1718	1795	1923	2040	2158	2260	2388	2508	2670	2900
		OVERALL DIMENSIONS			SEAT DIMENSIONS			BACK DIMENSIONS					
		W	D	H	W	D	H	W	H				
		IN 35	27	33	30	17.5	18	30	15				
		MM 889	686	838	762	445	457	762	381				
	RTA 00	1 per carton											

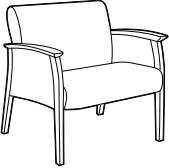
DESCRIPTION	MODEL# / FEATURES	STANDARD TEXTILE GRADES																																
		COM	2	3	4	5	6	7	8	9	10	11	12																					
 <p>GC3637WCA Wood</p> <p>Bariatric LB Single Seat Armchair, Closed Arms (Wood) COM: 3.5 YD 3.2 M Unit weight: 64 LB 29.1 KG Carton weight: 76 LB 34.47 KG Carton volume: 26.5 FT³ 0.75 MT³</p>		1760	1872	1967	2075	2254	2418	2583	2726	2905	3073	3300	3622																					
	<p>Active weight 500 lbs.</p> <p>Optional urethane armcaps. Please specify. No upcharge.</p>	<table border="1"> <thead> <tr> <th colspan="3">OVERALL DIMENSIONS</th> <th colspan="3">SEAT DIMENSIONS</th> <th colspan="2">BACK DIMENSIONS</th> </tr> <tr> <th>W</th> <th>D</th> <th>H</th> <th>W</th> <th>D</th> <th>H</th> <th>W</th> <th>H</th> </tr> </thead> <tbody> <tr> <td>IN 35</td> <td>27</td> <td>33</td> <td>30</td> <td>17.5</td> <td>18</td> <td>30</td> <td>15</td> </tr> <tr> <td>MM 889</td> <td>686</td> <td>838</td> <td>762</td> <td>445</td> <td>457</td> <td>762</td> <td>381</td> </tr> </tbody> </table>	OVERALL DIMENSIONS			SEAT DIMENSIONS			BACK DIMENSIONS		W	D	H	W	D	H	W	H	IN 35	27	33	30	17.5	18	30	15	MM 889	686	838	762	445	457	762	381
OVERALL DIMENSIONS			SEAT DIMENSIONS			BACK DIMENSIONS																												
W	D	H	W	D	H	W	H																											
IN 35	27	33	30	17.5	18	30	15																											
MM 889	686	838	762	445	457	762	381																											

PRIMACARE PATIENT



model GC3631 (HT)



model GC3632WCA (Wood)

STANDARD FEATURES

- Primacare is a family of products offering the most significant return on investment approach in the industry since every component can be repaired or replaced on site.
- **High traffic (HT) models:** Metal frame with die cast zinc connectors and metal-to-metal fasteners. Available in the following finishes: Black (TBL), Cloud (TIV), Designer White (TDW), Fog (TFO), Frost (TFR), Kalua (TKA), Latte (TLA), Mocha (TMO), Nevada (TNE), Sand (TSN), Shadow (TSH), Toast (TOA) and Tungsten (TTU).
- **Wood models:** Solid hardwood frame with die cast zinc connectors and metal-to-metal fastening. Available in the following finishes: Absolute (AAM), Charcoal Java (CJM), Cherry (ACM), Empire Mahogany (EMM), English Oak (EOM), Espresso Cafe (ECM), Fruitwood (TFM), Gray (HGM), Harvest Oak (HOM), Honey (AHM), Jet Onyx (JOM), Light Honey (LHM), Mahogany (TMM), Maple (AVM), Medium Walnut (MWM), Natural Walnut (NLW), Night (ASM), Noce Biondo (NBM), Noce Grigio (NGM), Noce Leggero (NEM), Noce Medio (NMM), Sandy Beach (SBM), Shaker Cherry (SKM), Silver Oak (SOM), Walnut (TWM), White (WHM), WC Cream (WTM) and Winter Cherry (WCM).
- Armcaps are securely fastened with metal-to-metal connectors which allow for field replacement if required.
- Easy grip forward extending armcap on models with arms.
- Replaceable seat covers and replaceable and/or removable seat cushions are standard.
- Seat cushion has a seamless waterfall front and clean out between and around the seat and back cushions.
- Models are standard with metal mesh seat deck. For mental health applications, the metal mesh seat deck can be covered with a solid moisture resistant surface, held in place with tamperproof fasteners. Contact your sales rep for a special quotation.
- All seat frames feature a wall saver design to prevent back contact with wall.
- Models ending in **CA / ARC**, have upholstered panel arm inserts closing the arm. (Closed arm panels are designed to be replaceable. Request a special quote to have them secured with tamperproof fasteners.)
- For healthcare textile options, visit the website at globalfurnituregroup.com.
- Can be upholstered in standard Global textiles if healthcare compliance is not required.
- Shipped fully assembled.

OPTIONAL FEATURES





- **High traffic (HT) models:** Wood armcaps are available. See far left column "Wood models" for finishes. Please specify. No upcharge.
- **High traffic (HT) and wood models:** Urethane armcaps are available in the following finishes: Black (BLK), Kalua (KAL), Latte (LAB), Mocha (J52), Shadow (SHW) and Toast (TOA). Please specify. No upcharge.
- For moisture barrier on seat, please specify **(MB)**. Add \$81 per seat. For bariatric models, add \$122 per seat.
- To add sealed seams to your product contact Customer Service. Upcharges vary.
- For Primacare tables, see page 59.





SUGGESTED APPLICATIONS

- Bariatric seating
- Guest seating
- Lobbies
- Lounge/Waiting
- Patient rooms
- Resident rooms
- Treatment/Exam rooms





HIGH TRAFFIC (HT) MODELS ARE LISTED FIRST, FOLLOWED BY WOOD MODELS.

DESCRIPTION	MODEL# / FEATURES	STANDARD TEXTILE GRADES															
		COM	2	3	4	5	6	7	8	9	10	11	12				
<p>MB Armchair Open Arms (HT) COM: 1.75 YD 1.6 M Unit weight: 56 LB 25.5 KG Carton weight: 64 LB 29.03 KG Carton volume: 17.5 FT³ 0.49 MT³</p>	<p>GC3631 Metal</p> <p>GC3631F Metal flex back</p>	1597	1653	1700	1755	1844	1926	2008	2080	2169	2253	2367	2528				
	<p>Active weight 500 lbs.</p> <p>Optional wood armcaps. Please specify. No upcharge.</p>	IN 25	27	36.5	20.5	17.5	18	20.5	18	MM 635	686	927	521	445	457	521	457
		RTA 00	1 per carton														
<p>MB Armchair Closed Arms (HT) COM: 2.75 YD 2.51 M Unit weight: 68 LB 30.9 KG Carton weight: 76 LB 34.47 KG Carton volume: 17.5 FT³ 0.49 MT³</p>	<p>GC3631CA Metal</p> <p>GC3631FCA Metal flex back</p>	1858	1946	2020	2106	2246	2375	2504	2617	2757	2889	3068	3321				
	<p>Active weight 500 lbs.</p> <p>Optional wood armcaps. Please specify. No upcharge.</p>	IN 25	27	36.5	20.5	17.5	18	20.5	18	MM 635	686	927	521	445	457	521	457
		RTA 00	1 per carton														
<p>MB Armchair Open Arms, Rear Tip and Move Wheels (HT) COM: 1.75 YD 1.6 M Unit weight: 56 LB 25.5 KG Carton weight: 64 LB 29.03 KG Carton volume: 23 FT³ 0.65 MT³</p>	<p>GC3631RC Metal</p>	1697	1753	1800	1855	1944	2026	2108	2180	2269	2353	2467	2628				
	<p>Active weight 500 lbs.</p> <p>Optional wood armcaps. Please specify. No upcharge.</p>	IN 25	29.5	36.5	20.5	17.5	18	20.5	18	MM 635	749	927	521	445	457	521	457
		RTA 00	1 per carton														

DESCRIPTION	MODEL# / FEATURES	STANDARD TEXTILE GRADES												
		COM	2	3	4	5	6	7	8	9	10	11	12	
 <p>MB Armchair Closed Arms, Rear Tip and Move Wheels (HT) COM: 2.75 YD 2.51 M Unit weight: 68 LB 30.9 KG Carton weight: 76 LB 34.47 KG Carton volume: 23 FT³ 0.65 MT³</p>	GC3631CARC Metal	1956	2044	2118	2204	2344	2473	2602	2715	2855	2987	3166	3419	
	Active weight 500 lbs.													
	Optional wood armcaps. Please specify. No upcharge.													
		RTA 00	1 per carton											
		OVERALL DIMENSIONS			SEAT DIMENSIONS			BACK DIMENSIONS						
		W	D	H	W	D	H	W	H					
		IN 25	29.5	36.5	20.5	17.5	18	20.5	18					
		MM 635	749	927	521	445	457	521	457					
 <p>MB Chair, Armless (HT) COM: 1.75 YD 1.6 M Unit weight: 46 LB 20.9 KG Carton weight: 54 LB 24.49 KG Carton volume: 20 FT³ 0.56 MT³</p>	GC3631NA Metal	1299	1355	1402	1457	1546	1628	1710	1782	1871	1955	2069	2230	
	Active weight 500 lbs.													
		RTA 00	1 per carton											
			OVERALL DIMENSIONS			SEAT DIMENSIONS			BACK DIMENSIONS					
		W	D	H	W	D	H	W	H					
		IN 22.5	27	36.5	20.5	17.5	18	20.5	18					
		MM 572	686	927	521	445	457	521	457					
 <p>HB Armchair Open Arms, Split Back (HT) COM: 2.25 YD 2.06 M Unit weight: 62 LB 28.2 KG Carton weight: 72 LB 32.66 KG Carton volume: 27.5 FT³ 0.77 MT³</p>	GC3632 Metal	1884	1956	2017	2087	2201	2307	2413	2505	2620	2728	2874	3081	
	Active weight 500 lbs.	GC3632F Metal flex back	2253	2325	2386	2456	2570	2676	2782	2874	2989	3097	3243	3450
		Fold down headrest allows caregiver to assist occupant.												
		Optional wood armcaps. Please specify. No upcharge.	RTA 00	1 per carton										
		OVERALL DIMENSIONS			SEAT DIMENSIONS			BACK DIMENSIONS						
		W	D	H	W	D	H	W	H					
		IN 25	27	48.5	20.5	17.5	18	20.5	30					
		MM 635	686	1232	521	445	457	521	762					
 <p>HB Armchair Closed Arms, Split Back (HT) COM: 3 YD 2.74 M Unit weight: 74 LB 33.6 KG Carton weight: 84 LB 38.1 KG Carton volume: 27.5 FT³ 0.77 MT³</p>	GC3632CA Metal	2149	2245	2326	2419	2572	2713	2854	2977	3130	3274	3469	3745	
	Active weight 500 lbs.	GC3632FCA Metal flex back	2520	2616	2697	2790	2943	3084	3225	3348	3501	3645	3840	4116
		Fold down headrest allows caregiver to assist occupant.												
		Optional wood armcaps. Please specify. No upcharge.	RTA 00	1 per carton										
		OVERALL DIMENSIONS			SEAT DIMENSIONS			BACK DIMENSIONS						
		W	D	H	W	D	H	W	H					
		IN 25	27	48.5	20.5	17.5	18	20.5	30					
		MM 635	686	1232	521	445	457	521	762					
 <p>HB Armchair Open Arms, Split Back, Rear Tip and Move Wheels (HT) COM: 2.25 YD 2.06 M Unit weight: 62 LB 28.2 KG Carton weight: 72 LB 32.66 KG Carton volume: 27.5 FT³ 0.77 MT³</p>	GC3632RC Metal	1985	2057	2118	2188	2302	2408	2514	2606	2721	2829	2975	3182	
	Active weight 500 lbs.													
		Fold down headrest allows caregiver to assist occupant.												
		Optional wood armcaps. Please specify. No upcharge.	RTA 00	1 per carton										
		OVERALL DIMENSIONS			SEAT DIMENSIONS			BACK DIMENSIONS						
		W	D	H	W	D	H	W	H					
		IN 25	29.5	48.5	20.5	17.5	18	20.5	30					
		MM 635	749	1232	521	445	457	521	762					

DESCRIPTION		MODEL# / FEATURES	STANDARD TEXTILE GRADES																																																																		
 <p>HB Armchair Closed Arms, Split Back, Rear Tip and Move Wheels (HT) COM: 3 YD 2.74 M Unit weight: 74 LB 33.6 KG Carton weight: 84 LB 38.1 KG Carton volume: 27.5 FT³ 0.77 MT³</p>	<p>Active weight 500 lbs.</p> <p>Fold down headrest allows caregiver to assist occupant.</p> <p>Optional wood armcaps. Please specify. No upcharge.</p>	GC3632CARC Metal	COM	2	3	4	5	6	7	8	9	10	11	12																																																							
		2251	2347	2428	2521	2674	2815	2956	3079	3232	3376	3571	3847																																																								
		<table border="1"> <thead> <tr> <th colspan="3">OVERALL DIMENSIONS</th> <th colspan="3">SEAT DIMENSIONS</th> <th colspan="2">BACK DIMENSIONS</th> </tr> <tr> <th>W</th><th>D</th><th>H</th> <th>W</th><th>D</th><th>H</th> <th>W</th><th>H</th> </tr> </thead> <tbody> <tr> <td>IN 25</td><td>29.5</td><td>48.5</td> <td>20.5</td><td>17.5</td><td>18</td> <td>20.5</td><td>30</td> </tr> <tr> <td>MM 635</td><td>749</td><td>1232</td> <td>521</td><td>445</td><td>457</td> <td>521</td><td>762</td> </tr> </tbody> </table>			OVERALL DIMENSIONS			SEAT DIMENSIONS			BACK DIMENSIONS		W	D	H	W	D	H	W	H	IN 25	29.5	48.5	20.5	17.5	18	20.5	30	MM 635	749	1232	521	445	457	521	762	<table border="1"> <thead> <tr> <th colspan="3">OVERALL DIMENSIONS</th> <th colspan="3">SEAT DIMENSIONS</th> <th colspan="2">BACK DIMENSIONS</th> </tr> <tr> <th>W</th><th>D</th><th>H</th> <th>W</th><th>D</th><th>H</th> <th>W</th><th>H</th> </tr> </thead> <tbody> <tr> <td>IN 22</td><td>27</td><td>48.5</td> <td>20.5</td><td>17.5</td><td>18</td> <td>20.5</td><td>30</td> </tr> <tr> <td>MM 559</td><td>686</td><td>1232</td> <td>521</td><td>445</td><td>457</td> <td>521</td><td>762</td> </tr> </tbody> </table>			OVERALL DIMENSIONS			SEAT DIMENSIONS			BACK DIMENSIONS		W	D	H	W	D	H	W	H	IN 22	27	48.5	20.5	17.5	18	20.5	30	MM 559	686	1232	521	445	457
OVERALL DIMENSIONS			SEAT DIMENSIONS			BACK DIMENSIONS																																																															
W	D	H	W	D	H	W	H																																																														
IN 25	29.5	48.5	20.5	17.5	18	20.5	30																																																														
MM 635	749	1232	521	445	457	521	762																																																														
OVERALL DIMENSIONS			SEAT DIMENSIONS			BACK DIMENSIONS																																																															
W	D	H	W	D	H	W	H																																																														
IN 22	27	48.5	20.5	17.5	18	20.5	30																																																														
MM 559	686	1232	521	445	457	521	762																																																														
<p>RTA 00</p> <p>1 per carton</p>																																																																					
 <p>HB Chair, Split Back, Armless (HT) COM: 2.25 YD 2.06 M Unit weight: 52 LB 23.6 KG Carton weight: 62 LB 28.12 KG Carton volume: 27.5 FT³ 0.77 MT³</p>	<p>Active weight 500 lbs.</p> <p>Fold down headrest allows caregiver to assist occupant.</p>	GC3632NA Metal	COM	2	3	4	5	6	7	8	9	10	11	12																																																							
		1532	1604	1665	1735	1849	1955	2061	2153	2268	2376	2522	2729																																																								
		<table border="1"> <thead> <tr> <th colspan="3">OVERALL DIMENSIONS</th> <th colspan="3">SEAT DIMENSIONS</th> <th colspan="2">BACK DIMENSIONS</th> </tr> <tr> <th>W</th><th>D</th><th>H</th> <th>W</th><th>D</th><th>H</th> <th>W</th><th>H</th> </tr> </thead> <tbody> <tr> <td>IN 23</td><td>26</td><td>40.5</td> <td>19</td><td>17.5</td><td>25.5</td> <td>19</td><td>15.5</td> </tr> <tr> <td>MM 584</td><td>660</td><td>1029</td> <td>483</td><td>445</td><td>648</td> <td>483</td><td>394</td> </tr> </tbody> </table>			OVERALL DIMENSIONS			SEAT DIMENSIONS			BACK DIMENSIONS		W	D	H	W	D	H	W	H	IN 23	26	40.5	19	17.5	25.5	19	15.5	MM 584	660	1029	483	445	648	483	394	<table border="1"> <thead> <tr> <th colspan="3">OVERALL DIMENSIONS</th> <th colspan="3">SEAT DIMENSIONS</th> <th colspan="2">BACK DIMENSIONS</th> </tr> <tr> <th>W</th><th>D</th><th>H</th> <th>W</th><th>D</th><th>H</th> <th>W</th><th>H</th> </tr> </thead> <tbody> <tr> <td>IN 23</td><td>26</td><td>40.5</td> <td>19</td><td>17.5</td><td>25.5</td> <td>19</td><td>15.5</td> </tr> <tr> <td>MM 584</td><td>660</td><td>1029</td> <td>483</td><td>445</td><td>648</td> <td>483</td><td>394</td> </tr> </tbody> </table>			OVERALL DIMENSIONS			SEAT DIMENSIONS			BACK DIMENSIONS		W	D	H	W	D	H	W	H	IN 23	26	40.5	19	17.5	25.5	19	15.5	MM 584	660	1029	483	445	648
OVERALL DIMENSIONS			SEAT DIMENSIONS			BACK DIMENSIONS																																																															
W	D	H	W	D	H	W	H																																																														
IN 23	26	40.5	19	17.5	25.5	19	15.5																																																														
MM 584	660	1029	483	445	648	483	394																																																														
OVERALL DIMENSIONS			SEAT DIMENSIONS			BACK DIMENSIONS																																																															
W	D	H	W	D	H	W	H																																																														
IN 23	26	40.5	19	17.5	25.5	19	15.5																																																														
MM 584	660	1029	483	445	648	483	394																																																														
<p>RTA 00</p> <p>1 per carton</p>																																																																					
 <p>Designed to immobilize the pelvis and hip joints after surgery.</p> <p>LB Hip Armchair Open Arms - Post Surgery (HT) COM: 1.5 YD 1.37 M Unit weight: 57 LB 25.9 KG Carton weight: 67 LB 30.39 KG Carton volume: 20 FT³ 0.56 MT³</p>	<p>Active weight 500 lbs.</p> <p>Optional wood armcaps. Please specify. No upcharge.</p>	GC3636 Metal	COM	2	3	4	5	6	7	8	9	10	11	12																																																							
		1840	1888	1929	1975	2052	2122	2193	2254	2331	2403	2500	2638																																																								
		<table border="1"> <thead> <tr> <th colspan="3">OVERALL DIMENSIONS</th> <th colspan="3">SEAT DIMENSIONS</th> <th colspan="2">BACK DIMENSIONS</th> </tr> <tr> <th>W</th><th>D</th><th>H</th> <th>W</th><th>D</th><th>H</th> <th>W</th><th>H</th> </tr> </thead> <tbody> <tr> <td>IN 35</td><td>27</td><td>36.5</td> <td>30</td><td>17.5</td><td>18</td> <td>30</td><td>18</td> </tr> <tr> <td>MM 889</td><td>686</td><td>927</td> <td>762</td><td>445</td><td>457</td> <td>762</td><td>457</td> </tr> </tbody> </table>			OVERALL DIMENSIONS			SEAT DIMENSIONS			BACK DIMENSIONS		W	D	H	W	D	H	W	H	IN 35	27	36.5	30	17.5	18	30	18	MM 889	686	927	762	445	457	762	457	<table border="1"> <thead> <tr> <th colspan="3">OVERALL DIMENSIONS</th> <th colspan="3">SEAT DIMENSIONS</th> <th colspan="2">BACK DIMENSIONS</th> </tr> <tr> <th>W</th><th>D</th><th>H</th> <th>W</th><th>D</th><th>H</th> <th>W</th><th>H</th> </tr> </thead> <tbody> <tr> <td>IN 35</td><td>27</td><td>36.5</td> <td>30</td><td>17.5</td><td>18</td> <td>30</td><td>18</td> </tr> <tr> <td>MM 889</td><td>686</td><td>927</td> <td>762</td><td>445</td><td>457</td> <td>762</td><td>457</td> </tr> </tbody> </table>			OVERALL DIMENSIONS			SEAT DIMENSIONS			BACK DIMENSIONS		W	D	H	W	D	H	W	H	IN 35	27	36.5	30	17.5	18	30	18	MM 889	686	927	762	445	457
OVERALL DIMENSIONS			SEAT DIMENSIONS			BACK DIMENSIONS																																																															
W	D	H	W	D	H	W	H																																																														
IN 35	27	36.5	30	17.5	18	30	18																																																														
MM 889	686	927	762	445	457	762	457																																																														
OVERALL DIMENSIONS			SEAT DIMENSIONS			BACK DIMENSIONS																																																															
W	D	H	W	D	H	W	H																																																														
IN 35	27	36.5	30	17.5	18	30	18																																																														
MM 889	686	927	762	445	457	762	457																																																														
<p>RTA 00</p> <p>1 per carton</p>																																																																					
 <p>Bariatric MB Armchair Open Arms (HT) COM: 2.75 YD 2.51 M Unit weight: 82 LB 37.3 KG Carton weight: 94 LB 42.64 KG Carton volume: 30.5 FT³ 0.86 MT³</p>	<p>Active weight 500 lbs.</p> <p>Optional wood armcaps. Please specify. No upcharge.</p>	GC3638 Metal	COM	2	3	4	5	6	7	8	9	10	11	12																																																							
		2064	2152	2226	2312	2452	2581	2710	2823	2963	3095	3274	3527																																																								
		<table border="1"> <thead> <tr> <th colspan="3">OVERALL DIMENSIONS</th> <th colspan="3">SEAT DIMENSIONS</th> <th colspan="2">BACK DIMENSIONS</th> </tr> <tr> <th>W</th><th>D</th><th>H</th> <th>W</th><th>D</th><th>H</th> <th>W</th><th>H</th> </tr> </thead> <tbody> <tr> <td>IN 35</td><td>27</td><td>36.5</td> <td>30</td><td>17.5</td><td>18</td> <td>30</td><td>18</td> </tr> <tr> <td>MM 889</td><td>686</td><td>927</td> <td>762</td><td>445</td><td>457</td> <td>762</td><td>457</td> </tr> </tbody> </table>			OVERALL DIMENSIONS			SEAT DIMENSIONS			BACK DIMENSIONS		W	D	H	W	D	H	W	H	IN 35	27	36.5	30	17.5	18	30	18	MM 889	686	927	762	445	457	762	457	<table border="1"> <thead> <tr> <th colspan="3">OVERALL DIMENSIONS</th> <th colspan="3">SEAT DIMENSIONS</th> <th colspan="2">BACK DIMENSIONS</th> </tr> <tr> <th>W</th><th>D</th><th>H</th> <th>W</th><th>D</th><th>H</th> <th>W</th><th>H</th> </tr> </thead> <tbody> <tr> <td>IN 35</td><td>27</td><td>36.5</td> <td>30</td><td>17.5</td><td>18</td> <td>30</td><td>18</td> </tr> <tr> <td>MM 889</td><td>686</td><td>927</td> <td>762</td><td>445</td><td>457</td> <td>762</td><td>457</td> </tr> </tbody> </table>			OVERALL DIMENSIONS			SEAT DIMENSIONS			BACK DIMENSIONS		W	D	H	W	D	H	W	H	IN 35	27	36.5	30	17.5	18	30	18	MM 889	686	927	762	445	457
OVERALL DIMENSIONS			SEAT DIMENSIONS			BACK DIMENSIONS																																																															
W	D	H	W	D	H	W	H																																																														
IN 35	27	36.5	30	17.5	18	30	18																																																														
MM 889	686	927	762	445	457	762	457																																																														
OVERALL DIMENSIONS			SEAT DIMENSIONS			BACK DIMENSIONS																																																															
W	D	H	W	D	H	W	H																																																														
IN 35	27	36.5	30	17.5	18	30	18																																																														
MM 889	686	927	762	445	457	762	457																																																														
<p>RTA 00</p> <p>1 per carton</p>																																																																					
 <p>Bariatric MB Armchair Closed Arms (HT) COM: 3.75 YD 3.43 M Unit weight: 92 LB 41.8 KG Carton weight: 104 LB 47.17 KG Carton volume: 30.5 FT³ 0.86 MT³</p>	<p>Active weight 500 lbs.</p> <p>Optional wood armcaps. Please specify. No upcharge.</p>	GC3638CA Metal	COM	2	3	4	5	6	7	8	9	10	11	12																																																							
		2320	2440	2541	2658	2849	3025	3201	3355	3546	3726	3970	4315																																																								
		<table border="1"> <thead> <tr> <th colspan="3">OVERALL DIMENSIONS</th> <th colspan="3">SEAT DIMENSIONS</th> <th colspan="2">BACK DIMENSIONS</th> </tr> <tr> <th>W</th><th>D</th><th>H</th> <th>W</th><th>D</th><th>H</th> <th>W</th><th>H</th> </tr> </thead> <tbody> <tr> <td>IN 35</td><td>27</td><td>36.5</td> <td>30</td><td>17.5</td><td>18</td> <td>30</td><td>18</td> </tr> <tr> <td>MM 889</td><td>686</td><td>927</td> <td>762</td><td>445</td><td>457</td> <td>762</td><td>457</td> </tr> </tbody> </table>			OVERALL DIMENSIONS			SEAT DIMENSIONS			BACK DIMENSIONS		W	D	H	W	D	H	W	H	IN 35	27	36.5	30	17.5	18	30	18	MM 889	686	927	762	445	457	762	457	<table border="1"> <thead> <tr> <th colspan="3">OVERALL DIMENSIONS</th> <th colspan="3">SEAT DIMENSIONS</th> <th colspan="2">BACK DIMENSIONS</th> </tr> <tr> <th>W</th><th>D</th><th>H</th> <th>W</th><th>D</th><th>H</th> <th>W</th><th>H</th> </tr> </thead> <tbody> <tr> <td>IN 35</td><td>27</td><td>36.5</td> <td>30</td><td>17.5</td><td>18</td> <td>30</td><td>18</td> </tr> <tr> <td>MM 889</td><td>686</td><td>927</td> <td>762</td><td>445</td><td>457</td> <td>762</td><td>457</td> </tr> </tbody> </table>			OVERALL DIMENSIONS			SEAT DIMENSIONS			BACK DIMENSIONS		W	D	H	W	D	H	W	H	IN 35	27	36.5	30	17.5	18	30	18	MM 889	686	927	762	445	457
OVERALL DIMENSIONS			SEAT DIMENSIONS			BACK DIMENSIONS																																																															
W	D	H	W	D	H	W	H																																																														
IN 35	27	36.5	30	17.5	18	30	18																																																														
MM 889	686	927	762	445	457	762	457																																																														
OVERALL DIMENSIONS			SEAT DIMENSIONS			BACK DIMENSIONS																																																															
W	D	H	W	D	H	W	H																																																														
IN 35	27	36.5	30	17.5	18	30	18																																																														
MM 889	686	927	762	445	457	762	457																																																														
<p>RTA 00</p> <p>1 per carton</p>																																																																					

DESCRIPTION	MODEL# / FEATURES	STANDARD TEXTILE GRADES											
		COM	2	3	4	5	6	7	8	9	10	11	12
 <p>Bariatric HB Armchair Open Arms, Split Back (HT) COM: 3.75 YD 3.43 M Unit weight: 67 LB 30.5 KG Carton weight: 77 LB 34.93 KG Carton volume: 33 FT³ 0.93 MT³</p>	GC3639 Metal	2422	2542	2643	2760	2951	3127	3303	3457	3648	3828	4072	4417
	Active weight 500 lbs.	OVERALL DIMENSIONS			SEAT DIMENSIONS			BACK DIMENSIONS					
	Fold down headrest allows caregiver to assist occupant.	IN	35	27	48.5	30	17.5	18	30	30			
	Optional wood armcaps. Please specify. No upcharge.	MM	889	686	1232	762	445	457	762	762			
		RTA 00	1 per carton										
 <p>Bariatric HB Armchair Closed Arms, Split Back (HT) COM: 4.75 YD 4.34 M Unit weight: 96 LB 43.6 KG Carton weight: 108 LB 48.99 KG Carton volume: 33 FT³ 0.93 MT³</p>	GC3639CA Metal	2681	2833	2961	3109	3351	3574	3797	3992	4234	4462	4771	5208
	Active weight 500 lbs.	OVERALL DIMENSIONS			SEAT DIMENSIONS			BACK DIMENSIONS					
	Fold down headrest allows caregiver to assist occupant.	IN	35	27	48.5	30	17.5	18	30	30			
	Optional wood armcaps. Please specify. No upcharge.	MM	889	686	1232	762	445	457	762	762			
		RTA 00	1 per carton										
 <p>HB Armchair Open Arms (HT) COM: 2.5 YD 2.29 M Unit weight: 62 LB 28.2 KG Carton weight: 72 LB 32.66 KG Carton volume: 27.5 FT³ 0.77 MT³</p>	GC3655 Metal	1651	1731	1799	1876	2004	2121	2239	2341	2469	2589	2751	2981
	Active weight 500 lbs.	OVERALL DIMENSIONS			SEAT DIMENSIONS			BACK DIMENSIONS					
	Optional wood armcaps. Please specify. No upcharge.	IN	25	27	48.5	20.5	17.5	18	20.5	30			
		MM	635	686	1232	521	445	457	521	762			
		RTA 00	1 per carton										
 <p>HB Armchair Closed Arms (HT) COM: 3.25 YD 2.97 M Unit weight: 74 LB 33.6 KG Carton weight: 84 LB 38.1 KG Carton volume: 27.5 FT³ 0.77 MT³</p>	GC3655CA Metal	1919	2023	2111	2212	2377	2530	2683	2816	2982	3138	3349	3648
	Active weight 500 lbs.	OVERALL DIMENSIONS			SEAT DIMENSIONS			BACK DIMENSIONS					
	Optional wood armcaps. Please specify. No upcharge.	IN	25	27	48.5	20.5	17.5	18	20.5	30			
		MM	635	686	1232	521	445	457	521	762			
		RTA 00	1 per carton										
 <p>HB Armchair Closed Arms, Rear Tip and Move Wheels (HT) COM: 3.25 YD 2.97 M Unit weight: 74 LB 33.6 KG Carton weight: 84 LB 38.1 KG Carton volume: 27.5 FT³ 0.77 MT³</p>	GC3655FCA Metal flex back	2287	2391	2479	2580	2745	2898	3051	3184	3350	3506	3717	4016
	Active weight 500 lbs.	OVERALL DIMENSIONS			SEAT DIMENSIONS			BACK DIMENSIONS					
	Optional wood armcaps. Please specify. No upcharge.	IN	25	27	48.5	20.5	17.5	18	20.5	30			
		MM	635	686	1232	521	445	457	521	762			
		RTA 00	1 per carton										
 <p>HB Armchair Closed Arms, Rear Tip and Move Wheels (HT) COM: 3.25 YD 2.97 M Unit weight: 74 LB 33.6 KG Carton weight: 84 LB 38.1 KG Carton volume: 27.5 FT³ 0.77 MT³</p>	GC3655CARC Metal	2020	2124	2212	2313	2478	2631	2784	2917	3083	3239	3450	3749
	Active weight 500 lbs.	OVERALL DIMENSIONS			SEAT DIMENSIONS			BACK DIMENSIONS					
	Optional wood armcaps. Please specify. No upcharge.	IN	25	29.5	48.5	20.5	17.5	18	20.5	30			
		MM	635	749	1232	521	445	457	521	762			
		RTA 00	1 per carton										

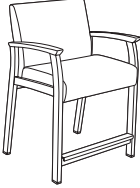
DESCRIPTION	MODEL# / FEATURES	STANDARD TEXTILE GRADES											
 <p>HB Armchair Open Arms, Rear Tip and Move Wheels (HT) COM: 2.5 YD 2.29 M Unit weight: 62 LB 28.2 KG Carton weight: 72 LB 32.66 KG Carton volume: 27.5 FT³ 0.77 MT³</p>	<p>GC3655RC Metal</p>	COM	2	3	4	5	6	7	8	9	10	11	12
		1750	1830	1898	1975	2103	2220	2338	2440	2568	2688	2850	3080
		OVERALL DIMENSIONS			SEAT DIMENSIONS			BACK DIMENSIONS					
		W	D	H	W	D	H	W	H				
IN	25	29.5	48.5	20.5	17.5	18	20.5	30					
MM	635	749	1232	521	445	457	521	762					
Active weight 500 lbs.		<p>Optional wood armcaps. Please specify. No upcharge.</p>											
		RTA 00		1 per carton									
 <p>HB Chair, Armless (HT) COM: 2.5 YD 2.29 M Unit weight: 52 LB 23.6 KG Carton weight: 62 LB 28.12 KG Carton volume: 27.5 FT³ 0.77 MT³</p>	<p>GC3655NA Metal</p>	COM	2	3	4	5	6	7	8	9	10	11	12
		1340	1420	1488	1565	1693	1810	1928	2030	2158	2278	2440	2670
		OVERALL DIMENSIONS			SEAT DIMENSIONS			BACK DIMENSIONS					
		W	D	H	W	D	H	W	H				
IN	22	27	48.5	20.5	17.5	18	20.5	30					
MM	559	686	1232	521	445	457	521	762					
Active weight 500 lbs.		<p>Optional wood armcaps. Please specify. No upcharge.</p>											
		RTA 00		1 per carton									
 <p>Bariatric HB Armchair Open Arms (HT) COM: 3.5 YD 3.2 M Unit weight: 67 LB 30.5 KG Carton weight: 79 LB 35.83 KG Carton volume: 33 FT³ 0.93 MT³</p>	<p>GC3656 Metal</p>	COM	2	3	4	5	6	7	8	9	10	11	12
		2155	2267	2362	2470	2649	2813	2978	3121	3300	3468	3695	4017
		OVERALL DIMENSIONS			SEAT DIMENSIONS			BACK DIMENSIONS					
		W	D	H	W	D	H	W	H				
IN	35	27	48.5	30	17.5	18	30	30					
MM	889	686	1232	762	445	457	762	762					
Active weight 500 lbs.		<p>Optional wood armcaps. Please specify. No upcharge.</p>											
		RTA 00		1 per carton									
 <p>Bariatric HB Armchair Closed Arms (HT) COM: 4.5 YD 4.11 M Unit weight: 96 LB 43.6 KG Carton weight: 108 LB 48.99 KG Carton volume: 33 FT³ 0.93 MT³</p>	<p>GC3656CA Metal</p>	COM	2	3	4	5	6	7	8	9	10	11	12
		2411	2555	2677	2816	3046	3257	3469	3653	3883	4099	4391	4805
		OVERALL DIMENSIONS			SEAT DIMENSIONS			BACK DIMENSIONS					
		W	D	H	W	D	H	W	H				
IN	35	27	48.5	30	17.5	18	30	30					
MM	889	686	1232	762	445	457	762	762					
Active weight 500 lbs.		<p>Optional wood armcaps. Please specify. No upcharge.</p>											
		RTA 00		1 per carton									
 <p>Wide Hip Armchair Open Arms - Post Surgery (HT) COM: 1.5 YD 1.37 M Unit weight: 68 LB 30.9 KG Carton weight: 78 LB 35.38 KG Carton volume: 20 FT³ 0.56 MT³</p>	<p>GC3657 Metal</p>	COM	2	3	4	5	6	7	8	9	10	11	12
		2239	2287	2328	2374	2451	2521	2592	2653	2730	2802	2899	3037
		OVERALL DIMENSIONS			SEAT DIMENSIONS			BACK DIMENSIONS					
		W	D	H	W	D	H	W	H				
IN	28	25	41	24	17.5	26	24	15.5					
MM	711	635	1041	610	445	660	610	394					
Active weight 500 lbs.		<p>Optional wood armcaps. Please specify. No upcharge.</p>											
		RTA 00		1 per carton									

Designed to immobilize the pelvis and hip joints after surgery.





DESCRIPTION	MODEL# / FEATURES	STANDARD TEXTILE GRADES											
		COM	2	3	4	5	6	7	8	9	10	11	12
	GC3631W Wood	1250	1306	1353	1408	1497	1579	1661	1733	1822	1906	2020	2181
	GC3631WF Wood flex back	1590	1646	1693	1748	1837	1919	2001	2073	2162	2246	2360	2521
MB Armchair, Open Arms (Wood) COM: 1.75 YD 1.6 M Unit weight: 44 LB 20 KG Carton weight: 52 LB 23.59 KG Carton volume: 20 FT³ 0.56 MT³	Active weight 350 lbs. Optional urethane armcaps. Please specify. No upcharge.	OVERALL DIMENSIONS			SEAT DIMENSIONS			BACK DIMENSIONS					
		W	D	H	W	D	H	W	H				
		IN 25	27	36.5	20.5	17.5	18	20.5	18				
		MM 635	686	927	521	445	457	521	457				
		RTA 00	1 per carton										





DESCRIPTION	MODEL# / FEATURES	STANDARD TEXTILE GRADES											
		COM	2	3	4	5	6	7	8	9	10	11	12
	GC3631WCA Wood	1450	1538	1612	1698	1838	1967	2096	2209	2349	2481	2660	2913
	GC3631WFCA Wood flex back	1785	1873	1947	2033	2173	2302	2431	2544	2684	2816	2995	3248
MB Armchair, Closed Arms (Wood) COM: 2.75 YD 2.51 M Unit weight: 54 LB 24.5 KG Carton weight: 62 LB 28.12 KG Carton volume: 17.5 FT³ 0.49 MT³	Active weight 350 lbs. Optional urethane armcaps. Please specify. No upcharge.	OVERALL DIMENSIONS			SEAT DIMENSIONS			BACK DIMENSIONS					
		W	D	H	W	D	H	W	H				
		IN 25	27	36.5	20.5	17.5	18	20.5	18				
		MM 635	686	927	521	445	457	521	457				
		RTA 00	1 per carton										



DESCRIPTION	MODEL# / FEATURES	STANDARD TEXTILE GRADES											
		COM	2	3	4	5	6	7	8	9	10	11	12
	GC3631WNA Wood	1120	1176	1223	1278	1367	1449	1531	1603	1692	1776	1890	2051
MB Chair, Armless (Wood) COM: 1.75 YD 1.6 M Unit weight: 34 LB 15.5 KG Carton weight: 42 LB 19.05 KG Carton volume: 20 FT³ 0.56 MT³	Active weight 350 lbs.	OVERALL DIMENSIONS			SEAT DIMENSIONS			BACK DIMENSIONS					
		W	D	H	W	D	H	W	H				
		IN 22.5	27	36.5	20.5	17.5	18	20.5	18				
		MM 572	686	927	521	445	457	521	457				
		RTA 00	1 per carton										

DESCRIPTION	MODEL# / FEATURES	STANDARD TEXTILE GRADES											
		COM	2	3	4	5	6	7	8	9	10	11	12
	GC3632W Wood	1472	1544	1605	1675	1789	1895	2001	2093	2208	2316	2462	2669
	GC3632WF Wood flex back	1811	1883	1944	2014	2128	2234	2340	2432	2547	2655	2801	3008
HB Armchair Open Arms, Split Back (Wood) COM: 2.25 YD 2.06 M Unit weight: 50 LB 22.7 KG Carton weight: 60 LB 27.22 KG Carton volume: 27.5 FT³ 0.77 MT³	Active weight 350 lbs. Fold down headrest allows caregiver to assist occupant. Optional urethane armcaps. Please specify. No upcharge.	OVERALL DIMENSIONS			SEAT DIMENSIONS			BACK DIMENSIONS					
		W	D	H	W	D	H	W	H				
		IN 25	27	48.5	20.5	17.5	18	20.5	30				
		MM 635	686	1232	521	445	457	521	762				
		RTA 00	1 per carton										

DESCRIPTION	MODEL# / FEATURES	STANDARD TEXTILE GRADES											
		COM	2	3	4	5	6	7	8	9	10	11	12
	GC3632WCA Wood	1679	1775	1856	1949	2102	2243	2384	2507	2660	2804	2999	3275
	GC3632WFCA Wood flex back	2015	2111	2192	2285	2438	2579	2720	2843	2996	3140	3335	3611
High Back Armchair Closed Arms, Split Back (Wood) COM: 3 YD 2.74 M Unit weight: 58 LB 26.4 KG Carton weight: 68 LB 30.84 KG Carton volume: 27.5 FT³ 0.77 MT³	Active weight 350 lbs. Fold down headrest allows caregiver to assist occupant. Optional urethane armcaps. Please specify. No upcharge.	OVERALL DIMENSIONS			SEAT DIMENSIONS			BACK DIMENSIONS					
		W	D	H	W	D	H	W	H				
		IN 25	27	48.5	20.5	17.5	18	20.5	30				
		MM 635	686	1232	521	445	457	521	762				
		RTA 00	1 per carton										

DESCRIPTION	MODEL# / FEATURES	STANDARD TEXTILE GRADES													
 <p>HB Chair, Split Back, Armless (Wood) COM: 2.25 YD 2.06 M Unit weight: 40 LB 18.2 KG Carton weight: 50 LB 22.68 KG Carton volume: 27.5 FT³ 0.77 MT³</p>	<p>GC3632WNA Wood</p>	COM	2	3	4	5	6	7	8	9	10	11	12		
		1318	1390	1451	1521	1635	1741	1847	1939	2054	2162	2308	2515		
		OVERALL DIMENSIONS			SEAT DIMENSIONS			BACK DIMENSIONS							
		W	D	H	W	D	H	W	H						
<p>Active weight 350 lbs.</p> <p>Fold down headrest allows caregiver to assist occupant.</p>	<p>IN 22 27 48.5 20.5 17.5 18 20.5 30 MM 559 686 1232 521 445 457 521 762</p> <p>RTA 00 1 per carton</p>														
		 <p>LB Hip Armchair Open Arms - Post Surgery (Wood) COM: 1.5 YD 1.37 M Unit weight: 47 LB 21.4 KG Carton weight: 57 LB 25.85 KG Carton volume: 20 FT³ 0.56 MT³</p> <p>Designed to immobilize the pelvis and hip joints after surgery.</p>	<p>GC3636W Wood</p>	COM	2	3	4	5	6	7	8	9	10	11	12
				1441	1489	1530	1576	1653	1723	1794	1855	1932	2004	2101	2239
				OVERALL DIMENSIONS			SEAT DIMENSIONS			BACK DIMENSIONS					
W	D			H	W	D	H	W	H						
<p>Active weight 350 lbs.</p> <p>Optional urethane armcaps. Please specify. No upcharge.</p>	<p>IN 23 26 40.5 19 17.5 25.5 19 15.5 MM 584 660 1029 483 445 648 483 394</p> <p>RTA 00 1 per carton</p>														
		 <p>LB Hip Armchair Closed Arms - Post Surgery (Wood) COM: 2 YD 1.83 M Unit weight: 52 LB 23.6 KG Carton weight: 62 LB 28.12 KG Carton volume: 20 FT³ 0.56 MT³</p> <p>Designed to immobilize the pelvis and hip joints after surgery.</p>	<p>GC3636WCA Wood</p>	COM	2	3	4	5	6	7	8	9	10	11	12
				1648	1712	1766	1828	1930	2024	2118	2200	2302	2398	2528	2712
				OVERALL DIMENSIONS			SEAT DIMENSIONS			BACK DIMENSIONS					
W	D			H	W	D	H	W	H						
<p>Active weight 350 lbs.</p> <p>Optional urethane armcaps. Please specify. No upcharge.</p>	<p>IN 23 26 40.5 19 17.5 25.5 19 15.5 MM 584 660 1029 483 445 648 483 394</p> <p>RTA 00 1 per carton</p>														
		 <p>Bariatric MB Armchair, Open Arms (Wood) COM: 2.75 YD 2.51 M Unit weight: 70 LB 31.8 KG Carton weight: 82 LB 37.19 KG Carton volume: 30.5 FT³ 0.86 MT³</p>	<p>GC3638W Wood</p>	COM	2	3	4	5	6	7	8	9	10	11	12
				1612	1700	1774	1860	2000	2129	2258	2371	2511	2643	2822	3075
				OVERALL DIMENSIONS			SEAT DIMENSIONS			BACK DIMENSIONS					
W	D			H	W	D	H	W	H						
<p>Active weight 500 lbs.</p> <p>Optional urethane armcaps. Please specify. No upcharge.</p>	<p>IN 35 27 36.5 30 17.5 18 30 18 MM 889 686 927 762 445 457 762 457</p> <p>RTA 00 1 per carton</p>														
		 <p>Bariatric MB Armchair, Closed Arms (Wood) COM: 3.75 YD 3.43 M Unit weight: 80 LB 36.4 KG Carton weight: 92 LB 41.73 KG Carton volume: 30.5 FT³ 0.86 MT³</p>	<p>GC3638WCA Wood</p>	COM	2	3	4	5	6	7	8	9	10	11	12
				1811	1931	2032	2149	2340	2516	2692	2846	3037	3217	3461	3806
				OVERALL DIMENSIONS			SEAT DIMENSIONS			BACK DIMENSIONS					
W	D			H	W	D	H	W	H						
<p>Active weight 500 lbs.</p> <p>Optional urethane armcaps. Please specify. No upcharge.</p>	<p>IN 35 27 36.5 30 17.5 18 30 18 MM 889 686 927 762 445 457 762 457</p> <p>RTA 00 1 per carton</p>														

DESCRIPTION	MODEL# / FEATURES	STANDARD TEXTILE GRADES												
		COM	2	3	4	5	6	7	8	9	10	11	12	
 <p>Bariatric HB Armchair, Split Back, Open Arms (Wood) COM: 3.75 YD 3.43 M Unit weight: 55 LB 25 KG Carton weight: 65 LB 29.48 KG Carton volume: 33 FT³ 0.93 MT³</p>	GC3639W Wood	1890	2010	2111	2228	2419	2595	2771	2925	3116	3296	3540	3885	
	Active weight 500 lbs.	OVERALL DIMENSIONS W D H			SEAT DIMENSIONS W D H			BACK DIMENSIONS W H						
	Fold down headrest allows caregiver to assist occupant.	IN 35	27	48.5	30	17.5	18	30	30					
	Optional urethane armcaps. Please specify. No upcharge.	MM 889	686	1232	762	445	457	762	762					
		RTA 00	1 per carton											
 <p>Bariatric HB Armchair, Split Back, Closed Arms (Wood) COM: 4.75 YD 4.34 M Unit weight: 65 LB 29.5 KG Carton weight: 75 LB 34.02 KG Carton volume: 33 FT³ 0.93 MT³</p>	GC3639WCA Wood	2088	2240	2368	2516	2758	2981	3204	3399	3641	3869	4178	4615	
	Active weight 500 lbs.	OVERALL DIMENSIONS W D H			SEAT DIMENSIONS W D H			BACK DIMENSIONS W H						
	Fold down headrest allows caregiver to assist occupant.	IN 35	27	48.5	30	17.5	18	30	30					
	Optional urethane armcaps. Please specify. No upcharge.	MM 889	686	1232	762	445	457	762	762					
		RTA 00	1 per carton											
 <p>HB Chair, Open Arms (Wood) COM: 2.5 YD 2.29 M Unit weight: 50 LB 22.7 KG Carton weight: 60 LB 27.22 KG Carton volume: 27.5 FT³ 0.77 MT³</p>	GC3655W Wood	1290	1370	1438	1515	1643	1760	1878	1980	2108	2228	2390	2620	
	Active weight 350 lbs.	GC3655WF Wood flex back	1624	1704	1772	1849	1977	2094	2212	2314	2442	2562	2724	2954
		OVERALL DIMENSIONS W D H			SEAT DIMENSIONS W D H			BACK DIMENSIONS W H						
		IN 25	27	48.5	20.5	17.5	18	20.5	30					
	MM 635	686	1232	521	445	457	521	762						
		RTA 00	1 per carton											
 <p>HB Chair, Armless (Wood) COM: 2.5 YD 2.29 M Unit weight: 40 LB 18.2 KG Carton weight: 50 LB 22.68 KG Carton volume: 27.5 FT³ 0.77 MT³</p>	GC3655WNA Wood	1151	1231	1299	1376	1504	1621	1739	1841	1969	2089	2251	2481	
	Active weight 350 lbs.	OVERALL DIMENSIONS W D H			SEAT DIMENSIONS W D H			BACK DIMENSIONS W H						
		IN 22	27	48.5	20.5	17.5	18	20.5	30					
		MM 559	686	1232	521	445	457	521	762					
		RTA 00	1 per carton											
 <p>HB Armchair, Closed Arms (Wood) COM: 3.25 YD 2.97 M Unit weight: 58 LB 26.4 KG Carton weight: 68 LB 30.84 KG Carton volume: 27.5 FT³ 0.77 MT³</p>	GC3655WCA Wood	1493	1597	1685	1786	1951	2104	2257	2390	2556	2712	2923	3222	
	Active weight 350 lbs.	GC3655WFCA Wood flex back	1831	1935	2023	2124	2289	2442	2595	2728	2894	3050	3261	3560
		OVERALL DIMENSIONS W D H			SEAT DIMENSIONS W D H			BACK DIMENSIONS W H						
		IN 25	27	48.5	20.5	17.5	18	20.5	30					
	MM 635	686	1232	521	445	457	521	762						
		RTA 00	1 per carton											

DESCRIPTION	MODEL# / FEATURES	STANDARD TEXTILE GRADES												
		COM	2	3	4	5	6	7	8	9	10	11	12	
 <p>Bariatric HB Armchair, Open Arms (Wood) COM: 3.5 YD 3.2 M Unit weight: 55 LB 25 KG Carton weight: 65 LB 29.48 KG Carton volume: 30.75 FT³ 0.87 MT³</p>	GC3656W Wood	1682	1794	1889	1997	2176	2340	2505	2648	2827	2995	3222	3544	
		OVERALL DIMENSIONS			SEAT DIMENSIONS			BACK DIMENSIONS						
		W	D	H	W	D	H	W	H					
		IN 35 MM 889	27 686	48.5 1232	30 762	17.5 445	18 457	30 762	30 762					
				RTA 00	1 per carton									
 <p>Bariatric HB Armchair, Closed Arms (Wood) COM: 4.5 YD 4.11 M Unit weight: 65 LB 29.5 KG Carton weight: 75 LB 34.02 KG Carton volume: 33 FT³ 0.93 MT³</p>	GC3656WCA Wood	1878	2022	2144	2283	2513	2724	2936	3120	3350	3566	3858	4272	
		OVERALL DIMENSIONS			SEAT DIMENSIONS			BACK DIMENSIONS						
		W	D	H	W	D	H	W	H					
		IN 35 MM 889	27 686	48.5 1232	30 762	17.5 445	18 457	30 762	30 762					
				RTA 00	1 per carton									
 <p>Wide Hip Armchair Open Arms - Post Surgery (Wood) COM: 1.5 YD 1.37 M Unit weight: 58 LB 26.4 KG Carton weight: 64 LB 29.03 KG Carton volume: 20 FT³ 0.56 MT³</p> <p>Designed to immobilize the pelvis and hip joints after surgery.</p>	GC3657W Wood	1784	1832	1873	1919	1996	2066	2137	2198	2275	2347	2444	2582	
		OVERALL DIMENSIONS			SEAT DIMENSIONS			BACK DIMENSIONS						
		W	D	H	W	D	H	W	H					
		IN 28 MM 711	25 635	41 1041	24 610	17.5 445	26 660	24 610	15.5 394					
				RTA 00	1 per carton									

PRIMACARE LOUNGE



model GC3641 (HT)



model GC3641W (Wood)

STANDARD FEATURES

- Primacare is a family of products offering the most significant return on investment approach in the industry since every component can be repaired or replaced on site.
- **High traffic (HT) models:** Metal frame with die cast zinc connectors and metal-to-metal fasteners. Available in the following finishes: Black (TBL), Cloud (TIV), Designer White (TDW), Fog (TFO), Frost (TFR), Kalua (TKA), Latte (TLA), Mocha (TMO), Nevada (TNE), Sand (TSN), Shadow (TSH), Toast (TOA) and Tungsten (TTU).
- **Wood models:** Solid hardwood frame and armcaps with die cast zinc connectors and metal-to-metal fastening. Available in the following finishes: Absolute (AAM), Charcoal Java (CJM), Cherry (ACM), Empire Mahogany (EMM), English Oak (EOM), Espresso Cafe (ECM), Fruitwood (TFM), Gray (HGM), Harvest Oak (HOM), Honey (AHM), Jet Onyx (JOM), Light Honey (LHM), Mahogany (TMM), Maple (AVM), Medium Walnut (MWM), Natural Walnut (NLW), Night (ASM), Noce Biondo (NBM), Noce Grigio (NGM), Noce Leggero (NEM), Noce Medio (NMM), Sandy Beach (SBM), Shaker Cherry (SKM), Silver Oak (SOM), Walnut (TWM), White (WHM), WC Cream (WTM) and Winter Cherry (WCM).
- Armcaps are securely fastened with metal-to-metal connectors which allow for field replacement if required.
- Easy grip forward extending armcap on models with arms.
- Replaceable seat covers and replaceable and/or removable seat cushions are standard.

- Seat cushion has a seamless waterfall front and clean out between and around the seat and back cushions.
- Models are standard with metal mesh seat deck. For mental health applications, the metal mesh seat deck can be covered with a solid moisture resistant surface, held in place with tamperproof fasteners. Contact your sales rep for a special quotation.
- All seat frames feature a wall saver design to prevent back contact with wall.
- Models ending in **CA** have upholstered panel arm inserts closing the arm. (Closed arm panels are designed to be replaceable. Request a special quote to have them secured with tamperproof fasteners.)
- For healthcare textile options, visit the website at globalfurnituregroup.com.
- Can be upholstered in standard Global textiles if healthcare compliance is not required.
- Shipped fully assembled.

HIGH TRAFFIC (HT) MODELS ARE LISTED FIRST, FOLLOWED BY WOOD MODELS.

OPTIONAL FEATURES

- **High traffic (HT) models:** Wood armcaps are available. See far left column "Wood models" for finishes. Please specify. No upcharge.
- **High traffic (HT) and wood models:** Urethane armcaps are available in the following finishes: Black (BLK), Kalua (KAL), Latte (LAB), Mocha (J52), Shadow (SHW) and Toast (TOA). Please specify. No upcharge.
- For moisture barrier on seat, please specify **(MB)**. Add \$122 per seat.
- To add sealed seams to your product contact Customer Service. Upcharges vary.
- For Primacare tables, see page 59.

SUGGESTED APPLICATIONS

- Bariatric seating
- Guest seating
- Lobbies
- Lounge/Waiting
- Patient rooms
- Resident rooms

DESCRIPTION	MODEL# / FEATURES	STANDARD TEXTILE GRADES											
		COM	2	3	4	5	6	7	8	9	10	11	12
 Bariatric Lounge Chair Open Arms (HT) COM: 3.25 YD 2.97 M Unit weight: 97 LB 44.1 KG Carton weight: 109 LB 49.44 KG Carton volume: 49.5 FT³ 1.4 MT³	GC3640 Metal	2865	2969	3057	3158	3323	3476	3629	3762	3928	4084	4295	4594
		OVERALL DIMENSIONS			SEAT DIMENSIONS			BACK DIMENSIONS					
		IN	40	32	33	36	20	17.25	36	16			
		MM	1016	813	838	914	508	438	914	406			
		RTA 00		1 per carton									
 Bariatric Lounge Chair Closed Arms (HT) COM: 5.75 YD 5.26 M Unit weight: 107 LB 48.6 KG Carton weight: 119 LB 53.98 KG Carton volume: 49.5 FT³ 1.4 MT³	GC3640CA Metal	3162	3346	3501	3680	3973	4243	4513	4749	5042	5318	5692	6221
		OVERALL DIMENSIONS			SEAT DIMENSIONS			BACK DIMENSIONS					
		IN	40	32	33	36	20	17.25	36	16			
		MM	1016	813	838	914	508	438	914	406			
		RTA 00		1 per carton									
 Lounge Chair Open Arms (HT) COM: 2.5 YD 2.29 M Unit weight: 66 LB 30 KG Carton weight: 78 LB 35.38 KG Carton volume: 29.5 FT³ 0.83 MT³	GC3641 Metal	2204	2284	2352	2429	2557	2674	2792	2894	3022	3142	3304	3534
		OVERALL DIMENSIONS			SEAT DIMENSIONS			BACK DIMENSIONS					
		IN	29	32	33	23	20	17.25	22.5	16			
		MM	737	813	838	584	508	438	572	406			
		RTA 00		1 per carton									

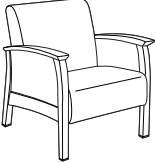
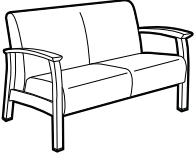
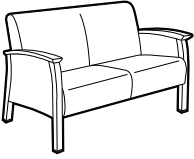
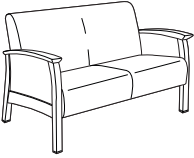
DESCRIPTION	MODEL# / FEATURES	STANDARD TEXTILE GRADES											
		COM	2	3	4	5	6	7	8	9	10	11	12
 <p>Lounge Chair Closed Arms (HT) COM: 3.75 YD 3.43 M Unit weight: 79 LB 35.9 KG Carton weight: 91 LB 41.28 KG Carton volume: 29.5 FT³ 0.83 MT³</p>	GC3641CA Metal	2541	2661	2762	2879	3070	3246	3422	3576	3767	3947	4191	4536
		OVERALL DIMENSIONS			SEAT DIMENSIONS			BACK DIMENSIONS					
		W	D	H	W	D	H	W	H				
	Active weight 500 lbs. Optional wood armcaps. Please specify. No upcharge.	IN 29 MM 737	32 813	33 838	23 584	20 508	17.25 438	22.5 572	16 406				
		RTA 00	1 per carton										
 <p>Lounge Chair Closed Arms, Laminate Panels (HT) COM: 2.5 YD 2.29 M Unit weight: 79 LB 35.9 KG Carton weight: 91 LB 41.28 KG Carton volume: 29.5 FT³ 0.83 MT³</p>	GC3641CAL Metal	2867	2947	3015	3092	3220	3337	3455	3557	3685	3805	3967	4197
		OVERALL DIMENSIONS			SEAT DIMENSIONS			BACK DIMENSIONS					
		W	D	H	W	D	H	W	H				
	Active weight 500 lbs. Optional wood armcaps. Please specify. No upcharge.	IN 29 MM 737	32 813	33 838	23 584	20 508	17.25 438	22.5 572	16 406				
		RTA 00	1 per carton										
 <p>Two Seat Sofa Open Arms (HT) COM: 4 YD 3.66 M Unit weight: 107 LB 48.6 KG Carton weight: 122 LB 55.34 KG Carton volume: 49.5 FT³ 1.4 MT³</p>	GC3642 Metal	3172	3300	3408	3532	3736	3924	4112	4276	4480	4672	4932	5300
		OVERALL DIMENSIONS			SEAT DIMENSIONS			BACK DIMENSIONS					
		W	D	H	W	D	H	W	H				
	Active weight 500 lbs/seat. Optional wood armcaps. Please specify. No upcharge.	IN 52 MM 1321	32 813	33 838	48 1219	20 508	17.25 438	48 1219	16 406				
		RTA 00	1 per carton										
 <p>Two Seat Sofa Closed Arms (HT) COM: 5.5 YD 5.03 M Unit weight: 117 LB 53.2 KG Carton weight: 132 LB 59.87 KG Carton volume: 49.5 FT³ 1.4 MT³</p>	GC3642CA Metal	3500	3676	3825	3995	4276	4534	4793	5018	5299	5563	5920	6426
		OVERALL DIMENSIONS			SEAT DIMENSIONS			BACK DIMENSIONS					
		W	D	H	W	D	H	W	H				
	Active weight 500 lbs/seat. Optional wood armcaps. Please specify. No upcharge.	IN 52 MM 1321	32 813	33 838	48 1219	20 508	17.25 438	48 1219	16 406				
		RTA 00	1 per carton										
 <p>Two Seat Sofa Closed Arms, Laminate Panels (HT) COM: 4 YD 3.66 M Unit weight: 117 LB 53.2 KG Carton weight: 132 LB 59.87 KG Carton volume: 49.5 FT³ 1.4 MT³</p>	GC3642CAL Metal	3836	3964	4072	4196	4400	4588	4776	4940	5144	5336	5596	5964
		OVERALL DIMENSIONS			SEAT DIMENSIONS			BACK DIMENSIONS					
		W	D	H	W	D	H	W	H				
	Active weight 500 lbs/seat. Optional wood armcaps. Please specify. No upcharge.	IN 52 MM 1321	32 813	33 838	48 1219	20 508	17.25 438	48 1219	16 406				
		RTA 00	1 per carton										

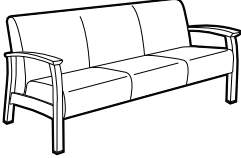
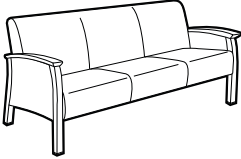
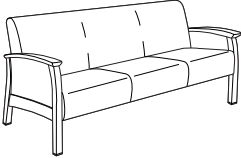
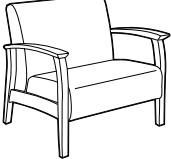
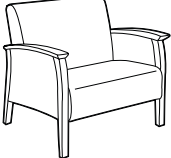
DESCRIPTION	MODEL# / FEATURES	STANDARD TEXTILE GRADES												
		COM	2	3	4	5	6	7	8	9	10	11	12	
 <p>Three Seat Sofa Open Arms (HT) COM: 6.25 YD 5.72 M Unit weight: 148 LB 67.3 KG Carton weight: 173 LB 78.47 KG Carton volume: 69.5 FT³ 1.96 MT³</p>	GC3643 Metal	4112	4312	4481	4675	4993	5287	5581	5837	6156	6456	6862	7437	
	Active weight 500 lbs./seat.	IN 75	32	33		71	20	17.25		71	16			
	Optional wood armcaps. Please specify. No upcharge.	MM 1905	813	838		1803	508	438		1803	406			
		RTA 00												1 per carton
		COM	2	3	4	5	6	7	8	9	10	11	12	
		OVERALL DIMENSIONS	SEAT DIMENSIONS			BACK DIMENSIONS								
		W	D	H	W	D	H	W	H					
 <p>Three Seat Sofa Closed Arms (HT) COM: 7.5 YD 6.86 M Unit weight: 158 LB 71.8 KG Carton weight: 183 LB 83.01 KG Carton volume: 69.5 FT³ 1.96 MT³</p>	GC3643CA Metal	4453	4693	4896	5128	5511	5863	6216	6523	6906	7266	7753	8443	
	Active weight 500 lbs./seat.	IN 75	32	33		71	20	17.25		71	16			
	Optional wood armcaps. Please specify. No upcharge.	MM 1905	813	838		1803	508	438		1803	406			
		RTA 00												1 per carton
		COM	2	3	4	5	6	7	8	9	10	11	12	
		OVERALL DIMENSIONS	SEAT DIMENSIONS			BACK DIMENSIONS								
		W	D	H	W	D	H	W	H					
 <p>Three Seat Sofa Closed Arms, Laminate Panels (HT) COM: 6.25 YD 5.72 M Unit weight: 158 LB 71.8 KG Carton weight: 183 LB 83.01 KG Carton volume: 69.5 FT³ 1.96 MT³</p>	GC3643CAL Metal	4778	4978	5147	5341	5659	5953	6247	6503	6822	7122	7528	8103	
	Active weight 500 lbs./seat.	IN 75	32	33		71	20	17.25		71	16			
	Optional wood armcaps. Please specify. No upcharge.	MM 1905	813	838		1803	508	438		1803	406			
		RTA 00												1 per carton
		COM	2	3	4	5	6	7	8	9	10	11	12	
		OVERALL DIMENSIONS	SEAT DIMENSIONS			BACK DIMENSIONS								
		W	D	H	W	D	H	W	H					
 <p>Bariatric Lounge Chair, Open Arms (Wood) COM: 3.25 YD 2.97 M Unit weight: 85 LB 38.6 KG Carton weight: 97 LB 44 KG Carton volume: 49.5 FT³ 1.4 MT³</p>	GC3640W Wood	2242	2346	2434	2535	2700	2853	3006	3139	3305	3461	3672	3971	
	Active weight 500 lbs.	IN 40	32	33		36	20	17.25		36	16			
	Optional urethane armcaps. Please specify. No upcharge.	MM 1016	813	838		914	508	438		914	406			
		RTA 00												1 per carton
		COM	2	3	4	5	6	7	8	9	10	11	12	
		OVERALL DIMENSIONS	SEAT DIMENSIONS			BACK DIMENSIONS								
		W	D	H	W	D	H	W	H					
 <p>Bariatric Lounge Chair, Closed Arms (Wood) COM: 5.75 YD 5.26 M Unit weight: 95 LB 43.2 KG Carton weight: 107 LB 48.53 KG Carton volume: 49.5 FT³ 1.4 MT³</p>	GC3640WCA Wood	2460	2644	2799	2978	3271	3541	3811	4047	4340	4616	4990	5519	
	Active weight 500 lbs.	IN 40	32	33		36	20	17.25		36	16			
	Optional urethane armcaps. Please specify. No upcharge.	MM 1016	813	838		914	508	438		914	406			
		RTA 00												1 per carton
		COM	2	3	4	5	6	7	8	9	10	11	12	
		OVERALL DIMENSIONS	SEAT DIMENSIONS			BACK DIMENSIONS								
		W	D	H	W	D	H	W	H					

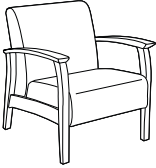
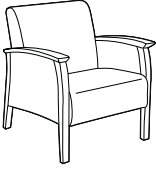
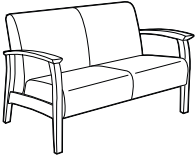
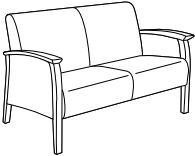
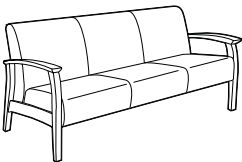
DESCRIPTION	MODEL# / FEATURES	STANDARD TEXTILE GRADES											
 <p>Lounge Chair, Open Arms (Wood) COM: 2.5 YD 2.29 M Unit weight: 54 LB 24.5 KG Carton weight: 66 LB 29.94 KG Carton volume: 29.5 FT³ 0.83 MT³</p>	<p>GC3641W Wood</p>	COM	2	3	4	5	6	7	8	9	10	11	12
		1725	1805	1873	1950	2078	2195	2313	2415	2543	2663	2825	3055
		OVERALL DIMENSIONS			SEAT DIMENSIONS			BACK DIMENSIONS					
		W	D	H	W	D	H	W	H				
IN	29	32	33	23	20	17.25	22.5	16					
MM	737	813	838	584	508	438	572	406					
Active weight 350 lbs.	Optional urethane armcaps. Please specify. No upcharge.	RTA 00	1 per carton										
 <p>Lounge Chair, Closed Arms (Wood) COM: 3.75 YD 3.43 M Unit weight: 67 LB 30.5 KG Carton weight: 79 LB 35.83 KG Carton volume: 29.5 FT³ 0.83 MT³</p>	<p>GC3641WCA Wood</p>	COM	2	3	4	5	6	7	8	9	10	11	12
		1983	2103	2204	2321	2512	2688	2864	3018	3209	3389	3633	3978
		OVERALL DIMENSIONS			SEAT DIMENSIONS			BACK DIMENSIONS					
		W	D	H	W	D	H	W	H				
IN	29	32	33	23	20	17.25	22.5	16					
MM	737	813	838	584	508	438	572	406					
Active weight 350 lbs.	Optional urethane armcaps. Please specify. No upcharge.	RTA 00	1 per carton										
 <p>Two Seat Sofa, Open Arms (Wood) COM: 4 YD 3.66 M Unit weight: 95 LB 43.2 KG Carton weight: 110 LB 49.9 KG Carton volume: 49.5 FT³ 1.4 MT³</p>	<p>GC3642W Wood</p>	COM	2	3	4	5	6	7	8	9	10	11	12
		2480	2608	2716	2840	3044	3232	3420	3584	3788	3980	4240	4608
		OVERALL DIMENSIONS			SEAT DIMENSIONS			BACK DIMENSIONS					
		W	D	H	W	D	H	W	H				
IN	52	32	33	48	20	17.25	48	16					
MM	1321	813	838	1219	508	438	1219	406					
Active weight 350 lbs/seat.	Optional urethane armcaps. Please specify. No upcharge.	RTA 00	1 per carton										
 <p>Two Seat Sofa, Closed Arms (Wood) COM: 5.5 YD 5.03 M Unit weight: 105 LB 47.7 KG Carton weight: 120 LB 54.43 KG Carton volume: 49.5 FT³ 1.4 MT³</p>	<p>GC3642WCA Wood</p>	COM	2	3	4	5	6	7	8	9	10	11	12
		2729	2905	3054	3224	3505	3763	4022	4247	4528	4792	5149	5655
		OVERALL DIMENSIONS			SEAT DIMENSIONS			BACK DIMENSIONS					
		W	D	H	W	D	H	W	H				
IN	52	32	33	48	20	17.25	48	16					
MM	1321	813	838	1219	508	438	1219	406					
Active weight 350 lbs/seat.	Optional urethane armcaps. Please specify. No upcharge.	RTA 00	1 per carton										
 <p>Three Seat Sofa, Open Arms (Wood) COM: 6.25 YD 5.72 M Unit weight: 136 LB 61.8 KG Carton weight: 161 LB 73.03 KG Carton volume: 69.5 FT³ 1.96 MT³</p>	<p>GC3643W Wood</p>	COM	2	3	4	5	6	7	8	9	10	11	12
		3212	3412	3581	3775	4093	4387	4681	4937	5256	5556	5962	6537
		OVERALL DIMENSIONS			SEAT DIMENSIONS			BACK DIMENSIONS					
		W	D	H	W	D	H	W	H				
IN	75	32	33	71	20	17.25	71	16					
MM	1905	813	838	1803	508	438	1803	406					
Active weight 350 lbs/seat.	Optional urethane armcaps. Please specify. No upcharge.	RTA 00	1 per carton										

DESCRIPTION

MODEL# / FEATURES

STANDARD TEXTILE GRADES

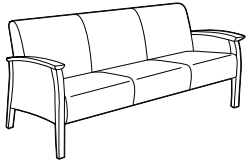

GC3643WCA
Wood

COM	2	3	4	5	6	7	8	9	10	11	12
3469	3709	3912	4144	4527	4879	5232	5539	5922	6282	6769	7459

OVERALL DIMENSIONS
W D H

SEAT DIMENSIONS
W D H

BACK DIMENSIONS
W H

Active weight 350 lbs/seat.

IN	75	32	33	71	20	17.25	71	16
MM	1905	813	838	1803	508	438	1803	406

Optional urethane armcaps.
Please specify. No upcharge.

RTA 00 1 per carton

Three Seat Sofa, Closed Arms (Wood)
COM: 7.5 YD | 6.86 M
Unit weight: 146 LB | 66.4 KG
Carton weight: 171 LB | 77.56 KG
Carton volume: 69.5 FT³ | 1.96 MT³

PRIMACARE FULLY UPHOLSTERED LOUNGE



model GC3676HB



model GC3677

STANDARD FEATURES

- Primacare is a family of products offering the most significant return on investment approach in the industry since every component can be repaired or replaced on site.
- Standard with fully upholstered arms.
- The seat frame features a beautifully angled back creating a wall saver design to prevent damage to walls.
- The structural frame is constructed of solid hardwood with metal mesh seat deck, die cast zinc connectors and metal-to-metal fastening, providing an exceptionally strong and durable solution.
- The arm panels, legs, seat, back and cushion covers are field replaceable.
- Seat cushion has a seamless waterfall front and clean out between and around the seat and back cushions.
- For mental health applications, the metal mesh seat deck can be covered with a solid moisture resistant surface, held in place with tamperproof fasteners. Contact your sales rep for a special quotation.
- For healthcare textile options, visit the website at globalfurnituregroup.com.
- Can be upholstered in standard Global textiles if healthcare compliance is not required.
- Left and right position reference is determined from the seated position.
- Shipped fully assembled.

OPTIONAL FEATURES

- Optional urethane (urethane) legs and armcaps available in the following finishes: Black (BLK), Kalua (KAL), Latte (LAB), Mocha (J52), Shadow (SHW) and Toast (TOA). See features column for upcharges.
- Optional wood legs and armcaps available in the following finishes: Absolute (AAM), Charcoal Java (CJM), Cherry (ACM), Empire Mahogany (EMM), English Oak (EOM), Espresso Cafe (ECM), Fruitwood (TFM), Gray (HGM), Harvest Oak (HOM), Honey (AHM), Jet Onyx (JOM), Light Honey (LHM), Mahogany (TMM), Maple (AVM), Medium Walnut (MWM), Neutral Walnut (NLW), Night (ASM), Noce Biondo (NBM), Noce Grigio (NGM), Noce Leggero (NEM), Noce Medio (NMM), Sandy Beach (SBM), Silver Oak (SOM), Walnut (TWM), White (WHM), WC Cream (WTM) and Winter Cherry (WCM). See features column for upcharges.
- Armcaps are securely fastened with metal-to-metal connectors which allow for field replacement if required. Armcaps cannot be retrofitted in the field on units with no existing armcaps.
- For moisture barrier on seat, please specify **(MB)**. Add \$122 per seat.
- To add sealed seams to your product contact Customer Service. Upcharges vary.
- For Primacare tables, see page 59.

SUGGESTED APPLICATIONS

- Bariatric setting
- Lobbies
- Guest seating
- Lounge/Waiting

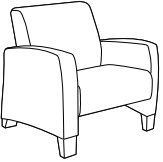
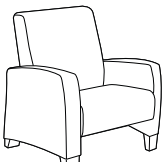
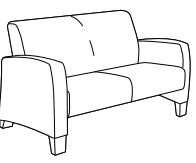
DESCRIPTION	MODEL# / FEATURES	STANDARD TEXTILE GRADES												
		COM	2	3	4	5	6	7	8	9	10	11	12	
 <p>Lounge Chair Fully Uph Arms, Urethane Legs COM: 6.25 YD 5.72 M Unit weight: 83 LB 37.7 KG Carton weight: 95 LB 43.09 KG Carton volume: 29.5 FT³ 0.83 MT³</p>	GC3676	1966	2166	2335	2529	2847	3141	3435	3691	4010	4310	4716	5291	
	Active weight 350 lbs.	OVERALL DIMENSIONS			SEAT DIMENSIONS			BACK DIMENSIONS						
	Optional wood legs. No upcharge.	IN	32.5	29	33	23	20	17.25	23	16				
	Optional urethane or wood armcaps. Add \$284.	MM	826	737	838	584	508	438	584	406				
		RTA 00	1 per carton											
 <p>HB Lounge Chair Fully Uph Arms, Urethane Legs COM: 6.5 YD 5.94 M Unit weight: 102 LB 46.4 KG Carton weight: 114 LB 51.71 KG Carton volume: 29.5 FT³ 0.83 MT³</p>	GC3676HB	2111	2319	2495	2696	3028	3333	3639	3905	4237	4549	4971	5569	
	Active weight 350 lbs.	OVERALL DIMENSIONS			SEAT DIMENSIONS			BACK DIMENSIONS						
	Optional wood legs. No upcharge.	IN	32.5	29	36	23	20	17.25	23	19				
	Optional urethane or wood armcaps. Add \$284.	MM	826	737	914	584	508	438	584	483				
		RTA 00	1 per carton											
 <p>Two Seat Sofa Fully Uph Arms, Urethane Legs COM: 7.5 YD 6.86 M Unit weight: 120 LB 54.5 KG Carton weight: 135 LB 61.23 KG Carton volume: 56.25 FT³ 1.59 MT³</p>	GC3677	2733	2973	3176	3408	3791	4143	4496	4803	5186	5546	6033	6723	
	Active weight 350 lbs/seat.	OVERALL DIMENSIONS			SEAT DIMENSIONS			BACK DIMENSIONS						
	Optional wood legs. No upcharge.	IN	55.5	29	33	45.5	20	17.25	45.5	16				
	Optional urethane or wood armcaps. Add \$284.	MM	1410	737	838	1156	508	438	1156	406				
		RTA 00	1 per carton											

DESCRIPTION MODEL# / FEATURES STANDARD TEXTILE GRADES

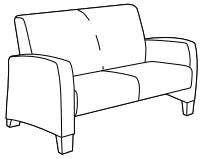

HB Two Seat Sofa Fully Uph Arms, Urethane Legs

COM: 7.75 YD | 7.09 M
 Unit weight: 127 LB | 57.7 KG
 Carton weight: 142 LB | 64.41 KG
 Carton volume: 56.25 FT³ | 1.59 MT³

GC3677HB

COM	2	3	4	5	6	7	8	9	10	11	12
3032	3280	3489	3730	4125	4489	4853	5171	5566	5938	6442	7155

Active weight 350 lbs/seat.

Optional wood legs.
 No upcharge.

Optional urethane or wood armcaps. Add \$284.

OVERALL DIMENSIONS			SEAT DIMENSIONS			BACK DIMENSIONS	
W	D	H	W	D	H	W	H

IN	55.5	29	36	45.5	20	17.25	45.5	19
MM	1410	737	914	1156	508	438	1156	483

RTA 00 1 per carton

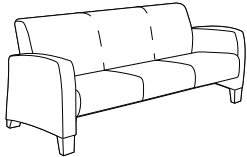

Three Seat Sofa Fully Uph Arms, Urethane Legs

COM: 9 YD | 8.23 M
 Unit weight: 156 LB | 70.9 KG
 Carton weight: 181 LB | 82.1 KG
 Carton volume: 69.5 FT³ | 1.96 MT³

GC3678

COM	2	3	4	5	6	7	8	9	10	11	12
3645	3933	4176	4455	4914	5337	5760	6129	6588	7020	7605	8433

Active weight 350 lbs/seat.

Optional wood legs.
 No upcharge.

Optional urethane or wood armcaps. Add \$284.

OVERALL DIMENSIONS			SEAT DIMENSIONS			BACK DIMENSIONS	
W	D	H	W	D	H	W	H

IN	78.5	29	33	68.5	20	17.25	68.5	16
MM	1994	737	838	1740	508	438	1740	406

RTA 00 1 per carton

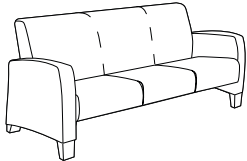

HB Three Seat Sofa Fully Uph Arms, Urethane Legs

COM: 9.25 YD | 8.46 M
 Unit weight: 163 LB | 74.1 KG
 Carton weight: 188 LB | 85.28 KG
 Carton volume: 69.5 FT³ | 1.96 MT³

GC3678HB

COM	2	3	4	5	6	7	8	9	10	11	12
4097	4393	4643	4930	5401	5836	6271	6650	7122	7566	8167	9018

Active weight 350 lbs/seat.

Optional wood legs.
 No upcharge.

Optional urethane or wood armcaps. Add \$284.

OVERALL DIMENSIONS			SEAT DIMENSIONS			BACK DIMENSIONS	
W	D	H	W	D	H	W	H

IN	78.5	29	36	68.5	20	17.25	68.5	19
MM	1994	737	914	1740	508	438	1740	483

RTA 00 1 per carton

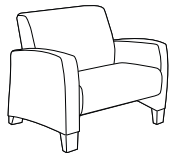

Bariatric Lounge Chair Fully Uph Arms, Urethane Legs

COM: 6.5 YD | 5.94 M
 Unit weight: 95 LB | 43.2 KG
 Carton weight: 107 LB | 48.53 KG
 Carton volume: 37.75 FT³ | 1.06 MT³

GC3679

COM	2	3	4	5	6	7	8	9	10	11	12
2303	2511	2687	2888	3220	3525	3831	4097	4429	4741	5163	5761

Active weight 500 lbs.

Optional wood legs.
 No upcharge.

Optional urethane or wood armcaps. Add \$284.

OVERALL DIMENSIONS			SEAT DIMENSIONS			BACK DIMENSIONS	
W	D	H	W	D	H	W	H

IN	42	29	33	32	20	17.25	32	16
MM	1067	737	838	813	508	438	813	406

RTA 00 1 per carton

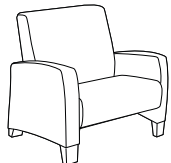

HB Bariatric Lounge Chair Fully Uph Arms, Urethane Legs

COM: 6.75 YD | 6.17 M
 Unit weight: 109 LB | 49.5 KG
 Carton weight: 121 LB | 54.88 KG
 Carton volume: 37.75 FT³ | 1.06 MT³

GC3679HB

COM	2	3	4	5	6	7	8	9	10	11	12
2497	2713	2895	3105	3449	3766	4083	4360	4704	5028	5467	6088

Active weight 500 lbs.

Optional wood legs.
 No upcharge.

Optional urethane or wood armcaps. Add \$284.

OVERALL DIMENSIONS			SEAT DIMENSIONS			BACK DIMENSIONS	
W	D	H	W	D	H	W	H

IN	42	29	36	32	20	17.25	32	19
MM	1067	737	914	813	508	438	813	483

RTA 00 1 per carton

PRIMACARE WINGBACK



model GC3691HB



model GC3692HB

STANDARD FEATURES



- Primacare is a family of products offering the most significant return on investment approach in the industry since every component can be repaired or replaced on site.
- Standard with Black urethane (urethane) legs and armcaps.
- Armcaps are securely fastened with metal-to-metal connectors which allow for field replacement if required.
- Easy grip forward extending armcap on models with arms.
- For added comfort, seat and back are standard with high density Ultracell foam.
- Replaceable seat covers and replaceable and/or removable seat cushions are standard.
- Seat cushion has a seamless waterfall front and clean out between and around the seat and back cushions.
- Models are standard with metal mesh seat deck. For mental health applications, the metal mesh seat deck can be covered with a solid moisture resistant surface, held in place with tamperproof fasteners. Contact your sales rep for a special quotation.
- For healthcare textile options, visit the website at globalfurnituregroup.com.
- Can be upholstered in standard Global textiles if healthcare compliance is not required.

OPTIONAL FEATURES

- Optional urethane (urethane) legs and armcaps available in the following finishes: Kalua (KAL), Latte (LAB), Mocha (J52), Shadow (SHW) and Toast (TOA). No upcharge.
- For optional wood legs and armcaps, refer to the Seating wood finishes in the Textiles and Finishes section.
For wood armcaps: Add \$65.
For wood legs: Add \$155.
- For moisture barrier on seat, please specify **(MB)**.
For one seater: Add \$122.
For two seater: Add \$242.
For bariatric models: Add \$162.
- To add sealed seams to your product contact Customer Service. Upcharges vary.
- For Primacare tables, see page 59.

SUGGESTED APPLICATIONS

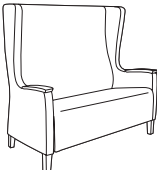
- Bariatric seating
- Lobbies
- Lounge/Waiting
- Guest seating
- Patient rooms
- Resident rooms

DESCRIPTION	MODEL# / FEATURES	STANDARD TEXTILE GRADES												
		COM	2	3	4	5	6	7	8	9	10	11	12	
 <p>Single Seater Wingback Armchair COM: 6.25 YD 5.72 M Unit weight: 77 LB 35 KG Carton weight: 94 LB 42.64 KG Carton volume: 29 FT³ 0.82 MT³</p>	GC3691HB	2727	2927	3096	3290	3609	3902	4196	4452	4771	5071	5477	6052	
	Active weight 350 lbs.	IN		30.5	28.5	45.5	22.5	18	19	19	26			
		MM		775	724	1156	572	457	483	483	660			
		RTA 00	1 per carton											
			OVERALL DIMENSIONS		SEAT DIMENSIONS			BACK DIMENSIONS						
		W	D	H	W	D	H	W	H					
 <p>Two Seater Wingback Armchair COM: 9.5 YD 8.69 M Unit weight: 133 LB 60.5 KG Carton weight: 163 LB 73.94 KG Carton volume: 52.5 FT³ 1.48 MT³</p>	GC3692HB	3742	4046	4303	4597	5082	5528	5975	6364	6849	7305	7922	8796	
	Active weight 350 lbs/seat.	IN		57.5	28.5	45.5	50	18	19	45	26			
		MM		1461	724	1156	1270	457	483	1143	660			
		RTA 00	1 per carton											
			OVERALL DIMENSIONS		SEAT DIMENSIONS			BACK DIMENSIONS						
		W	D	H	W	D	H	W	H					
 <p>Bariatric Single Seater Wingback Armchair COM: 8.25 YD 7.54 M Unit weight: 109 LB 49.5 KG Carton weight: 130 LB 58.97 KG Carton volume: 35.5 FT³ 1 MT³</p>	GC3694HB	3054	3318	3541	3797	4218	4605	4993	5331	5752	6148	6684	7443	
	Active weight 600 lbs.	IN		38	28.5	45.5	31	18	19	26.5	26			
		MM		965	724	1156	787	457	483	673	660			
		RTA 00	1 per carton											
			OVERALL DIMENSIONS		SEAT DIMENSIONS			BACK DIMENSIONS						
		W	D	H	W	D	H	W	H					

DESCRIPTION	MODEL# / FEATURES	STANDARD TEXTILE GRADES											
-------------	-------------------	-------------------------	--	--	--	--	--	--	--	--	--	--	--

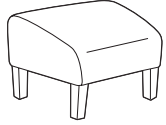

Standard Size Ottoman
 COM: 1.25 YD | 1.14 M
 Unit weight: 12 LB | 5.5 KG
 Carton weight: 17 LB | 7.71 KG
 Carton volume: 4.7 FT³ | 0.13 MT³

MODEL# / FEATURES	COM	2	3	4	5	6	7	8	9	10	11	12
GC3695	675	715	749	788	851	910	969	1020	1084	1144	1225	1340

OVERALL DIMENSIONS			SEAT DIMENSIONS			BACK DIMENSIONS	
W	D	H	W	D	H	W	H

Active weight 350 lbs.	IN 23	18	15.75	-	-	-	-	-
	MM 584	457	400	-	-	-	-	-

Add \$81 for (MB). RTA 00 1 per carton

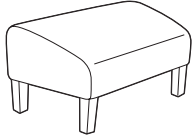

Bariatric Ottoman
 COM: 1.75 YD | 1.6 M
 Unit weight: 15 LB | 6.8 KG
 Carton weight: 20 LB | 9.07 KG
 Carton volume: 9 FT³ | 0.25 MT³

MODEL# / FEATURES	COM	2	3	4	5	6	7	8	9	10	11	12
GC3696	848	904	951	1006	1095	1177	1259	1331	1420	1504	1618	1779

OVERALL DIMENSIONS			SEAT DIMENSIONS			BACK DIMENSIONS	
W	D	H	W	D	H	W	H

Active weight 500 lbs.	IN 31.25	18	15.75	-	-	-	-	-
	MM 794	457	400	-	-	-	-	-

Add \$122 for (MB). RTA 00 1 per carton

PRIMACARE RECLINERS



model GC3608



model GC3609

STANDARD FEATURES

- Primacare is a family of products offering the most significant return on investment approach in the industry since every component can be repaired or replaced on site.
- Solid hardwood frame with die cast zinc connectors and metal-to-metal fastening. Available in the following finishes: Absolute (AAM), Charcoal Java (CJM), Cherry (ACM), Empire Mahogany (EMM), English Oak (EOM), Espresso Cafe (ECM), Fruitwood (TFM), Gray (HGM), Harvest Oak (HOM), Honey (AHM), Jet Onyx (JOM), Light Honey (LHM), Mahogany (TMM), Maple (AVM), Medium Walnut (MWM), Natural Walnut (NLW), Night (ASM), Noce Biondo (NBM), Noce Grigio (NGM), Noce Leggero (NEM), Noce Medio (NMM), Sandy Beach (SBM), Shaker Cherry (SKM), Silver Oak (SOM), Walnut (TWM), White (WHM), WC Cream (WTM) and Winter Cherry (WCM).
- Armcaps are securely fastened with metal-to-metal connectors which allow for field replacement if required.
- Easy grip forward extending armcap on models with arms.
- For healthcare textile options, visit the website at globalfurnituregroup.com.
- Can be upholstered in standard Global textiles if healthcare compliance is not required.
- Shipped easy to assemble.

OPTIONAL FEATURES



- Urethane armcaps are available in the following finishes: Black (BLK), Kalua (KAL), Latte (LAB), Mocha (J52), Shadow (SHW) and Toast (TOA). Please specify. No upcharge.
- Urethane armcaps are not available on models GC3606 and GC3609.
- For moisture barrier on seat, please specify (MB). Add \$122 per seat.
- To add sealed seams to your product contact Customer Service. Upcharges vary.
- For Primacare tables, see page 59.

GC3608 AND GC3609 ONLY

- To add a Reverse Recline mechanism, please specify (RR). No upcharge.
- Tablet arm with spill collector on the edge is available, offered in Black Phenolic material. From seated position, specify (LT) for left hand tablet or (RT) for right hand tablet. Add \$572. For left and right tablets, please specify (TB). Add \$1143.
- A Foley bag hook can be positioned on the left (LT) or right (RT). Add \$23. For left and right Foley bag hooks, please specify (LR). Add \$45.
- An IV pole that can be positioned on the left or right side is available. Specify (IV). Add \$247.
- An oxygen tank holder is available, please specify (OX). Add \$142.
- Footrest in Grey thermally fused laminate with a Black edge is available. Specify (FT). Add \$199.

SUGGESTED APPLICATIONS

- Guest seating
- Lobbies
- Lounge/Waiting
- Patient rooms
- Resident rooms
- Treatment/Exam rooms

DESCRIPTION	MODEL# / FEATURES	STANDARD TEXTILE GRADES											
		COM	2	3	4	5	6	7	8	9	10	11	12
 <p>Recliner Solid Wood Armcaps, Full Span COM: 6.5 YD 5.94 M Unit weight: 98 LB 44.5 KG Carton weight: 110 LB 49.9 KG Carton volume: 22.75 FT³ 0.64 MT³</p>	GC3605	2394	2602	2778	2979	3311	3616	3922	4188	4520	4832	5254	5852
	Active weight 350 lbs.												
	Head mat & replaceable seat cushion.												
	Optional urethane armcaps. Please specify. No upcharge.												
	Not available with casters.	RTA 2	1 per carton										
 <p>Recliner Partial (Front Only) Solid Wood Armcaps COM: 6.5 YD 5.94 M Unit weight: 98 LB 44.5 KG Carton weight: 110 LB 49.9 KG Carton volume: 22.75 FT³ 0.64 MT³</p>	GC3606	2237	2445	2621	2822	3154	3459	3765	4031	4363	4675	5097	5695
	Active weight 350 lbs.												
	Head mat & replaceable seat cushion.												
	Not available with casters.	RTA 2	1 per carton										

DESCRIPTION MODEL# / FEATURES STANDARD TEXTILE GRADES

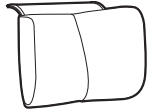

Headrest For Primacare Recliners Only

COM: 1.25 YD | 1.14 M
 Unit weight: 1.5 LB | 0.7 KG
 Carton weight: 3 LB | 1.36 KG
 Carton volume: 1 FT³ | 0.02 MT³

GC3607

COM	2	3	4	5	6	7	8	9	10	11	12
114	154	188	227	290	349	408	459	523	583	664	779

OVERALL DIMENSIONS			SEAT DIMENSIONS			BACK DIMENSIONS	
W	D	H	W	D	H	W	H

IN	14	4	9.5	-	-	-	-	-
MM	356	102	241	-	-	-	-	-

RTA 00  1 per carton



Motion Recliner Solid Wood Armcaps, Full Span

COM: 6.5 YD | 5.94 M
 Unit weight: 110 LB | 50 KG
 Carton weight: 120 LB | 54.43 KG
 Carton volume: 27.75 FT³ | 0.78 MT³

GC3608

COM	2	3	4	5	6	7	8	9	10	11	12
2989	3197	3373	3574	3906	4211	4517	4783	5115	5427	5849	6447

Active weight 400 lbs.

Optional urethane armcaps. Please specify. No upcharge.

Optional 4 manual locking casters w/push bar. Please specify **(MRC)**. No upcharge.

OVERALL DIMENSIONS			SEAT DIMENSIONS			BACK DIMENSIONS	
W	D	H	W	D	H	W	H

IN	30	39	46.5	23.5	20	19	22.5	29
MM	762	991	1181	597	508	483	572	737

RTA 2 1 per carton



Motion Recliner Partial (Front Only) Solid Wood Armcaps

COM: 6.5 YD | 5.94 M
 Unit weight: 110 LB | 50 KG
 Carton weight: 120 LB | 54.43 KG
 Carton volume: 27.75 FT³ | 0.78 MT³

Active weight 400 lbs.

Optional 4 manual locking casters w/push bar. Please specify **(MRC)**. No upcharge.

GC3609

COM	2	3	4	5	6	7	8	9	10	11	12
2566	2774	2950	3151	3483	3788	4094	4360	4692	5004	5426	6024

OVERALL DIMENSIONS			SEAT DIMENSIONS			BACK DIMENSIONS	
W	D	H	W	D	H	W	H

IN	30	39	46.5	23.5	20	19	22.5	29
MM	762	991	1181	597	508	483	572	737

RTA 2 1 per carton

PRIMACARE SLEEPERS



model GC3611



model GC3611 (pulled out)

STANDARD FEATURES



- Primacare is a family of products offering the most significant return on investment approach in the industry since every component can be repaired or replaced on site.
- Solid hardwood frame with die cast zinc connectors and metal-to-metal fastening. Available in the following finishes: Absolute (AAM), Charcoal Java (CJM), Cherry (ACM), Empire Mahogany (EMM), English Oak (EOM), Espresso Cafe (ECM), Fruitwood (TFM), Gray (HGM), Harvest Oak (HOM), Honey (AHM), Jet Onyx (JOM), Light Honey (LHM), Mahogany (TMM), Maple (AVM), Medium Walnut (MWM), Natural Walnut (NLW), Night (ASM), Noce Biondo (NBM), Noce Grigio (NGM), Noce Leggero (NEM), Noce Medio (NMM), Sandy Beach (SBM), Shaker Cherry (SKM), Silver Oak (SOM), Walnut (TWM), White (WHM), WC Cream (WTM) and Winter Cherry (WCM).
- Armcaps are securely fastened with metal-to-metal connectors which allow for field replacement if required.
- Easy grip forward extending armcap on models with arms.
- For healthcare textile options, visit the website at globalfurnituregroup.com.
- Can be upholstered in standard Global textiles if healthcare compliance is not required.
- Shipped fully assembled.

OPTIONAL FEATURES

- Urethane armcaps are available in the following finishes: Black (BLK), Kalua (KAL), Latte (LAB), Mocha (J52), Shadow (SHW) and Toast (TOA). Please specify. No upcharge.
- Tablet arm with spill collector on the edge is available, offered in Black Phenolic material. From a seated position, specify **(LT)** for left hand tablet or **(RT)** for right hand tablet. Add \$572. For left and right tablets, please specify **(TB)**. Add \$1143.
- For moisture barrier on seat, please specify **(MB)**. For single sleeper: Add \$122. For double sleeper: Add \$245.
- To add sealed seams to your product contact Customer Service. Upcharges vary.
- For Primacare tables, see page 59.

SUGGESTED APPLICATIONS

- Guest seating
- Lounge/Waiting
- Patient rooms
- Resident rooms
- Treatment/Exam rooms

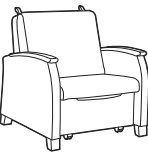
DESCRIPTION	MODEL# / FEATURES	STANDARD TEXTILE GRADES											
		COM	2	3	4	5	6	7	8	9	10	11	12
 <p>Single Sleeper Chair, Wood Legs COM: 7.5 YD 6.86 M Unit weight: 108 LB 49.1 KG Carton weight: 116 LB 52.62 KG Carton volume: 32.25 FT³ 0.91 MT³</p>	GC3610	3696	3936	4139	4371	4754	5106	5459	5766	6149	6509	6996	7686
	Active weight 350 lbs.												
	Sleep surface 24.5"W x 77"L												
	Optional urethane armcaps. Please specify. No upcharge.												
		RTA 00	1 per carton										
 <p>Single Sleeper Chair, Casters COM: 7.5 YD 6.86 M Unit weight: 108 LB 49.1 KG Carton weight: 116 LB 52.62 KG Carton volume: 32.25 FT³ 0.91 MT³</p>	GC3610C	3696	3936	4139	4371	4754	5106	5459	5766	6149	6509	6996	7686
	Active weight 350 lbs.												
	Sleep surface 24.5"W x 77"L												
	Optional urethane armcaps. Please specify. No upcharge.												
		RTA 00	1 per carton										
 <p>Single Sleeper Chair, Wide, Wood Legs COM: 9 YD 8.23 M Unit weight: 128 LB 58.2 KG Carton weight: 140 LB 63.5 KG Carton volume: 36.75 FT³ 1.04 MT³</p>	GC3611	3960	4248	4491	4770	5229	5652	6075	6444	6903	7335	7920	8748
	Active weight 350 lbs.												
	Sleep surface 30"W x 77"L												
	Optional urethane armcaps. Please specify. No upcharge.												
		RTA 00	1 per carton										

DESCRIPTION	MODEL# / FEATURES	STANDARD TEXTILE GRADES										
		COM	2	3	4	5	6	7	8	9	10	11



Single Sleeper Chair, Wide, Casters
 COM: 9 YD | 8.23 M
 Unit weight: 128 LB | 58.2 KG
 Carton weight: 140 LB | 63.5 KG
 Carton volume: 36.75 FT³ | 1.04 MT³

Active weight 350 lbs.

Sleep surface 30"W x 77"L.

Optional urethane armcaps.
 Please specify. No upcharge.

GC3611C	3960	4248	4491	4770	5229	5652	6075	6444	6903	7335	7920	8748
----------------	------	------	------	------	------	------	------	------	------	------	------	------

OVERALL DIMENSIONS			SEAT DIMENSIONS			BACK DIMENSIONS	
W	D	H	W	D	H	W	H

IN	37	37.5	38	30	20	18	30	21
MM	940	953	965	762	508	457	762	533

RTA 00 1 per carton

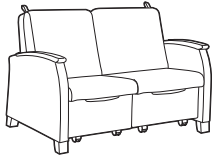

Double Sleeper Chair, Wood Legs
 COM: 11.75 YD | 10.74 M
 Unit weight: 205 LB | 93.2 KG
 Carton weight: 215 LB | 97.52 KG
 Carton volume: 60 FT³ | 1.69 MT³

Active weight 350 lbs/seat.

Each sleep surface is
 24.5"W x 77"L.

Optional urethane armcaps.
 Please specify. No upcharge.

GC3612	5526	5902	6219	6584	7183	7735	8287	8769	9368	9932	10696	11777
---------------	------	------	------	------	------	------	------	------	------	------	-------	-------

OVERALL DIMENSIONS			SEAT DIMENSIONS			BACK DIMENSIONS	
W	D	H	W	D	H	W	H

IN	56	36	38	48	19.5	18	48	21
MM	1422	914	965	1219	495	457	1219	533

RTA 00 1 per carton

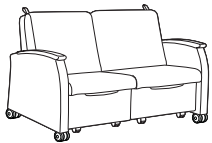

Double Sleeper Chair, Casters
 COM: 11.75 YD | 10.74 M
 Unit weight: 205 LB | 93.2 KG
 Carton weight: 215 LB | 97.52 KG
 Carton volume: 60 FT³ | 1.69 MT³

Active weight 350 lbs/seat.

Each sleep surface is
 24.5"W x 77"L.





Optional urethane armcaps.
 Please specify. No upcharge.

GC3612C	5526	5902	6219	6584	7183	7735	8287	8769	9368	9932	10696	11777
----------------	------	------	------	------	------	------	------	------	------	------	-------	-------

OVERALL DIMENSIONS			SEAT DIMENSIONS			BACK DIMENSIONS	
W	D	H	W	D	H	W	H

IN	56	36	38	48	19.5	18	48	21
MM	1422	914	965	1219	495	457	1219	533

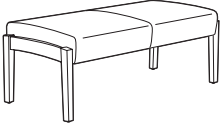
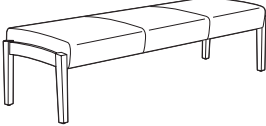
RTA 00 1 per carton

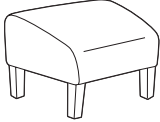
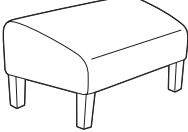
DESCRIPTION	MODEL# / FEATURES	STANDARD TEXTILE GRADES												
		COM	2	3	4	5	6	7	8	9	10	11	12	
 <p>Single Seat Bench (Wood) COM: 1.25 YD 1.14 M Unit weight: 20 LB 9.1 KG Carton weight: 26 LB 11.79 KG Carton volume: 9.75 FT³ 0.27 MT³</p>	GC3651W Wood	1130	1170	1204	1243	1306	1365	1424	1475	1539	1599	1680	1795	
	Active weight 350 lbs.	IN 26.5 MM 673	22.5 572	19 483	- -	- -	19 483	- -	- -	- -	- -	- -	- -	
		RTA 00		1 per carton										
			OVERALL DIMENSIONS			SEAT DIMENSIONS			BACK DIMENSIONS					
			W	D	H	W	D	H	W	H				
 <p>Two Seat Bench (Wood) COM: 2 YD 1.83 M Unit weight: 36 LB 16.4 KG Carton weight: 41 LB 18.6 KG Carton volume: 20.25 FT³ 0.57 MT³</p>	GC3652W Wood	1790	1854	1908	1970	2072	2166	2260	2342	2444	2540	2670	2854	
	Active weight 350 lbs/seat.	IN 49.5 MM 1257	22.5 572	19 483	- -	- -	19 483	- -	- -	- -	- -	- -	- -	
		RTA 00	1 per carton											
			OVERALL DIMENSIONS			SEAT DIMENSIONS			BACK DIMENSIONS					
			W	D	H	W	D	H	W	H				
 <p>Three Seat Bench (Wood) COM: 2.75 YD 2.51 M Unit weight: 55 LB 25 KG Carton weight: 61 LB 27.67 KG Carton volume: 28.75 FT³ 0.81 MT³</p>	GC3653W Wood	2449	2537	2611	2697	2837	2966	3095	3208	3348	3480	3659	3912	
	Active weight 350 lbs/seat.	IN 72.5 MM 1842	22.5 572	19 483	- -	- -	19 483	- -	- -	- -	- -	- -	- -	
		RTA 00		1 per carton										
			OVERALL DIMENSIONS			SEAT DIMENSIONS			BACK DIMENSIONS					
			W	D	H	W	D	H	W	H				
 <p>Standard Size Ottoman COM: 1.25 YD 1.14 M Unit weight: 12 LB 5.5 KG Carton weight: 17 LB 7.71 KG Carton volume: 4.7 FT³ 0.13 MT³</p>	GC3695	675	715	749	788	851	910	969	1020	1084	1144	1225	1340	
	Active weight 350 lbs.	IN 23 MM 584	18 457	15.75 400	- -	- -	- -	- -	- -	- -	- -	- -	- -	
	Standard leg is Black urethane.	Optional urethane colors or wood legs. No upcharge.												
		RTA 00	1 per carton											
			OVERALL DIMENSIONS			SEAT DIMENSIONS			BACK DIMENSIONS					
		W	D	H	W	D	H	W	H					
 <p>Bariatric Ottoman COM: 1.75 YD 1.6 M Unit weight: 15 LB 6.8 KG Carton weight: 20 LB 9.07 KG Carton volume: 9 FT³ 0.25 MT³</p>	GC3696	848	904	951	1006	1095	1177	1259	1331	1420	1504	1618	1779	
	Active weight 500 lbs.	IN 31.25 MM 794	18 457	15.75 400	- -	- -	- -	- -	- -	- -	- -	- -	- -	
	Standard leg is Black urethane.	Optional urethane colors or wood legs. No upcharge.												
		RTA 00	1 per carton											
			OVERALL DIMENSIONS			SEAT DIMENSIONS			BACK DIMENSIONS					
		W	D	H	W	D	H	W	H					

PRIMACARE MODULAR



STANDARD FEATURES

- Modular seating tops: Linking applications are available for medium and high back patient top units, low back guest top units and lounge top units.
- All modular seating top units are complete with frame and cushions. Leg/arm frames are ordered separately according to the desired specification.
- Frame design features a wall saver leg to prevent damage to walls. Frame construction ensures metal-to-metal fastening.
- For leg/arm frames and modular tables with power/USB module, refer to models ending in "M". Module includes two power outlets, four USB charging ports and a 6 foot long power cord. Available in Black or White (must be specified at time of order).
- Replaceable and/or removable seat and back cushions with replaceable cushion covers are standard.
- Seat cushion has a seamless waterfall front and clean out between and around the seat and back cushions.
- All **(CA)** models have closed upholstered arm panel inserts at each arm position.
- For added comfort, seats are standard with high density Ultracell foam.
- Active weight capacity up to 500 lbs/seat when using metal frame, fully upholstered frame or on bariatric models; up to 350 lbs/seat when using wood frame.
- For healthcare textile options, visit the website at globalfurnituregroup.com.
- Can be upholstered in standard Global textiles if healthcare compliance is not required.
- Left and right position reference is determined from the seated position.
- Metal leg/arm frames are available in the following finishes: Black (TBL), Cloud (TIV), Designer White (TDW), Fog (TFO), Frost (TFR), Kalua (TKA), Latte (TLA), Mocha (TMO), Nevada (TNE), Sand (TSN), Shadow (TSH), Toast (TOA) and Tungsten (TTU). Please specify.
- Wood leg/arm frames and armcaps are available in the following finishes: Absolute (AAM), Charcoal Java (CJM), Cherry (ACM), Empire Mahogany (EMM), English Oak (EOM), Espresso Cafe (ECM), Fruitwood (TFM), Gray (HGM), Harvest Oak (HOM), Honey (AHM), Jet Onyx (JOM), Light Honey (LHM), Mahogany (TMM), Maple (AVM), Medium Walnut (MWM), Natural Walnut (NLW), Night (ASM), Noce Biondo (NBM), Noce Grigio (NGM), Noce Leggero (NEM), Noce Medio (NMM), Sandy Beach (SBM), Shaker Cherry (SKM), Silver Oak (SOM), Walnut (TWM), White (WHM), WC Cream (WTM) and Winter Cherry (WCM). See features column for upcharges.
- Armcaps are securely fastened with metal-to-metal connectors which allows for field replacement if required. Armcaps cannot be retrofitted in the field on units with no existing armcaps.
- For moisture barrier on seat, please specify **(MB)**. Add \$81 per seat. For bariatric/lounge models, add \$122 per seat.
- To add sealed seams to your product contact Customer Service. Upcharges vary.

For Primacare freestanding tables, see page 59.
For Primacare Modular tables, see page 203.
For Primacare Modular lounge tables, see page 217.

SUGGESTED APPLICATIONS

- Bariatric seating
- Guest seating
- Lobbies
- Lounge/Waiting

OPTIONAL FEATURES

- Urethane armcaps are available in the following finishes: Black (BLK), Kalua (KAL), Latte (LAB), Mocha (J52), Shadow (SHW) and Toast (TOA).

MODULAR TABLES

Modular tables are offered with wood or metal legs. 1" thick table tops are available in thermally fused laminate (LP) and high pressure laminate (HP). Please select the appropriate model number for the finish you prefer.

Note: Modular tables are shipped KD (knock down) as per the published cube and weight. For freestanding Primacare tables, see page 59

Thermally fused laminate (LP):

Absolute Acajou (ACJ)	First Class (FCL)
Asian Night (ASN)	Quartered Mahogany (QTM)
Avant Cherry (AWC)	Noce Biondo (NBL)
Avant Honey (AWH)	Noce Grigio (NGL)
Black (BLK)	Noce Leggero (NEL)
Blizzard (BZD)	Noce Medio (NML)
Brushed Cobalt (BRC)	Sheer Beauty (SBY)
Clear Maple (CMB)	Stonedust (SDT)
Custom Grey (CGY)	Walnut Heights (WHE)
Dark Espresso (DES)	White Chocolate (WHC)
Designer White (DWT)	Winter Cherry (WCR)
Fashionista (FAS)	

High pressure laminate (HP):

Absolute Acajou (ACJ)	First Class (FCL)
Asian Night (ASN)	Quartered Mahogany (QTM)
Avant Cherry (W357)	Noce Biondo (NBL)
Avant Honey (W356)	Noce Grigio (NGL)
Black (BLK)	Noce Leggero (NEL)
Blizzard (BZD)	Noce Medio (NML)
Brushed Cobalt (BRC)	Sheer Beauty (SBY)
Clear Maple (CMB)	Stonedust (SDT)
Custom Grey (CGY)	Walnut Heights (WHE)
Dark Espresso (W142)	White Chocolate (WHC)
Designer White (DWT)	Winter Cherry (WCR)
Fashionista (FAS)	

Metal leg and frame finishes:

Available in Black (TBL), Cloud (TIV), Designer White (TDW), Fog (TFO), Frost (TFR), Kalua (TKA), Latte (TLA), Mocha (TMO), Nevada (TNE), Sand (TSN), Shadow (TSH), Toast (TOA) and Tungsten (TTU). Please specify.

SHIPPING INFORMATION:

Product components and parts will be shipped knocked down **(KD)**. Weight and volume are indicated with each item KD. They will not be shipped assembled.

Assembled with drawing:

Product orders that are part of a linked application may require a combination of complete units and components for build up to achieve the limitless configurations that are possible. CAD drawing must be submitted with order when requesting units ship assembled.

Global will provide assembled units under the following conditions:

1. Detailed drawing clearly indicating:
 - The layout and location of each model number being ordered (see sample following).
 - If multiple textiles are used - textile color codes must be clearly identified on drawing.
2. Global will carton assemble orders to a maximum of 3 regular seat positions, which is the largest carton available.
3. Global reserves the right to determine the best method of assembly based on the information provided with the order.

PACKAGE 1 - Primacare HT

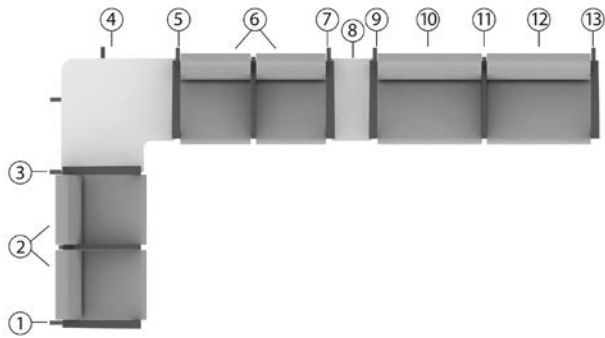

Always call out components as if seated in the chairs.

Item	Description	Qty	Model #	W x D x H	Yardage	Unit Weight	Carton Volume
1	Right End Frame with Right Armcap	1	GC3620RA	2.5 x 27 x 26.5	-	6	1.4
2, 6	Guest Low Back Two Seat Top w/Half Center Arm	2	GC3623TOP	42 x 25 x 19	3.25	58	43
3, 7	Seat to Table Center Linking Frame w/Left Armcap	2	GC3622TLA	2.5 x 27 x 26.5	-	6	1.4
4	Right Corner Table	1	GC3671R-HP	33 x 33 x 17	-	40	6
5, 9	Seat to Table Center Linking Frame w/Right Armcap	2	GC3622TRA	2.5 x 27 x 26.5	-	6	1.4
8	Narrow Center Table	1	GC3673-HP	12 x 23.87 x 5.5	-	14	2.1
10, 12	Guest Low Back Bariatric Top	2	GC3637TOP	30 x 25 x 19	2.5	43	26.5
11	Seat to Seat Center Linking Frame w/Narrow Armcap	1	GC3622LA	2.5 x 27 x 26.5	-	6	1.4
13	Left End Frame with Left Armcap	1	GC3620LA	2.5 x 27 x 26.5	-	6	1.4

PACKAGE 2 - Primacare HT

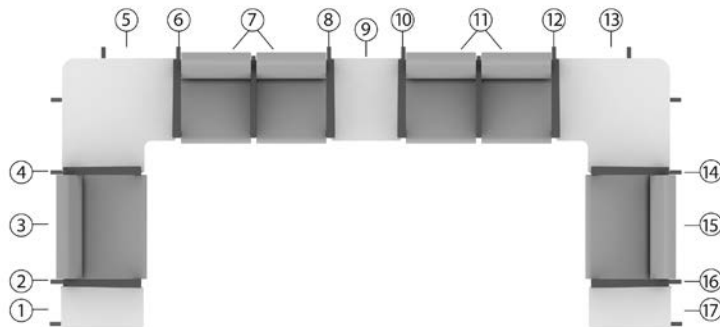

Always call out components as if seated in the chairs.

Item	Description	Qty	Model #	W x D x H	Yardage	Unit Weight	Carton Volume
1	Narrow Right End Table	1	GC3675R-HP	12 x 23.87 x 17	-	14	2.1
2, 6, 10, 14	Seat to Table Center Linking Frame w/Right Armcap	4	GC3622TRA	2.5 x 27 x 26.5	-	6	1.4
3, 15	Guest Low Back Bariatric Top	2	GC3637TOP	30 x 25 x 19	2.5	43	26.5
4, 8, 12, 16	Seat to Table Center Linking Frame w/Left Armcap	4	GC3622TLA	2.5 x 27 x 26.5	-	6	1.4
5	Right Corner Table	1	GC3671R-HP	33 x 33 x 17	-	40	6
7, 11	Guest Low Back Two Seat Top w/Half Center Arm	2	GC3623TOP	42 x 25 x 19	3.25	58	43
9	Regular Center Table	1	GC3672-HP	20.25 x 23.87 x 5.5	-	15	3.4
13	Left Corner Table	1	GC3671L-HP	33 x 33 x 17	-	46	6
17	Narrow Left End Table	1	GC3675L-HP	12 x 23.87 x 17	-	14	2.1

PACKAGE 3 - Primacare Wood

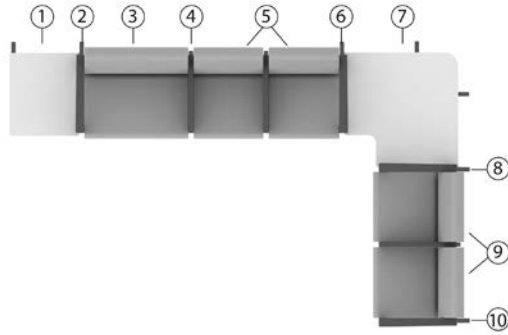

Always call out components as if seated in the chairs.

Item	Description	Qty	Model #	W x D x H	Yardage	Unit Weight	Carton Volume
1	Right End Run Table	1	GC3674WR-HP	20.25 x 23.87 x 17	-	15	3.4
2, 8	Seat to Table Center Linking Frame w/Right Armcap	2	GC3622WTRA	2.5 x 27 x 26.5	-	4	1.4
3	Guest Low Back Bariatric Top	1	GC3637TOP	30 x 25 x 19	2.5	43	26.5
4	Seat to Seat Center Linking Frame w/Narrow Armcap	1	GC3622WLA	2.5 x 27 x 26.5	-	4	1.4
5, 9	Guest Low Back Two Seat Top w/Half Center Arm	2	GC3623WTOP	42 x 25 x 19	3.25	60	43
6	Seat to Table Center Linking Frame w/Left Armcap	1	GC3622WTLA	2.5 x 27 x 26.5	-	4	1.4
7	Left Corner Table	1	GC3671WL-HP	33 x 33 x 17	-	46	6
10	Left End Frame w/Left Armcap	1	GC3620WLA	2 x 23 x 26	-	5	1.4

MODULAR TOP UNITS	SINGLE SEAT BARIATRIC		SINGLE SEAT BARIATRIC		TWO SEATER, NO CENTER ARM	TWO SEATER, CENTER ARM		THREE SEATER, NO CENTER ARMS	THREE SEATER, TWO ARMS	
	medium back	high back	medium back	high back	medium back	medium back	high back	medium back	medium back	high back
Guest seating	GC3620TOP	GC3637TOP	GC3655TOP	GC3656TOP	GC3621TOP	GC3623TOP GC3623WTOP	GC3623HB-TOP GC3623WHB-TOP	GC3624TOP	GC3626TOP GC3626WTOP	GC3626HB-TOP GC3626WHB-TOP
Patient seating	GC3631TOP	GC3638TOP	GC3655TOP	GC3656TOP		GC3623CATOP GC3623WCATOP	GC3623HBCA-TOP GC3623WHBCA-TOP		GC3626CATOP GC3626WCATOP	GC3626HBCA-TOP GC3626WHBCA-TOP

LEG / ARM FRAMES	Wood frame: Must select armcap Metal frame: Standard with Black urethane armcap (see notes for wood and urethane finish options)								LEFT, CLOSED LAMINATE PANEL	RIGHT, CLOSED LAMINATE PANEL
	LEFT, OPEN		RIGHT, OPEN		LEFT, CLOSED		RIGHT, CLOSED			
Metal (HT) End	GC3620LA	GC3620LAM	GC3620RA	GC3620RAM	GC3620LCA	GC3620LCAM	GC3620RCA	GC3620RCAM	GC3620LCAL	GC3620RCAL
Wood End	GC3620WLA	GC3620WLAM	GC3620WRA	GC3620WRAM	GC3620WLCA	GC3620WLCAM	GC3620WRCA	GC3620WRCAM		
Metal (HT) Center	GC3622LA				GC3622LCA				GC3622LCAL	
Wood Center	GC3622WLA				GC3622WLCA					
Metal (HT) Center table linking	GC3622TLA		GC3622TRA		GC3622TLCA		GC3622TRCA		GC3622TLCAL	GC3622TRCAL
Wood Center table linking	GC3622WTLA		GC3622WTRA		GC3622WTLCA		GC3622WTRCA			

For frame with power/USB module*, refer to models ending in "M"

End Frame: Armless

	LEFT	RIGHT
Metal End	GC3620LNA	GC3620RNA
Wood End	GC3620WLNA	GC3620WRNA

Central Linking Frame: Armless

























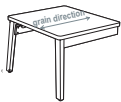

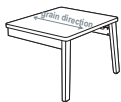
	CENTER
Metal	GC3622LNA
Wood	GC3622WLNA

(Center = link both sides)

*Power module includes two power outlets, four USB charging ports and a 6 foot long power cord. Available in Black or White (must be specified at time of order). Power module is mounted on the frame below seat support rail.

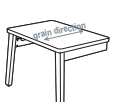
MODULAR TABLES

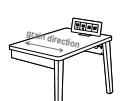
Tables include legs to support table top (except for center tables). All tables have a metal frame.

	LEFT		RIGHT	
Corner (laminite top with metal legs)	GC3671L-HP	GC3671LM-HP	GC3671R-HP	GC3671RM-HP
	GC3671L-LP	GC3671LM-LP	GC3671R-LP	GC3671RM-LP
				
Corner (laminite top with wood legs)	GC3671WL-HP	GC3671WLM-HP	GC3671WR-HP	GC3671WRM-HP
	GC3671WL-LP	GC3671WLM-LP	GC3671WR-LP	GC3671WRM-LP
				
Center (laminite top, connects to metal or wood frame)	GC3672-HP	GC3672M-HP		
	GC3672-LP	GC3672M-LP		
				
Narrow Center (laminite top, connects to metal or wood frame)	GC3673-HP	GC3673M-HP		
	GC3673-LP	GC3673M-LP		
				
End (laminite top with metal legs)	GC3674L-HP	GC3674LM-HP	GC3674R-HP	GC3674RM-HP
	GC3674L-LP	GC3674LM-LP	GC3674R-LP	GC3674RM-LP
				
End (laminite top with wood legs)	GC3674WL-HP	GC3674WLM-HP	GC3674WR-HP	GC3674WRM-HP
	GC3674WL-LP	GC3674WLM-LP	GC3674WR-LP	GC3674WRM-LP
				
Narrow End (laminite top with metal legs)	GC3675L-HP	GC3675LM-HP	GC3675R-HP	GC3675RM-HP
	GC3675L-LP	GC3675LM-LP	GC3675R-LP	GC3675RM-LP
				
Narrow End (laminite top with wood legs)	GC3675WL-HP	GC3675WLM-HP	GC3675WR-HP	GC3675WRM-HP
	GC3675WL-LP	GC3675WLM-LP	GC3675WR-LP	GC3675WRM-LP
				

For table with power/USB module*, refer to models ending in "M"

*Power module includes two power outlets, four USB charging ports and a 6 foot long power cord. Available in Black or White (must be specified at time of order). Power module is mounted **on surface** on narrow tables; mounted **in surface** on larger tables (as shown above).

DESCRIPTION MODEL# / FEATURES STANDARD TEXTILE GRADES



LB Guest Single Seat Top
 COM: 1.75 YD | 1.6 M
 Unit weight: 30 LB | 13.6 KG
 Carton weight: 36 LB | 16.33 KG
 Carton volume: 10 FT³ | 0.28 MT³

COM	2	3	4	5	6	7	8	9	10	11	12
704	760	807	862	951	1033	1115	1187	1276	1360	1474	1635

Active weight: see notes.

Single frame guest top unit with 1 low back and 1 seat cushion.

Must be connected to a full arm/leg frame.

	OVERALL DIMENSIONS			SEAT DIMENSIONS			BACK DIMENSIONS	
	W	D	H	W	D	H	W	H
IN	20.5	25	19	20.5	17.5	-	20.5	15
MM	521	635	483	521	445	-	521	381

RTA 00 1 per carton

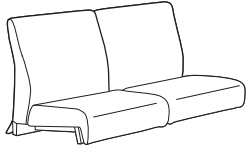

LB Guest Two Seat Top No Center Arm
 COM: 3.25 YD | 2.97 M
 Unit weight: 62 LB | 28.2 KG
 Carton weight: 72 LB | 32.66 KG
 Carton volume: 43 FT³ | 1.21 MT³

COM	2	3	4	5	6	7	8	9	10	11	12
1490	1594	1682	1783	1948	2101	2254	2387	2553	2709	2920	3219

Active weight: see notes.

Double frame guest top unit with 2 low back and 2 seat cushions.

Must be connected to a full arm/leg frame.

	OVERALL DIMENSIONS			SEAT DIMENSIONS			BACK DIMENSIONS	
	W	D	H	W	D	H	W	H
IN	40	25	19	40	17.5	-	40	15
MM	1016	635	483	1016	445	-	1016	381

RTA 00 1 per carton

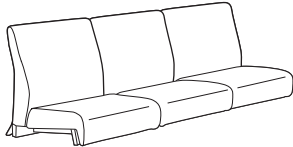

LB Guest Three Seat Top No Center Arm
 COM: 4.25 YD | 3.89 M
 Unit weight: 72 LB | 32.7 KG
 Carton weight: 82 LB | 37.19 KG
 Carton volume: 65.25 FT³ | 1.84 MT³

COM	2	3	4	5	6	7	8	9	10	11	12
2325	2461	2576	2708	2924	3124	3324	3498	3715	3919	4195	4586

Active weight: see notes.

Triple frame guest top unit with 3 low back and 3 seat cushions.

Must be connected to a full arm/leg frame.

	OVERALL DIMENSIONS			SEAT DIMENSIONS			BACK DIMENSIONS	
	W	D	H	W	D	H	W	H
IN	60	25	19	60	17.5	-	60	15
MM	1524	635	483	1524	445	-	1524	381

RTA 00 1 per carton

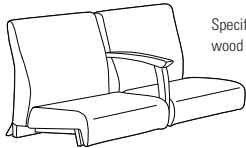

Specify armcap: wood or urethane.

LB Guest Two Seat Top Open Center Arm
 COM: 3.25 YD | 2.97 M
 Unit weight: metal: 58 LB | 26.4 KG | wood: 60 LB | 27.3 KG
 Carton weight: metal: 68 LB | 30.84 KG | wood: 68 LB | 30.84 KG
 Carton volume: 43 FT³ | 1.21 MT³

COM	2	3	4	5	6	7	8	9	10	11	12
2034	2138	2226	2327	2492	2645	2798	2931	3097	3253	3464	3763
1687	1791	1879	1980	2145	2298	2451	2584	2750	2906	3117	3416

Active weight: see notes.

Double low back frame guest top, 2 back and 2 seat cushions.

Must be connected to a full arm/leg frame.

	OVERALL DIMENSIONS			SEAT DIMENSIONS			BACK DIMENSIONS	
	W	D	H	W	D	H	W	H
IN	42	25	19	20.5	17.5	-	20.5	15
MM	1067	635	483	521	445	-	521	381

RTA 00 1 per carton

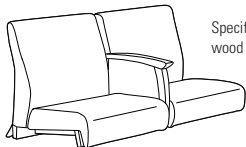

Specify armcap: wood or urethane.

LB Guest Two Seat Top Closed Center Arm, Metal
 COM: 3.5 YD | 3.2 M
 Unit weight: metal: 66 LB | 30 KG | wood: 66 LB | 30 KG
 Carton weight: metal: 74 LB | 33.57 KG | wood: 74 LB | 33.57 KG
 Carton volume: 43 FT³ | 1.21 MT³

COM	2	3	4	5	6	7	8	9	10	11	12
2263	2375	2470	2578	2757	2921	3086	3229	3408	3576	3803	4125
1795	1907	2002	2110	2289	2453	2618	2761	2940	3108	3335	3657





Active weight: see notes.

Double low back frame guest top, 2 back and 2 seat cushions.

Must be connected to a full arm/leg frame.

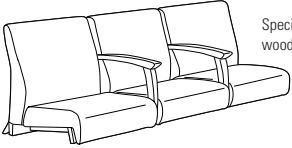
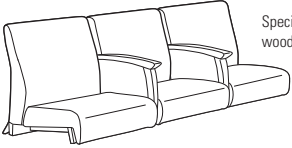
	OVERALL DIMENSIONS			SEAT DIMENSIONS			BACK DIMENSIONS	
	W	D	H	W	D	H	W	H
IN	42	25	19	20.5	17.5	-	20.5	15
MM	1067	635	483	521	445	-	521	381

RTA 00 1 per carton

DESCRIPTION	MODEL# / FEATURES	STANDARD TEXTILE GRADES											
		COM	2	3	4	5	6	7	8	9	10	11	12
 <p>Specify armcap: wood or urethane.</p> <p>LB Guest Three Seat Top Open Center Arm COM: 4.75 YD 4.34 M Unit weight: metal: 67 LB 30.5 KG wood: 67 LB 30.5 KG Carton weight: metal: 77 LB 34.93 KG wood: 77 LB 34.93 KG Carton volume: 65.25 FT³ 1.84 MT³</p>	GC3626TOP (metal)	3259	3411	3539	3687	3929	4152	4375	4570	4812	5040	5349	5786
	GC3626WTOP (wood)	2641	2793	2921	3069	3311	3534	3757	3952	4194	4422	4731	5168
<p>Due to the size and weight, this top requires at least 3 installers.</p> <p>Active weight: see notes.</p> <p>Triple low back frame guest top, 3 back and 3 seat cushions.</p> <p>Must be connected to a full arm/leg frame.</p>		OVERALL DIMENSIONS W D H			SEAT DIMENSIONS W D H			BACK DIMENSIONS W H					
		IN	64	25	19	20.5	17.5	-	20.5	15			
		MM	1626	635	483	521	445	-	521	381			
		RTA 00		1 per carton									
 <p>Specify armcap: wood or urethane.</p> <p>LB Guest Three Seat Top Closed Center Arms, Metal COM: 5.5 YD 5.03 M Unit weight: metal: 73 LB 33.2 KG wood: 77 LB 35 KG Carton weight: metal: 83 LB 37.65 KG wood: 87 LB 39.46 KG Carton volume: 65.25 FT³ 1.84 MT³</p>	GC3626CATOP (metal)	3535	3711	3860	4030	4311	4569	4828	5053	5334	5598	5955	6461
	GC3626WCATOP (wood)	2853	3029	3178	3348	3629	3887	4146	4371	4652	4916	5273	5779
<p>Due to the size and weight, this top requires at least 3 installers.</p> <p>Active weight: see notes.</p> <p>Triple low back frame guest top, 3 back and 3 seat cushions.</p> <p>Must be connected to a full arm/leg frame.</p>		OVERALL DIMENSIONS W D H			SEAT DIMENSIONS W D H			BACK DIMENSIONS W H					
		IN	64	25	19	20.5	17.5	-	20.5	15			
		MM	1626	635	483	521	445	-	521	381			
		RTA 00		1 per carton									
 <p>MB Patient Top COM: 1.75 YD 1.6 M Unit weight: 36 LB 16.4 KG Carton weight: 42 LB 19.05 KG Carton volume: 10 FT³ 0.28 MT³</p>	GC3631TOP	740	796	843	898	987	1069	1151	1223	1312	1396	1510	1671
	<p>Active weight: see notes.</p> <p>Single mid back frame patient top, 1 back and 1 seat cushion.</p> <p>Must be connected to a full arm/leg frame.</p>		OVERALL DIMENSIONS W D H			SEAT DIMENSIONS W D H			BACK DIMENSIONS W H				
		IN	20.5	25	22	20.5	17.5	-	20.5	18			
		MM	521	635	559	521	445	-	521	457			
		RTA 00		1 per carton									
 <p>LB Bariatric Guest Top COM: 2.5 YD 2.29 M Unit weight: 43 LB 19.5 KG Carton weight: 53 LB 24.04 KG Carton volume: 26.5 FT³ 0.75 MT³</p>	GC3637TOP	1137	1217	1285	1362	1490	1607	1725	1827	1955	2075	2237	2467
	<p>Active weight: see notes.</p> <p>Single low back frame bariatric guest top, 1 back and 1 seat cushion.</p> <p>Must be connected to a full arm/leg frame.</p>		OVERALL DIMENSIONS W D H			SEAT DIMENSIONS W D H			BACK DIMENSIONS W H				
		IN	30	25	19	30	17.5	-	30	15			
		MM	762	635	483	762	445	-	762	381			
		RTA 00		1 per carton									
 <p>MB Bariatric Patient Top COM: 2.75 YD 2.51 M Unit weight: 52 LB 23.6 KG Carton weight: 62 LB 28.12 KG Carton volume: 30.5 FT³ 0.86 MT³</p>	GC3638TOP	1192	1280	1354	1440	1580	1709	1838	1951	2091	2223	2402	2655
	<p>Active weight: see notes.</p> <p>Single mid back frame bariatric patient top, 1 back and 1 seat cushion.</p> <p>Must be connected to a full arm/leg frame.</p>		OVERALL DIMENSIONS W D H			SEAT DIMENSIONS W D H			BACK DIMENSIONS W H				
		IN	30	25	22	30	17.5	-	30	18			
		MM	762	635	559	762	445	-	762	457			
		RTA 00		1 per carton									

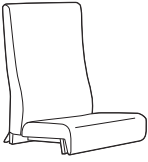
DESCRIPTION	MODEL# / FEATURES	STANDARD TEXTILE GRADES											
		COM	2	3	4	5	6	7	8	9	10	11	12
 <p>HB Patient Top COM: 2.5 YD 2.29 M Unit weight: metal: 42 LB 19.1 KG Carton weight: metal: 52 LB 23.59 KG Carton volume: 13.25 FT³ 0.37 MT³</p>	GC3655TOP	879	959	1027	1104	1232	1349	1467	1569	1697	1817	1979	2209
	Active weight: see notes.	OVERALL DIMENSIONS			SEAT DIMENSIONS			BACK DIMENSIONS					
		W	D	H	W	D	H	W	H				
	Single high back frame patient top, 1 back and 1 seat cushion.	IN 20.5 MM 521	25 635	34 864	20.5 521	17.5 445	- -	20.5 521	30 762				
Must be connected to a full arm/leg frame.	RTA 00	1 per carton											

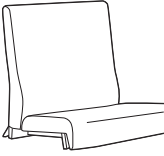
 <p>HB Bariatric Patient Top COM: 3.5 YD 3.2 M Unit weight: 52 LB 23.6 KG Carton weight: 62 LB 28.12 KG Carton volume: 33 FT³ 0.93 MT³</p>	GC3656TOP	1419	1531	1626	1734	1913	2077	2242	2385	2564	2732	2959	3281
	Active weight: see notes.	OVERALL DIMENSIONS			SEAT DIMENSIONS			BACK DIMENSIONS					
		W	D	H	W	D	H	W	H				
	Single high back frame bariatric patient top, 1 back and 1 seat cushion.	IN 30 MM 762	25 635	34 864	30 762	17.5 445	- -	30 762	30 762				
Must be connected to a full arm/leg frame.	RTA 00	1 per carton											

DESCRIPTION	MODEL# / FEATURES	STANDARD TEXTILE GRADES												
		COM	2	3	4	5	6	7	8	9	10	11	12	
 <p>Specify armcap: wood or urethane.</p> <p>HB Guest Two Seat Top Open Center Arm COM: 4.5 YD 4.11 M Unit weight: metal: 70 LB 31.8 KG wood: 70 LB 31.8 KG Carton weight: metal: 80 LB 36.29 KG wood: 80 LB 36.29 KG Carton volume: 43 FT³ 1.21 MT³</p>	GC3623HB-TOP (metal)	2151	2295	2417	2556	2786	2997	3209	3393	3623	3839	4131	4545	
		GC3623WHB-TOP (wood)	1788	1932	2054	2193	2423	2634	2846	3030	3260	3476	3768	4182
	Active weight: see notes.	OVERALL DIMENSIONS			SEAT DIMENSIONS			BACK DIMENSIONS						
	Double high back frame guest top, 2 back and 2 seat cushions.	IN 42 MM 1067	27 686	32 813	20.5 521	17.5 445	- -	20.5 521	28 711					
Must be connected to a full arm/leg frame.	RTA 00	1 per carton												

 <p>Specify armcap: wood or urethane.</p> <p>HB Guest Two Seat Top Closed Center Arm, Metal COM: 4.5 YD 4.11 M Unit weight: metal: 138 LB 62.7 KG wood: 138 LB 62.7 KG Carton weight: metal: 150 LB 68.04 KG wood: 150 LB 68.04 KG Carton volume: 43 FT³ 1.21 MT³</p>	GC3623HB-CA-TOP (metal)	2387	2531	2653	2792	3022	3233	3445	3629	3859	4075	4367	4781	
		GC3623WHB-CA-TOP (wood)	1905	2049	2171	2310	2540	2751	2963	3147	3377	3593	3885	4299
	Active weight: see notes.	OVERALL DIMENSIONS			SEAT DIMENSIONS			BACK DIMENSIONS						
	Double high back frame guest top, 2 back and 2 seat cushions.	IN 42 MM 1067	27 686	32 813	20.5 521	17.5 445	- -	20.5 521	28 711					
Must be connected to a full arm/leg frame.	RTA 00	1 per carton												

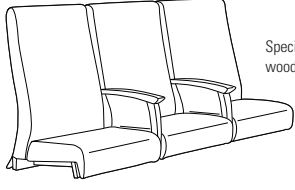
 <p>Specify armcap: wood or urethane.</p> <p>HB Guest Three Seat Top Open Center Arm COM: 6.25 YD 5.72 M Unit weight: metal: 77 LB 35 KG wood: 77 LB 35 KG Carton weight: metal: 92 LB 41.73 KG wood: 92 LB 41.73 KG Carton volume: 65.25 FT³ 1.84 MT³</p>	GC3626HB-TOP (metal)	3444	3644	3813	4007	4325	4619	4913	5169	5488	5788	6194	6769	
		GC3626WHB-TOP (wood)	2805	3005	3174	3368	3686	3980	4274	4530	4849	5149	5555	6130
	Due to the size and weight, this top requires at least 3 installers.	OVERALL DIMENSIONS			SEAT DIMENSIONS			BACK DIMENSIONS						
	Triple high back frame guest top, 3 back and 3 seat cushions.	IN 64 MM 1626	27 686	32 813	20.5 521	17.5 445	- -	20.5 521	28 711					
Must be connected to a full arm/leg frame.	RTA 00	1 per carton												

DESCRIPTION MODEL# / FEATURES STANDARD TEXTILE GRADES

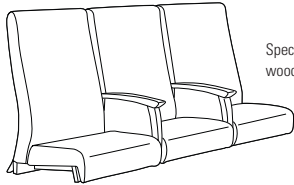

Specify armcap:
wood or urethane.

HB Guest Three Seat Top Closed Center Arms, Metal

COM: 7 YD | 6.4 M
Unit weight: metal: 160 LB | 72.7 KG | wood: 160 LB | 72.7 KG
Carton weight: metal: 175 LB | 79.38 KG | wood: 175 LB | 79.38 KG
Carton volume: 80.75 FT³ | 2.28 MT³

	COM	2	3	4	5	6	7	8	9	10	11	12
GC3626HBCA-TOP (metal)	3724	3948	4137	4354	4711	5040	5369	5656	6013	6349	6804	7448
GC3626WHBCA-TOP (wood)	3017	3241	3430	3647	4004	4333	4662	4949	5306	5642	6097	6741

Due to the size and weight, this top requires at least 3 installers.

Active weight: see notes.

Triple high back frame
guest top, 3 back and 3
seat cushions.

	OVERALL DIMENSIONS			SEAT DIMENSIONS			BACK DIMENSIONS	
	W	D	H	W	D	H	W	H
IN	64	27	32	20.5	17.5	-	20.5	28
MM	1626	686	813	521	445	-	521	711

Must be connected to a full arm/leg frame.

RTA 00 1 per carton

List price

GC3620LNA (metal)	353
GC3620WLN (wood)	223

	OVERALL DIMENSIONS			SEAT DIMENSIONS			BACK DIMENSIONS	
	W	D	H	W	D	H	W	H

For use in **left** side finished position of guest and/or patient seating units.

IN	1.25	24.25	16	-	-	-	-	-
MM	32	616	406	-	-	-	-	-

Does not allow linking to other units or tables.

RTA 00 1 per carton

List price

GC3620RNA (metal)	353
GC3620WRNA (wood)	223

	OVERALL DIMENSIONS			SEAT DIMENSIONS			BACK DIMENSIONS	
	W	D	H	W	D	H	W	H

For use in **right** side finished position of guest and/or patient seating units.

IN	1.25	24.25	16	-	-	-	-	-
MM	32	616	406	-	-	-	-	-

Does not allow linking to other units or tables.

RTA 00 1 per carton

List price

GC3620LA (metal)	448
GC3620LAM (w/power)	1467
GC3620WLA (wood)	306
GC3620WLAM (w/power)	1232

• Models GC3620LAM and GC3620WLAM have **power/USB** module (not shown).

Specify armcap:
wood or urethane.

	OVERALL DIMENSIONS			SEAT DIMENSIONS			BACK DIMENSIONS	
	W	D	H	W	D	H	W	H

For use in **left** side finished position of guest and/or patient seating units.

IN	2.5	27	26.5	-	-	-	-	-
MM	64	686	673	-	-	-	-	-

Does not allow linking to other units or tables.

RTA 00 1 per carton

List price

GC3620RA (metal)	448
GC3620RAM (w/power)	1467
GC3620WRA (wood)	306
GC3620WRAM (w/power)	1232

• Models GC3620RAM and GC3620WRAM have **power/USB** module (not shown).

Specify armcap:
wood or urethane.

	OVERALL DIMENSIONS			SEAT DIMENSIONS			BACK DIMENSIONS	
	W	D	H	W	D	H	W	H

For use in **right** side finished position of guest and/or patient seating units.

IN	2.5	27	26.5	-	-	-	-	-
MM	64	686	673	-	-	-	-	-

Does not allow linking to other units or tables.

RTA 00 1 per carton

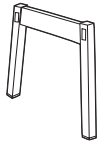

Left End Frame, Armless

COM: N/A
Unit weight: metal: 4 LB | 1.8 KG | wood: 3 LB | 1.4 KG
Carton weight: metal: 5 LB | 2.27 KG | wood: 4 LB | 1.81 KG
Carton volume: 1.2 FT³ | 0.03 MT³

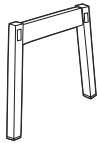

Right End Frame, Armless

COM: N/A
Unit weight: metal: 4 LB | 1.8 KG | wood: 3 LB | 1.4 KG
Carton weight: metal: 5 LB | 2.27 KG | wood: 4 LB | 1.81 KG
Carton volume: 1.2 FT³ | 0.03 MT³



Left End Frame, Open Arm

COM: N/A
Unit weight: metal: 6 LB | 2.7 KG | wood: 5 LB | 2.3 KG
Carton weight: metal: 10 LB | 4.54 KG | wood: 10 LB | 4.54 KG
Carton volume: 1.4 FT³ | 0.03 MT³



Right End Frame, Open Arm

COM: N/A
Unit weight: metal: 6 LB | 2.7 KG | wood: 5 LB | 2.3 KG
Carton weight: metal: 10 LB | 4.54 KG | wood: 10 LB | 4.54 KG
Carton volume: 1.4 FT³ | 0.03 MT³

DESCRIPTION MODEL# / FEATURES STANDARD TEXTILE GRADES

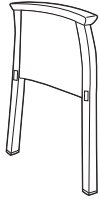

Left End Frame, Closed Arm

COM: 0.65 YD | 0.59 M
 Unit weight: metal: 10 LB | 4.5 KG | wood: 10 LB | 4.5 KG
 Carton weight: metal: 15 LB | 6.8 KG | wood: 15 LB | 6.8 KG
 Carton volume: 1.4 FT³ | 0.03 MT³

	COM	2	3	4	5	6	7	8	9	10	11	12
GC3620LCA (metal)	579	600	618	638	671	701	732	759	792	823	865	925
GC3620LCAM (w/power)	1597	1618	1636	1656	1689	1719	1750	1777	1810	1841	1883	1943
GC3620WLCA (wood)	399	420	438	458	491	521	552	579	612	643	685	745
GC3620WLCAM (w/power)	1329	1350	1368	1388	1421	1451	1482	1509	1542	1573	1615	1675

• Models GC3620LCAM and GC3620WLCAM have **power/USB** module (not shown).

Specify armcap:
wood or urethane.

	OVERALL DIMENSIONS			SEAT DIMENSIONS			BACK DIMENSIONS	
	W	D	H	W	D	H	W	H
IN	2.5	27	26.5	-	-	-	-	-
MM	64	686	673	-	-	-	-	-

For use in **left** side finished position of guest and/or patient seating units.

Does not allow linking to other units or tables.

RTA 00 1 per carton

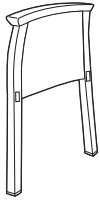

Right End Frame, Closed Arm

COM: 0.65 YD | 0.59 M
 Unit weight: metal: 10 LB | 4.5 KG | wood: 10 LB | 4.5 KG
 Carton weight: metal: 15 LB | 6.8 KG | wood: 15 LB | 6.8 KG
 Carton volume: 1.4 FT³ | 0.03 MT³

	COM	2	3	4	5	6	7	8	9	10	11	12
GC3620RCA (metal)	579	600	618	638	671	701	732	759	792	823	865	925
GC3620RCAM (w/power)	1597	1618	1636	1656	1689	1719	1750	1777	1810	1841	1883	1943
GC3620WRCA (wood)	399	420	438	458	491	521	552	579	612	643	685	745
GC3620WRCAM (w/power)	1329	1350	1368	1388	1421	1451	1482	1509	1542	1573	1615	1675

• Models GC3620RCAM and GC3620WRCAM have **power/USB** module (not shown).

Specify armcap:
wood or urethane.

	OVERALL DIMENSIONS			SEAT DIMENSIONS			BACK DIMENSIONS	
	W	D	H	W	D	H	W	H
IN	2.5	27	26.5	-	-	-	-	-
MM	64	686	673	-	-	-	-	-

For use in **right** side finished position of guest and/or patient seating units.

Does not allow linking to other units or tables.

RTA 00 1 per carton

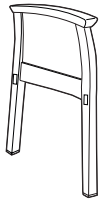

Left End Frame, Closed Arm, Laminate Panel

COM: N/A
 Unit weight: 15 LB | 6.8 KG
 Carton weight: 18 LB | 8.16 KG
 Carton volume: 1.4 FT³ | 0.03 MT³

List price

GC3620LCAL (metal) 740

Specify armcap:
wood or urethane.

	OVERALL DIMENSIONS			SEAT DIMENSIONS			BACK DIMENSIONS	
	W	D	H	W	D	H	W	H
IN	2.5	27	26.5	-	-	-	-	-
MM	64	686	673	-	-	-	-	-

For use in **left** side finished position of guest and/or patient seating units.

Does not allow linking to other units or tables.

RTA 00 1 per carton

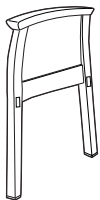

Right End Frame, Closed Arm, Laminate Panel

COM: N/A
 Unit weight: 15 LB | 6.8 KG
 Carton weight: 18 LB | 8.16 KG
 Carton volume: 1.4 FT³ | 0.03 MT³

List price

GC3620RCAL (metal) 740

Specify armcap:
wood or urethane.

	OVERALL DIMENSIONS			SEAT DIMENSIONS			BACK DIMENSIONS	
	W	D	H	W	D	H	W	H
IN	2.5	27	26.5	-	-	-	-	-
MM	64	686	673	-	-	-	-	-

For use in **right** side finished position of guest and/or patient seating units.

Does not allow linking to other units or tables.

RTA 00 1 per carton

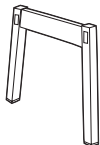

Seat to Seat Central Linking Frame, Armless

COM: N/A
 Unit weight: metal: 4 LB | 1.8 KG | wood: 3 LB | 1.4 KG
 Carton weight: metal: 5 LB | 2.27 KG | wood: 4 LB | 1.81 KG
 Carton volume: 1.2 FT³ | 0.03 MT³

List price



GC3622LNA (metal) 353







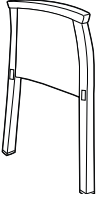
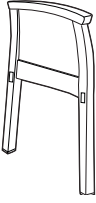

GC3622WLNA (wood) 223

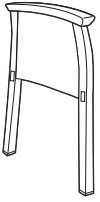
For **linking** guest and/or patient top seating units together only.

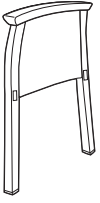
	OVERALL DIMENSIONS			SEAT DIMENSIONS			BACK DIMENSIONS	
	W	D	H	W	D	H	W	H
IN	1.25	24.25	16	-	-	-	-	-
MM	32	616	406	-	-	-	-	-

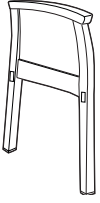
RTA 00 1 per carton

DESCRIPTION	MODEL# / FEATURES	STANDARD TEXTILE GRADES												
 <p>Center Frame, Open Arm COM: N/A Unit weight: metal: 6 LB 2.7 KG wood: 4 LB 1.8 KG Carton weight: metal: 10 LB 4.54 KG wood: 8 LB 3.63 KG Carton volume: 1.4 FT³ 0.03 MT³</p>	List price													
	GC3622LA (metal)	448												
	GC3622WLA (wood)	306												
	Specify armcap: wood or urethane.	OVERALL DIMENSIONS		SEAT DIMENSIONS			BACK DIMENSIONS							
			W	D	H	W	D	H	W	H				
			IN	2.5	27	26.5	-	-	-	-	-			
			MM	64	686	673	-	-	-	-	-			
			RTA 00		courier		1 per carton							
 <p>Center Frame, Closed Arm COM: 0.65 YD 0.59 M Unit weight: metal: 10 LB 4.5 KG wood: 6 LB 2.7 KG Carton weight: metal: 15 LB 6.8 KG wood: 10 LB 4.54 KG Carton volume: 1.4 FT³ 0.03 MT³</p>	List price													
	GC3622LCA (metal)	579	2	3	4	5	6	7	8	9	10	11	12	
	GC3622WLCA (wood)	399	420	438	458	491	521	552	579	612	643	685	745	
	Specify armcap: wood or urethane.	OVERALL DIMENSIONS		SEAT DIMENSIONS			BACK DIMENSIONS							
			W	D	H	W	D	H	W	H				
			IN	2.5	27	26.5	-	-	-	-	-			
			MM	64	686	673	-	-	-	-	-			
			RTA 00		courier		1 per carton							
 <p>Center Frame, Closed Arm, Laminate Panel COM: N/A Unit weight: 15 LB 6.8 KG Carton weight: 18 LB 8.16 KG Carton volume: 1.4 FT³ 0.03 MT³</p>	List price													
	GC3622LCAL (metal)	740												
	Specify armcap: wood or urethane.	OVERALL DIMENSIONS		SEAT DIMENSIONS			BACK DIMENSIONS							
				W	D	H	W	D	H	W	H			
			IN	2.5	27	26.5	-	-	-	-	-			
			MM	64	686	673	-	-	-	-	-			
			RTA 00		courier		1 per carton							
 <p>Center Frame, Open Arm COM: N/A Unit weight: metal: 6 LB 2.7 KG wood: 4 LB 1.8 KG Carton weight: metal: 10 LB 4.54 KG wood: 8 LB 3.63 KG Carton volume: 1.4 FT³ 0.03 MT³</p>	List price													
	GC3622TLA (metal)	481												
	GC3622WTLA (wood)	333												
	Specify armcap: wood or urethane.	OVERALL DIMENSIONS		SEAT DIMENSIONS			BACK DIMENSIONS							
			W	D	H	W	D	H	W	H				
			IN	2.5	27	26.5	-	-	-	-	-			
			MM	64	686	673	-	-	-	-	-			
			RTA 00		courier		1 per carton							
 <p>Center Frame, Open Arm COM: N/A Unit weight: metal: 6 LB 2.7 KG wood: 4 LB 1.8 KG Carton weight: metal: 10 LB 4.54 KG wood: 8 LB 3.63 KG Carton volume: 1.4 FT³ 0.03 MT³</p>	List price													
	GC3622TRA (metal)	481												
	GC3622WTRA (wood)	333												
	Specify armcap: wood or urethane.	OVERALL DIMENSIONS		SEAT DIMENSIONS			BACK DIMENSIONS							
			W	D	H	W	D	H	W	H				
			IN	2.5	27	26.5	-	-	-	-	-			
			MM	64	686	673	-	-	-	-	-			
			RTA 00		courier		1 per carton							

DESCRIPTION	MODEL# / FEATURES	STANDARD TEXTILE GRADES											
		COM	2	3	4	5	6	7	8	9	10	11	12
 <p>Center Frame, Closed Arm COM: 0.65 YD 0.59 M Unit weight: metal: 10 LB 4.5 KG wood: 6 LB 2.7 KG Carton weight: metal: 15 LB 6.8 KG wood: 10 LB 4.54 KG Carton volume: 1.4 FT³ 0.03 MT³</p>	GC3622TLCA (metal)	610	631	649	669	702	732	763	790	823	854	896	956
	GC3622WTLCA (wood)	430	451	469	489	522	552	583	610	643	674	716	776
Specify armcap: wood or urethane.		OVERALL DIMENSIONS			SEAT DIMENSIONS			BACK DIMENSIONS					
		W	D	H	W	D	H	W	H				
	For linking guest and/or patient top seating units table on the left side of the frame.	IN 2.5	27	26.5	-	-	-	-	-				
		MM 64	686	673	-	-	-	-	-				
		RTA 00		1 per carton									
 <p>Center Frame, Closed Arm COM: 0.65 YD 0.59 M Unit weight: metal: 10 LB 4.5 KG wood: 6 LB 2.7 KG Carton weight: metal: 15 LB 6.8 KG wood: 10 LB 4.54 KG Carton volume: 1.4 FT³ 0.03 MT³</p>	GC3622TRCA (metal)	610	631	649	669	702	732	763	790	823	854	896	956
	GC3622WTRCA (wood)	430	451	469	489	522	552	583	610	643	674	716	776
Specify armcap: wood or urethane.		OVERALL DIMENSIONS			SEAT DIMENSIONS			BACK DIMENSIONS					
		W	D	H	W	D	H	W	H				
	For linking guest and/or patient top seating units table on the right side of the frame.	IN 2.5	27	26.5	-	-	-	-	-				
		MM 64	686	673	-	-	-	-	-				
		RTA 00		1 per carton									
		List price											
 <p>Center Frame, Closed Arm, Laminate Panel COM: N/A Unit weight: 15 LB 6.8 KG Carton weight: 18 LB 8.16 KG Carton volume: 1.4 FT³ 0.03 MT³</p>	GC3622TLCAL (metal)	774											
	Specify armcap: wood or urethane.		OVERALL DIMENSIONS			SEAT DIMENSIONS			BACK DIMENSIONS				
		W	D	H	W	D	H	W	H				
	For linking guest and/or patient top seating units table on the left side of the frame.	IN 2.5	27	26.5	-	-	-	-	-				
		MM 64	686	673	-	-	-	-	-				
		RTA 00		1 per carton									
		List price											
 <p>Center Frame, Closed Arm, Laminate Panel COM: N/A Unit weight: 15 LB 6.8 KG Carton weight: 18 LB 8.16 KG Carton volume: 1.4 FT³ 0.03 MT³</p>	GC3622TRCAL (metal)	774											
	Specify armcap: wood or urethane.		OVERALL DIMENSIONS			SEAT DIMENSIONS			BACK DIMENSIONS				
		W	D	H	W	D	H	W	H				
	For linking guest and/or patient top seating units table on the right side of the frame.	IN 2.5	27	26.5	-	-	-	-	-				
		MM 64	686	673	-	-	-	-	-				
		RTA 00		1 per carton									

Modular tables:

Tops are 1" thick.

Wooden leg tables:

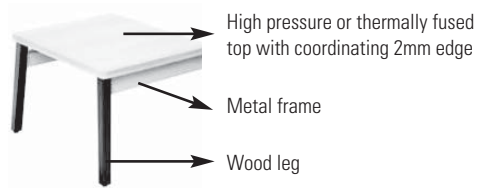

Metal leg tables:

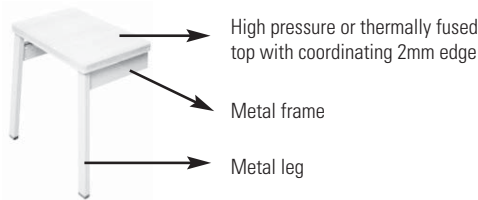

Table top finishes:

Thermally Fused Laminate (LP)

- Absolute Acajou (ACJ)
- Asian Night (ASN)
- Avant Cherry (AWC)
- Avant Honey (AWH)
- Black (BLK)
- Blizzard (BZD)
- Brushed Cobalt (BRC)
- Clear Maple (CMB)
- Custom Grey (CGY)
- Dark Espresso (DES)
- Designer White (DWT)
- Fashionista (FAS)
- First Class (FCL)
- Quartered Mahogany (QTM)
- Noce Biondo (NBL)
- Noce Grigio (NGL)
- Noce Leggero (NEL)
- Noce Medio (NML)
- Sheer Beauty (SBY)
- Stonedust (SDT)
- Storm (SOG)
- Walnut Heights (WHE)
- White Chocolate (WHC)
- Winter Cherry (WCR)

High Pressure Laminate (HP)

- Absolute Acajou (ACJ)
- Asian Night (ASN)
- Avant Cherry (W357)
- Avant Honey (W356)
- Black (BLK)
- Blizzard (BZD)
- Brushed Cobalt (BRC)
- Clear Maple (CMB)
- Custom Grey (CGY)
- Dark Espresso (W142)
- Designer White (DWT)
- Fashionista (FAS)
- First Class (FCL)
- Quartered Mahogany (QTM)
- Noce Biondo (NBL)
- Noce Grigio (NGL)
- Noce Leggero (NEL)
- Noce Medio (NML)
- Sheer Beauty (SBY)
- Stonedust (SDT)
- Storm (SOG)
- Walnut Heights (WHE)
- White Chocolate (WHC)
- Winter Cherry (WCR)

Wooden leg finishes (top, base, legs & apron):

- Absolute (AAM)
- Charcoal Java on Maple (CJM)
- Cherry on Maple (ACM)
- Empire Mahogany on Maple (EMM)
- English Oak on Maple (EOM)
- Medium Walnut on Maple (MWM)
- Espresso Cafe on Maple (ECM)
- Fruitwood on Maple (TFM)
- Gray (HGM)
- Harvest Oak on Maple (HOM)
- Honey on Maple (AHM)
- Jet Onyx on Maple (JOM)
- Light Honey on Maple (LHM)
- Maple on Maple (AVM)
- Natural Walnut (NLW)
- Night (ASM)
- Noce Biondo (NBM)
- Noce Grigio (NGM)
- Noce Leggero (NEM)
- Noce Medio (NMM)
- Shaker Cherry on Maple (SKM)
- Tiger Mahogany on Maple (TMM)
- Tiger Walnut on Maple (TWM)
- Winter Cherry on Maple (WCM)
- Sandy Beach on Maple (SBM)
- WC Cream (WTM)
- Silver Oak on Maple (SOM)
- White on Maple (WHM)

Metal leg finishes:

Black (TBL), Cloud (TIV), Designer White (TDW), Fog (TFO), Frost (TFR), Kalua (TKA), Latte (TLA), Mocha (TMO), Nevada (TNE), Sand (TSN), Shadow (TSH), Toast (TOA) and Tungsten (TTU). Please specify.

Metal frame finishes:

Black (TBL), Cloud (TIV), Designer White (TDW), Fog (TFO), Frost (TFR), Kalua (TKA), Latte (TLA), Mocha (TMO), Nevada (TNE), Sand (TSN), Shadow (TSH), Toast (TOA) and Tungsten (TTU). Please specify.

Power/USB modules:

For modular tables with power/USB module, refer to models ending in "M". Power module includes two power outlets, four USB charging ports and a 6 foot long power cord. Available in Black or White (must be specified at time of order). Power module is mounted **on surface** on narrow tables; mounted **in surface** on larger tables.



On surface power module on narrow tables

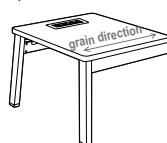

In surface power module on larger tables

MODULAR TABLES	MODEL #	DIMENSIONS ^{IN} _{MM}	WEIGHT ^{LB} _{KG}	VOLUME ^{FT³} _{MT³}	LIST PRICE
----------------	---------	---	---------------------------------------	---	------------

W x D x H

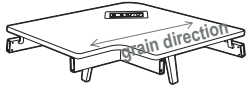

Left Corner Table, For Wood Frame

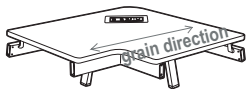

Left Corner Table, For Metal Frame



Right Corner Table, For Wood Frame

GC3671WL-LP	33 x 33 x 17 838 x 838 x 432	46 20.9	6 0.16	\$969
GC3671WLM-LP With power				\$1843
GC3671WL-HP	33 x 33 x 17 838 x 838 x 432	46 20.9	6 0.16	\$1040
GC3671WLM-HP With power				\$1910

- For a thermally fused laminate top (LP), specify model GC3671WL-LP.
- For a high pressure laminate top (HP), specify model GC3671WL-HP.
- Models GC3671WLM-LP and GC3671WLM-HP have a **power/USB** module mounted in surface.

Coordinating 2mm edge. Must be connected to full arm and leg with **wood** frames (GC3622WTLA/WTRA, GC3622WTLCA/WTRCA). This table allows for kneespace when specifying chairs in a corner position. 1 per carton.

- Includes 2 rear wood legs.

GC3671L-LP	33 x 33 x 17 838 x 838 x 432	45 20.5	6 0.16	\$1142
GC3671LM-LP With power				\$2098
GC3671L-HP	33 x 33 x 17 838 x 838 x 432	46 20.9	6 0.16	\$1213
GC3671LM-HP With power				\$2175

- For a thermally fused laminate top (LP), specify model GC3671L-LP.
- For a high pressure laminate top (HP), specify model GC3671L-HP.
- Models GC3671LM-LP and GC3671LM-HP have a **power/USB** module mounted in surface.

Coordinating 2mm edge. Must be connected to full arm and leg with **metal** frames (GC3622TLA/TRA, GC3622TLCA/TRCA). This table allows for kneespace when specifying chairs in a corner position. 1 per carton.

- Includes 2 rear metal legs.

GC3671WR-LP	33 x 33 x 17 838 x 838 x 432	46 20.9	6 0.16	\$969
GC3671WRM-LP With power				\$1843
GC3671WR-HP	33 x 33 x 17 838 x 838 x 432	46 20.9	6 0.16	\$1040
GC3671WRM-HP With power				\$1910

- For a thermally fused laminate top (LP), specify model GC3671WR-LP.
- For a high pressure laminate top (HP), specify model GC3671WR-HP.
- Models GC3671WRM-LP and GC3671WRM-HP have a **power/USB** module mounted in surface.

Coordinating 2mm edge. Must be connected to full arm and leg with **wood** frames (GC3622WTLA/WTRA, GC3622WTLCA/WTRCA). This table allows for kneespace when specifying chairs in a corner position. 1 per carton.

- Includes 2 rear wood legs.

MODULAR TABLES	MODEL #	DIMENSIONS ^{IN} _{MM}	WEIGHT ^{LB} _{KG}	VOLUME ^{FT³} _{MT³}	LIST PRICE
----------------	---------	---	---------------------------------------	---	------------



Right Corner Table, For Metal Frame

	W x D x H			
GC3671R-LP	33 x 33 x 17 838 x 838 x 432	46 20.9	6 0.16	\$1142
GC3671RM-LP With power				\$2098
GC3671R-HP	33 x 33 x 17 838 x 838 x 432	40 18.2	6 0.16	\$1213
GC3671RM-HP With power				\$2175

- For a thermally fused laminate top (LP), specify model GC3671R-LP.
- For a high pressure laminate top (HP), specify model GC3671R-HP.

- Models GC3671RM-LP and GC3671RM-HP have a **power/USB** module mounted in surface.

Coordinating 2mm edge. Must be connected to full arm and leg with **metal** frames (GC3622TLA/TRA, GC3622TLCA/TRCA). This table allows for kneespace when specifying chairs in a corner position. 1 per carton.

- Includes 2 rear metal legs (not shown).



Center Table

GC3672-LP	20.25 x 23.87 x 5.5 514 x 606 x 140	15 6.8	3.4 0.09	\$651
GC3672M-LP With power				\$1607
GC3672-HP	20.25 x 23.87 x 5.5 514 x 606 x 140	15 6.8	3.4 0.09	\$686
GC3672M-HP With power				\$1645

- For a thermally fused laminate top (LP), specify model GC3672-LP.
- For a high pressure laminate top (HP), specify model GC3672-HP.

- Models GC3672M-LP and GC3672M-HP have a **power/USB** module mounted in surface.

Coordinating 2mm edge. Regular center table for **wood** or **metal** (HT) frame. Must be connected to full arm and leg with **metal** or **wood** frames (GC3622TLA/TRA, GC3622TLCA/TRCA, GC3622WTLA/WTRA, GC3622WTLCA/WTRCA). 1 per carton.

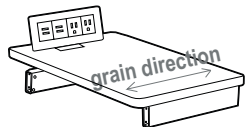

Narrow Center Table

GC3673-LP	12 x 23.87 x 5.5 305 x 606 x 140	14 6.4	2.1 0.05	\$633
GC3673M-LP With power				\$1592
GC3673-HP	12 x 23.87 x 5.5 305 x 606 x 140	14 6.4	2.1 0.05	\$667
GC3673M-HP With power				\$1628

- For a thermally fused laminate top (LP), specify model GC3673-LP.
- For a high pressure laminate top (HP), specify model GC3673-HP.

- Models GC3673M-LP and GC3673M-HP have a **power/USB** module mounted on surface.

Coordinating 2mm edge. Narrow center table for **wood** or **metal** (HT) frame. Must be connected to full arm and leg with **metal** or **wood** frames (GC3622TLA/TRA, GC3622TLCA/TRCA, GC3622WTLA/WTRA, GC3622WTLCA/WTRCA). 1 per carton.

MODULAR TABLES

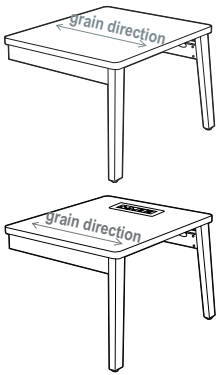

Left End Table, For Wood Frame

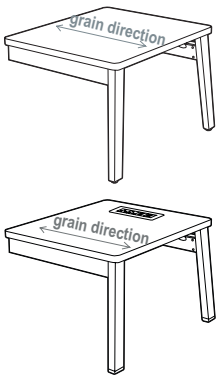

Left End Table, For Metal Frame

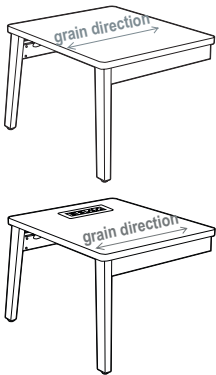

Right End Table, For Wood Frame

MODEL #	DIMENSIONS ^{IN} ^{MM} W x D x H	WEIGHT ^{LB} ^{KG}	VOLUME ^{FT³} ^{MT³}	LIST PRICE
GC3674WL-LP	20.25 x 23.87 x 17 514 x 606 x 432	14 6.4	3.4 0.09	\$817
GC3674WLM-LP With power				\$1690
GC3674WL-HP	20.25 x 23.87 x 17 514 x 606 x 432	15 6.8	3.4 0.09	\$850
GC3674WLM-HP With power				\$1722

- For a thermally fused laminate top (LP), specify model GC3674WL-LP.
- For a high pressure laminate top (HP), specify model GC3674WL-HP.
- Models GC3674WLM-LP and GC3674WLM-HP have a **power/USB** module mounted in surface.

Coordinating 2mm edge. Must be connected to full arm and leg with **wood** frames (GC3622WTLA or GC3622WTLCA). 1 per carton.

GC3674L-LP	20.25 x 23.87 x 17 514 x 606 x 432	14 6.4	3.4 0.09	\$972
GC3674LM-LP With power				\$1931
GC3674L-HP	20.25 x 23.87 x 17 514 x 606 x 432	15 6.8	3.4 0.09	\$1009
GC3674LM-HP With power				\$1967

- For a thermally fused laminate top (LP), specify model GC3674L-LP.
- For a high pressure laminate top (HP), specify model GC3674L-HP.
- Models GC3674LM-LP and GC3674LM-HP have a **power/USB** module mounted in surface.

Coordinating 2mm edge. Must be connected to full arm and leg with **metal** frames (GC3622TLA or GC3622TLCA). 1 per carton.

GC3674WR-LP	20.25 x 23.87 x 17 514 x 606 x 432	14 6.4	3.4 0.09	\$817
GC3674WRM-LP With power				\$1690
GC3674WR-HP	20.25 x 23.87 x 17 514 x 606 x 432	15 6.8	3.4 0.09	\$850
GC3674WRM-HP With power				\$1722

- For a thermally fused laminate top (LP), specify model GC3674WR-LP.
- For a high pressure laminate top (HP), specify model GC3674WR-HP.
- Models GC3674WRM-LP and GC3674WRM-HP have a **power/USB** module mounted in surface.

Coordinating 2mm edge. Must be connected to full arm and leg with **wood** frames (GC3622WTRA or GC3622WTRCA). 1 per carton.

SEATING

PRIMACARE™ MODULAR - GUEST/PATIENT P

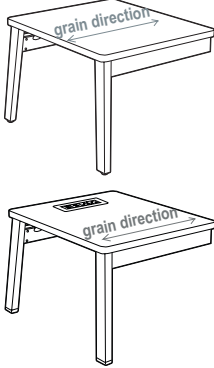
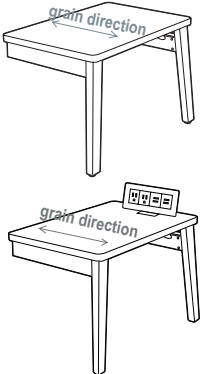
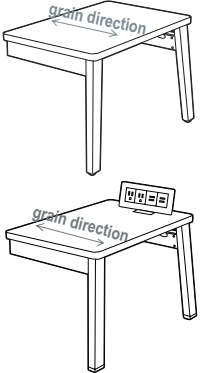
MODULAR TABLES	MODEL #	DIMENSIONS ^{IN} _{MM}	WEIGHT ^{LB} _{KG}	VOLUME ^{FT³} _{MT³}	LIST PRICE
 <p>Right End Table, For Metal Frame</p>	GC3674R-LP	20.25 x 23.87 x 17 514 x 606 x 432	14 6.4	3.4 0.09	\$972
	GC3674RM-LP With power				\$1931
	GC3674R-HP	20.25 x 23.87 x 17 514 x 606 x 432	15 6.8	3.4 0.09	\$1009
	GC3674RM-HP With power				\$1967
 <p>Narrow Left End Table, For Wood Frame</p>	GC3675WL-LP	12 x 23.87 x 17 305 x 606 x 432	14 6.4	2.1 0.05	\$802
	GC3675WLM-LP With power				\$1673
	GC3675WL-HP	12 x 23.87 x 17 305 x 606 x 432	14 6.4	2.1 0.05	\$835
	GC3675WLM-HP With power				\$1705
 <p>Narrow Left End Table, For Metal Frame</p>	GC3675L-LP	12 x 23.87 x 17 305 x 606 x 432	14 6.4	2.1 0.05	\$954
	GC3675LM-LP With power				\$1914
	GC3675L-HP	12 x 23.87 x 17 305 x 606 x 432	14 6.4	2.1 0.05	\$991
	GC3675LM-HP With power				\$1948

- For a thermally fused laminate top (LP), specify model GC3674R-LP.
- For a high pressure laminate top (HP), specify model GC3674R-HP.

- Models GC3674RM-LP and GC3674RM-HP have a **power/USB** module mounted in surface.

Coordinating 2mm edge. Must be connected to full arm and leg with **metal** frames (GC3622TRA or GC3622TRCA). 1 per carton.

- For a thermally fused laminate top (LP), specify model GC3675WL-LP.
- For a high pressure laminate top (HP), specify model GC3675WL-HP.

- Models GC3675WLM-LP and GC3675WLM-HP have a **power/USB** module mounted on surface.

Coordinating 2mm edge. Must be connected to full arm and leg with **wood** frames (GC3622WTLA or GC3622WTLCA). 1 per carton.

- For a thermally fused laminate top (LP), specify model GC3675L-LP.
- For a high pressure laminate top (HP), specify model GC3675L-HP.

- Models GC3675LM-LP and GC3675LM-HP have a **power/USB** module mounted on surface.

Coordinating 2mm edge. Must be connected to full arm and leg with **metal** frames (GC3622TLA or GC3622TLCA). 1 per carton.

MODULAR TABLES MODEL # DIMENSIONS ^{IN}/_{MM} WEIGHT ^{LB}/_{KG} VOLUME ^{FT³}/_{MT³} LIST PRICE

W x D x H

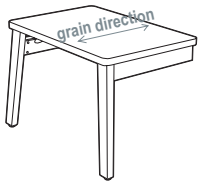

**Narrow Right End Table,
For Wood Frame**

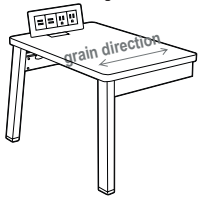
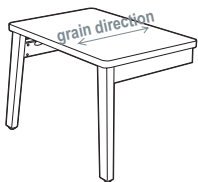

**Narrow Right End Table,
For Metal Frame**

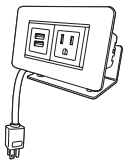

On Surface Power/Data Module

GC3675WR-LP	12 x 23.87 x 17 305 x 606 x 432	14 6.4	2.1 0.05	\$802
GC3675WRM-LP With power				\$1673
GC3675WR-HP	12 x 23.87 x 17 305 x 606 x 432	14 6.4	2.1 0.05	\$835
GC3675WRM-HP With power				\$1705

- For a thermally fused laminate top (LP), specify model GC3675WR-LP.
- For a high pressure laminate top (HP), specify model GC3675WR-HP.

- Models GC3675WRM-LP and GC3675WRM-HP have a **power/USB** module mounted on surface.

Coordinating 2mm edge. Must be connected to full arm and leg with **wood** frames (GC3622WTRA or GC3622WTRCA). 1 per carton.

GC3675R-LP	12 x 23.87 x 17 305 x 606 x 432	14 6.4	2.1 0.05	\$954
GC3675RM-LP With power				\$1914
GC3675R-HP	12 x 23.87 x 17 305 x 606 x 432	14 6.4	2.1 0.05	\$991
GC3675RM-HP With power				\$1948

- For a thermally fused laminate top (LP), specify model GC3675R-LP.
- For a high pressure laminate top (HP), specify model GC3675R-HP.

- Models GC3675RM-LP and GC3675RM-HP have a **power/USB** module mounted on surface.









Coordinating 2mm edge. Must be connected to full arm and leg with **metal** frames (GC3622TRA or GC3622TRCA). 1 per carton.

GC36410	- x - x - - x - x -	2 0.9	1 0.02	\$568
---------	------------------------	----------	-----------	--------------

Surface top mount power/data module with one power outlet and two USB charging ports. 6 foot cord. White. Can be mounted on all freestanding and modular tables.

MODULAR TOP UNITS















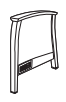

















FOR MODULAR LOUNGE AND FULLY UPHOLSTERED LOUNGE

	SINGLE SEAT	BARIATRIC	TWO SEATER	THREE SEATER
Lounge Seating	GC3641TOP 	GC3640TOP 	GC3642TOP 	GC3643TOP 
High Back Lounge Seating	GC3676HBTOP 	GC3679HBTOP 	GC3677HBTOP 	GC3678HBTOP 

LEG / ARM FRAMES

FOR MODULAR LOUNGE

Metal frame: Standard with Black urethane armcap (see notes for wood and urethane finish options) | Wood frame: Must select



	LEFT, OPEN	RIGHT, OPEN	LEFT, CLOSED	RIGHT, CLOSED	LEFT, CLOSED LAMINATE PANEL	RIGHT, CLOSED LAMINATE PANEL				
Metal (HT) End	GC3641LA 	GC3641LAM 	GC3641RA 	GC3641RAM 	GC3641LCA 	GC3641LCAM 	GC3641RCA 	GC3641RCAM 	GC3641LCAL 	GC3641RCAL 
Wood End	GC3641WLA 	GC3641WLAM 	GC3641WRA 	GC3641WRAM 	GC3641WLCA 	GC3641WLCAM 	GC3641WRCA 	GC3641WRCAM 		
Metal (HT) Center	GC36406LA 				GC36406LCA 				GC36406LCAL 	
Wood, Center	GC36406WLA 				GC36406WLCA 					
Metal (HT) Center table linking	GC36406TLA 		GC3622TRA 		GC36406TLCA 		GC36406TRCA 		GC36406TLCAL 	GC36406TRCAL 
Wood Center table linking	GC36406WTLA 		GC3622WTRA 		GC36406WTLCA 		GC36406WTRCA 			

For frame with power/USB module*, add "M" after model number

LEG / ARM FRAMES

FOR FULLY UPHOLSTERED MODULAR LOUNGE

Standard with Black urethane legs (see notes for wood and urethane finish options)
Optional armcap in wood or urethane (cannot be retrofitted in the field if the frame is ordered without armcap)

Fully Upholstered End	LEFT GC3676LA 	RIGHT GC3676RA 
Fully Upholstered Center	GC3676CFA 	

(Center = link both sides)

*Power module includes two power outlets, four USB charging ports and a 6 foot long power cord.
Available in Black or White (must be specified at time of order). Power module is mounted on the frame below seat support rail.

MODULAR TABLES FOR MODULAR LOUNGE AND FULLY UPHOLSTERED LOUNGE

Tables include legs to support table top (except for center tables). All tables have a metal frame.

LEFT

RIGHT

Corner
(laminated top with metal legs)

GC36403L-HP
GC36403L-LP

GC36403LM-HP
GC36403LM-LP

GC36403R-HP
GC36403R-LP

GC36403RM-HP
GC36403RM-LP



Corner
(laminated top with wood legs)

GC36403WL-HP
GC36403WL-LP

GC36403WLM-HP
GC36403WLM-LP

GC36403WR-HP
GC36403WR-LP

GC36403WRM-HP
GC36403WRM-LP

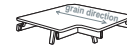

Center
(laminated top, connects to metal or wood frame)

GC36401-HP
GC36401-LP

GC36401M-HP
GC36401M-LP



Narrow Center
(laminated top, connects to metal or wood frame)

GC36402-HP
GC36402-LP

GC36402M-HP
GC36402M-LP



For table with power/USB module*, refer to models ending in "M"

End
(laminated top with metal legs)

GC36404L-HP
GC36404L-LP

GC36404LM-HP
GC36404LM-LP

GC36404R-HP
GC36404R-LP

GC36404RM-HP
GC36404RM-LP

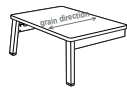

End
(laminated top with wood legs)

GC36404WL-HP
GC36404WL-LP

GC36404WLM-HP
GC36404WLM-LP

GC36404WR-HP
GC36404WR-LP

GC36404WRM-HP
GC36404WRM-LP



Narrow End
(laminated top with metal legs)

GC36405L-HP
GC36405L-LP

GC36405LM-HP
GC36405LM-LP

GC36405R-HP
GC36405R-LP

GC36405RM-HP
GC36405RM-LP

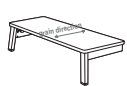
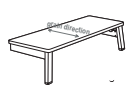

Narrow End
(laminated top with wood legs)

GC36405WL-HP
GC36405WL-LP

GC36405WLM-HP
GC36405WLM-LP

GC36405WR-HP
GC36405WR-LP

GC36405WRM-HP
GC36405WRM-LP

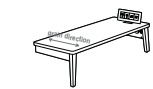
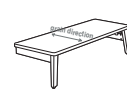

* Power module includes two power outlets, four USB charging ports and a 6 foot long power cord. Available in Black or White (must be specified at time of order). Power module is mounted **on surface** on narrow tables; mounted **in surface** on larger tables (as shown above).

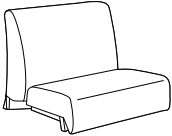
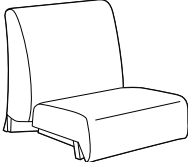
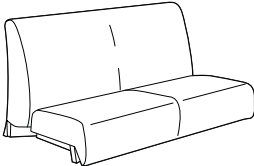
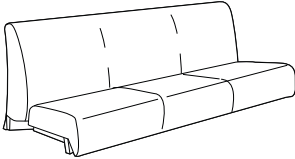
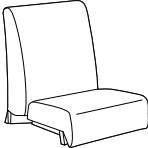
DESCRIPTION	MODEL# / FEATURES	STANDARD TEXTILE GRADES											
		COM	2	3	4	5	6	7	8	9	10	11	12
 <p>Lounge Bariatric Top COM: 3.25 YD 2.97 M Unit weight: 85 LB 38.6 KG Carton weight: 97 LB 44 KG Carton volume: 49.5 FT³ 1.4 MT³</p>	GC3640TOP	1654	1758	1846	1947	2112	2265	2418	2551	2717	2873	3084	3383
	Active weight: 500 lbs.	OVERALL DIMENSIONS			SEAT DIMENSIONS			BACK DIMENSIONS					
	Single frame lounge top unit with 1 back and 1 seat cushion.	W	D	H	W	D	H	W	H				
		IN 36	32	25	36	20	-	36	16				
	MM 914	813	635	914	508	-	914	406					
Must be connected to a full arm/leg frame.	RTA 00	1 per carton											
 <p>Lounge Single Seater Top COM: 2.5 YD 2.29 M Unit weight: 54 LB 24.5 KG Carton weight: 66 LB 29.9 KG Carton volume: 29.5 FT³ 0.83 MT³</p>	GC3641TOP	1099	1179	1247	1324	1452	1569	1687	1789	1917	2037	2199	2429
	Active weight: see notes.	OVERALL DIMENSIONS			SEAT DIMENSIONS			BACK DIMENSIONS					
	Single frame lounge top unit with 1 back and 1 seat cushion.	W	D	H	W	D	H	W	H				
		IN 25	32	25	23	20	-	22.5	16				
	MM 635	813	635	584	508	-	572	406					
Must be connected to a full arm/leg frame.	RTA 00	1 per carton											
 <p>Lounge Two Seater Top COM: 4 YD 3.66 M Unit weight: 95 LB 43.2 KG Carton weight: 110 LB 49.9 KG Carton volume: 49.5 FT³ 1.4 MT³</p>	GC3642TOP	1933	2061	2169	2293	2497	2685	2873	3037	3241	3433	3693	4061
	Active weight: see notes.	OVERALL DIMENSIONS			SEAT DIMENSIONS			BACK DIMENSIONS					
	Double frame lounge top unit with 2 back and 2 seat cushions.	W	D	H	W	D	H	W	H				
		IN 48	32	25	48	20	-	48	16				
	MM 1219	813	635	1219	508	-	1219	406					
Must be connected to a full arm/leg frame.	RTA 00	1 per carton											
 <p>Lounge Three Seater Top COM: 6.25 YD 5.72 M Unit weight: 136 LB 61.8 KG Carton weight: 161 LB 73.03 KG Carton volume: 69.5 FT³ 1.96 MT³</p>	GC3643TOP	2785	2985	3154	3348	3666	3960	4254	4510	4829	5129	5535	6110
	Due to the size and weight, this top requires at least 3 installers.	OVERALL DIMENSIONS			SEAT DIMENSIONS			BACK DIMENSIONS					
	Active weight: see notes.	W	D	H	W	D	H	W	H				
	Triple frame lounge top guest top, 3 back and 3 seat cushions.	IN 71	32	25	71	20	-	71	16				
	MM 1803	813	635	1803	508	-	1803	406					
Must be connected to a full arm/leg frame.	RTA 00	1 per carton											
 <p>HB Lounge Single Seater Top COM: 6.5 YD 5.94 M Unit weight: metal: 72 LB 32.7 KG Carton weight: metal: 92 LB 41.73 KG Carton volume: 29.5 FT³ 0.83 MT³</p>	GC3676HB-TOP	1244	1452	1628	1829	2161	2466	2772	3038	3370	3682	4104	4702
	Active weight: see notes.	OVERALL DIMENSIONS			SEAT DIMENSIONS			BACK DIMENSIONS					
	Single high back frame lounge top, 1 back and 1 seat cushion.	W	D	H	W	D	H	W	H				
		IN 23	29	36	23	20	-	23	19				
	MM 584	737	914	584	508	-	584	483					
Must be connected to a full arm/leg frame.	RTA 00	1 per carton											

DESCRIPTION MODEL# / FEATURES STANDARD TEXTILE GRADES

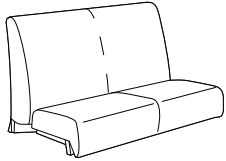

HB Lounge Two Seater Top
 COM: 7.75 YD | 7.09 M
 Unit weight: 97 LB | 44.1 KG
 Carton weight: 117 LB | 53.07 KG
 Carton volume: 56.25 FT³ | 1.59 MT³

GC3677HB-TOP

COM	2	3	4	5	6	7	8	9	10	11	12
2329	2577	2786	3027	3422	3786	4150	4468	4863	5235	5739	6452

Active weight: see notes.

Double high back frame lounge top, 1 back and 1 seat cushion.

Must be connected to a full arm/leg frame.

	OVERALL DIMENSIONS			SEAT DIMENSIONS			BACK DIMENSIONS	
	W	D	H	W	D	H	W	H
IN	45.5	29	36	45.5	20	-	45.5	19
MM	1156	737	914	1156	508	-	1156	483

RTA 00 1 per carton

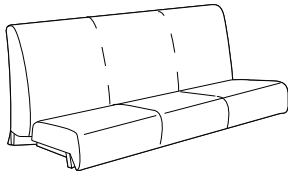

HB Lounge Three Seater Top
 COM: 9.25 YD | 8.46 M
 Unit weight: 133 LB | 60.5 KG
 Carton weight: 158 LB | 71.67 KG
 Carton volume: 69.5 FT³ | 1.96 MT³

GC3678HB-TOP

COM	2	3	4	5	6	7	8	9	10	11	12
3450	3746	3996	4283	4754	5189	5624	6003	6475	6919	7520	8371

Active weight: see notes.

Triple high back frame lounge top, 1 back and 1 seat cushion.

Must be connected to a full arm/leg frame.

	OVERALL DIMENSIONS			SEAT DIMENSIONS			BACK DIMENSIONS	
	W	D	H	W	D	H	W	H
IN	68.5	29	36	68.5	20	-	71	19
MM	1740	737	914	1740	508	-	1803	483

RTA 00 1 per carton

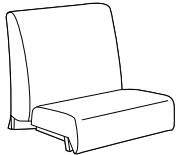

HB Lounge Bariatric Top
 COM: 6.75 YD | 6.17 M
 Unit weight: 80 LB | 36.4 KG
 Carton weight: 96 LB | 43.54 KG
 Carton volume: 37.75 FT³ | 1.06 MT³

GC3679HB-TOP

COM	2	3	4	5	6	7	8	9	10	11	12
1922	2138	2320	2530	2874	3191	3508	3785	4129	4453	4892	5513

Active weight: see notes.

Single high back frame bariatric lounge top, 1 back and 1 seat cushion.

Must be connected to a full arm/leg frame.

	OVERALL DIMENSIONS			SEAT DIMENSIONS			BACK DIMENSIONS	
	W	D	H	W	D	H	W	H
IN	32	29	36	32	20	-	32	19
MM	813	737	914	813	508	-	813	483

RTA 00 1 per carton

DESCRIPTION MODEL# / FEATURES STANDARD TEXTILE GRADES

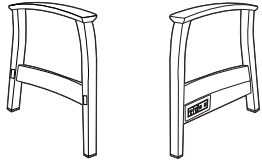

Lounge Left End Frame, Open Arm

COM: N/A
 Unit weight: metal: 7 LB | 3.2 KG | wood: 7 LB | 3.2 KG
 Carton weight: metal: 9.67 LB | 4.39 KG | wood: 11 LB | 4.99 KG
 Carton volume: 2.1 FT³ | 0.05 MT³

List price	
GC3641LA (metal)	545
GC3641LAM (w/power)	1568
GC3641WLA (wood)	375
GC3641WLAM (w/power)	1304

• Models GC3641LAM and GC3641WLAM have power/USB module.

Specify armcap: wood or urethane.	OVERALL DIMENSIONS			SEAT DIMENSIONS			BACK DIMENSIONS	
	W	D	H	W	D	H	W	H
For use in left side finished position of lounge seating units.	IN 3.5	29	25.25	-	-	-	-	-
	MM 89	737	641	-	-	-	-	-

Does not allow linking to other units or tables. **RTA 1** 1 per carton

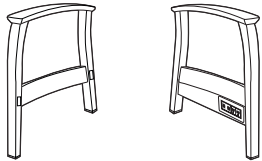

Lounge Right End Frame, Open Arm

COM: N/A
 Unit weight: metal: 7 LB | 3.2 KG | wood: 7 LB | 3.2 KG
 Carton weight: metal: 9.67 LB | 4.39 KG | wood: 11 LB | 4.99 KG
 Carton volume: 2.1 FT³ | 0.05 MT³

List price	
GC3641RA (metal)	545
GC3641RAM (w/power)	1568
GC3641WRA (wood)	375
GC3641WRAM (w/power)	1304

• Models GC3641RAM and GC3641WRAM have power/USB module.

Specify armcap: wood or urethane.	OVERALL DIMENSIONS			SEAT DIMENSIONS			BACK DIMENSIONS	
	W	D	H	W	D	H	W	H
For use in right side finished position of lounge seating units.	IN 3.5	29	25.25	-	-	-	-	-
	MM 89	737	641	-	-	-	-	-

Does not allow linking to other units or tables. **RTA 1** 1 per carton

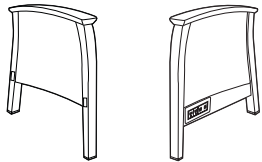

Lounge Left End Frame, Closed Arm

COM: 0.75 YD | 0.69 M
 Unit weight: metal: 7 LB | 3.2 KG | wood: 7 LB | 3.2 KG
 Carton weight: metal: 16.3 LB | 7.39 KG | wood: 11 LB | 4.99 KG
 Carton volume: 2.1 FT³ | 0.05 MT³

	COM	2	3	4	5	6	7	8	9	10	11	12
GC3641LCA (metal)	722	746	766	790	828	863	898	929	967	1003	1052	1121
GC3641LCAM (w/power)	1742	1766	1786	1810	1848	1883	1918	1949	1987	2023	2072	2141
GC3641WLCA (wood)	504	536	563	594	645	692	739	780	831	879	944	1036
GC3641WLCAM (w/power)	1430	1462	1489	1520	1571	1618	1665	1706	1757	1805	1870	1962

• Models GC3641LCAM and GC3641WLCAM have power/USB module.

Specify armcap: wood or urethane.	OVERALL DIMENSIONS			SEAT DIMENSIONS			BACK DIMENSIONS	
	W	D	H	W	D	H	W	H
For use in left side finished position of lounge seating units.	IN 3.5	29	25.25	-	-	-	-	-
	MM 89	737	641	-	-	-	-	-

Does not allow linking to other units or tables. **RTA 1** 1 per carton

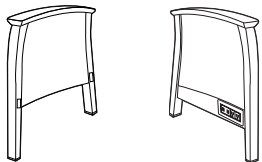

Lounge Right End Frame, Closed Arm

COM: 0.75 YD | 0.69 M
 Unit weight: metal: 7 LB | 3.2 KG | wood: 7 LB | 3.2 KG
 Carton weight: metal: 16.3 LB | 7.39 KG | wood: 11 LB | 4.99 KG
 Carton volume: 2.1 FT³ | 0.05 MT³

	COM	2	3	4	5	6	7	8	9	10	11	12
GC3641RCA (metal)	722	746	766	790	828	863	898	929	967	1003	1052	1121
GC3641RCAM (w/power)	1742	1766	1786	1810	1848	1883	1918	1949	1987	2023	2072	2141
GC3641WRCA (wood)	504	536	563	594	645	692	739	780	831	879	944	1036
GC3641WRCAM (w/power)	1430	1462	1489	1520	1571	1618	1665	1706	1757	1805	1870	1962

• Models GC3641RCAM and GC3641WRCAM have power/USB module.

Specify armcap: wood or urethane.	OVERALL DIMENSIONS			SEAT DIMENSIONS			BACK DIMENSIONS	
	W	D	H	W	D	H	W	H
For use in right side finished position of lounge seating units.	IN 3.5	29	25.25	-	-	-	-	-
	MM 89	737	641	-	-	-	-	-

Does not allow linking to other units or tables. **RTA 1** 1 per carton

DESCRIPTION MODEL# / FEATURES STANDARD TEXTILE GRADES

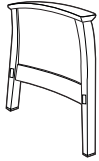

Lounge Left End Frame, Closed Arm, Laminate Panel
 COM: N/A
 Unit weight: 15 LB | 6.8 KG
 Carton weight: 18 LB | 8.16 KG
 Carton volume: 2.1 FT³ | 0.05 MT³

List price
GC3641LCAL (metal) 886

Specify armcap:
 wood or urethane.

OVERALL DIMENSIONS			SEAT DIMENSIONS			BACK DIMENSIONS	
W	D	H	W	D	H	W	H
IN 3.5	29	25.25	-	-	-	-	-
MM 89	737	641	-	-	-	-	-

For use in **left** side finished position of lounge seating units.
Does not allow linking to other units or tables.

RTA 1 1 per carton

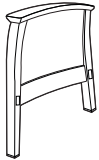

Lounge Right End Frame, Closed Arm, Laminate Panel
 COM: N/A
 Unit weight: 15 LB | 6.8 KG
 Carton weight: 18 LB | 8.16 KG
 Carton volume: 2.1 FT³ | 0.05 MT³

List price
GC3641RCAL (metal) 886

Specify armcap:
 wood or urethane.

OVERALL DIMENSIONS			SEAT DIMENSIONS			BACK DIMENSIONS	
W	D	H	W	D	H	W	H
IN 3.5	29	25.25	-	-	-	-	-
MM 89	737	641	-	-	-	-	-

For use in **right** side finished position of lounge seating units.
Does not allow linking to other units or tables.

RTA 1 1 per carton

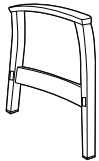

Lounge Center Frame, Open Arm
 COM: N/A
 Unit weight: metal: 7 LB | 3.2 KG | wood: 7 LB | 3.2 KG
 Carton weight: metal: 11 LB | 4.99 KG | wood: 11 LB | 4.99 KG
 Carton volume: 2.1 FT³ | 0.05 MT³

List price
GC36406LA (metal) 545
GC36406WLA (wood) 375

Specify armcap:
 wood or urethane.

OVERALL DIMENSIONS			SEAT DIMENSIONS			BACK DIMENSIONS	
W	D	H	W	D	H	W	H
IN 3.5	29	25.25	-	-	-	-	-
MM 89	737	641	-	-	-	-	-

For **linking** lounge top seating units together only.

RTA 1 1 per carton

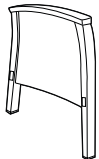

Lounge Center Frame, Closed Arm
 COM: 0.75 YD | 0.69 M
 Unit weight: metal: 7 LB | 3.2 KG | wood: 7 LB | 3.2 KG
 Carton weight: metal: 8.87 LB | 4.02 KG | wood: 11 LB | 4.99 KG
 Carton volume: 2.1 FT³ | 0.05 MT³

COM	2	3	4	5	6	7	8	9	10	11	12	
GC36406LCA (metal)	722	746	766	790	828	863	898	929	967	1003	1052	1121
GC36406WLCA (wood)	504	536	563	594	645	692	739	780	831	879	944	1036

Specify armcap:
 wood or urethane.

OVERALL DIMENSIONS			SEAT DIMENSIONS			BACK DIMENSIONS	
W	D	H	W	D	H	W	H
IN 3.5	29	25.25	-	-	-	-	-
MM 89	737	641	-	-	-	-	-

For **linking** lounge top seating units together only.

RTA 1 1 per carton

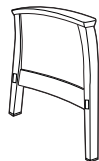

Lounge Center Frame, Closed Arm, Laminate Panel
 COM: N/A
 Unit weight: 15 LB | 6.8 KG
 Carton weight: 18 LB | 8.16 KG
 Carton volume: 2.1 FT³ | 0.05 MT³

List price
GC36406LCAL (metal) 886

Specify armcap:
 wood or urethane.

OVERALL DIMENSIONS			SEAT DIMENSIONS			BACK DIMENSIONS	
W	D	H	W	D	H	W	H
IN 3.5	29	25.25	-	-	-	-	-
MM 89	737	641	-	-	-	-	-

For **linking** lounge top seating units together only.

RTA 1 1 per carton

DESCRIPTION MODEL# / FEATURES STANDARD TEXTILE GRADES

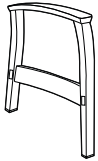

Lounge Center Frame, Open Arm

COM: N/A
 Unit weight: metal: 7 LB | 3.2 KG | wood: 7 LB | 3.2 KG
 Carton weight: metal: 11 LB | 4.99 KG | wood: 11 LB | 4.99 KG
 Carton volume: 2.1 FT³ | 0.05 MT³

List price										
GC36406TLA (metal)	545	OVERALL DIMENSIONS			SEAT DIMENSIONS			BACK DIMENSIONS		
GC36406WTLA (wood)	375	W	D	H	W	D	H	W	H	
Specify armcap: wood or urethane.		IN 3.5	29	25.25	-	-	-	-	-	
For linking lounge top seating units to modular table on the left side of the frame.		MM 89	737	641	-	-	-	-	-	
		RTA 1				1 per carton				

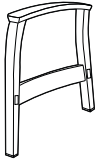

Lounge Center Frame, Open Arm

COM: N/A
 Unit weight: metal: 7 LB | 3.2 KG | wood: 7 LB | 3.2 KG
 Carton weight: metal: 2.24 LB | 1.02 KG | wood: 11 LB | 4.99 KG
 Carton volume: 2.1 FT³ | 0.05 MT³

List price										
GC36406TRA (metal)	545	OVERALL DIMENSIONS			SEAT DIMENSIONS			BACK DIMENSIONS		
GC36406WTRA (wood)	375	W	D	H	W	D	H	W	H	
Specify armcap: wood or urethane.		IN 3.5	29	25.25	-	-	-	-	-	
For linking lounge top seating units to modular table on the right side of the frame.		MM 89	737	641	-	-	-	-	-	
		RTA 1				1 per carton				

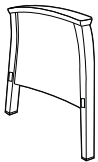

Lounge Center Frame, Closed Arm

COM: 0.75 YD | 0.69 M
 Unit weight: metal: 7 LB | 3.2 KG | wood: 7 LB | 3.2 KG
 Carton weight: metal: 8.87 LB | 4.02 KG | wood: 11 LB | 4.99 KG
 Carton volume: 2.1 FT³ | 0.05 MT³

COM	2	3	4	5	6	7	8	9	10	11	12	
GC36406TLCA (metal)	722	746	766	790	828	863	898	929	967	1003	1052	1121
GC36406WTLCA (wood)	504	536	563	594	645	692	739	780	831	879	944	1036
Specify armcap: wood or urethane.		OVERALL DIMENSIONS			SEAT DIMENSIONS			BACK DIMENSIONS				
		W	D	H	W	D	H	W	H			
For linking lounge top seating units to modular table on the left side of the frame.		IN 3.5	29	25.25	-	-	-	-	-			
		MM 89	737	641	-	-	-	-	-			
		RTA 1				1 per carton						

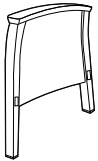

Lounge Center Frame, Closed Arm

COM: 0.75 YD | 0.69 M
 Unit weight: metal: 7 LB | 3.2 KG | wood: 7 LB | 3.2 KG
 Carton weight: metal: 11 LB | 4.99 KG | wood: 11 LB | 4.99 KG
 Carton volume: 2.1 FT³ | 0.05 MT³

COM	2	3	4	5	6	7	8	9	10	11	12	
GC36406TRCA (metal)	722	746	766	790	828	863	898	929	967	1003	1052	1121
GC36406WTRCA (wood)	504	536	563	594	645	692	739	780	831	879	944	1036
Specify armcap: wood or urethane.		OVERALL DIMENSIONS			SEAT DIMENSIONS			BACK DIMENSIONS				
		W	D	H	W	D	H	W	H			
For linking lounge top seating units to modular table on the right side of the frame.		IN 3.5	29	25.25	-	-	-	-	-			
		MM 89	737	641	-	-	-	-	-			
		RTA 1				1 per carton						

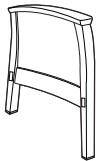

Lounge Center Frame, Closed Arm, Laminate Panel

COM: N/A
 Unit weight: 15 LB | 6.8 KG
 Carton weight: 18 LB | 8.16 KG
 Carton volume: 2.1 FT³ | 0.05 MT³

List price										
GC36406TLCAL (metal)	886	OVERALL DIMENSIONS			SEAT DIMENSIONS			BACK DIMENSIONS		
Specify armcap: wood or urethane.		W	D	H	W	D	H	W	H	
For linking lounge top seating units to modular table on the left side of the frame.		IN 3.5	29	25.25	-	-	-	-	-	
		MM 89	737	641	-	-	-	-	-	
		RTA 1				1 per carton				



Lounge Center Frame, Closed Arm, Laminate Panel

COM: N/A
 Unit weight: 15 LB | 6.8 KG
 Carton weight: 18 LB | 8.16 KG
 Carton volume: 2.1 FT³ | 0.05 MT³

List price										
GC36406TRCAL (metal)	886	OVERALL DIMENSIONS			SEAT DIMENSIONS			BACK DIMENSIONS		
Specify armcap: wood or urethane.		W	D	H	W	D	H	W	H	
For linking lounge top seating units to modular table on the right side of the frame.		IN 3.5	29	25.25	-	-	-	-	-	
		MM 89	737	641	-	-	-	-	-	
		RTA 1				1 per carton				

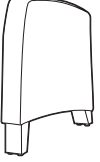
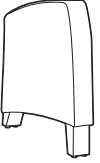
DESCRIPTION	MODEL# / FEATURES	STANDARD TEXTILE GRADES											
		COM	2	3	4	5	6	7	8	9	10	11	12
 <p>Center Frame, Fully Upholstered Arm COM: 1.75 YD 1.6 M Unit weight: metal: 15 LB 6.8 KG Carton weight: metal: 35 LB 15.88 KG Carton volume: 6 FT³ 0.16 MT³</p>	GC3676CFA	440	496	543	598	687	769	851	923	1012	1096	1210	1371
	Specify leg finish: wood or urethane.												
	Optional wood or urethane armcap. Please specify. Add \$142.	OVERALL DIMENSIONS			SEAT DIMENSIONS			BACK DIMENSIONS					
	For linking lounge top seating units together or to modular table.	IN	5	29	25.25	-	-	-	-	-	-	-	-
	MM	127	737	641	-	-	-	-	-	-	-	-	-
	RTA 00	1 per carton											
 <p>Left End Frame, Fully Upholstered Arm COM: 1.75 YD 1.6 M Unit weight: metal: 15 LB 6.8 KG Carton weight: metal: 20 LB 9.07 KG Carton volume: 6 FT³ 0.16 MT³</p>	GC3676LA	440	496	543	598	687	769	851	923	1012	1096	1210	1371
	Specify leg finish: wood or urethane.												
	Optional wood or urethane armcap. Please specify. Add \$142.	OVERALL DIMENSIONS			SEAT DIMENSIONS			BACK DIMENSIONS					
	For use in left side finished position of lounge seating units. Does not allow linking to other units or tables.	IN	5	29	25.25	-	-	-	-	-	-	-	-
	MM	127	737	641	-	-	-	-	-	-	-	-	-
	RTA 00	1 per carton											
 <p>Right End Frame, Fully Upholstered Arm COM: 1.75 YD 1.6 M Unit weight: metal: 15 LB 6.8 KG Carton weight: metal: 20 LB 9.07 KG Carton volume: 6 FT³ 0.16 MT³</p>	GC3676RA	440	496	543	598	687	769	851	923	1012	1096	1210	1371
	Specify leg finish: wood or urethane.												
	Optional wood or urethane armcap. Please specify. Add \$142.	OVERALL DIMENSIONS			SEAT DIMENSIONS			BACK DIMENSIONS					
	For use in right side finished position of lounge seating units. Does not allow linking to other units or tables.	IN	5	29	25.25	-	-	-	-	-	-	-	-
	MM	127	737	641	-	-	-	-	-	-	-	-	-
	RTA 00	1 per carton											

Modular tables for use with modular lounge and fully upholstered lounge units:

Tops are 1" thick.

Wooden leg tables:

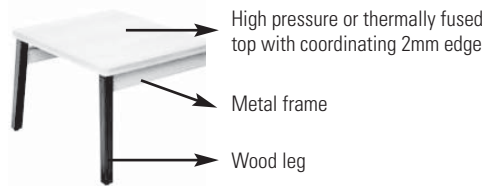

Metal leg tables:

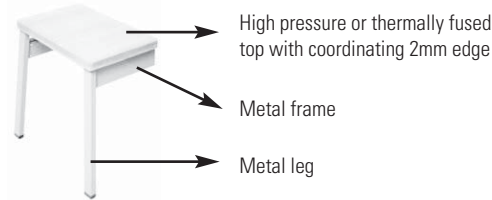

Table top finishes:

Thermally Fused Laminate (LP)

- Absolute Acajou (ACJ)
- Asian Night (ASN)
- Avant Cherry (AWC)
- Avant Honey (AWH)
- Black (BLK)
- Blizzard (BZD)
- Brushed Cobalt (BRC)
- Clear Maple (CMB)
- Custom Grey (CGY)
- Dark Espresso (DES)
- Designer White (DWT)
- Fashionista (FAS)
- First Class (FCL)
- Quartered Mahogany (QTM)
- Noce Biondo (NBL)
- Noce Grigio (NGL)
- Noce Leggero (NEL)
- Noce Medio (NML)
- Sheer Beauty (SBY)
- Stonedust (SDT)
- Storm (SOG)
- Walnut Heights (WHE)
- White Chocolate (WHC)
- Winter Cherry (WCR)

High Pressure Laminate (HP)

- Absolute Acajou (ACJ)
- Asian Night (ASN)
- Avant Cherry (W357)
- Avant Honey (W356)
- Black (BLK)
- Blizzard (BZD)
- Brushed Cobalt (BRC)
- Clear Maple (CMB)
- Custom Grey (CGY)
- Dark Espresso (W142)
- Designer White (DWT)
- Fashionista (FAS)
- First Class (FCL)
- Quartered Mahogany (QTM)
- Noce Biondo (NBL)
- Noce Grigio (NGL)
- Noce Leggero (NEL)
- Noce Medio (NML)
- Sheer Beauty (SBY)
- Stonedust (SDT)
- Storm (SOG)
- Walnut Heights (WHE)
- White Chocolate (WHC)
- Winter Cherry (WCR)

Wooden leg finishes (top, base, legs & apron):

- | | |
|--------------------------------|-------------------------------|
| Absolute (AAM) | Natural Walnut (NLW) |
| Charcoal Java on Maple (CJM) | Night (ASM) |
| Cherry on Maple (ACM) | Noce Biondo (NBM) |
| Empire Mahogany on Maple (EMM) | Noce Grigio (NGM) |
| English Oak on Maple (EOM) | Noce Leggero (NEM) |
| Medium Walnut on Maple (MWM) | Noce Medio (NMM) |
| Espresso Cafe on Maple (ECM) | Shaker Cherry on Maple (SKM) |
| Fruitwood on Maple (TFM) | Tiger Mahogany on Maple (TMM) |
| Gray (HGM) | Tiger Walnut on Maple (TWM) |
| Harvest Oak on Maple (HOM) | Winter Cherry on Maple (WCM) |
| Honey on Maple (AHM) | Sandy Beach on Maple (SBM) |
| Jet Onyx on Maple (JOM) | WC Cream (WTM) |
| Light Honey on Maple (LHM) | Silver Oak on Maple (SOM) |
| Maple on Maple (AVM) | White on Maple (WHM) |

Metal leg finishes:

Black (TBL), Cloud (TIV), Designer White (TDW), Fog (TFO), Frost (TFR), Kalua (TKA), Latte (TLA), Mocha (TMO), Nevada (TNE), Sand (TSN), Shadow (TSH), Toast (TOA) and Tungsten (TTU). Please specify.

Metal frame finishes:

Black (TBL), Cloud (TIV), Designer White (TDW), Fog (TFO), Frost (TFR), Kalua (TKA), Latte (TLA), Mocha (TMO), Nevada (TNE), Sand (TSN), Shadow (TSH), Toast (TOA) and Tungsten (TTU). Please specify.

Power/USB modules:

For modular tables with power/USB module, refer to models ending in "M". Module includes two power outlets, four USB charging ports and a 6 foot long power cord. Available in Black or White (must be specified at time of order). Power module is mounted **on surface** on narrow tables; mounted **in surface** on larger tables.

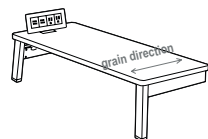

On surface power module on narrow tables

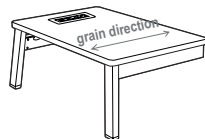

In surface power module on larger tables

MODULAR TABLES	MODEL #	DIMENSIONS ^{IN} _{MM}	WEIGHT ^{LB} _{KG}	VOLUME ^{FT³} _{MT³}	LIST PRICE
----------------	---------	---	---------------------------------------	---	------------

W x D x H



Center Table

GC36401-LP	20.25 x 28 x 13 514 x 711 x 330	18 8.2	3.5 0.09	\$785
GC36401M-LP With power				\$1744
GC36401-HP	20.25 x 28 x 13 514 x 711 x 330	18 8.2	3.5 0.09	\$821
GC36401M-HP With power				\$1780

- For a thermally fused laminate top (LP), specify model GC36401-LP.
- For a high pressure laminate top (HP), specify model GC36401-HP.

- Models GC36401M-LP and GC36401M-HP have a **power/USB** module mounted in surface.

Coordinating 2mm edge. Regular center table for **wood or metal lounge** frame. Must be connected to full arm and leg with **lounge** frames (GC36406TLA/TRA, GC36406TLCA/TRCA, GC36406WTLA/TRA, GC36406WTLCA/TRCA). 1 per carton.

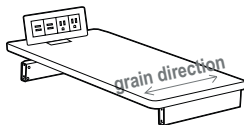

Narrow Center Table

GC36402-LP	12 x 28 x 13 305 x 711 x 330	15 6.8	2.1 0.05	\$757
GC36402M-LP With power				\$1717
GC36402-HP	12 x 28 x 13 305 x 711 x 330	15 6.8	2.1 0.05	\$791
GC36402M-HP With power				\$1750

- For a thermally fused laminate top (LP), specify model GC36402-LP.
- For a high pressure laminate top (HP), specify model GC36402-HP.

- Models GC36402M-LP and GC36402M-HP have a **power/USB** module mounted in surface.

Coordinating 2mm edge. Narrow center table for **wood or metal lounge** frame. Must be connected to full arm and leg with **lounge** frames (GC36406TLA/TRA, GC36406TLCA/TRCA, GC36406WTLA/TRA, GC36406WTLCA/TRCA). 1 per carton.

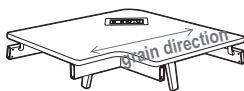

Left Corner Table, Wood Legs



GC36403WL-LP	37.12 x 37.12 x 13 943 x 943 x 330	41 18.6	6 0.16	\$1220
GC36403WLM-LP With power				\$2091
GC36403WL-HP	37.12 x 37.12 x 13 943 x 943 x 330	41 18.6	6 0.16	\$1294
GC36403WLM-HP With power				\$2164

- For a thermally fused laminate top (LP), specify model GC36403WL-LP.
- For a high pressure laminate top (HP), specify model GC36403WL-HP.

- Models GC36403WLM-LP and GC36403WLM-HP have a **power/USB** module mounted in surface.

Coordinating 2mm edge. Must be connected to full arm and leg with **wood lounge** frames (GC36406WTLA/TRA, GC36406WTLCA/TRCA). This table allows for kneespace when specifying chairs in a corner position. 1 per carton.

- Includes 2 rear wood legs (not shown).

MODULAR TABLES	MODEL #	DIMENSIONS ^{IN} _{MM}	WEIGHT ^{LB} _{KG}	VOLUME ^{FT³} _{MT³}	LIST PRICE
 <p>Left Corner Table, Metal Legs</p>	GC36403L-LP	37.12 x 37.12 x 13 943 x 943 x 330	41 18.6	6 0.16	\$1405
	GC36403LM-LP With power				\$2362
	GC36403L-HP	37.12 x 37.12 x 13 943 x 943 x 330	41 18.6	6 0.16	\$1485
	GC36403LM-HP With power				\$2444
 <p>Right Corner Table, Wood Legs</p>	GC36403WR-LP	37.12 x 37.12 x 13 943 x 943 x 330	41 18.6	6 0.16	\$1220
	GC36403WRM-LP With power				\$2091
	GC36403WR-HP	37.12 x 37.12 x 13 943 x 943 x 330	41 18.6	6 0.16	\$1294
	GC36403WRM-HP With power				\$2164
 <p>Right Corner Table, Metal Legs</p>	GC36403R-LP	37.12 x 37.12 x 13 943 x 943 x 330	41 18.6	6 0.16	\$1405
	GC36403RM-LP With power				\$2362
	GC36403R-HP	37.12 x 37.12 x 13 943 x 943 x 330	41 18.6	6 0.16	\$1485
	GC36403RM-HP With power				\$2444

- For a thermally fused laminate top (LP), specify model GC36403L-LP.
- For a high pressure laminate top (HP), specify model GC36403L-HP.

- Models GC36403LM-LP and GC36403LM-HP have a **power/USB** module mounted in surface.

Coordinating 2mm edge. Must be connected to full arm and leg with **metal lounge** frames (GC36406TLA/TRA, GC36406TLCA/TRCA). This table allows for kneespace when specifying chairs in a corner position. 1 per carton.

- Includes 2 rear metal legs (not shown).

- For a thermally fused laminate top (LP), specify model GC36403WR-LP.
- For a high pressure laminate top (HP), specify model GC36403WR-HP.

- Models GC36403WRM-LP and GC36403WRM-HP have a **power/USB** module mounted in surface.

Coordinating 2mm edge. Must be connected to full arm and leg with **wood lounge** frames (GC36406WTLA/TRA, GC36406WTLCA/TRCA). This table allows for kneespace when specifying chairs in a corner position. 1 per carton.

- Includes 2 rear wood legs (not shown).

- For a thermally fused laminate top (LP), specify model GC36403R-LP.
- For a high pressure laminate top (HP), specify model GC36403R-HP.

- Models GC36403RM-LP and GC36403RM-HP have a **power/USB** module mounted in surface.

Coordinating 2mm edge. Must be connected to full arm and leg with **metal lounge** frames (GC36406TLA/TRA, GC36406TLCA/TRCA). This table allows for kneespace when specifying chairs in a corner position. 1 per carton.

- Includes 2 rear metal legs (not shown).

MODULAR TABLES

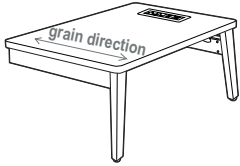
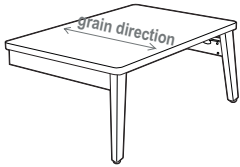

Left End Table, Wood Legs

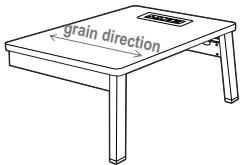
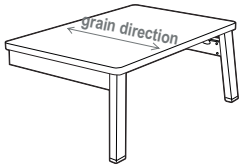

Left End Table, Metal Legs

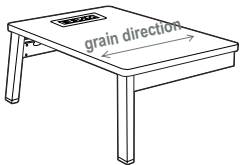
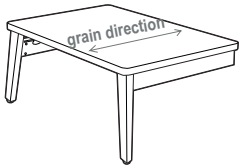

Right End Table, Wood Legs

MODEL #	DIMENSIONS ^{IN} ^{MM} W x D x H	WEIGHT ^{LB} ^{KG}	VOLUME ^{FT³} ^{MT³}	LIST PRICE
GC36404WL-LP	20.25 x 28 x 13 514 x 711 x 330	18 8.2	3.5 0.09	\$933
GC36404WLM-LP With power				\$1803
GC36404WL-HP	20.25 x 28 x 13 514 x 711 x 330	18 8.2	3.5 0.09	\$966
GC36404WLM-HP With power				\$1837

- For a thermally fused laminate top (LP), specify model GC36404WL-LP.
- For a high pressure laminate top (HP), specify model GC36404WL-HP.

- Models GC36404WLM-LP and GC36404WLM-HP have a **power/USB** module mounted in surface.

Coordinating 2mm edge. Must be connected to full arm and leg with **wood lounge** frames (GC36406WTLA or GC36406WTLCA). 1 per carton.

GC36404L-LP	20.25 x 28 x 13 514 x 711 x 330	18 8.2	3.5 0.09	\$1088
GC36404LM-LP With power				\$2045
GC36404L-HP	20.25 x 28 x 13 514 x 711 x 330	18 8.2	3.5 0.09	\$1124
GC36404LM-HP With power				\$2085

- For a thermally fused laminate top (LP), specify model GC36404L-LP.
- For a high pressure laminate top (HP), specify model GC36404L-HP.

- Models GC36404LM-LP and GC36404LM-HP have a **power/USB** module mounted in surface.

Coordinating 2mm edge. Must be connected to full arm and leg with **metal lounge** frames (GC36406TLA or GC36406TLCA). 1 per carton.

GC36404WR-LP	20.25 x 28 x 13 514 x 711 x 330	18 8.2	3.5 0.09	\$933
GC36404WRM-LP With power				\$1803
GC36404WR-HP	20.25 x 28 x 13 514 x 711 x 330	18 8.2	3.5 0.09	\$966
GC36404WRM-HP With power				\$1837

- For a thermally fused laminate top (LP), specify model GC36404WR-LP.
- For a high pressure laminate top (HP), specify model GC36404WR-HP.

- Models GC36404WRM-LP and GC36404WRM-HP have a **power/USB** module mounted in surface.

Coordinating 2mm edge. Must be connected to full arm and leg with **wood lounge** frames (GC36406WTRA or GC36406WTRCA). 1 per carton.

MODULAR TABLES	MODEL #	DIMENSIONS	IN MM	WEIGHT	LB KG	VOLUME FT ³ MT ³	LIST PRICE
----------------	---------	------------	----------	--------	----------	--	------------

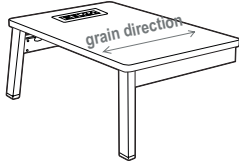
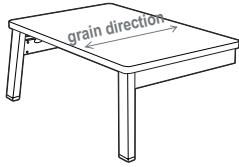

Right End Table, Metal Legs

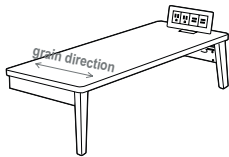
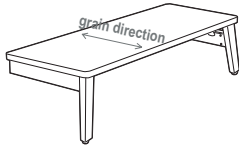

Narrow Left End Table, Wood Legs

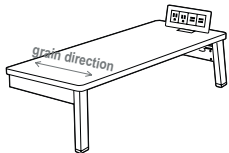
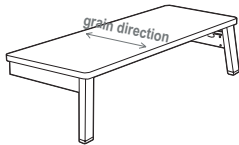

Narrow Left End Table, Metal Legs

	W x D x H				
GC36404R-LP	20.25 x 28 x 13	18	3.5	\$1088	
GC36404RM-LP With power	514 x 711 x 330	8.2	0.09	\$2045	
GC36404R-HP	20.25 x 28 x 13	18	3.5	\$1124	
GC36404RM-HP With power	514 x 711 x 330	8.2	0.09	\$2085	

- For a thermally fused laminate top (LP), specify model GC36404R-LP.
- For a high pressure laminate top (HP), specify model GC36404R-HP.

- Models GC36404RM-LP and GC36404RM-HP have a **power/USB** module mounted in surface.

Coordinating 2mm edge. Must be connected to full arm and leg with **metal lounge** frames (GC36406TRA or GC36406TRCA). 1 per carton.

GC36405WL-LP	12 x 28 x 13	15	2.1	\$911	
GC36405WLM-LP With power	305 x 711 x 330	6.8	0.05	\$1783	
GC36405WL-HP	12 x 28 x 13	15	2.1	\$938	
GC36405WLM-HP With power	305 x 711 x 330	6.8	0.05	\$1811	

- For a thermally fused laminate top (LP), specify model GC36405WL-LP.
- For a high pressure laminate top (HP), specify model GC36405WL-HP.

- Models GC36405WLM-LP and GC36405WLM-HP have a **power/USB** module mounted on surface.

Coordinating 2mm edge. Must be connected to full arm and leg with **wood lounge** frames (GC36406WTLA or GC36406WTLCA). 1 per carton.

GC36405L-LP	12 x 28 x 13	15	2.1	\$1064	
GC36405LM-LP With power	305 x 711 x 330	6.8	0.05	\$2024	
GC36405L-HP	12 x 28 x 13	15	2.1	\$1096	
GC36405LM-HP With power	305 x 711 x 330	6.8	0.05	\$2056	

- For a thermally fused laminate top (LP), specify model GC36405L-LP.
- For a high pressure laminate top (HP), specify model GC36405L-HP.

- Models GC36405LM-LP and GC36405LM-HP have a **power/USB** module mounted on surface.

Coordinating 2mm edge. Must be connected to full arm and leg with **metal lounge** frames (GC36406TLA or GC36406TLCA). 1 per carton.

MODULAR TABLES

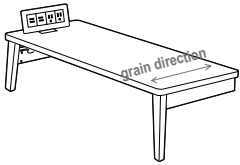
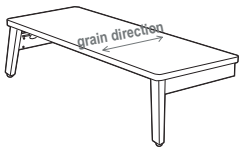

Narrow Right End Table, Wood Legs

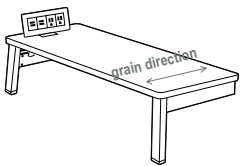
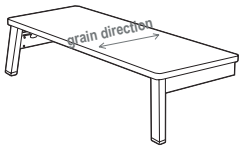

Narrow Right End Table, Metal Legs

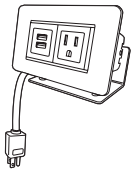

Power/Data Module for tables

MODEL #	DIMENSIONS ^{MM}	WEIGHT ^{KG}	VOLUME ^{MT³}	LIST PRICE
---------	--------------------------	----------------------	----------------------------------	------------

W x D x H

GC36405WR-LP	12 x 28 x 13 305 x 711 x 330	15 6.8	2.1 0.05	\$911
GC36405WRM-LP With power				\$1783
GC36405WR-HP	12 x 28 x 13 305 x 711 x 330	15 6.8	2.1 0.05	\$938
GC36405WRM-HP With power				\$1811

- For a thermally fused laminate top (LP), specify model GC36405WR-LP.
- For a high pressure laminate top (HP), specify model GC36405WR-HP.
- Models GC36405WRM-LP and GC36405WRM-HP have a **power/USB** module mounted on surface.

Coordinating 2mm edge. Must be connected to full arm and leg with **wood lounge** frames (GC36406WTRA or GC36406WTRCA). 1 per carton.

GC36405R-LP	12 x 28 x 13 305 x 711 x 330	15 6.8	2.1 0.05	\$1064
GC36405RM-LP With power				\$2024
GC36405R-HP	12 x 28 x 13 305 x 711 x 330	15 6.8	2.1 0.05	\$1096
GC36405RM-HP With power				\$2056

- For a thermally fused laminate top (LP), specify model GC36405R-LP.
- For a high pressure laminate top (HP), specify model GC36405R-HP.
- Models GC36405RM-LP and GC36405RM-HP have a **power/USB** module mounted on surface.

Coordinating 2mm edge. Must be connected to full arm and leg with **metal lounge** frames (GC36406TRA or GC36406TRCA). 1 per carton.

GC36410	- x - x - - x - x -	2 0.9	1 0.02	\$568
---------	------------------------	----------	-----------	--------------

Surface top mount power/data module with one power outlet, two USB charging ports. 6 foot cord. White. Can be mounted to all freestanding and modular tables.



Meet River+™, the next generation of our highly popular lounge series. Now with industry-leading support for workplace, education and healthcare, River+ performs at three times the BIFMA standard for true 24/7 applications in demanding environments. All models have been active weight tested to 600 lbs. including bariatric use. Multiple back and seat heights, 120-degree configurations and modular Aluminum arms are just a few of the many options that will make it yours.

To see the full River+ series, please refer to the Seating price list at globalfurnituregroup.com/ca/resources/pricelists.

Features and Benefits

- A modular series that is composed of straight, curved and corner sections.
- Units can be linked together to create a wide variety of layouts. Ganging hardware is standard and is factory installed. Ganging hardware swivels out of the way when not in use.
- The tapered legs are made of welded steel, with each leg bolted directly to the unit frame. Standard leg height is 6.5" with an optional 8" height. The leg height makes it easy to clean under the product.
- Seat to back connector components join back and seat; maintaining offset for clean out.
- All River+ seating models meet or exceed the applicable ANSI/BIFMA standards and are backed by Global's Heavy Duty warranty.
- Back shelf available on corner, two and three seater units in many low pressure laminate finishes. Shelf supports are Aluminum with accessory hook in three finishes.
- Upholstery options: fabric, vinyl or leather (leather recommended only for use on seat).
- For improved housekeeping and infection control practices, the underside of the seat can be finished with PVC (vinyl) and sealed to prevent penetration of liquids.
- Sealed seams option and steel bottom tamperproof protection is also available.
- For environmental certifications, please visit globalfurnituregroup.com.

SENATOR



Optional metal leg

model GC3392 (tapered wood legs)

STANDARD FEATURES

- The flared back design and creative curves enhance any healthcare environment without sacrificing comfort.
- Waterfall seamless front upholstered design with removable seat cushions for easy cleaning and protecting against bacteria.
- For added comfort, seats are standard with high density Ultracell foam.
- Standard with wood legs.
- For healthcare textiles and wood finish options, visit the website at globalfurnituregroup.com. Available in European beechwood species only (refer to finishes ending in "M").
- Can be upholstered in standard Global textiles if healthcare compliance is not required.
- Shipped fully assembled.

OPTIONAL FEATURES

- Optional metal legs are available in Black (TBL), Kalua (TKA), Latte (TLA), Mocha (TMO), Shadow (TSH), Toast (TOA) and Tungsten (TTU). Please specify. No upcharge.
- For hard surface floors, please specify opaque non-marking glides (**GL**). No upcharge.
- For steel cushion glide, please specify (**GI**). Add \$5.
- For non-slip glides, please specify (**NS**). Add \$22.
- For moisture barrier on seat, please specify (**MB**). See upcharges below.
- To add sealed seams to your product contact Customer Service. Upcharges vary.

SUGGESTED APPLICATIONS

- Lobbies
- Lounge/Waiting
- Patient rooms
- Resident rooms

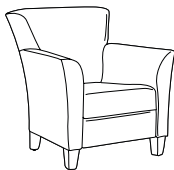
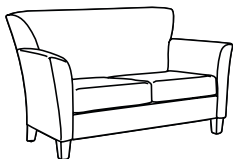
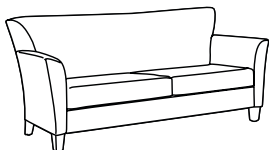
DESCRIPTION	MODEL# / FEATURES	STANDARD TEXTILE GRADES											
		COM	2	3	4	5	6	7	8	9	10	11	12
 Armchair COM: 5.25 YD 4.8 M Unit weight: 56 LB 25.5 KG Carton weight: 72 LB 32.66 KG Carton volume: 29.25 FT³ 0.82 MT³	GC3391	2065	2233	2375	2538	2805	3052	3299	3514	3782	4034	4375	4858
	Active weight 300 lbs.	IN 34	32.25	36		19.5	19	17.5		28	18.5		
	Removable seat cushion.	MM 864	819	914		495	483	445		711	470		
	Add \$122 for (MB).	RTA 00											
 Two Seat Sofa COM: 8.25 YD 7.54 M Unit weight: 90 LB 40.9 KG Carton weight: 116 LB 52.62 KG Carton volume: 55.5 FT³ 1.57 MT³	GC3392	2845	3109	3332	3588	4008	4396	4784	5122	5543	5939	6475	7234
	Active weight 300 lbs/seat.	IN 61	32.25	36		46	19	17.5		56	18.5		
	Removable seat cushions.	MM 1549	819	914		1168	483	445		1422	470		
	Add \$245 for (MB).	RTA 00											
 Three Seat Sofa COM: 9.5 YD 8.69 M Unit weight: 110 LB 50 KG Carton weight: 141 LB 63.96 KG Carton volume: 67 FT³ 1.89 MT³	GC3393	3681	3985	4242	4536	5021	5467	5914	6303	6788	7244	7861	8735
	Active weight 300 lbs/seat.	IN 76	32.25	36		61	19	17.5		71	18.5		
	Removable seat cushions.	MM 1930	819	914		1549	483	445		1803	470		
	Add \$366 for (MB).	RTA 00											

SLEEP-EEZ



model GC3614

Sleep surface dimensions:

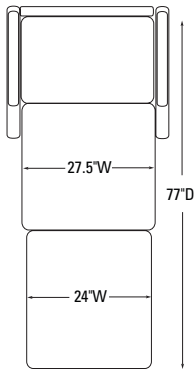

EXAMPLE SLEEP-EEZ ORDER CODE:

GC3614	-LX21	-PT	-	-SS
Model #	Textile	Armcaps	Moisture Barrier	Sealed seams

STANDARD FEATURES

- Sleep-Eez provides incredible comfort, requires zero wall clearance and can be easily opened and close by one person.
- It can be adjusted to create three functional positions: a chair, a chaise lounge and a sleep surface.
- The heavy duty steel mechanism will provide long-term performance.
- Commercial grade casters are standard. Front casters are non-swivel manual locking. Back casters are non-locking and swivel for better steering when moving the chair.
- Clean out space is provided between the seat and back cushions for housekeeping and infection prevention control.
- Sleep-Eez's construction allows for on-site replacement of all components, eliminating down time and enhancing the product's life.
- Standard with Black urethane (urethane) fully extended arms with a grip for ease of entry and exit from chair.
- For healthcare textile options, visit the website at globalfurnituregroup.com.
- Can be upholstered in standard Global textiles if healthcare compliance is not required.
- Shipped fully assembled.
- Measurements:
Chaise lounge: 35"W x 64"D x 35"H
Sleep surface: 24"W x 77"D

OPTIONAL FEATURES

- For moisture barrier on seat, please specify **(MB)**. Add \$122.
- To add sealed seams to your product, please specify **(SS)**. Add \$189.

SUGGESTED APPLICATIONS

- Lobbies
- Lounge/Waiting
- Office/Meeting
- Patient rooms
- Resident rooms
- Treatment/Exam rooms

Please add option codes in the following order:

- **Model number**
GC3614 Single sleeper chair
- **Textile**
Specify fabric code
- **Armcap finish**
(SS) Black urethane armcap
(LA) Latte urethane armcap
(KL) Kalua urethane armcap
(MC) Mocha urethane armcap
(SH) Shadow urethane armcap
(TO) Toast urethane armcap
(AB) Absolute wood armcap
(CJ) Charcoal Java wood armcap
(AC) Cherry wood armcap
(EP) Empire Mahogany wood armcap
(EM) English Oak wood armcap
(EC) Espresso Cafe wood armcap
(HG) Gray wood armcap
(HA) Harvest Oak wood armcap
(AH) Honey wood armcap
(JO) Jet Onyx wood armcap
(LH) Light Honey wood armcap
(AV) Maple wood armcap
(MW) Medium Walnut wood armcap
(NW) Natural Walnut wood armcap
(AT) Night wood armcap
(BI) Noce Biondo wood armcap
(GI) Noce Grigio wood armcap
(EI) Noce Leggero wood armcap
(MI) Noce Medio wood armcap
(SB) Sandy Beach wood armcap
(SM) Silver Oak wood armcap
(TF) Tiger Fruitwood wood armcap
(TM) Tiger Mahogany wood armcap
(TL) Tiger Walnut wood armcap
(WR) WC Cream wood armcap
(WH) White wood armcap
(WC) Winter Cherry wood armcap
- **Moisture Barrier**
(MB) Seat only
- **Sealed seams**
(SS) All sealed seams

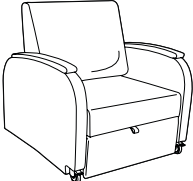
DESCRIPTION	MODEL# / FEATURES	STANDARD TEXTILE GRADES											
		COM	2	3	4	5	6	7	8	9	10	11	12
 Single Sleeper Chair COM: 8.5 YD 7.77 M Unit weight: 146 LB 66.4 KG Carton weight: 160 LB 72.57 KG Carton volume: 38 FT³ 1.07 MT³	GC3614	3171	3443	3673	3936	4370	4769	5169	5517	5951	6359	6911	7693
	Active weight 350 lbs.	OVERALL DIMENSIONS W D H			SEAT DIMENSIONS W D H			BACK DIMENSIONS W H					
		IN 35	37	35	27.5	21	17.5	27.5	18.5				
		MM 889	940	889	699	533	445	699	470				
		RTA 00		1 per carton									

STRAND



model **GC3707HB**



model **GC3702**

STANDARD FEATURES

- Strand is the perfect synthesis of versatility, comfort, durability and value pricing. Strand offers a pleasing look in a diverse range of solutions from single patient room chairs to waiting areas and public spaces.
- All models are standard in oval metal tube frame.
- Frame available in Black (TBL), Cloud (TIV), Designer White (TDW), Fog (TFO), Frost (TFR), Kalua (TKA), Latte (TLA), Mocha (TMO), Nevada (TNE), Sand (TSN), Shadow (TSH), Toast (TOA) and Tungsten (TTU). Please specify.
- The frame can be weighted and made with tamperproof fasteners for greater security in more challenging mental health spaces or correctional facilities. Request a special quote.
- Armcaps are standard in Black urethane (urethane).
- Left and right position reference is determined from the seated position.
- The seat and back are removable and field replaceable.
- For added comfort, seats are standard with high density Ultracell foam.
- All seat frames feature a wall saver design to prevent back contact with wall. Footstool and benches do not have wall saver legs.
- Standard seat height on all models is 18".
- Clean out space is provided between the seat and back cushions for easy housekeeping.
- Standard with Black plastic glides.
- Select models are offered with rear tip and move wheels. To activate wheels, tilt the chair back so the casters are in contact with the floor. This feature makes it easy to relocate the chair while unoccupied.
- Flex back models allow the back to move in a soothing rocking motion.
- Active weight capacity for standard single seat is 350 lbs. and 750 lbs. for bariatric seating.
- For healthcare textiles and wood finish options, visit the website at globalfurnituregroup.com.
- Can be upholstered in standard Global textiles if healthcare compliance is not required.



OPTIONAL FEATURES



- The seat cushion is slightly inclined to enhance comfort. An optional flat seat cushion is available. Please specify **(FS)**.
For one seater: Add \$33.
For two seater: Add \$70
For three seater: Add \$102.
For bariatric models: Add \$55.
- Wood armcaps are available in all Seating wood finishes (see features column for upcharges).
- Non-marking White glides are available. Please specify **(WH)**. No upcharge.
- For moisture barrier on seat, please specify **(MB)**.
For one seater: Add \$81.
For two seater: Add \$165.
For three seater: Add \$245.
For bariatric models: Add \$122.
- For improved housekeeping and infection control practices, please add **(SU)** to model number. The underside of the seat will be finished with vinyl and sealed to prevent penetration of liquids.
For one seater: Add \$39.
For two seater: Add \$79.
For three seater: Add \$117.
For bariatric models: Add \$59.

SUGGESTED APPLICATIONS

- Bariatric seating (some models)
- Guest seating
- Lobbies
- Lounge/Waiting
- Patient rooms
- Resident rooms
- Treatment/Exam rooms

For complementary tables, please refer to the GC Belong **freestanding** tables, page 42. (Not for use with GC Belong table bridges.)

DESCRIPTION	MODEL# / FEATURES	STANDARD TEXTILE GRADES											
		COM	2	3	4	5	6	7	8	9	10	11	12
 <p>Low Back Single Seat Armless Chair COM: 1.75 YD 1.6 M Unit weight: 35 LB 15.9 KG Carton weight: 43 LB 19.5 KG Carton volume: 17.5 FT³ 0.49 MT³</p>	GC3700	800	856	903	958	1047	1129	1211	1283	1372	1456	1570	1731
	Active weight 350 lbs.	OVERALL DIMENSIONS			SEAT DIMENSIONS			BACK DIMENSIONS					
		IN	24.5	27.5	34.5	22	18.5	18	21.5	17			
		MM	622	699	876	559	470	457	546	432			
	RTA 00	1 per carton											
 <p>Low Back Single Seat Armchair COM: 1.75 YD 1.6 M Unit weight: 40 LB 18.2 KG Carton weight: 48 LB 21.77 KG Carton volume: 17.5 FT³ 0.49 MT³</p>	GC3701	954	1010	1057	1112	1201	1283	1365	1437	1526	1610	1724	1885
	Active weight 350 lbs.	OVERALL DIMENSIONS			SEAT DIMENSIONS			BACK DIMENSIONS					
		IN	25.5	27.5	34.5	22	18.5	18	21.5	17			
		MM	648	699	876	559	470	457	546	432			
Wood armcap option: Add \$85.	RTA 00	1 per carton											

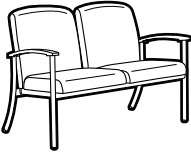
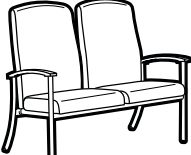
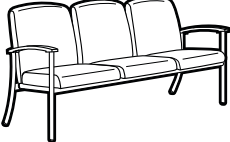
DESCRIPTION	MODEL# / FEATURES	STANDARD TEXTILE GRADES																																								
		COM	2	3	4	5	6	7	8	9	10	11	12																													
 <p>Designed to immobilize the pelvis and hip joints after surgery.</p> <p>Low Back Hip Armchair Post Surgery COM: 1.75 YD 1.6 M Unit weight: 45 LB 20.5 KG Carton weight: 53 LB 24.04 KG Carton volume: 17.5 FT³ 0.49 MT³</p>	GC3701-24 24" seat height	1145	1201	1248	1303	1392	1474	1556	1628	1717	1801	1915	2076																													
	<table border="1"> <thead> <tr> <th colspan="3">OVERALL DIMENSIONS</th> <th colspan="3">SEAT DIMENSIONS</th> <th colspan="2">BACK DIMENSIONS</th> </tr> <tr> <th>W</th> <th>D</th> <th>H</th> <th>W</th> <th>D</th> <th>H</th> <th>W</th> <th>H</th> </tr> </thead> <tbody> <tr> <td>IN 25.5</td> <td>27.5</td> <td>40.5</td> <td>22</td> <td>18.5</td> <td>24</td> <td>21.5</td> <td>17</td> </tr> <tr> <td>MM 648</td> <td>699</td> <td>1029</td> <td>559</td> <td>470</td> <td>610</td> <td>546</td> <td>432</td> </tr> </tbody> </table>	OVERALL DIMENSIONS			SEAT DIMENSIONS			BACK DIMENSIONS		W	D	H	W	D	H	W	H	IN 25.5	27.5	40.5	22	18.5	24	21.5	17	MM 648	699	1029	559	470	610	546	432	Active weight 350 lbs.	IN 25.5	27.5	40.5	22	18.5	24	21.5	17
	OVERALL DIMENSIONS			SEAT DIMENSIONS			BACK DIMENSIONS																																			
	W	D	H	W	D	H	W	H																																		
IN 25.5	27.5	40.5	22	18.5	24	21.5	17																																			
MM 648	699	1029	559	470	610	546	432																																			
Wood armcap option: Add \$85. RTA 00 1 per carton	MM 648	699	1029	559	470	610	546	432																																		
 <p>High Back Single Seat Armchair COM: 2 YD 1.83 M Unit weight: 45 LB 20.5 KG Carton weight: 53 LB 24.04 KG Carton volume: 20 FT³ 0.56 MT³</p>	GC3701HB	1004	1068	1122	1184	1286	1380	1474	1556	1658	1754	1884	2068																													
	<table border="1"> <thead> <tr> <th colspan="3">OVERALL DIMENSIONS</th> <th colspan="3">SEAT DIMENSIONS</th> <th colspan="2">BACK DIMENSIONS</th> </tr> <tr> <th>W</th> <th>D</th> <th>H</th> <th>W</th> <th>D</th> <th>H</th> <th>W</th> <th>H</th> </tr> </thead> <tbody> <tr> <td>IN 25.5</td> <td>27.5</td> <td>42.5</td> <td>22</td> <td>18</td> <td>18</td> <td>21.5</td> <td>25</td> </tr> <tr> <td>MM 648</td> <td>699</td> <td>1080</td> <td>559</td> <td>457</td> <td>457</td> <td>546</td> <td>635</td> </tr> </tbody> </table>	OVERALL DIMENSIONS			SEAT DIMENSIONS			BACK DIMENSIONS		W	D	H	W	D	H	W	H	IN 25.5	27.5	42.5	22	18	18	21.5	25	MM 648	699	1080	559	457	457	546	635	Active weight 350 lbs.	IN 25.5	27.5	42.5	22	18	18	21.5	25
	OVERALL DIMENSIONS			SEAT DIMENSIONS			BACK DIMENSIONS																																			
	W	D	H	W	D	H	W	H																																		
IN 25.5	27.5	42.5	22	18	18	21.5	25																																			
MM 648	699	1080	559	457	457	546	635																																			
Wood armcap option: Add \$85. RTA 00 1 per carton	MM 648	699	1080	559	457	457	546	635																																		
 <p>Low Back Two Seat Chair No Center Arm COM: 3.25 YD 2.97 M Unit weight: 60 LB 27.3 KG Carton weight: 68 LB 30.84 KG Carton volume: 43 FT³ 1.21 MT³</p>	GC3702	1515	1619	1707	1808	1973	2126	2279	2412	2578	2734	2945	3244																													
	<table border="1"> <thead> <tr> <th colspan="3">OVERALL DIMENSIONS</th> <th colspan="3">SEAT DIMENSIONS</th> <th colspan="2">BACK DIMENSIONS</th> </tr> <tr> <th>W</th> <th>D</th> <th>H</th> <th>W</th> <th>D</th> <th>H</th> <th>W</th> <th>H</th> </tr> </thead> <tbody> <tr> <td>IN 49.75</td> <td>27.5</td> <td>34.5</td> <td>44</td> <td>18.5</td> <td>18</td> <td>43</td> <td>17</td> </tr> <tr> <td>MM 1264</td> <td>699</td> <td>876</td> <td>1118</td> <td>470</td> <td>457</td> <td>1092</td> <td>432</td> </tr> </tbody> </table>	OVERALL DIMENSIONS			SEAT DIMENSIONS			BACK DIMENSIONS		W	D	H	W	D	H	W	H	IN 49.75	27.5	34.5	44	18.5	18	43	17	MM 1264	699	876	1118	470	457	1092	432	Active weight 350 lbs/seat.	IN 49.75	27.5	34.5	44	18.5	18	43	17
	OVERALL DIMENSIONS			SEAT DIMENSIONS			BACK DIMENSIONS																																			
	W	D	H	W	D	H	W	H																																		
IN 49.75	27.5	34.5	44	18.5	18	43	17																																			
MM 1264	699	876	1118	470	457	1092	432																																			
Wood armcap option: Add \$85. RTA 00 1 per carton	MM 1264	699	876	1118	470	457	1092	432																																		
 <p>High Back Two Seat Chair No Center Arm COM: 3.75 YD 3.43 M Unit weight: 67 LB 30.5 KG Carton weight: 75 LB 34.02 KG Carton volume: 56.5 FT³ 1.59 MT³</p>	GC3702HB	1616	1736	1837	1954	2145	2321	2497	2651	2842	3022	3266	3611																													
	<table border="1"> <thead> <tr> <th colspan="3">OVERALL DIMENSIONS</th> <th colspan="3">SEAT DIMENSIONS</th> <th colspan="2">BACK DIMENSIONS</th> </tr> <tr> <th>W</th> <th>D</th> <th>H</th> <th>W</th> <th>D</th> <th>H</th> <th>W</th> <th>H</th> </tr> </thead> <tbody> <tr> <td>IN 49.75</td> <td>27.5</td> <td>42.5</td> <td>44</td> <td>18.5</td> <td>18</td> <td>43</td> <td>25</td> </tr> <tr> <td>MM 1264</td> <td>699</td> <td>1080</td> <td>1118</td> <td>470</td> <td>457</td> <td>1092</td> <td>635</td> </tr> </tbody> </table>	OVERALL DIMENSIONS			SEAT DIMENSIONS			BACK DIMENSIONS		W	D	H	W	D	H	W	H	IN 49.75	27.5	42.5	44	18.5	18	43	25	MM 1264	699	1080	1118	470	457	1092	635	Active weight 350 lbs/seat.	IN 49.75	27.5	42.5	44	18.5	18	43	25
	OVERALL DIMENSIONS			SEAT DIMENSIONS			BACK DIMENSIONS																																			
	W	D	H	W	D	H	W	H																																		
IN 49.75	27.5	42.5	44	18.5	18	43	25																																			
MM 1264	699	1080	1118	470	457	1092	635																																			
Wood armcap option: Add \$85. RTA 00 1 per carton	MM 1264	699	1080	1118	470	457	1092	635																																		
 <p>Low Back Three Seat Chair No Center Arms COM: 4.5 YD 4.11 M Unit weight: 80 LB 36.4 KG Carton weight: 90 LB 40.82 KG Carton volume: 65.25 FT³ 1.84 MT³</p>	GC3703	2086	2230	2352	2491	2721	2932	3144	3328	3558	3774	4066	4480																													
	<table border="1"> <thead> <tr> <th colspan="3">OVERALL DIMENSIONS</th> <th colspan="3">SEAT DIMENSIONS</th> <th colspan="2">BACK DIMENSIONS</th> </tr> <tr> <th>W</th> <th>D</th> <th>H</th> <th>W</th> <th>D</th> <th>H</th> <th>W</th> <th>H</th> </tr> </thead> <tbody> <tr> <td>IN 71.25</td> <td>27.5</td> <td>34.5</td> <td>66</td> <td>18.5</td> <td>18</td> <td>64.5</td> <td>17</td> </tr> <tr> <td>MM 1810</td> <td>699</td> <td>876</td> <td>1676</td> <td>470</td> <td>457</td> <td>1638</td> <td>432</td> </tr> </tbody> </table>	OVERALL DIMENSIONS			SEAT DIMENSIONS			BACK DIMENSIONS		W	D	H	W	D	H	W	H	IN 71.25	27.5	34.5	66	18.5	18	64.5	17	MM 1810	699	876	1676	470	457	1638	432	Active weight 350 lbs/seat.	IN 71.25	27.5	34.5	66	18.5	18	64.5	17
	OVERALL DIMENSIONS			SEAT DIMENSIONS			BACK DIMENSIONS																																			
	W	D	H	W	D	H	W	H																																		
IN 71.25	27.5	34.5	66	18.5	18	64.5	17																																			
MM 1810	699	876	1676	470	457	1638	432																																			
Wood armcap option: Add \$85. RTA 00 1 per carton	MM 1810	699	876	1676	470	457	1638	432																																		

DESCRIPTION MODEL# / FEATURES STANDARD TEXTILE GRADES

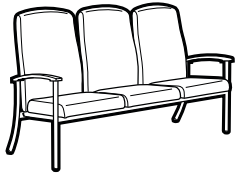

High Back Three Seat Chair No Center Arms
 COM: 5.25 YD | 4.8 M
 Unit weight: 86 LB | 39.1 KG
 Carton weight: 96 LB | 43.54 KG
 Carton volume: 80.75 FT³ | 2.28 MT³

COM	2	3	4	5	6	7	8	9	10	11	12	
GC3703HB	2236	2404	2546	2709	2976	3223	3470	3685	3953	4205	4546	5029

OVERALL DIMENSIONS			SEAT DIMENSIONS			BACK DIMENSIONS	
W	D	H	W	D	H	W	H

Active weight 350 lbs/seat.
 Wood armcap option:
 Add \$85.

IN	71.25	27.5	42.5	66	18.5	18	64.5	25
MM	1810	699	1080	1676	470	457	1638	635
RTA 00			1 per carton					

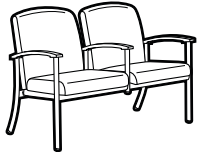

Low Back Two Seat Chair Half Center Arm
 COM: 3.25 YD | 2.97 M
 Unit weight: 65 LB | 29.5 KG
 Carton weight: 73 LB | 33.11 KG
 Carton volume: 43 FT³ | 1.21 MT³

COM	2	3	4	5	6	7	8	9	10	11	12	
GC3704	1675	1779	1867	1968	2133	2286	2439	2572	2738	2894	3105	3404

OVERALL DIMENSIONS			SEAT DIMENSIONS			BACK DIMENSIONS	
W	D	H	W	D	H	W	H

Active weight 350 lbs/seat.
 Wood armcap option:
 Add \$130.

IN	49.75	27.5	34.5	22	18.5	18	21.5	17
MM	1264	699	876	559	470	457	546	432
RTA 00			1 per carton					

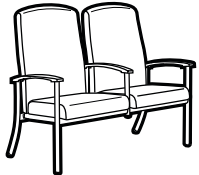

High Back Two Seat Chair Half Center Arm
 COM: 3.75 YD | 3.43 M
 Unit weight: 71 LB | 32.3 KG
 Carton weight: 79 LB | 35.83 KG
 Carton volume: 56.5 FT³ | 1.59 MT³

COM	2	3	4	5	6	7	8	9	10	11	12	
GC3704HB	1776	1896	1997	2114	2305	2481	2657	2811	3002	3182	3426	3771

OVERALL DIMENSIONS			SEAT DIMENSIONS			BACK DIMENSIONS	
W	D	H	W	D	H	W	H

Active weight 350 lbs/seat.
 Wood armcap option:
 Add \$130.

IN	49.75	27.5	42.5	44	18.5	18	43	25
MM	1264	699	1080	1118	470	457	1092	635
RTA 00			1 per carton					

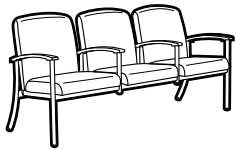

Low Back Three Seat Chair Half Center Arms
 COM: 4.5 YD | 4.11 M
 Unit weight: 90 LB | 40.9 KG
 Carton weight: 100 LB | 45.36 KG
 Carton volume: 65.25 FT³ | 1.84 MT³

COM	2	3	4	5	6	7	8	9	10	11	12	
GC3705	2406	2550	2672	2811	3041	3252	3464	3648	3878	4094	4386	4800

OVERALL DIMENSIONS			SEAT DIMENSIONS			BACK DIMENSIONS	
W	D	H	W	D	H	W	H

Active weight 350 lbs/seat.
 Wood armcap option:
 Add \$174.

IN	71.25	27.5	34.5	22	18.5	18	21.5	17
MM	1810	699	876	559	470	457	546	432
RTA 00			1 per carton					

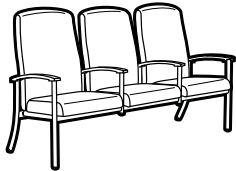





High Back Three Seat Chair Half Center Arms
 COM: 5.25 YD | 4.8 M
 Unit weight: 90 LB | 40.9 KG
 Carton weight: 100 LB | 45.36 KG
 Carton volume: 80.75 FT³ | 2.28 MT³

COM	2	3	4	5	6	7	8	9	10	11	12	
GC3705HB	2559	2727	2869	3032	3299	3546	3793	4008	4276	4528	4869	5352

OVERALL DIMENSIONS			SEAT DIMENSIONS			BACK DIMENSIONS	
W	D	H	W	D	H	W	H

Active weight 350 lbs/seat.
 Wood armcap option:
 Add \$174.

IN	71.25	27.5	42.5	66	18.5	18	64.5	25
MM	1810	699	1080	1676	470	457	1638	635
RTA 00			1 per carton					

DESCRIPTION	MODEL# / FEATURES	STANDARD TEXTILE GRADES											
		COM	2	3	4	5	6	7	8	9	10	11	12
 LB Armchair, Rear Tip and Move Wheels COM: 1.75 YD 1.6 M Unit weight: 40 LB 18.2 KG Carton weight: 48 LB 21.77 KG Carton volume: 17.5 FT³ 0.49 MT³	GC3707	1044	1100	1147	1202	1291	1373	1455	1527	1616	1700	1814	1975
		OVERALL DIMENSIONS			SEAT DIMENSIONS			BACK DIMENSIONS					
		W	D	H	W	D	H	W	H				
		IN 25.5 MM 648	27.5 699	34.5 876	22 559	18.5 470	18 457	21.5 546	17 432				
Active weight 350 lbs. Wood armcap option: Add \$85.	RTA 00	1 per carton											
 HB Armchair, Rear Tip and Move Wheels COM: 2 YD 1.83 M Unit weight: 43 LB 19.5 KG Carton weight: 50 LB 22.68 KG Carton volume: 20 FT³ 0.56 MT³	GC3707HB	1094	1158	1212	1274	1376	1470	1564	1646	1748	1844	1974	2158
		OVERALL DIMENSIONS			SEAT DIMENSIONS			BACK DIMENSIONS					
		W	D	H	W	D	H	W	H				
		IN 25.5 MM 648	27.5 699	42.5 1080	22 559	18 457	18 457	21 533	25 635				
Active weight 350 lbs. Wood armcap option: Add \$85.	RTA 00	1 per carton											
 Bariatric Low Back Armchair COM: 2.75 YD 2.51 M Unit weight: 49 LB 22.3 KG Carton weight: 60 LB 27.22 KG Carton volume: 26.5 FT³ 0.75 MT³	GC3711	1224	1312	1386	1472	1612	1741	1870	1983	2123	2255	2434	2687
		OVERALL DIMENSIONS			SEAT DIMENSIONS			BACK DIMENSIONS					
		W	D	H	W	D	H	W	H				
		IN 36 MM 914	27.5 699	34.5 876	32.5 826	18 457	18 457	31 787	17 432				
Active weight 750 lbs. Wood armcap option: Add \$85.	RTA 00	1 per carton											
 Bariatric Low Back Hip Armchair Post Surgery COM: 2.75 YD 2.51 M Unit weight: 52 LB 23.6 KG Carton weight: 63 LB 28.58 KG Carton volume: 30.5 FT³ 0.86 MT³	GC3711-24 24" seat height	1439	1527	1601	1687	1827	1956	2085	2198	2338	2470	2649	2902
		OVERALL DIMENSIONS			SEAT DIMENSIONS			BACK DIMENSIONS					
		W	D	H	W	D	H	W	H				
		IN 36 MM 914	27.5 699	40.5 1029	32.5 826	18 457	24 610	31 787	17 432				
Active weight 750 lbs. Wood armcap option: Add \$85.	RTA 00	1 per carton											
 Bariatric High Back Armchair COM: 3.25 YD 2.97 M Unit weight: 55 LB 25 KG Carton weight: 66 LB 29.94 KG Carton volume: 30.5 FT³ 0.86 MT³	GC3711HB	1294	1398	1486	1587	1752	1905	2058	2191	2357	2513	2724	3023
		OVERALL DIMENSIONS			SEAT DIMENSIONS			BACK DIMENSIONS					
		W	D	H	W	D	H	W	H				
		IN 36 MM 914	27.5 699	42.5 1080	32.5 826	18 457	18 457	31 787	25 635				
Active weight 750 lbs. Wood armcap option: Add \$85.	RTA 00	1 per carton											

Designed to immobilize the pelvis and hip joints after surgery.

DESCRIPTION MODEL# / FEATURES STANDARD TEXTILE GRADES



Bariatric LB Armchair, Rear Tip and Move Wheels
 COM: 2.75 YD | 2.51 M
 Unit weight: 49 LB | 22.3 KG
 Carton weight: 60 LB | 27.22 KG
 Carton volume: 26.5 FT³ | 0.75 MT³

Active weight 750 lbs.
 Wood armcap option:
 Add \$85.

COM	2	3	4	5	6	7	8	9	10	11	12	
GC3712	1317	1405	1479	1565	1705	1834	1963	2076	2216	2348	2527	2780

OVERALL DIMENSIONS			SEAT DIMENSIONS			BACK DIMENSIONS	
W	D	H	W	D	H	W	H

IN	36	27.5	34.5	32.5	18	18	31	17
MM	914	699	876	826	457	457	787	432

RTA 00 1 per carton



Bariatric HB Armchair, Rear Tip and Move Wheels
 COM: 3.25 YD | 2.97 M
 Unit weight: 56 LB | 25.5 KG
 Carton weight: 66 LB | 29.94 KG
 Carton volume: 30.5 FT³ | 0.86 MT³

Active weight 750 lbs.
 Wood armcap option:
 Add \$85.

COM	2	3	4	5	6	7	8	9	10	11	12	
GC3712HB	1383	1487	1575	1676	1841	1994	2147	2280	2446	2602	2813	3112

OVERALL DIMENSIONS			SEAT DIMENSIONS			BACK DIMENSIONS	
W	D	H	W	D	H	W	H

IN	36	27.5	42.5	31	18	18	30	25
MM	914	699	1080	787	457	457	762	635

RTA 00 1 per carton



Low Back Single Seat Armchair Flex Back
 COM: 1.75 YD | 1.6 M
 Unit weight: 41 LB | 18.6 KG
 Carton weight: 49 LB | 22.23 KG
 Carton volume: 17.5 FT³ | 0.49 MT³

Active weight 350 lbs.
 Wood armcap option:
 Add \$85.

COM	2	3	4	5	6	7	8	9	10	11	12	
GC3715	1160	1216	1263	1318	1407	1489	1571	1643	1732	1816	1930	2091

OVERALL DIMENSIONS			SEAT DIMENSIONS			BACK DIMENSIONS	
W	D	H	W	D	H	W	H

IN	25.5	27.5	34.5	22	18	18	21	17
MM	648	699	876	559	457	457	533	432

RTA 00 1 per carton



High Back Single Seat Armchair Flex Back
 COM: 2 YD | 1.83 M
 Unit weight: 43 LB | 19.5 KG
 Carton weight: 50 LB | 22.68 KG
 Carton volume: 20 FT³ | 0.56 MT³

Active weight 350 lbs.
 Wood armcap option:
 Add \$85.

COM	2	3	4	5	6	7	8	9	10	11	12	
GC3715HB	1212	1276	1330	1392	1494	1588	1682	1764	1866	1962	2092	2276

OVERALL DIMENSIONS			SEAT DIMENSIONS			BACK DIMENSIONS	
W	D	H	W	D	H	W	H

IN	25.5	27.5	42.5	22	18	18	21	25
MM	648	699	1080	559	457	457	533	635

RTA 00 1 per carton

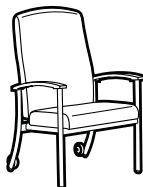

HB Armchair Flex Back, Rear Tip and Move Wheels
 COM: 2 YD | 1.83 M
 Unit weight: 43 LB | 19.5 KG
 Carton weight: 50 LB | 22.68 KG
 Carton volume: 20 FT³ | 0.56 MT³







Active weight 350 lbs.
 Wood armcap option:
 Add \$85.

COM	2	3	4	5	6	7	8	9	10	11	12	
GC3716HB	1302	1366	1420	1482	1584	1678	1772	1854	1956	2052	2182	2366

OVERALL DIMENSIONS			SEAT DIMENSIONS			BACK DIMENSIONS	
W	D	H	W	D	H	W	H

IN	25.5	27.5	42.5	22	18	18	21	25
MM	648	699	1080	559	457	457	533	635

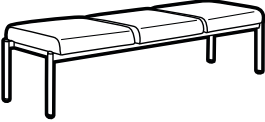
RTA 00 1 per carton

DESCRIPTION	MODEL# / FEATURES	STANDARD TEXTILE GRADES												
		COM	2	3	4	5	6	7	8	9	10	11	12	
 <p>High Back Single Seat Armchair Split Back COM: 2 YD 1.83 M Unit weight: 45 LB 20.5 KG Carton weight: 53 LB 24.04 KG Carton volume: 20 FT³ 0.56 MT³</p>	GC3717HB	1232	1296	1350	1412	1514	1608	1702	1784	1886	1982	2112	2296	
	Active weight 350 lbs.	OVERALL DIMENSIONS			SEAT DIMENSIONS			BACK DIMENSIONS						
	Fold down headrest.	W	D	H	W	D	H	W	H					
		IN	25.5	27.5	42.5	22	18	18	21.5	25				
		MM	648	699	1080	559	457	457	546	635				
Wood armcap option: Add \$85.		RTA 00	1 per carton											
 <p>Footstool Angled Top COM: 1 YD 0.91 M Unit weight: 13 LB 5.9 KG Carton weight: 16 LB 7.26 KG Carton volume: 3.5 FT³ 0.09 MT³</p>	GC3708	601	633	660	691	742	789	836	877	928	976	1041	1133	
	Active weight 350 lbs.	OVERALL DIMENSIONS			SEAT DIMENSIONS			BACK DIMENSIONS						
	Stores beneath any standard seating unit.	W	D	H	W	D	H	W	H					
		IN	16.5	18.5	10.5	-	-	-	-	-				
		MM	419	470	267	-	-	-	-	-				
Add \$81 for (MB).		RTA 00		1 per carton										
 <p>Two Seat Bench COM: 1.75 YD 1.6 M Unit weight: 40 LB 18.2 KG Carton weight: 48 LB 21.77 KG Carton volume: 23 FT³ 0.65 MT³</p>	GC3722	1028	1084	1131	1186	1275	1357	1439	1511	1600	1684	1798	1959	
	Active weight 350 lbs/seat.	OVERALL DIMENSIONS			SEAT DIMENSIONS			BACK DIMENSIONS						
	Add \$165 for (MB). Add \$70 for (FS).	W	D	H	W	D	H	W	H					
		IN	47.5	23.5	18	-	-	-	-	-				
		MM	1207	597	457	-	-	-	-	-				
		RTA 00		1 per carton										
 <p>Three Seat Bench COM: 2 YD 1.83 M Unit weight: 60 LB 27.3 KG Carton weight: 68 LB 30.84 KG Carton volume: 33.25 FT³ 0.94 MT³</p>	GC3723	1383	1447	1501	1563	1665	1759	1853	1935	2037	2133	2263	2447	
	Active weight 350 lbs/seat.	OVERALL DIMENSIONS			SEAT DIMENSIONS			BACK DIMENSIONS						
	Add \$245 for (MB). Add \$102 for (FS).	W	D	H	W	D	H	W	H					
		IN	70	23.5	18	-	-	-	-	-				
		MM	1778	597	457	-	-	-	-	-				
		RTA 00		1 per carton										

WILLOW



model W5AUUG



Wipeable shroud edge does not collect debris



No visible brackets or upholstery staples



Waterfall arm (WFA)



Forward grip assist arm (GAA)

		Willow chairs stacking capability	
		on floor	on dolly
Four-leg arm and armless chairs with glides only	Poly back/seat models	up to 6 high	up to 10 high
	Upholstered models	up to 4 high	up to 8 high
	Bariatric models	up to 4 high	up to 8 high
Bar and counter stools	Stools with arms	does not stack	N/A
	Armless stools	up to 4 high	N/A

Plastic component finish matching chart		
Chair type	Seat shroud	Arms + back shrouds
Poly back/seat	matches seat/back	matches seat/back
Upholstered back/seat	specify	specify
Poly back/upholstered seat	specify	specify
Upholstered back/poly seat	matches seat	specify

EXAMPLE WILLOW ORDER CODE:

W5AUU	NS	PU75	NS	PU75	WFA	BLK
Model #	Back seams	Back textile	Seat	Seat textile	Arm style	Arm + back shroud finish

BLK	CHM	ST	BLK	NB
Seat shroud finish	Frame finish	Glides type	Glides finish	Moisture barrier

Willow linking tables



For linking tables, see page 242.

STANDARD FEATURES

- Willow's durable design and open, welcoming form will ensure years of use. Freestanding chairs are available with four legs or sled base, in standard or bariatric width. Additional models include hip, counter and bar height stools. Corner, in-line and end linking tables are also available to complement the line.
- Chairs can be ganged with ganging brackets or with in-line and corner tables.
- Plastic seats and backs, reinforced nylon arms, back shrouds and seat shrouds are all available in 17 colors. See finish chart for matching color components.
- Ganging brackets are available in 13 paint finishes (see page 242).
- Tubular steel frame is available in 20 paint finishes and 4 plated finishes with an upcharge.
- Frame design features a wall saver leg to prevent contact with walls.
- Active weight capacity:
 - four-leg seating with casters: 300 lbs.
 - standard size seating with glides is 400 lbs.
 - bariatric models: 600 lbs.
- Plastic seat shrouds are standard on all models.
- Bariatric models are only available with upholstered seat and back.
- All models are standard with colored nylon glides (ST) in two finishes (Black or Sand).
- Upholstered seats have no seams for ease of cleaning.
- Four-leg models with glides are stackable. See chart. Stacking of models with caster is not recommended due to possible damage to plastic and upholstery.
- Armless stools are stackable. See chart.
- Four-leg and stool models are available with various glide options. Glides must be chosen to best suit flooring type and site conditions. For more information, please refer to glide selection chart (page 274).
- Tables used with Willow armchairs require 28" clearance under the surface top; counter height stools require 34.25" clearance; bar height stools require 40.25" clearance.
- Sled base models have nylon colored glides, non-marking natural glides for use on most floor surfaces, or with no glides for use on carpeted floors.
- For healthcare textile options, visit the website at globalfurnituregroup.com.
- Can be upholstered in standard Global textiles if healthcare compliance is not required.
- Shipped fully assembled.

OPTIONAL FEATURES

- Additional weight (CW) of 24 lbs. is available. Weighted four-leg chairs and armless stools are not stackable. Not available for models with casters.
- Power/USB units are available for use with in-line, corner and end tables. Tables are predrilled for field installation of undermount power. Clamp mount units are available. Order power units separately for field installation.
- Sealed seams may be specified on upholstered back models. Seats have no seams.
- Moisture barrier may be specified on seats.
- Sled base models offer a floor mount (FM) option. See upcharges. Mounting hardware not included

Please add option codes in the following order:

- Model number**
- Back/seat/seat shroud finish** (for plastic back/seat models)
 - Back finish** (for plastic back/upholstered seat models)

(BZB) Buzz Blue	(KAL) Kalua
(CCT) Cactus	(LAB) Latte
(CRO) Carrot	(J52) Mocha
(IVC) Cloud	(BLK) Night
(DJN) Dijon	(SND) Sand
(EGP) Eggplant	(SAR) Scarlet
(FOG) Fog	(SHW) Shadow
(FRO) Frost	(TOA) Toast
(INK) Ink	
- Back seams and textile** (upholstered back models)
 - (NS) No sealed seams.
 - (S2) Sealed seams. Add \$14. For bariatric models, add \$20. Specify back textile.
- Seat textile** (for upholstered seat models)
 - (NS) No sealed seams
 - Specify seat textile.
- Arm style** (models with arms only)
 - (WFA) Waterfall arm.
 - (GAA) Grip assist arm. Add \$30.
- Arm and back shroud finish**

(BZB) Buzz Blue	(KAL) Kalua
(CCT) Cactus	(LAB) Latte
(CRO) Carrot	(J52) Mocha
(IVC) Cloud	(BLK) Night
(DJN) Dijon	(SND) Sand
(EGP) Eggplant	(SAR) Scarlet
(FOG) Fog	(SHW) Shadow
(FRO) Frost	(TOA) Toast
(INK) Ink	
- Seat and seat shroud finish** (for upholstered back and plastic seat models)

(BZB) Buzz Blue	(KAL) Kalua
(CCT) Cactus	(LAB) Latte
(CRO) Carrot	(J52) Mocha
(IVC) Cloud	(BLK) Night
(DJN) Dijon	(SND) Sand
(EGP) Eggplant	(SAR) Scarlet
(FOG) Fog	(SHW) Shadow
(FRO) Frost	(TOA) Toast
(INK) Ink	
- Leg type** (for sled base models)
 - (NF) No floor mount.
 - (FM) Floor mounted. Add \$10.
- Frame finish**
 - Paint finishes. No upcharge.

(TBL) Black	(TIN) Ink
(TBZ) Buzz Blue	(TKA) Kalua
(TCC) Cactus	(TLA) Latte
(TCR) Carrot	(TMO) Mocha
(TIV) Cloud	(TNE) Nevada
(TDW) Designer White	(TSN) Sand
(TDJ) Dijon	(TSR) Scarlet
(TEG) Eggplant	(TSH) Shadow
(TFO) Fog	(TOA) Toast
(TFR) Frost	(TTU) Tungsten
 - Plated finish. See models for upcharges.

(CHM) Chrome	(SBR) Satin Brass
(BCH) Brushed Chrome	(ACO) Antique Copper
- Glide type** (for four-leg glide models)
 - (ST) Colored nylon glides for most surfaces.
 - (NM) Natural non-marking nylon glides for most surfaces.
 - (SG) Steel cushioned glides for carpeted surfaces. Add \$19.
 - (FG) Felt glides for most hard floor surfaces. Add \$19.
 - (RG) Rubber non-slip glides for most hard floor surfaces. Add \$19.
- Glide type** (for sled base models)
 - (ST) Colored nylon glides for most surfaces
 - (NM) Natural non-marking nylon glides for most surfaces.
 - (XG) No glides for carpeted surfaces.
- Glide finish** (for all ST glides)

(BLK) Black	(SND) Sand
-------------	------------
- Caster type** (for four-leg caster models)
 - (DC) 2" casters for carpeted surfaces.
 - (RC) 2" casters for most hard floor surfaces. Add \$17.
- Moisture barrier** (on seat)
 - (NB) No moisture barrier.
 - (MB) Moisture barrier. Add \$81. For bariatric models, add \$122.
- Additional weight**
 - (NC) No additional weight.
 - (CW) Additional weight of 24 lbs. Add \$700.

	GLIDES							
	Standard colored (ST) + non-marking (NM) glides - standard height		Steel cushion (SG) glides - 0.313" higher than standard		Felt pad (FG) glides - 0.375" higher than standard		Rubber non-slip (RG) glides - 0.563" higher than standard	
	SEAT HEIGHT (in)	ARM HEIGHT (in)	SEAT HEIGHT (in)	ARM HEIGHT (in)	SEAT HEIGHT (in)	ARM HEIGHT (in)	SEAT HEIGHT (in)	ARM HEIGHT (in)
ARMCHAIRS								
Plastic seat, standard arms	17	26.75	17.31	27.06	17.38	27.13	17.56	27.31
Plastic seat, grip assist arms	17	27	17.31	27.31	17.38	27.38	17.56	27.56
Upholstered seat, standard arms	18.25	26.75	18.56	27.06	18.63	27.13	18.81	27.31
Upholstered seat, grip assist arms	18.25	27	18.56	27.31	18.63	27.38	18.81	27.56
COUNTER STOOLS WITH ARMS								
Plastic seat, standard arms	23.25	33	23.56	33.31	23.63	33.38	23.81	33.56
Plastic seat, grip assist arms	23.25	33.25	23.56	33.56	23.63	33.63	23.81	33.81
Upholstered seat, standard arms	24.25	33	24.56	33.31	24.63	33.38	24.81	33.56
Upholstered seat, grip assist arms	24.25	33.25	24.56	33.56	24.63	33.63	24.81	33.81
BAR STOOLS WITH ARMS								
Plastic seat, standard arms	29.25	39	29.56	39.31	29.63	39.38	29.81	39.56
Plastic seat, grip assist arms	29.25	39.25	29.56	39.56	29.63	39.63	29.81	39.81
Upholstered seat, standard arms	30.25	39	30.56	39.31	30.63	39.38	30.81	39.56
Upholstered seat, grip assist arms	30.25	39.25	30.56	39.56	30.63	39.63	30.81	39.81

DESCRIPTION MODEL# / FEATURES STANDARD TEXTILE GRADES



Stacks 6 high on floor

List price
W5APPG 486
 w/glides



Caster model does not stack

W5APPC 626
 w/casters

Armchair, Poly Back and Seat
 COM: N/A
 Unit weight: 17.5 LB | 8 KG
 Carton weight: 20.88 LB | 9.47 KG
 Carton volume: 22.25 FT³ | 0.63 MT³

	OVERALL DIMENSIONS			SEAT DIMENSIONS			BACK DIMENSIONS	
	W	D	H	W	D	H	W	H
Frame plated finish options:	IN 24.25	23.5	32	17.75	17.5	17	16	16
Add \$33 for Chrome (CHM)	MM 616	597	813	451	445	432	406	406
Add \$119 for Brushed Chrome (BCH)								
Add \$176 for Antique Copper (ACO)								
Add \$176 for Satin Brass (SBR)	RTA 00	4 per carton (pricing for one chair, specifications for one chair with glides)						



Stacks 4 high on floor

	1	2	3	4	5	6	7	8	9	10	11	12
W5AUPG w/glides	540	556	570	585	611	634	658	678	704	728	760	806



Caster model does not stack

W5AUPC w/casters	680	696	710	725	751	774	798	818	844	868	900	946
-------------------------	-----	-----	-----	-----	-----	-----	-----	-----	-----	-----	-----	-----

Armchair, Uph Back and Poly Seat
 COM: 0.5 YD | 0.46 M
 Unit weight: 18 LB | 8.2 KG
 Carton weight: 21.38 LB | 9.7 KG
 Carton volume: 22.25 FT³ | 0.63 MT³

	OVERALL DIMENSIONS			SEAT DIMENSIONS			BACK DIMENSIONS	
	W	D	H	W	D	H	W	H
Frame plated finish options:	IN 24.25	23.5	32	17.75	17.5	17	16	16
Add \$33 for Chrome (CHM)	MM 616	597	819	451	425	432	419	406
Add \$119 for Brushed Chrome (BCH)								
Add \$176 for Antique Copper (ACO)								
Add \$176 for Satin Brass (SBR)	RTA 00	4 per carton (pricing for one chair, specifications for one chair with glides)						



Stacks 4 high on floor

	1	2	3	4	5	6	7	8	9	10	11	12
W5APUG w/glides	545	569	589	613	651	686	721	752	790	826	875	944



Caster model does not stack

W5APUC w/casters	685	709	729	753	791	826	861	892	930	966	1015	1084
-------------------------	-----	-----	-----	-----	-----	-----	-----	-----	-----	-----	------	------

Armchair, Poly Back and Uph Seat
 COM: 0.75 YD | 0.69 M
 Unit weight: 18 LB | 8.2 KG
 Carton weight: 21.38 LB | 9.7 KG
 Carton volume: 22.25 FT³ | 0.63 MT³

	OVERALL DIMENSIONS			SEAT DIMENSIONS			BACK DIMENSIONS	
	W	D	H	W	D	H	W	H
Frame plated finish options:	IN 24.25	23.5	32	18.25	17.75	18.25	16	15.25
Add \$33 for Chrome (CHM)	MM 616	597	813	464	451	464	406	387
Add \$119 for Brushed Chrome (BCH)								
Add \$176 for Antique Copper (ACO)								
Add \$176 for Satin Brass (SBR)	RTA 00	4 per carton (pricing for one chair, specifications for one chair with glides)						



Stacks 4 high on floor

	1	2	3	4	5	6	7	8	9	10	11	12
W5AUUG w/glides	599	639	673	712	776	834	893	944	1008	1068	1149	1264











Caster model does not stack

W5AUUC w/casters	739	779	813	852	916	974	1033	1084	1148	1208	1289	1404
-------------------------	-----	-----	-----	-----	-----	-----	------	------	------	------	------	------

Armchair, Uph Back and Seat
 COM: 1.25 YD | 1.14 M
 Unit weight: 18.5 LB | 8.4 KG
 Carton weight: 21.88 LB | 9.92 KG
 Carton volume: 22.25 FT³ | 0.63 MT³

	OVERALL DIMENSIONS			SEAT DIMENSIONS			BACK DIMENSIONS	
	W	D	H	W	D	H	W	H
Frame plated finish options:	IN 24.25	23.5	32.25	18.25	17	18.25	16.5	15.25
Add \$33 for Chrome (CHM)	MM 616	597	819	464	432	464	419	387
Add \$119 for Brushed Chrome (BCH)								
Add \$176 for Antique Copper (ACO)								
Add \$176 for Satin Brass (SBR)	RTA 00	4 per carton (pricing for one chair, specifications for one chair with glides)						

DESCRIPTION	MODEL# / FEATURES	STANDARD TEXTILE GRADES															
 <p>Stacks 6 high on floor</p>	<p>W5NPPG w/glides</p> <p>List price 471</p>																
	<p>W5NPPC w/casters</p> <p>611</p>																
 <p>Caster model does not stack</p>	<p>Armless Chair, Poly Back and Seat COM: N/A Unit weight: 15 LB 6.8 KG Carton weight: 18 LB 8.16 KG Carton volume: 18.5 FT³ 0.52 MT³</p>	<p>Frame plated finish options: Add \$33 for Chrome (CHM) Add \$119 for Brushed Chrome (BCH) Add \$176 for Antique Copper (ACO) Add \$176 for Satin Brass (SBR)</p>	<p>IN 20.75 23.5 32 MM 527 597 813</p>	<p>17.75 17.5 17 451 445 432</p>	<p>16 16 406 406</p>	<p>OVERALL DIMENSIONS W D H</p>						<p>SEAT DIMENSIONS W D H</p>			<p>BACK DIMENSIONS W H</p>		
	<p>RTA 00 4 per carton (pricing for one chair, specifications for one chair with glides)</p>																
 <p>Stacks 4 high on floor</p>	<p>W5NUPG w/glides</p>	1 2 3 4 5 6 7 8 9 10 11 12	525 541 555 570 596 619 643 663 689 713 745 791														
	<p>W5NUPC w/casters</p>	665 681 695 710 736 759 783 803 829 853 885 931															
 <p>Caster model does not stack</p>	<p>Armless Chair, Uph Back and Poly Seat COM: 0.5 YD 0.46 M Unit weight: 15.5 LB 7 KG Carton weight: 18.5 LB 8.39 KG Carton volume: 18.5 FT³ 0.52 MT³</p>	<p>Frame plated finish options: Add \$33 for Chrome (CHM) Add \$119 for Brushed Chrome (BCH) Add \$176 for Antique Copper (ACO) Add \$176 for Satin Brass (SBR)</p>	<p>IN 20.75 23.5 32.25 MM 527 597 819</p>	<p>17.75 16.75 17 451 425 432</p>	<p>16.5 16 419 406</p>	<p>OVERALL DIMENSIONS W D H</p>						<p>SEAT DIMENSIONS W D H</p>			<p>BACK DIMENSIONS W H</p>		
	<p>RTA 00 4 per carton (pricing for one chair, specifications for one chair with glides)</p>																
 <p>Stacks 4 high on floor</p>	<p>W5NPUG w/glides</p>	1 2 3 4 5 6 7 8 9 10 11 12	530 554 574 598 636 671 706 737 775 811 860 929														
	<p>W5NPUC w/casters</p>	670 694 714 738 776 811 846 877 915 951 1000 1069															
 <p>Caster model does not stack</p>	<p>Armless Chair, Poly Back and Uph Seat COM: 0.75 YD 0.69 M Unit weight: 15.5 LB 7 KG Carton weight: 18.5 LB 8.39 KG Carton volume: 18.5 FT³ 0.52 MT³</p>	<p>Frame plated finish options: Add \$33 for Chrome (CHM) Add \$119 for Brushed Chrome (BCH) Add \$176 for Antique Copper (ACO) Add \$176 for Satin Brass (SBR)</p>	<p>IN 20.75 23.5 32 MM 527 597 813</p>	<p>18.25 17.75 18.25 464 451 464</p>	<p>16 15.25 406 387</p>	<p>OVERALL DIMENSIONS W D H</p>						<p>SEAT DIMENSIONS W D H</p>			<p>BACK DIMENSIONS W H</p>		
	<p>RTA 00 4 per carton (pricing for one chair, specifications for one chair with glides)</p>																
 <p>Stacks 4 high on floor</p>	<p>W5NUUG w/glides</p>	1 2 3 4 5 6 7 8 9 10 11 12	584 624 658 697 761 819 878 929 993 1053 1134 1249														
	<p>W5NUUC w/casters</p>	724 764 798 837 901 959 1018 1069 1133 1193 1274 1389															
 <p>Caster model does not stack</p>	<p>Armless Chair, Uph Back and Seat COM: 1.25 YD 1.14 M Unit weight: 16 LB 7.3 KG Carton weight: 19 LB 8.62 KG Carton volume: 18.5 FT³ 0.52 MT³</p>	<p>Frame plated finish options: Add \$33 for Chrome (CHM) Add \$119 for Brushed Chrome (BCH) Add \$176 for Antique Copper (ACO) Add \$176 for Satin Brass (SBR)</p>	<p>IN 20.75 23.5 32.25 MM 527 597 819</p>	<p>18.25 17 18.25 464 432 464</p>	<p>16.5 15.25 419 387</p>	<p>OVERALL DIMENSIONS W D H</p>						<p>SEAT DIMENSIONS W D H</p>			<p>BACK DIMENSIONS W H</p>		
	<p>RTA 00 4 per carton (pricing for one chair, specifications for one chair with glides)</p>																

DESCRIPTION MODEL# / FEATURES STANDARD TEXTILE GRADES



Does not stack

Armchair, Sled Base, Poly Back and Seat
 COM: N/A
 Unit weight: 22 LB | 10 KG
 Carton weight: 29.5 LB | 13.38 KG
 Carton volume: 13.25 FT³ | 0.37 MT³

List price												
W6APP	575											
Add \$30 for grip assist arms (GAA)	OVERALL DIMENSIONS			SEAT DIMENSIONS			BACK DIMENSIONS					
	W	D	H	W	D	H	W	H				
	IN	24.25	23.75	32	17.75	17.75	17.75	16	16			
	MM	616	603	813	451	451	451	406	406			
	Frame plated finish options: Add \$42 for Chrome (CHM) Add \$145 for Brushed Chrome (BCH) Add \$213 for Antique Copper (ACO) Add \$213 for Satin Brass (SBR)											
	RTA 00	1 per carton										



Does not stack

Armchair, Sled Base, Uph Back and Poly Seat
 COM: 0.5 YD | 0.46 M
 Unit weight: 22.5 LB | 10.2 KG
 Carton weight: 30 LB | 13.61 KG
 Carton volume: 13.25 FT³ | 0.37 MT³

W6AUP	1	2	3	4	5	6	7	8	9	10	11	12
	629	645	659	674	700	723	747	767	793	817	849	895
Add \$30 for grip assist arms (GAA)	OVERALL DIMENSIONS			SEAT DIMENSIONS			BACK DIMENSIONS					
	W	D	H	W	D	H	W	H				
	IN	24.25	23.75	32.25	17.75	17.75	17.75	16.5	16			
	MM	616	603	819	451	451	451	419	406			
	Frame plated finish options: Add \$42 for Chrome (CHM) Add \$145 for Brushed Chrome (BCH) Add \$213 for Antique Copper (ACO) Add \$213 for Satin Brass (SBR)											
	RTA 00	1 per carton										



Does not stack

Armchair, Sled Base, Poly Back and Uph Seat
 COM: 0.75 YD | 0.69 M
 Unit weight: 22.5 LB | 10.2 KG
 Carton weight: 30 LB | 13.61 KG
 Carton volume: 13.25 FT³ | 0.37 MT³

W6APU	1	2	3	4	5	6	7	8	9	10	11	12
	634	658	678	702	740	775	810	841	879	915	964	1033
Add \$30 for grip assist arms (GAA)	OVERALL DIMENSIONS			SEAT DIMENSIONS			BACK DIMENSIONS					
	W	D	H	W	D	H	W	H				
	IN	24.25	23.75	32	18.25	17.75	18.25	16	15.25			
	MM	616	603	813	464	451	464	406	387			
	Frame plated finish options: Add \$42 for Chrome (CHM) Add \$145 for Brushed Chrome (BCH) Add \$213 for Antique Copper (ACO) Add \$213 for Satin Brass (SBR)											
	RTA 00	1 per carton										



Does not stack

Armchair, Sled Base, Uph Back and Seat
 COM: 1.25 YD | 1.14 M
 Unit weight: 23 LB | 10.5 KG
 Carton weight: 30.5 LB | 13.83 KG
 Carton volume: 13.25 FT³ | 0.37 MT³

W6AAU	1	2	3	4	5	6	7	8	9	10	11	12
	685	725	759	798	862	920	979	1030	1094	1154	1235	1350
Add \$30 for grip assist arms (GAA)	OVERALL DIMENSIONS			SEAT DIMENSIONS			BACK DIMENSIONS					
	W	D	H	W	D	H	W	H				
	IN	24.25	23.75	32.25	18.25	16.5	18.25	16.5	15.25			
	MM	616	603	819	464	419	464	419	387			
	Frame plated finish options: Add \$42 for Chrome (CHM) Add \$145 for Brushed Chrome (BCH) Add \$213 for Antique Copper (ACO) Add \$213 for Satin Brass (SBR)											
	RTA 00	1 per carton										



Does not stack

Armless Chair, Sled Base, Poly Back and Seat
 COM: N/A
 Unit weight: 19.5 LB | 8.9 KG
 Carton weight: 26.5 LB | 12.02 KG
 Carton volume: 11.75 FT³ | 0.33 MT³







List price												
W6NPP	560											
	OVERALL DIMENSIONS			SEAT DIMENSIONS			BACK DIMENSIONS					
	W	D	H	W	D	H	W	H				
	IN	20.75	23.5	32	17.75	17.75	17.75	16	16			
	MM	527	597	813	451	451	451	406	406			
	Frame plated finish options: Add \$42 for Chrome (CHM) Add \$145 for Brushed Chrome (BCH) Add \$213 for Antique Copper (ACO) Add \$213 for Satin Brass (SBR)											
	RTA 00	1 per carton										



Does not stack

Armless Chair, Sled Base, Uph Back and Poly Seat
 COM: 0.5 YD | 0.46 M
 Unit weight: 20 LB | 9.1 KG
 Carton weight: 27 LB | 12.25 KG
 Carton volume: 11.75 FT³ | 0.33 MT³

W6NUP	1	2	3	4	5	6	7	8	9	10	11	12
	614	630	644	659	685	708	732	752	778	802	834	880
	OVERALL DIMENSIONS			SEAT DIMENSIONS			BACK DIMENSIONS					
	W	D	H	W	D	H	W	H				
	IN	20.75	23.5	32.25	17.75	17.75	17.75	16.5	16			
	MM	527	597	819	451	451	451	419	406			
	Frame plated finish options: Add \$42 for Chrome (CHM) Add \$145 for Brushed Chrome (BCH) Add \$213 for Antique Copper (ACO) Add \$213 for Satin Brass (SBR)											
	RTA 00	1 per carton										

DESCRIPTION	MODEL# / FEATURES	STANDARD TEXTILE GRADES											
		1	2	3	4	5	6	7	8	9	10	11	12
 <p>Does not stack</p> <p>Armless Chair, Sled Base, Poly Back and Uph Seat COM: 0.75 YD 0.69 M Unit weight: 20 LB 9.1 KG Carton weight: 27 LB 12.25 KG Carton volume: 11.75 FT³ 0.33 MT³</p>	W6NPU	619	643	663	687	725	760	795	826	864	900	949	1018
		OVERALL DIMENSIONS			SEAT DIMENSIONS			BACK DIMENSIONS					
		W	D	H	W	D	H	W	H				
	Frame plated finish options:	IN 20.75	23.5	32	18.25	17.75	18.25	16	15.25				
	Add \$42 for Chrome (CHM)	MM 527	597	813	464	451	464	406	387				
	Add \$145 for Brushed Chrome (BCH)												
	Add \$213 for Antique Copper (ACO)												
	Add \$213 for Satin Brass (SBR)	RTA 00	1 per carton										
 <p>Does not stack</p> <p>Armless Chair, Sled Base, Uph Back and Seat COM: 1.25 YD 1.14 M Unit weight: 20.5 LB 9.3 KG Carton weight: 27.5 LB 12.47 KG Carton volume: 11.75 FT³ 0.33 MT³</p>	W6NUU	670	710	744	783	847	905	964	1015	1079	1139	1220	1335
		OVERALL DIMENSIONS			SEAT DIMENSIONS			BACK DIMENSIONS					
		W	D	H	W	D	H	W	H				
	Frame plated finish options:	IN 20.75	23.5	32.25	18.25	16.5	18.25	16.5	15.25				
	Add \$42 for Chrome (CHM)	MM 527	597	819	464	419	464	419	387				
	Add \$145 for Brushed Chrome (BCH)												
	Add \$213 for Antique Copper (ACO)												
	Add \$213 for Satin Brass (SBR)	RTA 00	1 per carton										
 <p>Stacks 4 high on floor</p> <p>Bariatric Armchair, Uph Back and Seat COM: 1.75 YD 1.6 M Unit weight: 30 LB 13.6 KG Carton weight: 41 LB 18.6 KG Carton volume: 20.5 FT³ 0.58 MT³</p>	W530AUU	889	945	992	1047	1136	1218	1300	1372	1461	1545	1659	1820
		OVERALL DIMENSIONS			SEAT DIMENSIONS			BACK DIMENSIONS					
		W	D	H	W	D	H	W	H				
	Frame plated finish options:	IN 35.25	23.5	32.25	29	17	18.25	26.75	15.25				
	Add \$57 for Chrome (CHM)	MM 895	597	819	737	432	464	679	387				
	Add \$185 for Brushed Chrome (BCH)												
	Add \$271 for Antique Copper (ACO)												
	Add \$271 for Satin Brass (SBR)	RTA 00	1 per carton										
	Add \$30 for grip assist arms (GAA)												
 <p>Stacks 4 high on floor</p> <p>Bariatric Armless Chair, Uph Back and Seat COM: 1.75 YD 1.6 M Unit weight: 27.5 LB 12.5 KG Carton weight: 37.5 LB 17.01 KG Carton volume: 16.75 FT³ 0.47 MT³</p>	W530NUU	874	930	977	1032	1121	1203	1285	1357	1446	1530	1644	1805
		OVERALL DIMENSIONS			SEAT DIMENSIONS			BACK DIMENSIONS					
		W	D	H	W	D	H	W	H				
	Frame plated finish options:	IN 31.75	23.5	32.25	29	17	18.25	26.75	15.25				
	Add \$57 for Chrome (CHM)	MM 806	597	819	737	432	464	679	387				
	Add \$185 for Brushed Chrome (BCH)												
	Add \$271 for Antique Copper (ACO)												
	Add \$271 for Satin Brass (SBR)	RTA 00	1 per carton										
 <p>Does not stack</p> <p>Bariatric Armchair, Sled Base, Uph Back and Seat COM: 1.75 YD 1.6 M Unit weight: 34 LB 15.5 KG Carton weight: 45 LB 20.41 KG Carton volume: 20.5 FT³ 0.58 MT³</p>	W630AUU	978	1034	1081	1136	1225	1307	1389	1461	1550	1634	1748	1909
		OVERALL DIMENSIONS			SEAT DIMENSIONS			BACK DIMENSIONS					
		W	D	H	W	D	H	W	H				
	Frame plated finish options:	IN 35.25	23.5	32.25	29	17	18.25	26.75	15.25				
	Add \$57 for Chrome (CHM)	MM 895	597	819	737	432	464	679	387				
	Add \$185 for Brushed Chrome (BCH)												
	Add \$271 for Antique Copper (ACO)												
	Add \$271 for Satin Brass (SBR)	RTA 00	1 per carton										
	Add \$30 for grip assist arms (GAA)												
 <p>Does not stack</p> <p>Bariatric Armless Chair, Sled Base, Uph Back and Seat COM: 1.75 YD 1.6 M Unit weight: 31.5 LB 14.3 KG Carton weight: 41.5 LB 18.82 KG Carton volume: 16.75 FT³ 0.47 MT³</p>	W630NUU	960	1016	1063	1118	1207	1289	1371	1443	1532	1616	1730	1891
		OVERALL DIMENSIONS			SEAT DIMENSIONS			BACK DIMENSIONS					
		W	D	H	W	D	H	W	H				
	Frame plated finish options:	IN 31.75	23.5	32.25	29	17	18.25	26.75	15.25				
	Add \$57 for Chrome (CHM)	MM 806	597	819	737	432	464	679	387				
	Add \$185 for Brushed Chrome (BCH)												
	Add \$271 for Antique Copper (ACO)												
	Add \$271 for Satin Brass (SBR)	RTA 00	1 per carton										

DESCRIPTION MODEL# / FEATURES STANDARD TEXTILE GRADES



Does not stack

Counter Stool w/Arms, Poly Back and Seat
 COM: N/A
 Unit weight: 23 LB | 10.5 KG
 Carton weight: 32.5 LB | 14.74 KG
 Carton volume: 15 FT³ | 0.42 MT³

List price												
W5CSAPP	631											
Add \$30 for grip assist arms (GAA)	OVERALL DIMENSIONS			SEAT DIMENSIONS			BACK DIMENSIONS					
	W	D	H	W	D	H	W	H				
Frame plated finish options:	IN	24.25	23.5	38.25	17.75	17.15	23.25	16	16			
Add \$60 for Chrome (CHM)	MM	616	597	972	451	436	591	406	406			
Add \$197 for Brushed Chrome (BCH)												
Add \$288 for Antique Copper (ACO)												
Add \$288 for Satin Brass (SBR)	RTA 00	1 per carton										



Does not stack

Counter Stool w/Arms, Uph Back and Poly Seat
 COM: 0.5 YD | 0.46 M
 Unit weight: 23.5 LB | 10.7 KG
 Carton weight: 33 LB | 14.97 KG
 Carton volume: 15 FT³ | 0.42 MT³

	1	2	3	4	5	6	7	8	9	10	11	12
W5CSAUP	685	701	715	730	756	779	803	823	849	873	905	951
Add \$30 for grip assist arms (GAA)	OVERALL DIMENSIONS			SEAT DIMENSIONS			BACK DIMENSIONS					
	W	D	H	W	D	H	W	H				
Frame plated finish options:	IN	24.25	23.5	38.25	17.75	16.5	23.25	16.5	16			
Add \$60 for Chrome (CHM)	MM	616	597	972	451	419	591	419	406			
Add \$197 for Brushed Chrome (BCH)												
Add \$288 for Antique Copper (ACO)												
Add \$288 for Satin Brass (SBR)	RTA 00	1 per carton										



Does not stack

Counter Stool w/Arms, Poly Back and Uph Seat
 COM: 0.75 YD | 0.69 M
 Unit weight: 23.5 LB | 10.7 KG
 Carton weight: 33 LB | 14.97 KG
 Carton volume: 15 FT³ | 0.42 MT³

	1	2	3	4	5	6	7	8	9	10	11	12
W5CSAPU	690	714	734	758	796	831	866	897	935	971	1020	1089
Add \$30 for grip assist arms (GAA)	OVERALL DIMENSIONS			SEAT DIMENSIONS			BACK DIMENSIONS					
	W	D	H	W	D	H	W	H				
Frame plated finish options:	IN	24.25	23.5	38.25	18.25	17.75	24.25	16	15.25			
Add \$60 for Chrome (CHM)	MM	616	597	972	464	451	616	406	387			
Add \$197 for Brushed Chrome (BCH)												
Add \$288 for Antique Copper (ACO)												
Add \$288 for Satin Brass (SBR)	RTA 00	1 per carton										



Does not stack

Counter Stool w/Arms, Uph Back and Seat
 COM: 1.25 YD | 1.14 M
 Unit weight: 24 LB | 10.9 KG
 Carton weight: 33.5 LB | 15.2 KG
 Carton volume: 15 FT³ | 0.42 MT³

	1	2	3	4	5	6	7	8	9	10	11	12
W5CSAUU	744	784	818	857	921	979	1038	1089	1153	1213	1294	1409
Add \$30 for grip assist arms (GAA)	OVERALL DIMENSIONS			SEAT DIMENSIONS			BACK DIMENSIONS					
	W	D	H	W	D	H	W	H				
Frame plated finish options:	IN	24.25	23.5	38.25	18.25	17	24.25	16.5	15.25			
Add \$60 for Chrome (CHM)	MM	616	597	972	464	432	616	419	387			
Add \$197 for Brushed Chrome (BCH)												
Add \$288 for Antique Copper (ACO)												
Add \$288 for Satin Brass (SBR)	RTA 00	1 per carton										



Stacks 4 on the floor

Armless Counter Stool, Poly Back and Seat
 COM: N/A
 Unit weight: 20.5 LB | 9.3 KG
 Carton weight: 29.5 LB | 13.38 KG
 Carton volume: 13.75 FT³ | 0.38 MT³







	1	2	3	4	5	6	7	8	9	10	11	12
W5CSNPP	616											
Add \$30 for grip assist arms (GAA)	OVERALL DIMENSIONS			SEAT DIMENSIONS			BACK DIMENSIONS					
	W	D	H	W	D	H	W	H				
Frame plated finish options:	IN	21.75	23.5	38.25	17.75	17.15	23.25	16	16			
Add \$60 for Chrome (CHM)	MM	552	597	972	451	436	591	406	406			
Add \$197 for Brushed Chrome (BCH)												
Add \$288 for Antique Copper (ACO)												
Add \$288 for Satin Brass (SBR)	RTA 00	1 per carton										



Stacks 4 on the floor

Armless Counter Stool, Uph Back and Poly Seat
 COM: 0.5 YD | 0.46 M
 Unit weight: 21 LB | 9.5 KG
 Carton weight: 30 LB | 13.61 KG
 Carton volume: 13.75 FT³ | 0.38 MT³

	1	2	3	4	5	6	7	8	9	10	11	12
W5CSNUP	670	686	700	715	741	764	788	808	834	858	890	936
Add \$30 for grip assist arms (GAA)	OVERALL DIMENSIONS			SEAT DIMENSIONS			BACK DIMENSIONS					
	W	D	H	W	D	H	W	H				
Frame plated finish options:	IN	21.75	23.5	38.25	17.75	16.5	23.25	16.5	16			
Add \$60 for Chrome (CHM)	MM	552	597	972	451	419	591	419	406			
Add \$197 for Brushed Chrome (BCH)												
Add \$288 for Antique Copper (ACO)												
Add \$288 for Satin Brass (SBR)	RTA 00	1 per carton										

DESCRIPTION	MODEL# / FEATURES	STANDARD TEXTILE GRADES											
		1	2	3	4	5	6	7	8	9	10	11	12
 <p>Stacks 4 on the floor</p> <p>Armless Counter Stool, Poly Back and Uph Seat COM: 0.75 YD 0.69 M Unit weight: 21 LB 9.5 KG Carton weight: 30 LB 13.61 KG Carton volume: 13.75 FT³ 0.38 MT³</p>	W5CSNPU	675	699	719	743	781	816	851	882	920	956	1005	1074
		OVERALL DIMENSIONS			SEAT DIMENSIONS			BACK DIMENSIONS					
			W	D	H	W	D	H	W	H			
	Frame plated finish options:	IN 21.75	23.5	38.25	18.25	17.75	24.25	16	15.25				
	Add \$60 for Chrome (CHM)	MM 552	597	972	464	451	616	406	387				
	Add \$197 for Brushed Chrome (BCH)												
	Add \$288 for Antique Copper (ACO)												
	Add \$288 for Satin Brass (SBR)	RTA 00	1 per carton										
 <p>Stacks 4 on the floor</p> <p>Armless Counter Stool, Uph Back and Seat COM: 1.25 YD 1.14 M Unit weight: 21.5 LB 9.8 KG Carton weight: 30.5 LB 13.83 KG Carton volume: 13.75 FT³ 0.38 MT³</p>	W5CSNUU	729	769	803	842	906	964	1023	1074	1138	1198	1279	1394
		OVERALL DIMENSIONS			SEAT DIMENSIONS			BACK DIMENSIONS					
			W	D	H	W	D	H	W	H			
	Frame plated finish options:	IN 21.75	23.5	38.25	18.25	17	24.25	16.5	15.25				
	Add \$60 for Chrome (CHM)	MM 552	597	972	464	432	616	419	387				
	Add \$197 for Brushed Chrome (BCH)												
	Add \$288 for Antique Copper (ACO)												
	Add \$288 for Satin Brass (SBR)	RTA 00	1 per carton										
 <p>Does not stack</p> <p>Bar Stool w/Arms, Poly Back and Seat COM: N/A Unit weight: 24.5 LB 11.1 KG Carton weight: 34.5 LB 15.65 KG Carton volume: 17 FT³ 0.48 MT³</p>	W5BSAPP	List price 636											
		OVERALL DIMENSIONS			SEAT DIMENSIONS			BACK DIMENSIONS					
			W	D	H	W	D	H	W	H			
	Add \$30 for grip assist arms (GAA)	IN 24.25	23.5	44	17.75	17.5	29.25	16	16				
	Add \$60 for Chrome (CHM)	MM 616	597	1118	451	445	743	406	406				
	Add \$197 for Brushed Chrome (BCH)												
	Add \$288 for Antique Copper (ACO)												
	Add \$288 for Satin Brass (SBR)	RTA 00	1 per carton										
 <p>Does not stack</p> <p>Bar Stool w/Arms, Uph Back and Poly Seat COM: 0.5 YD 0.46 M Unit weight: 25 LB 11.4 KG Carton weight: 35 LB 15.88 KG Carton volume: 17 FT³ 0.48 MT³</p>	W5BSAUP	690	706	720	735	761	784	808	828	854	878	910	956
		OVERALL DIMENSIONS			SEAT DIMENSIONS			BACK DIMENSIONS					
			W	D	H	W	D	H	W	H			
	Frame plated finish options:	IN 24.25	23.5	44.5	17.75	16.5	29.25	16.5	16				
	Add \$60 for Chrome (CHM)	MM 616	597	1130	451	419	743	419	406				
	Add \$197 for Brushed Chrome (BCH)												
	Add \$288 for Antique Copper (ACO)												
	Add \$288 for Satin Brass (SBR)	RTA 00	1 per carton										
 <p>Does not stack</p> <p>Bar Stool w/Arms, Poly Back and Uph Seat COM: 0.75 YD 0.69 M Unit weight: 25 LB 11.4 KG Carton weight: 35 LB 15.88 KG Carton volume: 17 FT³ 0.48 MT³</p>	W5BSAPU	695	711	725	740	766	789	813	833	859	883	915	961
		OVERALL DIMENSIONS			SEAT DIMENSIONS			BACK DIMENSIONS					
			W	D	H	W	D	H	W	H			
	Frame plated finish options:	IN 24.25	23.5	44	18.25	17.5	30.25	16	15.25				
	Add \$60 for Chrome (CHM)	MM 616	597	1118	464	445	768	406	387				
	Add \$197 for Brushed Chrome (BCH)												
	Add \$288 for Antique Copper (ACO)												
	Add \$288 for Satin Brass (SBR)	RTA 00	1 per carton										
 <p>Does not stack</p> <p>Bar Stool w/Arms, Uph Back and Seat COM: 1.25 YD 1.14 M Unit weight: 25.5 LB 11.6 KG Carton weight: 35.5 LB 16.1 KG Carton volume: 17 FT³ 0.48 MT³</p>	W5BSAUU	749	789	823	862	926	984	1043	1094	1158	1218	1299	1414
		OVERALL DIMENSIONS			SEAT DIMENSIONS			BACK DIMENSIONS					
			W	D	H	W	D	H	W	H			
	Frame plated finish options:	IN 24.25	23.5	44.5	18.25	16.75	30.25	16.5	15.25				
	Add \$60 for Chrome (CHM)	MM 616	597	1130	464	425	768	419	387				
	Add \$197 for Brushed Chrome (BCH)												
	Add \$288 for Antique Copper (ACO)												
	Add \$288 for Satin Brass (SBR)	RTA 00	1 per carton										

DESCRIPTION MODEL# / FEATURES STANDARD TEXTILE GRADES



Stacks 4 on the floor

Armless Bar Stool, Poly Back and Seat
 COM: N/A
 Unit weight: 22 LB | 10 KG
 Carton weight: 31.5 LB | 14.29 KG
 Carton volume: 15.75 FT³ | 0.44 MT³

List price											
W5BSNPP 621											
OVERALL DIMENSIONS			SEAT DIMENSIONS			BACK DIMENSIONS					
W	D	H	W	D	H	W	H				
IN 20.75	23.5	44	17.75	17.5	29.25	16	16				
MM 527	597	1118	451	445	743	406	406				
Frame plated finish options:											
Add \$60 for Chrome (CHM)											
Add \$197 for Brushed Chrome (BCH)											
Add \$288 for Antique Copper (ACO)											
Add \$288 for Satin Brass (SBR)											
RTA 00 1 per carton											



Stacks 4 on the floor

Armless Bar Stool, Uph Back and Poly Seat
 COM: 0.5 YD | 0.46 M
 Unit weight: 22.5 LB | 10.2 KG
 Carton weight: 32 LB | 14.51 KG
 Carton volume: 15.75 FT³ | 0.44 MT³

List price											
W5BSNUP											
1	2	3	4	5	6	7	8	9	10	11	12
675	691	705	720	746	769	793	813	839	863	895	941
OVERALL DIMENSIONS			SEAT DIMENSIONS			BACK DIMENSIONS					
W	D	H	W	D	H	W	H				
IN 20.75	23.5	44.5	17.75	16.5	29.25	16.5	16				
MM 527	597	1130	451	419	743	419	406				
Frame plated finish options:											
Add \$60 for Chrome (CHM)											
Add \$197 for Brushed Chrome (BCH)											
Add \$288 for Antique Copper (ACO)											
Add \$288 for Satin Brass (SBR)											
RTA 00 1 per carton											



Stacks 4 on the floor

Armless Bar Stool, Poly Back and Uph Seat
 COM: 0.75 YD | 0.69 M
 Unit weight: 22.5 LB | 10.2 KG
 Carton weight: 32 LB | 14.51 KG
 Carton volume: 15.75 FT³ | 0.44 MT³

List price											
W5BSNPU											
1	2	3	4	5	6	7	8	9	10	11	12
680	704	724	748	786	821	856	887	925	961	1010	1079
OVERALL DIMENSIONS			SEAT DIMENSIONS			BACK DIMENSIONS					
W	D	H	W	D	H	W	H				
IN 20.75	23.5	44	18.25	17.5	30.25	16	15.25				
MM 527	597	1118	464	445	768	406	387				
Frame plated finish options:											
Add \$60 for Chrome (CHM)											
Add \$197 for Brushed Chrome (BCH)											
Add \$288 for Antique Copper (ACO)											
Add \$288 for Satin Brass (SBR)											
RTA 00 1 per carton											



Stacks 4 on the floor

Armless Bar Stool, Uph Back and Seat
 COM: 1.25 YD | 1.14 M
 Unit weight: 23 LB | 10.5 KG
 Carton weight: 32.5 LB | 14.74 KG
 Carton volume: 15.75 FT³ | 0.44 MT³

List price											
W5BSNUU											
1	2	3	4	5	6	7	8	9	10	11	12
734	774	808	847	911	969	1028	1079	1143	1203	1284	1399
OVERALL DIMENSIONS			SEAT DIMENSIONS			BACK DIMENSIONS					
W	D	H	W	D	H	W	H				
IN 20.75	23.5	44.5	18.25	16.75	30.25	16.5	15.25				
MM 527	597	1130	464	425	768	419	387				
Frame plated finish options:											
Add \$60 for Chrome (CHM)											
Add \$197 for Brushed Chrome (BCH)											
Add \$288 for Antique Copper (ACO)											
Add \$288 for Satin Brass (SBR)											
RTA 00 1 per carton											



Does not stack

Hip Chair, Poly Back and Seat
 COM: N/A
 Unit weight: 25 LB | 11.4 KG
 Carton weight: 35.5 LB | 16.1 KG
 Carton volume: 17.75 FT³ | 0.5 MT³









List price											
W524APP 671											
Add \$30 for grip assist arms (GAA)											
OVERALL DIMENSIONS			SEAT DIMENSIONS			BACK DIMENSIONS					
W	D	H	W	D	H	W	H				
IN 24.25	24.25	38	17.75	17.5	22.25	16	16				
MM 616	616	965	451	445	565	406	406				
Frame plated finish options:											
Add \$57 for Chrome (CHM)											
Add \$185 for Brushed Chrome (BCH)											
Add \$271 for Antique Copper (ACO)											
Add \$271 for Satin Brass (SBR)											
RTA 00 1 per carton											



Does not stack

Hip Chair, Uph Back and Poly Seat
 COM: 0.5 YD | 0.46 M
 Unit weight: 25.5 LB | 11.6 KG
 Carton weight: 36 LB | 16.33 KG
 Carton volume: 17.75 FT³ | 0.5 MT³

List price											
W524AUP											
Add \$30 for grip assist arms (GAA)											
OVERALL DIMENSIONS			SEAT DIMENSIONS			BACK DIMENSIONS					
W	D	H	W	D	H	W	H				
IN 24.25	24.25	38.25	17.75	16.5	22.25	16.5	16.25				
MM 616	616	972	451	419	565	419	413				
Frame plated finish options:											
Add \$57 for Chrome (CHM)											
Add \$185 for Brushed Chrome (BCH)											
Add \$271 for Antique Copper (ACO)											
Add \$271 for Satin Brass (SBR)											
RTA 00 1 per carton											

DESCRIPTION	MODEL# / FEATURES	STANDARD TEXTILE GRADES											
		1	2	3	4	5	6	7	8	9	10	11	12
 <p>Does not stack</p> <p>Hip Chair, Poly Back and Uph Seat COM: 0.75 YD 0.69 M Unit weight: 25.5 LB 11.6 KG Carton weight: 36 LB 16.33 KG Carton volume: 17.75 FT³ 0.5 MT³</p>	W524APU	730	754	774	798	836	871	906	937	975	1011	1060	1129
	Add \$30 for grip assist arms (GAA)	OVERALL DIMENSIONS			SEAT DIMENSIONS			BACK DIMENSIONS					
		W	D	H	W	D	H	W	H				
	Frame plated finish options: Add \$57 for Chrome (CHM) Add \$185 for Brushed Chrome (BCH) Add \$271 for Antique Copper (ACO) Add \$271 for Satin Brass (SBR)	IN 24.25 MM 616	24.25 616	38 965	18.25 464	17.5 445	23.25 591	16 406	15.25 387				
	RTA 00	1 per carton											
 <p>Does not stack</p> <p>Hip Chair, Uph Back and Seat COM: 1.25 YD 1.14 M Unit weight: 26 LB 11.8 KG Carton weight: 36.5 LB 16.56 KG Carton volume: 17.75 FT³ 0.5 MT³</p>	W524AUU	784	824	858	897	961	1019	1078	1129	1193	1253	1334	1449
	Add \$30 for grip assist arms (GAA)	OVERALL DIMENSIONS			SEAT DIMENSIONS			BACK DIMENSIONS					
		W	D	H	W	D	H	W	H				
	Frame plated finish options: Add \$57 for Chrome (CHM) Add \$185 for Brushed Chrome (BCH) Add \$271 for Antique Copper (ACO) Add \$271 for Satin Brass (SBR)	IN 24.25 MM 616	24.25 616	38.25 972	18.25 464	16.5 419	23.25 591	16.5 419	15.25 387				
	RTA 00	1 per carton											
 <p>Does not stack</p> <p>Bariatric Hip Chair, Uph Back and Seat COM: 1.75 YD 1.6 M Unit weight: 38 LB 17.3 KG Carton weight: 50 LB 22.68 KG Carton volume: 23.75 FT³ 0.67 MT³</p>	W324AUU	1074	1130	1177	1232	1321	1403	1485	1557	1646	1730	1844	2005
	Casters not available.	OVERALL DIMENSIONS			SEAT DIMENSIONS			BACK DIMENSIONS					
	Add \$30 for grip assist arms (GAA)	W	D	H	W	D	H	W	H				
	Frame plated finish options: Add \$57 for Chrome (CHM) Add \$185 for Brushed Chrome (BCH) Add \$271 for Antique Copper (ACO) Add \$271 for Satin Brass (SBR)	IN 35.25 MM 895	24.25 616	38.5 978	29 737	17.5 445	23.25 591	26.75 679	15.25 387				
	RTA 00	1 per carton											
		List price											
	WDOL	435											
 <p>Dolly for Four-Leg Chairs COM: N/A Unit weight: 13 LB 5.9 KG Carton weight: 16 LB 7.26 KG Carton volume: 3.5 FT³ 0.09 MT³</p>	OVERALL DIMENSIONS			SEAT DIMENSIONS			BACK DIMENSIONS						
	Accommodates 10 standard four-leg chairs	W	D	H	W	D	H	W	H				
		IN 22 MM 559	23.75 603	9.25 235	-	-	-	-	-				
		RTA 00		1 per carton									
		List price											
	WDOL30	610											
 <p>Dolly for Bariatric Four-Leg Chairs COM: N/A Unit weight: 15 LB 6.8 KG Carton weight: 19 LB 8.62 KG Carton volume: 5 FT³ 0.14 MT³</p>	OVERALL DIMENSIONS			SEAT DIMENSIONS			BACK DIMENSIONS						
	Accommodates 4 bariatric four-leg chairs	W	D	H	W	D	H	W	H				
		IN 32.12 MM 816	23.75 603	9.25 235	-	-	-	-	-				
		RTA 00		1 per carton									
		List price											
	WPGBRK	92											
 <p>Ganging Bracket COM: N/A Unit weight: 4 LB 1.81 KG Carton weight: 2 LB 0.91 KG Carton volume: 2 FT³ 0.05 MT³</p>	OVERALL DIMENSIONS			SEAT DIMENSIONS			BACK DIMENSIONS						
	Does not accept power units. For use between 2 seated height arm or armless chairs where table top is not desired. Not usable with stool models.	W	D	H	W	D	H	W	H				
		IN 15 MM 381	9 229	1.25 32	-	-	-	-	-				
		RTA 00		1 per carton									

WILLOW LINKING TABLES



model WPT12G
120 degree corner linking table

model WPT12GL
end linking table - left



Willow seating



For Willow seating, see page 232.

EXAMPLE WILLOW TABLE ORDER CODE:

WPT90G	HPL	ACJ	CHM	ST	SND
Model #	Surface type	Top finish	Leg finish	Glide type	Glide finish









STANDARD FEATURES

- Linking tables can be used together in any combination with Willow four-leg or sled base chairs to create a wide variety of layouts.
- Connecting hardware is included.
- Legs and ganging brackets are available in 20 paint finishes or 4 plated finishes with an upcharge.
- Tables are available in thermally fused or high pressure laminate, and feature a flat edge with edge band.
- Various table glide options are available. Glides must be chosen to best suit flooring type and site conditions. For more information, please refer to glide selection chart (page 274).
- All tables (except 9" in-line linking table) are predrilled for center front field installation of undermount power. Specify separately.
- Undermount power unit (model SU2P10U) includes 1 AC and 2 USB-A charging ports with a 10' power cord and 3-prong plug. Specify Jet Black or White. Power units are not designed for daisy-chaining.
- Clamp mount (model SU2P10C) power includes 1 AC and 2 USB-A charging ports with a 10' power cord. Specify Jet Black or White. These units can be mounted on the back edge of all linking tables. Specify separately for field installation. Power units are not designed for daisy-chaining.

Please add option codes in the following order:

- **Model number**
- **Surface type**
(TFL) Thermally fused laminate
(HPL) High pressure laminate
- **Top finish**
(ACJ) Absolute Acajou (NBL) Noce Biondo
(ASN) Asian Night (NGL) Noce Grigio
(AWC) Avant Cherry (NEL) Noce Leggero
(AWH) Avant Honey (NML) Noce Medio
(BLK) Black (QTM) Quartered Mahogany
(BRC) Brushed Cobalt (SBY) Sheer Beauty
(CMB) Clear Maple (DEG) Dark Espresso (SOG) Storm Grey
(DWT) Designer White (WHE) Walnut Heights
(FAS) Fashionista (WHC) White Chocolate
(FCL) First Class (WCR) Winter Cherry
- **Leg finish**
Paint finishes. No upcharge
(TBL) Black (TIN) Ink
(TBZ) Buzz Blue (TKA) Kalua
(TCC) Cactus (TLA) Latte
(TCR) Carrot (TMO) Mocha
(TIV) Cloud (TNE) Nevada
(TDW) Designer White (TSN) Sand
(TDJ) Dijon (TSR) Scarlet
(TEG) Eggplant (TSH) Shadow
(TFO) Fog (TOA) Toast
(TFR) Frost (TTU) Tungsten
- Plated finish. See models for upcharges.
(CHM) Chrome (SBR) Satin Brass
(BCH) Brushed Chrome (ACO) Antique Copper
- **Bracket finish** (for linking tables)
Paint finishes. No upcharge
(TBL) Black (TMO) Mocha
(TIV) Cloud (TNE) Nevada
(TDW) Designer White (TSN) Sand
(TFO) Fog (TSH) Shadow
(TFR) Frost (TOA) Toast
(TKA) Kalua (TTU) Tungsten
(TLA) Latte
- **Glide type** (for models with legs)
(ST) Colored nylon glides for most surfaces. No upcharge.
(NM) Natural, non-marking nylon glides for most surfaces. No upcharge.
(SG) Steel cushioned glides for carpeted surfaces. See models for upcharges.
(FG) Felt glides for most hard floor surfaces. See models for upcharges.
(RG) Rubber non-slip glides for most hard floor surfaces. See models for upcharges.
- **Glide finish** (for all ST glides)
(BLK) Black
(SND) Sand

DESCRIPTION	MODEL# / FEATURES	STANDARD TEXTILE GRADES										
		List price	HPL add		OVERALL DIMENSIONS			SEAT DIMENSIONS		BACK DIMENSIONS		
	WPT90G	475	116		W	D	H	W	D	H	W	H
 <p>90 Degree Corner Linking Table COM: N/A Unit weight: 20 LB 9.1 KG Carton weight: 24 LB 10.89 KG Carton volume: 2.6 FT³ 0.07 MT³</p>	For glide option SG, FG or RG, add \$5.											
	Must be connected to a 4-leg or sled base chair. Includes 1 set of U-channel connectors and hardware.	IN 26.12 MM 664	26.12 664	17.62 448	-	-	-	-	-	-	-	-
	Shipped KD for assembly on site.	RTA 2	courier	1 per carton								

DESCRIPTION	MODEL# / FEATURES		STANDARD TEXTILE GRADES								
			List price	HPL add							
 <p>120 Degree Corner Linking Table COM: N/A Unit weight: 13.5 LB 6.1 KG Carton weight: 16.5 LB 7.48 KG Carton volume: 1.5 FT³ 0.04 MT³</p>	WPT12G		406	74							
	For glide option SG, FG or RG , add \$5.		OVERALL DIMENSIONS		SEAT DIMENSIONS			BACK DIMENSIONS			
			W	D	H	W	D	H	W	H	
	Must be connected to a 4-leg or sled base chair. Includes 1 set of U-channel connectors and hardware.		IN 12.62	31	17.5	-	-	-	-	-	
		MM 321	787	445	-	-	-	-	-		
Shipped KD for assembly on site.		RTA 2		1 per carton							
 <p>16" In-line Linking Table COM: N/A Unit weight: 10 LB 4.5 KG Carton weight: 12 LB 5.44 KG Carton volume: 0.9 FT³ 0.02 MT³</p>	WPT16G		265	47							
			OVERALL DIMENSIONS		SEAT DIMENSIONS			BACK DIMENSIONS			
			W	D	H	W	D	H	W	H	
	Must be connected to a 4-leg or sled base chair. Includes 1 set of U-channel connectors and hardware.		IN 16	15	2.75	-	-	-	-	-	
		MM 406	381	70	-	-	-	-	-		
Shipped KD for assembly on site.		RTA 00		1 per carton							
 <p>9" In-line Linking Table COM: N/A Unit weight: 7 LB 3.2 KG Carton weight: 8.5 LB 3.86 KG Carton volume: 0.7 FT³ 0.01 MT³</p>	WPT09G		207	33							
			OVERALL DIMENSIONS		SEAT DIMENSIONS			BACK DIMENSIONS			
			W	D	H	W	D	H	W	H	
	Must be connected to a 4-leg or sled base chair. Includes 1 set of U-channel connectors and hardware.		IN 9	15	2.75	-	-	-	-	-	
		MM 229	381	70	-	-	-	-	-		
Shipped KD for assembly on site.		RTA 00		1 per carton							
 <p>End Linking Table COM: N/A Unit weight: 10.5 LB 4.8 KG Carton weight: 13 LB 5.9 KG Carton volume: 1 FT³ 0.02 MT³</p>	WPTEGL		411	45							
	WPTEGR		411	45							
	Specify direction per seated use.										
	For glide option SG, FG or RG , add \$10.		OVERALL DIMENSIONS		SEAT DIMENSIONS			BACK DIMENSIONS			
		W	D	H	W	D	H	W	H		
Must be connected to a 4-leg or sled base chair. Includes 1 set of U-channel connectors and hardware.		IN 14	15	17.62	-	-	-	-	-		
		MM 356	381	448	-	-	-	-	-		
Shipped KD for assembly on site.		RTA 2		1 per carton							

DESCRIPTION MODEL# / FEATURES STANDARD TEXTILE GRADES

List price

SU2P10C 517



Power Unit, Clamp Attachment
 COM: N/A
 Unit weight: 3 LB | 1.36 KG
 Carton weight: 3 LB | 1.36 KG
 Carton volume: 0.5 FT³ | 0.01 MT³

Includes 1 AC and 2 USB-A ports.
 Tamper resistant with 10' cord.

	OVERALL DIMENSIONS			SEAT DIMENSIONS			BACK DIMENSIONS	
	W	D	H	W	D	H	W	H
IN	1.69	4.05	2.77	-	-	-	-	-
MM	43	103	70	-	-	-	-	-

RTA 00  1 per carton

List price

SU2P10U 517



Power Unit, Undermount Attachment
 COM: N/A
 Unit weight: 3 LB | 1.36 KG
 Carton weight: 3 LB | 1.36 KG
 Carton volume: 0.5 FT³ | 0.01 MT³

Includes 1 AC and 2 USB-A ports.
 Tamper resistant with 10' cord.

	OVERALL DIMENSIONS			SEAT DIMENSIONS			BACK DIMENSIONS	
	W	D	H	W	D	H	W	H
IN	1.69	4.05	2.77	-	-	-	-	-
MM	43	103	70	-	-	-	-	-

RTA 00  1 per carton

WINGBACK



model GC3787C

STANDARD FEATURES

- Traditional styling, easy to exit and features removable and replaceable seats.
- For added comfort, seats are standard with high density Ultracell foam.
- Standard glide is plastic.
- Wood legs are available in a variety of finishes. Available in Maple wood only species.
- For healthcare textiles and wood finish options, visit the website at globalfurnituregroup.com.
- Can be upholstered in standard Global textiles if Healthcare compliance is not required.
- Shipped fully assembled.

OPTIONAL FEATURES

- For non-slip glides, please specify **(NS)**. Add \$22.
- For hard surface floors, please specify opaque non-marking glides **(NM)**. No upcharge.
- To add sealed seams to your product contact Customer Service. Upcharges vary.
- For moisture barrier on seat, please specify **(MB)**. Add \$122.

SUGGESTED APPLICATIONS

- Guest seating
- Lobbies
- Lounge/Waiting
- Patient rooms
- Resident rooms

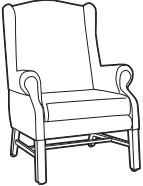
DESCRIPTION	MODEL# / FEATURES	STANDARD TEXTILE GRADES																																		
		COM	2	3	4	5	6	7	8	9	10	11	12																							
 <p>High Back Armchair - Chippendale Legs COM: 4.75 YD 4.34 M Unit weight: 42 LB 19.1 KG Carton weight: 50 LB 22.68 KG Carton volume: 22.25 FT³ 0.63 MT³</p>	GC3787C	1743	1895	2023	2171	2413	2636	2859	3054	3296	3524	3833	4270																							
	<p>Active weight 300 lbs.</p> <p>Removable seat cushion.</p>	<table border="1"> <thead> <tr> <th rowspan="2"></th> <th colspan="3">OVERALL DIMENSIONS</th> <th colspan="3">SEAT DIMENSIONS</th> <th colspan="2">BACK DIMENSIONS</th> </tr> <tr> <th>W</th> <th>D</th> <th>H</th> <th>W</th> <th>D</th> <th>H</th> <th>W</th> <th>H</th> </tr> </thead> <tbody> <tr> <td>IN</td> <td>29</td> <td>30</td> <td>39</td> <td>19.5</td> <td>18</td> <td>17.5</td> <td>19.5</td> <td>22</td> </tr> <tr> <td>MM</td> <td>737</td> <td>762</td> <td>991</td> <td>495</td> <td>457</td> <td>445</td> <td>495</td> <td>559</td> </tr> </tbody> </table>		OVERALL DIMENSIONS			SEAT DIMENSIONS			BACK DIMENSIONS		W	D	H	W	D	H	W	H	IN	29	30	39	19.5	18	17.5	19.5	22	MM	737	762	991	495	457	445	495
	OVERALL DIMENSIONS			SEAT DIMENSIONS			BACK DIMENSIONS																													
	W	D	H	W	D	H	W	H																												
IN	29	30	39	19.5	18	17.5	19.5	22																												
MM	737	762	991	495	457	445	495	559																												
	RTA 00	1 per carton																																		

seating

Work + Task

Doctor Buddy.....	249	GC Tritek	256
Ergonomic features	247	GC Tritek TS.....	258
Foot activated stools	251	GC Vion	260
Gala II.....	252	Harmony.....	262
Gala II TS.....	254	Mechanism adjustments	248

EACH HEALTHCARE CHAIR IS BUILT WITH FEATURES THAT ARE ERGONOMICALLY DESIGNED TO PROMOTE GOOD POSTURE AND PROVIDE MAXIMUM COMFORT. WHILE FULLY SUPPORTING YOUR BODY, THESE FEATURES SHOULD ALSO ALLOW YOU TO ADJUST YOUR CHAIR TO FIT YOU.



A TENSION ADJUSTMENT

Increase or decrease to match body weight. Allows you to rock comfortably, without heavy pushing, reducing muscle fatigue.



B CHAIR TILT LOCK

Lock the tilt movement in position(s) to accommodate your working posture. Allows you to lock your chair in a comfortable and supportive position. (Can be either single position, multiple position or infinite position.)



C SEAT HEIGHT

Raise or lower to allow your feet to rest flat on the floor. Avoids pressure under your thighs, easing blood flow.



D BACK/LUMBAR HEIGHT ADJUSTMENT

Raise or lower to position lumbar support in your lumbar area. Reduces likelihood of back pain.



E SEAT DEPTH

Change the depth of the seat to accommodate the length of your thighs. Keeps your back in contact with the backrest while avoiding pressure behind your knees. Can be sliding (MD) or manual.



F SEAT ANGLE ADJUSTMENT

Allows chair to tilt forward changing the angle of your thighs in relation to the floor. Helps reduce disc pressure during forward leaning tasks.



G BACK ANGLE ADJUSTMENT

Adjust to change the angle of your torso in relation to your thighs. Helps reduce disc pressure and relaxes your back muscles.



H ARM HEIGHT

Raise or lower to support your forearms. Reduces muscular effort in neck and shoulders, minimizing risk of pain.



J KNEE-TILT MOVEMENT

Chair tilts from a pivot point at the front of the seat, keeping your feet on the floor as you rock. Maintains stability.



L SYNCHRO-TILT MOVEMENT

Backrest reclines at a faster rate than the seat, increasing the angle between your torso and thighs. Enhances comfort and encourages dynamic body movement.



M WATERFALL SEAT EDGE

Reduces pressure at the back of your knees, contributing to good blood flow.



N CONTOURED CUSHION

Supports the body effectively, allowing you to sit longer without discomfort.



P VIBRATING SEAT & BACK

Soothing effect contributes to your relaxation during work breaks.



Q WIDTH ADJUSTABLE ARMS

Allows outward movement of armrests to match shoulder breadth. Ensures armrests properly support forearms, reducing muscular efforts in neck and shoulders.

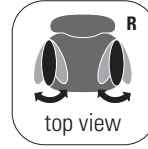

R ARM ROTATION

Rotate armcaps to support your forearms in various positions. Reduces muscular effort in neck and shoulders minimizing risk of pain.



S CENTRE TILT

Chair tilts from a pivot point under the centre of the seat allowing you to rock. When your feet are well supported, blood flow is enhanced.



U SOFT DESCENT PNEUMATIC LIFT

Gently and gradually lowering the seat helps you easily select proper seat height without causing a jerking motion.



V LUMBAR DEPTH ADJUSTMENT

Increase or decrease curvature of the back to match the profile of your lower back. Enhances comfort and support in the lower lumbar area.

MAXIMIZING YOUR ERGONOMIC SEATING

- Always select a chair that is designed for the type of work you perform and make certain the chair is comfortable for the length of time spent using it.
- Ensure that the seat and back cushions are contoured to fit your body, which will help eliminate pressure points.
- An ergonomically designed chair should allow changing positions easily.
- As you work, reposition yourself throughout the day to reduce strain and stress on specific muscle groups. If you change job functions, adjust your chair to fit the new task.
- Proper ergonomic seating should help eliminate many of the work related injuries that result from poor posture and poorly designed chairs.

TASK



ADJUSTMENTS

- (2) Pneumatic seat height
- (8) Manual seat depth
- Back/lumbar height **
- Swivel

POSTURE TASK



ADJUSTMENTS

- (2) Pneumatic seat height
- (3) Back angle
- (6) Back/lumbar height **
- Swivel

TILTER



ADJUSTMENTS

- (1) Tilt tension
- (2) Pneumatic seat height
- (9) Multiple position tilt lock *
- Centre tilt action
- Swivel

MULTI-TILTER

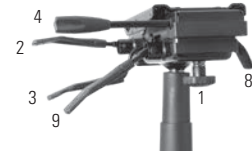

ADJUSTMENTS

- (1) Tilt tension
- (2) Pneumatic seat height
- (3) Back angle adjustment
- (4) Seat angle
- (8) Sliding seat depth adjustment (MD)
- (9) Infinite position tilt lock
- Back/lumbar height **
- Centre tilt action
- Swivel

SYNCHRO-TILTER



ADJUSTMENTS

- (1) Tilt tension
- (2) Pneumatic seat height
- (3) Back angle adjustment *
- (8) Sliding seat depth adjustment (MD)
- (9) Multiple position tilt lock/ Synchro tilt action
- Anti kick back *
- Back/lumbar height **
- Swivel

OPERATOR



ADJUSTMENTS

- (2) Pneumatic seat height
- (3) Back angle *(free float/lock)
- (4) Seat angle *(free float/lock)
- Back/lumbar height **
- With single lever operator mechanism, seat and back angle are controlled using lever 4 *
- Swivel

NOTES

- * Select models only.
- ** Ratchet back height adjustment on select models.
- Mechanisms shown are generic depictions and may differ from one chair to another.

DOCTOR BUDDY



model GC1105

model GC1111

STANDARD FEATURES









- Doctor Buddy is the perfect stool to provide comfort when performing office tasks or as an examination or feeding stool when caring for others.
- For the right comfort and support when performing tasks select Doctor Buddy with or without a back.
- Seat and back can be upholstered in vinyl or fabric. Seat is standard with high density Ultracell foam cushion.
- Models available with backrests: GC1111, GC1112, GC1113 & GC1114.
- Moisture resistant protection on the underside of seat pan.
- GC1104, GC1109, GC1111 & GC1113: 16" seat diameter.
- GC1105, GC1110, GC1112 & GC1114: 13.5" seat diameter.
- Black 5-prong injection molded base is standard.
- (C65) casters are standard.
- For healthcare textiles, visit the website at globalfurnituregroup.com.
- Can be upholstered in standard Global textiles only if Healthcare compliance is not required.









OPTIONAL FEATURES

- For improved housekeeping and infection control practices, please add (SU) to model number. The underside of the seat will be finished with vinyl and sealed to prevent penetration of liquids. Add \$39.
- **Casters/Glides**
 (C65) Dual wheel carpet casters. No upcharge.
 (C65R) Dual wheel hard floor casters. Add \$21.
 (C7) Set of 5 large Black slipper glides (for all surfaces). Can replace any Global casters. Glide is the same height as casters. No upcharge.
- To add sealed seams for seat and/or back, specify (SS). Upcharges vary, see model.
- Height adjustable footrest, please specify (R2). Add \$52.

SUGGESTED APPLICATIONS

- Dining/Cafeteria
- Office/Meeting
- Patient rooms
- Resident rooms
- Treatment/Exam rooms

DESCRIPTION	MODEL# / FEATURES	STANDARD TEXTILE GRADES											
		COM	2	3	4	5	6	7	8	9	10	11	12
 <p>16" Dia. Swivel Stool 5" Pneumatic, 22" Base COM: 0.75 YD 0.69 M Unit weight: 12 LB 5.5 KG Carton weight: 15 LB 6.8 KG Carton volume: 2.9 FT³ 0.08 MT³</p>	GC1104	386	410	430	454	492	527	562	593	631	667	716	785
	Active weight 300 lbs.												
	Add \$15 for (SS)												
	Ergonomic features: C	  1 per carton											
		OVERALL DIMENSIONS			SEAT DIMENSIONS			BACK DIMENSIONS					
		W	D	H	W	D	H	W	H				
		IN 16	16	18.5	16	-	16.5-21.5	-	-				
		MM 406	406	470	406	-	419-546	-	-				
 <p>14" Dia. Swivel Stool 5" Pneumatic, 20" Base COM: 0.75 YD 0.69 M Unit weight: 11 LB 5 KG Carton weight: 14 LB 6.35 KG Carton volume: 2.5 FT³ 0.07 MT³</p>	GC1105	327	351	371	395	433	468	503	534	572	608	657	726
	Active weight 300 lbs.												
	Add \$15 for (SS)												
	Ergonomic features: C	  1 per carton											
		OVERALL DIMENSIONS			SEAT DIMENSIONS			BACK DIMENSIONS					
		W	D	H	W	D	H	W	H				
		IN 13.5	13.5	18.5	13.5	-	16.5-21.5	-	-				
		MM 343	343	470	343	-	419-546	-	-				
 <p>16" Dia. Swivel Stool 10" Pneumatic, 22" Base COM: 0.75 YD 0.69 M Unit weight: 15 LB 6.8 KG Carton weight: 18 LB 8.16 KG Carton volume: 2.9 FT³ 0.08 MT³</p>	GC1109	471	495	515	539	577	612	647	678	716	752	801	870
	Active weight 300 lbs.												
	Add \$15 for (SS)												
	Ergonomic features: C	  1 per carton											
		OVERALL DIMENSIONS			SEAT DIMENSIONS			BACK DIMENSIONS					
		W	D	H	W	D	H	W	H				
		IN 16	16	27.5	16	-	22.5-32.5	-	-				
		MM 406	406	699	406	-	572-826	-	-				

DESCRIPTION	MODEL# / FEATURES	STANDARD TEXTILE GRADES												
		COM	2	3	4	5	6	7	8	9	10	11	12	
 <p>14" Dia. Swivel Stool 10" Pneumatic, 22" Base COM: 0.75 YD 0.69 M Unit weight: 14 LB 6.4 KG Carton weight: 17 LB 7.71 KG Carton volume: 2.9 FT³ 0.08 MT³</p>	GC1110	395	419	439	463	501	536	571	602	640	676	725	794	
	Active weight 300 lbs.	OVERALL DIMENSIONS			SEAT DIMENSIONS			BACK DIMENSIONS						
	Add \$15 for (SS)	IN	13.5	13.5	27.5	13.5	-	22.5-32.5	-	-	-	-	-	-
	Ergonomic features: C	MM	343	343	699	343	-	572-826	-	-	-	-	-	-
		RTA 1		1 per carton										
 <p>16" Dia. Swivel Stool with back 5" Pneumatic, 24" Base COM: 1 YD 0.91 M Unit weight: 24 LB 10.9 KG Carton weight: 32.5 LB 14.74 KG Carton volume: 15.5 FT³ 0.43 MT³</p>	GC1111	535	567	594	625	676	723	770	811	862	910	975	1067	
	Active weight 300 lbs.	OVERALL DIMENSIONS			SEAT DIMENSIONS			BACK DIMENSIONS						
	Add \$27 for (SS)	IN	16.5	20.5	29.75	16.5	15.5-17.5	16-21	14	11.25	-	-	-	-
	Ergonomic features: C	MM	419	521	756	419	394-445	406-533	356	286	-	-	-	-
		RTA 1		1 per carton										
 <p>14" Dia. Swivel Stool with back 5" Pneumatic, 24" Base COM: 0.75 YD 0.69 M Unit weight: 21 LB 9.5 KG Carton weight: 29 LB 13.15 KG Carton volume: 11.25 FT³ 0.31 MT³</p>	GC1112	476	500	520	544	582	617	652	683	721	757	806	875	
	Active weight 300 lbs.	OVERALL DIMENSIONS			SEAT DIMENSIONS			BACK DIMENSIONS						
	Add \$24 for (SS)	IN	13.5	17	29.75	13.5	12-14	16-21	14	11.25	-	-	-	-
	Ergonomic features: C	MM	343	432	756	343	305-356	406-533	356	286	-	-	-	-
		RTA 1		1 per carton										
 <p>16" Dia. Swivel Stool with back 10" Pneumatic, 24" Base COM: 1 YD 0.91 M Unit weight: 25 LB 11.4 KG Carton weight: 33.5 LB 15.2 KG Carton volume: 15.5 FT³ 0.43 MT³</p>	GC1113	620	652	679	710	761	808	855	896	947	995	1060	1152	
	Active weight 300 lbs.	OVERALL DIMENSIONS			SEAT DIMENSIONS			BACK DIMENSIONS						
	Add \$27 for (SS)	IN	16.5	20.5	38.75	16.5	15.5-17.5	22.5-32.5	14	11.25	-	-	-	-
	Ergonomic features: C	MM	419	521	984	419	394-445	572-826	356	286	-	-	-	-
		RTA 1		1 per carton										
 <p>14" Dia. Swivel Stool with back 10" Pneumatic, 24" Base COM: 0.75 YD 0.69 M Unit weight: 22 LB 10 KG Carton weight: 31 LB 14.06 KG Carton volume: 13.25 FT³ 0.37 MT³</p>	GC1114	544	568	588	612	650	685	720	751	789	825	874	943	
	Active weight 300 lbs.	OVERALL DIMENSIONS			SEAT DIMENSIONS			BACK DIMENSIONS						
	Add \$24 for (SS)	IN	13.5	17	38.75	13.5	12-14	22.5-32.5	14	11.25	-	-	-	-
	Ergonomic features: C	MM	343	432	984	343	305-356	572-826	356	286	-	-	-	-
		RTA 1		1 per carton										

FOOT ACTIVATED STOOLS



STANDARD FEATURES

- Foot activated stools allow the occupant to adjust the gas cylinder by pressing on the ring below the base with their foot, which frees up hands to manage other tasks while working in a lab.
- Raise the seat by pressing on the ring before sitting; or lower the seat by pressing on the ring while seated.
- Swivel stool with 8" gas cylinder provides seat height range of 21.5" to 29.5".
- Seamless upholstered seat cushion is constructed from high density Ultracell foam.
- Underside of seat cushion is finished with polyurethane.
- 14" seat diameter with 25" diameter Black 5-prong injection molded base.
- Standard with dual wheel hard floor casters (C10R).
- For healthcare textiles and finish options, visit the website at globalfurnituregroup.com.
- Can be upholstered in standard Global textiles only if Healthcare compliance is not required.

OPTIONAL FEATURES

- For improved housekeeping and infection control practices, please add (SU) to model number. The underside of the seat will be finished with vinyl and sealed to prevent penetration of liquids. Add \$39.

SUGGESTED APPLICATIONS

- Dining/Cafeteria
- Office/Meeting
- Patient rooms
- Resident rooms
- Treatment/Exam rooms

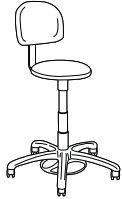
DESCRIPTION	MODEL# / FEATURES	STANDARD TEXTILE GRADES											
		COM	2	3	4	5	6	7	8	9	10	11	12
 <p>Lab Swivel Stool COM: 0.75 YD 0.69 M Unit weight: 19 LB 8.6 KG Carton weight: 28 LB 12.7 KG Carton volume: 14.5 FT³ 0.41 MT³</p>	GC9604FG	600	624	644	668	706	741	776	807	845	881	930	999
	Active weight 300 lbs.	IN 14		14	25.5	14	-	21.5-29.5		-	-		
		MM 356		356	648	356	-	546-749		-	-		
 <p>Lab Swivel Stool w/Small Upholstered Back COM: 1 YD 0.91 M Unit weight: 24 LB 10.9 KG Carton weight: 32 LB 14.51 KG Carton volume: 13 FT³ 0.36 MT³</p>	GC9668FG	734	766	793	824	875	922	969	1010	1061	1109	1174	1266
	Active weight 300 lbs.	IN 14		14	38	14	-	21.5-29.5		14	12.5		
		MM 356		356	965	356	-	546-749		356	318		
Ergonomic features:		C											
Ergonomic features:		RTA 00		1 per carton									
Ergonomic features:		RTA 1		1 per carton									

GALA II



model GC13011



model GC13015

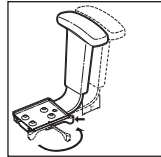

Vari-Width (WA) width adjustable arm extensions are standard when chair is ordered with adjustable arms.



model GC13021

MECHANISM OPTIONS:

Task mechanism (-6)

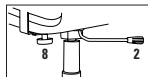

ADJUSTMENTS
(2) Pneumatic seat height
(8) Manual seat depth

Ergonomic features:
C, E, H, M, N, Q, R, U

Synchro-tilter mechanism (-0)

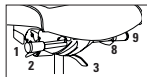

ADJUSTMENTS
(1) Tilt tension
(2) Pneumatic seat height
(3) Back angle
Back/lumbar height
(8) Sliding seat depth
(9) Multi position tilt lock
Synchro tilt action
Anti kick back

Ergonomic features:
A, B, C, D, E, G, H, L, M, N, Q, R, U

Multi-tilter mechanism (-3)

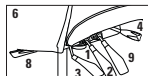

ADJUSTMENTS
(1) Tilt tension
(2) Pneumatic seat height
(3) Back angle
(4) Seat angle
(6) Back/lumbar height
(8) Sliding seat depth
(9) Infinite position tilt lock
Center tilt action

Ergonomic features:
A, B, C, D, E, F, G, H, M, N, Q, R, S, U

Posture task mechanism (-7)



ADJUSTMENTS
(2) Pneumatic seat height
(3) Back angle
Back/lumbar height
(8) Manual seat depth
20" diameter Chrome footrest

Ergonomic features:
C, D, G, H, M, N, Q, R, U, V

STANDARD FEATURES

- Gala II is designed to provide exceptional support and comfort throughout the work day.
- Available in three back heights and three seat sizes to fit a person's body type and movements while at work.
- Models with adjustable headrest available.
- Choice of four mechanisms: Task, synchro-tilter, multi-tilter and posture task. Stool models are available with posture task mechanism only.
- Vertical back height ratchet adjustment of 5.25" is standard on all models (except on task mechanism).
- Back support upright is 3" wide for extra strength.
- One-piece curved back features a pull over style upholstery cover for easy housekeeping and infection prevention practices.
- Standard with Global's high quality Soft Descent™ pneumatic lift which slowly and gently lowers the seat height of the chair making it easy to obtain the exact seat height you desire.
- Models with arms are standard with height adjustable arms (3B) with self-skinned urethane (SSU) armcaps.
- Vari-Width (WA) width adjustable arm extensions are standard. Allows the arms to move away from the seat by 2" on each side to allow space if desired for broader hip widths.
- Waterfall seamless seat front design with high density Ultracell foam for superior comfort and longevity.
- Underside of seat pan is completely sealed.
- Side activated sliding seat depth adjustment (MD) is standard on synchro-tilter and multi-tilter.
- 5-prong, injection molded, fiberglass reinforced nylon Black base with dual wheel carpet casters (C65).
- For healthcare textiles and finish options, visit the website at globalfurnituregroup.com.
- Can be upholstered in standard Global textiles only if Healthcare compliance is not required.
- To meet higher standards for housekeeping and infection control, Gala II has a seamless seat and one stitch pull over back upholstery, while still offering soft curves to the design. Note: Vinyl and woven treated textiles are thicker in nature and will experience wrinkles on some curves or corners as a result.

OPTIONAL FEATURES

- For moisture barrier on seat, please specify (MB). Add \$81.
- Back sealed seam available, please specify (S2). Upcharges vary.
- Optional Schukra™ depth adjustable lumbar support for personalized back support and comfort, please specify (SK). Add \$119.
- For additional arms/caster options, please refer to the Arm and Caster section (269). Optional casters may be priced higher than the standard casters for your chair and the difference will be charged. Lower priced optional casters will not be credited.





Please add option codes in the following order:

- **Model number**
GC13011 High back with arms
GC13011NA High back, armless
GC13012 Medium back with arms
GC13012NA Medium back, armless
GC13013 Low back with arms
GC13013NA Low back, armless
GC13015 Medium back stool with arms
GC13015NA Medium back stool, armless
GC13021 High Back w/Adj. Headrest with arms
GC13021NA High Back w/Adj. Headrest, armless
GC13022 Medium Back w/Adj. Headrest with arms
GC13022NA Medium Back w/Adj. Headrest, armless
- **Textile**
Specify textile code.
- **Mechanism**
(6) Task mechanism. No upcharge.
(0) Synchro-tilter mechanism. Add \$168.
(3) Multi-tilter mechanism. Add \$168.
(7) Posture task mechanism. Add \$99.
NOTE: Stool models are only available with Posture Task Mechanism, no upcharge.
- **Seat size**
(P) Petite
(S) Standard
(G) Generous
- **Arms**
(3B) Height adjustable arms. No upcharge. For additional arm options, please refer to Arm Selections section on page 271.
- **Base**
(BK) Black nylon spider base.
(AL) Polished aluminum base. Add \$131.
- **Casters**
(C65) Dual wheel carpet casters.
(C65R) Dual wheel hard floor casters. Add \$21.

EXAMPLE GALA II SELECT ORDER CODE:

GC13011	-WA53	-0	-S	-3B	-AL	-C65
Model number	Textile	Mechanism	Seat size	Arms	Base	Casters

DESCRIPTION	MODEL# / FEATURES	STANDARD TEXTILE GRADES											
		COM	2	3	4	5	6	7	8	9	10	11	12
	GC13011 With arms	734	803	861	928	1037	1138	1240	1328	1438	1541	1680	1878
	GC13011NA Armless	630	699	757	824	933	1034	1136	1224	1334	1437	1576	1774
	OVERALL DIMENSIONS	SEAT DIMENSIONS			BACK DIMENSIONS								
	W	D	H	W	D	H	W	H					
	IN 24.5	23.5	43	20.5	17-18	16.5-21.5	20	24.5					
	MM 622	597	1092	521	432-457	419-546	508	622					
	Active weight 300 lbs.												
	See series notes for mechanism options.												
	RTA 2	1 per carton											

DESCRIPTION	MODEL# / FEATURES	STANDARD TEXTILE GRADES											
		COM	2	3	4	5	6	7	8	9	10	11	12
 <p>Medium Back COM: 1.9 YD 1.74 M Unit weight: 43 LB 19.5 KG Carton weight: 53 LB 24.04 KG Carton volume: 10.5 FT³ 0.29 MT³</p>	GC13012 With arms	704	765	816	875	972	1061	1151	1229	1326	1417	1540	1715
	GC13012NA Armless	598	659	710	769	866	955	1045	1123	1220	1311	1434	1609
	OVERALL DIMENSIONS	W	D	H	SEAT DIMENSIONS			BACK DIMENSIONS		W	H		
	Active weight 300 lbs.	IN 24.5	23.5	39	20.5	17-18	16.5-21.5	20	20.5				
	MM 622	597	991	521	432-457	419-546	508	521					
See series notes for mechanism options.	RTA 2	1 per carton											
 <p>Low Back COM: 1.8 YD 1.65 M Unit weight: 41 LB 18.6 KG Carton weight: 51 LB 23.13 KG Carton volume: 10.5 FT³ 0.29 MT³</p>	GC13013 With arms	688	746	794	850	942	1026	1112	1186	1278	1364	1480	1646
	GC13013NA Armless	586	644	692	748	840	924	1010	1084	1176	1262	1378	1544
	OVERALL DIMENSIONS	W	D	H	SEAT DIMENSIONS			BACK DIMENSIONS		W	H		
	Active weight 300 lbs.	IN 24.5	23.5	35	20.5	17-18	16.5-21.5	20	16.5				
	MM 622	597	889	521	432-457	419-546	508	419					
See series notes for mechanism options.	RTA 2	1 per carton											
 <p>Medium Back Posture Task Stool COM: 1.8 YD 1.65 M Unit weight: 53 LB 24.1 KG Carton weight: 63 LB 28.58 KG Carton volume: 10.5 FT³ 0.29 MT³</p>	GC13015 With arms	913	971	1019	1075	1167	1251	1337	1411	1503	1589	1705	1871
	GC13015NA Armless	809	867	915	971	1063	1147	1233	1307	1399	1485	1601	1767
	OVERALL DIMENSIONS	W	D	H	SEAT DIMENSIONS			BACK DIMENSIONS		W	H		
	Active weight 300 lbs.	IN 24.5	23.5	51	20.5	17	24-34	20	20				
	MM 622	597	1295	521	432	610-864	508	508					
See series notes for mechanism options.	RTA 2	1 per carton											
 <p>High Back with Adjustable Headrest COM: 2.4 YD 2.19 M Unit weight: 49 LB 22.3 KG Carton weight: 61 LB 27.67 KG Carton volume: 10.5 FT³ 0.29 MT³</p>	GC13021 With arms	976	1053	1118	1192	1315	1427	1541	1639	1762	1877	2032	2253
	GC13021NA Armless	872	949	1014	1088	1211	1323	1437	1535	1658	1773	1928	2149
	OVERALL DIMENSIONS	W	D	H	SEAT DIMENSIONS			BACK DIMENSIONS		W	H		
	Active weight 300 lbs.	IN 24.5	23.5	50	20.5	17-18	16.5-21.5	20	31.5				
	MM 622	597	1270	521	432-457	419-546	508	800					
See series notes for mechanism options.	RTA 2	1 per carton											
 <p>Medium Back with Adjustable Headrest COM: 2.15 YD 1.97 M Unit weight: 47 LB 21.4 KG Carton weight: 59 LB 26.76 KG Carton volume: 10.5 FT³ 0.29 MT³</p>	GC13022 With arms	946	1015	1073	1140	1249	1350	1452	1540	1650	1753	1892	2090
	GC13022NA Armless	840	909	967	1034	1143	1244	1346	1434	1544	1647	1786	1984
	OVERALL DIMENSIONS	W	D	H	SEAT DIMENSIONS			BACK DIMENSIONS		W	H		
	Active weight 300 lbs.	IN 24.5	23.5	46	20.5	17	16.5-21.5	20	27.5				
	MM 622	597	1168	521	432	419-546	508	699					
See series notes for mechanism options.	RTA 2	1 per carton											

GALA II TS



model GCTS13011



model GCTS13015

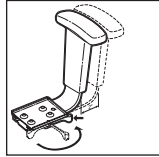

Vari-Width (WA) width adjustable arm extensions are standard when chair is ordered with adjustable arms.



model GCTS13021

MECHANISMS:

Synchro-tilter mechanism (-0)

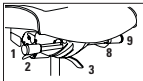

- ADJUSTMENTS**
- (1) Tilt tension
 - (2) Pneumatic seat height
 - (3) Back angle
 - Back/lumbar height
 - (8) Sliding seat depth
 - (9) Multi position tilt lock
 - Synchro tilt action
 - Anti kick back

Ergonomic features:
A, B, C, D, E, G, H, L, M, N, Q, R, U

Task mechanism (-6)

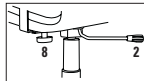

- ADJUSTMENTS**
- (2) Pneumatic seat height
 - (8) Manual seat depth

Ergonomic features:
C, E, H, M, N, Q, R, U

STANDARD FEATURES

- Gala II TS is designed for 24/7 applications to provide exceptional support and comfort throughout the work day.
- Available in three back heights and three seat sizes to fit a person's body type and movements while at work.
- Models with adjustable headrest available.
- Heavy duty synchro-tilter mechanism with side activated sliding seat depth adjustment (MD) and separate back angle adjustment for individual comfort are standard. Stool models are available with task mechanism only.
- Vertical back height ratchet adjustment of 5.25" is standard on all models (except on task mechanism).
- Back support upright is 3" wide for extra strength.
- One-piece curved back features a pull over style upholstery cover for easy housekeeping and infection prevention practices.
- Standard with Global's high quality Soft Descent™ pneumatic lift which slowly and gently lowers the seat height of the chair making it easy to obtain the exact seat height you desire.
- Models with arms are standard with height adjustable arms (3B) with self-skinned urethane (SSU) armcaps.
- Vari-Width (WA) width adjustable arm extensions are standard. Allows the arms to move away from the seat by 2" on each side to allow space if desired for broader hip widths.
- Waterfall seamless seat front design with high density Ultracell foam for superior comfort and longevity.
- Underside of seat pan is completely sealed.
- 5-prong, injection molded, fiberglass reinforced nylon Black base with dual wheel carpet casters (C10).
- For healthcare textiles and finish options, visit the website at globalfurnituregroup.com.
- Can be upholstered in standard Global textiles only if Healthcare compliance is not required.
- To meet higher standards for housekeeping and infection control, Gala II has a seamless seat and one stitch pull over back upholstery, while still offering soft curves to the design. Note: Vinyl and woven treated textiles are thicker in nature and will experience wrinkles on some curves or corners as a result.

OPTIONAL FEATURES

- For moisture barrier on seat, please specify (MB). Add \$81.
- Back sealed seam available, please specify (S2). Upcharges vary.
- Optional Schukra™ depth adjustable lumbar support for personalized back support and comfort, please specify (SK). Add \$119.
- For additional arms/caster options, please refer to the Arm and Caster section (269). Optional casters may be priced higher than the standard casters for your chair and the difference will be charged. Lower priced optional casters will not be credited.

Please add option codes in the following order:

- **Model number**
GCTS13011 High back with arms
GCTS13011NA High back, armless
GCTS13012 Medium back with arms
GCTS13012NA Medium back, armless
GCTS13013 Low back with arms
GCTS13013NA Low back, armless
GCTS13015 Medium back stool with arms
GCTS13015NA Medium back stool, armless
GCTS13021 High Back w/Adj. Headrest with arms
GCTS13021NA High Back w/Adj. Headrest, armless
GCTS13022 Medium Back w/Adj. Headrest with arms
GCTS13022NA Medium Back w/Adj. Headrest, armless
- **Textile**
Specify textile code.
- **Mechanism**
(0) Synchro-tilter mechanism. No upcharge.
(6) Task mechanism (models GCTS13015 and GCTS13015NA only). No upcharge.
- **Seat size**
(P) Petite
(S) Standard
(G) Generous
- **Arms**
(3B) Height adjustable arms. No upcharge.
For additional arm options, please refer to Arm Selections section on page 271.
- **Base**
(BK) Black nylon spider base.
(AL) Polished aluminum base. Add \$131.
- **Casters**
(C10) Dual wheel carpet casters.
(C10R) Dual wheel hard floor casters. Add \$20.

EXAMPLE GALA II TS ORDER CODE:

GCTS13011	-WA53	-0	-S	-3B	-B7	-C10R
Model number	Textile	Mechanism	Seat size	Arms	Base	Casters

DESCRIPTION



High Back Heavy Duty
COM: 2.15 YD | 1.97 M
Unit weight: 59 LB | 26.8 KG
Carton weight: 69 LB | 31.3 KG
Carton volume: 10.5 FT³ | 0.29 MT³

MODEL# / FEATURES

GCTS13011
With arms
GCTS13011NA
Armless





Active weight 350 lbs.
See series notes for mechanism options.

STANDARD TEXTILE GRADES

COM	2	3	4	5	6	7	8	9	10	11	12
1064	1133	1191	1258	1367	1468	1570	1658	1768	1871	2010	2208
960	1029	1087	1154	1263	1364	1466	1554	1664	1767	1906	2104

OVERALL DIMENSIONS			SEAT DIMENSIONS			BACK DIMENSIONS	
W	D	H	W	D	H	W	H
IN 24.5	23.5	43.5	20.5	17-18	17-21	20	24.5
MM 622	597	1105	521	432-457	432-533	508	622

RTA 2 1 per carton

DESCRIPTION	MODEL# / FEATURES	STANDARD TEXTILE GRADES											
		COM	2	3	4	5	6	7	8	9	10	11	12
 <p>Medium Back Heavy Duty COM: 1.9 YD 1.74 M Unit weight: 58 LB 26.4 KG Carton weight: 68 LB 30.84 KG Carton volume: 10.5 FT³ 0.29 MT³</p>	GCTS13012 With arms	1033	1094	1145	1204	1301	1390	1480	1558	1655	1746	1869	2044
	GCTS13012NA Armless	930	991	1042	1101	1198	1287	1377	1455	1552	1643	1766	1941
	OVERALL DIMENSIONS	W	D	H	SEAT DIMENSIONS			BACK DIMENSIONS					
		IN 24.5 MM 622	23.5 597	39.5 1003	20.5 521	17-18 432-457	17-21 432-533	20 508	20.5 521				
Active weight 350 lbs. See series notes for mechanism options.	RTA 2	1 per carton											
 <p>Low Back Heavy Duty COM: 1.8 YD 1.65 M Unit weight: 56 LB 25.5 KG Carton weight: 66 LB 29.94 KG Carton volume: 10.5 FT³ 0.29 MT³</p>	GCTS13013 With arms	1019	1077	1125	1181	1273	1357	1443	1517	1609	1695	1811	1977
	GCTS13013NA Armless	915	973	1021	1077	1169	1253	1339	1413	1505	1591	1707	1873
	OVERALL DIMENSIONS	W	D	H	SEAT DIMENSIONS			BACK DIMENSIONS					
		IN 24.5 MM 622	23.5 597	35.5 902	20.5 521	17-18 432-457	17-21 432-533	20 508	16.5 419				
Active weight 350 lbs. See series notes for mechanism options.	RTA 2	1 per carton											
 <p>Medium Back Heavy Duty Task Stool COM: 1.8 YD 1.65 M Unit weight: 47 LB 21.4 KG Carton weight: 57 LB 25.85 KG Carton volume: 10.5 FT³ 0.29 MT³</p>	GCTS13015 With arms	1242	1300	1348	1404	1496	1580	1666	1740	1832	1918	2034	2200
	GCTS13015NA Armless	1138	1196	1244	1300	1392	1476	1562	1636	1728	1814	1930	2096
	OVERALL DIMENSIONS	W	D	H	SEAT DIMENSIONS			BACK DIMENSIONS					
		IN 24.5 MM 622	23.5 597	48.5 1232	20.5 521	17 432	23.5-33.5 597-851	20 508	20.5 521				
Active weight 350 lbs. See series notes for mechanism options.	RTA 2	1 per carton											
 <p>High Back Heavy Duty with Adjustable Headrest COM: 2.4 YD 2.19 M Unit weight: 63 LB 28.6 KG Carton weight: 75 LB 34.02 KG Carton volume: 10.5 FT³ 0.29 MT³</p>	GCTS13021 With arms	1306	1383	1448	1522	1645	1757	1871	1969	2092	2207	2362	2583
	GCTS13021NA Armless	1202	1279	1344	1418	1541	1653	1767	1865	1988	2103	2258	2479
	OVERALL DIMENSIONS	W	D	H	SEAT DIMENSIONS			BACK DIMENSIONS					
		IN 24.5 MM 622	23.5 597	50.5 1283	20.5 521	17-18 432-457	17-21 432-533	20 508	31.5 800				
Active weight 350 lbs. See series notes for mechanism options.	RTA 2	1 per carton											
 <p>Medium Back Heavy Duty with Adjustable Headrest COM: 2.15 YD 1.97 M Unit weight: 62 LB 28.2 KG Carton weight: 74 LB 33.57 KG Carton volume: 10.5 FT³ 0.29 MT³</p>	GCTS13022 With arms	1275	1344	1402	1469	1578	1679	1781	1869	1979	2082	2221	2419
	GCTS13022NA Armless	1172	1241	1299	1366	1475	1576	1678	1766	1876	1979	2118	2316
	OVERALL DIMENSIONS	W	D	H	SEAT DIMENSIONS			BACK DIMENSIONS					
		IN 24.5 MM 622	23.5 597	46.5 1181	20.5 521	17 432	17-21 432-533	20 508	27.5 699				
Active weight 350 lbs. See series notes for mechanism options.	RTA 2	1 per carton											

GC TRITEK



model GC7472NA

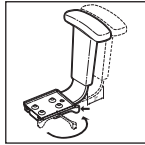

Vari-Width (WA) width adjustable arm extensions are standard when chair is ordered with adjustable arms.

MECHANISM OPTIONS:

Task mechanism (-6)

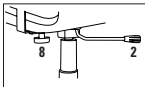

ADJUSTMENTS
(2) Pneumatic seat height
(8) Manual seat depth

Ergonomic features:
C, E, H, M, N, Q, R, U

Synchro-tilter mechanism (-0)

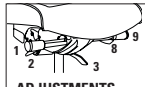

ADJUSTMENTS
(1) Tilt tension
(2) Pneumatic seat height
(3) Back angle
Back/lumbar height
(8) Sliding seat depth
(9) Multi position tilt lock
Synchro tilt action
Anti kick back

Ergonomic features:
A, B, C, D, E, G, H, L, M, N, Q, R, U

Multi-tilter mechanism (-3)



ADJUSTMENTS
(1) Tilt tension
(2) Pneumatic seat height
(3) Back angle
(4) Seat angle
(6) Back/lumbar height
(8) Sliding seat depth
(9) Infinite position tilt lock
Center tilt action

Ergonomic features:
A, B, C, D, E, F, G, H, M, N, Q, R, S, U

Posture task mechanism (-7)

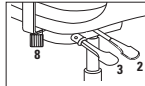

ADJUSTMENTS
(2) Pneumatic seat height
(3) Back angle
Back/lumbar height
(8) Manual seat depth
20" diameter Chrome footrest

Ergonomic features:
C, D, G, H, M, N, Q, R, U, V

STANDARD FEATURES

- GC Tritek is designed to meet every body shape and task, providing exceptional support and comfort throughout the work day.
- Available in three back heights and three seat sizes to fit a person's body type and movements while at work.
- Choice of four mechanisms: Task, synchro-tilter, multi-tilter and posture task. Stool models are available with posture task mechanism only.
- Side activated sliding seat depth adjustment (**MD**) and separate back angle adjustment is standard on synchro-tilter and multi-tilter.
- Durable Black polypropylene back shroud with unique upper back shape enables free lateral movement.
- Schukra™ depth adjustable lumbar support for personalized back support and comfort is standard on all models.
- Dual density foam spine pad embedded in the back of the chair forms to the user's shape.
- Vertical back height ratchet adjustment of 5.25".
- Back support upright is 3" wide for extra strength and durability.
- Standard with Global's high quality Soft Descent™ pneumatic lift which slowly and gently lowers the seat height of the chair making it easy to obtain the exact seat height you desire. 4" cylinder is standard on synchro-tilter models. 5" cylinder is standard on multi-tilter, task and posture task models.
- Models with arms are standard with height and width adjustable arms (**G6**) with sliding armcaps. Armcaps also articulate inwards and outwards to aim toward the keyboard or mouse area.
- Vari-Width (**WA**) width adjustable arm extensions are standard. Allows the arms to move away from the seat by 2" on each side to allow space if desired for broader hip widths.
- Waterfall seamless seat front design with high density Ultracell foam for superior comfort and longevity.
- Underside of seat pan is completely sealed.
- 5-prong, injection molded, fiberglass reinforced nylon Black base with dual wheel carpet casters (**C65**).
- Can be upholstered in standard Global textiles only if Healthcare compliance is not required.
- To meet higher standards for housekeeping and infection control, GC Tritek has a seamless seat and one stitch pullover back upholstery, while still offering soft curves to the design. Note: Vinyl and woven treated textiles are thicker in nature and will experience wrinkles on some curves or corners as a result.

OPTIONAL FEATURES

- For moisture barrier on seat, please specify (**MB**). Add \$81.
- To add sealed seams to your product, contact Customer Service. Upcharges vary.
- For additional arms/caster options, please refer to the Arm and Caster section (269). Optional casters may be priced higher than the standard casters for your chair and the difference will be charged. Lower priced optional casters will not be credited.

Please add option codes in the following order:



- Model number**
GC7471 Medium back with arms
GC7471NA Medium back, armless
GC7472 High back with arms
GC7472NA High back, armless
GC7473 Extended high back with arms
GC7473NA Extended high back, armless
GC7476 Medium back stool with arms
GC7476NA Medium back stool, armless
- Textile**
Specify textile code.
- Mechanism**
(6) Task mechanism. No upcharge.
(0) Synchro-tilter mechanism. Add \$168.
(3) Multi-tilter mechanism. Add \$168.
(7) Posture task mechanism. Add \$99 (no upcharge on stool models).
- Seat size**
(P) Petite
(S) Standard
(G) Generous
- Arms**
(G6) Height and width adjustable arms. No upcharge. For additional arm options, please refer to Arm Selections section on page 271.
- Base**
(BK) Black nylon B7B base.
(B7) Polished aluminum base. Add \$131.
- Casters/Glides**
(C65) Dual wheel carpet casters.
(C65R) Dual wheel hard floor casters. Add \$21.
(C7) Set of 5 large Black slipper glides (for all surfaces). Can replace any Global casters. Glide is the same height as casters. No upcharge.

EXAMPLE GC TRITEK ORDER CODE:

GC7471	-WA53	-0	-S	-G6	-B7	-C65R
--------	-------	----	----	-----	-----	-------

Model number Textile Mechanism Seat size Arms Base Casters/Glides

DESCRIPTION	MODEL# / FEATURES	STANDARD TEXTILE GRADES											
		COM	2	3	4	5	6	7	8	9	10	11	12
 GC7471 With arms		1108	1164	1211	1266	1355	1437	1519	1591	1680	1764	1878	2039
	GC7471NA Armless	1002	1058	1105	1160	1249	1331	1413	1485	1574	1658	1772	1933
		OVERALL DIMENSIONS			SEAT DIMENSIONS			BACK DIMENSIONS					
		W	D	H	W	D	H	W	H				
Medium Back COM: 1.75 YD 1.6 M Unit weight: 40 LB 18.2 KG Carton weight: 47 LB 21.32 KG Carton volume: 13 FT³ 0.36 MT³	Active weight 300 lbs.	IN 25.5	23	39	20.5	17-18	16.5-21.5	18.5	19				
		MM 648	584	991	521	432-457	419-546	470	483				
	See series notes for mechanism options.	RTA 2		1 per carton									

DESCRIPTION	MODEL# / FEATURES	STANDARD TEXTILE GRADES											
		COM	2	3	4	5	6	7	8	9	10	11	12
 <p>High Back COM: 1.9 YD 1.74 M Unit weight: 41 LB 18.6 KG Carton weight: 48 LB 21.77 KG Carton volume: 13 FT³ 0.36 MT³</p>	GC7472 With arms	1141	1202	1253	1312	1409	1498	1588	1666	1763	1854	1977	2152
	GC7472NA Armless	1038	1099	1150	1209	1306	1395	1485	1563	1660	1751	1874	2049
		OVERALL DIMENSIONS			SEAT DIMENSIONS			BACK DIMENSIONS					
		W	D	H	W	D	H	W	H				
		IN 25.5 MM 648	23 584	42 1067	20.5 521	17-18 432-457	16.5-21.5 419-546	18.5 470	22 559				
	Active weight 300 lbs.	See series notes for mechanism options.		RTA 2	1 per carton								
 <p>Extended High Back COM: 2 YD 1.83 M Unit weight: 43 LB 19.5 KG Carton weight: 50 LB 22.68 KG Carton volume: 13 FT³ 0.36 MT³</p>	GC7473 With arms	1175	1239	1293	1355	1457	1551	1645	1727	1829	1925	2055	2239
	GC7473NA Armless	1070	1134	1188	1250	1352	1446	1540	1622	1724	1820	1950	2134
		OVERALL DIMENSIONS			SEAT DIMENSIONS			BACK DIMENSIONS					
		W	D	H	W	D	H	W	H				
		IN 25.5 MM 648	23 584	47 1194	20.5 521	17-18 432-457	16.5-21.5 419-546	18.5 470	27 686				
	Active weight 300 lbs.	See series notes for mechanism options.		RTA 2	1 per carton								
 <p>Medium Back Posture Task Stool COM: 1.75 YD 1.6 M Unit weight: 50 LB 22.7 KG Carton weight: 57 LB 25.85 KG Carton volume: 13 FT³ 0.36 MT³</p>	GC7476 With arms	1313	1369	1416	1471	1560	1642	1724	1796	1885	1969	2083	2244
	GC7476NA Armless	1210	1266	1313	1368	1457	1539	1621	1693	1782	1866	1980	2141
		OVERALL DIMENSIONS			SEAT DIMENSIONS			BACK DIMENSIONS					
		W	D	H	W	D	H	W	H				
		IN 25.5 MM 648	23 584	49 1245	20.5 521	17 432	23.5-33.5 597-851	18.5 470	17.5 445				
	Active weight 300 lbs.	See series notes for mechanism options.		RTA 2	1 per carton								

GC TRITEK TS



model GCTS7473

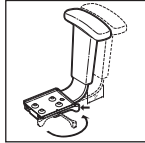

Vari-Width (WA) width adjustable arm extensions are standard when chair is ordered with adjustable arms.

MECHANISMS:

Synchro-tilter mechanism (-0)

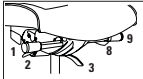

- ADJUSTMENTS**
- (1) Tilt tension
 - (2) Pneumatic seat height
 - (3) Back angle
 - Back/lumbar height
 - (8) Sliding seat depth
 - (9) Multi position tilt lock
 - Synchro tilt action
 - Anti kick back

Ergonomic features:
A, B, C, D, E, G, H, L, M, N, Q, R, U

Task mechanism (-6)

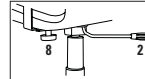

- ADJUSTMENTS**
- (2) Pneumatic seat height
 - (8) Manual seat depth

Ergonomic features:
C, E, H, M, N, Q, R, U

STANDARD FEATURES

- GC Tritek TS is designed for 24/7 applications to meet every body shape and task, providing exceptional support and comfort throughout the work day.
- Available in three back heights and three seat sizes to fit a person's body type and movements while at work.
- Heavy duty synchro-tilter mechanism with side activated sliding seat depth adjustment (**MD**) and separate back angle adjustment for individual comfort are standard. Stool models are available with task mechanism only.
- Durable Black polypropylene back shroud with unique upper back shape enables free lateral movement.
- Schukra™ depth adjustable lumbar support for personalized back support and comfort is standard on all models.
- Dual density foam spine pad embedded in the back of the chair forms to the user's shape.
- Vertical back height ratchet adjustment of 5.25".
- Back support upright is 3" wide for extra strength and durability.
- Standard with heavy duty 4" pneumatic gas lift.
- Models with arms are standard with height and width adjustable arms (**G6**) with sliding armcaps. Armcaps are low rise and also articulate inwards and outwards to aim toward the keyboard or mouse area.
- Vari-Width (**WA**) width adjustable arm extensions are standard. Allows the arms to move away from the seat by 2" on each side to allow space if desired for broader hip widths.
- Waterfall seamless seat front design with high density Ultracell foam for superior comfort and longevity.
- Underside of seat pan is completely sealed.
- 5-prong, injection molded, fiberglass reinforced nylon Black base with dual wheel carpet casters (**C10**).
- Can be upholstered in standard Global textiles only if Healthcare compliance is not required.
- To meet higher standards for housekeeping and infection control, GC Tritek TS has a seamless seat and one stitch pullover back upholstery, while still offering soft curves to the design. Note: that vinyl and woven treated textiles are thicker in nature and will experience wrinkles on some curves or corners as a result.

OPTIONAL FEATURES

- For moisture barrier on seat, please specify (**MB**). Add \$81.
- To add sealed seams to your product, contact Customer Service. Upcharges vary.
- For additional caster options, please refer to the Arm and Caster section (269). Optional casters may be priced higher than the standard casters for your chair and the difference will be charged. Lower priced optional casters will not be credited.



Please add option codes in the following order:

- **Model number**
GCTS7471 Medium back with arms
GCTS7471NA Medium back, armless
GCTS7472 High back with arms
GCTS7472NA High back, armless
GCTS7473 Extended high back with arms
GCTS7473NA Extended high back, armless
GCTS7477 Medium back stool with arms
GCTS7477NA Medium back stool, armless
- **Textile**
Specify textile code.
- **Mechanism**
(0) Synchro-tilter mechanism. No upcharge.
(6) Task mechanism (models GCTS7477 and GCTS7477NA only). No upcharge.
- **Seat size**
(P) Petite
(S) Standard
(G) Generous
- **Arms**
(G6) Height and width adjustable arms. No upcharge. For additional arm options, please refer to Arm Selections section on page 271.
- **Base**
(BK) Black nylon B7B base.
(B7) Polished aluminum base. Add \$131.
- **Casters/Glides**
(C10) Dual wheel carpet casters.
(C10R) Dual wheel hard floor casters. Add \$20.
(C7) Set of 5 large Black slipper glides (for all surfaces). Can replace any Global casters. Allows chair to remain at chair height. No upcharge.

EXAMPLE GC TRITEK TS ORDER CODE:

GCTS7471	-WA53	-0	-S	-G6	-B7	-C10R
Model number	Textile	Mechanism	Seat size	Arms	Base	Casters/Glides

DESCRIPTION	MODEL# / FEATURES	STANDARD TEXTILE GRADES											
		COM	2	3	4	5	6	7	8	9	10	11	12
 Medium Back Heavy Duty COM: 1.75 YD 1.6 M Unit weight: 54 LB 24.5 KG Carton weight: 61 LB 27.67 KG Carton volume: 13 FT³ 0.36 MT³	GCTS7471 With arms	1437	1493	1540	1595	1684	1766	1848	1920	2009	2093	2207	2368
	GCTS7471NA Armless	1334	1390	1437	1492	1581	1663	1745	1817	1906	1990	2104	2265
		OVERALL DIMENSIONS			SEAT DIMENSIONS			BACK DIMENSIONS					
		W	D	H	W	D	H	W	H				
	Active weight 350 lbs.	IN 25.5	24.5	38	20.5	17-20	17-21	18.5	18				
	See series notes for mechanism options.	MM 648	622	965	521	432-508	432-533	470	457				
		RTA 2		1 per carton									

DESCRIPTION	MODEL# / FEATURES	STANDARD TEXTILE GRADES												
		COM	2	3	4	5	6	7	8	9	10	11	12	
 <p>High Back Heavy Duty COM: 1.9 YD 1.74 M Unit weight: 58 LB 26.4 KG Carton weight: 65 LB 29.48 KG Carton volume: 13 FT³ 0.36 MT³</p>	GCTS7472 With arms	1471	1532	1583	1642	1739	1828	1918	1996	2093	2184	2307	2482	
	GCTS7472NA Armless	1366	1427	1478	1537	1634	1723	1813	1891	1988	2079	2202	2377	
		OVERALL DIMENSIONS			SEAT DIMENSIONS			BACK DIMENSIONS						
		W	D	H	W	D	H	W	H					
		IN 25.5	24.5	41	20.5	17-20	17-21	18.5	21					
		MM 648	622	1041	521	432-508	432-533	470	533					
		Active weight 350 lbs.												
		See series notes for mechanism options.	RTA 2	1 per carton										
	 <p>Extended High Back Heavy Duty COM: 2 YD 1.83 M Unit weight: 60 LB 27.3 KG Carton weight: 67 LB 30.39 KG Carton volume: 13 FT³ 0.36 MT³</p>	GCTS7473 With arms	1504	1568	1622	1684	1786	1880	1974	2056	2158	2254	2384	2568
		GCTS7473NA Armless	1400	1464	1518	1580	1682	1776	1870	1952	2054	2150	2280	2464
		OVERALL DIMENSIONS			SEAT DIMENSIONS			BACK DIMENSIONS						
		W	D	H	W	D	H	W	H					
		IN 25.5	24.5	46	20.5	17-20	17-21	18.5	26					
		MM 648	622	1168	521	432-508	432-533	470	660					
		Active weight 350 lbs.												
		See series notes for mechanism options.	RTA 2	1 per carton										
 <p>Medium Back Heavy Duty Task Stool COM: 1.75 YD 1.6 M Unit weight: 45 LB 20.5 KG Carton weight: 52 LB 23.59 KG Carton volume: 13 FT³ 0.36 MT³</p>		GCTS7477 With arms	1375	1431	1478	1533	1622	1704	1786	1858	1947	2031	2145	2306
		GCTS7477NA Armless	1271	1327	1374	1429	1518	1600	1682	1754	1843	1927	2041	2202
		OVERALL DIMENSIONS			SEAT DIMENSIONS			BACK DIMENSIONS						
		W	D	H	W	D	H	W	H					
		IN 25.5	23	49	20.5	17-18	23.5-33.5	18.5	19					
		MM 648	584	1245	521	432-457	597-851	470	483					
		Active weight 350 lbs.												
		See series notes for mechanism options.	RTA 2	1 per carton										

GC VION



model GC6322-4 (BLK-C)

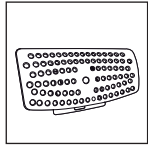

Optional Lumbar Pad (LS)
See right for details.

MECHANISMS:

Synchro-tilter mechanism (-0)

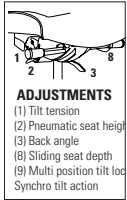

Ergonomic features:

A, B, C, E, G, H, L, M, N, Q, U

Tilter (-4)

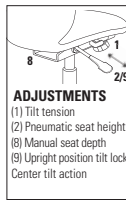

Ergonomic features:

A, B, C, E, H, M, N, Q, S, U

EXAMPLE GC VION ORDER CODE:

GC6322	-BAU	-A5	-ST	-ST	-HX01
Model number	Finish	Mesh	Seat size	Seat Foam	Seat Upholstery
-AF	-EE	-NB	-NS	-5L	
Arms	Casters	Moisture Barrier	Sealed Seams	Pneumatic Lift	

STANDARD FEATURES

- Vion is a comprehensive seating series offering a family of models to address multiple applications: task, management and conference.
- Series offers mid and high back models with either a mesh or upholstered back.
- Mechanism options available: synchro tilter (-0) and tilter (-4).
- All models are standard with height and width adjustable arms that feature a front to back sliding armcap.
- Standard with Global's high quality Soft Descent™ pneumatic lift which slowly and gently lowers the seat height of the chair making it easy to obtain the exact seat height you desire.
- Side activated sliding seat depth adjustment (MD) is standard on multi-tilter, synchro-tilter with back angle adjustment and weight sensing synchro tilter control mechanisms.
- Standard with 5-prong, injection molded, fiberglass reinforced nylon Governor base (B7) with dual wheel carpet casters (C1).
- Mesh back models are available in 10 standard Vion colors: Aqua (MS75), Black (MS69), Black Cherry (MS76), Blue (MS72), Dust (MS77), Ivory (MS78), Natural (MS74), Paprika (MS79), Rope (MS73) and Stone (MS71).
- Underside of the seat is upholstered in a coated textile. The joining of the textiles on the underside of the seat pan is sealed on all models.
- Upholstered back models feature Black textile (Jenny JN02) on the back side as standard.
- Upholstery options: fabric, vinyl or leather.

OPTIONAL FEATURES

- Vion back frames, arms and bases are available in 3 colours: Black, Shadow and Fog. See Vion finishes chart for options and upcharges. Armcaps are always black.
- Mesh back models are also available in 10 Dimension Mesh colours: Black (DBK), Berry (DBE), Chalk (DCL), Charcoal (DCH), Citrus (DCT), Cobalt (DCO), Fog (DST), Pool Blue (DPB), Sand (DSD) and Shadow (DGM). Add \$25.
- Optional lumbar pad (LS) can be added at time of order, please specify. Add \$17. Lumbar pad can also be ordered after sale as a kit, specify model GC6339 at \$32 list price. The Lumbar pad is adjustable up to 3".
- Seat available in memory foam, please specify (MF). Add \$106.
- Petite seat models (2" shorter and 2" narrower than the standard size seat) are available. Please specify by adding (P) to the model code. No upcharge.
- For hard surface flooring casters, please specify (C9R). Add \$21.
- For additional arm/caster options, please refer to the Arm and Caster section (269). Optional casters may be priced higher than the standard casters for your chair and the difference will be charged. Lower priced optional casters will not be credited.

VION FINISHES - TASK SEATING				
Back Frame	Base	SPECIFY CODE	Arm Options	SPECIFY CODE
Black	Black	BLK	Adjustable "T" arm (Black)	AS
Black	Polished Aluminum	BAU Add \$131	Adjustable "T" arm, fixed armcap (Black)	AF
			Adjustable "T" arm (Black, Chrome accent)	AC
Shadow	Shadow	SHW Add \$131	Adj. "T" arm, fixed armcap (Black, Chrome accent)	AD
			Adjustable "T" arm (Shadow)	SHA
Shadow	Polished Aluminum	SAU Add \$131	Adjustable "T" arm, fixed armcap (Shadow)	SHF
			Adjustable "T" arm (Shadow, Chrome accent)	SHR
Fog	Fog	FOG Add \$131	Adj. "T" arm, fixed armcap (Shadow, Chrome accent)	SHD
			Adjustable "T" arm (Fog)	FA
Fog	Polished Aluminum	FAU Add \$131	Adjustable "T" arm, fixed armcap (Fog)	FF
			Adjustable "T" arm (Fog, Chrome accent)	FC
			Adj. "T" arm, fixed armcap (Fog, Chrome accent)	CF
			Fixed "C" arm (Black)	C
Fog	Polished Aluminum	FAU Add \$131	Fixed "C" arm (shadow)	SHC
			Fixed "C" arm (Fog)	CC
			Fixed "C" arm (Polished aluminum)	CA - Add \$111

* All arms have Black SSU armcaps.

DESCRIPTION



mesh back

MB Synchro-Tilter w/Back Angle Adj.

COM: 1 YD | 0.91 M
 Unit weight: 46 LB | 20.9 KG
 Carton weight: 58 LB | 26.31 KG
 Carton volume: 10.5 FT³ | 0.29 MT³

MODEL# / FEATURES

MODEL# / FEATURES	COM	2	3	4	5	6	7	8	9	10	11	12
GC6322-0	1048	1080	1107	1138	1189	1236	1283	1324	1375	1423	1488	1580

Active weight 300 lbs.





See series notes for mechanism options.

STANDARD TEXTILE GRADES

OVERALL DIMENSIONS			SEAT DIMENSIONS			BACK DIMENSIONS	
W	D	H	W	D	H	W	H

IN	25.5	24	39.5	20	17-20	17.5-22.5	18.5	21
MM	648	610	1003	508	432-508	445-572	470	533

RTA 2 1 per carton

DESCRIPTION	MODEL# / FEATURES	STANDARD TEXTILE GRADES											
		COM	2	3	4	5	6	7	8	9	10	11	12
 <p>mesh back</p> <p>MB Tilter COM: 1 YD 0.91 M Unit weight: 40 LB 18.2 KG Carton weight: 52 LB 23.59 KG Carton volume: 10.5 FT³ 0.29 MT³</p>	GC6322-4	1013	1045	1072	1103	1154	1201	1248	1289	1340	1388	1453	1545
	Active weight 300 lbs.	IN 25.5 MM 648	24 610	37.5 953		20 508	17.5-19 445-483	16-21 406-533		18.5 470	21 533		
	See series notes for mechanism options.	<div style="display: flex; align-items: center;"> <div style="border: 1px solid black; padding: 2px; margin-right: 5px;">RTA 2</div> 1 per carton </div>											
 <p>upholstered back, standard seat</p> <p>HB Synchro-Tilter w/Back Angle Adj. COM: 1.25 YD 1.14 M Unit weight: 49 LB 22.3 KG Carton weight: 61 LB 27.67 KG Carton volume: 10.5 FT³ 0.29 MT³</p>	GC6331-0	1097	1137	1171	1210	1273	1332	1391	1442	1506	1566	1647	1762
	Active weight 300 lbs.	IN 25.5 MM 648	24 610	41.5 1054		20 508	17-20 432-508	17.5-22.5 445-572		18.5 470	23 584		
	See series notes for mechanism options.	<div style="display: flex; align-items: center;"> <div style="border: 1px solid black; padding: 2px; margin-right: 5px;">RTA 2</div> 1 per carton </div>											
 <p>upholstered back, standard seat</p> <p>HB Tilter COM: 1.25 YD 1.14 M Unit weight: 43 LB 19.5 KG Carton weight: 55 LB 24.95 KG Carton volume: 10.5 FT³ 0.29 MT³</p>	GC6331-4	1070	1110	1144	1183	1246	1305	1364	1415	1479	1539	1620	1735
	Active weight 300 lbs.	IN 25.5 MM 648	24 610	39.25 997		20 508	17.5-19 445-483	16-21 406-533		18.5 470	23 584		
	See series notes for mechanism options.	<div style="display: flex; align-items: center;"> <div style="border: 1px solid black; padding: 2px; margin-right: 5px;">RTA 2</div> 1 per carton </div>											
 <p>Lumbar Pad Kit for Vion COM: N/A Unit weight: 0.5 LB 0.2 KG Carton weight: 1.5 LB 0.68 KG Carton volume: 0.5 FT³ 0.01 MT³</p>	GC6339	32											
		IN 10.25 MM 260	3.5 89	5.25 133		- -	- -	- -		- -	- -		
		<div style="display: flex; align-items: center;"> <div style="border: 1px solid black; padding: 2px; margin-right: 5px;">RTA 00</div> 1 per carton </div>											

HARMONY



model GCTS35032-3

model GC35022-5

STANDARD FEATURES

- Harmony is the sized right solution for everyone with many applications.
- Compound curved back and seat comfortably match body shape.
- For added comfort, seats are standard with high density Ultracell foam.
- Standard with soft, durable, depth adjustable, sliding self-skinned urethane (SSU) armcaps that are warm to the touch. Armcaps articulate inwards and outwards 15°.
- Vari-Width (WA) width adjustable arm extensions are standard. Allows the arms to move away from the seat by 2" on each side to allow space if desired for broader hip widths.
- All models except bariatric multi-tilter: Height adjustable low rise (G6) arms are standard.
- Bariatric multi-tilters: Solid steel loop arm is standard. The arm is vinyl dipped to be warm to the touch and impact absorbent.
- Standard with Global's high quality Soft Descent™ pneumatic lift which slowly and gently lowers the seat height of the chair making it easy to obtain the exact seat height you desire (except HD 24HR multi-shift models and bariatric multi-tilters).
- Side activated sliding seat depth adjustment (MD) is standard on multi-tilters (non bariatric).
- Schukra™ depth adjustable lumbar support for personalized back support and comfort is standard on select models.
- Vertical back height ratchet adjustment of 5.25" is standard on all models (except bariatric multi-tilters, task chairs and operator stools).
- Back support upright is 3" wide for extra strength.
- All models except bariatric multi-tilter: 5-prong, injection molded, fiberglass reinforced nylon Black base with (C65) dual wheel carpet casters. Heavy duty 24HR multi-tilters: (C10) dual wheel carpet casters are standard.

- Bariatric multi-tilters: 6-prong Black steel base with (C98) large diameter 3" dual wheel carpet casters are standard.
- Can be upholstered in standard Global textiles only if Healthcare compliance is not required.
- For healthcare textiles and finish options, visit the website at globalfurnituregroup.com.
- Petite, standard and generous seats have the same list prices.

OPTIONAL FEATURES

- For improved housekeeping and infection control practices, please add (SU) to model number. The underside of the seat will be finished with vinyl and sealed to prevent penetration of liquids. Add \$39.
- Side activated sliding seat depth adjustment (MD) is optional on knee-tilters. Add \$32.
- Multi-tilters: For hard surface flooring casters, please specify (C65R). Add \$21.
- Heavy duty 24HR multi-tilters: For hard surface flooring casters, please specify (C10R). Add \$20.
- Bariatric multi-tilters: Standard arms and casters are made specifically for these models to provide maximum strength and durability. Therefore, no other casters or arms can be used.
- For moisture barrier on seat, please specify (MB). Add \$81. Bariatric models: Add \$122
- To add sealed seams to your product contact Customer Service. Upcharges vary.
- For additional arm/caster options, please refer the Arm and Caster section (page 269). Optional casters may be priced higher than the standard casters for your chair and the difference will be charged. Lower priced optional casters will not be credited.

SUGGESTED APPLICATIONS

- Office/Meeting
- Treatment/Exam rooms

Dimensional Information: Multi-tilters (including 24HR) (non bariatric)

	Armrest Clearance	Standard Arm Height	Seat Depth	Seat Height
Petite seat low rise 4" gas cylinder	17" - 23"	8" - 11"	17" - 19.5"	16" - 20"
Standard seat 4" Soft Descent™ gas cylinder	18" - 24"	8" - 11"	18" - 20.5"	18" - 22"
Generous seat 4" Soft Descent™ gas cylinder	18.5" - 24.5"	8" - 11"	19" - 21.5"	18" - 22"

Dimensional Information: Knee-tilters

	Armrest Clearance	Standard Arm Height	Seat Depth	Seat Height
Standard seat 4" Soft Descent™ gas cylinder	18" - 24"	8" - 11"	18" - 20.5" with optional (MD) mec	17.5" - 21.5"
Generous seat 4" Soft Descent™ gas cylinder	18" - 24.5"	8" - 11"	19" - 21.5" with optional (MD) mec	17.5" - 21.5"

DESCRIPTION MODEL# / FEATURES STANDARD TEXTILE GRADES





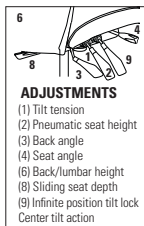

Low Back Multi-Tilter
COM: 1.75 YD | 1.6 M
Unit weight: 52 LB | 23.6 KG
Carton weight: 61 LB | 27.67 KG
Carton volume: 9.25 FT³ | 0.26 MT³



	COM	2	3	4	5	6	7	8	9	10	11	12
GC35012-3 Standard seat	900	956	1003	1058	1147	1229	1311	1383	1472	1556	1670	1831
GC35011-3 Petite seat												
IN W19.5 D17-20 H16-20 MM W495 D432-508 H406-508												

	OVERALL DIMENSIONS			SEAT DIMENSIONS			BACK DIMENSIONS	
	W	D	H	W	D	H	W	H
Active weight 300 lbs.	IN 26 MM 660	24 610	37.5 953	20.5 521	18-21 457-533	17.5-22.5 445-572	18.5 470	16.5-21.75 419-552

Ergonomic features: A, B, C, D, E, F, G, H, M, N, Q, R, S, U **RTA 2** 1 per carton

DESCRIPTION	MODEL# / FEATURES	STANDARD TEXTILE GRADES											
		COM	2	3	4	5	6	7	8	9	10	11	12
 <p>Side Chair Sled Base COM: 1.75 YD 1.6 M Unit weight: 30 LB 13.6 KG Carton weight: 35 LB 15.88 KG Carton volume: 13 FT³ 0.36 MT³</p>	GC35018	569	625	672	727	816	898	980	1052	1141	1225	1339	1500
	Active weight 300 lbs.	OVERALL DIMENSIONS W D H			SEAT DIMENSIONS W D H			BACK DIMENSIONS W H					
	Ergonomic features: M, N	IN 21	24	41.25	21	18	18	19.5	22.25				
		MM 533	610	1048	533	457	457	495	565				
 <p>Armchair Sled Base COM: 1.75 YD 1.6 M Unit weight: 35 LB 15.9 KG Carton weight: 40 LB 18.14 KG Carton volume: 13 FT³ 0.36 MT³</p>	GC35019	718	774	821	876	965	1047	1129	1201	1290	1374	1488	1649
	Active weight 300 lbs.	OVERALL DIMENSIONS W D H			SEAT DIMENSIONS W D H			BACK DIMENSIONS W H					
	Ergonomic features: M, N	IN 26	24	41.25	21	18	18	19.5	22.25				
		MM 660	610	1048	533	457	457	495	565				
 <div data-bbox="414 788 553 1010"> <p>ADJUSTMENTS</p> <ol style="list-style-type: none"> (1) Tilt tension (2) Pneumatic seat height (3) Back angle (4) Seat angle (6) Back/lumbar height (8) Sliding seat depth (9) Infinite position tilt lock </div> <p>MB Multi-Tilter COM: 1.75 YD 1.6 M Unit weight: 53 LB 24.1 KG Carton weight: 62 LB 28.12 KG Carton volume: 9.25 FT³ 0.26 MT³</p>	GC35022-3 Standard seat	944	1000	1047	1102	1191	1273	1355	1427	1516	1600	1714	1875
	GC35023-3 Generous seat	IN W21.5 D19-22 H17.5-22.5 MM W546 D483-559 H445-572											
	Active weight 300 lbs.	OVERALL DIMENSIONS W D H			SEAT DIMENSIONS W D H			BACK DIMENSIONS W H					
	Ergonomic features: A, B, C, D, E, F, G, H, M, N, Q, R, S, U	IN 26	24	42.5	20.5	18-21	17.5-22.5	19	19.5-24.75				
	MM 660	610	1080	521	457-533	445-572	483	495-629					
 <div data-bbox="414 1100 553 1322"> <p>ADJUSTMENTS</p> <ol style="list-style-type: none"> (1) Tilt tension (2) Pneumatic seat height (6) Back/lumbar height (8) Manual seat depth (9) Upright position tilt lock <p>Center tilt action</p> </div> <p>MB Tilter Standard Seat COM: 1.75 YD 1.6 M Unit weight: 44 LB 20 KG Carton weight: 53 LB 24.04 KG Carton volume: 9.25 FT³ 0.26 MT³</p>	GC35022-4	890	946	993	1048	1137	1219	1301	1373	1462	1546	1660	1821
	Active weight 300 lbs.	OVERALL DIMENSIONS W D H			SEAT DIMENSIONS W D H			BACK DIMENSIONS W H					
	Ergonomic features: A, B, C, D, E, F, G, H, M, N, Q, R, S, U	IN 26	24	42	20.5	18-19	17-22	19	19.5-24.75				
		MM 660	610	1067	521	457-483	432-559	483	495-629				
 <div data-bbox="414 1413 553 1634"> <p>ADJUSTMENTS</p> <ol style="list-style-type: none"> (2) Pneumatic seat height (3) Back angle (4) Seat angle (6) Back/lumbar height <p>Free floating seat & back</p> </div> <p>MB Operator Standard Seat COM: 1.75 YD 1.6 M Unit weight: 46 LB 20.9 KG Carton weight: 55 LB 24.95 KG Carton volume: 9.25 FT³ 0.26 MT³</p>	GC35022-5	904	960	1007	1062	1151	1233	1315	1387	1476	1560	1674	1835
	Active weight 300 lbs.	OVERALL DIMENSIONS W D H			SEAT DIMENSIONS W D H			BACK DIMENSIONS W H					
	Ergonomic features: C, D, F, G, H, M, N, Q, R, S, U	IN 26	24	40.5	20.5	18	17-22	19	19.5-24.75				
		MM 660	610	1029	521	457	432-559	483	495-629				

DESCRIPTION MODEL# / FEATURES STANDARD TEXTILE GRADES

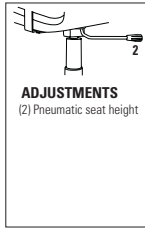

MB Task Standard Seat
COM: 1.75 YD | 1.6 M
Unit weight: 38 LB | 17.3 KG
Carton weight: 47 LB | 21.32 KG
Carton volume: 9.25 FT³ | 0.26 MT³

MODEL# / FEATURES	COM	2	3	4	5	6	7	8	9	10	11	12
GC35022-6	683	739	786	841	930	1012	1094	1166	1255	1339	1453	1614
Active weight 300 lbs.	OVERALL DIMENSIONS			SEAT DIMENSIONS			BACK DIMENSIONS					
	W	D	H	W	D	H	W	H				
	IN 26	24	42.5	20.5	17.5-18.5	17-22	19	20.5				
	MM 660	610	1080	521	445-470	432-559	483	521				
Ergonomic features: C, E, H, M, N, Q, R, U	RTA 2		1 per carton									

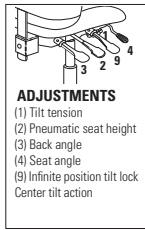

MB Bariatric Multi-Tilter
COM: 3 YD | 2.74 M
Unit weight: 90 LB | 40.9 KG
Carton weight: 114 LB | 51.71 KG
Carton volume: 29.5 FT³ | 0.83 MT³

MODEL# / FEATURES	COM	2	3	4	5	6	7	8	9	10	11	12
GC35024-3	2059	2155	2236	2329	2482	2623	2764	2887	3040	3184	3379	3655
Active weight 500 lbs.	OVERALL DIMENSIONS			SEAT DIMENSIONS			BACK DIMENSIONS					
	W	D	H	W	D	H	W	H				
	IN 29	26.5	42.5	25.5	20	16.5-20.5	22	24				
	MM 737	673	1080	648	508	419-521	559	610				
Ergonomic features: A, B, C, F, G, M, N, Q, S	RTA 00		1 per carton									

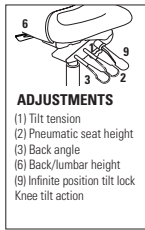

HB Knee-Tilter
COM: 2 YD | 1.83 M
Unit weight: 52 LB | 23.6 KG
Carton weight: 61 LB | 27.67 KG
Carton volume: 9.25 FT³ | 0.26 MT³

MODEL# / FEATURES	COM	2	3	4	5	6	7	8	9	10	11	12
GC35032-2 Standard seat GC35033-2 Generous seat	1124	1188	1242	1304	1406	1500	1594	1676	1778	1874	2004	2188
IN W21.5 D19-21.5 H17.5-22.5 MM W546 D483-546 H445-572												
Active weight 300 lbs.	OVERALL DIMENSIONS			SEAT DIMENSIONS			BACK DIMENSIONS					
	W	D	H	W	D	H	W	H				
	IN 26	24	44.5	20.5	18-20.5	17.5-22.5	19	22.5-27.5				
	MM 660	610	1130	521	457-521	445-572	483	572-705				
Ergonomic features: A, B, C, D, G, H, J, M, N, Q, R, U	RTA 2		1 per carton									

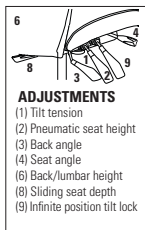





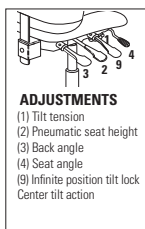



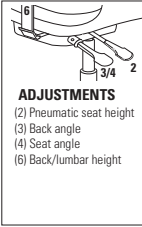

HB Multi-Tilter
COM: 2 YD | 1.83 M
Unit weight: 55 LB | 25 KG
Carton weight: 64 LB | 29.03 KG
Carton volume: 9.25 FT³ | 0.26 MT³

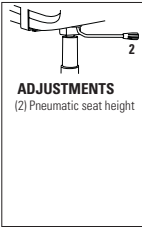
MODEL# / FEATURES	COM	2	3	4	5	6	7	8	9	10	11	12
GC35032-3 Standard seat GC35033-3 Generous seat	982	1046	1100	1162	1264	1358	1452	1534	1636	1732	1862	2046
IN W21.5 D19-22 H17.5-22.5 MM W546 D483-559 H445-572												
Active weight 300 lbs.	OVERALL DIMENSIONS			SEAT DIMENSIONS			BACK DIMENSIONS					
	W	D	H	W	D	H	W	H				
	IN 26	24	45	20.5	18-21	17.5-22.5	19	22.5-27.5				
	MM 660	610	1143	521	457-533	445-572	483	572-705				
Ergonomic features: A, B, C, D, E, F, G, H, M, N, Q, R, S, U	RTA 2		1 per carton									

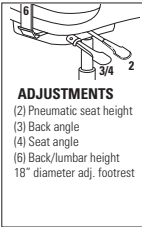

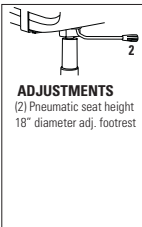
HB Bariatric Multi-Tilter
COM: 3.25 YD | 2.97 M
Unit weight: 92 LB | 41.8 KG
Carton weight: 118 LB | 53.52 KG
Carton volume: 33.5 FT³ | 0.94 MT³

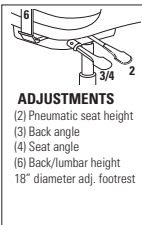
MODEL# / FEATURES	COM	2	3	4	5	6	7	8	9	10	11	12
GC35034-3	2156	2260	2348	2449	2614	2767	2920	3053	3219	3375	3586	3885
Active weight 500 lbs.	OVERALL DIMENSIONS			SEAT DIMENSIONS			BACK DIMENSIONS					
	W	D	H	W	D	H	W	H				
	IN 29	27.5	50.5	25.5	20	16.5-20.5	22	30				
	MM 737	699	1283	648	508	419-521	559	762				
Ergonomic features: A, B, C, F, G, M, N, Q, S	RTA 00		1 per carton									

DESCRIPTION	MODEL# / FEATURES	STANDARD TEXTILE GRADES														
		COM	2	3	4	5	6	7	8	9	10	11	12			
 <p>MB Operator Standard Seat Armless COM: 1.75 YD 1.6 M Unit weight: 40 LB 18.2 KG Carton weight: 49 LB 22.23 KG Carton volume: 9.25 FT³ 0.26 MT³</p>	 <p>ADJUSTMENTS (2) Pneumatic seat height (3) Back angle (4) Seat angle (6) Back/lumbar height</p>	GC35122-5	787	843	890	945	1034	1116	1198	1270	1359	1443	1557	1718		
		Active weight 300 lbs.	OVERALL DIMENSIONS			SEAT DIMENSIONS			BACK DIMENSIONS							
			W	D	H	W	D	H	W	H						
			IN 20.5 MM 521	24 610	40.5 1029	20.5 521	18 457	17-22 432-559	19 483	19.5-24.75 495-629						
	Ergonomic features: C, D, F, G, M, N, S, U	RTA 2		1 per carton												
 <p>MB Task Standard Seat Armless COM: 1.75 YD 1.6 M Unit weight: 32 LB 14.5 KG Carton weight: 41 LB 18.6 KG Carton volume: 9.25 FT³ 0.26 MT³</p>	 <p>ADJUSTMENTS (2) Pneumatic seat height</p>	GC35122-6	564	620	667	722	811	893	975	1047	1136	1220	1334	1495		
		Active weight 300 lbs.	OVERALL DIMENSIONS			SEAT DIMENSIONS			BACK DIMENSIONS							
			W	D	H	W	D	H	W	H						
			IN 20.5 MM 521	24 610	42.5 1080	20.5 521	17.5-18.5 445-470	17-22 432-559	19 483	20.5 521						
	Ergonomic features: C, E, M, N, U	RTA 2		1 per carton												
 <p>Low Back Operator Stool - Small Seat COM: 1.75 YD 1.6 M Unit weight: 46 LB 20.9 KG Carton weight: 55 LB 24.95 KG Carton volume: 9.25 FT³ 0.26 MT³</p>	 <p>ADJUSTMENTS (2) Pneumatic seat height (3) Back angle (4) Seat angle (6) Back/lumbar height 18" diameter adj. footrest</p>	GC35211-5	1135	1191	1238	1293	1382	1464	1546	1618	1707	1791	1905	2066		
		Active weight 300 lbs.	OVERALL DIMENSIONS			SEAT DIMENSIONS			BACK DIMENSIONS							
			W	D	H	W	D	H	W	H						
			IN 25 MM 635	23 584	47 1194	19.5 495	17.5 445	24-34 610-864	18.5 470	16.5-21.75 419-552						
	Ergonomic features: C, D, F, G, H, M, N, Q, R, S, U	RTA 2		1 per carton												
 <p>Low Back Task Stool - Small Seat COM: 1.75 YD 1.6 M Unit weight: 42 LB 19.1 KG Carton weight: 51 LB 23.13 KG Carton volume: 9.25 FT³ 0.26 MT³</p>	 <p>ADJUSTMENTS (2) Pneumatic seat height 18" diameter adj. footrest</p>	GC35211-6	911	967	1014	1069	1158	1240	1322	1394	1483	1567	1681	1842		
		Active weight 300 lbs.	OVERALL DIMENSIONS			SEAT DIMENSIONS			BACK DIMENSIONS							
			W	D	H	W	D	H	W	H						
			IN 25 MM 635	23 584	48 1219	19.5 495	17.5-18.5 445-470	24-34 610-864	18.5 470	17.5 445						
	Ergonomic features: C, E, H, M, N, Q, R, U	RTA 2		1 per carton												
 <p>LB Operator Stool Armless - Small Seat COM: 1.75 YD 1.6 M Unit weight: 40 LB 18.2 KG Carton weight: 49 LB 22.23 KG Carton volume: 9.25 FT³ 0.26 MT³</p>	 <p>ADJUSTMENTS (2) Pneumatic seat height (3) Back angle (4) Seat angle (6) Back/lumbar height 18" diameter adj. footrest</p>	GC35311-5	1016	1072	1119	1174	1263	1345	1427	1499	1588	1672	1786	1947		
		Active weight 300 lbs.	OVERALL DIMENSIONS			SEAT DIMENSIONS			BACK DIMENSIONS							
			W	D	H	W	D	H	W	H						
			IN 19.5 MM 495	23 584	47 1194	19.5 495	17.5 445	24-34 610-864	18.5 470	16.5-21.75 419-552						
	Ergonomic features: C, E, M, N, U	RTA 2		1 per carton												

DESCRIPTION MODEL# / FEATURES STANDARD TEXTILE GRADES



LB Task Stool Armless - Petite Seat
 COM: 1.75 YD | 1.6 M
 Unit weight: 36 LB | 16.4 KG
 Carton weight: 45 LB | 20.41 KG
 Carton volume: 9.25 FT³ | 0.26 MT³

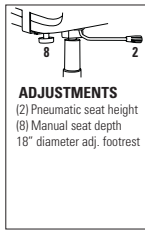

COM	2	3	4	5	6	7	8	9	10	11	12	
GC35311-6	792	848	895	950	1039	1121	1203	1275	1364	1448	1562	1723
OVERALL DIMENSIONS			SEAT DIMENSIONS			BACK DIMENSIONS						
W D H			W D H			W H						
IN 19.5 23 48			19.5 17.5-18.5 24-34			18.5 17.5						
MM 495 584 1219			495 445-470 610-864			470 445						
Active weight 300 lbs.												
Ergonomic features: C, E, M, N, U RTA 2 1 per carton												



LB Multi-Tilt w/Schukra
 COM: 1.75 YD | 1.6 M
 Unit weight: 52 LB | 23.6 KG
 Carton weight: 61 LB | 27.67 KG
 Carton volume: 9.25 FT³ | 0.26 MT³

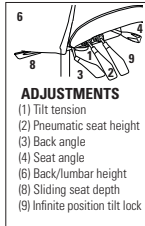

COM	2	3	4	5	6	7	8	9	10	11	12	
GC36012-3 Standard seat	1023	1079	1126	1181	1270	1352	1434	1506	1595	1679	1793	1954
GC36011-3 Petite seat												
IN W19.5 D17-20 H16-20 MM W495 D432-508 H406-508												
OVERALL DIMENSIONS			SEAT DIMENSIONS			BACK DIMENSIONS						
W D H			W D H			W H						
IN 26 24 37.5			20.5 18-21 17.5-22.5			18.5 16.5-21.75						
MM 660 610 953			521 457-533 445-572			470 419-552						
Active weight 300 lbs.												
Ergonomic features: A, B, C, D, E, F, G, H, M, N, Q, R, S, U, V RTA 2 1 per carton												



MB Multi-Tilter w/Schukra
 COM: 1.75 YD | 1.6 M
 Unit weight: 53 LB | 24.1 KG
 Carton weight: 62 LB | 28.12 KG
 Carton volume: 9.25 FT³ | 0.26 MT³

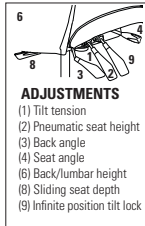

COM	2	3	4	5	6	7	8	9	10	11	12	
GC36022-3 Standard seat	1067	1123	1170	1225	1314	1396	1478	1550	1639	1723	1837	1998
GC36023-3 Generous seat												
IN W21.5 D19-22 H17.5-22.5 MM W546 D483-559 H445-572												
OVERALL DIMENSIONS			SEAT DIMENSIONS			BACK DIMENSIONS						
W D H			W D H			W H						
IN 26 24 42.5			20.5 18-21 17.5-22.5			19 19.5-24.75						
MM 660 610 1080			521 457-533 445-572			483 495-629						
Active weight 300 lbs.												
Ergonomic features: A, B, C, D, E, F, G, H, M, N, Q, R, S, U, V RTA 2 1 per carton												



HB Knee-Tilter w/Schukra
 COM: 2 YD | 1.83 M
 Unit weight: 55 LB | 25 KG
 Carton weight: 64 LB | 29.03 KG
 Carton volume: 9.25 FT³ | 0.26 MT³

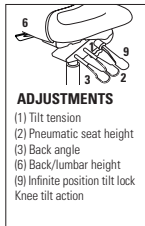







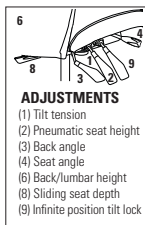

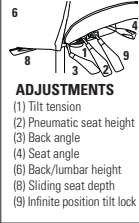

COM	2	3	4	5	6	7	8	9	10	11	12	
GC36032-2 Standard seat	1244	1308	1362	1424	1526	1620	1714	1796	1898	1994	2124	2308
GC36033-2 Generous seat												
IN W21.5 D19-21.5 H17.5-22.5 MM W546 D483-546 H445-572												
OVERALL DIMENSIONS			SEAT DIMENSIONS			BACK DIMENSIONS						
W D H			W D H			W H						
IN 26 24 45			20.5 18-20.5 17.5-22.5			19 22.5-27.75						
MM 660 610 1143			521 457-521 445-572			483 572-705						
Active weight 300 lbs.												
Ergonomic features: A, B, C, D, G, H, J, M, N, Q, R, S, U, V RTA 2 1 per carton												

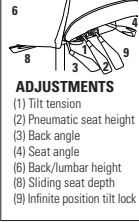

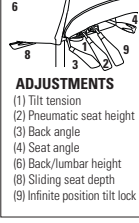
HB Multi-Tilter w/Schukra
 COM: 2 YD | 1.83 M
 Unit weight: 55 LB | 25 KG
 Carton weight: 64 LB | 29.03 KG
 Carton volume: 9.25 FT³ | 0.26 MT³

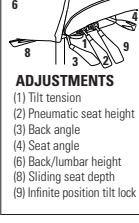

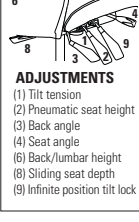
COM	2	3	4	5	6	7	8	9	10	11	12	
GC36032-3 Standard seat	1102	1166	1220	1282	1384	1478	1572	1654	1756	1852	1982	2166
GC36033-3 Generous seat												
IN W21.5 D19-22 H17.5-22.5 MM W546 D483-559 H445-572												
OVERALL DIMENSIONS			SEAT DIMENSIONS			BACK DIMENSIONS						
W D H			W D H			W H						
IN 26 24 45			20.5 18-21 17.5-22.5			19 22.5-27.75						
MM 660 610 1143			521 457-533 445-572			483 572-705						
Active weight 300 lbs.												
Ergonomic features: A, B, C, D, E, F, G, H, M, N, Q, R, S, U, V RTA 2 1 per carton												

DESCRIPTION	MODEL# / FEATURES	STANDARD TEXTILE GRADES																
		COM	2	3	4	5	6	7	8	9	10	11	12					
 <p>LB 24HR Multi-Tilter HD COM: 1.75 YD 1.6 M Unit weight: 54 LB 24.5 KG Carton weight: 63 LB 28.58 KG Carton volume: 9.25 FT³ 0.26 MT³</p>	 <p>ADJUSTMENTS (1) Tilt tension (2) Pneumatic seat height (3) Back angle (4) Seat angle (5) Back/lumbar height (6) Sliding seat depth (9) Infinite position tilt lock</p>	GCTS35012-3 Standard seat GCTS35011-3 Petite seat IN W19.5 D17-19.5 H16-20 MM W495 D432-495 H406-508	1110	1166	1213	1268	1357	1439	1521	1593	1682	1766	1880	2041				
		Active weight 350 lbs.	IN 26	24	37.5	20.5	18-20.5	18-22	18.5	16.5-21.75	MM 660	610	953	521	457-521	457-559	470	419-552
		Ergonomic features: A, B, C, D, E, F, G, H, M, N, Q, R, S	RTA 2		1 per carton													
				COM	2	3	4	5	6	7	8	9	10	11	12			
 <p>MB 24HR Multi-Tilter HD COM: 1.75 YD 1.6 M Unit weight: 55 LB 25 KG Carton weight: 64 LB 29.03 KG Carton volume: 9.25 FT³ 0.26 MT³</p>	 <p>ADJUSTMENTS (1) Tilt tension (2) Pneumatic seat height (3) Back angle (4) Seat angle (5) Back/lumbar height (6) Sliding seat depth (9) Infinite position tilt lock</p>	GCTS35022-3 Standard seat GCTS35023-3 Generous seat IN W21.5 D19-21.5 H18-22 MM W546 D483-546 H457-559	1153	1209	1256	1311	1400	1482	1564	1636	1725	1809	1923	2084				
		Active weight 350 lbs.	IN 26	24	42.5	20.5	18-20.5	18-22	19	19.5-24.75	MM 660	610	1080	521	457-521	457-559	483	495-629
		Ergonomic features: A, B, C, D, E, F, G, H, M, N, Q, R, S	RTA 2		1 per carton													
				COM	2	3	4	5	6	7	8	9	10	11	12			
 <p>HB 24HR Multi-Tilter HD COM: 2 YD 1.83 M Unit weight: 57 LB 25.9 KG Carton weight: 66 LB 29.94 KG Carton volume: 9.25 FT³ 0.26 MT³</p>	 <p>ADJUSTMENTS (1) Tilt tension (2) Pneumatic seat height (3) Back angle (4) Seat angle (5) Back/lumbar height (6) Sliding seat depth (9) Infinite position tilt lock</p>	GCTS35032-3 Standard seat GCTS35033-3 Generous seat IN W21.5 D19-21.5 H18-22 MM W546 D483-546 H457-559	1188	1252	1306	1368	1470	1564	1658	1740	1842	1938	2068	2252				
		Active weight 350 lbs.	IN 26	24	45	20.5	18-20.5	18-22	19	22.5-27.75	MM 660	610	1143	521	457-521	457-559	483	572-705
		Ergonomic features: A, B, C, D, E, F, G, H, M, N, Q, R, S	RTA 2		1 per carton													
				COM	2	3	4	5	6	7	8	9	10	11	12			
 <p>LB 24HR Multi-Tilter HD w/Schukra COM: 1.75 YD 1.6 M Unit weight: 54 LB 24.5 KG Carton weight: 63 LB 28.58 KG Carton volume: 9.25 FT³ 0.26 MT³</p>	 <p>ADJUSTMENTS (1) Tilt tension (2) Pneumatic seat height (3) Back angle (4) Seat angle (5) Back/lumbar height (6) Sliding seat depth (9) Infinite position tilt lock</p>	GCTS36012-3 Standard seat GCTS36011-3 Petite seat IN W19.5 D17-19.5 H16-20 MM W495 D432-495 H406-508	1230	1286	1333	1388	1477	1559	1641	1713	1802	1886	2000	2161				
		Active weight 350 lbs.	IN 26	24	37.5	20.5	18-20.5	18-22	18.5	16.5-21.75	MM 660	610	953	521	457-521	457-559	470	419-552
		Ergonomic features: A, B, C, D, E, F, G, H, M, N, Q, R, S, V	RTA 2		1 per carton													
				COM	2	3	4	5	6	7	8	9	10	11	12			
 <p>MB 24HR Multi-Tilter HD w/ Schukra COM: 1.75 YD 1.6 M Unit weight: 55 LB 25 KG Carton weight: 64 LB 29.03 KG Carton volume: 9.25 FT³ 0.26 MT³</p>	 <p>ADJUSTMENTS (1) Tilt tension (2) Pneumatic seat height (3) Back angle (4) Seat angle (5) Back/lumbar height (6) Sliding seat depth (9) Infinite position tilt lock</p>	GCTS36022-3 Standard seat GCTS36023-3 Generous seat IN W21.5 D19-21.5 H18-22 MM W546 D483-546 H457-559	1276	1332	1379	1434	1523	1605	1687	1759	1848	1932	2046	2207				
		Active weight 350 lbs.	IN 26	24	42.5	20.5	18-20.5	18-22	19	19.5-24.75	MM 660	610	1080	521	457-521	457-559	483	495-629
		Ergonomic features: A, B, C, D, E, F, G, H, M, N, Q, R, S, V	RTA 2		1 per carton													
				COM	2	3	4	5	6	7	8	9	10	11	12			

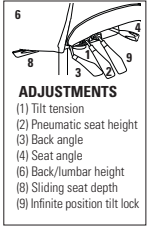
DESCRIPTION	MODEL# / FEATURES	STANDARD TEXTILE GRADES																																
		COM	2	3	4	5	6	7	8	9	10	11	12																					
 <p>HB 24HR Multi-Titer HD w/Schukra COM: 2 YD 1.83 M Unit weight: 57 LB 25.9 KG Carton weight: 66 LB 29.94 KG Carton volume: 9.25 FT³ 0.26 MT³</p>	 <p>ADJUSTMENTS (1) Tilt tension (2) Pneumatic seat height (3) Back angle (4) Seat angle (6) Back/lumbar height (8) Sliding seat depth (9) Infinite position tilt lock</p>	GCTS36032-3 Standard seat GCTS36033-3 Generous seat IN W21.5 D19-21.5 H18-22 MM W546 D483-546 H457-559	1312	1376	1430	1492	1594	1688	1782	1864	1966	2062	2192	2376																				
		Active weight 350 lbs. Ergonomic features: A, B, C, D, E, F, G, H, M, N, O, R, S, V	<table border="1"> <thead> <tr> <th colspan="3">OVERALL DIMENSIONS</th> <th colspan="3">SEAT DIMENSIONS</th> <th colspan="2">BACK DIMENSIONS</th> </tr> <tr> <th>W</th> <th>D</th> <th>H</th> <th>W</th> <th>D</th> <th>H</th> <th>W</th> <th>H</th> </tr> </thead> <tbody> <tr> <td>IN 26</td> <td>24</td> <td>45</td> <td>20.5</td> <td>18-20.5</td> <td>18-22</td> <td>19</td> <td>22.5-27.75</td> </tr> <tr> <td>MM 660</td> <td>610</td> <td>1143</td> <td>521</td> <td>457-521</td> <td>457-559</td> <td>483</td> <td>572-705</td> </tr> </tbody> </table>	OVERALL DIMENSIONS			SEAT DIMENSIONS			BACK DIMENSIONS		W	D	H	W	D	H	W	H	IN 26	24	45	20.5	18-20.5	18-22	19	22.5-27.75	MM 660	610	1143	521	457-521	457-559	483
OVERALL DIMENSIONS			SEAT DIMENSIONS			BACK DIMENSIONS																												
W	D	H	W	D	H	W	H																											
IN 26	24	45	20.5	18-20.5	18-22	19	22.5-27.75																											
MM 660	610	1143	521	457-521	457-559	483	572-705																											