

# seating

## Private + Public + Individual + Group Applications

Application guidelines .....	66	GC Sidero.....	125
Adeline.....	67	GC Sirena.....	135
Bishop.....	69	GC Vitrola.....	137
Calidon.....	70	GC Wind.....	140
Coast.....	75	Heather.....	142
Collingwood.....	76	Janna.....	143
Desmond.....	77	Nourish.....	144
Desmond HT.....	78	Oakville.....	147
Dreme.....	80	Primacare.....	148
Erin.....	83	River+.....	215
Frolick.....	85	Senator.....	216
GC Beach.....	90	Sleep-Eez.....	217
GC Belong.....	91	Splash.....	88
GC Citi.....	117	Strand.....	218
GC Comet.....	120	Willow.....	224
GC Islands.....	123	Wingback.....	237
GC Prairie.....	124		

## Work + Task

Doctor Buddy.....	241	GC Trittek.....	248
Ergonomic features.....	239	GC Trittek TS.....	250
Foot activated stools.....	243	GC Vion.....	252
Gala II.....	244	Harmony.....	254
Gala II TS.....	246	Mechanism adjustments....	240

SERIES	WOOD	METAL	BARIATRIC SEATING	DINING / CAFETERIA	GUEST SEATING	LOBBIES	LOUNGE / WAITING	OFFICE / MEETING	PATIENT ROOMS	RESIDENT ROOMS	STACKING	TASK	TREATMENT / EXAM ROOMS
ADELINE		•	•		•	•	•		•	•			•
BISHOP	•					•	•			•			
CALIDON	•		•		•	•	•		•	•			•
COAST	•						•		•	•			
COLLINGWOOD	•			•	•	•	•		•	•			
DESMOND	•			•	•	•	•	•	•	•			
DESMOND HT		•		•	•	•	•	•	•	•			
DOCTOR BUDDY		•		•				•	•	•		•	•
DREME									•	•			
ERIN	•	•		•	•	•	•		•	•			
FOOT ACTIVATED STOOLS		•		•				•	•	•		•	•
FROLICK		•	•	•	•	•	•	•	•	•	•		•
GALA II		•						•				•	•
GALA II TS		•						•				•	•
GC BEACH	•			•	•	•	•	•	•	•			
GC BELONG		•	•		•	•	•		•	•			•
GC CITI		•			•	•	•			•			
GC COMET		•	•	•	•	•	•	•	•	•	•		•
GC ISLANDS	•			•	•	•	•	•	•	•			
GC PRAIRIE	•					•	•			•			
GC SIDERO		•	•	•	•	•	•	•	•	•	•		•
GC SIRENA	•			•	•	•	•	•	•	•			
GC TRITEK		•						•				•	•
GC TRITEK TS		•						•				•	•
GC VION		•						•				•	•
GC VITROLA	•				•	•	•		•	•			
GC WIND		•				•	•	•	•	•			
HARMONY		•	•					•				•	•
HARMONY TS		•						•				•	•
HEATHER	•			•	•	•	•		•	•			
JANNA	•			•	•		•	•	•	•			•
NOURISH		•	•				•		•	•			•
OAKVILLE	•				•	•	•		•	•			
OTTOMANS	•	•			•	•	•		•	•			•
PRIMACARE	•		•	•	•	•	•		•	•			•
PRIMACARE HT		•	•	•	•	•	•		•	•			•
PRIMACARE MODULAR	•		•	•	•	•	•						
PRIMACARE WINGBACK	•	•	•		•	•	•		•	•			
RIVER+		•			•	•	•						
SENATOR	•	•				•	•		•	•			
SLEEP-EEZ		•				•	•	•	•	•			•
SPLASH		•		•	•	•	•	•	•	•	•		•
STRAND		•	•		•	•	•		•	•			•
THROW PILLOWS						•	•			•			
WILLOW		•	•	•	•	•	•	•	•	•	•		•
WINGBACK	•				•	•	•		•	•			

**HEAVY DUTY + 24/7 MODELS**

The following series feature specific models for Heavy Duty + 24/7 use:

GC Belong, Nourish, Primacare, Sleep-Eez, Strand, GC ritek, Bariatric models of GC Comet, Frolick and Harmony, and heavy duty 24 hour (TS) models of Gala II, Harmony and GC Tritek.

## ADELINE



model GC7680

### STANDARD FEATURES



- Flex back moves with the user, providing comfort and support while seated.
- Sleek oval tube steel frame is available in Black (TBL), Kalua (TKA), Latte (TLA), Mocha (TMO), Nevada (TNE), Shadow (TSH), Toast (TOA) and Tungsten (TTU). Please specify.
- Urethane armcaps are available in Black (BLK), Kalua (KAL), Latte (LAB), Mocha (J52), Shadow (SHW) and Toast (TOA). Please specify.
- Standard seat height on all models is 18".
- For healthcare textiles and finish options, visit the website at [globalfurnituregroup.com](http://globalfurnituregroup.com).
- For added comfort, seats are standard with high density Ultracell foam.
- The textile covered side panel on bariatric model GC7694 is covered in a coated textile in a choice of Ink Black (A16F), Warm Smoke (A08F), Chocolate Sundae (A23F), Gibraltar (A12F) or Illusion (A01F). Please specify.
- Standard glide is plastic.
- Shipped fully assembled.



### OPTIONAL FEATURES

- For hard surface floors, please specify opaque non-marking glides (**NM**). No upcharge.
- To add sealed seams to your product contact Customer Service. Upcharges vary.
- For moisture barrier on seat, please specify (**MB**). Add \$81. For bariatric models add \$122.
- For improved housekeeping and infection control practices, please add (**SU**) to model number. The underside of the seat will be finished with vinyl and sealed to prevent penetration of liquids. For standard models: Add \$39. For bariatric models: Add \$59.

### SUGGESTED APPLICATIONS

- Bariatric seating
- Guest seating
- Lobbies
- Lounge/Waiting
- Patient rooms
- Resident rooms
- Treatment/Exam rooms

DESCRIPTION	MODEL# / FEATURES	STANDARD TEXTILE GRADES											
		COM	2	3	4	5	6	7	8	9	10	11	12
 <p><b>Curved High Flex Back Armchair</b> COM: 2 YD   1.83 M Unit weight: 35 LB   15.9 KG Carton weight: 40 LB   18.14 KG Carton volume: 20 FT<sup>3</sup>   0.56 MT<sup>3</sup></p>	<b>GC7680</b>	1012	1076	1130	1192	1294	1388	1482	1564	1666	1762	1892	2076
	Active weight 350 lbs.	<b>OVERALL DIMENSIONS</b> W D H			<b>SEAT DIMENSIONS</b> W D H			<b>BACK DIMENSIONS</b> W H					
		IN 25.5	28	45	19.5	18	18	18	18	27			
		MM 648	711	1143	495	457	457	457	457	686			
		<b>RTA 00</b>		1 per carton									
 <p><b>Curved High Fixed Back Armchair</b> COM: 2 YD   1.83 M Unit weight: 40 LB   18.2 KG Carton weight: 46 LB   20.87 KG Carton volume: 20 FT<sup>3</sup>   0.56 MT<sup>3</sup></p>	<b>GC7681</b>	1064	1128	1182	1244	1346	1440	1534	1616	1718	1814	1944	2128
	Active weight 350 lbs.	<b>OVERALL DIMENSIONS</b> W D H			<b>SEAT DIMENSIONS</b> W D H			<b>BACK DIMENSIONS</b> W H					
		IN 25.5	28	45	19.5	18	18	18	18	27			
		MM 648	711	1143	495	457	457	457	457	686			
		<b>RTA 00</b>		1 per carton									
 <p><b>High Fixed Straight Top, Armchair</b> COM: 2 YD   1.83 M Unit weight: 38 LB   17.3 KG Carton weight: 45 LB   20.41 KG Carton volume: 20 FT<sup>3</sup>   0.56 MT<sup>3</sup></p>	<b>GC7692</b>	1012	1076	1130	1192	1294	1388	1482	1564	1666	1762	1892	2076
	Active weight 350 lbs.	<b>OVERALL DIMENSIONS</b> W D H			<b>SEAT DIMENSIONS</b> W D H			<b>BACK DIMENSIONS</b> W H					
		IN 25.5	26.5	45	19.5	18.5	18	20	27				
		MM 648	673	1143	495	470	457	508	686				
		<b>RTA 00</b>		1 per carton									

DESCRIPTION	MODEL# / FEATURES	STANDARD TEXTILE GRADES											
		COM	2	3	4	5	6	7	8	9	10	11	12
 <p><b>Low Fixed Straight Top Armchair, Bariatric</b>                      COM: 3.25 YD   2.97 M                      Unit weight: 61 LB   27.7 KG                      Carton weight: 71 LB   32.21 KG                      Carton volume: 23 FT³   0.65 MT³</p>	<b>GC7694</b>	1696	1800	1888	1989	2154	2307	2460	2593	2759	2915	3126	3425
		<b>OVERALL DIMENSIONS</b> W D H			<b>SEAT DIMENSIONS</b> W D H			<b>BACK DIMENSIONS</b> W H					
	Active weight 750 lbs.	IN	32.5	26.5	40.5	28	18.5	18	27	23.5			
		MM	826	673	1029	711	470	457	686	597			
		<b>RTA 00</b>	1 per carton										
 <p><b>High Flex Back Straight Top, Armchair</b>                      COM: 2 YD   1.83 M                      Unit weight: 36 LB   16.4 KG                      Carton weight: 43 LB   19.5 KG                      Carton volume: 20 FT³   0.56 MT³</p>	<b>GC7696</b>	1012	1076	1130	1192	1294	1388	1482	1564	1666	1762	1892	2076
		<b>OVERALL DIMENSIONS</b> W D H			<b>SEAT DIMENSIONS</b> W D H			<b>BACK DIMENSIONS</b> W H					
	Active weight 350 lbs.	IN	25.5	26.5	45	19.5	18.5	18	20	27			
		MM	648	673	1143	495	470	457	508	686			
		<b>RTA 00</b>	1 per carton										
 <p><b>High Fixed Straight Top Armchair, Sled Base</b>                      COM: 2 YD   1.83 M                      Unit weight: 40 LB   18.2 KG                      Carton weight: 47 LB   21.32 KG                      Carton volume: 20 FT³   0.56 MT³</p>	<b>GC7693</b>	1077	1141	1195	1257	1359	1453	1547	1629	1731	1827	1957	2141
		<b>OVERALL DIMENSIONS</b> W D H			<b>SEAT DIMENSIONS</b> W D H			<b>BACK DIMENSIONS</b> W H					
	Active weight 350 lbs.	IN	25.5	26.5	45	19.5	18.5	18	20	27			
		MM	648	673	1143	495	470	457	508	686			
		<b>RTA 00</b>	1 per carton										



## BISHOP



model GC3751

### STANDARD FEATURES

- Bishop offers a classic, traditional, rolled arm style design.
- Features removable and replaceable seat cushions.
- Wood frame and hardwood block legs are available in a variety of finishes. Available in Maple wood species only (refer to finishes ending in "M").
- For added comfort, seat and back are standard with high density Ultracell foam.
- Opaque non-marking glides are standard.
- For healthcare textiles and wood finish options, visit the website at [globalfurnituregroup.com](http://globalfurnituregroup.com).
- Can be upholstered in standard Global textiles if Healthcare compliance is not required.
- Shipped fully assembled.

### OPTIONAL FEATURES

- For non-slip glides, please specify **(NS)**. Add \$22.
- To add sealed seams to your product contact Customer Service. Upcharges vary.
- For moisture barrier on seat, please specify **(MB)**. See upcharges below.

### SUGGESTED APPLICATIONS

- Lobbies
- Lounge/Waiting
- Resident rooms

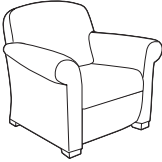
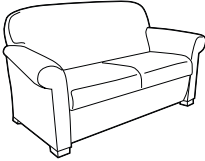
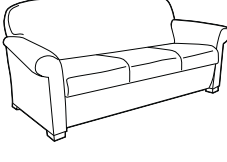
DESCRIPTION	MODEL# / FEATURES	STANDARD TEXTILE GRADES											
		COM	2	3	4	5	6	7	8	9	10	11	12
 <p><b>Lounge Chair</b> COM: 7.25 YD   6.63 M Unit weight: 69 LB   31.4 KG Carton weight: 75 LB   34.02 KG Carton volume: 30.25 FT<sup>3</sup>   0.85 MT<sup>3</sup></p>	<b>GC3751</b>	1977	2209	2405	2630	2999	3340	3681	3978	4348	4696	5167	5834
		<b>OVERALL DIMENSIONS</b>			<b>SEAT DIMENSIONS</b>			<b>BACK DIMENSIONS</b>					
		<b>W</b>	<b>D</b>	<b>H</b>	<b>W</b>	<b>D</b>	<b>H</b>	<b>W</b>	<b>H</b>				
	Active weight 300 lbs. Removable seat cushion. Add \$122 for <b>(MB)</b> .	IN 37 MM 940	32 813	34.5 876	21 533	18.5 470	17 432	28 711	17.5 445				
		<b>RTA 00</b>	1 per carton										
 <p><b>Two Seat Sofa</b> COM: 8.75 YD   8 M Unit weight: 107 LB   48.6 KG Carton weight: 112 LB   50.8 KG Carton volume: 55.75 FT<sup>3</sup>   1.57 MT<sup>3</sup></p>	<b>GC3752</b>	2793	3073	3309	3581	4027	4438	4849	5208	5654	6074	6643	7448
		<b>OVERALL DIMENSIONS</b>			<b>SEAT DIMENSIONS</b>			<b>BACK DIMENSIONS</b>					
		<b>W</b>	<b>D</b>	<b>H</b>	<b>W</b>	<b>D</b>	<b>H</b>	<b>W</b>	<b>H</b>				
	Active weight 300 lbs/seat. Removable seat cushions. Add \$245 for <b>(MB)</b> .	IN 63.5 MM 1613	32 813	34.5 876	47.5 1207	18.5 470	17 432	55 1397	17.5 445				
		<b>RTA 00</b>	1 per carton										
 <p><b>Three Seat Sofa</b> COM: 12 YD   10.97 M Unit weight: 145 LB   65.9 KG Carton weight: 155 LB   70.31 KG Carton volume: 74.75 FT<sup>3</sup>   2.11 MT<sup>3</sup></p>	<b>GC3753</b>	3554	3938	4262	4634	5246	5810	6374	6866	7478	8054	8834	9938
		<b>OVERALL DIMENSIONS</b>			<b>SEAT DIMENSIONS</b>			<b>BACK DIMENSIONS</b>					
		<b>W</b>	<b>D</b>	<b>H</b>	<b>W</b>	<b>D</b>	<b>H</b>	<b>W</b>	<b>H</b>				
	Active weight 300 lbs/seat. Removable seat cushions. Add \$366 for <b>(MB)</b> .	IN 90 MM 2286	32 813	34.5 876	74 1880	18.5 470	17 432	82 2083	17.5 445				
		<b>RTA 00</b>	1 per carton										

CALIDON



model GC36301



Tandem Side Table  
model GC36319R

Calidon freestanding tables



For Calidon freestanding tables, please see page 76 .

EXAMPLE CALIDON ORDER CODE:

GC36308	-NS	-PU75	-NS
---------	-----	-------	-----

Model # Sealed back seams Back/arm textile Sealed seat seams

-PU75	-AAM	-TPM-J-SLT	-NM	-NB
-------	------	------------	-----	-----

Seat textile Frame finish Power Glides Moisture barrier

CONTRASTING TEXTILES APPLICATION

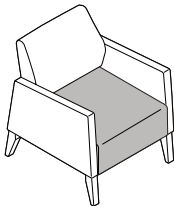

Back and arms are separate from seat.

POWER LOCATION DIAGRAM

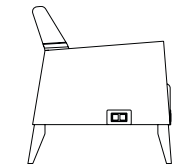

Right Side Power (SRT)  
Models GC36308, GC36309 and GC36310

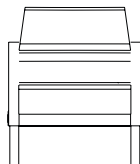

Front Power Not Available  
Model GC36308

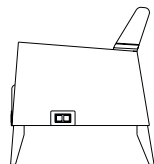

Left Side Power (SLT)  
Models GC36308, GC36309 and GC36310

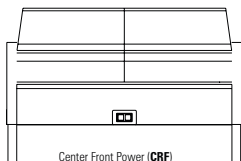

Center Front Power (CRF)  
Model GC36309 only

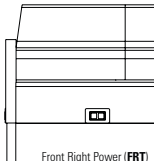

Front Right Power (FRT)  
Model GC36310 only

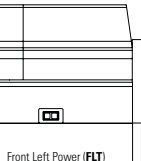

Front Left Power (FLT)  
Model GC36310 only

STANDARD FEATURES

- Calidon series consists of wood frame guest, lounge, bariatric and bench seating, in addition to fully upholstered lounge seating. Calidon freestanding and tandem/bridge tables complement the line.
- Calidon is designed for the rigors of high use environments. Lounge units include metal frame supports.
- Frame design features a wall saver leg to prevent back contact and damage to walls.
- All guest and lounge chairs feature a clean out between seat and back, and tall legs for ease of cleaning.
- For added comfort, seats are standard with high density Ultracell foam.
- Active weight capacity up to 400 lbs./seat for standard seating; up to 600 lbs. for bariatric seating.
- For healthcare textiles, visit the website at [globalfurnituregroup.com](http://globalfurnituregroup.com).
- Textiles with a minimum of 100,000 double rubs must be specified to meet Global 24/7 warranty coverage.
- Can be upholstered in standard Global textiles if Healthcare 24/7 application compliance is not required.
- Tandem table models (GC36319 to GC36321) connect to guest seating only. Tandem tables are specified left or right, as seated. Refer to page 76 for more details.
- No seating or bench models gang together.

OPTIONAL FEATURES

- All guest and lounge models can be specified with armcaps, securely fastened with metal-to-metal connectors, allowing for field replacement if required. Urethane armcaps are available on open (wood) arm models. Solid surface armcaps are available on open (wood) and fully upholstered arm models. Armcaps cannot be retrofitted in the field on units with no existing armcaps.
- Fully upholstered lounge seating can be specified with a tamper resistant power/USB unit, which includes one AC outlet, two 10-watt USB ports and a 10 ft long, 3-prong power cord. The power unit is Black with matching face plate and cord. Power is factory installed and must be specified at time of order. Add \$160. Power locations vary by model. See power location diagram.
- For contrasting textile specification, the back and arms are specified in one textile. The seat is specified separately. Use the Build-it tool on [globalfurnituregroup.com](http://globalfurnituregroup.com) for pricing.

SUGGESTED APPLICATIONS

- Bariatric seating
- Guest seating
- Lobbies
- Treatment/Exam rooms
- Patient rooms
- Resident rooms
- Lounge rooms

Please add option codes in the following order:

- **Model number**  
**GC36301 to GC36303** Guest chairs  
**GC36304** Bariatric guest chair  
**GC36305 to GC36307** Lounge chairs  
**GC36308 to GC36310** Fully upholstered lounge  
**GC36311 to GC36313** Benches  
**GC36318 to GC36320** Tandem/bridge tables
- **Sealed back seams**  
**(NS)** No sealed back seams.  
**(SS)** Sealed back seams. Upcharges vary, see model.
- **Back and arm textile**  
Specify textile code.
- **Sealed seat seams**  
**(NS)** No sealed seams.  
**(SS)** Sealed seat seams. Upcharges vary, see model.
- **Seat textile**  
Specify textile code.
- **Armcap option**  
**(FNA)** No armcaps.  
**(FAC)** With armcaps.
- **Frame finish**  
**(AAM)** Absolute  
**(CJM)** Charcoal Java  
**(ACM)** Cherry  
**(EMM)** Empire Mahogany  
**(EOM)** English Oak  
**(ECM)** Espresso Cafe  
**(TFM)** Fruitwood  
**(HGM)** Gray  
**(HOM)** Harvest Oak  
**(AHM)** Honey  
**(JOM)** Jet Onyx  
**(LHM)** Light Honey  
**(TMM)** Mahogany  
**(AVM)** Maple  
**(MWM)** Medium Walnut  
**(ASM)** Night  
**(NBM)** Noce Biondo  
**(NGM)** Noce Grigio  
**(NEM)** Noce Leggero  
**(NMM)** Noce Medio  
**(SBM)** Sandy Beach  
**(SKM)** Shaker Cherry  
**(SOM)** Silver Oak  
**(TWM)** Walnut  
**(WTM)** WC Cream  
**(WHM)** White  
**(WCM)** Winter Cherry
- **Armcap finish** (guest chairs only with **FAC** specified)  
**(SSU)** Urethane armcaps (for wood arm guest and lounge with **FAC** specified). Upcharges vary, see model.  
**Urethane finishes**  
**(BLK)** Black  
**(KAL)** Kalua  
**(LAB)** Latte  
**(J52)** Mocha  
**(SHW)** Shadow  
**(TOA)** Toast  
**(CO)** Solid surface. (for all wood and fully upholstered arm models with **FAC** specified). Upcharges vary, see model.  
**Solid surface finishes**  
**Grade 1:**  
**(SWH)** Designer White  
**Grade 2:**  
**(SBT)** Beige Tempest  
**(SBX)** Black Onyx Mirage  
**(SMG)** Milk Glass Spectra  
**(SFW)** Frosty White Mirage  
**(SHS)** Hot Stone  
**(SNM)** Northern Melange
- **Power/USB unit position** (fully upholstered, lounge models only, as specified below).  
**(NPM)** No power.  
**(TPM)** Tamper resistant power unit.  
**(J)** Black  
**(SRT)** Side right. Add \$160.  
**(SLT)** Side left. Add \$160.  
**(FLT)** Front left (three seater only). Add \$160.  
**(FRT)** Front right (three seater only). Add \$160.  
**(CRF)** Center front (two seater only). Add \$160.  
**(SLR)** Side left and right. Add \$322.  
**(FLR)** Front left and right. Add \$322.
- **Glides**  
**(NM)** Non-marking  
**(NS)** Non-slip. Guest single seat, bariatric and lounge chairs, add \$22. Guest two seater, add \$32. Guest three seater, add \$43.
- **Moisture Barrier** (seat only)  
**(NB)** No moisture barrier.  
**(MB)** Moisture barrier. Upcharges vary, see model.

DESCRIPTION	MODEL# / FEATURES	STANDARD TEXTILE GRADES											
		COM	2	3	4	5	6	7	8	9	10	11	12
 <p><b>Wood Guest Single Seat</b> COM: 1.9 YD   1.74 M Unit weight: 26 LB   11.8 KG Carton weight: 38 LB   17.24 KG Carton volume: 16.5 FT³   0.46 MT³</p>	<b>GC36301</b>	1164	1225	1276	1335	1432	1521	1611	1688	1785	1877	2000	2175
	Active weight 400 lbs.	<b>OVERALL DIMENSIONS</b>			<b>SEAT DIMENSIONS</b>			<b>BACK DIMENSIONS</b>					
		<b>W</b>	<b>D</b>	<b>H</b>	<b>W</b>	<b>D</b>	<b>H</b>	<b>W</b>	<b>H</b>				
	Solid surface GRD1 armcaps, add \$290. IN	23.5	26.5	34.5	21.5	18	18	21.5	16.5				
	Solid surface GRD2 armcaps, add \$310. MM	597	673	876	546	457	457	546	419				

Urethane armcaps, add \$96.  
Moisture barrier (MB), add \$81.  
Sealed back seams (SS), add \$27.  
Sealed seat seams (SS), add \$19. **RTA 00** 1 per carton

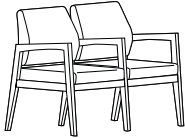
DESCRIPTION	MODEL# / FEATURES	STANDARD TEXTILE GRADES											
		COM	2	3	4	5	6	7	8	9	10	11	12
 <p><b>Wood Guest Two Seater, Full Center Arm</b> COM: 3.8 YD   3.47 M Unit weight: 50 LB   22.7 KG Carton weight: 68 LB   30.84 KG Carton volume: 31.75 FT³   0.89 MT³</p>	<b>GC36302</b>	2191	2313	2415	2533	2727	2905	3084	3240	3434	3616	3863	4213
	Active weight 400 lbs./seat	<b>OVERALL DIMENSIONS</b>			<b>SEAT DIMENSIONS</b>			<b>BACK DIMENSIONS</b>					
		<b>W</b>	<b>D</b>	<b>H</b>	<b>H</b>	<b>W</b>	<b>D</b>	<b>H</b>	<b>H</b>	<b>WH</b>			
	Solid surface GRD1 armcaps, add \$435. IN	46	26.5	34.5	21.5	18	18	21.5	16.5				
	Solid surface GRD2 armcaps, add \$465. MM	1168	673	876	546	457	457	546	419				

Urethane armcaps, add \$144.  
Moisture barrier (MB), add \$161.  
Sealed back seams (SS), add \$55.  
Sealed seat seams (SS), add \$38. **RTA 00** 1 per carton

DESCRIPTION	MODEL# / FEATURES	STANDARD TEXTILE GRADES											
		COM	2	3	4	5	6	7	8	9	10	11	12
 <p><b>Wood Guest Three Seater, Full Center Arms</b> COM: 5.7 YD   5.21 M Unit weight: 75 LB   34.1 KG Carton weight: 101 LB   45.81 KG Carton volume: 47.5 FT³   1.34 MT³</p>	<b>GC36303</b>	3220	3402	3556	3733	4024	4292	4560	4793	5084	5358	5728	6252
	Active weight 400 lbs./seat	<b>OVERALL DIMENSIONS</b>			<b>SEAT DIMENSIONS</b>			<b>BACK DIMENSIONS</b>					
		<b>W</b>	<b>D</b>	<b>H</b>	<b>W</b>	<b>D</b>	<b>H</b>	<b>W</b>	<b>H</b>				
	Solid surface GRD1 armcaps, add \$580. IN	68	26.5	34.5	21.5	18	18	21.5	16.5				
	Solid surface GRD2 armcaps, add \$620. MM	1727	673	876	546	457	457	546	419				

Urethane armcaps, add \$192.  
Moisture barrier (MB), add \$243.  
Sealed back seams (SS), add \$82.  
Sealed seat seams (SS), add \$57. **RTA 00** 1 per carton

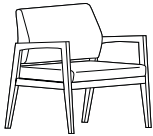
DESCRIPTION	MODEL# / FEATURES	STANDARD TEXTILE GRADES											
		COM	2	3	4	5	6	7	8	9	10	11	12
 <p><b>Wood Guest Bariatric Chair</b> COM: 2.5 YD   2.29 M Unit weight: 41 LB   18.6 KG Carton weight: 55 LB   24.95 KG Carton volume: 22.25 FT³   0.63 MT³</p>	<b>GC36304</b>	1698	1778	1846	1924	2050	2168	2286	2388	2516	2636	2798	3028
	Active weight 600 lbs.	<b>OVERALL DIMENSIONS</b>			<b>SEAT DIMENSIONS</b>			<b>BACK DIMENSIONS</b>					
		<b>W</b>	<b>D</b>	<b>H</b>	<b>W</b>	<b>D</b>	<b>H</b>	<b>W</b>	<b>H</b>				
	Solid surface GRD1 armcaps, add \$290. IN	32.75	26.5	34.5	31	18	18	30.5	16.5				
	Solid surface GRD2 armcaps, add \$310. MM	832	673	876	787	457	457	775	419				

Urethane armcaps, add \$96.  
Moisture barrier (MB), add \$122.  
Sealed back seams (SS), add \$30.  
Sealed seat seams (SS), add \$19. **RTA 00** 1 per carton

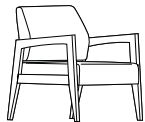
DESCRIPTION	MODEL# / FEATURES	STANDARD TEXTILE GRADES											
		COM	2	3	4	5	6	7	8	9	10	11	12
 <p><b>Wood Lounge Single Seat</b> COM: 2.5 YD   2.29 M Unit weight: 37 LB   16.8 KG Carton weight: 49 LB   22.23 KG Carton volume: 18.25 FT³   0.51 MT³</p>	<b>GC36305</b>	1576	1656	1724	1802	1928	2046	2164	2266	2394	2514	2676	2906
	Active weight 400 lbs.	<b>OVERALL DIMENSIONS</b>			<b>SEAT DIMENSIONS</b>			<b>BACK DIMENSIONS</b>					
		<b>W</b>	<b>D</b>	<b>H</b>	<b>W</b>	<b>D</b>	<b>H</b>	<b>W</b>	<b>H</b>				
	Solid surface GRD1 armcaps, add \$305. IN	25.75	29.5	32.5	24	21	16	23.5	16.5				
	Solid surface GRD2 armcaps, add \$329. MM	654	749	826	610	533	406	597	419				

Urethane armcaps, add \$144.  
Moisture barrier (MB), add \$81.  
Sealed back seams (SS), add \$31.  
Sealed seat seams (SS), add \$24. **RTA 00** 1 per carton

DESCRIPTION	MODEL# / FEATURES	STANDARD TEXTILE GRADES											
		COM	2	3	4	5	6	7	8	9	10	11	12

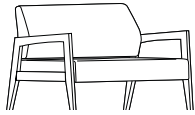

**Wood Lounge Two Seater**  
 COM: 4 YD | 3.66 M  
 Unit weight: 60 LB | 27.3 KG  
 Carton weight: 77 LB | 34.93 KG  
 Carton volume: 32.75 FT<sup>3</sup> | 0.92 MT<sup>3</sup>

MODEL# / FEATURES	COM	2	3	4	5	6	7	8	9	10	11	12
<b>GC36306</b>	2190	2318	2426	2551	2754	2942	3130	3294	3498	3690	3950	4318

Active weight 400 lbs./seat	OVERALL DIMENSIONS			SEAT DIMENSIONS			BACK DIMENSIONS		
	W	D	H	W	D	H	W	H	
Solid surface GRD1 armcaps, add \$305. IN	47.5	29.5	32.5	45	21	16	44.5	16.5	
Solid surface GRD2 armcaps, add \$329. MM	1207	749	826	1143	533	406	1130	419	
Urethane armcaps, add \$144. Moisture barrier (MB), add \$161. Sealed back seams (SS), add \$45. Sealed seat seams (SS), add \$34.	<b>RTA 00</b>	1 per carton							

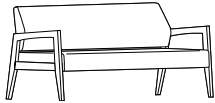

**Wood Lounge Three Seater**  
 COM: 5.25 YD | 4.8 M  
 Unit weight: 86 LB | 39.1 KG  
 Carton weight: 109 LB | 49.44 KG  
 Carton volume: 50.75 FT<sup>3</sup> | 1.43 MT<sup>3</sup>

MODEL# / FEATURES	COM	2	3	4	5	6	7	8	9	10	11	12
<b>GC36307</b>	2738	2906	3048	3211	3479	3725	3972	4187	4455	4707	5048	5531

Active weight 400 lbs./seat	OVERALL DIMENSIONS			SEAT DIMENSIONS			BACK DIMENSIONS		
	W	D	H	W	D	H	W	H	
Solid surface GRD1 armcaps, add \$305. IN	70.5	29.5	32.5	68	21	16	67.5	16.5	
Solid surface GRD2 armcaps, add \$329. MM	1791	749	826	1727	533	406	1715	419	
Urethane armcaps, add \$144. Moisture barrier (MB), add \$243. Sealed back seams (SS), add \$58. Sealed seat seams (SS), add \$45.	<b>RTA 00</b>	1 per carton							

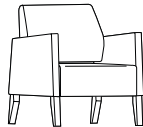

**Fully Upholstered Lounge Single Seat**  
 COM: 4 YD | 3.66 M  
 Unit weight: 46 LB | 20.9 KG  
 Carton weight: 58 LB | 26.31 KG  
 Carton volume: 18.75 FT<sup>3</sup> | 0.53 MT<sup>3</sup>

MODEL# / FEATURES	COM	2	3	4	5	6	7	8	9	10	11	12
<b>GC36308</b>	1713	1841	1949	2074	2277	2465	2653	2817	3021	3213	3473	3841

Active weight 400 lbs.	OVERALL DIMENSIONS			SEAT DIMENSIONS			BACK DIMENSIONS		
	W	D	H	W	D	H	W	H	
Solid surface GRD1 armcaps, add \$335. IN	27.5	29.5	33.5	24	21	16	23.5	17.5	
Solid surface GRD2 armcaps, add \$355. MM	699	749	851	610	533	406	597	445	
Moisture barrier (MB), add \$81. Sealed back and arm seams (SS), add \$104. Sealed seat seams (SS), add \$26. Power/USB module available.	<b>RTA 00</b>	1 per carton							

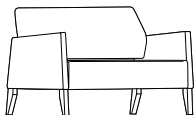

**Fully Upholstered Lounge Two Seater**  
 COM: 5.75 YD | 5.26 M  
 Unit weight: 72 LB | 32.7 KG  
 Carton weight: 89 LB | 40.37 KG  
 Carton volume: 33.75 FT<sup>3</sup> | 0.95 MT<sup>3</sup>

MODEL# / FEATURES	COM	2	3	4	5	6	7	8	9	10	11	12
<b>GC36309</b>	2328	2512	2668	2846	3139	3409	3680	3915	4209	4485	4858	5387

Active weight 400 lbs./seat	OVERALL DIMENSIONS			SEAT DIMENSIONS			BACK DIMENSIONS		
	W	D	H	W	D	H	W	H	
Solid surface GRD1 armcaps, add \$335. IN	49.5	29.5	33.5	44.5	18	16	45.5	17.5	
Solid surface GRD2 armcaps, add \$355. MM	1257	749	851	1130	457	406	1156	445	
Moisture barrier (MB), add \$161. Sealed back and arm seams (SS), add \$118. Sealed seat seams (SS), add \$37. Power/USB module available.	<b>RTA 00</b>	1 per carton							

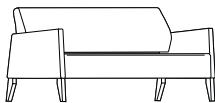

**Fully Upholstered Lounge Three Seater**  
 COM: 7 YD | 6.4 M  
 Unit weight: 99 LB | 45 KG  
 Carton weight: 123 LB | 55.79 KG  
 Carton volume: 52 FT<sup>3</sup> | 1.47 MT<sup>3</sup>

MODEL# / FEATURES	COM	2	3	4	5	6	7	8	9	10	11	12
<b>GC36310</b>	2875	3099	3288	3506	3862	4191	4520	4807	5164	5500	5955	6599

Active weight 400 lbs./seat	OVERALL DIMENSIONS			SEAT DIMENSIONS			BACK DIMENSIONS		
	W	D	H	W	D	H	W	H	
Solid surface GRD1 armcaps, add \$335. IN	71.5	29.5	33.5	66.5	18	16	67.5	17.5	
Solid surface GRD2 armcaps, add \$355. MM	1816	749	851	1689	457	406	1715	445	
Moisture barrier (MB), add \$243. Sealed back and arm seams (SS), add \$132. Sealed seat seams (SS), add \$47. Power/USB module available.	<b>RTA 00</b>	1 per carton							

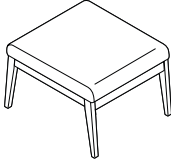
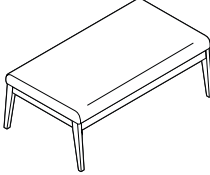
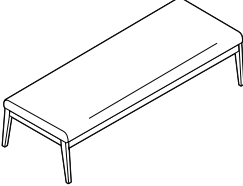
DESCRIPTION	MODEL# / FEATURES	STANDARD TEXTILE GRADES											
		COM	2	3	4	5	6	7	8	9	10	11	12
 <p><b>Single Seat Bench</b> COM: 1 YD   0.91 M Unit weight: 31 LB   14.1 KG Carton weight: 41 LB   18.6 KG Carton volume: 10 FT<sup>3</sup>   0.28 MT<sup>3</sup></p>	<b>GC36311</b>	1339	1371	1398	1429	1480	1527	1574	1615	1666	1714	1779	1871
		<b>OVERALL DIMENSIONS</b>			<b>SEAT DIMENSIONS</b>			<b>BACK DIMENSIONS</b>					
		<b>W</b>	<b>D</b>	<b>H</b>	<b>W</b>	<b>D</b>	<b>H</b>	<b>W</b>	<b>H</b>				
	Active weight 400 lbs.	IN 24 MM 610	28 711	18 457	24 610	26.75 679	18 457	-	-				
	Moisture barrier (MB), add \$81. Sealed seat seams (SS), add \$22.	<b>RTA 00</b>	1 per carton										
 <p><b>Two Seat Bench</b> COM: 2 YD   1.83 M Unit weight: 43 LB   19.5 KG Carton weight: 61 LB   27.67 KG Carton volume: 18.75 FT<sup>3</sup>   0.53 MT<sup>3</sup></p>	<b>GC36312</b>	1953	2017	2071	2133	2235	2329	2423	2505	2607	2703	2833	3017
		<b>OVERALL DIMENSIONS</b>			<b>SEAT DIMENSIONS</b>			<b>BACK DIMENSIONS</b>					
		<b>W</b>	<b>D</b>	<b>H</b>	<b>W</b>	<b>D</b>	<b>H</b>	<b>W</b>	<b>H</b>				
	Active weight 400 lbs./seat	IN 48 MM 1219	28 711	18 457	48 1219	26.75 679	18 457	-	-				
	Moisture barrier (MB), add \$161. Sealed seat seams (SS), add \$44.	<b>RTA 00</b>	1 per carton										
 <p><b>Three Seat Bench</b> COM: 3 YD   2.74 M Unit weight: 75 LB   34.1 KG Carton weight: 97 LB   44 KG Carton volume: 27.75 FT<sup>3</sup>   0.78 MT<sup>3</sup></p>	<b>GC36313</b>	2275	2371	2452	2545	2698	2839	2980	3103	3256	3400	3595	3871
		<b>OVERALL DIMENSIONS</b>			<b>SEAT DIMENSIONS</b>			<b>BACK DIMENSIONS</b>					
		<b>W</b>	<b>D</b>	<b>H</b>	<b>W</b>	<b>D</b>	<b>H</b>	<b>W</b>	<b>H</b>				
	Active weight 400 lbs./seat	IN 72 MM 1829	28 711	18 457	72 1829	26.75 679	18 457	-	-				
	Moisture barrier (MB), add \$243. Sealed seat seams (SS), add \$65.	<b>RTA 00</b>	1 per carton										

TABLES	MODEL #	DIMENSIONS <sup>IN</sup> <sub>MM</sub>	WEIGHT <sup>LB</sup> <sub>KG</sub>	VOLUME <sup>FT<sup>3</sup></sup> <sub>MT<sup>3</sup></sub>	LIST PRICE
--------	---------	---	---------------------------------------	---	------------

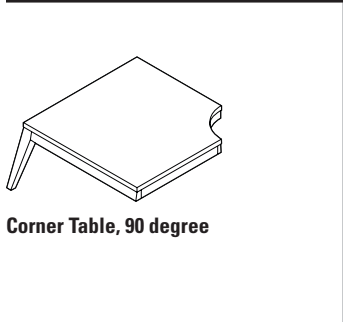

Corner Table, 90 degree

W x D x H					
GC36318	31.25 x 31.25 x 15.75	34	14.5	<b>\$711</b>	
	794 x 794 x 400	15.5	0.41		

- For a thermally fused laminate top (LP), specify model GC36318-LP.
- For a high pressure laminate top (HP), specify model GC36318-HP. Add \$72.
- For a solid surface top (CO), specify model GC36318-CO. Add \$1970 for Grade 1. Add \$2250 for Grade 2.

Coordinating edge and solid wood frame. Must be connected to a guest chair. Includes one set of U-channel connectors and hardware. 1 per carton. Power and data can be added on the surface of the table (LBT) or (RBT). Add \$232. See power location diagram for placement on page 76.

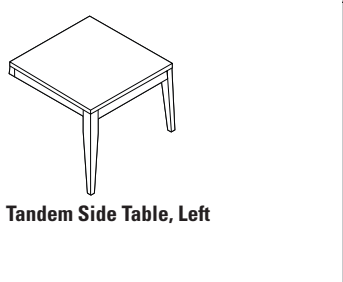

Tandem Side Table, Left

GC36319L	22.25 x 26.5 x 15.75	15	6.75	<b>\$474</b>	
	565 x 673 x 400	6.8	0.19		

- For a thermally fused laminate top (LP), specify model GC36319L-LP.
- For a high pressure laminate top (HP), specify model GC36319L-HP. Add \$42.
- For a solid surface top (CO), specify model GC36319L-CO. Add \$869 for Grade 1. Add \$1159 for Grade 2.

Coordinating edge and solid wood frame. Must be connected to a guest chair. Includes one set of U-channel connectors and hardware. 1 per carton. Power and data can be added on the surface of the table (CNT). Add \$232.

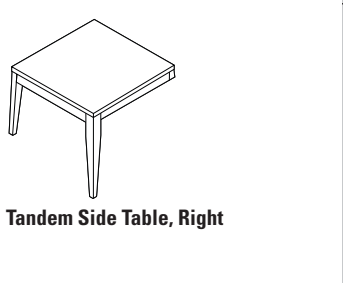

Tandem Side Table, Right

GC36319R	22.25 x 26.5 x 15.75	15	6.75	<b>\$474</b>	
	565 x 673 x 400	6.8	0.19		

- For a thermally fused laminate top (LP), specify model GC36319R-LP.
- For a high pressure laminate top (HP), specify model GC36319R-HP. Add \$42.
- For a solid surface top (CO), specify model GC36319R-CO. Add \$869 for Grade 1. Add \$1159 for Grade 2.

Coordinating edge and solid wood frame. Must be connected to a guest chair. Includes one set of U-channel connectors and hardware. 1 per carton. Power and data can be added on the surface of the table (CNT). Add \$232.

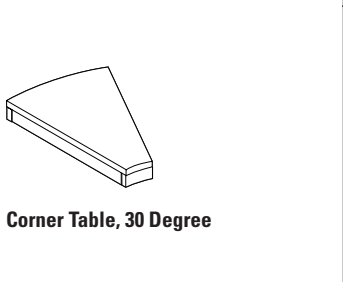

Corner Table, 30 Degree

GC36320	15.75 x 22.5 x 3	16	1.5	<b>\$357</b>	
	400 x 572 x 76	7.25	0.04		

- For a thermally fused laminate top (LP), specify model GC36320-LP.
- For a high pressure laminate top (HP), specify model GC36320-HP. Add \$42.
- For a solid surface top (CO), specify model GC36320-CO. Add \$690 for Grade 1. Add \$840 for Grade 2.

Coordinating edge and solid wood frame. Must be connected between two guest chairs. Includes two sets of U-channel connectors and hardware. 1 per carton. Power and data can be added on the surface of the table (CNT). Add \$232.

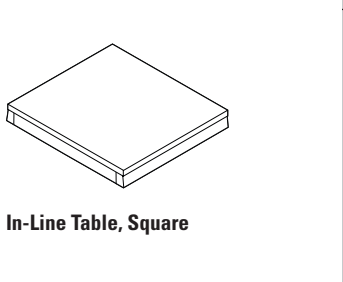

In-Line Table, Square

GC36321	23.5 x 21 x 3	16	1.9	<b>\$386</b>	
	597 x 533 x 76	7.3	0.05		

- For a thermally fused laminate top (LP), specify model GC36321-LP.
- For a high pressure laminate top (HP), specify model GC36321-HP. Add \$42.
- For a solid surface top (CO), specify model GC36321-CO. Add \$822 for Grade 1. Add \$1032 for Grade 2.

Coordinating edge and solid wood frame. Must be connected between two guest chairs. Includes two sets of U-channel connectors and hardware. 1 per carton. Power and data can be added on the surface of the table (CNT). Add \$232.

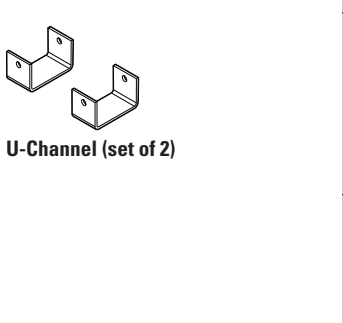

U-Channel (set of 2)

GC36322	1.5 x 2.87 x 1.62	0.5	0.1	<b>\$42</b>	
	38 x 73 x 41	0.2	-		

Includes hardware. 4 sets per carton.

COAST



model GC4172



Clean out space around seat cushions for easy housekeeping

STANDARD FEATURES

- The smooth low range glide adds relaxing motion while you sink back and coast in this ultra-comfortable chair.
- Adjustable non-marking glides are standard.
- For added comfort, seats are standard with high density Ultracell foam.
- Clean out space is provided between the seat and back cushions for easy housekeeping.
- Arms on the glider are fixed with a grip allowing the user to easily enter and exit from the chair. Combined with a smooth low-range motion mechanism, this eliminates the need for a locking mechanism.
- Standard with Black urethane fully extended arms.
- Left and right position reference is determined from the seated position.
- Seamless front upholstery method on the seat cushion prevents eventual breakdown of seams causing liquid penetration into the foam.
- For healthcare textiles and finish options, visit the website at globalfurnituregroup.com.
- Can be upholstered in standard Global textiles if Healthcare compliance is not required.
- Shipped fully assembled.

OPTIONAL FEATURES

- For moisture barrier on seat, please specify **(MB)**. Add \$81.
- To add sealed seams to your product, please specify **(SS)**. Add \$153.
- For adjustable non-slip glides, please specify **(NS)**. Add \$22.
- Tablet arm with spill collector on the edge is available, offered in Black Phenolic material. From seated position, specify **(LT)** for left hand tablet or **(RT)** for right hand tablet. Add \$572. For left and right tablets, please specify **(TB)**. Add \$1143.

SUGGESTED APPLICATIONS

- Patient rooms
- Resident rooms
- Lounge/Waiting

Please add option codes in the following order:

- **Model number**  
**GC4172** Glider/motion chair
- **Textile**  
Specify fabric code.
- **Armcap finish**  
**(BLK)** Black urethane armcap  
**(LAB)** Latte urethane armcap  
**(KAL)** Kalua urethane armcap  
**(J52)** Mocha urethane armcap  
**(SHW)** Shadow urethane armcap  
**(TOA)** Toast urethane armcap  
**(AAM)** Absolute wood armcap  
**(CJM)** Charcoal Java wood armcap  
**(ACM)** Cherry wood armcap  
**(EMM)** Empire Mahogany wood armcap  
**(EOM)** English Oak wood armcap  
**(ECM)** Espresso Cafe wood armcap  
**(HGM)** Gray wood armcap  
**(HOM)** Harvest Oak wood armcap  
**(AHM)** Honey wood armcap  
**(JOM)** Jet Onyx wood armcap  
**(LHM)** Light Honey wood armcap  
**(AVM)** Maple wood armcap  
**(MWM)** Medium Walnut wood armcap  
**(NLW)** Natural Walnut wood armcap  
**(ASM)** Night wood armcap  
**(NBM)** Noce Biondo wood armcap  
**(NGM)** Noce Grigio wood armcap  
**(NEM)** Noce Leggero wood armcap  
**(NMM)** Noce Medio wood armcap  
**(SBM)** Sandy Beach wood armcap  
**(SKM)** Shaker Cherry wood armcap  
**(SOM)** Silver Oak wood armcap  
**(TFM)** Tiger Fruitwood wood armcap  
**(TMM)** Tiger Mahogany wood armcap  
**(TWM)** Tiger Walnut wood armcap  
**(WTM)** WC Cream wood armcap  
**(WHM)** White wood armcap  
**(WCM)** Winter Chery wood armcap
- **Glides**  
**(ST)** Adjustable non-marking glides  
**(NS)** Adjustable non-slip glides
- **Moisture barrier**  
**(MB)** Seat only
- **Sealed seams**  
**(SS)** All sealed seams

EXAMPLE COAST ORDER CODE:

GC4172	-LX21	-SS	-ST	-	-
Model #	Textile	Armcaps	Glides	Moisture barrier	Sealed seams

DESCRIPTION	MODEL# / FEATURES	STANDARD TEXTILE GRADES																															
		COM	2	3	4	5	6	7	8	9	10	11	12																				
 <p><b>Glider/Motion Chair</b> COM: 5.5 YD   5.03 M Unit weight: 100 LB   45.5 KG Carton weight: 115 LB   52.16 KG Carton volume: 29.5 FT³   0.83 MT³</p>	<b>GC4172</b>	2221	2397	2546	2716	2997	3255	3514	3739	4020	4284	4641	5147																				
	<p>Active weight 350 lbs.</p> <p>Specify armcap: wood or urethane.</p>	<table border="1"> <thead> <tr> <th colspan="3">OVERALL DIMENSIONS</th> <th colspan="3">SEAT DIMENSIONS</th> <th colspan="2">BACK DIMENSIONS</th> </tr> <tr> <th>W</th> <th>D</th> <th>H</th> <th>W</th> <th>D</th> <th>H</th> <th>W</th> <th>H</th> </tr> </thead> <tbody> <tr> <td>IN 30</td> <td>31.5</td> <td>43.5</td> <td>21.5</td> <td>19.5</td> <td>18</td> <td>22</td> <td>28</td> </tr> <tr> <td>MM 762</td> <td>800</td> <td>1105</td> <td>546</td> <td>495</td> <td>457</td> <td>559</td> <td>711</td> </tr> </tbody> </table>	OVERALL DIMENSIONS			SEAT DIMENSIONS			BACK DIMENSIONS		W	D	H	W	D	H	W	H	IN 30	31.5	43.5	21.5	19.5	18	22	28	MM 762	800	1105	546	495	457	559
OVERALL DIMENSIONS			SEAT DIMENSIONS			BACK DIMENSIONS																											
W	D	H	W	D	H	W	H																										
IN 30	31.5	43.5	21.5	19.5	18	22	28																										
MM 762	800	1105	546	495	457	559	711																										
	<b>RTA 00</b>	1 per carton																															



COLLINGWOOD



model GC36510



STANDARD FEATURES

- Collingwood offers a cozy, streamlined design with classic curves.
- Features a clean out around the seat cushion for easy housekeeping.
- The seat underside is sealed with a non-porous material to support housekeeping and infection control protocols.
- Seat cushion is mechanically removable, if required.
- Legs are available in wood or urethane, in a variety of colors.
- For added comfort, seat cushions are standard with high density Ultracell foam.
- Opaque non-marking glides are standard.
- For healthcare textiles, visit the website at [globalfurnituregroup.com](http://globalfurnituregroup.com).
- Can be upholstered in standard Global textiles if healthcare compliance is not required.
- Shipped fully assembled.

SUGGESTED APPLICATIONS

- Dining/Cafeteria
- Guest seating
- Lobbies
- Lounge/Waiting
- Patient rooms
- Resident rooms

OPTIONAL FEATURES

Please add option codes in the following order:

- **Model number**  
**GC36510** Low Back Lounge Chair  
**GC36511** High Back Lounge Chair
- **Sealed back/arms seams (NS)** No sealed back seams.  
**(SS)** Sealed back seams. Upcharges vary, see model.
- **Back/arms textile**  
Specify textile code.
- **Sealed seat seams (NS)** No sealed seat seams.  
**(SS)** Sealed seat seams. Add \$27.
- **Seat textile**  
Specify textile code.
- **Wood leg finish**  
**(AAM)** Absolute **(MWM)** Medium Walnut  
**(BKM)** Black **(NLW)** Natural Walnut  
**(CJM)** Charcoal Java **(NSM)** Night  
**(ACM)** Cherry **(NBM)** Noce Biondo  
**(EMM)** Empire Mahogany **(NGM)** Noce Grigio  
**(EOM)** English Oak **(NEM)** Noce Leggero  
**(ECM)** Espresso Cafe **(NMM)** Noce Medio  
**(TFM)** Fruitwood **(SBM)** Sandy Beach  
**(HGM)** Gray **(SKM)** Shaker Cherry  
**(HOM)** Harvest Oak **(SOM)** Silver Oak  
**(AHM)** Honey **(TWM)** Walnut  
**(JOM)** Jet Onyx **(WTM)** WC Cream  
**(LHM)** Light Honey **(WHM)** White  
**(TMM)** Mahogany **(WCM)** Winter Cherry  
**(AVM)** Maple
- **Urethane leg finish**  
Add \$150.  
**(BLK)** Black **(J52)** Mocha  
**(KAL)** Kalua **(SHW)** Shadow  
**(LAB)** Latte **(TOA)** Toast
- **Glides**  
**(NM)** Non-marking glides. No upcharge  
**(RG)** Rubber, non-slip glides. Add \$21.  
**(SG)** Steel cushion glides. Add \$17.  
**(FG)** Felt glides. Add \$21.
- **Moisture barrier (seat only)**  
**(NB)** No moisture barrier. No upcharge.  
**(MB)** Moisture barrier. Add \$77.

EXAMPLE COLLINGWOOD ORDER CODE:

GC36510	NS	CE90	NS	CE90	AAM	NM	NB
Model #	Sealed back/arms seams	Back/arms textile	Sealed seat seams	Seat textile	Base	Glides	Moisture barrier

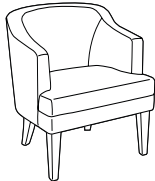
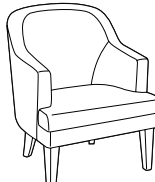
DESCRIPTION	MODEL# / FEATURES	STANDARD TEXTILE GRADES																																			
		1	2	3	4	5	6	7	8	9	10	11	12																								
 <b>Low Back Lounge Chair</b> COM: 4.5 YD   4.11 M Unit weight: 42 LB   19.1 KG Carton weight: 55 LB   24.95 KG Carton volume: 19.25 FT³   0.54 MT³	<b>GC36510</b>	1702	1846	1968	2108	2336	2548	2760	2944	3174	3390	3682	4096																								
	Active weight 350 lbs. Replaceable seat cushion. Add \$54 for sealed back seams <b>(SS)</b>	<table border="1"> <thead> <tr> <th colspan="3">OVERALL DIMENSIONS</th> <th colspan="3">SEAT DIMENSIONS</th> <th colspan="3">BACK DIMENSIONS</th> </tr> <tr> <th>W</th><th>D</th><th>H</th> <th>W</th><th>D</th><th>H</th> <th>W</th><th>H</th> </tr> </thead> <tbody> <tr> <td>IN 28</td><td>27.25</td><td>31</td> <td>21</td><td>19</td><td>18</td> <td>21.5</td><td>12.5</td> </tr> <tr> <td>MM 711</td><td>692</td><td>787</td> <td>533</td><td>483</td><td>457</td> <td>546</td><td>318</td> </tr> </tbody> </table>		OVERALL DIMENSIONS			SEAT DIMENSIONS			BACK DIMENSIONS			W	D	H	W	D	H	W	H	IN 28	27.25	31	21	19	18	21.5	12.5	MM 711	692	787	533	483	457	546	318	<b>RTA 00</b> 1 per carton
	OVERALL DIMENSIONS			SEAT DIMENSIONS			BACK DIMENSIONS																														
W	D	H	W	D	H	W	H																														
IN 28	27.25	31	21	19	18	21.5	12.5																														
MM 711	692	787	533	483	457	546	318																														
 <b>High Back Lounge Chair</b> COM: 5 YD   4.57 M Unit weight: 43 LB   19.5 KG Carton weight: 56 LB   25.4 KG Carton volume: 22.5 FT³   0.63 MT³	<b>GC36511</b>	1746	1906	2041	2197	2451	2686	2921	3126	3381	3621	3946	4406																								
	Active weight 350 lbs. Replaceable seat cushion. Add \$62 for sealed back seams <b>(SS)</b>	<table border="1"> <thead> <tr> <th colspan="3">OVERALL DIMENSIONS</th> <th colspan="3">SEAT DIMENSIONS</th> <th colspan="3">BACK DIMENSIONS</th> </tr> <tr> <th>W</th><th>D</th><th>H</th> <th>W</th><th>D</th><th>H</th> <th>W</th><th>H</th> </tr> </thead> <tbody> <tr> <td>IN 28</td><td>28.5</td><td>35.5</td> <td>21</td><td>19</td><td>18</td> <td>21.5</td><td>17</td> </tr> <tr> <td>MM 711</td><td>724</td><td>902</td> <td>533</td><td>483</td><td>457</td> <td>546</td><td>432</td> </tr> </tbody> </table>		OVERALL DIMENSIONS			SEAT DIMENSIONS			BACK DIMENSIONS			W	D	H	W	D	H	W	H	IN 28	28.5	35.5	21	19	18	21.5	17	MM 711	724	902	533	483	457	546	432	<b>RTA 00</b> 1 per carton
	OVERALL DIMENSIONS			SEAT DIMENSIONS			BACK DIMENSIONS																														
W	D	H	W	D	H	W	H																														
IN 28	28.5	35.5	21	19	18	21.5	17																														
MM 711	724	902	533	483	457	546	432																														



DESMOND



model GC4162

STANDARD FEATURES





- Clean lines and a contoured picture frame style back coordinate with any decor.
- Arms incorporate a firm grip extension to assist users in the entry and exit from the chair.
- Additional support rails on the legs ensure strength and durability.
- For added comfort, seats are standard with high density Ultracell foam.
- Opaque non-marking glides are standard.
- For healthcare textiles and wood finish options, visit the website at [globalfurnituregroup.com](http://globalfurnituregroup.com). Available in European beechwood species only (refer to finishes that end with an "M").
- Models ending in FC have front casters.
- Shipped fully assembled.

OPTIONAL FEATURES

- For non-slip glides, please specify **(NS)**. Add \$22. For models with front casters, add \$9.
- For moisture barrier on seat, please specify **(MB)**. Add \$81.

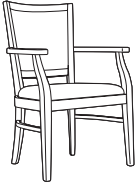
SUGGESTED APPLICATIONS

- Dining/Cafeteria
- Guest seating
- Lobbies
- Lounge/Waiting
- Office/Meeting
- Patient rooms
- Resident rooms

DESCRIPTION	MODEL# / FEATURES	STANDARD TEXTILE GRADES												
		COM	2	3	4	5	6	7	8	9	10	11	12	
 <p><b>Armchair</b> COM: 1.25 YD   1.14 M Unit weight: 19 LB   8.6 KG Carton weight: 24 LB   10.89 KG Carton volume: 14.5 FT³   0.41 MT³</p>	<b>GC4162</b>	1219	1259	1293	1332	1395	1454	1513	1564	1628	1688	1769	1884	
	Active weight 300 lbs.	<b>OVERALL DIMENSIONS</b> W D H IN 24 22.5 36 MM 610 572 914			<b>SEAT DIMENSIONS</b> W D H IN 22.5 18 17.5 MM 572 457 445			<b>BACK DIMENSIONS</b> W H IN 17.5 18.5 MM 445 470						
	<b>RTA 00</b> 1 per carton													
 <p><b>Armchair Front Casters</b> COM: 1.25 YD   1.14 M Unit weight: 19 LB   8.6 KG Carton weight: 24 LB   10.89 KG Carton volume: 14.5 FT³   0.41 MT³</p>	<b>GC4162FC</b>	1306	1346	1380	1419	1482	1541	1600	1651	1715	1775	1856	1971	
	Active weight 300 lbs.	<b>OVERALL DIMENSIONS</b> W D H IN 24 22.5 36 MM 610 572 914			<b>SEAT DIMENSIONS</b> W D H IN 22.5 18 17.5 MM 572 457 445			<b>BACK DIMENSIONS</b> W H IN 17.5 18.5 MM 445 470						
	<b>RTA 00</b> 1 per carton													
 <p><b>Side Chair</b> COM: 1.25 YD   1.14 M Unit weight: 17 LB   7.7 KG Carton weight: 22 LB   9.98 KG Carton volume: 14.5 FT³   0.41 MT³</p>	<b>GC4165</b>	1148	1188	1222	1261	1324	1383	1442	1493	1557	1617	1698	1813	
	Active weight 300 lbs.	<b>OVERALL DIMENSIONS</b> W D H IN 22.5 22.5 36 MM 572 572 914			<b>SEAT DIMENSIONS</b> W D H IN 22.5 18 17.5 MM 572 457 445			<b>BACK DIMENSIONS</b> W H IN 17.5 18.5 MM 445 470						
	<b>RTA 00</b> 1 per carton													
 <p><b>Side Chair Front Casters</b> COM: 1.25 YD   1.14 M Unit weight: 17 LB   7.7 KG Carton weight: 22 LB   9.98 KG Carton volume: 14.5 FT³   0.41 MT³</p>	<b>GC4165FC</b>	1232	1272	1306	1345	1408	1467	1526	1577	1641	1701	1782	1897	
	Active weight 300 lbs.	<b>OVERALL DIMENSIONS</b> W D H IN 22.5 22.5 36 MM 572 572 914			<b>SEAT DIMENSIONS</b> W D H IN 22.5 18 17.5 MM 572 457 445			<b>BACK DIMENSIONS</b> W H IN 17.5 18.5 MM 445 470						
	<b>RTA 00</b> 1 per carton													

**DESMOND HT**



model GC4290

**EXAMPLE DESMOND HT ORDER CODE:**

GC4290	-LX21	-TBL	-PT	-BK	-MB
Model #	Textile	Frame	Armcaps	Glides	Moisture barrier

**STANDARD FEATURES**

- Desmond HT is a metal framed chair with residential design while ensuring maximum strength and durability within very challenging applications.
- Available with four-legged metal welded frame with or without arms; with rear casters that allow the caregiver to tip and move chair without lifting; with lift mechanism and rear casters to assist the caregiver in turning the chair and moving the occupant to and from a table; or a bariatric model.
- Models with rear casters also allow the caregiver to turn the chair with occupant seated for better access to wheelchair or walker.
- The welded metal frame, welded cross rails on lower frame, metal-to-metal fasteners on seat pan, back insert and urethane armcaps enhance strength and durability, ensuring its performance in the most rigorous environments.
- Urethane armcaps are comfortable, durable, cleanable and replaceable. Designed to offer proper support while seated and the egress grip allows the occupant to use with confidence when getting in or out of the chair.
- For added comfort and long term performance the seat cushion is standard with high density Ultracell foam.
- The underside of the seat pan is moisture resistant, and the cushions have no exposed seams to support improved housekeeping and infection prevention practices.
- For healthcare textiles and finish options, visit the website at [globalfurnituregroup.com](http://globalfurnituregroup.com).
- Can be upholstered in standard Global textiles if Healthcare compliance is not required.
- Shipped fully assembled.

**OPTIONAL FEATURES**



- To add additional weight to your product, contact Customer Service for more information.
- For moisture barrier on seat, please specify **(MB)**. Add \$81. For bariatric model, add \$122.



Please add option codes in the following order:

- **Model number**  
**GC4290** Metal armchair  
**GC4291** Metal armchair w/two rear swivel casters  
**GC4292** Metal armchair w/two rear swivel casters and lift mechanism  
**GC4293** Metal bariatric armchair  
**GC4294** Metal side chair, armless
- **Textile**  
Specify fabric code.
- **Frame finish**  
**(TBL)** Black  
**(TIV)** Cloud  
**(TDW)** Designer White  
**(TFO)** Fog  
**(TFR)** Frost  
**(TKA)** Kalua  
**(TLA)** Latte  
**(TMO)** Mocha  
**(TNE)** Nevada  
**(TSN)** Sand  
**(TSH)** Shadow  
**(TOA)** Toast  
**(TTU)** Tungsten
- **Armcap finish**  
**(SS)** Black  
**(KL)** Kalua  
**(LA)** Latte  
**(MC)** Mocha  
**(SH)** Shadow  
**(TO)** Toast
- **Glides**  
**(BK)** Black plastic glides
- **Moisture barrier**  
**(MB)** Seat only

**SUGGESTED APPLICATIONS**

- Bariatric seating (model GC4293)
- Dining/Cafeteria
- Guest seating
- Lobbies
- Lounge/Waiting
- Office/Meeting
- Patient rooms
- Resident room

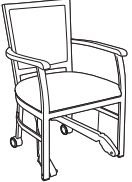
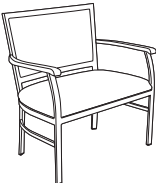
DESCRIPTION	MODEL# / FEATURES	STANDARD TEXTILE GRADES												
		COM	2	3	4	5	6	7	8	9	10	11	12	
 <p><b>Metal Armchair</b>                      COM: 1.25 YD   1.14 M                      Unit weight: 34 LB   15.5 KG                      Carton weight: 41 LB   18.6 KG                      Carton volume: 13.75 FT<sup>3</sup>   0.38 MT<sup>3</sup></p>	<b>GC4290</b>	1353	1393	1427	1466	1529	1588	1647	1698	1762	1822	1903	2018	
	Active weight 500 lbs.													
			<b>OVERALL DIMENSIONS</b>			<b>SEAT DIMENSIONS</b>			<b>BACK DIMENSIONS</b>					
			IN	24.5	23.5	35.75	23	19	18.5	18	17.5			
		MM	622	597	908	584	483	470	457	445				
		<b>RTA 00</b>	1 per carton											
 <p><b>Metal Armchair w/Two Rear Swivel Casters</b>                      COM: 1.25 YD   1.14 M                      Unit weight: 34 LB   15.5 KG                      Carton weight: 41 LB   18.6 KG                      Carton volume: 13.75 FT<sup>3</sup>   0.38 MT<sup>3</sup></p>	<b>GC4291</b>	1446	1486	1520	1559	1622	1681	1740	1791	1855	1915	1996	2111	
	Active weight 500 lbs.													
			<b>OVERALL DIMENSIONS</b>			<b>SEAT DIMENSIONS</b>			<b>BACK DIMENSIONS</b>					
			IN	24.5	23.5	35.75	23	19	18.5	18	17.5			
		MM	622	597	908	584	483	470	457	445				
		<b>RTA 00</b>	1 per carton											

DESCRIPTION	MODEL# / FEATURES	STANDARD TEXTILE GRADES											
		COM	2	3	4	5	6	7	8	9	10	11	12
 <p><b>Metal Armchair w/Two Rear Swivel Casters &amp; Lift Mec.</b>                      COM: 1.25 YD   1.14 M                      Unit weight: 37 LB   16.8 KG                      Carton weight: 44 LB   19.96 KG                      Carton volume: 13.75 FT³   0.38 MT³</p>	<p>GC4292</p> <p>Active weight 500 lbs.</p>	1864	1904	1938	1977	2040	2099	2158	2209	2273	2333	2414	2529
		<b>OVERALL DIMENSIONS</b> W D H			<b>SEAT DIMENSIONS</b> W D H			<b>BACK DIMENSIONS</b> W H					
		IN	24.5	23.5	35.75	23	19	18.5	18	17.5			
		MM	622	597	908	584	483	470	457	445			
		<b>RTA 00</b>		1 per carton									
 <p><b>Metal Bariatric Armchair</b>                      COM: 2.25 YD   2.06 M                      Unit weight: 40 LB   18.2 KG                      Carton weight: 48 LB   21.77 KG                      Carton volume: 20 FT³   0.56 MT³</p>	<p>GC4293</p> <p>Active weight 750 lbs.</p>	1809	1881	1942	2012	2126	2232	2338	2430	2545	2653	2799	3006
		<b>OVERALL DIMENSIONS</b> W D H			<b>SEAT DIMENSIONS</b> W D H			<b>BACK DIMENSIONS</b> W H					
		IN	35.5	23.5	35.75	34	19	18.5	29	17.5			
		MM	902	597	908	864	483	470	737	445			
		<b>RTA 00</b>		1 per carton									
 <p><b>Metal Armless Side Chair</b>                      COM: 1.25 YD   1.14 M                      Unit weight: 29 LB   13.2 KG                      Carton weight: 36 LB   16.33 KG                      Carton volume: 13.75 FT³   0.38 MT³</p>	<p>GC4294</p> <p>Active weight 500 lbs.</p>	1242	1282	1316	1355	1418	1477	1536	1587	1651	1711	1792	1907
		<b>OVERALL DIMENSIONS</b> W D H			<b>SEAT DIMENSIONS</b> W D H			<b>BACK DIMENSIONS</b> W H					
		IN	23	23.5	35.75	23	19	18.5	18	17.5			
		MM	584	597	908	584	483	470	457	445			
		<b>RTA 00</b>		1 per carton									

DREME



model GC35042



Drawer box surface

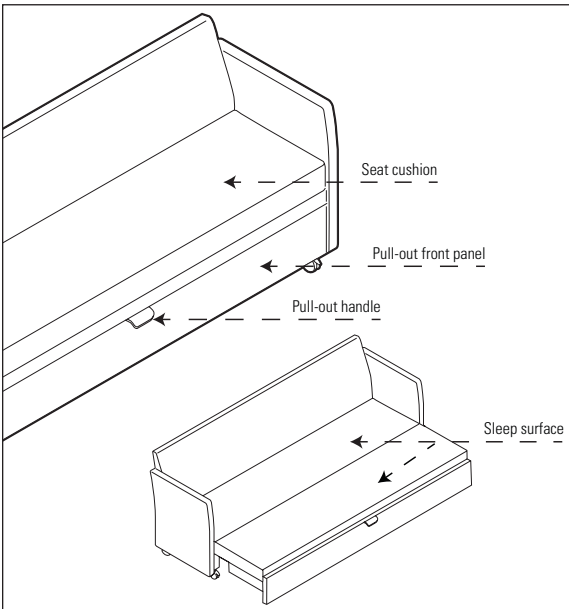

STANDARD FEATURES

- Dreme has a compact, comfortable design that offers a place to sit or easily converts into a generous sleep surface. The various configurations include a bench with or without back and with or without arms. All models are listed.
- The seat deck is a clean through metal platform for superior strength.
- The seat/sleep cushion is attached to the unit with straps that are held in place by metal-to-metal fasteners for unparalleled strength and durability. This allows sheets to be tucked in place.
- There is a clean out space to the floor at the back of the seat cushion in support of housekeeping and infection control practices.
- The seat cushion folds open to create a 36" deep sleep surface area. Foam is standard high density Ultracell, for enhanced comfort and long-term performance.
- Below the seat deck is a closed drawer box that pulls out, increasing the sleep area.
- The sleep surface cushion and drawer box covering are upholstered in Bantam Vinyl to ensure moisture barrier protection. These surfaces are 9:1 (water to bleach) cleanable. Please select **(BM)** color. See Morbern Bantam textile card for color samples.
- All other surfaces can be specified in your textile of choice.
- The drawer section of the unit has a Chrome handle to assist adjusting the unit from a bench to a sleep surface.
- The lower portion of the unit is supported by four heavy duty supporting non-locking casters when in sleep position and is standard without storage.
- Straps can be unfastened for field replacement of the cushion, if required for any reason.
- Dreme requires zero wall clearance to open into sleep position.
- Standard configuration for all models: two metal legs in front position, two non-locking swivel casters in back position (to assist with moving the unit). Optional front, locking, swivel casters **(BC)** are available. Add \$54.
- A tablet arm is available on units with arms only. The tablet surfaces attach to the outside of the arm (will add 4" to the length of the overall length per tablet). The tablet swivels up and can be moved over the arm and swiveled into place for use by the occupant. The oblong oval shaped tablet is a phenolic surface, strong, non-porous and extremely durable. It offers a no-spill edge and is standard in soft Black. Tablet designation is based on seated position. See models with tablet option for ordering.
- Interior sleep surface: 79"L x 37"W
- All textiles are railroaded across all Dreme components.
- For healthcare textiles, visit the website at [globalfurnituregroup.com](http://globalfurnituregroup.com).
- Can be upholstered in standard Global textiles if Healthcare compliance is not required.

OPTIONAL FEATURES

- The pull-out is available with a storage compartment option below the sleep surface. The storage compartment is divided into two sides and is finished in Storm Grey **(SOG)** laminate. The storage compartment must be ordered at time of original order and cannot be retrofitted, specify **(SR)**. Add \$327.
- Storage compartment lids have a pneumatic lift support, allowing the lid to stay open when accessing the interior storage area.
- An optional seamless White drawer liner is available for the storage compartment, as a set of two. Liners can be removed for ease of maintenance, specify **(SL)**. Add \$655.
- Pull-out front panel is available in upholstered or laminate finish with or without power units. Specify the following:  
**(FL)** laminate panel no power  
**(LP)** laminate panel with power. Add \$160  
**(FU)** upholstered panel  
**(UP)** upholstered panel with power. Add \$160  
 Select from all standard laminate finishes.
- Power module is available on the front panel, center front position. The unit includes one power and two USB-A, 10 watt charging ports and an 8 ft. long power cord. When the pull-out is in open position the remaining power cord length is 6 ft. The power module is Black with Black face plate and must be specified at time of order.
- **Leg finish/caster option:**  
**(TBL)** Black  
**(TLA)** Latte  
**(TKA)** Kalua  
**(TMO)** Mocha  
**(TSH)** Shadow  
**(TOA)** Toast  
**(TTU)** Tungsten  
**(BC)** Front, locking, swivel casters. Add \$54 (Casters are Black with Taupe center)
- **Sleep Surface Finish:**  
**(B21)** BM21 Apple  
**(B25)** BM25 Cosmic  
**(B23)** BM23 Dove  
**(B26)** BM26 Firelight  
**(B22)** BM22 Ghost  
**(B27)** BM27 Ginger  
**(B24)** BM24 Iron  
**(B20)** BM20 Rabbit  
**(B28)** BM28 Tropical
- For moisture barrier on seat and sleeping surface, please specify **(MB)**. Upcharges vary by model.
- To add sealed seams to your product, please specify **(SS)**. Upcharges vary by model.

SUGGESTED APPLICATIONS

- Lounge rooms
- Patient rooms
- Resident rooms
- Treatment/Exam rooms

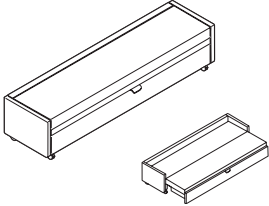
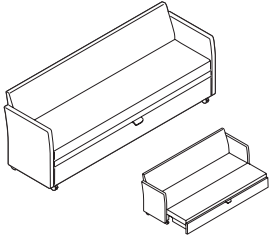
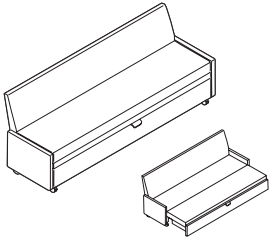
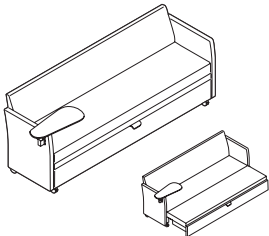
DESCRIPTION	MODEL# / FEATURES	STANDARD TEXTILE GRADES																															
		COM	2	3	4	5	6	7	8	9	10	11	12																				
 <p><b>Armless Sleeper</b> COM: 9.5 YD   8.69 M Unit weight: 143 LB   65 KG Carton weight: 158 LB   71.67 KG Carton volume: 22.75 FT³   0.64 MT³</p>	GC35041NA	4185	4489	4746	5040	5525	5971	6418	6807	7292	7748	8365	9239																				
	<p>Active weight 450 lbs.</p> <p>Add \$310 for (MB) Add \$299 for (SS)</p>	<table border="1"> <thead> <tr> <th colspan="3">OVERALL DIMENSIONS</th> <th colspan="3">SEAT DIMENSIONS</th> <th colspan="2">BACK DIMENSIONS</th> </tr> <tr> <th>W</th> <th>D</th> <th>H</th> <th>W</th> <th>D</th> <th>H</th> <th>W</th> <th>H</th> </tr> </thead> <tbody> <tr> <td>IN 82</td> <td>23</td> <td>18.5</td> <td>78</td> <td>-</td> <td>18.5</td> <td>-</td> <td>-</td> </tr> <tr> <td>MM 2083</td> <td>584</td> <td>470</td> <td>1981</td> <td>-</td> <td>470</td> <td>-</td> <td>-</td> </tr> </tbody> </table>	OVERALL DIMENSIONS			SEAT DIMENSIONS			BACK DIMENSIONS		W	D	H	W	D	H	W	H	IN 82	23	18.5	78	-	18.5	-	-	MM 2083	584	470	1981	-	470	-
OVERALL DIMENSIONS			SEAT DIMENSIONS			BACK DIMENSIONS																											
W	D	H	W	D	H	W	H																										
IN 82	23	18.5	78	-	18.5	-	-																										
MM 2083	584	470	1981	-	470	-	-																										
 <p><b>Sleeper w/Back and Arms</b> COM: 11.75 YD   10.74 M Unit weight: 195 LB   88.6 KG Carton weight: 210 LB   95.25 KG Carton volume: 46.25 FT³   1.3 MT³</p>	GC35042	4732	5108	5426	5790	6389	6941	7494	7975	8575	9139	9902	10983																				
	<p>Active weight 450 lbs.</p> <p>Add \$310 for (MB) Add \$371 for (SS)</p>	<table border="1"> <thead> <tr> <th colspan="3">OVERALL DIMENSIONS</th> <th colspan="3">SEAT DIMENSIONS</th> <th colspan="2">BACK DIMENSIONS</th> </tr> <tr> <th>W</th> <th>D</th> <th>H</th> <th>W</th> <th>D</th> <th>H</th> <th>W</th> <th>H</th> </tr> </thead> <tbody> <tr> <td>IN 82</td> <td>25</td> <td>32.5</td> <td>78</td> <td>18</td> <td>18.5</td> <td>78</td> <td>14</td> </tr> <tr> <td>MM 2083</td> <td>635</td> <td>826</td> <td>1981</td> <td>457</td> <td>470</td> <td>1981</td> <td>356</td> </tr> </tbody> </table>	OVERALL DIMENSIONS			SEAT DIMENSIONS			BACK DIMENSIONS		W	D	H	W	D	H	W	H	IN 82	25	32.5	78	18	18.5	78	14	MM 2083	635	826	1981	457	470	1981
OVERALL DIMENSIONS			SEAT DIMENSIONS			BACK DIMENSIONS																											
W	D	H	W	D	H	W	H																										
IN 82	25	32.5	78	18	18.5	78	14																										
MM 2083	635	826	1981	457	470	1981	356																										
 <p><b>Armless Sleeper w/Back</b> COM: 10.5 YD   9.6 M Unit weight: 175 LB   79.5 KG Carton weight: 190 LB   86.18 KG Carton volume: 46.25 FT³   1.3 MT³</p>	GC35042NA	4628	4964	5248	5573	6109	6602	7096	7526	8062	8566	9248	10214																				
	<p>Active weight 450 lbs.</p> <p>Add \$310 for (MB) Add \$299 for (SS)</p>	<table border="1"> <thead> <tr> <th colspan="3">OVERALL DIMENSIONS</th> <th colspan="3">SEAT DIMENSIONS</th> <th colspan="2">BACK DIMENSIONS</th> </tr> <tr> <th>W</th> <th>D</th> <th>H</th> <th>W</th> <th>D</th> <th>H</th> <th>W</th> <th>H</th> </tr> </thead> <tbody> <tr> <td>IN 82</td> <td>25</td> <td>32.5</td> <td>78</td> <td>18</td> <td>18.5</td> <td>78</td> <td>14</td> </tr> <tr> <td>MM 2083</td> <td>635</td> <td>826</td> <td>1981</td> <td>457</td> <td>470</td> <td>1981</td> <td>356</td> </tr> </tbody> </table>	OVERALL DIMENSIONS			SEAT DIMENSIONS			BACK DIMENSIONS		W	D	H	W	D	H	W	H	IN 82	25	32.5	78	18	18.5	78	14	MM 2083	635	826	1981	457	470	1981
OVERALL DIMENSIONS			SEAT DIMENSIONS			BACK DIMENSIONS																											
W	D	H	W	D	H	W	H																										
IN 82	25	32.5	78	18	18.5	78	14																										
MM 2083	635	826	1981	457	470	1981	356																										
 <p><b>Sleeper w/Back, Arms, Right Tablet</b> COM: 11.75 YD   10.74 M Unit weight: 200 LB   90.9 KG Carton weight: 215 LB   97.52 KG Carton volume: 48.5 FT³   1.37 MT³</p>	GC35042T	4981	5357	5675	6039	6638	7190	7743	8224	8824	9388	10151	11232																				
	<p>Specify (LT) for left tablet. Specify (TB) for tablet on both arms. Add \$238.</p> <p>Active weight 450 lbs.</p> <p>Add \$310 for (MB) Add \$371 for (SS)</p>	<table border="1"> <thead> <tr> <th colspan="3">OVERALL DIMENSIONS</th> <th colspan="3">SEAT DIMENSIONS</th> <th colspan="2">BACK DIMENSIONS</th> </tr> <tr> <th>W</th> <th>D</th> <th>H</th> <th>W</th> <th>D</th> <th>H</th> <th>W</th> <th>H</th> </tr> </thead> <tbody> <tr> <td>IN 86</td> <td>25</td> <td>32.5</td> <td>78</td> <td>18</td> <td>18.5</td> <td>78</td> <td>14</td> </tr> <tr> <td>MM 2184</td> <td>635</td> <td>826</td> <td>1981</td> <td>457</td> <td>470</td> <td>1981</td> <td>356</td> </tr> </tbody> </table>	OVERALL DIMENSIONS			SEAT DIMENSIONS			BACK DIMENSIONS		W	D	H	W	D	H	W	H	IN 86	25	32.5	78	18	18.5	78	14	MM 2184	635	826	1981	457	470	1981
OVERALL DIMENSIONS			SEAT DIMENSIONS			BACK DIMENSIONS																											
W	D	H	W	D	H	W	H																										
IN 86	25	32.5	78	18	18.5	78	14																										
MM 2184	635	826	1981	457	470	1981	356																										



ERIN



model GC36530



model GC36533



back textile

seat textile

STANDARD FEATURES

- Erin offers a streamlined silhouette brimming with mid-century modern style.
- A rounded arch gently curves around and under the seat to give extra support to user's upper back and sides, while creating an open clean out space at the back of the cushion.
- Tapered legs add style and elegance.
- Legs are available in wood or metal paint/plated finishes (noted).
- The seat underside is sealed with a non-porous material to support housekeeping and infection control protocols.
- Additional improved cleaning options include sealed seams (back and/or seat) and moisture barrier (seat). Upcharges apply.
- Assembled with tamper-resistant fasteners for greater security.
- For added comfort, seat cushions are standard with high density Ultracell foam.
- Glides are self-leveling. Choose from standard non-marking glides, rubber non-slip glides or felt glides (upcharges apply).
- For healthcare textiles, visit the website at [globalfurnituregroup.com](http://globalfurnituregroup.com).
- Can be upholstered in standard Global textiles if Healthcare 24/7 application compliance is not required.
- Shipped fully assembled.

SUGGESTED APPLICATIONS

- Dining/Cafeteria
- Guest seating
- Lobbies
- Lounge/Waiting
- Patient rooms
- Resident rooms

OPTIONAL FEATURES

Please add option codes in the following order:

- **Model number**  
**GC36530** Guest armless chair, wood legs  
**GC36531** Guest armless chair, metal legs  
**GC3632** Guest armchair, wood legs  
**GC3632** Guest armchair, metal legs
- **Sealed back seams**  
**(NS)** No sealed back seams  
**(SS)** Sealed back seams. Upcharges vary, see model. Add \$43.
- **Back textile**  
Specify textile code.
- **Sealed seat seams**  
**(NS)** No sealed seat seams  
**(SS)** Sealed seat seams. Add \$17.
- **Seat textile**  
Specify textile code.
- **Wood leg finish** (models GC36530 and GC36532)  
**(AAM)** Absolute **(MWM)** Medium Walnut  
**(BKM)** Black **(NLW)** Natural Walnut  
**(CJM)** Charcoal Java **(ASM)** Night  
**(ACM)** Cherry **(NBM)** Noce Biondo  
**(EMM)** Empire Mahogany **(NGM)** Noce Grigio  
**(EOM)** English Oak **(NEM)** Noce Leggero  
**(ECM)** Espresso Cafe **(NMM)** Noce Medio  
**(TFM)** Fruitwood **(SBM)** Sandy Beach  
**(HGM)** Gray **(SKM)** Shaker Cherry  
**(HOM)** Harvest Oak **(SOM)** Silver Oak  
**(AHM)** Honey **(TWM)** Walnut  
**(JOM)** Jet Onyx **(WTM)** WC Cream  
**(LHM)** Light Honey **(WHM)** White  
**(TMM)** Mahogany **(WCM)** Winter Cherry  
**(AVM)** Maple
- **Metal leg finish** (models GC36531 and GC36533)  
**(CHM)** Chrome **(TTU)** Tungsten  
**(TBL)** Black **(TKA)** Kalua  
**(TLA)** Latte **(TMO)** Mocha  
**(TSH)** Shadow **(TOA)** Toast
- **Glides**  
**(NM)** Non-marking glides. No upcharge  
**(RG)** Rubber, non-slip glides. Add \$43.  
**(FG)** Felt glides. Add \$43.
- **Moisture barrier**  
**(NB)** No moisture barrier. No upcharge.  
**(MB)** Moisture barrier (seat only). Add \$81.

EXAMPLE ERIN ORDER CODE:

GC36530	NS	CE90	NS	CE90	AAM	NM	NB
Model #	Sealed back seams	Back textile	Sealed seat seams	Seat textile	Leg finish	Glides	Moisture barrier

DESCRIPTION	MODEL# / FEATURES	STANDARD TEXTILE GRADES											
		1	2	3	4	5	6	7	8	9	10	11	12
 <b>Armless Guest Chair, Wood Legs</b> COM: 2.75 YD   2.51 M Unit weight: 23.5 LB   10.7 KG Carton weight: 32.5 LB   14.74 KG Carton volume: 13.25 FT³   0.37 MT³	<b>GC36530</b>	1509	1597	1671	1757	1897	2026	2155	2268	2408	2540	2719	2972
	Active weight 350 lbs.	<b>OVERALL DIMENSIONS</b> W D H			<b>SEAT DIMENSIONS</b> W D H			<b>BACK DIMENSIONS</b> W H					
		IN 24	22.25	34	19	18	19	15	15.5				
		MM 610	565	864	483	457	483	381	394				
		<b>RTA 00</b>		1 per carton									

DESCRIPTION MODEL# / FEATURES STANDARD TEXTILE GRADES



**Armless Guest Chair, Metal Legs**  
 COM: 2.75 YD | 2.51 M  
 Unit weight: 25.5 LB | 11.6 KG  
 Carton weight: 34.5 LB | 15.65 KG  
 Carton volume: 13.25 FT<sup>3</sup> | 0.37 MT<sup>3</sup>

Active weight 350 lbs.

MODEL#	1	2	3	4	5	6	7	8	9	10	11	12
<b>GC36531</b>	1428	1516	1590	1676	1816	1945	2074	2187	2327	2459	2638	2891

OVERALL DIMENSIONS			SEAT DIMENSIONS			BACK DIMENSIONS	
W	D	H	W	D	H	W	H

IN	24	22.25	34	19	18	19	15	15.5
MM	610	565	864	483	457	483	381	394

**RTA 00** 1 per carton



**Guest Armchair, Wood Legs**  
 COM: 2.75 YD | 2.51 M  
 Unit weight: 24 LB | 10.9 KG  
 Carton weight: 33 LB | 14.97 KG  
 Carton volume: 13.25 FT<sup>3</sup> | 0.37 MT<sup>3</sup>

Active weight 350 lbs.

MODEL#	1	2	3	4	5	6	7	8	9	10	11	12
<b>GC36532</b>	1509	1597	1671	1757	1897	2026	2155	2268	2408	2540	2719	2972

OVERALL DIMENSIONS			SEAT DIMENSIONS			BACK DIMENSIONS	
W	D	H	W	D	H	W	H

IN	24	22	34.25	19	18.5	18.5	17	15.75
MM	610	559	870	483	470	470	432	400

**RTA 00** 1 per carton



**Guest Armchair, Metal Legs**  
 COM: 2.75 YD | 2.51 M  
 Unit weight: 26 LB | 11.8 KG  
 Carton weight: 35 LB | 15.88 KG  
 Carton volume: 13.25 FT<sup>3</sup> | 0.37 MT<sup>3</sup>

Active weight 350 lbs.

MODEL#	1	2	3	4	5	6	7	8	9	10	11	12
<b>GC36533</b>	1428	1516	1590	1676	1816	1945	2074	2187	2327	2459	2638	2891

OVERALL DIMENSIONS			SEAT DIMENSIONS			BACK DIMENSIONS	
W	D	H	W	D	H	W	H

IN	24	22	34.25	19	18.5	18.5	17	15.75
MM	610	559	870	483	470	470	432	400

**RTA 00** 1 per carton



FROLICK & SPLASH



model GC3001

model GC3011

Three different back constructions



**Separate panel piece** closes the lower back to conceal the support bracket. Offered on select **Frolick** models.



**Single piece back** with a pullover style upholstery cover and exposed support brackets fastened on the outer back. Offered on select **Frolick** models.



**Two-piece back** covering the back support brackets when fastened in place. Offered on **Splash** models.

STANDARD FEATURES

- Frolick & Splash are multi-purpose stacking chairs that share generous widths between the arms, great comfort and a frame built for greater strength and stability. Each series offers a different back design with special features to best address the application and infection prevention practices.
- Four-legged standard size models stack 5 high on floor and 8 high on GC3010 dolly.
- Four-legged bariatric models stack 2 high only on floor. No dolly available.
- Sled base models do not stack.
- Standard size models offer 19" seat width with 21.5" clearance between the armrests. Bariatric size models (Frolick) offer 31.5" seat width with 33.5" clearance between the armrests.
- For a smaller scale bariatric chair, refer to GC Comet #GC2180 which offers 18.5" seat depth with 28" clearance between armrests.
- Heavy duty round, tubular gusseted frames available. Please specify finish.
- Active weight capacity is up to 300 lbs. for standard models; 500 lbs. for bariatric models.
- Protective Platinum color seat shroud is standard on all models (except bariatric models GC3003 and GC3023).
- To respond to higher expectations for housekeeping and infection control practices, select models with a one-piece back. Description of back is noted with each model.
- Wall saver rear legs eliminate accidental damage to walls.
- Armrests are fiberglass reinforced nylon and have a flat profile. Fully extended to front of seat edge to assist in entry and exit from the chair.
- Armrests are standard in Black.
- For added comfort, seats are standard with high density Ultracell foam.
- For ganging brackets, see model 2180 on page 122.
- Black frames are standard with Black glides and front leg caps on armless models. All other frame colors are standard with Platinum glides and front leg caps on armless models.
- For healthcare textile and finish options, visit the website at globalfurnituregroup.com.
- Can be upholstered in standard Global textiles if Healthcare compliance is not required.

OPTIONAL FEATURES

- A selection of glide options is available. Glides must be chosen to best suit flooring type and site conditions. For more information, please refer to the glide section (page 265).
- For hard surface floors, please specify opaque non-marking glides (**NM**). No upcharge.
- Glides with felt pads (**FG**) are available for vinyl sheet, cork or laminate flooring, please specify. Add \$43.
- Glides with rubber pads (**RG**) are available for vinyl, hardwood, laminate, stone or ceramic flooring, please specify. Add \$43.
- Armrests available in Shadow (**SHW**) and Toast (**TOA**). Please specify. Add \$25.
- To add sealed seams to your product contact Customer Service. Pricing is based on the model number, available on the website Build It tool.
- For moisture barrier on seat, please specify (**MB**). Add \$81. Bariatric models: Add \$122.
- For improved housekeeping and infection control practices sealed underside (**SU**) on the seat shroud can be removed and the underside of the seat can be finished with vinyl and sealed to prevent penetration of liquids. The back seam that closes upholstery on underside of the back will also be sealed.
- **Frame finish**  
Paint finishes. No upcharge.  
(**TBL**) Black (TIN) Ink  
(**TBZ**) Buzz Blue (TKA) Kalua  
(**TCC**) Cactus (TLA) Latte  
(**TCR**) Carrot (TMO) Mocha  
(**TIV**) Cloud (TNE) Nevada  
(**TDW**) Designer White (TSN) Sand  
(**TDJ**) Dijon (TSR) Scarlet  
(**TEG**) Eggplant (TSH) Shadow  
(**TFO**) Fog (TOA) Toast  
(**TFR**) Frost (TTU) Tungsten  
Plated finish. See models for upcharges.  
(**CHM**) Chrome

SUGGESTED APPLICATIONS

- Bariatric seating (Frolick)
- Dining/Cafeteria
- Guest seating
- Lobbies
- Lounge/Waiting
- Office/Meeting
- Patient rooms
- Resident rooms
- Stacking
- Treatment/Exam rooms

DESCRIPTION



**Frolick Stacking Armchair, Four-Legged**  
COM: 1.25 YD | 1.14 M  
Unit weight: 22 LB | 10 KG  
Carton weight: 25.67 LB | 11.64 KG  
Carton volume: 24 FT³ | 0.67 MT³

MODEL# / FEATURES

**GC3001**  
2-piece rectangular back

Active weight 300 lbs.  
Stacks 5 high on floor.  
Chrome (CHM) frame finish, add \$147

STANDARD TEXTILE GRADES

COM	2	3	4	5	6	7	8	9	10	11	12
491	531	565	604	668	726	785	836	900	960	1041	1156

OVERALL DIMENSIONS SEAT DIMENSIONS BACK DIMENSIONS

	W	D	H	W	D	H	W	H
IN	25	24.5	36	19	18	18.5	19.5	17
MM	635	622	914	483	457	470	495	432

RTA 00

3 per carton (pricing and specifications are for one chair)

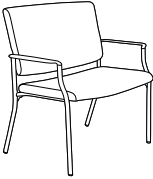

DESCRIPTION	MODEL# / FEATURES	STANDARD TEXTILE GRADES											
		COM	2	3	4	5	6	7	8	9	10	11	12
 <p><b>Frolick Stacking Armless Chair, Four-Legged</b> COM: 1.25 YD   1.14 M Unit weight: 20 LB   9.1 KG Carton weight: 23.67 LB   10.74 KG Carton volume: 24 FT³   0.67 MT³</p>	<p><b>GC3002</b> 2-piece rectangular back</p>	452	492	526	565	629	687	746	797	861	921	1002	1117
		<b>OVERALL DIMENSIONS</b>			<b>SEAT DIMENSIONS</b>			<b>BACK DIMENSIONS</b>					
		<b>W</b>	<b>D</b>	<b>H</b>	<b>W</b>	<b>D</b>	<b>H</b>	<b>W</b>	<b>H</b>				
		IN 21 MM 533	24.5 622	36 914	19 483	18 457	18.5 470	19.5 495	17 432				
<p>Active weight 300 lbs. Stacks 5 high on floor. Chrome (CHM) frame finish, add \$132</p>		<b>RTA 00</b>	3 per carton (pricing and specifications are for one chair)										

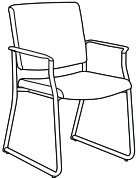
DESCRIPTION	MODEL# / FEATURES	STANDARD TEXTILE GRADES											
		COM	2	3	4	5	6	7	8	9	10	11	12
 <p><b>Frolick Bariatric Armchair, Four-Legged</b> COM: 2.25 YD   2.06 M Unit weight: 35 LB   15.9 KG Carton weight: 46 LB   20.87 KG Carton volume: 28.25 FT³   0.79 MT³</p>	<p><b>GC3003</b> 2-piece rectangular back</p>	1133	1205	1266	1336	1450	1556	1662	1754	1869	1977	2123	2330
		<b>OVERALL DIMENSIONS</b>			<b>SEAT DIMENSIONS</b>			<b>BACK DIMENSIONS</b>					
		<b>W</b>	<b>D</b>	<b>H</b>	<b>W</b>	<b>D</b>	<b>H</b>	<b>W</b>	<b>H</b>				
		IN 37 MM 940	24.5 622	36.5 927	31.5 800	18 457	18.5 470	32 813	18.5 470				
<p>Active weight 500 lbs. Stacks 2 high. Chrome (CHM) frame finish, add \$206</p>		<b>RTA 00</b>	1 per carton										

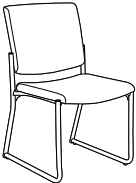
DESCRIPTION	MODEL# / FEATURES	STANDARD TEXTILE GRADES											
		COM	2	3	4	5	6	7	8	9	10	11	12
 <p><b>Frolick Armchair, Sled Base</b> COM: 1.25 YD   1.14 M Unit weight: 26 LB   11.8 KG Carton weight: 36 LB   16.33 KG Carton volume: 15.5 FT³   0.43 MT³</p>	<p><b>GC3021</b> 2-piece rectangular back</p>	554	594	628	667	731	789	848	899	963	1023	1104	1219
		<b>OVERALL DIMENSIONS</b>			<b>SEAT DIMENSIONS</b>			<b>BACK DIMENSIONS</b>					
		<b>W</b>	<b>D</b>	<b>H</b>	<b>W</b>	<b>D</b>	<b>H</b>	<b>W</b>	<b>H</b>				
		IN 25 MM 635	24.5 622	36 914	18 457	17 432	18.5 470	18.75 476	18 457				
<p>Active weight 300 lbs. Does not stack. Chrome (CHM) frame finish, add \$176</p>		<b>RTA 00</b>	1 per carton										

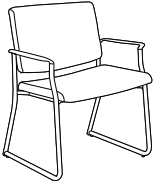
DESCRIPTION	MODEL# / FEATURES	STANDARD TEXTILE GRADES											
		COM	2	3	4	5	6	7	8	9	10	11	12
 <p><b>Frolick Armless Chair, Sled Base</b> COM: 1.25 YD   1.14 M Unit weight: 25 LB   11.4 KG Carton weight: 35 LB   15.88 KG Carton volume: 15.5 FT³   0.43 MT³</p>	<p><b>GC3022</b> 2-piece rectangular back</p>	511	551	585	624	688	746	805	856	920	980	1061	1176
		<b>OVERALL DIMENSIONS</b>			<b>SEAT DIMENSIONS</b>			<b>BACK DIMENSIONS</b>					
		<b>W</b>	<b>D</b>	<b>H</b>	<b>W</b>	<b>D</b>	<b>H</b>	<b>W</b>	<b>H</b>				
		IN 21 MM 533	24.5 622	36 914	19 483	18 457	18.5 470	19.5 495	17 432				
<p>Active weight 300 lbs. Does not stack. Chrome (CHM) frame finish, add \$158</p>		<b>RTA 00</b>	1 per carton										

DESCRIPTION	MODEL# / FEATURES	STANDARD TEXTILE GRADES											
		COM	2	3	4	5	6	7	8	9	10	11	12
 <p><b>Frolick Bariatric Armchair, Sled Base</b> COM: 2.25 YD   2.06 M Unit weight: 40 LB   18.2 KG Carton weight: 51 LB   23.13 KG Carton volume: 28.25 FT³   0.79 MT³</p>	<p><b>GC3023</b> 2-piece rectangular back</p>	1190	1262	1323	1393	1507	1613	1719	1811	1926	2034	2180	2387
		<b>OVERALL DIMENSIONS</b>			<b>SEAT DIMENSIONS</b>			<b>BACK DIMENSIONS</b>					
		<b>W</b>	<b>D</b>	<b>H</b>	<b>W</b>	<b>D</b>	<b>H</b>	<b>W</b>	<b>H</b>				
		IN 37 MM 940	24.5 622	36.5 927	31.5 800	18 457	18.5 470	32 813	18.5 470				
<p>Active weight 500 lbs. Does not stack. Chrome (CHM) frame finish, add \$247</p>		<b>RTA 00</b>	1 per carton										

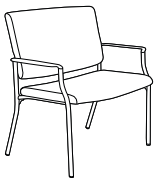
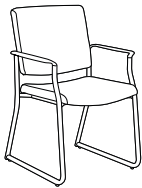
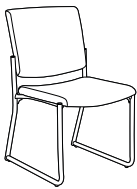
DESCRIPTION	MODEL# / FEATURES	STANDARD TEXTILE GRADES											
		COM	2	3	4	5	6	7	8	9	10	11	12
 <p><b>Frolick Stacking Armchair, Four-Legged</b>                      COM: 1.25 YD   1.14 M                      Unit weight: 22 LB   10 KG                      Carton weight: 25.67 LB   11.64 KG                      Carton volume: 24 FT³   0.67 MT³</p>	<b>GC3031</b> 1-piece rectangular back	491	531	565	604	668	726	785	836	900	960	1041	1156
	<p>Active weight 300 lbs.</p> <p>Stacks 5 high on floor.                      Chrome (CHM) frame finish, add \$147</p>	<p>IN 25 24.5 36 19 18 18.5 19.5 17                      MM 635 622 914 483 457 470 495 432</p>	<p><b>OVERALL DIMENSIONS</b> W D H</p>	<p><b>SEAT DIMENSIONS</b> W D H</p>	<p><b>BACK DIMENSIONS</b> W H</p>								
	<p><b>RTA 00</b> 3 per carton (pricing and specifications are for one chair)</p>												
 <p><b>Frolick Stacking Armless Chair, Four-Legged</b>                      COM: 1.25 YD   1.14 M                      Unit weight: 19 LB   8.6 KG                      Carton weight: 22.67 LB   10.28 KG                      Carton volume: 24 FT³   0.67 MT³</p>	<b>GC3032</b> 1-piece rectangular back	452	492	526	565	629	687	746	797	861	921	1002	1117
	<p>Active weight 300 lbs.</p> <p>Stacks 5 high on floor.                      Chrome (CHM) frame finish, add \$132</p>	<p>IN 21 24.5 36 19 18 18.5 19.5 17                      MM 533 622 914 483 457 470 495 432</p>	<p><b>OVERALL DIMENSIONS</b> W D H</p>	<p><b>SEAT DIMENSIONS</b> W D H</p>	<p><b>BACK DIMENSIONS</b> W H</p>								
	<p><b>RTA 00</b> 3 per carton (pricing and specifications are for one chair)</p>												
 <p><b>Frolick Bariatric Stacking Armchair, Four-Legged</b>                      COM: 2.25 YD   2.06 M                      Unit weight: 35 LB   15.9 KG                      Carton weight: 46 LB   20.87 KG                      Carton volume: 28.25 FT³   0.79 MT³</p>	<b>GC3033</b> 1-piece rectangular back	1133	1205	1266	1336	1450	1556	1662	1754	1869	1977	2123	2330
	<p>Active weight 500 lbs.</p> <p>Stacks 2 high.                      Chrome (CHM) frame finish, add \$206</p>	<p>IN 37 24.5 36.5 31.5 18 18.5 32 18.5                      MM 940 622 927 800 457 470 813 470</p>	<p><b>OVERALL DIMENSIONS</b> W D H</p>	<p><b>SEAT DIMENSIONS</b> W D H</p>	<p><b>BACK DIMENSIONS</b> W H</p>								
	<p><b>RTA 00</b> 1 per carton</p>												
 <p><b>Frolick Armchair, Sled Base</b>                      COM: 1.25 YD   1.14 M                      Unit weight: 26 LB   11.8 KG                      Carton weight: 36 LB   16.33 KG                      Carton volume: 15.5 FT³   0.43 MT³</p>	<b>GC3034</b> 1-piece rectangular back	554	594	628	667	731	789	848	899	963	1023	1104	1219
	<p>Active weight 300 lbs.</p> <p>Does not stack.                      Chrome (CHM) frame finish, add \$176</p>	<p>IN 25 24.5 36 18 17 18.5 18.75 18                      MM 635 622 914 457 432 470 476 457</p>	<p><b>OVERALL DIMENSIONS</b> W D H</p>	<p><b>SEAT DIMENSIONS</b> W D H</p>	<p><b>BACK DIMENSIONS</b> W H</p>								
	<p><b>RTA 00</b> 1 per carton</p>												
 <p><b>Frolick Armless Chair, Sled Base</b>                      COM: 1.25 YD   1.14 M                      Unit weight: 25 LB   11.4 KG                      Carton weight: 35 LB   15.88 KG                      Carton volume: 15.5 FT³   0.43 MT³</p>	<b>GC3035</b> 1-piece rectangular back	511	551	585	624	688	746	805	856	920	980	1061	1176
	<p>Active weight 300 lbs.</p> <p>Does not stack.                      Chrome (CHM) frame finish, add \$158</p>	<p>IN 21 24.5 36 19 18 18.5 19.5 17                      MM 533 622 914 483 457 470 495 432</p>	<p><b>OVERALL DIMENSIONS</b> W D H</p>	<p><b>SEAT DIMENSIONS</b> W D H</p>	<p><b>BACK DIMENSIONS</b> W H</p>								
	<p><b>RTA 00</b> 1 per carton</p>												

DESCRIPTION MODEL# / FEATURES STANDARD TEXTILE GRADES

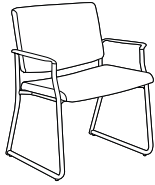

**Frolick Bariatric Armchair, Sled Base**  
 COM: 2.25 YD | 2.06 M  
 Unit weight: 40 LB | 18.2 KG  
 Carton weight: 51 LB | 23.13 KG  
 Carton volume: 28.25 FT³ | 0.79 MT³

COM	2	3	4	5	6	7	8	9	10	11	12	
GC3036	1190	1262	1323	1393	1507	1613	1719	1811	1926	2034	2180	2387

1-piece rectangular back

OVERALL DIMENSIONS			SEAT DIMENSIONS			BACK DIMENSIONS	
W	D	H	W	D	H	W	H

IN	37	24.5	36.5	31.5	18	18.5	32	18.5
MM	940	622	927	800	457	470	813	470
				<b>RTA 00</b>	1 per carton			

Active weight 500 lbs.

Does not stack.  
 Chrome (CHM) frame finish, add \$247



**Splash Stacking Armchair, Four-Legged**  
 COM: 1.25 YD | 1.14 M  
 Unit weight: 23 LB | 10.5 KG  
 Carton weight: 26.67 LB | 12.1 KG  
 Carton volume: 24 FT³ | 0.67 MT³

COM	2	3	4	5	6	7	8	9	10	11	12	
GC3011	491	531	565	604	668	726	785	836	900	960	1041	1156

2-piece fan back

OVERALL DIMENSIONS			SEAT DIMENSIONS			BACK DIMENSIONS	
W	D	H	W	D	H	W	H

IN	25	24.25	35.5	19.5	18.5	18.5	20	17.5
MM	635	616	902	495	470	470	508	445
				<b>RTA 00</b>	3 per carton (pricing and specifications are for one chair)			

Active weight 300 lbs.

Stacks 5 high on floor.  
 Chrome (CHM) frame finish, add \$147



**Splash Stacking Armless Chair, Four-Legged**  
 COM: 1.25 YD | 1.14 M  
 Unit weight: 21 LB | 9.5 KG  
 Carton weight: 24.67 LB | 11.19 KG  
 Carton volume: 24 FT³ | 0.67 MT³

COM	2	3	4	5	6	7	8	9	10	11	12	
GC3012	452	492	526	565	629	687	746	797	861	921	1002	1117

2-piece fan back

OVERALL DIMENSIONS			SEAT DIMENSIONS			BACK DIMENSIONS	
W	D	H	W	D	H	W	H

IN	21	24.25	35.5	19.5	18.5	18.5	20	17.5
MM	533	616	902	495	470	470	508	445
				<b>RTA 00</b>	3 per carton (pricing and specifications are for one chair)			

Active weight 300 lbs.

Stacks 5 high on floor.  
 Chrome (CHM) frame finish, add \$132



**Splash Armchair, Sled Base**  
 COM: 1.25 YD | 1.14 M  
 Unit weight: 28 LB | 12.7 KG  
 Carton weight: 36.5 LB | 16.56 KG  
 Carton volume: 15.5 FT³ | 0.43 MT³

COM	2	3	4	5	6	7	8	9	10	11	12	
GC3013	554	594	628	667	731	789	848	899	963	1023	1104	1219

2-piece fan back

OVERALL DIMENSIONS			SEAT DIMENSIONS			BACK DIMENSIONS	
W	D	H	W	D	H	W	H

IN	25	24.25	35.5	19.5	18.5	18.5	20	17.5
MM	635	616	902	495	470	470	508	445
				<b>RTA 00</b>	1 per carton			

Active weight 300 lbs.

Does not stack.  
 Chrome (CHM) frame finish, add \$176

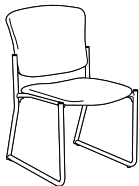

**Splash Side Armless Chair, Sled Base**  
 COM: 1.25 YD | 1.14 M  
 Unit weight: 26 LB | 11.8 KG  
 Carton weight: 36 LB | 16.33 KG  
 Carton volume: 15.5 FT³ | 0.43 MT³

COM	2	3	4	5	6	7	8	9	10	11	12	
GC3014	511	551	585	624	688	746	805	856	920	980	1061	1176



2-piece fan back

OVERALL DIMENSIONS			SEAT DIMENSIONS			BACK DIMENSIONS	
W	D	H	W	D	H	W	H

IN	21	24.25	35.5	19.5	18.5	18.5	20	17.5
MM	533	616	902	495	470	470	508	445
				<b>RTA 00</b>	1 per carton			

Active weight 300 lbs.

Does not stack.  
 Chrome (CHM) frame finish, add \$158

DESCRIPTION	MODEL# / FEATURES	STANDARD TEXTILE GRADES									
		List price									
	<b>GC3010</b>	293									
			OVERALL DIMENSIONS			SEAT DIMENSIONS			BACK DIMENSIONS		
			W	D	H	W	D	H	W	H	
<b>Dolly for Frolick or Splash</b> COM: - YD   - M Unit weight: 13 LB   5.9 KG Carton weight: 16 LB   7.26 KG Carton volume: 3.8 FT <sup>3</sup>   0.1 MT <sup>3</sup>	Standard size, four-legged models (only) stack 8 high.	IN 23.25	24.75	12.25	-	-	-	-	-		
		MM 591	629	311	-	-	-	-	-		
		<span style="background-color: black; color: white; padding: 2px;">RTA 1</span>		1 per carton							

GC BEACH



model GC4077



model GC4078

STANDARD FEATURES



- Elegant wood seating with a choice of an upholstered or vertical wood slat back.
- Frame construction is beech hardwood.
- Legs are equipped with White non-marking polypropylene glides. Suitable for both carpet and hard surface flooring.
- All cushions are fixed and non-removable.
- Cushions are made with highly resilient foam and seats are equipped with a synthetic rubberized webbing suspension system for extra comfort.
- Seat cushion underside is finished with Black polyurethane.
- Does not stack.
- Can be upholstered in standard Global textiles if healthcare compliance is not required.

OPTIONAL FEATURES

- Wood frame available in Absolute (AAM), Black (BKM), Cherry (ACM), English Oak (EOM), Espresso Cafe (ECM), Fruitwood (TFM), Gray (HGM), Honey (AHM), Mahogany (TMM), Maple (AVM), Medium Walnut (MWM), Natural Walnut (NLW), Night (ASM), Noce Biondo (NBM), Noce Grigio (NGM), Noce Leggero (NEM), Noce Medio (NMM), Sandy Beach (SBM), Shaker Cherry (SKM), Silver Oak (SOM), Walnut (TWM), WC Cream (WTM), White (WHM) and Winter Cherry (WCM). Please specify.
- For moisture barrier on seat, please specify **(MB)**. Add \$81 per seat.

SUGGESTED APPLICATIONS

- Dining/Cafeteria
- Guest seating
- Lobbies
- Lounge/Waiting
- Office/Meeting
- Patient rooms
- Resident rooms

DESCRIPTION	MODEL# / FEATURES	STANDARD TEXTILE GRADES												
		COM	2	3	4	5	6	7	8	9	10	11	12	
 <p><b>Armchair w/Upholstered Back</b> COM: 1 YD   0.91 M Unit weight: 15 LB   6.8 KG Carton weight: 20 LB   9.07 KG Carton volume: 14.75 FT<sup>3</sup>   0.41 MT<sup>3</sup></p>	<b>GC4077</b>	838	870	897	928	979	1026	1073	1114	1165	1213	1278	1370	
		<b>OVERALL DIMENSIONS</b>			<b>SEAT DIMENSIONS</b>			<b>BACK DIMENSIONS</b>						
		<b>W</b>	<b>D</b>	<b>H</b>	<b>W</b>	<b>D</b>	<b>H</b>	<b>W</b>	<b>H</b>					
		IN 22	22.25	33.5	19.5	18.5	18.75	19.5	15.5					
		MM 559	565	851	495	470	476	495	394					
		<b>RTA 00</b>		1 per carton										
 <p><b>Armchair w/Vertical Wood Slat Back</b> COM: 1 YD   0.91 M Unit weight: 15 LB   6.8 KG Carton weight: 20 LB   9.07 KG Carton volume: 14.75 FT<sup>3</sup>   0.41 MT<sup>3</sup></p>	<b>GC4078</b>	838	870	897	928	979	1026	1073	1114	1165	1213	1278	1370	
		<b>OVERALL DIMENSIONS</b>			<b>SEAT DIMENSIONS</b>			<b>BACK DIMENSIONS</b>						
		<b>W</b>	<b>D</b>	<b>H</b>	<b>W</b>	<b>D</b>	<b>H</b>	<b>W</b>	<b>H</b>					
		IN 22	22.25	33.5	19.5	19	18.75	19.5	15.5					
		MM 559	565	851	495	483	476	495	394					
		<b>RTA 00</b>		1 per carton										

## GC BELONG



model GC4231

model GC4231HB

## STANDARD FEATURES

- The GC Belong series was developed for active and transient environments with rigorous demands.
- Elliptical metal tube frame. Available in Black (TBL), Cloud (TIV), Designer White (TDW), Fog (TFO), Frost (TFR), Kalua (TKA), Latte (TLA), Mocha (TMO), Nevada (TNE), Sand (TSN), Shadow (TSH), Toast (TOA) and Tungsten (TTU). Please specify.
- Urethane armcaps are available in Black (BLK), Kalua (KAL), Latte (LAB), Mocha (J52), Shadow (SHW) and Toast (TOA). Please specify. Wood armcaps are also available in all healthcare wood finishes. Please specify. For upcharge refer to individual models.
- The frame can be weighted and made with tamperproof fasteners for greater security in more challenging mental health spaces or correctional facilities. Request a special quote.
- The seat and back are removable and field replaceable.
- For added comfort, seats are standard with high density Ultracell foam.
- All seat frames feature a wall saver design to prevent back contact with wall. **Note:** In order to allow full flex of the back on models GC4242, GC4242HB, GC4243 and GC4243HB, a 10.5" wall clearance is required.
- Ottomans and benches do not have wall saver legs.
- Seat height on standard models and benches is 18".
- Seat height on GC4231-24 and GC4241-24 is 24".
- Standard with Black glides.
- Select models are offered with **rear tip and move wheels**. To activate wheels, tilt the chair back so the wheels are in contact with the floor. This feature makes it easy to relocate the chair while unoccupied.
- Clean out space is provided between the seat and back cushions for easy housekeeping.

- Left and right position reference is determined from the seated position.
- Flex back models feature a torsion control mechanism which allows the back to move 14° in a soothing rocking motion.
- For healthcare textiles and wood finish options, visit the website at [globalfurnituregroup.com](http://globalfurnituregroup.com).
- Can be upholstered in standard Global textiles if healthcare compliance is not required.

## OPTIONAL FEATURES

- For hard surface floors, please specify opaque non-marking glides (**NM**). No upcharge.
- For moisture barrier on seat, please specify (**MB**). Add \$81 per seat. For bariatric models, add \$122 per seat.
- For improved housekeeping and infection control practices, please add (**SU**) to model number. The underside of the seat will be finished with vinyl and sealed to prevent penetration of liquids. For standard models: Add \$35. For bariatric models: Add \$47. Upcharges may vary.

## SUGGESTED APPLICATIONS

- Bariatric seating
- Guest seating
- Lobbies
- Lounge/Waiting
- Patient rooms
- Resident rooms
- Treatment/Exam rooms

For freestanding GC Belong tables, see page 42

## GC BELONG BENCHES &amp; BRIDGES

- Units with links can only gang with a bridge. They cannot gang directly with another link unit. (Link units have side brackets.)
- Available in one, two or three seat models.
- A bridge unit suspends between two other units using their links. A bridge is not freestanding. (A bridge does not have legs.)
- Benches have no front or back facing distinction, so models with links can be reversed.
- All bridge models can be ganged to seat units with link.

## GC BELONG MODULAR TABLES

- Table heights are 16".
- 1" thick tops are available in thermally fused laminate (LP) and high pressure laminate (HP). Please select the appropriate model number for the finish you prefer.
- 2mm edging color coordinated with laminate finish is standard for all tops. Finish must be specified at the time of order.
- Refer to the following lists when selecting a finish color. Must specify both a top color and leg finish at time of order.



















## Thermally Fused Laminate (LP)

Absolute Acajou (ACJ)  
 Asian Night (ASN)  
 Avant Cherry (AWC)  
 Avant Honey (AWH)  
 Brushed Cobalt (BRC)  
 Clear Maple (CMB)  
 Dark Espresso (DES)  
 Designer White (DWT)  
 Fashionista (FAS)  
 First Class (FCL)  
 Quartered Mahogany (QTM)  
 Noce Biondo (NBL)  
 Noce Grigio (NGL)  
 Noce Leggero (NEL)  
 Noce Medio (NML)  
 Sheer Beauty (SBY)  
 Walnut Heights (WHE)  
 White Chocolate (WHC)  
 Winter Cherry (WCR)

## High Pressure Laminate (HP)













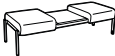



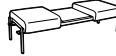







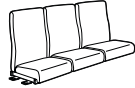



Absolute Acajou (ACJ)  
 Asian Night (ASN)  
 Avant Cherry (W357)  
 Avant Honey (W356)  
 Brushed Cobalt (BRC)  
 Clear Maple (CMB)  
 Dark Espresso (W142)  
 Designer White (DWT)  
 Fashionista (FAS)  
 First Class (FCL)  
 Quartered Mahogany (QTM)  
 Noce Biondo (NBL)  
 Noce Grigio (NGL)  
 Noce Leggero (NEL)  
 Noce Medio (NML)  
 Sheer Beauty (SBY)  
 Walnut Heights (WHE)  
 White Chocolate (WHC)  
 Winter Cherry (WCR)

	one seater armless	one seater two arms	two seater two arms	two seater three arms	three seater two arms	three seater four arms	two seater one table, two arms
<b>LOW BACK</b>							
Freestanding units	GC4230 	GC4231 	GC4232 	GC4234 	GC4233 	GC4235 	GC4236 
Ganging units with link on left side		GC4231L 	GC4232L 	GC4234L 	GC4233L 	GC4235L 	GC4236L 
Ganging units with link on right side		GC4231R 	GC4232R 	GC4234R 	GC4233R 	GC4235R 	GC4236R 
Ganging units with links on both sides		GC4231B 	GC4232B 	GC4234B 	GC4233B 	GC4235B 	GC4236B 
<b>HIGH BACK</b>							
Freestanding units	GC4230HB 	GC4231HB 	GC4232HB 	GC4234HB 	GC4233HB 	GC4235HB 	GC4236HB 
Ganging units with link on left side		GC4231HBL 	GC4232HBL 	GC4234HBL 	GC4233HBL 	GC4235HBL 	GC4236HBL 
Ganging units with link on right side		GC4231HBR 	GC4232HBR 	GC4234HBR 	GC4233HBR 	GC4235HBR 	GC4236HBR 
Ganging units with links on both sides		GC4231HBB 	GC4232HBB 	GC4234HBB 	GC4233HBB 	GC4235HBB 	GC4236HBB 













<b>SPECIALTY</b>							
Freestanding units with casters	GC4240 	GC4240HB 	Ganging bariatric units with link on left side		GC4241L 	GC4241HBL 	
Freestanding Bariatric units	GC4241 	GC4241HB 	Ganging bariatric units with link on right side		GC4241R 	GC4241HBR 	GC4244HB 
Freestanding flex back units	GC4242 	GC4242HB 	Ganging bariatric units with link on both sides		GC4241B 	GC4241HBB 	GC4245HB 
Freestanding flex back units with casters	GC4243 	GC4243HB 	Hip height chair with wedged cushion 24" seat height		GC4231-24 	GC4241-24 (bariatric) 	



**BENCHES & BRIDGES**

	GC4251	GC4252	GC4253	GC4256			
Freestanding units							
	GC4251L	GC4252L	GC4253L	GC4256L			
Ganging units with reversible hook/link							
	GC4251B	GC4252B	GC4253B	GC4256B			
Ganging units with hooks on both sides							
	GC4259						
Ottoman							
	GC4261HB	GC4262HB	GC4264HB	GC4263HB	GC4265HB	GC4266HB	GC4269HB (bariatric)
HB add on bridge, no legs							
	GC4261	GC4262	GC4264	GC4263	GC4265	GC4266	GC4269 (bariatric)
LB add on bridge, no legs							
	GC4271	GC4272	GC4273	GC4276			
Bench add on bridge, no legs							

**TABLES**

	GC4281-LP GC4281-HP	GC4282-LP GC4282-HP	GC4283-LP GC4283-HP	GC4284-LP GC4284-HP	GC4288-LP GC4288-HP
Freestanding					
	GC4285-LP GC4285-HP	GC4286-LP GC4286-HP	GC4287-LP GC4287-HP		
					
	GC4274-LP GC4274-HP	GC4275-LP GC4275-HP	GC4277-LP GC4277-HP	GC4278-LP GC4278-HP	
Bridges					

- A bridge unit suspends between two other units with legs and is supported by their linking brackets.
- A bridge unit is **not** freestanding and cannot be made freestanding.
- Units with legs and links can only gang with a bridge. They **cannot** gang directly with another link unit with legs.
- Bridges **cannot** gang directly with another bridge.

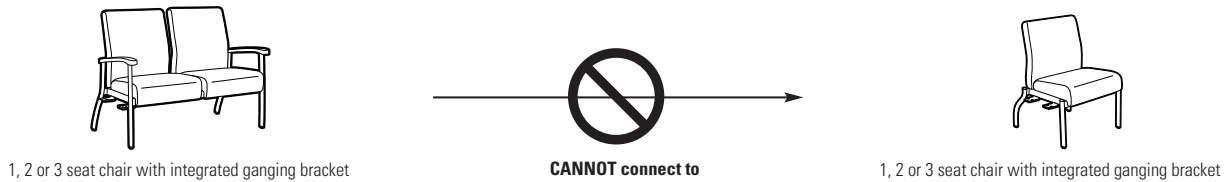
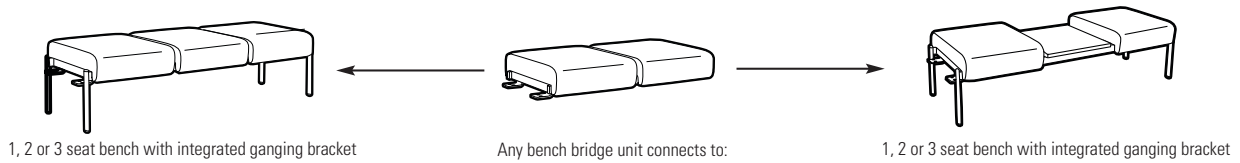
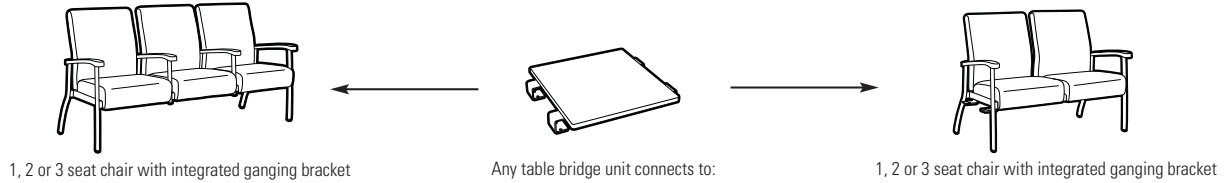
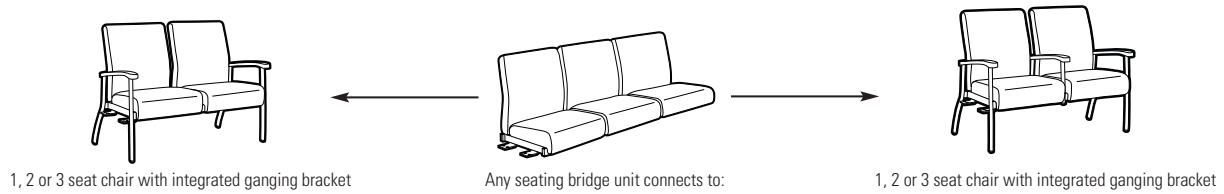

**PACKAGE 1**

Description	Qty	Model #	W x D x H	Yardage	Unit Weight	Carton Volume
Low Back Three Seat Chair	4	GC4235	74.5 x 26 x 37.5	5	130	65.25



**PACKAGE 2**

Description	Qty	Model #	W x D x H	Yardage	Unit Weight	Carton Volume
Low Back Three Seat Chair	1	GC4233B	72.75 x 26 x 37.5	5	122	65.25
Low Back Armchair, Left	1	GC4231L	26.5 x 28 x 37.5	1.75	41	20.25
Low Back Armchair, Right	1	GC4231R	26.5 x 28 x 37.5	1.75	41	20.25
End Corner Table Bridge	2	GC4277-HP	35 x 35 x 16	-	40	6





**PACKAGE 3**

Description	Qty	Model #	W x D x H	Yardage	Unit Weight	Carton Volume
Low Back Three Seat Chair	1	GC4235R	74.5 x 26 x 37.5	5	131	65.25
Bariatric Low Back Armchair, Left	1	GC4241L	37.5 x 28 x 37.5	3	57	30.5
Low Back Armchair, Left	1	GC4231L	26.5 x 28 x 37.5	1.75	41	20.25
Low Back Armchair, Right	1	GC4231R	26.5 x 28 x 37.5	1.75	41	20.25
End Corner Table Bridge	1	GC4277-HP	35 x 35 x 16	-	40	6
Rectangular Coffee Table	1	GC4283-HP	22 x 54 x 16	-	30	6
Square Table Top	1	GC4275-HP	23 x 23 x 1	-	14	3.4







DESCRIPTION	MODEL# / FEATURES	STANDARD TEXTILE GRADES											
		COM	2	3	4	5	6	7	8	9	10	11	12
 <p><b>LB Chair Armless</b> COM: 1.75 YD   1.6 M Unit weight: 33 LB   15 KG Carton weight: 45.5 LB   20.64 KG Carton volume: 20.25 FT³   0.57 MT³</p>	<b>GC4230</b>	942	998	1045	1100	1189	1271	1353	1425	1514	1598	1712	1873
		<b>OVERALL DIMENSIONS</b>			<b>SEAT DIMENSIONS</b>			<b>BACK DIMENSIONS</b>					
		<b>W</b>	<b>D</b>	<b>H</b>	<b>W</b>	<b>D</b>	<b>H</b>	<b>W</b>	<b>H</b>				
	Active weight 500 lbs.	IN 24.75 MM 629	28 711	37.5 953	22 559	18 457	18 457	21.5 546	19.5 495				
	<b>RTA 00</b>	1 per carton											

 <p><b>HB Chair Armless</b> COM: 2 YD   1.83 M Unit weight: 37 LB   16.8 KG Carton weight: 49.5 LB   22.45 KG Carton volume: 20.25 FT³   0.57 MT³</p>	<b>GC4230HB</b>	992	1056	1110	1172	1274	1368	1462	1544	1646	1742	1872	2056
		<b>OVERALL DIMENSIONS</b>			<b>SEAT DIMENSIONS</b>			<b>BACK DIMENSIONS</b>					
		<b>W</b>	<b>D</b>	<b>H</b>	<b>W</b>	<b>D</b>	<b>H</b>	<b>W</b>	<b>H</b>				
	Active weight 500 lbs.	IN 24.75 MM 629	28 711	42.5 1080	22 559	18 457	18 457	21.5 546	24.5 622				
	<b>RTA 00</b>	1 per carton											

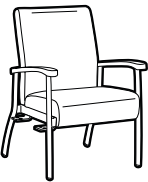
 <p><b>LB Armchair</b> COM: 1.75 YD   1.6 M Unit weight: 41 LB   18.6 KG Carton weight: 53.5 LB   24.27 KG Carton volume: 20.25 FT³   0.57 MT³</p>	<b>GC4231</b>	1230	1286	1333	1388	1477	1559	1641	1713	1802	1886	2000	2161
		<b>OVERALL DIMENSIONS</b>			<b>SEAT DIMENSIONS</b>			<b>BACK DIMENSIONS</b>					
		<b>W</b>	<b>D</b>	<b>H</b>	<b>W</b>	<b>D</b>	<b>H</b>	<b>W</b>	<b>H</b>				
	Active weight 500 lbs. Wood armcap option: Add \$49.	IN 26.5 MM 673	28 711	37.5 953	22 559	18 457	18 457	21.5 546	19.5 495				
	<b>RTA 00</b>	1 per carton											

 <p><b>LB Armchair - Left</b> COM: 1.75 YD   1.6 M Unit weight: 41 LB   18.6 KG Carton weight: 53.5 LB   24.27 KG Carton volume: 20.25 FT³   0.57 MT³</p>	<b>GC4231L</b>	1261	1317	1364	1419	1508	1590	1672	1744	1833	1917	2031	2192
	Ganging.	<b>OVERALL DIMENSIONS</b>			<b>SEAT DIMENSIONS</b>			<b>BACK DIMENSIONS</b>					
		<b>W</b>	<b>D</b>	<b>H</b>	<b>W</b>	<b>D</b>	<b>H</b>	<b>W</b>	<b>H</b>				
	Active weight 500 lbs. Wood armcap option: Add \$49.	IN 26.5 MM 673	28 711	37.5 953	22 559	18 457	18 457	21.5 546	19.5 495				
	<b>RTA 00</b>	1 per carton											

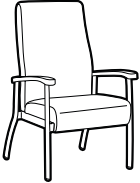
 <p><b>LB Armchair - Right</b> COM: 1.75 YD   1.6 M Unit weight: 41 LB   18.6 KG Carton weight: 53.5 LB   24.27 KG Carton volume: 20.25 FT³   0.57 MT³</p>	<b>GC4231R</b>	1261	1317	1364	1419	1508	1590	1672	1744	1833	1917	2031	2192
	Ganging.	<b>OVERALL DIMENSIONS</b>			<b>SEAT DIMENSIONS</b>			<b>BACK DIMENSIONS</b>					
		<b>W</b>	<b>D</b>	<b>H</b>	<b>W</b>	<b>D</b>	<b>H</b>	<b>W</b>	<b>H</b>				
	Active weight 500 lbs. Wood armcap option: Add \$49.	IN 26.5 MM 673	28 711	37.5 953	22 559	18 457	18 457	21.5 546	19.5 495				
	<b>RTA 00</b>	1 per carton											

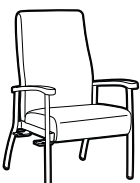
DESCRIPTION	MODEL# / FEATURES	STANDARD TEXTILE GRADES																
 <p><b>LB Armchair - Left &amp; Right</b>                      COM: 1.75 YD   1.6 M                      Unit weight: 41 LB   18.6 KG                      Carton weight: 53.5 LB   24.27 KG                      Carton volume: 20.25 FT<sup>3</sup>   0.57 MT<sup>3</sup></p>	<b>GC4231B</b>	COM	2	3	4	5	6	7	8	9	10	11	12					
		1293	1349	1396	1451	1540	1622	1704	1776	1865	1949	2063	2224					
	Ganging.	<b>OVERALL DIMENSIONS</b>			<b>SEAT DIMENSIONS</b>			<b>BACK DIMENSIONS</b>										
	Active weight 500 lbs.	IN	26.5	28	37.5	22	18	18	21.5	19.5	MM	673	711	953	559	457	457	546
Wood armcap option: Add \$49.		<b>RTA 00</b>	1 per carton															
 <p><b>HB Armchair</b>                      COM: 2 YD   1.83 M                      Unit weight: 46 LB   20.9 KG                      Carton weight: 58.5 LB   26.54 KG                      Carton volume: 20.25 FT<sup>3</sup>   0.57 MT<sup>3</sup></p>	<b>GC4231HB</b>	COM	2	3	4	5	6	7	8	9	10	11	12					
		1277	1341	1395	1457	1559	1653	1747	1829	1931	2027	2157	2341					
	Ganging.	<b>OVERALL DIMENSIONS</b>			<b>SEAT DIMENSIONS</b>			<b>BACK DIMENSIONS</b>										
	Active weight 500 lbs.	IN	26.5	28	42.5	22	18	18	21.5	24.5	MM	673	711	1080	559	457	457	546
Wood armcap option: Add \$49.		<b>RTA 00</b>	1 per carton															
 <p><b>HB Armchair - Left</b>                      COM: 2 YD   1.83 M                      Unit weight: 46 LB   20.9 KG                      Carton weight: 58.5 LB   26.54 KG                      Carton volume: 20.25 FT<sup>3</sup>   0.57 MT<sup>3</sup></p>	<b>GC4231HBL</b>	COM	2	3	4	5	6	7	8	9	10	11	12					
		1312	1376	1430	1492	1594	1688	1782	1864	1966	2062	2192	2376					
	Ganging.	<b>OVERALL DIMENSIONS</b>			<b>SEAT DIMENSIONS</b>			<b>BACK DIMENSIONS</b>										
	Active weight 500 lbs.	IN	26.5	28	42.5	22	18	18	21.5	24.5	MM	673	711	1080	559	457	457	546
Wood armcap option: Add \$49.		<b>RTA 00</b>	1 per carton															
 <p><b>HB Armchair - Right</b>                      COM: 2 YD   1.83 M                      Unit weight: 46 LB   20.9 KG                      Carton weight: 58.5 LB   26.54 KG                      Carton volume: 20.25 FT<sup>3</sup>   0.57 MT<sup>3</sup></p>	<b>GC4231HBR</b>	COM	2	3	4	5	6	7	8	9	10	11	12					
		1312	1376	1430	1492	1594	1688	1782	1864	1966	2062	2192	2376					
	Ganging.	<b>OVERALL DIMENSIONS</b>			<b>SEAT DIMENSIONS</b>			<b>BACK DIMENSIONS</b>										
	Active weight 500 lbs.	IN	26.5	28	42.5	22	18	18	21.5	24.5	MM	673	711	1080	559	457	457	546
Wood armcap option: Add \$49.		<b>RTA 00</b>	1 per carton															

DESCRIPTION MODEL# / FEATURES STANDARD TEXTILE GRADES



**HB Armchair - Left & Right**  
 COM: 2 YD | 1.83 M  
 Unit weight: 48 LB | 21.8 KG  
 Carton weight: 60.5 LB | 27.44 KG  
 Carton volume: 20.25 FT³ | 0.57 MT³

COM	2	3	4	5	6	7	8	9	10	11	12	
<b>GC4231HBB</b>	1346	1410	1464	1526	1628	1722	1816	1898	2000	2096	2226	2410
<b>OVERALL DIMENSIONS</b>			<b>SEAT DIMENSIONS</b>			<b>BACK DIMENSIONS</b>						
W D H			W D H			W H						
Ganging.												
Active weight 500 lbs.			in 26.5 28 42.5			22 18 18			21.5 24.5			
Wood armcap option:			mm 673 711 1080			559 457 457			546 622			
Add \$49.			<b>RTA 00</b>			1 per carton						



Designed to immobilize the pelvis and hip joints after surgery.

**LB Armchair, Post Surgery**  
 COM: 1.75 YD | 1.6 M  
 Unit weight: 45 LB | 20.5 KG  
 Carton weight: 57.5 LB | 26.08 KG  
 Carton volume: 24.25 FT³ | 0.68 MT³

COM	2	3	4	5	6	7	8	9	10	11	12	
<b>GC4231-24</b>	1360	1416	1463	1518	1607	1689	1771	1843	1932	2016	2130	2291
<b>OVERALL DIMENSIONS</b>			<b>SEAT DIMENSIONS</b>			<b>BACK DIMENSIONS</b>						
W D H			W D H			W H						
Active weight 500 lbs.			in 26.5 28.75 43.5			22 18 24			21.5 19.5			
Wood armcap option:			mm 673 730 1105			559 457 610			546 495			
Add \$49.			<b>RTA 00</b>			1 per carton						

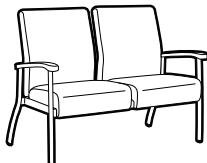

**LB Two Seat Chair No Center Arm**  
 COM: 3.5 YD | 3.2 M  
 Unit weight: 82 LB | 37.3 KG  
 Carton weight: 94 LB | 42.64 KG  
 Carton volume: 43 FT³ | 1.21 MT³

COM	2	3	4	5	6	7	8	9	10	11	12	
<b>GC4232</b>	2090	2202	2297	2405	2584	2748	2913	3056	3235	3403	3630	3952
<b>OVERALL DIMENSIONS</b>			<b>SEAT DIMENSIONS</b>			<b>BACK DIMENSIONS</b>						
W D H			W D H			W H						
Active weight 500 lbs/seat.			in 49.75 26 37.5			44 18 18			44 19.5			
Wood armcap option:			mm 1264 660 953			1118 457 457			1118 495			
Add \$49.			<b>RTA 00</b>			1 per carton						

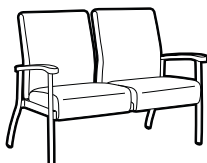

**LB Two Seat Chair No Center Arm - Left**  
 COM: 3.5 YD | 3.2 M  
 Unit weight: 83 LB | 37.7 KG  
 Carton weight: 95 LB | 43.09 KG  
 Carton volume: 43 FT³ | 1.21 MT³

COM	2	3	4	5	6	7	8	9	10	11	12	
<b>GC4232L</b>	2123	2235	2330	2438	2617	2781	2946	3089	3268	3436	3663	3985
<b>OVERALL DIMENSIONS</b>			<b>SEAT DIMENSIONS</b>			<b>BACK DIMENSIONS</b>						
W D H			W D H			W H						
Ganging.												
Active weight 500 lbs/seat.			in 49.75 26 37.5			44 18 18			44 19.5			
Wood armcap option:			mm 1264 660 953			1118 457 457			1118 495			
Add \$49.			<b>RTA 00</b>			1 per carton						

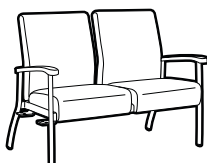

**LB Two Seat Chair No Center Arm - Right**  
 COM: 3.5 YD | 3.2 M  
 Unit weight: 83 LB | 37.7 KG  
 Carton weight: 95 LB | 43.09 KG  
 Carton volume: 43 FT³ | 1.21 MT³

COM	2	3	4	5	6	7	8	9	10	11	12	
<b>GC4232R</b>	2123	2235	2330	2438	2617	2781	2946	3089	3268	3436	3663	3985
<b>OVERALL DIMENSIONS</b>			<b>SEAT DIMENSIONS</b>			<b>BACK DIMENSIONS</b>						
W D H			W D H			W H						
Ganging.												
Active weight 500 lbs/seat.			in 49.75 26 37.5			44 18 18			44 19.5			
Wood armcap option:			mm 1264 660 953			1118 457 457			1118 495			
Add \$49.			<b>RTA 00</b>			1 per carton						

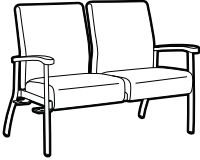
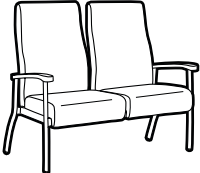
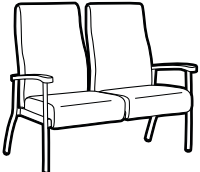
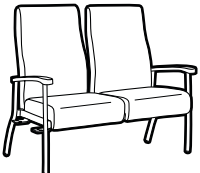
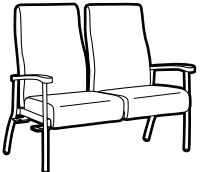
DESCRIPTION	MODEL# / FEATURES	STANDARD TEXTILE GRADES											
		COM	2	3	4	5	6	7	8	9	10	11	12
 <p><b>LB Two Seat Chair No Center Arm - Left &amp; Right</b>                      COM: 3.5 YD   3.2 M                      Unit weight: 84 LB   38.2 KG                      Carton weight: 96 LB   43.54 KG                      Carton volume: 43 FT³   1.21 MT³</p>	<b>GC4232B</b>	2155	2267	2362	2470	2649	2813	2978	3121	3300	3468	3695	4017
	Ganging.	<b>OVERALL DIMENSIONS</b>			<b>SEAT DIMENSIONS</b>			<b>BACK DIMENSIONS</b>					
	Active weight 500 lbs. Wood armcap option: Add \$49.	IN 49.75 MM 1264	26 660	37.5 953	44 1118	18 457	18 457	44 1118	19.5 495				
		<b>RTA 00</b>	1 per carton										
 <p><b>HB Two Seat Chair No Center Arm</b>                      COM: 4 YD   3.66 M                      Unit weight: 83 LB   37.7 KG                      Carton weight: 95 LB   43.09 KG                      Carton volume: 56.5 FT³   1.59 MT³</p>	<b>GC4232HB</b>	2187	2315	2423	2547	2751	2939	3127	3291	3495	3687	3947	4315
	Ganging.	<b>OVERALL DIMENSIONS</b>			<b>SEAT DIMENSIONS</b>			<b>BACK DIMENSIONS</b>					
	Active weight 500 lbs. Wood armcap option: Add \$49.	IN 49.75 MM 1264	26 660	42.5 1080	44 1118	18 457	18 457	44 1118	24.5 622				
		<b>RTA 00</b>	1 per carton										
 <p><b>HB Two Seat Chair No Center Arm - Left</b>                      COM: 4 YD   3.66 M                      Unit weight: 84 LB   38.2 KG                      Carton weight: 96 LB   43.54 KG                      Carton volume: 56.5 FT³   1.59 MT³</p>	<b>GC4232HBL</b>	2222	2350	2458	2582	2786	2974	3162	3326	3530	3722	3982	4350
	Ganging.	<b>OVERALL DIMENSIONS</b>			<b>SEAT DIMENSIONS</b>			<b>BACK DIMENSIONS</b>					
	Active weight 500 lbs/seat. Wood armcap option: Add \$49.	IN 49.75 MM 1264	26 660	42.5 1080	44 1118	18 457	18 457	44 1118	24.5 622				
		<b>RTA 00</b>	1 per carton										
 <p><b>HB Two Seat Chair No Center Arm - Right</b>                      COM: 4 YD   3.66 M                      Unit weight: 84 LB   38.2 KG                      Carton weight: 96 LB   43.54 KG                      Carton volume: 56.5 FT³   1.59 MT³</p>	<b>GC4232HBR</b>	2222	2350	2458	2582	2786	2974	3162	3326	3530	3722	3982	4350
	Ganging.	<b>OVERALL DIMENSIONS</b>			<b>SEAT DIMENSIONS</b>			<b>BACK DIMENSIONS</b>					
	Active weight 500 lbs/seat. Wood armcap option: Add \$49.	IN 49.75 MM 1264	26 660	42.5 1080	44 1118	18 457	18 457	44 1118	24.5 622				
		<b>RTA 00</b>	1 per carton										
 <p><b>HB Two Seat Chair No Center Arm - Left &amp; Right</b>                      COM: 4 YD   3.66 M                      Unit weight: 86 LB   39.1 KG                      Carton weight: 98 LB   44.45 KG                      Carton volume: 56.5 FT³   1.59 MT³</p>	<b>GC4232HBB</b>	2252	2380	2488	2612	2816	3004	3192	3356	3560	3752	4012	4380
	Ganging.	<b>OVERALL DIMENSIONS</b>			<b>SEAT DIMENSIONS</b>			<b>BACK DIMENSIONS</b>					
	Active weight 500 lbs/seat. Wood armcap option: Add \$49.	IN 49.75 MM 1264	26 660	42.5 1080	44 1118	18 457	18 457	44 1118	24.5 622				
		<b>RTA 00</b>	1 per carton										

DESCRIPTION MODEL# / FEATURES STANDARD TEXTILE GRADES

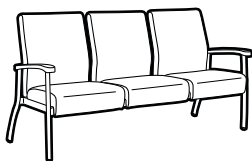

**LB Three Seat Chair No Center Arms**  
 COM: 5 YD | 4.57 M  
 Unit weight: 120 LB | 54.5 KG  
 Carton weight: 132 LB | 59.87 KG  
 Carton volume: 65.25 FT³ | 1.84 MT³

COM	2	3	4	5	6	7	8	9	10	11	12	
<b>GC4233</b>	2957	3117	3252	3407	3662	3897	4132	4337	4592	4832	5157	5617

OVERALL DIMENSIONS			SEAT DIMENSIONS			BACK DIMENSIONS	
W	D	H	W	D	H	W	H

Active weight 500 lbs/seat.	IN 72.75	26	37.5	70	18	18	70	19.5
	MM 1848	660	953	1778	457	457	1778	495
Wood armcap option: Add \$49.	<b>RTA 00</b>		1 per carton					

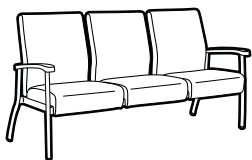

**LB Three Seat Chair No Center Arms - Left**  
 COM: 5 YD | 4.57 M  
 Unit weight: 122 LB | 55.5 KG  
 Carton weight: 134 LB | 60.78 KG  
 Carton volume: 65.25 FT³ | 1.84 MT³

COM	2	3	4	5	6	7	8	9	10	11	12	
<b>GC4233L</b>	2991	3151	3286	3441	3696	3931	4166	4371	4626	4866	5191	5651

OVERALL DIMENSIONS			SEAT DIMENSIONS			BACK DIMENSIONS	
W	D	H	W	D	H	W	H

Ganging.	IN 72.75	26	37.5	70	18	18	70	19.5
	MM 1848	660	953	1778	457	457	1778	495
Wood armcap option: Add \$49.	<b>RTA 00</b>		1 per carton					

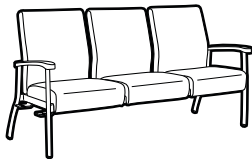

**LB Three Seat Chair No Center Arms - Right**  
 COM: 5 YD | 4.57 M  
 Unit weight: 122 LB | 55.5 KG  
 Carton weight: 134 LB | 60.78 KG  
 Carton volume: 65.25 FT³ | 1.84 MT³

COM	2	3	4	5	6	7	8	9	10	11	12	
<b>GC4233R</b>	2991	3151	3286	3441	3696	3931	4166	4371	4626	4866	5191	5651

OVERALL DIMENSIONS			SEAT DIMENSIONS			BACK DIMENSIONS	
W	D	H	W	D	H	W	H

Ganging.	IN 72.75	26	37.5	70	18	18	70	19.5
	MM 1848	660	953	1778	457	457	1778	495
Wood armcap option: Add \$49.	<b>RTA 00</b>		1 per carton					

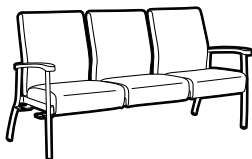

**LB Three Seat Chair No Center Arms - Left & Right**  
 COM: 5 YD | 4.57 M  
 Unit weight: 122 LB | 55.5 KG  
 Carton weight: 134 LB | 60.78 KG  
 Carton volume: 65.25 FT³ | 1.84 MT³

COM	2	3	4	5	6	7	8	9	10	11	12	
<b>GC4233B</b>	3024	3184	3319	3474	3729	3964	4199	4404	4659	4899	5224	5684

OVERALL DIMENSIONS			SEAT DIMENSIONS			BACK DIMENSIONS	
W	D	H	W	D	H	W	H

Ganging.	IN 72.75	26	37.5	70	18	18	70	19.5
	MM 1848	660	953	1778	457	457	1778	495
Wood armcap option: Add \$49.	<b>RTA 00</b>		1 per carton					

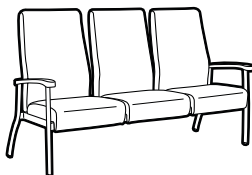

**HB Three Seat Chair No Center Arms**  
 COM: 5.75 YD | 5.26 M  
 Unit weight: 126 LB | 57.3 KG  
 Carton weight: 138 LB | 62.6 KG  
 Carton volume: 80.75 FT³ | 2.28 MT³

COM	2	3	4	5	6	7	8	9	10	11	12	
<b>GC4233HB</b>	3103	3287	3442	3621	3914	4184	4454	4690	4983	5259	5633	6162

OVERALL DIMENSIONS			SEAT DIMENSIONS			BACK DIMENSIONS	
W	D	H	W	D	H	W	H

Active weight 500 lbs/seat.	IN 72.75	26	42.5	70	18	18	70	24.5
	MM 1848	660	1080	1778	457	457	1778	622
Wood armcap option: Add \$49.	<b>RTA 00</b>		1 per carton					

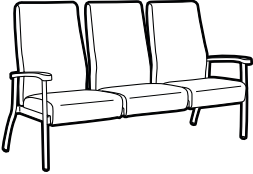
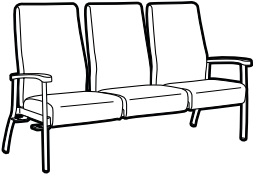
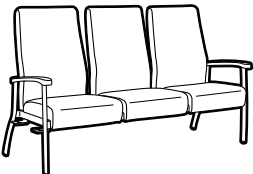
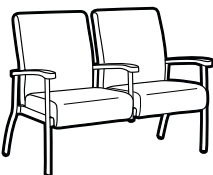
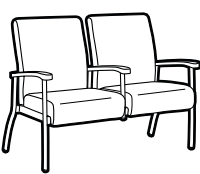

DESCRIPTION	MODEL# / FEATURES	STANDARD TEXTILE GRADES															
 <p><b>HB Three Seat Chair No Center Arms - Left</b>                      COM: 5.75 YD   5.26 M                      Unit weight: 128 LB   58.2 KG                      Carton weight: 140 LB   63.5 KG                      Carton volume: 80.75 FT³   2.28 MT³</p>	<b>GC4233HBL</b>	COM	2	3	4	5	6	7	8	9	10	11	12				
		3137	3321	3476	3655	3948	4218	4488	4724	5017	5293	5667	6196				
	Ganging:  Active weight 500 lbs/seat.  Wood armcap option: Add \$49.		<b>OVERALL DIMENSIONS</b> W D H			<b>SEAT DIMENSIONS</b> W D H			<b>BACK DIMENSIONS</b> W H								
		IN 72.75	26	42.5	70	18	18	70	24.5	MM 1848	660	1080	1778	457	457	1778	622
		<b>RTA 00</b>	1 per carton														
 <p><b>HB Three Seat Chair No Center Arms - Right</b>                      COM: 5.75 YD   5.26 M                      Unit weight: 128 LB   58.2 KG                      Carton weight: 140 LB   63.5 KG                      Carton volume: 80.75 FT³   2.28 MT³</p>	<b>GC4233HBR</b>	COM	2	3	4	5	6	7	8	9	10	11	12				
		3137	3321	3476	3655	3948	4218	4488	4724	5017	5293	5667	6196				
	Ganging:  Active weight 500 lbs/seat.  Wood armcap option: Add \$49.		<b>OVERALL DIMENSIONS</b> W D H			<b>SEAT DIMENSIONS</b> W D H			<b>BACK DIMENSIONS</b> W H								
		IN 72.75	26	42.5	70	18	18	70	24.5	MM 1848	660	1080	1778	457	457	1778	622
		<b>RTA 00</b>	1 per carton														
 <p><b>HB Three Seat Chair No Center Arms - Left &amp; Right</b>                      COM: 5.75 YD   5.26 M                      Unit weight: 128 LB   58.2 KG                      Carton weight: 140 LB   63.5 KG                      Carton volume: 80.75 FT³   2.28 MT³</p>	<b>GC4233HBB</b>	COM	2	3	4	5	6	7	8	9	10	11	12				
		3170	3354	3509	3688	3981	4251	4521	4757	5050	5326	5700	6229				
	Ganging:  Active weight 500 lbs/seat.  Wood armcap option: Add \$49.		<b>OVERALL DIMENSIONS</b> W D H			<b>SEAT DIMENSIONS</b> W D H			<b>BACK DIMENSIONS</b> W H								
		IN 72.75	26	42.5	70	18	18	70	24.5	MM 1848	660	1080	1778	457	457	1778	622
		<b>RTA 00</b>	1 per carton														
 <p><b>LB Two Seat Chair Half Center Arm</b>                      COM: 3.5 YD   3.2 M                      Unit weight: 88 LB   40 KG                      Carton weight: 100 LB   45.36 KG                      Carton volume: 43 FT³   1.21 MT³</p>	<b>GC4234</b>	COM	2	3	4	5	6	7	8	9	10	11	12				
		2277	2389	2484	2592	2771	2935	3100	3243	3422	3590	3817	4139				
	Ganging:  Active weight 500 lbs/seat.  Wood armcap option: Add \$74.		<b>OVERALL DIMENSIONS</b> W D H			<b>SEAT DIMENSIONS</b> W D H			<b>BACK DIMENSIONS</b> W H								
		IN 50.75	26	37.5	22	18	18	21.5	19.5	MM 1289	660	953	559	457	457	546	495
		<b>RTA 00</b>	1 per carton														
 <p><b>LB Two Seat Chair Half Center Arm - Left</b>                      COM: 3.5 YD   3.2 M                      Unit weight: 89 LB   40.5 KG                      Carton weight: 101 LB   45.81 KG                      Carton volume: 43 FT³   1.21 MT³</p>	<b>GC4234L</b>	COM	2	3	4	5	6	7	8	9	10	11	12				
		2309	2421	2516	2624	2803	2967	3132	3275	3454	3622	3849	4171				
	Ganging:  Active weight 500 lbs/seat.  Wood armcap option: Add \$74.		<b>OVERALL DIMENSIONS</b> W D H			<b>SEAT DIMENSIONS</b> W D H			<b>BACK DIMENSIONS</b> W H								
		IN 50.75	26	37.5	22	18	18	21.5	19.5	MM 1289	660	953	559	457	457	546	495
		<b>RTA 00</b>	1 per carton														

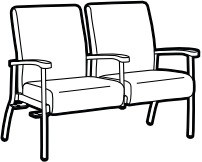
DESCRIPTION	MODEL# / FEATURES	STANDARD TEXTILE GRADES											
		COM	2	3	4	5	6	7	8	9	10	11	12
 <p><b>LB Two Seat Chair Half Center Arm - Right</b> COM: 3.5 YD   3.2 M Unit weight: 89 LB   40.5 KG Carton weight: 101 LB   45.81 KG Carton volume: 43 FT³   1.21 MT³</p>	<b>GC4234R</b>	2309	2421	2516	2624	2803	2967	3132	3275	3454	3622	3849	4171
	<p>Ganging.</p> <p>Active weight 500 lbs/seat.</p> <p>Wood armcap option: Add \$74.</p>	<b>OVERALL DIMENSIONS</b> W D H			<b>SEAT DIMENSIONS</b> W D H			<b>BACK DIMENSIONS</b> W H					
		IN 50.75	26	37.5		22	18	18		21.5	19.5		
		MM 1289	660	953		559	457	457		546	495		
		<b>RTA 00</b>	1 per carton										

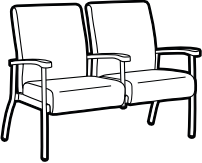
DESCRIPTION	MODEL# / FEATURES	STANDARD TEXTILE GRADES											
		COM	2	3	4	5	6	7	8	9	10	11	12
 <p><b>LB Two Seat Chair Half Center Arm - Left &amp; Right</b> COM: 3.5 YD   3.2 M Unit weight: 90 LB   40.9 KG Carton weight: 102 LB   46.27 KG Carton volume: 43 FT³   1.21 MT³</p>	<b>GC4234B</b>	2343	2455	2550	2658	2837	3001	3166	3309	3488	3656	3883	4205
	<p>Ganging.</p> <p>Active weight 500 lbs/seat.</p> <p>Wood armcap option: Add \$74.</p>	<b>OVERALL DIMENSIONS</b> W D H			<b>SEAT DIMENSIONS</b> W D H			<b>BACK DIMENSIONS</b> W H					
		IN 50.75	26	37.5		22	18	18		21	19.5		
		MM 1289	660	953		559	457	457		533	495		
		<b>RTA 00</b>	1 per carton										

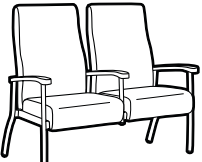
DESCRIPTION	MODEL# / FEATURES	STANDARD TEXTILE GRADES											
		COM	2	3	4	5	6	7	8	9	10	11	12
 <p><b>HB Two Seat Chair Half Center Arm</b> COM: 4 YD   3.66 M Unit weight: 92 LB   41.8 KG Carton weight: 104 LB   47.17 KG Carton volume: 56.5 FT³   1.59 MT³</p>	<b>GC4234HB</b>	2378	2506	2614	2738	2942	3130	3318	3482	3686	3878	4138	4506
	<p>Active weight 500 lbs/seat.</p> <p>Wood armcap option: Add \$74.</p>	<b>OVERALL DIMENSIONS</b> W D H			<b>SEAT DIMENSIONS</b> W D H			<b>BACK DIMENSIONS</b> W H					
		IN 50.75	26	42.5		22	18	18		21.5	24.5		
		MM 1289	660	1080		559	457	457		546	622		
		<b>RTA 00</b>	1 per carton										

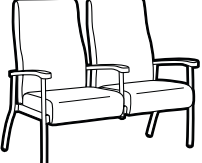
DESCRIPTION	MODEL# / FEATURES	STANDARD TEXTILE GRADES											
		COM	2	3	4	5	6	7	8	9	10	11	12
 <p><b>HB Two Seat Chair Half Center Arm - Left</b> COM: 4 YD   3.66 M Unit weight: 93 LB   42.3 KG Carton weight: 104 LB   47.17 KG Carton volume: 56.5 FT³   1.59 MT³</p>	<b>GC4234HBL</b>	2410	2538	2646	2770	2974	3162	3350	3514	3718	3910	4170	4538
	<p>Ganging.</p> <p>Active weight 500 lbs/seat.</p> <p>Wood armcap option: Add \$74.</p>	<b>OVERALL DIMENSIONS</b> W D H			<b>SEAT DIMENSIONS</b> W D H			<b>BACK DIMENSIONS</b> W H					
		IN 50.75	26	42.5		22	18	18		21.5	24.5		
		MM 1289	660	1080		559	457	457		546	622		
		<b>RTA 00</b>	1 per carton										

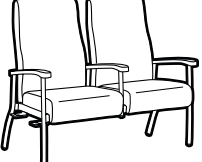
DESCRIPTION	MODEL# / FEATURES	STANDARD TEXTILE GRADES											
		COM	2	3	4	5	6	7	8	9	10	11	12
 <p><b>HB Two Seat Chair Half Center Arm - Right</b> COM: 4 YD   3.66 M Unit weight: 93 LB   42.3 KG Carton weight: 104 LB   47.17 KG Carton volume: 56.5 FT³   1.59 MT³</p>	<b>GC4234HBR</b>	2410	2538	2646	2770	2974	3162	3350	3514	3718	3910	4170	4538
	<p>Ganging.</p> <p>Active weight 500 lbs/seat.</p> <p>Wood armcap option: Add \$74.</p>	<b>OVERALL DIMENSIONS</b> W D H			<b>SEAT DIMENSIONS</b> W D H			<b>BACK DIMENSIONS</b> W H					
		IN 50.75	26	42.5		22	18	18		21.5	24.5		
		MM 1289	660	1080		559	457	457		546	622		
		<b>RTA 00</b>	1 per carton										

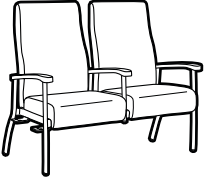
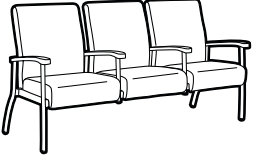
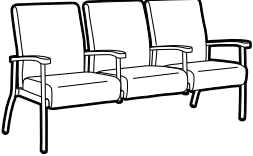
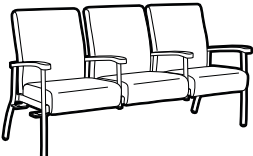
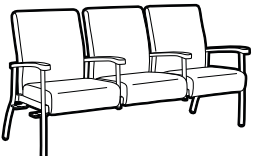
DESCRIPTION	MODEL# / FEATURES	STANDARD TEXTILE GRADES																
 <p><b>HB Two Seat Chair Half Center Arm - Left &amp; Right</b>                      COM: 1.25 YD   3.66 M                      Unit weight: 96 LB   43.6 KG                      Carton weight: 108 LB   48.99 KG                      Carton volume: 56.5 FT³   1.59 MT³</p>	<b>GC4234HBB</b>	COM	2	3	4	5	6	7	8	9	10	11	12					
	2441	2569	2677	2801	3005	3193	3381	3545	3749	3941	4201	4569						
	Ganging.	<b>OVERALL DIMENSIONS</b>			<b>SEAT DIMENSIONS</b>			<b>BACK DIMENSIONS</b>										
Active weight 500 lbs/seat.	IN	50.75	26	42.5	22	18	18	21	24.5	MM	1289	660	1080	559	457	457	533	622
Wood armcap option: Add \$74.	<b>RTA 00</b>		1 per carton															
 <p><b>LB Three Seat Chair Half Center Arms</b>                      COM: 5 YD   4.57 M                      Unit weight: 130 LB   59.1 KG                      Carton weight: 142 LB   64.41 KG                      Carton volume: 65.25 FT³   1.84 MT³</p>	<b>GC4235</b>	COM	2	3	4	5	6	7	8	9	10	11	12					
	3334	3494	3629	3784	4039	4274	4509	4714	4969	5209	5534	5994						
	Ganging.	<b>OVERALL DIMENSIONS</b>			<b>SEAT DIMENSIONS</b>			<b>BACK DIMENSIONS</b>										
Active weight 500 lbs/seat.	IN	74.5	26	37.5	22	18	18	21.5	19.5	MM	1892	660	953	559	457	457	546	495
Wood armcap option: Add \$99.	<b>RTA 00</b>		1 per carton															
 <p><b>LB Three Seat Chair Half Center Arms - Left</b>                      COM: 5 YD   4.57 M                      Unit weight: 131 LB   59.5 KG                      Carton weight: 143 LB   64.86 KG                      Carton volume: 65.25 FT³   1.84 MT³</p>	<b>GC4235L</b>	COM	2	3	4	5	6	7	8	9	10	11	12					
	3364	3524	3659	3814	4069	4304	4539	4744	4999	5239	5564	6024						
	Ganging.	<b>OVERALL DIMENSIONS</b>			<b>SEAT DIMENSIONS</b>			<b>BACK DIMENSIONS</b>										
Active weight 500 lbs/seat.	IN	74.5	26	37.5	22	18	18	21.5	19.5	MM	1892	660	953	559	457	457	546	495
Wood armcap option: Add \$99.	<b>RTA 00</b>		1 per carton															
 <p><b>LB Three Seat Chair Half Center Arms - Right</b>                      COM: 5 YD   4.57 M                      Unit weight: 131 LB   59.5 KG                      Carton weight: 143 LB   64.86 KG                      Carton volume: 65.25 FT³   1.84 MT³</p>	<b>GC4235R</b>	COM	2	3	4	5	6	7	8	9	10	11	12					
	3364	3524	3659	3814	4069	4304	4539	4744	4999	5239	5564	6024						
	Ganging.	<b>OVERALL DIMENSIONS</b>			<b>SEAT DIMENSIONS</b>			<b>BACK DIMENSIONS</b>										
Active weight 500 lbs/seat.	IN	74.5	26	37.5	22	18	18	21.5	19.5	MM	1892	660	953	559	457	457	546	495
Wood armcap option: Add \$99.	<b>RTA 00</b>		1 per carton															
 <p><b>LB Three Seat Chair Half Center Arms - Left &amp; Right</b>                      COM: 5 YD   4.57 M                      Unit weight: 132 LB   60 KG                      Carton weight: 144 LB   65.32 KG                      Carton volume: 65.25 FT³   1.84 MT³</p>	<b>GC4235B</b>	COM	2	3	4	5	6	7	8	9	10	11	12					
	3401	3561	3696	3851	4106	4341	4576	4781	5036	5276	5601	6061						
	Ganging.	<b>OVERALL DIMENSIONS</b>			<b>SEAT DIMENSIONS</b>			<b>BACK DIMENSIONS</b>										
Active weight 500 lbs/seat.	IN	74.5	26	37.5	22	18	18	21.5	19.5	MM	1892	660	953	559	457	457	546	495
Wood armcap option: Add \$99.	<b>RTA 00</b>		1 per carton															

DESCRIPTION MODEL# / FEATURES STANDARD TEXTILE GRADES

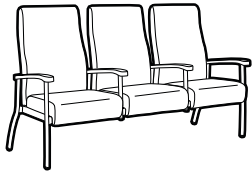

**HB Three Seat Chair Half Center Arms**  
 COM: 5.75 YD | 5.26 M  
 Unit weight: 136 LB | 61.8 KG  
 Carton weight: 148 LB | 67.13 KG  
 Carton volume: 80.75 FT³ | 2.28 MT³

MODEL# / FEATURES	COM	2	3	4	5	6	7	8	9	10	11	12
<b>GC4235HB</b>	3481	3665	3820	3999	4292	4562	4832	5068	5361	5637	6011	6540

OVERALL DIMENSIONS			SEAT DIMENSIONS			BACK DIMENSIONS	
W	D	H	W	D	H	W	H

Active weight 500 lbs/seat.	IN 74.5	26	42.5	22	18	18	21.5	24.5
Wood armcap option: Add \$99.	MM 1892	660	1080	559	457	457	546	622
	<b>RTA 00</b>	1 per carton						

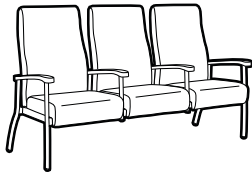

**HB Three Seat Chair Half Center Arms - Left**  
 COM: 5.75 YD | 5.26 M  
 Unit weight: 137 LB | 62.3 KG  
 Carton weight: 149 LB | 67.59 KG  
 Carton volume: 80.75 FT³ | 2.28 MT³

MODEL# / FEATURES	COM	2	3	4	5	6	7	8	9	10	11	12
<b>GC4235HBL</b>	3514	3698	3853	4032	4325	4595	4865	5101	5394	5670	6044	6573

OVERALL DIMENSIONS			SEAT DIMENSIONS			BACK DIMENSIONS	
W	D	H	W	D	H	W	H

Ganging.	IN 74.5	26	42.5	22	18	18	21.5	24.5
Active weight 500 lbs/seat.	MM 1892	660	1080	559	457	457	546	622
Wood armcap option: Add \$99.	<b>RTA 00</b>	1 per carton						

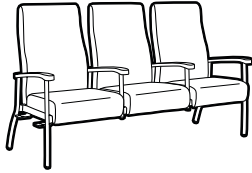

**HB Three Seat Chair Half Center Arms - Right**  
 COM: 5.75 YD | 5.26 M  
 Unit weight: 137 LB | 62.3 KG  
 Carton weight: 159 LB | 72.12 KG  
 Carton volume: 80.75 FT³ | 2.28 MT³

MODEL# / FEATURES	COM	2	3	4	5	6	7	8	9	10	11	12
<b>GC4235HBR</b>	3514	3698	3853	4032	4325	4595	4865	5101	5394	5670	6044	6573

OVERALL DIMENSIONS			SEAT DIMENSIONS			BACK DIMENSIONS	
W	D	H	W	D	H	W	H

Ganging.	IN 74.5	26	42.5	22	18	18	21.5	24.5
Active weight 500 lbs/seat.	MM 1892	660	1080	559	457	457	546	622
Wood armcap option: Add \$99.	<b>RTA 00</b>	1 per carton						

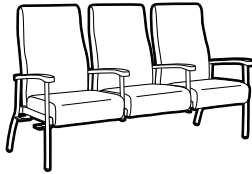

**HB Three Seat Chair Half Center Arms - Left & Right**  
 COM: 5.75 YD | 5.26 M  
 Unit weight: 138 LB | 62.7 KG  
 Carton weight: 160 LB | 72.57 KG  
 Carton volume: 80.75 FT³ | 2.28 MT³

MODEL# / FEATURES	COM	2	3	4	5	6	7	8	9	10	11	12
<b>GC4235HBB</b>	3547	3731	3886	4065	4358	4628	4898	5134	5427	5703	6077	6606

OVERALL DIMENSIONS			SEAT DIMENSIONS			BACK DIMENSIONS	
W	D	H	W	D	H	W	H

Ganging.	IN 74.5	26	42.5	22	18	18	21.5	24.5
Active weight 500 lbs/seat.	MM 1892	660	1080	559	457	457	546	622
Wood armcap option: Add \$99.	<b>RTA 00</b>	1 per carton						

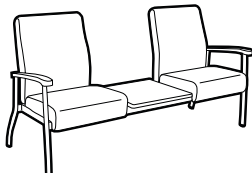

**LB Two Seat Chair w/Center Table Top**  
 COM: 3.5 YD | 3.2 M  
 Unit weight: 94 LB | 42.7 KG  
 Carton weight: 106 LB | 48.08 KG  
 Carton volume: 65.25 FT³ | 1.84 MT³

MODEL# / FEATURES	COM	2	3	4	5	6	7	8	9	10	11	12
<b>GC4236</b>	2712	2824	2919	3027	3206	3370	3535	3678	3857	4025	4252	4574

OVERALL DIMENSIONS			SEAT DIMENSIONS			BACK DIMENSIONS	
W	D	H	W	D	H	W	H

Active weight 500 lbs/seat.	IN 72.75	26	37.5	44	18	18	44	19.5
Wood armcap option: Add \$49.	MM 1848	660	953	1118	457	457	1118	495
Table top only offered in high pressure laminate.	<b>RTA 00</b>	1 per carton						

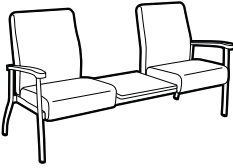
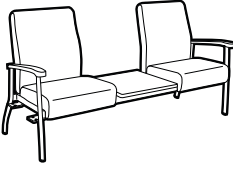
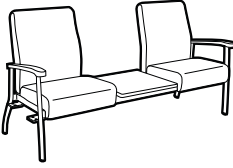
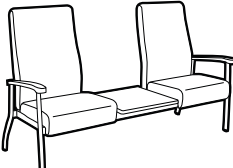
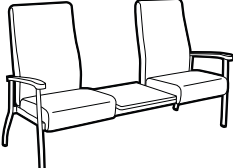
DESCRIPTION	MODEL# / FEATURES	STANDARD TEXTILE GRADES												
		COM	2	3	4	5	6	7	8	9	10	11	12	
 <p><b>LB Two Seat Chair w/Center Table Top - Left</b>                      COM: 3.5 YD   3.2 M                      Unit weight: 95 LB   43.2 KG                      Carton weight: 107 LB   48.53 KG                      Carton volume: 65.25 FT<sup>3</sup>   1.84 MT<sup>3</sup></p>	<b>GC4236L</b>	2743	2855	2950	3058	3237	3401	3566	3709	3888	4056	4283	4605	
	Ganging.													
	Active weight 500 lbs/seat.	<b>OVERALL DIMENSIONS</b>			<b>SEAT DIMENSIONS</b>			<b>BACK DIMENSIONS</b>						
	Wood armcap option: Add \$49.	IN 72.75	26	37.5	44	18	18	44	19.5					
	Table top only offered in high pressure laminate.	MM 1848	660	953	1118	457	457	1118	495					
 <p><b>LB Two Seat Chair w/Center Table Top - Right</b>                      COM: 3.5 YD   3.2 M                      Unit weight: 95 LB   43.2 KG                      Carton weight: 107 LB   48.53 KG                      Carton volume: 65.25 FT<sup>3</sup>   1.84 MT<sup>3</sup></p>	<b>GC4236R</b>	2743	2855	2950	3058	3237	3401	3566	3709	3888	4056	4283	4605	
	Ganging.													
	Active weight 500 lbs/seat.	<b>OVERALL DIMENSIONS</b>			<b>SEAT DIMENSIONS</b>			<b>BACK DIMENSIONS</b>						
	Wood armcap option: Add \$49.	IN 72.75	26	37.5	44	18	18	44	19.5					
	Table top only offered in high pressure laminate.	MM 1848	660	953	1118	457	457	1118	495					
 <p><b>LB Two Seat Chair w/Center Table Top - Left &amp; Right</b>                      COM: 3.5 YD   3.2 M                      Unit weight: 96 LB   43.6 KG                      Carton weight: 108 LB   48.99 KG                      Carton volume: 65.25 FT<sup>3</sup>   1.84 MT<sup>3</sup></p>	<b>GC4236B</b>	2778	2890	2985	3093	3272	3436	3601	3744	3923	4091	4318	4640	
	Ganging.													
	Active weight 500 lbs/seat.	<b>OVERALL DIMENSIONS</b>			<b>SEAT DIMENSIONS</b>			<b>BACK DIMENSIONS</b>						
	Wood armcap option: Add \$49.	IN 72.75	26	37.5	44	18	18	44	19.5					
	Table top only offered in high pressure laminate.	MM 1848	660	953	1118	457	457	1118	495					
 <p><b>HB Two Seat Chair w/Center Table Top</b>                      COM: 4 YD   3.66 M                      Unit weight: 98 LB   44.5 KG                      Carton weight: 110 LB   49.9 KG                      Carton volume: 80.75 FT<sup>3</sup>   2.28 MT<sup>3</sup></p>	<b>GC4236HB</b>	2809	2937	3045	3169	3373	3561	3749	3913	4117	4309	4569	4937	
	Ganging.													
	Active weight 500 lbs/seat.	<b>OVERALL DIMENSIONS</b>			<b>SEAT DIMENSIONS</b>			<b>BACK DIMENSIONS</b>						
	Wood armcap option: Add \$49.	IN 72.75	26	42.5	44	18	18	44	24.5					
	Table top only offered in high pressure laminate.	MM 1848	660	1080	1118	457	457	1118	622					
 <p><b>HB Two Seat Chair w/Center Table Top - Left</b>                      COM: 4 YD   3.66 M                      Unit weight: 99 LB   45 KG                      Carton weight: 111 LB   50.35 KG                      Carton volume: 80.75 FT<sup>3</sup>   2.28 MT<sup>3</sup></p>	<b>GC4236HBL</b>	2841	2969	3077	3201	3405	3593	3781	3945	4149	4341	4601	4969	
	Ganging.													
	Active weight 500 lbs/seat.	<b>OVERALL DIMENSIONS</b>			<b>SEAT DIMENSIONS</b>			<b>BACK DIMENSIONS</b>						
	Wood armcap option: Add \$49.	IN 72.75	26	42.5	44	18	18	44	24.5					
	Table top only offered in high pressure laminate.	MM 1848	660	1080	1118	457	457	1118	622					

DESCRIPTION MODEL# / FEATURES STANDARD TEXTILE GRADES

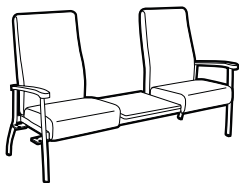

**HB Two Seat Chair w/Center Table Top - Right**

COM: 4 YD | 3.66 M  
 Unit weight: 99 LB | 45 KG  
 Carton weight: 111 LB | 50.35 KG  
 Carton volume: 80.75 FT³ | 2.28 MT³

COM	2	3	4	5	6	7	8	9	10	11	12
2841	2969	3077	3201	3405	3593	805	3945	4149	4341	4601	4969

Ganging.  
 Active weight 500 lbs/seat.

Wood armcap option:  
 Add \$49.

Table top only offered in  
 high pressure laminate.

OVERALL DIMENSIONS			SEAT DIMENSIONS			BACK DIMENSIONS	
W	D	H	W	D	H	W	H
IN 72.75	26	42.5	44	18	18	44	24.5
MM 1848	660	1080	1118	457	457	1118	622

RTA 00 1 per carton

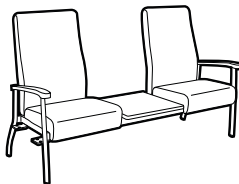

**HB Two Seat Chair w/Center Table Top - Left & Right**

COM: 4 YD | 3.66 M  
 Unit weight: 102 LB | 46.4 KG  
 Carton weight: 114 LB | 51.71 KG  
 Carton volume: 80.75 FT³ | 2.28 MT³

COM	2	3	4	5	6	7	8	9	10	11	12
2875	3003	3111	3235	3439	3627	3815	3979	4183	4375	4635	5003

Ganging.  
 Active weight 500 lbs/seat.

Wood armcap option:  
 Add \$49.

Table top only offered in  
 high pressure laminate.

OVERALL DIMENSIONS			SEAT DIMENSIONS			BACK DIMENSIONS	
W	D	H	W	D	H	W	H
IN 72.75	26	42.5	44	18	18	44	24.5
MM 1848	660	1080	1118	457	457	1118	622

RTA 00 1 per carton



**LB Armchair w/Rear Casters**

COM: 1.75 YD | 1.6 M  
 Unit weight: 41 LB | 18.6 KG  
 Carton weight: 49 LB | 22.23 KG  
 Carton volume: 20.25 FT³ | 0.57 MT³

COM	2	3	4	5	6	7	8	9	10	11	12
1328	1384	1431	1486	1575	1657	1739	1811	1900	1984	2098	2259

Active weight 500 lbs.  
 Wood armcap option:  
 Add \$49.

OVERALL DIMENSIONS			SEAT DIMENSIONS			BACK DIMENSIONS	
W	D	H	W	D	H	W	H
IN 26.75	27.5	37.5	22	18	18	21.5	19.5
MM 679	699	953	559	457	457	546	495

RTA 00 1 per carton



**HB Armchair w/Rear Casters**

COM: 2 YD | 1.83 M  
 Unit weight: 46 LB | 20.9 KG  
 Carton weight: 54 LB | 24.49 KG  
 Carton volume: 22.25 FT³ | 0.63 MT³

COM	2	3	4	5	6	7	8	9	10	11	12
1376	1440	1494	1556	1658	1752	1846	1928	2030	2126	2256	2440

Active weight 500 lbs.  
 Wood armcap option:  
 Add \$49.

OVERALL DIMENSIONS			SEAT DIMENSIONS			BACK DIMENSIONS	
W	D	H	W	D	H	W	H
IN 26.75	27.5	42.5	22	18	18	21.5	24.5
MM 679	699	1080	559	457	457	546	622

RTA 00 1 per carton

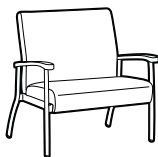

**Bariatric LB Armchair**

COM: 3 YD | 2.74 M  
 Unit weight: 56 LB | 25.5 KG  
 Carton weight: 70 LB | 31.75 KG  
 Carton volume: 30.5 FT³ | 0.86 MT³





COM	2	3	4	5	6	7	8	9	10	11	12
1637	1733	1814	1907	2060	2201	2342	2465	2618	2762	2957	3233

Active weight 750 lbs.  
 Wood armcap option:  
 Add \$49.

Armless bariatric models  
 are not available.



OVERALL DIMENSIONS			SEAT DIMENSIONS			BACK DIMENSIONS	
W	D	H	W	D	H	W	H
IN 37.5	28	37.5	32.5	18	18	32.5	19.5
MM 953	711	953	826	457	457	826	495

RTA 00 1 per carton

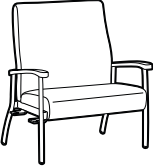
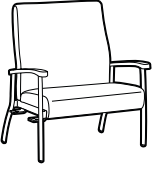
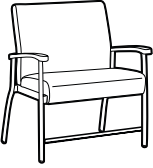
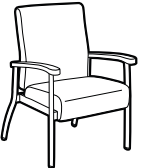
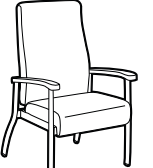
DESCRIPTION	MODEL# / FEATURES	STANDARD TEXTILE GRADES												
		COM	2	3	4	5	6	7	8	9	10	11	12	
 <p><b>Bariatric LB Armchair - Left</b>                      COM: 3 YD   2.74 M                      Unit weight: 57 LB   25.9 KG                      Carton weight: 71 LB   32.21 KG                      Carton volume: 30.5 FT³   0.86 MT³</p>	<b>GC4241L</b>	1671	1767	1848	1941	2094	2235	2376	2499	2652	2796	2991	3267	
	Ganging.													
	Active weight 750 lbs.													
	Wood armcap option: Add \$49.	IN	37.5	28	37.5		32.5	18	18		32.5	19.5		
	Armless bariatric models are <u>not</u> available.	MM	953	711	953		826	457	457		826	495		
	<b>RTA 00</b>	1 per carton												
 <p><b>Bariatric LB Armchair - Right</b>                      COM: 3 YD   2.74 M                      Unit weight: 57 LB   25.9 KG                      Carton weight: 71 LB   32.21 KG                      Carton volume: 30.5 FT³   0.86 MT³</p>	<b>GC4241R</b>	1671	1767	1848	1941	2094	2235	2376	2499	2652	2796	2991	3267	
	Ganging.													
	Active weight 750 lbs.													
	Wood armcap option: Add \$49.	IN	37.5	28	37.5		32.5	18	18		32.5	19.5		
	Armless bariatric models are <u>not</u> available.	MM	953	711	953		826	457	457		826	495		
	<b>RTA 00</b>	1 per carton												
 <p><b>Bariatric LB Armchair - Left &amp; Right</b>                      COM: 3 YD   2.74 M                      Unit weight: 57 LB   25.9 KG                      Carton weight: 71 LB   32.21 KG                      Carton volume: 30.5 FT³   0.86 MT³</p>	<b>GC4241B</b>	1706	1802	1883	1976	2129	2270	2411	2534	2687	2831	3026	3302	
	Ganging.													
	Active weight 750 lbs.													
	Wood armcap option: Add \$49.	IN	37.5	28	37.5		32.5	18	18		32.5	19.5		
	Armless bariatric models are <u>not</u> available.	MM	953	711	953		826	457	457		826	495		
	<b>RTA 00</b>	1 per carton												
 <p><b>Bariatric HB Armchair</b>                      COM: 3.25 YD   2.97 M                      Unit weight: 59 LB   26.8 KG                      Carton weight: 73 LB   33.11 KG                      Carton volume: 30.5 FT³   0.86 MT³</p>	<b>GC4241HB</b>	1719	1823	1911	2012	2177	2330	2483	2616	2782	2938	3149	3448	
	Ganging.													
	Active weight 750 lbs.													
	Wood armcap option: Add \$49.	IN	37.5	28	43		32.5	18	18		32.5	24.5		
	Armless bariatric models are <u>not</u> available.	MM	953	711	1092		826	457	457		826	622		
	<b>RTA 00</b>	1 per carton												
 <p><b>Bariatric HB Armchair - Left</b>                      COM: 3.25 YD   2.97 M                      Unit weight: 60 LB   27.3 KG                      Carton weight: 73 LB   33.11 KG                      Carton volume: 15.5 FT³   0.86 MT³</p>	<b>GC4241HBL</b>	1754	1858	1946	2047	2212	2365	2518	2651	2817	2973	3184	3483	
	Ganging.													
	Active weight 750 lbs.													
	Wood armcap option: Add \$49.	IN	37.5	28	43		32.5	18	18		32.5	24.5		
	Armless bariatric models are <u>not</u> available.	MM	953	711	1092		826	457	457		826	622		
	<b>RTA 00</b>	1 per carton												

DESCRIPTION	MODEL# / FEATURES	STANDARD TEXTILE GRADES											
		COM	2	3	4	5	6	7	8	9	10	11	12
 <p><b>Bariatric HB Armchair - Right</b>                      COM: 3.25 YD   2.97 M                      Unit weight: 60 LB   27.3 KG                      Carton weight: 74 LB   33.57 KG                      Carton volume: 30.5 FT³   0.86 MT³</p>	<b>GC4241HBR</b>	1754	1858	1946	2047	2212	2365	2518	2651	2817	2973	3184	3483
	Ganging.												
	Active weight 750 lbs.	<b>OVERALL DIMENSIONS</b>			<b>SEAT DIMENSIONS</b>			<b>BACK DIMENSIONS</b>					
		<b>W</b>	<b>D</b>	<b>H</b>	<b>W</b>	<b>D</b>	<b>H</b>	<b>W</b>	<b>H</b>				
	Wood armcap option: Add \$49.	IN 37.5 MM 953	28 711	43 1092	32.5 826	18 457	18 457	32.5 826	24.5 622				
Armless bariatric models are <u>not</u> available.	<b>RTA 00</b>	1 per carton											
 <p><b>Bariatric HB Armchair - Left &amp; Right</b>                      COM: 3.25 YD   2.97 M                      Unit weight: 60 LB   27.3 KG                      Carton weight: 74 LB   33.57 KG                      Carton volume: 30.5 FT³   0.86 MT³</p>	<b>GC4241HBB</b>	1788	1892	1980	2081	2246	2399	2552	2685	2851	3007	3218	3517
	Ganging.												
	Active weight 750 lbs.	<b>OVERALL DIMENSIONS</b>			<b>SEAT DIMENSIONS</b>			<b>BACK DIMENSIONS</b>					
		<b>W</b>	<b>D</b>	<b>H</b>	<b>W</b>	<b>D</b>	<b>H</b>	<b>W</b>	<b>H</b>				
	Wood armcap option: Add \$49.	IN 37.5 MM 953	28 711	43 1092	32.5 826	18 457	18 457	32.5 826	24.5 622				
Armless bariatric models are <u>not</u> available.	<b>RTA 00</b>	1 per carton											
 <p>Designed to immobilize the pelvis and hip joints after surgery.</p> <p><b>Bariatric LB Armchair Post Surgery</b>                      COM: 3 YD   2.74 M                      Unit weight: 64 LB   29.1 KG                      Carton weight: 76 LB   34.47 KG                      Carton volume: 33.5 FT³   0.94 MT³</p>	<b>GC4241-24</b> 24" seat height	1796	1892	1973	2066	2219	2360	2501	2624	2777	2921	3116	3392
	Active weight 750 lbs.	<b>OVERALL DIMENSIONS</b>			<b>SEAT DIMENSIONS</b>			<b>BACK DIMENSIONS</b>					
		<b>W</b>	<b>D</b>	<b>H</b>	<b>W</b>	<b>D</b>	<b>H</b>	<b>W</b>	<b>H</b>				
	Wood armcap option: Add \$49.	IN 37.5 MM 953	28.75 730	43.5 1105	32.5 826	18 457	24 610	32.5 826	19.5 495				
	Armless bariatric models are <u>not</u> available.	<b>RTA 00</b>	1 per carton										
 <p><b>LB Armchair Flex Back</b>                      COM: 1.75 YD   1.6 M                      Unit weight: 41 LB   18.6 KG                      Carton weight: 53 LB   24.04 KG                      Carton volume: 20.25 FT³   0.57 MT³</p>	<b>GC4242</b>	1590	1646	1693	1748	1837	1919	2001	2073	2162	2246	2360	2521
	Active weight 500 lbs.	<b>OVERALL DIMENSIONS</b>			<b>SEAT DIMENSIONS</b>			<b>BACK DIMENSIONS</b>					
		<b>W</b>	<b>D</b>	<b>H</b>	<b>W</b>	<b>D</b>	<b>H</b>	<b>W</b>	<b>H</b>				
	Wood armcap option: Add \$49.	IN 26.5 MM 673	28 711	37.5 953	22 559	18 457	18 457	21.5 546	19.5 495				
		<b>RTA 00</b>	1 per carton										
 <p><b>HB Armchair Flex Back</b>                      COM: 2 YD   1.83 M                      Unit weight: 48 LB   21.8 KG                      Carton weight: 61 LB   27.67 KG                      Carton volume: 22.25 FT³   0.63 MT³</p>	<b>GC4242HB</b>	1638	1702	1756	1818	1920	2014	2108	2190	2292	2388	2518	2702
	Active weight 500 lbs.	<b>OVERALL DIMENSIONS</b>			<b>SEAT DIMENSIONS</b>			<b>BACK DIMENSIONS</b>					
		<b>W</b>	<b>D</b>	<b>H</b>	<b>W</b>	<b>D</b>	<b>H</b>	<b>W</b>	<b>H</b>				
	Wood armcap option: Add \$49.	IN 26.5 MM 673	28 711	43 1092	22 559	18 457	18 457	21.5 546	24.5 622				
		<b>RTA 00</b>	1 per carton										



DESCRIPTION	MODEL# / FEATURES	STANDARD TEXTILE GRADES																																											
 <p><b>LB Armchair Flex Back w/Rear Casters</b> COM: 1.75 YD   1.6 M Unit weight: 41 LB   18.6 KG Carton weight: 49 LB   22.23 KG Carton volume: 20.25 FT³   0.57 MT³</p>	<b>GC4243</b>	COM	2	3	4	5	6	7	8	9	10	11	12																																
	Active weight 500 lbs.	1685	1741	1788	1843	1932	2014	2096	2168	2257	2341	2455	2616																																
	Wood armcap option: Add \$49.	<table border="1"> <thead> <tr> <th colspan="3">OVERALL DIMENSIONS</th> <th colspan="3">SEAT DIMENSIONS</th> <th colspan="3">BACK DIMENSIONS</th> </tr> <tr> <th>W</th><th>D</th><th>H</th> <th>W</th><th>D</th><th>H</th> <th>W</th><th>H</th> </tr> </thead> <tbody> <tr> <td>IN 26.75</td><td>27.5</td><td>37.5</td> <td>22</td><td>18</td><td>18</td> <td>21.5</td><td>19.5</td> </tr> <tr> <td>MM 679</td><td>699</td><td>953</td> <td>559</td><td>457</td><td>457</td> <td>546</td><td>495</td> </tr> </tbody> </table>												OVERALL DIMENSIONS			SEAT DIMENSIONS			BACK DIMENSIONS			W	D	H	W	D	H	W	H	IN 26.75	27.5	37.5	22	18	18	21.5	19.5	MM 679	699	953	559	457	457	546
OVERALL DIMENSIONS			SEAT DIMENSIONS			BACK DIMENSIONS																																							
W	D	H	W	D	H	W	H																																						
IN 26.75	27.5	37.5	22	18	18	21.5	19.5																																						
MM 679	699	953	559	457	457	546	495																																						
 <p><b>HB Armchair Flex Back w/Rear Casters</b> COM: 2 YD   1.83 M Unit weight: 43 LB   19.5 KG Carton weight: 51 LB   23.13 KG Carton volume: 22.25 FT³   0.63 MT³</p>	<b>GC4243HB</b>	COM	2	3	4	5	6	7	8	9	10	11	12																																
	Active weight 500 lbs.	1738	1802	1856	1918	2020	2114	2208	2290	2392	2488	2618	2802																																
	Wood armcap option: Add \$49.	<table border="1"> <thead> <tr> <th colspan="3">OVERALL DIMENSIONS</th> <th colspan="3">SEAT DIMENSIONS</th> <th colspan="3">BACK DIMENSIONS</th> </tr> <tr> <th>W</th><th>D</th><th>H</th> <th>W</th><th>D</th><th>H</th> <th>W</th><th>H</th> </tr> </thead> <tbody> <tr> <td>IN 26.75</td><td>27.5</td><td>42.5</td> <td>22</td><td>18</td><td>18</td> <td>21.5</td><td>24.5</td> </tr> <tr> <td>MM 679</td><td>699</td><td>1080</td> <td>559</td><td>457</td><td>457</td> <td>546</td><td>622</td> </tr> </tbody> </table>												OVERALL DIMENSIONS			SEAT DIMENSIONS			BACK DIMENSIONS			W	D	H	W	D	H	W	H	IN 26.75	27.5	42.5	22	18	18	21.5	24.5	MM 679	699	1080	559	457	457	546
OVERALL DIMENSIONS			SEAT DIMENSIONS			BACK DIMENSIONS																																							
W	D	H	W	D	H	W	H																																						
IN 26.75	27.5	42.5	22	18	18	21.5	24.5																																						
MM 679	699	1080	559	457	457	546	622																																						
 <p><b>HB Armchair Split Back</b> COM: 2.25 YD   2.06 M Unit weight: 46 LB   20.9 KG Carton weight: 54 LB   24.49 KG Carton volume: 20.25 FT³   0.57 MT³</p>	<b>GC4244HB</b>	COM	2	3	4	5	6	7	8	9	10	11	12																																
	Active weight 500 lbs.	1516	1588	1649	1719	1833	1939	2045	2137	2252	2360	2506	2713																																
	Fold down headrest allows caregiver to assist occupant. Wood armcap option: Add \$49.	<table border="1"> <thead> <tr> <th colspan="3">OVERALL DIMENSIONS</th> <th colspan="3">SEAT DIMENSIONS</th> <th colspan="3">BACK DIMENSIONS</th> </tr> <tr> <th>W</th><th>D</th><th>H</th> <th>W</th><th>D</th><th>H</th> <th>W</th><th>H</th> </tr> </thead> <tbody> <tr> <td>IN 26.75</td><td>26</td><td>42.5</td> <td>22</td><td>18</td><td>18</td> <td>21.5</td><td>24.5</td> </tr> <tr> <td>MM 679</td><td>660</td><td>1080</td> <td>559</td><td>457</td><td>457</td> <td>546</td><td>622</td> </tr> </tbody> </table>												OVERALL DIMENSIONS			SEAT DIMENSIONS			BACK DIMENSIONS			W	D	H	W	D	H	W	H	IN 26.75	26	42.5	22	18	18	21.5	24.5	MM 679	660	1080	559	457	457	546
OVERALL DIMENSIONS			SEAT DIMENSIONS			BACK DIMENSIONS																																							
W	D	H	W	D	H	W	H																																						
IN 26.75	26	42.5	22	18	18	21.5	24.5																																						
MM 679	660	1080	559	457	457	546	622																																						
 <p><b>HB Armchair Split Back w/Rear Casters</b> COM: 2.25 YD   2.06 M Unit weight: 46 LB   20.9 KG Carton weight: 54 LB   24.49 KG Carton volume: 20.25 FT³   0.57 MT³</p>	<b>GC4245HB</b>	COM	2	3	4	5	6	7	8	9	10	11	12																																
	Active weight 500 lbs.	1613	1685	1746	1816	1930	2036	2142	2234	2349	2457	2603	2810																																
	Fold down headrest allows caregiver to assist occupant. Wood armcap option: Add \$49.	<table border="1"> <thead> <tr> <th colspan="3">OVERALL DIMENSIONS</th> <th colspan="3">SEAT DIMENSIONS</th> <th colspan="3">BACK DIMENSIONS</th> </tr> <tr> <th>W</th><th>D</th><th>H</th> <th>W</th><th>D</th><th>H</th> <th>W</th><th>H</th> </tr> </thead> <tbody> <tr> <td>IN 26.75</td><td>26</td><td>42.5</td> <td>22</td><td>18</td><td>18</td> <td>21.5</td><td>24.5</td> </tr> <tr> <td>MM 679</td><td>660</td><td>1080</td> <td>559</td><td>457</td><td>457</td> <td>546</td><td>622</td> </tr> </tbody> </table>												OVERALL DIMENSIONS			SEAT DIMENSIONS			BACK DIMENSIONS			W	D	H	W	D	H	W	H	IN 26.75	26	42.5	22	18	18	21.5	24.5	MM 679	660	1080	559	457	457	546
OVERALL DIMENSIONS			SEAT DIMENSIONS			BACK DIMENSIONS																																							
W	D	H	W	D	H	W	H																																						
IN 26.75	26	42.5	22	18	18	21.5	24.5																																						
MM 679	660	1080	559	457	457	546	622																																						
 <p><b>Single Seat Bench</b> COM: 1.5 YD   1.37 M Unit weight: 25 LB   11.4 KG Carton weight: 30 LB   13.61 KG Carton volume: 13 FT³   0.36 MT³</p>	<b>GC4251</b>	COM	2	3	4	5	6	7	8	9	10	11	12																																
	Active weight 500 lbs.	795	843	884	930	1007	1077	1148	1209	1286	1358	1455	1593																																
	Wood armcap option: Add \$49.	<table border="1"> <thead> <tr> <th colspan="3">OVERALL DIMENSIONS</th> <th colspan="3">SEAT DIMENSIONS</th> <th colspan="3">BACK DIMENSIONS</th> </tr> <tr> <th>W</th><th>D</th><th>H</th> <th>W</th><th>D</th><th>H</th> <th>W</th><th>H</th> </tr> </thead> <tbody> <tr> <td>IN 24.75</td><td>26.5</td><td>18</td> <td>-</td><td>-</td><td>-</td> <td>-</td><td>-</td> </tr> <tr> <td>MM 629</td><td>673</td><td>457</td> <td>-</td><td>-</td><td>-</td> <td>-</td><td>-</td> </tr> </tbody> </table>												OVERALL DIMENSIONS			SEAT DIMENSIONS			BACK DIMENSIONS			W	D	H	W	D	H	W	H	IN 24.75	26.5	18	-	-	-	-	-	MM 629	673	457	-	-	-	-
OVERALL DIMENSIONS			SEAT DIMENSIONS			BACK DIMENSIONS																																							
W	D	H	W	D	H	W	H																																						
IN 24.75	26.5	18	-	-	-	-	-																																						
MM 629	673	457	-	-	-	-	-																																						

DESCRIPTION MODEL# / FEATURES STANDARD TEXTILE GRADES



**Single Seat Bench - Reversible (One Side)**

COM: 1.5 YD | 1.37 M  
 Unit weight: 26 LB | 11.8 KG  
 Carton weight: 31 LB | 14.06 KG  
 Carton volume: 13 FT³ | 0.36 MT³

MODEL#	STANDARD TEXTILE GRADES											
	COM	2	3	4	5	6	7	8	9	10	11	12
<b>GC4251L</b>	826	874	915	961	1038	1108	1179	1240	1317	1389	1486	1624
Ganging.	<b>OVERALL DIMENSIONS</b>			<b>SEAT DIMENSIONS</b>			<b>BACK DIMENSIONS</b>					
	<b>W</b>	<b>D</b>	<b>H</b>	<b>W</b>	<b>D</b>	<b>H</b>	<b>W</b>	<b>H</b>				
Active weight 500 lbs.	IN 25.75	26.5	18	-	-	-	-	-				
	MM 654	673	457	-	-	-	-	-				
	<b>RTA 00</b>	<b>courier</b>	1 per carton									



**Single Seat Bench - Left & Right**

COM: 1.5 YD | 1.37 M  
 Unit weight: 27 LB | 12.3 KG  
 Carton weight: 32 LB | 14.51 KG  
 Carton volume: 13 FT³ | 0.36 MT³

MODEL#	STANDARD TEXTILE GRADES											
	COM	2	3	4	5	6	7	8	9	10	11	12
<b>GC4251B</b>	860	908	949	995	1072	1142	1213	1274	1351	1423	1520	1658
Ganging.	<b>OVERALL DIMENSIONS</b>			<b>SEAT DIMENSIONS</b>			<b>BACK DIMENSIONS</b>					
	<b>W</b>	<b>D</b>	<b>H</b>	<b>W</b>	<b>D</b>	<b>H</b>	<b>W</b>	<b>H</b>				
Active weight 500 lbs.	IN 26.75	26.5	18	-	-	-	-	-				
	MM 679	673	457	-	-	-	-	-				
	<b>RTA 00</b>	<b>courier</b>	1 per carton									

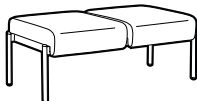

**Two Seat Bench**

COM: 2.25 YD | 2.06 M  
 Unit weight: 45 LB | 20.5 KG  
 Carton weight: 53 LB | 24.04 KG  
 Carton volume: 23 FT³ | 0.65 MT³

MODEL#	STANDARD TEXTILE GRADES											
	COM	2	3	4	5	6	7	8	9	10	11	12
<b>GC4252</b>	1426	1498	1559	1629	1743	1849	1955	2047	2162	2270	2416	2623
Ganging.	<b>OVERALL DIMENSIONS</b>			<b>SEAT DIMENSIONS</b>			<b>BACK DIMENSIONS</b>					
	<b>W</b>	<b>D</b>	<b>H</b>	<b>W</b>	<b>D</b>	<b>H</b>	<b>W</b>	<b>H</b>				
Active weight 500 lbs/seat.	IN 47.75	26.5	18	-	-	-	-	-				
	MM 1213	673	457	-	-	-	-	-				
	<b>RTA 00</b>	<b>courier</b>	1 per carton									

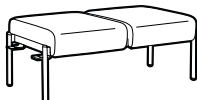

**Two Seat Bench - Reversible (One Side)**

COM: 2.25 YD | 2.06 M  
 Unit weight: 46 LB | 20.9 KG  
 Carton weight: 54 LB | 24.49 KG  
 Carton volume: 23 FT³ | 0.65 MT³



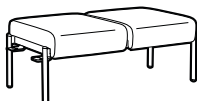



MODEL#	STANDARD TEXTILE GRADES											
	COM	2	3	4	5	6	7	8	9	10	11	12
<b>GC4252L</b>	1458	1530	1591	1661	1775	1881	1987	2079	2194	2302	2448	2655
Ganging.	<b>OVERALL DIMENSIONS</b>			<b>SEAT DIMENSIONS</b>			<b>BACK DIMENSIONS</b>					
	<b>W</b>	<b>D</b>	<b>H</b>	<b>W</b>	<b>D</b>	<b>H</b>	<b>W</b>	<b>H</b>				
Active weight 500 lbs/seat.	IN 48.75	26.5	18	-	-	-	-	-				
	MM 1238	673	457	-	-	-	-	-				
	<b>RTA 00</b>	<b>courier</b>	1 per carton									

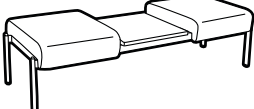

**Two Seat Bench - Left & Right**

COM: 2.25 YD | 2.06 M  
 Unit weight: 47 LB | 21.4 KG  
 Carton weight: 55 LB | 24.95 KG  
 Carton volume: 23 FT³ | 0.65 MT³

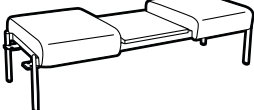
MODEL#	STANDARD TEXTILE GRADES											
	COM	2	3	4	5	6	7	8	9	10	11	12
<b>GC4252B</b>	1490	1562	1623	1693	1807	1913	2019	2111	2226	2334	2480	2687
Ganging.	<b>OVERALL DIMENSIONS</b>			<b>SEAT DIMENSIONS</b>			<b>BACK DIMENSIONS</b>					
	<b>W</b>	<b>D</b>	<b>H</b>	<b>W</b>	<b>D</b>	<b>H</b>	<b>W</b>	<b>H</b>				
Active weight 500 lbs/seat.	IN 49.75	26.5	18	-	-	-	-	-				
	MM 1264	673	457	-	-	-	-	-				
	<b>RTA 00</b>	<b>courier</b>	1 per carton									

DESCRIPTION	MODEL# / FEATURES	STANDARD TEXTILE GRADES												
		COM	2	3	4	5	6	7	8	9	10	11	12	
 <p><b>Three Seat Bench</b> COM: 3 YD   2.74 M Unit weight: 65 LB   29.5 KG Carton weight: 73 LB   33.11 KG Carton volume: 33.25 FT³   0.94 MT³</p>	<b>GC4253</b>	2098	2194	2275	2368	2521	2662	2803	2926	3079	3223	3418	3694	
	Active weight 500 lbs/seat.	<b>OVERALL DIMENSIONS</b> W D H			<b>SEAT DIMENSIONS</b> W D H			<b>BACK DIMENSIONS</b> W H						
		IN 70.75	26.5	18	-	-	-	-	-	-	-	-	-	-
		MM 1797	673	457	-	-	-	-	-	-	-	-	-	-
		<b>RTA 00</b>	1 per carton											
 <p><b>Three Seat Bench - Reversible (One Side)</b> COM: 3 YD   2.74 M Unit weight: 66 LB   30 KG Carton weight: 74 LB   33.57 KG Carton volume: 33.25 FT³   0.94 MT³</p>	<b>GC4253L</b>	2129	2225	2306	2399	2552	2693	2834	2957	3110	3254	3449	3725	
	Ganging.	<b>OVERALL DIMENSIONS</b> W D H			<b>SEAT DIMENSIONS</b> W D H			<b>BACK DIMENSIONS</b> W H						
	Active weight 500 lbs/seat.	IN 71.75	26.5	18	-	-	-	-	-	-	-	-	-	
		MM 1822	673	457	-	-	-	-	-	-	-	-	-	
		<b>RTA 00</b>	1 per carton											
 <p><b>Three Seat Bench - Left &amp; Right</b> COM: 3 YD   2.74 M Unit weight: 67 LB   30.5 KG Carton weight: 75 LB   34.02 KG Carton volume: 33.25 FT³   0.94 MT³</p>	<b>GC4253B</b>	2161	2257	2338	2431	2584	2725	2866	2989	3142	3286	3481	3757	
	Ganging.	<b>OVERALL DIMENSIONS</b> W D H			<b>SEAT DIMENSIONS</b> W D H			<b>BACK DIMENSIONS</b> W H						
	Active weight 500 lbs/seat.	IN 72.75	26.5	18	-	-	-	-	-	-	-	-	-	
		MM 1848	673	457	-	-	-	-	-	-	-	-	-	
		<b>RTA 00</b>	1 per carton											
 <p><b>Two Seat Bench w/Center Table Top</b> COM: 2.25 YD   2.06 M Unit weight: 60 LB   27.3 KG Carton weight: 68 LB   30.84 KG Carton volume: 33.25 FT³   0.94 MT³</p>	<b>GC4256</b>	2047	2119	2180	2250	2364	2470	2576	2668	2783	2891	3037	3244	
	Active weight 500 lbs/seat.	<b>OVERALL DIMENSIONS</b> W D H			<b>SEAT DIMENSIONS</b> W D H			<b>BACK DIMENSIONS</b> W H						
	Table top only offered in high pressure laminate.	IN 70.75	26.5	18	-	-	-	-	-	-	-	-	-	
		MM 1797	673	457	-	-	-	-	-	-	-	-	-	
		<b>RTA 00</b>		1 per carton										
 <p><b>Two Seat Bench w/Center Table Top - Reversible (One Side)</b> COM: 2.25 YD   2.06 M Unit weight: 64 LB   29.1 KG Carton weight: 72 LB   32.66 KG Carton volume: 33.25 FT³   0.94 MT³</p>	<b>GC4256L</b>	2082	2154	2215	2285	2399	2505	2611	2703	2818	2926	3072	3279	
	Ganging.	<b>OVERALL DIMENSIONS</b> W D H			<b>SEAT DIMENSIONS</b> W D H			<b>BACK DIMENSIONS</b> W H						
	Active weight 500 lbs/seat.	IN 71.75	26.5	18	-	-	-	-	-	-	-	-	-	
	Table top only offered in high pressure laminate.	MM 1822	673	457	-	-	-	-	-	-	-	-	-	
		<b>RTA 00</b>		1 per carton										

DESCRIPTION MODEL# / FEATURES STANDARD TEXTILE GRADES

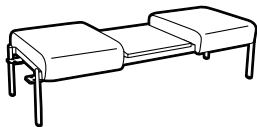

**Two Seat Bench w/Center Table Top - Left & Right**

COM: 2.25 YD | 2.06 M  
 Unit weight: 62 LB | 28.2 KG  
 Carton weight: 70 LB | 31.75 KG  
 Carton volume: 33.25 FT³ | 0.94 MT³

Active weight 500 lbs/seat.

Table top only offered in high pressure laminate.

COM	2	3	4	5	6	7	8	9	10	11	12
2112	2184	2245	2315	2429	2535	2641	2733	2848	2956	3102	3309

OVERALL DIMENSIONS			SEAT DIMENSIONS			BACK DIMENSIONS	
W	D	H	W	D	H	W	H
IN 72.75	26.5	18	-	-	-	-	-
MM 1848	673	457	-	-	-	-	-

RTA 00  1 per carton



**Ottoman Angled Cushion Top**

COM: 1 YD | 0.91 M  
 Unit weight: 14 LB | 6.4 KG  
 Carton weight: 16 LB | 7.26 KG  
 Carton volume: 3.6 FT³ | 0.1 MT³

Active weight 500 lbs.

COM	2	3	4	5	6	7	8	9	10	11	12
458	490	517	548	599	646	693	734	785	833	898	990

OVERALL DIMENSIONS			SEAT DIMENSIONS			BACK DIMENSIONS	
W	D	H	W	D	H	W	H
IN 17.75	19	10.5	-	-	-	-	-
MM 451	483	267	-	-	-	-	-

RTA 00  1 per carton



**LB Single Seat Armless Bridge - Left & Right**

COM: 1.75 YD | 1.6 M  
 Unit weight: 31 LB | 14.1 KG  
 Carton weight: 36 LB | 16.33 KG  
 Carton volume: 13 FT³ | 0.36 MT³

Active weight 500 lbs.

**Not freestanding.**  
 Suspends between 2 units via linking brackets.

COM	2	3	4	5	6	7	8	9	10	11	12
919	975	1022	1077	1166	1248	1330	1402	1491	1575	1689	1850

OVERALL DIMENSIONS			SEAT DIMENSIONS			BACK DIMENSIONS	
W	D	H	W	D	H	W	H
IN 26.75	24	25.5	22	18	-	21.5	19.5
MM 679	610	648	559	457	-	546	495

RTA 00  1 per carton



**HB Single Seat Armless Bridge - Left & Right**

COM: 2 YD | 1.83 M  
 Unit weight: 36 LB | 16.4 KG  
 Carton weight: 41 LB | 18.6 KG  
 Carton volume: 14.5 FT³ | 0.41 MT³

Active weight 500 lbs.

**Not freestanding.**  
 Suspends between 2 units via linking brackets.

COM	2	3	4	5	6	7	8	9	10	11	12
967	1031	1085	1147	1249	1343	1437	1519	1621	1717	1847	2031

OVERALL DIMENSIONS			SEAT DIMENSIONS			BACK DIMENSIONS	
W	D	H	W	D	H	W	H
IN 26.75	24	30.5	22	18	-	21.5	24.5
MM 679	610	775	559	457	-	546	622

RTA 00  1 per carton

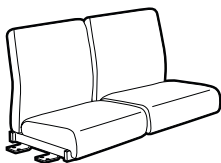

**LB Two Seat Armless Bridge - Left & Right**

COM: 3.5 YD | 3.2 M  
 Unit weight: 60 LB | 27.3 KG  
 Carton weight: 66 LB | 29.94 KG  
 Carton volume: 23 FT³ | 0.65 MT³







Active weight 500 lbs/seat.

**Not freestanding.**  
 Suspends between 2 units via linking brackets.

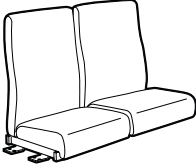
COM	2	3	4	5	6	7	8	9	10	11	12
1780	1892	1987	2095	2274	2438	2603	2746	2925	3093	3320	3642

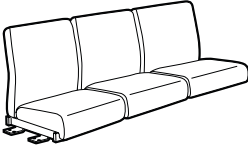
OVERALL DIMENSIONS			SEAT DIMENSIONS			BACK DIMENSIONS	
W	D	H	W	D	H	W	H
IN 49.75	24	25.5	44	18	-	44	19.5
MM 1264	610	648	1118	457	-	1118	495

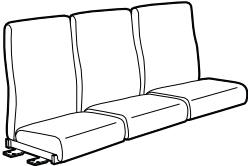
RTA 00  1 per carton

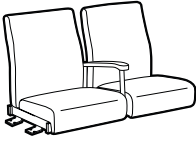
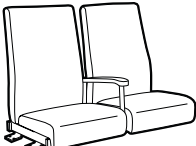
DESCRIPTION	MODEL# / FEATURES	STANDARD TEXTILE GRADES															
		COM	2	3	4	5	6	7	8	9	10	11	12				
 <p><b>HB Two Seat Armless Bridge - Left &amp; Right</b>                      COM: 4 YD   3.66 M                      Unit weight: 64 LB   29.1 KG                      Carton weight: 72 LB   32.66 KG                      Carton volume: 24 FT<sup>3</sup>   0.67 MT<sup>3</sup></p>	<b>GC4262HB</b>	1876	2004	2112	2236	2440	2628	2816	2980	3184	3376	3636	4004				
	Ganging/linking.	<b>OVERALL DIMENSIONS</b>			<b>SEAT DIMENSIONS</b>			<b>BACK DIMENSIONS</b>									
	Active weight 500 lbs/seat.	IN 49.75	24	30.5	44	18	-	44	24.5	MM 1264	610	775	1118	457	-	1118	622
	<b>Not freestanding.</b> Suspends between 2 units via linking brackets.	<b>RTA 00</b>		1 per carton													
 <p><b>LB Three Seat Armless Bridge - Left &amp; Right</b>                      COM: 5 YD   4.57 M                      Unit weight: 68 LB   30.9 KG                      Carton weight: 74 LB   33.57 KG                      Carton volume: 38.75 FT<sup>3</sup>   1.09 MT<sup>3</sup></p>	<b>GC4263</b>	2648	2808	2943	3098	3353	3588	3823	4028	4283	4523	4848	5308				
	Ganging/linking.	<b>OVERALL DIMENSIONS</b>			<b>SEAT DIMENSIONS</b>			<b>BACK DIMENSIONS</b>									
	Active weight 500 lbs/seat.	IN 72.75	24	25.5	70	18	-	70	19.5	MM 1848	610	648	1778	457	-	1778	495
	<b>Not freestanding.</b> Suspends between 2 units via linking brackets.	<b>RTA 00</b>		1 per carton													
 <p><b>HB Three Seat Armless Bridge - Left &amp; Right</b>                      COM: 5 YD   4.57 M                      Unit weight: 74 LB   33.6 KG                      Carton weight: 80 LB   36.29 KG                      Carton volume: 38.75 FT<sup>3</sup>   1.09 MT<sup>3</sup></p>	<b>GC4263HB</b>	2796	2980	3135	3314	3607	3877	4147	4383	4676	4952	5326	5855				
	Ganging/linking.	<b>OVERALL DIMENSIONS</b>			<b>SEAT DIMENSIONS</b>			<b>BACK DIMENSIONS</b>									
	Active weight 500 lbs/seat.	IN 72.75	24	30.5	70	18	-	70	24.5	MM 1848	610	775	1778	457	-	1778	622
	<b>Not freestanding.</b> Suspends between 2 units via linking brackets.	<b>RTA 00</b>		1 per carton													
 <p><b>LB Two Seat Bridge Half Center Arm - Left &amp; Right</b>                      COM: 3.5 YD   3.2 M                      Unit weight: 52 LB   23.6 KG                      Carton weight: 58 LB   26.31 KG                      Carton volume: 27.25 FT<sup>3</sup>   0.77 MT<sup>3</sup></p>	<b>GC4264</b>	1967	2079	2174	2282	2461	2625	2790	2933	3112	3280	3507	3829				
	Ganging/linking.	<b>OVERALL DIMENSIONS</b>			<b>SEAT DIMENSIONS</b>			<b>BACK DIMENSIONS</b>									
	Active weight 500 lbs/seat.	IN 50.75	24	25.5	22	18	-	21.5	19.5	MM 1289	610	648	559	457	-	546	4951
	Wood armcap option: Add \$25.	<b>RTA 00</b>		1 per carton													
 <p><b>HB Two Seat Bridge Half Center Arm - Left &amp; Right</b>                      COM: 4 YD   3.66 M                      Unit weight: 62 LB   28.2 KG                      Carton weight: 68 LB   30.84 KG                      Carton volume: 27.25 FT<sup>3</sup>   0.77 MT<sup>3</sup></p>	<b>GC4264HB</b>	2066	2194	2302	2426	2630	2818	3006	3170	3374	3566	3826	4194				
	Ganging/linking.	<b>OVERALL DIMENSIONS</b>			<b>SEAT DIMENSIONS</b>			<b>BACK DIMENSIONS</b>									
	Active weight 500 lbs/seat.	IN 50.75	24	30.5	22	18	-	21.5	24.5	MM 1289	610	775	559	457	-	546	622
	<b>Not freestanding.</b> Suspends between 2 units via linking brackets.	<b>RTA 00</b>		1 per carton													

DESCRIPTION MODEL# / FEATURES STANDARD TEXTILE GRADES

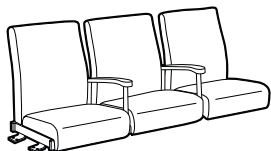

**LB Three Seat Bridge Half Center Arms - Left & Right**  
 COM: 5 YD | 4.57 M  
 Unit weight: 72 LB | 32.7 KG  
 Carton weight: 78 LB | 35.38 KG  
 Carton volume: 38.75 FT³ | 1.09 MT³

COM	2	3	4	5	6	7	8	9	10	11	12	
<b>GC4265</b>	3024	3184	3319	3474	3729	3964	4199	4404	4659	4899	5224	5684
Ganging/linking.												
Active weight 500 lbs/seat.												
OVERALL DIMENSIONS			SEAT DIMENSIONS			BACK DIMENSIONS						
W	D	H	W	D	H	W	H					
IN 74.25	24	25.5	22	18	-	21.5	19.5					
MM 1886	610	648	559	457	-	546	495					
Wood armcap option: Add \$49.												
RTA 00  1 per carton												

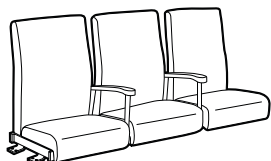

**HB Three Seat Bridge Half Center Arms - Left & Right**  
 COM: 5.75 YD | 5.26 M  
 Unit weight: 80 LB | 36.4 KG  
 Carton weight: 86 LB | 39.01 KG  
 Carton volume: 38.75 FT³ | 1.09 MT³

COM	2	3	4	5	6	7	8	9	10	11	12	
<b>GC4265HB</b>	3170	3354	3509	3688	3981	4251	4521	4757	5050	5326	5700	6229
Ganging/linking.												
Active weight 500 lbs/seat.												
OVERALL DIMENSIONS			SEAT DIMENSIONS			BACK DIMENSIONS						
W	D	H	W	D	H	W	H					
IN 74.25	24	30.5	22	18	-	21.5	24.5					
MM 1886	610	775	559	457	-	546	622					
Wood armcap option: Add \$49.												
RTA 00  1 per carton												

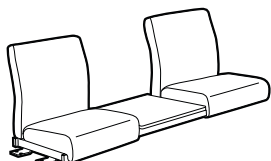

**LB Two Seat Armless Bridge Center Table Top - Left & Right**  
 COM: 3.5 YD | 3.2 M  
 Unit weight: 54 LB | 24.5 KG  
 Carton weight: 60 LB | 27.22 KG  
 Carton volume: 38.75 FT³ | 1.09 MT³

COM	2	3	4	5	6	7	8	9	10	11	12	
<b>GC4266</b>	2399	2511	2606	2714	2893	3057	3222	3365	3544	3712	3939	4261
Ganging/linking.												
Active weight 500 lbs/seat.												
OVERALL DIMENSIONS			SEAT DIMENSIONS			BACK DIMENSIONS						
W	D	H	W	D	H	W	H					
IN 72.75	24	25.5	22	18	-	21.5	19.5					
MM 1848	610	648	559	457	-	546	495					
Table top only offered in high pressure laminate.												
RTA 00  1 per carton												

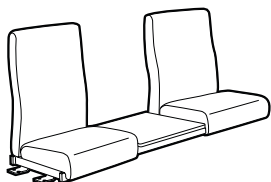





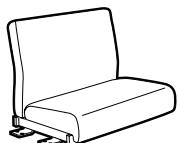



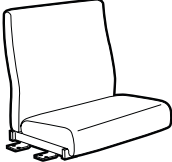

**HB Two Seat Armless Bridge Center Table Top - Left & Right**  
 COM: 4 YD | 3.66 M  
 Unit weight: 60 LB | 27.3 KG  
 Carton weight: 66 LB | 29.94 KG  
 Carton volume: 38.75 FT³ | 1.09 MT³

COM	2	3	4	5	6	7	8	9	10	11	12	
<b>GC4266HB</b>	2499	2627	2735	2859	3063	3251	3439	3603	3807	3999	4259	4627
Ganging/linking.												
Active weight 500 lbs/seat.												
OVERALL DIMENSIONS			SEAT DIMENSIONS			BACK DIMENSIONS						
W	D	H	W	D	H	W	H					
IN 72.75	24	30.5	22	18	-	21.5	24.5					
MM 1848	610	775	559	457	-	546	622					
Table top only offered in high pressure laminate.												
RTA 00  1 per carton												

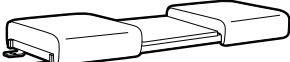

**Bariatric LB Armless Bridge - Left & Right**  
 COM: 3 YD | 2.74 M  
 Unit weight: 38 LB | 17.3 KG  
 Carton weight: 44 LB | 19.96 KG  
 Carton volume: 26.5 FT³ | 0.75 MT³

COM	2	3	4	5	6	7	8	9	10	11	12	
<b>GC4269</b>	1328	1424	1505	1598	1751	1892	2033	2156	2309	2453	2648	2924
Ganging/linking.												
Active weight 750 lbs.												
OVERALL DIMENSIONS			SEAT DIMENSIONS			BACK DIMENSIONS						
W	D	H	W	D	H	W	H					
IN 37.5	24	25.5	32.5	18	-	32.5	19.5					
MM 953	610	648	826	457	-	826	495					
Suspends between 2 units via linking brackets.												
RTA 00  1 per carton												

DESCRIPTION	MODEL# / FEATURES	STANDARD TEXTILE GRADES															
		COM	2	3	4	5	6	7	8	9	10	11	12				
 <p><b>Bariatric HB Armless Bridge - Left &amp; Right</b>                      COM: 3.25 YD   2.97 M                      Unit weight: 44 LB   20 KG                      Carton weight: 50 LB   22.68 KG                      Carton volume: 26.5 FT³   0.75 MT³</p>	<b>GC4269HB</b>	1409	1513	1601	1702	1867	2020	2173	2306	2472	2628	2839	3138				
	Ganging/linking.	<b>OVERALL DIMENSIONS</b>			<b>SEAT DIMENSIONS</b>			<b>BACK DIMENSIONS</b>									
	Active weight 750 lbs.	IN 37.5	24	30.5	32.5	18	-	32.5	24.5	MM 953	610	775	826	457	-	826	622
	Not freestanding. Suspends between 2 units via linking brackets.	<b>RTA 00</b>		1 per carton													
 <p><b>Single Seat Bench Bridge - Left &amp; Right</b>                      COM: 1.5 YD   1.37 M                      Unit weight: 20 LB   9.1 KG                      Carton weight: 24 LB   10.89 KG                      Carton volume: 2.9 FT³   0.08 MT³</p>	<b>GC4271</b>	772	820	861	907	984	1054	1125	1186	1263	1335	1432	1570				
	Ganging/linking.	<b>OVERALL DIMENSIONS</b>			<b>SEAT DIMENSIONS</b>			<b>BACK DIMENSIONS</b>									
	Active weight 500 lbs.	IN 24.75	26.5	6	-	-	-	-	-	MM 629	673	152	-	-	-	-	
	Not freestanding. Suspends between 2 units via linking brackets.	<b>RTA 00</b>		1 per carton													
 <p><b>Two Seat Bench Bridge - Left &amp; Right</b>                      COM: 2.25 YD   2.06 M                      Unit weight: 58 LB   26.4 KG                      Carton weight: 64 LB   29.03 KG                      Carton volume: 9.25 FT³   0.26 MT³</p>	<b>GC4272</b>	1400	1472	1533	1603	1717	1823	1929	2021	2136	2244	2390	2597				
	Ganging/linking.	<b>OVERALL DIMENSIONS</b>			<b>SEAT DIMENSIONS</b>			<b>BACK DIMENSIONS</b>									
	Active weight 500 lbs/seat.	IN 49.75	26.5	6	-	-	-	-	-	MM 1264	673	152	-	-	-	-	
	Not freestanding. Suspends between 2 units via linking brackets.	<b>RTA 00</b>		1 per carton													
 <p><b>Three Seat Bench Bridge - Left &amp; Right</b>                      COM: 3 YD   2.74 M                      Unit weight: 62 LB   28.2 KG                      Carton weight: 68 LB   30.84 KG                      Carton volume: 9.25 FT³   0.26 MT³</p>	<b>GC4273</b>	2071	2167	2248	2341	2494	2635	2776	2899	3052	3196	3391	3667				
	Ganging/linking.	<b>OVERALL DIMENSIONS</b>			<b>SEAT DIMENSIONS</b>			<b>BACK DIMENSIONS</b>									
	Active weight 500 lbs/seat.	IN 72.75	26.5	6	-	-	-	-	-	MM 1848	673	152	-	-	-	-	
	Not freestanding. Suspends between 2 units via linking brackets.	<b>RTA 00</b>		1 per carton													
 <p><b>Two Seat Bench Bridge Center Table Top - Left &amp; Right</b>                      COM: 2.25 YD   2.06 M                      Unit weight: 28 LB   12.7 KG                      Carton weight: 32 LB   14.51 KG                      Carton volume: 9.25 FT³   0.26 MT³</p>	<b>GC4276</b>	2023	2095	2156	2226	2340	2446	2552	2644	2759	2867	3013	3220				
	Ganging/linking.	<b>OVERALL DIMENSIONS</b>			<b>SEAT DIMENSIONS</b>			<b>BACK DIMENSIONS</b>									
	Active weight 500 lbs/seat.	IN 72.75	26	6	-	-	-	-	-	MM 1848	660	152	-	-	-	-	
	Not freestanding. Suspends between 2 units via linking brackets.  Table top only offered in high pressure laminate.	<b>RTA 00</b>		1 per carton													

DESCRIPTION	MODEL# / FEATURES	STANDARD TEXTILE GRADES			
-------------	-------------------	-------------------------	--	--	--

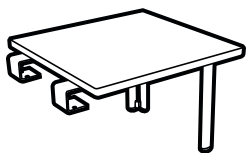

End Table Bridge, Not Freestanding

GC4274-LP	23 x 23 x 16	20	3.4	<b>\$560</b>
	584 x 584 x 406	9.1	0.09	
GC4274-HP	23 x 23 x 16	20	3.4	<b>\$592</b>
	584 x 584 x 406	9.1	0.09	

- For a thermally fused laminate top (LP), specify model GC4274-LP.
- For a high pressure laminate top (HP), specify model GC4274-HP.

**1 end suspends to a seating unit via linking brackets.** Coordinating 2mm edge. Oval steel tube legs. Reversible. 1 per carton.

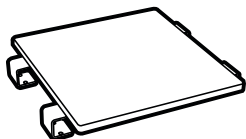

Square Table Top, Not Freestanding

GC4275-LP	23 x 23 x 1	14	3.4	<b>\$371</b>
	584 x 584 x 25	6.4	0.09	
GC4275-HP	23 x 23 x 1	14	3.4	<b>\$401</b>
	584 x 584 x 25	6.4	0.09	

- For a thermally fused laminate top (LP), specify model GC4275-LP.
- For a high pressure laminate top (HP), specify model GC4275-HP.

**Suspends between two seating units via linking brackets.** Coordinating 2mm edge. No legs. Reversible. 1 per carton.



End Corner Table Bridge, Not Freestanding

GC4277-LP	35 x 35 x 16	40	6	<b>\$581</b>
	889 x 889 x 406	18.2	0.16	
GC4277-HP	35 x 35 x 16	40	6	<b>\$654</b>
	889 x 889 x 406	18.2	0.16	

- For a thermally fused laminate top (LP), specify model GC4277-LP.
- For a high pressure laminate top (HP), specify model GC4277-HP.

**Suspends between two seating units via linking brackets.** Coordinating 2mm edge. Oval steel tube legs. Can be used for right or left corner. 1 per carton.



End Corner Curve Table Bridge, Not Freestanding

GC4278-LP	35 x 35 x 16	40	6	<b>\$581</b>
	889 x 889 x 406	18.2	0.16	
GC4278-HP	35 x 35 x 16	40	6	<b>\$654</b>
	889 x 889 x 406	18.2	0.16	

- For a thermally fused laminate top (LP), specify model GC4278-LP.
- For a high pressure laminate top (HP), specify model GC4278-HP.

**Suspends between two seating units via linking brackets.** Coordinating 2mm edge. Oval steel tube legs. Can be used for right or left corner. 1 per carton



GC CITI



model GC7875LTL (TBL)

Leg options



5" tubular metal leg (shown in Tungsten finish)



5" tapered, softened edge, wood leg (shown in Maple finish)

STANDARD FEATURES

- Fully upholstered contemporary design, complements timeless decor. Proportions are compact, 31" deep, works well in public spaces, lounges and lobbies.
- The steel leg brings a lightness of scale, while satisfying the need for accessibility.
- GC Citi seat and table legs are 5" high tubular metal, standard in a Tungsten finish.
- The seat is fastened into place and removable over an open frame structure eliminating all barriers and traps below the surface.
- The seat cushion is fully encased by the upholstery with a nylon zippered opening for access if replacement is required. This method of upholstery when using Crypton or vinyl textiles prevents the interior construction from contact with spills and body fluids that could affect the products long-term performance.
- All models have removable cushions. Cushions feature removable covers.
- The interior wood frame has an interlocking construction providing superior strength and long-term durability.
- Arm height on all models is 25".
- Casters are not available on this series.
- Citi table tops are available in either tempered glass or laminate. See the Global Seating list price book for details.
- Tablets are made from thermally fused laminate.
- Tablet arms measure 12"D x 16.5"W. Available right hand seated (RT), left hand seated (LT) or both right and left hand (LRT).
- For added comfort, seats are standard with high density Ultracell foam.
- Laminate tables and tablets are offered in the following finishes: Absolute Acajou (ACJ), Asian Night (ASN), Avant Cherry (AWC), Avant Honey (AWH), Black (BLK), Blizzard (BZD), Brushed Cobalt (BRC), Clear Maple (CMB), Custom Grey (CGY), Dark Espresso (DES), Designer White (DWT), Fashionista (FAS), First Class (FCL), Quartered Mahogany (QTM), Noce Biondo (NBL), Noce Grigio (NGL), Noce Leggero (NEL), Noce Medio (NML), Sheer Beauty (SBY), Stonedust (SDT), Walnut Heights (WHE), White Chocolate (WHC) and Winter Cherry (WCR). Please specify.
- For healthcare textiles and wood finish options, visit the website at [globalfurnituregroup.com](http://globalfurnituregroup.com).
- Can be upholstered in standard Global textiles if healthcare compliance is not required.
- Shipped fully assembled.

OPTIONAL FEATURES

- For two and three seat units with tablet arms, after the 6 digit model number:
  - Add (LTL) for left hand laminate tablet or (RTL) for right hand laminate tablet. Add \$412.
- To add sealed seams to your product contact Customer Service. Upcharges vary.
- For moisture barrier on seat, please specify (MB). Add \$122 per seat.
- Leg options:
  - (MTL) Cylindrical metal legs  
Paint finishes. No upcharge.
  - (TBL) Black
  - (TTU) Tungsten  
Plated finish. Add \$68.
  - (CHM) Chrome
  - (WDL) Non-cylindrical wood legs  
Wood finishes. Add \$300.
  - (AAM) Absolute
  - (BKM) Black
  - (CJM) Charcoal Java
  - (ACM) Cherry
  - (EMM) Empire Mahogany
  - (EOM) English Oak
  - (ECM) Espresso Cafe
  - (TFM) Fruitwood
  - (HGM) Gray
  - (HOM) Harvest Oak
  - (AHM) Honey
  - (JOM) Jet Onyx
  - (LHM) Light Honey
  - (TMM) Mahogany
  - (AVM) Maple
  - (MWM) Medium Walnut
  - (NLW) Natural Walnut
  - (ASM) Night
  - (NBM) Noce Biondo
  - (NGM) Noce Grigio
  - (NEM) Noce Leggero
  - (NMM) Noce Medio
  - (SBM) Sandy Beach
  - (SKM) Shaker Cherry
  - (SOM) Silver Oak
  - (TWM) Walnut
  - (WTM) WC Cream
  - (WHM) White
  - (WCM) Winter Cherry

SUGGESTED APPLICATIONS

- Guest seating
- Lobbies
- Lounge/Waiting
- Resident rooms

For matching tables, see Citi series in the Global Seating list price book.

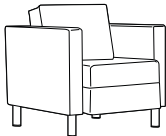
DESCRIPTION	MODEL# / FEATURES	STANDARD TEXTILE GRADES											
		COM	2	3	4	5	6	7	8	9	10	11	12
 <p><b>Lounge Chair</b> COM: 4.75 YD   4.34 M Unit weight: 57 LB   25.9 KG Carton weight: 67 LB   30.39 KG Carton volume: 21 FT<sup>3</sup>   0.59 MT<sup>3</sup></p>	<b>GC7875</b>	1303	1455	1583	1731	1973	2196	2419	2614	2856	3084	3393	3830
	Active weight 300 lbs.	<b>OVERALL DIMENSIONS</b> W D H IN 30 31 30 MM 762 787 762			<b>SEAT DIMENSIONS</b> W D H IN 22 19.5 17.5 MM 559 495 445			<b>BACK DIMENSIONS</b> W H IN 22 12.5 MM 559 318					
	<b>RTA 00</b>	1 per carton											

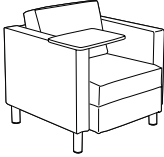

DESCRIPTION	MODEL# / FEATURES	STANDARD TEXTILE GRADES											
		COM	2	3	4	5	6	7	8	9	10	11	12
 <p><b>Lounge Chair w/Laminate Tablet - Left</b>                      COM: 4.75 YD   4.34 M                      Unit weight: 65 LB   29.5 KG                      Carton weight: 78 LB   35.38 KG                      Carton volume: 22.5 FT³   0.63 MT³</p>	<b>GC7875LTL</b>	1715	1867	1995	2143	2385	2608	2831	3026	3268	3496	3805	4242
		OVERALL DIMENSIONS			SEAT DIMENSIONS			BACK DIMENSIONS					
		W	D	H	W	D	H	W	H				
		IN 31.5 MM 800	33.5 851	30 762	22 559	19.5 495	17.5 445	22 559	12.5 318				
		RTA 2		1 per carton									

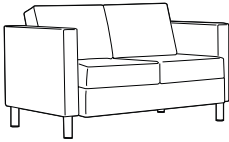
 <p><b>Lounge Chair w/Laminate Tablet - Right</b>                      COM: 4.75 YD   4.34 M                      Unit weight: 65 LB   29.5 KG                      Carton weight: 75 LB   34.02 KG                      Carton volume: 22.5 FT³   0.63 MT³</p>	<b>GC7875RTL</b>	1715	1867	1995	2143	2385	2608	2831	3026	3268	3496	3805	4242
		OVERALL DIMENSIONS			SEAT DIMENSIONS			BACK DIMENSIONS					
		W	D	H	W	D	H	W	H				
		IN 31.5 MM 800	33.5 851	30 762	22 559	19.5 495	17.5 445	22 559	12.5 318				
		RTA 00		1 per carton									

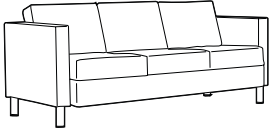
 <p><b>Two Seat Sofa</b>                      COM: 7 YD   6.4 M                      Unit weight: 113 LB   51.4 KG                      Carton weight: 125 LB   56.7 KG                      Carton volume: 36 FT³   1.01 MT³</p>	<b>GC7876</b>	1854	2078	2267	2485	2841	3170	3499	3786	4143	4479	4934	5578
		OVERALL DIMENSIONS			SEAT DIMENSIONS			BACK DIMENSIONS					
		W	D	H	W	D	H	W	H				
		IN 51.25 MM 1302	31 787	30 762	43.25 1099	19.5 495	17.5 445	43.25 1099	12.5 318				
		RTA 00		1 per carton									

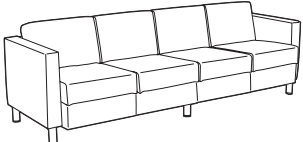
 <p><b>Three Seat Sofa</b>                      COM: 9 YD   8.23 M                      Unit weight: 149 LB   67.7 KG                      Carton weight: 163 LB   73.94 KG                      Carton volume: 50.25 FT³   1.42 MT³</p>	<b>GC7877</b>	2417	2705	2948	3228	3686	4109	4532	4901	5360	5792	6377	7205
		OVERALL DIMENSIONS			SEAT DIMENSIONS			BACK DIMENSIONS					
		W	D	H	W	D	H	W	H				
		IN 72.5 MM 1842	31 787	30 762	64.5 1638	19.5 495	17.5 445	64.5 1638	12.5 318				
		RTA 00		1 per carton									

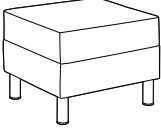
 <p><b>Four Seat Sofa</b>                      COM: 11.5 YD   10.52 M                      Unit weight: 188 LB   85.5 KG                      Carton weight: 204 LB   92.53 KG                      Carton volume: 69 FT³   1.95 MT³</p>	<b>GC7878</b>	3015	3383	3694	4050	4637	5177	5718	6189	6776	7328	8075	9133
		OVERALL DIMENSIONS			SEAT DIMENSIONS			BACK DIMENSIONS					
		W	D	H	W	D	H	W	H				
		IN 93.5 MM 2375	31 787	30 762	85.5 2172	19.5 495	17.5 445	85.5 2172	12.5 318				
		RTA 00		1 per carton									

DESCRIPTION	MODEL# / FEATURES	STANDARD TEXTILE GRADES											
		COM	2	3	4	5	6	7	8	9	10	11	12
 <p><b>Ottoman</b>                      COM: 1.75 YD   1.6 M                      Unit weight: 23 LB   10.5 KG                      Carton weight: 27 LB   12.25 KG                      Carton volume: 7.5 FT<sup>3</sup>   0.21 MT<sup>3</sup></p>	<b>GC7879</b>	677	733	780	835	924	1006	1088	1160	1249	1333	1447	1608
	Active weight 300 lbs.	<b>OVERALL DIMENSIONS</b> W      D      H			<b>SEAT DIMENSIONS</b> W      D      H			<b>BACK DIMENSIONS</b> W      H					
		IN 22	22	17	-	-	17	-	-				
		MM 559	559	432	-	-	432	-	-				
						1 per carton							

GC COMET



model GC2180 (TUN)

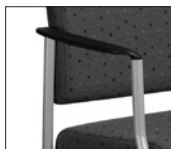

Black plastic arms



Wall saver leg

STANDARD FEATURES

- The rounded steel frame and durable seat cushion will ensure years of use.
- Black plastic arms are standard.
- Round tubular steel frame.
- Active weight capacity is up to 300 lbs. for standard models; 500 lbs. for bariatric models.
- For added comfort, seats are standard with high density Ultracell foam.
- Standard glide is a plastic dome shape on back legs, flat glide on front legs.
- Ganging hardware is available for standard models.
- Standard models stack 5 high on floor, 8 high on dolly.
- Bariatric models stack 2 high on floor. No dolly available.
- For healthcare textiles and finish options, visit the website at [globalfurnituregroup.com](http://globalfurnituregroup.com).
- Can be upholstered in standard Global textiles if Healthcare compliance is not required.
- Shipped fully assembled.



OPTIONAL FEATURES





- Plastic arms available in Shadow (SHW) and Toast (TOA). Please specify. Add \$25.
- A selection of glide options is available. Glides must be chosen to best suit flooring type and site conditions. For more information, please refer to the glide section (page 265).
- For thick carpeted floors, request four dome/ball glides for ease of movement. No upcharge.
- Steel cushioned glides (B) are available on four-legged models. Add \$17.

- Glides with felt pads (FG) are available for vinyl sheet, cork or laminate flooring, please specify. Add \$43.
- Glides with rubber pads (RG) are available for vinyl, hardwood, laminate, stone or ceramic flooring, please specify. Add \$43.
- For improved housekeeping and infection control practices, please add (SU) to model number. The underside of the seat will be finished with vinyl and sealed to prevent penetration of liquids. For standard models: Add \$41. For bariatric models: Add \$59.
- For moisture barrier on seat, please specify (MB). Add \$81. Bariatric models: Add \$122.
- **Frame finish**  
Paint finishes. No upcharge.  
(TBL) Black (TIN) Ink  
(TBZ) Buzz Blue (TKA) Kalua  
(TCC) Cactus (TLA) Latte  
(TCR) Carrot (TMO) Mocha  
(TIV) Cloud (TNE) Nevada  
(TDW) Designer White (TSN) Sand  
(TDJ) Dijon (TSR) Scarlet  
(TEG) Eggplant (TSH) Shadow  
(TFO) Fog (TOA) Toast  
(TFR) Frost (TTU) Tungsten  
Plated finish. Add \$26.  
(CHM) Chrome

SUGGESTED APPLICATIONS

- Bariatric seating
- Dining/Cafeteria
- Guest seating
- Lobbies
- Lounge/Waiting
- Office/Meeting
- Patient rooms
- Resident rooms
- Stacking
- Treatment/Exam

DESCRIPTION	MODEL# / FEATURES	STANDARD TEXTILE GRADES												
		COM	2	3	4	5	6	7	8	9	10	11	12	
 <p><b>Medium Back Stacking Armchair</b> COM: 1 YD   0.91 M Unit weight: 14 LB   6.4 KG Carton weight: 16.67 LB   7.56 KG Carton volume: 13.75 FT<sup>3</sup>   0.38 MT<sup>3</sup></p>	<p>Active weight 300 lbs. Stacks 5 high on floor. Stacks 8 high on dolly.</p>	<b>GC2173</b>	377	409	436	467	518	565	612	653	704	752	817	909
		<p><b>OVERALL DIMENSIONS</b></p> <p>W D H</p>			<p><b>SEAT DIMENSIONS</b></p> <p>W D H</p>			<p><b>BACK DIMENSIONS</b></p> <p>W H</p>						
		IN 23	24.5	32	18	17	18.5	17.5	13.5					
MM 584	622	813	457	432	470	445	343							
		<b>RTA 00</b>	3 per carton (pricing and specifications are for one chair)											
 <p><b>High Back Stacking Armchair</b> COM: 1.25 YD   1.14 M Unit weight: 15 LB   6.8 KG Carton weight: 18 LB   8.16 KG Carton volume: 17.75 FT<sup>3</sup>   0.5 MT<sup>3</sup></p>	<p>Active weight 300 lbs. Stacks 5 high on floor. Stacks 8 high on dolly.</p>	<b>GC2173HB</b>	430	470	504	543	606	665	724	775	839	899	980	1095
		<p><b>OVERALL DIMENSIONS</b></p> <p>W D H</p>			<p><b>SEAT DIMENSIONS</b></p> <p>W D H</p>			<p><b>BACK DIMENSIONS</b></p> <p>W H</p>						
		IN 23	24.5	36.5	18	17.5	18	17.5	18					
MM 584	622	927	457	445	457	445	457							
		<b>RTA 00</b>	3 per carton (pricing and specifications are for one chair)											

DESCRIPTION	MODEL# / FEATURES	STANDARD TEXTILE GRADES																																												
		COM	2	3	4	5	6	7	8	9	10	11	12																																	
 <p><b>Medium Back Stacking Chair, Armless</b>                      COM: 1 YD   0.91 M                      Unit weight: 13 LB   5.9 KG                      Carton weight: 15.67 LB   7.11 KG                      Carton volume: 14.25 FT³   0.4 MT³</p>	<b>GC2174</b>	301	333	360	391	442	489	536	577	628	676	741	833																																	
	Active weight 300 lbs.	<table border="1"> <thead> <tr> <th colspan="3">OVERALL DIMENSIONS</th> <th colspan="3">SEAT DIMENSIONS</th> <th colspan="3">BACK DIMENSIONS</th> </tr> <tr> <th>W</th> <th>D</th> <th>H</th> <th>W</th> <th>D</th> <th>H</th> <th>W</th> <th>H</th> </tr> </thead> <tbody> <tr> <td>IN 20</td> <td>24.5</td> <td>32</td> <td>18</td> <td>17</td> <td>18.5</td> <td>17.5</td> <td>13.5</td> </tr> <tr> <td>MM 508</td> <td>622</td> <td>813</td> <td>457</td> <td>432</td> <td>470</td> <td>445</td> <td>343</td> </tr> </tbody> </table>												OVERALL DIMENSIONS			SEAT DIMENSIONS			BACK DIMENSIONS			W	D	H	W	D	H	W	H	IN 20	24.5	32	18	17	18.5	17.5	13.5	MM 508	622	813	457	432	470	445	343
	OVERALL DIMENSIONS			SEAT DIMENSIONS			BACK DIMENSIONS																																							
	W	D	H	W	D	H	W	H																																						
IN 20	24.5	32	18	17	18.5	17.5	13.5																																							
MM 508	622	813	457	432	470	445	343																																							
Stacks 5 high on floor. Stacks 8 high on dolly.	<table border="1"> <thead> <tr> <th colspan="13">RTA 00</th> </tr> </thead> <tbody> <tr> <td colspan="13">3 per carton (pricing and specifications are for one chair)</td> </tr> </tbody> </table>												RTA 00													3 per carton (pricing and specifications are for one chair)																				
RTA 00																																														
3 per carton (pricing and specifications are for one chair)																																														
 <p><b>High Back Stacking Chair, Armless</b>                      COM: 1.25 YD   1.14 M                      Unit weight: 14 LB   6.4 KG                      Carton weight: 17 LB   7.71 KG                      Carton volume: 17.75 FT³   0.5 MT³</p>	<b>GC2174HB</b>	396	436	470	509	572	631	690	741	805	865	946	1061																																	
	Active weight 300 lbs.	<table border="1"> <thead> <tr> <th colspan="3">OVERALL DIMENSIONS</th> <th colspan="3">SEAT DIMENSIONS</th> <th colspan="3">BACK DIMENSIONS</th> </tr> <tr> <th>W</th> <th>D</th> <th>H</th> <th>W</th> <th>D</th> <th>H</th> <th>W</th> <th>H</th> </tr> </thead> <tbody> <tr> <td>IN 20</td> <td>24.5</td> <td>36.5</td> <td>18</td> <td>17.5</td> <td>18</td> <td>17.5</td> <td>18</td> </tr> <tr> <td>MM 508</td> <td>622</td> <td>927</td> <td>457</td> <td>445</td> <td>457</td> <td>445</td> <td>457</td> </tr> </tbody> </table>												OVERALL DIMENSIONS			SEAT DIMENSIONS			BACK DIMENSIONS			W	D	H	W	D	H	W	H	IN 20	24.5	36.5	18	17.5	18	17.5	18	MM 508	622	927	457	445	457	445	457
	OVERALL DIMENSIONS			SEAT DIMENSIONS			BACK DIMENSIONS																																							
	W	D	H	W	D	H	W	H																																						
IN 20	24.5	36.5	18	17.5	18	17.5	18																																							
MM 508	622	927	457	445	457	445	457																																							
Stacks 2 high on floor. Stacks 8 high on dolly.	<table border="1"> <thead> <tr> <th colspan="13">RTA 00</th> </tr> </thead> <tbody> <tr> <td colspan="13">3 per carton (pricing and specifications are for one chair)</td> </tr> </tbody> </table>												RTA 00													3 per carton (pricing and specifications are for one chair)																				
RTA 00																																														
3 per carton (pricing and specifications are for one chair)																																														
 <p><b>Bariatric Stacking Armchair</b>                      COM: 1.75 YD   1.6 M                      Unit weight: 35 LB   15.9 KG                      Carton weight: 46 LB   20.87 KG                      Carton volume: 26.75 FT³   0.75 MT³</p>	<b>GC2180</b>	1135	1191	1238	1293	1382	1464	1546	1618	1707	1791	1905	2066																																	
	Active weight 500 lbs.	<table border="1"> <thead> <tr> <th colspan="3">OVERALL DIMENSIONS</th> <th colspan="3">SEAT DIMENSIONS</th> <th colspan="3">BACK DIMENSIONS</th> </tr> <tr> <th>W</th> <th>D</th> <th>H</th> <th>W</th> <th>D</th> <th>H</th> <th>W</th> <th>H</th> </tr> </thead> <tbody> <tr> <td>IN 31.5</td> <td>27</td> <td>38</td> <td>26.5</td> <td>18.5</td> <td>18</td> <td>26.5</td> <td>20</td> </tr> <tr> <td>MM 800</td> <td>686</td> <td>965</td> <td>673</td> <td>470</td> <td>457</td> <td>673</td> <td>508</td> </tr> </tbody> </table>												OVERALL DIMENSIONS			SEAT DIMENSIONS			BACK DIMENSIONS			W	D	H	W	D	H	W	H	IN 31.5	27	38	26.5	18.5	18	26.5	20	MM 800	686	965	673	470	457	673	508
	OVERALL DIMENSIONS			SEAT DIMENSIONS			BACK DIMENSIONS																																							
	W	D	H	W	D	H	W	H																																						
IN 31.5	27	38	26.5	18.5	18	26.5	20																																							
MM 800	686	965	673	470	457	673	508																																							
Stacks 2 high on floor. (no dolly available)	<table border="1"> <thead> <tr> <th colspan="13">RTA 00</th> </tr> </thead> <tbody> <tr> <td colspan="13">1 per carton</td> </tr> </tbody> </table>												RTA 00													1 per carton																				
RTA 00																																														
1 per carton																																														
 <p><b>Square Medium Back Stacking Armchair</b>                      COM: 1 YD   0.91 M                      Unit weight: 14 LB   6.4 KG                      Carton weight: 17.33 LB   7.86 KG                      Carton volume: 15.5 FT³   0.43 MT³</p>	<b>GC2183</b>	377	409	436	467	518	565	612	653	704	752	817	909																																	
	Active weight 300 lbs.	<table border="1"> <thead> <tr> <th colspan="3">OVERALL DIMENSIONS</th> <th colspan="3">SEAT DIMENSIONS</th> <th colspan="3">BACK DIMENSIONS</th> </tr> <tr> <th>W</th> <th>D</th> <th>H</th> <th>W</th> <th>D</th> <th>H</th> <th>W</th> <th>H</th> </tr> </thead> <tbody> <tr> <td>IN 23</td> <td>22.5</td> <td>32</td> <td>18</td> <td>17.5</td> <td>18</td> <td>17.5</td> <td>13.5</td> </tr> <tr> <td>MM 584</td> <td>572</td> <td>813</td> <td>457</td> <td>445</td> <td>457</td> <td>445</td> <td>343</td> </tr> </tbody> </table>												OVERALL DIMENSIONS			SEAT DIMENSIONS			BACK DIMENSIONS			W	D	H	W	D	H	W	H	IN 23	22.5	32	18	17.5	18	17.5	13.5	MM 584	572	813	457	445	457	445	343
	OVERALL DIMENSIONS			SEAT DIMENSIONS			BACK DIMENSIONS																																							
	W	D	H	W	D	H	W	H																																						
IN 23	22.5	32	18	17.5	18	17.5	13.5																																							
MM 584	572	813	457	445	457	445	343																																							
Stacks 5 high on floor. Stacks 8 high on dolly.	<table border="1"> <thead> <tr> <th colspan="13">RTA 00</th> </tr> </thead> <tbody> <tr> <td colspan="13">3 per carton (pricing and specifications are for one chair)</td> </tr> </tbody> </table>												RTA 00													3 per carton (pricing and specifications are for one chair)																				
RTA 00																																														
3 per carton (pricing and specifications are for one chair)																																														
 <p><b>Square High Back Stacking Armchair</b>                      COM: 1 YD   0.91 M                      Unit weight: 15 LB   6.8 KG                      Carton weight: 18.33 LB   8.31 KG                      Carton volume: 15.5 FT³   0.43 MT³</p>	<b>GC2183HB</b>	438	470	497	528	579	626	673	714	765	813	878	970																																	
	Active weight 300 lbs.	<table border="1"> <thead> <tr> <th colspan="3">OVERALL DIMENSIONS</th> <th colspan="3">SEAT DIMENSIONS</th> <th colspan="3">BACK DIMENSIONS</th> </tr> <tr> <th>W</th> <th>D</th> <th>H</th> <th>W</th> <th>D</th> <th>H</th> <th>W</th> <th>H</th> </tr> </thead> <tbody> <tr> <td>IN 23</td> <td>22.5</td> <td>35.5</td> <td>18</td> <td>17.5</td> <td>18</td> <td>17.5</td> <td>17</td> </tr> <tr> <td>MM 584</td> <td>572</td> <td>902</td> <td>457</td> <td>445</td> <td>457</td> <td>445</td> <td>432</td> </tr> </tbody> </table>												OVERALL DIMENSIONS			SEAT DIMENSIONS			BACK DIMENSIONS			W	D	H	W	D	H	W	H	IN 23	22.5	35.5	18	17.5	18	17.5	17	MM 584	572	902	457	445	457	445	432
	OVERALL DIMENSIONS			SEAT DIMENSIONS			BACK DIMENSIONS																																							
	W	D	H	W	D	H	W	H																																						
IN 23	22.5	35.5	18	17.5	18	17.5	17																																							
MM 584	572	902	457	445	457	445	432																																							
Stacks 5 high on floor. Stacks 8 high on dolly.	<table border="1"> <thead> <tr> <th colspan="13">RTA 00</th> </tr> </thead> <tbody> <tr> <td colspan="13">3 per carton (pricing and specifications are for one chair)</td> </tr> </tbody> </table>												RTA 00													3 per carton (pricing and specifications are for one chair)																				
RTA 00																																														
3 per carton (pricing and specifications are for one chair)																																														

DESCRIPTION MODEL# / FEATURES STANDARD TEXTILE GRADES



**Square Medium Stacking Side Chair**  
 COM: 1 YD | 0.91 M  
 Unit weight: 13 LB | 5.9 KG  
 Carton weight: 16.33 LB | 7.41 KG  
 Carton volume: 15.5 FT³ | 0.43 MT³

MODEL#	COM	2	3	4	5	6	7	8	9	10	11	12
<b>GC2184</b>	301	333	360	391	442	489	536	577	628	676	741	833

OVERALL DIMENSIONS			SEAT DIMENSIONS			BACK DIMENSIONS	
W	D	H	W	D	H	W	H

Active weight 300 lbs.  
 Stacks 5 high on floor.  
 Stacks 8 high on dolly.

IN	20	22.5	32	18	17.5	18	17.5	13.5
MM	508	572	813	457	445	457	445	343

**RTA 00** 3 per carton (pricing and specifications are for one chair)



**Fan Back Stacking Armchair**  
 COM: 1.25 YD | 1.14 M  
 Unit weight: 19 LB | 8.6 KG  
 Carton weight: 24 LB | 10.89 KG  
 Carton volume: 15.5 FT³ | 0.43 MT³

MODEL#	COM	2	3	4	5	6	7	8	9	10	11	12
<b>GC2194</b>	516	556	590	629	692	751	810	861	925	985	1066	1181

OVERALL DIMENSIONS			SEAT DIMENSIONS			BACK DIMENSIONS	
W	D	H	W	D	H	W	H

Active weight 300 lbs.  
 Stacks 5 high on floor.  
 Stacks 8 high on dolly.

IN	23	24.5	35	18	16	18	18.5	16
MM	584	622	889	457	406	457	470	406

**RTA 00** 2 per carton (pricing and specifications are for one chair)



**Fan Back Stacking Side Chair**  
 COM: 1.25 YD | 1.14 M  
 Unit weight: 16 LB | 7.3 KG  
 Carton weight: 21 LB | 9.53 KG  
 Carton volume: 15.5 FT³ | 0.43 MT³

MODEL#	COM	2	3	4	5	6	7	8	9	10	11	12
<b>GC2195</b>	445	485	519	558	621	680	739	790	854	914	995	1110

OVERALL DIMENSIONS			SEAT DIMENSIONS			BACK DIMENSIONS	
W	D	H	W	D	H	W	H

Active weight 300 lbs.  
 Stacks 5 high on floor.  
 Stacks 8 high on dolly.

IN	20	24.5	35	18	16	18	18.5	16
MM	508	622	889	457	406	457	470	406

**RTA 00** 2 per carton (pricing and specifications are for one chair)

List price

<b>2125WS</b>	310
---------------	-----

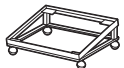

**Dolly**  
 COM: N/A  
 Unit weight: 13 LB | 5.9 KG  
 Carton weight: 16 LB | 7.26 KG  
 Carton volume: 3.8 FT³ | 0.1 MT³

OVERALL DIMENSIONS			SEAT DIMENSIONS			BACK DIMENSIONS	
W	D	H	W	D	H	W	H

IN	23.25	24.75	12.25	-	-	-	-	-
MM	591	629	311	-	-	-	-	-

**RTA 00**  1 per carton

List price

<b>2180</b>	16
-------------	----

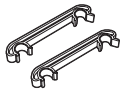

**Snap On Ganging Brackets - Set of 2**  
 COM: N/A  
 Unit weight: 0.09 LB | 0.04 KG  
 Carton weight: 0.2 LB | 0.09 KG  
 Carton volume: 1 FT³ | 0.02 MT³

Snap-on ganging bracket  
 Recommended clamp  
 location is 3" above the  
 floor on back and front legs.

OVERALL DIMENSIONS			SEAT DIMENSIONS			BACK DIMENSIONS	
W	D	H	W	D	H	W	H

IN	0.87	7.75	1.5	-	-	-	-	-
MM	22	197	38	-	-	-	-	-

**RTA 00**  1 per carton (pricing is for the set, specifications are for one bracket)

GC ISLANDS



model GC4075



model GC4076

STANDARD FEATURES



- GC Islands offers wood guest seating with contemporary styling.
- Two back styles: Upholstered back pad or horizontal wood slat back.
- Legs are equipped with White non-marking polypropylene glides. Suitable for both carpet and hard surface flooring.
- All cushions are fixed and non-removable.
- Cushions are made with highly resilient foam and seats are equipped with a synthetic rubberized webbing suspension system for extra comfort.
- Seat cushion underside is finished with a Black impermeable surface material.
- Does not stack.
- Can be upholstered in standard Global textiles if healthcare compliance is not required.

OPTIONAL FEATURES

- Wood frame available in Absolute (AAM), Black (BKM), Cherry (ACM), English Oak (EOM), Espresso Cafe (ECM), Fruitwood (TFM), Gray (HGM), Honey (AHM), Mahogany (TMM), Maple (AVM), Medium Walnut (MWM), Natural Walnut (NLW), Night (ASM), Noce Biondo (NBM), Noce Grigio (NGM), Noce Leggero (NEM), Noce Medio (NMM), Sandy Beach (SGM), Shaker Cherry (SKM), Silver Oak (SOM), Walnut (TWM), WC Cream (WTM), White (WHM) and Winter Cherry (WCM).
- For moisture barrier on seat, please specify **(MB)**. Add \$81 per seat.
- Upholstered back sealed seam available, please specify **(S2)**. Add \$27.

SUGGESTED APPLICATIONS

- Dining/Cafeteria
- Guest seating
- Lobbies
- Lounge/Waiting
- Office/Meeting
- Patient rooms
- Resident rooms

DESCRIPTION	MODEL# / FEATURES	STANDARD TEXTILE GRADES												
		COM	2	3	4	5	6	7	8	9	10	11	12	
 <p><b>Armchair - Upholstered Back</b>                      COM: 1.5 YD   1.37 M                      Unit weight: 19 LB   8.6 KG                      Carton weight: 25 LB   11.34 KG                      Carton volume: 14.75 FT<sup>3</sup>   0.41 MT<sup>3</sup></p>	<b>GC4075</b>	919	967	1008	1054	1131	1201	1272	1333	1410	1482	1579	1717	
	Active weight 300 lbs.													
	Does not stack.													
			<b>OVERALL DIMENSIONS</b>			<b>SEAT DIMENSIONS</b>			<b>BACK DIMENSIONS</b>					
			<b>W</b>	<b>D</b>	<b>H</b>	<b>W</b>	<b>D</b>	<b>H</b>	<b>W</b>	<b>H</b>				
		IN 24.5	23.5	32	20.5	18	18.5	19	13					
		MM 622	597	813	521	457	470	483	330					
		<b>RTA 00</b>	1 per carton											
 <p><b>Armchair - Horizontal Wood Slat Back</b>                      COM: 1 YD   0.91 M                      Unit weight: 19 LB   8.6 KG                      Carton weight: 25 LB   11.34 KG                      Carton volume: 14.75 FT<sup>3</sup>   0.41 MT<sup>3</sup></p>	<b>GC4076</b>	990	1022	1049	1080	1131	1178	1225	1266	1317	1365	1430	1522	
	Active weight 300 lbs.													
	Does not stack.													
			<b>OVERALL DIMENSIONS</b>			<b>SEAT DIMENSIONS</b>			<b>BACK DIMENSIONS</b>					
			<b>W</b>	<b>D</b>	<b>H</b>	<b>W</b>	<b>D</b>	<b>H</b>	<b>W</b>	<b>H</b>				
		IN 24.5	23.5	32	20.5	18	18.5	19	13					
		MM 622	597	813	521	457	470	483	330					
		<b>RTA 00</b>	1 per carton											

GC PRAIRIE



model GC3481



model GC3482

STANDARD FEATURES







- Features barrel shaped arms that provide an attractive and enticing appearance.
- GC Prairie is fully upholstered.
- Tapered wood skirt and legs.
- Removable cushions and covers.
- Elasticized seat suspension system for extra comfort built into cushions.
- Seamless front upholstery on the seat cushion prevents eventual breakdown of seams causing liquid penetration into the foam.
- For added comfort, seats are standard with high density Ultracell foam.
- For healthcare textiles and wood finish options, visit the website at [globalfurnituregroup.com](http://globalfurnituregroup.com). Available in Maple wood species only (refer to finishes ending in "M").
- Can be upholstered in standard Global textiles if Healthcare compliance is not required.
- Shipped fully assembled.

OPTIONAL FEATURES

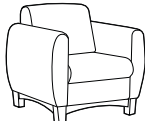
- For non-slip glides, please specify **(NS)**. Add \$22.
- Tapered wood legs are available in Absolute (AAM), Charcoal Java (CJM), Cherry (ACM), Empire Mahogany (EMM), English Oak (EOM), Espresso Cafe (ECM), Fruitwood (TFM), Gray (HGM), Harvest Oak (HOM), Honey (AHM), Jet Onyx (JOM), Light Honey (LHM), Mahogany (TMM), Maple (AVM), Medium Walnut (MWM), Natural Walnut (NLW), Night (ASM), Noce Biondo (NBM), Noce Grigio (NGM), Noce Leggero (NEM), Noce Medio (NMM), Sandy Beach (SBM), Silver Oak (SOM), Walnut (TWM), WC Cream (WTM), White (WHM) and Winter Cherry (WCM). Please specify. Genuine Maple faced veneers and solids are used.
- To add sealed seams to your product contact Customer Service. Upcharges vary.
- For moisture barrier on seat, please specify **(MB)**. See upcharges below.

SUGGESTED APPLICATIONS

- Lobbies
- Lounge/Waiting
- Resident rooms

DESCRIPTION	MODEL# / FEATURES	STANDARD TEXTILE GRADES												
		COM	2	3	4	5	6	7	8	9	10	11	12	
 <b>Lounge Chair</b> COM: 4.5 YD   4.11 M Unit weight: 70 LB   31.8 KG Carton weight: 80 LB   36.29 KG Carton volume: 19.25 FT <sup>3</sup>   0.54 MT <sup>3</sup>	<b>GC3481</b>  Active weight 300 lbs.  Add \$122 for <b>(MB)</b> .	1516	1660	1782	1921	2151	2362	2574	2758	2988	3204	3496	3910	
		<b>OVERALL DIMENSIONS</b>			<b>SEAT DIMENSIONS</b>			<b>BACK DIMENSIONS</b>						
		<b>W</b>	<b>D</b>	<b>H</b>	<b>W</b>	<b>D</b>	<b>H</b>	<b>W</b>	<b>H</b>					
		IN 32	29	30.5	21	19	16	21	14.5					
MM 813	737	775	533	483	406	533	368							
		<b>RTA 00</b>		1 per carton										
 <b>Two Seat Sofa</b> COM: 6.75 YD   6.17 M Unit weight: 96 LB   43.6 KG Carton weight: 106 LB   48.08 KG Carton volume: 41.25 FT <sup>3</sup>   1.16 MT <sup>3</sup>	<b>GC3482</b>  Active weight 300 lbs./seat.  Add \$245 for <b>(MB)</b> .	2068	2284	2466	2676	3020	3337	3654	3931	4275	4599	5038	5659	
		<b>OVERALL DIMENSIONS</b>			<b>SEAT DIMENSIONS</b>			<b>BACK DIMENSIONS</b>						
		<b>W</b>	<b>D</b>	<b>H</b>	<b>W</b>	<b>D</b>	<b>H</b>	<b>W</b>	<b>H</b>					
		IN 52.5	29	30.5	42	19	16	42	14.5					
MM 1334	737	775	1067	483	406	1067	368							
		<b>RTA 00</b>		1 per carton										
 <b>Three Seat Sofa</b> COM: 10.75 YD   9.83 M Unit weight: 135 LB   61.4 KG Carton weight: 150 LB   68.04 KG Carton volume: 55.5 FT <sup>3</sup>   1.57 MT <sup>3</sup>	<b>GC3483</b>  Active weight 300 lbs./seat.  Add \$366 for <b>(MB)</b> .	2610	2954	3244	3578	4126	4631	5136	5577	6125	6641	7340	8329	
		<b>OVERALL DIMENSIONS</b>			<b>SEAT DIMENSIONS</b>			<b>BACK DIMENSIONS</b>						
		<b>W</b>	<b>D</b>	<b>H</b>	<b>W</b>	<b>D</b>	<b>H</b>	<b>W</b>	<b>H</b>					
		IN 73.5	29	30.5	63.5	19	16	63.5	14.5					
MM 1867	737	775	1613	483	406	1613	368							
		<b>RTA 00</b>		1 per carton										



GC SIDERO



model GC6900

model GC6900HB



model GC6924

model GC6926

SEAT WIDTH	STACKING CAPABILITIES
19.5"	Four-legged armchairs and side chairs can stack up to 5 high on the floor or 8 high on dolly #2125WS. Sled base armchairs and side chairs do not stack.
24"	Four-legged armchairs and side chairs can stack up to 5 high on the floor, no dolly is available. Sled base armchairs and side chairs do not stack.
30" bariatric	Four-legged armchairs can stack up to 2 high on the floor, no dolly is available. Sled base models do not stack.

STANDARD FEATURES

- GC Sidero is a collection of contemporary multi-purpose stacking chairs with a sculpted look, featuring wide, curved arms, and a round tubular wall saver steel frame.
- Available in arm and armless models (except on bariatric models) with three seat widths, two back heights, and a four-legged and sled base frame.
- Offers options that allow the chair to meet rigorous infection prevention control requirements.
- Compound curved back provides comfort and support in multiple seated positions.
- Rugged steel frame made from round welded steel tubing with a 7/8" steel dia.
- Frames feature a wall saver design to prevent back contact with wall.
- Standard glide is durable Black polypropylene.
- For added comfort, seats are standard with high density Ultracell foam.
- Three seat widths: 19.5" (standard size), 24" (mid size) and 30" (bariatric).
- Two different back constructions are offered:
  - Concealed back attachment: two-piece back covering the back support brackets when fastened in place.
  - Single piece back with a pullover style upholstery cover and exposed support bracket fastened on the outer back.
- Low back and high back models are available:
  - Low back version is available on all three seat widths: 15.5" (394mm) high.
  - High back version on 19" and 24" seat widths: 21" (533mm) high.
  - High back version on bariatric 30" seat width: 21.75" (552mm) high.
- Fiberglass nylon reinforced arms have a generous width and extend to the front of the seat. They offer additional support and help to stabilize users as they sit or exit the chair. Available in Black only.
- Select GC Sidero models are equipped with a polypropylene seat shroud that helps avoid frame imprints on upholstered seats when chairs are stacked. Protective seat shroud is standard on all 19.5" seat width models.
- 30" bariatric and 24" seat width models do not have a seat shroud and are standard with a vinyl covered seat underside.
- For healthcare textiles and finish options, visit the website at [globalfurnituregroup.com](http://globalfurnituregroup.com).
- Can be upholstered in standard Global textiles if Healthcare compliance is not required.

OPTIONAL FEATURES

- A selection of glide options is available. Glides must be chosen to best suit flooring type and site conditions. For more information, please refer to the glide section (page 265).
- For hard surface floors, please specify opaque non-marking glides (NM). No upcharge.
- To respond to higher expectations for housekeeping and infection control practices, single piece back underside and all seat pan undersides can be completely sealed and seat shroud (if standard on the model) would be removed.
  - For standard models with single piece back, please specify (BSS). Add \$51.
  - For standard models with concealed attachment back, please specify (SU). Add \$32.
  - For 24" width models with single piece back, please specify (BSS). Add \$58.
  - For 24" width models with concealed attachment back, please specify (SU). Add \$41.
  - For bariatric models with single piece back, please specify (BSS). Add \$73.
  - For bariatric models with concealed attachment back, please specify (SU). Add \$59.
- Steel cushioned glides (B) are available on four-legged models. Add \$17.
- Glides with felt pads (FG) are available for vinyl sheet, cork or laminate flooring, please specify. Add \$43.
- Glides with rubber pads (RG) are available for vinyl, hardwood, laminate, stone or ceramic flooring, please specify. Add \$43.
- For moisture barrier on seat, please specify (MB). See below for upcharges:
  - 19.5" seat width units: Add \$81.
  - 24" seat width units: Add \$81.
  - 30" seat width bariatric units: Add \$122.
- Frame finish**  
Paint finishes. No upcharge.
 

(TBL) Black	(TMO) Mocha
(TIV) Cloud	(TNE) Nevada
(TDW) Designer White	(TSN) Sand
(TFO) Fog	(TSH) Shadow
(TFR) Frost	(TOA) Toast
(TKA) Kalua	(TTU) Tungsten
(TLA) Latte	

 Plated finish. Add \$26.  
(CHM) Chrome

SUGGESTED APPLICATIONS

- Bariatric seating (some models)
- Dining/Cafeteria
- Guest seating
- Lobbies
- Lounge/Waiting
- Office/Meeting
- Patient rooms
- Resident rooms
- Stacking
- Treatment/Exam rooms

DESCRIPTION	MODEL# / FEATURES	STANDARD TEXTILE GRADES											
		COM	2	3	4	5	6	7	8	9	10	11	12
 <b>LB Concealed Attachment Armchair, Four-Legged</b> COM: 1.25 YD   1.14 M Unit weight: 23 LB   10.5 KG Carton weight: 31.5 LB   14.29 KG Carton volume: 15.5 FT³   0.43 MT³	Active weight 300 lbs.  RTA 00	491	531	565	604	667	726	785	836	900	960	1041	1156
		OVERALL DIMENSIONS			SEAT DIMENSIONS			BACK DIMENSIONS					
		W	D	H	W	D	H	W	H				
		IN	25.5	24	33	19.5	18	17.5	19	15.5			
		MM	648	610	838	495	457	445	483	394			
			1 per carton										

DESCRIPTION MODEL# / FEATURES STANDARD TEXTILE GRADES



**HB Concealed Attachment Armchair, Four-Legged**  
 COM: 1.75 YD | 1.6 M  
 Unit weight: 25 LB | 11.4 KG  
 Carton weight: 34 LB | 15.42 KG  
 Carton volume: 17.75 FT³ | 0.5 MT³

Active weight 300 lbs.

COM	2	3	4	5	6	7	8	9	10	11	12
596	652	699	754	843	925	1007	1079	1168	1252	1366	1527

OVERALL DIMENSIONS			SEAT DIMENSIONS			BACK DIMENSIONS	
W	D	H	W	D	H	W	H

IN 25.5	24	38.5	19.5	18	17.5	19	21
MM 648	610	978	495	457	445	483	533

RTA 00 1 per carton



**LB Concealed Attachment Side Chair, Four-Legged**  
 COM: 1.25 YD | 1.14 M  
 Unit weight: 20 LB | 9.1 KG  
 Carton weight: 28 LB | 12.7 KG  
 Carton volume: 13.75 FT³ | 0.38 MT³

Active weight 300 lbs.

COM	2	3	4	5	6	7	8	9	10	11	12
462	502	536	575	638	697	756	807	871	931	1012	1127

OVERALL DIMENSIONS			SEAT DIMENSIONS			BACK DIMENSIONS	
W	D	H	W	D	H	W	H

IN 21	24	33	19.5	18	17.5	19	15.5
MM 533	610	838	495	457	445	483	394

RTA 00 1 per carton



**HB Concealed Attachment Side Chair, Four-Legged**  
 COM: 1.75 YD | 1.6 M  
 Unit weight: 22 LB | 10 KG  
 Carton weight: 31 LB | 14.06 KG  
 Carton volume: 17.75 FT³ | 0.5 MT³

Active weight 300 lbs.

COM	2	3	4	5	6	7	8	9	10	11	12
566	622	669	724	813	895	977	1049	1138	1222	1336	1497

OVERALL DIMENSIONS			SEAT DIMENSIONS			BACK DIMENSIONS	
W	D	H	W	D	H	W	H

IN 21	24	38.5	19.5	18	17.5	19	21
MM 533	610	978	495	457	445	483	533

RTA 00 1 per carton



**LB Concealed Attachment Armchair, Sled Base**  
 COM: 1.25 YD | 1.14 M  
 Unit weight: 26 LB | 11.8 KG  
 Carton weight: 34.5 LB | 15.65 KG  
 Carton volume: 15.5 FT³ | 0.43 MT³

Active weight 300 lbs.

COM	2	3	4	5	6	7	8	9	10	11	12
593	633	667	706	769	828	887	938	1002	1062	1143	1258

OVERALL DIMENSIONS			SEAT DIMENSIONS			BACK DIMENSIONS	
W	D	H	W	D	H	W	H

IN 25.5	24	33	19.5	18	17.5	19	15.5
MM 648	610	838	495	457	445	483	394

RTA 00 1 per carton



**HB Concealed Attachment Armchair, Sled Base**  
 COM: 1.75 YD | 1.6 M  
 Unit weight: 28 LB | 12.7 KG  
 Carton weight: 37 LB | 16.78 KG  
 Carton volume: 17.75 FT³ | 0.5 MT³





Active weight 300 lbs.

COM	2	3	4	5	6	7	8	9	10	11	12
695	751	798	853	942	1024	1106	1178	1267	1351	1465	1626

OVERALL DIMENSIONS			SEAT DIMENSIONS			BACK DIMENSIONS	
W	D	H	W	D	H	W	H

IN 25.5	24	38.5	19.5	18	17.5	19	21
MM 648	610	978	495	457	445	483	533

RTA 00 1 per carton

DESCRIPTION	MODEL# / FEATURES	STANDARD TEXTILE GRADES											
		COM	2	3	4	5	6	7	8	9	10	11	12
 <p><b>LB Concealed Attachment Std Side Chair, Sled Base</b>                      COM: 1.25 YD   1.14 M                      Unit weight: 24 LB   10.9 KG                      Carton weight: 32 LB   14.51 KG                      Carton volume: 13.75 FT³   0.38 MT³</p>	<b>GC6903</b>	561	601	635	674	737	796	855	906	970	1030	1111	1226
		<b>OVERALL DIMENSIONS</b>			<b>SEAT DIMENSIONS</b>			<b>BACK DIMENSIONS</b>					
		<b>W</b>	<b>D</b>	<b>H</b>	<b>W</b>	<b>D</b>	<b>H</b>	<b>W</b>	<b>H</b>				
		IN 21 MM 533	24 610	33 838	19.5 495	18 457	17.5 445	19 483	15.5 394				
		<b>RTA 00</b>	1 per carton										
 <p><b>HB Concealed Attachment Std Side Chair, Sled Base</b>                      COM: 1.75 YD   1.6 M                      Unit weight: 26 LB   11.8 KG                      Carton weight: 35 LB   15.88 KG                      Carton volume: 17.75 FT³   0.5 MT³</p>	<b>GC6903HB</b>	663	719	766	821	910	992	1074	1146	1235	1319	1433	1594
		<b>OVERALL DIMENSIONS</b>			<b>SEAT DIMENSIONS</b>			<b>BACK DIMENSIONS</b>					
		<b>W</b>	<b>D</b>	<b>H</b>	<b>W</b>	<b>D</b>	<b>H</b>	<b>W</b>	<b>H</b>				
		IN 21 MM 533	24 610	38.5 978	19.5 495	18 457	17.5 445	19 483	21 533				
		<b>RTA 00</b>	1 per carton										
 <p><b>Low Single Piece Back Std Side Chair, Four-Legged</b>                      COM: 1.25 YD   1.14 M                      Unit weight: 20 LB   9.1 KG                      Carton weight: 28 LB   12.7 KG                      Carton volume: 13.75 FT³   0.38 MT³</p>	<b>GC6912</b>	462	502	536	575	638	697	756	807	871	931	1012	1127
		<b>OVERALL DIMENSIONS</b>			<b>SEAT DIMENSIONS</b>			<b>BACK DIMENSIONS</b>					
		<b>W</b>	<b>D</b>	<b>H</b>	<b>W</b>	<b>D</b>	<b>H</b>	<b>W</b>	<b>H</b>				
		IN 21 MM 533	24 610	33 838	19.5 495	18 457	17.5 445	19 483	15.5 394				
		<b>RTA 00</b>	1 per carton										
 <p><b>High Single Piece Back Std Side Chair, Four-Legged</b>                      COM: 1.75 YD   1.6 M                      Unit weight: 22 LB   10 KG                      Carton weight: 31 LB   14.06 KG                      Carton volume: 17.75 FT³   0.5 MT³</p>	<b>GC6912HB</b>	566	622	669	724	813	895	977	1049	1138	1222	1336	1497
		<b>OVERALL DIMENSIONS</b>			<b>SEAT DIMENSIONS</b>			<b>BACK DIMENSIONS</b>					
		<b>W</b>	<b>D</b>	<b>H</b>	<b>W</b>	<b>D</b>	<b>H</b>	<b>W</b>	<b>H</b>				
		IN 21 MM 533	24 610	38.5 978	19.5 495	18 457	17.5 445	19 483	21 533				
		<b>RTA 00</b>	1 per carton										
 <p><b>Low Single Piece Back Std Armchair, Four-Legged</b>                      COM: 1.25 YD   1.14 M                      Unit weight: 23 LB   10.5 KG                      Carton weight: 31.5 LB   14.29 KG                      Carton volume: 15.5 FT³   0.43 MT³</p>	<b>GC6913</b>	491	531	565	604	667	726	785	836	900	960	1041	1156
		<b>OVERALL DIMENSIONS</b>			<b>SEAT DIMENSIONS</b>			<b>BACK DIMENSIONS</b>					
		<b>W</b>	<b>D</b>	<b>H</b>	<b>W</b>	<b>D</b>	<b>H</b>	<b>W</b>	<b>H</b>				
		IN 25.5 MM 648	24 610	33 838	19.5 495	18 457	17.5 445	19 483	15.5 394				
		<b>RTA 00</b>	1 per carton										

DESCRIPTION MODEL# / FEATURES STANDARD TEXTILE GRADES



COM	2	3	4	5	6	7	8	9	10	11	12	
<b>GC6913HB</b>	596	652	699	754	843	925	1007	1079	1168	1252	1366	1527

OVERALL DIMENSIONS			SEAT DIMENSIONS			BACK DIMENSIONS	
W	D	H	W	D	H	W	H

**High Single Piece Back Std Armchair, Four-Legged**  
 COM: 1.75 YD | 1.6 M  
 Unit weight: 25 LB | 11.4 KG  
 Carton weight: 34 LB | 15.42 KG  
 Carton volume: 17.75 FT³ | 0.5 MT³

Active weight 300 lbs.

IN	25.5	24	38.5	19.5	18	17.5	19	21
MM	648	610	978	495	457	445	483	533

**RTA 00** 1 per carton



COM	2	3	4	5	6	7	8	9	10	11	12	
<b>GC6914</b>	593	633	667	706	769	828	887	938	1002	1062	1143	1258

OVERALL DIMENSIONS			SEAT DIMENSIONS			BACK DIMENSIONS	
W	D	H	W	D	H	W	H

**Low Single Piece Back Std Armchair, Sled Base**  
 COM: 1.25 YD | 1.14 M  
 Unit weight: 26 LB | 11.8 KG  
 Carton weight: 34.5 LB | 15.65 KG  
 Carton volume: 15.5 FT³ | 0.43 MT³

Active weight 300 lbs.

IN	25.5	24	33	19.5	18	17.5	19	15.5
MM	648	610	838	495	457	445	483	394

**RTA 00** 1 per carton



COM	2	3	4	5	6	7	8	9	10	11	12	
<b>GC6914HB</b>	695	751	798	853	942	1024	1106	1178	1267	1351	1465	1626

OVERALL DIMENSIONS			SEAT DIMENSIONS			BACK DIMENSIONS	
W	D	H	W	D	H	W	H

**High Single Piece Back Std Armchair, Sled Base**  
 COM: 1.75 YD | 1.6 M  
 Unit weight: 28 LB | 12.7 KG  
 Carton weight: 37 LB | 16.78 KG  
 Carton volume: 17.75 FT³ | 0.5 MT³

Active weight 300 lbs.

IN	25.5	24	38.5	19.5	18	17.5	19	21
MM	648	610	978	495	457	445	483	533

**RTA 00** 1 per carton



COM	2	3	4	5	6	7	8	9	10	11	12	
<b>GC6915</b>	561	601	635	674	737	796	855	906	970	1030	1111	1226

OVERALL DIMENSIONS			SEAT DIMENSIONS			BACK DIMENSIONS	
W	D	H	W	D	H	W	H

**Low Single Piece Back Std Sidechair, Sled Base**  
 COM: 1.25 YD | 1.14 M  
 Unit weight: 24 LB | 10.9 KG  
 Carton weight: 32 LB | 14.51 KG  
 Carton volume: 13.75 FT³ | 0.38 MT³

Active weight 300 lbs.

IN	21	24	33	19.5	18	17.5	19	15.5
MM	533	610	838	495	457	445	483	394

**RTA 00** 1 per carton



COM	2	3	4	5	6	7	8	9	10	11	12	
<b>GC6915HB</b>	663	719	766	821	910	992	1074	1146	1235	1319	1433	1594





OVERALL DIMENSIONS			SEAT DIMENSIONS			BACK DIMENSIONS	
W	D	H	W	D	H	W	H

**High Single Piece Back Std Sidechair, Sled Base**  
 COM: 1.75 YD | 1.6 M  
 Unit weight: 26 LB | 11.8 KG  
 Carton weight: 34 LB | 15.42 KG  
 Carton volume: 14.5 FT³ | 0.41 MT³

Active weight 300 lbs.

IN	21	24	38.5	19.5	18	17.5	19	21
MM	533	610	978	495	457	445	483	533

**RTA 00** 1 per carton

DESCRIPTION	MODEL# / FEATURES	STANDARD TEXTILE GRADES												
		COM	2	3	4	5	6	7	8	9	10	11	12	
 <p><b>Low Single Piece Back Mid Size Armchair, Four-Legged</b>                      COM: 1.75 YD   1.6 M                      Unit weight: 26 LB   11.8 KG                      Carton weight: 36 LB   16.33 KG                      Carton volume: 23 FT³   0.65 MT³</p>	GC6916	789	845	892	947	1036	1118	1200	1272	1361	1445	1559	1720	
	Active weight 500 lbs.													
			OVERALL DIMENSIONS			SEAT DIMENSIONS			BACK DIMENSIONS					
			W	D	H	W	D	H	W	H				
		IN 30.5	24	33	24	18	17.5	24	15.5					
		MM 775	610	838	610	457	445	610	394					
		RTA 00		1 per carton										
 <p><b>High Single Piece Back Mid Size Armchair, Four-Legged</b>                      COM: 2 YD   1.83 M                      Unit weight: 29 LB   13.2 KG                      Carton weight: 40 LB   18.14 KG                      Carton volume: 26.75 FT³   0.75 MT³</p>	GC6916HB	878	942	996	1058	1160	1254	1348	1430	1532	1628	1758	1942	
	Active weight 500 lbs.													
			OVERALL DIMENSIONS			SEAT DIMENSIONS			BACK DIMENSIONS					
			W	D	H	W	D	H	W	H				
		IN 30.5	24	38.5	24	18	17.5	24	21					
		MM 775	610	978	610	457	445	610	533					
		RTA 00		1 per carton										
 <p><b>Low Single Piece Back Mid Size Side Chair, Four-Legged</b>                      COM: 1.75 YD   1.6 M                      Unit weight: 22 LB   10 KG                      Carton weight: 30 LB   13.61 KG                      Carton volume: 14.5 FT³   0.41 MT³</p>	GC6917	757	813	860	915	1004	1086	1168	1240	1329	1413	1527	1688	
	Active weight 500 lbs.													
			OVERALL DIMENSIONS			SEAT DIMENSIONS			BACK DIMENSIONS					
			W	D	H	W	D	H	W	H				
		IN 26	24	33	24	18	17.5	24	15.5					
		MM 660	610	838	610	457	445	610	394					
		RTA 00		1 per carton										
 <p><b>High Single Piece Back Mid Size Sidechair, Four-Legged</b>                      COM: 2 YD   1.83 M                      Unit weight: 25 LB   11.4 KG                      Carton weight: 33 LB   14.97 KG                      Carton volume: 17.75 FT³   0.5 MT³</p>	GC6917HB	848	912	966	1028	1130	1224	1318	1400	1502	1598	1728	1912	
	Active weight 500 lbs.													
			OVERALL DIMENSIONS			SEAT DIMENSIONS			BACK DIMENSIONS					
			W	D	H	W	D	H	W	H				
		IN 26	24	38.5	24	18	17.5	24	21					
		MM 660	610	978	610	457	445	610	533					
		RTA 00		1 per carton										
 <p><b>Low Single Piece Back Mid Size Armchair, Sled Base</b>                      COM: 1.75 YD   1.6 M                      Unit weight: 28 LB   12.7 KG                      Carton weight: 38 LB   17.24 KG                      Carton volume: 23 FT³   0.65 MT³</p>	GC6918	899	955	1002	1057	1146	1228	1310	1382	1471	1555	1669	1830	
	Active weight 500 lbs.													
			OVERALL DIMENSIONS			SEAT DIMENSIONS			BACK DIMENSIONS					
			W	D	H	W	D	H	W	H				
		IN 30.5	24	33	24	18	17.5	24	15.5					
		MM 775	610	838	610	457	445	610	394					
		RTA 00		1 per carton										

DESCRIPTION MODEL# / FEATURES STANDARD TEXTILE GRADES



**High Single Piece Back Mid Size Armchair, Sled Base**  
 COM: 2 YD | 1.83 M  
 Unit weight: 31 LB | 14.1 KG  
 Carton weight: 39 LB | 17.69 KG  
 Carton volume: 18.25 FT³ | 0.51 MT³

Active weight 500 lbs.

MODEL#	COM	2	3	4	5	6	7	8	9	10	11	12
<b>GC6918HB</b>	988	1052	1106	1168	1270	1364	1458	1540	1642	1738	1868	2052

OVERALL DIMENSIONS			SEAT DIMENSIONS			BACK DIMENSIONS	
W	D	H	W	D	H	W	H

IN	30.5	24	38.5	24	18	17.5	24	21
MM	775	610	978	610	457	445	610	533

**RTA 00** 1 per carton



**Low Single Piece Back Mid Size Sidechair, Sled Base**  
 COM: 1.75 YD | 1.6 M  
 Unit weight: 26 LB | 11.8 KG  
 Carton weight: 34 LB | 15.42 KG  
 Carton volume: 14.5 FT³ | 0.41 MT³

Active weight 500 lbs.

MODEL#	COM	2	3	4	5	6	7	8	9	10	11	12
<b>GC6919</b>	866	922	969	1024	1113	1195	1277	1349	1438	1522	1636	1797

OVERALL DIMENSIONS			SEAT DIMENSIONS			BACK DIMENSIONS	
W	D	H	W	D	H	W	H

IN	26	24	33	24	18	17.5	24	15.5
MM	660	610	838	610	457	445	610	394

**RTA 00** 1 per carton



**High Single Piece Back Mid Size Sidechair, Sled Base**  
 COM: 2 YD | 1.83 M  
 Unit weight: 28 LB | 12.7 KG  
 Carton weight: 37 LB | 16.78 KG  
 Carton volume: 17.75 FT³ | 0.5 MT³

Active weight 500 lbs.

MODEL#	COM	2	3	4	5	6	7	8	9	10	11	12
<b>GC6919HB</b>	957	1021	1075	1137	1239	1333	1427	1509	1611	1707	1837	2021

OVERALL DIMENSIONS			SEAT DIMENSIONS			BACK DIMENSIONS	
W	D	H	W	D	H	W	H

IN	26	24	38.5	24	18	17.5	24	21
MM	660	610	978	610	457	445	610	533

**RTA 00** 1 per carton



**Bariatric Low Single Piece Back Armchair, Four-Legged**  
 COM: 2.5 YD | 2.29 M  
 Unit weight: 36 LB | 16.4 KG  
 Carton weight: 46 LB | 20.87 KG  
 Carton volume: 20.5 FT³ | 0.58 MT³

Active weight 500 lbs.

MODEL#	COM	2	3	4	5	6	7	8	9	10	11	12
<b>GC6920</b>	1081	1161	1229	1306	1434	1551	1669	1771	1899	2019	2181	2411

OVERALL DIMENSIONS			SEAT DIMENSIONS			BACK DIMENSIONS	
W	D	H	W	D	H	W	H

IN	36.5	26	33	30	18	17.5	30	15.5
MM	927	660	838	762	457	445	762	394

**RTA 00** 1 per carton



**Bariatric High Single Piece Back Armchair, Four-Legged**  
 COM: 2.75 YD | 2.51 M  
 Unit weight: 37 LB | 16.8 KG  
 Carton weight: 49 LB | 21.77 KG  
 Carton volume: 28.25 FT³ | 0.79 MT³





Active weight 500 lbs.





MODEL#	COM	2	3	4	5	6	7	8	9	10	11	12
<b>GC6920HB</b>	1110	1198	1272	1358	1498	1627	1756	1869	2009	2141	2320	2573

OVERALL DIMENSIONS			SEAT DIMENSIONS			BACK DIMENSIONS	
W	D	H	W	D	H	W	H





IN	36.5	26	38.5	30	18	17.5	30	21
MM	927	660	978	762	457	445	762	533

**RTA 00** 1 per carton

DESCRIPTION	MODEL# / FEATURES	STANDARD TEXTILE GRADES											
		COM	2	3	4	5	6	7	8	9	10	11	12
 <p><b>Bariatric Low Single Piece Back Armchair, Sled Base</b>                      COM: 2.5 YD   2.29 M                      Unit weight: 38 LB   17.3 KG                      Carton weight: 48 LB   21.77 KG                      Carton volume: 20.5 FT³   0.58 MT³</p>	<p>Active weight 500 lbs.</p>	1188	1268	1336	1413	1541	1658	1776	1878	2006	2126	2288	2518
		OVERALL DIMENSIONS			SEAT DIMENSIONS			BACK DIMENSIONS					
		W	D	H	W	D	H	W	H				
		IN MM	36.5 927	26 660	33 838	30 762	18 457	17.5 445	30 762	15.5 394			
		RTA 00		1 per carton									
 <p><b>Bariatric High Single Piece Back Armchair, Sled Base</b>                      COM: 2.75 YD   2.51 M                      Unit weight: 39 LB   17.7 KG                      Carton weight: 50 LB   22.68 KG                      Carton volume: 28.25 FT³   0.79 MT³</p>	<p>Active weight 500 lbs.</p>	1218	1306	1380	1466	1606	1735	1864	1977	2117	2249	2428	2681
		OVERALL DIMENSIONS			SEAT DIMENSIONS			BACK DIMENSIONS					
		W	D	H	W	D	H	W	H				
		IN MM	36.5 927	26 660	38.5 978	30 762	18 457	17.5 445	30 762	21 533			
		RTA 00		1 per carton									
 <p><b>Bariatric LB Concealed Attachment Armchair, Sled Base</b>                      COM: 2.5 YD   2.29 M                      Unit weight: 38 LB   17.3 KG                      Carton weight: 48 LB   21.77 KG                      Carton volume: 20.5 FT³   0.58 MT³</p>	<p>Active weight 500 lbs.</p>	1188	1268	1336	1413	1541	1658	1776	1878	2006	2126	2288	2518
		OVERALL DIMENSIONS			SEAT DIMENSIONS			BACK DIMENSIONS					
		W	D	H	W	D	H	W	H				
		IN MM	36.5 927	26 660	33 838	30 762	18 457	17.5 445	30 762	15.5 394			
		RTA 00		1 per carton									
 <p><b>Bariatric HB Concealed Attachment Armchair, Sled Base</b>                      COM: 2.5 YD   2.29 M                      Unit weight: 38 LB   17.3 KG                      Carton weight: 48 LB   21.77 KG                      Carton volume: 20.5 FT³   0.58 MT³</p>	<p>Active weight 500 lbs.</p>	1210	1306	1387	1480	1633	1774	1915	2038	2191	2335	2530	2806
		OVERALL DIMENSIONS			SEAT DIMENSIONS			BACK DIMENSIONS					
		W	D	H	W	D	H	W	H				
		IN MM	36.5 927	26 660	38.5 978	30 762	18 457	17.5 445	30 762	21 533			
		RTA 00		1 per carton									
 <p><b>Bariatric LB Concealed Attachment Armchair, Four-Legged</b>                      COM: 2.5 YD   2.29 M                      Unit weight: 36 LB   16.4 KG                      Carton weight: 46 LB   20.87 KG                      Carton volume: 20.5 FT³   0.58 MT³</p>	<p>Active weight 500 lbs.</p>	1127	1207	1275	1352	1480	1597	1715	1817	1945	2065	2227	2457
		OVERALL DIMENSIONS			SEAT DIMENSIONS			BACK DIMENSIONS					
		W	D	H	W	D	H	W	H				
		IN MM	36.5 927	26 660	33 838	30 762	18 457	17.5 445	30 762	15.5 394			
		RTA 00		1 per carton									

DESCRIPTION	MODEL# / FEATURES	STANDARD TEXTILE GRADES												
		COM	2	3	4	5	6	7	8	9	10	11	12	
 <p><b>Bariatric HB Concealed Attachment Armchair, Four-Legged</b>                      COM: 3 YD   2.74 M                      Unit weight: 37 LB   16.8 KG                      Carton weight: 48 LB   21.77 KG                      Carton volume: 28.25 FT<sup>3</sup>   0.79 MT<sup>3</sup></p>	<b>GC6923HB</b>  Active weight 500 lbs.  RTA 00 1 per carton	1148	1244	1325	1418	1571	1712	1853	1976	2129	2273	2468	2744	
		<b>OVERALL DIMENSIONS</b> W D H			<b>SEAT DIMENSIONS</b> W D H			<b>BACK DIMENSIONS</b> W H						
		IN 36.5	26	38.5	30	18	17.5	30	21					
		MM 927	660	978	762	457	445	762	533					
 <p><b>LB Concealed Attachment Mid Size Armchair, Four-Legged</b>                      COM: 2.5 YD   2.29 M                      Unit weight: 26 LB   11.8 KG                      Carton weight: 36 LB   16.33 KG                      Carton volume: 23 FT<sup>3</sup>   0.65 MT<sup>3</sup></p>	<b>GC6924</b>  Active weight 500 lbs.  RTA 00 1 per carton	765	845	913	990	1118	1235	1353	1455	1583	1703	1865	2095	
		<b>OVERALL DIMENSIONS</b> W D H			<b>SEAT DIMENSIONS</b> W D H			<b>BACK DIMENSIONS</b> W H						
		IN 30.5	24	33	24	18	17.5	24	15.5					
		MM 775	610	838	610	457	445	610	394					
 <p><b>HB Concealed Attachment Mid Size Armchair, Four-Legged</b>                      COM: 2.75 YD   2.51 M                      Unit weight: 29 LB   13.2 KG                      Carton weight: 41 LB   18.6 KG                      Carton volume: 26.75 FT<sup>3</sup>   0.75 MT<sup>3</sup></p>	<b>GC6924HB</b>  Active weight 500 lbs.  RTA 00 1 per carton	854	942	1016	1102	1242	1371	1500	1613	1753	1885	2064	2317	
		<b>OVERALL DIMENSIONS</b> W D H			<b>SEAT DIMENSIONS</b> W D H			<b>BACK DIMENSIONS</b> W H						
		IN 30.5	24	38.5	24	18	17.5	24	21					
		MM 775	610	978	610	457	445	610	533					
 <p><b>LB Concealed Attachment Mid Size Sidechair, Four-Legged</b>                      COM: 2.5 YD   2.29 M                      Unit weight: 22 LB   10 KG                      Carton weight: 30 LB   13.61 KG                      Carton volume: 14.5 FT<sup>3</sup>   0.41 MT<sup>3</sup></p>	<b>GC6925</b>  Active weight 500 lbs.  RTA 00 1 per carton	733	813	881	958	1086	1203	1321	1423	1551	1671	1833	2063	
		<b>OVERALL DIMENSIONS</b> W D H			<b>SEAT DIMENSIONS</b> W D H			<b>BACK DIMENSIONS</b> W H						
		IN 26	24	33	24	18	17.5	24	15.5					
		MM 660	610	838	610	457	445	610	394					
 <p><b>HB Concealed Attachment Mid Size Sidechair, Four-Legged</b>                      COM: 2.75 YD   2.51 M                      Unit weight: 25 LB   11.4 KG                      Carton weight: 35.5 LB   16.1 KG                      Carton volume: 24 FT<sup>3</sup>   0.67 MT<sup>3</sup></p>	<b>GC6925HB</b>  Active weight 500 lbs.  RTA 00 1 per carton	824	912	986	1072	1212	1341	1470	1583	1723	1855	2034	2287	
		<b>OVERALL DIMENSIONS</b> W D H			<b>SEAT DIMENSIONS</b> W D H			<b>BACK DIMENSIONS</b> W H						
		IN 26	24	38.5	24	18	17.5	24	21					
		MM 660	610	978	610	457	445	610	533					

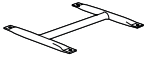

DESCRIPTION	MODEL# / FEATURES	STANDARD TEXTILE GRADES											
		COM	2	3	4	5	6	7	8	9	10	11	12
 <p><b>LB Concealed Attachment Mid Size Armchair, Sled Base</b>                      COM: 2.5 YD   2.29 M                      Unit weight: 28 LB   12.7 KG                      Carton weight: 36 LB   16.33 KG                      Carton volume: 16 FT³   0.45 MT³</p>	<b>GC6926</b>	875	955	1023	1100	1228	1345	1463	1565	1693	1813	1975	2205
		<b>OVERALL DIMENSIONS</b>			<b>SEAT DIMENSIONS</b>			<b>BACK DIMENSIONS</b>					
		<b>W</b>	<b>D</b>	<b>H</b>	<b>W</b>	<b>D</b>	<b>H</b>	<b>W</b>	<b>H</b>				
		IN 30.5 MM 775	24 610	33 838	24 610	18 457	17.5 445	24 610	15.5 394				
		<b>RTA 00</b>	1 per carton										
 <p><b>HB Concealed Attachment Mid Size Armchair, Sled Base</b>                      COM: 2.75 YD   2.51 M                      Unit weight: 31 LB   14.1 KG                      Carton weight: 42 LB   19.05 KG                      Carton volume: 26.75 FT³   0.75 MT³</p>	<b>GC6926HB</b>	964	1052	1126	1212	1352	1481	1610	1723	1863	1995	2174	2427
		<b>OVERALL DIMENSIONS</b>			<b>SEAT DIMENSIONS</b>			<b>BACK DIMENSIONS</b>					
		<b>W</b>	<b>D</b>	<b>H</b>	<b>W</b>	<b>D</b>	<b>H</b>	<b>W</b>	<b>H</b>				
		IN 30.5 MM 775	24 610	38.5 978	24 610	18 457	17.5 445	24 610	21 533				
		<b>RTA 00</b>	1 per carton										
 <p><b>LB Concealed Attachment Mid Size Sidechair, Sled Base</b>                      COM: 2.5 YD   2.29 M                      Unit weight: 26 LB   11.8 KG                      Carton weight: 34 LB   15.42 KG                      Carton volume: 14.5 FT³   0.41 MT³</p>	<b>GC6927</b>	842	922	990	1067	1195	1312	1430	1532	1660	1780	1942	2172
		<b>OVERALL DIMENSIONS</b>			<b>SEAT DIMENSIONS</b>			<b>BACK DIMENSIONS</b>					
		<b>W</b>	<b>D</b>	<b>H</b>	<b>W</b>	<b>D</b>	<b>H</b>	<b>W</b>	<b>H</b>				
		IN 26 MM 660	24 610	33 838	24 610	18 457	17.5 445	24 610	15.5 394				
		<b>RTA 00</b>	1 per carton										
 <p><b>HB Concealed Attachment Mid Size Sidechair, Sled Base</b>                      COM: 2.75 YD   2.51 M                      Unit weight: 28 LB   12.7 KG                      Carton weight: 37 LB   16.78 KG                      Carton volume: 17.75 FT³   0.5 MT³</p>	<b>GC6927HB</b>	933	1021	1095	1181	1321	1450	1579	1692	1832	1964	2143	2396
		<b>OVERALL DIMENSIONS</b>			<b>SEAT DIMENSIONS</b>			<b>BACK DIMENSIONS</b>					
		<b>W</b>	<b>D</b>	<b>H</b>	<b>W</b>	<b>D</b>	<b>H</b>	<b>W</b>	<b>H</b>				
		IN 26 MM 660	24 610	38.5 978	24 610	18 457	17.5 445	24 610	21 533				
		<b>RTA 00</b>	1 per carton										

DESCRIPTION	MODEL# / FEATURES	STANDARD TEXTILE GRADES						
		List price						
	GC6928	84						
 <p><b>Metal Ganging Connector for Armchairs</b>                      COM: N/A                      Unit weight: 2 LB   0.9 KG                      Carton weight: 4 LB   1.81 KG                      Carton volume: 0.4 FT³   0.01 MT³</p>		<b>OVERALL DIMENSIONS</b>			<b>SEAT DIMENSIONS</b>			<b>BACK DIMENSIONS</b>
		<b>W</b>	<b>D</b>	<b>H</b>	<b>W</b>	<b>D</b>	<b>H</b>	<b>WH</b>
	IN	12	13.75	1	-	-	-	-
	MM	305	349	25	-	-	-	-
		<b>RTA 00</b>		<b>courier</b>				

		List price						
	GC6929	84						
 <p><b>Metal Ganging Connector for Armless Chairs</b>                      COM: N/A                      Unit weight: 1.5 LB   0.7 KG                      Carton weight: 3.5 LB   1.59 KG                      Carton volume: 0.4 FT³   0.01 MT³</p>		<b>OVERALL DIMENSIONS</b>			<b>SEAT DIMENSIONS</b>			<b>BACK DIMENSIONS</b>
		<b>W</b>	<b>D</b>	<b>H</b>	<b>W</b>	<b>D</b>	<b>H</b>	<b>W</b>
	IN	7.87	13.75	1	-	-	-	-
	MM	200	349	25	-	-	-	-
		<b>RTA 00</b>		<b>courier</b>				

GC SIRENA



model GC3380



model GC3380CTRL

STANDARD FEATURES

- A modern take on a classic design, GC Sirena remains relevant, charming and diverse offering simple, clean, flexible lines that will complement and create a sense of warmth in any room. The soft curves and comfortable fit make it the right solution for relaxation or meetings.
- Models are available with complementary round bun shaped foot design or swivel casters in Black only.
- For tablet models, please specify left hand or right hand tablet at time of order (determined from the seated position). See models below.
- Tablets rotate and are non-removable. Overall tablet size is 17"W by 14"D.
- Laminate tablet surfaces are 1.5" thick.
- **(C1M)** dual wheel carpet casters are standard on select models.
- The interior wood frame is an interlocking construction providing superior strength and long-term durability.
- Clean out space is provided around the seat pan for easy housekeeping and infection prevention practices.
- Seat cushion can be removed if replacement is required.
- For added comfort, seats are standard with high density Ultracell foam.
- For textile options, visit the Healthcare vertical section on [globalfurnituregroup.com](http://globalfurnituregroup.com).
- Can be upholstered in standard Global textiles if Healthcare compliance is not required.

OPTIONAL FEATURES

- Laminate tablets are offered in the following laminate finishes: Absolute Acajou (ACJ), Asian Night (ASN), Avant Cherry (AWC), Avant Honey (AWH), Black (BLK), Blizzard (BZD) Brushed Cobalt (BRC), Clear Maple (CMB), Custom Grey (CGY), Dark Espresso (DES), Designer White (DWT), Fashionista (FAS), First Class (FCL), Quartered Mahogany (QTM), Noce Biondo (NBL), Noce Grigio (NGL), Noce Leggero (NEL), Noce Medio (NML), Sheer Beauty (SBY), Stonedust (SDT) Walnut Heights (WHE), White Chocolate (WHC) and Winter Cherry (WCR). Please specify.
- For less demanding areas, models are available with a tapered cylindrical 3 3/4" high wood leg to create a 19" seat height for models GC3380 and GC3380-CW. Add \$366.
- To add sealed seams to your product contact Customer Service. Upcharges vary.
- For moisture barrier on seat, please specify **(MB)**. Add \$122.

SUGGESTED APPLICATIONS

- Dining/Cafeteria
- Guest seating
- Lobbies
- Lounge/Waiting
- Office/Meeting
- Patient rooms
- Resident rooms

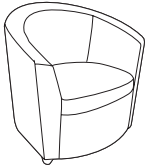
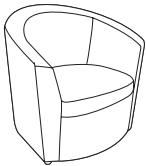
DESCRIPTION	MODEL# / FEATURES	STANDARD TEXTILE GRADES												
		COM	2	3	4	5	6	7	8	9	10	11	12	
 <p><b>Club Chair w/Seat Clean Out</b> COM: 4.25 YD   3.89 M Unit weight: 45 LB   20.5 KG Carton weight: 52 LB   23.59 KG Carton volume: 19.25 FT<sup>3</sup>   0.54 MT<sup>3</sup></p>	<b>GC3380</b>	1152	1288	1403	1535	1751	1951	2151	2325	2542	2746	3022	3413	
	Active weight 300 lbs.	IN	30.5	29.5	28.5	20	20	17.5	19	11.5				
		MM	775	749	724	508	508	445	483	292				
		<b>RTA 00</b>	1 per carton											
 <p><b>Club Chair on Casters w/Seat Clean Out</b> COM: 4.25 YD   3.89 M Unit weight: 47 LB   21.4 KG Carton weight: 52 LB   23.59 KG Carton volume: 19.25 FT<sup>3</sup>   0.54 MT<sup>3</sup></p>	<b>GC3380C</b>	1242	1378	1493	1625	1841	2041	2241	2415	2632	2836	3112	3503	
	Active weight 300 lbs.	IN	30.5	29.5	29.5	20	20	18	19	12.5				
		MM	775	749	749	508	508	457	483	318				
		<b>RTA 00</b>	1 per carton											

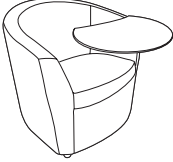
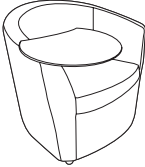
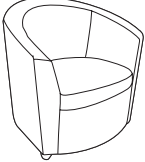
DESCRIPTION	MODEL# / FEATURES	STANDARD TEXTILE GRADES											
		COM	2	3	4	5	6	7	8	9	10	11	12
 <p><b>Club Chair on Casters w/Seat Clean Out and LP Tablet - Left</b>                      COM: 4.25 YD   3.89 M                      Unit weight: 57 LB   25.9 KG                      Carton weight: 62 LB   28.12 KG                      Carton volume: 19.25 FT<sup>3</sup>   0.54 MT<sup>3</sup></p>	<b>GC3380CLTL</b>  Active weight 300 lbs.	1652	1788	1903	2035	2251	2451	2651	2825	3042	3246	3522	3913
		<b>OVERALL DIMENSIONS</b>			<b>SEAT DIMENSIONS</b>			<b>BACK DIMENSIONS</b>					
		<b>W</b>	<b>D</b>	<b>H</b>	<b>W</b>	<b>D</b>	<b>H</b>	<b>W</b>	<b>H</b>				
		IN 32	29.5	29.5	20	20	18	19	12.5				
		MM 813	749	749	508	508	457	483	318				
		<b>RTA 00</b>	1 per carton										
 <p><b>Club Chair on Casters w/Seat Clean Out and LP Tablet - Right</b>                      COM: 4.25 YD   3.89 M                      Unit weight: 57 LB   25.9 KG                      Carton weight: 62 LB   28.12 KG                      Carton volume: 19.25 FT<sup>3</sup>   0.54 MT<sup>3</sup></p>	<b>GC3380CRTL</b>  Active weight 300 lbs.	1652	1788	1903	2035	2251	2451	2651	2825	3042	3246	3522	3913
		<b>OVERALL DIMENSIONS</b>			<b>SEAT DIMENSIONS</b>			<b>BACK DIMENSIONS</b>					
		<b>W</b>	<b>D</b>	<b>H</b>	<b>W</b>	<b>D</b>	<b>H</b>	<b>W</b>	<b>H</b>				
		IN 32	29.5	29.5	20	20	18	19	12.5				
		MM 813	749	749	508	508	457	483	318				
		<b>RTA 00</b>	1 per carton										
 <p><b>Weighted Club Chair w/Seat Clean Out</b>                      COM: 4.25 YD   3.89 M                      Unit weight: 98 LB   44.5 KG                      Carton weight: 108 LB   48.99 KG                      Carton volume: 19.25 FT<sup>3</sup>   0.54 MT<sup>3</sup></p>	<b>GC3380-CW</b>  Active weight 300 lbs.	1419	1555	1670	1802	2018	2218	2418	2592	2809	3013	3289	3680
		<b>OVERALL DIMENSIONS</b>			<b>SEAT DIMENSIONS</b>			<b>BACK DIMENSIONS</b>					
		<b>W</b>	<b>D</b>	<b>H</b>	<b>W</b>	<b>D</b>	<b>H</b>	<b>W</b>	<b>H</b>				
		IN 30.5	29.5	28.5	20	20	17.5	19	11.5				
		MM 775	749	724	508	508	445	483	292				
		<b>RTA 00</b>	1 per carton										

GC VITROLA



model GC8271LB

model GC8272HB with optional urethane armcaps



EXAMPLE GC VITROLA ORDER CODE:

GC8271HB	-NS	-WA50	-NS	-WA50
Model #	Sealed back/arms seams	Back/arms textile	Sealed seat seams	Seat textile

-NC	-	-WOD	-AAM	-RS	-NB	-NM
Arm type	Armcap finish	Leg type	Leg finish	Fastener type	Moisture barrier	Glide

STANDARD FEATURES

- Classic soft seating upholstery design with swooping arms, designed to support healthcare applications.
- Available in two back heights.
- Clean out space is provided between the seat and back cushions for easy housekeeping.
- The seat underside is sealed with a non-porous material to support housekeeping and infection control protocols.
- All units are supported by a durable metal seat frame.
- Seat cushion is mechanically removable for replacement.
- For added comfort, seats are standard with high density Ultracell foam.
- Back spring structure provides comfort and durability.
- Tapered legs are available in Maple wood in a variety of finishes or optional in urethane.
- Arms are fully upholstered.
- White non-marking nylon glides are standard.
- Available with contrasting fabrics. Specify arms, back and front rail separate from seat cushion (see model image).
- Textiles with a minimum of 100,000 double rubs must be specified to meet Global 24/7 warranty coverage.
- For healthcare textiles and finish options, visit the website at [globalfurnituregroup.com](http://globalfurnituregroup.com).
- Can be upholstered in standard Global textiles if Healthcare 24/7 application compliance is not required. Global's Limited Lifetime warranty applies.
- Shipped fully assembled.
- Active weight capacity is up to 350 lbs./seat for standard seating; up to 600 lbs. for bariatric seating.

OPTIONAL FEATURES

- A selection of glide options is available, see glide types. Glides must be chosen to best suit flooring type and site conditions.
- Sealed seams are available on chair backs and arms and/or seat (upcharges apply).
- Moisture barrier may be added to seat cushions only (upcharge applies)
- Optional urethane or solid surface armcaps are available, see upcharges.
- Optional urethane tapered legs are available, see upcharges

SUGGESTED APPLICATIONS

- Lobbies
- Lounge/Waiting
- Patient rooms
- Resident rooms

Please add option codes in the following order:

- **Model number**  
**GC8271LB** Lounge chair  
**GC8271HB** High back lounge chair  
**GC8271BLB** Bariatric lounge chair  
**GC8271BHB** High back bariatric lounge chair  
**GC8272LB** Two seat sofa  
**GC8272HB** High back two seat sofa  
**GC8273LB** Three seat sofa  
**GC8273HB** High back three seat sofa  
**GC8275** Bench  
**GC8275B** Bariatric width bench
- **Back and arm seams**  
**(NS)** No sealed seams.  
**(S2)** Sealed back and arm seams. Upcharges vary, see model.
- **Back and arm textile**  
Specify back and arm textile.
- **Seat seams**  
**(NS)** No sealed seams.  
**(SE)** Sealed seat seams. Upcharges vary, see model.
- **Seat textile**  
Specify seat textile.
- **Arm type**  
**(NC)** No armcap  
**(SSU)** Urethane armcap  
**(CO)** Solid surface armcap
- **Armcap finish - urethane - add \$144**  
**(BLK)** Black **(J52)** Mocha  
**(KAL)** Kalua **(SHW)** Shadow  
**(LAB)** Latte **(TOA)** Toast

Armcap finish - Solid surface

- Grade 1 - add \$320**  
**(SHW)** Designer White
- Grade 2 - add \$340**  
**(SBT)** Beige Tempest  
**(SBM)** Black Onyx Mirage  
**(SFW)** Frosty White Mirage  
**(SHS)** Hot Stone  
**(SMG)** Milk Glass Spectra  
**(SNM)** Northern Melange

- **Leg type**  
**(WOD)** Wood  
**(SSU)** Urethane. Add \$144
- **Leg finish - wood**  
**(AAM)** Absolute **(MWM)** Medium Walnut  
**(BKM)** Black **(NLW)** Natural Walnut  
**(ACM)** Cherry **(ASM)** Night  
**(CJM)** Charcoal Java **(NBM)** Noce Biondo  
**(EMM)** Empire Mahogany **(NGM)** Noce Grigio  
**(EOM)** English Oak **(NEM)** Noce Leggero  
**(ECM)** Espresso Cafe **(NMM)** Noce Medio  
**(TFM)** Fruitwood **(SBM)** Sandy Beach  
**(HGM)** Gray **(SKM)** Shaker Cherry  
**(HOM)** Harvest Oak **(SOM)** Silver Oak  
**(AHM)** Honey **(TWM)** Walnut  
**(JOM)** Jet Onyx **(WTM)** WC Cream  
**(LHM)** Light Honey **(WHM)** White  
**(TMM)** Mahogany **(WCM)** Winter Cherry  
**(AVM)** Maple

Leg finish - urethane

- (BLK)** Black **(J52)** Mocha  
**(KAL)** Kalua **(SHW)** Shadow  
**(LAB)** Latte **(TOA)** Toast

- **Fastener type**  
**(RS)** Standard fasteners.  
**(TP)** Tamperproof fasteners. Add \$70.
- **Moisture barrier** (seat only, not available with sealed seams option)  
**(NB)** No moisture barrier.  
**(MB)** Moisture barrier. Upcharges vary, see model.
- **Glides**  
**(NM)** Non-marking glides for most surfaces.  
**(SG)** Steel cushioned glides for carpeted surfaces. Add \$17.  
**(RG)** Rubber non-slip glides for most hard floor surfaces. Add \$22.  
**(FG)** Felt glides for most hard floor surfaces. Add \$22.





DESCRIPTION	MODEL# / FEATURES	STANDARD TEXTILE GRADES											
		1	2	3	4	5	6	7	8	9	10	11	12
	<b>GC8271LB</b>	1806	1990	2146	2324	2617	2887	3158	3393	3687	3963	4336	4865
		OVERALL DIMENSIONS			SEAT DIMENSIONS			BACK DIMENSIONS					
		W	D	H	W	D	H	W	H				
		Active weight 350 lbs.	IN 28.25 MM 718	32.25 819	34.25 870	21.5 546	19.25 489	18.5 470	22.5 572	15.75 400			
Moisture barrier (MB), add \$81		Sealed back + arm seams (S2), add \$134		Sealed seat seams (SE), add \$18		RTA 00		1 per carton					

DESCRIPTION	MODEL# / FEATURES	STANDARD TEXTILE GRADES											
		1	2	3	4	5	6	7	8	9	10	11	12
	<b>GC8271HB</b>	1959	2159	2328	2522	2840	3134	3428	3684	4003	4303	4709	5284
		OVERALL DIMENSIONS			SEAT DIMENSIONS			BACK DIMENSIONS					
		W	D	H	W	D	H	W	H				
		Active weight 350 lbs.	IN 28.25 MM 718	33.75 857	42 1067	21.5 546	19.25 489	18.5 470	22.5 572	23.5 597			
Moisture barrier (MB), add \$81		Sealed back + arm seams (S2), add \$158		Sealed seat seams (SE), add \$18		RTA 00		1 per carton					

DESCRIPTION	MODEL# / FEATURES	STANDARD TEXTILE GRADES											
		1	2	3	4	5	6	7	8	9	10	11	12
	<b>GC8271BLB</b>	2140	2340	2509	2703	3021	3315	3609	3865	4184	4484	4890	5465
		OVERALL DIMENSIONS			SEAT DIMENSIONS			BACK DIMENSIONS					
		W	D	H	W	D	H	W	H				
		Active weight 600 lbs.	IN 39 MM 991	32.25 819	34.25 870	32 813	19.25 489	18.5 470	33 838	15.75 400			
Moisture barrier (MB), add \$122		Sealed back + arm seams (S2), add \$138		Sealed seat seams (SE), add \$18		RTA 00		1 per carton					

DESCRIPTION	MODEL# / FEATURES	STANDARD TEXTILE GRADES											
		1	2	3	4	5	6	7	8	9	10	11	12
	<b>GC8271BHB</b>	2332	2556	2745	2963	3319	3648	3977	4264	4621	4957	5412	6056
		OVERALL DIMENSIONS			SEAT DIMENSIONS			BACK DIMENSIONS					
		W	D	H	W	D	H	W	H				
		Active weight 600 lbs.	IN 39 MM 991	33.75 857	42 1067	32 813	19.25 489	18.5 470	33 838	23.5 597			
Moisture barrier (MB), add \$122		Sealed back + arm seams (S2), add \$162		Sealed seat seams (SE), add \$18		RTA 00		1 per carton					

DESCRIPTION	MODEL# / FEATURES	STANDARD TEXTILE GRADES											
		1	2	3	4	5	6	7	8	9	10	11	12
	<b>GC8272LB</b>	2465	2673	2849	3050	3382	3687	3993	4259	4591	4903	5325	5923
		OVERALL DIMENSIONS			SEAT DIMENSIONS			BACK DIMENSIONS					
		W	D	H	W	D	H	W	H				
		Active weight 350 lbs / seat	IN 50.5 MM 1283	32.25 819	34.25 870	43.5 1105	19.25 489	18.5 470	43.5 1105	15.75 400			
Moisture barrier (MB), add \$162		Sealed back + arm seams (S2), add \$161		Sealed seat seams (SE), add \$38		RTA 00		1 per carton					

DESCRIPTION	MODEL# / FEATURES	STANDARD TEXTILE GRADES											
		1	2	3	4	5	6	7	8	9	10	11	12
 <p><b>High Back Two Seat Sofa</b> COM: 7.5 YD   6.86 M Unit weight: 99.5 LB   45.2 KG Carton weight: 116.5 LB   52.84 KG Carton volume: 48.25 FT³   1.36 MT³</p>	<b>GC8272HB</b>	2749	2989	3192	3424	3807	4159	4512	4819	5202	5562	6049	6739
		<b>OVERALL DIMENSIONS</b>			<b>SEAT DIMENSIONS</b>			<b>BACK DIMENSIONS</b>					
		<b>W</b>	<b>D</b>	<b>H</b>	<b>W</b>	<b>D</b>	<b>H</b>	<b>W</b>	<b>H</b>				
	Active weight 350 lbs./seat	IN 50.5 MM 1283	33.75 857	42 1067	43.5 1105	19.25 489	18.5 470	43.5 1105	23.5 597				
		Moisture barrier (MB), add \$162		Sealed back + arm seams (S2), add \$185		Sealed seat seams (SE), add \$38		RTA 00		1 per carton			
 <p><b>Three Seat Sofa</b> COM: 8.25 YD   7.54 M Unit weight: 109 LB   49.5 KG Carton weight: 133 LB   60.33 KG Carton volume: 56.75 FT³   1.6 MT³</p>	<b>GC8273LB</b>	3268	3532	3755	4011	4431	4819	5207	5545	5966	6362	6898	7657
		<b>OVERALL DIMENSIONS</b>			<b>SEAT DIMENSIONS</b>			<b>BACK DIMENSIONS</b>					
		<b>W</b>	<b>D</b>	<b>H</b>	<b>W</b>	<b>D</b>	<b>H</b>	<b>W</b>	<b>H</b>				
	Active weight 350 lbs./seat	IN 71.5 MM 1816	32.25 819	34.25 870	65 1651	19.25 489	18.5 470	65 1651	15.75 400				
		Moisture barrier (MB), add \$243		Sealed back + arm seams (S2), add \$188		Sealed seat seams (SE), add \$59		RTA 00		1 per carton			
 <p><b>High Back Three Seat Sofa</b> COM: 9.25 YD   8.46 M Unit weight: 127.5 LB   58 KG Carton weight: 153.5 LB   69.63 KG Carton volume: 68.75 FT³   1.94 MT³</p>	<b>GC8273HB</b>	3691	3987	4237	4524	4995	5430	5865	6244	6716	7160	7761	8612
		<b>OVERALL DIMENSIONS</b>			<b>SEAT DIMENSIONS</b>			<b>BACK DIMENSIONS</b>					
		<b>W</b>	<b>D</b>	<b>H</b>	<b>W</b>	<b>D</b>	<b>H</b>	<b>W</b>	<b>H</b>				
	Active weight 350 lbs./seat	IN 71.5 MM 1816	33.75 857	42 1067	65 1651	19.25 489	18.5 470	65 1651	23.5 597				
		Moisture barrier (MB), add \$243		Sealed back + arm seams (S2), add \$213		Sealed seat seams (SE), add \$59		RTA 00		1 per carton			
 <p><b>Bench</b> COM: 1.5 YD   1.37 M Unit weight: 24.5 LB   11.1 KG Carton weight: 30.5 LB   13.83 KG Carton volume: 8 FT³   0.22 MT³</p>	<b>GC8275</b>	648	696	737	783	860	930	1001	1062	1139	1211	1308	1446
		<b>OVERALL DIMENSIONS</b>			<b>SEAT DIMENSIONS</b>			<b>BACK DIMENSIONS</b>					
		<b>W</b>	<b>D</b>	<b>H</b>	<b>W</b>	<b>D</b>	<b>H</b>	<b>W</b>	<b>H</b>				
	Active weight 350 lbs.	IN 24 MM 610	24 610	18 457	-	-	-	-	-				
		Moisture barrier (MB), add \$81		Sealed seat seams (SE), add \$19		RTA 00		1 per carton					
 <p><b>Bariatric Width Bench</b> COM: 2 YD   1.83 M Unit weight: 33 LB   15 KG Carton weight: 39 LB   17.69 KG Carton volume: 8 FT³   0.22 MT³</p>	<b>GC8275B</b>	910	974	1028	1090	1192	1286	1380	1462	1564	1660	1790	1974
		<b>OVERALL DIMENSIONS</b>			<b>SEAT DIMENSIONS</b>			<b>BACK DIMENSIONS</b>					
		<b>W</b>	<b>D</b>	<b>H</b>	<b>W</b>	<b>D</b>	<b>H</b>	<b>W</b>	<b>H</b>				
	Active weight 600 lbs.	IN 34 MM 864	24 610	18 457	-	-	-	-	-				
		Moisture barrier (MB), add \$122		Sealed seat seams (SE), add \$19		RTA 00		1 per carton					

GC WIND



model GC3361HB

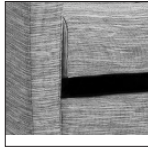

Removable Seat Cushion



Tubular Steel Leg



model GC3363HB

STANDARD FEATURES

- An attractive, sleek and modern lounge series with tubular legs.
- Seat cushions are easily removable for cleaning and the open frame is great for housekeeping access. Cushion covers are removable.
- For added comfort, seats are standard with high density Ultracell foam.
- Standard glide is Black plastic.
- For healthcare textiles and finish options, visit the website at [globalfurnituregroup.com](http://globalfurnituregroup.com).
- Can be upholstered in standard Global textiles if Healthcare compliance is not required.
- Shipped fully assembled.

SUGGESTED APPLICATIONS

- Lobbies
- Lounge/Waiting
- Office/Meeting
- Patient rooms
- Resident rooms

OPTIONAL FEATURES

- For hard surface floors, please specify opaque non-marking glides **(NM)**. No upcharge.
- To add sealed seams to your product contact Customer Service. Upcharges vary.
- For moisture barrier on seat, please specify **(MB)**. See below for upcharges:  
Lounge chair: Add \$122.  
Two seat sofa: Add \$245.  
Three seat sofa: Add \$366.
- **Frame finish**  
Paint finishes. No upcharge.  
**(TBL)** Black **(TIN)** Ink  
**(TBZ)** Buzz Blue **(TKA)** Kalua  
**(TCC)** Cactus **(TLA)** Latte  
**(TCR)** Carrot **(TMO)** Mocha  
**(TIV)** Cloud **(TNE)** Nevada  
**(TDW)** Designer White **(TSN)** Sand  
**(TDJ)** Dijon **(TSR)** Scarlet  
**(TEG)** Eggplant **(TSH)** Shadow  
**(TFO)** Fog **(TOA)** Toast  
**(TFR)** Frost **(TTU)** Tungsten  
Plated finish. See below for upcharges.  
**(CHM)** Chrome **(SBR)** Satin Brass  
**(BCH)** Brushed Chrome **(ACO)** Antique Copper
- Upcharges apply for plated finishes:  
**(CHM)** Chrome. No upcharge.  
**(BCH)** Brushed Chrome. Add \$49 for lounge chair. Add \$84 for two seat sofa. Add \$174 for three seat sofa.  
**(SBR)** Satin Brass. Add \$132 for lounge chair. Add \$204 for two seat sofa. Add \$399 for three seat sofa.  
**(ACO)** Antique Copper. Add \$132 for lounge chair. Add \$204 for two seat sofa. Add \$399 for three seat sofa.

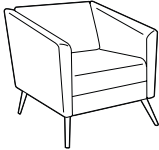
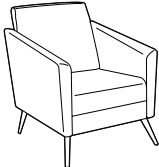
DESCRIPTION	MODEL# / FEATURES	STANDARD TEXTILE GRADES											
		COM	2	3	4	5	6	7	8	9	10	11	12
 <b>Lounge Chair</b> COM: 4.25 YD   3.89 M Unit weight: 55 LB   25 KG Carton weight: 62 LB   28.12 KG Carton volume: 16.5 FT³   0.46 MT³	<b>GC3361</b>	1781	1917	2032	2164	2380	2580	2780	2954	3171	3375	3651	4042
	Active weight 300 lbs. Removable seat cushions.	<b>OVERALL DIMENSIONS</b>			<b>SEAT DIMENSIONS</b>			<b>BACK DIMENSIONS</b>					
		<b>W</b>	<b>D</b>	<b>H</b>	<b>W</b>	<b>D</b>	<b>H</b>	<b>W</b>	<b>H</b>				
		IN 27.5 MM 699	29 737	28.5 724	19.5 495	19 483	17 432	19 483	12 305				
	<b>RTA 00</b>	1 per carton											
 <b>High Back Lounge Chair</b> COM: 4.75 YD   4.34 M Unit weight: 62 LB   28.2 KG Carton weight: 69 LB   31.3 KG Carton volume: 23 FT³   0.65 MT³	<b>GC3361HB</b>	2040	2192	2320	2468	2710	2933	3156	3351	3593	3821	4130	4567
	Active weight 300 lbs. Removable seat cushions.	<b>OVERALL DIMENSIONS</b>			<b>SEAT DIMENSIONS</b>			<b>BACK DIMENSIONS</b>					
		<b>W</b>	<b>D</b>	<b>H</b>	<b>W</b>	<b>D</b>	<b>H</b>	<b>W</b>	<b>H</b>				
		IN 27.5 MM 699	29 737	36 914	19.5 495	19 483	17 432	19 483	19.5 495				
	<b>RTA 00</b>	1 per carton											



DESCRIPTION	MODEL# / FEATURES	STANDARD TEXTILE GRADES											
		COM	2	3	4	5	6	7	8	9	10	11	12

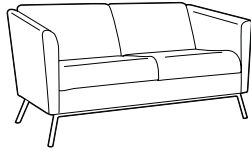

<b>GC3362</b>	2332	2564	2760	2985	3354	3695	4036	4333	4703	5051	5522	6189
Active weight 300 lbs/seat. Removable seat cushions.	<b>OVERALL DIMENSIONS</b>			<b>SEAT DIMENSIONS</b>			<b>BACK DIMENSIONS</b>					
	<b>W</b>	<b>D</b>	<b>H</b>	<b>W</b>	<b>D</b>	<b>H</b>	<b>W</b>	<b>H</b>				
	IN 54.5	29	28.5	46.5	19	17	46.5	12				
	MM 1384	737	724	1181	483	432	1181	305				
	<b>RTA 00</b>	1 per carton										

**Two Seat Sofa**  
COM: 7.25 YD | 6.63 M  
Unit weight: 95 LB | 43.2 KG  
Carton weight: 102 LB | 46.27 KG  
Carton volume: 30 FT³ | 0.84 MT³

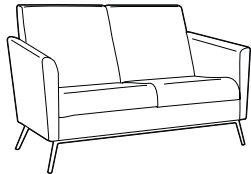

<b>GC3362HB</b>	2834	3090	3306	3554	3962	4338	4714	5042	5450	5834	6354	7090
Active weight 300 lbs/seat. Removable seat cushions.	<b>OVERALL DIMENSIONS</b>			<b>SEAT DIMENSIONS</b>			<b>BACK DIMENSIONS</b>					
	<b>W</b>	<b>D</b>	<b>H</b>	<b>W</b>	<b>D</b>	<b>H</b>	<b>W</b>	<b>H</b>				
	IN 54.5	29	36	46.5	19	17	46.5	19.5				
	MM 1384	737	914	1181	483	432	1181	495				
	<b>RTA 00</b>	1 per carton										

**High Back Two Seat Sofa**  
COM: 8 YD | 7.32 M  
Unit weight: 100 LB | 45.5 KG  
Carton weight: 107 LB | 48.53 KG  
Carton volume: 44.75 FT³ | 1.26 MT³

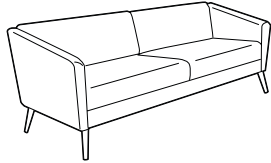

<b>GC3363</b>	2872	3208	3492	3817	4353	4846	5340	5770	6306	6810	7492	8458
Active weight 300 lbs/seat. Removable seat cushions.	<b>OVERALL DIMENSIONS</b>			<b>SEAT DIMENSIONS</b>			<b>BACK DIMENSIONS</b>					
	<b>W</b>	<b>D</b>	<b>H</b>	<b>W</b>	<b>D</b>	<b>H</b>	<b>W</b>	<b>H</b>				
	IN 78	29	28.5	70.5	19	17	70.5	12				
	MM 1981	737	724	1791	483	432	1791	305				
	<b>RTA 00</b>	1 per carton										

**Three Seat Sofa**  
COM: 10.5 YD | 9.6 M  
Unit weight: 125 LB | 56.8 KG  
Carton weight: 135 LB | 61.23 KG  
Carton volume: 42.5 FT³ | 1.2 MT³

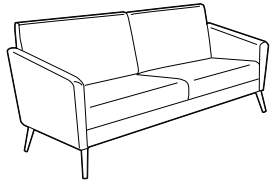

<b>GC3363HB</b>	3597	3989	4320	4700	5324	5900	6476	6978	7603	8191	8987	10114
Active weight 300 lbs/seat. Removable seat cushions.	<b>OVERALL DIMENSIONS</b>			<b>SEAT DIMENSIONS</b>			<b>BACK DIMENSIONS</b>					
	<b>W</b>	<b>D</b>	<b>H</b>	<b>W</b>	<b>D</b>	<b>H</b>	<b>W</b>	<b>H</b>				
	IN 78	29	36	70.5	19	17	70.5	19.5				
	MM 1981	737	914	1791	483	432	1791	495				
	<b>RTA 00</b>	1 per carton										

**High Back Three Seat Sofa**  
COM: 12.25 YD | 11.2 M  
Unit weight: 130 LB | 59.1 KG  
Carton weight: 140 LB | 63.5 KG  
Carton volume: 62.25 FT³ | 1.76 MT³

HEATHER



model GC3770

STANDARD FEATURES



- Contemporary slim line design is compact and stylish for a variety of different environments.
- Seat cushions are easily removable for cleaning and the open frame below the cushion eliminates traps.
- Wood legs are available in a variety of finishes. Available in Maple wood species only (refer to finishes ending in "M").
- Matching tapered leg tables are also available, see Tables section.
- For added comfort, seats are standard with high density Ultracell foam.
- Opaque non-marking glides are standard.
- For healthcare textiles and wood finish options, visit the website at [globalfurnituregroup.com](http://globalfurnituregroup.com).
- This product can be upholstered in standard Global textiles only if Healthcare compliance is not required.
- Shipped fully assembled.

OPTIONAL FEATURES

- For non-slip glides, please specify **(NS)**. Add \$22.
- For steel cushion glide, please specify **(GI)**. Add \$5.
- To add sealed seams to your product contact Customer Service. Upcharges vary.
- For moisture barrier on seat, please specify **(MB)**. Add \$81.

SUGGESTED APPLICATIONS

- Dining/Cafeteria
- Guest seating
- Lobbies
- Lounge/Waiting
- Patient rooms
- Resident rooms

DESCRIPTION	MODEL# / FEATURES	STANDARD TEXTILE GRADES												
		COM	2	3	4	5	6	7	8	9	10	11	12	
 <p><b>High Back Lounge Chair</b> COM: 3.25 YD   2.97 M Unit weight: 35 LB   15.9 KG Carton weight: 40 LB   18.14 KG Carton volume: 17 FT<sup>3</sup>   0.48 MT<sup>3</sup></p>	<b>GC3770</b>	1327	1431	1519	1620	1785	1938	2091	2224	2390	2546	2757	3056	
		<b>OVERALL DIMENSIONS</b>			<b>SEAT DIMENSIONS</b>			<b>BACK DIMENSIONS</b>						
		<b>W</b>	<b>D</b>	<b>H</b>	<b>W</b>	<b>D</b>	<b>H</b>	<b>W</b>	<b>H</b>					
	Active weight 300 lbs. Removable seat cushion.	IN 24 MM 610	24.5 622	36.5 927	18.5 470	17 432	18 457	19.5 495	18.5 470					
		<b>RTA 00</b>		1 per carton										
 <p><b>Low Back Lounge Chair</b> COM: 3 YD   2.74 M Unit weight: 32 LB   14.5 KG Carton weight: 36 LB   16.33 KG Carton volume: 13.25 FT<sup>3</sup>   0.37 MT<sup>3</sup></p>	<b>GC3771</b>	1241	1337	1418	1511	1664	1805	1946	2069	2222	2366	2561	2837	
		<b>OVERALL DIMENSIONS</b>			<b>SEAT DIMENSIONS</b>			<b>BACK DIMENSIONS</b>						
		<b>W</b>	<b>D</b>	<b>H</b>	<b>W</b>	<b>D</b>	<b>H</b>	<b>W</b>	<b>H</b>					
	Active weight 300 lbs. Removable seat cushion.	IN 24 MM 610	24.5 622	31.5 800	18.5 470	17 432	18 457	19.5 495	13.5 343					
		<b>RTA 00</b>		1 per carton										

JANNA



model GC7609

STANDARD FEATURES







- Very often tight spaces create a challenge when additional seating is required for guests. Janna's unique folding frame is the perfect solution for temporary seating, especially where space is at a premium.
- Molded wood veneer frame.
- Concealed folding mechanism uses metal-to-metal construction details with lock tight fasteners.
- For added comfort, seats are standard with high density Ultracell foam.
- Non-marking nylon glides are standard.
- For healthcare textiles and wood finish options, visit the website at [globalfurnituregroup.com](http://globalfurnituregroup.com). Available in Maple wood species only.
- Can be upholstered in standard Global textiles if Healthcare compliance is not required.
- Shipped fully assembled.

OPTIONAL FEATURES

- White cushioned glides (B) are available. Add \$5.
- For wall mounting bracket, please specify (WH). Add \$38.
- For moisture barrier on seat, please specify (MB). Add \$81.

SUGGESTED APPLICATIONS

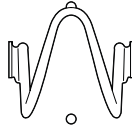
- Dining/Cafeteria
- Guest seating
- Lounge/Waiting
- Office/Meeting
- Patient rooms
- Resident rooms
- Treatment/Exam

DESCRIPTION	MODEL# / FEATURES	STANDARD TEXTILE GRADES											
		COM	2	3	4	5	6	7	8	9	10	11	12
 <p><b>Folding Chair Upholstered Seat and Back</b> COM: 1 YD   0.91 M Unit weight: 17 LB   7.7 KG Carton weight: 19 LB   8.62 KG Carton volume: 7 FT³   0.19 MT³</p>	<b>GC7609</b>	634	666	693	724	775	822	869	910	961	1009	1074	1166
	Active weight 300 lbs.	<b>OVERALL DIMENSIONS</b> W D H			<b>SEAT DIMENSIONS</b> W D H			<b>BACK DIMENSIONS</b> W H					
	IN 19	22.5	32.5	16	17.5	18.5	16	13.5					
	MM 483	572	826	406	445	470	406	343					
	<b>RTA 00</b>		2 per carton (pricing and specifications are for one chair)										
 <p><b>Folding Chair Wood Back Upholstered Seat</b> COM: 1 YD   0.91 M Unit weight: 17 LB   7.7 KG Carton weight: 19 LB   8.62 KG Carton volume: 7 FT³   0.19 MT³</p>	<b>GC7611</b>	598	630	657	688	739	786	833	874	925	973	1038	1130
	Active weight 300 lbs.	<b>OVERALL DIMENSIONS</b> W D H			<b>SEAT DIMENSIONS</b> W D H			<b>BACK DIMENSIONS</b> W H					
	IN 19	22.5	32.5	16	17.5	18.5	16	13.5					
	MM 483	572	826	406	445	470	406	343					
	<b>RTA 00</b>		2 per carton (pricing and specifications are for one chair)										
 <p><b>Wall Mounting Bracket</b> COM: N/A Unit weight: 0.5 LB   0.2 KG Carton weight: 1.5 LB   0.68 KG Carton volume: 0.1 FT³   0.003 MT³</p>	List price												
	<b>GC7607</b>	50											
	For Janna series only.	<b>OVERALL DIMENSIONS</b> W D H			<b>SEAT DIMENSIONS</b> W D H			<b>BACK DIMENSIONS</b> W H					
	Allows for hanging of one chair on a wall or a door.	IN 3	1.5	3.5	-	-	-	-	-				
If ordering after the original purchase, specify GC7607.	MM 76	38	89	-	-	-	-	-					
Two (one pair) per package in Chrome finish. One bracket connects to the underside of the chair seat. The other bracket connects to the wall or door.	<b>RTA 00</b>		1 per carton										

NOURISH



model GC3683



model GC3685



Headrest adjustment handle



Tip and Move (T&M) wheels, height adjustable legs



Transfer arm

STANDARD FEATURES

- Nourish is an innovative state of the art patient chair, developed in consultation with leading healthcare professionals. It curves around the body, providing additional comfort during periods of recovery.
- All chair models have left and right, easy to operate transfer arms. Transfer arms allow for ease of movement in and out of the chair and provide easy caregiver access to assist the user.
- Models with fixed legs have a standard seat height of 18.5".
- Models with adjustable legs have adjustment pins to conveniently adapt seat heights from 17" to 20". The 20" seat height models (-20) have a seat height adjustment range of 20"-23". Front and back legs can be adjusted separately, allowing modification of seat pitch, forward or backward.
- Models with rear casters allow for 'tip and move' so that the chair can be conveniently relocated while unoccupied. The optional push bar aids staff in moving the chair (see upcharge). Push bar matches frame finish.
- Select models have a unique Schukra depth adjustable headrest solution integrated inside the back near the user's neck area. The depth is controlled by a handle on the lower outer back cushion.
- Schukra depth adjustable lumbar support for additional comfort is standard on select models.
- For added comfort, seats are standard with high density Ultracell foam.
- Metal frame is available in several paint finishes.
- The arm structure finish is Tungsten, with a urethane armcap, available in five finishes.
- Active weight capacity for standard single seat is 350 lbs. and 750 lbs. for bariatric seating.
- For healthcare textile and finish options, visit our website at [globalfurnituregroup.com](http://globalfurnituregroup.com).
- Can be upholstered in standard Global textiles if Healthcare compliance is not required.

Please add option codes in the following order

- **Model number**  
Specify model number.
- **Back seams and textile**  
**(NS)** No sealed seams.  
**(S2)** Sealed back seams. Add \$55.  
For bariatric model, add \$89.  
**Back textile**  
Specify textile code.
- **Seat seams and textile**  
**(NS)** No sealed seat seams.  
**(SE)** Sealed seat seams. Add \$20.  
For bariatric model, add \$23.  
**Seat textile**  
Specify textile code.
- **Sealed seat underside**  
**(ST)** No sealed seat underside.  
**(SU)** Sealed seat underside. Add \$39.  
For bariatric model, add \$47.
- **Frame finish**  
**(TBL)** Black  
**(TIV)** Cloud  
**(TDW)** Designer White  
**(TFO)** Fog  
**(TFR)** Frost  
**(TKA)** Kalua  
**(TLA)** Latte  
**(TMO)** Mocha  
**(TNE)** Nevada  
**(TSN)** Sand  
**(TSH)** Shadow  
**(TOA)** Toast  
**(TTU)** Tungsten
- **Back push bar** (matches frame finish)  
**(NBR)** No push bar.  
**(PBR)** Back push bar. Add \$81.
- **Armcap finish**  
**(BLK)** Black  
**(KAL)** Kalua  
**(LAB)** Latte  
**(J52)** Mocha  
**(SHW)** Shadow  
**(TOA)** Toast
- **Moisture barrier** (seat only, not available with sealed seams option)  
**(NB)** No moisture barrier.  
**(MB)** Moisture barrier. Add \$81.  
For bariatric model, add \$124.





SUGGESTED APPLICATIONS



- Bariatric seating (model GC3685)
- Lounge/Waiting
- Patient rooms
- Resident rooms
- Treatment/Exam rooms

EXAMPLE NOURISH ORDER CODE:

GC3681	NS	FU75	NS	FU75	ST	TMO	NBR	J52	NB
Model #	Back seams	Back textile	Seat seams	Seat textile	Seat underside	Frame finish	Push bar	Armcap finish	Moisture barrier

DESCRIPTION	MODEL# / FEATURES	STANDARD TEXTILE GRADES											
		COM	2	3	4	5	6	7	8	9	10	11	12
 <p><b>High Back Patient Chair</b> COM: 2 YD   1.83 M Unit weight: 42 LB   19.1 KG Carton weight: 52 LB   23.59 KG Carton volume: 33.5 FT<sup>3</sup>   0.94 MT<sup>3</sup></p>	<b>GC3681</b> Adjustable 17"-20" seat height	2015	2079	2133	2196	2297	2391	2485	2567	2669	2765	2895	3079
	<b>GC3681-20</b> Adjustable 20"-23" seat height	2063	2127	2181	2244	2345	2439	2533	2615	2717	2813	2943	3127
	<b>GC3681XH</b> Fixed 18.5" seat height	1968	2032	2086	2149	2250	2344	2438	2520	2622	2718	2848	3032
		OVERALL DIMENSIONS			SEAT DIMENSIONS			BACK DIMENSIONS					
		W	D	H	W	D	H	W	H				
Active weight 350 lbs.		IN 28.5	29	45.5	20	18.5	17	20	29				
Optional push bar, add \$81.		MM 724	737	1156	508	470	432	508	737				
		<b>RTA 00</b>		1 per carton (specifications are for model GC3681)									

DESCRIPTION	MODEL# / FEATURES	STANDARD TEXTILE GRADES																																									
		COM	2	3	4	5	6	7	8	9	10	11	12																														
 <p><b>High Back Patient Chair w/Schukra Lumbar</b> COM: 2 YD   1.83 M Unit weight: 42 LB   19.1 KG Carton weight: 52 LB   23.59 KG Carton volume: 33.5 FT³   0.94 MT³</p>	<b>GC3682</b> Adjustable 17"-20" seat height	2145	2209	2263	2326	2427	2521	2615	2697	2799	2895	3025	3209																														
	<b>GC3682-20</b> Adjustable 20"-23" seat height	2196	2260	2314	2377	2478	2572	2666	2748	2850	2946	3076	3260																														
	<b>GC3682XH</b> Fixed 18.5" seat height	2098	2162	2216	2279	2380	2474	2568	2650	2752	2848	2978	3162																														
	<table border="1"> <thead> <tr> <th colspan="3">OVERALL DIMENSIONS</th> <th colspan="3">SEAT DIMENSIONS</th> <th colspan="2">BACK DIMENSIONS</th> </tr> <tr> <th>W</th> <th>D</th> <th>H</th> <th>W</th> <th>D</th> <th>H</th> <th>W</th> <th>H</th> </tr> </thead> <tbody> <tr> <td>IN 28.5</td> <td>29</td> <td>45.5</td> <td>20</td> <td>18.5</td> <td>17</td> <td>20</td> <td>29</td> </tr> <tr> <td>MM 724</td> <td>737</td> <td>1156</td> <td>508</td> <td>470</td> <td>432</td> <td>508</td> <td>737</td> </tr> </tbody> </table> <p>Active weight 350 lbs. Optional push bar: Add \$81.</p> <p><b>RTA 00</b> 1 per carton (specifications are for model GC3682)</p>	OVERALL DIMENSIONS			SEAT DIMENSIONS			BACK DIMENSIONS		W	D	H	W	D	H	W	H	IN 28.5	29	45.5	20	18.5	17	20	29	MM 724	737	1156	508	470	432	508	737										
OVERALL DIMENSIONS			SEAT DIMENSIONS			BACK DIMENSIONS																																					
W	D	H	W	D	H	W	H																																				
IN 28.5	29	45.5	20	18.5	17	20	29																																				
MM 724	737	1156	508	470	432	508	737																																				
 <p><b>High Back Patient Chair w/Schukra Headrest</b> COM: 2 YD   1.83 M Unit weight: 42 LB   19.1 KG Carton weight: 52 LB   23.59 KG Carton volume: 33.5 FT³   0.94 MT³</p>	<b>GC3683</b> Adjustable 17"-20" seat height	2145	2209	2263	2326	2427	2521	2615	2697	2799	2895	3025	3209																														
	<b>GC3683-20</b> Adjustable 20"-23" seat height	2196	2260	2314	2377	2478	2572	2666	2748	2850	2946	3076	3260																														
	<b>GC3683XH</b> Fixed 18.5" seat height	2098	2162	2216	2279	2380	2474	2568	2650	2752	2848	2978	3162																														
	<table border="1"> <thead> <tr> <th colspan="3">OVERALL DIMENSIONS</th> <th colspan="3">SEAT DIMENSIONS</th> <th colspan="2">BACK DIMENSIONS</th> </tr> <tr> <th>W</th> <th>D</th> <th>H</th> <th>W</th> <th>D</th> <th>H</th> <th>W</th> <th>H</th> </tr> </thead> <tbody> <tr> <td>IN 28.5</td> <td>29</td> <td>45.5</td> <td>20</td> <td>18.5</td> <td>17</td> <td>20</td> <td>29</td> </tr> <tr> <td>MM 724</td> <td>737</td> <td>1156</td> <td>508</td> <td>470</td> <td>432</td> <td>508</td> <td>737</td> </tr> </tbody> </table> <p>Active weight 350 lbs. Optional push bar, add \$81.</p> <p><b>RTA 00</b> 1 per carton (specifications are for model GC3683)</p>	OVERALL DIMENSIONS			SEAT DIMENSIONS			BACK DIMENSIONS		W	D	H	W	D	H	W	H	IN 28.5	29	45.5	20	18.5	17	20	29	MM 724	737	1156	508	470	432	508	737										
OVERALL DIMENSIONS			SEAT DIMENSIONS			BACK DIMENSIONS																																					
W	D	H	W	D	H	W	H																																				
IN 28.5	29	45.5	20	18.5	17	20	29																																				
MM 724	737	1156	508	470	432	508	737																																				
 <p><b>High Back Patient Chair w/Schukra Lumbar &amp; Headrest</b> COM: 2 YD   1.83 M Unit weight: 42 LB   19.1 KG Carton weight: 52 LB   23.59 KG Carton volume: 33.5 FT³   0.94 MT³</p>	<b>GC3684</b> Adjustable 17"-20" seat height	2273	2337	2391	2454	2555	2649	2743	2825	2927	3023	3153	3337																														
	<b>GC3684-20</b> Adjustable 20"-23" seat height	2323	2387	2441	2504	2605	2699	2793	2875	2977	3073	3203	3387																														
	<b>GC3684XH</b> Fixed 18.5" seat height	2226	2290	2344	2407	2508	2602	2696	2778	2880	2976	3106	3290																														
	<table border="1"> <thead> <tr> <th colspan="3">OVERALL DIMENSIONS</th> <th colspan="3">SEAT DIMENSIONS</th> <th colspan="2">BACK DIMENSIONS</th> </tr> <tr> <th>W</th> <th>D</th> <th>H</th> <th>W</th> <th>D</th> <th>H</th> <th>W</th> <th>H</th> </tr> </thead> <tbody> <tr> <td>IN 28.5</td> <td>29</td> <td>45.5</td> <td>20</td> <td>18.5</td> <td>17</td> <td>20</td> <td>29</td> </tr> <tr> <td>MM 724</td> <td>737</td> <td>1156</td> <td>508</td> <td>470</td> <td>432</td> <td>508</td> <td>737</td> </tr> </tbody> </table> <p>Active weight 350 lbs. Optional push bar, add \$81.</p> <p><b>RTA 00</b> 1 per carton (specifications are for model GC3684)</p>	OVERALL DIMENSIONS			SEAT DIMENSIONS			BACK DIMENSIONS		W	D	H	W	D	H	W	H	IN 28.5	29	45.5	20	18.5	17	20	29	MM 724	737	1156	508	470	432	508	737										
OVERALL DIMENSIONS			SEAT DIMENSIONS			BACK DIMENSIONS																																					
W	D	H	W	D	H	W	H																																				
IN 28.5	29	45.5	20	18.5	17	20	29																																				
MM 724	737	1156	508	470	432	508	737																																				
 <p><b>Bariatric High Back Patient Chair (no height adjustment)</b> COM: 3.25 YD   2.97 M Unit weight: 60 LB   27.3 KG Carton weight: 70 LB   31.75 KG Carton volume: 45 FT³   1.27 MT³</p>	<b>GC3685</b> Fixed 18.5" seat height	2496	2600	2688	2789	2954	3107	3260	3393	3559	3715	3926	4225																														
	<table border="1"> <thead> <tr> <th colspan="3">OVERALL DIMENSIONS</th> <th colspan="3">SEAT DIMENSIONS</th> <th colspan="2">BACK DIMENSIONS</th> </tr> <tr> <th>W</th> <th>D</th> <th>H</th> <th>W</th> <th>D</th> <th>H</th> <th>W</th> <th>H</th> </tr> </thead> <tbody> <tr> <td>IN 40</td> <td>29</td> <td>47</td> <td>35</td> <td>18.5</td> <td>18.5</td> <td>35</td> <td>29</td> </tr> <tr> <td>MM 1016</td> <td>737</td> <td>1194</td> <td>889</td> <td>470</td> <td>470</td> <td>889</td> <td>737</td> </tr> </tbody> </table> <p>Active weight 750 lbs. Optional push bar, add \$81.</p> <p><b>RTA 00</b> 1 per carton</p>	OVERALL DIMENSIONS			SEAT DIMENSIONS			BACK DIMENSIONS		W	D	H	W	D	H	W	H	IN 40	29	47	35	18.5	18.5	35	29	MM 1016	737	1194	889	470	470	889	737										
	OVERALL DIMENSIONS			SEAT DIMENSIONS			BACK DIMENSIONS																																				
	W	D	H	W	D	H	W	H																																			
IN 40	29	47	35	18.5	18.5	35	29																																				
MM 1016	737	1194	889	470	470	889	737																																				

DESCRIPTION	MODEL# / FEATURES	STANDARD TEXTILE GRADES											
		COM	2	3	4	5	6	7	8	9	10	11	12
 <p><b>Footstool</b> COM: 1 YD   0.91 M Unit weight: 15 LB   6.8 KG Carton weight: 18 LB   8.16 KG Carton volume: 3.6 FT³   0.1 MT³</p>	<p><b>GC3686</b></p> <p>Active weight 350 lbs.</p> <p>Can be stored beneath any Nourish chair when not in use.</p>	488	520	547	578	629	676	723	764	815	863	928	1020
		OVERALL DIMENSIONS			SEAT DIMENSIONS			BACK DIMENSIONS					
		W	D	H	W	D	H	W	H				
		IN 17 MM 432	17.5 445	12.5 318	-	-	-	-	-				
		<b>RTA 00</b>		1 per carton									

DESCRIPTION	MODEL# / FEATURES	STANDARD TEXTILE GRADES											
		COM	2	3	4	5	6	7	8	9	10	11	12
 <p><b>High Back Patient Chair w/Four Manual Locking Casters (no height adjustment)</b> COM: 2 YD   1.83 M Unit weight: 42 LB   19.1 KG Carton weight: 52 LB   23.59 KG Carton volume: 33.5 FT³   0.94 MT³</p>	<p><b>GC3698</b></p> <p>Fixed 17" seat height</p> <p>Active weight 500 lbs.</p> <p>Optional push bar, add \$81.</p>	2573	2637	2691	2754	2855	2949	3043	3125	3227	3323	3453	3637
		OVERALL DIMENSIONS			SEAT DIMENSIONS			BACK DIMENSIONS					
		W	D	H	W	D	H	W	H				
		IN 28.5 MM 724	29 737	45.5 1156	20 508	18.5 470	17 432	20 508	29 737				
		<b>RTA 00</b>	1 per carton										

OAKVILLE



model GC36500



STANDARD FEATURES

- Oakville offers a modern take on wingback seating for social settings, resident rooms and lounge areas.
- Features a clean out space at the back of the seat cushion for easy housekeeping.
- The seat underside is sealed with a non-porous material to support housekeeping and infection control protocols.
- For added comfort, seat cushions are standard with high density Ultracell foam.
- Legs are available in wood or urethane, in a variety of colors.
- Choose from standard non-marking glides, steel cushioned glides, rubber non-slip glides or felt glides (upcharges apply).
- Assembled with tamper-resistant fasteners for greater security.
- For healthcare textiles, visit the website at [globalfurnituregroup.com](http://globalfurnituregroup.com).
- The Lifetime Warranty (for healthcare and 24/7 environments) applies for all Oakville models when performance textiles are selected.
- Can be upholstered in standard Global textiles if Healthcare compliance is not required.

SUGGESTED APPLICATIONS

- Guest seating
- Lobbies
- Lounge/Waiting
- Patient rooms
- Resident rooms

OPTIONAL FEATURES

Please add option codes in the following order:

- **Model number**  
**GC36500** High Back Lounge Chair
- **Sealed back/arms seams**  
**(NS)** No sealed back seams.  
**(SS)** Sealed back seams. Add \$148.
- **Back/arms textile**  
Specify textile code.
- **Sealed seat seams**  
**(NS)** No sealed seat seams.  
**(SS)** Sealed seat seams. Add \$27.
- **Seat textile**  
Specify textile code.
- **Wood leg finish**  
**(AAM)** Absolute  
**(BKM)** Black  
**(CJM)** Charcoal Java  
**(ACM)** Cherry  
**(EMM)** Empire Mahogany  
**(EOM)** English Oak  
**(ECM)** Espresso Cafe  
**(TFM)** Fruitwood  
**(HGM)** Grey  
**(HOM)** Harvest Oak  
**(AHM)** Honey  
**(JOM)** Jet Onyx  
**(LHM)** Light Honey  
**(TMM)** Mahogany  
**(AVM)** Maple  
**(MWM)** Medium Walnut  
**(NLW)** Natural Walnut  
**(ASM)** Night  
**(NBM)** Noce Biondo  
**(NGM)** Noce Grigio  
**(NEM)** Noce Leggero  
**(NMM)** Noce Medio  
**(SBM)** Sandy Beach  
**(SKM)** Shaker Cherry  
**(SOM)** Silver Oak  
**(TWM)** Walnut  
**(WTM)** WC Cream  
**(WHM)** White  
**(WCM)** Winter Cherry
- **Urethane leg finish**  
Add \$63.  
**(BLK)** Black  
**(KAL)** Kalua  
**(LAB)** Latte  
**(J52)** Mocha  
**(SHW)** Shadow  
**(TOA)** Toast
- **Glides**  
**(NM)** Non-marking glides. No upcharge  
**(RG)** Rubber, non-slip glides. Add \$22.  
**(SG)** Steel cushion glides. Add \$17.  
**(FG)** Felt glides. Add \$22.
- **Moisture barrier** (seat only)  
**(NB)** No moisture barrier. No upcharge.  
**(MB)** Moisture barrier. Add \$81.

EXAMPLE OAKVILLE ORDER CODE:

GC36500	NS	CE90	NS	CE90	BLK	NM	NB
Model #	Sealed back/arms seams	Back/arms textile	Sealed seat seams	Seat textile	Leg finish	Glides	Moisture barrier

DESCRIPTION	MODEL# / FEATURES	STANDARD TEXTILE GRADES											
		1	2	3	4	5	6	7	8	9	10	11	12
 <b>High Back Lounge Chair</b> COM: 5.5 YD   5.03 M Unit weight: 59.5 LB   27 KG Carton weight: 75.5 LB   34.25 KG Carton volume: 19.25 FT³   0.54 MT³	GC36500	2394	2570	2719	2890	3169	3428	3687	3912	4193	4457	4814	5320
	Active weight 350 lbs. OVERALL DIMENSIONS W D H SEAT DIMENSIONS W D H BACK DIMENSIONS W H	IN 30 30 41.25 MM 762 762 1048	IN 20.5 21 18.5 MM 521 533 470	IN 21.75 23.75 MM 552 603									
	RTA 00	1 per carton											



GC3616W Dining armchair with open arms

Primacare™ set a benchmark for healthcare seating. All the features, all the looks and quite possibly the most extensive offering of its kind for both acute care and long-term care applications.

Under the skin of every Primacare chair is a heart of solid steel waiting to meet the rigorous demands of any environment.

The Primacare series includes more than 40 models that extend from patient rooms to waiting areas, dining rooms to treatment centers including bariatric hip chair solutions.

**FEATURES**



Open arms



Closed arms - fully upholstered side panels on select models



Arm grip extension - to assist getting in and out of the chair safely

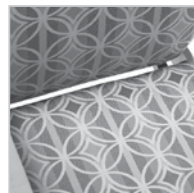

Separate seat and back - provides clean out for housekeeping staff



Fold down headrest - to provide access for caregiver assistance



Removable upholstery - for ease of cleaning and replacement



Solid wood frame - in hardwood for long life and a warm look



Metal-to-metal connector - provides unparalleled strength and durability

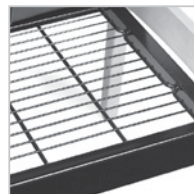

Metal mesh pan - superior comfort and hygiene for patient incontinence



Wall saver legs - offer first contact to protect walls and chair backs on most models

**AVAILABLE TEXTILES AND FINISHES**

Please see the healthcare Textile and Finishes section at [globalfurnituregroup.com](http://globalfurnituregroup.com) for all details including wood finishes.

**SUGGESTED APPLICATIONS**

- Bariatric seating (some models)
- Dining/Cafeteria
- Guest seating
- Lobbies
- Lounge/Waiting
- Patient rooms
- Resident rooms
- Treatment/Exam rooms



**DINING** - available with wood or metal frames



**GUEST** - available with wood or metal frames



**PATIENT** - available with wood or metal frames



**HIP CHAIRS** - available with wood or metal frames



**LOUNGE** - available with wood or metal legs



\*Upholstered closed arm panels are available on wood frame models (dining, lounge and low back guest armchairs) and all metal frame models.

**FULLY UPHOLSTERED LOUNGE** - available with wood or urethane legs

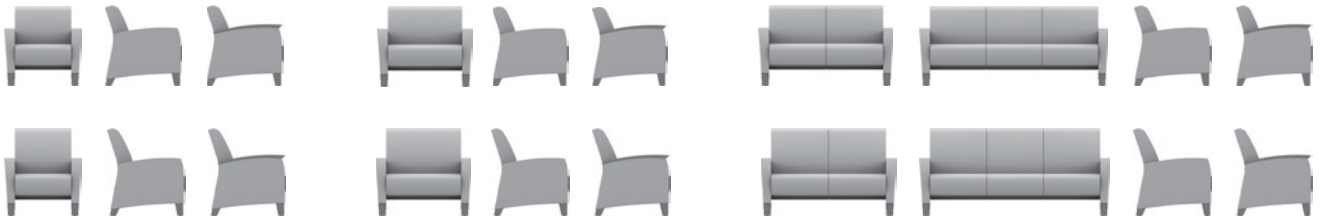

**WINGBACK ARMCHAIR** - available with wood or urethane armcaps and legs



**RECLINERS** - available with wood or urethane armcaps



**SLEEPERS** - available with wood or urethane armcaps



**BENCHES** - available with wood or metal legs



(urethane or wood legs only)

**MODULAR GUEST/PATIENT** - see page 193.

**MODULAR LOUNGE** - see page 208.

PRIMACARE DINING



model GC3616CA (HT)



model GC3616W (Wood)

STANDARD FEATURES

- Primacare is a family of products offering the most significant return on investment approach in the industry since every component can be repaired or replaced on site.
- **High traffic (HT) models:** Metal frame with die cast zinc connectors and metal-to-metal fasteners. Available in the following finishes: Black (TBL), Cloud (TIV), Designer White (TDW), Fog (TFO), Frost (TFR), Kalua (TKA), Latte (TLA), Mocha (TMO), Nevada (TNE), Sand (TSN), Shadow (TSH), Toast (TOA) and Tungsten (TTU).
- **Wood models:** Solid hardwood frame with die cast zinc connectors and metal-to-metal fastening. Available in the following finishes: Absolute (AAM), Charcoal Java (CJM), Cherry (ACM), Empire Mahogany (EMM), English Oak (EOM), Espresso Cafe (ECM), Fruitwood (TFM), Gray (HGM), Harvest Oak (HOM), Honey (AHM), Jet Onyx (JOM), Light Honey (LHM), Mahogany (TMM), Maple (AVM), Medium Walnut (MWM), Natural Walnut (NLW), Night (ASM), Noce Biondo (NBM), Noce Grigio (NGM), Noce Leggero (NEM), Noce Medio (NMM), Sandy Beach (SBM), Shaker Cherry (SKM), Silver Oak (SOM), Walnut (TWM), White (WHM), WC Cream (WTM) and Winter Cherry (WCM).
- Armcaps are securely fastened with metal-to-metal connectors which allow for field replacement if required.
- Easy grip forward extending armcap on models with arms.
- Replaceable seat covers and replaceable and/or removable seat cushions are standard.

- Seat cushion has a seamless waterfall front and clean out between and around the seat and back cushions.
- Models are standard with metal mesh seat deck. For mental health applications, the metal mesh seat deck can be covered with a solid moisture resistant surface, held in place with tamperproof fasteners. Contact your Global sales rep for a special quotation.
- All seat frames feature a wall saver design to prevent back contact with wall.
- **GC3616WCA** and **GC3616CA** have upholstered panel arm inserts closing the arm. (Closed arm panels are designed to be replaceable. Request a special quote to have them secured with tamperproof fasteners.)
- For healthcare textile options, visit the website at [globalfurnituregroup.com](http://globalfurnituregroup.com).
- Can be upholstered in standard Global textiles if healthcare compliance is not required.
- Shipped fully assembled.

**HIGH TRAFFIC (HT) MODELS ARE LISTED FIRST, FOLLOWED BY WOOD MODELS.**





OPTIONAL FEATURES



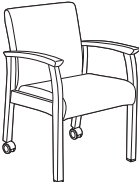
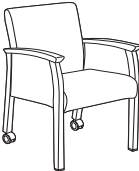

- **High traffic (HT) models:** Wood armcaps are available. See far left column "Wood models" for finishes. Please specify. No upcharge.
- **High traffic (HT) and wood models:** Urethane armcaps are available in the following finishes: Black (BLK), Kalua (KAL), Latte (LAB), Mocha (J52), Shadow (SHW) and Toast (TOA). Please specify. No upcharge.
- For moisture barrier on seat, please specify **(MB)**. Add \$81 per seat.
- To add sealed seams to your product contact Customer Service. Upcharges vary.
- For Primacare tables, see page 59.

SUGGESTED APPLICATIONS

- Dining/Cafeteria
- Guest seating
- Lobbies
- Lounge/Waiting
- Patient rooms
- Resident rooms

DESCRIPTION	MODEL# / FEATURES	STANDARD TEXTILE GRADES															
<p><b>Dining Chair, Open Arms (HT)</b> COM: 1.5 YD   1.37 M Unit weight: 50 LB   22.7 KG Carton weight: 58 LB   26.31 KG Carton volume: 13.25 FT³   0.37 MT³</p>	<p><b>GC3616</b> Metal</p> <p>Active weight 500 lbs.</p> <p>Optional wood armcaps. Please specify. No upcharge.</p>	COM	2	3	4	5	6	7	8	9	10	11	12				
		1433	1481	1522	1568	1645	1715	1786	1847	1924	1996	2093	2231				
		<b>OVERALL DIMENSIONS</b>			<b>SEAT DIMENSIONS</b>			<b>BACK DIMENSIONS</b>									
		IN	23	23	34.5	19	17.5	18	19	16.5	MM	584	584	876	483	445	457
	<b>RTA 00</b>	1 per carton															
<p><b>Dining Chair, Closed Arms (HT)</b> COM: 2 YD   1.83 M Unit weight: 58 LB   26.4 KG Carton weight: 66 LB   29.94 KG Carton volume: 13.25 FT³   0.37 MT³</p>	<p><b>GC3616CA</b> Metal</p> <p>Active weight 500 lbs.</p> <p>Optional wood armcaps. Please specify. No upcharge.</p>	COM	2	3	4	5	6	7	8	9	10	11	12				
		1649	1713	1767	1829	1931	2025	2119	2201	2303	2399	2529	2713				
		<b>OVERALL DIMENSIONS</b>			<b>SEAT DIMENSIONS</b>			<b>BACK DIMENSIONS</b>									
		IN	23	23	34.5	19	17.5	18	19	16.5	MM	584	584	876	483	445	457
	<b>RTA 00</b>	1 per carton															
<p><b>Dining Chair, Closed Arms, Laminate Panels (HT)</b> COM: 1.5 YD   1.37 M Unit weight: 58 LB   26.4 KG Carton weight: 66 LB   29.94 KG Carton volume: 13.25 FT³   0.37 MT³</p>	<p><b>GC3616CAL</b> Metal</p> <p>Active weight 500 lbs.</p> <p>Optional wood armcaps. Please specify. No upcharge.</p>	COM	2	3	4	5	6	7	8	9	10	11	12				
		1950	1998	2039	2085	2162	2232	2303	2364	2441	2513	2610	2748				
		<b>OVERALL DIMENSIONS</b>			<b>SEAT DIMENSIONS</b>			<b>BACK DIMENSIONS</b>									
		IN	23	23	34.5	19	17.5	18	19	16.5	MM	584	584	876	483	445	457
	<b>RTA 00</b>	1 per carton															

DESCRIPTION	MODEL# / FEATURES	STANDARD TEXTILE GRADES											
		COM	2	3	4	5	6	7	8	9	10	11	12
 <p><b>Dining Chair, Open Arms, Rear Swivel Casters (HT)</b>                      COM: 1.5 YD   1.37 M                      Unit weight: 50 LB   22.7 KG                      Carton weight: 58 LB   26.31 KG                      Carton volume: 13.25 FT<sup>3</sup>   0.37 MT<sup>3</sup></p>	<b>GC3616RC</b> Metal	1522	1570	1611	1657	1734	1804	1875	1936	2013	2085	2182	2320
		<b>OVERALL DIMENSIONS</b> W D H			<b>SEAT DIMENSIONS</b> W D H			<b>BACK DIMENSIONS</b> W H					
	Active weight 500 lbs.	IN 23	23	34.5	19	17.5	18	19	16.5				
	Optional wood armcaps. Please specify. No upcharge.	MM 584	584	876	483	445	457	483	419				
	<b>RTA 00</b>	1 per carton											
 <p><b>Dining Chair, Closed Arms, Rear Swivel Casters (HT)</b>                      COM: 2 YD   1.83 M                      Unit weight: 58 LB   26.4 KG                      Carton weight: 66 LB   29.94 KG                      Carton volume: 13.25 FT<sup>3</sup>   0.37 MT<sup>3</sup></p>	<b>GC3616CARC</b> Metal	1737	1801	1855	1917	2019	2113	2207	2289	2391	2487	2617	2801
		<b>OVERALL DIMENSIONS</b> W D H			<b>SEAT DIMENSIONS</b> W D H			<b>BACK DIMENSIONS</b> W H					
	Active weight 500 lbs.	IN 23	23	34.5	19	17.5	18	19	16.5				
	Optional urethane armcaps. Please specify. No upcharge.	MM 584	584	876	483	445	457	483	419				
	<b>RTA 00</b>	1 per carton											
 <p>Allows caregiver to gently move a seated person to and from a table.</p> <p><b>Dining Chair, Open Arms, Rear Swivel Casters &amp; Lift Mec. (HT)</b>                      COM: 1.5 YD   1.37 M                      Unit weight: 51 LB   23.2 KG                      Carton weight: 59 LB   26.76 KG                      Carton volume: 13.25 FT<sup>3</sup>   0.37 MT<sup>3</sup></p>	<b>GC3616RCEZ</b> Metal	1983	2031	2072	2118	2195	2265	2336	2397	2474	2546	2643	2781
		<b>OVERALL DIMENSIONS</b> W D H			<b>SEAT DIMENSIONS</b> W D H			<b>BACK DIMENSIONS</b> W H					
	Active weight 500 lbs.	IN 23	23	34.5	19	17.5	18	19	16.5				
	Optional wood armcaps. Please specify. No upcharge.	MM 584	584	876	483	445	457	483	419				
	<b>RTA 00</b>	1 per carton											
 <p><b>Dining Chair Open Arms (Wood)</b>                      COM: 1.5 YD   1.37 M                      Unit weight: 40 LB   18.2 KG                      Carton weight: 50 LB   22.68 KG                      Carton volume: 13.25 FT<sup>3</sup>   0.37 MT<sup>3</sup></p>	<b>GC3616W</b> Wood	1181	1229	1270	1316	1393	1463	1534	1595	1672	1744	1841	1979
		<b>OVERALL DIMENSIONS</b> W D H			<b>SEAT DIMENSIONS</b> W D H			<b>BACK DIMENSIONS</b> W H					
	Active weight 350 lbs.	IN 23	23	34.5	19	17.5	18	19	16.5				
	Optional urethane armcaps. Please specify. No upcharge.	MM 584	584	876	483	445	457	483	419				
	<b>RTA 00</b>	1 per carton											
 <p><b>Dining Chair Closed Arms (Wood)</b>                      COM: 2 YD   1.83 M                      Unit weight: 48 LB   21.8 KG                      Carton weight: 58 LB   26.31 KG                      Carton volume: 13.25 FT<sup>3</sup>   0.37 MT<sup>3</sup></p>	<b>GC3616WCA</b> Wood	1357	1421	1475	1537	1639	1733	1827	1909	2011	2107	2237	2421
		<b>OVERALL DIMENSIONS</b> W D H			<b>SEAT DIMENSIONS</b> W D H			<b>BACK DIMENSIONS</b> W H					
	Active weight 350 lbs.	IN 23	23	34.5	19	17.5	18	19	16.5				
	Optional urethane armcaps. Please specify. No upcharge.	MM 584	584	876	483	445	457	483	419				
	<b>RTA 00</b>	1 per carton											

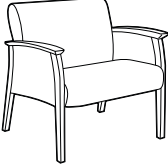
DESCRIPTION	MODEL# / FEATURES	STANDARD TEXTILE GRADES											
 <p><b>Dining Chair Open Arms, Front Casters (Wood)</b> COM: 1.5 YD   1.37 M Unit weight: 40 LB   18.2 KG Carton weight: 50 LB   22.68 KG Carton volume: 13.25 FT³   0.37 MT³</p>	<b>GC3616WFC</b> Wood	COM	2	3	4	5	6	7	8	9	10	11	12
		1266	1314	1355	1401	1478	1548	1619	1680	1757	1829	1926	2064
		<b>OVERALL DIMENSIONS</b>			<b>SEAT DIMENSIONS</b>			<b>BACK DIMENSIONS</b>					
		W	D	H	W	D	H	W	H				
	IN	23	23	34.5	19	17.5	18	19	16.5				
	MM	584	584	876	483	445	457	483	419				
		<b>RTA 00</b>	1 per carton										
	Active weight 350 lbs.												
	Optional urethane armcaps. Please specify. No upcharge.												
 <p><b>Bariatric LB Single Seat Armchair Open Arms (HT)</b> COM: 2.5 YD   2.29 M Unit weight: 66 LB   30 KG Carton weight: 78 LB   35.38 KG Carton volume: 26.5 FT³   0.75 MT³</p>	<b>GC3637</b> Metal	COM	2	3	4	5	6	7	8	9	10	11	12
		2009	2089	2157	2234	2362	2479	2597	2699	2827	2947	3109	3339
		<b>OVERALL DIMENSIONS</b>			<b>SEAT DIMENSIONS</b>			<b>BACK DIMENSIONS</b>					
		W	D	H	W	D	H	W	H				
	IN	35	27	33	30	17.5	18	30	15				
	MM	889	686	838	762	445	457	762	381				
		<b>RTA 00</b>	1 per carton										
	Active weight 500 lbs.												
	Optional wood armcaps. Please specify. No upcharge.												
 <p><b>Bariatric LB Single Seat Armchair Closed Arms (HT)</b> COM: 3.5 YD   3.2 M Unit weight: 76 LB   34.5 KG Carton weight: 88 LB   39.92 KG Carton volume: 26.5 FT³   0.75 MT³</p>	<b>GC3637CA</b> Metal	COM	2	3	4	5	6	7	8	9	10	11	12
		2257	2369	2464	2572	2751	2915	3080	3223	3402	3570	3797	4119
		<b>OVERALL DIMENSIONS</b>			<b>SEAT DIMENSIONS</b>			<b>BACK DIMENSIONS</b>					
		W	D	H	W	D	H	W	H				
	IN	35	27	33	30	17.5	18	30	15				
	MM	889	686	838	762	445	457	762	381				
		<b>RTA 00</b>	1 per carton										
	Active weight 500 lbs.												
	Optional wood armcaps. Please specify. No upcharge.												
 <p><b>Bariatric LB Single Seat Armchair, Open Arms (Wood)</b> COM: 3.5 YD   3.2 M Unit weight: 54 LB   24.5 KG Carton weight: 66 LB   29.94 KG Carton volume: 26.5 FT³   0.75 MT³</p>	<b>GC3637W</b> Wood	COM	2	3	4	5	6	7	8	9	10	11	12
		1653	1733	1801	1878	2006	2123	2241	2343	2471	2591	2753	2983
		<b>OVERALL DIMENSIONS</b>			<b>SEAT DIMENSIONS</b>			<b>BACK DIMENSIONS</b>					
		W	D	H	W	D	H	W	H				
	IN	35	27	33	30	17.5	18	30	15				
	MM	889	686	838	762	445	457	762	381				
		<b>RTA 00</b>	1 per carton										
	Active weight 500 lbs.												
	Optional urethane armcaps. Please specify. No upcharge.												
 <p><b>Bariatric LB Single Seat Armchair, Closed Arms (Wood)</b> COM: 3.5 YD   3.2 M Unit weight: 64 LB   29.1 KG Carton weight: 76 LB   34.47 KG Carton volume: 26.5 FT³   0.75 MT³</p>	<b>GC3637WCA</b> Wood	COM	2	3	4	5	6	7	8	9	10	11	12
		1854	1966	2061	2169	2348	2512	2677	2820	2999	3167	3394	3716
		<b>OVERALL DIMENSIONS</b>			<b>SEAT DIMENSIONS</b>			<b>BACK DIMENSIONS</b>					
		W	D	H	W	D	H	W	H				
	IN	35	27	33	30	17.5	18	30	15				
	MM	889	686	838	762	445	457	762	381				
		<b>RTA 00</b>	1 per carton										
	Active weight 500 lbs.												
	Optional urethane armcaps. Please specify. No upcharge.												

PRIMACARE GUEST



model GC3620CA (HT)



model GC3625W (Wood)

STANDARD FEATURES

- Primacare is a family of products offering the most significant return on investment approach in the industry since every component can be repaired or replaced on site.
- High traffic (HT) models:** Metal frame with die cast zinc connectors and metal-to-metal fasteners. Available in the following finishes: Black (TBL), Cloud (TIV), Designer White (TDW), Fog (TFO), Frost (TFR), Kalua (TKA), Latte (TLA), Mocha (TMO), Nevada (TNE), Sand (TSN), Shadow (TSH), Toast (TOA) and Tungsten (TTU).
- Wood models:** Solid hardwood frame with die cast zinc connectors and metal-to-metal fastening. Available in the following finishes: Absolute (AAM), Charcoal Java (CJM), Cherry (ACM), Empire Mahogany (EMM), English Oak (EOM), Espresso Cafe (ECM), Fruitwood (TFM), Gray (HGM), Harvest Oak (HOM), Honey (AHM), Jet Onyx (JOM), Light Honey (LHM), Mahogany (TMM), Maple (AVM), Medium Walnut (MWM), Natural Walnut (NLW), Night (ASM), Noce Biondo (NBM), Noce Grigio (NGM), Noce Leggero (NEM), Noce Medio (NMM), Sandy Beach (SBM), Shaker Cherry (SKM), Silver Oak (SOM), Walnut (TWM), White (WHM), WC Cream (WTM) and Winter Cherry (WCM).
- Armchairs are securely fastened with metal-to-metal connectors which allow for field replacement if required.
- Easy grip forward extending armcap on models with arms.
- Replaceable seat covers and replaceable and/or removable seat cushions are standard.

- Seat cushion has a seamless waterfall front and clean out between and around the seat and back cushions.
- Models are standard with metal mesh seat deck. For mental health applications, the metal mesh seat deck can be covered with a solid moisture resistant surface, held in place with tamperproof fasteners. Contact your sales rep for a special quotation.
- All seat frames feature a wall saver design to prevent back contact with wall.
- Models ending in **CA / ARC**, have upholstered panel arm inserts closing the arm. (Closed arm panels are designed to be replaceable).
- For healthcare textile options, visit the website at [globalfurnituregroup.com](http://globalfurnituregroup.com).
- Can be upholstered in standard Global textiles if healthcare compliance is not required.
- Shipped fully assembled.

**HIGH TRAFFIC (HT) MODELS ARE LISTED FIRST, FOLLOWED BY WOOD MODELS.**

OPTIONAL FEATURES

- High traffic (HT) models:** Wood armcaps are available. See far left column "Wood models" for finishes. Please specify. No upcharge.
- High traffic (HT) and wood models:** Urethane armcaps are available in the following finishes: Black (BLK), Kalua (KAL), Latte (LAB), Mocha (J52), Shadow (SHW) and Toast (TOA). Please specify. No upcharge.
- For moisture barrier on seat, please specify **(MB)**. Add \$81 per seat.
- To add sealed seams to your product contact Customer Service. Upcharges vary.
- For Primacare tables, see page 59.

SUGGESTED APPLICATIONS

- Bariatric seating
- Guest seating
- Lobbies
- Lounge/Waiting
- Patient rooms
- Resident rooms

DESCRIPTION	MODEL# / FEATURES	STANDARD TEXTILE GRADES												
		COM	2	3	4	5	6	7	8	9	10	11	12	
<p><b>LB Armchair Open Arms (HT)</b> COM: 1.75 YD   1.6 M Unit weight: 54 LB   24.5 KG Carton weight: 62 LB   28.12 KG Carton volume: 17.5 FT³   0.49 MT³</p>	GC3620 Metal	1558	1614	1661	1716	1805	1887	1969	2041	2130	2214	2328	2489	
	GC3620F Metal flex back	1930	1986	2033	2088	2177	2259	2341	2413	2502	2586	2700	2861	
	<b>OVERALL DIMENSIONS</b>		<b>SEAT DIMENSIONS</b>			<b>BACK DIMENSIONS</b>								
	W D H IN 25 27 33 MM 635 686 838		W D H 20.5 17.5 18 521 445 457			W H 20.5 15 521 381								
Active weight 500 lbs.		RTA 00 1 per carton												
Optional wood armcaps. Please specify. No upcharge.														
<p><b>LB Armchair Closed Arms (HT)</b> COM: 2.75 YD   2.51 M Unit weight: 64 LB   29.1 KG Carton weight: 72 LB   32.66 KG Carton volume: 17.5 FT³   0.49 MT³</p>	GC3620CA Metal	1810	1898	1972	2058	2198	2327	2456	2569	2709	2841	3020	3273	
	GC3620FCA Metal flex back	2178	2266	2340	2426	2566	2695	2824	2937	3077	3209	3388	3641	
	<b>OVERALL DIMENSIONS</b>		<b>SEAT DIMENSIONS</b>			<b>BACK DIMENSIONS</b>								
	W D H IN 25 27 33 MM 635 686 838		W D H 20.5 17.5 18 521 445 457			W H 20.5 15 521 381								
Active weight 500 lbs.		RTA 00 1 per carton												
Optional wood armcaps. Please specify. No upcharge.														
<p><b>LB Armchair Closed Arms, Rear Tip and Move Wheels (HT)</b> COM: 2.75 YD   2.51 M Unit weight: 64 LB   29.1 KG Carton weight: 72 LB   32.66 KG Carton volume: 23 FT³   0.65 MT³</p>	GC3620CARC Metal	1909	1997	2071	2157	2297	2426	2555	2668	2808	2940	3119	3372	
	<b>OVERALL DIMENSIONS</b>		<b>SEAT DIMENSIONS</b>			<b>BACK DIMENSIONS</b>								
	W D H IN 25 29.5 33 MM 635 749 838		W D H 20.5 17.5 18 521 445 457			W H 20.5 15 521 381								
	Active weight 500 lbs.		RTA 00 1 per carton											
Optional wood armcaps. Please specify. No upcharge.														

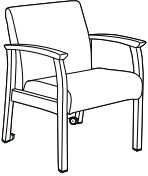
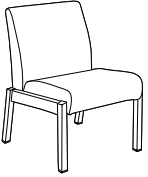
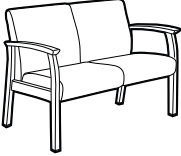
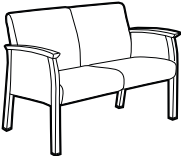
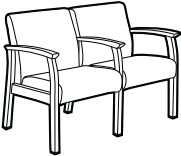
DESCRIPTION	MODEL# / FEATURES	STANDARD TEXTILE GRADES											
		COM	2	3	4	5	6	7	8	9	10	11	12
 <p><b>GC3620RC</b> Metal</p> <p><b>LB Armchair Open Arms, Rear Tip and Move Wheels (HT)</b> COM: 1.75 YD   1.6 M Unit weight: 54 LB   24.5 KG Carton weight: 62 LB   28.12 KG Carton volume: 23 FT<sup>3</sup>   0.65 MT<sup>3</sup></p>	<p>Active weight 500 lbs.</p> <p>Optional wood armcaps. Please specify. No upcharge.</p>	1661	1717	1764	1819	1908	1990	2072	2144	2233	2317	2431	2592
		<b>OVERALL DIMENSIONS</b>			<b>SEAT DIMENSIONS</b>			<b>BACK DIMENSIONS</b>					
		<b>W</b>	<b>D</b>	<b>H</b>	<b>W</b>	<b>D</b>	<b>H</b>	<b>W</b>	<b>H</b>				
		IN 25 MM 635	29.5 749	33 838	20.5 521	17.5 445	18 457	20.5 521	15 381				
		<b>RTA 00</b>	1 per carton										
 <p><b>GC3620NA</b> Metal</p> <p><b>LB Single Seat Chair, Armless (HT)</b> COM: 1.75 YD   1.6 M Unit weight: 52 LB   23.6 KG Carton weight: 60 LB   27.22 KG Carton volume: 17.5 FT<sup>3</sup>   0.49 MT<sup>3</sup></p>	<p>Active weight 500 lbs.</p>	1270	1326	1373	1428	1517	1599	1681	1753	1842	1926	2040	2201
		<b>OVERALL DIMENSIONS</b>			<b>SEAT DIMENSIONS</b>			<b>BACK DIMENSIONS</b>					
		<b>W</b>	<b>D</b>	<b>H</b>	<b>W</b>	<b>D</b>	<b>H</b>	<b>W</b>	<b>H</b>				
		IN 23.5 MM 597	27 686	33 838	20.5 521	17.5 445	18 457	20.5 521	15 381				
		<b>RTA 00</b>	1 per carton										
 <p><b>GC3621</b> Metal</p> <p><b>LB Two Seat Chair No Center Arm, Open Arms (HT)</b> COM: 3.25 YD   2.97 M Unit weight: 80 LB   36.4 KG Carton weight: 92 LB   41.73 KG Carton volume: 43 FT<sup>3</sup>   1.21 MT<sup>3</sup></p>	<p>Active weight 500 lbs/seat.</p> <p>Optional wood armcaps. Please specify. No upcharge.</p>	2373	2477	2565	2666	2831	2984	3137	3270	3436	3592	3803	4102
		<b>OVERALL DIMENSIONS</b>			<b>SEAT DIMENSIONS</b>			<b>BACK DIMENSIONS</b>					
		<b>W</b>	<b>D</b>	<b>H</b>	<b>W</b>	<b>D</b>	<b>H</b>	<b>W</b>	<b>H</b>				
		IN 45 MM 1143	27 686	33 838	40 1016	17.5 445	18 457	40 1016	15 381				
		<b>RTA 00</b>	1 per carton										
 <p><b>GC3621CA</b> Metal</p> <p><b>LB Two Seat Chair No Center Arm, Closed Arms (HT)</b> COM: 3.25 YD   3.43 M Unit weight: 88 LB   40 KG Carton weight: 100 LB   45.36 KG Carton volume: 43 FT<sup>3</sup>   1.21 MT<sup>3</sup></p>	<p>Active weight 500 lbs/seat.</p> <p>Optional wood armcaps. Please specify. No upcharge.</p>	2638	2758	2859	2976	3167	3343	3519	3673	3864	4044	4288	4633
		<b>OVERALL DIMENSIONS</b>			<b>SEAT DIMENSIONS</b>			<b>BACK DIMENSIONS</b>					
		<b>W</b>	<b>D</b>	<b>H</b>	<b>W</b>	<b>D</b>	<b>H</b>	<b>W</b>	<b>H</b>				
		IN 45 MM 1143	27 686	33 838	40 1016	17.5 445	18 457	40 1016	15 381				
		<b>RTA 00</b>	1 per carton										
 <p><b>GC3622</b> Metal</p> <p><b>LB Two Seat Chair Full Center Arm, Open Arms (HT)</b> COM: 3.25 YD   2.97 M Unit weight: 86 LB   39.1 KG Carton weight: 98 LB   44.45 KG Carton volume: 43 FT<sup>3</sup>   1.21 MT<sup>3</sup></p>	<p>Active weight 500 lbs/seat.</p> <p>Optional wood armcaps. Please specify. No upcharge.</p>	2867	2971	3059	3160	3325	3478	3631	3764	3930	4086	4297	4596
		<b>OVERALL DIMENSIONS</b>			<b>SEAT DIMENSIONS</b>			<b>BACK DIMENSIONS</b>					
		<b>W</b>	<b>D</b>	<b>H</b>	<b>W</b>	<b>D</b>	<b>H</b>	<b>W</b>	<b>H</b>				
		IN 46 MM 1168	27 686	33 838	20.5 521	17.5 445	18 457	20.5 521	15 381				
		<b>RTA 00</b>	1 per carton										

DESCRIPTION MODEL# / FEATURES STANDARD TEXTILE GRADES

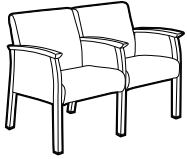

**LB Two Seat Chair Full Center Arm, Closed Arms (HT)**  
 COM: 4.5 YD | 4.11 M  
 Unit weight: 106 LB | 48.2 KG  
 Carton weight: 118 LB | 53.52 KG  
 Carton volume: 43 FT³ | 1.21 MT³

COM	2	3	4	5	6	7	8	9	10	11	12	
GC3622CA	3248	3392	3514	3653	3883	4094	4306	4490	4720	4936	5228	5642

	OVERALL DIMENSIONS			SEAT DIMENSIONS			BACK DIMENSIONS	
	W	D	H	W	D	H	W	H
Active weight 500 lbs/seat.	IN 46	27	33	20.5	17.5	18	20.5	15
Optional wood armcaps. Please specify. No upcharge.	MM 1168	686	838	521	445	457	521	381
	RTA 00			1 per carton				

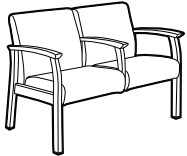

**LB Two Seat Chair Half Center Arm, Open Arms (HT)**  
 COM: 3.25 YD | 2.97 M  
 Unit weight: 82 LB | 37.3 KG  
 Carton weight: 94 LB | 42.64 KG  
 Carton volume: 43 FT³ | 1.21 MT³

COM	2	3	4	5	6	7	8	9	10	11	12	
GC3623	2731	2835	2923	3024	3189	3342	3495	3628	3794	3950	4161	4460

	OVERALL DIMENSIONS			SEAT DIMENSIONS			BACK DIMENSIONS	
	W	D	H	W	D	H	W	H
Active weight 500 lbs/seat.	IN 46	27	33	20.5	17.5	18	20.5	15
Optional wood armcaps. Please specify. No upcharge.	MM 1168	686	838	521	445	457	521	381
	RTA 00			1 per carton				

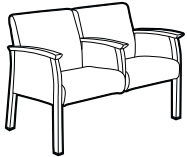

**LB Two Seat Chair Half Center Arm, Closed Arms (HT)**  
 COM: 4.5 YD | 4.11 M  
 Unit weight: 94 LB | 42.7 KG  
 Carton weight: 106 LB | 48.08 KG  
 Carton volume: 43 FT³ | 1.21 MT³

COM	2	3	4	5	6	7	8	9	10	11	12	
GC3623CA	3193	3337	3459	3598	3828	4039	4251	4435	4665	4881	5173	5587

	OVERALL DIMENSIONS			SEAT DIMENSIONS			BACK DIMENSIONS	
	W	D	H	W	D	H	W	H
Active weight 500 lbs/seat.	IN 46	27	33	20.5	17.5	18	20.5	15
Optional wood armcaps. Please specify. No upcharge.	MM 1168	686	838	521	445	457	483	381
	RTA 00			1 per carton				

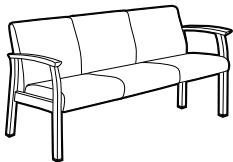

**LB Three Seat Chair No Center Arms, Open Arms (HT)**  
 COM: 4.25 YD | 3.89 M  
 Unit weight: 114 LB | 51.8 KG  
 Carton weight: 137 LB | 62.14 KG  
 Carton volume: 65.25 FT³ | 1.84 MT³

COM	2	3	4	5	6	7	8	9	10	11	12	
GC3624	3230	3366	3481	3613	3829	4029	4229	4403	4620	4824	5100	5491

	OVERALL DIMENSIONS			SEAT DIMENSIONS			BACK DIMENSIONS	
	W	D	H	W	D	H	W	H
Active weight 500 lbs/seat.	IN 65	27	33	60	17.5	18	60	15
Optional wood armcaps. Please specify. No upcharge.	MM 1651	686	838	1524	445	457	1524	381
	RTA 00			1 per carton				

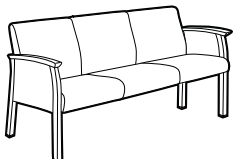

**LB Three Seat Chair No Center Arms, Closed Arms (HT)**  
 COM: 5.25 YD | 4.8 M  
 Unit weight: 124 LB | 56.4 KG  
 Carton weight: 147 LB | 66.68 KG  
 Carton volume: 65.25 FT³ | 1.84 MT³

COM	2	3	4	5	6	7	8	9	10	11	12	
GC3624CA	3477	3645	3787	3950	4217	4464	4711	4926	5194	5446	5787	6270

	OVERALL DIMENSIONS			SEAT DIMENSIONS			BACK DIMENSIONS	
	W	D	H	W	D	H	W	H
Active weight 500 lbs/seat.	IN 65	27	33	60	17.5	18	60	15
Optional wood armcaps. Please specify. No upcharge.	MM 1651	686	838	1524	445	457	1524	381
	RTA 00			1 per carton				

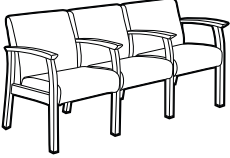
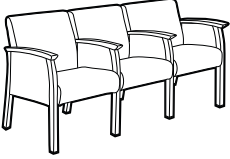
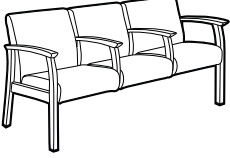
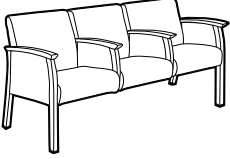
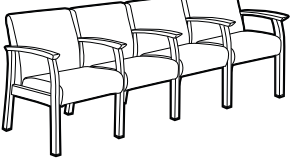

DESCRIPTION	MODEL# / FEATURES	STANDARD TEXTILE GRADES											
		COM	2	3	4	5	6	7	8	9	10	11	12
 <p><b>LB Three Seat Chair Full Center Arms, Open Arms (HT)</b>                      COM: 4.75 YD   4.34 M                      Unit weight: 137 LB   62.3 KG                      Carton weight: 162 LB   73.48 KG                      Carton volume: 65.25 FT<sup>3</sup>   1.84 MT<sup>3</sup></p>	<p><b>GC3625</b> Metal</p>	4201	4353	4481	4629	4871	5094	5317	5512	5754	5982	6291	6728
		<b>OVERALL DIMENSIONS</b>			<b>SEAT DIMENSIONS</b>			<b>BACK DIMENSIONS</b>					
		<b>W</b>	<b>D</b>	<b>H</b>	<b>W</b>	<b>D</b>	<b>H</b>	<b>W</b>	<b>H</b>				
		IN 69 MM 1753	27 686	33 838	20.5 521	17.5 445	18 457	20.5 521	15 381				
			<b>RTA 00</b>	1 per carton									
 <p><b>LB Three Seat Chair Full Center Arms, Closed Arms (HT)</b>                      COM: 6.25 YD   5.72 M                      Unit weight: 147 LB   66.8 KG                      Carton weight: 172 LB   78.02 KG                      Carton volume: 65.25 FT<sup>3</sup>   1.84 MT<sup>3</sup></p>	<p><b>GC3625CA</b> Metal</p>	4713	4913	5082	5276	5594	5888	6182	6438	6757	7057	7463	8038
		<b>OVERALL DIMENSIONS</b>			<b>SEAT DIMENSIONS</b>			<b>BACK DIMENSIONS</b>					
		<b>W</b>	<b>D</b>	<b>H</b>	<b>W</b>	<b>D</b>	<b>H</b>	<b>W</b>	<b>H</b>				
		IN 69 MM 1753	27 686	33 838	20.5 521	17.5 445	18 457	20.5 521	15 381				
			<b>RTA 00</b>	1 per carton									
 <p><b>LB Three Seat Chair Half Center Arms, Open Arms (HT)</b>                      COM: 4.75 YD   4.34 M                      Unit weight: 124 LB   56.4 KG                      Carton weight: 147 LB   66.68 KG                      Carton volume: 65.25 FT<sup>3</sup>   1.84 MT<sup>3</sup></p>	<p><b>GC3626</b> Metal</p>	3872	4024	4152	4300	4542	4765	4988	5183	5425	5653	5962	6399
		<b>OVERALL DIMENSIONS</b>			<b>SEAT DIMENSIONS</b>			<b>BACK DIMENSIONS</b>					
		<b>W</b>	<b>D</b>	<b>H</b>	<b>W</b>	<b>D</b>	<b>H</b>	<b>W</b>	<b>H</b>				
		IN 69 MM 1753	27 686	33 838	20.5 521	17.5 445	18 457	20.5 521	15 381				
			<b>RTA 00</b>	1 per carton									
 <p><b>LB Three Seat Chair Half Center Arms, Closed Arms (HT)</b>                      COM: 6.25 YD   5.72 M                      Unit weight: 134 LB   60.9 KG                      Carton weight: 157 LB   71.21 KG                      Carton volume: 65.25 FT<sup>3</sup>   1.84 MT<sup>3</sup></p>	<p><b>GC3626CA</b> Metal</p>	4386	4586	4755	4949	5267	5561	5855	6111	6430	6730	7136	7711
		<b>OVERALL DIMENSIONS</b>			<b>SEAT DIMENSIONS</b>			<b>BACK DIMENSIONS</b>					
		<b>W</b>	<b>D</b>	<b>H</b>	<b>W</b>	<b>D</b>	<b>H</b>	<b>W</b>	<b>H</b>				
		IN 69 MM 1753	27 686	33 838	20.5 521	17.5 445	18 457	20.5 521	15 381				
			<b>RTA 00</b>	1 per carton									
 <p><b>LB Four Seat Chair Full Center Arms, Open Arms (HT)</b>                      COM: 6 YD   5.49 M                      Unit weight: 172 LB   78.2 KG                      Carton weight: 197 LB   89.36 KG                      Carton volume: 43 FT<sup>3</sup>   1.21 MT<sup>3</sup></p>	<p><b>GC3628</b> Metal</p>	5546	5738	5900	6086	6392	6674	6956	7202	7508	7796	8186	8738
		<b>OVERALL DIMENSIONS</b>			<b>SEAT DIMENSIONS</b>			<b>BACK DIMENSIONS</b>					
		<b>W</b>	<b>D</b>	<b>H</b>	<b>W</b>	<b>D</b>	<b>H</b>	<b>W</b>	<b>H</b>				
		IN 93 MM 2362	27 686	33 838	20.5 521	17.5 445	18 457	20.5 521	15 381				
			<b>RTA 2</b>	2 cartons									

DESCRIPTION MODEL# / FEATURES STANDARD TEXTILE GRADES

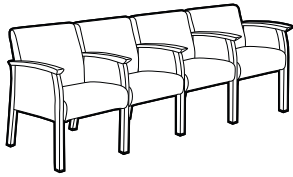

**LB Four Seat Chair Full Center Arms, Closed Arms (HT)**  
 COM: 8 YD | 7.32 M  
 Unit weight: 182 LB | 82.7 KG  
 Carton weight: 207 LB | 93.89 KG  
 Carton volume: 43 FT³ | 1.21 MT³

COM	2	3	4	5	6	7	8	9	10	11	12	
<b>GC3628CA</b>	6182	6438	6654	6902	7310	7686	8062	8390	8798	9182	9702	10438

Metal

Active weight 500 lbs./seat.  
 Optional wood armcaps.  
 Please specify. No upcharge.

OVERALL DIMENSIONS			SEAT DIMENSIONS			BACK DIMENSIONS	
W	D	H	W	D	H	W	H

IN	93	27	33	20.5	17.5	18	20.5	15
MM	2362	686	838	521	445	457	521	381

RTA 2 2 cartons

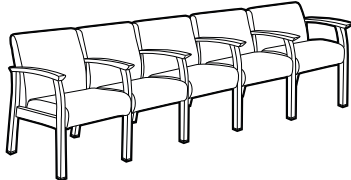

**LB Five Seat Chair Full Center Arms, Open Arms (HT)**  
 COM: 7.5 YD | 6.86 M  
 Unit weight: 224 LB | 101.8 KG  
 Carton weight: 249 LB | 112.94 KG  
 Carton volume: 43 FT³ | 1.21 MT³

COM	2	3	4	5	6	7	8	9	10	11	12	
<b>GC3630</b>	6879	7119	7322	7554	7937	8289	8642	8949	9332	9692	10179	10869

Metal

Active weight 500 lbs./seat.  
 Optional wood armcaps.  
 Please specify. No upcharge.

OVERALL DIMENSIONS			SEAT DIMENSIONS			BACK DIMENSIONS	
W	D	H	W	D	H	W	H

IN	115	27	33	20.5	17.5	18	20.5	15
MM	2921	686	838	521	445	457	521	381

RTA 2 2 cartons

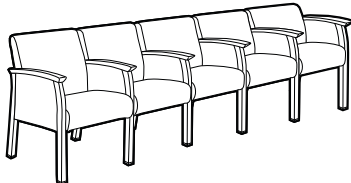

**LB Five Seat Chair Full Center Arms, Closed Arms (HT)**  
 COM: 10 YD | 9.14 M  
 Unit weight: 236 LB | 107.3 KG  
 Carton weight: 261 LB | 118.39 KG  
 Carton volume: 43 FT³ | 1.21 MT³

COM	2	3	4	5	6	7	8	9	10	11	12	
<b>GC3630CA</b>	7640	7960	8230	8540	9050	9520	9990	10400	10910	11390	12040	12960

Metal

Active weight 500 lbs./seat.  
 Optional wood armcaps.  
 Please specify. No upcharge.

OVERALL DIMENSIONS			SEAT DIMENSIONS			BACK DIMENSIONS	
W	D	H	W	D	H	W	H

IN	115	27	33	20.5	17.5	18	20.5	15
MM	2921	686	838	521	445	457	521	381

RTA 2 2 cartons

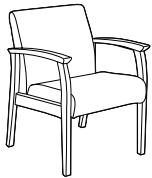

**LB Single Seat Armchair Open Arms (Wood)**  
 COM: 1.75 YD | 1.6 M  
 Unit weight: 42 LB | 19.1 KG  
 Carton weight: 50 LB | 22.68 KG  
 Carton volume: 17.5 FT³ | 0.49 MT³

COM	2	3	4	5	6	7	8	9	10	11	12	
<b>GC3620W</b>	1286	1342	1389	1444	1533	1615	1697	1769	1858	1942	2056	2217

Wood

Active weight 350 lbs.  
 Optional urethane armcaps.  
 Please specify. No upcharge.

OVERALL DIMENSIONS			SEAT DIMENSIONS			BACK DIMENSIONS	
W	D	H	W	D	H	W	H

IN	25	27	33	20.5	17.5	18	20.5	15
MM	635	686	838	521	445	457	521	381

RTA 00 1 per carton

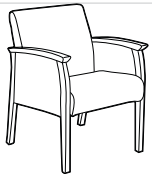

**LB Single Seat Armchair Closed Arms (Wood)**  
 COM: 2.75 YD | 2.51 M  
 Unit weight: 52 LB | 23.6 KG  
 Carton weight: 60 LB | 27.22 KG  
 Carton volume: 17.5 FT³ | 0.49 MT³

COM	2	3	4	5	6	7	8	9	10	11	12	
<b>GC3620WCA</b>	1486	1574	1648	1734	1874	2003	2132	2245	2385	2517	2696	2949

Wood



Active weight 350 lbs.  
 Optional urethane armcaps.  
 Please specify. No upcharge.

OVERALL DIMENSIONS			SEAT DIMENSIONS			BACK DIMENSIONS	
W	D	H	W	D	H	W	H

IN	25	27	33	20.5	17.5	18	20.5	15
MM	635	686	838	521	445	457	521	381

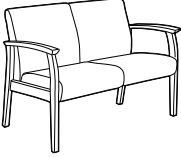
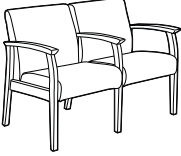
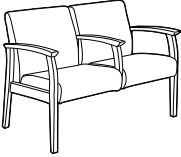
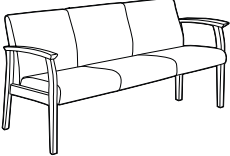
RTA 00 1 per carton

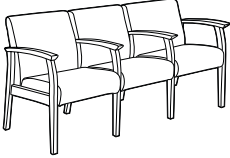
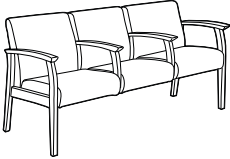
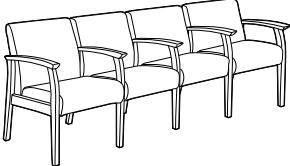
DESCRIPTION	MODEL# / FEATURES	STANDARD TEXTILE GRADES											
		COM	2	3	4	5	6	7	8	9	10	11	12
 <p><b>LB Single Seat Chair, Armless (Wood)</b>                      COM: 1.75 YD   1.6 M                      Unit weight: 40 LB   18.2 KG                      Carton weight: 48 LB   21.77 KG                      Carton volume: 17.5 FT³   0.49 MT³</p>	<b>GC3620WNA</b> Wood	1152	1208	1255	1310	1399	1481	1563	1635	1724	1808	1922	2083
		<b>OVERALL DIMENSIONS</b>			<b>SEAT DIMENSIONS</b>			<b>BACK DIMENSIONS</b>					
		<b>W</b>	<b>D</b>	<b>H</b>	<b>W</b>	<b>D</b>	<b>H</b>	<b>W</b>	<b>H</b>				
		IN 23.5 MM 597	27 686	33 838	20.5 521	17.5 445	18 457	20.5 521	15 381				
		<b>RTA 00</b>	1 per carton										
 <p><b>LB Two Seat Chair No Center Arm, Open Arms (Wood)</b>                      COM: 3.25 YD   2.97 M                      Unit weight: 68 LB   30.9 KG                      Carton weight: 80 LB   36.29 KG                      Carton volume: 43 FT³   1.21 MT³</p>	<b>GC3621W</b> Wood	1952	2056	2144	2245	2410	2563	2716	2849	3015	3171	3382	3681
		<b>OVERALL DIMENSIONS</b>			<b>SEAT DIMENSIONS</b>			<b>BACK DIMENSIONS</b>					
		<b>W</b>	<b>D</b>	<b>H</b>	<b>W</b>	<b>D</b>	<b>H</b>	<b>W</b>	<b>H</b>				
		IN 45 MM 1143	27 686	33 838	40 1016	17.5 445	18 457	40 1016	15 381				
		<b>RTA 00</b>	1 per carton										
 <p><b>LB Two Seat Chair Full Center Arm, Open Arms (Wood)</b>                      COM: 3.25 YD   2.97 M                      Unit weight: 74 LB   33.6 KG                      Carton weight: 86 LB   39.01 KG                      Carton volume: 43 FT³   1.21 MT³</p>	<b>GC3622W</b> Wood	2360	2464	2552	2653	2818	2971	3124	3257	3423	3579	3790	4089
		<b>OVERALL DIMENSIONS</b>			<b>SEAT DIMENSIONS</b>			<b>BACK DIMENSIONS</b>					
		<b>W</b>	<b>D</b>	<b>H</b>	<b>W</b>	<b>D</b>	<b>H</b>	<b>W</b>	<b>H</b>				
		IN 46 MM 1168	27 686	33 838	20.5 521	17.5 445	18 457	20.5 521	15 381				
		<b>RTA 00</b>	1 per carton										
 <p><b>LB Two Seat Chair Half Center Arm, Open Arms (Wood)</b>                      COM: 3.25 YD   2.97 M                      Unit weight: 70 LB   31.8 KG                      Carton weight: 82 LB   37.19 KG                      Carton volume: 43 FT³   1.21 MT³</p>	<b>GC3623W</b> Wood	2249	2353	2441	2542	2707	2860	3013	3146	3312	3468	3679	3978
		<b>OVERALL DIMENSIONS</b>			<b>SEAT DIMENSIONS</b>			<b>BACK DIMENSIONS</b>					
		<b>W</b>	<b>D</b>	<b>H</b>	<b>W</b>	<b>D</b>	<b>H</b>	<b>W</b>	<b>H</b>				
		IN 46 MM 1168	27 686	33 838	20.5 521	17.5 445	18 457	20.5 521	15 381				
		<b>RTA 00</b>	1 per carton										
 <p><b>LB Three Seat Chair No Center Arm, Open Arms (Wood)</b>                      COM: 4.25 YD   3.89 M                      Unit weight: 102 LB   46.4 KG                      Carton weight: 125 LB   56.7 KG                      Carton volume: 65.25 FT³   1.84 MT³</p>	<b>GC3624W</b> Wood	2657	2793	2908	3040	3256	3456	3656	3830	4047	4251	4527	4918
		<b>OVERALL DIMENSIONS</b>			<b>SEAT DIMENSIONS</b>			<b>BACK DIMENSIONS</b>					
		<b>W</b>	<b>D</b>	<b>H</b>	<b>W</b>	<b>D</b>	<b>H</b>	<b>W</b>	<b>H</b>				
		IN 65 MM 1651	27 686	33 838	60 1524	17.5 445	18 457	60 1524	15 381				
		<b>RTA 00</b>	1 per carton										

DESCRIPTION	MODEL# / FEATURES	STANDARD TEXTILE GRADES											
		COM	2	3	4	5	6	7	8	9	10	11	12
 <p><b>LB Three Seat Chair Full Center Arms, Open Arms (Wood)</b>                      COM: 4.75 YD   4.34 M                      Unit weight: 125 LB   56.8 KG                      Carton weight: 150 LB   68.04 KG                      Carton volume: 65.25 FT<sup>3</sup>   1.84 MT<sup>3</sup></p>	<p><b>GC3625W</b> Wood</p>	3462	3614	3742	3890	4132	4355	4578	4773	5015	5243	5552	5989
		OVERALL DIMENSIONS			SEAT DIMENSIONS			BACK DIMENSIONS					
		W	D	H	W	D	H	W	H				
		IN 69 MM 1753	27 686	33 876	20.5 521	17.5 445	18 457	20.5 521	15 381				
			RTA 00		1 per carton								
 <p><b>LB Three Seat Chair Half Center Arms, Open Arms (Wood)</b>                      COM: 4.75 YD   4.34 M                      Unit weight: 112 LB   50.9 KG                      Carton weight: 135 LB   61.23 KG                      Carton volume: 65.25 FT<sup>3</sup>   1.84 MT<sup>3</sup></p>	<p><b>GC3626W</b> Wood</p>	3187	3339	3467	3615	3857	4080	4303	4498	4740	4968	5277	5714
		OVERALL DIMENSIONS			SEAT DIMENSIONS			BACK DIMENSIONS					
		W	D	H	W	D	H	W	H				
		IN 69 MM 1753	27 686	33 838	20.5 521	17.5 445	18 457	20.5 521	15 381				
			RTA 00		1 per carton								
 <p><b>LB Four Seat Chair Full Center Arms, Open Arms (Wood)</b>                      COM: 6 YD   5.49 M                      Unit weight: 160 LB   72.7 KG                      Carton weight: 185 LB   83.91 KG                      Carton volume: 43 FT<sup>3</sup>   1.21 MT<sup>3</sup></p>	<p><b>GC3628W</b> Wood</p>	4569	4761	4923	5109	5415	5697	5979	6225	6531	6819	7209	7761
		OVERALL DIMENSIONS			SEAT DIMENSIONS			BACK DIMENSIONS					
		W	D	H	W	D	H	W	H				
		IN 93 MM 2362	27 686	33 838	20.5 521	17.5 445	18 457	20.5 521	15 381				
			RTA 4		2 cartons								
 <p><b>LB Five Seat Chair Full Center Arms, Open Arms (Wood)</b>                      COM: 7.5 YD   6.86 M                      Unit weight: 202 LB   91.8 KG                      Carton weight: 227 LB   102.97 KG                      Carton volume: 43 FT<sup>3</sup>   1.21 MT<sup>3</sup></p>	<p><b>GC3630W</b> Wood</p>	5670	5910	6113	6345	6728	7080	7433	7740	8123	8483	8970	9660
		OVERALL DIMENSIONS			SEAT DIMENSIONS			BACK DIMENSIONS					
		W	D	H	W	D	H	W	H				
		IN 115 MM 2921	27 686	33 838	20.5 521	17.5 445	18 457	20.5 521	15 381				
			RTA 4		2 cartons								
 <p><b>Bariatric LB Single Seat Armchair Open Arms (HT)</b>                      COM: 2.5 YD   2.29 M                      Unit weight: 66 LB   30 KG                      Carton weight: 78 LB   35.38 KG                      Carton volume: 26.5 FT<sup>3</sup>   0.75 MT<sup>3</sup></p>	<p><b>GC3637</b> Metal</p>	2009	2089	2157	2234	2362	2479	2597	2699	2827	2947	3109	3339
		OVERALL DIMENSIONS			SEAT DIMENSIONS			BACK DIMENSIONS					
		W	D	H	W	D	H	W	H				
		IN 35 MM 889	27 686	33 838	30 762	17.5 445	18 457	30 762	15 381				
			RTA 00		1 per carton								



PRIMACARE PATIENT



model GC3631 (HT)



model GC3632WCA (Wood)

STANDARD FEATURES

- Primacare is a family of products offering the most significant return on investment approach in the industry since every component can be repaired or replaced on site.
- **High traffic (HT) models:** Metal frame with die cast zinc connectors and metal-to-metal fasteners. Available in the following finishes: Black (TBL), Cloud (TIV), Designer White (TDW), Fog (TFO), Frost (TFR), Kalua (TKA), Latte (TLA), Mocha (TMO), Nevada (TNE), Sand (TSN), Shadow (TSH), Toast (TOA) and Tungsten (TTU).
- **Wood models:** Solid hardwood frame with die cast zinc connectors and metal-to-metal fastening. Available in the following finishes: Absolute (AAM), Charcoal Java (CJM), Cherry (ACM), Empire Mahogany (EMM), English Oak (EOM), Espresso Cafe (ECM), Fruitwood (TFM), Gray (HGM), Harvest Oak (HOM), Honey (AHM), Jet Onyx (JOM), Light Honey (LHM), Mahogany (TMM), Maple (AVM), Medium Walnut (MWM), Natural Walnut (NLW), Night (ASM), Noce Biondo (NBM), Noce Grigio (NGM), Noce Leggero (NEM), Noce Medio (NMM), Sandy Beach (SBM), Shaker Cherry (SKM), Silver Oak (SOM), Walnut (TWM), White (WHM), WC Cream (WTM) and Winter Cherry (WCM).
- Armcaps are securely fastened with metal-to-metal connectors which allow for field replacement if required.
- Easy grip forward extending armcap on models with arms.
- Replaceable seat covers and replaceable and/or removable seat cushions are standard.

- Seat cushion has a seamless waterfall front and clean out between and around the seat and back cushions.
- Models are standard with metal mesh seat deck. For mental health applications, the metal mesh seat deck can be covered with a solid moisture resistant surface, held in place with tamperproof fasteners. Contact your sales rep for a special quotation.
- All seat frames feature a wall saver design to prevent back contact with wall.
- Models ending in **CA / ARC**, have upholstered panel arm inserts closing the arm. (Closed arm panels are designed to be replaceable.
- For healthcare textile options, visit the website at [globalfurnituregroup.com](http://globalfurnituregroup.com).
- Can be upholstered in standard Global textiles if healthcare compliance is not required.
- Shipped fully assembled.

**HIGH TRAFFIC (HT) MODELS ARE LISTED FIRST, FOLLOWED BY WOOD MODELS.**

OPTIONAL FEATURES

- **High traffic (HT) models:** Wood armcaps are available. See far left column "Wood models" for finishes. Please specify. No upcharge.
- **High traffic (HT) and wood models:** Urethane armcaps are available in the following finishes: Black (BLK), Kalua (KAL), Latte (LAB), Mocha (J52), Shadow (SHW) and Toast (TOA). Please specify. No upcharge.
- For moisture barrier on seat, please specify **(MB)**. Add \$81 per seat. For bariatric models, add \$122 per seat.
- To add sealed seams to your product contact Customer Service. Upcharges vary.
- For Primacare tables, see page 59.

SUGGESTED APPLICATIONS

- Bariatric seating
- Guest seating
- Lobbies
- Lounge/Waiting
- Patient rooms
- Resident rooms
- Treatment/Exam rooms

DESCRIPTION MODEL# / FEATURES STANDARD TEXTILE GRADES



**MB Armchair Open Arms (HT)**  
COM: 1.75 YD | 1.6 M  
Unit weight: 56 LB | 25.5 KG  
Carton weight: 64 LB | 29.03 KG  
Carton volume: 17.5 FT³ | 0.49 MT³

MODEL# / FEATURES	STANDARD TEXTILE GRADES											
	COM	2	3	4	5	6	7	8	9	10	11	12
<b>GC3631</b> Metal	1597	1653	1700	1755	1844	1926	2008	2080	2169	2253	2367	2528
<b>GC3631F</b> Metal flex back	1968	2024	2071	2126	2215	2297	2379	2451	2540	2624	2738	2899
	OVERALL DIMENSIONS			SEAT DIMENSIONS			BACK DIMENSIONS					
	W	D	H	W	D	H	W	D	H			
Active weight 500 lbs.	IN 25	27	36.5	20.5	17.5	18	20.5	18				
Optional wood armcaps. Please specify. No upcharge.	MM 635	686	927	521	445	457	521	457				
	<b>RTA 00</b>		1 per carton									





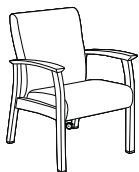

**MB Armchair Closed Arms (HT)**  
COM: 2.75 YD | 2.51 M  
Unit weight: 68 LB | 30.9 KG  
Carton weight: 76 LB | 34.7 KG  
Carton volume: 17.5 FT³ | 0.49 MT³

MODEL# / FEATURES	STANDARD TEXTILE GRADES											
	COM	2	3	4	5	6	7	8	9	10	11	12
<b>GC3631CA</b> Metal	1858	1946	2020	2106	2246	2375	2504	2617	2757	2889	3068	3321
<b>GC3631FCA</b> Metal flex back	2226	2314	2388	2474	2614	2743	2872	2985	3125	3257	3436	3689
	OVERALL DIMENSIONS			SEAT DIMENSIONS			BACK DIMENSIONS					
	W	D	H	W	D	H	W	D	H			
Active weight 500 lbs.	IN 25	27	36.5	20.5	17.5	18	20.5	18				
Optional wood armcaps. Please specify. No upcharge.	MM 635	686	927	521	445	457	521	457				
	<b>RTA 00</b>		1 per carton									



**MB Armchair Open Arms, Rear Tip and Move Wheels (HT)**  
COM: 1.75 YD | 1.6 M  
Unit weight: 56 LB | 25.5 KG  
Carton weight: 64 LB | 29.03 KG  
Carton volume: 23 FT³ | 0.65 MT³

MODEL# / FEATURES	STANDARD TEXTILE GRADES											
	COM	2	3	4	5	6	7	8	9	10	11	12
<b>GC3631RC</b> Metal	1697	1753	1800	1855	1944	2026	2108	2180	2269	2353	2467	2628
	OVERALL DIMENSIONS			SEAT DIMENSIONS			BACK DIMENSIONS					
	W	D	H	W	D	H	W	D	H			
Active weight 500 lbs.	IN 25	29.5	36.5	20.5	17.5	18	20.5	18				
Optional wood armcaps. Please specify. No upcharge.	MM 635	749	927	521	445	457	521	457				
	<b>RTA 00</b>		1 per carton									

DESCRIPTION	MODEL# / FEATURES	STANDARD TEXTILE GRADES											
		COM	2	3	4	5	6	7	8	9	10	11	12
 <p><b>MB Armchair Closed Arms, Rear Tip and Move Wheels (HT)</b>                      COM: 2.75 YD   2.51 M                      Unit weight: 68 LB   30.9 KG                      Carton weight: 76 LB   34.47 KG                      Carton volume: 23 FT³   0.65 MT³</p>	<b>GC3631CARC</b> Metal	1956	2044	2118	2204	2344	2473	2602	2715	2855	2987	3166	3419
		<b>OVERALL DIMENSIONS</b>			<b>SEAT DIMENSIONS</b>			<b>BACK DIMENSIONS</b>					
		<b>W</b>	<b>D</b>	<b>H</b>	<b>W</b>	<b>D</b>	<b>H</b>	<b>W</b>	<b>H</b>				
		IN 25 MM 635	29.5 749	36.5 927	20.5 521	17.5 445	18 457	20.5 521	18 457				
	Active weight 500 lbs.	Optional wood armcaps. Please specify. No upcharge.			1 per carton								
 <p><b>HB Armchair Open Arms, Split Back (HT)</b>                      COM: 2.25 YD   2.06 M                      Unit weight: 62 LB   28.2 KG                      Carton weight: 72 LB   32.66 KG                      Carton volume: 27.5 FT³   0.77 MT³</p>	<b>GC3632</b> Metal	1884	1956	2017	2087	2201	2307	2413	2505	2620	2728	2874	3081
	<b>GC3632F</b> Metal flex back	2253	2325	2386	2456	2570	2676	2782	2874	2989	3097	3243	3450
		<b>OVERALL DIMENSIONS</b>			<b>SEAT DIMENSIONS</b>			<b>BACK DIMENSIONS</b>					
		<b>W</b>	<b>D</b>	<b>H</b>	<b>W</b>	<b>D</b>	<b>H</b>	<b>W</b>	<b>H</b>				
	IN 25 MM 635	27 686	48.5 1232	20.5 521	17.5 445	18 457	20.5 521	30 762					
	Active weight 500 lbs.	Fold down headrest allows caregiver to assist occupant.			1 per carton								
	Optional wood armcaps. Please specify. No upcharge.												
 <p><b>HB Armchair Closed Arms, Split Back (HT)</b>                      COM: 3 YD   2.74 M                      Unit weight: 74 LB   33.6 KG                      Carton weight: 84 LB   38.1 KG                      Carton volume: 27.5 FT³   0.77 MT³</p>	<b>GC3632CA</b> Metal	2149	2245	2326	2419	2572	2713	2854	2977	3130	3274	3469	3745
	<b>GC3632FCA</b> Metal flex back	2520	2616	2697	2790	2943	3084	3225	3348	3501	3645	3840	4116
		<b>OVERALL DIMENSIONS</b>			<b>SEAT DIMENSIONS</b>			<b>BACK DIMENSIONS</b>					
		<b>W</b>	<b>D</b>	<b>H</b>	<b>W</b>	<b>D</b>	<b>H</b>	<b>W</b>	<b>H</b>				
	IN 25 MM 635	27 686	48.5 1232	20.5 521	17.5 445	18 457	20.5 521	30 762					
	Active weight 500 lbs.	Fold down headrest allows caregiver to assist occupant.			1 per carton								
	Optional wood armcaps. Please specify. No upcharge.												
 <p><b>HB Armchair Open Arms, Split Back, Rear Tip and Move Wheels (HT)</b>                      COM: 2.25 YD   2.06 M                      Unit weight: 62 LB   28.2 KG                      Carton weight: 72 LB   32.66 KG                      Carton volume: 27.5 FT³   0.77 MT³</p>	<b>GC3632RC</b> Metal	1985	2057	2118	2188	2302	2408	2514	2606	2721	2829	2975	3182
		<b>OVERALL DIMENSIONS</b>			<b>SEAT DIMENSIONS</b>			<b>BACK DIMENSIONS</b>					
		<b>W</b>	<b>D</b>	<b>H</b>	<b>W</b>	<b>D</b>	<b>H</b>	<b>W</b>	<b>H</b>				
		IN 25 MM 635	29.5 749	48.5 1232	20.5 521	17.5 445	18 457	20.5 521	30 762				
	Active weight 500 lbs.	Fold down headrest allows caregiver to assist occupant.			1 per carton								
	Optional wood armcaps. Please specify. No upcharge.												
 <p><b>HB Armchair Closed Arms, Split Back, Rear Tip and Move Wheels (HT)</b>                      COM: 3 YD   2.74 M                      Unit weight: 74 LB   33.6 KG                      Carton weight: 84 LB   38.1 KG                      Carton volume: 27.5 FT³   0.77 MT³</p>	<b>GC3632CARC</b> Metal	2251	2347	2428	2521	2674	2815	2956	3079	3232	3376	3571	3847
		<b>OVERALL DIMENSIONS</b>			<b>SEAT DIMENSIONS</b>			<b>BACK DIMENSIONS</b>					
		<b>W</b>	<b>D</b>	<b>H</b>	<b>W</b>	<b>D</b>	<b>H</b>	<b>W</b>	<b>H</b>				
		IN 25 MM 635	29.5 749	48.5 1232	20.5 521	17.5 445	18 457	20.5 521	30 762				
	Active weight 500 lbs.	Fold down headrest allows caregiver to assist occupant.			1 per carton								
	Optional wood armcaps. Please specify. No upcharge.												

DESCRIPTION MODEL# / FEATURES STANDARD TEXTILE GRADES



Designed to immobilize the pelvis and hip joints after surgery.

**LB Hip Armchair Open Arms - Post Surgery (HT)**

COM: 1.5 YD | 1.37 M  
Unit weight: 57 LB | 25.9 KG  
Carton weight: 67 LB | 30.39 KG  
Carton volume: 20 FT³ | 0.56 MT³

**GC3636**  
Metal

Active weight 500 lbs.

Optional wood armcaps.  
Please specify. No upcharge.

COM	2	3	4	5	6	7	8	9	10	11	12
1840	1888	1929	1975	2052	2122	2193	2254	2331	2403	2500	2638

OVERALL DIMENSIONS			SEAT DIMENSIONS			BACK DIMENSIONS	
W	D	H	W	D	H	W	H

IN	23	26	40.5	19	17.5	25.5	19	15.5
MM	584	660	1029	483	445	648	483	394

**RTA 00** 1 per carton



**Bariatric MB Armchair Open Arms (HT)**

COM: 2.75 YD | 2.51 M  
Unit weight: 82 LB | 37.3 KG  
Carton weight: 94 LB | 42.64 KG  
Carton volume: 30.5 FT³ | 0.86 MT³

**GC3638**  
Metal

Active weight 500 lbs.

Optional wood armcaps.  
Please specify. No upcharge.

COM	2	3	4	5	6	7	8	9	10	11	12
2064	2152	2226	2312	2452	2581	2710	2823	2963	3095	3274	3527

OVERALL DIMENSIONS			SEAT DIMENSIONS			BACK DIMENSIONS	
W	D	H	W	D	H	W	H

IN	35	27	36.5	30	17.5	18	30	18
MM	889	686	927	762	445	457	762	457

**RTA 00** 1 per carton



**Bariatric MB Armchair Closed Arms (HT)**

COM: 3.75 YD | 3.43 M  
Unit weight: 92 LB | 41.8 KG  
Carton weight: 104 LB | 47.17 KG  
Carton volume: 30.5 FT³ | 0.86 MT³

**GC3638CA**  
Metal

Active weight 500 lbs.

Optional wood armcaps.  
Please specify. No upcharge.

COM	2	3	4	5	6	7	8	9	10	11	12
2320	2440	2541	2658	2849	3025	3201	3355	3546	3726	3970	4315

OVERALL DIMENSIONS			SEAT DIMENSIONS			BACK DIMENSIONS	
W	D	H	W	D	H	W	H

IN	35	27	36.5	30	17.5	18	30	18
MM	889	686	927	762	445	457	762	457

**RTA 00** 1 per carton



**Bariatric HB Armchair Open Arms, Split Back (HT)**

COM: 3.75 YD | 3.43 M  
Unit weight: 67 LB | 30.5 KG  
Carton weight: 77 LB | 34.93 KG  
Carton volume: 33 FT³ | 0.93 MT³

**GC3639**  
Metal

Active weight 500 lbs.

Fold down headrest allows caregiver to assist occupant.  
Optional wood armcaps.  
Please specify. No upcharge.





COM	2	3	4	5	6	7	8	9	10	11	12
2422	2542	2643	2760	2951	3127	3303	3457	3648	3828	4072	4417

OVERALL DIMENSIONS			SEAT DIMENSIONS			BACK DIMENSIONS	
W	D	H	W	D	H	W	H

IN	35	27	48.5	30	17.5	18	30	30
MM	889	686	1232	762	445	457	762	762

**RTA 00** 1 per carton



DESCRIPTION	MODEL# / FEATURES	STANDARD TEXTILE GRADES											
 <p><b>Bariatric HB Armchair Closed Arms, Split Back (HT)</b>                      COM: 4.75 YD   4.34 M                      Unit weight: 96 LB   43.6 KG                      Carton weight: 108 LB   48.99 KG                      Carton volume: 33 FT³   0.93 MT³</p>	<b>GC3639CA</b> Metal	COM	2	3	4	5	6	7	8	9	10	11	12
	Active weight 500 lbs.	2681	2833	2961	3109	3351	3574	3797	3992	4234	4462	4771	5208
	Fold down headrest allows caregiver to assist occupant.	<b>OVERALL DIMENSIONS</b>			<b>SEAT DIMENSIONS</b>			<b>BACK DIMENSIONS</b>					
	Optional wood armcaps. Please specify. No upcharge.	IN	35	27	48.5	30	17.5	18	30	30			
	MM	889	686	1232	762	445	457	762	762				
		<b>RTA 00</b>	1 per carton										
 <p><b>HB Armchair Open Arms (HT)</b>                      COM: 2.5 YD   2.29 M                      Unit weight: 62 LB   28.2 KG                      Carton weight: 72 LB   32.66 KG                      Carton volume: 27.5 FT³   0.77 MT³</p>	<b>GC3655</b> Metal	COM	2	3	4	5	6	7	8	9	10	11	12
	Active weight 500 lbs.	1651	1731	1799	1876	2004	2121	2239	2341	2469	2589	2751	2981
	Optional wood armcaps. Please specify. No upcharge.	<b>OVERALL DIMENSIONS</b>			<b>SEAT DIMENSIONS</b>			<b>BACK DIMENSIONS</b>					
		IN	25	27	48.5	20.5	17.5	18	20.5	30			
	MM	635	686	1232	521	445	457	521	762				
		<b>RTA 00</b>	1 per carton										
 <p><b>HB Armchair Closed Arms (HT)</b>                      COM: 3.25 YD   2.97 M                      Unit weight: 74 LB   33.6 KG                      Carton weight: 84 LB   38.1 KG                      Carton volume: 27.5 FT³   0.77 MT³</p>	<b>GC3655CA</b> Metal	COM	2	3	4	5	6	7	8	9	10	11	12
	Active weight 500 lbs.	1919	2023	2111	2212	2377	2530	2683	2816	2982	3138	3349	3648
	Optional wood armcaps. Please specify. No upcharge.	<b>OVERALL DIMENSIONS</b>			<b>SEAT DIMENSIONS</b>			<b>BACK DIMENSIONS</b>					
		IN	25	27	48.5	20.5	17.5	18	20.5	30			
	MM	635	686	1232	521	445	457	521	762				
		<b>RTA 00</b>	1 per carton										
 <p><b>HB Armchair Closed Arms, Rear Tip and Move Wheels (HT)</b>                      COM: 3.25 YD   2.97 M                      Unit weight: 74 LB   33.6 KG                      Carton weight: 84 LB   38.1 KG                      Carton volume: 27.5 FT³   0.77 MT³</p>	<b>GC3655CARC</b> Metal	COM	2	3	4	5	6	7	8	9	10	11	12
	Active weight 500 lbs.	2020	2124	2212	2313	2478	2631	2784	2917	3083	3239	3450	3749
	Optional wood armcaps. Please specify. No upcharge.	<b>OVERALL DIMENSIONS</b>			<b>SEAT DIMENSIONS</b>			<b>BACK DIMENSIONS</b>					
		IN	25	29.5	48.5	20.5	17.5	18	20.5	30			
	MM	635	749	1232	521	445	457	521	762				
		<b>RTA 00</b>	1 per carton										
 <p><b>HB Armchair Open Arms, Rear Tip and Move Wheels (HT)</b>                      COM: 2.5 YD   2.29 M                      Unit weight: 62 LB   28.2 KG                      Carton weight: 72 LB   32.66 KG                      Carton volume: 27.5 FT³   0.77 MT³</p>	<b>GC3655RC</b> Metal	COM	2	3	4	5	6	7	8	9	10	11	12
	Active weight 500 lbs.	1750	1830	1898	1975	2103	2220	2338	2440	2568	2688	2850	3080
	Optional wood armcaps. Please specify. No upcharge.	<b>OVERALL DIMENSIONS</b>			<b>SEAT DIMENSIONS</b>			<b>BACK DIMENSIONS</b>					
		IN	25	29.5	48.5	20.5	17.5	18	20.5	30			
	MM	635	749	1232	521	445	457	521	762				
		<b>RTA 00</b>	1 per carton										

DESCRIPTION MODEL# / FEATURES STANDARD TEXTILE GRADES



**Bariatric HB Armchair Open Arms (HT)**  
 COM: 3.5 YD | 3.2 M  
 Unit weight: 67 LB | 30.5 KG  
 Carton weight: 79 LB | 35.83 KG  
 Carton volume: 33 FT³ | 0.93 MT³

COM	2	3	4	5	6	7	8	9	10	11	12	
GC3656 Metal	2155	2267	2362	2470	2649	2813	2978	3121	3300	3468	3695	4017

OVERALL DIMENSIONS			SEAT DIMENSIONS			BACK DIMENSIONS	
W	D	H	W	D	H	W	H

Active weight 500 lbs.  
 Optional wood armcaps.  
 Please specify. No upcharge.

IN	35	27	48.5	30	17.5	18	30	30
MM	889	686	1232	762	445	457	762	762
	RTA 00		1 per carton					



**Bariatric HB Armchair Closed Arms (HT)**  
 COM: 4.5 YD | 4.11 M  
 Unit weight: 96 LB | 43.6 KG  
 Carton weight: 108 LB | 48.99 KG  
 Carton volume: 33 FT³ | 0.93 MT³

COM	2	3	4	5	6	7	8	9	10	11	12	
GC3656CA Metal	2411	2555	2677	2816	3046	3257	3469	3653	3883	4099	4391	4805

OVERALL DIMENSIONS			SEAT DIMENSIONS			BACK DIMENSIONS	
W	D	H	W	D	H	W	H

Active weight 500 lbs.  
 Optional wood armcaps.  
 Please specify. No upcharge.

IN	35	27	48.5	30	17.5	18	30	30
MM	889	686	1232	762	445	457	762	762
	RTA 00		1 per carton					

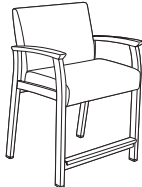

Designed to immobilize the pelvis and hip joints after surgery.

**Wide Hip Armchair Open Arms - Post Surgery (HT)**  
 COM: 1.5 YD | 1.37 M  
 Unit weight: 68 LB | 30.9 KG  
 Carton weight: 78 LB | 35.38 KG  
 Carton volume: 20 FT³ | 0.56 MT³

COM	2	3	4	5	6	7	8	9	10	11	12	
GC3657 Metal	2239	2287	2328	2374	2451	2521	2592	2653	2730	2802	2899	3037

OVERALL DIMENSIONS			SEAT DIMENSIONS			BACK DIMENSIONS	
W	D	H	W	D	H	W	H

Active weight 500 lbs.  
 Optional wood armcaps.  
 Please specify. No upcharge.

IN	28	25	41	24	17.5	26	24	15.5
MM	711	635	1041	610	445	660	610	394
	RTA 00		1 per carton					



**MB Armchair, Open Arms (Wood)**  
 COM: 1.75 YD | 1.6 M  
 Unit weight: 44 LB | 20 KG  
 Carton weight: 52 LB | 23.59 KG  
 Carton volume: 20 FT³ | 0.56 MT³

COM	2	3	4	5	6	7	8	9	10	11	12	
GC3631W Wood	1315	1371	1418	1473	1562	1644	1726	1798	1887	1971	2085	2246
GC3631WF Wood flex back	1672	1728	1775	1830	1919	2001	2083	2155	2244	2328	2442	2603

OVERALL DIMENSIONS			SEAT DIMENSIONS			BACK DIMENSIONS	
W	D	H	W	D	H	W	H

Active weight 350 lbs.  
 Optional urethane armcaps.  
 Please specify. No upcharge.

IN	25	27	36.5	20.5	17.5	18	20.5	18
MM	635	686	927	521	445	457	521	457
	RTA 00		1 per carton					



**MB Chair, Armless (Wood)**  
 COM: 1.75 YD | 1.6 M  
 Unit weight: 34 LB | 15.5 KG  
 Carton weight: 42 LB | 19.05 KG  
 Carton volume: 20 FT³ | 0.56 MT³



COM	2	3	4	5	6	7	8	9	10	11	12	
GC3631WNA Wood	1179	1235	1282	1337	1426	1508	1590	1662	1751	1835	1949	2110

OVERALL DIMENSIONS			SEAT DIMENSIONS			BACK DIMENSIONS	
W	D	H	W	D	H	W	H

Active weight 350 lbs.

IN	22.5	27	36.5	20.5	17.5	18	20.5	18
MM	572	686	927	521	445	457	521	457
	RTA 00		1 per carton					

DESCRIPTION	MODEL# / FEATURES	STANDARD TEXTILE GRADES												
<p><b>HB Armchair Open Arms, Split Back (Wood)</b> COM: 2.25 YD   2.06 M Unit weight: 50 LB   22.7 KG Carton weight: 60 LB   27.22 KG Carton volume: 27.5 FT³   0.77 MT³</p>	GC3632W Wood	COM	2	3	4	5	6	7	8	9	10	11	12	
	GC3632WF Wood flex back	1549	1621	1682	1752	1866	1972	2078	2170	2285	2393	2539	2746	
	Active weight 350 lbs.	<b>OVERALL DIMENSIONS</b>			<b>SEAT DIMENSIONS</b>			<b>BACK DIMENSIONS</b>						
	Fold down headrest allows caregiver to assist occupant.	W	D	H	W	D	H	W	H					
<p><b>LB Hip Armchair Open Arms - Post Surgery (Wood)</b> COM: 1.5 YD   1.37 M Unit weight: 47 LB   21.4 KG Carton weight: 57 LB   25.85 KG Carton volume: 20 FT³   0.56 MT³</p> <p>Designed to immobilize the pelvis and hip joints after surgery.</p>	GC3636W Wood	COM	2	3	4	5	6	7	8	9	10	11	12	
	Active weight 350 lbs.	1515	1563	1604	1650	1727	1797	1868	1929	2006	2078	2175	2313	
	Optional urethane armcaps. Please specify. No upcharge.	<b>OVERALL DIMENSIONS</b>			<b>SEAT DIMENSIONS</b>			<b>BACK DIMENSIONS</b>						
		W	D	H	W	D	H	W	H					
<p><b>Bariatric MB Armchair, Open Arms (Wood)</b> COM: 2.75 YD   2.51 M Unit weight: 70 LB   31.8 KG Carton weight: 82 LB   37.19 KG Carton volume: 30.5 FT³   0.86 MT³</p>	GC3638W Wood	COM	2	3	4	5	6	7	8	9	10	11	12	
	Active weight 500 lbs.	1697	1785	1859	1945	2085	2214	2343	2456	2596	2728	2907	3160	
	Optional urethane armcaps. Please specify. No upcharge.	<b>OVERALL DIMENSIONS</b>			<b>SEAT DIMENSIONS</b>			<b>BACK DIMENSIONS</b>						
		W	D	H	W	D	H	W	H					
<p><b>Bariatric HB Armchair, Split Back, Open Arms (Wood)</b> COM: 3.75 YD   3.43 M Unit weight: 55 LB   25 KG Carton weight: 65 LB   29.48 KG Carton volume: 33 FT³   0.93 MT³</p>	GC3639W Wood	COM	2	3	4	5	6	7	8	9	10	11	12	
	Active weight 500 lbs.	1991	2111	2212	2329	2520	2696	2872	3026	3217	3397	3641	3986	
	Fold down headrest allows caregiver to assist occupant.	<b>OVERALL DIMENSIONS</b>			<b>SEAT DIMENSIONS</b>			<b>BACK DIMENSIONS</b>						
	Optional urethane armcaps. Please specify. No upcharge.	W	D	H	W	D	H	W	H					
<p><b>HB Chair, Open Arms (Wood)</b> COM: 2.5 YD   2.29 M Unit weight: 50 LB   22.7 KG Carton weight: 60 LB   27.22 KG Carton volume: 27.5 FT³   0.77 MT³</p>	GC3655W Wood	COM	2	3	4	5	6	7	8	9	10	11	12	
	Active weight 350 lbs.	1359	1439	1507	1584	1712	1829	1947	2049	2177	2297	2459	2689	
		GC3655WF Wood flex back	1709	1789	1857	1934	2062	2179	2297	2399	2527	2647	2809	3039
		<b>OVERALL DIMENSIONS</b>			<b>SEAT DIMENSIONS</b>			<b>BACK DIMENSIONS</b>						
	W	D	H	W	D	H	W	H						

DESCRIPTION	MODEL# / FEATURES	STANDARD TEXTILE GRADES												
		COM	2	3	4	5	6	7	8	9	10	11	12	
 <p><b>Bariatric HB Armchair, Open Arms (Wood)</b>                      COM: 3.5 YD   3.2 M                      Unit weight: 55 LB   25 KG                      Carton weight: 65 LB   29.48 KG                      Carton volume: 30.75 FT³   0.87 MT³</p>	<b>GC3656W</b> Wood	1772	1884	1979	2087	2266	2430	2595	2738	2917	3085	3312	3634	
		<b>OVERALL DIMENSIONS</b>			<b>SEAT DIMENSIONS</b>			<b>BACK DIMENSIONS</b>						
		<b>W</b>	<b>D</b>	<b>H</b>	<b>W</b>	<b>D</b>	<b>H</b>	<b>W</b>	<b>H</b>					
		IN 35	27	48.5	30	17.5	18	30	30					
		MM 889	686	1232	762	445	457	762	762					
	Active weight 500 lbs.	<b>RTA 00</b>		1 per carton										
	Optional urethane armcaps. Please specify. No upcharge.													
 <p><b>Wide Hip Armchair Open Arms - Post Surgery (Wood)</b>                      COM: 1.5 YD   1.37 M                      Unit weight: 58 LB   26.4 KG                      Carton weight: 64 LB   29.03 KG                      Carton volume: 20 FT³   0.56 MT³</p> <p>Designed to immobilize the pelvis and hip joints after surgery.</p>	<b>GC3657W</b> Wood	1876	1924	1965	2011	2088	2158	2229	2290	2367	2439	2536	2674	
		<b>OVERALL DIMENSIONS</b>			<b>SEAT DIMENSIONS</b>			<b>BACK DIMENSIONS</b>						
		<b>W</b>	<b>D</b>	<b>H</b>	<b>W</b>	<b>D</b>	<b>H</b>	<b>W</b>	<b>H</b>					
		IN 28	25	41	24	17.5	26	24	15.5					
		MM 711	635	1041	610	445	660	610	394					
	Active weight 350 lbs.	<b>RTA 00</b>		1 per carton										
	Optional urethane armcaps. Please specify. No upcharge.													

PRIMACARE LOUNGE



model GC3641 (HT)



model GC3641W (Wood)

STANDARD FEATURES

- Primacare is a family of products offering the most significant return on investment approach in the industry since every component can be repaired or replaced on site.
- **High traffic (HT) models:** Metal frame with die cast zinc connectors and metal-to-metal fasteners. Available in the following finishes: Black (TBL), Cloud (TIV), Designer White (TDW), Fog (TFO), Frost (TFR), Kalua (TKA), Latte (TLA), Mocha (TMO), Nevada (TNE), Sand (TSN), Shadow (TSH), Toast (TOA) and Tungsten (TTU).
- **Wood models:** Solid hardwood frame and armcaps with die cast zinc connectors and metal-to-metal fastening. Available in the following finishes: Absolute (AAM), Charcoal Java (CJM), Cherry (ACM), Empire Mahogany (EMM), English Oak (EOM), Espresso Cafe (ECM), Fruitwood (TFM), Gray (HGM), Harvest Oak (HOM), Honey (AHM), Jet Onyx (JOM), Light Honey (LHM), Mahogany (TMM), Maple (AVM), Medium Walnut (MWM), Natural Walnut (NLW), Night (ASM), Noce Biondo (NBM), Noce Grigio (NGM), Noce Leggero (NEM), Noce Medio (NMM), Sandy Beach (SBM), Shaker Cherry (SKM), Silver Oak (SOM), Walnut (TWM), White (WHM), WC Cream (WTM) and Winter Cherry (WCM).
- Armcaps are securely fastened with metal-to-metal connectors which allow for field replacement if required.
- Easy grip forward extending armcap on models with arms.
- Replaceable seat covers and replaceable and/or removable seat cushions are standard.
- Seat cushion has a seamless waterfall front and clean out between and around the seat and back cushions.
- Models are standard with metal mesh seat deck. For mental health applications, the metal mesh seat deck can be covered with a solid moisture resistant surface, held in place with tamperproof fasteners. Contact your sales rep for a special quotation.
- All seat frames feature a wall saver design to prevent back contact with wall.
- Models ending in **CA** have upholstered panel arm inserts closing the arm. (Closed arm panels are designed to be replaceable. Request a special quote to have them secured with tamperproof fasteners.)
- For healthcare textile options, visit the website at [globalfurnituregroup.com](http://globalfurnituregroup.com).
- Can be upholstered in standard Global textiles if healthcare compliance is not required.
- Shipped fully assembled.

OPTIONAL FEATURES

- **High traffic (HT) models:** Wood armcaps are available. See far left column "Wood models" for finishes. Please specify. No upcharge.
- **High traffic (HT) and wood models:** Urethane armcaps are available in the following finishes: Black (BLK), Kalua (KAL), Latte (LAB), Mocha (J52), Shadow (SHW) and Toast (TOA). Please specify. No upcharge.
- For moisture barrier on seat, please specify **(MB)**. Add \$122 per seat.
- To add sealed seams to your product contact Customer Service. Upcharges vary.
- For Primacare tables, see page 59.

SUGGESTED APPLICATIONS

- Bariatric seating
- Guest seating
- Lobbies
- Lounge/Waiting
- Patient rooms
- Resident rooms

**HIGH TRAFFIC (HT) MODELS ARE LISTED FIRST, FOLLOWED BY WOOD MODELS.**

DESCRIPTION	MODEL# / FEATURES	STANDARD TEXTILE GRADES											
		COM	2	3	4	5	6	7	8	9	10	11	12
 <b>Bariatric Lounge Chair Open Arms (HT)</b> COM: 3.25 YD   2.97 M Unit weight: 97 LB   44.1 KG Carton weight: 109 LB   49.44 KG Carton volume: 49.5 FT³   1.4 MT³	GC3640 Metal	2865	2969	3057	3158	3323	3476	3629	3762	3928	4084	4295	4594
			<b>OVERALL DIMENSIONS</b>			<b>SEAT DIMENSIONS</b>			<b>BACK DIMENSIONS</b>				
			W	D	H	W	D	H	W	H			
			IN 40	32	33	36	20	17.25	36	16			
		MM 1016	813	838	914	508	438	914	406				
		<b>RTA 00</b>		1 per carton									
 <b>Bariatric Lounge Chair Closed Arms (HT)</b> COM: 5.75 YD   5.26 M Unit weight: 107 LB   48.6 KG Carton weight: 119 LB   53.98 KG Carton volume: 49.5 FT³   1.4 MT³	GC3640CA Metal	3162	3346	3501	3680	3973	4243	4513	4749	5042	5318	5692	6221
			<b>OVERALL DIMENSIONS</b>			<b>SEAT DIMENSIONS</b>			<b>BACK DIMENSIONS</b>				
			W	D	H	W	D	H	W	H			
			IN 40	32	33	36	20	17.25	36	16			
		MM 1016	813	838	914	508	438	914	406				
		<b>RTA 00</b>		1 per carton									
 <b>Lounge Chair Open Arms (HT)</b> COM: 2.5 YD   2.29 M Unit weight: 66 LB   30 KG Carton weight: 78 LB   35.38 KG Carton volume: 29.5 FT³   0.83 MT³	GC3641 Metal	2204	2284	2352	2429	2557	2674	2792	2894	3022	3142	3304	3534
			<b>OVERALL DIMENSIONS</b>			<b>SEAT DIMENSIONS</b>			<b>BACK DIMENSIONS</b>				
			W	D	H	W	D	H	W	H			
			IN 29	32	33	23	20	17.25	22.5	16			
		MM 737	813	838	584	508	438	572	406				
		<b>RTA 00</b>		1 per carton									

DESCRIPTION MODEL# / FEATURES STANDARD TEXTILE GRADES



**GC3641CA**  
Metal

COM	2	3	4	5	6	7	8	9	10	11	12
2541	2661	2762	2879	3070	3246	3422	3576	3767	3947	4191	4536

OVERALL DIMENSIONS			SEAT DIMENSIONS			BACK DIMENSIONS	
W	D	H	W	D	H	W	H

**Lounge Chair Closed Arms (HT)**  
COM: 3.75 YD | 3.43 M  
Unit weight: 79 LB | 35.9 KG  
Carton weight: 91 LB | 41.28 KG  
Carton volume: 29.5 FT³ | 0.83 MT³

Active weight 500 lbs.  
Optional wood armcaps.  
Please specify. No upcharge.  
**RTA 00** 1 per carton

IN	29	32	33	23	20	17.25	22.5	16
MM	737	813	838	584	508	438	572	406

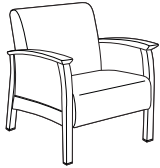

**GC3641CAL**  
Metal

COM	2	3	4	5	6	7	8	9	10	11	12
2867	2947	3015	3092	3220	3337	3455	3557	3685	3805	3967	4197

OVERALL DIMENSIONS			SEAT DIMENSIONS			BACK DIMENSIONS	
W	D	H	W	D	H	W	H

**Lounge Chair Closed Arms, Laminate Panels (HT)**  
COM: 2.5 YD | 2.29 M  
Unit weight: 79 LB | 35.9 KG  
Carton weight: 91 LB | 41.28 KG  
Carton volume: 29.5 FT³ | 0.83 MT³

Active weight 500 lbs.  
Optional wood armcaps.  
Please specify. No upcharge.  
**RTA 00** 1 per carton

IN	29	32	33	23	20	17.25	22.5	16
MM	737	813	838	584	508	438	572	406

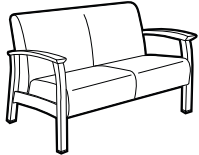

**GC3642**  
Metal

COM	2	3	4	5	6	7	8	9	10	11	12
3172	3300	3408	3532	3736	3924	4112	4276	4480	4672	4932	5300

OVERALL DIMENSIONS			SEAT DIMENSIONS			BACK DIMENSIONS	
W	D	H	W	D	H	W	H

**Two Seat Sofa Open Arms (HT)**  
COM: 4 YD | 3.66 M  
Unit weight: 107 LB | 48.6 KG  
Carton weight: 122 LB | 55.34 KG  
Carton volume: 49.5 FT³ | 1.4 MT³

Active weight 500 lbs/seat.  
Optional wood armcaps.  
Please specify. No upcharge.  
**RTA 00** 1 per carton

IN	52	32	33	48	20	17.25	48	16
MM	1321	813	838	1219	508	438	1219	406

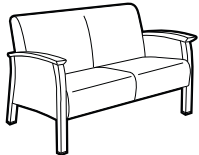

**GC3642CA**  
Metal

COM	2	3	4	5	6	7	8	9	10	11	12
3500	3676	3825	3995	4276	4534	4793	5018	5299	5563	5920	6426

OVERALL DIMENSIONS			SEAT DIMENSIONS			BACK DIMENSIONS	
W	D	H	W	D	H	W	H

**Two Seat Sofa Closed Arms (HT)**  
COM: 5.5 YD | 5.03 M  
Unit weight: 117 LB | 53.2 KG  
Carton weight: 132 LB | 59.87 KG  
Carton volume: 49.5 FT³ | 1.4 MT³

Active weight 500 lbs/seat.  
Optional wood armcaps.  
Please specify. No upcharge.  
**RTA 00** 1 per carton

IN	52	32	33	48	20	17.25	48	16
MM	1321	813	838	1219	508	438	1219	406

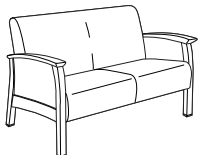

**GC3642CAL**  
Metal

COM	2	3	4	5	6	7	8	9	10	11	12
3836	3964	4072	4196	4400	4588	4776	4940	5144	5336	5596	5964

OVERALL DIMENSIONS			SEAT DIMENSIONS			BACK DIMENSIONS	
W	D	H	W	D	H	W	H

**Two Seat Sofa Closed Arms, Laminate Panels (HT)**  
COM: 4 YD | 3.66 M  
Unit weight: 117 LB | 53.2 KG  
Carton weight: 132 LB | 59.87 KG  
Carton volume: 49.5 FT³ | 1.4 MT³

Active weight 500 lbs/seat.  
Optional wood armcaps.  
Please specify. No upcharge.  
**RTA 00** 1 per carton

IN	52	32	33	48	20	17.25	48	16
MM	1321	813	838	1219	508	438	1219	406

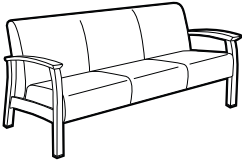
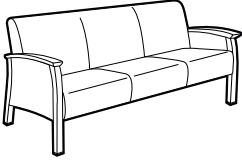
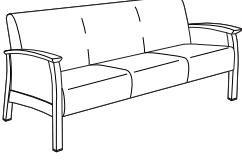
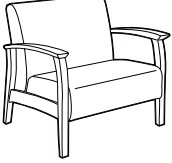
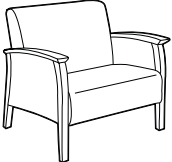
DESCRIPTION	MODEL# / FEATURES	STANDARD TEXTILE GRADES											
		COM	2	3	4	5	6	7	8	9	10	11	12
 <p><b>Three Seat Sofa Open Arms (HT)</b> COM: 6.25 YD   5.72 M Unit weight: 148 LB   67.3 KG Carton weight: 173 LB   78.47 KG Carton volume: 69.5 FT³   1.96 MT³</p>	<b>GC3643</b> Metal	4112	4312	4481	4675	4993	5287	5581	5837	6156	6456	6862	7437
		<b>OVERALL DIMENSIONS</b>			<b>SEAT DIMENSIONS</b>			<b>BACK DIMENSIONS</b>					
			<b>W</b>	<b>D</b>	<b>H</b>	<b>W</b>	<b>D</b>	<b>H</b>	<b>W</b>	<b>H</b>			
		Active weight 500 lbs/seat. Optional wood armcaps. Please specify. No upcharge.	IN 75 MM 1905	32 813	33 838	71 1803	20 508	17.25 438	71 1803	16 406			
		<b>RTA 00</b>	1 per carton										
 <p><b>Three Seat Sofa Closed Arms (HT)</b> COM: 7.5 YD   6.86 M Unit weight: 158 LB   71.8 KG Carton weight: 183 LB   83.01 KG Carton volume: 69.5 FT³   1.96 MT³</p>	<b>GC3643CA</b> Metal	4453	4693	4896	5128	5511	5863	6216	6523	6906	7266	7753	8443
		<b>OVERALL DIMENSIONS</b>			<b>SEAT DIMENSIONS</b>			<b>BACK DIMENSIONS</b>					
			<b>W</b>	<b>D</b>	<b>H</b>	<b>W</b>	<b>D</b>	<b>H</b>	<b>W</b>	<b>H</b>			
		Active weight 500 lbs/seat. Optional wood armcaps. Please specify. No upcharge.	IN 75 MM 1905	32 813	33 838	71 1803	20 508	17.25 438	71 1803	16 406			
		<b>RTA 00</b>	1 per carton										
 <p><b>Three Seat Sofa Closed Arms, Laminate Panels (HT)</b> COM: 6.25 YD   5.72 M Unit weight: 158 LB   71.8 KG Carton weight: 183 LB   83.01 KG Carton volume: 69.5 FT³   1.96 MT³</p>	<b>GC3643CAL</b> Metal	4778	4978	5147	5341	5659	5953	6247	6503	6822	7122	7528	8103
		<b>OVERALL DIMENSIONS</b>			<b>SEAT DIMENSIONS</b>			<b>BACK DIMENSIONS</b>					
			<b>W</b>	<b>D</b>	<b>H</b>	<b>W</b>	<b>D</b>	<b>H</b>	<b>W</b>	<b>H</b>			
		Active weight 500 lbs/seat. Optional wood armcaps. Please specify. No upcharge.	IN 75 MM 1905	32 813	33 838	71 1803	20 508	17.25 438	71 1803	16 406			
		<b>RTA 00</b>	1 per carton										
 <p><b>Bariatric Lounge Chair, Open Arms (Wood)</b> COM: 3.25 YD   2.97 M Unit weight: 85 LB   38.6 KG Carton weight: 97 LB   44 KG Carton volume: 49.5 FT³   1.4 MT³</p>	<b>GC3640W</b> Wood	2359	2463	2551	2652	2817	2970	3123	3256	3422	3578	3789	4088
		<b>OVERALL DIMENSIONS</b>			<b>SEAT DIMENSIONS</b>			<b>BACK DIMENSIONS</b>					
			<b>W</b>	<b>D</b>	<b>H</b>	<b>W</b>	<b>D</b>	<b>H</b>	<b>W</b>	<b>H</b>			
		Active weight 500 lbs. Optional urethane armcaps. Please specify. No upcharge.	IN 40 MM 1016	32 813	33 838	36 914	20 508	17.25 438	36 914	16 406			
		<b>RTA 00</b>	1 per carton										
 <p><b>Bariatric Lounge Chair, Closed Arms (Wood)</b> COM: 5.75 YD   5.26 M Unit weight: 95 LB   43.2 KG Carton weight: 107 LB   48.53 KG Carton volume: 49.5 FT³   1.4 MT³</p>	<b>GC3640WCA</b> Wood	2592	2776	2931	3110	3403	3673	3943	4179	4472	4748	5122	5651
		<b>OVERALL DIMENSIONS</b>			<b>SEAT DIMENSIONS</b>			<b>BACK DIMENSIONS</b>					
			<b>W</b>	<b>D</b>	<b>H</b>	<b>W</b>	<b>D</b>	<b>H</b>	<b>W</b>	<b>H</b>			
		Active weight 500 lbs. Optional urethane armcaps. Please specify. No upcharge.	IN 40 MM 1016	32 813	33 838	36 914	20 508	17.25 438	36 914	16 406			
		<b>RTA 00</b>	1 per carton										

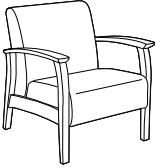
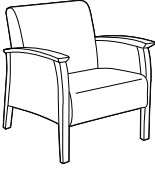
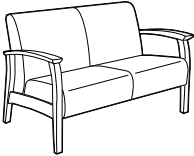
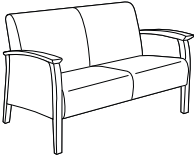
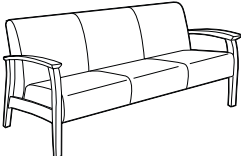
DESCRIPTION	MODEL# / FEATURES	STANDARD TEXTILE GRADES												
		COM	2	3	4	5	6	7	8	9	10	11	12	
 <p><b>Lounge Chair, Open Arms (Wood)</b> COM: 2.5 YD   2.29 M Unit weight: 54 LB   24.5 KG Carton weight: 66 LB   29.94 KG Carton volume: 29.5 FT³   0.83 MT³</p>	<b>GC3641W</b> Wood	1815	1895	1963	2040	2168	2285	2403	2505	2633	2753	2915	3145	
		<b>OVERALL DIMENSIONS</b> W D H			<b>SEAT DIMENSIONS</b> W D H			<b>BACK DIMENSIONS</b> W H						
		IN 29	32	33	23	20	17.25	22.5	16					
		MM 737	813	838	584	508	438	572	406					
Active weight 350 lbs.	Optional urethane armcaps. Please specify. No upcharge.	<b>RTA 00</b>		1 per carton										
 <p><b>Lounge Chair, Closed Arms (Wood)</b> COM: 3.75 YD   3.43 M Unit weight: 67 LB   30.5 KG Carton weight: 79 LB   35.83 KG Carton volume: 29.5 FT³   0.83 MT³</p>	<b>GC3641WCA</b> Wood	2088	2208	2309	2426	2617	2793	2969	3123	3314	3494	3738	4083	
		<b>OVERALL DIMENSIONS</b> W D H			<b>SEAT DIMENSIONS</b> W D H			<b>BACK DIMENSIONS</b> W H						
		IN 29	32	33	23	20	17.25	22.5	16					
		MM 737	813	838	584	508	438	572	406					
Active weight 350 lbs.	Optional urethane armcaps. Please specify. No upcharge.	<b>RTA 00</b>		1 per carton										
 <p><b>Two Seat Sofa, Open Arms (Wood)</b> COM: 4 YD   3.66 M Unit weight: 95 LB   43.2 KG Carton weight: 110 LB   49.9 KG Carton volume: 49.5 FT³   1.4 MT³</p>	<b>GC3642W</b> Wood	2610	2738	2846	2970	3174	3362	3550	3714	3918	4110	4370	4738	
		<b>OVERALL DIMENSIONS</b> W D H			<b>SEAT DIMENSIONS</b> W D H			<b>BACK DIMENSIONS</b> W H						
		IN 52	32	33	48	20	17.25	48	16					
		MM 1321	813	838	1219	508	438	1219	406					
Active weight 350 lbs/seat.	Optional urethane armcaps. Please specify. No upcharge.	<b>RTA 00</b>		1 per carton										
 <p><b>Two Seat Sofa, Closed Arms (Wood)</b> COM: 5.5 YD   5.03 M Unit weight: 105 LB   47.7 KG Carton weight: 120 LB   54.43 KG Carton volume: 49.5 FT³   1.4 MT³</p>	<b>GC3642WCA</b> Wood	2874	3050	3199	3369	3650	3908	4167	4392	4673	4937	5294	5800	
		<b>OVERALL DIMENSIONS</b> W D H			<b>SEAT DIMENSIONS</b> W D H			<b>BACK DIMENSIONS</b> W H						
		IN 52	32	33	48	20	17.25	48	16					
		MM 1321	813	838	1219	508	438	1219	406					
Active weight 350 lbs/seat.	Optional urethane armcaps. Please specify. No upcharge.	<b>RTA 00</b>		1 per carton										
 <p><b>Three Seat Sofa, Open Arms (Wood)</b> COM: 6.25 YD   5.72 M Unit weight: 136 LB   61.8 KG Carton weight: 161 LB   73.03 KG Carton volume: 69.5 FT³   1.96 MT³</p>	<b>GC3643W</b> Wood	3383	3583	3752	3946	4264	4558	4852	5108	5427	5727	6133	6708	
		<b>OVERALL DIMENSIONS</b> W D H			<b>SEAT DIMENSIONS</b> W D H			<b>BACK DIMENSIONS</b> W H						
		IN 75	32	33	71	20	17.25	71	16					
		MM 1905	813	838	1803	508	438	1803	406					
Active weight 350 lbs/seat.	Optional urethane armcaps. Please specify. No upcharge.	<b>RTA 00</b>		1 per carton										

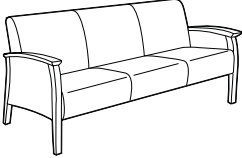

DESCRIPTION	MODEL# / FEATURES	STANDARD TEXTILE GRADES																																
		COM	2	3	4	5	6	7	8	9	10	11	12																					
 <p><b>Three Seat Sofa, Closed Arms (Wood)</b>                      COM: 7.5 YD   6.86 M                      Unit weight: 146 LB   66.4 KG                      Carton weight: 171 LB   77.56 KG                      Carton volume: 69.5 FT³   1.96 MT³</p>	<p><b>GC3643WCA</b>                      Wood</p>	3654	3894	4097	4329	4712	5064	5417	5724	6107	6467	6954	7644																					
	<p>Active weight: 350 lbs/seat.                      Optional urethane armcaps.                      Please specify. No upcharge.</p>	<table border="1"> <thead> <tr> <th colspan="3">OVERALL DIMENSIONS</th> <th colspan="3">SEAT DIMENSIONS</th> <th colspan="2">BACK DIMENSIONS</th> </tr> <tr> <th>W</th> <th>D</th> <th>H</th> <th>W</th> <th>D</th> <th>H</th> <th>W</th> <th>H</th> </tr> </thead> <tbody> <tr> <td>IN 75</td> <td>32</td> <td>33</td> <td>71</td> <td>20</td> <td>17.25</td> <td>71</td> <td>16</td> </tr> <tr> <td>MM 1905</td> <td>813</td> <td>838</td> <td>1803</td> <td>508</td> <td>438</td> <td>1803</td> <td>406</td> </tr> </tbody> </table>	OVERALL DIMENSIONS			SEAT DIMENSIONS			BACK DIMENSIONS		W	D	H	W	D	H	W	H	IN 75	32	33	71	20	17.25	71	16	MM 1905	813	838	1803	508	438	1803	406
OVERALL DIMENSIONS			SEAT DIMENSIONS			BACK DIMENSIONS																												
W	D	H	W	D	H	W	H																											
IN 75	32	33	71	20	17.25	71	16																											
MM 1905	813	838	1803	508	438	1803	406																											

PRIMACARE FULLY UPHOLSTERED LOUNGE



model GC3676HB



model GC3677

STANDARD FEATURES

- Primacare is a family of products offering the most significant return on investment approach in the industry since every component can be repaired or replaced on site.
- Standard with fully upholstered arms.
- The seat frame features a beautifully angled back creating a wall saver design to prevent damage to walls.
- The structural frame is constructed of solid hardwood with metal mesh seat deck, die cast zinc connectors and metal-to-metal fastening, providing an exceptionally strong and durable solution.
- The arm panels, legs, seat, back and cushion covers are field replaceable.
- Seat cushion has a seamless waterfall front and clean out between and around the seat and back cushions.
- For mental health applications, the metal mesh seat deck can be covered with a solid moisture resistant surface, held in place with tamperproof fasteners. Contact your sales rep for a special quotation.
- For healthcare textile options, visit the website at [globalfurnituregroup.com](http://globalfurnituregroup.com).
- Can be upholstered in standard Global textiles if healthcare compliance is not required.
- Left and right position reference is determined from the seated position.
- Shipped fully assembled.

OPTIONAL FEATURES

- Optional urethane (urethane) legs and armcaps available in the following finishes: Black (BLK), Kalua (KAL), Latte (LAB), Mocha (J52), Shadow (SHW) and Toast (TOA). See features column for upcharges.
- Optional wood legs and armcaps available in the following finishes: Absolute (AAM), Charcoal Java (CJM), Cherry (ACM), Empire Mahogany (EMM), English Oak (EOM), Espresso Cafe (ECM), Fruitwood (TFM), Gray (HGM), Harvest Oak (HOM), Honey (AHM), Jet Onyx (JOM), Light Honey (LHM), Mahogany (TMM), Maple (AVM), Medium Walnut (MWM), Neutral Walnut (NLW), Night (ASM), Noce Biondo (NBM), Noce Grigio (NGM), Noce Leggero (NEM), Noce Medio (NMM), Sandy Beach (SBM), Silver Oak (SOM), Walnut (TWM), White (WHM), WC Cream (WTM) and Winter Cherry (WCM). See features column for upcharges.
- Armcaps are securely fastened with metal-to-metal connectors which allow for field replacement if required. Armcaps cannot be retrofitted in the field on units with no existing armcaps.
- For moisture barrier on seat, please specify **(MB)**. Add \$122 per seat.
- To add sealed seams to your product contact Customer Service. Upcharges vary.
- For Primacare tables, see page 59.

SUGGESTED APPLICATIONS

- Bariatric setting
- Lobbies
- Guest seating
- Lounge/Waiting

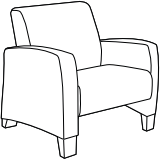
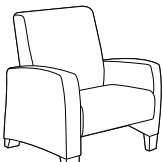
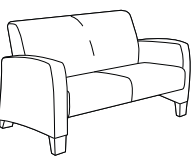
DESCRIPTION	MODEL# / FEATURES	STANDARD TEXTILE GRADES												
		COM	2	3	4	5	6	7	8	9	10	11	12	
 <p><b>Lounge Chair Fully Uph Arms, Urethane Legs</b>                      COM: 6.25 YD   5.72 M                      Unit weight: 83 LB   37.7 KG                      Carton weight: 95 LB   43.09 KG                      Carton volume: 29.5 FT³   0.83 MT³</p>	<b>GC3676</b>	1966	2166	2335	2529	2847	3141	3435	3691	4010	4310	4716	5291	
	Active weight 350 lbs.	<b>OVERALL DIMENSIONS</b>			<b>SEAT DIMENSIONS</b>			<b>BACK DIMENSIONS</b>						
	Optional wood legs. No upcharge.	IN	32.5	29	33		23	20	17.25		23	16		
	Optional urethane or wood armcaps. Add \$284.	MM	826	737	838		584	508	438		584	406		
		<b>RTA 00</b>	1 per carton											
 <p><b>HB Lounge Chair Fully Uph Arms, Urethane Legs</b>                      COM: 6.5 YD   5.94 M                      Unit weight: 102 LB   46.4 KG                      Carton weight: 114 LB   51.71 KG                      Carton volume: 29.5 FT³   0.83 MT³</p>	<b>GC3676HB</b>	2111	2319	2495	2696	3028	3333	3639	3905	4237	4549	4971	5569	
	Active weight 350 lbs.	<b>OVERALL DIMENSIONS</b>			<b>SEAT DIMENSIONS</b>			<b>BACK DIMENSIONS</b>						
	Optional wood legs. No upcharge.	IN	32.5	29	36		23	20	17.25		23	19		
	Optional urethane or wood armcaps. Add \$284.	MM	826	737	914		584	508	438		584	483		
		<b>RTA 00</b>	1 per carton											
 <p><b>Two Seat Sofa Fully Uph Arms, Urethane Legs</b>                      COM: 7.5 YD   6.86 M                      Unit weight: 120 LB   54.5 KG                      Carton weight: 135 LB   61.23 KG                      Carton volume: 56.25 FT³   1.59 MT³</p>	<b>GC3677</b>	2733	2973	3176	3408	3791	4143	4496	4803	5186	5546	6033	6723	
	Active weight 350 lbs/seat.	<b>OVERALL DIMENSIONS</b>			<b>SEAT DIMENSIONS</b>			<b>BACK DIMENSIONS</b>						
	Optional wood legs. No upcharge.	IN	55.5	29	33		45.5	20	17.25		45.5	16		
	Optional urethane or wood armcaps. Add \$284.	MM	1410	737	838		1156	508	438		1156	406		
		<b>RTA 00</b>	1 per carton											

# SEATING

# PRIMACARE™ FULLY UPHOLSTERED LOUNGE P

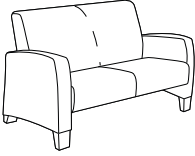
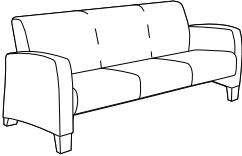
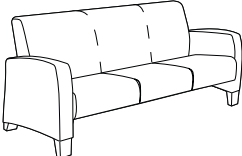
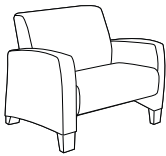
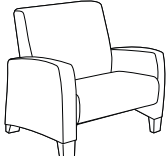
DESCRIPTION	MODEL# / FEATURES	STANDARD TEXTILE GRADES											
		COM	2	3	4	5	6	7	8	9	10	11	12
 <p><b>HB Two Seat Sofa Fully Uph Arms, Urethane Legs</b>                      COM: 7.75 YD   7.09 M                      Unit weight: 127 LB   57.7 KG                      Carton weight: 142 LB   64.41 KG                      Carton volume: 56.25 FT³   1.59 MT³</p>	<b>GC3677HB</b>	3032	3280	3489	3730	4125	4489	4853	5171	5566	5938	6442	7155
	Active weight 350 lbs/seat.	<b>OVERALL DIMENSIONS</b>			<b>SEAT DIMENSIONS</b>			<b>BACK DIMENSIONS</b>					
	Optional wood legs. No upcharge.	<b>W</b>	<b>D</b>	<b>H</b>	<b>W</b>	<b>D</b>	<b>H</b>	<b>W</b>	<b>H</b>				
	Optional urethane or wood armcaps. Add \$284.	IN 55.5	29	36	45.5	20	17.25	45.5	19				
		MM 1410	737	914	1156	508	438	1156	483				
	<b>RTA 00</b>	1 per carton											
 <p><b>Three Seat Sofa Fully Uph Arms, Urethane Legs</b>                      COM: 9 YD   8.23 M                      Unit weight: 156 LB   70.9 KG                      Carton weight: 181 LB   82.1 KG                      Carton volume: 69.5 FT³   1.96 MT³</p>	<b>GC3678</b>	3645	3933	4176	4455	4914	5337	5760	6129	6588	7020	7605	8433
	Active weight 350 lbs/seat.	<b>OVERALL DIMENSIONS</b>			<b>SEAT DIMENSIONS</b>			<b>BACK DIMENSIONS</b>					
	Optional wood legs. No upcharge.	<b>W</b>	<b>D</b>	<b>H</b>	<b>W</b>	<b>D</b>	<b>H</b>	<b>W</b>	<b>H</b>				
	Optional urethane or wood armcaps. Add \$284.	IN 78.5	29	33	68.5	20	17.25	68.5	16				
		MM 1994	737	838	1740	508	438	1740	406				
	<b>RTA 00</b>	1 per carton											
 <p><b>HB Three Seat Sofa Fully Uph Arms, Urethane Legs</b>                      COM: 9.25 YD   8.46 M                      Unit weight: 163 LB   74.1 KG                      Carton weight: 188 LB   85.28 KG                      Carton volume: 69.5 FT³   1.96 MT³</p>	<b>GC3678HB</b>	4097	4393	4643	4930	5401	5836	6271	6650	7122	7566	8167	9018
	Active weight 350 lbs/seat.	<b>OVERALL DIMENSIONS</b>			<b>SEAT DIMENSIONS</b>			<b>BACK DIMENSIONS</b>					
	Optional wood legs. No upcharge.	<b>W</b>	<b>D</b>	<b>H</b>	<b>W</b>	<b>D</b>	<b>H</b>	<b>W</b>	<b>H</b>				
	Optional urethane or wood armcaps. Add \$284.	IN 78.5	29	36	68.5	20	17.25	68.5	19				
		MM 1994	737	914	1740	508	438	1740	483				
	<b>RTA 00</b>	1 per carton											
 <p><b>Bariatric Lounge Chair Fully Uph Arms, Urethane Legs</b>                      COM: 6.5 YD   5.94 M                      Unit weight: 95 LB   43.2 KG                      Carton weight: 107 LB   48.53 KG                      Carton volume: 37.75 FT³   1.06 MT³</p>	<b>GC3679</b>	2303	2511	2687	2888	3220	3525	3831	4097	4429	4741	5163	5761
	Active weight 500 lbs.	<b>OVERALL DIMENSIONS</b>			<b>SEAT DIMENSIONS</b>			<b>BACK DIMENSIONS</b>					
	Optional wood legs. No upcharge.	<b>W</b>	<b>D</b>	<b>H</b>	<b>W</b>	<b>D</b>	<b>H</b>	<b>W</b>	<b>H</b>				
	Optional urethane or wood armcaps. Add \$284.	IN 42	29	33	32	20	17.25	32	16				
		MM 1067	737	838	813	508	438	813	406				
	<b>RTA 00</b>	1 per carton											
 <p><b>HB Bariatric Lounge Chair Fully Uph Arms, Urethane Legs</b>                      COM: 6.75 YD   6.17 M                      Unit weight: 109 LB   49.5 KG                      Carton weight: 121 LB   54.88 KG                      Carton volume: 37.75 FT³   1.06 MT³</p>	<b>GC3679HB</b>	2497	2713	2895	3105	3449	3766	4083	4360	4704	5028	5467	6088
	Active weight 500 lbs.	<b>OVERALL DIMENSIONS</b>			<b>SEAT DIMENSIONS</b>			<b>BACK DIMENSIONS</b>					
	Optional wood legs. No upcharge.	<b>W</b>	<b>D</b>	<b>H</b>	<b>W</b>	<b>D</b>	<b>H</b>	<b>W</b>	<b>H</b>				
	Optional urethane or wood armcaps. Add \$284.	IN 42	29	36	32	20	17.25	32	19				
		MM 1067	737	914	813	508	438	813	483				
	<b>RTA 00</b>	1 per carton											

PRIMACARE WINGBACK



model GC3691HB



model GC3692HB

STANDARD FEATURES



- Primacare is a family of products offering the most significant return on investment approach in the industry since every component can be repaired or replaced on site.
- Standard with Black urethane (urethane) legs and armcaps.
- Armcaps are securely fastened with metal-to-metal connectors which allow for field replacement if required.
- Easy grip forward extending armcap on models with arms.
- For added comfort, seat and back are standard with high density Ultracell foam.
- Replaceable seat covers and replaceable and/or removable seat cushions are standard.
- Seat cushion has a seamless waterfall front and clean out between and around the seat and back cushions.
- Models are standard with metal mesh seat deck. For mental health applications, the metal mesh seat deck can be covered with a solid moisture resistant surface, held in place with tamperproof fasteners. Contact your sales rep for a special quotation.
- For healthcare textile options, visit the website at [globalfurnituregroup.com](http://globalfurnituregroup.com).
- Can be upholstered in standard Global textiles if healthcare compliance is not required.

OPTIONAL FEATURES

- Optional urethane (urethane) legs and armcaps available in the following finishes: Kalua (KAL), Latte (LAB), Mocha (J52), Shadow (SHW) and Toast (TOA). No upcharge.
- For optional wood legs and armcaps, refer to the Seating wood finishes in the Textiles and Finishes section.  
For wood armcaps: Add \$65.  
For wood legs: Add \$155.
- For moisture barrier on seat, please specify **(MB)**.  
For one seater: Add \$122.  
For two seater: Add \$242.  
For bariatric models: Add \$162.
- To add sealed seams to your product contact Customer Service. Upcharges vary.
- For Primacare tables, see page 59.

SUGGESTED APPLICATIONS

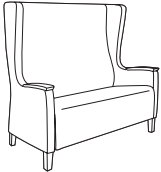
- Bariatric seating
- Lobbies
- Lounge/Waiting
- Guest seating
- Patient rooms
- Resident rooms

DESCRIPTION	MODEL# / FEATURES	STANDARD TEXTILE GRADES											
		COM	2	3	4	5	6	7	8	9	10	11	12
 <p><b>Single Seater Wingback Armchair</b> COM: 6.25 YD   5.72 M Unit weight: 77 LB   35 KG Carton weight: 94 LB   42.64 KG Carton volume: 29 FT³   0.82 MT³</p>	<b>GC3691HB</b>	2727	2927	3096	3290	3609	3902	4196	4452	4771	5071	5477	6052
	Active weight 350 lbs.	<b>OVERALL DIMENSIONS</b> W D H			<b>SEAT DIMENSIONS</b> W D H			<b>BACK DIMENSIONS</b> W H					
		IN 30.5	28.5	45.5	22.5	18	19	19	26				
		MM 775	724	1156	572	457	483	483	660				
	<b>RTA 00</b>	1 per carton											
 <p><b>Two Seater Wingback Armchair</b> COM: 9.5 YD   8.69 M Unit weight: 133 LB   60.5 KG Carton weight: 163 LB   73.94 KG Carton volume: 52.5 FT³   1.48 MT³</p>	<b>GC3692HB</b>	3742	4046	4303	4597	5082	5528	5975	6364	6849	7305	7922	8796
	Active weight 350 lbs/seat.	<b>OVERALL DIMENSIONS</b> W D H			<b>SEAT DIMENSIONS</b> W D H			<b>BACK DIMENSIONS</b> W H					
		IN 57.5	28.5	45.5	50	18	19	45	26				
		MM 1461	724	1156	1270	457	483	1143	660				
	<b>RTA 00</b>	1 per carton											
 <p><b>Bariatric Single Seater Wingback Armchair</b> COM: 8.25 YD   7.54 M Unit weight: 109 LB   49.5 KG Carton weight: 130 LB   58.97 KG Carton volume: 35.5 FT³   1 MT³</p>	<b>GC3694HB</b>	3054	3318	3541	3797	4218	4605	4993	5331	5752	6148	6684	7443
	Active weight 600 lbs.	<b>OVERALL DIMENSIONS</b> W D H			<b>SEAT DIMENSIONS</b> W D H			<b>BACK DIMENSIONS</b> W H					
		IN 38	28.5	45.5	31	18	19	26.5	26				
		MM 965	724	1156	787	457	483	673	660				
	<b>RTA 00</b>	1 per carton											

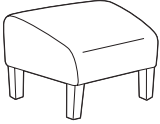
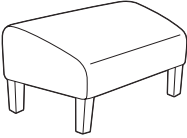
DESCRIPTION	MODEL# / FEATURES	STANDARD TEXTILE GRADES											
		COM	2	3	4	5	6	7	8	9	10	11	12
 <p><b>Standard Size Ottoman</b> COM: 1.25 YD   1.14 M Unit weight: 12 LB   5.5 KG Carton weight: 17 LB   7.71 KG Carton volume: 4.7 FT³   0.13 MT³</p>	<b>GC3695</b>	675	715	749	788	851	910	969	1020	1084	1144	1225	1340
		<b>OVERALL DIMENSIONS</b> W D H			<b>SEAT DIMENSIONS</b> W D H			<b>BACK DIMENSIONS</b> W H					
	Active weight 350 lbs.	IN 23	18	15.75	-	-	-	-	-	-	-	-	-
	Add \$81 for (MB).	MM 584	457	400	-	-	-	-	-	-	-	-	-
		<b>RTA 00</b>		1 per carton									
 <p><b>Bariatric Ottoman</b> COM: 1.75 YD   1.6 M Unit weight: 15 LB   6.8 KG Carton weight: 20 LB   9.07 KG Carton volume: 9 FT³   0.25 MT³</p>	<b>GC3696</b>	848	904	951	1006	1095	1177	1259	1331	1420	1504	1618	1779
		<b>OVERALL DIMENSIONS</b> W D H			<b>SEAT DIMENSIONS</b> W D H			<b>BACK DIMENSIONS</b> W H					
	Active weight 500 lbs.	IN 31.25	18	15.75	-	-	-	-	-	-	-	-	
	Add \$122 for (MB).	MM 794	457	400	-	-	-	-	-	-	-	-	
		<b>RTA 00</b>		1 per carton									

PRIMACARE RECLINERS



model GC3608



model GC3609

STANDARD FEATURES

- Primacare is a family of products offering the most significant return on investment approach in the industry since every component can be repaired or replaced on site.
- Solid hardwood frame with die cast zinc connectors and metal-to-metal fastening. Available in the following finishes: Absolute (AAM), Charcoal Java (CJM), Cherry (ACM), Empire Mahogany (EMM), English Oak (EOM), Espresso Cafe (ECM), Fruitwood (TFM), Gray (HGM), Harvest Oak (HOM), Honey (AHM), Jet Onyx (JOM), Light Honey (LHM), Mahogany (TMM), Maple (AVM), Medium Walnut (MWM), Natural Walnut (NLW), Night (ASM), Noce Biondo (NBM), Noce Grigio (NGM), Noce Leggero (NEM), Noce Medio (NMM), Sandy Beach (SBM), Shaker Cherry (SKM), Silver Oak (SOM), Walnut (TWM), White (WHM), WC Cream (WTM) and Winter Cherry (WCM).
- Armcaps are securely fastened with metal-to-metal connectors which allow for field replacement if required.
- Easy grip forward extending armcap on models with arms.
- For healthcare textile options, visit the website at [globalfurnituregroup.com](http://globalfurnituregroup.com).
- Can be upholstered in standard Global textiles if healthcare compliance is not required.
- Shipped easy to assemble.

OPTIONAL FEATURES

- Urethane armcaps are available in the following finishes: Black (BLK), Kalua (KAL), Latte (LAB), Mocha (J52), Shadow (SHW) and Toast (TOA). Please specify. No upcharge.
- Urethane armcaps are not available on models GC3606 and GC3609.
- For moisture barrier on seat, please specify (MB). Add \$122 per seat.
- To add sealed seams to your product contact Customer Service. Upcharges vary.
- For Primacare tables, see page 59.





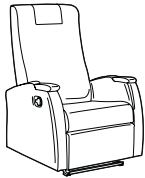

GC3608 AND GC3609 ONLY

- To add a Reverse Recline mechanism, please specify (RR). No upcharge.
- Tablet arm with spill collector on the edge is available, offered in Black Phenolic material. From seated position, specify (LT) for left hand tablet or (RT) for right hand tablet. Add \$572. For left and right tablets, please specify (TB). Add \$1143.
- A Foley bag hook can be positioned on the left (LT) or right (RT). Add \$23. For left and right Foley bag hooks, please specify (LR). Add \$45.
- An IV pole that can be positioned on the left or right side is available. Specify (IV). Add \$247.
- An oxygen tank holder is available, please specify (OX). Add \$142.
- Footrest in Grey thermally fused laminate with a Black edge is available. Specify (FT). Add \$199.

SUGGESTED APPLICATIONS

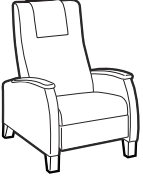
- Guest seating
- Lobbies
- Lounge/Waiting
- Patient rooms
- Resident rooms
- Treatment/Exam rooms

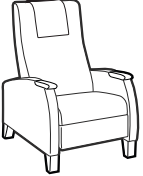
DESCRIPTION	MODEL# / FEATURES	STANDARD TEXTILE GRADES											
		COM	2	3	4	5	6	7	8	9	10	11	12
 <p><b>Recliner Solid Wood Armcaps, Full Span</b> COM: 6.5 YD   5.94 M Unit weight: 98 LB   44.5 KG Carton weight: 110 LB   49.9 KG Carton volume: 22.75 FT³   0.64 MT³</p>	<b>GC3605</b>	2524	2732	2908	3109	3441	3746	4052	4318	4650	4962	5384	5982
	Active weight 350 lbs.												
	Head mat & replaceable seat cushion.												
	Optional urethane armcaps. Please specify. No upcharge.												
Not available with casters.		<b>RTA 2</b>		1 per carton									
 <p><b>Recliner Partial (Front Only) Solid Wood Armcaps</b> COM: 6.5 YD   5.94 M Unit weight: 98 LB   44.5 KG Carton weight: 110 LB   49.9 KG Carton volume: 22.75 FT³   0.64 MT³</p>	<b>GC3606</b>	2359	2567	2743	2944	3276	3581	3887	4153	4485	4797	5219	5817
	Active weight 350 lbs.												
	Head mat & replaceable seat cushion.												
	Not available with casters.	<b>RTA 2</b>		1 per carton									

DESCRIPTION	MODEL# / FEATURES	STANDARD TEXTILE GRADES												
		COM	2	3	4	5	6	7	8	9	10	11	12	
 <p><b>Headrest For Primacare Recliners Only</b>                      COM: 1.25 YD   1.14 M                      Unit weight: 1.5 LB   0.7 KG                      Carton weight: 3 LB   1.36 KG                      Carton volume: 1 FT³   0.02 MT³</p>	<b>GC3607</b>	122	162	196	235	298	357	416	467	531	591	672	787	
		<b>OVERALL DIMENSIONS</b>			<b>SEAT DIMENSIONS</b>			<b>BACK DIMENSIONS</b>						
		<b>W</b>	<b>D</b>	<b>H</b>	<b>W</b>	<b>D</b>	<b>H</b>	<b>W</b>	<b>H</b>					
		IN 14	4	9.5	-	-	-	-	-					
	MM 356	102	241	-	-	-	-	-						
		<b>RTA 00</b>		1 per carton										
 <p><b>Motion Recliner Solid Wood Armcaps, Full Span</b>                      COM: 6.5 YD   5.94 M                      Unit weight: 110 LB   50 KG                      Carton weight: 120 LB   54.43 KG                      Carton volume: 27.75 FT³   0.78 MT³</p>	<b>GC3608</b>	3149	3357	3533	3734	4066	4371	4677	4943	5275	5587	6009	6607	
		<b>OVERALL DIMENSIONS</b>			<b>SEAT DIMENSIONS</b>			<b>BACK DIMENSIONS</b>						
		<b>W</b>	<b>D</b>	<b>H</b>	<b>W</b>	<b>D</b>	<b>H</b>	<b>W</b>	<b>H</b>					
		IN 30	39	46.5	23.5	20	19	22.5	29					
	MM 762	991	1181	597	508	483	572	737						
		<b>RTA 2</b>		1 per carton										
		Active weight 400 lbs. Optional urethane armcaps. Please specify. No upcharge. Optional 4 manual locking casters w/push bar. Please specify (MRC). No upcharge.												
 <p><b>Motion Recliner Partial (Front Only) Solid Wood Armcaps</b>                      COM: 6.5 YD   5.94 M                      Unit weight: 110 LB   50 KG                      Carton weight: 120 LB   54.43 KG                      Carton volume: 27.75 FT³   0.78 MT³</p>	<b>GC3609</b>	2705	2913	3089	3290	3622	3927	4233	4499	4831	5143	5565	6163	
		<b>OVERALL DIMENSIONS</b>			<b>SEAT DIMENSIONS</b>			<b>BACK DIMENSIONS</b>						
		<b>W</b>	<b>D</b>	<b>H</b>	<b>W</b>	<b>D</b>	<b>H</b>	<b>W</b>	<b>H</b>					
		IN 30	39	46.5	23.5	20	19	22.5	29					
	MM 762	991	1181	597	508	483	572	737						
		<b>RTA 2</b>		1 per carton										
		Active weight 400 lbs. Optional 4 manual locking casters w/push bar. Please specify (MRC). No upcharge.												

PRIMACARE SLEEPERS



model GC3611



model GC3611 (pulled out)

STANDARD FEATURES



- Primacare is a family of products offering the most significant return on investment approach in the industry since every component can be repaired or replaced on site.
- Solid hardwood frame with die cast zinc connectors and metal-to-metal fastening. Available in the following finishes: Absolute (AAM), Charcoal Java (CJM), Cherry (ACM), Empire Mahogany (EMM), English Oak (EOM), Espresso Cafe (ECM), Fruitwood (TFM), Gray (HGM), Harvest Oak (HOM), Honey (AHM), Jet Onyx (JOM), Light Honey (LHM), Mahogany (TMM), Maple (AVM), Medium Walnut (MWM), Natural Walnut (NLW), Night (ASM), Noce Biondo (NBM), Noce Grigio (NGM), Noce Leggero (NEM), Noce Medio (NMM), Sandy Beach (SBM), Shaker Cherry (SKM), Silver Oak (SOM), Walnut (TWM), White (WHM), WC Cream (WTM) and Winter Cherry (WCM).
- Armcaps are securely fastened with metal-to-metal connectors which allow for field replacement if required.
- Easy grip forward extending armcap on models with arms.
- For healthcare textile options, visit the website at [globalfurnituregroup.com](http://globalfurnituregroup.com).
- Can be upholstered in standard Global textiles if healthcare compliance is not required.
- Shipped fully assembled.

OPTIONAL FEATURES

- Urethane armcaps are available in the following finishes: Black (BLK), Kalia (KAL), Latte (LAB), Mocha (J52), Shadow (SHW) and Toast (TOA). Please specify. No upcharge.
- Tablet arm with spill collector on the edge is available, offered in Black Phenolic material. From a seated position, specify **(LT)** for left hand tablet or **(RT)** for right hand tablet. Add \$572. For left and right tablets, please specify **(TB)**. Add \$1143.
- For moisture barrier on seat, please specify **(MB)**. For single sleeper: Add \$122. For double sleeper: Add \$245.
- To add sealed seams to your product contact Customer Service. Upcharges vary.
- For Primacare tables, see page 59.

SUGGESTED APPLICATIONS

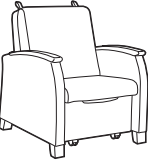
- Guest seating
- Lounge/Waiting
- Patient rooms
- Resident rooms
- Treatment/Exam rooms

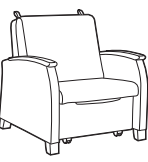
DESCRIPTION	MODEL# / FEATURES	STANDARD TEXTILE GRADES											
		COM	2	3	4	5	6	7	8	9	10	11	12
 <p><b>Single Sleeper Chair, Wood Legs</b> COM: 7.5 YD   6.86 M Unit weight: 108 LB   49.1 KG Carton weight: 116 LB   52.62 KG Carton volume: 32.25 FT<sup>3</sup>   0.91 MT<sup>3</sup></p>	<b>GC3610</b>												
	Active weight 350 lbs.												
	Sleep surface 24.5"W x 77"L.												
	Optional urethane armcaps. Please specify. No upcharge.	<b>RTA 00</b>	1 per carton										
		COM	2	3	4	5	6	7	8	9	10	11	12
		<b>OVERALL DIMENSIONS</b>			<b>SEAT DIMENSIONS</b>			<b>BACK DIMENSIONS</b>					
		<b>W</b>	<b>D</b>	<b>H</b>	<b>W</b>	<b>D</b>	<b>H</b>	<b>W</b>	<b>H</b>				
	IN	31.5	37.5	38	24	20	18	24	21				
	MM	800	953	965	610	508	457	610	533				
 <p><b>Single Sleeper Chair, Casters</b> COM: 7.5 YD   6.86 M Unit weight: 108 LB   49.1 KG Carton weight: 116 LB   52.62 KG Carton volume: 32.25 FT<sup>3</sup>   0.91 MT<sup>3</sup></p>	<b>GC3610C</b>												
	Active weight 350 lbs.												
	Sleep surface 24.5"W x 77"L.												
	Optional urethane armcaps. Please specify. No upcharge.	<b>RTA 00</b>	1 per carton										
		COM	2	3	4	5	6	7	8	9	10	11	12
		<b>OVERALL DIMENSIONS</b>			<b>SEAT DIMENSIONS</b>			<b>BACK DIMENSIONS</b>					
		<b>W</b>	<b>D</b>	<b>H</b>	<b>W</b>	<b>D</b>	<b>H</b>	<b>W</b>	<b>H</b>				
	IN	31.5	37.5	38	24	20	18	24	21				
	MM	800	953	965	610	508	457	610	533				
 <p><b>Single Sleeper Chair, Wide, Wood Legs</b> COM: 9 YD   8.23 M Unit weight: 128 LB   58.2 KG Carton weight: 140 LB   63.5 KG Carton volume: 36.75 FT<sup>3</sup>   1.04 MT<sup>3</sup></p>	<b>GC3611</b>												
	Active weight 350 lbs.												
	Sleep surface 30"W x 77"L.												
	Optional urethane armcaps. Please specify. No upcharge.	<b>RTA 00</b>	1 per carton										
		COM	2	3	4	5	6	7	8	9	10	11	12
		<b>OVERALL DIMENSIONS</b>			<b>SEAT DIMENSIONS</b>			<b>BACK DIMENSIONS</b>					
		<b>W</b>	<b>D</b>	<b>H</b>	<b>W</b>	<b>D</b>	<b>H</b>	<b>W</b>	<b>H</b>				
	IN	37	37.5	38	30	20	18	30	21				
	MM	940	953	965	762	508	457	762	533				

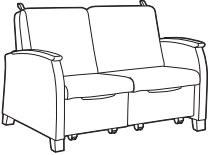
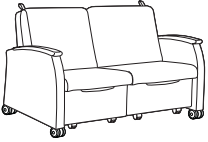

DESCRIPTION	MODEL# / FEATURES	STANDARD TEXTILE GRADES										
		COM	2	3	4	5	6	7	8	9	10	11
 <p><b>Single Sleeper Chair, Wide, Casters</b>                      COM: 9 YD   8.23 M                      Unit weight: 128 LB   58.2 KG                      Carton weight: 140 LB   63.5 KG                      Carton volume: 36.75 FT<sup>3</sup>   1.04 MT<sup>3</sup></p>	<b>GC3611C</b>											
	Active weight 350 lbs.											
	Sleep surface 30"W x 77"L.											
	Optional urethane armcaps. Please specify. No upcharge.	<b>RTA 00</b>	1 per carton									
 <p><b>Double Sleeper Chair, Wood Legs</b>                      COM: 11.75 YD   10.74 M                      Unit weight: 205 LB   93.2 KG                      Carton weight: 215 LB   97.52 KG                      Carton volume: 60 FT<sup>3</sup>   1.69 MT<sup>3</sup></p>	<b>GC3612</b>											
	Active weight 350 lbs/seat.											
	Each sleep surface is 24.5"W x 77"L.											
	Optional urethane armcaps. Please specify. No upcharge.	<b>RTA 00</b>	1 per carton									
 <p><b>Double Sleeper Chair, Casters</b>                      COM: 11.75 YD   10.74 M                      Unit weight: 205 LB   93.2 KG                      Carton weight: 215 LB   97.52 KG                      Carton volume: 60 FT<sup>3</sup>   1.69 MT<sup>3</sup></p>	<b>GC3612C</b>											
	Active weight 350 lbs/seat.											
	Each sleep surface is 24.5"W x 77"L.											
	Optional urethane armcaps. Please specify. No upcharge.	<b>RTA 00</b>	1 per carton									

PRIMACARE BENCHES



model GC3651 (HT)



model GC3652W (Wood)

STANDARD FEATURES







- Primacare is a family of products offering the most significant return on investment approach in the industry since every component can be repaired or replaced on site.
- **High traffic (HT) models:** Metal frame with die cast zinc connectors and metal-to-metal fasteners. Available in the following finishes: Black (TBL), Cloud (TIV), Designer White (TDW), Fog (TFO), Frost (TFR), Kalua (TKA), Latte (TLA), Mocha (TMO), Nevada (TNE), Sand (TSN), Shadow (TSH), Toast (TOA) and Tungsten (TTU).
- **Wood models:** Solid hardwood frame with die cast zinc connectors and metal-to-metal fastening. Available in the following finishes: Absolute (AAM), Charcoal Java (CJM), Cherry (ACM), Empire Mahogany (EMM), English Oak (EOM), Espresso Cafe (ECM), Fruitwood (TFM), Gray (HGM), Harvest Oak (HOM), Honey (AHM), Jet Onyx (JOM), Light Honey (LHM), Mahogany (TMM), Maple (AVM), Medium Walnut (MWM), Natural Walnut (NLW), Night (ASM), Noce Biondo (NBM), Noce Grigio (NGM), Noce Leggero (NEM), Noce Medio (NMM), Sandy Beach (SBM), Shaker Cherry (SKM), Silver Oak (SOM), Walnut (TWM), White (WHM), WC Cream (WTM) and Winter Cherry (WCM).
- **Ottoman models:** legs are standard in Black (BLK) urethane (urethane). Available as an option in the following finishes: Mocha (J52), Shadow (SHW) and Toast (TOA). Optional wood legs are also available, refer to the Seating wood finishes in the Textiles and Finishes section.
- Replaceable and/or removable cushions are standard.
- For healthcare textile options, visit the website at [globalfurnituregroup.com](http://globalfurnituregroup.com).
- Can be upholstered in standard Global textiles if healthcare compliance is not required.
- Shipped fully assembled.
- **HIGH TRAFFIC (HT) MODELS ARE LISTED FIRST, FOLLOWED BY WOOD MODELS.**



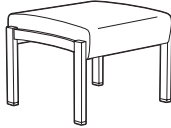

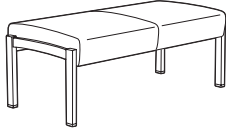
OPTIONAL FEATURES

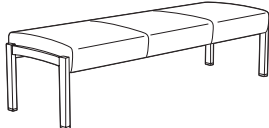
- For moisture barrier on seat, please specify **(MB)**. Add \$81 per seat.
- To add sealed seams to your product contact Customer Service. Upcharges vary.
- For Primacare tables, see page 59.

SUGGESTED APPLICATIONS

- Guest seating
- Lounge/Waiting
- Patient rooms
- Resident rooms

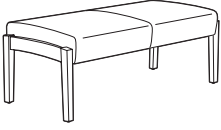
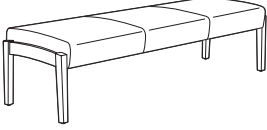
DESCRIPTION	MODEL# / FEATURES	STANDARD TEXTILE GRADES											
		COM	2	3	4	5	6	7	8	9	10	11	12
 <p><b>Single Seat Bench (HT)</b> COM: 1.25 YD   1.14 M Unit weight: 26 LB   11.8 KG Carton weight: 31 LB   14.06 KG Carton volume: 9.75 FT<sup>3</sup>   0.27 MT<sup>3</sup></p>	<p>GC3651 Metal</p>	1400	1440	1474	1513	1576	1635	1694	1745	1809	1869	1950	2065
		OVERALL DIMENSIONS			SEAT DIMENSIONS			BACK DIMENSIONS					
		W	D	H	W	D	H	W	H				
		IN 26.5 MM 673	22.5 572	19 483	- -	- -	19 483	- -	- -				
				1 per carton									
 <p><b>Two Seat Bench (HT)</b> COM: 2 YD   1.83 M Unit weight: 42 LB   19.1 KG Carton weight: 48 LB   21.77 KG Carton volume: 20.25 FT<sup>3</sup>   0.57 MT<sup>3</sup></p>	<p>GC3652 Metal</p>	2127	2191	2245	2307	2409	2503	2597	2679	2781	2877	3007	3191
		OVERALL DIMENSIONS			SEAT DIMENSIONS			BACK DIMENSIONS					
		W	D	H	W	D	H	W	H				
		IN 49.5 MM 1257	22.5 572	19 483	- -	- -	19 483	- -	- -				
				1 per carton									
 <p><b>Three Seat Bench (HT)</b> COM: 2.75 YD   2.51 M Unit weight: 60 LB   27.3 KG Carton weight: 66 LB   29.94 KG Carton volume: 28.75 FT<sup>3</sup>   0.81 MT<sup>3</sup></p>	<p>GC3653 Metal</p>	2856	2944	3018	3104	3244	3373	3502	3615	3755	3887	4066	4319
		OVERALL DIMENSIONS			SEAT DIMENSIONS			BACK DIMENSIONS					
		W	D	H	W	D	H	W	H				
		IN 72.5 MM 1842	22.5 572	19 483	- -	- -	19 483	- -	- -				
				1 per carton									

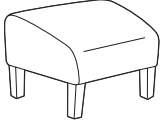
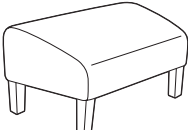
DESCRIPTION	MODEL# / FEATURES	STANDARD TEXTILE GRADES											
		COM	2	3	4	5	6	7	8	9	10	11	12
 <p><b>Single Seat Bench (Wood)</b> COM: 1.25 YD   1.14 M Unit weight: 20 LB   9.1 KG Carton weight: 26 LB   11.79 KG Carton volume: 9.75 FT³   0.27 MT³</p>	<b>GC3651W</b> Wood	1189	1229	1263	1302	1365	1424	1483	1534	1598	1658	1739	1854
		<b>OVERALL DIMENSIONS</b>			<b>SEAT DIMENSIONS</b>			<b>BACK DIMENSIONS</b>					
			<b>W</b>	<b>D</b>	<b>H</b>	<b>W</b>	<b>D</b>	<b>H</b>	<b>W</b>	<b>H</b>			
	Active weight 350 lbs.	IN	26.5	22.5	19	-	-	19	-	-			
		MM	673	572	483	-	-	483	-	-			
	<b>RTA 00</b>		1 per carton										
 <p><b>Two Seat Bench (Wood)</b> COM: 2 YD   1.83 M Unit weight: 36 LB   16.4 KG Carton weight: 41 LB   18.6 KG Carton volume: 20.25 FT³   0.57 MT³</p>	<b>GC3652W</b> Wood	1883	1947	2001	2063	2165	2259	2353	2435	2537	2633	2763	2947
		<b>OVERALL DIMENSIONS</b>			<b>SEAT DIMENSIONS</b>			<b>BACK DIMENSIONS</b>					
			<b>W</b>	<b>D</b>	<b>H</b>	<b>W</b>	<b>D</b>	<b>H</b>	<b>W</b>	<b>H</b>			
	Active weight 350 lbs/seat.	IN	49.5	22.5	19	-	-	19	-	-			
		MM	1257	572	483	-	-	483	-	-			
	<b>RTA 00</b>	1 per carton											
 <p><b>Three Seat Bench (Wood)</b> COM: 2.75 YD   2.51 M Unit weight: 55 LB   25 KG Carton weight: 61 LB   27.67 KG Carton volume: 28.75 FT³   0.81 MT³</p>	<b>GC3653W</b> Wood	2576	2664	2738	2824	2964	3093	3222	3335	3475	3607	3786	4039
		<b>OVERALL DIMENSIONS</b>			<b>SEAT DIMENSIONS</b>			<b>BACK DIMENSIONS</b>					
			<b>W</b>	<b>D</b>	<b>H</b>	<b>W</b>	<b>D</b>	<b>H</b>	<b>W</b>	<b>H</b>			
	Active weight 350 lbs/seat.	IN	72.5	22.5	19	-	-	19	-	-			
		MM	1842	572	483	-	-	483	-	-			
	<b>RTA 00</b>		1 per carton										
 <p><b>Standard Size Ottoman</b> COM: 1.25 YD   1.14 M Unit weight: 12 LB   5.5 KG Carton weight: 17 LB   7.71 KG Carton volume: 4.7 FT³   0.13 MT³</p>	<b>GC3695</b>	675	715	749	788	851	910	969	1020	1084	1144	1225	1340
		<b>OVERALL DIMENSIONS</b>			<b>SEAT DIMENSIONS</b>			<b>BACK DIMENSIONS</b>					
			<b>W</b>	<b>D</b>	<b>H</b>	<b>W</b>	<b>D</b>	<b>H</b>	<b>W</b>	<b>H</b>			
	Active weight 350 lbs.	IN	23	18	15.75	-	-	-	-	-			
	Standard leg is Black urethane.	MM	584	457	400	-	-	-	-	-			
Optional urethane colors or wood legs. No upcharge.	<b>RTA 00</b>	1 per carton											
 <p><b>Bariatric Ottoman</b> COM: 1.75 YD   1.6 M Unit weight: 15 LB   6.8 KG Carton weight: 20 LB   9.07 KG Carton volume: 9 FT³   0.25 MT³</p>	<b>GC3696</b>	848	904	951	1006	1095	1177	1259	1331	1420	1504	1618	1779
		<b>OVERALL DIMENSIONS</b>			<b>SEAT DIMENSIONS</b>			<b>BACK DIMENSIONS</b>					
			<b>W</b>	<b>D</b>	<b>H</b>	<b>W</b>	<b>D</b>	<b>H</b>	<b>W</b>	<b>H</b>			
	Active weight 500 lbs.	IN	31.25	18	15.75	-	-	-	-	-			
	Standard leg is Black urethane.	MM	794	457	400	-	-	-	-	-			
Optional urethane colors or wood legs. No upcharge.	<b>RTA 00</b>	1 per carton											

PRIMACARE MODULAR



STANDARD FEATURES

- Modular seating tops: Linking applications are available for medium and high back patient top units, low back guest top units and lounge top units.
  - All modular seating top units are complete with frame and cushions. Leg/arm frames are ordered separately according to the desired specification.
  - Frame design features a wall saver leg to prevent damage to walls. Frame construction ensures metal-to-metal fastening.
  - For leg/arm frames and modular tables with power/USB module, refer to models ending in "M". Module includes two power outlets, four USB charging ports and a 6 foot long power cord. Available in Black or White (must be specified at time of order).
  - Replaceable and/or removable seat and back cushions with replaceable cushion covers are standard.
  - Seat cushion has a seamless waterfall front and clean out between and around the seat and back cushions.
  - All **(CA)** models have closed upholstered arm panel inserts at each arm position.
  - For added comfort, seats are standard with high density Ultracell foam.
  - Active weight capacity up to 500 lbs/seat when using metal frame, fully upholstered frame or on bariatric models; up to 350 lbs/seat when using wood frame.
  - For healthcare textile options, visit the website at [globalfurnituregroup.com](http://globalfurnituregroup.com).
  - Can be upholstered in standard Global textiles if healthcare compliance is not required.
  - Left and right position reference is determined from the seated position.
- Metal leg/arm frames are available in the following finishes: Black (TBL), Cloud (TIV), Designer White (TDW), Fog (TFO), Frost (TFR), Kalua (TKA), Latte (TLA), Mocha (TMO), Nevada (TNE), Sand (TSN), Shadow (TSH), Toast (TOA) and Tungsten (TTU). Please specify.
  - Wood leg/arm frames and armcaps are available in the following finishes: Absolute (AAM), Charcoal Java (CJM), Cherry (ACM), Empire Mahogany (EMM), English Oak (EOM), Espresso Cafe (ECM), Fruitwood (TFM), Gray (HGM), Harvest Oak (HOM), Honey (AHM), Jet Onyx (JOM), Light Honey (LHM), Mahogany (TMM), Maple (AVM), Medium Walnut (MWM), Natural Walnut (NLW), Night (ASM), Noce Biondo (NBM), Noce Grigio (NGM), Noce Leggero (NEM), Noce Medio (NMM), Sandy Beach (SBM), Shaker Cherry (SKM), Silver Oak (SOM), Walnut (TWM), White (WHM), WC Cream (WTM) and Winter Cherry (WCM). See features column for upcharges.
  - Armcaps are securely fastened with metal-to-metal connectors which allows for field replacement if required. Armcaps cannot be retrofitted in the field on units with no existing armcaps.
  - For moisture barrier on seat, please specify **(MB)**. Add \$81 per seat. For bariatric/lounge models, add \$122 per seat.
  - To add sealed seams to your product contact Customer Service. Upcharges vary.

For Primacare freestanding tables, see page 59.  
 For Primacare Modular tables, see page 196.  
 For Primacare Modular lounge tables, see page 210.

SUGGESTED APPLICATIONS

- Bariatric seating
- Guest seating
- Lobbies
- Lounge/Waiting

OPTIONAL FEATURES

- Urethane armcaps are available in the following finishes: Black (BLK), Kalua (KAL), Latte (LAB), Mocha (J52), Shadow (SHW) and Toast (TOA).

MODULAR TABLES

Modular tables are offered with wood or metal legs. 1" thick table tops are available in high pressure laminate (HP). Please select the appropriate model number for the finish you prefer.

**Note:** Modular tables are shipped KD (knock down) as per the published cube and weight. For freestanding Primacare tables, see page 59

High pressure laminate (HP):

Absolute Acajou (ACJ)	First Class (FCL)
Asian Night (ASN)	Quartered Mahogany (QTM)
Avant Cherry (W357)	Noce Biondo (NBL)
Avant Honey (W356)	Noce Grigio (NGL)
Black (BLK)	Noce Leggero (NEL)
Blizzard (BZD)	Noce Medio (NML)
Brushed Cobalt (BRC)	Sheer Beauty (SBY)
Clear Maple (CMB)	Stonedust (SDT)
Custom Grey (CGY)	Walnut Heights (WHE)
Dark Espresso (W142)	White Chocolate (WHC)
Designer White (DWT)	Winter Cherry (WCR)
Fashionista (FAS)	

Metal leg and frame finishes:

Available in Black (TBL), Cloud (TIV), Designer White (TDW), Fog (TFO), Frost (TFR), Kalua (TKA), Latte (TLA), Mocha (TMO), Nevada (TNE), Sand (TSN), Shadow (TSH), Toast (TOA) and Tungsten (TTU). Please specify.

SHIPPING INFORMATION:

Product components and parts will be shipped knocked down (**KD**). Weight and volume are indicated with each item KD. They will not be shipped assembled.

Assembled with drawing:

Product orders that are part of a linked application may require a combination of complete units and components for build up to achieve the limitless configurations that are possible. CAD drawing must be submitted with order when requesting units ship assembled.

Global will provide assembled units under the following conditions:

1. Detailed drawing clearly indicating:
  - The layout and location of each model number being ordered (see sample following).
  - If multiple textiles are used - textile color codes must be clearly identified on drawing.
2. Global will carton assemble orders to a maximum of 3 regular seat positions, which is the largest carton available.
3. Global reserves the right to determine the best method of assembly based on the information provided with the order.

PACKAGE 1 - Primacare HT

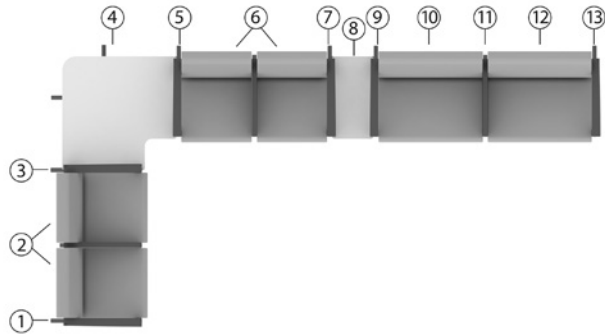

Always call out components as if seated in the chairs.

Item	Description	Qty	Model #	W x D x H	Yardage	Unit Weight	Carton Volume
1	Right End Frame with Right Armcap	1	GC3620RA	2.5 x 27 x 26.5	-	6	1.4
2, 6	Guest Low Back Two Seat Top w/Half Center Arm	2	GC3623TOP	42 x 25 x 19	3.25	58	43
3, 7	Seat to Table Center Linking Frame w/Left Armcap	2	GC3622TLA	2.5 x 27 x 26.5	-	6	1.4
4	Right Corner Table	1	GC3671R-HP	33 x 33 x 17	-	40	6
5, 9	Seat to Table Center Linking Frame w/Right Armcap	2	GC3622TRA	2.5 x 27 x 26.5	-	6	1.4
8	Narrow Center Table	1	GC3673-HP	12 x 23.87 x 5.5	-	14	2.1
10, 12	Guest Low Back Bariatric Top	2	GC3637TOP	30 x 25 x 19	2.5	43	26.5
11	Seat to Seat Center Linking Frame w/Narrow Armcap	1	GC3622LA	2.5 x 27 x 26.5	-	6	1.4
13	Left End Frame with Left Armcap	1	GC3620LA	2.5 x 27 x 26.5	-	6	1.4

PACKAGE 2 - Primacare HT

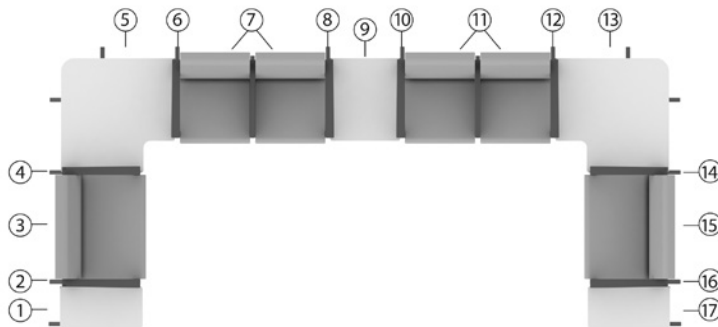

Always call out components as if seated in the chairs.

Item	Description	Qty	Model #	W x D x H	Yardage	Unit Weight	Carton Volume
1	Narrow Right End Table	1	GC3675R-HP	12 x 23.87 x 17	-	14	2.1
2, 6, 10, 14	Seat to Table Center Linking Frame w/Right Armcap	4	GC3622TRA	2.5 x 27 x 26.5	-	6	1.4
3, 15	Guest Low Back Bariatric Top	2	GC3637TOP	30 x 25 x 19	2.5	43	26.5
4, 8, 12, 16	Seat to Table Center Linking Frame w/Left Armcap	4	GC3622TLA	2.5 x 27 x 26.5	-	6	1.4
5	Right Corner Table	1	GC3671R-HP	33 x 33 x 17	-	40	6
7, 11	Guest Low Back Two Seat Top w/Half Center Arm	2	GC3623TOP	42 x 25 x 19	3.25	58	43
9	Regular Center Table	1	GC3672-HP	20.25 x 23.87 x 5.5	-	15	3.4
13	Left Corner Table	1	GC3671L-HP	33 x 33 x 17	-	46	6
17	Narrow Left End Table	1	GC3675L-HP	12 x 23.87 x 17	-	14	2.1

PACKAGE 3 - Primacare Wood

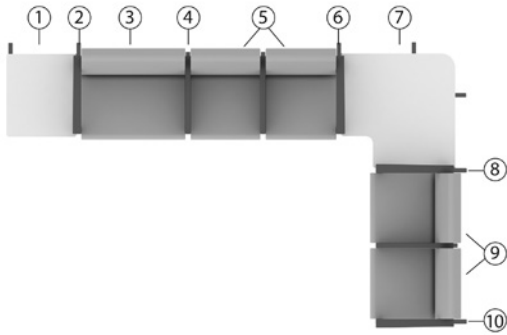

Always call out components as if seated in the chairs.

Item	Description	Qty	Model #	W x D x H	Yardage	Unit Weight	Carton Volume
1	Right End Run Table	1	GC3674WR-HP	20.25 x 23.87 x 17	-	15	3.4
2, 8	Seat to Table Center Linking Frame w/Right Armcap	2	GC3622WTRA	2.5 x 27 x 26.5	-	4	1.4
3	Guest Low Back Bariatric Top	1	GC3637TOP	30 x 25 x 19	2.5	43	26.5
4	Seat to Seat Center Linking Frame w/Narrow Armcap	1	GC3622WLA	2.5 x 27 x 26.5	-	4	1.4
5, 9	Guest Low Back Two Seat Top w/Half Center Arm	2	GC3623WTOP	42 x 25 x 19	3.25	60	43
6	Seat to Table Center Linking Frame w/Left Armcap	1	GC3622WTLA	2.5 x 27 x 26.5	-	4	1.4
7	Left Corner Table	1	GC3671WL-HP	33 x 33 x 17	-	46	6
10	Left End Frame w/Left Armcap	1	GC3620WLA	2 x 23 x 26	-	5	1.4

**MODULAR TOP UNITS**

	SINGLE SEAT BARIATRIC	TWO SEATER, NO CENTER ARM	TWO SEATER, CENTER ARM	THREE SEATER, NO CENTER ARMS	THREE SEATER, TWO ARMS		
<b>Guest seating</b>	<p>medium back</p> <p>GC3620TOP GC3637TOP</p>	<p>medium back</p> <p>GC3621TOP</p>	<p>medium back</p> <p>GC3623TOP GC3623WTOP</p>	<p>high back</p> <p>GC3623HB-TOP GC3623WHB-TOP</p>	<p>medium back</p> <p>GC3624TOP</p>	<p>medium back</p> <p>GC3626TOP GC3626WTOP</p>	<p>high back</p> <p>GC3626HB-TOP GC3626WHB-TOP</p>
<b>Patient seating</b>	<p>medium back</p> <p>GC3631TOP GC3638TOP</p>		<p>GC3623CATOP GC3623HBCA-TOP</p>		<p>GC3626CATOP GC3626HBCA-TOP</p>		

**LEG / ARM FRAMES**

**Wood frame: Must select armcap**  
**Metal frame: Standard with Black urethane armcap (see notes for wood and urethane finish options)**

	LEFT, OPEN	RIGHT, OPEN	LEFT, CLOSED	RIGHT, CLOSED	LEFT, CLOSED LAMINATE PANEL	RIGHT, CLOSED LAMINATE PANEL
<b>Metal (HT) End</b>	GC3620LA GC3620LAM	GC3620RA GC3620RAM	GC3620LCA GC3620LCAM	GC3620RCA GC3620RCAM	GC3620LCAL	GC3620RCAL
<b>Wood End</b>	GC3620WLA GC3620WLAM	GC3620WRA GC3620WRAM				
<b>Metal (HT) Center</b>	GC3622LA		GC3622LCA		GC3622LCAL	
<b>Wood Center</b>	GC3622WLA					
<b>Metal (HT) Center table linking</b>	GC3622TLA	GC3622TRA	GC3622TLCA	GC3622TRCA	GC3622TLCAL	GC3622TRCAL
<b>Wood Center table linking</b>	GC3622WTLA	GC3622WTRA				

For frame with power/USB module\*, refer to models ending in "M"

**End Frame: Armless**

**Central Linking Frame: Armless**

	LEFT	RIGHT
<b>Metal End</b>	GC3620LNA	GC3620RNA
<b>Wood End</b>	GC3620WLNNA	GC3620WRNNA

	CENTER
<b>Metal</b>	GC3622LNA
<b>Wood</b>	GC3622WLNNA

(Center = link both sides)

\*Power module includes two power outlets, four USB charging ports and a 6 foot long power cord. Available in Black or White (must be specified at time of order).

**MODULAR TABLES**

Tables include legs to support table top (except for center tables). All tables have a metal frame.

LEFT

RIGHT

**Corner**  
(high pressure laminate top with **metal legs**)

GC3671L-HP

GC3671LM-HP

GC3671R-HP

GC3671RM-HP



**Corner**  
(high pressure laminate top with **wood legs**)

GC3671WL-HP

GC3671WLM-HP

GC3671WR-HP

GC3671WRM-HP



**Center**  
(high pressure laminate top, connects to metal or wood frame)

GC3672-HP

GC3672M-HP



**Narrow Center**  
(high pressure laminate top, connects to metal or wood frame)

GC3673-HP

GC3673M-HP



For table with power/USB module\*, refer to models ending in "M"

**End**  
(high pressure laminate top with **metal legs**)

GC3674L-HP

GC3674LM-HP

GC3674R-HP

GC3674RM-HP



**End**  
(high pressure laminate top with **wood legs**)

GC3674WL-HP

GC3674WLM-HP

GC3674WR-HP

GC3674WRM-HP



**Narrow End**  
(high pressure laminate top with **metal legs**)

GC3675L-HP

GC3675LM-HP

GC3675R-HP

GC3675RM-HP



**Narrow End**  
(high pressure laminate top with **wood legs**)

GC3675WL-HP

GC3675WLM-HP

GC3675WR-HP

GC3675WRM-HP



\*Power module includes two power outlets, four USB charging ports and a 6 foot long power cord. Available in Black or White (must be specified at time of order). Power module is mounted **on surface** on narrow tables; mounted **in surface** on larger tables (as shown above).

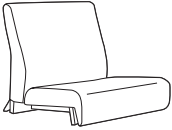
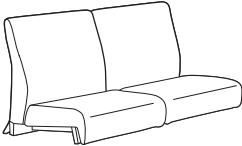
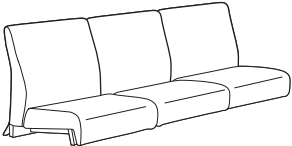
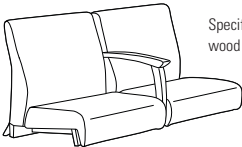
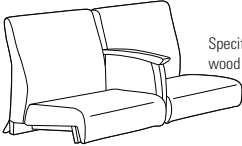

DESCRIPTION	MODEL# / FEATURES	STANDARD TEXTILE GRADES												
		COM	2	3	4	5	6	7	8	9	10	11	12	
 <p><b>LB Guest Single Seat Top</b> COM: 1.75 YD   1.6 M Unit weight: 30 LB   13.6 KG Carton weight: 36 LB   16.33 KG Carton volume: 10 FT<sup>3</sup>   0.28 MT<sup>3</sup></p>	<b>GC3620TOP</b>	742	798	845	900	989	1071	1153	1225	1314	1398	1512	1673	
	Active weight: see notes.	<b>OVERALL DIMENSIONS</b>			<b>SEAT DIMENSIONS</b>			<b>BACK DIMENSIONS</b>						
	Single frame guest top unit with 1 low back and 1 seat cushion.	<b>W</b>	<b>D</b>	<b>H</b>	<b>W</b>	<b>D</b>	<b>H</b>	<b>W</b>	<b>H</b>					
		IN 20.5	25	19	20.5	17.5	-	20.5	15					
	MM 521	635	483	521	445	-	521	381						
<b>Must be connected to a full arm/leg frame.</b>	<b>RTA 00</b>	1 per carton												
 <p><b>LB Guest Two Seat Top No Center Arm</b> COM: 3.25 YD   2.97 M Unit weight: 62 LB   28.2 KG Carton weight: 72 LB   32.66 KG Carton volume: 43 FT<sup>3</sup>   1.21 MT<sup>3</sup></p>	<b>GC3621TOP</b>	1570	1674	1762	1863	2028	2181	2334	2467	2633	2789	3000	3299	
	Active weight: see notes.	<b>OVERALL DIMENSIONS</b>			<b>SEAT DIMENSIONS</b>			<b>BACK DIMENSIONS</b>						
	Double frame guest top unit with 2 low back and 2 seat cushions.	<b>W</b>	<b>D</b>	<b>H</b>	<b>W</b>	<b>D</b>	<b>H</b>	<b>W</b>	<b>H</b>					
		IN 40	25	19	40	17.5	-	40	15					
	MM 1016	635	483	1016	445	-	1016	381						
<b>Must be connected to a full arm/leg frame.</b>	<b>RTA 00</b>	1 per carton												
 <p><b>LB Guest Three Seat Top No Center Arm</b> COM: 4.25 YD   3.89 M Unit weight: 72 LB   32.7 KG Carton weight: 82 LB   37.19 KG Carton volume: 65.25 FT<sup>3</sup>   1.84 MT<sup>3</sup></p>	<b>GC3624TOP</b>	2448	2584	2699	2831	3047	3247	3447	3621	3838	4042	4318	4709	
	Active weight: see notes.	<b>OVERALL DIMENSIONS</b>			<b>SEAT DIMENSIONS</b>			<b>BACK DIMENSIONS</b>						
	Triple frame guest top unit with 3 low back and 3 seat cushions.	<b>W</b>	<b>D</b>	<b>H</b>	<b>W</b>	<b>D</b>	<b>H</b>	<b>W</b>	<b>H</b>					
		IN 60	25	19	60	17.5	-	60	15					
	MM 1524	635	483	1524	445	-	1524	381						
<b>Must be connected to a full arm/leg frame.</b>	<b>RTA 00</b>	1 per carton												
 <p>Specify armcap: wood or urethane.</p> <p><b>LB Guest Two Seat Top Open Center Arm</b> COM: 3.25 YD   2.97 M Unit weight: metal: 58 LB   26.4 KG   wood: 60 LB   27.3 KG Carton weight: metal: 68 LB   30.84 KG   wood: 68 LB   30.84 KG Carton volume: 43 FT<sup>3</sup>   1.21 MT<sup>3</sup></p>	<b>GC3623TOP (metal)</b>	2034	2138	2226	2327	2492	2645	2798	2931	3097	3253	3464	3763	
		<b>GC3623WTOP (wood)</b>	1777	1881	1969	2070	2235	2388	2541	2674	2840	2996	3207	3506
	Active weight: see notes.	<b>OVERALL DIMENSIONS</b>			<b>SEAT DIMENSIONS</b>			<b>BACK DIMENSIONS</b>						
	Double low back frame guest top, 2 back and 2 seat cushions.	<b>W</b>	<b>D</b>	<b>H</b>	<b>W</b>	<b>D</b>	<b>H</b>	<b>W</b>	<b>H</b>					
	IN 42	25	19	20.5	17.5	-	20.5	15						
	MM 1067	635	483	521	445	-	521	381						
<b>Must be connected to a full arm/leg frame.</b>	<b>RTA 00</b>	1 per carton												
 <p>Specify armcap: wood or urethane.</p> <p><b>LB Guest Two Seat Top Closed Center Arm, Metal</b> COM: 3.5 YD   3.2 M Unit weight: metal: 66 LB   30 KG   wood: 66 LB   30 KG Carton weight: metal: 74 LB   33.57 KG   wood: 74 LB   33.57 KG Carton volume: 43 FT<sup>3</sup>   1.21 MT<sup>3</sup></p>	<b>GC3623CATOP (metal)</b>	2263	2375	2470	2578	2757	2921	3086	3229	3408	3576	3803	4125	
	Active weight: see notes.	<b>OVERALL DIMENSIONS</b>			<b>SEAT DIMENSIONS</b>			<b>BACK DIMENSIONS</b>						
	Double low back frame guest top, 2 back and 2 seat cushions.	<b>W</b>	<b>D</b>	<b>H</b>	<b>W</b>	<b>D</b>	<b>H</b>	<b>W</b>	<b>H</b>					
		IN 42	25	19	20.5	17.5	-	20.5	15					
	MM 1067	635	483	521	445	-	521	381						
<b>Must be connected to a full arm/leg frame.</b>	<b>RTA 00</b>	1 per carton												

DESCRIPTION MODEL# / FEATURES STANDARD TEXTILE GRADES

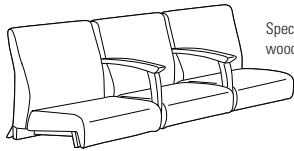

Specify armcap:  
wood or urethane.

**LB Guest Three Seat Top Open Center Arm**

COM: 4.75 YD | 4.34 M  
Unit weight: metal: 67 LB | 30.5 KG | wood: 67 LB | 30.5 KG  
Carton weight: metal: 77 LB | 34.93 KG | wood: 77 LB | 34.93 KG  
Carton volume: 65.25 FT<sup>3</sup> | 1.84 MT<sup>3</sup>

COM	2	3	4	5	6	7	8	9	10	11	12	
<b>GC3626TOP</b> (metal)	3259	3411	3539	3687	3929	4152	4375	4570	4812	5040	5349	5786
<b>GC3626WTOP</b> (wood)	2781	2933	3061	3209	3451	3674	3897	4092	4334	4562	4871	5308

Due to the size and weight, this top requires at least 3 installers.

Active weight: see notes.

	OVERALL DIMENSIONS			SEAT DIMENSIONS			BACK DIMENSIONS	
	W	D	H	W	D	H	W	H
Triple low back frame guest top, 3 back and 3 seat cushions.	IN 64	25	19	20.5	17.5	-	20.5	15
	MM 1626	635	483	521	445	-	521	381

**Must be connected to a full arm/leg frame.**

**RTA 00** 1 per carton

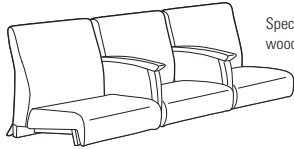

Specify armcap:  
wood or urethane.

**LB Guest Three Seat Top Closed Center Arms, Metal**

COM: 5.5 YD | 5.03 M  
Unit weight: metal: 73 LB | 33.2 KG | wood: 77 LB | 35 KG  
Carton weight: metal: 83 LB | 37.65 KG | wood: 87 LB | 39.46 KG  
Carton volume: 65.25 FT<sup>3</sup> | 1.84 MT<sup>3</sup>

COM	2	3	4	5	6	7	8	9	10	11	12	
<b>GC3626CATOP</b> (metal)	3535	3711	3860	4030	4311	4569	4828	5053	5334	5598	5955	6461

Due to the size and weight, this top requires at least 3 installers.

Active weight: see notes.

	OVERALL DIMENSIONS			SEAT DIMENSIONS			BACK DIMENSIONS	
	W	D	H	W	D	H	W	H
Triple low back frame guest top, 3 back and 3 seat cushions.	IN 64	25	19	20.5	17.5	-	20.5	15
	MM 1626	635	483	521	445	-	521	381

**Must be connected to a full arm/leg frame.**

**RTA 00** 1 per carton

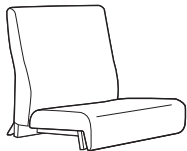

**MB Patient Top**

COM: 1.75 YD | 1.6 M  
Unit weight: 36 LB | 16.4 KG  
Carton weight: 42 LB | 19.05 KG  
Carton volume: 10 FT<sup>3</sup> | 0.28 MT<sup>3</sup>

COM	2	3	4	5	6	7	8	9	10	11	12	
<b>GC3631TOP</b>	780	836	883	938	1027	1109	1191	1263	1352	1436	1550	1711

Active weight: see notes.

Single mid back frame patient top, 1 back and 1 seat cushion.

	OVERALL DIMENSIONS			SEAT DIMENSIONS			BACK DIMENSIONS	
	W	D	H	W	D	H	W	H
	IN 20.5	25	22	20.5	17.5	-	20.5	18
	MM 521	635	559	521	445	-	521	457

**Must be connected to a full arm/leg frame.**

**RTA 00** 1 per carton



**LB Bariatric Guest Top**

COM: 2.5 YD | 2.29 M  
Unit weight: 43 LB | 19.5 KG  
Carton weight: 53 LB | 24.04 KG  
Carton volume: 26.5 FT<sup>3</sup> | 0.75 MT<sup>3</sup>

COM	2	3	4	5	6	7	8	9	10	11	12	
<b>GC3637TOP</b>	1198	1278	1346	1423	1551	1668	1786	1888	2016	2136	2298	2528

Active weight: see notes.

Single low back frame bariatric guest top, 1 back and 1 seat cushion.

	OVERALL DIMENSIONS			SEAT DIMENSIONS			BACK DIMENSIONS	
	W	D	H	W	D	H	W	H
	IN 30	25	19	30	17.5	-	30	15
	MM 762	635	483	762	445	-	762	381

**Must be connected to a full arm/leg frame.**

**RTA 00** 1 per carton



**MB Bariatric Patient Top**

COM: 2.75 YD | 2.51 M  
Unit weight: 52 LB | 23.6 KG  
Carton weight: 62 LB | 28.12 KG  
Carton volume: 30.5 FT<sup>3</sup> | 0.86 MT<sup>3</sup>

COM	2	3	4	5	6	7	8	9	10	11	12	
<b>GC3638TOP</b>	1256	1344	1418	1504	1644	1773	1902	2015	2155	2287	2466	2719



Active weight: see notes.

Single mid back frame bariatric patient top, 1 back and 1 seat cushion.

	OVERALL DIMENSIONS			SEAT DIMENSIONS			BACK DIMENSIONS	
	W	D	H	W	D	H	W	H
	IN 30	25	22	30	17.5	-	30	18
	MM 762	635	559	762	445	-	762	457

**Must be connected to a full arm/leg frame.**

**RTA 00** 1 per carton

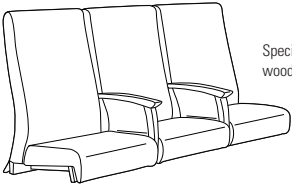
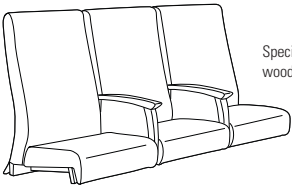
DESCRIPTION	MODEL# / FEATURES	STANDARD TEXTILE GRADES											
		COM	2	3	4	5	6	7	8	9	10	11	12
 <p>Specify armcap: wood or urethane.</p> <p><b>HB Guest Two Seat Top Open Center Arm</b> COM: 4.5 YD   4.11 M Unit weight: metal: 70 LB   31.8 KG   wood: 70 LB   31.8 KG Carton weight: metal: 80 LB   36.29 KG   wood: 80 LB   36.29 KG Carton volume: 43 FT<sup>3</sup>   1.21 MT<sup>3</sup></p>	GC3623HB-TOP (metal)	2151	2295	2417	2556	2786	2997	3209	3393	3623	3839	4131	4545
	GC3623WHB-TOP (wood)	1885	2029	2151	2290	2520	2731	2943	3127	3357	3573	3865	4279
Active weight: see notes.		OVERALL DIMENSIONS			SEAT DIMENSIONS			BACK DIMENSIONS					
		W	D	H	W	D	H	W	H				
Double high back frame guest top, 2 back and 2 seat cushions.		IN 42	27	32	20.5	17.5	-	20.5	28				
		MM 1067	686	813	521	445	-	521	711				
<b>Must be connected to a full arm/leg frame.</b>		RTA 00		1 per carton									
 <p>Specify armcap: wood or urethane.</p> <p><b>HB Guest Two Seat Top Closed Center Arm, Metal</b> COM: 4.5 YD   4.11 M Unit weight: metal: 138 LB   62.7 KG   wood: 138 LB   62.7 KG Carton weight: metal: 150 LB   68.04 KG   wood: 150 LB   68.04 KG Carton volume: 43 FT<sup>3</sup>   1.21 MT<sup>3</sup></p>	GC3623HBCA-TOP (metal)	2387	2531	2653	2792	3022	3233	3445	3629	3859	4075	4367	4781
	Active weight: see notes.		OVERALL DIMENSIONS			SEAT DIMENSIONS			BACK DIMENSIONS				
		W	D	H	W	D	H	W	H				
Double high back frame guest top, 2 back and 2 seat cushions.		IN 42	27	32	20.5	17.5	-	20.5	28				
		MM 1067	686	813	521	445	-	521	711				
<b>Must be connected to a full arm/leg frame.</b>		RTA 00		1 per carton									
 <p>Specify armcap: wood or urethane.</p> <p><b>HB Guest Three Seat Top Open Center Arm</b> COM: 6.25 YD   5.72 M Unit weight: metal: 77 LB   35 KG   wood: 77 LB   35 KG Carton weight: metal: 92 LB   41.73 KG   wood: 92 LB   41.73 KG Carton volume: 65.25 FT<sup>3</sup>   1.84 MT<sup>3</sup></p>	GC3626HB-TOP (metal)	3444	3644	3813	4007	4325	4619	4913	5169	5488	5788	6194	6769
	GC3626WHB-TOP (wood)	2955	3155	3324	3518	3836	4130	4424	4680	4999	5299	5705	6280
Due to the size and weight, this top requires at least 3 installers.		OVERALL DIMENSIONS			SEAT DIMENSIONS			BACK DIMENSIONS					
Active weight: see notes.		W	D	H	W	D	H	W	H				
Triple high back frame guest top, 3 back and 3 seat cushions.		IN 64	27	32	20.5	17.5	-	20.5	28				
		MM 1626	686	813	521	445	-	521	711				
<b>Must be connected to a full arm/leg frame.</b>		RTA 00		1 per carton									
 <p>Specify armcap: wood or urethane.</p> <p><b>HB Guest Three Seat Top Closed Center Arms, Metal</b> COM: 7 YD   6.4 M Unit weight: metal: 160 LB   72.7 KG   wood: 160 LB   72.7 KG Carton weight: metal: 175 LB   79.38 KG   wood: 175 LB   79.38 KG Carton volume: 80.75 FT<sup>3</sup>   2.28 MT<sup>3</sup></p>	GC3626HBCA-TOP (metal)	3724	3948	4137	4354	4711	5040	5369	5656	6013	6349	6804	7448
	Due to the size and weight, this top requires at least 3 installers.		OVERALL DIMENSIONS			SEAT DIMENSIONS			BACK DIMENSIONS				
Active weight: see notes.		W	D	H	W	D	H	W	H				
Triple high back frame guest top, 3 back and 3 seat cushions.		IN 64	27	32	20.5	17.5	-	20.5	28				
		MM 1626	686	813	521	445	-	521	711				
<b>Must be connected to a full arm/leg frame.</b>		RTA 00		1 per carton									

DESCRIPTION MODEL# / FEATURES STANDARD TEXTILE GRADES

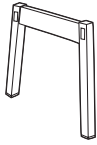

**Left End Frame, Armless**

COM: N/A  
 Unit weight: metal: 4 LB | 1.8 KG | wood: 3 LB | 1.4 KG  
 Carton weight: metal: 5 LB | 2.27 KG | wood: 4 LB | 1.81 KG  
 Carton volume: 1.2 FT³ | 0.03 MT³

List price

<b>GC3620LNA</b> (metal)	353
<b>GC3620WLNA</b> (wood)	234

For use in **left** side finished position of guest and/or patient seating units.

**Does not allow linking to other units or tables.**

OVERALL DIMENSIONS			SEAT DIMENSIONS			BACK DIMENSIONS	
W	D	H	W	D	H	W	H

IN	1.25	24.25	16	-	-	-	-
MM	32	616	406	-	-	-	-

**RTA 00**  1 per carton

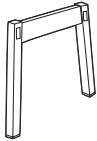

**Right End Frame, Armless**

COM: N/A  
 Unit weight: metal: 4 LB | 1.8 KG | wood: 3 LB | 1.4 KG  
 Carton weight: metal: 5 LB | 2.27 KG | wood: 4 LB | 1.81 KG  
 Carton volume: 1.2 FT³ | 0.03 MT³

For use in **right** side finished position of guest and/or patient seating units.

**Does not allow linking to other units or tables.**

List price

<b>GC3620RNA</b> (metal)	353
<b>GC3620WRNA</b> (wood)	234

OVERALL DIMENSIONS			SEAT DIMENSIONS			BACK DIMENSIONS	
W	D	H	W	D	H	W	H

IN	1.25	24.25	16	-	-	-	-
MM	32	616	406	-	-	-	-

**RTA 00**  1 per carton

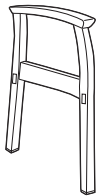

**Left End Frame, Open Arm**

COM: N/A  
 Unit weight: metal: 6 LB | 2.7 KG | wood: 5 LB | 2.3 KG  
 Carton weight: metal: 10 LB | 4.54 KG | wood: 10 LB | 4.54 KG  
 Carton volume: 1.4 FT³ | 0.03 MT³

For use in **left** side finished position of guest and/or patient seating units.

**Does not allow linking to other units or tables.**

List price

<b>GC3620LA</b> (metal)	448
<b>GC3620LAM</b> (w/power)	1467
<b>GC3620WLA</b> (wood)	321
<b>GC3620WLAM</b> (w/power)	1294

• Models GC3620LAM and GC3620WLAM have **power/USB** module (not shown).

Specify armcap: wood or urethane.

OVERALL DIMENSIONS			SEAT DIMENSIONS			BACK DIMENSIONS	
W	D	H	W	D	H	W	H

IN	2.5	27	26.5	-	-	-	-
MM	64	686	673	-	-	-	-

**RTA 00**  1 per carton



**Right End Frame, Open Arm**

COM: N/A  
 Unit weight: metal: 6 LB | 2.7 KG | wood: 5 LB | 2.3 KG  
 Carton weight: metal: 10 LB | 4.54 KG | wood: 10 LB | 4.54 KG  
 Carton volume: 1.4 FT³ | 0.03 MT³

For use in **right** side finished position of guest and/or patient seating units.

**Does not allow linking to other units or tables.**

List price

<b>GC3620RA</b> (metal)	448
<b>GC3620RAM</b> (w/power)	1467
<b>GC3620WRA</b> (wood)	321
<b>GC3620WRAM</b> (w/power)	1294









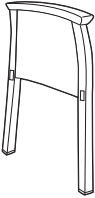

• Models GC3620RAM and GC3620WRAM have **power/USB** module (not shown).

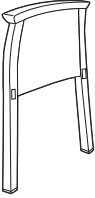
Specify armcap: wood or urethane.

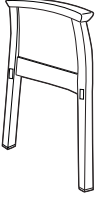
OVERALL DIMENSIONS			SEAT DIMENSIONS			BACK DIMENSIONS	
W	D	H	W	D	H	W	H

IN	2.5	27	26.5	-	-	-	-
MM	64	686	673	-	-	-	-

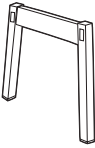
**RTA 00**  1 per carton

DESCRIPTION	MODEL# / FEATURES	STANDARD TEXTILE GRADES												
		COM	2	3	4	5	6	7	8	9	10	11	12	
 <p><b>Left End Frame, Closed Arm</b> COM: 0.65 YD   0.59 M Unit weight: metal: 10 LB   4.5 KG   wood: 10 LB   4.5 KG Carton weight: metal: 15 LB   6.8 KG   wood: 15 LB   6.8 KG Carton volume: 1.4 FT³   0.03 MT³</p>	GC3620LCA (metal)	579	600	618	638	671	701	732	759	792	823	865	925	
	GC3620LCAM (w/power)	1597	1618	1636	1656	1689	1719	1750	1777	1810	1841	1883	1943	
	<p>• Model GC3620LCAM has <b>power/USB</b> module (not shown).</p> <p>Specify armcap: wood or urethane.</p>	<b>OVERALL DIMENSIONS</b> W D H			<b>SEAT DIMENSIONS</b> W D H			<b>BACK DIMENSIONS</b> W H						
	<p>For use in <b>left</b> side finished position of guest and/or patient seating units. <b>Does not allow linking to other units or tables.</b></p>	IN 2.5 MM 64	27 686	26.5 673	-	-	-	-	-	-	-	-	-	
		RTA 00		1 per carton										
 <p><b>Right End Frame, Closed Arm</b> COM: 0.65 YD   0.59 M Unit weight: metal: 10 LB   4.5 KG   wood: 10 LB   4.5 KG Carton weight: metal: 15 LB   6.8 KG   wood: 15 LB   6.8 KG Carton volume: 1.4 FT³   0.03 MT³</p>	GC3620RCA (metal)	579	600	618	638	671	701	732	759	792	823	865	925	
	GC3620RCAM (w/power)	1597	1618	1636	1656	1689	1719	1750	1777	1810	1841	1883	1943	
	<p>• Model GC3620RCAM has <b>power/USB</b> module (not shown).</p> <p>Specify armcap: wood or urethane.</p>	<b>OVERALL DIMENSIONS</b> W D H			<b>SEAT DIMENSIONS</b> W D H			<b>BACK DIMENSIONS</b> W H						
	<p>For use in <b>right</b> side finished position of guest and/or patient seating units. <b>Does not allow linking to other units or tables.</b></p>	IN 2.5 MM 64	27 686	26.5 673	-	-	-	-	-	-	-	-	-	
		RTA 00		1 per carton										
 <p><b>Left End Frame, Closed Arm, Laminate Panel</b> COM: N/A Unit weight: 15 LB   6.8 KG Carton weight: 18 LB   8.16 KG Carton volume: 1.4 FT³   0.03 MT³</p>	List price													
	GC3620LCA (metal)	740												
	<p>Specify armcap: wood or urethane.</p>	<b>OVERALL DIMENSIONS</b> W D H			<b>SEAT DIMENSIONS</b> W D H			<b>BACK DIMENSIONS</b> W H						
	<p>For use in <b>left</b> side finished position of guest and/or patient seating units. <b>Does not allow linking to other units or tables.</b></p>	IN 2.5 MM 64	27 686	26.5 673	-	-	-	-	-	-	-	-	-	
		RTA 00		1 per carton										
 <p><b>Right End Frame, Closed Arm, Laminate Panel</b> COM: N/A Unit weight: 15 LB   6.8 KG Carton weight: 18 LB   8.16 KG Carton volume: 1.4 FT³   0.03 MT³</p>	List price													
	GC3620RCA (metal)	740												
	<p>Specify armcap: wood or urethane.</p>	<b>OVERALL DIMENSIONS</b> W D H			<b>SEAT DIMENSIONS</b> W D H			<b>BACK DIMENSIONS</b> W H						
	<p>For use in <b>right</b> side finished position of guest and/or patient seating units. <b>Does not allow linking to other units or tables.</b></p>	IN 2.5 MM 64	27 686	26.5 673	-	-	-	-	-	-	-	-	-	
		RTA 00		1 per carton										
 <p><b>Seat to Seat Central Linking Frame, Armless</b> COM: N/A Unit weight: metal: 4 LB   1.8 KG   wood: 3 LB   1.4 KG Carton weight: metal: 5 LB   2.27 KG   wood: 4 LB   1.81 KG Carton volume: 1.2 FT³   0.03 MT³</p>	List price													
	GC3622LNA (metal)	353												
		GC3622WLNA (wood) 234												
	<p>For <b>linking</b> guest and/or patient top seating units together only.</p>	<b>OVERALL DIMENSIONS</b> W D H			<b>SEAT DIMENSIONS</b> W D H			<b>BACK DIMENSIONS</b> W H						
		IN 1.25 MM 32	24.25 616	16 406	-	-	-	-	-	-	-	-	-	
		RTA 00		1 per carton										

DESCRIPTION MODEL# / FEATURES STANDARD TEXTILE GRADES



**Center Frame, Open Arm**

COM: N/A  
 Unit weight: metal: 6 LB | 2.7 KG | wood: 4 LB | 1.8 KG  
 Carton weight: metal: 10 LB | 4.54 KG | wood: 8 LB | 3.63 KG  
 Carton volume: 1.4 FT³ | 0.03 MT³

List price

**GC3622LA** (metal) 448

**GC3622WLA** (wood) 321

Specify armcap:  
 wood or urethane.

For **linking** guest and/or patient top seating units together only.

OVERALL DIMENSIONS			SEAT DIMENSIONS			BACK DIMENSIONS	
W	D	H	W	D	H	W	H

IN	2.5	27	26.5	-	-	-	-
MM	64	686	673	-	-	-	-

**RTA 00** 1 per carton

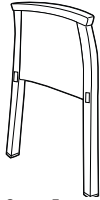

**Center Frame, Closed Arm**

COM: 0.65 YD | 0.59 M  
 Unit weight: metal: 10 LB | 4.5 KG | wood: 6 LB | 2.7 KG  
 Carton weight: metal: 15 LB | 6.8 KG | wood: 10 LB | 4.54 KG  
 Carton volume: 1.4 FT³ | 0.03 MT³

COM	2	3	4	5	6	7	8	9	10	11	12	
<b>GC3622LCA</b> (metal)	579	600	618	638	671	701	732	759	792	823	865	925

Specify armcap:  
 wood or urethane.

For **linking** guest and/or patient top seating units together only.

OVERALL DIMENSIONS			SEAT DIMENSIONS			BACK DIMENSIONS	
W	D	H	W	D	H	W	H

IN	2.5	27	26.5	-	-	-	-
MM	64	686	673	-	-	-	-

**RTA 00** 1 per carton

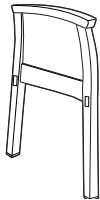

**Center Frame, Closed Arm, Laminate Panel**

COM: N/A  
 Unit weight: 15 LB | 6.8 KG  
 Carton weight: 18 LB | 8.16 KG  
 Carton volume: 1.4 FT³ | 0.03 MT³

List price

**GC3622LCA** (metal) 740

Specify armcap:  
 wood or urethane.

For **linking** guest and/or patient top seating units together only.

OVERALL DIMENSIONS			SEAT DIMENSIONS			BACK DIMENSIONS	
W	D	H	W	D	H	W	H

IN	2.5	27	26.5	-	-	-	-
MM	64	686	673	-	-	-	-

**RTA 00** 1 per carton

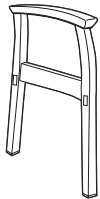

**Center Frame, Open Arm**

COM: N/A  
 Unit weight: metal: 6 LB | 2.7 KG | wood: 4 LB | 1.8 KG  
 Carton weight: metal: 10 LB | 4.54 KG | wood: 8 LB | 3.63 KG  
 Carton volume: 1.4 FT³ | 0.03 MT³

List price

**GC3622TLA** (metal) 481

**GC3622WTLA** (wood) 350

Specify armcap:  
 wood or urethane.

For **linking** guest and/or patient top seating units table on the **left** side of the frame.

OVERALL DIMENSIONS			SEAT DIMENSIONS			BACK DIMENSIONS	
W	D	H	W	D	H	W	H

IN	2.5	27	26.5	-	-	-	-
MM	64	686	673	-	-	-	-

**RTA 00** 1 per carton



**Center Frame, Open Arm**

COM: N/A  
 Unit weight: metal: 6 LB | 2.7 KG | wood: 4 LB | 1.8 KG  
 Carton weight: metal: 10 LB | 4.54 KG | wood: 8 LB | 3.63 KG  
 Carton volume: 1.4 FT³ | 0.03 MT³

List price

**GC3622TRA** (metal) 481

**GC3622WTRA** (wood) 350







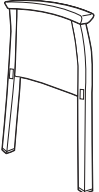

Specify armcap:  
 wood or urethane.

For **linking** guest and/or patient top seating units table on the **right** side of the frame.

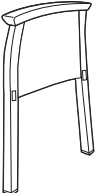
OVERALL DIMENSIONS			SEAT DIMENSIONS			BACK DIMENSIONS	
W	D	H	W	D	H	W	H

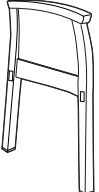
IN	2.5	27	26.5	-	-	-	-
MM	64	686	673	-	-	-	-

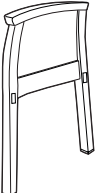
**RTA 00** 1 per carton

DESCRIPTION	MODEL# / FEATURES	STANDARD TEXTILE GRADES											
		COM	2	3	4	5	6	7	8	9	10	11	12
 <p><b>Center Frame, Closed Arm</b> COM: 0.65 YD   0.59 M Unit weight: metal: 10 LB   4.5 KG   wood: 6 LB   2.7 KG Carton weight: metal: 15 LB   6.8 KG   wood: 10 LB   4.54 KG Carton volume: 1.4 FT³   0.03 MT³</p>	<b>GC3622TLCA</b> (metal)	610	631	649	669	702	732	763	790	823	854	896	956
	Specify armcap: wood or urethane.	<b>OVERALL DIMENSIONS</b>			<b>SEAT DIMENSIONS</b>			<b>BACK DIMENSIONS</b>					
		<b>W</b>	<b>D</b>	<b>H</b>	<b>W</b>	<b>D</b>	<b>H</b>	<b>W</b>	<b>H</b>				
	For <b>linking</b> guest and/or patient top seating units table on the <b>left</b> side of the frame.	IN 2.5 MM 64	27 686	26.5 673	-	-	-	-	-				
	<b>RTA 00</b>		1 per carton										
 <p><b>Center Frame, Closed Arm</b> COM: 0.65 YD   0.59 M Unit weight: metal: 10 LB   4.5 KG   wood: 6 LB   2.7 KG Carton weight: metal: 15 LB   6.8 KG   wood: 10 LB   4.54 KG Carton volume: 1.4 FT³   0.03 MT³</p>	<b>GC3622TRCA</b> (metal)	610	631	649	669	702	732	763	790	823	854	896	956
	Specify armcap: wood or urethane.	<b>OVERALL DIMENSIONS</b>			<b>SEAT DIMENSIONS</b>			<b>BACK DIMENSIONS</b>					
		<b>W</b>	<b>D</b>	<b>H</b>	<b>W</b>	<b>D</b>	<b>H</b>	<b>W</b>	<b>H</b>				
	For <b>linking</b> guest and/or patient top seating units table on the <b>right</b> side of the frame.	IN 2.5 MM 64	27 686	26.5 673	-	-	-	-	-				
	<b>RTA 00</b>		1 per carton										
 <p><b>Center Frame, Closed Arm, Laminate Panel</b> COM: N/A Unit weight: 15 LB   6.8 KG Carton weight: 18 LB   8.16 KG Carton volume: 1.4 FT³   0.03 MT³</p>	List price												
	<b>GC3622TLCAL</b> (metal)	774											
	Specify armcap: wood or urethane.	<b>OVERALL DIMENSIONS</b>			<b>SEAT DIMENSIONS</b>			<b>BACK DIMENSIONS</b>					
	For <b>linking</b> guest and/or patient top seating units table on the <b>left</b> side of the frame.	IN 2.5 MM 64	27 686	26.5 673	-	-	-	-	-				
	<b>RTA 00</b>		1 per carton										
 <p><b>Center Frame, Closed Arm, Laminate Panel</b> COM: N/A Unit weight: 15 LB   6.8 KG Carton weight: 18 LB   8.16 KG Carton volume: 1.4 FT³   0.03 MT³</p>	List price												
	<b>GC3622TRCAL</b> (metal)	774											
	Specify armcap: wood or urethane.	<b>OVERALL DIMENSIONS</b>			<b>SEAT DIMENSIONS</b>			<b>BACK DIMENSIONS</b>					
	For <b>linking</b> guest and/or patient top seating units table on the <b>right</b> side of the frame.	IN 2.5 MM 64	27 686	26.5 673	-	-	-	-	-				
	<b>RTA 00</b>		1 per carton										

**Modular tables:**

Tops are 1" thick.

Wooden leg tables:

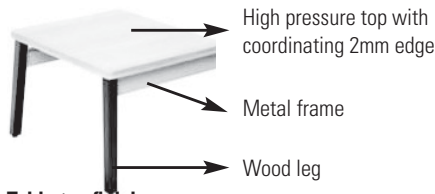

Metal leg tables:

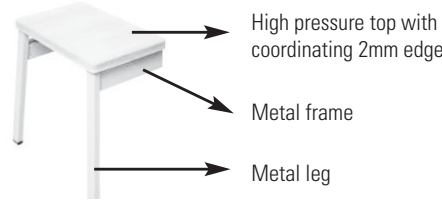

**Table top finishes:**

**High Pressure Laminate (HP)**

- Absolute Acajou (ACJ)
- Asian Night (ASN)
- Avant Cherry (W357)
- Avant Honey (W356)
- Black (BLK)
- Blizzard (BZD)
- Brushed Cobalt (BRC)
- Clear Maple (CMB)
- Custom Grey (CGY)
- Dark Espresso (W142)
- Designer White (DWT)
- Fashionista (FAS)
- First Class (FCL)
- Quartered Mahogany (QTM)
- Noce Biondo (NBL)
- Noce Grigio (NGL)
- Noce Leggero (NEL)
- Noce Medio (NML)
- Sheer Beauty (SBY)
- Stonedust (SDT)
- Storm (SOG)
- Walnut Heights (WHE)
- White Chocolate (WHC)
- Winter Cherry (WCR)

**Wooden leg finishes (top, base, legs & apron):**

- |                                |                               |
|--------------------------------|-------------------------------|
| Absolute (AAM)                 | Natural Walnut (NLW)          |
| Charcoal Java on Maple (CJM)   | Night (ASM)                   |
| Cherry on Maple (ACM)          | Noce Biondo (NBM)             |
| Empire Mahogany on Maple (EMM) | Noce Grigio (NGM)             |
| English Oak on Maple (EOM)     | Noce Leggero (NEM)            |
| Medium Walnut on Maple (MWM)   | Noce Medio (NMM)              |
| Espresso Cafe on Maple (ECM)   | Shaker Cherry on Maple (SKM)  |
| Fruitwood on Maple (TFM)       | Tiger Mahogany on Maple (TMM) |
| Gray (HGM)                     | Tiger Walnut on Maple (TWM)   |
| Harvest Oak on Maple (HOM)     | Winter Cherry on Maple (WCM)  |
| Honey on Maple (AHM)           | Sandy Beach on Maple (SBM)    |
| Jet Onyx on Maple (JOM)        | WC Cream (WTM)                |
| Light Honey on Maple (LHM)     | Silver Oak on Maple (SOM)     |
| Maple on Maple (AVM)           | White on Maple (WHM)          |

**Metal leg finishes:**

Black (TBL), Cloud (TIV), Designer White (TDW), Fog (TFO), Frost (TFR), Kalua (TKA), Latte (TLA), Mocha (TMO), Nevada (TNE), Sand (TSN), Shadow (TSH), Toast (TOA) and Tungsten (TTU). Please specify.

**Metal frame finishes:**

Black (TBL), Cloud (TIV), Designer White (TDW), Fog (TFO), Frost (TFR), Kalua (TKA), Latte (TLA), Mocha (TMO), Nevada (TNE), Sand (TSN), Shadow (TSH), Toast (TOA) and Tungsten (TTU). Please specify.

**Power/USB modules:**

For modular tables with power/USB module, refer to models ending in "M". Power module includes two power outlets, four USB charging ports and a 6 foot long power cord. Available in Black or White (must be specified at time of order). Power module is mounted **on surface** on narrow tables; mounted **in surface** on larger tables.



On surface power module on narrow tables

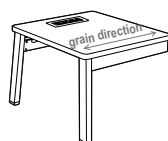

In surface power module on larger tables

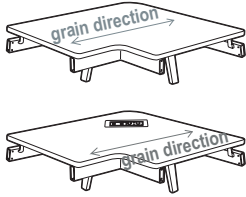
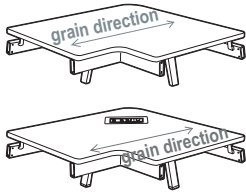
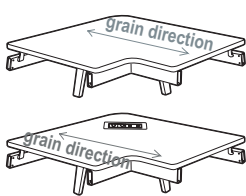

MODULAR TABLES	MODEL #	DIMENSIONS <sup>IN</sup> <sub>MM</sub>	WEIGHT <sup>LB</sup> <sub>KG</sub>	VOLUME <sup>FT<sup>3</sup></sup> <sub>MT<sup>3</sup></sub>	LIST PRICE
 <p><b>Left Corner Table, High Pressure For Wood Frame</b></p>	GC3671WL-HP	33 x 33 x 17 838 x 838 x 432	46 20.9	6 0.16	<b>\$1092</b>
	GC3671WLM-HP With power				<b>\$2006</b>
 <p><b>Left Corner Table, High Pressure For Metal Frame</b></p>	GC3671L-HP	33 x 33 x 17 838 x 838 x 432	46 20.9	6 0.16	<b>\$1213</b>
	GC3671LM-HP With power				<b>\$2175</b>
 <p><b>Right Corner Table, High Pressure For Wood Frame</b></p>	GC3671WR-HP	33 x 33 x 17 838 x 838 x 432	46 20.9	6 0.16	<b>\$1092</b>
	GC3671WRM-HP With power				<b>\$2006</b>

- Model GC3671WLM-HP has a **power/USB** module mounted in surface.

Coordinating 2mm edge. Must be connected to full arm and leg with **wood** frames (GC3622WTLA/WTRA). This table allows for kneespace when specifying chairs in a corner position. 1 per carton.

- Includes 2 rear wood legs.

- Model GC3671LM-HP has a **power/USB** module mounted in surface.

Coordinating 2mm edge. Must be connected to full arm and leg with **metal** frames (GC3622TLA/TRA, GC3622TLCA/TRCA). This table allows for kneespace when specifying chairs in a corner position. 1 per carton.

- Includes 2 rear metal legs.

- Model GC3671WRM-HP has a **power/USB** module mounted in surface.

Coordinating 2mm edge. Must be connected to full arm and leg with **wood** frames (GC3622WTLA/WTRA, GC3622WTLCA/WTRCA). This table allows for kneespace when specifying chairs in a corner position. 1 per carton.

- Includes 2 rear wood legs.

MODULAR TABLES	MODEL #	DIMENSIONS <sup>IN</sup> <sub>MM</sub>	WEIGHT <sup>LB</sup> <sub>KG</sub>	VOLUME <sup>FT<sup>3</sup></sup> <sub>MT<sup>3</sup></sub>	LIST PRICE
----------------	---------	---	---------------------------------------	---	------------

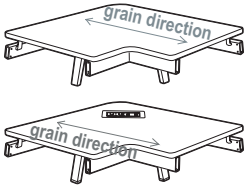

**Right Corner Table, High Pressure For Metal Frame**

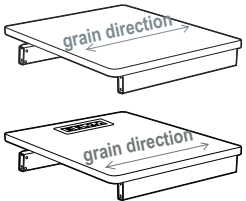

**Center Table, High Pressure**

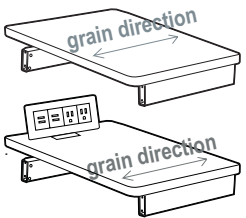

**Narrow Center Table, High Pressure**

	W x D x H			
GC3671R-HP	33 x 33 x 17	40	6	<b>\$1213</b>
GC3671RM-HP With power	838 x 838 x 432	18.2	0.16	<b>\$2175</b>

- Model GC3671RM-HP has a **power/USB** module mounted in surface.

Coordinating 2mm edge. Must be connected to full arm and leg with **metal** frames (GC3622TLA/TRA). This table allows for kneespace when specifying chairs in a corner position. 1 per carton.

- Includes 2 rear metal legs (not shown).

GC3672-HP	20.25 x 23.87 x 5.5	15	3.4	<b>\$686</b>
GC3672M-HP With power	514 x 606 x 140	6.8	0.09	<b>\$1645</b>

- Model GC3672M-HP has a **power/USB** module mounted in surface.

Coordinating 2mm edge. Regular center table for **wood** or **metal** (HT) frame. Must be connected to full arm and leg with **metal** or **wood** frames (GC3622TLA/TRA, GC3622TLCA/TRCA, GC3622WTLA/WTRA). 1 per carton.

GC3673-HP	12 x 23.87 x 5.5	14	2.1	<b>\$667</b>
GC3673M-HP With power	305 x 606 x 140	6.4	0.05	<b>\$1628</b>

- Model GC3673M-HP has a **power/USB** module mounted on surface.

Coordinating 2mm edge. Narrow center table for **wood** or **metal** (HT) frame. Must be connected to full arm and leg with **metal** or **wood** frames (GC3622TLA/TRA, GC3622TLCA/TRCA, GC3622WTLA/WTRA). 1 per carton.

# SEATING

# PRIMACARE™ MODULAR - GUEST/PATIENT P

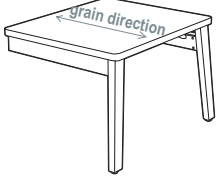
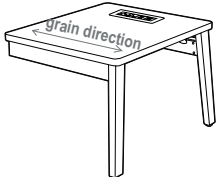
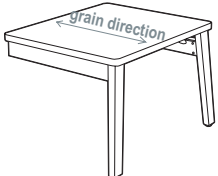
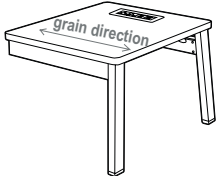
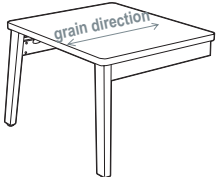
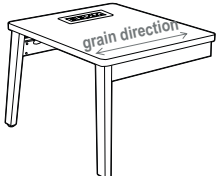
MODULAR TABLES	MODEL #	DIMENSIONS <sup>IN</sup> <sub>MM</sub>	WEIGHT <sup>LB</sup> <sub>KG</sub>	VOLUME <sup>FT<sup>3</sup></sup> <sub>MT<sup>3</sup></sub>	LIST PRICE
	GC3674WL-HP	20.25 x 23.87 x 17	15	3.4	<b>\$893</b>
	GC3674WLM-HP With power	514 x 606 x 432	6.8	0.09	<b>\$1808</b>
<ul style="list-style-type: none"> <li>Model GC3674WLM-HP has a <b>power/USB</b> module mounted in surface.</li> </ul> <p>Coordinating 2mm edge. Must be connected to full arm and leg with <b>wood</b> frames (GC3622WTLA). 1 per carton.</p>					
	GC3674L-HP	20.25 x 23.87 x 17	15	3.4	<b>\$1009</b>
	GC3674LM-HP With power	514 x 606 x 432	6.8	0.09	<b>\$1967</b>
<ul style="list-style-type: none"> <li>Model GC3674LM-HP has a <b>power/USB</b> module mounted in surface.</li> </ul> <p>Coordinating 2mm edge. Must be connected to full arm and leg with <b>metal</b> frames (GC3622TLA). 1 per carton.</p>					
	GC3674WR-HP	20.25 x 23.87 x 17	15	3.4	<b>\$893</b>
	GC3674WRM-HP With power	514 x 606 x 432	6.8	0.09	<b>\$1808</b>
<ul style="list-style-type: none"> <li>Model GC3674WRM-HP has a <b>power/USB</b> module mounted in surface.</li> </ul> <p>Coordinating 2mm edge. Must be connected to full arm and leg with <b>wood</b> frames (GC3622WTRA). 1 per carton.</p>					
	GC3674L-HP	20.25 x 23.87 x 17	15	3.4	<b>\$1009</b>
	GC3674LM-HP With power	514 x 606 x 432	6.8	0.09	<b>\$1967</b>
<ul style="list-style-type: none"> <li>Model GC3674LM-HP has a <b>power/USB</b> module mounted in surface.</li> </ul> <p>Coordinating 2mm edge. Must be connected to full arm and leg with <b>metal</b> frames (GC3622TLA). 1 per carton.</p>					
	GC3674WR-HP	20.25 x 23.87 x 17	15	3.4	<b>\$893</b>
	GC3674WRM-HP With power	514 x 606 x 432	6.8	0.09	<b>\$1808</b>
<ul style="list-style-type: none"> <li>Model GC3674WRM-HP has a <b>power/USB</b> module mounted in surface.</li> </ul> <p>Coordinating 2mm edge. Must be connected to full arm and leg with <b>wood</b> frames (GC3622WTRA). 1 per carton.</p>					
	GC3674L-HP	20.25 x 23.87 x 17	15	3.4	<b>\$1009</b>
	GC3674LM-HP With power	514 x 606 x 432	6.8	0.09	<b>\$1967</b>
<ul style="list-style-type: none"> <li>Model GC3674LM-HP has a <b>power/USB</b> module mounted in surface.</li> </ul> <p>Coordinating 2mm edge. Must be connected to full arm and leg with <b>metal</b> frames (GC3622TLA). 1 per carton.</p>					

MODULAR TABLES	MODEL #	DIMENSIONS <sup>IN</sup> <sub>MM</sub>	WEIGHT <sup>LB</sup> <sub>KG</sub>	VOLUME <sup>FT<sup>3</sup></sup> <sub>MT<sup>3</sup></sub>	LIST PRICE
----------------	---------	---	---------------------------------------	---	------------

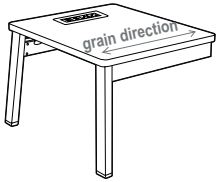
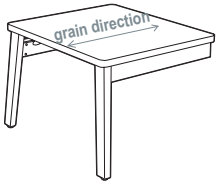

**Right End Table, High Pressure For Metal Frame**

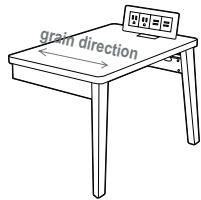
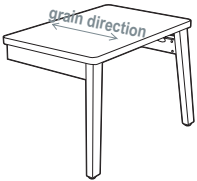

**Narrow Left End Table, High Pressure For Wood Frame**

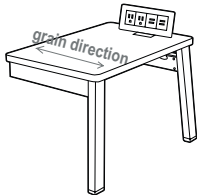
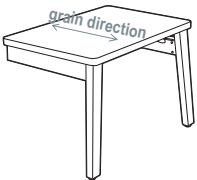

**Narrow Left End Table, High Pressure For Metal Frame**

GC3674R-HP	20.25 x 23.87 x 17 514 x 606 x 432	15 6.8	3.4 0.09	<b>\$1009</b>
GC3674RM-HP With power				<b>\$1967</b>

- Model GC3674RM-HP has a **power/USB** module mounted in surface.

Coordinating 2mm edge. Must be connected to full arm and leg with **metal** frames (GC3622TRA). 1 per carton.

GC3675WL-HP	12 x 23.87 x 17 305 x 606 x 432	14 6.4	2.1 0.05	<b>\$877</b>
GC3675WLM-HP With power				<b>\$1790</b>

- Model GC3675WLM-HP has a **power/USB** module mounted on surface.

Coordinating 2mm edge. Must be connected to full arm and leg with **wood** frames (GC3622WTLA). 1 per carton.

GC3675L-HP	12 x 23.87 x 17 305 x 606 x 432	14 6.4	2.1 0.05	<b>\$991</b>
GC3675LM-HP With power				<b>\$1948</b>

- Model GC3675LM-HP has a **power/USB** module mounted on surface.

Coordinating 2mm edge. Must be connected to full arm and leg with **metal** frames (GC3622TLA ). 1 per carton

MODULAR TABLES	MODEL #	DIMENSIONS <sup>IN</sup> <sub>MM</sub>	WEIGHT <sup>LB</sup> <sub>KG</sub>	VOLUME <sup>FT<sup>3</sup></sup> <sub>MT<sup>3</sup></sub>	LIST PRICE
----------------	---------	---	---------------------------------------	---	------------

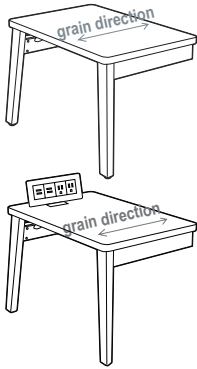

**Narrow Right End Table, High Pressure For Wood Frame**

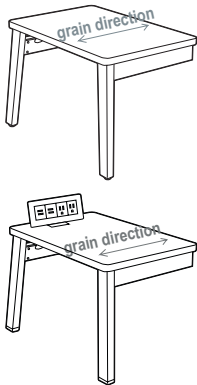

**Narrow Right End Table, High Pressure For Metal Frame**

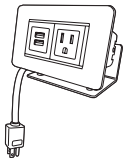

**On Surface Power/Data Module**

	W x D x H			
GC3675WR-HP	12 x 23.87 x 17	14	2.1	<b>\$877</b>
GC3675WRM-HP With power	305 x 606 x 432	6.4	0.05	<b>\$1790</b>

- Model GC3675WRM-HP has a **power/USB** module mounted on surface.

Coordinating 2mm edge. Must be connected to full arm and leg with **wood** frames (GC3622WTRA). 1 per carton.

GC3675R-HP	12 x 23.87 x 17	14	2.1	<b>\$991</b>
GC3675RM-HP With power	305 x 606 x 432	6.4	0.05	<b>\$1948</b>









- Model GC3675RM-HP has a **power/USB** module mounted on surface.

Coordinating 2mm edge. Must be connected to full arm and leg with **metal** frames (GC3622TRA). 1 per carton.

GC36410	- x - x -	2	1	<b>\$596</b>
	- x - x -	0.9	0.02	





















Surface top mount power/data module with one power outlet and two USB charging ports. 6 foot cord. White. Can be mounted on all freestanding and modular tables.

**MODULAR TOP UNITS** **FOR MODULAR LOUNGE AND FULLY UPHOLSTERED LOUNGE**

	SINGLE SEAT	BARIATRIC	TWO SEATER	THREE SEATER
<b>Lounge Seating</b>	GC3641TOP 	GC3640TOP 	GC3642TOP 	GC3643TOP 
<b>High Back Lounge Seating</b>	GC3676HBTOP 	GC3679HBTOP 	GC3677HBTOP 	GC3678HBTOP 

**LEG / ARM FRAMES** **FOR MODULAR LOUNGE**

**Metal frame: Standard with Black urethane armcap (see notes for wood and urethane finish options) | Wood frame: Must select**

	LEFT, OPEN		RIGHT, OPEN		LEFT, CLOSED		RIGHT, CLOSED		LEFT, CLOSED LAMINATE PANEL	RIGHT, CLOSED LAMINATE PANEL
<b>Metal (HT) End</b>	GC3641LA 	GC3641LAM 	GC3641RA 	GC3641RAM 	GC3641LCA 	GC3641LCAM 	GC3641RCA 	GC3641RCAM 	GC3641LCAL 	GC3641RCAL 
<b>Wood End</b>	GC3641WLA 	GC3641WLAM 	GC3641WRA 	GC3641WRAM 	GC3641WLCA 	GC3641WLCAM 	GC3641WRCA 	GC3641WRCAM 		
<b>Metal (HT) Center</b>	GC36406LA 				GC36406LCA 				GC36406LCAL 	

<b>Metal (HT) Center table linking</b>	GC36406TLA 	GC36406TRA 	GC36406TLCA 	GC36406TRCA 	GC36406TLCAL 	GC36406TRCAL 
--	---	---	--	---	---	---

**LEG / ARM FRAMES** **FOR FULLY UPHOLSTERED MODULAR LOUNGE**

**Standard with Black urethane legs (see notes for wood and urethane finish options)**  
**Optional armcap in wood or urethane (cannot be retrofitted in the field if the frame is ordered without armcap)**

<b>Fully Upholstered End</b>	LEFT GC3676LA 	RIGHT GC3676RA 
<b>Fully Upholstered Center</b>	GC3676CFA 	

(Center = link both sides)

\*Power module includes two power outlets, four USB charging ports and a 6 foot long power cord.  
 Available in Black or White (must be specified at time of order). Power module is mounted on the frame below seat support rail.

**MODULAR TABLES FOR MODULAR LOUNGE AND FULLY UPHOLSTERED LOUNGE**

Tables include legs to support table top (except for center tables). All tables have a metal frame.

LEFT

RIGHT

**Corner**  
(high pressure laminate top with **metal legs**)

GC36403L-HP

GC36403LM-HP

GC36403R-HP

GC36403RM-HP



**Corner**  
(high pressure laminate top with **wood legs**)

GC36403WL-HP

GC36403WLM-HP

GC36403WR-HP

GC36403WRM-HP



**Center**  
(high pressure laminate top, connects to metal or wood frame)

GC36401-HP

GC36401M-HP



**Narrow Center**  
(high pressure laminate top, connects to metal or wood frame)

GC36402-HP

GC36402M-HP



For table with power/USB module\*, refer to models ending in "M"

**End**  
(high pressure laminate top with **metal legs**)

GC36404L-HP

GC36404LM-HP

GC36404R-HP

GC36404RM-HP

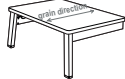

**End**  
(high pressure laminate top with **wood legs**)

GC36404WL-HP

GC36404WLM-HP

GC36404WR-HP

GC36404WRM-HP



**Narrow End**  
(high pressure laminate top with **metal legs**)

GC36405L-HP

GC36405LM-HP

GC36405R-HP

GC36405RM-HP

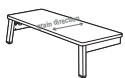

**Narrow End**  
(high pressure laminate top with **wood legs**)

GC36405WL-HP

GC36405WLM-HP

GC36405WR-HP

GC36405WRM-HP

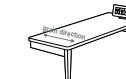

\* Power module includes two power outlets, four USB charging ports and a 6 foot long power cord. Available in Black or White (must be specified at time of order). Power module is mounted **on surface** on narrow tables; mounted **in surface** on larger tables (as shown above).

DESCRIPTION MODEL# / FEATURES STANDARD TEXTILE GRADES

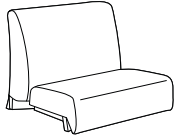

**Lounge Bariatric Top**  
 COM: 3.25 YD | 2.97 M  
 Unit weight: 85 LB | 38.6 KG  
 Carton weight: 97 LB | 44 KG  
 Carton volume: 49.5 FT³ | 1.4 MT³

COM	2	3	4	5	6	7	8	9	10	11	12	
GC3640TOP	1742	1846	1934	2035	2200	2353	2506	2639	2805	2961	3172	3471

Active weight: 500 lbs.

Single frame lounge top unit with 1 back and 1 seat cushion.

**Must be connected to a full arm/leg frame.**

	OVERALL DIMENSIONS			SEAT DIMENSIONS			BACK DIMENSIONS	
	W	D	H	W	D	H	W	H
IN	36	32	25	36	20	-	36	16
MM	914	813	635	914	508	-	914	406

**RTA 00** 1 per carton

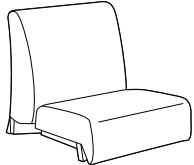

**Lounge Single Seater Top**  
 COM: 2.5 YD | 2.29 M  
 Unit weight: 54 LB | 24.5 KG  
 Carton weight: 66 LB | 29.9 KG  
 Carton volume: 29.5 FT³ | 0.83 MT³

COM	2	3	4	5	6	7	8	9	10	11	12	
GC3641TOP	1158	1238	1306	1383	1511	1628	1746	1848	1976	2096	2258	2488

Active weight: see notes.

Single frame lounge top unit with 1 back and 1 seat cushion.

**Must be connected to a full arm/leg frame.**

	OVERALL DIMENSIONS			SEAT DIMENSIONS			BACK DIMENSIONS	
	W	D	H	W	D	H	W	H
IN	25	32	25	23	20	-	22.5	16
MM	635	813	635	584	508	-	572	406

**RTA 00** 1 per carton

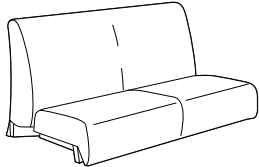

**Lounge Two Seater Top**  
 COM: 4 YD | 3.66 M  
 Unit weight: 95 LB | 43.2 KG  
 Carton weight: 110 LB | 49.9 KG  
 Carton volume: 49.5 FT³ | 1.4 MT³

COM	2	3	4	5	6	7	8	9	10	11	12	
GC3642TOP	2036	2164	2272	2396	2600	2788	2976	3140	3344	3536	3796	4164

Active weight: see notes.

Double frame lounge top unit with 2 back and 2 seat cushions.

**Must be connected to a full arm/leg frame.**

	OVERALL DIMENSIONS			SEAT DIMENSIONS			BACK DIMENSIONS	
	W	D	H	W	D	H	W	H
IN	48	32	25	48	20	-	48	16
MM	1219	813	635	1219	508	-	1219	406

**RTA 00** 1 per carton

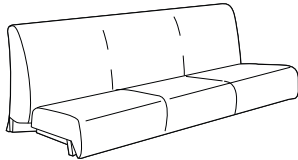

**Lounge Three Seater Top**  
 COM: 6.25 YD | 5.72 M  
 Unit weight: 136 LB | 61.8 KG  
 Carton weight: 161 LB | 73.03 KG  
 Carton volume: 69.5 FT³ | 1.96 MT³

COM	2	3	4	5	6	7	8	9	10	11	12	
GC3643TOP	2934	3134	3303	3497	3815	4109	4403	4659	4978	5278	5684	6259

Due to the size and weight, this top requires at least 3 installers.

Active weight: see notes.

Triple frame lounge top guest top, 3 back and 3 seat cushions.

**Must be connected to a full arm/leg frame.**

	OVERALL DIMENSIONS			SEAT DIMENSIONS			BACK DIMENSIONS	
	W	D	H	W	D	H	W	H
IN	71	32	25	71	20	-	71	16
MM	1803	813	635	1803	508	-	1803	406

**RTA 00** 1 per carton

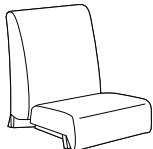

**HB Lounge Single Seater Top**  
 COM: 6.5 YD | 5.94 M  
 Unit weight: metal: 72 LB | 32.7 KG  
 Carton weight: metal: 92 LB | 41.73 KG  
 Carton volume: 29.5 FT³ | 0.83 MT³

COM	2	3	4	5	6	7	8	9	10	11	12	
GC3676HB-TOP	1244	1452	1628	1829	2161	2466	2772	3038	3370	3682	4104	4702

Active weight: see notes.

Single high back frame lounge top, 1 back and 1 seat cushion.

**Must be connected to a full arm/leg frame.**

	OVERALL DIMENSIONS			SEAT DIMENSIONS			BACK DIMENSIONS	
	W	D	H	W	D	H	W	H
IN	23	29	36	23	20	-	23	19
MM	584	737	914	584	508	-	584	483

**RTA 00** 1 per carton



DESCRIPTION	MODEL# / FEATURES	STANDARD TEXTILE GRADES											
		COM	2	3	4	5	6	7	8	9	10	11	12

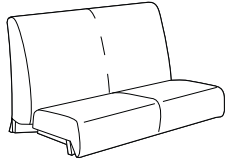

**HB Lounge Two Seater Top**  
 COM: 7.75 YD | 7.09 M  
 Unit weight: 97 LB | 44.1 KG  
 Carton weight: 117 LB | 53.07 KG  
 Carton volume: 56.25 FT³ | 1.59 MT³

**GC3677HB-TOP**

COM	2	3	4	5	6	7	8	9	10	11	12
2329	2577	2786	3027	3422	3786	4150	4468	4863	5235	5739	6452

Active weight: see notes.

Double high back frame lounge top, 1 back and 1 seat cushion.

	OVERALL DIMENSIONS			SEAT DIMENSIONS			BACK DIMENSIONS	
	W	D	H	W	D	H	W	H
IN	45.5	29	36	45.5	20	-	45.5	19
MM	1156	737	914	1156	508	-	1156	483

**Must be connected to a full arm/leg frame.**

**RTA 00** 1 per carton

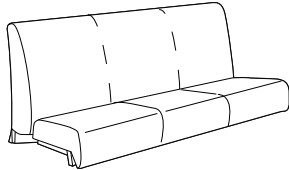

**HB Lounge Three Seater Top**  
 COM: 9.25 YD | 8.46 M  
 Unit weight: 133 LB | 60.5 KG  
 Carton weight: 158 LB | 71.67 KG  
 Carton volume: 69.5 FT³ | 1.96 MT³

**GC3678HB-TOP**

COM	2	3	4	5	6	7	8	9	10	11	12
3450	3746	3996	4283	4754	5189	5624	6003	6475	6919	7520	8371

Active weight: see notes.

Triple high back frame lounge top, 1 back and 1 seat cushion.

	OVERALL DIMENSIONS			SEAT DIMENSIONS			BACK DIMENSIONS	
	W	D	H	W	D	H	W	H
IN	68.5	29	36	68.5	20	-	71	19
MM	1740	737	914	1740	508	-	1803	483

**Must be connected to a full arm/leg frame.**

**RTA 00** 1 per carton

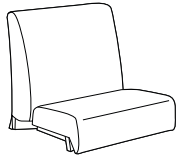

**HB Lounge Bariatric Top**  
 COM: 6.75 YD | 6.17 M  
 Unit weight: 80 LB | 36.4 KG  
 Carton weight: 96 LB | 43.54 KG  
 Carton volume: 37.75 FT³ | 1.06 MT³

**GC3679HB-TOP**

COM	2	3	4	5	6	7	8	9	10	11	12
1922	2138	2320	2530	2874	3191	3508	3785	4129	4453	4892	5513

Active weight: see notes.

Single high back frame bariatric lounge top, 1 back and 1 seat cushion.

	OVERALL DIMENSIONS			SEAT DIMENSIONS			BACK DIMENSIONS	
	W	D	H	W	D	H	W	H
IN	32	29	36	32	20	-	32	19
MM	813	737	914	813	508	-	813	483

**Must be connected to a full arm/leg frame.**

**RTA 00** 1 per carton

DESCRIPTION MODEL# / FEATURES STANDARD TEXTILE GRADES

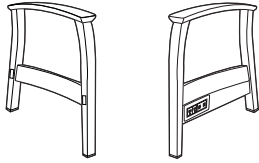

**Lounge Left End Frame, Open Arm**  
 COM: N/A  
 Unit weight: metal: 7 LB | 3.2 KG | wood: 7 LB | 3.2 KG  
 Carton weight: metal: 9.67 LB | 4.39 KG | wood: 11 LB | 4.99 KG  
 Carton volume: 2.1 FT³ | 0.05 MT³

List price

GC3641LA (metal)	545
GC3641LAM (w/power)	1568
GC3641WLA (wood)	394
GC3641WLAM (w/power)	1369

• Models GC3641LAM and GC3641WLAM have **power/USB** module.

Specify armcap:  
 wood or urethane.

	OVERALL DIMENSIONS			SEAT DIMENSIONS			BACK DIMENSIONS	
	W	D	H	W	D	H	W	H

For use in **left** side finished position of lounge seating units.

IN	3.5	29	25.25	-	-	-	-	-
MM	89	737	641	-	-	-	-	-

Does not allow linking to other units or tables.

RTA 1  1 per carton

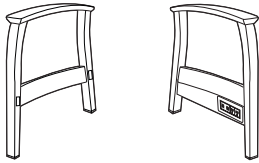

**Lounge Right End Frame, Open Arm**  
 COM: N/A  
 Unit weight: metal: 7 LB | 3.2 KG | wood: 7 LB | 3.2 KG  
 Carton weight: metal: 9.67 LB | 4.39 KG | wood: 11 LB | 4.99 KG  
 Carton volume: 2.1 FT³ | 0.05 MT³

List price

GC3641RA (metal)	545
GC3641RAM (w/power)	1568
GC3641WRA (wood)	394
GC3641WRAM (w/power)	1369

• Models GC3641LAM and GC3641WLAM have **power/USB** module.

Specify armcap:  
 wood or urethane.

	OVERALL DIMENSIONS			SEAT DIMENSIONS			BACK DIMENSIONS	
	W	D	H	W	D	H	W	H

For use in **right** side finished position of lounge seating units.

IN	3.5	29	25.25	-	-	-	-	-
MM	89	737	641	-	-	-	-	-

Does not allow linking to other units or tables.

RTA 1  1 per carton

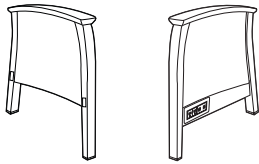

**Lounge Left End Frame, Closed Arm**  
 COM: 0.75 YD | 0.69 M  
 Unit weight: metal: 7 LB | 3.2 KG | wood: 7 LB | 3.2 KG  
 Carton weight: metal: 16.3 LB | 7.39 KG | wood: 11 LB | 4.99 KG  
 Carton volume: 2.1 FT³ | 0.05 MT³

	COM	2	3	4	5	6	7	8	9	10	11	12
--	-----	---	---	---	---	---	---	---	---	----	----	----

GC3641LCA (metal)	722	746	766	790	828	863	898	929	967	1003	1052	1121
GC3641LCAM (w/power)	1742	1766	1786	1810	1848	1883	1918	1949	1987	2023	2072	2141
GC3641WLCA (wood)	531	563	590	621	672	719	766	807	858	906	971	1063
GC3641WLCAM (w/power)	1503	1535	1562	1593	1644	1691	1738	1779	1830	1878	1943	2035

• Models GC3641LCAM and GC3641WLCAM have **power/USB** module.

Specify armcap:  
 wood or urethane.

	OVERALL DIMENSIONS			SEAT DIMENSIONS			BACK DIMENSIONS	
	W	D	H	W	D	H	W	H

For use in **left** side finished position of lounge seating units.

IN	3.5	29	25.25	-	-	-	-	-
MM	89	737	641	-	-	-	-	-

Does not allow linking to other units or tables.

RTA 1  1 per carton

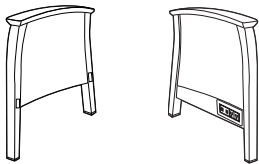

**Lounge Right End Frame, Closed Arm**  
 COM: 0.75 YD | 0.69 M  
 Unit weight: metal: 7 LB | 3.2 KG | wood: 7 LB | 3.2 KG  
 Carton weight: metal: 16.3 LB | 7.39 KG | wood: 11 LB | 4.99 KG  
 Carton volume: 2.1 FT³ | 0.05 MT³

	COM	2	3	4	5	6	7	8	9	10	11	12
--	-----	---	---	---	---	---	---	---	---	----	----	----

GC3641RCA (metal)	722	746	766	790	828	863	898	929	967	1003	1052	1121
GC3641RCAM (w/power)	1742	1766	1786	1810	1848	1883	1918	1949	1987	2023	2072	2141
GC3641WRCA (wood)	531	563	590	621	672	719	766	807	858	906	971	1063
GC3641WRCAM (w/power)	1503	1535	1562	1593	1644	1691	1738	1779	1830	1878	1943	2035

• Models GC3641RCAM and GC3641WRCAM have **power/USB** module.

Specify armcap:  
 wood or urethane.









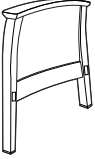

	OVERALL DIMENSIONS			SEAT DIMENSIONS			BACK DIMENSIONS	
	W	D	H	W	D	H	W	H

For use in **right** side finished position of lounge seating units.

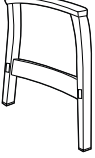
IN	3.5	29	25.25	-	-	-	-	-
MM	89	737	641	-	-	-	-	-

Does not allow linking to other units or tables.

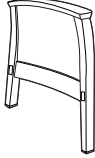
RTA 1  1 per carton

DESCRIPTION	MODEL# / FEATURES	STANDARD TEXTILE GRADES											
 <p><b>Lounge Left End Frame, Closed Arm, Laminate Panel</b> COM: N/A Unit weight: 15 LB   6.8 KG Carton weight: 18 LB   8.16 KG Carton volume: 2.1 FT³   0.05 MT³</p>	<p>List price</p> <p><b>GC3641LCAL</b> (metal) 886</p>												
	Specify armcap: wood or urethane.	<p><b>OVERALL DIMENSIONS</b></p> <p>W D H</p>			<p><b>SEAT DIMENSIONS</b></p> <p>W D H</p>			<p><b>BACK DIMENSIONS</b></p> <p>W H</p>					
	For use in <b>left</b> side finished position of lounge seating units.	IN	3.5	29	25.25	-	-	-	-	-	-	-	
	MM	89	737	641	-	-	-	-	-	-	-		
<p><b>Does not allow linking to other units or tables.</b></p> <p>RTA 1  1 per carton</p>													
 <p><b>Lounge Right End Frame, Closed Arm, Laminate Panel</b> COM: N/A Unit weight: 15 LB   6.8 KG Carton weight: 18 LB   8.16 KG Carton volume: 2.1 FT³   0.05 MT³</p>	<p>List price</p> <p><b>GC3641RCAL</b> (metal) 886</p>												
	Specify armcap: wood or urethane.	<p><b>OVERALL DIMENSIONS</b></p> <p>W D H</p>			<p><b>SEAT DIMENSIONS</b></p> <p>W D H</p>			<p><b>BACK DIMENSIONS</b></p> <p>W H</p>					
	For use in <b>right</b> side finished position of lounge seating units.	IN	3.5	29	25.25	-	-	-	-	-	-		
	MM	89	737	641	-	-	-	-	-	-			
<p><b>Does not allow linking to other units or tables.</b></p> <p>RTA 1  1 per carton</p>													
 <p><b>Lounge Center Frame, Open Arm</b> COM: N/A Unit weight: metal: 7 LB   3.2 KG   wood: 7 LB   3.2 KG Carton weight: metal: 11 LB   4.99 KG   wood: 11 LB   4.99 KG Carton volume: 2.1 FT³   0.05 MT³</p>	<p>List price</p> <p><b>GC36406LA</b> (metal) 545</p>												
	Specify armcap: wood or urethane.	<p><b>OVERALL DIMENSIONS</b></p> <p>W D H</p>			<p><b>SEAT DIMENSIONS</b></p> <p>W D H</p>			<p><b>BACK DIMENSIONS</b></p> <p>W H</p>					
	For <b>linking</b> lounge top seating units together only.	IN	3.5	29	25.25	-	-	-	-	-	-		
	MM	89	737	641	-	-	-	-	-	-			
<p><b>Does not allow linking to other units or tables.</b></p> <p>RTA 1  1 per carton</p>													
 <p><b>Lounge Center Frame, Closed Arm</b> COM: 0.75 YD   0.69 M Unit weight: metal: 7 LB   3.2 KG   wood: 7 LB   3.2 KG Carton weight: metal: 8.87 LB   4.02 KG   wood: 11 LB   4.99 KG Carton volume: 2.1 FT³   0.05 MT³</p>	<p>COM</p> <p><b>GC36406LCA</b> (metal)</p>	2	3	4	5	6	7	8	9	10	11	12	
	Specify armcap: wood or urethane.	722	746	766	790	828	863	898	929	967	1003	1052	1121
	For <b>linking</b> lounge top seating units together only.	<p><b>OVERALL DIMENSIONS</b></p> <p>W D H</p>			<p><b>SEAT DIMENSIONS</b></p> <p>W D H</p>			<p><b>BACK DIMENSIONS</b></p> <p>W H</p>					
	IN	3.5	29	25.25	-	-	-	-	-	-	-	-	
MM	89	737	641	-	-	-	-	-	-	-			
<p><b>Does not allow linking to other units or tables.</b></p> <p>RTA 1  1 per carton</p>													
 <p><b>Lounge Center Frame, Closed Arm, Laminate Panel</b> COM: N/A Unit weight: 15 LB   6.8 KG Carton weight: 18 LB   8.16 KG Carton volume: 2.1 FT³   0.05 MT³</p>	<p>List price</p> <p><b>GC36406LCAL</b> (metal) 886</p>												
	Specify armcap: wood or urethane.	<p><b>OVERALL DIMENSIONS</b></p> <p>W D H</p>			<p><b>SEAT DIMENSIONS</b></p> <p>W D H</p>			<p><b>BACK DIMENSIONS</b></p> <p>W H</p>					
	For <b>linking</b> lounge top seating units together only.	IN	3.5	29	25.25	-	-	-	-	-	-		
	MM	89	737	641	-	-	-	-	-	-			
<p><b>Does not allow linking to other units or tables.</b></p> <p>RTA 1  1 per carton</p>													

DESCRIPTION MODEL# / FEATURES STANDARD TEXTILE GRADES

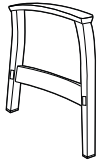

**Lounge Center Frame, Open Arm**

COM: N/A  
 Unit weight: metal: 7 LB | 3.2 KG | wood: 7 LB | 3.2 KG  
 Carton weight: metal: 11 LB | 4.99 KG | wood: 11 LB | 4.99 KG  
 Carton volume: 2.1 FT³ | 0.05 MT³

List price  
**GC36406TLA** (metal) 545

Specify armcap:  
 wood or urethane.

For **linking** lounge top seating units to modular table on the **left** side of the frame.

OVERALL DIMENSIONS			SEAT DIMENSIONS			BACK DIMENSIONS	
W	D	H	W	D	H	W	H
IN 3.5	29	25.25	-	-	-	-	-
MM 89	737	641	-	-	-	-	-

**RTA 1**  1 per carton

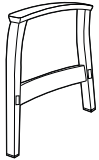

**Lounge Center Frame, Open Arm**

COM: N/A  
 Unit weight: metal: 7 LB | 3.2 KG | wood: 7 LB | 3.2 KG  
 Carton weight: metal: 2.24 LB | 1.02 KG | wood: 11 LB | 4.99 KG  
 Carton volume: 2.1 FT³ | 0.05 MT³

List price  
**GC36406TRA** (metal) 545

Specify armcap:  
 wood or urethane.

For **linking** lounge top seating units to modular table on the **right** side of the frame.

OVERALL DIMENSIONS			SEAT DIMENSIONS			BACK DIMENSIONS	
W	D	H	W	D	H	W	H
IN 3.5	29	25.25	-	-	-	-	-
MM 89	737	641	-	-	-	-	-

**RTA 1**  1 per carton

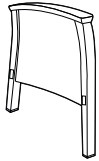

**Lounge Center Frame, Closed Arm**

COM: 0.75 YD | 0.69 M  
 Unit weight: metal: 7 LB | 3.2 KG | wood: 7 LB | 3.2 KG  
 Carton weight: metal: 8.87 LB | 4.02 KG | wood: 11 LB | 4.99 KG  
 Carton volume: 2.1 FT³ | 0.05 MT³

COM	2	3	4	5	6	7	8	9	10	11	12	
<b>GC36406TLCA</b> (metal)	722	746	766	790	828	863	898	929	967	1003	1052	1121

Specify armcap:  
 wood or urethane.

For **linking** lounge top seating units to modular table on the **left** side of the frame.

OVERALL DIMENSIONS			SEAT DIMENSIONS			BACK DIMENSIONS	
W	D	H	W	D	H	W	H
IN 3.5	29	25.25	-	-	-	-	-
MM 89	737	641	-	-	-	-	-

**RTA 1**  1 per carton

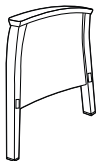

**Lounge Center Frame, Closed Arm**

COM: 0.75 YD | 0.69 M  
 Unit weight: metal: 7 LB | 3.2 KG | wood: 7 LB | 3.2 KG  
 Carton weight: metal: 11 LB | 4.99 KG | wood: 11 LB | 4.99 KG  
 Carton volume: 2.1 FT³ | 0.05 MT³

COM	2	3	4	5	6	7	8	9	10	11	12	
<b>GC36406TRCA</b> (metal)	722	746	766	790	828	863	898	929	967	1003	1052	1121

Specify armcap:  
 wood or urethane.

For **linking** lounge top seating units to modular table on the **right** side of the frame.

OVERALL DIMENSIONS			SEAT DIMENSIONS			BACK DIMENSIONS	
W	D	H	W	D	H	W	H
IN 3.5	29	25.25	-	-	-	-	-
MM 89	737	641	-	-	-	-	-

**RTA 1**  1 per carton

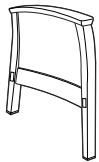

**Lounge Center Frame, Closed Arm, Laminate Panel**

COM: N/A  
 Unit weight: 15 LB | 6.8 KG  
 Carton weight: 18 LB | 8.16 KG  
 Carton volume: 2.1 FT³ | 0.05 MT³





List price  
**GC36406TLCAL** (metal) 886

Specify armcap:  
 wood or urethane.

For **linking** lounge top seating units to modular table on the **left** side of the frame.

OVERALL DIMENSIONS			SEAT DIMENSIONS			BACK DIMENSIONS	
W	D	H	W	D	H	W	H
IN 3.5	29	25.25	-	-	-	-	-
MM 89	737	641	-	-	-	-	-

**RTA 1**  1 per carton

DESCRIPTION	MODEL# / FEATURES	STANDARD TEXTILE GRADES											
 <p><b>Lounge Center Frame, Closed Arm, Laminate Panel</b> COM: N/A Unit weight: 15 LB   6.8 KG Carton weight: 18 LB   8.16 KG Carton volume: 2.1 FT³   0.05 MT³</p>	<p>List price</p> <p><b>GC36406TRCAL</b> (metal) 886</p>												
	<p>Specify armcap: wood or urethane.</p>	<p><b>OVERALL DIMENSIONS</b></p> <p>W D H</p>			<p><b>SEAT DIMENSIONS</b></p> <p>W D H</p>			<p><b>BACK DIMENSIONS</b></p> <p>W H</p>					
	<p>For <b>linking</b> lounge top seating units to modular table on the <b>right</b> side of the frame.</p>	<p>IN 3.5 29 25.25</p> <p>MM 89 737 641</p>	-	-	-	-	-	-	-	-	-	-	-
	<p><b>RTA 1</b>  1 per carton</p>												
		COM	2	3	4	5	6	7	8	9	10	11	12
	<b>GC3676CFA</b>	440	496	543	598	687	769	851	923	1012	1096	1210	1371
 <p><b>Center Frame, Fully Upholstered Arm</b> COM: 1.75 YD   1.6 M Unit weight: metal: 15 LB   6.8 KG Carton weight: metal: 35 LB   15.88 KG Carton volume: 6 FT³   0.16 MT³</p>	<p>Specify leg finish: wood or urethane.</p>												
	<p>Optional wood or urethane armcap. Please specify. Add \$142.</p>	<p><b>OVERALL DIMENSIONS</b></p> <p>W D H</p>			<p><b>SEAT DIMENSIONS</b></p> <p>W D H</p>			<p><b>BACK DIMENSIONS</b></p> <p>W H</p>					
	<p>For <b>linking</b> lounge top seating units together or to modular table.</p>	<p>IN 5 29 25.25</p> <p>MM 127 737 641</p>	-	-	-	-	-	-	-	-	-	-	-
	<p><b>RTA 00</b> 1 per carton</p>												
		COM	2	3	4	5	6	7	8	9	10	11	12
	<b>GC3676LA</b>	440	496	543	598	687	769	851	923	1012	1096	1210	1371
 <p><b>Left End Frame, Fully Upholstered Arm</b> COM: 1.75 YD   1.6 M Unit weight: metal: 15 LB   6.8 KG Carton weight: metal: 20 LB   9.07 KG Carton volume: 6 FT³   0.16 MT³</p>	<p>Specify leg finish: wood or urethane.</p>												
	<p>Optional wood or urethane armcap. Please specify. Add \$142.</p>	<p><b>OVERALL DIMENSIONS</b></p> <p>W D H</p>			<p><b>SEAT DIMENSIONS</b></p> <p>W D H</p>			<p><b>BACK DIMENSIONS</b></p> <p>W H</p>					
	<p>For use in <b>left</b> side finished position of lounge seating units. <b>Does not allow linking to other units or tables.</b></p>	<p>IN 5 29 25.25</p> <p>MM 127 737 641</p>	-	-	-	-	-	-	-	-	-	-	-
	<p><b>RTA 00</b> 1 per carton</p>												
		COM	2	3	4	5	6	7	8	9	10	11	12
	<b>GC3676RA</b>	440	496	543	598	687	769	851	923	1012	1096	1210	1371
 <p><b>Right End Frame, Fully Upholstered Arm</b> COM: 1.75 YD   1.6 M Unit weight: metal: 15 LB   6.8 KG Carton weight: metal: 20 LB   9.07 KG Carton volume: 6 FT³   0.16 MT³</p>	<p>Specify leg finish: wood or urethane.</p>												
	<p>Optional wood or urethane armcap. Please specify. Add \$142.</p>	<p><b>OVERALL DIMENSIONS</b></p> <p>W D H</p>			<p><b>SEAT DIMENSIONS</b></p> <p>W D H</p>			<p><b>BACK DIMENSIONS</b></p> <p>W H</p>					
	<p>For use in <b>right</b> side finished position of lounge seating units. <b>Does not allow linking to other units or tables.</b></p>	<p>IN 5 29 25.25</p> <p>MM 127 737 641</p>	-	-	-	-	-	-	-	-	-	-	-
	<p><b>RTA 00</b> 1 per carton</p>												
		COM	2	3	4	5	6	7	8	9	10	11	12
	<b>GC3676RA</b>	440	496	543	598	687	769	851	923	1012	1096	1210	1371

**Modular tables for use with modular lounge and fully upholstered lounge units:**

Tops are 1" thick.

Wooden leg tables:

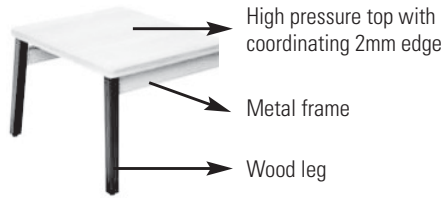

Metal leg tables:

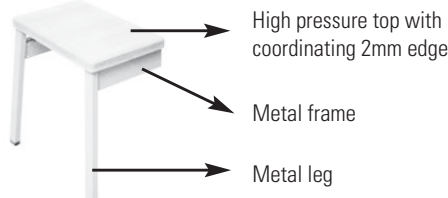

**Table top finishes:**

**High Pressure Laminate (HP)**

- Absolute Acajou (ACJ)
- Asian Night (ASN)
- Avant Cherry (W357)
- Avant Honey (W356)
- Black (BLK)
- Blizzard (BZD)
- Brushed Cobalt (BRC)
- Clear Maple (CMB)
- Custom Grey (CGY)
- Dark Espresso (W142)
- Designer White (DWT)
- Fashionista (FAS)
- First Class (FCL)
- Quartered Mahogany (QTM)
- Noce Biondo (NBL)
- Noce Grigio (NGL)
- Noce Leggero (NEL)
- Noce Medio (NML)
- Sheer Beauty (SBY)
- Stonedust (SDT)
- Storm (SOG)
- Walnut Heights (WHE)
- White Chocolate (WHC)
- Winter Cherry (WCR)

**Wooden leg finishes (top, base, legs & apron):**

- |                                |                               |
|--------------------------------|-------------------------------|
| Absolute (AAM)                 | Natural Walnut (NLW)          |
| Charcoal Java on Maple (CJM)   | Night (ASM)                   |
| Cherry on Maple (ACM)          | Noce Biondo (NBM)             |
| Empire Mahogany on Maple (EMM) | Noce Grigio (NGM)             |
| English Oak on Maple (EOM)     | Noce Leggero (NEM)            |
| Medium Walnut on Maple (MWM)   | Noce Medio (NMM)              |
| Espresso Cafe on Maple (ECM)   | Shaker Cherry on Maple (SKM)  |
| Fruitwood on Maple (TFM)       | Tiger Mahogany on Maple (TMM) |
| Gray (HGM)                     | Tiger Walnut on Maple (TWM)   |
| Harvest Oak on Maple (HOM)     | Winter Cherry on Maple (WCM)  |
| Honey on Maple (AHM)           | Sandy Beach on Maple (SBM)    |
| Jet Onyx on Maple (JOM)        | WC Cream (WTM)                |
| Light Honey on Maple (LHM)     | Silver Oak on Maple (SOM)     |
| Maple on Maple (AVM)           | White on Maple (WHM)          |

**Metal leg finishes:**

Black (TBL), Cloud (TIV), Designer White (TDW), Fog (TFO), Frost (TFR), Kalua (TKA), Latte (TLA), Mocha (TMO), Nevada (TNE), Sand (TSN), Shadow (TSH), Toast (TOA) and Tungsten (TTU). Please specify.

**Metal frame finishes:**

Black (TBL), Cloud (TIV), Designer White (TDW), Fog (TFO), Frost (TFR), Kalua (TKA), Latte (TLA), Mocha (TMO), Nevada (TNE), Sand (TSN), Shadow (TSH), Toast (TOA) and Tungsten (TTU). Please specify.

**Power/USB modules:**



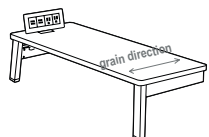

For modular tables with power/USB module, refer to models ending in "M". Module includes two power outlets, four USB charging ports and a 6 foot long power cord. Available in Black or White (must be specified at time of order). Power module is mounted **on surface** on narrow tables; mounted **in surface** on larger tables.

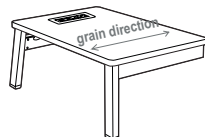

On surface power module on narrow tables



In surface power module on larger tables

MODULAR TABLES	MODEL #	DIMENSIONS <sup>IN</sup> <sub>MM</sub>	WEIGHT <sup>LB</sup> <sub>KG</sub>	VOLUME <sup>FT<sup>3</sup></sup> <sub>MT<sup>3</sup></sub>	LIST PRICE
 <p><b>Center Table, High Pressure</b></p>	GC36401-HP	20.25 x 28 x 13 514 x 711 x 330	18 8.2	3.5 0.09	<b>\$821</b>
	GC36401M-HP With power				<b>\$1780</b>
<ul style="list-style-type: none"> <li>Model GC36401M-HP has a <b>power/USB</b> module mounted in surface.</li> </ul> <p>Coordinating 2mm edge. Regular center table for <b>wood or metal lounge</b> frame. Must be connected to full arm and leg with <b>lounge</b> frames (GC36406TLA/TRA, GC36406TLCA/TRCA, GC36406WTLA/TRA, GC36406WTLCA/TRCA). 1 per carton.</p>					
 <p><b>Narrow Center Table, High Pressure</b></p>	GC36402-HP	12 x 28 x 13 305 x 711 x 330	15 6.8	2.1 0.05	<b>\$791</b>
	GC36402M-HP With power				<b>\$1750</b>
<ul style="list-style-type: none"> <li>Model GC36402M-HP has a <b>power/USB</b> module mounted in surface.</li> </ul> <p>Coordinating 2mm edge. Narrow center table for <b>wood or metal lounge</b> frame. Must be connected to full arm and leg with <b>lounge</b> frames (GC36406TLA/TRA, GC36406TLCA/TRCA, GC36406WTLA/TRA, GC36406WTLCA/TRCA). 1 per carton.</p>					
 <p><b>Left Corner Table, High Pressure Wood Legs</b></p>	GC36403WL-HP	37.12 x 37.12 x 13 943 x 943 x 330	41 18.6	6 0.16	<b>\$1359</b>
	GC36403WLM-HP With power				<b>\$2272</b>
<ul style="list-style-type: none"> <li>Model GC36403WLM-HP has a <b>power/USB</b> module mounted in surface.</li> </ul> <p>Coordinating 2mm edge. Must be connected to full arm and leg with <b>wood lounge</b> frames (GC36406WTLA/TRA, GC36406WTLCA/TRCA). This table allows for kneespace when specifying chairs in a corner position. 1 per carton.</p> <ul style="list-style-type: none"> <li>Includes 2 rear wood legs (not shown).</li> </ul>					
 <p><b>Left Corner Table, High Pressure Metal Legs</b></p>	GC36403L-HP	37.12 x 37.12 x 13 943 x 943 x 330	41 18.6	6 0.16	<b>\$1485</b>
	GC36403LM-HP With power				<b>\$2444</b>
<ul style="list-style-type: none"> <li>Model GC36403LM-HP has a <b>power/USB</b> module mounted in surface.</li> </ul> <p>Coordinating 2mm edge. Must be connected to full arm and leg with <b>metal lounge</b> frames (GC36406TLA/TRA, GC36406TLCA/TRCA). This table allows for kneespace when specifying chairs in a corner position. 1 per carton.</p> <ul style="list-style-type: none"> <li>Includes 2 rear metal legs (not shown).</li> </ul>					

MODULAR TABLES	MODEL #	DIMENSIONS <sup>IN</sup> <sub>MM</sub>	WEIGHT <sup>LB</sup> <sub>KG</sub>	VOLUME <sup>FT<sup>3</sup></sup> <sub>MT<sup>3</sup></sub>	LIST PRICE
----------------	---------	---	---------------------------------------	---	------------



grain direction



grain direction

**Right Corner Table, High Pressure Wood Legs**

		W x D x H			
GC36403WR-HP		37.12 x 37.12 x 13	41	6	<b>\$1359</b>
GC36403WRM-HP	With power	943 x 943 x 330	18.6	0.16	<b>\$2272</b>

- Models GC36403WRM-HP have a **power/USB** module mounted in surface.

Coordinating 2mm edge. Must be connected to full arm and leg with **wood lounge** frames (GC36406WTLA/TRA, GC36406WTLCA/TRCA). This table allows for kneespace when specifying chairs in a corner position. 1 per carton.

- Includes 2 rear wood legs (not shown).



grain direction



grain direction

**Right Corner Table, High Pressure Metal Legs**

GC36403R-HP		37.12 x 37.12 x 13	41	6	<b>\$1485</b>
GC36403RM-HP	With power	943 x 943 x 330	18.6	0.16	<b>\$2444</b>

- Models GC36403RM-HP has a **power/USB** module mounted in surface.

Coordinating 2mm edge. Must be connected to full arm and leg with **metal lounge** frames (GC36406TLA/TRA, GC36406TLCA/TRCA). This table allows for kneespace when specifying chairs in a corner position. 1 per carton.

- Includes 2 rear metal legs (not shown).

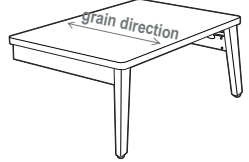

grain direction

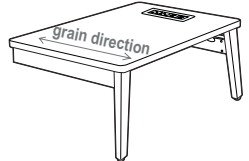

grain direction

**Left End Table, High Pressure Wood Legs**

GC36404WL-HP		20.25 x 28 x 13	18	3.5	<b>\$1014</b>
GC36404WLM-HP	With power	514 x 711 x 330	8.2	0.09	<b>\$1929</b>

- Models GC36404WLM-HP has a **power/USB** module mounted in surface.

Coordinating 2mm edge. Must be connected to full arm and leg with **wood lounge** frames (GC36406WTLA or GC36406WTLCA). 1 per carton.

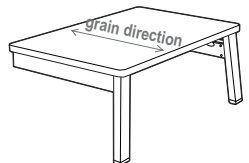

grain direction

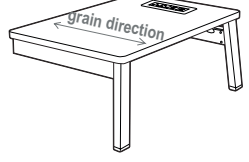

grain direction

**Left End Table, High Pressure Metal Legs**

GC36404L-HP		20.25 x 28 x 13	18	3.5	<b>\$1124</b>
GC36404LM-HP	With power	514 x 711 x 330	8.2	0.09	<b>\$2085</b>

- Models GC36404LM-HP has a **power/USB** module mounted in surface.

Coordinating 2mm edge. Must be connected to full arm and leg with **metal lounge** frames (GC36406TLA or GC36406TLCA). 1 per carton.

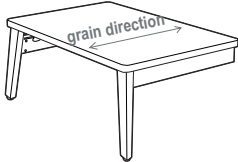
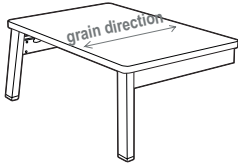
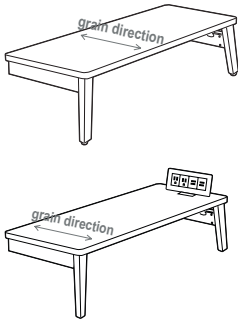

MODULAR TABLES	MODEL #	DIMENSIONS <sup>IN</sup> <sub>MM</sub>	WEIGHT <sup>LB</sup> <sub>KG</sub>	VOLUME <sup>FT<sup>3</sup></sup> <sub>MT<sup>3</sup></sub>	LIST PRICE
 <p><b>Right End Table, High Pressure Wood Legs</b></p>	GC36404WR-HP	20.25 x 28 x 13 514 x 711 x 330	18 8.2	3.5 0.09	<b>\$1014</b>
	GC36404WRM-HP With power				<b>\$1929</b>
<ul style="list-style-type: none"> <li>Models GC36404WRM-HP has a <b>power/USB</b> module mounted in surface.</li> </ul> <p>Coordinating 2mm edge. Must be connected to full arm and leg with <b>wood lounge</b> frames (GC36406WTRA or GC36406WTRCA). 1 per carton.</p>					
 <p><b>Right End Table, High Pressure Metal Legs</b></p>	GC36404R-HP	20.25 x 28 x 13 514 x 711 x 330	18 8.2	3.5 0.09	<b>\$1124</b>
	GC36404RM-HP With power				<b>\$2085</b>
<ul style="list-style-type: none"> <li>Models GC36404RM-HP has a <b>power/USB</b> module mounted in surface.</li> </ul> <p>Coordinating 2mm edge. Must be connected to full arm and leg with <b>metal lounge</b> frames (GC36406TRA or GC36406TRCA). 1 per carton.</p>					
 <p><b>Narrow Left End Table, High Pressure Wood Legs</b></p>	GC36405WL-HP	12 x 28 x 13 305 x 711 x 330	15 6.8	2.1 0.05	<b>\$985</b>
	GC36405WLM-HP With power				<b>\$1902</b>
<ul style="list-style-type: none"> <li>Models GC36405WLM-HP has a <b>power/USB</b> module mounted on surface.</li> </ul> <p>Coordinating 2mm edge. Must be connected to full arm and leg with <b>wood lounge</b> frames (GC36406WTLA or GC36406WTLCA). 1 per carton.</p>					

MODULAR TABLES	MODEL #	DIMENSIONS	IN MM	WEIGHT	LB KG	VOLUME	FT <sup>3</sup> MT <sup>3</sup>	LIST PRICE
----------------	---------	------------	----------	--------	----------	--------	------------------------------------	------------

W x D x H

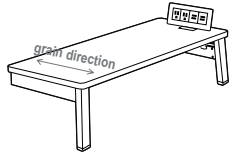
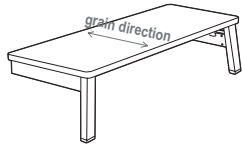

**Narrow Left End Table, High Pressure Metal Legs**

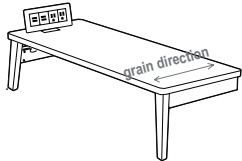
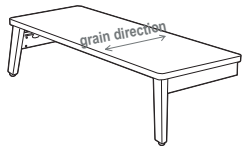

**Narrow Right End Table, High Pressure Wood Legs**

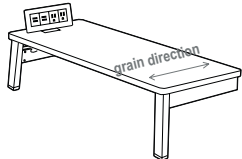
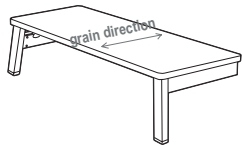

**Narrow Right End Table, High pressure Metal Legs**

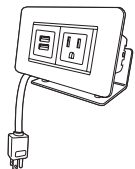

**Power/Data Module for tables**

GC36405L-HP	12 x 28 x 13	15	2.1	<b>\$1096</b>
GC36405LM-HP With power	305 x 711 x 330	6.8	0.05	<b>\$2056</b>

- Models C36405LM-HP has a **power/USB** module mounted on surface.

Coordinating 2mm edge. Must be connected to full arm and leg with **metal lounge** frames (GC36406TLA or GC36406TLCA). 1 per carton.

GC36405WR-HP	12 x 28 x 13	15	2.1	<b>\$985</b>
GC36405WRM-HP With power	305 x 711 x 330	6.8	0.05	<b>\$1902</b>

- Models GC36405WRM-HP has a **power/USB** module mounted on surface.

Coordinating 2mm edge. Must be connected to full arm and leg with **wood lounge** frames (GC36406WTRA or GC36406WTRCA). 1 per carton.

GC36405R-HP	12 x 28 x 13	15	2.1	<b>\$1096</b>
GC36405RM-HP With power	305 x 711 x 330	6.8	0.05	<b>\$2056</b>

- Models GC36405RM-HP has a **power/USB** module mounted on surface.

Coordinating 2mm edge. Must be connected to full arm and leg with **metal lounge** frames (GC36406TRA or GC36406TRCA). 1 per carton.

GC36410	- x - x -	2	1	<b>\$596</b>
	- x - x -	0.9	0.02	

Surface top mount power/data module with one power outlet, two USB charging ports. 6 foot cord. White. Can be mounted to all freestanding and modular tables.



Meet River+™, the next generation of our highly popular lounge series. Now with industry-leading support for workplace, education and healthcare, River+ performs at three times the BIFMA standard for true 24/7 applications in demanding environments. All models have been active weight tested to 600 lbs. including bariatric use. Multiple back and seat heights, 120-degree configurations and modular Aluminum arms are just a few of the many options that will make it yours.

To see the full River+ series, please refer to the Seating price list at [globalfurnituregroup.com/ca/resources/pricelists](http://globalfurnituregroup.com/ca/resources/pricelists).

#### Features and Benefits

- A modular series that is composed of straight, curved and corner sections.
- Units can be linked together to create a wide variety of layouts. Ganging hardware is standard and is factory installed. Ganging hardware swivels out of the way when not in use.
- The tapered legs are made of welded steel, with each leg bolted directly to the unit frame. Standard leg height is 6.5" with an optional 8" height. The leg height makes it easy to clean under the product.
- Seat to back connector components join back and seat; maintaining offset for clean out.
- All River+ seating models meet or exceed the applicable ANSI/BIFMA standards and are backed by Global's Heavy Duty warranty.
- Back shelf available on corner, two and three seater units in many low pressure laminate finishes. Shelf supports are Aluminum with accessory hook in three finishes.
- Upholstery options: fabric, vinyl or leather (leather recommended only for use on seat).
- For improved housekeeping and infection control practices, the underside of the seat can be finished with PVC (vinyl) and sealed to prevent penetration of liquids.
- Sealed seams option and steel bottom tamperproof protection is also available.
- For environmental certifications, please visit [globalfurnituregroup.com](http://globalfurnituregroup.com).

**SENATOR**

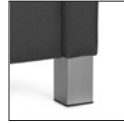

Optional metal leg

model GC3392 (tapered wood legs)

**STANDARD FEATURES**

- The flared back design and creative curves enhance any healthcare environment without sacrificing comfort.
- Waterfall seamless front upholstered design with removable seat cushions for easy cleaning and protecting against bacteria.
- For added comfort, seats are standard with high density Ultracell foam.
- Standard with wood legs.
- For healthcare textiles and wood finish options, visit the website at [globalfurnituregroup.com](http://globalfurnituregroup.com). Available in European beechwood species only (refer to finishes ending in "M").
- Can be upholstered in standard Global textiles if healthcare compliance is not required.
- Shipped fully assembled.

**OPTIONAL FEATURES**

- Optional metal legs are available in Black (TBL), Kalua (TKA), Latte (TLA), Mocha (TMO), Shadow (TSH), Toast (TOA) and Tungsten (TTU). Please specify. No upcharge.
- For hard surface floors, please specify opaque non-marking glides (**GL**). No upcharge.
- For steel cushion glide, please specify (**GI**). Add \$5.
- For non-slip glides, please specify (**NS**). Add \$22.
- For moisture barrier on seat, please specify (**MB**). See upcharges below.
- To add sealed seams to your product contact Customer Service. Upcharges vary.

**SUGGESTED APPLICATIONS**

- Lobbies
- Lounge/Waiting
- Patient rooms
- Resident rooms

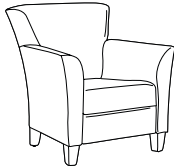
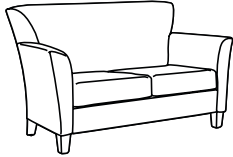
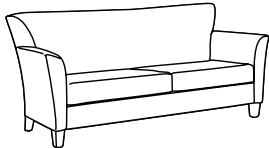
DESCRIPTION	MODEL# / FEATURES	STANDARD TEXTILE GRADES											
		COM	2	3	4	5	6	7	8	9	10	11	12
 <b>Armchair</b> COM: 5.25 YD   4.8 M Unit weight: 56 LB   25.5 KG Carton weight: 72 LB   32.66 KG Carton volume: 29.25 FT³   0.82 MT³	<b>GC3391</b>	2065	2233	2375	2538	2805	3052	3299	3514	3782	4034	4375	4858
		<b>OVERALL DIMENSIONS</b>			<b>SEAT DIMENSIONS</b>			<b>BACK DIMENSIONS</b>					
		W	D	H	W	D	H	W	H				
Active weight 300 lbs.	IN 34	32.25	36	19.5	19	17.5	28	18.5					
Removable seat cushion.	MM 864	819	914	495	483	445	711	470					
Add \$122 for ( <b>MB</b> ).	<b>RTA 00</b>	1 per carton											
 <b>Two Seat Sofa</b> COM: 8.25 YD   7.54 M Unit weight: 90 LB   40.9 KG Carton weight: 116 LB   52.62 KG Carton volume: 55.5 FT³   1.57 MT³	<b>GC3392</b>	2845	3109	3332	3588	4008	4396	4784	5122	5543	5939	6475	7234
		<b>OVERALL DIMENSIONS</b>			<b>SEAT DIMENSIONS</b>			<b>BACK DIMENSIONS</b>					
		W	D	H	W	D	H	W	H				
Active weight 300 lbs/seat.	IN 61	32.25	36	46	19	17.5	56	18.5					
Removable seat cushions.	MM 1549	819	914	1168	483	445	1422	470					
Add \$245 for ( <b>MB</b> ).	<b>RTA 00</b>	1 per carton											
 <b>Three Seat Sofa</b> COM: 9.5 YD   8.69 M Unit weight: 110 LB   50 KG Carton weight: 141 LB   63.96 KG Carton volume: 67 FT³   1.89 MT³	<b>GC3393</b>	3681	3985	4242	4536	5021	5467	5914	6303	6788	7244	7861	8735
		<b>OVERALL DIMENSIONS</b>			<b>SEAT DIMENSIONS</b>			<b>BACK DIMENSIONS</b>					
		W	D	H	W	D	H	W	H				
Active weight 300 lbs/seat.	IN 76	32.25	36	61	19	17.5	71	18.5					
Removable seat cushions.	MM 1930	819	914	1549	483	445	1803	470					
Add \$366 for ( <b>MB</b> ).	<b>RTA 00</b>	1 per carton											

SLEEP-EEZ



model GC3614

Sleep surface dimensions:

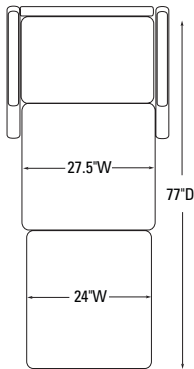

EXAMPLE SLEEP-EEZ ORDER CODE:

GC3614	-LX21	-PT	-	-SS
Model #	Textile	Armcaps	Moisture Barrier	Sealed seams

STANDARD FEATURES

- Sleep-Eez provides incredible comfort, requires zero wall clearance and can be easily opened and close by one person.
- It can be adjusted to create three functional positions: a chair, a chaise lounge and a sleep surface.
- The heavy duty steel mechanism will provide long-term performance.
- Commercial grade casters are standard. Front casters are non-swivel manual locking. Back casters are non-locking and swivel for better steering when moving the chair.
- Clean out space is provided between the seat and back cushions for housekeeping and infection prevention control.
- Sleep-Eez's construction allows for on-site replacement of all components, eliminating down time and enhancing the product's life.
- Standard with Black urethane (urethane) fully extended arms with a grip for ease of entry and exit from chair.
- For healthcare textile options, visit the website at [globalfurnituregroup.com](http://globalfurnituregroup.com).
- Can be upholstered in standard Global textiles if healthcare compliance is not required.
- Shipped fully assembled.
- Measurements:  
Chaise lounge: 35"W x 64"D x 35"H  
Sleep surface: 24"W x 77"D

OPTIONAL FEATURES

- For moisture barrier on seat, please specify **(MB)**. Add \$122.
- To add sealed seams to your product, please specify **(SS)**. Add \$189.

SUGGESTED APPLICATIONS

- Lobbies
- Lounge/Waiting
- Office/Meeting
- Patient rooms
- Resident rooms
- Treatment/Exam rooms

Please add option codes in the following order:

- **Model number**  
**GC3614** Single sleeper chair
- **Textile**  
Specify fabric code
- **Armcap finish**  
**(BLK)** Black urethane armcap  
**(LAB)** Latte urethane armcap  
**(KAL)** Kalua urethane armcap  
**(J52)** Mocha urethane armcap  
**(SHW)** Shadow urethane armcap  
**(TOA)** Toast urethane armcap  
**(AAM)** Absolute wood armcap  
**(CJM)** Charcoal Java wood armcap  
**(ACM)** Cherry wood armcap  
**(EMM)** Empire Mahogany wood armcap  
**(EOM)** English Oak wood armcap  
**(ECM)** Espresso Cafe wood armcap  
**(HGM)** Gray wood armcap  
**(HOM)** Harvest Oak wood armcap  
**(AHM)** Honey wood armcap  
**(JOM)** Jet Onyx wood armcap  
**(LHM)** Light Honey wood armcap  
**(AVM)** Maple wood armcap  
**(MWM)** Medium Walnut wood armcap  
**(NLW)** Natural Walnut wood armcap  
**(ASM)** Night wood armcap  
**(NBM)** Noce Biondo wood armcap  
**(NGM)** Noce Grigio wood armcap  
**(NEM)** Noce Leggero wood armcap  
**(NMM)** Noce Medio wood armcap  
**(SBM)** Sandy Beach wood armcap  
**(SOM)** Silver Oak wood armcap  
**(TFM)** Tiger Fruitwood wood armcap  
**(TMM)** Tiger Mahogany wood armcap  
**(TWM)** Tiger Walnut wood armcap  
**(WTM)** WC Cream wood armcap  
**(WHM)** White wood armcap  
**(WCM)** Winter Cherry wood armcap
- **Moisture Barrier**  
**(MB)** Seat only
- **Sealed seams**  
**(SS)** All sealed seams

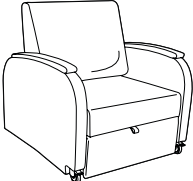
DESCRIPTION	MODEL# / FEATURES	STANDARD TEXTILE GRADES											
		COM	2	3	4	5	6	7	8	9	10	11	12
 <b>Single Sleeper Chair</b> COM: 8.5 YD   7.77 M Unit weight: 146 LB   66.4 KG Carton weight: 160 LB   72.57 KG Carton volume: 38 FT <sup>3</sup>   1.07 MT <sup>3</sup>	<b>GC3614</b>	3412	3684	3914	4177	4611	5010	5410	5758	6192	6600	7152	7934
	Active weight 350 lbs.	<b>OVERALL DIMENSIONS</b> W D H			<b>SEAT DIMENSIONS</b> W D H			<b>BACK DIMENSIONS</b> W H					
		IN 35	37	35	27.5	21	17.5	27.5	18.5				
		MM 889	940	889	699	533	445	699	470				
		<b>RTA 00</b>		1 per carton									

STRAND



model GC3707HB



model GC3702

STANDARD FEATURES

- Strand is the perfect synthesis of versatility, comfort, durability and value pricing. Strand offers a pleasing look in a diverse range of solutions from single patient room chairs to waiting areas and public spaces.
- All models are standard in oval metal tube frame.
- Frame available in Black (TBL), Cloud (TIV), Designer White (TDW), Fog (TFO), Frost (TFR), Kalua (TKA), Latte (TLA), Mocha (TMO), Nevada (TNE), Sand (TSN), Shadow (TSH), Toast (TOA) and Tungsten (TTU). Please specify.
- The frame can be weighted and made with tamperproof fasteners for greater security in more challenging mental health spaces or correctional facilities. Request a special quote.
- Armcaps are standard in Black urethane (urethane).
- Left and right position reference is determined from the seated position.
- The seat and back are removable and field replaceable.
- For added comfort, seats are standard with high density Ultracell foam.
- All seat frames feature a wall saver design to prevent back contact with wall. Footstool and benches do not have wall saver legs.
- Standard seat height on all models is 18".
- Clean out space is provided between the seat and back cushions for easy housekeeping.
- Standard with Black plastic glides.
- Select models are offered with rear tip and move wheels. To activate wheels, tilt the chair back so the casters are in contact with the floor. This feature makes it easy to relocate the chair while unoccupied.
- Flex back models allow the back to move in a soothing rocking motion.
- Active weight capacity for standard single seat is 350 lbs. and 750 lbs. for bariatric seating.
- For healthcare textiles and wood finish options, visit the website at [globalfurnituregroup.com](http://globalfurnituregroup.com).
- Can be upholstered in standard Global textiles if healthcare compliance is not required.



OPTIONAL FEATURES



- The seat cushion is slightly inclined to enhance comfort. An optional flat seat cushion is available. Please specify **(FS)**.  
For one seater: Add \$33.  
For two seater: Add \$70  
For three seater: Add \$102.  
For bariatric models: Add \$55.
- Wood armcaps are available in all Seating wood finishes (see features column for upcharges).
- Non-marking White glides are available. Please specify **(WH)**. No upcharge.
- For moisture barrier on seat, please specify **(MB)**.  
For one seater: Add \$81.  
For two seater: Add \$165.  
For three seater: Add \$245.  
For bariatric models: Add \$122.
- For improved housekeeping and infection control practices, please add **(SU)** to model number. The underside of the seat will be finished with vinyl and sealed to prevent penetration of liquids.  
For one seater: Add \$39.  
For two seater: Add \$79.  
For three seater: Add \$117.  
For bariatric models: Add \$59.

SUGGESTED APPLICATIONS

- Bariatric seating (some models)
- Guest seating
- Lobbies
- Lounge/Waiting
- Patient rooms
- Resident rooms
- Treatment/Exam rooms

For complementary tables, please refer to the GC Belong **freestanding** tables, page 42. (Not for use with GC Belong table bridges.)

DESCRIPTION	MODEL# / FEATURES	STANDARD TEXTILE GRADES											
		COM	2	3	4	5	6	7	8	9	10	11	12
 <p><b>Low Back Single Seat Armless Chair</b> COM: 1.75 YD   1.6 M Unit weight: 35 LB   15.9 KG Carton weight: 43 LB   19.5 KG Carton volume: 17.5 FT³   0.49 MT³</p>	<b>GC3700</b>	843	899	946	1001	1090	1172	1254	1326	1415	1499	1613	1774
	Active weight 350 lbs.	<b>OVERALL DIMENSIONS</b>			<b>SEAT DIMENSIONS</b>			<b>BACK DIMENSIONS</b>					
		IN	24.5	27.5	34.5	22	18.5	18	21.5	17			
		MM	622	699	876	559	470	457	546	432			
	<b>RTA 00</b>	1 per carton											
 <p><b>Low Back Single Seat Armchair</b> COM: 1.75 YD   1.6 M Unit weight: 40 LB   18.2 KG Carton weight: 48 LB   21.77 KG Carton volume: 17.5 FT³   0.49 MT³</p>	<b>GC3701</b>	1005	1061	1108	1163	1252	1334	1416	1488	1577	1661	1775	1936
	Active weight 350 lbs.	<b>OVERALL DIMENSIONS</b>			<b>SEAT DIMENSIONS</b>			<b>BACK DIMENSIONS</b>					
		IN	25.5	27.5	34.5	22	18.5	18	21.5	17			
		MM	648	699	876	559	470	457	546	432			
Wood armcap option: Add \$85.	<b>RTA 00</b>	1 per carton											

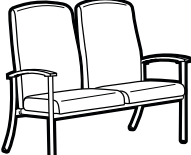
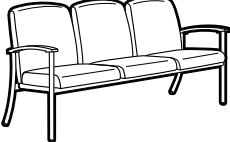
DESCRIPTION	MODEL# / FEATURES	STANDARD TEXTILE GRADES											
		COM	2	3	4	5	6	7	8	9	10	11	12
 <p>Designed to immobilize the pelvis and hip joints after surgery.</p> <p><b>Low Back Hip Armchair Post Surgery</b>                      COM: 1.75 YD   1.6 M                      Unit weight: 45 LB   20.5 KG                      Carton weight: 53 LB   24.04 KG                      Carton volume: 17.5 FT³   0.49 MT³</p>	<b>GC3701-24</b> 24" seat height	1205	1261	1308	1363	1452	1534	1616	1688	1777	1861	1975	2136
	Active weight 350 lbs.	IN 25.5 MM 648	27.5 699	40.5 1029	22 559	18.5 470	24 610	21.5 546	17 432				
	Wood armcap option: Add \$85.	<b>RTA 00</b> 1 per carton											
			<b>OVERALL DIMENSIONS</b> W D H			<b>SEAT DIMENSIONS</b> W D H			<b>BACK DIMENSIONS</b> W H				
 <p><b>High Back Single Seat Armchair</b>                      COM: 2 YD   1.83 M                      Unit weight: 45 LB   20.5 KG                      Carton weight: 53 LB   24.04 KG                      Carton volume: 20 FT³   0.56 MT³</p>	<b>GC3701HB</b>	1057	1121	1175	1237	1339	1433	1527	1609	1711	1807	1937	2121
	Active weight 350 lbs.	IN 25.5 MM 648	27.5 699	42.5 1080	22 559	18 457	18 457	21.5 546	25 635				
	Wood armcap option: Add \$85.	<b>RTA 00</b> 1 per carton											
			<b>OVERALL DIMENSIONS</b> W D H			<b>SEAT DIMENSIONS</b> W D H			<b>BACK DIMENSIONS</b> W H				
 <p><b>Low Back Two Seat Chair No Center Arm</b>                      COM: 3.25 YD   2.97 M                      Unit weight: 60 LB   27.3 KG                      Carton weight: 68 LB   30.84 KG                      Carton volume: 43 FT³   1.21 MT³</p>	<b>GC3702</b>	1596	1700	1788	1889	2054	2207	2360	2493	2659	2815	3026	3325
	Active weight 350 lbs/seat.	IN 49.75 MM 1264	27.5 699	34.5 876	44 1118	18.5 470	18 457	43 1092	17 432				
	Wood armcap option: Add \$85.	<b>RTA 00</b> 1 per carton											
			<b>OVERALL DIMENSIONS</b> W D H			<b>SEAT DIMENSIONS</b> W D H			<b>BACK DIMENSIONS</b> W H				
 <p><b>High Back Two Seat Chair No Center Arm</b>                      COM: 3.75 YD   3.43 M                      Unit weight: 67 LB   30.5 KG                      Carton weight: 75 LB   34.02 KG                      Carton volume: 56.5 FT³   1.59 MT³</p>	<b>GC3702HB</b>	1703	1823	1924	2041	2232	2408	2584	2738	2929	3109	3353	3698
	Active weight 350 lbs/seat.	IN 49.75 MM 1264	27.5 699	42.5 1080	44 1118	18.5 470	18 457	43 1092	25 635				
	Wood armcap option: Add \$85.	<b>RTA 00</b> 1 per carton											
			<b>OVERALL DIMENSIONS</b> W D H			<b>SEAT DIMENSIONS</b> W D H			<b>BACK DIMENSIONS</b> W H				
 <p><b>Low Back Three Seat Chair No Center Arms</b>                      COM: 4.5 YD   4.11 M                      Unit weight: 80 LB   36.4 KG                      Carton weight: 90 LB   40.82 KG                      Carton volume: 65.25 FT³   1.84 MT³</p>	<b>GC3703</b>	2198	2342	2464	2603	2833	3044	3256	3440	3670	3886	4178	4592
	Active weight 350 lbs/seat.	IN 71.25 MM 1810	27.5 699	34.5 876	66 1676	18.5 470	18 457	64.5 1638	17 432				
	Wood armcap option: Add \$85.	<b>RTA 00</b> 1 per carton											
			<b>OVERALL DIMENSIONS</b> W D H			<b>SEAT DIMENSIONS</b> W D H			<b>BACK DIMENSIONS</b> W H				

DESCRIPTION MODEL# / FEATURES STANDARD TEXTILE GRADES

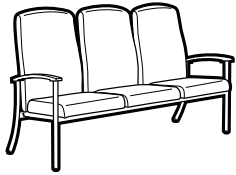

**High Back Three Seat Chair No Center Arms**  
 COM: 5.25 YD | 4.8 M  
 Unit weight: 86 LB | 39.1 KG  
 Carton weight: 96 LB | 43.54 KG  
 Carton volume: 80.75 FT<sup>3</sup> | 2.28 MT<sup>3</sup>

COM	2	3	4	5	6	7	8	9	10	11	12	
<b>GC3703HB</b>	2356	2524	2666	2829	3096	3343	3590	3805	4073	4325	4666	5149

OVERALL DIMENSIONS			SEAT DIMENSIONS			BACK DIMENSIONS	
W	D	H	W	D	H	W	H

Active weight 350 lbs/seat.  
 Wood armcap option:  
 Add \$85.

IN	71.25	27.5	42.5	66	18.5	18	64.5	25
MM	1810	699	1080	1676	470	457	1638	635
	<b>RTA 00</b>	1 per carton						

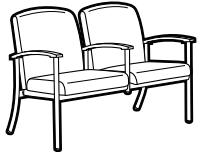

**Low Back Two Seat Chair Half Center Arm**  
 COM: 3.25 YD | 2.97 M  
 Unit weight: 65 LB | 29.5 KG  
 Carton weight: 73 LB | 33.11 KG  
 Carton volume: 43 FT<sup>3</sup> | 1.21 MT<sup>3</sup>

COM	2	3	4	5	6	7	8	9	10	11	12	
<b>GC3704</b>	1764	1868	1956	2057	2222	2375	2528	2661	2827	2983	3194	3493

OVERALL DIMENSIONS			SEAT DIMENSIONS			BACK DIMENSIONS	
W	D	H	W	D	H	W	H

Active weight 350 lbs/seat.  
 Wood armcap option:  
 Add \$130.

IN	49.75	27.5	34.5	22	18.5	18	21.5	17
MM	1264	699	876	559	470	457	546	432
	<b>RTA 00</b>	1 per carton						

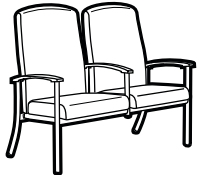

**High Back Two Seat Chair Half Center Arm**  
 COM: 3.75 YD | 3.43 M  
 Unit weight: 71 LB | 32.3 KG  
 Carton weight: 79 LB | 35.83 KG  
 Carton volume: 56.5 FT<sup>3</sup> | 1.59 MT<sup>3</sup>

COM	2	3	4	5	6	7	8	9	10	11	12	
<b>GC3704HB</b>	1871	1991	2092	2209	2400	2576	2752	2906	3097	3277	3521	3866

OVERALL DIMENSIONS			SEAT DIMENSIONS			BACK DIMENSIONS	
W	D	H	W	D	H	W	H

Active weight 350 lbs/seat.  
 Wood armcap option:  
 Add \$130.

IN	49.75	27.5	42.5	44	18.5	18	43	25
MM	1264	699	1080	1118	470	457	1092	635
	<b>RTA 00</b>	1 per carton						

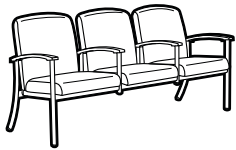

**Low Back Three Seat Chair Half Center Arms**  
 COM: 4.5 YD | 4.11 M  
 Unit weight: 90 LB | 40.9 KG  
 Carton weight: 100 LB | 45.36 KG  
 Carton volume: 65.25 FT<sup>3</sup> | 1.84 MT<sup>3</sup>

COM	2	3	4	5	6	7	8	9	10	11	12	
<b>GC3705</b>	2534	2678	2800	2939	3169	3380	3592	3776	4006	4222	4514	4928

OVERALL DIMENSIONS			SEAT DIMENSIONS			BACK DIMENSIONS	
W	D	H	W	D	H	W	H

Active weight 350 lbs/seat.  
 Wood armcap option:  
 Add \$174.

IN	71.25	27.5	34.5	22	18.5	18	21.5	17
MM	1810	699	876	559	470	457	546	432
	<b>RTA 00</b>	1 per carton						

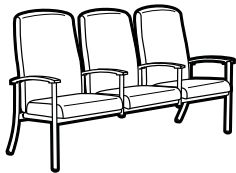

**High Back Three Seat Chair Half Center Arms**  
 COM: 5.25 YD | 4.8 M  
 Unit weight: 90 LB | 40.9 KG  
 Carton weight: 100 LB | 45.36 KG  
 Carton volume: 80.75 FT<sup>3</sup> | 2.28 MT<sup>3</sup>





COM	2	3	4	5	6	7	8	9	10	11	12	
<b>GC3705HB</b>	2695	2863	3005	3168	3435	3682	3929	4144	4412	4664	5005	5488

OVERALL DIMENSIONS			SEAT DIMENSIONS			BACK DIMENSIONS	
W	D	H	W	D	H	W	H

Active weight 350 lbs/seat.  
 Wood armcap option:  
 Add \$174.

IN	71.25	27.5	42.5	66	18.5	18	64.5	25
MM	1810	699	1080	1676	470	457	1638	635
	<b>RTA 00</b>	1 per carton						



DESCRIPTION	MODEL# / FEATURES	STANDARD TEXTILE GRADES											
		COM	2	3	4	5	6	7	8	9	10	11	12
 <p><b>LB Armchair, Rear Tip and Move Wheels</b>                      COM: 1.75 YD   1.6 M                      Unit weight: 40 LB   18.2 KG                      Carton weight: 48 LB   21.77 KG                      Carton volume: 17.5 FT³   0.49 MT³</p>	<b>GC3707</b>	1099	1155	1202	1257	1346	1428	1510	1582	1671	1755	1869	2030
		<b>OVERALL DIMENSIONS</b>			<b>SEAT DIMENSIONS</b>			<b>BACK DIMENSIONS</b>					
		<b>W</b>	<b>D</b>	<b>H</b>	<b>W</b>	<b>D</b>	<b>H</b>	<b>W</b>	<b>H</b>				
		IN 25.5 MM 648	27.5 699	34.5 876	22 559	18.5 470	18 457	21.5 546	17 432				
	Active weight 350 lbs.												
	Wood armcap option: Add \$85.												
		<b>RTA 00</b>	1 per carton										
 <p><b>HB Armchair, Rear Tip and Move Wheels</b>                      COM: 2 YD   1.83 M                      Unit weight: 43 LB   19.5 KG                      Carton weight: 50 LB   22.68 KG                      Carton volume: 20 FT³   0.56 MT³</p>	<b>GC3707HB</b>	1152	1216	1270	1332	1434	1528	1622	1704	1806	1902	2032	2216
		<b>OVERALL DIMENSIONS</b>			<b>SEAT DIMENSIONS</b>			<b>BACK DIMENSIONS</b>					
		<b>W</b>	<b>D</b>	<b>H</b>	<b>W</b>	<b>D</b>	<b>H</b>	<b>W</b>	<b>H</b>				
		IN 25.5 MM 648	27.5 699	42.5 1080	22 559	18 457	18 457	21 533	25 635				
	Active weight 350 lbs.												
	Wood armcap option: Add \$85.												
		<b>RTA 00</b>	1 per carton										
 <p><b>Bariatric Low Back Armchair</b>                      COM: 2.75 YD   2.51 M                      Unit weight: 49 LB   22.3 KG                      Carton weight: 60 LB   27.22 KG                      Carton volume: 26.5 FT³   0.75 MT³</p>	<b>GC3711</b>	1290	1378	1452	1538	1678	1807	1936	2049	2189	2321	2500	2753
		<b>OVERALL DIMENSIONS</b>			<b>SEAT DIMENSIONS</b>			<b>BACK DIMENSIONS</b>					
		<b>W</b>	<b>D</b>	<b>H</b>	<b>W</b>	<b>D</b>	<b>H</b>	<b>W</b>	<b>H</b>				
		IN 36 MM 914	27.5 699	34.5 876	32.5 826	18 457	18 457	31 787	17 432				
	Active weight 750 lbs.												
	Wood armcap option: Add \$85.												
		<b>RTA 00</b>	1 per carton										
 <p><b>Bariatric High Back Armchair</b>                      COM: 3.25 YD   2.97 M                      Unit weight: 55 LB   25 KG                      Carton weight: 66 LB   29.94 KG                      Carton volume: 30.5 FT³   0.86 MT³</p>	<b>GC3711HB</b>	1364	1468	1556	1657	1822	1975	2128	2261	2427	2583	2794	3093
		<b>OVERALL DIMENSIONS</b>			<b>SEAT DIMENSIONS</b>			<b>BACK DIMENSIONS</b>					
		<b>W</b>	<b>D</b>	<b>H</b>	<b>W</b>	<b>D</b>	<b>H</b>	<b>W</b>	<b>H</b>				
		IN 36 MM 914	27.5 699	42.5 1080	32.5 826	18 457	18 457	31 787	25 635				
	Active weight 750 lbs.												
	Wood armcap option: Add \$85.												
		<b>RTA 00</b>	1 per carton										
 <p><b>Bariatric LB Armchair, Rear Tip and Move Wheels</b>                      COM: 2.75 YD   2.51 M                      Unit weight: 49 LB   22.3 KG                      Carton weight: 60 LB   27.22 KG                      Carton volume: 26.5 FT³   0.75 MT³</p>	<b>GC3712</b>	1387	1475	1549	1635	1775	1904	2033	2146	2286	2418	2597	2850
		<b>OVERALL DIMENSIONS</b>			<b>SEAT DIMENSIONS</b>			<b>BACK DIMENSIONS</b>					
		<b>W</b>	<b>D</b>	<b>H</b>	<b>W</b>	<b>D</b>	<b>H</b>	<b>W</b>	<b>H</b>				
		IN 36 MM 914	27.5 699	34.5 876	32.5 826	18 457	18 457	31 787	17 432				
	Active weight 750 lbs.												
	Wood armcap option: Add \$85.												
		<b>RTA 00</b>	1 per carton										

**DESCRIPTION MODEL# / FEATURES STANDARD TEXTILE GRADES**



**Low Back Single Seat Armchair Flex Back**  
 COM: 1.75 YD | 1.6 M  
 Unit weight: 41 LB | 18.6 KG  
 Carton weight: 49 LB | 22.23 KG  
 Carton volume: 17.5 FT³ | 0.49 MT³

Active weight 350 lbs.  
 Wood armcap option:  
 Add \$85.

COM	2	3	4	5	6	7	8	9	10	11	12
1221	1277	1324	1379	1468	1550	1632	1704	1793	1877	1991	2152

OVERALL DIMENSIONS			SEAT DIMENSIONS			BACK DIMENSIONS	
W	D	H	W	D	H	W	H

IN 25.5	27.5	34.5	22	18	18	21	17
MM 648	699	876	559	457	457	533	432

**RTA 00** 1 per carton

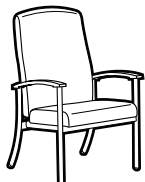

**High Back Single Seat Armchair Flex Back**  
 COM: 2 YD | 1.83 M  
 Unit weight: 43 LB | 19.5 KG  
 Carton weight: 50 LB | 22.68 KG  
 Carton volume: 20 FT³ | 0.56 MT³

Active weight 350 lbs.  
 Wood armcap option:  
 Add \$85.

COM	2	3	4	5	6	7	8	9	10	11	12
1276	1340	1394	1456	1558	1652	1746	1828	1930	2026	2156	2340

OVERALL DIMENSIONS			SEAT DIMENSIONS			BACK DIMENSIONS	
W	D	H	W	D	H	W	H

IN 25.5	27.5	42.5	22	18	18	21	25
MM 648	699	1080	559	457	457	533	635

**RTA 00** 1 per carton

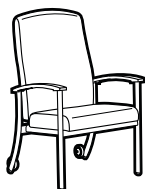

**HB Armchair Flex Back, Rear Tip and Move Wheels**  
 COM: 2 YD | 1.83 M  
 Unit weight: 43 LB | 19.5 KG  
 Carton weight: 50 LB | 22.68 KG  
 Carton volume: 20 FT³ | 0.56 MT³

Active weight 350 lbs.  
 Wood armcap option:  
 Add \$85.

COM	2	3	4	5	6	7	8	9	10	11	12
1370	1434	1488	1550	1652	1746	1840	1922	2024	2120	2250	2434

OVERALL DIMENSIONS			SEAT DIMENSIONS			BACK DIMENSIONS	
W	D	H	W	D	H	W	H

IN 25.5	27.5	42.5	22	18	18	21	25
MM 648	699	1080	559	457	457	533	635

**RTA 00** 1 per carton



**High Back Single Seat Armchair Split Back**  
 COM: 2 YD | 1.83 M  
 Unit weight: 45 LB | 20.5 KG  
 Carton weight: 53 LB | 24.04 KG  
 Carton volume: 20 FT³ | 0.56 MT³

Active weight 350 lbs.  
 Fold down headrest.  
 Wood armcap option:  
 Add \$85.

COM	2	3	4	5	6	7	8	9	10	11	12
1297	1361	1415	1477	1579	1673	1767	1849	1951	2047	2177	2361

OVERALL DIMENSIONS			SEAT DIMENSIONS			BACK DIMENSIONS	
W	D	H	W	D	H	W	H

IN 25.5	27.5	42.5	22	18	18	21.5	25
MM 648	699	1080	559	457	457	546	635

**RTA 00** 1 per carton



**Footstool Angled Top**  
 COM: 1 YD | 0.91 M  
 Unit weight: 13 LB | 5.9 KG  
 Carton weight: 16 LB | 7.26 KG  
 Carton volume: 3.5 FT³ | 0.09 MT³



Active weight 350 lbs.  
 Stores beneath any standard seating unit.  
 Add \$81 for (MB).



COM	2	3	4	5	6	7	8	9	10	11	12
633	665	692	723	774	821	868	909	960	1008	1073	1165

OVERALL DIMENSIONS			SEAT DIMENSIONS			BACK DIMENSIONS	
W	D	H	W	D	H	W	H

IN 16.5	18.5	10.5	-	-	-	-	-
MM 419	470	267	-	-	-	-	-

**RTA 00**  1 per carton

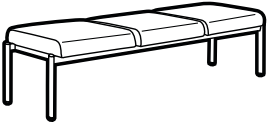
DESCRIPTION	MODEL# / FEATURES	STANDARD TEXTILE GRADES																															
		COM	2	3	4	5	6	7	8	9	10	11	12																				
 <p><b>Two Seat Bench</b> COM: 1.75 YD   1.6 M Unit weight: 40 LB   18.2 KG Carton weight: 48 LB   21.77 KG Carton volume: 23 FT<sup>3</sup>   0.65 MT<sup>3</sup></p>	<b>GC3722</b>	1082	1138	1185	1240	1329	1411	1493	1565	1654	1738	1852	2013																				
	<p>Active weight 350 lbs/seat.</p> <p>Add \$165 for <b>(MB)</b>.</p> <p>Add \$70 for <b>(FS)</b>.</p>	<table border="1"> <thead> <tr> <th colspan="3">OVERALL DIMENSIONS</th> <th colspan="3">SEAT DIMENSIONS</th> <th colspan="2">BACK DIMENSIONS</th> </tr> <tr> <th>W</th> <th>D</th> <th>H</th> <th>W</th> <th>D</th> <th>H</th> <th>W</th> <th>H</th> </tr> </thead> <tbody> <tr> <td>IN 47.5</td> <td>23.5</td> <td>18</td> <td>-</td> <td>-</td> <td>-</td> <td>-</td> <td>-</td> </tr> <tr> <td>MM 1207</td> <td>597</td> <td>457</td> <td>-</td> <td>-</td> <td>-</td> <td>-</td> <td>-</td> </tr> </tbody> </table> <p>RTA 00  1 per carton</p>	OVERALL DIMENSIONS			SEAT DIMENSIONS			BACK DIMENSIONS		W	D	H	W	D	H	W	H	IN 47.5	23.5	18	-	-	-	-	-	MM 1207	597	457	-	-	-	-
OVERALL DIMENSIONS			SEAT DIMENSIONS			BACK DIMENSIONS																											
W	D	H	W	D	H	W	H																										
IN 47.5	23.5	18	-	-	-	-	-																										
MM 1207	597	457	-	-	-	-	-																										

DESCRIPTION	MODEL# / FEATURES	STANDARD TEXTILE GRADES																															
		COM	2	3	4	5	6	7	8	9	10	11	12																				
 <p><b>Three Seat Bench</b> COM: 2 YD   1.83 M Unit weight: 60 LB   27.3 KG Carton weight: 68 LB   30.84 KG Carton volume: 33.25 FT<sup>3</sup>   0.94 MT<sup>3</sup></p>	<b>GC3723</b>	1455	1519	1573	1635	1737	1831	1925	2007	2109	2205	2335	2519																				
	<p>Active weight 350 lbs/seat.</p> <p>Add \$245 for <b>(MB)</b>.</p> <p>Add \$102 for <b>(FS)</b>.</p>	<table border="1"> <thead> <tr> <th colspan="3">OVERALL DIMENSIONS</th> <th colspan="3">SEAT DIMENSIONS</th> <th colspan="2">BACK DIMENSIONS</th> </tr> <tr> <th>W</th> <th>D</th> <th>H</th> <th>W</th> <th>D</th> <th>H</th> <th>W</th> <th>H</th> </tr> </thead> <tbody> <tr> <td>IN 70</td> <td>23.5</td> <td>18</td> <td>-</td> <td>-</td> <td>-</td> <td>-</td> <td>-</td> </tr> <tr> <td>MM 1778</td> <td>597</td> <td>457</td> <td>-</td> <td>-</td> <td>-</td> <td>-</td> <td>-</td> </tr> </tbody> </table> <p>RTA 00  1 per carton</p>	OVERALL DIMENSIONS			SEAT DIMENSIONS			BACK DIMENSIONS		W	D	H	W	D	H	W	H	IN 70	23.5	18	-	-	-	-	-	MM 1778	597	457	-	-	-	-
OVERALL DIMENSIONS			SEAT DIMENSIONS			BACK DIMENSIONS																											
W	D	H	W	D	H	W	H																										
IN 70	23.5	18	-	-	-	-	-																										
MM 1778	597	457	-	-	-	-	-																										

WILLOW



model W5AUUG



Wipeable shroud edge does not collect debris



No visible brackets or upholstery staples



Waterfall arm (WFA)



Forward grip assist arm (GAA)

		Willow chairs stacking capability	
		on floor	on dolly
Four-leg arm and armless chairs with glides only	Poly back/seat models	up to 6 high	up to 10 high
	Upholstered models	up to 4 high	up to 8 high
	Bariatric models	up to 4 high	up to 8 high
Bar and counter stools	Stools with arms	does not stack	N/A
	Armless stools	up to 4 high	N/A

Plastic component finish matching chart		
Chair type	Seat shroud	Arms + back shrouds
Poly back/seat	matches seat/back	matches seat/back
Upholstered back/seat	specify	specify
Poly back/upholstered seat	specify	specify
Upholstered back/poly seat	matches seat	specify

EXAMPLE WILLOW ORDER CODE:

W5AUU	NS	PU75	NS	PU75	WFA	BLK
Model #	Back seams	Back textile	Seat	Seat textile	Arm style	Arm + back shroud finish

BLK	CHM	ST	BLK	NB
Seat shroud finish	Frame finish	Glides type	Glides finish	Moisture barrier

Willow linking tables



For linking tables, see page 234.

STANDARD FEATURES

- Willow's durable design and open, welcoming form will ensure years of use. Freestanding chairs are available with four legs or sled base, in standard or bariatric width. Additional models include hip, counter and bar height stools. Corner, in-line and end linking tables are also available to complement the line.
- Chairs can be ganged with ganging brackets or with in-line and corner tables.
- Plastic seats and backs, reinforced nylon arms, back shrouds and seat shrouds are all available in 17 colors. See finish chart for matching color components.
- Ganging brackets are available in 13 paint finishes (see page 234).
- Tubular steel frame is available in 20 paint finishes and 4 plated finishes with an upcharge.
- Frame design features a wall saver leg to prevent contact with walls.
- Active weight capacity:
  - four-leg seating with casters: 300 lbs.
  - standard size seating with glides is 400 lbs.
  - bariatric models: 600 lbs.
- Plastic seat shrouds are standard on all models.
- Bariatric models are only available with upholstered seat and back.
- All models are standard with colored nylon glides (ST) in two finishes (Black or Sand).
- Upholstered seats have no seams for ease of cleaning.
- Four-leg models with glides are stackable. See chart. Stacking of models with caster is not recommended due to possible damage to plastic and upholstery.
- Armless stools are stackable. See chart.
- Four-leg and stool models are available with various glide options. Glides must be chosen to best suit flooring type and site conditions. For more information, please refer to glide selection chart (page 265).
- Tables used with Willow armchairs require 28" clearance under the surface top; counter height stools require 34.25" clearance; bar height stools require 40.25" clearance.
- Sled base models have nylon colored glides, non-marking natural glides for use on most floor surfaces, or with no glides for use on carpeted floors.
- For healthcare textile options, visit the website at [globalfurnituregroup.com](http://globalfurnituregroup.com).
- Can be upholstered in standard Global textiles if healthcare compliance is not required.
- Shipped fully assembled.

OPTIONAL FEATURES

- Additional weight (CW) of 24 lbs. is available. Weighted four-leg chairs and armless stools are not stackable. Not available for models with casters.
- Power/USB units are available for use with in-line, corner and end tables. Tables are predrilled for field installation of undermount power. Clamp mount units are available. Order power units separately for field installation.
- Sealed seams may be specified on upholstered back models. Seats have no seams.
- Moisture barrier may be specified on seats.
- Sled base models offer a floor mount (FM) option. See upcharges. Mounting hardware not included

Please add option codes in the following order:

- Model number**
- Back/seat/seat shroud finish** (for plastic back/seat models)
  - Back finish** (for plastic back/upholstered seat models)
 

(BZB) Buzz Blue	(KAL) Kalua
(CCT) Cactus	(LAB) Latte
(CRO) Carrot	(J52) Mocha
(IVC) Cloud	(BLK) Night
(DJN) Dijon	(SND) Sand
(EGP) Eggplant	(SAR) Scarlet
(FOG) Fog	(SHW) Shadow
(FRO) Frost	(TOA) Toast
(INK) Ink	
- Back seams and textile** (upholstered back models)
  - (NS) No sealed seams.
  - (S2) Sealed seams. Add \$14. For bariatric models, add \$20. Specify back textile.
- Seat textile** (for upholstered seat models)
  - (NS) No sealed seams
  - Specify seat textile.
- Arm style** (models with arms only)
  - (WFA) Waterfall arm.
  - (GAA) Grip assist arm. Add \$30.
- Arm and back shroud finish**

(BZB) Buzz Blue	(KAL) Kalua
(CCT) Cactus	(LAB) Latte
(CRO) Carrot	(J52) Mocha
(IVC) Cloud	(BLK) Night
(DJN) Dijon	(SND) Sand
(EGP) Eggplant	(SAR) Scarlet
(FOG) Fog	(SHW) Shadow
(FRO) Frost	(TOA) Toast
(INK) Ink	
- Seat and seat shroud finish** (for upholstered back and plastic seat models)
 





(BZB) Buzz Blue	(KAL) Kalua
(CCT) Cactus	(LAB) Latte
(CRO) Carrot	(J52) Mocha
(IVC) Cloud	(BLK) Night
(DJN) Dijon	(SND) Sand
(EGP) Eggplant	(SAR) Scarlet
(FOG) Fog	(SHW) Shadow
(FRO) Frost	(TOA) Toast
(INK) Ink	
- Leg type** (for sled base models)
  - (NF) No floor mount.
  - (FM) Floor mounted. Add \$10.
- Frame finish**
  - Paint finishes. No upcharge.
 









(TBL) Black	(TIN) Ink
(TBZ) Buzz Blue	(TKA) Kalua
(TCC) Cactus	(TLA) Latte
(TCR) Carrot	(TMO) Mocha
(TIV) Cloud	(TNE) Nevada
(TDW) Designer White	(TSN) Sand
(TDJ) Dijon	(TSR) Scarlet
(TEG) Eggplant	(TSH) Shadow
(TFO) Fog	(TOA) Toast
(TFR) Frost	(TTU) Tungsten
  - Plated finish. See models for upcharges.
 

(CHM) Chrome	(SBR) Satin Brass
(BCH) Brushed Chrome	(ACO) Antique Copper
- Glide type** (for four-leg glide models)
  - (ST) Colored nylon glides for most surfaces.
  - (NM) Natural non-marking nylon glides for most surfaces.
  - (SG) Steel cushioned glides for carpeted surfaces. Add \$19.
  - (FG) Felt glides for most hard floor surfaces. Add \$19.
  - (RG) Rubber non-slip glides for most hard floor surfaces. Add \$19.
- Glide type** (for sled base models)
  - (ST) Colored nylon glides for most surfaces
  - (NM) Natural non-marking nylon glides for most surfaces.
  - (XG) No glides for carpeted surfaces.
- Glide finish** (for all ST glides)
 

(BLK) Black	(SND) Sand
-------------	------------
- Caster type** (for four-leg caster models)
  - (DC) 2" casters for carpeted surfaces.
  - (RC) 2" casters for most hard floor surfaces. Add \$17.
- Moisture barrier** (on seat)
  - (NB) No moisture barrier.
  - (MB) Moisture barrier. Add \$81. For bariatric models, add \$122.
- Additional weight**
  - (NC) No additional weight.
  - (CW) Additional weight of 24 lbs. Add \$700.

	GLIDES							
	Standard colored (ST) + non-marking (NM) glides - standard height		Steel cushion (SG) glides - 0.313" higher than standard		Felt pad (FG) glides - 0.375" higher than standard		Rubber non-slip (RG) glides - 0.563" higher than standard	
	SEAT HEIGHT (in)	ARM HEIGHT (in)	SEAT HEIGHT (in)	ARM HEIGHT (in)	SEAT HEIGHT (in)	ARM HEIGHT (in)	SEAT HEIGHT (in)	ARM HEIGHT (in)
<b>ARMCHAIRS</b>								
Plastic seat, standard arms	17	26.75	17.31	27.06	17.38	27.13	17.56	27.31
Plastic seat, grip assist arms	17	27	17.31	27.31	17.38	27.38	17.56	27.56
Upholstered seat, standard arms	18.25	26.75	18.56	27.06	18.63	27.13	18.81	27.31
Upholstered seat, grip assist arms	18.25	27	18.56	27.31	18.63	27.38	18.81	27.56
<b>COUNTER STOOLS WITH ARMS</b>								
Plastic seat, standard arms	23.25	33	23.56	33.31	23.63	33.38	23.81	33.56
Plastic seat, grip assist arms	23.25	33.25	23.56	33.56	23.63	33.63	23.81	33.81
Upholstered seat, standard arms	24.25	33	24.56	33.31	24.63	33.38	24.81	33.56
Upholstered seat, grip assist arms	24.25	33.25	24.56	33.56	24.63	33.63	24.81	33.81
<b>BAR STOOLS WITH ARMS</b>								
Plastic seat, standard arms	29.25	39	29.56	39.31	29.63	39.38	29.81	39.56
Plastic seat, grip assist arms	29.25	39.25	29.56	39.56	29.63	39.63	29.81	39.81
Upholstered seat, standard arms	30.25	39	30.56	39.31	30.63	39.38	30.81	39.56
Upholstered seat, grip assist arms	30.25	39.25	30.56	39.56	30.63	39.63	30.81	39.81

DESCRIPTION	MODEL# / FEATURES	STANDARD TEXTILE GRADES																																								
 <p>Stacks 6 high on floor</p>	<p>List price</p> <p><b>W5APPG</b> w/glides 486</p> <p><b>W5APPC</b> w/casters 626</p>																																									
	<p>Add \$30 for grip assist arms (GAA)</p> <p>Frame plated finish options:                      Add \$33 for Chrome (CHM)                      Add \$119 for Brushed Chrome (BCH)                      Add \$176 for Antique Copper (ACO)                      Add \$176 for Satin Brass (SBR)</p>	<table border="1"> <thead> <tr> <th colspan="3">OVERALL DIMENSIONS</th> <th colspan="3">SEAT DIMENSIONS</th> <th colspan="2">BACK DIMENSIONS</th> </tr> <tr> <th>W</th> <th>D</th> <th>H</th> <th>W</th> <th>D</th> <th>H</th> <th>W</th> <th>H</th> </tr> </thead> <tbody> <tr> <td>IN 24.25</td> <td>23.5</td> <td>32</td> <td>17.75</td> <td>17.5</td> <td>17</td> <td>16</td> <td>16</td> </tr> <tr> <td>MM 616</td> <td>597</td> <td>813</td> <td>451</td> <td>445</td> <td>432</td> <td>406</td> <td>406</td> </tr> </tbody> </table>	OVERALL DIMENSIONS			SEAT DIMENSIONS			BACK DIMENSIONS		W	D	H	W	D	H	W	H	IN 24.25	23.5	32	17.75	17.5	17	16	16	MM 616	597	813	451	445	432	406	406	<p>RTA 00 4 per carton (pricing for one chair, specifications for one chair with glides)</p>							
OVERALL DIMENSIONS			SEAT DIMENSIONS			BACK DIMENSIONS																																				
W	D	H	W	D	H	W	H																																			
IN 24.25	23.5	32	17.75	17.5	17	16	16																																			
MM 616	597	813	451	445	432	406	406																																			
<p><b>Armchair, Poly Back and Seat</b>                      COM: N/A                      Unit weight: 17.5 LB   8 KG                      Carton weight: 20.75 LB   9.41 KG                      Carton volume: 26.75 FT<sup>3</sup>   0.75 MT<sup>3</sup></p>																																										
 <p>Caster model does not stack</p>	<p><b>W5AUPG</b> w/glides</p> <p><b>W5AUPC</b> w/casters</p>																																									
	<p>Add \$30 for grip assist arms (GAA)</p> <p>Frame plated finish options:                      Add \$33 for Chrome (CHM)                      Add \$119 for Brushed Chrome (BCH)                      Add \$176 for Antique Copper (ACO)                      Add \$176 for Satin Brass (SBR)</p>	<table border="1"> <thead> <tr> <th>1</th><th>2</th><th>3</th><th>4</th><th>5</th><th>6</th><th>7</th><th>8</th><th>9</th><th>10</th><th>11</th><th>12</th> </tr> </thead> <tbody> <tr> <td>540</td><td>556</td><td>570</td><td>585</td><td>611</td><td>634</td><td>658</td><td>678</td><td>704</td><td>728</td><td>760</td><td>806</td> </tr> <tr> <td>680</td><td>696</td><td>710</td><td>725</td><td>751</td><td>774</td><td>798</td><td>818</td><td>844</td><td>868</td><td>900</td><td>946</td> </tr> </tbody> </table>	1	2	3	4	5	6	7	8	9	10	11	12	540	556	570	585	611	634	658	678	704	728	760	806	680	696	710	725	751	774	798	818	844	868	900	946	<p>RTA 00 4 per carton (pricing for one chair, specifications for one chair with glides)</p>			
1	2	3	4	5	6	7	8	9	10	11	12																															
540	556	570	585	611	634	658	678	704	728	760	806																															
680	696	710	725	751	774	798	818	844	868	900	946																															
<p><b>Armchair, Uph Back and Poly Seat</b>                      COM: 0.5 YD   0.46 M                      Unit weight: 18 LB   8.2 KG                      Carton weight: 21.25 LB   9.64 KG                      Carton volume: 26.75 FT<sup>3</sup>   0.75 MT<sup>3</sup></p>																																										
 <p>Stacks 4 high on floor</p>	<p><b>W5APUG</b> w/glides</p> <p><b>W5APUC</b> w/casters</p>																																									
	<p>Add \$30 for grip assist arms (GAA)</p> <p>Frame plated finish options:                      Add \$33 for Chrome (CHM)                      Add \$119 for Brushed Chrome (BCH)                      Add \$176 for Antique Copper (ACO)                      Add \$176 for Satin Brass (SBR)</p>	<table border="1"> <thead> <tr> <th colspan="3">OVERALL DIMENSIONS</th> <th colspan="3">SEAT DIMENSIONS</th> <th colspan="2">BACK DIMENSIONS</th> </tr> <tr> <th>W</th> <th>D</th> <th>H</th> <th>W</th> <th>D</th> <th>H</th> <th>W</th> <th>H</th> </tr> </thead> <tbody> <tr> <td>IN 24.25</td> <td>23.5</td> <td>32</td> <td>17.75</td> <td>17.5</td> <td>17</td> <td>16</td> <td>16</td> </tr> <tr> <td>MM 616</td> <td>597</td> <td>819</td> <td>451</td> <td>425</td> <td>432</td> <td>419</td> <td>406</td> </tr> </tbody> </table>	OVERALL DIMENSIONS			SEAT DIMENSIONS			BACK DIMENSIONS		W	D	H	W	D	H	W	H	IN 24.25	23.5	32	17.75	17.5	17	16	16	MM 616	597	819	451	425	432	419	406	<p>RTA 00 4 per carton (pricing for one chair, specifications for one chair with glides)</p>							
OVERALL DIMENSIONS			SEAT DIMENSIONS			BACK DIMENSIONS																																				
W	D	H	W	D	H	W	H																																			
IN 24.25	23.5	32	17.75	17.5	17	16	16																																			
MM 616	597	819	451	425	432	419	406																																			
<p><b>Armchair, Uph Back and Poly Seat</b>                      COM: 0.5 YD   0.46 M                      Unit weight: 18 LB   8.2 KG                      Carton weight: 21.25 LB   9.64 KG                      Carton volume: 26.75 FT<sup>3</sup>   0.75 MT<sup>3</sup></p>																																										
 <p>Caster model does not stack</p>	<p><b>W5APUG</b> w/glides</p> <p><b>W5APUC</b> w/casters</p>																																									
	<p>Add \$30 for grip assist arms (GAA)</p> <p>Frame plated finish options:                      Add \$33 for Chrome (CHM)                      Add \$119 for Brushed Chrome (BCH)                      Add \$176 for Antique Copper (ACO)                      Add \$176 for Satin Brass (SBR)</p>	<table border="1"> <thead> <tr> <th>1</th><th>2</th><th>3</th><th>4</th><th>5</th><th>6</th><th>7</th><th>8</th><th>9</th><th>10</th><th>11</th><th>12</th> </tr> </thead> <tbody> <tr> <td>545</td><td>569</td><td>589</td><td>613</td><td>651</td><td>686</td><td>721</td><td>752</td><td>790</td><td>826</td><td>875</td><td>944</td> </tr> <tr> <td>685</td><td>709</td><td>729</td><td>753</td><td>791</td><td>826</td><td>861</td><td>892</td><td>930</td><td>966</td><td>1015</td><td>1084</td> </tr> </tbody> </table>	1	2	3	4	5	6	7	8	9	10	11	12	545	569	589	613	651	686	721	752	790	826	875	944	685	709	729	753	791	826	861	892	930	966	1015	1084	<p>RTA 00 4 per carton (pricing for one chair, specifications for one chair with glides)</p>			
1	2	3	4	5	6	7	8	9	10	11	12																															
545	569	589	613	651	686	721	752	790	826	875	944																															
685	709	729	753	791	826	861	892	930	966	1015	1084																															
<p><b>Armchair, Poly Back and Uph Seat</b>                      COM: 0.75 YD   0.69 M                      Unit weight: 18 LB   8.2 KG                      Carton weight: 21.25 LB   9.64 KG                      Carton volume: 26.75 FT<sup>3</sup>   0.75 MT<sup>3</sup></p>																																										
 <p>Stacks 4 high on floor</p>	<p><b>W5AUUG</b> w/glides</p> <p><b>W5AUUC</b> w/casters</p>																																									
	<p>Add \$30 for grip assist arms (GAA)</p> <p>Frame plated finish options:                      Add \$33 for Chrome (CHM)                      Add \$119 for Brushed Chrome (BCH)                      Add \$176 for Antique Copper (ACO)                      Add \$176 for Satin Brass (SBR)</p>	<table border="1"> <thead> <tr> <th colspan="3">OVERALL DIMENSIONS</th> <th colspan="3">SEAT DIMENSIONS</th> <th colspan="2">BACK DIMENSIONS</th> </tr> <tr> <th>W</th> <th>D</th> <th>H</th> <th>W</th> <th>D</th> <th>H</th> <th>W</th> <th>H</th> </tr> </thead> <tbody> <tr> <td>IN 24.25</td> <td>23.5</td> <td>32.25</td> <td>18.25</td> <td>17</td> <td>18.25</td> <td>16.5</td> <td>15.25</td> </tr> <tr> <td>MM 616</td> <td>597</td> <td>819</td> <td>464</td> <td>432</td> <td>464</td> <td>419</td> <td>387</td> </tr> </tbody> </table>	OVERALL DIMENSIONS			SEAT DIMENSIONS			BACK DIMENSIONS		W	D	H	W	D	H	W	H	IN 24.25	23.5	32.25	18.25	17	18.25	16.5	15.25	MM 616	597	819	464	432	464	419	387	<p>RTA 00 4 per carton (pricing for one chair, specifications for one chair with glides)</p>							
OVERALL DIMENSIONS			SEAT DIMENSIONS			BACK DIMENSIONS																																				
W	D	H	W	D	H	W	H																																			
IN 24.25	23.5	32.25	18.25	17	18.25	16.5	15.25																																			
MM 616	597	819	464	432	464	419	387																																			
<p><b>Armchair, Uph Back and Seat</b>                      COM: 1.25 YD   1.14 M                      Unit weight: 18.5 LB   8.4 KG                      Carton weight: 21.75 LB   9.87 KG                      Carton volume: 26.75 FT<sup>3</sup>   0.75 MT<sup>3</sup></p>																																										

DESCRIPTION		MODEL# / FEATURES		STANDARD TEXTILE GRADES											
 <p>Stacks 6 high on floor</p>			List price												
	<b>W5NPPG</b>	w/glides	471												
 <p>Caster model does not stack</p>															
	<b>W5NPPC</b>	w/casters	611												
<p><b>Armless Chair, Poly Back and Seat</b>                      COM: N/A                      Unit weight: 15 LB   6.8 KG                      Carton weight: 18.25 LB   8.28 KG                      Carton volume: 19.25 FT<sup>3</sup>   0.54 MT<sup>3</sup></p>		<p>Frame plated finish options:                      Add \$33 for Chrome (<b>CHM</b>)                      Add \$119 for Brushed Chrome (<b>BCH</b>)                      Add \$176 for Antique Copper (<b>ACO</b>)                      Add \$176 for Satin Brass (<b>SBR</b>)</p>		IN	20.75	23.5	32	17.75	17.5	17	16	16			
				MM	527	597	813	451	445	432	406	406			
				<b>RTA 00</b>	4 per carton (pricing for one chair, specifications for one chair with glides)										
 <p>Stacks 4 high on floor</p>				1	2	3	4	5	6	7	8	9	10	11	12
	<b>W5NUPG</b>	w/glides		525	541	555	570	596	619	643	663	689	713	745	791
 <p>Caster model does not stack</p>															
	<b>W5NUPC</b>	w/casters		665	681	695	710	736	759	783	803	829	853	885	931
<p><b>Armless Chair, Uph Back and Poly Seat</b>                      COM: 0.5 YD   0.46 M                      Unit weight: 15.5 LB   7 KG                      Carton weight: 18.75 LB   8.5 KG                      Carton volume: 19.25 FT<sup>3</sup>   0.54 MT<sup>3</sup></p>		<p>Frame plated finish options:                      Add \$33 for Chrome (<b>CHM</b>)                      Add \$119 for Brushed Chrome (<b>BCH</b>)                      Add \$176 for Antique Copper (<b>ACO</b>)                      Add \$176 for Satin Brass (<b>SBR</b>)</p>		IN	20.75	23.5	32.25	17.75	16.75	17	16.5	16			
				MM	527	597	819	451	425	432	419	406			
				<b>RTA 00</b>	4 per carton (pricing for one chair, specifications for one chair with glides)										
 <p>Stacks 4 high on floor</p>				1	2	3	4	5	6	7	8	9	10	11	12
	<b>W5NPUG</b>	w/glides		530	554	574	598	636	671	706	737	775	811	860	929
 <p>Caster model does not stack</p>															
	<b>W5NPUC</b>	w/casters		670	694	714	738	776	811	846	877	915	951	1000	1069
<p><b>Armless Chair, Poly Back and Uph Seat</b>                      COM: 0.75 YD   0.69 M                      Unit weight: 15.5 LB   7 KG                      Carton weight: 18.75 LB   8.5 KG                      Carton volume: 19.25 FT<sup>3</sup>   0.54 MT<sup>3</sup></p>		<p>Frame plated finish options:                      Add \$33 for Chrome (<b>CHM</b>)                      Add \$119 for Brushed Chrome (<b>BCH</b>)                      Add \$176 for Antique Copper (<b>ACO</b>)                      Add \$176 for Satin Brass (<b>SBR</b>)</p>		IN	20.75	23.5	32	18.25	17.75	18.25	16	15.25			
				MM	527	597	813	464	451	464	406	387			
				<b>RTA 00</b>	4 per carton (pricing for one chair, specifications for one chair with glides)										
 <p>Stacks 4 high on floor</p>				1	2	3	4	5	6	7	8	9	10	11	12
	<b>W5NUUG</b>	w/glides		584	624	658	697	761	819	878	929	993	1053	1134	1249
 <p>Caster model does not stack</p>															
	<b>W5NUUC</b>	w/casters		724	764	798	837	901	959	1018	1069	1133	1193	1274	1389
<p><b>Armless Chair, Uph Back and Seat</b>                      COM: 1.25 YD   1.14 M                      Unit weight: 16 LB   7.3 KG                      Carton weight: 19.25 LB   8.73 KG                      Carton volume: 19.25 FT<sup>3</sup>   0.54 MT<sup>3</sup></p>		<p>Frame plated finish options:                      Add \$33 for Chrome (<b>CHM</b>)                      Add \$119 for Brushed Chrome (<b>BCH</b>)                      Add \$176 for Antique Copper (<b>ACO</b>)                      Add \$176 for Satin Brass (<b>SBR</b>)</p>		IN	20.75	23.5	32.25	18.25	17	18.25	16.5	15.25			
				MM	527	597	819	464	432	464	419	387			
				<b>RTA 00</b>	4 per carton (pricing for one chair, specifications for one chair with glides)										

DESCRIPTION MODEL# / FEATURES STANDARD TEXTILE GRADES



Does not stack

**Armchair, Sled Base, Poly Back and Seat**  
 COM: N/A  
 Unit weight: 22 LB | 10 KG  
 Carton weight: 30.5 LB | 13.83 KG  
 Carton volume: 15.5 FT³ | 0.43 MT³

List price												
<b>W6APP</b>	575											
Add \$30 for grip assist arms (GAA)	OVERALL DIMENSIONS			SEAT DIMENSIONS			BACK DIMENSIONS					
	W	D	H	W	D	H	W	H				
Frame plated finish options:	IN	24.25	23.75	32	17.75	17.75	17.75	16	16			
Add \$42 for Chrome (CHM)	MM	616	603	813	451	451	451	406	406			
Add \$145 for Brushed Chrome (BCH)												
Add \$213 for Antique Copper (ACO)												
Add \$213 for Satin Brass (SBR)	RTA 00	1 per carton										



Does not stack

**Armchair, Sled Base, Uph Back and Poly Seat**  
 COM: 0.5 YD | 0.46 M  
 Unit weight: 22.5 LB | 10.2 KG  
 Carton weight: 30.5 LB | 13.83 KG  
 Carton volume: 15.5 FT³ | 0.43 MT³

<b>W6AUP</b>	1	2	3	4	5	6	7	8	9	10	11	12
	629	645	659	674	700	723	747	767	793	817	849	895
Add \$30 for grip assist arms (GAA)	OVERALL DIMENSIONS			SEAT DIMENSIONS			BACK DIMENSIONS					
	W	D	H	W	D	H	W	H				
Frame plated finish options:	IN	24.25	23.75	32.25	17.75	17.75	17.75	16.5	16			
Add \$42 for Chrome (CHM)	MM	616	603	819	451	451	451	419	406			
Add \$145 for Brushed Chrome (BCH)												
Add \$213 for Antique Copper (ACO)												
Add \$213 for Satin Brass (SBR)	RTA 00	1 per carton										



Does not stack

**Armchair, Sled Base, Poly Back and Uph Seat**  
 COM: 0.75 YD | 0.69 M  
 Unit weight: 22.5 LB | 10.2 KG  
 Carton weight: 30.5 LB | 13.83 KG  
 Carton volume: 15.5 FT³ | 0.43 MT³

<b>W6APU</b>	1	2	3	4	5	6	7	8	9	10	11	12
	634	658	678	702	740	775	810	841	879	915	964	1033
Add \$30 for grip assist arms (GAA)	OVERALL DIMENSIONS			SEAT DIMENSIONS			BACK DIMENSIONS					
	W	D	H	W	D	H	W	H				
Frame plated finish options:	IN	24.25	23.75	32	18.25	17.75	18.25	16	15.25			
Add \$42 for Chrome (CHM)	MM	616	603	813	464	451	464	406	387			
Add \$145 for Brushed Chrome (BCH)												
Add \$213 for Antique Copper (ACO)												
Add \$213 for Satin Brass (SBR)	RTA 00	1 per carton										



Does not stack

**Armchair, Sled Base, Uph Back and Seat**  
 COM: 1.25 YD | 1.14 M  
 Unit weight: 23 LB | 10.5 KG  
 Carton weight: 31 LB | 14.06 KG  
 Carton volume: 15.5 FT³ | 0.43 MT³

<b>W6AAU</b>	1	2	3	4	5	6	7	8	9	10	11	12
	685	725	759	798	862	920	979	1030	1094	1154	1235	1350
Add \$30 for grip assist arms (GAA)	OVERALL DIMENSIONS			SEAT DIMENSIONS			BACK DIMENSIONS					
	W	D	H	W	D	H	W	H				
Frame plated finish options:	IN	24.25	23.75	32.25	18.25	16.5	18.25	16.5	15.25			
Add \$42 for Chrome (CHM)	MM	616	603	819	464	419	464	419	387			
Add \$145 for Brushed Chrome (BCH)												
Add \$213 for Antique Copper (ACO)												
Add \$213 for Satin Brass (SBR)	RTA 00	1 per carton										



Does not stack

**Armless Chair, Sled Base, Poly Back and Seat**  
 COM: N/A  
 Unit weight: 19.5 LB | 8.9 KG  
 Carton weight: 27.5 LB | 12.47 KG  
 Carton volume: 13.75 FT³ | 0.38 MT³

List price												
<b>W6NPP</b>	560											
	OVERALL DIMENSIONS			SEAT DIMENSIONS			BACK DIMENSIONS					
	W	D	H	W	D	H	W	H				
Frame plated finish options:	IN	20.75	23.5	32	17.75	17.75	17.75	16	16			
Add \$42 for Chrome (CHM)	MM	527	597	813	451	451	451	406	406			
Add \$145 for Brushed Chrome (BCH)												
Add \$213 for Antique Copper (ACO)												
Add \$213 for Satin Brass (SBR)	RTA 00	1 per carton										









Does not stack

**Armless Chair, Sled Base, Uph Back and Poly Seat**  
 COM: 0.5 YD | 0.46 M  
 Unit weight: 20 LB | 9.1 KG  
 Carton weight: 28 LB | 12.7 KG  
 Carton volume: 13.75 FT³ | 0.38 MT³

<b>W6NUP</b>	1	2	3	4	5	6	7	8	9	10	11	12
	614	630	644	659	685	708	732	752	778	802	834	880
	OVERALL DIMENSIONS			SEAT DIMENSIONS			BACK DIMENSIONS					
	W	D	H	W	D	H	W	H				
Frame plated finish options:	IN	20.75	23.5	32.25	17.75	17.75	17.75	16.5	16			
Add \$42 for Chrome (CHM)	MM	527	597	819	451	451	451	419	406			
Add \$145 for Brushed Chrome (BCH)												
Add \$213 for Antique Copper (ACO)												
Add \$213 for Satin Brass (SBR)	RTA 00	1 per carton										



DESCRIPTION	MODEL# / FEATURES	STANDARD TEXTILE GRADES											
		1	2	3	4	5	6	7	8	9	10	11	12
 <p>Does not stack</p> <p><b>Armless Chair, Sled Base, Poly Back and Uph Seat</b>                      COM: 0.75 YD   0.69 M                      Unit weight: 20 LB   9.1 KG                      Carton weight: 28 LB   12.7 KG                      Carton volume: 13.75 FT<sup>3</sup>   0.38 MT<sup>3</sup></p>	<b>W6NPU</b>	619	643	663	687	725	760	795	826	864	900	949	1018
		<b>OVERALL DIMENSIONS</b>			<b>SEAT DIMENSIONS</b>			<b>BACK DIMENSIONS</b>					
		<b>W</b>	<b>D</b>	<b>H</b>	<b>W</b>	<b>D</b>	<b>H</b>	<b>W</b>	<b>H</b>				
	Frame plated finish options:	IN 20.75	23.5	32	18.25	17.75	18.25	16	15.25				
	Add \$42 for Chrome ( <b>CHM</b> )	MM 527	597	813	464	451	464	406	387				
	Add \$145 for Brushed Chrome ( <b>BCH</b> )												
	Add \$213 for Antique Copper ( <b>ACO</b> )												
	Add \$213 for Satin Brass ( <b>SBR</b> )	<b>RTA 00</b>	1 per carton										
 <p>Does not stack</p> <p><b>Armless Chair, Sled Base, Uph Back and Seat</b>                      COM: 1.25 YD   1.14 M                      Unit weight: 20.5 LB   9.3 KG                      Carton weight: 28.5 LB   12.93 KG                      Carton volume: 13.75 FT<sup>3</sup>   0.38 MT<sup>3</sup></p>	<b>W6NUU</b>	670	710	744	783	847	905	964	1015	1079	1139	1220	1335
		<b>OVERALL DIMENSIONS</b>			<b>SEAT DIMENSIONS</b>			<b>BACK DIMENSIONS</b>					
		<b>W</b>	<b>D</b>	<b>H</b>	<b>W</b>	<b>D</b>	<b>H</b>	<b>W</b>	<b>H</b>				
	Frame plated finish options:	IN 20.75	23.5	32.25	18.25	16.5	18.25	16.5	15.25				
	Add \$42 for Chrome ( <b>CHM</b> )	MM 527	597	819	464	419	464	419	387				
	Add \$145 for Brushed Chrome ( <b>BCH</b> )												
	Add \$213 for Antique Copper ( <b>ACO</b> )												
	Add \$213 for Satin Brass ( <b>SBR</b> )	<b>RTA 00</b>	1 per carton										
 <p>Stacks 4 high on floor</p> <p><b>Bariatric Armchair, Uph Back and Seat</b>                      COM: 1.75 YD   1.6 M                      Unit weight: 30 LB   13.6 KG                      Carton weight: 41 LB   18.6 KG                      Carton volume: 20.5 FT<sup>3</sup>   0.58 MT<sup>3</sup></p>	<b>W530AUU</b>	889	945	992	1047	1136	1218	1300	1372	1461	1545	1659	1820
		<b>OVERALL DIMENSIONS</b>			<b>SEAT DIMENSIONS</b>			<b>BACK DIMENSIONS</b>					
		<b>W</b>	<b>D</b>	<b>H</b>	<b>W</b>	<b>D</b>	<b>H</b>	<b>W</b>	<b>H</b>				
	Frame plated finish options:	IN 35.25	23.5	32.25	29	17	18.25	26.75	15.25				
	Add \$57 for Chrome ( <b>CHM</b> )	MM 895	597	819	737	432	464	679	387				
	Add \$185 for Brushed Chrome ( <b>BCH</b> )												
	Add \$271 for Antique Copper ( <b>ACO</b> )												
	Add \$271 for Satin Brass ( <b>SBR</b> )	<b>RTA 00</b>	1 per carton										
	Add \$30 for grip assist arms ( <b>GAA</b> )												
 <p>Stacks 4 high on floor</p> <p><b>Bariatric Armless Chair, Uph Back and Seat</b>                      COM: 1.75 YD   1.6 M                      Unit weight: 27.5 LB   12.5 KG                      Carton weight: 37.5 LB   17.01 KG                      Carton volume: 16.75 FT<sup>3</sup>   0.47 MT<sup>3</sup></p>	<b>W530NUU</b>	874	930	977	1032	1121	1203	1285	1357	1446	1530	1644	1805
		<b>OVERALL DIMENSIONS</b>			<b>SEAT DIMENSIONS</b>			<b>BACK DIMENSIONS</b>					
		<b>W</b>	<b>D</b>	<b>H</b>	<b>W</b>	<b>D</b>	<b>H</b>	<b>W</b>	<b>H</b>				
	Frame plated finish options:	IN 31.75	23.5	32.25	29	17	18.25	26.75	15.25				
	Add \$57 for Chrome ( <b>CHM</b> )	MM 806	597	819	737	432	464	679	387				
	Add \$185 for Brushed Chrome ( <b>BCH</b> )												
	Add \$271 for Antique Copper ( <b>ACO</b> )												
	Add \$271 for Satin Brass ( <b>SBR</b> )	<b>RTA 00</b>	1 per carton										
 <p>Does not stack</p> <p><b>Bariatric Armchair, Sled Base, Uph Back and Seat</b>                      COM: 1.75 YD   1.6 M                      Unit weight: 34 LB   15.5 KG                      Carton weight: 45 LB   20.41 KG                      Carton volume: 20.5 FT<sup>3</sup>   0.58 MT<sup>3</sup></p>	<b>W630AUU</b>	978	1034	1081	1136	1225	1307	1389	1461	1550	1634	1748	1909
		<b>OVERALL DIMENSIONS</b>			<b>SEAT DIMENSIONS</b>			<b>BACK DIMENSIONS</b>					
		<b>W</b>	<b>D</b>	<b>H</b>	<b>W</b>	<b>D</b>	<b>H</b>	<b>W</b>	<b>H</b>				
	Frame plated finish options:	IN 35.25	23.5	32.25	29	17	18.25	26.75	15.25				
	Add \$57 for Chrome ( <b>CHM</b> )	MM 895	597	819	737	432	464	679	387				
	Add \$185 for Brushed Chrome ( <b>BCH</b> )												
	Add \$271 for Antique Copper ( <b>ACO</b> )												
	Add \$271 for Satin Brass ( <b>SBR</b> )	<b>RTA 00</b>	1 per carton										
	Add \$30 for grip assist arms ( <b>GAA</b> )												
 <p>Does not stack</p> <p><b>Bariatric Armless Chair, Sled Base, Uph Back and Seat</b>                      COM: 1.75 YD   1.6 M                      Unit weight: 31.5 LB   14.3 KG                      Carton weight: 41.5 LB   18.82 KG                      Carton volume: 16.75 FT<sup>3</sup>   0.47 MT<sup>3</sup></p>	<b>W630NUU</b>	960	1016	1063	1118	1207	1289	1371	1443	1532	1616	1730	1891
		<b>OVERALL DIMENSIONS</b>			<b>SEAT DIMENSIONS</b>			<b>BACK DIMENSIONS</b>					
		<b>W</b>	<b>D</b>	<b>H</b>	<b>W</b>	<b>D</b>	<b>H</b>	<b>W</b>	<b>H</b>				
	Frame plated finish options:	IN 31.75	23.5	32.25	29	17	18.25	26.75	15.25				
	Add \$57 for Chrome ( <b>CHM</b> )	MM 806	597	819	737	432	464	679	387				
	Add \$185 for Brushed Chrome ( <b>BCH</b> )												
	Add \$271 for Antique Copper ( <b>ACO</b> )												
	Add \$271 for Satin Brass ( <b>SBR</b> )	<b>RTA 00</b>	1 per carton										

DESCRIPTION MODEL# / FEATURES STANDARD TEXTILE GRADES



Does not stack

**Counter Stool w/Arms, Poly Back and Seat**  
 COM: N/A  
 Unit weight: 23 LB | 10.5 KG  
 Carton weight: 32 LB | 14.51 KG  
 Carton volume: 17.75 FT³ | 0.5 MT³

List price											
<b>W5CSAPP</b> 631											
Add \$30 for grip assist arms (GAA)											
<b>OVERALL DIMENSIONS</b>			<b>SEAT DIMENSIONS</b>			<b>BACK DIMENSIONS</b>					
W	D	H	W	D	H	W	H				
IN 24.25	23.5	38.25	17.75	17.15	23.25	16	16				
MM 616	597	972	451	436	591	406	406				
Frame plated finish options: IN 24.25 23.5 38.25 17.75 17.15 23.25 16 16 Add \$60 for Chrome (CHM) MM 616 597 972 451 436 591 406 406 Add \$197 for Brushed Chrome (BCH) Add \$288 for Antique Copper (ACO) <b>RTA 00</b> 1 per carton Add \$288 for Satin Brass (SBR)											



Does not stack

**Counter Stool w/Arms, Uph Back and Poly Seat**  
 COM: 0.5 YD | 0.46 M  
 Unit weight: 23.5 LB | 10.7 KG  
 Carton weight: 32.5 LB | 14.74 KG  
 Carton volume: 17.75 FT³ | 0.5 MT³

1 2 3 4 5 6 7 8 9 10 11 12											
<b>W5CSAUP</b> 685 701 715 730 756 779 803 823 849 873 905 951											
Add \$30 for grip assist arms (GAA)											
<b>OVERALL DIMENSIONS</b>			<b>SEAT DIMENSIONS</b>			<b>BACK DIMENSIONS</b>					
W	D	H	W	D	H	W	H				
IN 24.25	23.5	38.25	17.75	16.5	23.25	16.5	16				
MM 616	597	972	451	419	591	419	406				
Frame plated finish options: IN 24.25 23.5 38.25 17.75 16.5 23.25 16.5 16 Add \$60 for Chrome (CHM) MM 616 597 972 451 419 591 419 406 Add \$197 for Brushed Chrome (BCH) Add \$288 for Antique Copper (ACO) <b>RTA 00</b> 1 per carton Add \$288 for Satin Brass (SBR)											



Does not stack

**Counter Stool w/Arms, Poly Back and Uph Seat**  
 COM: 0.75 YD | 0.69 M  
 Unit weight: 23.5 LB | 10.7 KG  
 Carton weight: 32.5 LB | 14.74 KG  
 Carton volume: 17.75 FT³ | 0.5 MT³

1 2 3 4 5 6 7 8 9 10 11 12											
<b>W5CSAPU</b> 690 714 734 758 796 831 866 897 935 971 1020 1089											
Add \$30 for grip assist arms (GAA)											
<b>OVERALL DIMENSIONS</b>			<b>SEAT DIMENSIONS</b>			<b>BACK DIMENSIONS</b>					
W	D	H	W	D	H	W	H				
IN 24.25	23.5	38.25	18.25	17.75	24.25	16	15.25				
MM 616	597	972	464	451	616	406	387				
Frame plated finish options: IN 24.25 23.5 38.25 18.25 17.75 24.25 16 15.25 Add \$60 for Chrome (CHM) MM 616 597 972 464 451 616 406 387 Add \$197 for Brushed Chrome (BCH) Add \$288 for Antique Copper (ACO) <b>RTA 00</b> 1 per carton Add \$288 for Satin Brass (SBR)											



Does not stack

**Counter Stool w/Arms, Uph Back and Seat**  
 COM: 1.25 YD | 1.14 M  
 Unit weight: 24 LB | 10.9 KG  
 Carton weight: 33 LB | 14.97 KG  
 Carton volume: 17.75 FT³ | 0.5 MT³

1 2 3 4 5 6 7 8 9 10 11 12											
<b>W5CSAUU</b> 744 784 818 857 921 979 1038 1089 1153 1213 1294 1409											
Add \$30 for grip assist arms (GAA)											
<b>OVERALL DIMENSIONS</b>			<b>SEAT DIMENSIONS</b>			<b>BACK DIMENSIONS</b>					
W	D	H	W	D	H	W	H				
IN 24.25	23.5	38.25	18.25	17	24.25	16.5	15.25				
MM 616	597	972	464	432	616	419	387				
Frame plated finish options: IN 24.25 23.5 38.25 18.25 17 24.25 16.5 15.25 Add \$60 for Chrome (CHM) MM 616 597 972 464 432 616 419 387 Add \$197 for Brushed Chrome (BCH) Add \$288 for Antique Copper (ACO) <b>RTA 00</b> 1 per carton Add \$288 for Satin Brass (SBR)											



Stacks 4 on the floor

**Armless Counter Stool, Poly Back and Seat**  
 COM: N/A  
 Unit weight: 20.5 LB | 9.3 KG  
 Carton weight: 30.5 LB | 13.83 KG  
 Carton volume: 15.5 FT³ | 0.43 MT³







1 2 3 4 5 6 7 8 9 10 11 12											
<b>W5CSNPP</b> 616											
Add \$30 for grip assist arms (GAA)											
<b>OVERALL DIMENSIONS</b>			<b>SEAT DIMENSIONS</b>			<b>BACK DIMENSIONS</b>					
W	D	H	W	D	H	W	H				
IN 21.75	23.5	38.25	17.75	17.15	23.25	16	16				
MM 552	597	972	451	436	591	406	406				
Frame plated finish options: IN 21.75 23.5 38.25 17.75 17.15 23.25 16 16 Add \$60 for Chrome (CHM) MM 552 597 972 451 436 591 406 406 Add \$197 for Brushed Chrome (BCH) Add \$288 for Antique Copper (ACO) <b>RTA 00</b> 1 per carton Add \$288 for Satin Brass (SBR)											



Stacks 4 on the floor

**Armless Counter Stool, Uph Back and Poly Seat**  
 COM: 0.5 YD | 0.46 M  
 Unit weight: 21 LB | 9.5 KG  
 Carton weight: 31 LB | 14.06 KG  
 Carton volume: 15.5 FT³ | 0.43 MT³

1 2 3 4 5 6 7 8 9 10 11 12											
<b>W5CSNUP</b> 670 686 700 715 741 764 788 808 834 858 890 936											
Add \$30 for grip assist arms (GAA)											
<b>OVERALL DIMENSIONS</b>			<b>SEAT DIMENSIONS</b>			<b>BACK DIMENSIONS</b>					
W	D	H	W	D	H	W	H				
IN 21.75	23.5	38.25	17.75	16.5	23.25	16.5	16				
MM 552	597	972	451	419	591	419	406				
Frame plated finish options: IN 21.75 23.5 38.25 17.75 16.5 23.25 16.5 16 Add \$60 for Chrome (CHM) MM 552 597 972 451 419 591 419 406 Add \$197 for Brushed Chrome (BCH) Add \$288 for Antique Copper (ACO) <b>RTA 00</b> 1 per carton Add \$288 for Satin Brass (SBR)											

DESCRIPTION	MODEL# / FEATURES	STANDARD TEXTILE GRADES											
		1	2	3	4	5	6	7	8	9	10	11	12
 <p>Stacks 4 on the floor</p> <p><b>Armless Counter Stool, Poly Back and Uph Seat</b>                      COM: 0.75 YD   0.69 M                      Unit weight: 21 LB   9.5 KG                      Carton weight: 31 LB   14.06 KG                      Carton volume: 15.5 FT³   0.43 MT³</p>	<b>W5CSNPU</b>	675	699	719	743	781	816	851	882	920	956	1005	1074
		<b>OVERALL DIMENSIONS</b>			<b>SEAT DIMENSIONS</b>			<b>BACK DIMENSIONS</b>					
		<b>W</b>	<b>D</b>	<b>H</b>	<b>W</b>	<b>D</b>	<b>H</b>	<b>W</b>	<b>H</b>				
		IN	MM		IN	MM		IN	MM	IN	MM		
 <p>Stacks 4 on the floor</p> <p><b>Armless Counter Stool, Uph Back and Seat</b>                      COM: 1.25 YD   1.14 M                      Unit weight: 21.5 LB   9.8 KG                      Carton weight: 31.5 LB   14.29 KG                      Carton volume: 15.5 FT³   0.43 MT³</p>	<b>W5CSNUU</b>	729	769	803	842	906	964	1023	1074	1138	1198	1279	1394
		<b>OVERALL DIMENSIONS</b>			<b>SEAT DIMENSIONS</b>			<b>BACK DIMENSIONS</b>					
		<b>W</b>	<b>D</b>	<b>H</b>	<b>W</b>	<b>D</b>	<b>H</b>	<b>W</b>	<b>H</b>				
		IN	MM		IN	MM		IN	MM	IN	MM		
 <p>Does not stack</p> <p><b>Bar Stool w/Arms, Poly Back and Seat</b>                      COM: N/A                      Unit weight: 24.5 LB   11.1 KG                      Carton weight: 34.5 LB   15.65 KG                      Carton volume: 20.5 FT³   0.58 MT³</p>	<b>W5BSAPP</b>	List price 636											
		<b>OVERALL DIMENSIONS</b>			<b>SEAT DIMENSIONS</b>			<b>BACK DIMENSIONS</b>					
		<b>W</b>	<b>D</b>	<b>H</b>	<b>W</b>	<b>D</b>	<b>H</b>	<b>W</b>	<b>H</b>				
		IN	MM		IN	MM		IN	MM	IN	MM		
 <p>Does not stack</p> <p><b>Bar Stool w/Arms, Uph Back and Poly Seat</b>                      COM: 0.5 YD   0.46 M                      Unit weight: 25 LB   11.4 KG                      Carton weight: 35 LB   15.88 KG                      Carton volume: 20.5 FT³   0.58 MT³</p>	<b>W5BSAUP</b>	690	706	720	735	761	784	808	828	854	878	910	956
		<b>OVERALL DIMENSIONS</b>			<b>SEAT DIMENSIONS</b>			<b>BACK DIMENSIONS</b>					
		<b>W</b>	<b>D</b>	<b>H</b>	<b>W</b>	<b>D</b>	<b>H</b>	<b>W</b>	<b>H</b>				
		IN	MM		IN	MM		IN	MM	IN	MM		
 <p>Does not stack</p> <p><b>Bar Stool w/Arms, Poly Back and Uph Seat</b>                      COM: 0.75 YD   0.69 M                      Unit weight: 25 LB   11.4 KG                      Carton weight: 35 LB   15.88 KG                      Carton volume: 20.5 FT³   0.58 MT³</p>	<b>W5BSAPU</b>	695	719	739	763	801	836	871	902	940	976	1025	1094
		<b>OVERALL DIMENSIONS</b>			<b>SEAT DIMENSIONS</b>			<b>BACK DIMENSIONS</b>					
		<b>W</b>	<b>D</b>	<b>H</b>	<b>W</b>	<b>D</b>	<b>H</b>	<b>W</b>	<b>H</b>				
		IN	MM		IN	MM		IN	MM	IN	MM		
 <p>Does not stack</p> <p><b>Bar Stool w/Arms, Uph Back and Seat</b>                      COM: 1.25 YD   1.14 M                      Unit weight: 25.5 LB   11.6 KG                      Carton weight: 35.5 LB   16.1 KG                      Carton volume: 20.5 FT³   0.58 MT³</p>	<b>W5BSAUU</b>	749	789	823	862	926	984	1043	1094	1158	1218	1299	1414
		<b>OVERALL DIMENSIONS</b>			<b>SEAT DIMENSIONS</b>			<b>BACK DIMENSIONS</b>					
		<b>W</b>	<b>D</b>	<b>H</b>	<b>W</b>	<b>D</b>	<b>H</b>	<b>W</b>	<b>H</b>				
		IN	MM		IN	MM		IN	MM	IN	MM		

DESCRIPTION MODEL# / FEATURES STANDARD TEXTILE GRADES



Stacks 4 on the floor

**Armless Bar Stool, Poly Back and Seat**  
 COM: N/A  
 Unit weight: 22 LB | 10 KG  
 Carton weight: 32.5 LB | 14.74 KG  
 Carton volume: 15.25 FT³ | 0.43 MT³

List price											
<b>W5BSNPP</b> 621											
<b>OVERALL DIMENSIONS</b>				<b>SEAT DIMENSIONS</b>				<b>BACK DIMENSIONS</b>			
<b>W</b>	<b>D</b>	<b>H</b>		<b>W</b>	<b>D</b>	<b>H</b>		<b>W</b>	<b>H</b>		
IN 20.75	23.5	44		17.75	17.5	29.25		16	16		
MM 527	597	1118		451	445	743		406	406		
Frame plated finish options:											
Add \$60 for Chrome ( <b>CHM</b> )											
Add \$197 for Brushed Chrome ( <b>BCH</b> )											
Add \$288 for Antique Copper ( <b>ACO</b> )											
Add \$288 for Satin Brass ( <b>SBR</b> )											
RTA 00 1 per carton											



Stacks 4 on the floor

**Armless Bar Stool, Uph Back and Poly Seat**  
 COM: 0.5 YD | 0.46 M  
 Unit weight: 22.5 LB | 10.2 KG  
 Carton weight: 33 LB | 14.97 KG  
 Carton volume: 15.25 FT³ | 0.43 MT³

List price											
<b>W5BSNUP</b>											
1	2	3	4	5	6	7	8	9	10	11	12
675	691	705	720	746	769	793	813	839	863	895	941
<b>OVERALL DIMENSIONS</b>				<b>SEAT DIMENSIONS</b>				<b>BACK DIMENSIONS</b>			
<b>W</b>	<b>D</b>	<b>H</b>		<b>W</b>	<b>D</b>	<b>H</b>		<b>W</b>	<b>H</b>		
IN 20.75	23.5	44.5		17.75	16.5	29.25		16.5	16		
MM 527	597	1130		451	419	743		419	406		
Frame plated finish options:											
Add \$60 for Chrome ( <b>CHM</b> )											
Add \$197 for Brushed Chrome ( <b>BCH</b> )											
Add \$288 for Antique Copper ( <b>ACO</b> )											
Add \$288 for Satin Brass ( <b>SBR</b> )											
RTA 00 1 per carton											



Stacks 4 on the floor

**Armless Bar Stool, Poly Back and Uph Seat**  
 COM: 0.75 YD | 0.69 M  
 Unit weight: 22.5 LB | 10.2 KG  
 Carton weight: 33 LB | 14.97 KG  
 Carton volume: 15.25 FT³ | 0.43 MT³

List price											
<b>W5BSNPU</b>											
1	2	3	4	5	6	7	8	9	10	11	12
680	704	724	748	786	821	856	887	925	961	1010	1079
<b>OVERALL DIMENSIONS</b>				<b>SEAT DIMENSIONS</b>				<b>BACK DIMENSIONS</b>			
<b>W</b>	<b>D</b>	<b>H</b>		<b>W</b>	<b>D</b>	<b>H</b>		<b>W</b>	<b>H</b>		
IN 20.75	23.5	44		18.25	17.5	30.25		16	15.25		
MM 527	597	1118		464	445	768		406	387		
Frame plated finish options:											
Add \$60 for Chrome ( <b>CHM</b> )											
Add \$197 for Brushed Chrome ( <b>BCH</b> )											
Add \$288 for Antique Copper ( <b>ACO</b> )											
Add \$288 for Satin Brass ( <b>SBR</b> )											
RTA 00 1 per carton											



Stacks 4 on the floor

**Armless Bar Stool, Uph Back and Seat**  
 COM: 1.25 YD | 1.14 M  
 Unit weight: 23 LB | 10.5 KG  
 Carton weight: 33.5 LB | 15.2 KG  
 Carton volume: 15.25 FT³ | 0.43 MT³

List price											
<b>W5BSNUU</b>											
1	2	3	4	5	6	7	8	9	10	11	12
734	774	808	847	911	969	1028	1079	1143	1203	1284	1399
<b>OVERALL DIMENSIONS</b>				<b>SEAT DIMENSIONS</b>				<b>BACK DIMENSIONS</b>			
<b>W</b>	<b>D</b>	<b>H</b>		<b>W</b>	<b>D</b>	<b>H</b>		<b>W</b>	<b>H</b>		
IN 20.75	23.5	44.5		18.25	16.75	30.25		16.5	15.25		
MM 527	597	1130		464	425	768		419	387		
Frame plated finish options:											
Add \$60 for Chrome ( <b>CHM</b> )											
Add \$197 for Brushed Chrome ( <b>BCH</b> )											
Add \$288 for Antique Copper ( <b>ACO</b> )											
Add \$288 for Satin Brass ( <b>SBR</b> )											
RTA 00 1 per carton											



Does not stack

**Hip Chair, Poly Back and Seat**  
 COM: N/A  
 Unit weight: 25 LB | 11.4 KG  
 Carton weight: 34 LB | 15.42 KG  
 Carton volume: 17.75 FT³ | 0.5 MT³









List price											
<b>W524APP</b> 671											
Add \$30 for grip assist arms ( <b>GAA</b> )											
<b>OVERALL DIMENSIONS</b>				<b>SEAT DIMENSIONS</b>				<b>BACK DIMENSIONS</b>			
<b>W</b>	<b>D</b>	<b>H</b>		<b>W</b>	<b>D</b>	<b>H</b>		<b>W</b>	<b>H</b>		
IN 24.25	24.25	38		17.75	17.5	22.25		16	16		
MM 616	616	965		451	445	565		406	406		
Frame plated finish options:											
Add \$57 for Chrome ( <b>CHM</b> )											
Add \$185 for Brushed Chrome ( <b>BCH</b> )											
Add \$271 for Antique Copper ( <b>ACO</b> )											
Add \$271 for Satin Brass ( <b>SBR</b> )											
RTA 00 1 per carton											



Does not stack

**Hip Chair, Uph Back and Poly Seat**  
 COM: 0.5 YD | 0.46 M  
 Unit weight: 25.5 LB | 11.6 KG  
 Carton weight: 36 LB | 16.33 KG  
 Carton volume: 17.75 FT³ | 0.5 MT³

List price											
<b>W524AUP</b>											
Add \$30 for grip assist arms ( <b>GAA</b> )											
<b>OVERALL DIMENSIONS</b>				<b>SEAT DIMENSIONS</b>				<b>BACK DIMENSIONS</b>			
<b>W</b>	<b>D</b>	<b>H</b>		<b>W</b>	<b>D</b>	<b>H</b>		<b>W</b>	<b>H</b>		
IN 24.25	24.25	38.25		17.75	16.5	22.25		16.5	16.25		
MM 616	616	972		451	419	565		419	413		
Frame plated finish options:											
Add \$57 for Chrome ( <b>CHM</b> )											
Add \$185 for Brushed Chrome ( <b>BCH</b> )											
Add \$271 for Antique Copper ( <b>ACO</b> )											
Add \$271 for Satin Brass ( <b>SBR</b> )											
RTA 00 1 per carton											

DESCRIPTION	MODEL# / FEATURES	STANDARD TEXTILE GRADES											
		1	2	3	4	5	6	7	8	9	10	11	12
 <p>Does not stack</p> <p><b>Hip Chair, Poly Back and Uph Seat</b>                      COM: 0.75 YD   0.69 M                      Unit weight: 25.5 LB   11.6 KG                      Carton weight: 34.5 LB   15.65 KG                      Carton volume: 17.75 FT³   0.5 MT³</p>	<b>W524APU</b>	730	754	774	798	836	871	906	937	975	1011	1060	1129
	Add \$30 for grip assist arms (GAA)	<b>OVERALL DIMENSIONS</b>			<b>SEAT DIMENSIONS</b>			<b>BACK DIMENSIONS</b>					
		W	D	H	W	D	H	W	H				
	Frame plated finish options: Add \$57 for Chrome (CHM) Add \$185 for Brushed Chrome (BCH) Add \$271 for Antique Copper (ACO) Add \$271 for Satin Brass (SBR)	IN 24.25 MM 616	24.25 616	38 965	18.25 464	17.5 445	23.25 591	16 406	15.25 387				
	<b>RTA 00</b>	1 per carton											
 <p>Does not stack</p> <p><b>Hip Chair, Uph Back and Seat</b>                      COM: 1.25 YD   1.14 M                      Unit weight: 26 LB   11.8 KG                      Carton weight: 35 LB   15.88 KG                      Carton volume: 17.75 FT³   0.5 MT³</p>	<b>W524AUU</b>	784	824	858	897	961	1019	1078	1129	1193	1253	1334	1449
	Add \$30 for grip assist arms (GAA)	<b>OVERALL DIMENSIONS</b>			<b>SEAT DIMENSIONS</b>			<b>BACK DIMENSIONS</b>					
		W	D	H	W	D	H	W	H				
	Frame plated finish options: Add \$57 for Chrome (CHM) Add \$185 for Brushed Chrome (BCH) Add \$271 for Antique Copper (ACO) Add \$271 for Satin Brass (SBR)	IN 24.25 MM 616	24.25 616	38.25 972	18.25 464	16.5 419	23.25 591	16.5 419	15.25 387				
	<b>RTA 00</b>	1 per carton											
 <p>Does not stack</p> <p><b>Bariatric Hip Chair, Uph Back and Seat</b>                      COM: 1.75 YD   1.6 M                      Unit weight: 38 LB   17.3 KG                      Carton weight: 50 LB   22.68 KG                      Carton volume: 23.75 FT³   0.67 MT³</p>	<b>W324AUU</b>	1074	1130	1177	1232	1321	1403	1485	1557	1646	1730	1844	2005
	Casters not available.	<b>OVERALL DIMENSIONS</b>			<b>SEAT DIMENSIONS</b>			<b>BACK DIMENSIONS</b>					
	Add \$30 for grip assist arms (GAA)	W	D	H	W	D	H	W	H				
	Frame plated finish options: Add \$57 for Chrome (CHM) Add \$185 for Brushed Chrome (BCH) Add \$271 for Antique Copper (ACO) Add \$271 for Satin Brass (SBR)	IN 35.25 MM 895	24.25 616	38.5 978	29 737	17.5 445	23.25 591	26.75 679	15.25 387				
	<b>RTA 00</b>	1 per carton											
		List price											
	<b>WDOL</b>	435											
 <p><b>Dolly for Four-Leg Chairs</b>                      COM: N/A                      Unit weight: 13 LB   5.9 KG                      Carton weight: 16 LB   7.26 KG                      Carton volume: 3.5 FT³   0.09 MT³</p>	<b>OVERALL DIMENSIONS</b>			<b>SEAT DIMENSIONS</b>			<b>BACK DIMENSIONS</b>						
		W	D	H	W	D	H	W	H				
	Accommodates 10 standard four-leg chairs	IN 22 MM 559	23.75 603	9.25 235	-	-	-	-	-				
		<b>RTA 00</b>		1 per carton									
		List price											
	<b>WDOL30</b>	610											
 <p><b>Dolly for Bariatric Four-Leg Chairs</b>                      COM: N/A                      Unit weight: 15 LB   6.8 KG                      Carton weight: 19 LB   8.62 KG                      Carton volume: 5 FT³   0.14 MT³</p>	<b>OVERALL DIMENSIONS</b>			<b>SEAT DIMENSIONS</b>			<b>BACK DIMENSIONS</b>						
		W	D	H	W	D	H	W	H				
	Accommodates 4 bariatric four-leg chairs	IN 32.12 MM 816	23.75 603	9.25 235	-	-	-	-	-				
		<b>RTA 00</b>		1 per carton n									
		List price											
	<b>WPGBRK</b>	92											
 <p><b>Ganging Bracket</b>                      COM: N/A                      Unit weight: 4 LB   1.81 KG                      Carton weight: 2 LB   0.91 KG                      Carton volume: 2 FT³   0.05 MT³</p>	<b>OVERALL DIMENSIONS</b>			<b>SEAT DIMENSIONS</b>			<b>BACK DIMENSIONS</b>						
		W	D	H	W	D	H	W	H				
	Does not accept power units. For use between 2 seated height arm or armless chairs where table top is not desired. Not usable with stool models.	IN 15 MM 381	9 229	1.25 32	-	-	-	-	-				
		<b>RTA 00</b>		1 per carton									

WILLOW LINKING TABLES



model WPT12G  
120 degree corner linking table



model WPTEGL  
end linking table - left



Willow seating



For Willow seating, see page 224.

EXAMPLE WILLOW TABLE ORDER CODE:

WPT90G	HPL	ACJ	CHM	ST	SND
Model #	Surface type	Top finish	Leg finish	Glide type	Glide finish









STANDARD FEATURES

- Linking tables can be used together in any combination with Willow four-leg or sled base chairs to create a wide variety of layouts.
- Connecting hardware is included.
- Legs and ganging brackets are available in 20 paint finishes or 4 plated finishes with an upcharge.
- Tables are available in thermally fused or high pressure laminate, and feature a flat edge with edge band.
- Various table glide options are available. Glides must be chosen to best suit flooring type and site conditions. For more information, please refer to glide selection chart (page 265).
- All tables (except 9" in-line linking table) are predrilled for center front field installation of undermount power. Specify separately.
- Undermount power unit (model SU2P10U) includes 1 AC and 2 USB-A charging ports with a 10' power cord and 3-prong plug. Specify Jet Black or White. Power units are not designed for daisy-chaining.
- Clamp mount (model SU2P10C) power includes 1 AC and 2 USB-A charging ports with a 10' power cord. Specify Jet Black or White. These units can be mounted on the back edge of all linking tables. Specify separately for field installation. Power units are not designed for daisy-chaining.

Please add option codes in the following order:

- **Model number**
- **Surface type**  
(TFL) Thermally fused laminate  
(HPL) High pressure laminate
- **Top finish**  
(ACJ) Absolute Acajou (NBL) Noce Biondo  
(ASN) Asian Night (NGL) Noce Grigio  
(AWC) Avant Cherry (NEL) Noce Leggero  
(AWH) Avant Honey (NML) Noce Medio  
(BLK) Black (QTM) Quartered Mahogany  
(BRC) Brushed Cobalt (SBY) Sheer Beauty  
(CMB) Clear Maple (SOG) Storm Grey  
(DES) Dark Espresso (DWT) Designer White (WHE) Walnut Heights  
(FAS) Fashionista (WHC) White Chocolate  
(FCL) First Class (WCR) Winter Cherry
- **Leg finish**  
Paint finishes. No upcharge  
(TBL) Black (TIN) Ink  
(TBZ) Buzz Blue (TKA) Kalua  
(TCC) Cactus (TLA) Latte  
(TCR) Carrot (TMO) Mocha  
(TIV) Cloud (TNE) Nevada  
(TDW) Designer White (TSN) Sand  
(TDJ) Dijon (TSR) Scarlet  
(TEG) Eggplant (TSH) Shadow  
(TFO) Fog (TOA) Toast  
(TFR) Frost (TTU) Tungsten
- Plated finish. See models for upcharges.  
(CHM) Chrome (SBR) Satin Brass  
(BCH) Brushed Chrome (ACO) Antique Copper
- **Bracket finish** (for linking tables)  
Paint finishes. No upcharge  
(TBL) Black (TMO) Mocha  
(TIV) Cloud (TNE) Nevada  
(TDW) Designer White (TSN) Sand  
(TFO) Fog (TSH) Shadow  
(TFR) Frost (TOA) Toast  
(TKA) Kalua (TTU) Tungsten  
(TLA) Latte
- **Glide type** (for models with legs)  
(ST) Colored nylon glides for most surfaces. No upcharge.  
(NM) Natural, non-marking nylon glides for most surfaces. No upcharge.  
(SG) Steel cushioned glides for carpeted surfaces. See models for upcharges.  
(FG) Felt glides for most hard floor surfaces. See models for upcharges.  
(RG) Rubber non-slip glides for most hard floor surfaces. See models for upcharges.
- **Glide finish** (for all ST glides)  
(BLK) Black  
(SND) Sand

DESCRIPTION	MODEL# / FEATURES	STANDARD TEXTILE GRADES							
		List price	HPL add						
	WPT90G	475	116						
 <p><b>90 Degree Corner Linking Table</b> COM: N/A Unit weight: 20 LB   9.1 KG Carton weight: 24 LB   10.89 KG Carton volume: 2.6 FT<sup>3</sup>   0.07 MT<sup>3</sup></p>	For glide option SG, FG or RG, add \$5.  Must be connected to a 4-leg or sled base chair. Includes 1 set of U-channel connectors and hardware.  Shipped KD for assembly on site.	<b>OVERALL DIMENSIONS</b>			<b>SEAT DIMENSIONS</b>			<b>BACK DIMENSIONS</b>	
		W	D	H	W	D	H	W	H
		IN 26.12 MM 664	26.12 664	17.62 448	-	-	-	-	-

DESCRIPTION	MODEL# / FEATURES		STANDARD TEXTILE GRADES								
			List price	HPL add							
 <p><b>120 Degree Corner Linking Table</b> COM: N/A Unit weight: 13.5 LB   6.1 KG Carton weight: 16.5 LB   7.48 KG Carton volume: 1.5 FT³   0.04 MT³</p>	<b>WPT12G</b>		406	74							
	For glide option <b>SG, FG</b> or <b>RG</b> , add \$5.			<b>OVERALL DIMENSIONS</b>			<b>SEAT DIMENSIONS</b>			<b>BACK DIMENSIONS</b>	
				<b>W</b>	<b>D</b>	<b>H</b>	<b>W</b>	<b>D</b>	<b>H</b>	<b>W</b>	<b>H</b>
	Must be connected to a 4-leg or sled base chair. Includes 1 set of U-channel connectors and hardware.	IN 12.62	31	17.5	-	-	-	-	-	-	-
		MM 321	787	445	-	-	-	-	-	-	
Shipped KD for assembly on site.	<b>RTA 2</b>		1 per carton								
 <p><b>16" In-line Linking Table</b> COM: N/A Unit weight: 10 LB   4.5 KG Carton weight: 12 LB   5.44 KG Carton volume: 0.9 FT³   0.02 MT³</p>	<b>WPT16G</b>		265	47							
				<b>OVERALL DIMENSIONS</b>			<b>SEAT DIMENSIONS</b>			<b>BACK DIMENSIONS</b>	
				<b>W</b>	<b>D</b>	<b>H</b>	<b>W</b>	<b>D</b>	<b>H</b>	<b>W</b>	<b>H</b>
	Must be connected to a 4-leg or sled base chair. Includes 1 set of U-channel connectors and hardware.	IN 16	15	2.75	-	-	-	-	-	-	-
		MM 406	381	70	-	-	-	-	-	-	
Shipped KD for assembly on site.	<b>RTA 00</b>		1 per carton								
 <p><b>9" In-line Linking Table</b> COM: N/A Unit weight: 7 LB   3.2 KG Carton weight: 8.5 LB   3.86 KG Carton volume: 0.7 FT³   0.01 MT³</p>	<b>WPT09G</b>		207	33							
				<b>OVERALL DIMENSIONS</b>			<b>SEAT DIMENSIONS</b>			<b>BACK DIMENSIONS</b>	
				<b>W</b>	<b>D</b>	<b>H</b>	<b>W</b>	<b>D</b>	<b>H</b>	<b>W</b>	<b>H</b>
	Must be connected to a 4-leg or sled base chair. Includes 1 set of U-channel connectors and hardware.	IN 9	15	2.75	-	-	-	-	-	-	-
		MM 229	381	70	-	-	-	-	-	-	
Shipped KD for assembly on site.	<b>RTA 00</b>		1 per carton								
 <p><b>End Linking Table</b> COM: N/A Unit weight: 10.5 LB   4.8 KG Carton weight: 13 LB   5.9 KG Carton volume: 1 FT³   0.02 MT³</p>	<b>WPTEGL</b>		411	45							
	<b>WPTEGR</b>		411	45							
	Specify direction per seated use.										
	For glide option <b>SG, FG</b> or <b>RG</b> , add \$10.			<b>OVERALL DIMENSIONS</b>			<b>SEAT DIMENSIONS</b>			<b>BACK DIMENSIONS</b>	
			<b>W</b>	<b>D</b>	<b>H</b>	<b>W</b>	<b>D</b>	<b>H</b>	<b>W</b>	<b>H</b>	
Must be connected to a 4-leg or sled base chair. Includes 1 set of U-channel connectors and hardware.	IN 14	15	17.62	-	-	-	-	-	-	-	
		MM 356	381	448	-	-	-	-	-	-	
Shipped KD for assembly on site.	<b>RTA 2</b>		1 per carton								

DESCRIPTION MODEL# / FEATURES STANDARD TEXTILE GRADES

List price

SU2P10C 517



**Power Unit, Clamp Attachment**  
 COM: N/A  
 Unit weight: 3 LB | 1.36 KG  
 Carton weight: 3 LB | 1.36 KG  
 Carton volume: 0.5 FT³ | 0.01 MT³

Includes 1 AC and 2 USB-A ports.  
 Tamper resistant with 10' cord.

	OVERALL DIMENSIONS			SEAT DIMENSIONS			BACK DIMENSIONS	
	W	D	H	W	D	H	W	H
IN	1.69	4.05	2.77	-	-	-	-	-
MM	43	103	70	-	-	-	-	-

**RTA 00**  1 per carton

List price

SU2P10U 517



**Power Unit, Undermount Attachment**  
 COM: N/A  
 Unit weight: 3 LB | 1.36 KG  
 Carton weight: 3 LB | 1.36 KG  
 Carton volume: 0.5 FT³ | 0.01 MT³

Includes 1 AC and 2 USB-A ports.  
 Tamper resistant with 10' cord.

	OVERALL DIMENSIONS			SEAT DIMENSIONS			BACK DIMENSIONS	
	W	D	H	W	D	H	W	H
IN	1.69	4.05	2.77	-	-	-	-	-
MM	43	103	70	-	-	-	-	-

**RTA 00**  1 per carton



WINGBACK



model GC3787C

STANDARD FEATURES

- Traditional styling, easy to exit and features removable and replaceable seats.
- For added comfort, seats are standard with high density Ultracell foam.
- Standard glide is plastic.
- Wood legs are available in a variety of finishes. Available in Maple wood only species.
- For healthcare textiles and wood finish options, visit the website at globalfurnituregroup.com.
- Can be upholstered in standard Global textiles if Healthcare compliance is not required.
- Shipped fully assembled.

OPTIONAL FEATURES

- For non-slip glides, please specify **(NS)**. Add \$22.
- For hard surface floors, please specify opaque non-marking glides **(NM)**. No upcharge.
- To add sealed seams to your product contact Customer Service. Upcharges vary.
- For moisture barrier on seat, please specify **(MB)**. Add \$122.

SUGGESTED APPLICATIONS

- Guest seating
- Lobbies
- Lounge/Waiting
- Patient rooms
- Resident rooms

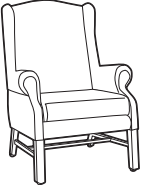
DESCRIPTION	MODEL# / FEATURES	STANDARD TEXTILE GRADES																																			
		COM	2	3	4	5	6	7	8	9	10	11	12																								
 <p><b>High Back Armchair - Chippendale Legs</b>                      COM: 4.75 YD   4.34 M                      Unit weight: 42 LB   19.1 KG                      Carton weight: 50 LB   22.68 KG                      Carton volume: 25.5 FT³   0.72 MT³</p>	<b>GC3787C</b>	1743	1895	2023	2171	2413	2636	2859	3054	3296	3524	3833	4270																								
	<p>Active weight 300 lbs.</p> <p>Removable seat cushion.</p>	<table border="1"> <thead> <tr> <th rowspan="2"></th> <th colspan="3">OVERALL DIMENSIONS</th> <th colspan="3">SEAT DIMENSIONS</th> <th colspan="2">BACK DIMENSIONS</th> </tr> <tr> <th>W</th> <th>D</th> <th>H</th> <th>W</th> <th>D</th> <th>H</th> <th>W</th> <th>H</th> </tr> </thead> <tbody> <tr> <td>IN</td> <td>29</td> <td>30</td> <td>39</td> <td>19.5</td> <td>18</td> <td>17.5</td> <td>19.5</td> <td>22</td> </tr> <tr> <td>MM</td> <td>737</td> <td>762</td> <td>991</td> <td>495</td> <td>457</td> <td>445</td> <td>495</td> <td>559</td> </tr> </tbody> </table>		OVERALL DIMENSIONS			SEAT DIMENSIONS			BACK DIMENSIONS		W	D	H	W	D	H	W	H	IN	29	30	39	19.5	18	17.5	19.5	22	MM	737	762	991	495	457	445	495	559
	OVERALL DIMENSIONS			SEAT DIMENSIONS			BACK DIMENSIONS																														
	W	D	H	W	D	H	W	H																													
IN	29	30	39	19.5	18	17.5	19.5	22																													
MM	737	762	991	495	457	445	495	559																													

# seating

## Work + Task

Doctor Buddy.....	241	GC Tritek .....	248
Ergonomic features .....	239	GC Tritek TS.....	250
Foot activated stools .....	243	GC Vion .....	252
Gala II.....	244	Harmony.....	254
Gala II TS.....	246	Mechanism adjustments ....	240

EACH HEALTHCARE CHAIR IS BUILT WITH FEATURES THAT ARE ERGONOMICALLY DESIGNED TO PROMOTE GOOD POSTURE AND PROVIDE MAXIMUM COMFORT. WHILE FULLY SUPPORTING YOUR BODY, THESE FEATURES SHOULD ALSO ALLOW YOU TO ADJUST YOUR CHAIR TO FIT YOU.



## A TENSION ADJUSTMENT

Increase or decrease to match body weight. Allows you to rock comfortably, without heavy pushing, reducing muscle fatigue.



## B CHAIR TILT LOCK

Lock the tilt movement in position(s) to accommodate your working posture. Allows you to lock your chair in a comfortable and supportive position. (Can be either single position, multiple position or infinite position.)



## C SEAT HEIGHT

Raise or lower to allow your feet to rest flat on the floor. Avoids pressure under your thighs, easing blood flow.



## D BACK/LUMBAR HEIGHT ADJUSTMENT

Raise or lower to position lumbar support in your lumbar area. Reduces likelihood of back pain.



## E SEAT DEPTH

Change the depth of the seat to accommodate the length of your thighs. Keeps your back in contact with the backrest while avoiding pressure behind your knees. Can be sliding (MD) or manual.



## F SEAT ANGLE ADJUSTMENT

Allows chair to tilt forward changing the angle of your thighs in relation to the floor. Helps reduce disc pressure during forward leaning tasks.



## G BACK ANGLE ADJUSTMENT

Adjust to change the angle of your torso in relation to your thighs. Helps reduce disc pressure and relaxes your back muscles.



## H ARM HEIGHT

Raise or lower to support your forearms. Reduces muscular effort in neck and shoulders, minimizing risk of pain.



## J KNEE-TILT MOVEMENT

Chair tilts from a pivot point at the front of the seat, keeping your feet on the floor as you rock. Maintains stability.



## L SYNCHRO-TILT MOVEMENT

Backrest reclines at a faster rate than the seat, increasing the angle between your torso and thighs. Enhances comfort and encourages dynamic body movement.



## M WATERFALL SEAT EDGE

Reduces pressure at the back of your knees, contributing to good blood flow.



## N CONTOURED CUSHION

Supports the body effectively, allowing you to sit longer without discomfort.



## P VIBRATING SEAT & BACK

Soothing effect contributes to your relaxation during work breaks.



## Q WIDTH ADJUSTABLE ARMS

Allows outward movement of armrests to match shoulder breadth. Ensures armrests properly support forearms, reducing muscular efforts in neck and shoulders.



## R ARM ROTATION

Rotate armcaps to support your forearms in various positions. Reduces muscular effort in neck and shoulders minimizing risk of pain.



## S CENTRE TILT

Chair tilts from a pivot point under the centre of the seat allowing you to rock. When your feet are well supported, blood flow is enhanced.



## U SOFT DESCENT PNEUMATIC LIFT

Gently and gradually lowering the seat helps you easily select proper seat height without causing a jerking motion.



## V LUMBAR DEPTH ADJUSTMENT

Increase or decrease curvature of the back to match the profile of your lower back. Enhances comfort and support in the lower lumbar area.

## MAXIMIZING YOUR ERGONOMIC SEATING

- Always select a chair that is designed for the type of work you perform and make certain the chair is comfortable for the length of time spent using it.
- Ensure that the seat and back cushions are contoured to fit your body, which will help eliminate pressure points.
- An ergonomically designed chair should allow changing positions easily.
- As you work, reposition yourself throughout the day to reduce strain and stress on specific muscle groups. If you change job functions, adjust your chair to fit the new task.
- Proper ergonomic seating should help eliminate many of the work related injuries that result from poor posture and poorly designed chairs.

## TASK



### ADJUSTMENTS

- (2) Pneumatic seat height
- (8) Manual seat depth
- Back/lumbar height \*\*
- Swivel

## POSTURE TASK



### ADJUSTMENTS

- (2) Pneumatic seat height
- (3) Back angle
- (6) Back/lumbar height \*\*
- Swivel

## TILTER



### ADJUSTMENTS

- (1) Tilt tension
- (2) Pneumatic seat height
- (9) Multiple position tilt lock \*
- Centre tilt action
- Swivel

## MULTI-TILTER



### ADJUSTMENTS

- (1) Tilt tension
- (2) Pneumatic seat height
- (3) Back angle adjustment
- (4) Seat angle
- (8) Sliding seat depth adjustment (MD)
- (9) Infinite position tilt lock
- Back/lumbar height \*\*
- Centre tilt action
- Swivel

## SYNCHRO-TILTER



### ADJUSTMENTS

- (1) Tilt tension
- (2) Pneumatic seat height
- (3) Back angle adjustment \*
- (8) Sliding seat depth adjustment (MD)
- (9) Multiple position tilt lock/ Synchro tilt action
- Anti kick back \*
- Back/lumbar height \*\*
- Swivel

## OPERATOR



### ADJUSTMENTS

- (2) Pneumatic seat height
- (3) Back angle \*(free float/lock)
- (4) Seat angle \*(free float/lock)
- Back/lumbar height \*\*
- With single lever operator mechanism, seat and back angle are controlled using lever 4 \*
- Swivel

### NOTES

- \* Select models only.
- \*\* Ratchet back height adjustment on select models.
- Mechanisms shown are generic depictions and may differ from one chair to another.

DOCTOR BUDDY



model GC1105

model GC1111

STANDARD FEATURES









- Doctor Buddy is the perfect stool to provide comfort when performing office tasks or as an examination or feeding stool when caring for others.
- For the right comfort and support when performing tasks select Doctor Buddy with or without a back.
- Seat and back can be upholstered in vinyl or fabric. Seat is standard with high density Ultracell foam cushion.
- Models available with backrests: GC1111, GC1112, GC1113 & GC1114.
- Moisture resistant protection on the underside of seat pan.
- GC1104, GC1109, GC1111 & GC1113: 16" seat diameter.
- GC1105, GC1110, GC1112 & GC1114: 13.5" seat diameter.
- Black 5-prong injection molded base is standard.
- (C65) casters are standard.
- For healthcare textiles, visit the website at [globalfurnituregroup.com](http://globalfurnituregroup.com).
- Can be upholstered in standard Global textiles only if Healthcare compliance is not required.











OPTIONAL FEATURES

- For improved housekeeping and infection control practices, please add (SU) to model number. The underside of the seat will be finished with vinyl and sealed to prevent penetration of liquids. Add \$39.
- **Casters/Glides**  
 (C65) Dual wheel carpet casters. No upcharge.  
 (C65R) Dual wheel hard floor casters. Add \$21.  
 (C7) Set of 5 large Black slipper glides (for all surfaces). Can replace any Global casters. Glide is the same height as casters. No upcharge.
- To add sealed seams for seat and/or back, specify (SS). Upcharges vary, see model.
- Height adjustable footrest, please specify (R2). Add \$52.

SUGGESTED APPLICATIONS

- Dining/Cafeteria
- Office/Meeting
- Patient rooms
- Resident rooms
- Treatment/Exam rooms

DESCRIPTION	MODEL# / FEATURES	STANDARD TEXTILE GRADES											
		COM	2	3	4	5	6	7	8	9	10	11	12
 <b>16" Dia. Swivel Stool 5" Pneumatic, 22" Base</b> COM: 0.75 YD   0.69 M Unit weight: 12 LB   5.5 KG Carton weight: 15 LB   6.8 KG Carton volume: 2.9 FT³   0.08 MT³	<b>GC1104</b>	386	410	430	454	492	527	562	593	631	667	716	785
	Active weight 300 lbs.												
	Add \$15 for (SS)												
	Ergonomic features: C	  1 per carton											
		<b>OVERALL DIMENSIONS</b>			<b>SEAT DIMENSIONS</b>			<b>BACK DIMENSIONS</b>					
		<b>W</b>	<b>D</b>	<b>H</b>	<b>W</b>	<b>D</b>	<b>H</b>	<b>W</b>	<b>H</b>				
		IN 16	16	18.5	16	-	16.5-21.5	-	-				
		MM 406	406	470	406	-	419-546	-	-				
 <b>14" Dia. Swivel Stool 5" Pneumatic, 20" Base</b> COM: 0.75 YD   0.69 M Unit weight: 11 LB   5 KG Carton weight: 14 LB   6.35 KG Carton volume: 2.5 FT³   0.07 MT³	<b>GC1105</b>	327	351	371	395	433	468	503	534	572	608	657	726
	Active weight 300 lbs.												
	Add \$15 for (SS)												
	Ergonomic features: C	  1 per carton											
		<b>OVERALL DIMENSIONS</b>			<b>SEAT DIMENSIONS</b>			<b>BACK DIMENSIONS</b>					
		<b>W</b>	<b>D</b>	<b>H</b>	<b>W</b>	<b>D</b>	<b>H</b>	<b>W</b>	<b>H</b>				
		IN 13.5	13.5	18.5	13.5	-	16.5-21.5	-	-				
		MM 343	343	470	343	-	419-546	-	-				
 <b>16" Dia. Swivel Stool 10" Pneumatic, 22" Base</b> COM: 0.75 YD   0.69 M Unit weight: 15 LB   6.8 KG Carton weight: 18 LB   8.16 KG Carton volume: 2.9 FT³   0.08 MT³	<b>GC1109</b>	471	495	515	539	577	612	647	678	716	752	801	870
	Active weight 300 lbs.												
	Add \$15 for (SS)												
	Ergonomic features: C	  1 per carton											
		<b>OVERALL DIMENSIONS</b>			<b>SEAT DIMENSIONS</b>			<b>BACK DIMENSIONS</b>					
		<b>W</b>	<b>D</b>	<b>H</b>	<b>W</b>	<b>D</b>	<b>H</b>	<b>W</b>	<b>H</b>				
		IN 16	16	27.5	16	-	22.5-32.5	-	-				
		MM 406	406	699	406	-	572-826	-	-				

DESCRIPTION	MODEL# / FEATURES	STANDARD TEXTILE GRADES											
		COM	2	3	4	5	6	7	8	9	10	11	12
 <p><b>14" Dia. Swivel Stool 10" Pneumatic, 22" Base</b>                      COM: 0.75 YD   0.69 M                      Unit weight: 14 LB   6.4 KG                      Carton weight: 17 LB   7.71 KG                      Carton volume: 2.9 FT³   0.08 MT³</p>	<b>GC1110</b>	395	419	439	463	501	536	571	602	640	676	725	794
		<b>OVERALL DIMENSIONS</b>			<b>SEAT DIMENSIONS</b>			<b>BACK DIMENSIONS</b>					
		<b>W</b>	<b>D</b>	<b>H</b>	<b>W</b>	<b>D</b>	<b>H</b>	<b>W</b>	<b>H</b>				
		IN 13.5 MM 343	13.5 343	27.5 699	13.5 343	- -	22.5-32.5 572-826	- -	- -				
Active weight 300 lbs. Add \$15 for (SS) Ergonomic features: C		<b>RTA 1</b>		1 per carton									
 <p><b>16" Dia. Swivel Stool with back 5" Pneumatic, 24" Base</b>                      COM: 1 YD   0.91 M                      Unit weight: 24 LB   10.9 KG                      Carton weight: 32.5 LB   14.74 KG                      Carton volume: 15.5 FT³   0.43 MT³</p>	<b>GC1111</b>	535	567	594	625	676	723	770	811	862	910	975	1067
		<b>OVERALL DIMENSIONS</b>			<b>SEAT DIMENSIONS</b>			<b>BACK DIMENSIONS</b>					
		<b>W</b>	<b>D</b>	<b>H</b>	<b>W</b>	<b>D</b>	<b>H</b>	<b>W</b>	<b>H</b>				
		IN 16.5 MM 419	20.5 521	29.75 756	16.5 419	15.5-17.5 394-445	16-21 406-533	14 356	11.25 286				
Active weight 300 lbs. Add \$27 for (SS) Ergonomic features: C		<b>RTA 1</b>		1 per carton									
 <p><b>14" Dia. Swivel Stool with back 5" Pneumatic, 24" Base</b>                      COM: 0.75 YD   0.69 M                      Unit weight: 21 LB   9.5 KG                      Carton weight: 29 LB   13.15 KG                      Carton volume: 11.25 FT³   0.31 MT³</p>	<b>GC1112</b>	476	500	520	544	582	617	652	683	721	757	806	875
		<b>OVERALL DIMENSIONS</b>			<b>SEAT DIMENSIONS</b>			<b>BACK DIMENSIONS</b>					
		<b>W</b>	<b>D</b>	<b>H</b>	<b>W</b>	<b>D</b>	<b>H</b>	<b>W</b>	<b>H</b>				
		IN 13.5 MM 343	17 432	29.75 756	13.5 343	12-14 305-356	16-21 406-533	14 356	11.25 286				
Active weight 300 lbs. Add \$24 for (SS) Ergonomic features: C		<b>RTA 1</b>		1 per carton									
 <p><b>16" Dia. Swivel Stool with back 10" Pneumatic, 24" Base</b>                      COM: 1 YD   0.91 M                      Unit weight: 25 LB   11.4 KG                      Carton weight: 33.5 LB   15.2 KG                      Carton volume: 15.5 FT³   0.43 MT³</p>	<b>GC1113</b>	620	652	679	710	761	808	855	896	947	995	1060	1152
		<b>OVERALL DIMENSIONS</b>			<b>SEAT DIMENSIONS</b>			<b>BACK DIMENSIONS</b>					
		<b>W</b>	<b>D</b>	<b>H</b>	<b>W</b>	<b>D</b>	<b>H</b>	<b>W</b>	<b>H</b>				
		IN 16.5 MM 419	20.5 521	38.75 984	16.5 419	15.5-17.5 394-445	22.5-32.5 572-826	14 356	11.25 286				
Active weight 300 lbs. Add \$27 for (SS) Ergonomic features: C		<b>RTA 1</b>		1 per carton									
 <p><b>14" Dia. Swivel Stool with back 10" Pneumatic, 24" Base</b>                      COM: 0.75 YD   0.69 M                      Unit weight: 22 LB   10 KG                      Carton weight: 31 LB   14.06 KG                      Carton volume: 13.25 FT³   0.37 MT³</p>	<b>GC1114</b>	544	568	588	612	650	685	720	751	789	825	874	943
		<b>OVERALL DIMENSIONS</b>			<b>SEAT DIMENSIONS</b>			<b>BACK DIMENSIONS</b>					
		<b>W</b>	<b>D</b>	<b>H</b>	<b>W</b>	<b>D</b>	<b>H</b>	<b>W</b>	<b>H</b>				
		IN 13.5 MM 343	17 432	38.75 984	13.5 343	12-14 305-356	22.5-32.5 572-826	14 356	11.25 286				
Active weight 300 lbs. Add \$24 for (SS) Ergonomic features: C		<b>RTA 1</b>		1 per carton									



GALA II



model GC13011



model GC13015

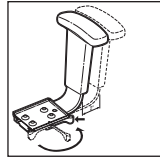

**Vari-Width (WA)** width adjustable arm extensions are standard when chair is ordered with adjustable arms.



model GC13021

MECHANISM OPTIONS:

Task mechanism (-6)

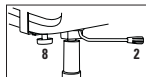

**ADJUSTMENTS**  
(2) Pneumatic seat height  
(8) Manual seat depth

**Ergonomic features:**  
C, E, H, M, N, Q, R, U

Synchro-tilter mechanism (-0)

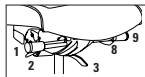

**ADJUSTMENTS**  
(1) Tilt tension  
(2) Pneumatic seat height  
(3) Back angle  
Back/lumbar height  
(8) Sliding seat depth  
(9) Multi position tilt lock  
Synchro tilt action  
Anti kick back

**Ergonomic features:**  
A, B, C, D, E, G, H, L, M, N, Q, R, U

Multi-tilter mechanism (-3)

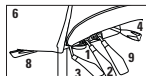

**ADJUSTMENTS**  
(1) Tilt tension  
(2) Pneumatic seat height  
(3) Back angle  
(4) Seat angle  
(6) Back/lumbar height  
(8) Sliding seat depth  
(9) Infinite position tilt lock  
Center tilt action

**Ergonomic features:**  
A, B, C, D, E, F, G, H, M, N, Q, R, S, U

Posture task mechanism (-7)



**ADJUSTMENTS**  
(2) Pneumatic seat height  
(3) Back angle  
Back/lumbar height  
(8) Manual seat depth  
20" diameter Chrome footrest

**Ergonomic features:**  
C, D, G, H, M, N, Q, R, U, V

STANDARD FEATURES

- Gala II is designed to provide exceptional support and comfort throughout the work day.
- Available in three back heights and three seat sizes to fit a person's body type and movements while at work.
- Models with adjustable headrest available.
- Choice of four mechanisms: Task, synchro-tilter, multi-tilter and posture task. Stool models are available with posture task mechanism only.
- Vertical back height ratchet adjustment of 5.25" is standard on all models (except on task mechanism).
- Back support upright is 3" wide for extra strength.
- One-piece curved back features a pull over style upholstery cover for easy housekeeping and infection prevention practices.
- Standard with Global's high quality Soft Descent™ pneumatic lift which slowly and gently lowers the seat height of the chair making it easy to obtain the exact seat height you desire.
- Models with arms are standard with height adjustable arms (3B) with self-skinned urethane (SSU) armcaps.
- Vari-Width (WA) width adjustable arm extensions are standard. Allows the arms to move away from the seat by 2" on each side to allow space if desired for broader hip widths.
- Waterfall seamless seat front design with high density Ultracell foam for superior comfort and longevity.
- Underside of seat pan is completely sealed.
- Side activated sliding seat depth adjustment (MD) is standard on synchro-tilter and multi-tilter.
- 5-prong, injection molded, fiberglass reinforced nylon Black base with dual wheel carpet casters (C65).
- For healthcare textiles and finish options, visit the website at [globalfurnituregroup.com](http://globalfurnituregroup.com).
- Can be upholstered in standard Global textiles only if Healthcare compliance is not required.
- To meet higher standards for housekeeping and infection control, Gala II has a seamless seat and one stitch pull over back upholstery, while still offering soft curves to the design. Note: Vinyl and woven treated textiles are thicker in nature and will experience wrinkles on some curves or corners as a result.

OPTIONAL FEATURES

- For moisture barrier on seat, please specify (MB). Add \$81.
- Back sealed seam available, please specify (S2). Upcharges vary.
- Optional Schukra™ depth adjustable lumbar support for personalized back support and comfort, please specify (SK). Add \$119.
- For additional arms/caster options, please refer to the Arm and Caster section (260). Optional casters may be priced higher than the standard casters for your chair and the difference will be charged. Lower priced optional casters will not be credited.

Please add option codes in the following order:





- **Model number**  
GC13011 High back with arms  
GC13011NA High back, armless  
GC13012 Medium back with arms  
GC13012NA Medium back, armless  
GC13013 Low back with arms  
GC13013NA Low back, armless  
GC13015 Medium back stool with arms  
GC13015NA Medium back stool, armless  
GC13021 High Back w/Adj. Headrest with arms  
GC13021NA High Back w/Adj. Headrest, armless  
GC13022 Medium Back w/Adj. Headrest with arms  
GC13022NA Medium Back w/Adj. Headrest, armless
- **Textile**  
Specify textile code.
- **Mechanism**  
(6) Task mechanism. No upcharge.  
(0) Synchro-tilter mechanism. Add \$168.  
(3) Multi-tilter mechanism. Add \$168.  
(7) Posture task mechanism. Add \$99.  
NOTE: Stool models are only available with Posture Task Mechanism, no upcharge.
- **Seat size**  
(P) Petite  
(S) Standard  
(G) Generous
- **Arms**  
(3B) Height adjustable arms. No upcharge.  
For additional arm options, please refer to Arm Selections section on page 262.
- **Base**  
(BK) Black nylon spider base.  
(AL) Polished aluminum base. Add \$131.
- **Casters**  
(C65) Dual wheel carpet casters.  
(C65R) Dual wheel hard floor casters. Add \$21.

EXAMPLE GALA II SELECT ORDER CODE:

GC13011	-WA53	-0	-S	-3B	-AL	-C65
Model number	Textile	Mechanism	Seat size	Arms	Base	Casters

DESCRIPTION	MODEL# / FEATURES	STANDARD TEXTILE GRADES											
		COM	2	3	4	5	6	7	8	9	10	11	12
 <b>High Back</b> COM: 1.85 YD   1.69 M Unit weight: 45 LB   20.5 KG Carton weight: 55 LB   24.95 KG Carton volume: 10.5 FT³   0.29 MT³	<b>GC13011</b> With arms	744	803	853	911	1004	1092	1179	1254	1349	1438	1558	1728
	<b>GC13011NA</b> Armless	640	699	749	807	900	988	1075	1150	1245	1334	1454	1624
		OVERALL DIMENSIONS			SEAT DIMENSIONS			BACK DIMENSIONS					
		W	D	H	W	D	H	W		H			
		IN 24.5	23.5	43	20.5	17-18	16.5-21.5	20		24.5			
		MM 622	597	1092	521	432-457	419-546	508		622			
	Active weight 300 lbs.												
	See series notes for mechanism options.												
		RTA 2		1 per carton									



DESCRIPTION	MODEL# / FEATURES	STANDARD TEXTILE GRADES											
		COM	2	3	4	5	6	7	8	9	10	11	12
 <p><b>Medium Back</b> COM: 1.9 YD   1.74 M Unit weight: 43 LB   19.5 KG Carton weight: 53 LB   24.04 KG Carton volume: 10.5 FT³   0.29 MT³</p>	<b>GC13012</b> With arms	704	765	816	875	972	1062	1151	1228	1326	1417	1540	1715
	<b>GC13012NA</b> Armless	608	659	702	752	833	909	984	1049	1131	1208	1312	1459
	<b>OVERALL DIMENSIONS</b>	<b>W</b>	<b>D</b>	<b>H</b>	<b>SEAT DIMENSIONS</b>	<b>W</b>	<b>D</b>	<b>H</b>	<b>BACK DIMENSIONS</b>	<b>W</b>	<b>H</b>		
	Active weight 300 lbs.	IN 24.5	23.5	39	20.5	17-18	16.5-21.5	20	20.5				
	MM 622	597	991	521	432-457	419-546	508	521					
See series notes for mechanism options.	<b>RTA 2</b>	1 per carton											
 <p><b>Low Back</b> COM: 1.5 YD   1.37 M Unit weight: 41 LB   18.6 KG Carton weight: 51 LB   23.13 KG Carton volume: 10.5 FT³   0.29 MT³</p>	<b>GC13013</b> With arms	698	746	786	833	909	980	1051	1112	1189	1261	1358	1496
	<b>GC13013NA</b> Armless	596	644	684	731	807	878	949	1010	1087	1159	1256	1394
	<b>OVERALL DIMENSIONS</b>	<b>W</b>	<b>D</b>	<b>H</b>	<b>SEAT DIMENSIONS</b>	<b>W</b>	<b>D</b>	<b>H</b>	<b>BACK DIMENSIONS</b>	<b>W</b>	<b>H</b>		
	Active weight 300 lbs.	IN 24.5	23.5	35	20.5	17-18	16.5-21.5	20	16.5				
	MM 622	597	889	521	432-457	419-546	508	419					
See series notes for mechanism options.	<b>RTA 2</b>	1 per carton											
 <p><b>Medium Back Posture Task Stool</b> COM: 1.5 YD   1.37 M Unit weight: 53 LB   24.1 KG Carton weight: 63 LB   28.58 KG Carton volume: 10.5 FT³   0.29 MT³</p>	<b>GC13015</b> With arms	923	971	1011	1058	1134	1205	1276	1337	1414	1486	1583	1721
	<b>GC13015NA</b> Armless	819	867	907	954	1030	1101	1172	1233	1310	1382	1479	1617
	<b>OVERALL DIMENSIONS</b>	<b>W</b>	<b>D</b>	<b>H</b>	<b>SEAT DIMENSIONS</b>	<b>W</b>	<b>D</b>	<b>H</b>	<b>BACK DIMENSIONS</b>	<b>W</b>	<b>H</b>		
	Active weight 300 lbs.	IN 24.5	23.5	51	20.5	17	24-34	20	20				
	MM 622	597	1295	521	432	610-864	508	508					
See series notes for mechanism options.	<b>RTA 2</b>	1 per carton											
 <p><b>High Back with Adjustable Headrest</b> COM: 2.1 YD   1.92 M Unit weight: 49 LB   22.3 KG Carton weight: 61 LB   27.67 KG Carton volume: 10.5 FT³   0.29 MT³</p>	<b>GC13021</b> With arms	986	1053	1110	1175	1282	1381	1480	1565	1673	1774	1910	2103
	<b>GC13021NA</b> Armless	882	949	1006	1071	1178	1277	1376	1461	1569	1670	1806	1999
	<b>OVERALL DIMENSIONS</b>	<b>W</b>	<b>D</b>	<b>H</b>	<b>SEAT DIMENSIONS</b>	<b>W</b>	<b>D</b>	<b>H</b>	<b>BACK DIMENSIONS</b>	<b>W</b>	<b>H</b>		
	Active weight 300 lbs.	IN 24.5	23.5	50	20.5	17-18	16.5-21.5	20	31.5				
	MM 622	597	1270	521	432-457	419-546	508	800					
See series notes for mechanism options.	<b>RTA 2</b>	1 per carton											
 <p><b>Medium Back with Adjustable Headrest</b> COM: 1.85 YD   1.69 M Unit weight: 47 LB   21.4 KG Carton weight: 59 LB   26.76 KG Carton volume: 10.5 FT³   0.29 MT³</p>	<b>GC13022</b> With arms	956	1015	1065	1123	1216	1304	1391	1466	1561	1650	1770	1940
	<b>GC13022NA</b> Armless	850	909	959	1017	1110	1198	1285	1360	1455	1544	1664	1834
	<b>OVERALL DIMENSIONS</b>	<b>W</b>	<b>D</b>	<b>H</b>	<b>SEAT DIMENSIONS</b>	<b>W</b>	<b>D</b>	<b>H</b>	<b>BACK DIMENSIONS</b>	<b>W</b>	<b>H</b>		
	Active weight 300 lbs.	IN 24.5	23.5	46	20.5	17	16.5-21.5	20	27.5				
	MM 622	597	1168	521	432	419-546	508	699					
See series notes for mechanism options.	<b>RTA 2</b>	1 per carton											

GALA II TS



model GCTS13011



model GCTS13015

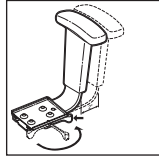

Vari-Width (WA) width adjustable arm extensions are standard when chair is ordered with adjustable arms.



model GCTS13021

MECHANISMS:

Synchro-tilter mechanism (-0)

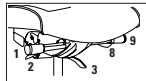

- ADJUSTMENTS**
- (1) Tilt tension
  - (2) Pneumatic seat height
  - (3) Back angle
  - Back/lumbar height
  - (8) Sliding seat depth
  - (9) Multi position tilt lock
  - Synchro tilt action
  - Anti kick back

**Ergonomic features:**  
A, B, C, D, E, G, H, L, M, N, Q, R, U

Task mechanism (-6)

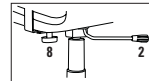

- ADJUSTMENTS**
- (2) Pneumatic seat height
  - (8) Manual seat depth

**Ergonomic features:**  
C, E, H, M, N, Q, R, U

STANDARD FEATURES

- Gala II TS is designed for 24/7 applications to provide exceptional support and comfort throughout the work day.
- Available in three back heights and three seat sizes to fit a person's body type and movements while at work.
- Models with adjustable headrest available.
- Heavy duty synchro-tilter mechanism with side activated sliding seat depth adjustment (MD) and separate back angle adjustment for individual comfort are standard. Stool models are available with task mechanism only.
- Vertical back height ratchet adjustment of 5.25" is standard on all models (except on task mechanism).
- Back support upright is 3" wide for extra strength.
- One-piece curved back features a pull over style upholstery cover for easy housekeeping and infection prevention practices.
- Standard with Global's high quality Soft Descent™ pneumatic lift which slowly and gently lowers the seat height of the chair making it easy to obtain the exact seat height you desire.
- Models with arms are standard with height adjustable arms (3B) with self-skinned urethane (SSU) armcaps.
- Vari-Width (WA) width adjustable arm extensions are standard. Allows the arms to move away from the seat by 2" on each side to allow space if desired for broader hip widths.
- Waterfall seamless seat front design with high density Ultracell foam for superior comfort and longevity.
- Underside of seat pan is completely sealed.
- 5-prong, injection molded, fiberglass reinforced nylon Black base with dual wheel carpet casters (C10).
- For healthcare textiles and finish options, visit the website at [globalfurnituregroup.com](http://globalfurnituregroup.com).
- Can be upholstered in standard Global textiles only if Healthcare compliance is not required.
- To meet higher standards for housekeeping and infection control, Gala II has a seamless seat and one stitch pull over back upholstery, while still offering soft curves to the design. Note: Vinyl and woven treated textiles are thicker in nature and will experience wrinkles on some curves or corners as a result.

OPTIONAL FEATURES

- For moisture barrier on seat, please specify (MB). Add \$81.
- Back sealed seam available, please specify (S2). Upcharges vary.
- Optional Schukra™ depth adjustable lumbar support for personalized back support and comfort, please specify (SK). Add \$119.
- For additional arms/caster options, please refer to the Arm and Caster section (260). Optional casters may be priced higher than the standard casters for your chair and the difference will be charged. Lower priced optional casters will not be credited.

Please add option codes in the following order:

- **Model number**  
GCTS13011 High back with arms  
GCTS13011NA High back, armless  
GCTS13012 Medium back with arms  
GCTS13012NA Medium back, armless  
GCTS13013 Low back with arms  
GCTS13013NA Low back, armless  
GCTS13015 Medium back stool with arms  
GCTS13015NA Medium back stool, armless  
GCTS13021 High Back w/Adj. Headrest with arms  
GCTS13021NA High Back w/Adj. Headrest, armless  
GCTS13022 Medium Back w/Adj. Headrest with arms  
GCTS13022NA Medium Back w/Adj. Headrest, armless
- **Textile**  
Specify textile code.
- **Mechanism**  
(0) Synchro-tilter mechanism. No upcharge.  
(6) Task mechanism (models GCTS13015 and GCTS13015NA only). No upcharge.
- **Seat size**  
(P) Petite  
(S) Standard  
(G) Generous
- **Arms**  
(3B) Height adjustable arms. No upcharge.  
For additional arm options, please refer to Arm Selections section on page 262.
- **Base**  
(BK) Black nylon spider base.  
(AL) Polished aluminum base. Add \$131.
- **Casters**  
(C10) Dual wheel carpet casters.  
(C10R) Dual wheel hard floor casters. Add \$20.

EXAMPLE GALA II TS ORDER CODE:

GCTS13011	-WA53	-0	-S	-3B	-B7	-C10R
Model number	Textile	Mechanism	Seat size	Arms	Base	Casters

DESCRIPTION



**High Back Heavy Duty**  
COM: 1.85 YD | 1.69 M  
Unit weight: 59 LB | 26.8 KG  
Carton weight: 69 LB | 31.3 KG  
Carton volume: 10.5 FT³ | 0.29 MT³

MODEL# / FEATURES

GCTS13011  
With arms  
GCTS13011NA  
Armless





Active weight 350 lbs.  
  
See series notes for mechanism options.

STANDARD TEXTILE GRADES

COM	2	3	4	5	6	7	8	9	10	11	12
1074	1133	1183	1241	1334	1422	1509	1584	1679	1768	1888	2058
970	1029	1079	1137	1230	1318	1405	1480	1575	1664	1784	1954

OVERALL DIMENSIONS			SEAT DIMENSIONS			BACK DIMENSIONS	
W	D	H	W	D	H	W	H
IN 24.5	23.5	43.5	20.5	17-18	17-21	20	24.5
MM 622	597	1105	521	432-457	432-533	508	622

RTA 2 1 per carton

DESCRIPTION	MODEL# / FEATURES	STANDARD TEXTILE GRADES											
		COM	2	3	4	5	6	7	8	9	10	11	12
 <p><b>Medium Back Heavy Duty</b> COM: 1.6 YD   1.46 M Unit weight: 58 LB   26.4 KG Carton weight: 68 LB   30.84 KG Carton volume: 10.5 FT³   0.29 MT³</p>	<b>GCTS13012</b> With arms	1043	1094	1137	1187	1268	1344	1419	1484	1566	1643	1747	1894
	<b>GCTS13012NA</b> Armless	940	991	1034	1084	1165	1241	1316	1381	1463	1540	1644	1791
	<b>OVERALL DIMENSIONS</b>	<b>W</b>	<b>D</b>	<b>H</b>	<b>SEAT DIMENSIONS</b>			<b>BACK DIMENSIONS</b>					
		IN 24.5 MM 622	23.5 597	39.5 1003	20.5 521	17-18 432-457	17-21 432-533	20 508	20.5 521				
Active weight 350 lbs.  See series notes for mechanism options.	<b>RTA 2</b>	1 per carton											
 <p><b>Low Back Heavy Duty</b> COM: 1.5 YD   1.37 M Unit weight: 56 LB   25.5 KG Carton weight: 66 LB   29.94 KG Carton volume: 10.5 FT³   0.29 MT³</p>	<b>GCTS13013</b> With arms	1029	1077	1117	1164	1240	1311	1382	1443	1520	1592	1689	1827
	<b>GCTS13013NA</b> Armless	925	973	1013	1060	1136	1207	1278	1339	1416	1488	1585	1723
	<b>OVERALL DIMENSIONS</b>	<b>W</b>	<b>D</b>	<b>H</b>	<b>SEAT DIMENSIONS</b>			<b>BACK DIMENSIONS</b>					
		IN 24.5 MM 622	23.5 597	35.5 902	20.5 521	17-18 432-457	17-21 432-533	20 508	16.5 419				
Active weight 350 lbs.  See series notes for mechanism options.	<b>RTA 2</b>	1 per carton											
 <p><b>Medium Back Heavy Duty Task Stool</b> COM: 1.5 YD   1.37 M Unit weight: 47 LB   21.4 KG Carton weight: 57 LB   25.85 KG Carton volume: 10.5 FT³   0.29 MT³</p>	<b>GCTS13015</b> With arms	1252	1300	1340	1387	1463	1534	1605	1666	1743	1815	1912	2050
	<b>GCTS13015NA</b> Armless	1148	1196	1236	1283	1359	1430	1501	1562	1639	1711	1808	1946
	<b>OVERALL DIMENSIONS</b>	<b>W</b>	<b>D</b>	<b>H</b>	<b>SEAT DIMENSIONS</b>			<b>BACK DIMENSIONS</b>					
		IN 24.5 MM 622	23.5 597	48.5 1232	20.5 521	17 432	23.5-33.5 597-851	20 508	20.5 521				
Active weight 350 lbs.  See series notes for mechanism options.	<b>RTA 2</b>	1 per carton											
 <p><b>High Back Heavy Duty with Adjustable Headrest</b> COM: 2.1 YD   1.92 M Unit weight: 63 LB   28.6 KG Carton weight: 75 LB   34.02 KG Carton volume: 10.5 FT³   0.29 MT³</p>	<b>GCTS13021</b> With arms	1316	1383	1440	1505	1612	1711	1810	1895	2003	2104	2240	2433
	<b>GCTS13021NA</b> Armless	1212	1279	1336	1401	1508	1607	1706	1791	1899	2000	2136	2329
	<b>OVERALL DIMENSIONS</b>	<b>W</b>	<b>D</b>	<b>H</b>	<b>SEAT DIMENSIONS</b>			<b>BACK DIMENSIONS</b>					
		IN 24.5 MM 622	23.5 597	50.5 1283	20.5 521	17-18 432-457	17-21 432-533	20 508	31.5 800				
Active weight 350 lbs.  See series notes for mechanism options.	<b>RTA 2</b>	1 per carton											
 <p><b>Medium Back Heavy Duty with Adjustable Headrest</b> COM: 1.85 YD   1.69 M Unit weight: 62 LB   28.2 KG Carton weight: 74 LB   33.57 KG Carton volume: 10.5 FT³   0.29 MT³</p>	<b>GCTS13022</b> With arms	1285	1344	1394	1452	1545	1633	1720	1795	1890	1979	2099	2269
	<b>GCTS13022NA</b> Armless	1182	1241	1291	1349	1442	1530	1617	1692	1787	1876	1996	2166
	<b>OVERALL DIMENSIONS</b>	<b>W</b>	<b>D</b>	<b>H</b>	<b>SEAT DIMENSIONS</b>			<b>BACK DIMENSIONS</b>					
		IN 24.5 MM 622	23.5 597	46.5 1181	20.5 521	17 432	17-21 432-533	20 508	27.5 699				
Active weight 350 lbs.  See series notes for mechanism options.	<b>RTA 2</b>	1 per carton											

GC TRITEK



model GC7472NA

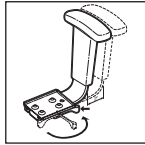

**Vari-Width (WA)** width adjustable arm extensions are standard when chair is ordered with adjustable arms.

MECHANISM OPTIONS:

Task mechanism (-6)

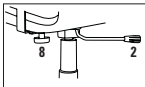

**ADJUSTMENTS**  
(2) Pneumatic seat height  
(8) Manual seat depth

**Ergonomic features:**  
C, E, H, M, N, Q, R, U

Synchro-tilter mechanism (-0)

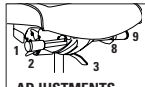

**ADJUSTMENTS**  
(1) Tilt tension  
(2) Pneumatic seat height  
(3) Back angle  
Back/lumbar height  
(8) Sliding seat depth  
(9) Multi position tilt lock  
Synchro tilt action  
Anti kick back

**Ergonomic features:**  
A, B, C, D, E, G, H, L, M, N, Q, R, U

Multi-tilter mechanism (-3)



**ADJUSTMENTS**  
(1) Tilt tension  
(2) Pneumatic seat height  
(3) Back angle  
(4) Seat angle  
(6) Back/lumbar height  
(8) Sliding seat depth  
(9) Infinite position tilt lock  
Center tilt action

**Ergonomic features:**  
A, B, C, D, E, F, G, H, M, N, Q, R, S, U

Posture task mechanism (-7)

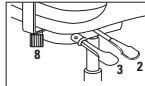

**ADJUSTMENTS**  
(2) Pneumatic seat height  
(3) Back angle  
Back/lumbar height  
(8) Manual seat depth  
20" diameter Chrome footrest

**Ergonomic features:**  
C, D, G, H, M, N, Q, R, U, V

STANDARD FEATURES

- GC Tritek is designed to meet every body shape and task, providing exceptional support and comfort throughout the work day.
- Available in three back heights and three seat sizes to fit a person's body type and movements while at work.
- Choice of four mechanisms: Task, synchro-tilter, multi-tilter and posture task. Stool models are available with posture task mechanism only.
- Side activated sliding seat depth adjustment (**MD**) and separate back angle adjustment is standard on synchro-tilter and multi-tilter.
- Durable Black polypropylene back shroud with unique upper back shape enables free lateral movement.
- Schukra™ depth adjustable lumbar support for personalized back support and comfort is standard on all models.
- Dual density foam spine pad embedded in the back of the chair forms to the user's shape.
- Vertical back height ratchet adjustment of 5.25".
- Back support upright is 3" wide for extra strength and durability.
- Standard with Global's high quality Soft Descent™ pneumatic lift which slowly and gently lowers the seat height of the chair making it easy to obtain the exact seat height you desire. 4" cylinder is standard on synchro-tilter models. 5" cylinder is standard on multi-tilter, task and posture task models.
- Models with arms are standard with height and width adjustable arms (**G6**) with sliding armcaps. Armcaps also articulate inwards and outwards to aim toward the keyboard or mouse area.
- Vari-Width (**WA**) width adjustable arm extensions are standard. Allows the arms to move away from the seat by 2" on each side to allow space if desired for broader hip widths.
- Waterfall seamless seat front design with high density Ultracell foam for superior comfort and longevity.
- Underside of seat pan is completely sealed.
- 5-prong, injection molded, fiberglass reinforced nylon Black base with dual wheel carpet casters (**C65**).
- Can be upholstered in standard Global textiles only if Healthcare compliance is not required.
- To meet higher standards for housekeeping and infection control, GC Tritek has a seamless seat and one stitch pullover back upholstery, while still offering soft curves to the design. Note: Vinyl and woven treated textiles are thicker in nature and will experience wrinkles on some curves or corners as a result.

OPTIONAL FEATURES

- For moisture barrier on seat, please specify (**MB**). Add \$81.
- To add sealed seams to your product, contact Customer Service. Upcharges vary.
- For additional arms/caster options, please refer to the Arm and Caster section (260). Optional casters may be priced higher than the standard casters for your chair and the difference will be charged. Lower priced optional casters will not be credited.

Please add option codes in the following order:



- Model number**  
**GC7471** Medium back with arms  
**GC7471NA** Medium back, armless  
**GC7472** High back with arms  
**GC7472NA** High back, armless  
**GC7473** Extended high back with arms  
**GC7476** Medium back stool with arms  
**GC7476NA** Medium back stool, armless
- Textile**  
Specify textile code.
- Mechanism**  
(6) Task mechanism. No upcharge.  
(0) Synchro-tilter mechanism. Add \$168.  
(3) Multi-tilter mechanism. Add \$168.  
(7) Posture task mechanism. Add \$99 (no upcharge on stool models).
- Seat size**  
(P) Petite  
(S) Standard  
(G) Generous
- Arms**  
(G6) Height and width adjustable arms. No upcharge. For additional arm options, please refer to Arm Selections section on page 262.
- Base**  
(BK) Black nylon B7B base.  
(B7) Polished aluminum base. Add \$131.
- Casters/Glides**  
(C65) Dual wheel carpet casters.  
(C65R) Dual wheel hard floor casters. Add \$21.  
(C7) Set of 5 large Black slipper glides (for all surfaces). Can replace any Global casters. Glide is the same height as casters. No upcharge.

EXAMPLE GC TRITEK ORDER CODE:

GC7471	-WA53	-0	-S	-G6	-B7	-C65R
--------	-------	----	----	-----	-----	-------

Model number    Textile    Mechanism    Seat size    Arms    Base    Casters/Glides

DESCRIPTION	MODEL# / FEATURES	STANDARD TEXTILE GRADES											
		COM	2	3	4	5	6	7	8	9	10	11	12
 <b>GC7471</b> With arms  <b>GC7471NA</b> Armless		1108	1164	1211	1266	1355	1437	1519	1591	1680	1764	1878	2039
		1002	1058	1105	1160	1249	1331	1413	1485	1574	1658	1772	1933
		<b>OVERALL DIMENSIONS</b>			<b>SEAT DIMENSIONS</b>			<b>BACK DIMENSIONS</b>					
		<b>W</b>	<b>D</b>	<b>H</b>	<b>W</b>	<b>D</b>	<b>H</b>	<b>W</b>	<b>H</b>				
		IN 25.5	23	39	20.5	17-18	16.5-21.5	18.5	19				
		MM 648	584	991	521	432-457	419-546	470	483				
<b>Medium Back</b> COM: 1.75 YD   1.6 M Unit weight: 40 LB   18.2 KG Carton weight: 47 LB   21.32 KG Carton volume: 13 FT <sup>3</sup>   0.36 MT <sup>3</sup>	Active weight 300 lbs.  See series notes for mechanism options.	<b>RTA 2</b>		1 per carton									

DESCRIPTION	MODEL# / FEATURES	STANDARD TEXTILE GRADES											
		COM	2	3	4	5	6	7	8	9	10	11	12
 <p><b>High Back</b> COM: 1.9 YD   1.74 M Unit weight: 41 LB   18.6 KG Carton weight: 48 LB   21.77 KG Carton volume: 13 FT³   0.36 MT³</p>	<b>GC7472</b> With arms	1141	1202	1253	1312	1409	1498	1588	1666	1763	1854	1977	2152
	<b>GC7472NA</b> Armless	1038	1099	1150	1209	1306	1395	1485	1563	1660	1751	1874	2049
		<b>OVERALL DIMENSIONS</b>			<b>SEAT DIMENSIONS</b>			<b>BACK DIMENSIONS</b>					
		<b>W</b>	<b>D</b>	<b>H</b>	<b>W</b>	<b>D</b>	<b>H</b>	<b>W</b>	<b>H</b>				
		IN 25.5 MM 648	23 584	42 1067	20.5 521	17-18 432-457	16.5-21.5 419-546	18.5 470	22 559				
	Active weight 300 lbs.	See series notes for mechanism options.		<b>RTA 2</b>	1 per carton								
 <p><b>Extended High Back</b> COM: 2 YD   1.83 M Unit weight: 43 LB   19.5 KG Carton weight: 50 LB   22.68 KG Carton volume: 13 FT³   0.36 MT³</p>	<b>GC7473</b> With arms	1175	1239	1293	1355	1457	1551	1645	1727	1829	1925	2055	2239
	<b>GC7473NA</b> Armless	1070	1134	1188	1250	1352	1446	1540	1622	1724	1820	1950	2134
		<b>OVERALL DIMENSIONS</b>			<b>SEAT DIMENSIONS</b>			<b>BACK DIMENSIONS</b>					
		<b>W</b>	<b>D</b>	<b>H</b>	<b>W</b>	<b>D</b>	<b>H</b>	<b>W</b>	<b>H</b>				
		IN 25.5 MM 648	23 584	47 1194	20.5 521	17-18 432-457	16.5-21.5 419-546	18.5 470	27 686				
	Active weight 300 lbs.	See series notes for mechanism options.		<b>RTA 2</b>	1 per carton								
 <p><b>Medium Back Posture Task Stool</b> COM: 1.75 YD   1.6 M Unit weight: 50 LB   22.7 KG Carton weight: 57 LB   25.85 KG Carton volume: 13 FT³   0.36 MT³</p>	<b>GC7476</b> With arms	1313	1369	1416	1471	1560	1642	1724	1796	1885	1969	2083	2244
	<b>GC7476NA</b> Armless	1210	1266	1313	1368	1457	1539	1621	1693	1782	1866	1980	2141
		<b>OVERALL DIMENSIONS</b>			<b>SEAT DIMENSIONS</b>			<b>BACK DIMENSIONS</b>					
		<b>W</b>	<b>D</b>	<b>H</b>	<b>W</b>	<b>D</b>	<b>H</b>	<b>W</b>	<b>H</b>				
		IN 25.5 MM 648	23 584	49 1245	20.5 521	17 432	23.5-33.5 597-851	18.5 470	17.5 445				
	Active weight 300 lbs.	See series notes for mechanism options.		<b>RTA 2</b>	1 per carton								

GC TRITEK TS



model GCTS7473

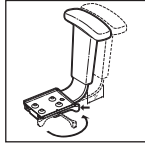

**Vari-Width (WA)** width adjustable arm extensions are standard when chair is ordered with adjustable arms.

**MECHANISMS:**

**Synchro-tilter mechanism (-0)**

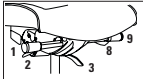

**ADJUSTMENTS**  
 (1) Tilt tension  
 (2) Pneumatic seat height  
 (3) Back angle  
 Back/lumbar height  
 (8) Sliding seat depth  
 (9) Multi position tilt lock  
 Synchro tilt action  
 Anti kick back

**Ergonomic features:**  
 A, B, C, D, E, G, H, L, M, N, Q, R, U

**Task mechanism (-6)**

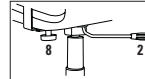

**ADJUSTMENTS**  
 (2) Pneumatic seat height  
 (8) Manual seat depth

**Ergonomic features:**  
 C, E, H, M, N, Q, R, U

**STANDARD FEATURES**

- GC Tritek TS is designed for 24/7 applications to meet every body shape and task, providing exceptional support and comfort throughout the work day.
- Available in three back heights and three seat sizes to fit a person's body type and movements while at work.
- Heavy duty synchro-tilter mechanism with side activated sliding seat depth adjustment (**MD**) and separate back angle adjustment for individual comfort are standard. Stool models are available with task mechanism only.
- Durable Black polypropylene back shroud with unique upper back shape enables free lateral movement.
- Schukra™ depth adjustable lumbar support for personalized back support and comfort is standard on all models.
- Dual density foam spine pad embedded in the back of the chair forms to the user's shape.
- Vertical back height ratchet adjustment of 5.25".
- Back support upright is 3" wide for extra strength and durability.
- Standard with heavy duty 4" pneumatic gas lift.
- Models with arms are standard with height and width adjustable arms (**G6**) with sliding armcaps. Armcaps are low rise and also articulate inwards and outwards to aim toward the keyboard or mouse area.
- Vari-Width (**WA**) width adjustable arm extensions are standard. Allows the arms to move away from the seat by 2" on each side to allow space if desired for broader hip widths.
- Waterfall seamless seat front design with high density Ultracell foam for superior comfort and longevity.
- Underside of seat pan is completely sealed.
- 5-prong, injection molded, fiberglass reinforced nylon Black base with dual wheel carpet casters (**C10**).
- Can be upholstered in standard Global textiles only if Healthcare compliance is not required.
- To meet higher standards for housekeeping and infection control, GC Tritek TS has a seamless seat and one stitch pullover back upholstery, while still offering soft curves to the design. Note: that vinyl and woven treated textiles are thicker in nature and will experience wrinkles on some curves or corners as a result.

**OPTIONAL FEATURES**

- For moisture barrier on seat, please specify (**MB**). Add \$81.
- To add sealed seams to your product, contact Customer Service. Upcharges vary.
- For additional caster options, please refer to the Arm and Caster section (260). Optional casters may be priced higher than the standard casters for your chair and the difference will be charged. Lower priced optional casters will not be credited.



Please add option codes in the following order:

- **Model number**  
**GCTS7471** Medium back with arms  
**GCTS7471NA** Medium back, armless  
**GCTS7472** High back with arms  
**GCTS7472NA** High back, armless  
**GCTS7473** Extended high back with arms  
**GCTS7477** Medium back stool with arms  
**GCTS7477NA** Medium back stool, armless
- **Textile**  
 Specify textile code.
- **Mechanism**  
**(0)** Synchro-tilter mechanism. No upcharge.  
**(6)** Task mechanism (models GCTS7477 and GCTS7477NA only). No upcharge.
- **Seat size**  
**(P)** Petite  
**(S)** Standard  
**(G)** Generous
- **Arms**  
**(G6)** Height and width adjustable arms. No upcharge. For additional arm options, please refer to Arm Selections section on page 262.
- **Base**  
**(BK)** Black nylon B7B base.  
**(B7)** Polished aluminum base. Add \$131.
- **Casters/Glides**  
**(C10)** Dual wheel carpet casters.  
**(C10R)** Dual wheel hard floor casters. Add \$20.  
**(C7)** Set of 5 large Black slipper glides (for all surfaces). Can replace any Global casters. Allows chair to remain at chair height. No upcharge.

**EXAMPLE GC TRITEK TS ORDER CODE:**

GCTS7471	-WA53	-0	-S	-G6	-B7	-C10R
Model number	Textile	Mechanism	Seat size	Arms	Base	Casters/Glides

DESCRIPTION	MODEL# / FEATURES	STANDARD TEXTILE GRADES											
		COM	2	3	4	5	6	7	8	9	10	11	12
 <b>Medium Back Heavy Duty</b> COM: 1.75 YD   1.6 M Unit weight: 54 LB   24.5 KG Carton weight: 61 LB   27.67 KG Carton volume: 13 FT³   0.36 MT³	<b>GCTS7471</b> With arms	1437	1493	1540	1595	1684	1766	1848	1920	2009	2093	2207	2368
	<b>GCTS7471NA</b> Armless	1334	1390	1437	1492	1581	1663	1745	1817	1906	1990	2104	2265
		OVERALL DIMENSIONS			SEAT DIMENSIONS			BACK DIMENSIONS					
		W	D	H	W	D	H	W	H				
	Active weight 350 lbs.	IN 25.5	24.5	38	20.5	17-20	17-21	18.5	18				
	See series notes for mechanism options.	MM 648	622	965	521	432-508	432-533	470	457				
		<b>RTA 2</b>		1 per carton									

DESCRIPTION	MODEL# / FEATURES	STANDARD TEXTILE GRADES											
		COM	2	3	4	5	6	7	8	9	10	11	12
 <p><b>High Back Heavy Duty</b> COM: 1.9 YD   1.74 M Unit weight: 58 LB   26.4 KG Carton weight: 65 LB   29.48 KG Carton volume: 13 FT<sup>3</sup>   0.36 MT<sup>3</sup></p>	<p><b>GCTS7472</b> With arms</p> <p><b>GCTS7472NA</b> Armless</p>	1471	1532	1583	1642	1739	1828	1918	1996	2093	2184	2307	2482
	<p>Active weight 350 lbs.</p> <p>See series notes for mechanism options.</p>	IN 25.5 MM 648	24.5 622	41 1041	20.5 521	17-20 432-508	17-21 432-533	18.5 470	21 533				
		<b>RTA 2</b>	1 per carton										
 <p><b>Extended High Back Heavy Duty</b> COM: 2 YD   1.83 M Unit weight: 60 LB   27.3 KG Carton weight: 67 LB   30.39 KG Carton volume: 13 FT<sup>3</sup>   0.36 MT<sup>3</sup></p>	<p><b>GCTS7473</b> With arms</p>	1504	1568	1622	1684	1786	1880	1974	2056	2158	2254	2384	2568
	<p>Active weight 350 lbs.</p> <p>See series notes for mechanism options.</p>	IN 25.5 MM 648	24.5 622	46 1168	20.5 521	17-20 432-508	17-21 432-533	18.5 470	26 660				
		<b>RTA 2</b>	1 per carton										
 <p><b>Medium Back Heavy Duty Task Stool</b> COM: 1.75 YD   1.6 M Unit weight: 45 LB   20.5 KG Carton weight: 52 LB   23.59 KG Carton volume: 13 FT<sup>3</sup>   0.36 MT<sup>3</sup></p>	<p><b>GCTS7477</b> With arms</p> <p><b>GCTS7477NA</b> Armless</p>	1375	1431	1478	1533	1622	1704	1786	1858	1947	2031	2145	2306
	<p>Active weight 350 lbs.</p> <p>See series notes for mechanism options.</p>	IN 25.5 MM 648	23 584	49 1245	20.5 521	17-18 432-457	23.5-33.5 597-851	18.5 470	19 483				
		<b>RTA 2</b>	1 per carton										



GC VION



model GC6322-0 (BAU-AS)



Optional Lumbar Pad (LS)  
See right for details.

MECHANISMS:

Synchro-tilter mechanism (-0)

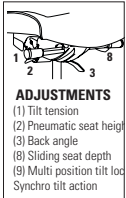

Ergonomic features:

A, B, C, E, G, H, L, M, N, Q, U

STANDARD FEATURES

- GC Vion is part of the comprehensive Vion series, offering a variety of models to address multiple applications in healthcare environments.
- Series offers mid and high back models with either a mesh or upholstered back.
- Mechanism available: synchro tilter (-0).
- All models are standard with height and width adjustable arms that feature a front to back sliding armcap.
- Standard with Global's high quality Soft Descent™ pneumatic lift which slowly and gently lowers the seat height of the chair making it easy to obtain the exact seat height you desire.
- Side activated sliding seat depth adjustment (MD) is standard on synchro-tilter with back angle adjustment.
- Standard with 5-prong, injection molded, fiberglass reinforced nylon Governor base (B7) with dual wheel carpet casters (C1).
- Mesh back models are available in 10 standard Vion colors: Aqua (MS75), Black (MS69), Black Cherry (MS76), Blue (MS72), Dust (MS77), Ivory (MS78), Natural (MS74), Paprika (MS79), Rope (MS73) and Stone (MS71).
- Underside of the seat is upholstered in a coated textile. The joining of the textiles on the underside of the seat pan is sealed on all models.
- Upholstered back models feature Black textile (Jenny JN02) on the back side as standard.
- Upholstery options: fabric, vinyl or leather.

OPTIONAL FEATURES

- Vion back frames, arms and bases are available in 3 colours: Black, Shadow and Fog. See Vion finishes chart for options and upcharges. Armcaps are always black.
- Mesh back models are also available in 10 Dimension Mesh colours: Black (DBK), Berry (DBE), Chalk (DCL), Charcoal (DCH), Citrus (DCT), Cobalt (DCO), Fog (DST), Pool Blue (DPB), Sand (DSD) and Shadow (DGM). Add \$25.
- Optional lumbar pad (LS) can be added at time of order, please specify. Add \$17. Lumbar pad can also be ordered after sale as a kit, specify model 6339 at \$32 list price. The Lumbar pad is adjustable up to 3".
- Seat available in memory foam, please specify (MF). Add \$106.
- Petite seat models (2" shorter and 2" narrower than the standard size seat) are available. Please specify by adding (P) to the model code. No upcharge.
- For hard surface flooring casters, please specify (C9R). Add \$21.
- For additional arm/caster options, please refer to the Arm and Caster section (260). Optional casters may be priced higher than the standard casters for your chair and the difference will be charged. Lower priced optional casters will not be credited.

EXAMPLE GC VION ORDER CODE:

GC6322	-BAU	-A5	-ST	-ST	-HX01
Model number	Finish	Mesh	Seat size	Seat Foam	Seat Upholstery
-AF	-EE	-NB	-NS	-5L	
Arms	Casters	Moisture Barrier	Sealed Seams	Pneumatic Lift	

VION FINISHES - TASK SEATING				
Back Frame	Base	SPECIFY CODE	Arm Options	SPECIFY CODE
Black	Black	BLK	Adjustable "T" arm (Black) Adjustable "T" arm, fixed armcap (Black)	AS AF
Black	Polished Aluminum	BAU Add \$131	Adjustable "T" arm (Black, Chrome accent) Adj. "T" arm, fixed armcap (Black, Chrome accent)	AC AD
Shadow	Shadow	SHW Add \$131	Adjustable "T" arm (Shadow) Adjustable "T" arm, fixed armcap (Shadow)	SHA SHF
Shadow	Polished Aluminum	SAU Add \$131	Adjustable "T" arm (Shadow, Chrome accent) Adj. "T" arm, fixed armcap (Shadow, Chrome accent)	SHR SHD
Fog	Fog	FOG Add \$131	Adjustable "T" arm (Fog) Adjustable "T" arm, fixed armcap (Fog)	FA FF
Fog	Polished Aluminum	FAU Add \$131	Adjustable "T" arm (Fog, Chrome accent) Adj. "T" arm, fixed armcap (Fog, Chrome accent) Fixed "C" arm (Black) Fixed "C" arm (shadow) Fixed "C" arm (Fog) Fixed "C" arm (Polished aluminum)	FC CF C SHC CC CA - Add \$111

\* All arms have Black SSU armcaps.

DESCRIPTION	MODEL# / FEATURES	STANDARD TEXTILE GRADES											
		COM	2	3	4	5	6	7	8	9	10	11	12
 mesh back	GC6322-0	1048	1080	1107	1138	1189	1236	1283	1324	1375	1423	1488	1580
		OVERALL DIMENSIONS			SEAT DIMENSIONS			BACK DIMENSIONS					
		W	D	H	W	D	H	W	H				
MB Synchro-Tilter w/Back Angle Adj. COM: 1 YD   0.91 M Unit weight: 46 LB   20.9 KG Carton weight: 58 LB   26.31 KG Carton volume: 10.5 FT³   0.29 MT³	Active weight 300 lbs.	IN 25.5	24	39.5	20	17-20	17.5-22.5	18.5	21				
	See series notes for mechanism options.	MM 648	610	1003	508	432-508	445-572	470	533				
					RTA 2						1 per carton		



DESCRIPTION	MODEL# / FEATURES	STANDARD TEXTILE GRADES											
		COM	2	3	4	5	6	7	8	9	10	11	12
 <p>upholstered back, standard seat</p> <p><b>HB Synchro-Tilter w/Back Angle Adj.</b>                      COM: 1.25 YD   1.14 M                      Unit weight: 49 LB   22.3 KG                      Carton weight: 61 LB   27.67 KG                      Carton volume: 10.5 FT³   0.29 MT³</p>	<b>GC6331-0</b>	1097	1137	1171	1210	1273	1332	1391	1442	1506	1566	1647	1762
		<b>OVERALL DIMENSIONS</b>			<b>SEAT DIMENSIONS</b>			<b>BACK DIMENSIONS</b>					
			<b>W</b>	<b>D</b>	<b>H</b>	<b>W</b>	<b>D</b>	<b>H</b>	<b>W</b>	<b>H</b>			
	Active weight 300 lbs.	IN 25.5 MM 648	24 610	41.5 1054	20 508	17-20 432-508	17.5-22.5 445-572	18.5 470	23 584				
	See series notes for mechanism options.	<b>RTA 2</b>	1 per carton										

HARMONY



model GCTS35032-3

model GC35022-5

STANDARD FEATURES

- Harmony is the sized right solution for everyone with many applications.
- Compound curved back and seat comfortably match body shape.
- For added comfort, seats are standard with high density Ultracell foam.
- Standard with soft, durable, depth adjustable, sliding self-skinned urethane (SSU) armcaps that are warm to the touch. Armcaps articulate inwards and outwards 15°.
- Vari-Width (WA) width adjustable arm extensions are standard. Allows the arms to move away from the seat by 2" on each side to allow space if desired for broader hip widths.
- All models except bariatric multi-tilter: Height adjustable low rise (G6) arms are standard.
- Bariatric multi-tilters: Solid steel loop arm is standard. The arm is vinyl dipped to be warm to the touch and impact absorbent.
- Standard with Global's high quality Soft Descent™ pneumatic lift which slowly and gently lowers the seat height of the chair making it easy to obtain the exact seat height you desire (except HD 24HR multi-shift models and bariatric multi-tilters).
- Side activated sliding seat depth adjustment (MD) is standard on multi-tilters (non bariatric).
- Schukra™ depth adjustable lumbar support for personalized back support and comfort is standard on select models.
- Vertical back height ratchet adjustment of 5.25" is standard on all models (except bariatric multi-tilters, task chairs and operator stools).
- Back support upright is 3" wide for extra strength.
- All models except bariatric multi-tilter: 5-prong, injection molded, fiberglass reinforced nylon Black base with (C65) dual wheel carpet casters. Heavy duty 24HR multi-tilters: (C10) dual wheel carpet casters are standard.

- Bariatric multi-tilters: 6-prong Black steel base with (C98) large diameter 3" dual wheel carpet casters are standard.
- Can be upholstered in standard Global textiles only if Healthcare compliance is not required.
- For healthcare textiles and finish options, visit the website at globalfurnituregroup.com.
- Petite, standard and generous seats have the same list prices.

OPTIONAL FEATURES

- For improved housekeeping and infection control practices, please add (SU) to model number. The underside of the seat will be finished with vinyl and sealed to prevent penetration of liquids. Add \$39.
- Multi-tilters: For hard surface flooring casters, please specify (C65R). Add \$21.
- Heavy duty 24HR multi-tilters: For hard surface flooring casters, please specify (C10R). Add \$20.
- Bariatric multi-tilters: Standard arms and casters are made specifically for these models to provide maximum strength and durability. Therefore, no other casters or arms can be used.
- For moisture barrier on seat, please specify (MB). Add \$81. Bariatric models: Add \$122
- To add sealed seams to your product contact Customer Service. Upcharges vary.
- For additional arm/caster options, please refer the Arm and Caster section (page 260). Optional casters may be priced higher than the standard casters for your chair and the difference will be charged. Lower priced optional casters will not be credited.

SUGGESTED APPLICATIONS

- Office/Meeting
- Treatment/Exam rooms

Dimensional Information: Multi-tilters (including 24HR) (non bariatric)

	Armrest Clearance	Standard Arm Height	Seat Depth	Seat Height
<b>Petite seat</b> low rise 4" gas cylinder	17" - 23"	8" - 11"	17" - 19.5"	16" - 20"
<b>Standard seat</b> 4" Soft Descent™ gas cylinder	18" - 24"	8" - 11"	18" - 20.5"	18" - 22"
<b>Generous seat</b> 4" Soft Descent™ gas cylinder	18.5" - 24.5"	8" - 11"	19" - 21.5"	18" - 22"

DESCRIPTION MODEL# / FEATURES STANDARD TEXTILE GRADES





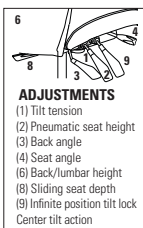







**Low Back Multi-Tilter**  
COM: 1.75 YD | 1.6 M  
Unit weight: 52 LB | 23.6 KG  
Carton weight: 61 LB | 27.67 KG  
Carton volume: 10.5 FT³ | 0.29 MT³



	COM	2	3	4	5	6	7	8	9	10	11	12
<b>GC35012-3</b> Standard seat	900	956	1003	1058	1147	1229	1311	1383	1472	1556	1670	1831
<b>GC35011-3</b> Petite seat												
IN W19.5 D17-20 H16-20   MM W495 D432-508 H406-508												

	OVERALL DIMENSIONS			SEAT DIMENSIONS			BACK DIMENSIONS	
	W	D	H	W	D	H	W	H
Active weight 300 lbs.	IN 26	24	37.5	20.5	18-21	17.5-22.5	18.5	16.5-21.75
	MM 660	610	953	521	457-533	445-572	470	419-552

Ergonomic features:  
A, B, C, D, E, F, G, H, M, N, Q, R, S, U **RTA 2** 1 per carton

DESCRIPTION	MODEL# / FEATURES	STANDARD TEXTILE GRADES											
		COM	2	3	4	5	6	7	8	9	10	11	12
 <p><b>Armchair Sled Base</b> COM: 1.75 YD   1.6 M Unit weight: 35 LB   15.9 KG Carton weight: 40 LB   18.14 KG Carton volume: 13 FT³   0.36 MT³</p>	<b>GC35019</b>	718	774	821	876	965	1047	1129	1201	1290	1374	1488	1649
		<b>OVERALL DIMENSIONS</b>			<b>SEAT DIMENSIONS</b>			<b>BACK DIMENSIONS</b>					
		<b>W</b>	<b>D</b>	<b>H</b>	<b>W</b>	<b>D</b>	<b>H</b>	<b>W</b>	<b>H</b>				
	Active weight 300 lbs.	IN 26 MM 660	24 610	41.25 1048	21 533	18 457	18 457	19.5 495	22.25 565				
Ergonomic features: M, N		<b>RTA 2</b>		1 per carton									
 <div data-bbox="414 473 560 695"> <p><b>ADJUSTMENTS</b> (1) Tilt tension (2) Pneumatic seat height (3) Back angle (4) Seat angle (5) Back/lumbar height (6) Sliding seat depth (9) Infinite position tilt lock</p> </div> <p>COM: 1.75 YD   1.6 M Unit weight: 53 LB   24.1 KG Carton weight: 62 LB   28.12 KG Carton volume: 10.5 FT³   0.29 MT³</p>	<b>GC35022-3</b> Standard seat <b>GC35023-3</b> Generous seat IN W21.5 D19-22 H17.5-22.5   MM W546 D483-559 H445-572	944	1000	1047	1102	1191	1273	1355	1427	1516	1600	1714	1875
		<b>OVERALL DIMENSIONS</b>			<b>SEAT DIMENSIONS</b>			<b>BACK DIMENSIONS</b>					
		<b>W</b>	<b>D</b>	<b>H</b>	<b>W</b>	<b>D</b>	<b>H</b>	<b>W</b>	<b>H</b>				
	Active weight 300 lbs.	IN 26 MM 660	24 610	42.5 1080	20.5 521	18-21 457-533	17.5-22.5 445-572	19 483	19.5-24.75 495-629				
Ergonomic features: A, B, C, D, E, F, G, H, M, N, Q, R, S, U		<b>RTA 2</b>		1 per carton									
 <div data-bbox="414 796 560 1018"> <p><b>ADJUSTMENTS</b> (1) Tilt tension (2) Pneumatic seat height (6) Back/lumbar height (8) Manual seat depth (9) Upright position tilt lock Center tilt action</p> </div> <p>COM: 1.75 YD   1.6 M Unit weight: 44 LB   20 KG Carton weight: 53 LB   24.04 KG Carton volume: 10.5 FT³   0.29 MT³</p>	<b>GC35022-4</b>	890	946	993	1048	1137	1219	1301	1373	1462	1546	1660	1821
		<b>OVERALL DIMENSIONS</b>			<b>SEAT DIMENSIONS</b>			<b>BACK DIMENSIONS</b>					
		<b>W</b>	<b>D</b>	<b>H</b>	<b>W</b>	<b>D</b>	<b>H</b>	<b>W</b>	<b>H</b>				
	Active weight 300 lbs.	IN 26 MM 660	24 610	42 1067	20.5 521	18-19 457-483	17-22 432-559	19 483	19.5-24.75 495-629				
Ergonomic features: A, B, C, D, E, H, M, N, Q, R, S, U		<b>RTA 2</b>		1 per carton									
 <div data-bbox="414 1098 560 1320"> <p><b>ADJUSTMENTS</b> (2) Pneumatic seat height (3) Back angle (4) Seat angle Back/lumbar height Free floating seat &amp; back</p> </div> <p>COM: 1.75 YD   1.6 M Unit weight: 46 LB   20.9 KG Carton weight: 55 LB   24.95 KG Carton volume: 10.5 FT³   0.29 MT³</p>	<b>GC35022-5</b>	904	960	1007	1062	1151	1233	1315	1387	1476	1560	1674	1835
		<b>OVERALL DIMENSIONS</b>			<b>SEAT DIMENSIONS</b>			<b>BACK DIMENSIONS</b>					
		<b>W</b>	<b>D</b>	<b>H</b>	<b>W</b>	<b>D</b>	<b>H</b>	<b>W</b>	<b>H</b>				
	Active weight 300 lbs.	IN 26 MM 660	24 610	40.5 1029	20.5 521	18 457	17-22 432-559	19 483	19.5-24.75 495-629				
Ergonomic features: C, D, F, G, H, M, N, Q, R, S, U		<b>RTA 2</b>		1 per carton									
 <div data-bbox="414 1421 560 1643"> <p><b>ADJUSTMENTS</b> (2) Pneumatic seat height</p> </div> <p>COM: 1.75 YD   1.6 M Unit weight: 38 LB   17.3 KG Carton weight: 47 LB   21.32 KG Carton volume: 10.5 FT³   0.29 MT³</p>	<b>GC35022-6</b>	683	739	786	841	930	1012	1094	1166	1255	1339	1453	1614
		<b>OVERALL DIMENSIONS</b>			<b>SEAT DIMENSIONS</b>			<b>BACK DIMENSIONS</b>					
		<b>W</b>	<b>D</b>	<b>H</b>	<b>W</b>	<b>D</b>	<b>H</b>	<b>W</b>	<b>H</b>				
	Active weight 300 lbs.	IN 26 MM 660	24 610	42.5 1080	20.5 521	17.5-18.5 445-470	17-22 432-559	19 483	20.5 521				
Ergonomic features: C, E, H, M, N, Q, R, U		<b>RTA 2</b>		1 per carton									

DESCRIPTION MODEL# / FEATURES STANDARD TEXTILE GRADES



**MB Bariatric Multi-Tilter**  
 COM: 3 YD | 2.74 M  
 Unit weight: 90 LB | 40.9 KG  
 Carton weight: 114 LB | 51.71 KG  
 Carton volume: 29.5 FT³ | 0.83 MT³

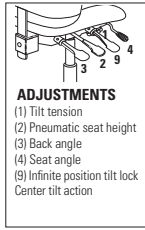

COM	2	3	4	5	6	7	8	9	10	11	12	
<b>GC35024-3</b>	2059	2155	2236	2329	2482	2623	2764	2887	3040	3184	3379	3655
<b>OVERALL DIMENSIONS</b>			<b>SEAT DIMENSIONS</b>			<b>BACK DIMENSIONS</b>						
W D H			W D H			W H						
Active weight 500 lbs.												
IN	29	26.5	42.5	25.5	20	16.5-20.5	22	24				
MM	737	673	1080	648	508	419-521	559	610				
Ergonomic features: A, B, C, F, G, M, N, Q, S			RTA 00			1 per carton						



**HB Multi-Tilter**  
 COM: 2 YD | 1.83 M  
 Unit weight: 55 LB | 25 KG  
 Carton weight: 64 LB | 29.03 KG  
 Carton volume: 10.5 FT³ | 0.29 MT³

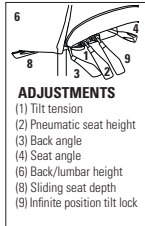

COM	2	3	4	5	6	7	8	9	10	11	12	
<b>GC35032-3</b> Standard seat	982	1046	1100	1162	1264	1358	1452	1534	1636	1732	1862	2046
<b>GC35033-3</b> Generous seat												
IN W21.5 D19-22 H17.5-22.5	MM W546 D483-559 H445-572											
<b>OVERALL DIMENSIONS</b>			<b>SEAT DIMENSIONS</b>			<b>BACK DIMENSIONS</b>						
W D H			W D H			W H						
Active weight 300 lbs.												
IN	26	24	45	20.5	18-21	17.5-22.5	19	22.5-27.75				
MM	660	610	1143	521	457-533	445-572	483	572-705				
Ergonomic features: A, B, C, D, E, F, G, H, M, N, Q, R, S, U			RTA 2			courier			1 per carton			



**HB Bariatric Multi-Tilter**  
 COM: 3.25 YD | 2.97 M  
 Unit weight: 92 LB | 41.8 KG  
 Carton weight: 118 LB | 53.52 KG  
 Carton volume: 33.5 FT³ | 0.94 MT³

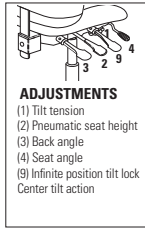

COM	2	3	4	5	6	7	8	9	10	11	12	
<b>GC35034-3</b>	2156	2260	2348	2449	2614	2767	2920	3053	3219	3375	3586	3885
<b>OVERALL DIMENSIONS</b>			<b>SEAT DIMENSIONS</b>			<b>BACK DIMENSIONS</b>						
W D H			W D H			W H						
Active weight 500 lbs.												
IN	29	27.5	50.5	25.5	20	16.5-20.5	22	30				
MM	737	699	1283	648	508	419-521	559	762				
Ergonomic features: A, B, C, F, G, M, N, Q, S			RTA 00			1 per carton						



**MB Operator Standard Seat Armless**  
 COM: 1.75 YD | 1.6 M  
 Unit weight: 40 LB | 18.2 KG  
 Carton weight: 49 LB | 22.23 KG  
 Carton volume: 10.5 FT³ | 0.29 MT³

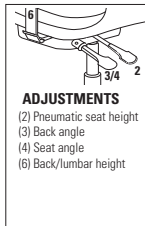







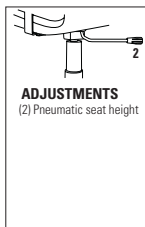

COM	2	3	4	5	6	7	8	9	10	11	12	
<b>GC35122-5</b>	787	843	890	945	1034	1116	1198	1270	1359	1443	1557	1718
<b>OVERALL DIMENSIONS</b>			<b>SEAT DIMENSIONS</b>			<b>BACK DIMENSIONS</b>						
W D H			W D H			W H						
Active weight 300 lbs.												
IN	20.5	24	40.5	20.5	18	17-22	19	19.5-24.75				
MM	521	610	1029	521	457	432-559	483	495-629				
Ergonomic features: C, D, F, G, M, N, S, U			RTA 2			courier			1 per carton			

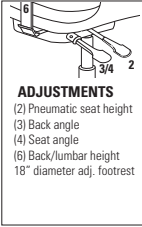

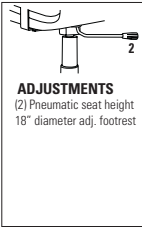
**MB Task Standard Seat Armless**  
 COM: 1.75 YD | 1.6 M  
 Unit weight: 32 LB | 14.5 KG  
 Carton weight: 41 LB | 18.6 KG  
 Carton volume: 10.5 FT³ | 0.29 MT³

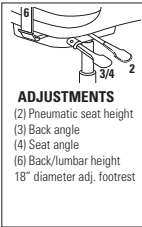

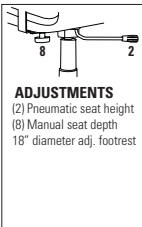
COM	2	3	4	5	6	7	8	9	10	11	12	
<b>GC35122-6</b>	564	620	667	722	811	893	975	1047	1136	1220	1334	1495
<b>OVERALL DIMENSIONS</b>			<b>SEAT DIMENSIONS</b>			<b>BACK DIMENSIONS</b>						
W D H			W D H			W H						
Active weight 300 lbs.												
IN	20.5	24	42.5	20.5	17.5-18.5	17-22	19	20.5				
MM	521	610	1080	521	445-470	432-559	483	521				
Ergonomic features: C, E, M, N, U			RTA 2			1 per carton						

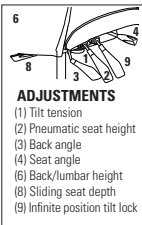
DESCRIPTION		MODEL# / FEATURES	STANDARD TEXTILE GRADES												
 <p><b>Low Back Operator Stool - Small Seat</b> COM: 1.75 YD   1.6 M Unit weight: 46 LB   20.9 KG Carton weight: 55 LB   24.95 KG Carton volume: 10.5 FT³   0.29 MT³</p>	 <p><b>ADJUSTMENTS</b> (2) Pneumatic seat height (3) Back angle (4) Seat angle (6) Back/lumbar height 18" diameter adj. footrest</p>	GC35211-5	COM	2	3	4	5	6	7	8	9	10	11	12	
		1135	1191	1238	1293	1382	1464	1546	1618	1707	1791	1905	2066		
		Active weight 300 lbs.			<b>OVERALL DIMENSIONS</b> W D H IN 25 23 47 MM 635 584 1194			<b>SEAT DIMENSIONS</b> W D H 19.5 17.5 24-34 495 445 610-864			<b>BACK DIMENSIONS</b> W H 18.5 16.5-21.75 470 419-552				
Ergonomic features: C, D, F, G, H, M, N, Q, R, S, U		RTA 2	courier		1 per carton										
 <p><b>Low Back Task Stool - Small Seat</b> COM: 1.75 YD   1.6 M Unit weight: 42 LB   19.1 KG Carton weight: 51 LB   23.13 KG Carton volume: 10.5 FT³   0.29 MT³</p>	 <p><b>ADJUSTMENTS</b> (2) Pneumatic seat height 18" diameter adj. footrest</p>	GC35211-6	COM	2	3	4	5	6	7	8	9	10	11	12	
		911	967	1014	1069	1158	1240	1322	1394	1483	1567	1681	1842		
		Active weight 300 lbs.			<b>OVERALL DIMENSIONS</b> W D H IN 25 23 48 MM 635 584 1219			<b>SEAT DIMENSIONS</b> W D H 19.5 17.5-18.5 24-34 495 445-470 610-864			<b>BACK DIMENSIONS</b> W H 18.5 17.5 470 445				
Ergonomic features: C, E, H, M, N, Q, R, U		RTA 2	courier		1 per carton										
 <p><b>LB Operator Stool Armless - Small Seat</b> COM: 1.75 YD   1.6 M Unit weight: 40 LB   18.2 KG Carton weight: 49 LB   22.23 KG Carton volume: 10.5 FT³   0.29 MT³</p>	 <p><b>ADJUSTMENTS</b> (2) Pneumatic seat height (3) Back angle (4) Seat angle (6) Back/lumbar height 18" diameter adj. footrest</p>	GC35311-5	COM	2	3	4	5	6	7	8	9	10	11	12	
		1016	1072	1119	1174	1263	1345	1427	1499	1588	1672	1786	1947		
		Active weight 300 lbs.			<b>OVERALL DIMENSIONS</b> W D H IN 19.5 23 47 MM 495 584 1194			<b>SEAT DIMENSIONS</b> W D H 19.5 17.5 24-34 495 445 610-864			<b>BACK DIMENSIONS</b> W H 18.5 16.5-21.75 470 419-552				
Ergonomic features: C, E, M, N, U		RTA 2	courier		1 per carton										
 <p><b>LB Task Stool Armless - Petite Seat</b> COM: 1.75 YD   1.6 M Unit weight: 36 LB   16.4 KG Carton weight: 45 LB   20.41 KG Carton volume: 10.5 FT³   0.29 MT³</p>	 <p><b>ADJUSTMENTS</b> (2) Pneumatic seat height (8) Manual seat depth 18" diameter adj. footrest</p>	GC35311-6	COM	2	3	4	5	6	7	8	9	10	11	12	
		792	848	895	950	1039	1121	1203	1275	1364	1448	1562	1723		
		Active weight 300 lbs.			<b>OVERALL DIMENSIONS</b> W D H IN 19.5 23 48 MM 495 584 1219			<b>SEAT DIMENSIONS</b> W D H 19.5 17.5-18.5 24-34 495 445-470 610-864			<b>BACK DIMENSIONS</b> W H 18.5 17.5 470 445				
Ergonomic features: C, E, M, N, U		RTA 2	courier		1 per carton										
 <p><b>LB Multi-Tilt w/Schukra</b> COM: 1.75 YD   1.6 M Unit weight: 52 LB   23.6 KG Carton weight: 61 LB   27.67 KG Carton volume: 10.5 FT³   0.29 MT³</p>	 <p><b>ADJUSTMENTS</b> (1) Tilt tension (2) Pneumatic seat height (3) Back angle (4) Seat angle (6) Back/lumbar height (8) Sliding seat depth (9) Infinite position tilt lock</p>	GC36012-3 Standard seat GC36011-3 Petite seat	COM	2	3	4	5	6	7	8	9	10	11	12	
		1023	1079	1126	1181	1270	1352	1434	1506	1595	1679	1793	1954		
		Active weight 300 lbs.			<b>OVERALL DIMENSIONS</b> W D H IN 26 24 37.5 MM 660 610 953			<b>SEAT DIMENSIONS</b> W D H 20.5 18-21 17.5-22.5 521 457-533 445-572			<b>BACK DIMENSIONS</b> W H 18.5 16.5-21.75 470 419-552				
Ergonomic features: A, B, C, D, E, F, G, H, M, N, Q, R, S, U, V		RTA 2	courier		1 per carton										

DESCRIPTION MODEL# / FEATURES STANDARD TEXTILE GRADES



**MB Multi-Tilter w/Schukra**  
 COM: 1.75 YD | 1.6 M  
 Unit weight: 53 LB | 24.1 KG  
 Carton weight: 62 LB | 28.12 KG  
 Carton volume: 10.5 FT³ | 0.29 MT³

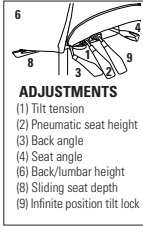

COM	2	3	4	5	6	7	8	9	10	11	12	
<b>GC36022-3</b> Standard seat	1067	1123	1170	1225	1314	1396	1478	1550	1639	1723	1837	1998
<b>GC36023-3</b> Generous seat	IN W21.5 D19-22 H17.5-22.5   MM W546 D483-559 H445-572											
OVERALL DIMENSIONS			SEAT DIMENSIONS			BACK DIMENSIONS						
W	D	H	W	D	H	W	H					
IN 26	24	42.5	20.5	18-21	17.5-22.5	19	19.5-24.75					
MM 660	610	1080	521	457-533	445-572	483	495-629					
Active weight 300 lbs.												
Ergonomic features: A, B, C, D, E, F, G, H, M, N, Q, R, S, U, V <b>RTA 2</b> 1 per carton												



**HB Multi-Tilter w/Schukra**  
 COM: 2 YD | 1.83 M  
 Unit weight: 55 LB | 25 KG  
 Carton weight: 64 LB | 29.03 KG  
 Carton volume: 10.5 FT³ | 0.29 MT³

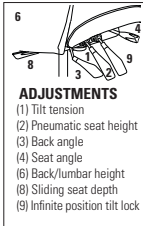

COM	2	3	4	5	6	7	8	9	10	11	12	
<b>GC36032-3</b> Standard seat	1102	1166	1220	1282	1384	1478	1572	1654	1756	1852	1982	2166
<b>GC36033-3</b> Generous seat	IN W21.5 D19-22 H17.5-22.5   MM W546 D483-559 H445-572											
OVERALL DIMENSIONS			SEAT DIMENSIONS			BACK DIMENSIONS						
W	D	H	W	D	H	W	H					
IN 26	24	45	20.5	18-21	17.5-22.5	19	22.5-27.75					
MM 660	610	1143	521	457-533	445-572	483	572-705					
Active weight 300 lbs.												
Ergonomic features: A, B, C, D, E, F, G, H, M, N, Q, R, S, U, V <b>RTA 2</b> 1 per carton												



**LB 24HR Multi-Tilter HD**  
 COM: 1.75 YD | 1.6 M  
 Unit weight: 54 LB | 24.5 KG  
 Carton weight: 63 LB | 28.58 KG  
 Carton volume: 10.5 FT³ | 0.29 MT³

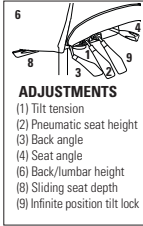

COM	2	3	4	5	6	7	8	9	10	11	12	
<b>GCTS35012-3</b> Standard seat	1110	1166	1213	1268	1357	1439	1521	1593	1682	1766	1880	2041
<b>GCTS35011-3</b> Petite seat	IN W19.5 D17-19.5 H16-20   MM W495 D432-495 H406-508											
OVERALL DIMENSIONS			SEAT DIMENSIONS			BACK DIMENSIONS						
W	D	H	W	D	H	W	H					
IN 26	24	37.5	20.5	18-20.5	18-22	18.5	16.5-21.75					
MM 660	610	953	521	457-521	457-559	470	419-552					
Active weight 350 lbs.												
Ergonomic features: A, B, C, D, E, F, G, H, M, N, Q, R, S <b>RTA 2</b> 1 per carton												



**MB 24HR Multi-Tilter HD**  
 COM: 1.75 YD | 1.6 M  
 Unit weight: 55 LB | 25 KG  
 Carton weight: 64 LB | 29.03 KG  
 Carton volume: 10.5 FT³ | 0.29 MT³

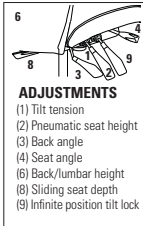





COM	2	3	4	5	6	7	8	9	10	11	12	
<b>GCTS35022-3</b> Standard seat	1153	1209	1256	1311	1400	1482	1564	1636	1725	1809	1923	2084
<b>GCTS35023-3</b> Generous seat	IN W21.5 D19-21.5 H18-22   MM W546 D483-546 H457-559											
OVERALL DIMENSIONS			SEAT DIMENSIONS			BACK DIMENSIONS						
W	D	H	W	D	H	W	H					
IN 26	24	42.5	20.5	18-20.5	18-22	19	19.5-24.75					
MM 660	610	1080	521	457-521	457-559	483	495-629					
Active weight 350 lbs.												
Ergonomic features: A, B, C, D, E, F, G, H, M, N, Q, R, S <b>RTA 2</b> 1 per carton												

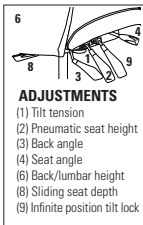

**HB 24HR Multi-Tilter HD**  
 COM: 2 YD | 1.83 M  
 Unit weight: 57 LB | 25.9 KG  
 Carton weight: 66 LB | 29.94 KG  
 Carton volume: 10.5 FT³ | 0.29 MT³

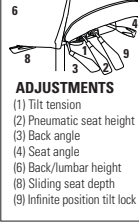

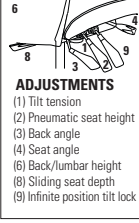
COM	2	3	4	5	6	7	8	9	10	11	12	
<b>GCTS35032-3</b> Standard seat	1188	1252	1306	1368	1470	1564	1658	1740	1842	1938	2068	2252
<b>GCTS35033-3</b> Generous seat	IN W21.5 D19-21.5 H18-22   MM W546 D483-546 H457-559											
OVERALL DIMENSIONS			SEAT DIMENSIONS			BACK DIMENSIONS						
W	D	H	W	D	H	W	H					
IN 26	24	45	20.5	18-20.5	18-22	19	22.5-27.75					
MM 660	610	1143	521	457-521	457-559	483	572-705					
Active weight 350 lbs.												
Ergonomic features: A, B, C, D, E, F, G, H, M, N, Q, R, S <b>RTA 2</b> 1 per carton												

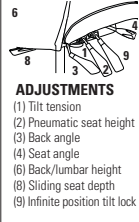
DESCRIPTION	MODEL# / FEATURES	STANDARD TEXTILE GRADES												
		COM	2	3	4	5	6	7	8	9	10	11	12	
 <p><b>LB 24HR Multi-Tilter HD w/Schukra</b>                      COM: 1.75 YD   1.6 M                      Unit weight: 54 LB   24.5 KG                      Carton weight: 63 LB   28.58 KG                      Carton volume: 10.5 FT³   0.29 MT³</p>	 <p><b>ADJUSTMENTS</b>                      (1) Tilt tension                      (2) Pneumatic seat height                      (3) Back angle                      (4) Seat angle                      (6) Back/lumbar height                      (8) Sliding seat depth                      (9) Infinite position tilt lock</p>	<b>GCTS36012-3</b> Standard seat <b>GCTS36011-3</b> Petite seat IN W19.5 D17-19.5 H16-20   MM W495 D432-495 H406-508	1230	1286	1333	1388	1477	1559	1641	1713	1802	1886	2000	2161
		Active weight 350 lbs.	<b>OVERALL DIMENSIONS</b> W D H			<b>SEAT DIMENSIONS</b> W D H			<b>BACK DIMENSIONS</b> W H					
			IN 26	24	37.5	20.5	18-20.5	18-22	18.5	16.5-21.75				
			MM 660	610	953	521	457-521	457-559	470	419-552				
	Ergonomic features: A, B, C, D, E, F, G, H, M, N, Q, R, S, V	RTA 2	courier	1 per carton										
 <p><b>MB 24HR Multi-Tilter HD w/Schukra</b>                      COM: 1.75 YD   1.6 M                      Unit weight: 55 LB   25 KG                      Carton weight: 64 LB   29.03 KG                      Carton volume: 10.5 FT³   0.29 MT³</p>	 <p><b>ADJUSTMENTS</b>                      (1) Tilt tension                      (2) Pneumatic seat height                      (3) Back angle                      (4) Seat angle                      (6) Back/lumbar height                      (8) Sliding seat depth                      (9) Infinite position tilt lock</p>	<b>GCTS36022-3</b> Standard seat <b>GCTS36023-3</b> Generous seat IN W21.5 D19-21.5 H18-22   MM W546 D483-546 H457-559	1276	1332	1379	1434	1523	1605	1687	1759	1848	1932	2046	2207
		Active weight 350 lbs.	<b>OVERALL DIMENSIONS</b> W D H			<b>SEAT DIMENSIONS</b> W D H			<b>BACK DIMENSIONS</b> W H					
			IN 26	24	42.5	20.5	18-20.5	18-22	19	19.5-24.75				
			MM 660	610	1080	521	457-521	457-559	483	495-629				
	Ergonomic features: A, B, C, D, E, F, G, H, M, N, Q, R, S, V	RTA 2	courier	1 per carton										
 <p><b>HB 24HR Multi-Tilter HD w/Schukra</b>                      COM: 2 YD   1.83 M                      Unit weight: 57 LB   25.9 KG                      Carton weight: 66 LB   29.94 KG                      Carton volume: 10.5 FT³   0.29 MT³</p>	 <p><b>ADJUSTMENTS</b>                      (1) Tilt tension                      (2) Pneumatic seat height                      (3) Back angle                      (4) Seat angle                      (6) Back/lumbar height                      (8) Sliding seat depth                      (9) Infinite position tilt lock</p>	<b>GCTS36032-3</b> Standard seat <b>GCTS36033-3</b> Generous seat IN W21.5 D19-21.5 H18-22   MM W546 D483-546 H457-559	1312	1376	1430	1492	1594	1688	1782	1864	1966	2062	2192	2376
		Active weight 350 lbs.	<b>OVERALL DIMENSIONS</b> W D H			<b>SEAT DIMENSIONS</b> W D H			<b>BACK DIMENSIONS</b> W H					
			IN 26	24	45	20.5	18-20.5	18-22	19	22.5-27.75				
			MM 660	610	1143	521	457-521	457-559	483	572-705				
	Ergonomic features: A, B, C, D, E, F, G, H, M, N, Q, R, S, V	RTA 2	courier	1 per carton										